

UNIV OF
TORONTO
LIBRARY

1034

2

-

~~Section 13~~
~~No. 710~~

Digitized by the Internet Archive
in 2008 with funding from
Microsoft Corporation

<http://www.archive.org/details/collieryengineer33londuoft>

Technol.
Mines
M. & M. Dept.

12
C

The Colliery Engineer

Formerly
Mines and Minerals

VOLUME XXXIII

August 1912, to July 1913

SCRANTON, PA.
INTERNATIONAL TEXTBOOK CO.
1913

131201
8/2/14



INDEX

INDEX A--Authors, Subjects, and Titles of Articles

(Separate Indexes of "Book Reviews," "Personals and Obituaries," "Catalogs Received," and "Trade Notices" follow "Index A")

	Page		Page		Page	
A CCIDENTS	59	American Mine Safety Association.....	476	B AILEY, E. G., DETERMINING COAL	197	
Accidents and Tests of Explosives, Pub-	137	American Mining Congress.....	116	VALUES	197	
lications on.....	118	American Mining Congress, November, 1912,	189,	Bailey, Frank, Platinum Near Princeton,	278	
Accidents, Cause and Prevention of Mine..	1	377	B. C., 237--Princeton, B. C., Mining Notes	72	
Accidents, Cause for.....	293	American Museum of Safety.....	484	Baines, J. J., A New English Coal Field....	526	
Accidents, Fire Boss and Mine.....	197	American Red Cross.....	140	Baldwin-Westinghouse Mine Locomotive....	616	
Accidents in French Coal Mines, 1910.....	146	Ammonia-Sulphate Plant.....	351	Bamling, John, Rock Dump for Slope.....	284	
Accidents in Pa., Coal-Mine.....	181	Amortizing and Interest Charges.....	415	Banks, L. M., Mill Feed Sampler.....	613	
Accident, Preventable Shaft-Sinking.....	361	"Ampere"	495	Bargoed Colliery, Gas Engines.....	590,	
Accidents, Some Features of Mine Disasters	573	Analyses, Some Air.....	264	Barometer in Mining, Use of.....	572	
Acetylene, Carbide Lamp Abuse.....	316	Analyses, Mine Air.....	312	Barometers, Mercurial and Aneroid.....	479	
Acetylene Dangers.....	507	Analysis, Portable Apparatus for Firedamp	283	Barometric Changes, Forecasting.....	66,	
Acetylene Lamps.....	372	Anderson, Amil A., Lithium.....	339	Barometric Pressure and Mine Gases.....	477	
Acetylene Lamps, Dangers of.....	316	Ankylostomiasis in Italian Sulphur Mines...	183	Barr, James Allen, Florida Phosphate Prac-	152	
Acetylene Lamps, Gases from.....189, 254,	400	Annual First-Aid Contests, 1912.....	373	tice, 265--Tennessee Phosphate Practice....	178	
Acetylene Mine Lamp, New.....	254	Anthracite, Chemical Interpolation of.....	569	Barytes, Correction.....	95	
Acids on Concrete, Action of.....	254	Anthracite Culm Piles, Working.....	117	Barytes in Missouri.....	679	
Action of Acids on Concrete.....	245	Anthracite, Increase of Price.....	264	Bath House at Cameron Colliery.....	481	
Adobe Dust for Prevention of Coal-Dust	572	Anthracite in Rocky Mountains.....	504	Bath-House Proposition.....	237	
Explosions	107	Anthracite Mine-Cave Commission Report, 468,	4	Battle Creek Mine, Tennessee.....	476	
Afterdamp	400	Anthracite Mine, Cerrillos.....	353	Baseball Diamond, To Lay Out.....	523	
Ahmeek Mining Co., Concrete Shaft Lining	264	Anthracite Mine Law, Proposed.....	471	Bear Valley Coal Deposits, P. & R. C. & I.	658	
Ainsworth & Sons, Wm., Arnold Acetylene	352	Anthracite Mines in Arkansas.....	535	Co.	616	
Mine Lamp.....	221	Anthracite Mines, Machine Mining in.....	635	Belt, Long-Lived Leather.....	342	
Air Analyses, Some.....	87	Anthracite Mine Workings, Flushing.....	429	Berry Safety Catch.....	269	
Air Analyses, Mine.....	242	Anthracite Mining, Facts About.....	405	"Billy White" Cut, The.....	599	
Air-Balanced Hoisting Engine.....	38	Anthracite Mining, Increased Cost of.....	529	Birds in Coal Mines.....	212	
Air Blast, or Earth Movement.....	136	Anthracite Region, Taxing Coal Land.....	537	Bismuth	27	
Air Compression.....	528	Anthracite Stripping, Derringer.....	160	Bituminous Mine Law of Pennsylvania, 1911	382	
Air Compression, Altitude and.....	137	Anthracite Under Cover, Storing and Re-	155	Blasting Coal on to Pans.....	243	
Air-Compressor Cylinder Lubrication.....	532	handling	189	Blasting, Electric Shot Firing.....	87	
Air Compressors, Fusible Signal Plugs for..	460	Anthracite Workings, Flushing.....	57	Blasts, Wind.....	57	
Air Compressors, Receivers of.....	141	Antimony	189	Bleaching Powder.....	644	
Air Compressors, Temperature Control for...	88	Antimony Ores.....	181	Blisters for Sampling.....	138	
Air-Current, Humidifying.....	508	"Anxious" Answered.....	471	Blocks for Inclines, Automatic.....	305	
Air-Currents, Moistening Mine.....	413	A Preventable Shaft-Sinking Accident.....	105	Blower in German Colliery, Carbon-Dioxide	385	
Air, Humidifying Mine.....	67	Archbald, Hugh, Machine Mining in Anthra-	454	Blowpipe Bead Without Platinum Wire.....	277	
Air, Humidity of Mine.....	322	cite Mines.....	231	Bond, Josiah, Men vs. Machines.....	462	
Air Meter, Control of Mine-Ventilation....	513	Areas, Calculation of.....	210	Bond, Temporary Electric.....	1	
Air, Power and Quantity.....	25	Are "Heat Waves" Visible?.....	697	Books, Technical.....	316, 451,	
Airways With Circular-Shaped Tops.....	521	Armstrong Cork Co., Nonpareil High-Pres-	52	Booster Fans.....	419	
Alabama Accidents, 1912.....	318,	sure Covering.....	301	Booth, W. H., Too Much Ventilation.....	327	
Alabama Mines, First Aid in.....	289	Argonaut Mine and Mill.....	401	Bore Holes, Controlling the Direction of....	250	
Alabama Notes.....	534	Arizona, Turquoise in.....	679	Boring Under Pressure, Horizontal Mine....	224	
Alaska Coal Lands, Development of.....	35	Arkansas, Mining Steep-Dipping Coal.....	229	Brady, F. R., Rhigolene.....	156	
Alaska, Gold and Tin Production, Seward	130	As Applied to Family Affairs.....	398	Breaking an Agreement.....	404	
Peninsula	1912	Asbestos	125	Briggs, Henry, Testing for Firedamp With	439	
Alaska, Gold Washing, Front Cover, October,	48	Asbestos Mines in China.....	196	Wire Loop.....	612	
Alaskan Earthquake, Great.....	582	Ash, Clinkering of Coal.....	47	Briquet Production, 1912.....	459	
Alaska Railroad Construction.....	289	Ash, Simon H., Automatic Blocks for In-	225	Briquets in South Wales.....	687	
Allen American Manganese Steel Co., Edgar	88	clines, 138--Derailing Switches for Slopes,	669	Briquetting Coal.....	193	
Allowable Error in Closing Survey.....	193	Asphalt Minerals.....	661	Briquetting, Coal Washing and.....	242	
Alstaden Colliery, Coal Washing and Bri-	38	Assay of Cyanide Solution.....	18	Briquetting Lignite.....	594	
quetting	212	Assessing and Taxing Coal in the Ground...	557	Bristol's Recording Differential Pressure	590	
Altitude and Air Compression.....	249	Assessment of Coal in the Ground.....	89	Gauges	582	
Amalgamation, Manganese in Gold.....	503,	Atlantic Fleet, The.....	134	British Columbia, Coal and Coke in.....	422	
American Exports of Coal.....	503,	Australian Mine Ventilation.....	209	British Columbia, Ground Hog Coal Field...	87	
American Institute of Electrical Engineers,	144	Australia, Tin Ore Dressing and Metallurgy	138	89	British Mining Electric Lamp Contest.....	462
.....	144	in	385	British Tests for Miners' Safety Lamps....	324	
American Institute of Mining Engineers,	144	Australia, Victoria State Coal Mine.....	385	Broken Hill Ores, Treatment of.....	462	
February, 1913, Meeting, 499--Personal	144	Authentic Petroleum Lore.....	385	Brownell Engine.....	324	
Views Re Affairs.....	144	Automatic Blocks for Inclines.....	385	Bryden, C. L., Foreign Mining Costumes....	324	
	144	Automatic Sand Sluicer.....	385		324	

	Page		Page		Page
Buckner No. 2 Mine.....	121	Chester, T., Heat Waves Visible, 572—Mer- curial and Aneroid Barometers.....	572	Collars, Reinforcing.....	717
Buckner No. 2 Mine, Correction.....	175	China, Asbestos Mines in.....	398	COLLIERY ENGINEER, THE.....	403
Buffalo Foundry & Machine Co., Steam Hammers.....	658	China, Coal Mining in Northern.....	29	Colorado Coal Deposits, Steamboat Springs.....	521
Buggy, D. L. & W.....	382	Chloral Hydrate as a Solvent.....	344	Colorado First-Aid Contest.....	78
Buggy for Low Places in Anthracite Mines.....	474	Chloride of Lime.....	57	C. F. & I. Co. Emergency Car.....	483
Bulletin No. 47, U. S. Bureau of Mines.....	118	Christian, L. A., Air-Compressor Cylinder Lubrication, 136—Lubrication of Mine-Car Wheels.....	250	Colorado Mineral Production, 1911.....	286
Bunsen Coal Co., Vermillion Mine.....	130	Christopher No. 2 Mine, Correction.....	175	Colorado Personals.....	366
Bureau of Mines Examinations for Sanitary Engineers.....	217	Churn-Drill Examination of Placers.....	92	Combustion of Gas and Dust.....	372
Bureau of Mines, Hogan on.....	197	Cincinnati Mine Disaster, The.....	636	Commercial Sampling of Coal.....	199
Bureau of Mines, Publications on Mine Acci- dents and Tests of Explosives.....	137	Cincinnati Mine Explosion.....	701	Commission, Mine Cave, Protection of Sur- face Over Coal Mines.....	234
Bureau of Mines, The U. S.....	380	Civil Service Idea of a "Mine Technologist" Classification of Coal.....	61	Commission, Report of Anthracite Mine Cave.....	468, 504
Burroughs, Wilbur G., Coal Fields of Ohio.....	544	Cincinnati Mine Explosion.....	598	Common-Sense Mine Ventilation.....	409
Butler, H. E., Bath-House Proposition.....	481	Civil Service Idea of a "Mine Technologist" Classifier, Woodbury Slime.....	397	Compensation Law, West Virginia Work- man's.....	649
Butte and Superior Mill, Concentration at.....	160	Cleaning Coke-Oven Gas.....	349	Compressors, Fusible Signal Plugs for Air.....	528
C ABLES FOR MINES, ELECTRIC.....	309	Clinkering of Coal Ash.....	125	Compressors, Temperature Control for Air.....	532
Cadeby Mine Explosion.....	68	Coal, American Exports of.....	249	Concentration at Butte and Superior Mill.....	160
Calcium Carbide.....	254	Coal and Coke in British Columbia.....	590	Concentration, Economic Efficiency in Lead.....	211
Calculation of Areas.....	105	Coal Ash, Clinkering of.....	125	Concrete, Action of Acids on.....	254
Calendar, New.....	173	Coal, Classification of.....	139	Concrete Coal Pockets.....	304
California Oil in Peru.....	171	Coal, Commercial Sampling of.....	199	Concrete in Mine Construction.....	623
Calumet and Hecla.....	284	Coal, Convict-Mined.....	61	Concrete Shaft Lining.....	107
Calvin vs. Henrietta Coal Mining Co.....	366	Coal Cost and Coal Loading Machines.....	11	Connellsville Coke Production, First Quar- ter, 1913.....	584
Cambria County Coal Development.....	366	Coal Cutters, Power Consumption of.....	471	Conservation and Commercialism.....	694
Cameron Colliery, Bath House.....	679	Coal Cutting Machines in Anthracite Mines Coal Discoveries in Holland.....	414	Consolidation Coal Co., Report, 1912.....	584
Campbell, James A., Rope Turning.....	575	Coal Dust and Coal Loading Machines, Cor- rection.....	125	Control of Mine Ventilation.....	413
Canadian Mining Institute.....	116, 379	Coal Dust and Steam.....	372	Controlling the Direction of Bore Holes.....	327
Canada, Northwestern.....	582	Coal-Dust Question, The.....	245	Conveyers, Machine Mining in Anthracite Mines.....	471
Canaries in Coal Mines.....	599	Coal Exports, U. S.....	244	Conveyers, Moving Minerals in Thin Flat Beds.....	310
Candlestick, A Drift.....	396	Coal Field, A New English.....	72	Conveyer System of Mining Coal.....	144
Canmore Coal, Analyses.....	582	Coal Fields of Ohio.....	544	Convict-Mined Coal.....	61
Capacity of Cylindrical Tanks Defined.....	103	Coal in the Ground, Assessing and Taxing.....	669	Cookery, Camp.....	168
Capacity of Rolls.....	197	Coal in Transvaal, S. A.....	418	Copper Cliff Mine.....	384
Cape Breton, N. S., Notes.....	318	Coal Loader, Portable.....	593	Corbett, R. H., Air Balanced Hoisting En- gine.....	221
Capping Winding Ropes, Method of Socket- ing or.....	195	Coal-Mine Accidents in Pennsylvania.....	146	Correction, Flushing Anthracite Workings.....	598
Carbide Lamp Abuse.....	573	Coal-Mine Employes in the United States.....	352	Correction, Montana Coal Output.....	702
Carbide, Handling Slacked.....	254	Coal-Mine Fires.....	690	Correspondence and Letter Box. Acetylene Dangers, 316—Acetylene Lamps, 507—After- damp, 572—Air Blast or Earth Movement, 87—Allowable Errors in Closing Survey, 88—"Anxious" Answered, 189—Are "Heat Waves" Visible, 454—Booster Fans, 316, 454—British Electric Mining Lamp Contest, 144—Calcium Carbide, 254—Carbide-Lamp Abuse, 573—Carbon Monoxide, Combusti- bility, 644—Cement Gun for Preventing Dust, 700—Centrifugal Pumps, 254, 507— Changing the Hoisting Rope, 454, 575—Cin- cinnati Mine Explosion, 701—Coal Dust and Steam, 372—Combustion of Gas and Dust, 372—Conveyer System for Mining Coal, 144 —Dangers of Acetylene Lamps, 372—Fossils in Coal, 316—Gases, 254—Gases From Acety- lene Lamps, 189, 254, 316—Handling Slacked Carbide, 254—Hay! 508—Heat Waves Visible, 572—How to Mine, 644—Humidifying Mine Air, 88—Humidity of Mine Air, 508— Influence of Drafts in Mine Explosions, 576—Law Regarding Mine Inspectors, 454, 574, 760—Location of Regulator, 644—Mer- curial and Aneroid Barometers, 572—Method of Mining, 507—Mine Drainage, 316—Motive Column, 644—Pulling Pillars, 644—Rock Dump Wanted, 144—Rope Turning, 575—Sci- entific Management, 254, 318—Scientific Management Applied to Coal Mining, 701— Shaft Sinking, 317—Shaft Sinking in Wet Ground, 700—Size of Pillars, 644—Societies, 189—Source of Blackdamp, 316—Stone Dust in Mines, 317—To Remove Marsh Gas, 372— Treatment of Broken Hill Ores, 87—Use of Barometer in Mining, 645—Use and Care of Safety Lamps, 573—Use for Old Wire Rope, 645—Waste in Mining, 373, 509—Wind Blasts.....	87
Carbon Dioxide, Adding to Mine Air to Prevent Explosion.....	119	Coal Miner in the Cabinet.....	520	Cory, Edwin M., Raising Shaft at Rolling Mill Mine.....	288
Carbon-Dioxide Blower in German Colliery Carbon Monoxide, Combustibility of.....	365, 644	Coal Miner, The.....	348	Cost of Anthracite Mining, Increased.....	1
Carbon Monoxide in Illuminating Gas.....	206	Coal Mines, Amortizing and Interest Charges.....	415	Cost of Milling in South Africa.....	280
Carbon Monoxide in Lamp Flame.....	597	Coal-Mine Superintendent's Duty.....	6		
Carbon Monoxide Is Not a Supporter of Combustion.....	663	Coal-Mine Ventilation.....	423		
Carbonite and Monobel.....	252	Coal Mining Institute of America.....	568		
Car Cleaning Device.....	525	Coal Mining Institute of America.....	December, 1912, 189, 378		
Car, C. F. & I. Co., Emergency.....	483	Coal Mining Institute of America, June, 1912, Meeting.....	15		
Car Couplings.....	428	Coal Mining Institutes.....	298, 420		
Car Dumper.....	5-1	Coal Mining and Mining Schools.....	661		
Care of Tools.....	263	Coal Mining in Northern China.....	29		
Carne, J. E., Tin Ore Dressing and Metal- lurgy.....	89	Coal Mining Notes.....	263, 318		
Carpenter, Frank G., Creep in the Panama Canal.....	39	Coal Mining on the Surface, Effect of.....	548, 617		
Car Shortage.....	118	Coal, Preparation of a Domestic.....	426		
Cartledge, Oscar, Buckner No. 2 Mine, 121— Preventable Shaft Sinking Accident, 181— Why Is a Stopping?.....	190	Coal Production, West Virginia, 1912.....	630		
Catskill Aqueduct, Sinking Shaft.....	497	Coal, Pumping Through.....	365		
Cause and Prevention of Mine Accidents.....	118	Coal Statistics, Illinois.....	232		
Cause of a Mine Disaster (Oklahoma).....	2	Coal Statistics, Michigan, 1911.....	141		
Causes of Fires in Metal Mines.....	218	Coal Statistics, 1912.....	512		
Caves, Protection of Surface Over Coal Mines.....	234	Coal Stripping in Kansas.....	407		
Cave System, Improvements in.....	56	Coal Trade of Natal.....	382		
Cement Gun for Preventing Dust.....	700	Coal Under Water, Storing.....	697		
Centrifugal Pumps.....	254, 507	Coal Values, Determining.....	191		
Cerritos, Anthracite Mine.....	4	Coal Washing and Briquetting, Germany.....	193		
Charge, Edwin M., Farming Power of Chemistry.....	693	Coal Waste, Bulletin 47.....	118		
Changing the Hoisting Rope.....	454, 575	Cobalt District.....	117		
Characteristics of the Mexican Miner.....	41	Cokedale, Colo., Checking Inspectors' Work Coke From Coal.....	683, 257		
Charlton, W. H., Insurance on Mine Prop- erty.....	666	Coke in Kentucky, Production of, 1911.....	143		
Chart Classifying Mine Gases.....	1913	Coke, Manufacture of.....	351		
Chemical Interpolation of Anthracite.....	373	Coke, Oil, and Patriotism.....	118		
Chemistry, Farming Power of.....	693	Coke Oven Gas, Cleaning.....	349		
		Coke Oven Gas, Use of.....	368		
		Coke Oven, Muller By-Product.....	12		
		Coke Ovens at Marianna, Pa., Waste Heat.....	135		
		Coke Production, Connellsville, First Quar- ter, 1913.....	584		
		Coking Test, The Pishel.....	674		
		Cole, W. N., Surveying.....	519		

INDEX

v

	Page		Page
Cost of Mining Anthracite, Increased.....	26	Dumper for Mine Cars.....	51
Costs of Carrying Unmined Coal in the Ground.....	415	Dunlop, John, Safety First.....	721
Costumes, Foreign Mining.....	324	Du Pont Powder Co., First Permissible Explosives.....	145
Coulomb, The.....	442	Durham Coal & Iron Co., Washery at Soddy Mine.....	295
Couplings, Car.....	4-8	Dust, Cement Gun for Preventing.....	700
Creep in the Panama Canal.....	39	Dust, Combustion of Gas and.....	372
Crocker, W. J., A Drift Candlestick, 376—Efficiency in Mining, 395—Mine Surveying Wrinkles, 300—The "Billy White" Cut.....	269	Dust Explosions.....	258
Crossheads, Safety.....	396	Dust Explosions, Preventing by Reduction of Oxygen in Air.....	119
Crozer Land Association.....	585	Dust in Mines, Stone.....	317
Cuban Iron Ores, Lake Superior and.....	340	Dust of Its Dangers, Robbing Coal.....	307
Culm Piles, Working Anthracite.....	569	Dust Question, The Coal.....	245
Cunard Steamship Company Mine.....	513	Dynamite, High Explosives in Northern Mines.....	655
"Curie," The Standard for Radium.....	47	EARLY DUST EXPLOSIONS, SAVANNA, INDIAN TERRITORY.....	126
Currens, Warren W., Asbestos.....	229	Early Instance of First Aid.....	195
Currents, Stray Electric.....	356	Earnest, D. C., Testing Texas Lump Lignite	180
Cutters, Power Consumption of Coal.....	8	Earning Power of Chemistry.....	693
Cutting Props.....	596	Earthquake, Great Alaskan.....	48
Cyaniding, Practical, Part 1, 42—Part 2, 169—Part 3, 165—Part 4, 213—Part 5, 270—Part 6, 335—Concluded.....	391	Economical Shaft Sinking.....	151
Cyanide Solution, Assay of.....	225	Economic Efficiency in Lead Concentration	211
Cylindrical Tanks, To Find Capacity of.....	103	Editorial Notes.....	59, 117, 175, 233, 345, 403, 467, 522, 597, 661
DALRYMPLE, JAMES, HUMIDIFYING MINE AIR.....	88	Educational Notices.....	306
Dalzell, S. M., Longwall Mining in Illinois	606	Effect of Coal Mining on the Surface.....	548, 617
Danger Signals in Pennsylvania.....	242	Efficiency in Mining.....	395
Danger Signals, Suggestion to State Mine Inspectors.....	345	Ehle, Mark, Equalizing Load Moments on Hoisting Engines.....	399
Dangers of Acetylene Lamps.....	372	Elba, Ore Loading on the Island of.....	35
Daum Co., A. F., Fuses for Electric Lines.....	231	Eldorado Mine Explosion.....	509
Davis, Fred W., Changing the Hoisting Rope.....	575	Electrical Knowledge for Mine Foremen.....	347
Davis, Hywel, Relative Vocational Hazards	485	Electric Bond, Temporary.....	462
Davy Lamp.....	446	Electric Cables for Mines.....	369
Dawson, Thomas W., Temperature Control for Air Compressors.....	532	Electric Circuit in Mines, Old Wire Ropes for Return.....	248
Decay of Timber.....	605	Electric Currents in Coal Mines, Stray.....	346, 356
Deane Steam Pump Co.....	231	Electric Hoist.....	465
Dean, Samuel, Stone Dust in Mines, 317—The Coal-Dust Question.....	245	Electric Lamp, Gas Ignition by Tungsten Filament.....	126
Deep Michigan Shafts.....	325	Electric Mining-Lamp Contest, British.....	144
Deep Mining in California, Results of.....	210	Electricity in Mines.....	292
D. L. & W. Blasting Coal on to Pans (Buggy), 382—Buggy, 474—Pumping Through Coal.....	365	Electricity in Mines, Practical Talks.....	715
Denver Office, Discontinuance.....	175	Electric Shot Firing.....	449, 489, 562, 629,
Depth of Oil Wells.....	371	Electric Sinking Pump.....	723
Derrailing Switches for Slopes.....	196	Electric Switch, Locking Device for.....	401
Derrick, Timber Setting.....	724	Emergency, C. F. & I. Co.....	483
Derringer Anthracite Stripping.....	5	Employes' Association of River Coal.....	418
Description of Tonnage Map.....	603	Employes in the United States, Coal-Mine.....	352
Desoller, T. C., Rock House of Quincy Mining Co.....	325	Employes to Mine Foremen, Relation of.....	577
Determining Coal Values.....	191	England, Coke, Oil, and Patriotism.....	118
Development of Alaska Coal Lands.....	534	English Coal Field, A New.....	72
Diseases of Metals.....	230	English Colliery, Fast Hoisting at.....	455
Dixon, Charlton, Improvements in the Caving System.....	56	Equalizing Load Moments on Hoisting Engine.....	399
Dixon-Pocahontas Coal Co.....	585	Error in Closing Survey, Allowable.....	88
Dobbins, J. L., Coal Mining in Northern China.....	29	Eucalyptus Oil for Ore Dressing.....	113
Domestic Camp Science.....	168	Evans, Edgar C., Barometric Pressure and Mine Gas.....	66
Doors, Standard-Size Mine.....	552	Everybody Happy.....	233
Dorr, Odin, Calcium Carbide.....	254	Examination Questions:	
Drafts in Mine Explosions, Influence of.....	576	Colorado State Mine Inspector, 1911.....	319, 369,
Draper Colliery, Accident.....	523	Pennsylvania Anthracite Mine Foreman and Assistant Foreman, Pottsville, March, 1913.....	651,
Diamonds, Formation of.....	339	Pennsylvania Bituminous Fire Boss, April, 1912.....	254, 261,
Diamond, To Lay Out a Baseball.....	476	Pennsylvania Bituminous Regions Mine Foreman, Second Grade, 1912.....	254, 261,
Dick, James E., Churn-Drill Examination of Placers.....	92, 161	Pennsylvania Inspector of Mines, Pottsville, May, 1913.....	719
Difficulties.....	222	Utah Mine Foremen, October, 1911.....	22,
Difficulties in Mine Surveying.....	59	West Virginia Fire Bosses and Mine Foremen, 1912.....	500,
Direct-Current Turbogenerators.....	172	Exhausting Mines, Economical Period for.....	415
Direction of Bore Holes, Controlling the.....	327	Explosion, Cadeby Mine.....	68
Disasters, Some Features of Mine.....	364	Explosion, Eldorado Mine.....	509
Discipline in Mining.....	585	Explosion, Hastings Coal Mine.....	2,
Dredging Up to Date, Gold.....	53	Explosion, Imperial No. 3 Mine.....	685
Drift Candlestick.....	396	Explosion, Kiebs, Indian Territory.....	60
Drill Examination of Placers, Churn.....	92, 161	Explosion, Latham Coal Mine, Illinois.....	521
Drill, Gasoline Rock.....	463	Explosion of Gas by Electric Lamp.....	126
Driving a Tunnel in Japan.....	331	Explosion, Oklahoma.....	2
		Explosion, Valley Camp Mine.....	523
		Explosion, Scott Colliery Disaster.....	703
		Explosions, Dust.....	258
		Explosions, Dust, Preventing by Reduction of Oxygen in Air.....	119
		Explosions, Early Dust, Savanna, Indian Territory.....	136
		Explosions, Influence of Drafts in Mine.....	576
		Explosions, July Gas.....	3
		Explosives, First Permissible.....	145
		Explosives in Coal Mines, Use of.....	459
		Explosives in Northern Mines, Use of High Explosives, Publications on Mine Accidents and Tests of.....	137
		Extraction Results on the Rand, Gold.....	280
		FACTS ABOUT ANTHRACITE MINING	202
		Facts and Theories Relating to Fans.....	429
		"Factum" Air Meter.....	413
		Fan Capacity.....	518
		Fan, Reversing an Air-Current.....	622
		Fans, Booster.....	316, 451
		Fans, Facts and Theories Relating to.....	429
		Fast Hoisting at English Colliery.....	455
		Field Ink Stand.....	164
		Filling on the Rand, Sand.....	99,
		Filling, Mining by Timbering and.....	36
		Filters.....	270
		Fire-Assay Reducer.....	332
		Fire Boss and Mine Accidents.....	293
		Fire Boss, Increasing the Efficiency of.....	145
		Firedamp With Wire Loop, Testing for.....	439
		Fire, North Mt. Lyell Mine.....	330
		Fireproof Shaft, Vermillion Mine.....	130
		Fire Protection of Mines.....	624
		Fire Sale, U. S. Geological Survey.....	680
		Fires, Coal-Mine.....	690
		Fires in Metal Mines, Causes of.....	218
		Fires in Mines and Some of Their Causes.....	72
		First Aid.....	Front Cover, November, 1912
		First Aid, An Early Instance of.....	195
		First-Aid Contest, Annual, 1912.....	183
		First-Aid Contest, Colorado.....	78
		First-Aid Contest, Gary, West Virginia.....	68
		First Aid in Alabama Mines.....	25
		First Aid in Kentucky.....	484
		First-Aid Work, Practical.....	596
		Flooding of Superba Mine.....	69
		Florida Phosphate Practice.....	265
		Flushing Anthracite Workings.....	535, 537
		Flushing Anthracite Workings, Correction.....	598
		Flushing on the Rand.....	99,
		Forbes, C. R., Some Problems in Mine Surveying.....	226
		Forecasting Barometric Changes.....	479
		Foreign Mining Costumes.....	324
		Foreman From Four Points of View, The Successful Mine.....	510
		Forestry as Related to Mining.....	511
		Forest Fires.....	661
		Forests, National.....	173
		Formation of Diamonds.....	339
		Formation of Magmas.....	115
		Formosa Mining Industry, 1911.....	211
		Formulas and Their Use.....	443
		Fossils in Coal.....	316
		Foster, Rufus J., Proposed Anthracite Mine Law.....	353
		Franklin, Jr., Mine, Rock House.....	221
		Freibergers, Old.....	379
		French Coal Mines, Accidents in, 1910.....	197
		French Coal Output Per Man.....	189
		Frick Coke Co. Amusement Hall at Leisenring No. 1.....	303
		Fritz, John.....	404
		Frog and Latches, Spring.....	239
		Fuller, John T., Sealing Off a Loading Place	104
		Fume Control, Mammoth System of.....	323
		Fuses for Electrical Lines.....	231
		Fusible Signal Plugs for Air Compressors.....	528
		GANNON, T. J., TO REMOVE MARSH GAS.....	372

	Page		Page
Gardens, Premiums for Yards and	62	Hastings, Mine Explosion.....	2
Gardner, James H., Rock Phosphate in Kentucky	207	Hay!	507
Gary, West Virginia, First-Aid Contest at	68	Hazard Mfg. Co., Mining Machinery Exhibit	659
Gas and Dust, Combustion of.....	372	Hazards, Relative Vocational.....	485
Gas, Barometric Pressure and Mine.....	66	Heat Waves Visible.....	572
Gas Chart.....	1913	Henderson, H. G., Calculation of Areas, 105— Difficulties in Mine Surveying, 359—Notes on Mine Surveying.....	169
Gas, Cleaning Coke-Oven.....	349	Hinkle, Peter, Safety Catch for Hoists.....	461
Gas Field, Kansas and Oklahoma.....	386	Hirschberg, Leonard Keene, Formation of Diamonds	339
Gases	254	Hoard, Henry, Windblasts.....	87
Gases, Barometric Pressure and Mine.....	477	Hodges, Fusible Signal Plugs.....	528
Gases From Acetylene Lamps.....	189, 254,	Hogan, Malachi.....	175
Gases Met With in Coal Mines.....	445, 492, 564,	Hogan on, B. T. U.....	299
Gases, Properties and Laws of.....	492	Hogan on the Bureau of Mines.....	197
Gas Explosions, July.....	3	Hogan on the Election of Mine Inspectors... "Hogan, Telling".....	421 313
Gas Ignition by Tungsten Filament Electric Lamp	126	Hogs as Indicators.....	726
Gaskill, J. C., Common-Sense Mine Ventila- tion	409	Hoist, Electric.....	465
Gas, Natural, Rhigolene.....	224	Hoisting at English Colliery, Fast.....	455
Gasoline Motors in Mines.....	75	Hoisting Calculations.....	519
Gasoline Rock Drill.....	463	Hoisting Engines, Air Balanced.....	221
Gas Power for Collieries.....	613	Hoisting Engines, Equalizing Load Moments on	399
Gas Producer, Status of.....	3	Hoisting Plants, Power Consumption of.....	49
Gas, To Remove Marsh.....	372	Hoisting Ropes.....	578
Gas, Use of Coke-Oven.....	378	Hoisting Rope, Changing the.....	575
Gas Wells in Coal Regions, Regulation of Oil and.....	598	Hoisting, Speed of.....	571
Gatun Lock Gate, First Test of.....	164	Holes, Controlling the Direction of Bore.....	327
Gauges, Bristol's Recording Differential-Pressure	594	Holland, Coal Discoveries in.....	414
Gay-Lussac's Law.....	564	Holloway, William, Capacity of Fan.....	518
Gedosh, H., Booster Fans.....	454	Holmes on Coal Production.....	71
General Electric Co., Locking Device for Electric Switch, 401—Storage Battery Gathering Locomotive.....	592	Homestake Electric Plant.....	230
Geology	59	Homestake, Mining by Timbering and Fill- ing	36
Georgia, Ocher Deposits of.....	46	Hookworm Disease in Southern Mines.....	558
Germany, Mine Supports in.....	240	Hooper, J. de B., Coal Dust and Steam, 372— Humidity of Mine Air, 508—Law Regarding Mine Inspectors.....	454, 700
Gloman, C. K., Gas Chart.....	1913	Hore, Reginald E., Sudbury Nickel-Copper Industry	383
Gloman's Gas Chart, Criticism of.....	572	Horizontal Mine Boring Under Pressure....	250
Gilpin County, Gulch Mining in.....	223	Horsepower	597
Gilser, H. S., Brakpan Mines, Ltd.....	156	Horsepower and Kilowatt.....	71
Godwin, J., Sapphire Mines of Northern Kashmir	174	Hoskin, Arthur J., Gulch Mining in Gilpin County 223—Markets for Joplin Ores, 103— Random Thoughts on Prospecting, 58—Re- vival of Mining at Red Cliff.....	147
Gold Dredging Up to Date.....	53	Howells Mining Drill Co., Mining Machinery Exhibit, 659—Power-Driven Auger Drills..	724
Golden Gate Mill.....	391	How to Mine.....	644
Gold Extraction Results on the Rand.....	280	"Huckleberry Miners".....	661
Goldfield Consolidated Mill.....	394	Humidifying the Air-Current.....	88,
Gold Production, Seward Peninsula.....	35	Humidity of Mine Air.....	508
Gold Production, 1912, World's.....	365	Hutchinson and Evans, Barometric Pressure and Mine Gases.....	477
Gold, Russian.....	342	Hutchinson, J. W., Barometric Pressure and Mine Gas.....	66
Goulds Mfg. Co., Electric Sinking Pump....	723	Hyatt Roller Bearing, Stine Fan.....	527
Goulds Triplex Mine Pumps.....	659		
Grass Valley, California, Economical Shaft Sinking	151	I DEAL METHOD OF MINING.....	665
Griffith, William, Assessing and Taxing Coal in the Ground.....	669	Igniter, Safety-Lamp.....	400
Ground Hog Field, B. C.....	582	Igniters, Cerium.....	362
Guide, Single Shaft.....	98	Illinois "Bullgine".....	381
Gulch Mining in Gilpin County.....	223	Illinois Civil Service Examination.....	251
Gunsolus, F. H., Use of Explosives in Coal Mines, 459—Use of High Explosives in Northern Mines.....	655	Illinois Coal Statistics.....	232
		Illinois Mine Rescue Station, Manager for..	62
H AAS, FRANK, WASTE IN MINING... 509		Illinois, New Geographical Map of.....	603
Hachita, M. S., Chemical Interpolation of Anthracite.....	373	Illinois Notes.....	521
Haines, Samuel, Shaft Sinking.....	571	Illinois State Inspectors of Mines, Photo...	129
Hall at Leisenring No. 1.....	303	Illinois State Mining School, Dedication....	600
Hamilton No. 8 Mine.....	255	Imperial No. 3 Mine Explosion.....	685
Hamilton, Wm. E., Storing and Rehandling Anthracite	529	Improvements in the Caving System.....	56
Hammon, W. H., Use of Barometer in Mining	645	Increased Cost of Mining Anthracite.....	26
Handy, H. L., Repairing a Large Rope Sheave	604	Increase in Platinum Production.....	344
Handy, R. S., Economic Efficiency in Lead Concentration	211	Increasing the Efficiency of the Fire Boss...	145
Hanger for Steam Line.....	503	Indiana Mine Law.....	583
Hangers, Steam Pipe.....	579	Indicator for Water Station.....	561
Harris Pyrite Co., Shaft Sinking Device....	332	Influence of Drafts in Mine Explosions....	576
Harris, Samuel, Shaft Sinking	317	Ingersoll-Rand Co., Fusible Signal Plugs....	528
Hastings Coal-Mine Disaster	9	Ink Stand, A Field.....	164
		Inspectors, Hogan on the Election of Mine...	421
		Inspectors, Law Regarding Mine.....	454, 574,
		Inspectors of Mines, Illinois State, Photo...	129
		Inspectors, Selection of State Mine.....	346
		Inspectors, Suggestion to State Mine.....	345
		Inspectors' Work, Checking.....	683
		Institutes, Coal Mining.....	420
		Institution of Mining and Metallurgical Engineers	480
		Insurance on Mine Property.....	696
		Interest Charges, Amortizing and.....	415
		International Congress of Applied Chemistry	116
		International Engineering Congress.....	699
		International Geological Congress.....	116, 503
		Interpolation of Anthracite, Chemical.....	373
		Iowa Coal Statistics, 1912.....	513
		Iowa Mine Reports.....	318
		Iron and Steel Institute of Great Britain...	503
		Iron Mask Mine, Gilman, Colorado.....	148
		Iron Mining in Missouri.....	227
		Iron Ore Loading on the Island of Elba....	33
		Iron Ores, Lake Superior and Cuban.....	340
		Island Creek Coal Co., Report, 1912.....	584
		"It Is to Laugh".....	554
		J APAN, DRIVING A TUNNEL IN.....	331
		Jellio	628
		Jennings, S. J., Discipline in Mining, 585— Raising Water, 452—System of Mining An- thracite	453
		Jig Design, Recent.....	170
		Johnston, Jesse K., Humidifying the Air- Current	460
		Johnstown, Valley Smokeless Coal Co.....	366
		Jones, E. R., Concrete Shaft Lining.....	107
		Jones, E. W., Carbide Lamp Abuse.....	573
		Jones, J. E., Timber Setting Derrick.....	724
		Jones, Louis Cleveland, Amortizing and Interest Charges.....	415
		Johnson, F. S., Calcium Carbide.....	254
		Joplin Ores, Markets for.....	103
		July Gas Explosions.....	3
		K ANSAS AND OKLAHOMA GAS FIELDS	386
		Kansas, Coal Stripping in.....	407
		Kansas, Hamilton No. 8 Mine.....	255
		Kansas Strippings.....	521
		Kansas Workmen's Compensation Law.....	583
		Kashmir, Sapphire Mines of Northern.....	174
		Keeping Snow Off the Tracks.....	381
		Kelvin's Memorial, Lord.....	120
		Kentucky Coal Fields, Southern.....	63
		Kentucky Coal Mines, 1911.....	120
		Kentucky First-Aid Contest.....	379
		Kentucky Mining Institute.....	704
		Kentucky Mining Institute, December, 1912, Meeting	299
		Kentucky Mining Institute, June, 1912, Meet- ing	16
		Kentucky Notes.....	521
		Kentucky, Pond Creek Coal Co.....	583
		Kentucky, Production of Coke, 1911.....	143
		Kentucky State University, Practical Miners' Course.....	516
		Kerr, Mark B., Economical Shaft Sinking...	151
		Kilowatt, Horsepower and.....	71
		King, Austin F., Gasoline Motors in Mines, 75—Coal-Mine Ventilation.....	423
		Krebs, Indian Territory, Dust Explosion....	126
		Krebs, Indian Territory, Explosion.....	60
		Krzyanowski, Coal-Mine Fires.....	692
		L ABORATORY, NEW UNIVERSITY MINING	116
		Lady Victoria Mine.....	671
		Laing, John, Waste in Mining.....	373
		Lake Commerce for June, 1912.....	79
		Lakes, Arthur, Gold Dredging Up to Date...	53
		Lakes, Harold, Characteristics of Mexican Miner	41
		Lake Superior and Cuban Iron Ores.....	340
		Lake Superior Mining Institute, August, 1912, Meeting.....	15, 127
		Lamp Contest, British Electric Mining....	144
		Lamp, Plummet.....	526
		Lamps, British Tests for Miners' Safety...	422
		Lamps, Use and Care of Safety.....	408, 573

	Page		Page		Page
Lands, Taxing Coal.....	495	Montana Coal Output, Correction.....	702	Montana Coal Statistics, 1912.....	513, 584
Langerfeld, Arthur, Langerfeld Coal and Slate Separator.....	656	Moorshead, A. J., Organization as Affecting Mining, 627—Waste in Coal Mining.....	441	Morrison, A. Cressy, Gases From Acetylene Lamp.....	254
Laske, Bergrath, Carbon Dioxide Blower in German Colliery.....	305	Motive Column.....	644	Motor for Fan Drive.....	465
Latches, Spring Frog and.....	279	Motor for Stamp Mill Drive.....	289	Motors in Mines, Gasoline.....	75
Latham Coal Mine, Illinois, Explosion.....	521	Motors in Mines, Gasoline.....	75	Motor Truck.....	239
Lathrop Coal Co.....	172	Moving Minerals in Thin Flat Beds.....	310	Mt. Lyell Fire, North.....	330
La Viers, H., Successful Mine Foreman From Four Points of View.....	510	Mt. Lyell Fire, North.....	330	Mowat, David M., Facts and Theories Relating to Fans.....	429
Law of Pennsylvania Regarding Safety Lamps.....	233	Muller By-Product Coke Oven.....	12	Mueller, Frank E., Washery at Soddy Mine.....	295
Law, Proposed Anthracite Mine.....	353	Mulling in South Africa, Cost of.....	289	Mule, Ode to the Mine.....	557
Law Regarding Mine Inspectors.....	454, 574	Mine Accidents, 1911, Pennsylvania.....	482	Muller By-Product Coke Oven.....	12
Laws, Coal-Mine.....	404	Mine-Air Analysis.....	352	NATAL COAL TRADE OF.....	
Law, West Virginia Workman's Compensation.....	649	Mine Air, Moistening.....	69	Natal Coal Output.....	670
"Laying Up Treasures".....	61	Mine-Car Wheels, Lubrication of.....	25	National Forests.....	173
Lead Concentration, Economic Efficiency in.....	211	Mine-Cave Commission Report.....	504	National Mine-Accident Record.....	523
Leasing of Metal Mines.....	52	Mine Caves, Protection of Surface.....	234	Near Doomed City.....	704
Lehigh Valley Coal Co., Lunch House at Colliery.....	482	Mine Drainage.....	180	Newbattle, Notable Scottish Colliery.....	671
Lemont Mine, Flooding.....	69	Mine Foreman, The.....	201	New Electric Mine Pump.....	231
Lewisburg Mine, First Aid in Alabama Mines.....	25	Mine-Gas Chart Supplement.....	329	New English Coal Field.....	72
Life of Treated Timbers.....	310	Mine Inspectors' Institute, June, 1912, Meeting.....	283	New Geographical Map of Illinois.....	603
Lignite, Briquetting.....	242	Mine Law, Pennsylvania Bituminous, 1911.....	696	New Jersey Mineral Production.....	86
Lignite, Testing Texas Lamp.....	180	Mine Property, Insurance on.....	348	New Mexico, Cerrillos Anthracite Mine.....	4
Limestone in Syria, Self-Burning.....	201	Miner, The Coal.....	415	New Mexico, Magdalena Mining District.....	275
Limonite, Pipe Ore, Secondary.....	329	Mines, Amortizing and Interest Charges.....	415	New Mining Machinery.....	17, 27, 172, 231, 289, 343, 366, 400, 526, 592, 656,
Link-Belt Co., Portable Coal Loader.....	593	Mines, Economical Period for Exhausting.....	415	New Steel Mine Support.....	201
Lithium.....	283	Mine Management.....	578	New Type of Mine Trolley.....	723
Lloyd, Bert, Changing the Hoisting Rope, 575—Increasing the Efficiency of Fire Boss, 145—Reversing an Air-Current, 622—Use for Old Wire Rope.....	645	Mineral Pigments in Pennsylvania.....	285	Newton, Leonard V., The Classification of Coal.....	139
Lloyd, W. B., "Anxious" Answered.....	189	Mines, Scientific Management of.....	60	New-University Mining Laboratory (Illinois).....	116
Lloyd, W. D., Hoisting Ropes.....	578	Mine Support, New Steel.....	201	Nicholson, W. H., Mining Machinery Exhibit.....	659
Lloyd, Strauss L., Phosphate Ore Dressing, 333—Manufacture of Acid Phosphate.....	329	Mine Supports in Germany.....	240	Nickel-Copper Industry, Sudbury.....	383
Locking Device for Electric Switch.....	401	Mine Surveying, Notes on.....	169	Nigeria Coal Deposits.....	530
Loader, Portable Coal.....	593	Mine Surveying, Some Problems in.....	226	1911 Bituminous Mine Law of Pennsylvania.....	27
Loading Machines, Coal Cost and Coal.....	11	Mine Surveying Wrinkles.....	300	Nonpareil High-Pressure Covering.....	231
Locomotive, New-Type Mine.....	526	Mine Surveyor and Mining Engineer.....	59	Normal Volumetric Solutions.....	155
Locomotive, Storage-Battery Electric.....	343	Mine Ventilation.....	632, 712	North American Construction Co.....	289
Locomotive, Storage-Battery Gathering.....	592	"Mine Technologist," Civil Service Idea of.....	61	North Mount Lyell Mine Fire.....	330
Long-Lived Leather Belt, A.....	616	Mining, An Ideal Method of.....	665	Northwestern Improvement Co.....	263
Longwall Advancing.....	517	Mining Anthracite, Increased Cost of.....	26	Northwest Mining Convention.....	379
Longwall Mining in Illinois.....	606	Mining Anthracite, System of.....	452	Norwood, C. J., First Aid in Kentucky, 484—Kentucky Coal Mines, 1911, 120—Stray Electric Currents.....	356
Lord Kelvin's Memorial.....	120	Mining Bituminous, System.....	453	Notable Scottish Colliery.....	671
Loup Creek, West Virginia, Mining on.....	19	Mining by Timbering and Filling.....	36	Notes on Mines and Mining.....	521, 582, 649,
Low Cost at Wasp No. 2 Mine.....	281	Mining Building at Pennsylvania State College.....	250	Notes on Mine Surveying.....	169
Lubricating Oil, Specifications for.....	681	Mining in Northern China, Coal.....	29	Nova Scotia Coal Trade, 1912.....	525
Lubrication, Air-Compressor Cylinder.....	136	Mine Inspectors' Reports, Uniformity in.....	60	Nova Scotia Gold Production.....	220
Lubrication of Mine-Car Wheels.....	250	Mining Institutes' Summer Meetings.....	182	No. 2 Mine, United Coal Mining Co.....	612
Lucas, F. E., Manufacture of Coke.....	351	Mining Institute, The Panther Valley.....	659	OTHER DEPOSITS OF GEORGIA.....	
Lunch House at Colliery.....	482	Mining Machinery Exhibit.....	659	Ode to the Mine Mule.....	557
Lyman, G. E., Fire Protection of Mines.....	624	Mining on Loup Creek, West Virginia.....	19	Ohio Brass Co., Temporary Electric Bond.....	462
Lynch, Pat. J., Size of Pillars.....	644	Mining on the Surface, Effect of Coal.....	548	Ohio Coal Fields.....	544
MACHINE MINING IN ANTHRACITE MINES.....			471	Ohio Mine Run Law.....	522
Machines, Coal Cost and Coal Loading.....	11	Mining Societies and Institutes.....	377	Oil and Gas Wells in Coal Regions, Regulation of.....	598
Machines vs. Men.....	277	Mining Society Notes.....	217	Oil, Specifications for Lubricating.....	681
Magma, Formation of.....	115	Mining Steep Dipping Coal.....	301	Oils, Specific Gravity Determination of Mineral.....	555
Mammoth System of Fume Control.....	323	Mining Terms, Proper.....	176	Oil Wells, Depth of.....	371
Management of Mines, The Scientific.....	60	Mining Waste in Coal.....	60	Oklahoma.....	367
Manager for Illinois Mine-Rescue Station.....	62	Mining With the Pneumoelectric.....	593	Oklahoma Blasting Law.....	584
Manganese Discoveries in Philippines.....	396	Minor, Prof. W. H., Fires in Mines and Some of Their Causes.....	72	Oklahoma, Cause of a Mine Disaster.....	2
Manganese in Gold Amalgamation.....	289	Mischiefous Statements.....	292	Oklahoma Coals, Report on.....	522
Manganese Steel for Economy.....	329	Missouri, Barytes in.....	95	Oklahoma Gas Fields, Kansas and.....	386
Manufacture of Acid Phosphate.....	329	Missouri, Iron Mining in.....	597	Old Rails as Stringers.....	312
Manufacture of Coke.....	351	"Model Mine".....	603	Old Wire Ropes for Return Circuit in Mines.....	248
Map, Description of Tonnage.....	603	Moderwell, C. M., No. 2 Mine, United Coal Mining Co.....	612	Once More the "Dowser".....	48
Maps, Photographing Blueprint.....	689	Moistening Mine Air.....	88	Ore Loading on the Island of Elba.....	33
Marianna, Pa., Waste-Heat Coke Oven at.....	135	Moistening Mine Ventilating Currents.....	141	Organization as Affecting Mining.....	627
Markets for Joplin Ores.....	103	Moistening the Air-Current.....	460	Orme, Tennessee, Battle Creek Mine.....	237
Martin, Al. H., Mammoth System of Fume Control, 323—The Results of Deep Mining in California.....	210	Moisture in Coal.....	318	Owens, W. D., Increased Cost of Mining Anthracite.....	26
Martin, C. V., Plummet Lamp.....	526	Monel Metal's Resistance to Corrosive Action.....	108	Oxone, Sodium Peroxide.....	236
Marshall, J. J., Mining on Loup Creek.....	19	Monobel and Carbonite.....	252		
Masurite Explosive Co., First Permissible Explosive.....	145	Monongahela River Consolidation Coal and Coke Co., Employees' Association.....	418		
Masonry vs. Wooden Air Stoppings.....	662				

	Page		Page		Page
Oxygen, Reducing Percentage in Air to Prevent Explosions.....	119	Princeton, B. C., Coal Mines.....	263	Rolling Mill Mine, Shaft Raising at.....	288
PAINTS IN PENNSYLVANIA, MINERAL	285	Princeton, B. C., Mining Notes.....	278	Rondout Tunnel, Unwatering.....	497
Pam, Edgar, Sand Filling on the Rand.....	219	Prize Contest, 264, 306, 363, 451, 517, 580, 646,	705	Ropes, Changing Hoisting.....	454
Panama Canal, Creep in.....	39	Proper Mining Terms.....	176	Ropes, Hoisting.....	578
Panama-Pacific Exposition.....	699	Proposed Anthracite Mine Law.....	353	Ropes, Methods of Socketing or Capping Wind-	195
Pans, Blasting Coal On to.....	382	Props, Cutting.....	596	ing.....	684
Pantagraph, Use of the.....	286	Prospect Colliery, Lunch House.....	482	Rope Splicing, Three-Two Method.....	575
Panther Valley Mining Institute.....	182	Prospecting, Random Thoughts on.....	58	Rope Turning.....	609
Panther, W. Va., The Lathrop Coal Co.....	179	Protection of Surface Over Coal Mines.....	234	Ropiequet, R. W., Transportation Problem, The,	342
Paral and Pachuca Tanks.....	393	Pryor, Dr. J. W., Hookworm Disease in Southern	558	Russian Gold.....	287
Parker, E. W., Facts About Anthracite Mining	202	Mines.....		Russian Platinum Industry.....	287
Palmer, Le Roy A., Centrifugal Pumps, 507—Low	281	Publications on Mine Accidents and Tests of		SAFE TIMBERING.....	555
Cost at Wasp No. 2 Mine.....	281	Explosives.....	137	Safety Blocks for Inclines.....	188
Payne, Henry M., Scientific Management Applied	701	Pulling Pillars.....	644	Safety Catch, Berry.....	342
to Coal Mining.....	701	Pulverized Coal Burning, Mt. Braddock.....	365	Safety Catch for Hoists, New.....	461
Peabody, Francis S., Conservation and Commer-	694	Pumping Through Coal.....	177	Safety Crossheads.....	396
cialism.....	694	Putting Money Into the Ground.....	177	Safety First.....	721
Pelton Waterwheel.....	97	QUARRYING COAL AT TOFIELD, ALTA.	601	Safety Lamp, Description of.....	446
Penn-Mary, New Steel Mine Support.....	201	Quincy Mining Co., Rock House of.....	325	Safety Lamp Igniter.....	400
Pennsylvania Coal Co., Concrete Coal Pocket	304	RADIUM, "CURIE," THE STANDARD	47	Safety Lamps, British Test for Miners'.....	422
Pennsylvania, Coal Mine Accidents in.....	146	FOR.....	47	Safety Lamps for Pennsylvania.....	233
Pennsylvania Coal Statistics, 1912.....	512	Rafferty, M. J., To Stop a Squeeze.....	451	Safety Lamps, Use and Care of.....	408, 573
Pennsylvania, Danger Signals in.....	242	Railroads Invisibile.....	496	St. Bernard Mining Co., Forestry as Related to	511
Pennsylvania, 1911, Bituminous Mine Law	27	Rails as Stringers, Old.....	312	Mining.....	511
Pennsylvania Notes.....	522	Rails on Side, Track Extension With.....	308	Sampler, Mill Feed.....	284
Pennsylvania State College, Mining Building at	468	Railway Strikes a National Menace.....	533	Sampling, Blister Plates for.....	219
Perkins, Frank C., Horizontal Mine Boring	250	Raising Shaft at Rolling Mill Mine.....	288	Sampling of Coal, Commercial.....	199
Under Pressure.....	250	Raising Water.....	452	Sand Filling on the Rand.....	219
Permissible Explosives, First.....	145	Rakousin, M., Specific Gravity Determination of	555	Sand Sluicer, Automatic.....	385
Permissible, Explosives, Monobel and Carbonite	252	Mineral Oils.....	555	Sapphire Mines of Northern Kashmir.....	174
Personal Views Re Affairs American Institute	144	Randall, John, Practical Cyaniding.....	42, 109,	Sapphires of Siam.....	282
Mining Engineers.....	144	165, 213, 270, 335,	391	Saunders, W. L., Driving a Tunnel in Japan....	331
Petroleum Lore, Authentic.....	209	Random Thoughts on Prospecting.....	58	Savanna, Indian Territory, Dust Explosion....	126
Pfeifer, G. W., Gases From Acetylene Lamps	316	Rand, Sand Filling on the.....	99,	Saved by the Mine Telephone.....	481
P. & R. C. and I. Co., Flushing Anthracite Work-	587	Rash, Frank D., Forestry as Related to Mining,	511	Schellenberg, F. Z., Use of Barometer in Mining,	645
ings.....	587	Rathburn, Tenn., Washery at Soddy Mine.....	295	Schetzl, Erich, Electric Spot Firing.....	243
Philadelphia & Reading Coal and Iron Co., Sub-	293	Rational Mine Sociology.....	303	Schneider, Geo. W., Concentration at Butte and	160
stantial Sympathy.....	293	Ration List, Oregon Agricultural College.....	289	Superior Mill.....	160
Phosphate in Kentucky, Rock.....	207	Ready-Made Houses.....	289	Scientific Management Applied to Coal Mining..	701
Phosphate, Manufacture of Acid.....	329	Receivers of Air Compressors.....	137	Scientific Management.....	254, 317,
Phosphate Ore Dressing.....	333	Recent Jig Design.....	170	Scientific Management of Mines.....	60
Phosphate Practice, Florida.....	265	Red Cliff, Revival of Mining at.....	147	Scobee, Barry, Coal Stripping in Kansas.....	407
Phosphate Practice, Tennessee.....	152	Red Cross, American.....	140	Scott, C. E., Commercial Sampling of Coal....	199
Photographing Blueprint Maps.....	689	Reddie, Roy, Recent Jig Design.....	170	Scott Colliery Disaster.....	703
Pigments in Pennsylvania, Mineral.....	285	Reducer, Fire Assay.....	332	Scott, L. L., Gasoline Rock Drill.....	463
Pillars, Size of.....	644	Regulation of Oil and Gas Wells in Coal Regions	598	Scottish Colliery, A Notable.....	671
Pillars? Why Leave Shaft.....	305	Regulator, Location of.....	644	Sealing Off a Loading Place.....	104
Pipe Cutter.....	461	Reinforcing Collars.....	717	Seattle, Alaska Expedition.....	367
Pipe Hangers, Steam.....	503	Repairing a Large Rope Sheave.....	604	Sectional Units Switchboard.....	232
Pit Car Cleaning Device for Self-Dumping Cages	525	Reversing an Air-Current.....	622	Self-Burning Limestone in Syria.....	201
Pipe Ore, Secondary Lunonite.....	329	Revival of Mining at Red Cliff.....	147	Selection of State Mine Inspectors.....	346
Pisel Coking Test.....	674	Rhigolene.....	224	Self-Starting Motor.....	592
Pittsburg Coal Co.'s Relief Department.....	379	Relation of Engineers to Mine Foremen.....	577	Shaft Guide, Single.....	98
Placers, Churn-Drill Examination of.....	492	Relative Vocational Hazards.....	485	Shaft Head, Temporary.....	257
Platinum and Allied Metals.....	390	Report of Anthracite Mine Cave Commission....	168	Shaft Lining, Concrete.....	107
Platinum, Determining.....	287	Rescue Work in Mine Disasters.....	662	Shaft Pillars, Why Leave?.....	305
Platinum Industry, Russian.....	287	Results of Deep Mining in California.....	210	Shaft Raising at Rolling Mill Mine.....	288
Platinum Near Princeton, B. C.....	287	Reynolds, Sim, Robbing Coal Dust of Its	135	Shaft Sinking.....	317, 571
Platinum Production, Increase in.....	344	Dangers, 307—Waste Heat Coke Ovens,	616	Shaft-Sinking Accident, Preventable.....	181
Platinum Wire, Blow-Pipe Bead Without.....	526	Mariana, Pa.....	616	Shaft Sinking, Economical.....	151
Plummet Lamp.....	593	Reynolds, Wm. H., and J. T., Who is Respon-	560	Shaft Sinking by Freezing Process.....	322
Pneumelectric, Mining With the.....	593	sible?.....	514	Shaft Sinking, Catskill Aqueduct.....	497
Pocahontas Consolidated Collieries Co., Report	584	Reynolds, W. H. and Sim, Stopping Ventilation	514	Shaft-Sinking Device.....	332
1912.....	584	at Firing Time.....	361	Shaft-Sinking Practice, South African.....	220
Poet and Prospector.....	1	Rice, George S., Coal Mine Fires, 690—Some	361	Shaft Sinking in Wet Ground.....	700
Political Campaigns.....	583	Features of Mine Disasters.....	307	Shaft Upraising Profitable.....	159
Pond Creek Coal Co.....	87	Robbing Coal Dust of Its Dangers.....	279	Shaile Dust for Preventing Explosions.....	245
Prole, William, Treatment of Broken Hill Ores..	312	Robertson, Wm. Fleet, Standard Silver Mine..	121	Sheave, Repairing a Large Rope.....	604
Portable Apparatus for Firedamp Analysis....	593	Roberts, Warren, Buckner No. 2 Mine.....	603	Shot Firers Saved by Telephone.....	481
Portable Coal Loader.....	366	Robinson, Carcl, Description of Tonnage Map ..	507	Shot Firing, Electric.....	243
Portville, Lease of Coal Lands to Baird Snyder,	67	Robinson, Charles H., Methods of Mining ..	616	Signals in Pennsylvania, Danger.....	242
Jr.....	67	Rock Dump for Slope.....	114	Silver, Price of.....	117
Power and Quantity of Air.....	114	Rock Dump Wanted.....	221	Sinclair, Jos. H., Quarrying Coal at Tofield,	601
Power Consumption of Coal Cutters.....	724	Rock House, Franklin, Jr., Mine.....	325	Alberta.....	332
Power Consumption of Hoisting Plants.....	49	Rock House of Quincy Mining Co.....	712	Sinking Device, Shaft.....	317, 571
Power-Driven, Auger Drills.....	335, 391,	Rock Phosphate in Kentucky.....	379	Sinking, Shaft.....	644
Practical Colliery.....	42, 109, 165, 213, 270,	Rocky Mountain Coal Mining Institute, 291, 298,	649	Size of Pillars.....	87
335, 391,	516	Rocky Mountain Coal Mining Institute, Salt	649	Sizer, F. L., Air Blast or Earth Movement ..	397
629,	712	Lab Meeting.....	480	Slime Classifier, Woodbury.....	196
Practical Methods of Mining.....	413, 487, 502,	Rocky Mountain Coal Mining Institute, Trin-	426	Slopes, Derailing Switches for.....	385
629,	126	Mad Chapter.....	426	Sluicer, Automatic Sand.....	681
Premiums for Yards and Plants.....	126	Rogers, J. D., Preparation of a Domestic Coal....	426	Smith, A. D., Specifications for Lubricating Oil ..	681
Preparation of a Domestic Coal.....	426				
Preservation of Mine Tools.....	83				

	Page		Page		Page
Smith, George W., Booster Fan.....	451	System of Mining Andhra Itas.....	452	United States Coal Exports.....	244
Smoke Problem, The.....	158	System of Mining Bituminous.....	453	United States Geological Survey Fire Sale.....	680
Snow Off the Tracks, Keeping.....	381			University Mining Laboratory (Illinois).....	116
Society Meetings.....	116	TANKS, DEFINED CAPACITY OF CYLINDRICAL	103	Unwatering Two Notable Excavations.....	497
Sociology, Rational Mine.....	303	Tapping Water Under Pressure.....	250	Upraising Shaft, Profitable.....	159
Socketing or Capping Winding Ropes, Method of	193	Tasmania, North Mt. Lyell Mine Fire.....	330	Uruguay Minerals.....	329
Soddy Mine, Tenn., Washery at.....	295	Taxing Coal in the Ground, Assessing and.....	669	Use of the Barometer in Mining.....	590, 645
Sodium Peroxide, Oxone.....	236	Taxing Coal Land.....	405	Use and Care of Safety Lamps.....	408, 573
Solutions Volumetric, Normal.....	155	Tefft, T. A., Causes of Fires in Metal Mines.....	218	Use of Explosives in Coal Mines.....	459
Some Features of Mine Disasters.....	361	Telephone, Saved by the Mine.....	481	Use of High Explosives in Northern Mines.....	655
Some Problems in Mine Surveying.....	226	"Telling Hogan".....	313	Use for Old Wire Rope.....	645
Somerset County, Pennsylvania, Development.....	524	Temperature Control for Air Compressors.....	532	Use of the Pantagraph.....	286
Somerville, D. H., Dangers of Acetylene Lamps.....	372	Temple Iron Co., Dissolution.....	698	Utah, Report of Mine Inspectors.....	367
Source of Blackdamp.....	316	Temporary Shaft Head.....	257	Utah, Report of Mine Inspectors, 1912.....	367
South African Shaft Sinking Practice.....	220	Tennessee Mine Foremen's Society.....	698		
Southern Kentucky Coal Field.....	63	Tennessee Phosphate Practice.....	182	VALLEY CAMP MINE EXPLOSION	523
Specifications for Lubricating Oil.....	681	Terms, Proper Mining.....	176	Value of Study to Mining Men.....	260
Specific Gravity Determination of Mineral Oils.....	555	Testing for Firedamp With Wire Loop.....	439	Values, Determining Coal.....	191
Speed of Hoisting.....	371	Testing Texas Lump Lignite.....	180	Vaughn, L. D., Safety-Lamp Igniter.....	400
Spencer Breaker, Dunmore, Langerfeld Coal and Slate Separator.....	656	Tests of Explosives, Publications on Mine Acci- dents and.....	137	Ventilation, Australian Mine.....	557
Spike Puller.....	594	Tests for Miners' Safety Lamps, British.....	422	Ventilation, Common Sense Mine.....	409
Spiral Steam Turbine.....	464	Texas Lump Lignite, Testing.....	180	Ventilation, Coal Mine.....	423
Splicing, Three-Two Method of Rope.....	681	THE COLLIERY ENGINEER, Statement of Owner- ship.....		Ventilation at Firing Time, Stopping.....	514
Spring Frog and Latches.....	239	The Kentucky Mining Institute.....	596	Ventilation, Mine.....	632
Squeeze, To Stop a.....	451	The Magdalena Mining District.....	275	Ventilation, Too Much.....	419
Stag Cañon Fuel Co., Increasing the Efficiency of Fire Boss.....	145	Thompson, C. H., Coal Cost and Coal Loading Machines, 11—Coal Dust and Coal Loading Machines, Correction.....	125	Vernillion Mine, Fireproof Shaft.....	130
Standard Silver Mine.....	279	Three-Two Method of Rope Splicing.....	684	Verner, John, Influence of Drafts in Mine Explo- sions, 376—"Telling Hogan".....	313
Standard-Size Mine Doors.....	628	Tietig, Chester, Cement Gun for Preventing Dust.....	700	Victor-American Fuel Co., Hastings Explosion.....	9
Statement of Ownership of THE COLLIERY ENGI- NEER	176, 596	Timbers, Life of Treated.....	310	Victoria Australia, State Coal Mine.....	134
State Coal Mine, Australia.....	134	Timber Setting Derrick.....	724	S Virginia Iron Mines, Improvements in Caving System.....	56
State College, Mining Building at Pennsylvania.....	468	Timbers, Preservation of Mine.....	83	Vocational Hazards, Relative.....	485
Status of the Gas Producer.....	3	Timbering and Filling, Mining by.....	36	Volume 33.....	2
Steam, Coal Dust and.....	372	Timbering, Mine Supports in Germany.....	249	Volumetric Solutions, Normal.....	155
Steam Hammers.....	658	Timbering, Safe.....	555	Vulcan Iron Works, Electric Hoist.....	465
Steam Line Suspension.....	503	Tin Discovery, No Reward for.....	104	Vulcan Iron Works, Mining Machinery Exhibit.....	659
Steam Pipe Hangers.....	579	Tin Ore Dressing and Metallurgy.....	89		
Steam Plants.....	348	Toengs, Albert L., Mining by Timbering and Filling.....	36	WALKER, SYDNEY F., CLEANING COKE- OVEN GAS, 349—Gas Power for Col- lieries.....	613
Stearns Coal Co.....	63	Tofield, Alberta, Quarrying Coal at.....	601	Wales, Briquets in South.....	459
Stearns Coal and Lumber Co., Bath House.....	481	Toledo Pipe Threading Machine Co., Pipe Cutter Tonnage Map, Description of.....	461	Wants.....	24
Steele, A. A., Mining Steep Dipping Coal, 301— Moistening Mine Ventilating Currents.....	141	Track Extension With Rails on Side.....	190	Washery at Soddy Mine, Tenn.....	295
Stewart, James, Spring Frog and Latches.....	239	Tracks, Keeping Snow Off.....	381	Washington Notes.....	524
Stine Fan With Hyatt Roller Bearing.....	527	Track Seal.....	104	Wasp No. 2 Mine, Low Costs at.....	281
Stockett, D. H. J., Shaft Sinking in Wet Ground.....	709	Trade Press Association, 1912.....	697	Waste of Coal, Bulletin 47.....	118
Stoek, Professor, Examination.....	59	Transportation Problem, The.....	609	Waste in Coal Mining.....	441
Stone Dust in Mines.....	317	Treatment of Broken Hill Ores.....	87	Waste Heat Coke Ovens at Marianna, Pa.....	135
Stoppings, Concrete, Superior Coal Co.....	521	Tree Planting, St. Bernard Mining Co.....	392	Waste in Mining.....	373, 509
Stoppings, Masonry vs. Wooden Air.....	662	Trinidad Chapter, Rocky Mountain Coal Mining Institute.....	356	Water, Raising.....	452
Stopping Ventilation at Firing Time.....	514	Tunnel Driving, The "Billy White" Cut.....	404	Water Under Pressure, Tapping.....	250
Stopping? Why is a.....	190	Tunnel Driving, Fast.....	260	Waterwheel, Pelton.....	97
Storage Battery Electric Locomotive.....	343	Tunnels, Pennsylvania, at New York.....	713	Watkins, J. R., Use and Care of Safety Lamps.....	573
Storage Battery Gathering Locomotive.....	592	Turbine, Spiral Steam.....	464	Weather Map, Use of.....	479
Storing Coal Under Water.....	697	Turbogenerators, Direct-Current.....	172	Webb, H. S., Electricity in Mines.....	449, 489, 609
Storing and Rehandling Anthracite Under Cover Stors No. 1 Mine, Pumping Through Coal.....	365	Turner, Thomas, The Mine Foreman.....	375	Weldin, Wm. Archie, Scientific Management.....	553
Stratton's Independence Mill.....	392	Turning Rope.....	575	Welfare Work at Coal Mines.....	481, 469
Stray Electric Currents.....	340, 356	Turquoise in Arizona.....	52	Welles, Francis G., Allowable Error in Closing Survey, 88—Combustion of Gas and Dust.....	372
Strikes a National Menace, Railway.....	543	Tuttle, Edgar G., Magdalena Mining District.....	275	Western Electric Co., Sectional Units Switch- board, 232—Storing Coal Under Water.....	697
Strikes in Anthracite Mines.....	404	Two-Speed A.-C. Motor.....	465	Western Mining "Camps".....	680
Stripping in Kansas, Coal.....	407	UNDERGROUND CONVEYERS	310	Westinghouse, Direct-Current Turbogenerators.....	172
Strohm, R. T., Mechanics of Mining.....	448, 487, 566, 633,	Underground Seismograph.....	726	Westinghouse Electric & Mfg. Co., 289—New Mine Trolley, 723—Self-Starting Motor, 592— Two-Speed Motor.....	165
Substantial Sympathy.....	293	Underwood Breaker.....	304	West Virginia, Coal Company Reports, 1912.....	584
Successful Mine Foreman From Four Points o. View.....	510	Underwood, Temporary Shaft Head.....	257	West Virginia Coal Mining Institute, June, 1912, Meeting.....	15
Sudbury Nickel-Copper Industry.....	383	Uniformity in Mine Inspectors' Reports.....	60	West Virginia Coal Mining Institute.....	600
Suggestion to State Mine Inspectors.....	345	United Cut in Wages.....	355	West Virginia Institute, December, 1912, Meet- ing.....	298
Sulphur Mines in Mexico.....	91	United Coal Mining Co., Buckner No. 2 Mine.....	121	West Virginia, Loup Creek, Mining on.....	19
Sulphur Mining.....	228	United Coal Mining Co., No. 2 Mine.....	612	West Virginia, Shooting Off the Solid.....	698
Superba Mine, Flooding of.....	69	Units of Measure.....	579	West Virginia Workmen's Compensation Law.....	649
Superintendent's Duty, Coal Mine.....	6	United States Bureau of Mines.....	117,	Wheatley, Robert S., Afterdamp.....	572
Supplement, The Mine Gas Chart.....	467	United States Bureau of Mines, Bulletin 47.....	118	Wherry, Edgar T., Acetylene Dangers.....	316
Surface, Effect of Coal Mining on the.....	548,	United States Coal and Coke Co., Premiums for Yards and Gardens.....	62	Whiteside, G. F., Colorado First-Aid Contest.....	78
Surface Over Coal Mines, Protection of.....	234			Who Is Responsible?.....	560
Survey, Allowable Error in Closing.....	88			Why Is a Stopping?.....	190
Surveying.....	519			Why Leave Shaft Pillars?.....	305
Surveying, Difficulties in Mine.....	359			Wilkinson, George, Hoisting Calculations.....	519
Surveying, Notes on Mine.....	169			Wiley, Day Allen, Lake Superior and Cuban Iron Ores.....	340
Surveying, Some Problems in Mine.....	226				
Surveying Wrinkles, Mine.....	300				
Switches for Slopes, Derailing.....	196				
Sykes, S. W., Power Consumption of Hoisting Plants.....	49, 114				

Williams, J. B., Location of Regulator... 644
Williams, J. Harvey, The Lathrop Coal Co 179
Williamson, H. A., Photographing Blueprint Maps 689
Wilson, Alexander, Longwall Mining, 517—Three-Two Method of Rope Splicing, 684—System of Mining Bituminous... 453
Wilson, E. B., Clinkering of Coal Ash, 125—Formation of Magmas, 115—Muller By-Product Coke Oven... 12
Wilson, W. B., Coal Miner in the Cabinet 520
Windblasts... 87
Wire Loop, Testing for Firedamp With... 439
Wire Ropes for Return Circuit in Mines... 248
Wire Rope Splicing, Three-Two Method... 684
Wire Rope, Use for Old... 645
Wittich, Lucius L., Barytes, in Missouri, 95—Electric Shot Firing, 243—Hamilton, No. 8 Mine, 255—Iron Mining in Missouri, 227—Kansas and Oklahoma Gas Fields, 386—Shaft Upraising Profitable... 159
Woodbury Slime Classifier 397
Worker, Coe L., Ode to the Mine Mule... 357
Working Anthracite Culm Piles... 569
Wright, Edward T., Woodbury Slime Classifier 397
Wysocki, St., Coal Mine Fires... 692

YALE, B. C., EXAGGERATED REPORT OF EXPLOSION... 467
Yards and Gardens, Premiums for... 62
Young, C. M., Dust Explosions... 258

ZINC AND LEAD ALLOY... 168
Zinc Shaving Lathe... 273

Index B—Book Review

AGRICOLA DE RE METALLICA... 710
Air Compression and Transmission... 711
American Mine Accounting... 496
BIRMINGHAM DISTRICT MINERAL LAND REFERENCE... 568
Book of Standards 495
Building Stones and Clay Products... 495
Bureau of Mines Publications... 32
Business of Mining, The... 203
Business Prospects Year Book, 1913... 360

CALCULUS... 710
Characteristics and Limitations of the Series Transformer... 568
Chemical Arithmetic and Furnace Charges... 256
Coal, by Somermeier... 291
Coal Mining in Arkansas... 256
Concrete Costs... 208
Cyanide Practice in Mexico... 414
DAVIS HANDBOOK OF THE PORCUPINE GOLD DISTRICT... 28
Days of Gold... 256
Department of Mines, Canada... 116
Design of Steel Mill Building... 257
Determinative Mineralogy... 495
Digest of Compensation Laws... 711

ELECTRICAL INJURIES... 28
Electrical Trades Dictionary and Handbook Energy and Velocity Diagrams of Large Gas Engines... 294
Entropy-Temperature and Transmission Diagrams for Air... 203
Essentials of Electricity... 643
Explosion Proof Motors... 496
Explosion Proof Motors... 257
Expansion of the Dewey Decimal System of Classification Applied to the Engineering Industries... 360
GEOLOGY... 294

HEALTH... 1913... 496
H... 173
INDUSTRIAL... 716
Index of Mining Literature, by Crane... 25
Crane... 1

JOHNSON'S FIRST-AID MANUAL... 495
KENTUCKY GEOLOGICAL SURVEY... 32
LAKE SUPERIOR IRON ORE ANNUAL, 1913... 711
MAP OF WEST VIRGINIA COAL FIELDS... 613
Metal Statistics, 1913... 496
Metallurgy of Iron and Steel, by Stoughton... 294
Methods of Air Analysis, H. J. Haldane... 256
Mineral Resources of Missouri... 496
Mining World Index of Current Literature... 256
Mining World Index of Current Engineering Literature, Vol. 2... 643
Modern Copper Smelting... 414

NEW JERSEY GEOLOGICAL SURVEY... 32
PETROLEUM IN SOUTHERN CALIFORNIA... 643
Practical Field Geology... 203
REPORT OF COAST AND GEODETIC SURVEY, 1912... 568
Report of Department of Public Works, Alberta, 1911... 495
Resources of Tennessee... 496

SMOLEY'S PARALLEL TABLES OF LOGARITHMS AND SQUARES... 291
South African Mining Directory... 568
Strength of Materials, by Merriman... 256
Study of Minerals, The... 28

THE EXAMINATION OF PROSPECTS... 173
The Mineral Industry, Vol. 20... 203
Topographic and Geologic Survey, Pennsylvania... 32

U. S. DEPARTMENT OF AGRICULTURE... 116
U. S. Geological Survey Publications... 116
University of Illinois Bulletins... 32

VIRGINIA GEOLOGICAL SURVEY... 643
Virginia Geological Survey... 203

WASHINGTON GEOLOGICAL SURVEY... 256

Index C—Personals and Obituaries

ARONS, J... 178
Adams, Prof. Frank D... 62
Adler, Dr. Felix... 664
Ashbridge, P. B... 536
Ashley, John E... 406
Atkinson, J. B... 664
BAILEY, E. G... 236
Baldwin, Frank... 470
Barnett, Walter W... 120
Barton, George S... 294
Beattie, James F... 236
Beatty, James... 470
Black, Robert M... 178
Blowbert, William F... 536
Boag, D. C... 4
Boucher, I. A... 358
Bovee, J. M... 62
Boyle, John J... 536
Brasher, W. R... 178
Briggs, Frank O. (Obit.)... 635
Brinsmade, R. B... 358
Broman, D. J... 4
Brown, James Crosby... 406
Bryden, Prof. C. L... 236
Burns, Joseph... 664

CALLBREATH, J. F... 120
Curman, J. B... 62
Cameron, A. P... 120
Carpenter, Arthur H... 62
Carter, Thomas Lane (Obit.)... 164
Cartridge, Oscar... 178

Cary, Governor... 536
Chance, Edmund M... 470, 664
Chapman, M. T... 536
Chauvenet, Prof. Regis... 664
Chittenden, Alfred Knight... 406
Clark, J. Shephard (Obit.)... 635
Coleman, John... 536
Collins, C. P... 406
Colvocresses, George M... 294
Conners, Edward J... 536
Cook, William H... 4
Coolidge, C. E... 178
Cox, W. Ray... 4
Coxe, E. M., E. H... 4
Crawford, Geo. L... 62
Cunningham, Mr... 664
Cunningham, B. L... 4
Cunningham, W. H... 120

DAVIDSON, MR... 358
Davis, John T... 664
Day, E. B... 236
Delamater, G. R... 236
De Lashmutt, Ivan... 120
Denny, G. A... 4
Denver & Rio Grande Railroad... 178
Dickson, Archibald A. C... 178
Dickson, William Brown... 294
Dobbins, Prof. J. L... 4
Dorrance, Jr., Charles... 470
Drake, N. F... 120
Drenneen, Everet... 470
Du Bois, Prof. Emile Chaix... 129
Dunlop, John... 178

EARLE, E. P... 62
Elliott, A. H... 236
Elliott, R. H... 62
Evans, George Watkin... 4, 178, 406, 294, 470, 664
Eye, C. M... 120

FAY, CHARLES L... 178
Fazenbaker, Thos... 664
Fohl, W. E... 178
Fohs, F. Julius... 470, 536
Fraser, C. F... 664
Freil, Patrick J... 358, 470
Fritz, John (Obit.)... 404
Fuller, John T... 178
Fulton, Alexander (Obit.)... 586

GARDNER, DR. JAMES H... 178, 470
Garrett, R. E... 62
Gayley, Dr. James... 406
Gibson, Jr., John... 664
Gilday, Frank... 536
Glazier, R. C... 120
Grady, P. A... 4
Grogan, Thomas F... 470
Guidas, Andrew... 664
Guiterman, Franklin... 4

HAANEL, PH. D., EUGENE... 635, 664
Haddock, E. J... 358
Haines, Samuel... 406
Hall, William... 358
Hammil, Benj. S... 536
Hamilton, F. McN... 635
Hamilton, W. E... 294
Hanna, John... 536
Harvey, John V... 62
Harvey, Thomas... 406
Hawthorne, John... 664
Hayes, John G... 120
Healy, J. F... 664
Hearter, J. H... 178
Hennen, Robert D... 470
Herrick, H. N... 120
Hill, F. A... 406
Hill, George... 635
Hoar, Luke... 536
Hoing, J. B... 236
Holmes, Dr. J. A... 358, 635
Hoover, H. C... 358
Hornberger, J. B... 536
Hoskins, Arthur J... 178, 358
Hosler, Rusb N... 178, 236

Page		Page		Page
178	Hughes, E. M., V. H.	120	Winchell, Alexander N.	62
358	Hutchins, J. P.	358	Woodruff, Hon. Timothy L.	358
406	I NGALLS, W. R.	536	Y ARWORTH, JOSEPH	536
62	J ACKLING, D. C.	294	Z AHN, DR. GUSTER W.	120
406	Jackson, Wemyss	294	Zimmerman, J. M.	358
536	Jeffries, J. A.	358		
358	Jeremiah, Thomas	536		
75	Jessup, George Maxwell (Obit.)	536		
175	John, Evan D.	62		
62	Johns, Alfred L.	406	R AGAN, FRANK	406
175	Johnson, C. S.	406	Ramlow, W. G.	406
358	Jones, William J.	236	Ransome, Dr. F. L.	236
178	K EENAN, CHESTER T.	635	Redfield, Hon. William C.	635
178	Kemp, Prof. J. F.	120	Reel, M. C.	120
702	Kennedy, Orran W. (Obit.)	178	Reese, John P.	178
4	Kenner, A. R.	62	Reid, Walter L.	62
470	Kingsland, R. L.	4	Reynolds, Sim	4
120	Kling, Leroy A.	536	Rice, George S.	536
536	Koch, Joseph	4	Robb, Jr., Edward M.	4
178	Koester, Frank	178	Roberts, J. C.	178
586	Krom, Stephen R. (Obit.)	358	Rogers, W. C.	358
536	L AKES, PROF. ARTHUR	664	Rowan, E. J.	664
62	Latimer, B. J.	536	Rudd, John	536
702	Leavenworth, Woodworth (Obit.)	536	Ryan, M. J.	536
406	Lewis, David L.	357	S AMPSON, PROF. R. (OBIT.)	357
120, 178	Lewis, Robert S.	635	Scheiler, H. W.	635
406	Lewis, Telford	536	Schniewind, Dr. Frederick	536
635	Lindgren, Waldemar	470	Schoew, Karl F.	470
406	Lloyd, W. B.	120	Scholz, Carl	120
236	Long, Sam T.	664	Seip, Robert H.	664
470	Lynch, B. J.	664	Shaw, Harry William	664
470	Lyon, F. R.	635	Sheafer, William L. (Obit.)	635
358	M AINE, CHARLES T.	635	Sherrod, John M.	635
120	Malcolmson, Charles T.	178	Shields, Dr. M. J.	178
358	Marinelli, Dr. Clinton	301	Sill, Harley A.	301
470	Massachusetts Institute of Technology	178	Sill, Rush T.	178
4	Matthews, Harry S.	470	Simpson, William G. (Obit.)	470
358	May, Capt. W. A.	178	Sizer, F. L.	178
406	McArto, Geo.	470	Small, Thomas	470
120	McBride, Sir Richard	358	Smith, Weed	358
536	McCarthy, John E.	470	Smyth, John G.	470
164	McClellan, George D.	536	Soubrey, William A.	536
406	McClure, Geo. W. (Obit.)	470	Steinback, Samuel	470
4	McCormick, Vance G.	294	Stoek, H. H.	294
470	McCullough, C. E., Ernest	664	Streeter, Robert L.	664
536	McGee, Edgar I.	358	Swartley, Arthur	358
470	McGinley, Anthony	664	Swink, Elmer	664
470	McHugh, Neil	358	Swives, Jacob	358
357	McKee, Dr. Frank L. (Obit.)	120	T ANGYE, W. H.	120
536	McLaughlin, John	536	Thomas, David A.	536
357	McLaughlin, Martin (Obit.)	536	Thomas, Fred R.	536
120	McNaughton, George	470	Thomas, John P.	470
178	McMahon, Samuel M.	406	Thomas, Thomas	406
702	McQuail, William H. (Obit.)	178	Thompson, James S.	178
406	McSpadden, J. C.	120	Tierney, John J.	120
62	Meents, Edward	120	Toenges, Albert L.	120
536	Menzies, J. F.	4	Toll, Rensallaer	4
62	Merritt, J. W.	62	Tomlinson, W. E.	62
664	Metcalf, John	62	Townsend, Morgan T.	62
236	Michigan College of Mines	258	Townsend, W. A.	258
120	Miller, L. F.	164	Traer, G. W.	164
120	Milton, Henry D.	536	Tweedale, W. W. (Obit.)	536
664	Mitchell, W. E.	62	V ANBARNEVELD, CHARLES E.	62
120	Moore, Marshall G.	4	Van Diest, E. C.	4
406	Morgan, T. D.	357	Van Zualenberg, A.	357
358	Morris, Robert	4	W AGNER, MAJOR EMIL C. (OBIT.)	4
358	Moses, Thomas	664	Walker, M. A.	664
536	Motter, William B.	294	Walsh, P. J.	294
635	Moyer, Samuel L. (Obit.)	664	Waltman, William D.	664
664	Mullen, E. F.	4	Watson, H. L.	4
4	Myers, John P.	536	Western Electric Co.	536
536	N ELSON, WILBUR A.	664	Whalen, Patrick	664
178	Newell, Dr. F. H.	236	Wheeler, Milton	236
358	Newsam, Richard	470	White, Dave	470
664	Nicholson, William	536	Whitney & Kemmerer	536
635	Nixon, W. M.	358	Whitmayer, Charles	358
178	O 'CONNOR, F. G. S., WILLIAM	358	Williams, Benj.	358
120	Oestreich, Dr. Karl	536	Williams, J. E.	536
178	Old Freihergers	664	Wills, George S.	664
470	Osler, George		Wilson, H. M.	

Index D—Catalogs Received

A CKLEY BRAKE AND SUPPLY CO.	402
Albany Lubricating Co.	344, 650, 726
Aldrich Pump Department	532
Allen American Manganese Steel Co., Edgar	290, 402, 532, 726
Allis-Chalmers Co.	14, 88
American Blower Co.	466, 650
American Brass Co.	726
American Conveyer Co.	650
American Mine Door Co.	726
American Well Works	290
Armstrong Cork Co.	650
Asbestos Protected Metal Co.	532, 650
Ajax Metal Co.	466
B ABCOCK & WILCOX CO.	402
Baldwin Locomotive Works	232, 402
Barco Brass and Joint Co.	290
Bartlett & Snow Co., C. O.	650
Bausch & Lomb Optical Co.	596
Bittenbender Co., Inc.	402
Brennan Drilling Co., J. A.	232
Bristol Co., The	466, 650, 726
Buffalo Fdy. & Mach. Co.	650
Bury Compressor Co.	532
C AMERON STEAM PUMP WORKS, A. S.	466
Card Iron Works Co., C. S.	466, 650
Carnegie Steel Co.	726
Central Foundry Co.	532
Chalmers & Williams, Inc.	532
Chicago Pneumatic Tool Co., 14, 232, 290, 402,	466, 532, 596, 650,
Chuse Engine & Mfg. Co.	650
Crestline Mfg. Co.	88
Cross Engineering Co.	532
D ARBY & SONS CO., EDWARD	402
Davis Instrument Mfg. Co.	650
Deane Steam Pump Co.	290, 402, 466
De Laval Steam Turbine Co.	344
Denver Engineering Works	290, 532, 650
Dixon Crucible Co., Joseph	650, 726
Dodge Co., The J. M.	290
du Pont de Nemours Powder Co., E. I.	88, 290, 466
E ARLE GEAR AND MACHINE CO.	290
Electric Railway Equipment Co.	232
F LORY MFG. CO., S.	232
Foot Bros. Gear and Machine Co.	232
G ARDNER GOVERNOR CO.	290, 726
Garlock Packing Co.	650
General Electric Co.	14, 88, 232, 296, 344, 466, 596
Green Fuel Economizer Co.	88, 344
Goodman Mfg. Co.	402
Goulds Mfg. Co.	532, 596
Goyne Steam Pump Co.	290
H AZARD MFG. CO.	466
Heine Safety Boiler Co.	532
Hess-Bright Mfg. Co.	650
Hyatt Roller Bearing Co.	88
I LLINOIS STOKER CO.	344
Improved Equipment Co.	726
Independent Powder Co.	232, 726
Industrial Instrument Co.	14, 88, 596
Ingersoll-Rand Co.	14, 88, 232, 290, 532
International Praeposit Co.	402
J OHNSON, J. M. & O. R.	88
Johnson & Sons (Leeds), Ltd., Wm.	290
Jeffrey Mfg. Co.	14, 88, 232, 532
K EELER CO., E.	88, 290
Keuffel & Esser Co.	232
Keystone Lubricating Co.	466

INDEX

	Page		Page		Page
L AGONDA MFG. CO.	650	W ATT MINING CAR WHEEL CO.	466, 726	I LLINOIS STOKER CO.	344
Lea-Courtenay Co., Inc.	402	Wenman Pump Mfg. Co.	726		
Leschen & Sons Rope Co., A.	166	Weston Dobson & Co., Inc.	402	J EFFREY MFG. CO.	74, 188, 596
Lidgerwood Mfg. Co.	14	Wheeler Condenser and Engineering Co.	726	John Davis & Son (Derby) Ltd.	188
Link-Belt Co.	232	White & Wyckoff Mfg. Co.	402	Johns-Manville Co., H. W.	344, 402, 531, 466
Lunkenheimer Co.	402	Wisconsin Engine Co.	14	Jones, O. M.	290
		Williams & Co., J. H.	402		
M ACOMBER & WHYTE ROPE CO.	14	Williams Patent Crusher and Pulv. Co.	650		
McKiernan-Terry Drill Co.	290, 402			L ATHBURY-D'OLIER ENGINEERING CO.	401
Michigan Pipe Co.	402			Lea-Courtenay Co.	402
Minnesota Manufacturers Association	402			Link-Belt Co.	466
Morris Machine Works	402			Lord Co., George W.	290
Myers-Whaley Co.	650			Ludlow-Saylor Wire Co.	172
				Lunkenheimer Co.	18, 290
N ATIONAL TUBE CO.	344				
Nelison Valve Co.	14			M ICHIGAN PIPE CO.	402
New York Blasting Supply Co.	532, 596				
Nordberg Mfg. Co.	232			N ATIONAL TUBE CO.	531, 595, 659
O HIO BRASS CO., THE	14, 726				
Osborne Valve and Joint Co.	726			O HIO BRASS CO.	18, 74
				Orenstein-Arthur Koppel Co.	466, 660, 725
P EASE CO., C. F.	344			Ottumwa Iron Works	74
Platt Iron Works Co.	532				
Power and Mining Machinery Co.	232, 402			P RESCOTT STEAM PUMP CO.	172
Proske, T. H.	650				
Pulsometer Steam Pump Co.	232				
				R ICHARDS AND STAFF, JOS. A.	173
R ICHARDSON-PHENIX CO.	232			Roberts & Schaefer Co.	18, 173, 289, 343, 412, 466, 665, 725
Ridgway Dynamo and Engine Co.	14			Roebbling's Sons Co., John A.	401
Roberts & Schaefer Co.	402, 596				
Rockwell, W. S.	232			S COTTDALE FDY. & MACH. CO.	660
Roebbling's Sons Co., John	402, 466, 726			Sirocco Engineering Co.	402
Roessler & Hasslacher Chemical Co.	402, 726			Stromberg-Carlson Tel. Mfg. Co.	401
				Sullivan Machinery Co.	18, 401, 660
S COTT DRILL CO.	596			Swaren & Co., J. W.	172
Servus Rescue Equipment Co.	14				
Spencer Heater Co.	88			T AYLOR IRON & STEEL CO.	74
Springfield Boiler & Mfg. Co.	14			Taylor, Wharton Iron & Steel Co.	188
Standard Steel Works Co.	726			Trade Press Association	660
Stark Rolling Mill Co.	726				
Stromberg-Carlson Telephone Mfg. Co.	14			V ALLEY IRON WORKS	595
Strong, Carlisle & Hammond Co.	14, 314			Vulcan Iron Works	18
Sturtevant Co., B. F.	290				
Sturtevant Mill Co.	650			W EINMAN PUMP MFG. CO.	595
Sullivan Machinery Co.	290, 466, 596			Western Electric Co.	192, 188, 289, 344, 531, 595, 660
Sutton, Steele & Steele	290			William & Co., J. H.	188
Symons Brothers Co.	290			Worthington, Henry R.	172
V ULCAN IRON WORKS CO.	650				

Index E—Trade Notices

A DAMS CO., S. JARVIS	289
Albany Lubricating Co.	531
Alicia Crushing Plant	188
American Blower Co.	402
American Mine Door Co.	725
Armstrong Cork Co.	172
Atlas Car and Mfg. Co.	73
B ARTLETT & SNOW CO., C. O.	189
Blethen, Fred M.	401
Bureau of Foreign and Domestic Commerce	594
C ARNEGIE STEEL CO.	725
Chamberlin Co.	725
Cook's Sons, Adam	531
Cory & Co.	660
Crawford & McCrimmon Co.	725
D AVIS INSTRUMENT MFG. CO.	290
Davis & Son (Derby) Ltd., John	172, 466
Deane Steam Pump Co.	466
De Laval Steam Turbine Co.	188, 591
Dixon Crucible Co., Joseph	290, 401, 466, 725
E LECTRIC SERVICE SUPPLIES CO.	74
Exeter Machine Works	402, 660
F AIRBANKS, MORSE & CO.	531
G ENERAL ELECTRIC CO.	18, 74, 343, 725
Goulds Mfg. Co.	402
Goyne Steam Pump Co.	343
H AYWARD & CO., S. F.	660
Heine Safety Boiler Co.	594
Hirsch Electric Mine Lamp Co.	595
Hewitt Roller Bearing Co.	74

Mines and Minerals

Vol. XXXIII.—No. 1.

SCRANTON, PA.—AUGUST, 1912—DENVER, COLO.

Price, 25 Cents

PUBLISHED MONTHLY AT SCRANTON, PA.

ESTABLISHED 1881

INTERNATIONAL TEXTBOOK CO., PUBLISHERS

T. J. FOSTER, President S. P. ALLEN, Secretary E. H. LAWALL, Treasurer
RUFUS J. FOSTER, Vice-President and Manager

EUGENE B. WILSON, Editor ARTHUR J. HOSKIN, Associate Editor
WESTERN EDITORIAL OFFICE: 1221-1222 First Nat'l Bank Bldg., Denver, Colo.
CHICAGO OFFICE: 1006 Michigan Ave.

Entered at the Post Office at Scranton, Pa., as second-class matter
Address all business communications to MINES AND MINERALS, SCRANTON, PA.
CABLE ADDRESS, "RETSCOF, SCRANTON"

LONDON OFFICE: INTERNATIONAL BUILDINGS, KINGSWAY, LONDON, W. C.
SOUTH AFRICAN OFFICE: MANSION HOUSE CHAMBERS, ALDERLEY STREET, CAPE TOWN.

NEW ZEALAND OFFICE: 63 DIXON STREET, WELLINGTON.

AUSTRALIAN OFFICE: 83 PITT STREET, SYDNEY.

SUBSCRIPTION RATES

Single Copies.....	25 cents
Yearly Subscription, including postage:	
To United States, Mexico, Cuba, Porto Rico, Hawaii, and Philippines.....	\$2.00
To Canada.....	2.50
To all other countries.....	3.00
The date after your name on the wrapper is that of the month to which your subscription has been paid. If you do not want to continue your subscription after that time, kindly notify us.	
Notice to discontinue or change of address should be sent to the Scranton office.	
When notifying us of a change of address always give your FORMER as well as your present address.	

TABLE OF CONTENTS

Editorial—

Editorial Notes—The Hastings Mine Explosion—The Cause of a Mine Disaster—Volume XXXIII—The Status of the Gas Producer July Gas Explosions.....	1
Personals.....	4
Cerrillos Anthracite Mine.....	4

COAL MINING AND PREPARATION

The Derringer Anthracite Stripping.....	5
The Coal Mine Superintendent's Duty.....	6
Power Consumption of Coal Cutters, by G. W. Thomas.....	8
The Hastings Coal Mine Disaster.....	9
Coal Dust and Coal Loading Machines, by C. H. Thompson.....	11
The Muller By-Product Coke Oven, by E. B. Wilson.....	12
Catalogs Received.....	14
Mining Institutes' Summer Meetings.....	15
Trade Notices.....	18
Mining on Loup Creek, W. Va., by J. J. Marshall.....	19

Answers to Examination Questions—

Mine Foremen's Examination, Utah, October, 1911.....	22
First Aid in Alabama Mines, by J. F. Smith.....	25
The Increased Cost of Mining Anthracite, by W. D. Owens.....	26
1911 Bituminous Mine Law of Pennsylvania.....	27
Book Reviews.....	28
Coal Mining in Northern China, by J. L. Dobbins.....	29
Books Received.....	32

ORE MINING AND METALLURGY

Ore Loading on the Island of Elba.....	33
Gold and Tin Production of Seward Peninsula.....	35
Mining by Timbering and Filling, by Albert L. Tuenges.....	36
Creep in the Panama Canal, by Frank G. Carpenter.....	39
Characteristics of the Mexican Miner, by Harold Lakes.....	41
Practical Cyaniding—Part 1, by John Randall.....	42
The Ocher Deposits of Georgia, by S. W. McCallie.....	46
Asphalt Minerals.....	47
Great Alaskan Earthquake.....	48
Power Consumption of Hoisting Plants, by S. W. Sykes.....	49
Turquoise in Arizona.....	52
The Leasing of Metal Mines.....	52
Gold Dredging Up to Date, by Arthur Lakes.....	53
Improvements in the Caving System, by Chariton Dixon.....	56
Random Thoughts on Prospecting, by A. J. Hoskin.....	58

Squibs—

Horsepower on Air, 8—The Atlantic Fleet, 18—Wants, 24—Altitude and Air Compression, 38—"Curie," the Standard for Radium, 47—Once More the "Dowser," 48—Bleaching Powder.....	57
--	----

AS A RULE, the operating heads of large mining plants secure most loyal support from their employes by taking a kindly interest in them, and encouraging a respectful familiarity—but, too much familiarity, and alleged humorous comments on personal appearance or traits of character, from either outsiders or employes, are distasteful to the man of ability and prominence, and tend to detract from his force and authority.

采采

WITHIN the past 2 or 3 years a number of books have been published on subjects relating to mining, metallurgy, geology, and mineralogy. At the present time there is an over-abundance of books which add 50 cents worth of new material to old subject matter and are priced at from \$3.50 to \$4.50. It is a pity publishers are unable to grasp this point and present the manuscript to readers who have had experience and know the wants of mining men in general.

采采

ON another page we publish an important article on the "Increased Cost of Anthracite Mining," by Wm. D. Owens, division superintendent of the Lehigh Valley Coal Co. Mr. Owens is one of the oldest and most experienced mine officials in the Anthracite region. He does not write from the standpoint of the accountant, but from the viewpoint of the man who has filled practically every position about a mine from the lowest to that of a division superintendent, and whose experience covers a period of half a century.

采采

A HOT political campaign has a tendency to reduce the consumption of coal—for steam purposes. If all Americans would realize that no matter which party wins the country will not go to the "demnition bow wows," there would not be such a contraction in business, and the mining industry with all others would profit thereby. The tariff is the issue. Protection means high prices, tariff for revenue only means low wages. You pay your poll tax and take your choice. Meanwhile the politicians keep things hot, and the ordinary citizen is the fellow who eventually pays for the hot air.

采采

THERE is a cause for every mine accident. As a rule American mine owners and mine managers use every possible precaution to remove the cause. Occasionally, as in other lines of business, carelessness or recklessness results in disaster.

When this is the case, the blame should rest solely on the culpable party. Sometimes accidents occur in mines at which every possible precaution is taken. The management of such mines should not be classed with the careless or reckless management, as they frequently are by those not familiar with mining conditions. The reckless or careless mine official is not only a menace to his employes and his employer's property, but he is frequently the cause of much indirect trouble and annoyance to the careful and competent official.

來 來

The Hastings Mine Explosion

THE contention of Mr. Bert Lloyd that no fire boss should enter a gassy mine until his lamp had been inspected by a second person seems to have been verified in the Hastings, Colo., explosion. The glass in the fire boss' lamp was found so loose that an explosion inside the lamp could be communicated to the surrounding atmosphere. No man is infallible, and breaks in the gauze, dirt, oil spots, loose joints, etc., might escape one person's observation, but be discovered by a second man.

來 來

The Cause of a Mine Disaster

IN OUR July issue we criticized certain portions of the Oklahoma Mine Law. As stated there, the law is not wholly faulty, and if Section 3 of Article VII of that law had been strictly observed or enforced, the disastrous explosion at the San Bois mine on March 20, which caused the death of 73 men, would probably not have occurred.

This section reads as follows: "It shall be the duty of the mine foreman to see that the proper breakthroughs are made in all the room pillars at such distances as in the judgment of the mine inspector may be deemed necessary for proper ventilation, but not more than 30 feet apart where gas exists, and in no case more than 40 feet apart, and the ventilation shall be conducted through said breakthroughs into rooms by means of check doors made of canvas or other suitable material, placed on the entries, or in other proper places, and he shall not permit any room to be opened in advance of the ventilating current, or when the rooms already made are not connected. He shall also see that the air-current is conducted to the face of all the entries, airways, rooms, and other advance workings, so as to dilute and render harmless all noxious and poisonous gases. Should the mine inspector discover any room, entry, airway, or other working places being driven in advance of the air-current contrary to the requirements of this section, he shall order the workmen working such places to cease work at once, until the law is complied with."

We have received information that a squeeze which affected the workings off the entry in which the explosion originated so cracked the wooden stoppings that the ventilating current was, in a large measure, short-

circuited, causing accumulations of gas in the rooms near the face of the entry. Besides, in some instances the cross-cuts were 75 feet apart, instead of 30 feet apart as the law stipulates. The same information states that the fire boss on occasions started cross-cuts at the required points, but his orders were countermanded by the foreman on account of the expense due to the high yardage rates prevailing in Oklahoma.

If the statements made us, are correct, and they appear to be well founded, radical reform is necessary in the Department of Mines of Oklahoma. We are informed on reliable authority that Inspector Haley of the district in which the mine is located, visited it frequently, in fact, oftener than the law required. If such conditions existed, as are stated above, it is evident that his inspections must have been of a very superficial nature. We are not prepared to say that such superficial inspections were wholly the fault of Mr. Haley. It is probable that they were due to necessary haste owing to the great territory embraced in his district. Even if the number of mines in his territory is limited, the time required to cover it with somewhat limited train service, naturally militates against the spending of the proper time in the mine, and the consequent important feature of a comprehensive knowledge of conditions existing in all parts of the workings.

Mine accidents due to violations of the mine laws, or of the rules of common sense, are a source of trouble to mine owners and mine managers who strictly observe the laws, and who use every endeavor to protect the lives of their employes. Therefore, mine officials who jeopardize the lives of their employes and the property of their employers by non-compliance with the law, are in a measure enemies of mine owners and mine managers who do obey the statutes.

Experience in Pennsylvania and other prominent coal-mining states has proved that careful inspections and rational enforcements of the mine laws have not been a burden on progressive mine owners and mine officials. In fact, in many instances the larger mining companies go farther than the law requires in their efforts to conserve the lives of their employes and the safety of their property. If the safety of the miners and the mines of Oklahoma is to be conserved, it is evident that the new state must revise its mine laws and provide more inspectors—men of proved technical knowledge, character, and good judgment—and it should require a strict compliance with both the letter and the spirit of the law.

來 來

Volume XXXIII

THIS issue of MINES AND MINERALS begins a new volume, No. 33. Commencing with Volume 32, the front cover was changed from an advertising medium to an artistic frontispiece, and this feature will be continued. Each frontispiece was chosen to show some phase of active mining that would be attractive to the numerous readers, and it is believed, from the

extraordinary sales of particular issues, that not only the material inside, but the outside, has appealed to the mining fraternity as never before. It has been the policy of MINES AND MINERALS to avoid, wherever possible, publishing articles so long that they must be continued in the next issue. Beginning with this issue, a series of articles on "Practical Cyaniding," by Mr. John Randall, noted throughout the Western States as one of the foremost in this branch of metallurgy is commenced. Each article will completely cover one branch of the subject, and the entire series of articles teems with information deduced from Mr. Randall's practice in Colorado, Dakota, and elsewhere. These articles will not be printed in book form and there is no other method of obtaining them except through a subscription to MINES AND MINERALS, as all rights are reserved.

The system adopted of separating the articles pertaining to coal from those pertaining to metal will be continued. In the variety of subjects treated there is sure to be something of value to every miner or metallurgist, and often a single suggestion may be worth many times the subscription price.

Next to knowing, is to know where to find what you want to know. The correspondents of MINES AND MINERALS are in nearly every mining field on the globe. From this vast territory authentic information is obtained on new systems of mining, new machinery for lessening the cost, and new metallurgical processes and improvements in old processes. This information is condensed and precisely worded, two features which appeal to professional men.

采 采

The Status of the Gas Producer

ROBERT H. FERNALD, in Technical Paper No. 9, United States Bureau of Mines, has recorded his investigations on producer-gas production relative to its commercial value in places where good coal is lacking or is expensive.

His tests in the gas producer have shown that many fuels of so low grade as to be practically valueless for steaming purposes, such as slack coal, bone coal, and lignite, may be economically converted into producer gas and may thus generate sufficient power to render them of high commercial value.

He estimates that on an average each coal tested in the producer-gas plant developed two and one-half times the power that it would develop in the ordinary steam-boiler plant.

He found that the low-grade lignite of North Dakota developed as much power when converted into producer gas as did the best West Virginia bituminous coals burned under the steam boiler.

It has been demonstrated that the low-grade coals, high in sulphur and ash, now left underground, can be used economically in the gas producer for the ultimate production of power, heat, and light, and should, therefore, be mined at the same time as the high-grade coal.

As a smoke preventer, the gas producer is one of the

most efficient devices on the market, and furthermore, it reduces the fuel consumption, not 10 or 15 per cent. as claimed for the ordinary smoke preventing device offered for use in steam plants, but 50 to 60 per cent.

The establishment of producer-gas plants at the mines and the distribution of electric energy or gas over large areas will also tend to eliminate smoke. When a large percentage of the small, isolated, power and heating plants and all steam locomotives have been removed from the larger cities, the atmosphere of these cities will be much clearer, and heavy financial losses directly traceable to smoke will be eliminated.

采 采

July Gas Explosions

WHY gas explosions should be more numerous in the warm months than in the cold months is a mystery. Is it possible that humidity near the earth's surface causes a rarification of the upper atmosphere and so sufficient fall in barometer to permit gas to escape in abnormal quantities? In other words, does humidity have an influence which causes gas explosions, in opposition to its influence on dust explosions in coal mines? On July 15, 16, 17, and 18, dates which include the Avoca and South Wilkes-Barre gas explosions, the barometer stood at 29.07 inches without perceptible change; but on the morning of July 19 the humidity was dissipated and the mercury arose to 29.27 inches, which is about normal for those places.

During July an unusual number of gas explosions occurred in the anthracite fields of Pennsylvania and elsewhere. At about 6 A. M., July 9, a very serious explosion occurred in the Cadeby colliery, Conisboro, Yorkshire, England. The first explosion killed 31, including Douglas Chambers, the mine manager. Three other explosions are said to have followed during the day, killing a large number of rescuers, among whom were Chief Mine Inspector W. H. Pickering, and Government Mine Inspectors Hewitt and Tickle. Newspaper reports have given the total number of killed as 75, the majority of whom were rescuers.

On July 11, at 9 o'clock, there was a gas explosion at the Panama mine of the Ben Franklin Coal Co., at Moundsville, W. Va. This accident was caused by an open lamp carried by men into the mine after a shut-down of 3 days.

On July 16, six persons were reported killed and several injured at the Gayton coal mines, 15 miles from Richmond, Va. This was a gas explosion.

On the evening of July 17, there was an explosion of gas in No. 4 tunnel of No. 3 shaft at No. 5 colliery of the Lehigh & Wilkes-Barre Coal Co., South Wilkes-Barre, Pa. The explosion caused the death of three miners and injured four others. It is believed the explosion was caused by one of the miners firing a blast which ignited a pocket of gas.

On July 18, at 9:30 A. M., nine men were burned in the Langeliffe colliery of the Delaware & Hudson Co., at Avoca, Pa. This gas explosion was due to a naked light, and it is probable that three of the injured will die.

Personals

William H. Cook, former chief chemist for the El Paso Smelting Works, is now chemist for the Fresno Company, at Fresno, California.

M. A. Walker, M. E., has resigned from Coal Age Staff to take up construction engineering with Fairbanks, Morse & Company, Chicago.

G. A. Denny is the Mexican correspondent for the Institution of Mining and Metallurgy, London, England.

A. R. Kenner is general superintendent of the Rio Piata Mining Co., Guazaperas, Chi., Mexico.

Sim Reynolds, inside manager of the Marianna mine of the Pittsburgh-Buffalo Company, has accepted a position as Inspector for the W. J. Rainey Company Uniontown, Pa.

Edward M. Robb, Jr., of the Pilares mine in Mexico, temporarily resigned his position as chief engineer of the Montezuma Copper Company in 1911. He was succeeded by Raymond Burnham, who has resigned and is now in Chicago.

Geo. Watkin Evans, mining engineer, of Seattle, is making a thorough examination of the Ground Hog Coal Field in Northern British Columbia.

D. C. Boag, graduate of the mining course of Pennsylvania State College, has been appointed assistant to the general manager of Solvay Collieries Company, Marytown, W. Va.

A. Van Zualenberg is superintendent of the Planta del Carmen Cyanide Works, at San Luis Potosi, Mexico. Mr. Van Zualenberg was at one time engaged in silver-lead smelting in San Luis Potosi and returned to the States.

The Western Electric Company has opened a branch house at Houston, Texas, with H. P. Hess, F. G. Caldwell, and M. A. Schon in charge.

The Governor of Kentucky has made the following appointments: State Geologist, J. B. Hoising, Lexington, Ky.; Geological Advisory Board, Governor James B. McCreary, Hon. J. C. C. Mayo, Paintsville, Ky., Hon. R. H. Vansant, Ashland, Ky., Gen. Percy Haley, Frankfort, Ky., Hon. L. B. Herrington, Richmond, Ky.

William Poole has resigned his position as Director of the Queensland State School of Mines, Charters Towers, Queensland, to accept the position of Principal of the State School at Ballarat, Australia.

Morgan H. Townsend, formerly representative of MINES AND MINERALS in the western States, but now with the Stearns-Rohrer Manufacturing Company, of Denver, returned on June 26 to Miss Iva M. Smith at Breckenridge, Colo.

Ernest McCullough, C. E., of Chicago, will deliver a series of lectures on mining methods at the 6 weeks' summer school at Weir City, Kans.

H. H. Stock, E. M., former editor of MINES AND MINERALS, now head of the school of mines in the University of Illinois, attended the meeting of the Society for the Advancement of Scientific Education. He has been visiting in Wilkes-Barre and Scranton with his wife and daughter, working hard to enjoy a vacation.

E. H. Cox, E. M., of Birmingham, Ala., is inspecting the coal fields and working methods employed by the operators in West Virginia along the Norfolk & Western Railroad.

W. Ray Cox, of Colorado, has been appointed professor of mining and geology in the Pei Yang University, Tientsin, China.

D. J. Broman, chief mine inspector of Texas, is inspecting the methods of mining adopted at the coal mines near Birmingham, Alabama.

Franklin Guiterman, who has moved from Denver to New York to take charge of the technical investigations for the American Smelting and Refining Co., has resigned as trustee of the Colorado School of Mines.

Prof. J. L. Dobbins, of the Pei Yang University, China, has an interesting article on the "Coal Fields of China" in this issue of MINES AND MINERALS, and will shortly have another article on "Mining Enterprises in China."

A. W. Pollock has been elected vice-president and general manager of the Wyoming Coal Co., at Monarch, Wyo.

B. L. Cunningham is assistant geologist for the Southern Pacific Railroad, with headquarters in the Flood Building, San Francisco, Cal.

W. E. Tomlinson is foreman at the mines of the Utah Copper Company, Birmingham, Utah.

W. G. Ramlow has recently been made superintendent of the Dolly Varden mine at Alma, Colo. This property was a famous silver producer years ago, but has been inactive for a long time.

John F. Myers is chemist and assayer for the Eagle M. & M. Company, at Belden, Colo.

P. A. Grady has resigned as mine inspector of the 12th district in West Virginia to superintend mines for the Davy-Pocahontas Coal Company at Roderfield. Mr. Grady has been engaged in coal mining since he was a boy. He acquired his education under adverse circumstances, but his determination and grit eventually landed him in the position of mine inspector. He is a graduate of the International Correspondence Schools, and being exceptionally earnest we predict his success in his new position.

Capt. W. A. May, General Manager of the Pennsylvania Coal Company, the

New York, Susquehanna and Western Coal Co., and graduate of the class of 1876 of Lafayette College, was elected a trustee of his alma mater at commencement this June.

采 采

Cerrillos Anthracite Mine

This mine, formerly known as the Lucas mine, is located at the town of Madrid, Santa Fe County, N. Mex. The bed worked by the Albuquerque and Cerrillos Coal Co. is known as No. 6. This bed in one place shows badly altered semianthracite and even graphite. In another place to the south in the Cerrillos mine, there is excellent anthracite from $3\frac{1}{2}$ to $3\frac{2}{3}$ feet in thickness, and in still another place this same bed of coal is bituminous and is 5 feet 5 inches thick. The differences in the coal are chiefly due to the alterations resulting from the approach of eruptive trachyte. A slope was sunk at the No. 4 anthracite mine to a depth of 1,460 feet on an average dip of 15 degrees.

The system of mining as described by Joe E. Sheridan, United States Mine Inspector, in the mine report of New Mexico, for 1910, is as follows: The rooms are turned off the main slope alternately on either side, 50 feet apart. The room necks are driven 75 feet across manways and air-courses, parallel to the main slope, before the rooms are widened. The rooms are then made 25 feet wide and 400 feet long. Coal is shot off the solid; holes are tamped with slack and coal cuttings, and the miners fire their own shots. The fire boss inspects the mine before the men are allowed to enter, and no man on the day shift is allowed to enter this mine until 6:30 A. M., or until such time as the mine has been examined by the fire boss. At a depth of 1,460 feet, on the dip, entries have been driven about one-fourth of a mile in the virgin territory, developing a body of excellent anthracite with every indication of greater reserves beyond the present development.

The mine was operated 258 days in 1911. The total output was 32,612 tons, consisting of all sizes from slack to 7-inch lump. All of this coal was shipped to market, the average price being \$3.30. The mine is equipped with a 60-horsepower hoist and exhaust fan, double, 7 feet diameter, which furnishes about 13,920 cubic feet of air per minute when making 105 revolutions. There is an escape way through the old workings to No. 3 opening, and while this is not an approved second opening it is permitted on account of the company intending to sink another slope farther to the south which will be connected with the present No. 4 slope by a cross-entry from the bottoms of the two slopes.

COAL MINING & PREPARATION

The Derringer Anthracite Stripping

Removal of Large Quantities of Coal from Pockets Near the Surface—Interesting Geological Conditions

Written for Mines and Minerals

THE Carboniferous formation in Northeastern Pennsylvania has been subjected to great pressure which folded and metamorphosed the strata, noticeably in the eastern and the western middle fields. In several places in the middle fields, the Mammoth bed was closely folded; and later, after the strata above were eroded, canoe-shaped basins of anthracite were left, some of which are of fairly good size.

So far as is known, are these canoe-shaped coal pockets found, and being in different fields their sections naturally vary, which makes the coal beds between the Mammoth and the Buck Mountain difficult to correlate, particularly as in one place a bed will be thin and mixed with slate while

other pockets will be found between, and possibly each side of, these two. Derringer is 11 miles from Hazleton on the Nescopeck branch of the Pennsylvania Railroad. The coal and land, which is leased by the Lehigh Valley Coal Co., belongs to the Tench Coxe estate. For quite a number of years the Coxe and Derringer interests were in litigation over property in this vicinity; finally, however,



FIG. 1. ANTHRACITE STRIPPING AT DERRINGER, PA.

To illustrate more fully the conditions that prevail a section of the Morea coal pocket is shown in Fig. 3. Morea is near the eastern end of the western middle anthracite field, while Derringer, the place to be described, is in the western part of the eastern middle field about 12 miles directly north of Morea and on another mountain range. These two mountains run diagonally, and merge near Hazleton. In no other

in another place it will be excellent coal.

In the Morea section there is a cover of rock in the center of the pocket; in the Derringer, on Black Creek, district the coal is covered with soil, the erosion having been deeper than on the western middle field. The first coal pocket found in the eastern middle field was at Hollywood, near Milnesville, about 10 miles directly east from Derringer; it is probable, therefore, that

the land was awarded to the Coxe estate.

The first Derringer breaker, designed by Eckley B. Coxe, was burned in 1884; and the second one, shown in Fig. 4, constructed on the same plans, was completed in 1886. The life of wooden breakers is placed at 20 years, and this one having commenced to disintegrate, is being dismantled, although in its generation it was a model and contains features which are not altogether

discarded in more modern structures. While not sure, the writer is under the impression that the exhaust fan to remove dust from inside the breaker was first installed at Derringer. The *évasé* chimney

the Gamma coal, 3 feet thick, and the Buck Mountain bed, 12 feet thick, just above the Pottsville conglomerate, have not been touched. Within a comparatively short time the coal pocket, shown in section,

coal is next attacked and loaded by steam shovel into dump ears that are hauled out of the open cut by locomotives. The grade is so heavy it requires two locomotives to pull five dump cars holding 2 cubic yards each out of the pit on the zigzag track shown. The surface water which drains into the pit, supplies the boilers of three locomotives, the steam shovel, and the pump boiler shown in the background. It is pumped to a tank on the hill where the surplus can flow to waste. Except in extremely wet weather the quantity of water which accumulates is not great.

來 來

The Coal Mine Superintendent's Duty

Written for Mines and Minerals

The superintendent should visit all rooms in the mine and travel all the haulage roads and traveling roads and air-courses often enough to be thoroughly familiar with them. He should know the conditions in all working places, so that if, at any time, the pit boss, fire boss, or men working a place call his attention to anything regarding it, he can talk with a thorough knowledge of conditions at that point.

He should also see personally that all coal is being loaded out clean, that sufficient timber is kept convenient to the men, also that the men are using enough and in a proper manner to insure reasonable safety to themselves.

He should know that all rails, ties, and spikes are removed from places that are finished or abandoned. A few hours' work will take the track out of a room, if done as soon as the room is finished. If let go for any length of time, it may

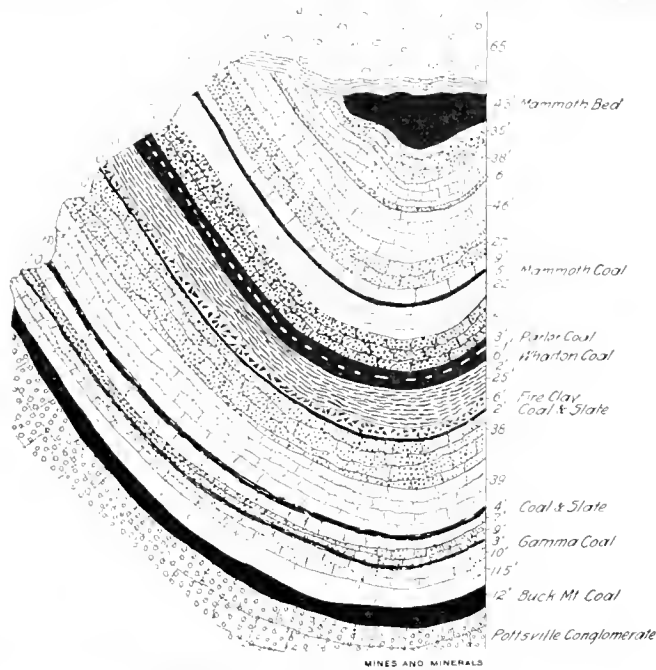

FIG. 2. SECTION AT DERRINGER

to the fan in the second breaker is seen near the top to the left. The fan, approximately 10 feet in diameter, is of the Guibal type.

Since the Derringer breaker has been out of commission the coal from this operation is hauled on the surface to one of the company's nearby breakers for preparation, it being considered good business policy to concentrate the preparation. Until recently the coal mined at Derringer came from what engineers believe is a split of the Mammoth

Fig. 2, was discovered, and immediately diamond drill holes were put down to ascertain its length, width, and thickness. These holes disclosed the fact that it is a canoe-shaped basin about 1,200 feet long, with an average thickness in the center of 43 feet; a width at the top of 104 feet; and a dirt cover that will probably average 40 feet in thickness.

That portion of the coal pocket on the Lehigh Valley Coal Co.'s lease is about

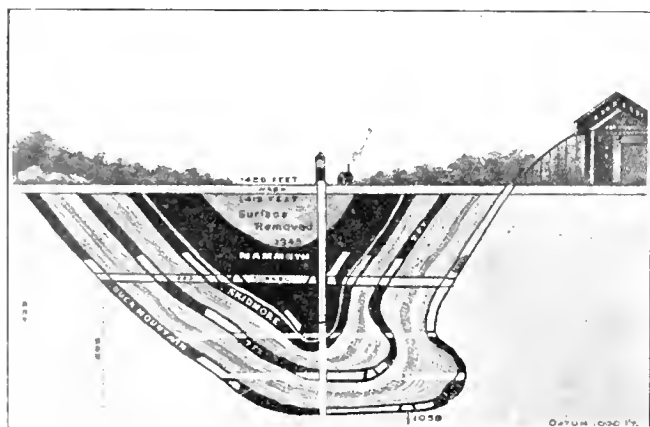

FIG. 3. SECTION AT MOREA COLLIERY

bed 5 feet thick; the Parlor bed, 3 feet thick, 43 feet below the Mammoth split; and the Wharton bed, 6 feet thick, separated from the Parlor bed by 1 foot of slate. Work has just commenced on the Wharton bed, while

700 feet long and the quantity approximates 125,000 tons. The method followed in stripping is shown in Fig. 1. The steam shovel first removes the dirt cover, which is loaded into dump cars and wasted. The

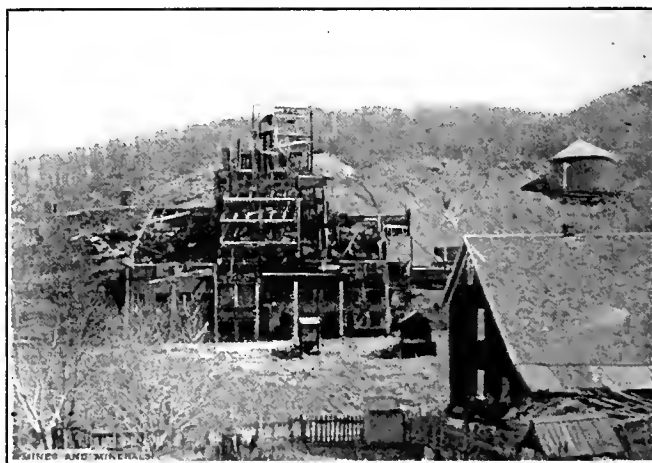

FIG. 4. DISMANTLED BREAKER AT DERRINGER

take a few days, and in some cases rails are so badly covered with falls from the roof as to make it unprofitable to try to recover them. This is carelessness and waste of property, and something a superintendent

ent should never allow to happen. The superintendent should see that all haulage roads are kept clean. Where the roads are dry and dusty, they should be cleaned and watered, always remembering that it is much easier to water the place where the dust lay than it is to water the dust. In case of wet roads a ditch should be made to drain the water off, and no mud or dust should be allowed to accumulate on the rail. A clean rail and a well-oiled mine car will add greatly to the working capacity of a mule and help keep haulage costs to a minimum.

The superintendent should know that his fire bosses are steady, sober men, and that they get their regular rest. A fire boss who hangs around saloons until 9 or 10 o'clock at night is not a fit man to examine a mine in the morning. His intentions may be all right, but physically he is not in shape to get around, and the sooner the superintendent gets a fire boss who keeps entirely out of saloons to take his place, the better it will be for every one around the mine. He should know that the fire boss examines his own safety lamp before lighting it to go into the mine, and that he reports conditions in the book provided for that purpose immediately when he comes out, when the existing conditions are fresh in his mind. The superintendent should always look in this book before going into the mine, and if anything out of the ordinary is reported in any part of the mine, make it his business to visit that section, see if conditions were correctly reported and proper steps taken by the fire boss or pit boss to remedy the defects.

He should arrange for getting timbers and supplies into the mine without delaying the output. At most mines there is a time on each shift when 10 minutes' delay will affect the output more than 30 minutes will at some other time in the shift. The superintendent should arrange not to interfere with production by sending in timbers or other supplies at the "peak of the load." This work, if attended to regularly, can be done at a time of day when it will not delay the haulage system nor cripple the production.

The superintendent should know that all ropes used for hoisting or haulage are kept in good condition, that they are treated with the best rope compound or dressing that can be had to suit the conditions under which they are working. In case of rope haulage, there should be a close supervision kept on condition and position of sheaves and rollers. A few trips with a rope sawing on a rail over a knuckle, or on a defective sheave wheel round a curve, are harder on the rope than months of ordinary wear.

The superintendent should select the very best and most reliable men he has to take care of rollers and sheaves, and

should keep a supply of the most staple kind of material on hand.

At most mines the gathering of coal and the first stage of the hauling is done by mules. Every superintendent will admit that if he gets what makes a good day's production started from the working places, he has a chance to get it out; but if the facilities for getting it started are not in good shape, no matter how efficient his organization is along the balance of the way to the tippie, he has no chance. In this case the production depends on the mules; and the condition of the mules depends in a large measure on the care they get in the stable and in the mine, by the stable boss, the driver boss, and the drivers. Every superintendent should know that his stable boss feeds his mules regularly in the morning, giving them sufficient time to eat before sending them out to work. A watchman's clock hanging in the stable with a key beside it is a great help in this direction. He should know that the stable boss uses some judgment in feeding and watering the mules, that each mule gets all it wants to eat, and no more. Oats left over in feed-boxes and a full ration dumped in on top of them are only wasted. He should know that the stable boss gives each mule a second chance to drink after its work at least 1 hour after going to the stable. A stable boss who takes care of 30 to 35 working mules and is ready to go home for the night 30 minutes after the mules go to the stable is a very poor man for the job. There is at least 2 hours' work for him cleaning collars and harness, cleaning mules, examining their feet, seeing that they are all eating, and giving them a second opportunity to drink.

The superintendent should know that his driver boss and drivers take good care of the mules in the mine, see that the collar and hames fit the mule, that side chains are of equal length and covered where they come in contact with the mule, and that under no circumstances is a sprag or a small mine prop used for whip.

The superintendent should visit the boiler room often and know that the boilers are washed as often as necessary. Also that after each boiler is washed the master mechanic or some competent person should inspect it by going inside with a hammer and trying all the braces, noticing if there is any scale on the shell or between the flues, also if there is any pitting, especially along the water line; also going into the firebox and combustion chamber and noticing the condition of the boiler there, also brickwork in these places. A record should be kept of the condition of each boiler, with the date of examination. After steam is up in the boiler, the safety valves should be made to work and steam gauge noticed to see if they are working together. The super-

intendent should see that all steam lines are put up so that they will drain, have traps provided where they are needed, all joints kept tight, and all steam pipes covered with a good pipe covering. By attending to this he will save a good many tons of coal in a month, besides having the satisfaction of knowing that his plant is in a safe condition and looking better.

The superintendent should have all supplies kept in a storeroom with some one person in charge of it. Where supplies are scattered, some in the blacksmith shop, some in the carpenter shop, and some in the engine room, with every one taking some article as it is needed, it is impossible to keep track of them. There should be one man in full charge of everything in the supply line whose duty it should be to keep a record of all supplies received, also supplies given out, what job they were got out for and who got them, this record being turned in to the office every night in the same manner as the time sheets, and the mine clerk should enter this list on his supply sheets daily. By doing this, when the end of the month comes everything will be accounted for and charged to the proper account, and when the annual inventory is taken the superintendent will not have to give a lot of explanations that do not explain in regard to a shortage of supplies on hand.

The superintendent should know that all scales are in good weighing order and that all coal is weighed and a correct record kept of the weight. Weigh bosses and tippie men sometimes are in a hurry and run mine cars over the scales without stopping to weigh them, depending on their ability to guess the weight. This, for various reasons, the superintendent should never permit. One reason is that it will be impossible to have his weights check at the end of the month. The paid miners' weight and the production of the mine will not tally. Another and more important reason is that the miners are not getting paid for what they actually produce. This will surely lead to trouble among the men, something the successful superintendent always tries to avoid.

The superintendent should impress upon every one whose duty it is to use oil or grease for lubrication, that it is on the bearing that oil must be put to get good results, not beside it. Oil spilled outside of bearings is money wasted. It is also a source of danger. In every building around a mine where oil and waste are used a metal can with cover should be provided for the dirty waste and this dirty waste removed regularly and burned.

The superintendent should remember that stoves are a great source of danger around mine buildings especially in a shaft

house, near the mouth of the slope, or in the tippie. A few lengths of old pipe and a little spare time of the machinist can fix a radiator to take the place of the stove, and in most cases the exhaust steam can be utilized to heat it.

Smoking and matches should be positively prohibited in any building around the mouth of a coal mine.

The superintendent should know personally that all fire-protection apparatus provided is kept in A-1 condition. Fire hose, if provided, should be kept on a reel in a convenient place so that it is easy of access both day and night, and should be dried and replaced at once after being used, and should be used for no other purpose than fire protection. Fire extinguishers should be placed where they can be reached easily in case of fire, recharged regularly, and protected from freezing. Those persons around a mine whose duty it would be to fight fires should have a fire drill at least once a month so that they may be familiar with all of the fire apparatus and its position.

The superintendent should by his actions in the care of the company's interests set an example to every employe. He should keep out of saloons, and place no dependence on any man who frequents them, and above all things, he should under all conditions be loyal to the company he works for. When he cannot do that, he should quit.



Power Consumption of Coal Cutters

By G. W. Thomas

The consumption of power by coal cutters is an element of great importance when the adoption of machine mining is under consideration. Calculated consumption of power, based on the construction of the machine and assumed conditions under which the machine will work are seldom convincing to the practical mine manager. A test to determine the cutting capacity and power consumption of a Sullivan continuous cutter was conducted between December 13, 1911, and January 13, 1912, in Mine No. 2 of the Lumaghi Coal Co., at Collinsville, Ill., and the results are now available for publication. The test was made to determine the cutting capacity and power consumption of the machine, as shown by measurements, time observations, and readings from a recording wattmeter. The machine had a 30-horsepower shunt wound motor, was new, and in good order.

The No. 2 Lumaghi mine works the No. 6 seam, which is 8 feet high and practically level, although small horsebacks occur in some localities. The coal varies in hardness in different parts of the mine, but is free from sulphur or other impurities.

There is a good slate roof, so that close timbering is not required, and mining is done in the coal, as close as possible to the fireclay bottom. The mine was formerly worked on the double-entry plan, but the panel system is now in vogue.

Two areas were assigned for the test, in one of which the coal was rated as "hard," in the other as "soft," and a territory of 21 rooms in each was set aside. The work was done in these rooms and in cross-cuts between the rooms. The places ranged from 18 to 45 feet in width, and averaged 31 feet. The machine first cut in the "hard" territory, working 3 alternate days, single shift. The same procedure was followed in the "soft" territory, so that the test covered six shifts. Cutting in this way, over the territory described, enabled the loaders to keep enough rooms cleaned up so that a full day's cutting was ready for the machine every other day.

do only with actual mining; and, since the length of the moves varied, observations began in each room with the unloading of the machine from its truck, and ended when it was reloaded and ready to move to the next place. The following is a sample set of readings:

Operation	Time	Watt-Hours
Unloading.....	2:00	0
Finished.....	2:06	150
Sumping.....	2:06	150
Finished.....	2:11	600
Cutting face.....	2:15	600
Finished.....	2:35	4,300
Loading.....	2:50	4,500

Average voltage.....	225
Average depth cuts.....	73 inches
Width of room.....	24 feet
Watts per square foot.....	30.8

"Unloading" includes moving the machine into place against the right rib.

TABLE 1. SUMMARY OF READINGS

Date	No. of Places	Face, Feet	Average Depth Inches	Square Feet	Actual Cutting Time		Total Watt-Hours	Weight Per Square Foot	Average Voltage
					Hours	Min.			
Dec. 13, 1911....	6	168' 10"	70.0	984.3	6	17	43,475	44.1	191
Dec. 16, 1911....	9	186' 8"	72.1	1,121.5	6	26	48,575	43.3	193
Dec. 19, 1911....	5	145' 2"	72.1	872.2	5	16	35,600	40.8	191
Jan. 1, 1912.....	5	149' 5"	73.1	910.1	6	22	38,800	42.6	194
Jan. 5, 1912.....	5	168' 9"	72.8	1,023.7	5	42	45,600	44.5	185
Jan. 8, 1912.....	5	181' 11"	70.2	1,064.2	6	52	51,900	48.7	193
Total.....	32	1,000' 9"	71.7	5,976.0	36	45	263,950	44	191.1

TABLE OF TOTALS AND AVERAGES

Days	Hours Cutting	Places Cut	Face Feet	Average Depth Inches	Total Square Feet Cut	Total Tons Mined	Total Watt-Hours	Average Voltage
6	36 45	32	1,000.75	71.7	5,976	1,770.66	263,950	191.1

TABLE OF RATES

Face, Feet Per Hour	Face, Feet Per Day	Square Feet Per Hour	Square Feet Per Day	Tons Per Day	Watt-Hours	
					Per Square Foot	Per Ton
27.2	166.79	162.6	962.7	295.11	44	147.37

The readings and measurements were made by two observers, who checked each other's work and who made affidavit at the conclusion of the test as to the fairness of its conditions and the accuracy of the results contained in their reports.

The observations taken in each working place included the time, at the beginning and end of each part of the operation; the power consumed, shown on a recording wattmeter of standard make; the average voltage, shown by a voltmeter in the room; the width of the room or breakthrough, and the depth of the undercut. After each room was completed, the wattmeter was reset at zero.

No readings were taken while the machine was moving on its truck, as the test had to

Table 1 is a summary of the six reports covering the daily performance of the machine.

The machine had 24 loaders assigned to it, and "kept up the cutting" for all these men.



To find the actual horsepower in air delivered by a ventilating fan: Multiply the number of cubic feet of air delivered per minute by the water gauge and divide the product by 6.345. If a fan is delivering 100,000 cubic feet against 2-inch water gauge, what is the actual horsepower output of the fan? Solution: $\frac{100,000 \times 2}{6.345} = 31.5$ horsepower.

The Hastings Coal Mine Disaster

A Description of the Mine and the Rescue Work—Effects of the Explosion Probable Cause

Written for Mines and Minerals

THE Hastings coal mine of the Victor-American Fuel Co. is reached by the Colorado & Southeastern Railroad, and is 16½ miles north of Trinidad

Two coal beds are worked, known locally as the "A" and "B" seams. Until the year 1908, the entire daily output, approximating 1,500 tons, was mined from the upper, or "A" seam, which varies from 5 to 7 feet in thickness. In August of that year, a new slope on a 12½-per-cent. grade was excavated through the measures to the "B" seam. On account of the large area developed in the upper workings and the fact that a portion of these workings were retreating, the coal was easily mined, and the work of development in the "B" seam was not pushed with great rapidity until the past 18 months. At the present time, the "B" operations are producing about 12½ per cent. of the entire mine output.

Hastings, while not seriously troubled by water, like other operations in the Trinidad district going to the dip, is obliged to do considerable pumping. The mine is therefore comparatively wet, and sprinkling operations are not a serious burden. On account of the moisture, Hastings, from the dust standpoint, has always been one of the safest mines in the Trinidad district. The mine has always made a small amount of gas, but an ample quantity of air was always maintained by a 90" x 90" Sirocco fan, which can, at any time, be speeded up to furnish double its ordinary capacity.

The very latest and best types of safety and electric lamps are used throughout

the mine, no open lights being permitted under any circumstances. All the lamps are filled, cleaned, and inspected by the regular lamp inspector before being carried into the mine. Permissible powder is used exclusively, and each miner is permitted to take but enough for his shift into the mine at one time. Shots are tamped with adobe and are discharged by the regular shot firers.

All places are inspected after the evening shots are fired, and again in the morning before the day shift goes to work. In addition, a regular inspector, whose duties are confined to this property alone, makes a careful examination daily, and at frequent and regular intervals the Chief Inspector makes his rounds.

In order to promote an interest in helmet and first-aid work, the company was preparing an elaborate contest to be given in

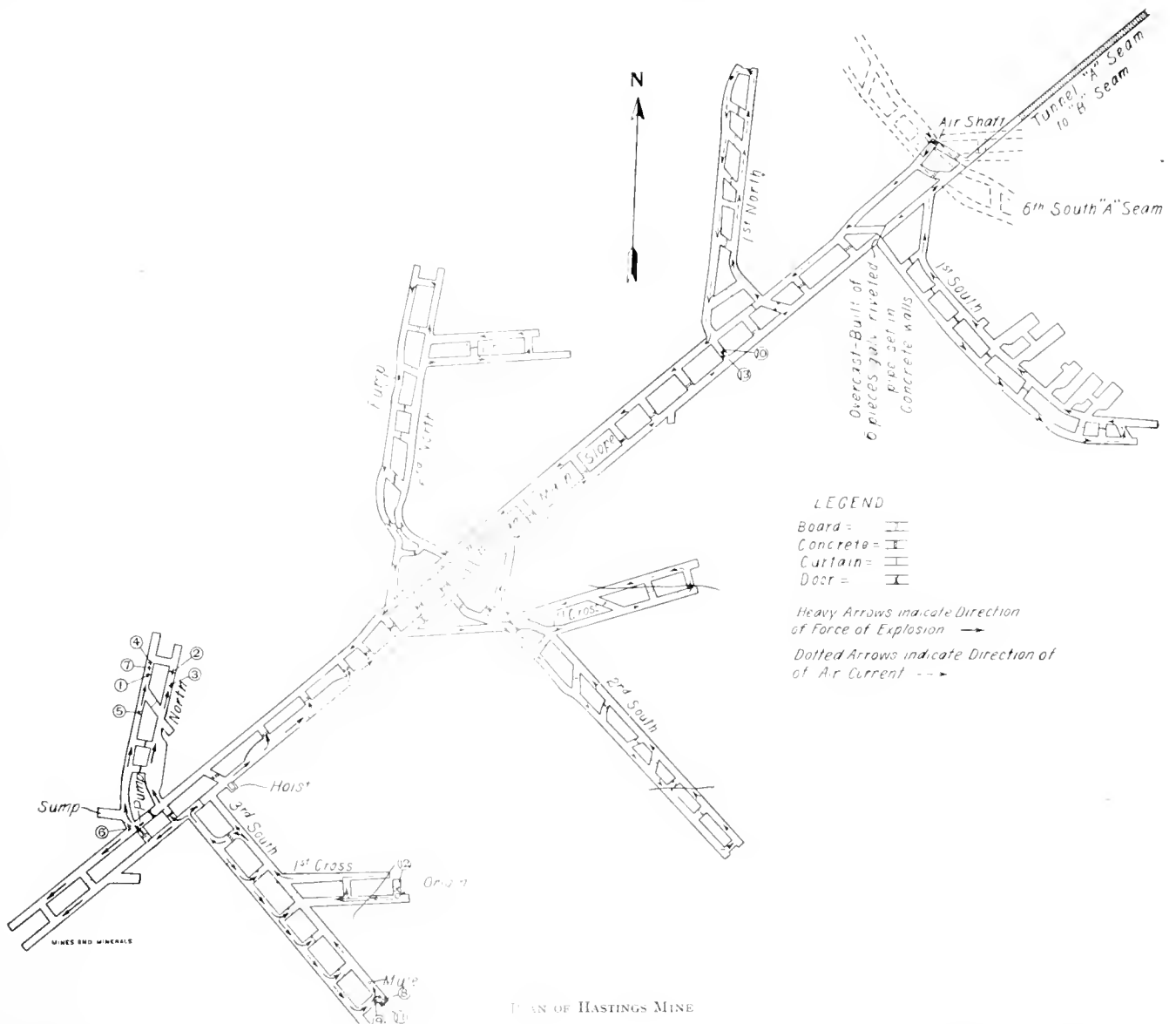

PLAN OF HASTINGS MINE

Walsenburg on June 22, in which rescue and first-aid teams from the several mines of the company were to compete for a silver cup. This has stimulated the rescue work to a very appreciable extent, and keen interest has been manifested in this line of work by all participating.

It so happened that on the night of June 18, the first-aid and rescue crews at

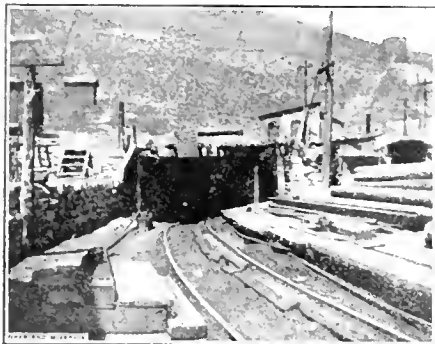

MAIN SLOPE, HASTINGS MINE

Hastings mine were having their practice in the emergency hospital, which is located near the pit mouth. It also happened that the regular monthly meeting of the superintendent, pit, and fire bosses was being held in the mine office about 600 feet away.

The accident happened about 9:30, while these two meetings were in progress, and it was first discovered by some of the first-aid crew, who noticed the odor of fire; and upon going to the door of the hospital, one of their number discovered smoke issuing from both the main haulage and manways of the mine. An alarm was immediately given, and the superintendent, James Cameron, accompanied by A. E. Thompson, Hastings mine inspector, and Harry Winters, lamp inspector, rushed into the mine and penetrated as far as the bottom of the air shaft in the "B" seam, Mr. Thompson, a little later, getting as far as the first south entry. In the meantime, D. H. Reese, captain of the helmet crew, had organized his men and was rushing helmets and rescue paraphernalia from the instruction car, which was standing in the yard, to the mouth of the mine. This crew, led by their captain, entered the mine shortly after 10 o'clock and worked unceasingly until 4 in the morning. The first men found, Nos. 10 and 13, were on the main slope. One of them, No. 13*, was alive and was immediately conveyed to the outside, where he was taken care of by the company surgeon. His partner, No. 10, was crushed by falling rock and timbers; both these men were slightly burned.

The helmet crew pushed forward into the lower workings of the mine, which were filled with smoke, and succeeded in exploring the main air-course, and the third north and south entries. Their examination at this time was for the purpose of

rescuing any possibly living men, and to determine the presence of fire, if any existed. Seven bodies were found, but were not removed from the mine at this time.

In the meantime, the superintendent organized a force numbering 22 men, which immediately began putting up brattices with as great rapidity as possible, to replace the concrete stoppings, all of which were blown down. This was a work of considerable difficulty as, on account of the caved condition of the main slope, all material had to be conveyed into the "B" seam by way of the shaft at the outby end of the air-course, which was in very fair condition.

At 7 o'clock on Wednesday morning, Mr. Reese, with a crew of 20 men, most of them equipped with helmets, again entered the mine to more thoroughly explore the workings at the foot of the slope, and to continue the search for bodies, the first of which was taken to the temporary morgue that afternoon at 3 o'clock. While not the last body found, that of John Thomas, the fire boss, was the most difficult to remove, and it was consequently the last one taken out, at 3:50 on Thursday morning.

Cause and Effect of the Explosion.—Various theories have been formulated as to the exact cause of the accident. It was thought that a spark from the electric pump, located near the mouth of the back entry of the third north entry, might have ignited a volume of gas liberated by one of the shots fired after the day shift had retired from the mine.

A second theory was that, in some manner, possibly by a blown-out shot, a body of gas in the back entry of the third south entry was ignited, and this theory had a number of advocates, as the direction in which the stoppings separating the main and back entries were blown, the position of the bodies of the men, the mule and the car, would all seem to indicate that the explosive force had made its way through the last cross-cut, having originated somewhere in the back entry. Against this theory was the fact that no one was working in the face of the back entry, there being but two diggers in this portion of the mine and they were at work in the face of the main entry, and it appeared, upon further investigation, that they had loaded a car of coal and that the driver and the mule had come in to get it when the explosion occurred.

The fire boss, John Thomas, was working up in the face of the back entry of the first cross off the third south entry, putting up a brattice in order to improve the circulation of the air, as it was becoming somewhat sluggish, owing to the fact that the last cross-cut was not through and the face of the entry had advanced considerably beyond the one through which the air passed from the back into the main entry of the first cross.

When ventilation in this portion had

been reestablished so that a more careful search could be made, it was found that a considerable quantity of rock piled along the rib in the back entry off the first cross, had been blown outward into the main entry.

When Mr. Thomas' safety lamp was examined, it was found that the asbestos gasket upon which the glass globe rests had, in some manner, become folded over, leaving a small air gap through which it is thought a volume of gas was ignited. As Mr. Thomas was one of the official inspectors or bosses, it is possible that his lamp was not given the inspection that was accorded to those of all diggers and company men, so that this condition of the gasket was due to his haste, or neglect, when making ready to go underground when he went on shift. His body was considerably burned, but was not badly broken, so that it would seem that the explosion had not gained any great violence until it was propagated in the main entry of the third south entry. The theory, with the imperfect lamp as the cause of the accident, is strengthened by the following facts: the bodies Nos. 8, 9, and 11 were hurled with terrific violence against the face of the entry and were not seriously burned. The mule was hurled outward, and was practically torn in two, though not seriously burned.

These facts, together with the location and condition of the remainder of the men, had considerable weight in deciding the direction of the lines of force, as shown in Fig. 1. No. 6, the pumper, was somewhat burned, but not badly enough to cause his death, and it appears that he, like Nos. 1, 2, 3, 4, 5, and 7, met his death by suffocation caused by afterdamp.

It was learned afterward that No. 13, of the two rock men working up the slope, had retired to the cross-cut for a drink of water and that he was standing there when

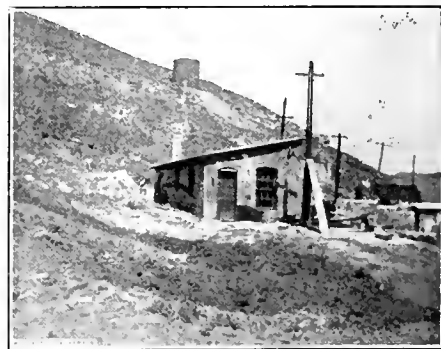

EMERGENCY HOSPITAL, HASTINGS MINE

the mine "let go." Had he been out in the entry with his partner, No. 10, the chances are that he, too, would have been killed.

A few cars were standing on the slope near the mouth of the back entry of the third south; these were apparently acted upon by equal and opposite forces, as they were turned completely around and badly shattered.

* This is the first man in a mine disaster rescued by a helmet corps in the United States.

A deposit of coke dust on the timbers was easily discernible, and its location helped to determine the direction of the travel of the explosive forces.

All the stoppings between the main slope and air-course were built of concrete, of approximately 20-inch thickness, and well backed up with rock; without exception these were blown out in the direction of the back entry. Two stoppings in the "A" seam were blown out; with this exception, no other damage was done there.

A trip of 18 cars was standing on the slope between the first and second north entries. This was well covered with fallen rock and debris, but was not derailed or otherwise disturbed. The haulage rope attached to this trip was so deeply imbedded in fallen timber and rock that it was impossible to withdraw it by means of the hoist after it was detached from the trip, and it was therefore cut in order that it might be operated for taking out the wreckage and bringing in material.

In the region where the explosion was of greatest violence, it is probable that half a dozen cars of rock would represent the amount which fell. From this point outby, very few timbers were left in the slope, and a considerable number of falls from the roofs blocked the entry.

In the rock tunnel, all timbers were blown down.

Rescue Work.—It is seldom that the work of exploration and rescue is carried on with greater promptness and efficiency than that following this disaster. The first-aid and helmet crews, with the assistance of extra men about the mine, worked untiringly, and the rapidity with which they covered the ground and brought out the bodies is highly commendable. Besides those already mentioned, among the many who risked their lives should be named: Assistant engineers J. E. Hanes, F. S. Dunlevy, Lewis Hufty, and L. M. Kuhns; superintendents and men about the mines, John Yates, N. Bivens, J. Wennberg, J. Walker, J. F. Randock, E. Hart, Archie Bell, Fred Cornish, J. Milton, W. H. Cunningham, W. Wilcox, J. Walker, Jr., J. E. Cameron, Robert McCune, Andy Young, Tom Barron, Pat Gallagher, Geo. Smith, J. P. Bares, Wm. Mates, Jas. Brown, Ed. Flynn, Gus Wennberg, Joe Gaymay, Joe Robinson, A. Washington, B. Butalino, Pete Aime, Tony Arbo, John Arbo, Ben Vigil, Joe Curo, and Frank Lottice.

The Government Rescue Car No. 2, in charge of Prof. J. C. Roberts, was in Colorado Springs when the accident was reported, and proceeded to the scene of the disaster on the first train. Professor Roberts rendered especially efficient service.

Mr. King, Deputy State Coal Mine Inspector for the Trinidad district, was upon the ground at 7 o'clock of the morning following the explosion, and he, with Chief Inspector Dalrymple and two other deputy coal mine inspectors who arrived

on the evening train of the same day, gave their very best efforts to the work.

At best, an accident of this kind is a sad affair. There have been many fatalities in coal-mining operations over the country, and there is no question that all the leading operators have been improving their underground conditions, introducing new safety devices and appliances as fast as known or discovered; the operators of Hastings mine were no exception, and an honest, conscientious endeavor has been maintained to insure the safety of the miners, to the greatest possible extent. It is extremely unfortunate that, in spite of the many precautions taken, a serious accident of this kind can originate from so slight a cause.

◀ ▶

Coal Dust and Coal Loading Machines

*Written for Mines and Minerals by C. H. Thompson, G. M.**

There has seldom, if ever, been a time in the history of the coal-mining business when the margin between the actual, honestly computed cost of a ton of coal and its actual, honestly computed selling price has been so narrow. Emphasis is laid upon these two factors because, in many cases, the computed cost per ton is not the true cost, but is nearly always less by a few cents.

There is a tendency to slight the factor of plant depreciation and it is difficult to arrive at a proper factor to cover the depreciation of the mine, caused by increased difficulties in haulage, drainage, and ventilation, all of which may rise jointly and inopportunely and demand a change of plans and an enlargement of plant. As a result, mining companies declare profits sometimes which are not real.

To minimize cost is the prime function of the mine manager. No matter what his conception of a safe and well-ordered mine may be, everything must defer to the cost sheet. Mine fatalities, sometimes attributed to lack of skill in mine management, are often the result of commercial conditions beyond the power of the mining companies to remedy. One of the largest factors of the coal cost sheet is loading. Manual loading will not stand a cut, considering the scarcity of labor and the present cost of living.

The introduction of a successful coal loader on the market will bring the best opportunity the coal operator has ever had to cheapen the cost of his coal by lowering this stubborn factor of loading. Assuming that a new device, such as an electrical shovel, with a guarantee of 150 tons or more per day, dependent on coal conditions, is produced and on the market, such a machine will present interesting features to the average coal operator. If such a shovel in a seam of coal 5 feet thick or

* Darbyville, Lee Co., Va.

thicker, with fair conditions as to top and bottom, with two operators, can do the work of, say, 18 average men in machine-cut coal, it will be a great boon. It is a well-known fact that the average mining machine, whether a motor, a drill, an undercut cutter, or a loader, rarely gets the chance to do maximum duty. If delays due to moving from place to place over a large territory could be eliminated, the daily performance of all of the above machines could be greatly increased.

The most natural plan in case of mechanical loading would be to apportion the territory to a loading machine so that it could be kept at work practically all the time. This would mean that the cutter, the motor, and the drill, all under the same supervision as the loader, could be likewise kept busy. Under such a plan, carefully worked out and adhered to, the cost of coal in the mine car ought to be considerably more than cut in two. The question of double shifting all these machines where the mine car equipment is sufficient is also an interesting phase of the project and lends an elasticity to it that can never be gotten on any manual basis. Such a shovel will not break the coal up as badly as hand loading, as it could be made to handle lumps that two men would not attempt to lift into a car, and there will not be the shatter to the small coal because it will be carried and not thrown into the car.

The advantages of a successful loading machine will not be confined to the loading of the coal merely, but will extend to nearly every department of the mine. The possibility of cutting and cleaning up a chamber more than once in a shift means that a much smaller development will yield a larger tonnage than with hand loading. The investment for rails and ties even is proportionately decreased. Fewer men in the mine, and these almost entirely skilled men, reduces the chances of serious accidents to a minimum. Ventilation will be simplified, the actual requirements of air being much less and the working places being more concentrated. Haulage is alike affected and the saving in this item should be material. If the cost of a machine does not exceed the cost of the houses requisite for the number of men eliminated, it is probable the depreciation will be less in the machine than in the houses. Social and sanitary conditions would be improved in camp life owing to a selective system of employing men made possible by the reign of mechanical operation of the mine in all branches.

The necessity for minimizing underground accidents can best be met by minimizing the number of men employed there; and if mechanical loading can accomplish this and in addition put a premium on skill, it will rapidly cause a new era in coal mining which will tend to greater efficiency and economy to the operator and greater safety and better living conditions to the employees.

The Muller By-Product Coke Oven

A Description of the Construction and Operation of an Improved Coke Oven Possessing a Number of Novel Features

By Eugene B. Wilson*

SINCE the introduction of by-product coke ovens, it has been the aim of designers to improve on their method of firing, in order to insure a continuous, direct, and uniform heating of the retort. The object of this endeavor is to shorten the coking period; to avoid wear

One of the good features of by-product ovens is the increased yield of coke over the beehive ovens, which varies from

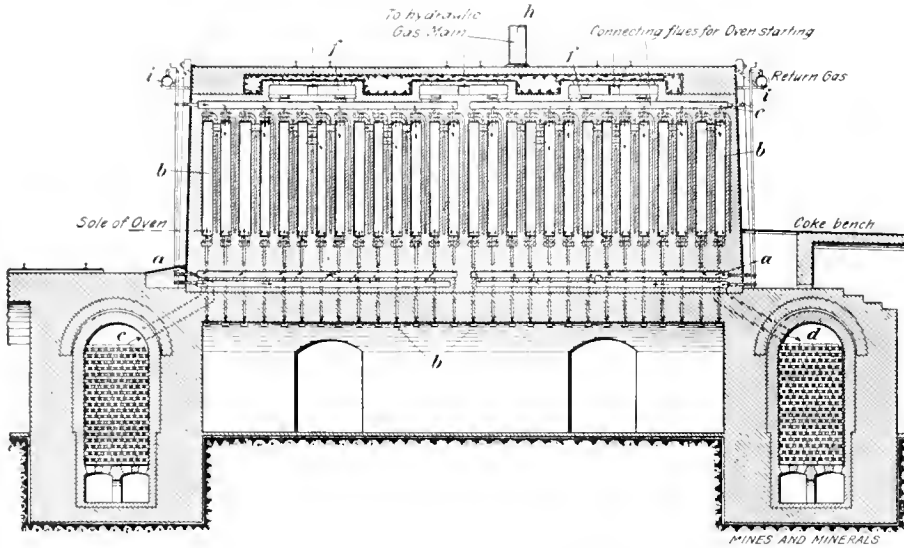

FIG. 1. SECTION THROUGH THE HEATING WALL

and tear on the retort walls; to increase the yield in by-products, including gas, which will be high in calorific value. If the by-product ovens now in use are examined critically, it will be seen that, whether the heating chambers or flues are constructed in two or more sections, only from one-half to one-quarter of the ovens are heated directly by fresh gas and air, the other parts receiving the waste heat which is about 300° C. lower in temperature than the direct heat.

In consequence of the direction of the heat current being reversed from time to time, as the regenerative stoves cool off, the oven walls are subject to fluctuating temperatures which cause them to crack and leak, and the quality of the coke to gradually deteriorate. With each reversal of the heating current one part of the coking charge has its heat lowered and the other part has its heat raised, with the result that the coke is brittle and seamed with cracks.

The gas and air inlets to the ovens are mostly constructed so that the flame jets are more or less inefficient, as the air passes through a large opening in a compact stream, generally vertical or slightly oblique to the entering current of gas, thus producing more or less large flame jets which, striking the wall, destroy or injure them, even when constructed of the best refractory materials.

23 per cent. to 8 per cent. For example, the Conneville coal should furnish 68.38 per cent. coke; in beehive ovens it yields 64 per cent., thus it takes 1.562 tons of coal to make 1 ton of coke. When the same coal is coked in retort ovens it yields 72 per cent. of coke, thus conserving 340 pounds of coal for each ton of coke made, when compared with the product from beehive ovens. Pocahontas coal cokes in beehive ovens at the expense of some of its fixed carbon, and only under exceptional circumstances yields 62 per cent. coke. In retort ovens it has yielded 85 per cent. of coke, thus saving 874 pounds of coal for every ton of coke made. In addition to this saving in coal, by-product ovens save gas, nevertheless the heat in the upper part of the oven above the charge is so great that the gases are partly dissociated, in which condition graphite results and part of the by-products are lost beyond recovery.

This introduction is preliminary to a description of the Muller by-product oven, and is intended to draw attention to the particular features incorporated in its construction. The Muller oven has now been in successful operation for 7 months. By reference to Fig. 1, which is a section through the oven heating wall, it will be seen that the combustion or heating flues *a* are provided at their lower and upper ends with tuyères for supplying and mixing gas and hot air for combustion. The tuyères are constructed, as shown in

Fig. 2, in a way that will convey the gas and air-current into the heating flues so that their movement will be parallel with and not baffle each other. In this way the

flame jets are prevented from impinging at any particular place on the wall of the heating flues; also by this arrangement there is an intimate mingling of air and gas which insures a rotary movement from the tuyère nozzles into the combustion flues. In the illustration, Fig. 2, *a* is the air flue leading to the tuyères *b*, while *c* is the gas flue leading to the heating flues *d*. In the lower or sole flues, the air flue is used alternately to convey hot air to the heating flues and waste heat to the regenerators. Owing to the large openings, the tuyères admit of an adequate supply of air closely corresponding to requirements, that is, from four to five times the quantity of gas admitted. Because of the air entering the heating flues through the four nozzles, the air can be blown in by means of a fan, and thus insure a long flame suitable for the height of the oven walls. This feature has considerable bearing on the height of the oven.

For the purpose of conducting away the waste gases, every two or four heating flues are connected by small passages at their upper ends, as shown in Figs. 1 and 3. Ordinarily this is done by a horizontal flue extending along the upper part of the oven, above the flue walls, a feature which tends to weaken the oven wall. It is evidently better to conduct the waste gases within two combined heating flues than to carry them one-half the length of the oven

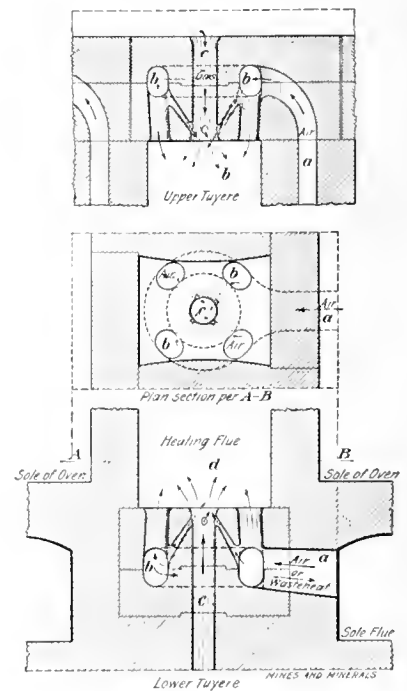

FIG. 2

*A paper presented at the Johnstown, Pa., 1912, meeting of the Coal Mining Institute of America.

through a long horizontal chamber to the 15 or 16 heating flues of the other half of the oven, as is done in some oven designs.

Underneath the combustion flues the gas supply channels *a*, Fig. 1, are arranged side by side and superposed. These are connected so that the gas supply from below is regulated from each three or four heating flues. Suitable connecting passages conduct the gas upwards through the gas nozzles of the tuyères into the heating flues. To avoid the connecting passages becoming clogged by obstructions of any kind, vertical openings *b* from the foundation arches are provided and these have removable plugs which enable all the vertical combustion flues *b* to be inspected from time to time.

The sole channels *a*, Fig. 3, alternately serve for supplying hot air for combustion from one generator *b* to the heating flues *c*, shown in dotted lines, and for conveying the waste gases from the combustion flues to the other regenerator *d*. The subdivision of this sole channel into four parts, as shown in the section of the ovens, Fig. 4, is for the purpose of regulating the incoming air and the withdrawal of the waste heat gases from the heating flues. This arrangement has been adopted to produce a uniform draft and pressure. From the sole channels, part of the hot air passes through small passages formed in the intermediate binder bricks of the walls and ascends to the upper tuyère nozzle, where it furnishes hot air from above to the downwardly flowing products of combustion. In the roof of the oven above the upper tuyères, one or two gas flues *e* are arranged, which are alternately connected with those flues having a downward draft for combustion. Separate passages and connecting flues *f*, leading from the charging holes into the upper gas supply passages and to the heating flues, are provided for use when the oven is being started, or in case the oven should be worked without recovery of the by-products as a waste-heat oven.

A further improvement is that the crude-gas collecting space *a* above the coking charge in the oven section, Fig. 4, is sur-

rounded on the sides and top by special insulating material, which is extended down the heating flues toward the charge in order to lose the heat from the flues from radiating into this space. The gas collecting spaces thus cooled has a lower temperature than the charge; consequently, since the generated gases passing out of the coking charge its whole length find a cooler space, there is no possibility of the hydrocarbons in the gases decomposing.

the combustion and keep the temperature as high as that in the upward flues, which is easily attained with a small quantity of gas. The waste heat or gases finally descend through the lower tuyères and passages to the sole channels, and then through one or other of the regenerators to the boiler or chimney stack.

After the reversal of a suitable three-way cock in the branches of the gas supply pipes and of the reversing valve of the two

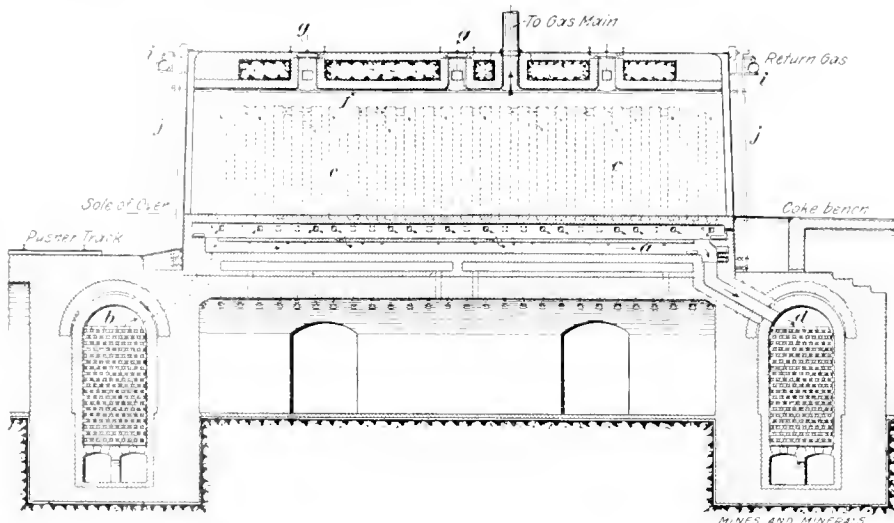

FIG. 3. SECTION THROUGH THE OVEN CHAMBER

The operation of the coke oven is as follows: The retorts are charged with coal in the usual manner, either from the top through the charging hole *g*, Figs. 3 and 4, or through an end door if compressed coal is used. The gases generated are conducted from the collecting spaces above the charge, through vertical off-takes *h*, Fig. 4, and stand pipes, to the condensing or by-product plant. After the separation of tar, ammonia, and benzol, a small part of the gas to be used for heating the oven walls is conducted through pipes *i* along the sides of the battery of ovens. Small branch pipes *j* provided with valves or stop-cocks project into the upper as well as into the lower gas channels on each side of the oven walls.

Supposing now the regenerative system is employed. The gas passes from the lower channels through the tuyères alternately into half the number of tuyères in one wall, that is, into one side of one or two combined pairs of heating flues. Just below the sole of the oven hot air also enters from one regenerator, the sole channel, and lateral passages through the tuyères, and mixes with the issuing gas which, burning, flows upwards. The resulting products of combustion are now conducted through the upper passages into the next flues of one or two combined pairs. Since much of the heating power is lost on the way upwards, each of the flues having a downward combustion receives through the upper tuyères an auxiliary supply of fresh gas and hot air in order to enliven

regenerators alongside the battery, the supply of gas and air flows in the reverse direction, and likewise the flames in the combustion flues. If no regenerators are employed for heating the air, the direction of the flow of gas and air and that of the products of combustion in the supply pipes and channels always remains the same.

The method of heating the walls permits of efficiently utilizing the heating gases, and by means of the continuous upper supply of additional fresh gas and hot air to the waste gases, an extremely uniform heating of all parts of the wall is insured. The supply of gas and air to every set of three or four flues can be readily controlled and regulated at will by the pipes and stop-cocks and the dampers in the sole channels, so that a very uniform distribution of gas and air is attained. On account of the positions of the gas and air supply tuyères, an exceedingly high temperature is applied exclusively to the coking charge, consequently the oven can be run at a considerable saving of fuel.

In addition to the economy in fuel gas being realized on account of the high temperature obtainable at the sides of the coal charge, and on account of the cooled gas-collecting space, there is an increased yield of gas of a higher illuminating and calorific value, also the yield of ammonia and benzol is materially increased. Further, on account of the constant temperature over the whole retort wall, the coke produced is of superior quality to that of other ovens where only one-half of the

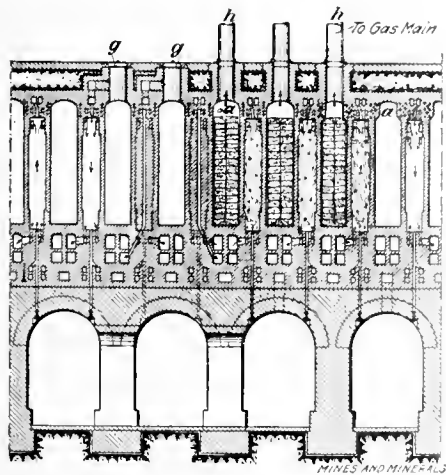

FIG. 4. CROSS SECTION THROUGH THE OVENS

oven wall is directly heated alternately. On the other hand, the arrangement of the heating facilities and the tuyères in the combustion flues insures a short travel of the burning flames, which permits practically an unlimited height to the walls of the retort. As a combustion flame of 10 feet in length can easily be produced to suit any requirements, a capacity of 10 tons of coke and more per oven per day is obtainable.

Owing to the complete, uniform, speedy and economical coking process, the Muller coke ovens not only obtain increased by-products of distillation, but also a good sound coke can be obtained from an expanding coal, or a low-grade coal, usually regarded as non-coking. This is due to the good control and easy application of a high temperature to the charge.

The ovens are designed to work, either with regenerators, when it is desired to have surplus gas for illuminating or power purposes, or without regenerators, as waste-heat ovens, when the waste gases from the ovens are to be used for steam raising. The design and improved details of construction of the new oven are based upon careful observation and the result of more than 15 years practical experience in the construction and working of coking plants.

The claims made for the Muller ovens are as follows:

1. Easy control and regulation of the distribution of hot air and gas from outside the ovens, by means of regulating cocks at twelve different places.
2. Accessibility and inspection of each individual combustion flue, as well as of the whole oven.
3. No formation of flames which will destroy the oven walls, because of the construction and position of the tuyères.
4. The tuyères assure a very intimate mixing of gas and air. Therefore, the greatest amount of heat is obtained with a minimum amount of gas from the fact that very hot air is used to obtain combustion.
5. Absolutely uniform, continuous, and intensive heat, immediately and exclusively applied to that particular part of the oven wall beside the coking charge, where the heat is most needed for a short coking period.
7. Entire omission of longitudinal combustion, and gas-transfer channels in the walls.
8. Strongest construction of the whole oven, with special reference to unlimited height, strength, and durability of the retort walls.
9. Less cost for maintenance and labor.
10. Unsurpassed production of coke of uniform sound quality and minimum amount of breeze.
11. Production of gas of increased illuminating and calorific value.
12. Increased yield of ammonia and benzol.
13. Increase in surplus gas according

to the coal used, from 45 to 60 per cent. of the total gas generated.

14. Prevention of the formation of naphthaline and graphite.

15. Use of expanding coals and of low-grade coals.

A description of the by-product plant for the recovery of sulphate of ammonia and tar from the gases belongs more to the province of the chemist than to the coke maker. The chief aim of Mr. Muller's by-product plant is the recovery of tar and ammonia from the gases in a direct manner. In order to do this it is essential first to separate the tar from the hot gases, so that during the following passage of the gases through the acid bath in the saturator the ammoniacal salts may not be diluted by tarry substances and rendered unsalable. To attain this end, the hot gases which come direct from the coke ovens are introduced into the tar washeries, which work on the principle of condensation by shock; that is, the gas is repeatedly split up into innumerable fine streams and caused to dash against the plane surfaces of special grids, which at the same time are constantly sprayed from above by hot gas water.

The gases in addition to being separated in the fine streams are purified by the repeated dash in a most perfect manner. When the last traces of tar have been removed the gas leaves the washer in a pure and dry hot state. The products of condensation obtained in the tar washer, namely, tar and gas water, run automatically through a siphon pipe into a settling tank where separation according to specific gravity takes place. The tar is then pumped into a high level tank and is ready for sale, and the recovered hot gas water is pumped upon the tar washer to be reused as a washing liquid. The hot gas still charged with all the ammonia constituents is now passed from the tar washer directly into the sulphuric-acid bath of the saturator in which the ammonia is recovered in the form of sulphate.

In the Muller patents, in addition to the higher percentage of ammonia recovered in the oven gas, namely, 20 per cent., an additional 6 per cent. yield of ammonia is obtained in the saturator. The sulphate of ammonia, crystallizing in the saturator by the reaction of ammonia upon sulphuric acid, is raked on to a draining table and then into a centrifugal drying machine, which leaves the salt in a salable condition. All the mother liquor which flows from the draining table and from the centrifugal drier runs into a liquor cask which automatically returns the liquor to the saturator for future treatment. The gases which are thoroughly purified for ammonia are now drawn from the saturator through a pair of common water coolers (in order to be cooled down for the benzol absorption) by means of the exhauster, which forces the gas through three benzol washers and finally into the gas holder, in which it is

to be stored to be used partly for heating the ovens and the surplus for illuminating or motor power purposes.

The new method of recovering ammonia in a direct manner without the aid of steam or lime, and the construction of the new apparatus, enables the by-product recovery plant and its operation to be considerably simplified, and the recovery of the by-products is effected in an economical way. Further, the employment of the usual apparatus for scrubbing and distilling the ammonia, with its inevitable poisonous effluent liquor and mud nuisance, is entirely dispensed with.

The writer is indebted to Mr. Muller for the illustrations and the new information on by-product coke ovens incorporated in this paper.

來 來

Catalogs Received

Macomber & Whyte Rope Co., Chicago, Ill., The Whyte Line, 12 pages.

Allis-Chalmers Co., Milwaukee, Wis., Bulletin No. 1626, Hydraulic Turbines, 8 pages.

Chicago Pneumatic Tool Co., 50 Church Street, New York, N. Y., Booklet No. 115, The Anatomy of the Little Giant, 24 pages.

Jeffrey Mfg. Co., Columbus, Ohio, General Catalog No. 82, Jeffrey Quality, 576 pages.

General Electric Co., Schenectady, N. Y., Bulletin No. 4954, Horn Type Lightning Arresters for Series Lighting Circuits, 12 pages.

Industrial Instrument Co., Foxboro, Mass., Bulletin No. 62, Tachometers and Tachographs, 24 pages.

Ingersoll-Rand Co., 11 Broadway, New York, N. Y., "Radialaxe" Air Driven Coal Cutters, 20 pages.

Ohio Brass Co., Mansfield, Ohio, General Catalog No. 12, Electric Railway and Mine Haulage, 487 pages.

Lidgerwood Mfg. Co., New York, N. Y., Bulletin No. 31, Lidgerwood Cableways, Locks, and Dams, 48 pages.

Ridgway Dynamo and Engine Co., Ridgway, Pa., Bulletin No. 25, Direct-Current Generators, 16 pages; Bulletin No. 26, Motor-Generator Sets, 16 pages.

Nelson Valve Co., Chestnut Hill, Philadelphia, Pa., Catalog S, Nelson Steel Valves and Fittings, 63 pages.

Springfield Boiler and Mfg. Co., Springfield, Ill., Springfield Boilers, 47 pages.

Servus Rescue Equipment Co., Newark, N. J., Servus Oxygen Rescue Apparatus, 12 pages.

Stromberg-Carlson Telephone Mfg. Co., Rochester, N. Y., The Power of Advertising, 28 pages.

The Wisconsin Engine Co., Corliss, Wis., Adams Wisconsin Kerosene Gas Engines, 50 to 200 H. P., 8 pages.

THE seventeenth annual meeting of the Lake Superior Mining Institute will be held in the Copper Country, with headquarters at

Houghton, Mich., on August 28, 29, and 30, 1912. Arrangements are now under way and an interesting meeting is assured. Members are invited to prepare papers for this meeting, and forward them to the secretary as soon as possible, so that copies can be printed and mailed in advance. This will give an opportunity for more thorough discussion. The subject of "Mining Methods" on the various ranges, presented at the last meeting, should be further taken up, so that in time all the

Mining Institutes' Summer Meetings

Programs and Proceedings of Various Institute Meetings and Lists of Those in Attendance

Store Management in Relation to Mining Communities," Charles H. Lantz, General Manager, Buxton & Landstreet Co., Thomas, W. Va.

"The Projection and Development of a Mining School," E. N. Zern, Professor Mining Engineering, West Virginia University, Morgantown, W. Va.; "Mine Accidents and Their Prevention" (stereopticon), Ira D. Shaw, International Secretary Y. M. C. A., Pittsburg, Pa.

"Coal Mine Accidents," David Victor,

Among those in attendance were:

Wheeling: T. E. Plummer, J. C. McKinley, R. F. Hamilton.

Charleston: W. C. Alexander, W. L. C. Alston, W. H. Daffren, G. P. Crummett, T. E. Embleton, James Martin, A. J. King, F. C. Cornet, Theodore Swann, E. B. Taggart, J. T. Parks, Nason P. Pritchard, D. Q. Prenlet, G. A. Wiley, F. T. Scott, W. A. Reese, W. C. Shoemaker, J. S. Weakland, W. E. Knight, D. E. Frierson, J. N. Dewall, John M. Laing, Neil Robinson, D. C. Kennedy, J. S. Cunningham, John Dickson, C. H. Kent, J. R. Guard, James Kay, C. E. Krebs, J. E. Farquahr, P. E. Demmler,



SOME OF THOSE PRESENT AT THE MEETING OF THE KENTUCKY MINING INSTITUTE

ranges in the Lake Superior district will be covered.

Attention has been called to the subject of "Uniform Mining Laws," "Workmen's Compensation Law," and "Safety Appliances," which should be taken up in special papers. Communications should be addressed to A. J. Yungbluth, secretary, Ishpeming, Mich.

WEST VIRGINIA COAL MINING INSTITUTE

The ninth semiannual meeting of the West Virginia Coal Mining Institute was held at Charleston June 6, 7, 8. The meeting was largely attended and considerable interest was taken in the proceedings. The following program was arranged and carried through without a hitch: Address of welcome, Governor William E. Glasscock; President's address, Frank Haas; 5-minute talks by the vice-presidents; "The Use of Gasoline Motors in Coal Mines," A. J. King, Mining Engineer, Charleston, W. Va.

"Quality and Quantity of Mine Air," Karl F. Schoew, Mine Inspector, Fairmont, W. Va.; "Points of Interest in Mine Ventilation," J. T. Beard, Associate Editor *Coal Age*, New York, N. Y.; "Successful

Chief Mine Inspector, The Consolidated Coal Co., Fairmont, W. Va.; "Safety in Coal Mines, Especially in West Virginia," F. C. Cornet, Mining Engineer, Charleston, W. Va.; "Some Experiences in the Drainage of Mines," C. E. Tucker, Superintendent, The Consolidated Coal Co., Frostburg, Md.

Trip to the Blue Creek oil field, which is 15 miles from Charleston, on the Coal & Coke Railway. Just after leaving, an excellent new oil well commenced to flow at the rate of 200 barrels per day.

Banquet at Hotel Ruffner; toastmaster, Ex-Governor William A. McCorkle. Speakers, Hon. George E. Price, Railways and Coal; Hon. Malcolm Jackson, Laws; Hon. Henry G. Davis, Pioneer Days; Dr. J. A. Holmes, Scientific Research; Dr. J. C. White, Geology; Hon. L. E. Tierney, Practical Mining; J. C. McKinley; Hon. Z. T. Vinson; Frank Haas, Institute Work; Hon. George S. Laidley, Education; Dr. J. E. Robins, Village Sanitation; William Seymour Edwards, Oil and Gas.

Automobile ride over city of Charleston, returning to State House at 11 o'clock; A paper on "Lubrication," by L. A. Christian, Consulting Engineer, Keystone Lubricating Co., Pittsburg, Pa.

E. B. Snider, D. D. Teets, Jr., A. W. Pruitt, A. P. Rand.

Fairmont: J. C. Gaskill, Everett Drennan, K. F. Schoew, C. H. Tarleton, R. E. Rightmire, David Victor.

Huntington: J. W. Latimer, T. F. Bailey, James Clark, H. M. Ensign, J. S. Walker, Jr., D. C. Schonthal, G. W. Stevens, Jr., W. N. Oliver, Jr., J. W. Heron, H. M. Shaul, D. R. Phillipi.

Pittsburg: W. E. Fohl, J. R. Mason, E. B. Day, J. P. McIntosh, P. W. Bristol, J. R. Cameron, H. E. Marks, L. A. Christian, W. J. Jolmson, Howard Curry, E. N. Zern, Winthrop Slocum, E. P. Roberts.

J. S. Healy, Elkins; L. E. Ermentrout, Borderland; J. C. Grymes, Wake Forest; F. W. Berryman, Tunnelton; D. S. Donley, W. S. Duvey, Page; C. M. Fenton, Marting; J. H. Claggett, Boomer; J. E. Cawley, Black Betsy; D. K. Graham, Eccles; R. T. Munn, Hinton; J. J. Lincoln, Elkhorn; J. R. Little, Maybeury; C. R. Jones, Morgantown; T. H. Claggett, Bluefield; C. I. Biddison, Pando; L. B. Holliday, Beckley; Daniel Howard, Clarksburg; Adam Lindley, W. Jones, Gulf; J. H. Laing, Berlin; Joseph Hoylman,

Coulton; Lawson Blankinsop, Bower; Dr. T. H. Elliott, Gauley Bridge; J. N. Sweitzer, Red Star; W. R. Thurmond, Oak Hill; E. P. McOliver, Mason; James H. Boyd, Newlyn; J. W. Herron, Hutchinson; P. A. Grady, Williamson; Charles Johnson, Big Chimney; William Nicholson, Bluefield; E. A. Henry, Clifton; J. H. Jackson, Montgomery; D. Evendoll, Sharon; J. W. Bischoff, Coulton; Thomas Davis, Bower; Bonner Heir, Chelyan; Josiah Keeley, Thomaston; A. C. Poole, Mt. Hope; J. H. Pierce, Mucklow; Albert Renard, Alderson; J. A. Milton, Coalburg; James Ranshard, Welch; R. S. Ord, Maybeury; Joseph Virgin, Plymouth; George Spreading, Ward; J. Page, Decota; Carl Robinson, Slump; F. L. Schoew, Chatteroy; E. E. White, Glen White; J. W. Straughn, Pratt; P. J. Stanton, Harding; Thomas Petkoski, Eccles; T. G. Wood, Sullivan; W. H. Stewart, Winnefred; L. D. Rhoades, Fayette; L. B. Stevens, Clarksburg; Gilbert Smith, Consho; W. M. Reynolds, Fayetteville; L. D. Vaughn, Grafton; Dr. I. C. White, Morgantown; C. R. Senstreck, Black Betsey; J. S. Boyd, Newlyn; J. A. Within, Coalburg; E. H. Shonk, Miami; O. E. Tucker, R. A. Walter, J. D. Snyder, Frostburg, Md.; F. L. Garrison, Cincinnati, Ohio; J. E. Beebe, *The Black Diamond*, Chicago, Ill.; E. B. Wilson, MINES AND MINERALS, Scranton, Pa.; David Newton, Connellsville, Pa.; C. A. Booker, Dante, Va.; W. Jones, New York, N. Y.; William Clifford, Jeanette, Pa.; F. Darlington, Great Barrington, Mass.; P. G. Gossler, New York, N. Y.; W. G. Conley, Scranton, Pa.; J. T. Beard, *The Coal Age*, New York; Herbert Davis, Baltimore, Md.; J. T. Overstreet, Roanoke, Va.; A. D. Shonts, Plymouth, Pa.; I. D. Shaw, Ben Avon, Pa.; W. W. Hall, Ashland, Ky.

KENTUCKY MINING INSTITUTE

The Kentucky Mining Institute held its first annual meeting June 10 and 11, at Lexington, in the College of Mines and Metallurgy, State University. Henry S. Barker, president of the college, delivered the address of welcome. The response was made by J. E. Butler, superintendent of the Stearns Coal and Lumber Co. Both addresses were on subjects pertaining to mining, and Judge Barker expounded some of his ideas on Kentucky mining affairs and their expansion in an impressive manner. In the business session, F. D. Rash, manager of St. Bernard Mining Co., Earlinton, Ky., was elected president. W. H. Cunningham, Ashland, Ky., vice-president First District; Dr. S. R. Collier, West Liberty, vice-president Second District; J. E. Butler, Stearns, vice-president Third District; B. R. Hutchcraft, Lexington, Ky., vice-president Fourth District; W. C. Taylor, Greenville, Ky., vice-president Fifth District; L. R. Long, Hopkinsville, Ky., vice-president Sixth District; C. S.

Nunn, Marion, Ky., vice-president Seventh District. T. J. Barr was reelected secretary, and M. L. Conley, treasurer. Papers were read on "Abridged History of Coal Dust Explosions," by E. B. Wilson; on "Coal Cutting," by E. L. Thomas, Southern Manager of the Sullivan Machinery Co.; on "Mine Haulage," by C. A. Bray, of the General Electric Co.; a paper on the "Hydraulic Cartridge vs. Powder," by R. G. Stevens was presented, but unfortunately was read only by title, Mr. Stevens being kept from attendance; demonstration and lecture on "Mine Fire-Fighting Apparatus," by James L. Bowie, Jr.; illustrated lecture by E. B. Sutton, Bureau of Mines, Knoxville. Mr. Sutton brought the United States Mine Rescue Car for demonstrating and inspection purposes. The meeting was carried on with vigor and snap, no time being wasted during the 2 days' session. The following 51 of a total membership of about 100 were at the meeting, which speaks well for its future: R. B. Hutchcraft, vice-president, Lexington, Ky.; Prof. C. J. Norwood, Lexington, Ky.; Henry S. Barker, president State University, Lexington, Ky.; Hywel Davies, Louisville, Ky.; E. B. Wilson, editor of MINES AND MINERALS, Scranton, Pa.; J. E. Butler, general manager Stearns Coal Co., Stearns, Ky.; F. Julius Fohs, mining geologist, Lexington, Ky.; E. B. Day, vice-president Coal and Coke Operator, Pittsburg, Pa.; H. H. Ashmore, Keystone Lubricating Co., Knoxville, Tenn.; J. H. Danahay, special agent Henry Clay Fire Insurance Co., Lexington, Ky.; H. LaViers, manager North East Coal Co., Paintsville, Ky.; J. C. Knuckles, president and general manager, Ferndale Coal Co., Ferndale, Ky.; Hugh M. Stokes, superintendent Continental Coal Corporation, Straight Creek, Ky.; T. J. Barr, assistant inspector of mines, Lexington; R. A. Casebier, assistant foreman, Lam Coal Co., Bevier, Ky.; W. T. Underwood, president Mt. Morgan Coal Co., Williamsburg, Ky.; H. D. Jones, assistant inspector of mines, Central City, Ky.; R. R. Atkins, mining engineer, Kentucky Block Cannel Coal Co., Cannel City, Ky.; R. D. Clerc, mine foreman for Cleare Coal Co., Coalton, Ky.; Henry Neal, distributor L. H. Ramsey & Co., Lexington; White L. Carns, motorman, Ely, Ky.; R. J. Carns, foreman, Rim, Ky.; Frank D. Rash, vice-president St. Bernard Mining Co., Earlinton, Ky.; John P. Barton, mine foreman for Campbell Coal Co., Coalmont, Ky.; Perry V. Cole, assistant inspector of mines, Barbourville, Ky.; C. R. Conner, of Cunningham & Conner, consulting engineers, Ashland, Ky., and Huntington, W. Va.; Wm. L. Caming, engineer, Jackson, Ky.; A. E. Morgan, superintendent Majestic Collieries Co., Majestic, Ky.; Thos. O. Long, assistant inspector of mines, Earlinton, Ky.; W. L. Moss, vice-president and general manager Continental Coal Corporation, Pineville, Ky.; R. D. Quickel,

fuel agent, Q. & C. Route, Lexington; W. W. Hall, president Chatfield Coal Co., vice-president Cedar Point Coal Co., Ashland, Ky.; M. D. Daniel, assistant inspector of mines, Ashland, Ky.; V. B. Abbott, chief engineer Consolidation Coal Co., Elkhorn Division, Jenkins, Ky.; W. L. Stollsworth, superintendent, Cany, Ky.; J. W. Cockill, general manager Big Branch Coal Co., Lookout, Ky.; Hiram Silvers, superintendent, Rim, Ky.; E. Dissinger, Professor State University, Lexington; John F. Pfoff, mine foreman, Mt. Morgan Coal Co., Williamsburg, Ky.; E. M. Howard, physician and surgeon, Continental Coal Corporation, Rim, Ky.; G. C. Rogers, student, Lexington; J. S. McHargue, Lexington; Henry K. Leighow, general manager KK. Fire Brick Co., Haldeman, Ky.; G. B. Rachley, Davisburg, Ky.; George Barton, Grays, Ky.; Robert Birch, Wilton, Ky.; C. M. Danir, mine foreman, Mahan Jellico Coal Co., Packard, Ky.; Forest Bice, Clay, Ky.; T. S. Mabrey, Bevier, Ky.; C. A. Bray, electrical engineer, Cincinnati, Ohio; E. L. Thomas, manager Sullivan Machinery Co., Knoxville, Tenn.

THE COAL MINING INSTITUTE OF AMERICA

The Coal Mining Institute of America held its fifty-sixth semiannual meeting at Johnstown, Pa., June 25 and 26. C. S. Price, President of the Cambria Steel Co., being indisposed, the dean of Pennsylvania mining engineers, John Fulton, gave an address of welcome. Jesse K. Johnston, vice-president of the Institute, responded with a few well-chosen words, which voiced the sentiments of the members. The business session then opened with an informal discussion on the "Weak Links in the Operating Chain of Coal Mines." In the afternoon, State Mine Inspectors Nicholas Evans and T. W. Evans presided over the question box. In the evening there was a banquet with H. S. Endsley, Esq., toastmaster; Mr. John Fulton, Mr. C. C. Geer, and Mr. Frank Gray, speakers. Mr. Fulton gave a reminiscence of the early days of mining at Broad Top and Johnstown, and brought matters up to the present day. Mr. Geer, being a lawyer, amused the diners with a Biblical, encyclopedic, and newspaper account of mining. Mr. Gray encouraged coal mining generally, also first-aid work. He is in the powder business. Mr. Endsley, as toastmaster, mixed levity and seriousness in a manner which delighted his audience. Mr. Geer tried to persuade Mr. W. R. Calverly to sing one of Harry Lauder's songs, but he balked. Wednesday morning was devoted to first-aid demonstrations.

Wednesday noon the members were lunched by the Cambria Steel Co., after which they were taken on a special train through the steel works. It is stated that there are over 100 miles of tracks in connection with these works, and while the Cambria Steel Co. does not receive the

publicity of some other steel works, it is an exceedingly large plant. On boarding the special observation cars the visitors were taken through the Gautier works to the by-product coke ovens, where they went through the Franklin coal tippie, coal-washing plant, by-product coke oven plant, and then through the No. 7 and No. 8 blast furnace engine house. Here they boarded the train and were taken to the plate mill. On departing they were taken to the Franklin power house, then to the Franklin open-hearth department, and to the car shops where steel cars were in the process of construction; then to the forge shops, beam yard, and structural machine shops, apast the Gautier works to the Cambria plant.

dent of the institute, presided. After receiving a warm welcome from Governor Harmon, Mr. Karb, and J. E. Todd, president, Wednesday a business session was held and papers read by Karl F. Schoew, on "Quality and Quantity of Mine Air"; by J. J. Rutledge, on "A Suggestion in Regard to Good Mine Inspection." On Thursday Chas. H. Nesbit presented a paper on "Need of Better Discipline and Cooperation in Mining." Frank I. Pearce presented a paper on the "Coal Mining Industry in Indiana." A visit was made in the afternoon to the Jeffrey Mfg. Co.'s works, where a large delegation of Jeffrey employes welcomed the visitors and conducted them through the plant. One of

before placing on the market, and also the locomotive test machine, were shown and explained.

A banquet was held at the Great Southern Hotel for members and guests on Thursday evening and over 100 attended.

The accompanying photograph of the inspectors and guests was taken at the works of the Jeffrey Mfg. Co. The names of those shown in the photograph are as follows: First row—sitting on ground—left to right—Thomas Moses, Superintendent of Mines, Westville, Ill.; John Laing, Chief Department of Mines, Mrs. John Laing, Charleston, W. Va.; J. T. Beard, Associate Editor *Coal Age*, New York.

Second row—Miss Devore and Miss



MINE INSPECTORS AND GUESTS AT COLUMBUS MEETING

From there the train took them to the blooming, billet, and beam mills, then to the Bessemer steel works, No. 1 mill, 18-inch mill, and shops to the east end of the wire mill. Here they left the train and passed through the wire and rod mill drawing room, wire fence room, nail mills, to the western end of the wire plant where they entrained. From here the visitors were taken to Hinckston Run and returned by way of ore yards on No. 1 to 4 and 5 to 6 blast furnace trestles, thence to the hotel.

The entire trip took nearly 5 hours and was enjoyed by every one. The members are indebted for this enjoyable outing to Mr. C. S. Price, president of the steel company, and to Mr. M. G. Moore, who so kindly conducted them through the various departments.

MINE INSPECTORS' INSTITUTE

The fourth annual meeting of the Mine Inspectors' Institute of the United States was held in the Great Southern Hotel, Columbus, Ohio, June 17, 18, 19, 20, and 21. The sessions commenced Tuesday morning. The day was given up to organization and addresses. John Laing, Presi-

the interesting sights was the construction of fans, one 36-inch fan being able to furnish 45,000 cubic feet of air per minute; another 8-foot, double-inlet, blowing fan was set in motion and furnished so great a blast none of the visitors were able to remain in front of it. Another sight was the construction of an 18-foot fan and housing. This fan has a capacity of 450,000 cubic feet under normal conditions. The members were taken through the shops, where they saw the assembling of electric coal cutters, drills, locomotives, and other mining machines. They next visited the molding shops where power molding machines are in use. It will be remembered that the introduction of these machines caused a long strike, molders being opposed to them as a usurpation of their work. Several other departments were visited where chains were being tested, the forge shop, machine shop, chain and conveyer shops, etc. The visitors could not help admiring the attractive little storage-battery locomotives which were hauling material about the works here and there. The experimental works, where working models and apparatus perfected

Jenkins, Bellaire, Ohio; Alexander Smith, Mine Inspector, Mrs. Alexander Smith, New Philadelphia, Ohio; Frank Parsons, District Mine Inspector, Mrs. Frank Parsons, Clarksburg, W. Va.; Miss Devore, Bellaire, Ohio; Miss Smith, New Philadelphia, Ohio; W. H. Miller, Mine Inspector, Mrs. W. H. Miller, Massilon, Ohio; Mrs. Thos. Moses, Westville, Ill.; Mrs. Jas. Martin, Charleston, W. Va.; Mr. Jas. Martin, Charleston, W. Va.; Mr. E. A. Henry, District Mine Inspector, Mrs. E. A. Henry, Clifton, W. Va.; Mrs. Isaac Hill, Zanesville, Ohio.

Third row—Robert S. Wheatley, Mine Inspector, Salineville, Ohio; Edw. Flynn, Pratt City, Ala., Inspector for T. C. I. & R. R. Co.; Thos. Graham, Department of Mines, Vistoria, B. C.; Thos. Hudson, State Inspector of Mines, Galva, Ill.; Edw. Kennedy, Mine Inspector, Carbon Hill, Ohio; John D. McDonald, Glouster, Ohio, Mine Inspector; Thos. S. Lowther, Bituminous Mine Inspector, Punxsutawney, Pa.; John Dunlop, State Mine Inspector, Peoria, Ill.; Ed. Boyle, Chief State Mine Inspector, McAlester, Okla.; J. W. Paul, Mining Engineer of Bureau of Mines,

Pittsburg, Pa.; Clarence Hall, Explosives Engineer, Bureau of Mines, Pittsburg, Pa.; D. J. Roderick, Anthracite Mine Inspector, Hazleton, Pa.; Mr. Roderick, visitor, Columbus, Ohio; Geo. E. Sylvester, Chief Mine Inspector, Rockwood, Tenn.; Isaac Hill, Mine Inspector, Zanesville, Ohio; L. D. Devore, Bellaire, Ohio, Mine Inspector; Mr. Thos. Morrison, District Mine Inspector, Mrs. Thos. Morrison, Sherodsville, Ohio.

Fourth row—John F. Bell, Bituminous Mine Inspector, Dravosburg, Pa.; Lot Jenkins, Mine Inspector, Bellaire, Ohio; C. P. McGregor, Bituminous Mine Inspector, Carnegie, Pa.; Oscar Carlidge, State Inspector of Mines, Marion, Ill.; W. W. Williams, State Inspector of Mines, Marion, Ill.; Thos. Little, State Inspector of Mines, Murphysboro, Ill.; Jas. Taylor, State Inspector of Mines, Peoria, Ill.; Martin Bolt, State Inspector of Mines, Springfield, Ill.; Chas. H. Nesbitt, Chief Mine Inspector, Birmingham, Ala.; Karl F. Schoew, District Mine Inspector, Fairmont, W. Va.; R. Y. Muir, District Mine Inspector, Prince, W. Va.; M. D. Daniel, Assistant Inspector of Mines, Ashland, Ky.; W. W. Hall, Ashland, Ky.; Arthur Mitchell, District Mine Inspector, Bluefield, W. Va.; Lance B. Holliday, Beckley, W. Va., District Mine Inspector; James Hennessy, Barton, Ohio, Mine Inspector; Thomas Wangler, Columbus, Ohio; Frank Haley, Henrietta, Okla., District Mine Inspector; John Burks, Mine Inspector, Wellston, Ohio; D. T. Davis, Anthracite Mine Inspector, Wilkes-Barre, Pa.; Geo. Davis, visitor, Columbus, Ohio; J. J. Rutledge, Mining Engineer, Bureau of Mines, Pittsburg, Pa.

The following officers were elected to serve during the ensuing year: President, Thos. K. Adams, Pennsylvania; vice-president, D. J. Roderick, Pennsylvania; vice-president, Edward Flynn, Alabama; secretary, J. W. Paul, Pennsylvania; treasurer, R. T. Rhys, Iowa; assistant secretary, R. S. Wheatley, Ohio; editor, J. T. Beard, New York.

Trade Notices

New Office Building.—The Vulcan Iron Works, of Wilkes-Barre, Pa., are about to erect an office building the cost of which is estimated at \$100,000. The structure, 67×83 feet, will be built of concrete, steel, and brick and will be directly opposite their present building. The basement will contain four office rooms, a vault, and a room for machinery exhibits. On the first floor will be ten office rooms, a vault, and a large entrance hall. On the second floor will be nine office rooms, a vault, and vestibule. A drafting room, a vault, and one office occupy the third floor. Elevators will connect the various floors.

Non-Return Boiler Stop-Valve.—It is evident that should a tube be blown out or a fitting ruptured in one of the boilers

of a battery, the steam from the other boilers would rush into the header and discharge into the disabled one. To avoid the possibility of such an occurrence, The Lunkenheimer Company have designed a non-return valve to be inserted in the steam pipe between the boiler and the header; then should an accident occur to the boiler permitting the steam to escape, the valve attached to that boiler will immediately close. This will prevent the escape of steam from the other boilers connected with it in the battery, the danger to life and property will be greatly lessened, and the plant can be operated with the other boilers, without interference, thereby preventing loss of time and money. This valve will prevent steam from being turned into a boiler which has been cut out for cleaning or repairs, as it cannot be opened by hand when pressure is on the header side. It can, however, be closed when desired. Valves for this purpose have been made before, but this improved valve has special features which obviate difficulties which have been met, such as chattering and wear from sudden variations of pressure in ordinary work. It is worth while writing for a complete description, which can be had for the asking.

New Electric Equipment.—The Ophir Consolidated Mining Company, Ophir, Utah, will make additions to its electrical equipment consisting of one 50-horsepower, three 35-horsepower, and one 15-horsepower motors and three 50 kva. transformers. The Homestake Mining Company, Lead, S. D., will also add five motors to the electrical equipment in its mines. These consist of one 10-, two 15- and two 25-horsepower motors. All these will be furnished by the General Electric Company.

Coal Handling Machinery.—The Roberts and Schaefer Company have recently been awarded a contract for designing and building a large traveling coal bridge, aggregating over \$100,000, for installation at the docks of the Clarkson Coal & Dock Company, Duluth, Minn. They also have closed a contract for a complete coal mining and coal washing plant for the American Fuel Company at Thompson's, Utah; and a coal tippie for the Virginia-Pocahontas Coal Company at Coalwood, W. Va. Besides these they also have received orders for Holmen locomotive coaling stations from the St. Louis and San Francisco railroad and the Michigan Central railroad.

Sullivan Machinery Company Office in W. Va.—For convenience of users of their machines, the Sullivan Machinery Company have opened an office at 841 Court St., Huntington, W. Va., J. S. Walker, Manager. A complete stock of parts and supplies for Sullivan continuous electric undercutters, compressed air

punchers, rock drills, and hammer drills will be kept on hand, and all express and rush freight shipments will be taken care of from Huntington, but in some cases large freight orders for parts for mine stock will be filled from the factory.

Current Connectors for Mine Use.—For making quick connection of circuits in mines to the trolley wire, the Ohio Brass Company, of Mansfield, Ohio, is offering two new devices. One is a current tap for lighting or other circuits carrying small current and is so designed that it may be quickly applied to the trolley wire and offers no obstruction to the trolley wheel passing under it. It consists of two sherardized malleable iron castings held together by a brass screw which, when tightened, causes the jaws to grip both wires, and it will fit any ordinary lighting circuit wire and any size of grooved or figure 8 trolley wire. The other is a cutting machine connector, designed for connecting to the trolley wire the cables from cutting machines and other apparatus requiring a comparatively heavy current for operation. It is mechanically strong, with heavy phosphor bronze contacts and springs, and is provided with a brass sleeve which fits over the insulation to prevent the breaking of the cable due to sharp bends at the point where it is soldered to the connector. It is regularly drilled for No. 2 cable and is tinned for soldering. The spring jaws will fit any round, figure 8, or grooved wire, being simply slipped over the wire either from above or below.

來 來

The Atlantic Fleet

The Atlantic Fleet of the United States comprises 102 vessels of all classes, with a displacement of 577,285 tons. Exclusive of submarines, these vessels represent 946,811 horsepower; all the battleships, cruisers, and torpedo boats, except the Iowa, have water-tube boilers. At the time of the Spanish-American war only four warships outside of the torpedo boats were equipped with water-tube boilers. Seventeen of the destroyers burn oil as fuel, and the Delaware, North Dakota, Utah, and Florida, four recently built battleships, burn oil in conjunction with coal. The fleet has a fuel-oil tank ship and eight colliers to supply it with fuel. The capacity of the colliers is 58,813 tons; the aggregate coal-bunker capacity of the fleet is 81,450 tons, or a total of 140,263 tons of coal. If the entire fleet was propelled at full power it would consume 20,000 tons of coal per day, or about 3 acres of 5-foot coal bed per day. The Government has invested \$123,397,400 in this fleet, and so long as it keeps in motion and new ships are constructed, it is a good asset of the "coal and iron trade."

THE following article is abstracted from a paper read at the Fairmont meeting of the West Virginia Coal Mining Institute:

Methods Employed in the Removal of Coal from the No. 2 Gas Seam in the Kanawha District

*By J. J. Marshall**

Unfortunately there has been, and still is, a more or less general impression that coal mining is purely a game of chance. We hear success or failure spoken of as good luck or bad luck. Likewise a "creep" or a "squeeze" is spoken of as though it were something which man could neither foresee nor prevent. However, we live and learn, and skill is now coming to be generally recognized as a controlling factor in mine management. The financial success or failure of a coal mine operation is due directly to cause and effect; and owing to the "intimate

The No. 2 Gas bed is classified as belonging to the Kanawha measures, and is the third workable bed above the Raleigh sandstone, the first being the "Eagle," or Clarion; the second, the "Powellton," which is worked locally on Armstrong Creek, Fayette County, where it is about 40 feet below the No. 2 Gas bed, but which is not worked anywhere else, to my knowledge. The No. 2 Gas bed, which was erroneously correlated with the Lower Kittanning of Pennsylvania Series, along its eastern escarpment is frequently divided into two

appearance in the vicinity of Hawks Nest, in the Gauley and Cotton Hill mountains, at an elevation of about 900 feet above the river, and has been worked extensively at Ansted since 1873, where it is known locally as the "Ansted Seam." This bed passes under the railway grade at East Bank, 27 miles to the westward. Numerous rivers and small streams drain this region, and erosion has carved the once continuous beds of coal into irregular and fantastic shapes. The resulting long and broken outcrop lines offer many difficult problems in both outside and inside haulage, but these disadvantages are compensated by the absence of firedamp, which escapes and is rarely found in dangerous

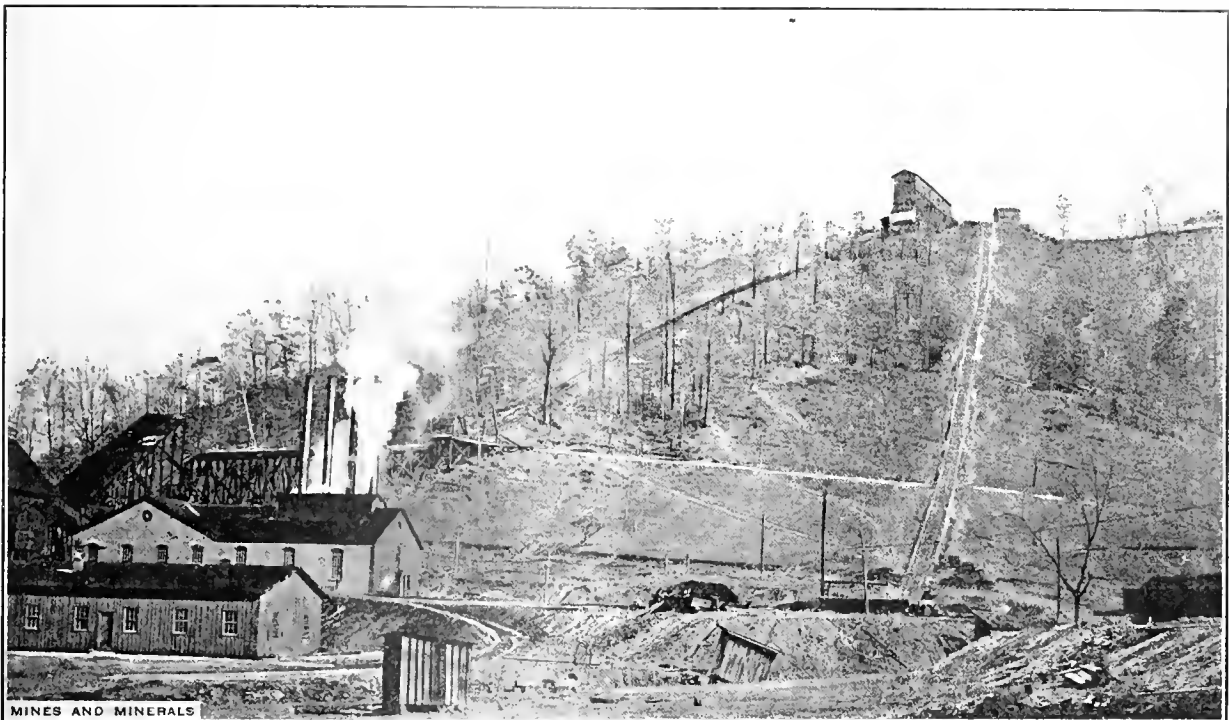

FIG. 1. DRUM HOUSE AND PLANES, LOUP CREEK COLLIERY CO., PAGE, W. VA.

connection of its several parts," it is imperative that in judging any one phase all other interdependent factors should be kept in mind. The cause may be divided into three parts—the character of the problems presented for solution; the general plan selected as combining the solutions of these problems; and, lastly, the manner in which the general plan is interpreted and the details executed by the operating department. The effect is automatically registered on the cost sheet, which is only a true index when considered as an average for a term of years. The percentage of recovery is also due to cause and effect; for, given certain conditions and certain methods of mining, the result is inevitable.

or more benches by slate bands varying in thickness from a few inches to 50 feet, but the aggregate thickness of these benches along the eastern escarpment invariably totals about 9 feet. In many places both splits can be worked together, but as a rule they must be worked separately. This bed, in common with all the beds of this district, thins down to the westward, as it approaches the Ohio River syncline, and changes both chemically and physically. Physically this bed is marked by face and butt cleats, and this is taken advantage of in mining, as all face-choat workings get full benefit of both grade and drainage, the face cleatage workings being in the direction of the maximum rise. In traveling westward on the Chesapeake & Ohio Railway, the No. 2 Gas coal bed makes its first

quantities under such conditions. The drainage problem is also simplified.

The Loup Creek colliery is working the No. 2 Gas coal bed in the mountains, around Page, W. Va., which rise to a height of 2,700 feet above sea level, or 1,700 feet above Loup Creek. There the No. 2 Gas coal is 700 feet above the creek and dips N 22° W at the average rate of 100 feet to the mile. Thus the cover over the coal varies from only a few feet at the outcrop to a maximum of 1,000 feet in the center of the mountain, the summits being capped by the Black Flint ledge. Beginning at the lower tippie, the first 420 feet of elevation to the bench formed at the outcrop of the Eagle bed is overcome by means of a double-tracked incline, 1,000 feet long. Here is located the upper tippie and drum house,

* Mining Engineer and Assistant General Manager, Loup Creek Colliery Co.

and to it is brought the coal from both the Eagle and No. 2 Gas beds. The remaining elevation to the No. 2 Gas coal is overcome by means of a tramroad, with a minimum radius of curvature of 150 feet, a maximum grade of 2.8 per cent., and which by rising toward the dip of the coal gains slightly and reaches the coal at No. 7 drift mouth at a distance of 8,300 feet from the tippie. From No. 7 northward to No. 2, the tramroad follows the outcrop of the coal on grades varying from -1.50 to $-.25$ per cent., and with a minimum radius of curvature of 100 feet. In this locality the No. 2 Gas coal bed is made up of two benches which are separated by a slate of variable thickness. This dividing slate may be compared to a finely tapered wedge; beginning with a thickness of 10 inches at No. 2, it gradually thickens until 30 inches is reached near the mouth of the face entry. From this point southward the increase is rapid until a maximum of about 40 feet is finally reached. Twenty-four inches has been found to be the economical thickness beyond which it is not practicable to move this slate.

At first No. 7 was thought to be the last entry where both benches could be mined simultaneously, but later on, when it was found that the slate was thinner under the center of the mountain than at the outcrop, it was taken up in No. 8 entry left, and both benches worked. The aggregate thickness of the two benches averages about 9 feet, the upper bench ranging in thickness from 4 feet 6 inches to 5 feet 6 inches of clean coal, and the lower bench from 3 feet 6 inches to 4 feet of clean coal. Where it is impossible to mine both benches together, the upper bench only has been taken so far, and the lower bench is left intact for separate working in the future. In this paper that part of the mine where both benches are taken is termed the "high coal," and the part where only the upper bench is taken, the "upper coal."

From No. 7 entry northward to the point of the ridge, the mountain being narrow, the coal is developed by pairs of cross-entries, each of which is an independent drift opening, and has been worked as such. From No. 7 entry southward, the mountain widens to a maximum width of over 6,000 feet, and is split by a pair of face entries from which butt entries are turned right and left. In the high coal the entries are driven 10 feet wide and 110 feet center to center, rooms 400 feet long, and barrier pillar 100 feet. In the upper coal the entries are driven 10 feet wide and 70 feet center to center, rooms 350 feet long, and barrier pillar, 100 feet. All rooms are on 60-foot centers, 25-foot rooms, and 35-foot pillar. All are 14 feet high, and driven as prescribed, and from 10 to 14 feet wide. From No. 7 a few "Pneumelectric"

punchers, the coal is mined by pick work, the mining seam being in the middle of the upper bench.

The outside tramroad is laid with 65-pound steel rails, the entries with 35-pound, and the rooms with 16-pound steel rails of standard sections. All roads are 44-inch gauge, all turnouts and track details in general are standardized and factory made, to avoid duplications of parts, and confusion and delay when making repairs. A height of 5 feet, over the rail, is maintained in the main entry, and in the cross-entries $4\frac{1}{2}$ feet over the rail is maintained. Loose slate is taken down, and except where it is impossible to avoid their use, no timbers are allowed in haulways. Permanent haulways are brought to a grade wherever necessary, and all haulways are kept in a clean, dry, safe, and serviceable condition, experience having shown that, even where trip movement is not considered, it is cheaper to maintain a haulway in this manner than to keep a dirty and unsafe haulway in passable condition. Slate and track cleanings, from narrow work, are loaded into the mine cars and sent to the slate dump. The mine cars are built by, or the materials ordered from, the Watt Mining Car Wheel Co., and are of wooden construction, height over rail 3 feet; 3 belt; flared top; 16-inch loose wheel; end brake; weight 2,000 pounds; average load, 2.6 gross tons of coal; and are equipped with patent spring bumpers. From the time the coal leaves the face, until it is dumped into the railroad car, the object has been to make gravity do the work; and only on secondary haulways is there any grade against the load, and even these exceptions are unimportant. Haulage on the outside tramroad is effected by means of 25-ton steam locomotives, of which there are on hand three—one built by the Baldwin Locomotive Works, and two by the H. K. Porter Co. One steam locomotive can, and has, returned 60 empties up the grade, which makes the capacity 156 gross tons per round trip from the main assembling point at No. 7. The time required for a round trip is about 45 minutes. To gather the cars and deliver them to the steam locomotive on the outside tramroad, there is a 500-volt, direct-current, electric haulage system, and, except in the high coal from entries No. 7 to No. 3, mules have been replaced by 5-ton Westinghouse and General Electric gathering motors. Mules are in use in entries from No. 7 to No. 3, but in the territory served by the main entry, the gathering motor delivers the cars to the double partings at the mouth of the cross-entries. A 10-ton electric locomotive gathers from these double partings and delivers to the steam locomotive, which, in the meantime, has gathered from the mule hauls and is back at the main

assembling point near entry No. 7. The 10-ton parting locomotive is the secondary unit of a 20-ton tandem, the primary unit of which can be added at any time. From entry No. 7 the trip is dropped down grade to the upper tippie, where the mine cars are unloaded by a Philips automatic cross-over dump (capacity three cars per minute), into the chute, which holds 75 tons. From this chute the coal is loaded into 8-ton capacity self-dumping monitors which descend and discharge into the chute at the lower tippie, the time required for this entire operation being from $1\frac{1}{2}$ to 2 minutes.

Having followed the coal from the face to the railroad car, attention is directed to the electric current as it makes its circuit. Four 150-horsepower boilers furnish steam to a 50-horsepower Corliss engine which is belt connected to a line shaft that drives 160-kilowatt, 250-volt, General Electric generators, which, being connected in series, give 550 volts at the switchboard. The power line, consisting of three 4-0 copper wires, transmits the current to the mouth of the main entry and delivers 520 volts; from this point the current is transmitted to the motors and pumps by one 4-0 grooved trolley wire. The return is made through the rail, both rails being cross bonded every 500 feet. All electric wiring and bonding is kept in repair, one man and a boy being detailed to take care of the erection and maintenance.

Drainage in many instances can be made to take care of itself in the natural manner; for instance, several entries are drained by openings driven through the outcrop. Siphons are used to unwater holes which cannot be drained by ditching but are within, say, 1,500 feet of an outside opening. Where neither of the above methods is practicable electric pumps are called into service, or, if it is merely a few gallons which have accumulated at a working face, our old friend, the water box, is made to do duty. The pumping equipment consists of three rotary pumps, geared to 5-horsepower motors, with a capacity of 50 gallons per minute, and one rotary pump geared to a 10-horsepower motor, capacity 100 gallons per minute. The general direction of advance being toward the rise, the new work is not in any danger of being hampered by water from the old work.

There has been no indication of explosive gas; and the dust problem, owing to the natural conditions, offers no serious cause for apprehension; nevertheless, this is not overlooked, and by keeping the roadways clean, regulating the air-current, and, when necessary, using water in the dry places, the possibility of a dust explosion is made still more unlikely. If an explosion, or some other catastrophe, did occur, the conditions are such that,

generally speaking, it would probably be local in its effect and the survivors would have numerous avenues through which it would be possible for them to escape.

The entries from No. 7 to No. 3, inclusive, are ventilated by means of the ordinary basket-grate furnace and wooden stack. The area of cross-section being large, and the distance the air travels being short, this method has proved sufficient. In June, 1909, the furnace at the mouth of the main airway was replaced by a 60-inch, double-inlet, Sirocco fan

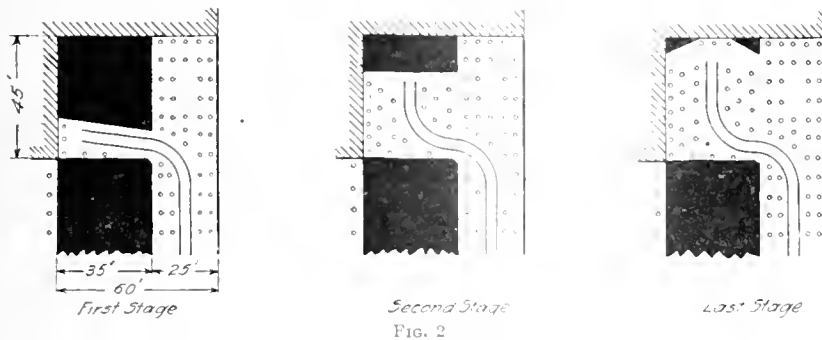

Second Stage
Last Stage
Fig. 2

which was guaranteed to deliver 100,000 cubic feet of air per minute at a 2-inch water gauge. This guarantee called for two 35-horsepower motors, but only one was installed, and it has not been found necessary to install the second one, the fan fulfilling all present requirements and delivering with ease 80,000 cubic feet of air per minute. The fan is installed to either force or exhaust, but so far only the exhaust method has been used. The speed of the motor is varied by means of a field control rheostat, which is a valuable feature. When moisture is being precipitated on the roof of the mine, or when an excess of moisture is being carried out of the mine, the speed of the fan can be readily regulated to deliver, at the working face, only enough air to fulfill actual requirements. By applying "the rule of reason" under these conditions, to supply to the miner more air than he actually requires, is to unnecessarily increase the risk of his being killed by a slate fall or by a dust explosion. The numerous openings on the outcrop facilitate ventilation, as well as drainage and timber supply, and, by using them as intakes, the speed of the fresh air-current is kept uniformly low. The stoppings, in the main entries, are built of brick or stone, and in the butt entries, of plank. Brattice cloth is used wherever it is necessary to deflect the current up into the rooms.

With the ordinary method of driving rooms and drawing pillars on the advance, the mine is now in condition to work the butt entries on the retreating system. This reversal in general method

is now being pushed without lessening the output, and adding materially to the safety of the mine.

Advances and rooms are driven on centers, the pillars for which are put in with a timber, and from these the miner can check in the course of his place in a few minutes. The pillars are drawn in steps, and Fig. 2 shows the details of the method used.

The roof of the mine varies considerably in both disposition and composition, and is of blue slate, sand slate, or sandstone and slate mixed. It is usually

stratified for a distance of from, say, 75 to 100 feet, when a massive sandstone ledge is reached, and this latter is very hard to break.

In the high coal, the floor of the mine may be classed as good and is 8 inches of slate and then sandstone. In the upper coal, the floor, which is the previously mentioned dividing slate, is good in solid work and usually so in pillar work. In the latter case it has only given trouble when thin and in contact with water, in which case it may slack and creep. In the entries from No. 7 to No. 2, inclusive, the rooms were worked on the advance and were turned as soon as available. The general method of pillar mining, in this section, has been to take out the room

and due to this cause the retreat has been seriously interfered with.

The pillar drawing in No. 7 entry was advanced in strict accordance with the general method, and all indications were that the roof was breaking as soon as the coal was removed; however, a squeeze came on and it was only by hard work that the entry, from room 12 to room 20, could be kept open. This made a change in method imperative, so No. 27 room was converted into a haulway, and the coal from beyond the affected area was hauled that way to No. 8 left. An attempt was then made to start in the center of the affected area and retreat in both directions, but it was found impossible to get enough open space to insure a good fall. The men were all withdrawn and the roof allowed to settle, then by working only one place on each side, a good start was made toward getting a fall that would break the top far enough up to relieve the pressure. The only reasons to assign for this trouble are, that the previously mentioned sandstone ledge had not been broken, or that the roof was subjected to unknown strains. This occurrence is a concrete example of the advisability of working on the retreating system, and had it not been for the outlet through No. 8 left, the coal beyond the affected area would either have been lost or the profit therefrom would have been eaten up by the cost of maintaining an outlet.

Generally speaking, the methods followed have necessitated only a minimum amount of dead work, of mine timber, and of trackwork and track materials. Also the large blocks of coal, which are at present left intact, should prevent the general extension of any trouble which may be brought about by the removal of pillar coal.

On June 30, 1911, the percentage of recovery stood as follows:

COAL AREAS AND PERCENTAGES OBTAINED

	Total Area From Which the Coal Has Been Extracted Acres	Total Area in Which the Coal Has Been Lost Acres	Total Acres	Percentage of Recovery Per Cent.
High coal (both benches).....	77.75	6.86	84.61	91.8
Upper coal (upper bench only).....	67.00	.87	67.87	98.7
	144.75	7.73	152.48	94.9

pillar to within 100 feet of the entry on the advance, and then draw the barrier pillar, chain pillar, and room stump retreating.

The general grade of No. 6 entry is very nearly level, but there are several depressions which, due to the pillars being mined to the rise, catch a considerable volume of water during the rainy season,

In cost of production, the aim has been to secure a *minimum average*, rather than to let each month stand for itself alone. The cost of labor and material per gross ton of coal mined was less for the year 1910 than for the year 1906, and for the five years inclusive the difference between maximum and minimum was less than 3 cents.

Answers to Examination Questions

Answers to Questions Asked at the Examination for Mine Foremen, Held in Utah, October, 1911

(Continued from July)

OWING to an error the answer to Ques. 2, page 723, in our July number is given as 3.33 per cent. instead of 3.22 per cent.

QUES. 1.—(a) What in your opinion should be done with torn brattice cloth found on entries and other mine workings? **(b)** What are the dangers attending the presence of such material in the mine?

ANS.—(a) Torn brattice cloth, pieces of wood, as well as all other combustible material, should be gathered up and removed from the mine. **(b)** These waste materials are apt to catch fire from various agencies, but largely from burning wicking thrown upon them by a miner in changing the cotton in his lamp. One, at least, of recent dust explosions originated from a mine fire which was started by some drivers setting fire to the combustible rubbish near a brattice where they were accustomed to eat their dinners. The blaze of the burning rubbish was communicated to the nearby brattice, which in turn set fire to the coal. Dust was fed into the fire, which probably generated a certain amount of CO , until, within about an hour from the starting of the fire by the drivers, the mine exploded, resulting in the death of over 75 men.

QUES. 2.—As mine foreman, what arrangement would you make respecting miners carrying tools, such as picks, shovels, drills, etc., in the man trip?

ANS.—If practicable all supplies of this nature should be carried in a separate car from the men. If this is not possible, care should be taken to see that the end gate is closed so that nothing may drop out and derail the trip, and nothing should be allowed to project above the top of the car to come in contact with trolley wires, the roof, or timbers. In all cases where men are carried in the same car as tools, the latter should be laid upon the floor and not carried in the hand or upon the shoulder.

QUES. 3.—(a) If the barometer reads 23.20, what is the pressure on a square inch? **(b)** On a square foot?

ANS. (a) Assuming the temperature to be $32^{\circ} F.$, the pressure per square inch is found by multiplying the height of the barometer in inches by the weight of a column of mercury 1 inch high; that is, by the weight of 1 cubic inch of mercury, or .4911 pound. We then have, $23.20 \times .4911 = 11.39352$ pounds as the pressure per square inch. **(b)** The pressure per square foot is, of course, the pressure per square inch multiplied by 144, or $11.39352 \times 144 = 1,640.66$ + pounds.

QUES. 4.—Explain three ways in which an explosion can occur in a coal mine where the safety lamp gives no indication of gas?

ANS.—It is necessary to assume the presence of explosive dust; for without either gas or dust, an explosion is not possible. It must be remembered that very small quantities of marsh gas that cannot be detected by means of even the best safety lamp are a source of danger in the presence of the dry dust so prevalent in American mines. Probably the chief initial, or first, cause of explosions in dusty mines must be laid to blown-out shots, due to overcharged and misplaced holes in which black powder has been fired. By undercutting the face to at least 6 inches more than the depth of the shot hole, by properly placing the holes, and by using the right amount (and no more) of permissible, short flame, explosives, the danger from this source may be reduced to a minimum. In connection with the above, the dust from machine cuttings should be loaded out of the mine, and, where practicable, the rooms should be watered for a distance of from 60 to 90 feet back from the face.

A second, but less common, cause of explosions are mine fires. In the confined passageways of a mine, owing to lack of sufficient air to furnish enough oxygen for complete combustion, coal in burning will form more or less CO , itself a combustible gas. A sudden accession of fresh air may cause the CO to explode, or dust may be drawn into the fire and originate a dust explosion. Mine fires may be prevented by constant watchfulness on the part of those in authority that they may be extinguished before getting beyond control; by loading out all gob that contains carbon, as well as all fine coal; by keeping uncovered electric wires from coming in contact with wood, etc., and by removing from the mine all inflammable material such as old brattice cloth, chips, shavings, and the like.

A third cause of explosions is due to the use of electricity in mining operations. Numerous mine fires are known to have been started by uncovered wires coming in contact with wood and other combustible materials, but explosions from electricity are brought about by short-circuiting of the current in the presence of clouds of dust. A fall of roof may bring down the wires into contact with the rail or with the iron

work of mine cars or with water or air pipes and the like. The high temperature of the arc thus produced will distil the gas from the dust, and, if the current is continued

for a sufficient length of time, will generate enough gas to cause an explosion which may be communicated to the dust. The explosion at Starkville, Colo., is known to have been, and that at Monogah, W. Va., is, by the best authorities, believed to have been, caused by the short-circuiting of the electric current, in each instance the wires having been brought down by a runaway trip knocking out the supporting posts. Means of prevention are not sure. The use of storage battery locomotives, with machine wires in conduits buried alongside the track, will, of course, prevent explosions due to short-circuiting of the wires; but such means are, in many cases, not possible by reason of the cost. In any case overhead wires should be so supported as to reduce to a minimum the chance of their being knocked down by runaway trips.

QUES. 5.—If going into a working place you found the miner's lamp full of explosive gas, how would you treat it?

ANS.—The lamp should be approached cautiously so that no air-currents may be stirred up to force the flame through the gauze. It should be lowered slowly through the gas, placed under the coat and thus smothered. Before being relighted it should be most carefully examined for imperfections in the gauze.

QUES. 6.—How would you arrange electric wires on haulage roads to avoid, as far as possible, the danger of accident to workmen engaged on such roads due to live wires?

ANS.—The headings should be driven straight so that the wires may be placed a uniform distance from the rib and as far from the track as possible. By driving the headings straight the traveling way may always be placed on the side of the entry *opposite* the trolley wire. The trolley wire should be placed in an inverted wooden trough with sides 3 inches or more in depth so that a man's head may not come in contact with the wire when standing on the rail; and so that iron tools carried on the shoulder may not touch it. The road bed should be carefully drained and kept dry, as moisture tends to increase the severity of the shock. Above all, the men themselves should be instructed in the dangers connected with electricity and taught not to carry iron tools on their shoulders when traveling on a road where there are naked trolley wires.

QUES. 7.—If a slope 3,000 feet long on a

15-degree pitch was making 500 gallons of water per minute, how would you determine the horsepower of a pump to handle the water in 16 hours out of the 24 hours, allowing 20 per cent. for friction?

ANS.—Since all the pumping is done in 16 hours out of the 24, or in two thirds of the time, the required discharge is equal to $500 \times \frac{3}{2} = 750$ gallons per minute. Since an allowance of 20 per cent. is to be made for friction, the pump must be sufficiently powerful to raise 20 per cent. more than this amount of water, that is, the pump must be capable of raising $750 + (750 \times .20) = 750 + 150 = 900$ gallons per minute. The head is found from the formula, $H = L \times \text{sine angle of slope} = 3,000 \times \text{sine } 15^\circ = 3,000 \times .25882 = 776.46$ feet. The weight of a gallon of water may be taken as $8\frac{1}{8}$ pounds and the total weight of water to be raised in 1 minute is $900 \times 8\frac{1}{8} = 7,500$ pounds. From the preceding, the horsepower of the pump is

$$HP = \frac{7500 \times 776.46}{33,000} = 176.44$$

The result may be obtained by finding the horsepower required to raise 500 gallons a minute through the required distance; multiplying this by $\frac{3}{2}$, as the water is raised in $\frac{2}{3}$ of a day, and adding to this last result $\frac{1}{5}$ of itself as the 20 per cent. allowance for friction.

QUES. 8.—Where, and under what conditions would you consider the use of electricity safe in a dry and dusty mine in which explosive gases are generated?

ANS.—The conditions described are the most dangerous that can occur. Any answer to this question would probably be disputed by those in favor as well as by those not in favor of the use of electricity in mines. However, it will hardly be denied that under the described conditions, more than the usual precautions must be observed to render the use of electricity safe. Most persons will agree that low-voltage haulage is permissible on the main and other entries where there is an ample volume of air, no holes or pots in the roof where gas may accumulate, and where the roads are always sufficiently wet to keep down the dust. Whether electricity may be used to operate coal-cutting machines in the rooms will depend upon how well the air-current is kept up to the face. If the air is kept up to the face and the motors are encased in gas- and dust-proof casings, there appears no valid reason why electricity may not be used to operate the coal-cutting machinery, particularly if the bng dust, etc., is kept well watered down. Under the described conditions many would advocate the use of compressed air for both haulage and coal-cutting purposes. Under no circumstances could a gas or dust explosion

result through the use or abuse of compressed-air haulage or coal-cutting machinery.

QUES. 9.—What is afterdamp and why is it at times so much more deadly than at other times?

ANS.—Afterdamp is the intimate mixture with the mine air of the gaseous products of combustion resulting from an explosion of marsh gas or coal dust, or of both. Or it may be defined as air in which a greater or less proportion of the oxygen has been replaced by various gaseous products of combustion. The chief constituents are usually and in the order named, nitrogen, oxygen, carbon dioxide, and watery vapor with variable amounts of carbon monoxide. The latter gas is the most dangerous constituent of afterdamp, even in most minute quantities. Should the explosion result from the detonation of large quantities of powder, etc., or of dust in a space where there was not sufficient oxygen for the complete combustion of all the car-

angle whose tangent is .80000 equals $38^\circ 40'$, approximately. As this entry is driven to the right from the entry AB , its bearing is less than the bearing of AB by the amount of the angle CAB and is equal to $85^\circ 20' - 38^\circ 40' = 46^\circ 40'$. The bearing of the entry AC is therefore $N 46^\circ 40' W$.

(b) The length of the entry AC may be found by solving the right angled triangle and finding the hypotenuse arithmetically, thus:

$$AC = \sqrt{220^2 + 176^2} = \sqrt{79,376} = 281.75$$

The distance may be found by trigonometry, thus:

$$AC = \frac{BC}{\sin CAB} = \frac{176}{\sin 38^\circ 40'} = \frac{176}{.62479} = 281.694$$

The discrepancy in the results by the use of the two methods is of interest. The first method is exact, and the difference is due to the fact that the angle CAB is not exactly $38^\circ 40'$ but just a trifle more than $38^\circ 39' 30''$ and is naturally taken as $38^\circ 40'$. If the sine of the true angle is used, .62468, the result is the same by either method.

QUES. 11.—How would you deal with a strong feeder of gas in the middle of a ventilating district with a view of continuing work in the remaining portion of the district?

ANS.—In determining the method of handling such a feeder, much will depend upon local conditions and the position of the feeder in the mine with respect to the intake and return; matters which are not stated. As a general rule the feeder itself or the district in which it is should be walled off by a brick or concrete stopping, in which is inserted a pipe to convey the firedamp directly to the return air-conrse. In some coal fields a bore hole from the surface would be sunk to the feeder to draw off the gas. It will be noted that when pillars are drawn extreme care must be taken not to allow a sudden outburst of gas into the workings because of the crushing of the stoppings put in to seal off the feeder.

QUES. 12.—How does coal dust in a mine influence an explosion?

ANS.—The dust of certain coals, particularly when dry and in a finely powdered state, will extend the effects of an explosion far beyond the initial point. The exceptions are so very few that it may be laid down as a fact that all of the explosions which have occurred in American mines since that at Pocahontas in 1884, would have resulted in a relatively insignificant loss of life had it not been for the presence of coal dust. Over 95 per cent. of explosions in American mines have taken place in those where the volatile matter in the coal was between 18 and 35 per cent., where the coal was friable and readily ground into fine dust, and where this dust would readily coke

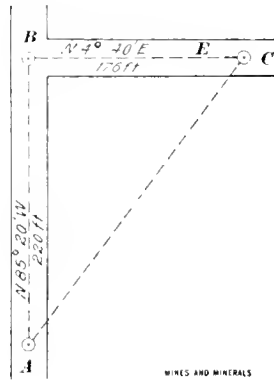

FIG. 1

bon, the proportion of CO in the afterdamp would be much greater than if powder did not figure in the explosion or if there was enough oxygen present to completely burn all the carbon to carbon dioxide. The deadliness of the afterdamp, then, depends upon the proportion of CO contained in it, and this, in turn, depends upon the materials concerned in the explosion and the local conditions prevailing at the time of the explosion.

QUES. 10.—It is desired of running an entry from A to C (Fig. 1). (a) What will be its direction? (b) What is the distance between A and C ?

ANS.—(a) The entry AB is in the fourth quadrant, and the entry BC is in the first quadrant, and the angle between their center lines is the sum of their bearings, or is $85^\circ 20' + 4^\circ 40' = 90^\circ$; hence the problem resolves itself into the solution of a right-angled triangle with its right angle at B . The angle BAC , which determines the bearing of the entry AC , is found from the relation, $\tan A = \frac{BC}{BA} = \frac{176}{220} = .80000$. The

in the ordinary beehive oven. It would seem from this, that the coking or non-coking qualities of a coal have a marked influence upon whether its dust will or will not lend itself to the propagation of an explosion. It would seem that in the presence of great heat, such as that generated by an explosion of firedamp, by the arc produced by short-circuiting an electric current, by a powder explosion, etc., that the volatile matters in the dust are instantly driven off and as quickly ignited; thus producing a true explosion, which is nothing but an instantaneous combustion.

QUES. 13.—One of the entries runs into a fault. How would you determine if it was an up or down fault?

ANS.—It is not always possible to tell from an inspection of the face of the entry alone whether the throw has been up or down. In *most* mining districts it will be found that in *most* cases the *foot wall side has slipped down along the hanging wall side* as shown in Fig. 2, producing what is known as a *normal fault*. By reason of this, is given a rule found in many books; viz., when a fault is encountered, if the hanging wall is overhead the faulted portion of the seam has gone downward, but if it is under foot, the faulted portion is to be looked for at a higher level. If the reader will imagine himself in an entry driven on the levels *A* and *B*, respectively, in Fig. 2, which shows a normal fault, the reasons for this so-called rule will be apparent. Not infrequently the coal or the containing rocks are bent slightly up or down in the direction of throw, and this is a valuable guide to the position of the missing portion of the seam. In arid regions where there is little surface soil or vegetation the fault itself is often shown on the surface, a particular layer of rock being at different levels at two near-by points. Again, something may be told from the character or composition of the rock met in the fault plane in the face of the entry. In some cases it is possible to identify it with a rock found at a higher level in sinking the shaft; in which case the throw is down and its distance is determined by the distance between this rock and the coal as measured in the shaft. After developments are fairly well under way in any given mining region it is pretty well known whether faults are generally normal or reversed, and about the extent of the throw. Diamond-drill holes at the face will determine the direction and amount of the throw and, when any uncertainty exists, should be drilled.

QUES. 14.—In your experience and opinion, what is the surest way to prevent a dust explosion?

ANS.—The only sure way of preventing dust explosions is to prohibit the use

underground of anything which could produce a flame. This would involve mining the coal by undercutting and breaking down with wedges or hydraulic cartridges; would require compressed-air haulage and coal-cutting machinery instead of that driven by electricity; would necessitate the use of storage-battery electric lamps in place of the customary open oil lights, and would require the prohibition of smoking in the mine. If the above precautions be adopted there can be no blown-out shots, electric arcs due to short-circuiting of the current, mine fires at doors and brattices, or firing of marsh gas, which are the chief initial causes of dust explosions.

On the other hand, the adoption of all the above appliances is not always economically possible, and the mine foreman is generally called up to "take care of" the dust either by what may be called the "wet" or the "dry" method. Whichever method is adopted, all precautions should be taken to limit the amount of dust made in mining by seeing that the coal is undercut at least 6 inches beyond the end of the deepest shot hole; that only permissible short-flame powders are used and these in well placed and properly



FIG. 2

charged holes. Bug and other dust should be loaded out with coal and hauled in as tight cars as possible. The haulage roads should be kept in good shape so that the danger of a runaway trip knocking out the posts and short-circuiting the current is reduced to a minimum. Electric lamps of the storage-battery type should be used in the work-in places, no matches should be allowed in the mine, and all rubbish which might be fired in any way should be removed. Despite all precautions in the way of preventing the formation of dust, a certain amount of the finest and consequently the most dangerous dust will always be present in the workings. The question is, then, the choice of a method of taking care of this fine dust.

It will be admitted that if the workings of a mine are absolutely wet, no propagation of an explosion by means of dust is possible, and it will also be admitted that if inert rock dust is substituted for coal dust a dust explosion is equally impossible. That is, either the wet or the dry method, if carried to the limit will absolutely prevent an explosion. Which is preferable will depend upon

circumstances. The wet methods of dust treatment, involving either the watering of the headings or watering in connection with preliminary moistening (with or without preheating) at the intake, have the preference in this country over the rock-dust methods of treatment. This is probably largely a matter of prejudice, and because every one knows that water puts out fire and it is fire which causes an explosion. On the other hand, the dry, or rock-dust, method of dust treatment has many points in its favor that cannot be claimed for the wet methods. It is much cheaper and is much more healthful and experiments have proved it equally as efficacious as the wet methods in preventing the spread of an explosion otherwise started. The use of any of the wet methods produces very disagreeable conditions underground, which disagreeable conditions are accentuated if the air is preheated at the intake. In the last case, the roads are apt to be deep in mud, the timbers are frequently festooned with moss and rot, in a short time producing dangerous falls, the air is foggy and is so warm and moisture laden that the least exertion brings out intense perspiration. Likewise, darkness, moisture, and heat are conditions highly favorable to the growth of tuberculosis and other germs. On the other hand, a mine treated by the rock-dust method is cool and dry and is a pleasant, healthful place in which to work, provided there is no silica in the fine rock dust.

There seems but little doubt that when further experiments have determined what proportion of rock dust to coal dust (for any particular mine) is necessary to prevent an explosion, and some way has been devised by which the dust may be cheaply sprayed into each working place, that the dry method of dust treatment by reason of its simplicity, economy, and healthfulness will supplant the present wet methods.

Wants—Too Late for Classification

MINE FOREMAN wanted for position in Southern California Ore Mine. Man not over 45 years of age, an American and one who has had at least 15 years' experience in coal mining on highly inclined veins. Must thoroughly understand mine timbering, shaft, drift, and stope, also ventilation. Must understand handling men and how to get results. If you cannot produce ore cheaper than the other fellow don't answer this. Good opportunity for the right party. State experience and for whom now employed, whether married or single, and wages expected. Address, 522, care MINES AND MINERALS.

SHIFT BOSS.—We have several openings for miners who understand mining by the long-wall method, who are capable of taking charge of a small gang of men and working a three hundred foot face. Wages \$3.00 per day. Steady work is guaranteed. Write giving experience and reference. Mines situated in Southwest Virginia on L. & N. R. R. and V. & S. W. R. R. THE VIRGINIA-LEE COMPANY, St. Charles, Va.

WANTED.—Position as General Superintendent of large coal operation by a graduate engineer 41 years of age with eighteen years' experience. Address: No. 504, MINES AND MINERALS.

First Aid in Alabama Mines

By J. F. Smith*

Not only are state mine laws being rigidly enforced, but coal companies have formulated colliery rules, which, if followed by the miners, are sure to result in a less number of accidents than heretofore. Coal operators have a personal interest in the welfare of every man in their employ, a fact demonstrated at the National First Aid meet in Pittsburg last October, where operators from every coal field in the United States assembled to witness the dexterity of first-aid teams from the collieries.

The Alabama Consolidated Coal and Iron Co. takes great pride in the efficiency of the well-trained first-aid-to-the-injured corps and mine-rescue teams at its Lewisburg mines near Birmingham, Ala.

Several months ago the First-Aid Society was organized, and from its inception rapidly became popular with the mine workers,

located at the Lewisburg mines, as it no doubt has in other coal mines where first-aid teams have been formed and organized. The methods of handling injured miners have been carefully studied, and to facilitate the work two underground hospitals or emergency wards have been fixed up inside the mine by the company. One of these emergency rooms—that of the Cheatham ward is shown in Fig. 1. It will be seen that it is fitted with Johnson's first-aid cabinet, a closet for blankets, cushions, and extra Red Cross supplies, and with a stretcher in place on a hospital car. The men shown in this illustration, reading from left to right, are Dr. G. B. Scott, Dr. T. A. Cheatham, for whom the ward is named, and Mine Foreman J. F. Smith. This ward is 2 miles west from the mouth of the slope in the Mary Lee mine. No effort is made to detain a patient in these wards after first aid has been rendered, but the section of the mine stops

ham; several of his men are also receiving instruction at present, so that Lewisburg is not very far behind the most progressive in emergency and rescue work.

Much attention has been given to sanitary conditions in Lewisburg, so that the sanitary officer seldom finds it necessary to use authority in enforcing sanitary rules. The value of sanitation is indelibly impressed, and with the citizens of Lewisburg and Mary Lee camp cleanliness is a matter of personal pride. The following rules are posted in conspicuous places that there shall be no excuse for not knowing:

1. Every person renting a house is held personally responsible for sanitation of premises; heads of various departments responsible for buildings and premises coming under their supervision.
2. Around each house, a space of 6 feet shall be cleared of weeds, trash, debris, etc., and yards kept reasonably clean.
3. Paper, cans, bottles and all other



FIG. 1. CHEATHAM WARD, UNDERGROUND HOSPITAL



FIG. 2. JUNIOR FIRST AID TEAM, IN SCOTT WARD

who were quick to appreciate the advantages to be derived from a practical knowledge of the human body and the methods to be followed in the treatment of common injuries, which if neglected for a time might lead to serious if not fatal termination.

Each man who became interested was given a copy of the manual used by the New York First-Aid Society, and a life-sized manikin was obtained and practical demonstrations in first-aid work were systematically given by the writer. Dr. Thomas A. Cheatham, of Birmingham, aided in the instruction by giving a series of readily understood and practical lectures; after which Dr. G. B. Scott quizzed the students to learn the extent of their information. The general instruction given the society as a body was found to be inadequate to meet all emergencies, and four teams of five men each were selected for special training in first-aid work.

The wisdom of this step has been dem-

onstrated in the case of a miner who was work long enough for the hospital car to be rushed to the surface and the patient taken to the Mary Lee Hospital close at hand, where the resident surgeon has an operating room with surgical conveniences.

There is another underground hospital in the eastern part of the mine about $1\frac{1}{2}$ miles from the tippie and at a point where all mine cars from that part of the mine must pass. This second, or Scott ward, shown in Fig. 2, is fitted up the same as the Cheatham ward. The photograph is unusually interesting, as it shows a junior first-aid team, composed of boys who work in the mine as trappers. These youngsters are even more enthusiastic and quicker to learn than their friendly rivals of more mature years. The boys are now veterans, having done creditable work, and consequently feel lighted if not given the first chance in every emergency case. The author of this article has had quite an experience in the use of helmets, and has taken a regular government course of instruction at the Bureau of Mines station in Birmingham.

trash must be destroyed; garbage promptly disposed of; dead animals burned, buried, or removed from the camp.

4. Toilets shall be cleaned and limed twice a month; excreta burned or buried.

5. Stables shall be cleaned twice a month and manure properly disposed of.

6. Stagnant water (wash tubs, garbage pails, etc.) will not be tolerated.

7. Hogs shall be kept in reasonably clean pens at least 50 feet away from any building.

8. Contagious diseases (diphtheria, scarlet fever, measles, etc.) shall be quarantined and houses placarded; typhoid fever and whooping cough isolated; smallpox sent to the pest house.

9. Violations of sanitary rules must be reported to sanitary officer or company physician.

10. A fine of fifty cents (50c.) shall be imposed for first violation of rules, one dollar (\$1.00) for second, and third offence reported to the company with recommendation from First-Aid Society. All fines shall be turned into treasury of First-Aid Society.

* Mine Foreman, Alabama Consolidated Coal and Iron Co.

TO EXPLAIN in an intelligent manner why the present cost of mining is so much higher in the Wyoming Valley than it was some 40 years ago, when I first held an official position in the mining industry, it is necessary to consider all the operations required in mining the coal and in preparing it for market. Therefore, to be as concise in my statements as possible I have divided it into several departments as follows:

The Increased Cost of Mining Anthracite

A Comparison of the Present Mining Conditions with those Existing Thirty or More Years Ago

Written for *Mines and Minerals* by W. D. Owens*

1. *Mining Thick Seams.*—The mining of anthracite 30 or 40 years ago was generally, if not all, from beds not less than 6 feet to 12 feet or more in thickness; also this mining was carried on near the surface and above the water level. What was mined below water level was in new ground, and there were no streams of water to contend with. The result of this was that the miner was able to extract the coal entirely by the use of black powder, and the yield per keg of 25 pounds was generally about 25 mine cars; and I have known of some even going much above this average. The average today for the same capacity mine cars will only run about 12 cars per keg, and in many places the product is not more than from six to eight cars, and even then much stronger powder has to be used.

2. *Mining Thin Seams.*—It is now a common thing to mine seams of coal that are so thin that a miner could not enter them, if it was not for the rock or slate lying in strata between the coal benches; and these strata of slate are often as thick in the aggregate as the coal contained in the whole seam. The fact that the seams now being mined are much less in thickness than those mined heretofore, necessitates blasting down roof rock or blasting bottom rock, as the case may be, so as to procure the proper height for mules and cars to travel. In a seam 3 to 4 feet thick, it requires from 24 inches to 36 inches of rock to be blasted out for height, and, of course, more as the seam becomes thinner.

The slate intervening between benches of coal generally has no partings and is fastened to the coal; therefore, the companies are now paying about the same price per mine car, with the wage advances added of course, as they did 30 or 40 years ago, when cleaner and thicker seams were mined; in addition, they have to pay so much per yard on the rib of a breast, varying from 50 cents to \$3.70, and perhaps more in some places; also to pay for the intervening slate, laminated through the seam, which often aggregates from 15 inches to 36 inches in thickness, and, in addition to all this, pay for blasting the top or bottom rock and towing the same away.

Many of these places again are wet; that is, some little water drips from the seam, causing all the coal mined to be wet, and the miner who has to work in such places has his clothes all wet through, from the fact that he cannot work by standing upon his feet, but has to either work in a sitting position, or in a kind of reclining position, and, if such places are worked somewhat to the dip, the water generally must be bailed out by the miner, amounting to one car per day, or one car every 2 days, as the case may be, and which, of course, has to be paid for. The quantity is generally so small that it does not pay to establish a pump and lay a line of pipes for it.

3. *Material and Labor.*—Owing to the fact that the material necessary to maintain the operation is much more when mining a thin seam than a thick one, because the advancement is much more rapid for the same tonnage produced, naturally this calls for a much higher percentage in the company hands employed necessary to keep the mine in proper condition for its operation; that is, more bratticemen, car runners and drivers, tracklayers, etc., and more mules, or other motive power, compared with what was necessary to produce the same tonnage during the period mentioned for comparison. To this must be added the increased distance for all transportation, haulage of coal and other materials, the cost of which cannot be less than three times what it was 40 years ago.

4. *Increased Depth and Ventilation.* Since nearly all the coal mined at present is derived from a much greater depth and the area of all passages for the required volume of air to travel therein are much less proportionately, and deep mining produces more firedamp, it requires larger volumes of air to circulate through the mines, which cannot, at least, be less than twice the quantity necessary during the period mentioned heretofore. To accomplish this, the machinery for transportation and ventilation must be increased in power and capacity proportionally. The operating expense in ventilation is naturally much higher, owing to numerous causes, such as the difficulty in conducting the proper quantity of air to the working faces, caused by so much rock stowed in the breasts, derived from the rock contained in the seam and from bottom or roof to make height; besides much of this rock is in the way when it is necessary to build brattice to conduct the ventilation to the working face. The bad effect caused by squeezes in old workings, which had pillars too small to carry the heavy load resting upon them, also causes leakage of air,

frequently making proper ventilation very difficult.

5. *Increased Water.* The quantity of water that must be pumped from the mines at the present time, as compared with the period alluded to, is at least 10 times more, and the comparative depth to raise the water to the surface is greatly increased as well. A colliery under my charge about 30 years ago, where the mining was done entirely in a shaft about 250 feet deep, and which was shipping an average of about 25,000 tons of coal per month, had only one small Blake pump, 6 in. X 12 in. X 12 in., delivering water to the surface, and that was in operation only about 12 hours out of every 24. At two of the collieries under my charge at present, one delivers an average of 5,000 gallons and the other about 6,000 gallons per minute against heads of 400 feet and 500 feet, respectively. In other words, the one pumps to the surface about 37 tons of water for every ton of coal shipped from the colliery, and the other pumps about 26 tons of water for every ton of coal prepared at the colliery. It is evident to the reader that to contend with such quantities of water necessitates the installation of larger capacity pumps, with larger steam cylinders, so as to develop the power required. To install such pumps it is necessary to have column pipes and bore holes from the surface to the pump station, and generally such bore holes are expensive, because they have to be driven through gravel, sand, and boulders to a depth of 100 to 150 feet before solid rock is encountered, and in boring through such material, it is next to impossible to get a perpendicular hole. Into such holes again, a casing pipe has to be inserted, either iron or terra cotta, or a wooden pipe cased in with cement. It should also be remembered that there are now in the Wyoming Valley many shafts from 1,000 to 1,500 feet in depth. The reader can imagine, therefore, what has to be done under such conditions with large inflows of water.

6. *Breakers.*—Almost all breakers have been rebuilt, or otherwise remodeled, so as to be able to accomplish the proper preparation of the dirtier coal for the market. The necessity for this was enforced upon the operators, owing to the fact that the seams of coal are so very dirty, particularly as compared with coal mined 30 years ago, which was dumped from the mine car over a few bars to separate the coal for sizing. The most of it was so pure that it could be sent direct into a railroad car with little slate picking. But now we have to resort to the operation of many rolls, shakers, screens, automatic pickers, and jigs, to separate the impurities from the coal and to automatically separate the coal from the slate, as well as expend much hand labor

*Division Engineer at the Lehigh Valley Coal Co.

in addition. The waste derived from the shakers and jigs is carried with the water back again into the mines, necessitating bore holes and long pipe lines, varying from 1,000 to 6,000 feet in length and differing in size from 3 inches to 8 inches in diameter. The life of these pipes is comparatively short, owing to the great wear on them from high velocity of the water and dirt traveling through and the action of sulphuric acid. This acid water is carried into the mine sumps and taken up by the pump, and the effect of such water on the life and durability of the pumps and their connections is very severe indeed. Again, the refuse discharged from the pipe lines from the washeries has to be taken care of by the employment of a number of men to build batteries of props and planks, or stone walls, and in many cases both kinds must be put up in the same place. The strength of such batteries must be according to the pitch of the seam in which the silt is deposited, and if the silt is very fine, the stopping must be nearly water-tight in its construction. This fine dirt and water has a bad effect upon the pillars in some localities, where there is a thin stratum of sandy clay between the roof and the seam of coal, and sometimes under the coal; the water often-times penetrates through the clay, leaving the roof without support and washing out the deposited silt, carrying it down into the gangways or into the main sump of the pumping station. Then great expense is entailed in cleaning out the sump and in loading the clay into mine cars to send it outside for deposit on the surface.

7. *Steam Production.*—The great increase in the boiler capacity required can be best illustrated by a comparison of two collieries; one under my charge nearly 30 years ago, which had 12 cylinder boilers, figured to develop about 200 horsepower. That mine shipped an average of 25,000 tons per month, while one of the collieries under my charge at present, shipping about the same tonnage per month, has a steam boiler plant rated at 3,000 horsepower.

The cause for such increase in steaming capacity is to be found in the many necessary slopes, planes, and shafts operated by steam machinery; electric hoisting engines and electric motors used for transportation of coal and other material; the increased machinery necessary to operate breakers and ventilating fans; and last, but not least, the high pressure and great quantity of steam required to operate mine pumps to deliver water to the surface.

The effect of all the aforesaid causes combined results in making the cost per ton of prepared coal about three and one-half times higher than it was between 30 and 40 years ago.

Of course, the much higher price paid for materials is also a great item in increasing the cost of the coal.

The danger from accidents to life and limb has increased very materially through

the necessity of having to use so much more powder of various grades, to mine comparatively the same quantity of coal.

I believe that the various matters set forth in the foregoing statement will satisfactorily explain why the mining of anthracite is now so much more expensive than heretofore.

1911 Bituminous Mine Law of Pennsylvania

An Analysis of the Portion of the Law Which Will Increase Cost of Mining

(Continued from June)

ARTICLE VIII.—SIGNALING APPARATUS, SAFETY CATCHES, HOISTING MACHINERY, ROPES, BOILERS, AND CONNECTIONS

SECTION 1. " * * * In all gaseous mines telephone connections shall be made from the surface to the main section of the mines. While the convenience of mine telephones cannot be questioned, the installation and maintenance cost are naturally high, due to falls and to action of the mine atmosphere on the wires, insulation, and the telephones.

" * * *, and an efficient safety device that will prevent overwinding shall be attached to every engine used for lowering and hoisting persons." This requirement for an overwinding device is new and will necessitate a considerable expenditure at shafts not equipped therewith. This section and Section 2 contain several minor requirements that are new but not important as far as expense is concerned. They pertain to cage attachments, cage testing, safety gates, and bridle chains.

SECTION 6. "All boilers used for generating steam in and about the mines shall be kept in good condition, and the superintendent shall have them examined and inspected by a duly qualified person once every six months, and the report of said inspection shall be posted at the mine office." This section is entirely new.

SECTION 8. "No boiler used for generating steam shall be placed or allowed to remain inside of any mine without the consent of the inspector, which shall be given in writing to the superintendent, and if the inspector allows said boiler to be placed inside the mine it shall be enclosed in a fire-proof building within fifty feet of the bottom of an upcast shaft, which shaft shall not be less than thirty-five square feet in area." The new law makes the allowance of an inside boiler entirely optional with the inspector and increases the minimum area of twenty-five square feet in Article VIII, Section 1, in the old law, to thirty-five square feet.

ARTICLE IX.—VENTILATION

SECTION 1. " * * * In a non-gaseous mine the minimum quantity of air shall

Added to this, it must be remembered that in the years from 1880-1881, the companies advanced the employes 30 per cent., which was given in three instalments; and again between 1900 and 1902 an average of about 25 per cent. was added to the earnings of the employes, and recently still further advances.

not be less than one hundred and fifty cubic feet per minute for each person employed. In a mine wherein explosive gas is being generated in such quantities that it can be detected by an approved safety lamp, the minimum quantity of air shall not be less than two hundred cubic feet per minute for each person employed therein, and as much more in either case as one or more of the inspectors may deem requisite. The return air from each split where from seventy to ninety persons are employed shall be conducted by an overcast or an undercast into the return airway, which shall lead to the main outlet. In the old law (Article IV, Section 1), the minimum quantity of air for non-gaseous and gaseous mines was only one hundred and one hundred and fifty cubic feet per minute, respectively. This required increase of fifty and thirty-three per cent. will incur additional expense. It is rather surprising that the new law, like the old one, does not specify a minimum which must actually pass through the working places. The requirement to overcast the return air from each split where from seventy to ninety persons are employed puts a premium on splits with over sixty-nine men and is rather a peculiar distinction. "No permanent door shall be erected or allowed to remain in the main entry in any mine, unless its removal shall be deemed impracticable by the inspector." This is new and may lead to expensive revisions in the ventilating systems of some mines.

SECTION 2. "Where five or more persons are employed at any one time in a mine, it shall be the duty of the operator or the superintendent to provide ample ventilation in accordance with Section 1 of this article: Provided, That it shall not be lawful to use a furnace for ventilating any mine wherein explosive gas is being generated." The old law (Article IV, Section 2) required ventilation only where more than ten persons were employed. According to Article XX, Section 1, Rule 5, of the old law, "In mines where firedamp is generated, when the furnace fire has been put out it shall not be relighted, except in his (the mine foreman's) presence, or that of his

assistant under his instructions." This sanctioned the use of a furnace in a gaseous mine, whereas the new law prohibits it. "Six months after the passage of this act, not more than *seventy* persons shall be permitted to work in the same continuous air-current, unless in the judgment of the inspector of the district it is impracticable to comply with this requirement, in which case a larger number, not exceeding *ninety* persons, may be permitted to work therein." In Article IV, Section 2, of the old law, *sixty-five* were allowed, with a maximum of *one hundred* if sanctioned by the inspector. The raising of the one figure may be more than offset by the reduction of the other figure.

SECTION 5. "*In all mines all new stoppings in cutthroughs between the main intake and return airways shall be substantially built of masonry, concrete, or other incombustible material, and shall be of ample strength; and in mines generating explosive gas all new stoppings and the renewal of old stoppings in cross-entries shall be built of masonry, concrete, or other incombustible materials.* Stoppings in cross-entries in non-gaseous mines may be built of timber. * * * *Temporary stoppings shall be erected in cutthroughs in rooms to conduct the ventilation to the face of each room, and such stopping may be constructed of timber or brattice cloth.*" In the old law (Article IV, Section 2) the only specifications for stoppings read: "And all stoppings between main intake and return airways hereinafter built or replaced shall be *substantially built with suitable material*, which shall be approved by the inspector of the district." The term "substantially built" in the old law did not necessarily mean masonry, and the above quoted specification applied to main entries only. The almost universal requirement for masonry stoppings in the new law will add considerable expense to the maintenance of ventilation in all mines, but especially those which are undergoing development. The distinction between conducting air into each room and to the face of each room has already been mentioned.

SECTION 6. "* * * No main or principal ventilating fan shall be placed inside of any mine. No auxiliary fan, unless driven by electricity or compressed air, shall be placed in any mine. If the fan be electrically driven, the motor shall be placed in the intake airway." These provisions are new, but will not likely affect many mines.

SECTION 7. *In every mine all new air bridges, overcasts or undercasts shall be substantially built of masonry, concrete, or other incombustible material, of ample strength, or shall be driven through the solid strata.* In Article IV, Section 3, of the old law, these requirements applied only to gaseous mines.

SECTION 8. "* * * All principal doors shall be so placed that, when one door is open, as a precaution has the same effect upon

the same current shall be closed and remain closed to prevent any stoppage of the air-current. An attendant shall be employed at each principal door (that is, the door that controls the main air-current in the entries) through which cars are hauled. * * * Provided, that the same attendant may attend two doors if his absence from the first door does not endanger the safety of the employees. *At every door on any inclined plane or road whereon haulage is done by machinery, an attendant shall always be on duty during working hours.* * * *." The requirement for a second door to remain closed when a principal door is open is new and will be a source of considerable annoyance and delay in many mines in which hauling is done with motors, as the doors will have to be placed far enough apart to allow a motor and its entire trip to stand between them. The old law (Article IV, Section 3) permitted the same person to attend two doors if they were not over 100 feet apart, but the new law absolutely prohibits the attendant from absenting himself from a door on an inclined plane or mechanical haulage road, although it allows him to attend two doors when haulage is not done by machinery, under certain conditions.

SECTION 9. "No product of petroleum or alcohol, or any compound that *in the opinion of the inspector* will contaminate the air to such an extent as to be injurious to the health of the miner, shall be used as motive power in any mine." This is new and places in the hands of the inspector the right to decide whether gasoline motors may be used.

ARTICLE X.—LOCKED SAFETY LAMPS AND OPEN LIGHTS; DEFINING WHEN EITHER OR BOTH CAN BE USED

SECTION 3. "The use of open lights is strictly prohibited in the return air-current of any portion of a mine that is ventilated by the same continuous air-current that ventilates any other portion of said mine in which locked safety lamps are used. The provisions of this section shall not apply to any mine wherein explosive gas is generated only at the face of active entries." This section is new, and while the first part appears rather formidable, the latter part modifies it somewhat.

SECTION 4. "If at any time one portion of a mine is worked by the use of locked safety lamps while another portion is worked by the use of open lights, the return air from the gaseous portion shall be conducted directly into a return airway leading to the fan or to the outlet: Provided, That when a portion of a mine is worked by the use of locked safety lamps and other portions are worked by the use of open lights, it shall be the duty of the mine foreman to provide a suitable danger station, with an attendant on duty at all times during working hours, day and night, whose duty it shall be to see that the employes from the open light portion are

not allowed to enter the locked safety lamp portion unless they are provided with locked safety lamps by said attendant." This section is entirely new, and the fact that compliance therewith as to ventilation and as to providing attendants will increase the cost of operation in mixed-lamp mines is very apparent.

來 來 Book Review

ELECTRICAL INJURIES, by Chas. A. Lauffer, M. D., Medical Director of Relief Department of the Westinghouse Electric and Mfg. Co., East Pittsburg, Pa. This book is 16 mo., 77 pages. Publishers, John Wiley & Son, New York. Price 50 cents.

By prompt action at resuscitation many lives have been saved. The first 40 pages deals with electrical injuries, and factors in causation of contact burns and serious shock. This is followed by minor surgery and first aid, infections and their causes; the effects of occupation on health; and lastly by questions on the matter of the text.

THE DAVIS HANDBOOK OF THE PORCUPINE GOLD DISTRICT is issued by H. P. Davis, 25 Broad Street, New York. Mr. Davis compiled an excellent little handbook on the Cobalt district which has been of great assistance to the writer in answering questions. There are five sections in the Porcupine Handbook, with map. The first edition is 5,000, and a record of each purchaser is kept in order to supply him with revised directories. Section I contains introduction, key map, historical sketch of Porcupine, Porcupine in general, and the geology. Section II gives a directory of incorporated companies and of operating syndicates. Section III reviews the Cobalt district. Section IV reviews South Lorrain, Montreal River, and Gowganda districts. Section V furnishes general information for prospectors and mine owners. The book has 132 pages of nicely printed reading matter, illustrations, and index.

THE STUDY OF MINERALS, by Austin F. Rogers, Associate Professor of Mineralogy and Petrography, Leland Stanford, Jr., University; 522 pages 7½×5 inches, 591 illustrations, flexible leather; price \$3.50. McGraw-Hill Book Publishing Co., New York. The book is divided into eight parts, and contains a glossary, which is an added and useful feature, and is somewhat more elaborate and definite than certain other books on minerals which have recently appeared on the market. Part I, on the "Form of Minerals"; Part II, on the "Physical Properties of Minerals"; Part III, on the "Optical Properties of Minerals"; and Part IV, on the "Chemical Properties of Minerals," are arranged in an excellent manner for reference. While the book is claimed by the author to be for first-year students, we claim it is for 25- or 35-year students, for who, that is not a college professor, can do without a mineralogy after leaving the study at college?

Coal Mining in Northern China

Shallow Shafts Sunk Without Explosives and Operated Entirely by Hand—Coal and Water Carried Out on Men's Backs

*Written for Mines and Minerals by J. L. Dobbins**

AMONG the coal-producing regions of China, the fields of central and southern Shansi have long been considered important factors in China's source of supply. But while coal has been known to exist also in the northern part of the same province, its importance and its wide extent have only very recently been recognized to the extent of providing means for its transportation; and the development of the mines of this district has been held back to very meager proportions because of this lack of adequate transportation. So, up to the present time, the limiting bounds of these fields have remained quite undetermined, as there has been no incentive for additional

touches. And at present an extension of that line is under construction, which will tap a part of this coal-bearing region which lies just west of the city of Ta Tung Fu.

Two large and distinct coal deposits have been clearly indicated by the workings already opened—deposits which are separated by several low ranges of hills, and are of apparently distinct and independent origins. These in each case have been shown to be continuous over the areas lying enclosed between

extension. This is about 100 li south-west from Ta Tung Fu and about 40 li east of Tso Yun. (See accompanying map.)

The location of all these points is given in reference to their distance from Ta Tung Fu, as that is the largest city of northern Shansi, a walled city of about 200,000 population, and it is also the terminus of the present extension of the Imperial Peking Kalgan Railway. As such, Ta Tung Fu becomes the base for all future projected transportation lines for this whole region, upon which the future of these mines so largely depends. Surveys for a further extension of the railroad westward from Ta Tung Fu to Kwei Hua Cheng have been made and its

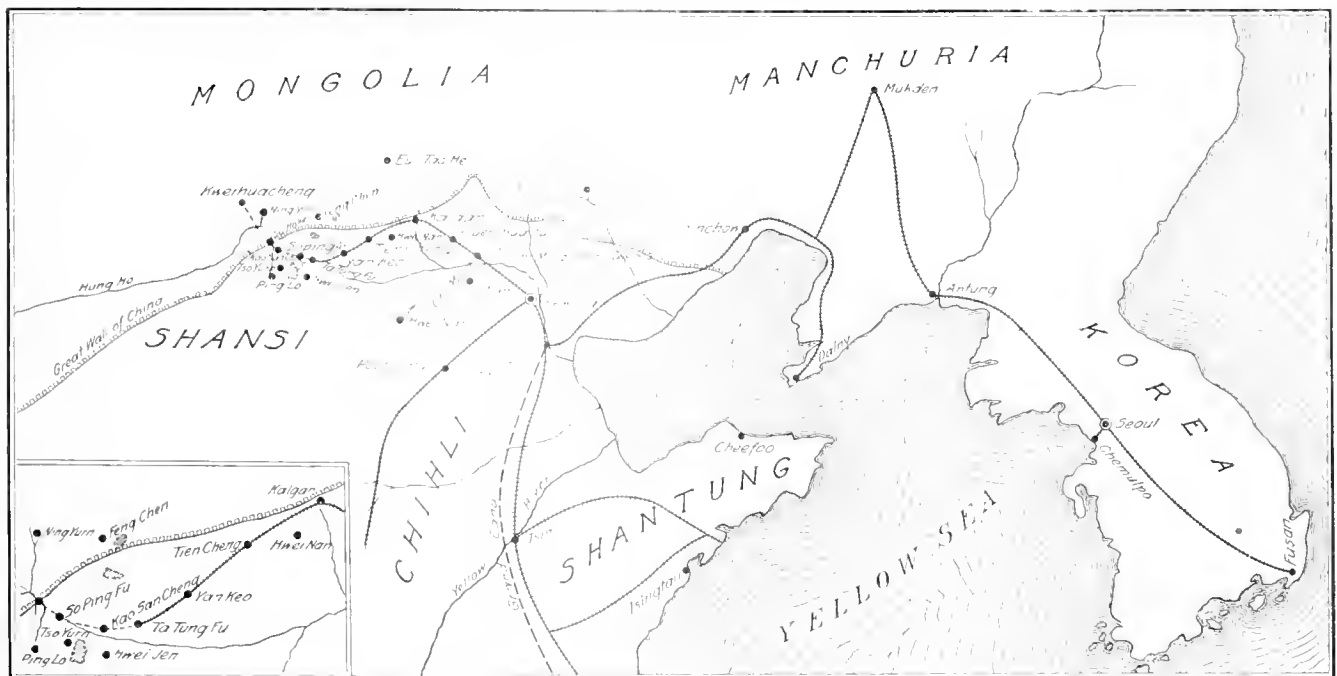

FIG. 1. MAP OF PART OF CHINA, SHOWING COAL FIELDS OF NORTHERN SHANSI

prospecting; but the probability of the immediate advent of railroads into this field has given new impetus to the development of the mines now in it.

Mining, even by the primitive native methods, has been carried on here only during the last 35 years, and that merely to the extent of supplying the needs of local consumption within the radius of profitable haul by cart or with mule or donkey pack trains. But the large extent of the coal beds which these shallow workings have disclosed and the excellent quality of the coal produced, have led to the recognition of these northern fields as a profitable source of the future fuel supply for the Imperial Peking Kalgan Railway, and for the cities which it

the present workings, but to what extent they continue beyond these is entirely unknown, as definite limits of the coal seams encountered have not been reached in any of the workings.

One of these districts lies north and west of Ta Tung Fu, its nearest mine being about 40 Chinese li* (13 miles) from that city. This deposit has been known for about 35 years and has a present proved area of about 150 square li, the axis of which extends in a north-easterly to south-westerly direction for a length of about 30 li. The second field, which is of more recent discovery, is of much larger known area, and also farther from the city and the present railroad

construction decided upon, but at present Ta Tung Fu is the nearest point for rail connection.

During a recent trip by pony across northern Shansi, the writer had opportunity to visit the more distant of these coal fields; and as the conditions obtaining there, and the general methods of operating, were quite typical of all the native mines of Shansi, a description of these as found will be given.

This trip was made during the wet season; and out of a total of eight mines visited, three were flooded and could not be entered on that account. One other, known as the Pai Tso Wang Kwang, was worked through an adit which had been driven along an almost horizontal coal seam which outcropped on the side walls of a deeply eroded ravine. This was a

*Professor Railway Engineering, Imperial Peking Yang University, Tientsin, China.

newly opened mine, having been worked for only three years, with a force of about 15 men; and this one seam, of an average thickness of 7 feet, constituted the entire known coal of the mine, for no further prospecting had been attempted or even thought necessary so long as the coal in

Of the other mines visited, all were worked with two shafts each, one an incline for entrance and for carrying out coal, and the other a nearby vertical shaft for the sole purpose of hoisting water. This arrangement of shafts, each with its particular function, seems to be typi-

trated were quite the same. The shafts first cut through the surface layer of loess, whose thickness depended upon the amount of surface erosion, and then through a single stratum of limestone which merged at depth into a fine-grained, compact shale of great transverse



ENTRANCE TO MINE OWNED BY MR. TU, WHO STANDS AT RIGHT OF PICTURE

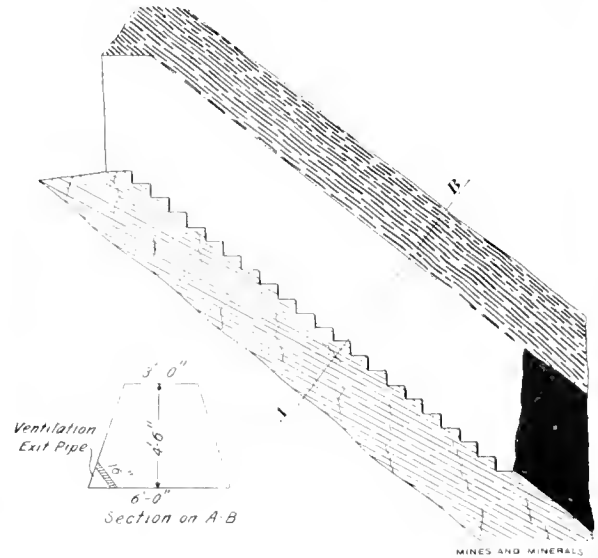

SECTION ON TYPICAL INCLINED SHAFT

sight seemed to be sufficient for the needs of the immediate future. The development had been confined to this one level only, and had been without dead work, as the adit right from the surface lay in good coal, and all subsequent cross-cutting had also been entirely within it. The dip of the seam was followed on approximately a minus 2-per-cent. grade, quite without regard for drainage; but fortunately in to the 480-foot depth already penetrated, the seam had proved to be very free from water. That which did accumulate in the sumps dug for the purpose was easily disposed of by two coolies employed in carrying it out, each man working a total of about 8 hours a day.

This mine was worked on a sort of cooperative basis, with an output ranging from 4 to 6 tons a day, according to the demands of the immediate market. The men who operated it regarded it as a very profitable undertaking.

Analyses of samples taken at this mine show the coal to be a bituminous coal high in volatile matter and in sulphur, and very low in its percentage of fixed carbon. The following is the analysis: Moisture, 9.47; ash, 11.18; volatile matter, 30.92; fixed carbon, 45.45; sulphur, 2.98.

These results, when compared with those from the other mines of the district, indicate also that this seam is entirely distinct from those found in the other workings, all of which showed very close agreement in the analyses of the samples taken from them.

cal of all the mines of this region, and is accounted for as an outgrowth of the method of bringing all the mined coal to the surface on the backs of the miners, up the incline shaft. Water was at first also handled only in this way, but in most cases where the



VENTILATING FURNACE AT INCLINED SHAFT, CHINA

flow increased until this was found to be insufficient for removing it all, the vertical shaft and windlass were used, but always for water only.

At all the mines of this district, the surface formations and the strata pene-

strength. This was bedded almost horizontally, with a dip of about 3 degrees to the west, the thickness ranging from 75 to 90 feet. Just below this and the underlying thin stratum of slate, the first coal seams were encountered. In all but one of the mines visited, no attempts had been made to explore to any greater depth, and the workings were confined to the first seam of paying thickness that was encountered.

This was due partly to the difficulties involved in sinking farther in the presence of the relatively large flow of water without adequate means for handling it, and largely also to the fact that the output from a single seam was usually more than sufficient to supply the limited demand for the coal. In the one case, in a mine owned by a Mr. Tu, in which the shaft was sunk beyond the first seam, three more seams were cut in a depth of 23 feet, of 2½, 7, and 4 feet respective thicknesses, separated by 3-foot layers of shale. In this case it was later explained to the writer that this additional depth had been sunk merely in order to provide a sump for collecting the water to be hoisted from the mine, rather than for prospecting, and this sump had been sunk only 4 feet below the foot-wall of the last coal seam encountered.

These shallow workings, located but a mile or two apart throughout this district have been sufficient to block out a very large tonnage of excellent coal, lying very near the surface, and which can be easily mined in commercial quantities when modern methods and machinery

are used; and while they set the lower limits of the tonnage in sight, the full extent of these deposits can only be guessed at until diamond drills have been brought on the ground, and systematic prospecting has determined the depth and the lateral limits to which these fields extend.

Small ranges of low rolling hills of loess are the surface indications charac-

teristic of this entire region, in which the underlying sandstone can only be seen at points of deepest erosion. And in the absence of any evidence to the contrary, the existence of a continuous coal bed is probable, extending even beyond the present proved area. This Tso Yun district is now marked out by workings that extend 50 li in a north and south direction, with width varying up to 12 li.

Small ranges of low rolling hills of loess are the surface indications charac-

teristic of this entire region, in which the underlying sandstone can only be seen at points of deepest erosion. And in the absence of any evidence to the contrary, the existence of a continuous coal bed is probable, extending even beyond the present proved area. This Tso Yun district is now marked out by workings that extend 50 li in a north and south direction, with width varying up to 12 li.

The coal from all the different workings here has the same luster and hardness and shows the same resistance to slaking and weathering when exposed to the open air. The coal is bituminous, and assays of samples taken from four different mines gave the following average results:

Moisture, 8.85; ash, 2.99; volatile matter, 22.60; fixed carbon, 65.20; sulphur, .36.

The very slight variations from this general average in the analyses of individual samples from the several different workings, together with the entire absence of any surface indications of faulting, and the very uniform depth at which the coal was encountered in the different mines, all point conclusively to the continuity of these seams throughout this area; while the different quality of the coal obtained from the Pai Tso Wang Kwang, and the higher elevation at which it was found there, show this seam to have been of independent, and probably later, origin than the other deposits.

The small depths to which it has been necessary to sink to reach this coal, together with the compactness and

strength of the overlying strata, were all favorable to the methods used by the Chinese for sinking and handling the coal. All the sinking was done entirely without the use of explosives, and the shafts were cut through the solid rock to exact dimensions by the slow method of drilling and wedging the larger pieces out, and then dressing the sides and top to size by chiseling.

about 5 feet 10 inches high. All the shafts were entirely without timbering except at the surface; and the steps for the inclines were cut in the solid stone, in situ, across the entire width of the base. These were roughly cut out at the time of sinking and later chiseled to regular size.

The incline is the only means used for entrance and exit from most of these mines, the vertical shaft being used only



MINES AND MINERALS

"HOISTING" 220 LB. OF COAL FROM CHINESE MINE.



COAL STOCK PILE AT MINE OF MR. TU

The dimensions of the vertical shafts for hoisting water were usually 4 feet by 6 feet, and the inclined shafts were always of trapezoidal section, about 6 feet at the base, 3 feet at the top, and about 4 feet 6 inches high, these dimen-

for water; and all of the coal and frequently much of the water, too, when the hoist alone is insufficient to keep it down, is carried up the incline on the backs of the miners. The wear on these steps which such heavy usage would otherwise cause is much lessened by the fact that these carriers are usually barefooted; they also are generally burdened with very little other apparel of any kind except the shoulder pads and heavy leather harness with which they secure their heavy loads of coal to their backs.

Partly because of this method of hoisting the coal to the surface and partly because of the subsequent long haul over the uneven roads which is necessary to reach any market, the coal is carefully blocked out and mined in large lumps, all pieces whose greatest dimension is less than 6 inches being thrown with the waste and the dust coal, and used to back fill the stoped-out chambers. In the mines visited, the writer estimated this loss in dust and small lumps left in the stopes to be from 30 to 35 per cent., much of which would be saved were a different means of tramming and hoisting in use.

Where the seams mined were thick enough for a man to walk erect in the excavated chamber, the lumps of coal are loaded on to the carrier's back right at the face of the workings and he then proceeds out through the long, tortuous and usually low passages and up the incline without any relief from his load until he places it on the stock pile near the mouth of the incline. The loads



VIEW DOWN INCLINE. NOTE REGULARITY OF SECTION, THE STEPS, AND MUD-PLASTERED VENTILATING PIPES AT RIGHT

sions being for a section perpendicular to the axis of the shaft. These inclines were at angles of 38 degrees to 40 degrees with the horizontal, so the section of a vertical plane through them would be

handled in this way by one man are sometimes enormous, the writer having on one occasion seen a man bring out on his back a lump which weighed 180 catties* (240 pounds), and later noticed several lumps on the stock pile which weighed over 200 catties apiece, all of which had been brought out in the same way.

While the extreme cheapness of labor has made this method of handling the coal possible and in most cases apparently satisfactory for the small tonnages required to supply the limited demand, the lack of pumps has been a more serious difficulty when the flow of water in the mines has been large.

In some cases this inability to handle the water has been the cause of entirely stopping operations, and in many others the expense of operation is divided, with the larger portion devoted to unwatering the mine and the smaller to the actual cost of handling the coal.

At Hsien Lung Kow, the most southerly of the mines in the Tso Yun district, continuous hoisting with balanced buckets on a windlass was not sufficient to keep the water down, and an additional line of water carriers was steadily at work in the incline. Here the coal seam was 7 feet thick with a dip of almost 4 degrees to the west, so that by properly conducting the water to the sump just to the west of the foot of the incline, where both bucket hoist and carriers kept it down, the development work could go on in the eastern part of the mine. This was a new mine with only a small force of men at work, and no coal was being mined, except that taken out in development work in driving along the seam; but the following division of labor which obtained there between unwatering and mining illustrates by an extreme case the proportion which this unwatering may bear to the total expense where pumps were unknown.

Here the vertical lift at the hoist was 85 feet, and a 30-inch drum hoisting two large wooden buckets in balance was operated by four men, averaging 72 seconds a round trip and raising about 1,500 gallons per hour. Two shifts of men, 12 men a shift, were carrying water up the incline, in woven willow pails slung from poles which they balanced on their shoulders, leaving one hand free to help them climb. They carried about 10 gallons a trip and were paid by the trip. Each shift consisted of 350 trips for which the carrier was paid 350 copper cash, equivalent to about 19 cents United States gold. The men at the hoist received the same pay as the miners, 240 copper cash a day, for shifts of about 10 hours. There were thus required for this unwatering 60 men a day, including

two bosses and two tally men, to handle 110,000 gallons, while only 16 men, in two shifts, were engaged in actual mining.

The Tiao La Sü mine, in about the center of the Tso Yun district, is less troubled by water than the above rather extreme case, and affords an excellent example of successful operation of one of these mines on such a scale as these methods permit. This mine was opened in 1903, and has since then maintained an average daily output of 30 tons a day of lump coal, all of which has come from a single 7-foot seam, 100 feet below the surface. Here one shift of six men, working 8 hours a day, was sufficient to hoist all the water, which was allowed to collect in the sump during the rest of the day. The entire force of men at work numbered 42.

The sump and the vertical shaft were located some distance to the west of the incline at the lowest point of the workings, as the seam also dipped slightly to the west. Below the incline and around the sump, pillars of coal were left in place to support the overburden, and the stopes were run out radially from a point near the foot of the incline, giving the stepped-out chambers a fan-shaped appearance as the supporting walls diverged from each other. An extreme case of this was evident in one chamber, the working face of which had a clear width, as paced, of 210 feet and an unobstructed length, radially, of over 100 feet to the nearest supporting pillars. The seam here was of very uniform thickness, and being almost horizontal, the excavated chamber had the appearance of a 100'×200' room with a low horizontal roof, entirely unsupported and held up only by its own beam action. The older workings of the mine showed some signs of bad caving, but the limestone roofs in the newer stopes had stood without any signs of failure, despite their unusually great unsupported spans. The coal here was mined in large lumps with very little waste, as the uniform thickness of the seam made the undercutting and breaking out of large blocks easy. The piles of waste used for backfilling were therefore rather widely separated.

Ventilation was very simply secured in this mine by keeping a coal fire burning near the sump at the foot of the vertical shaft. This was sufficient to create the necessary updraft there; and the two drifts connecting this shaft to the rest of the workings were both fitted with doors, so that either could be closed when the other needed the ventilation. The down draft was always down the incline.

In the other mines ventilation was obtained by means of a suction stove placed at the mouth of the incline, the air pipe for which was merely a triangular wooden trough leading from the

workings below. This was placed in the lower corner of the incline and sealed with mud plaster. These stoves were usually conical, built up of brick and mud, from 5 to 7 feet in diameter and 20 to 25 feet high. The down draft entered through both shafts. As no explosives were used and the coal itself was rather free from noxious gases, this simple means of ventilating gave very satisfactory results.

Because of the cheapness of labor, and the ability of the Chinese miners to do hard work, coal is produced at these small mines at such low cost that it can be sold at a profit for ½ cash per catty for lump coal at the mouth of the mine, which price is equivalent to about \$.37 in gold a ton. The individual outputs of these several workings are small, averaging under rather than over 15 tons a day scattered throughout all the different coal fields of the province and their total output is even now very considerable. And they are the forerunners of a later extensive development that will come with the advent of adequate transportation facilities and the subsequent installation of modern machinery and modern methods. And by blocking out immense tonnages of coal, they have prepared the way for the advent of the railways, and have assured them of a large traffic whenever they are prepared to handle it.

Books Received

BUREAU OF MINES, Washington, D. C. Technical Paper No. 11, The Use of Mice and Birds for Detecting Carbon Monoxide After Mine Fires and Explosions, by George A. Burrell.

UNIVERSITY OF ILLINOIS, Urbana, Ill. Bulletin No. 57, Superheated Steam in Locomotive Service (a review of Publication No. 127 of the Carnegie Institution of Washington), by W. F. M. Goss; Bulletin No. 58, A New Analysis of the Cylinder Performance of Reciprocating Engines, by J. Paul Clayton; Bulletin No. 59, The Effects of Cold Weather Upon Train Resistance and Tonnage Rating, by Edward C. Schmidt and F. W. Marquis.

NEW JERSEY GEOLOGICAL SURVEY, Trenton, N. J., Bulletin No. 6, Annual Administrative Report of the State Geologist for the Year 1911, including a Report on Shark River Inlet, by C. C. Vermeule, Consulting Engineer.

KENTUCKY GEOLOGICAL SURVEY, Lexington, Ky., Bulletin No. 18, Serial No. 25, Coals of the Region Drained by the Quicksand Creeks in Breathitt, Floyd, and Knott Counties, by F. Julius Fohs.

TOPOGRAPHIC AND GEOLOGIC SURVEY, Harrisburg, Pa., Report No. 4, The Mineral Pigments of Pennsylvania, by Benjamin L. Miller; Report No. 5, Preliminary Report on the Tale and Serpentine of Northampton County and the Portland Cement Materials of the Lehigh District.

*A catty is equal to 16 ounces or 1 1/2 pounds.

ORE MINING & METALLURGY



Ore Loading on the Island of Elba

THE Elba Mining Co. possesses on the island of Elba rich and extensive deposits of iron ore which is smelted and fabricated in its blast furnaces and steel works at Portoferraio and Follonica. The Savona company, which works Elba iron ores in its plants at Bagnoli near Naples, likewise takes some part of the production. The ores are also smelted at the Piombino iron works.

Methods Employed for Transporting Iron Ore and Loading It Into Ships Under Difficult Conditions

Written for Mines and Minerals

The ore is a hard spathic brown ironstone of compact, or crystalline, structure with traces of other veins. It is mined by open cut, especially at Giove Portello, where the best class of ore is found. Fig. 5 shows a mine working in the Rio Albano deposits. In the whole mining district about 2,000

and their conveyance to vessels in the open sea, but to the fact that the sea on this exposed coast is only sufficiently smooth for about 150 days in the year for the ores to be loaded in deep water. This is why the ores had to be loaded in as large quantities as possible in a minimum time, for which, as a rule, empty ships in sufficient numbers were available. In fact, serious difficulties in the service were not anti-

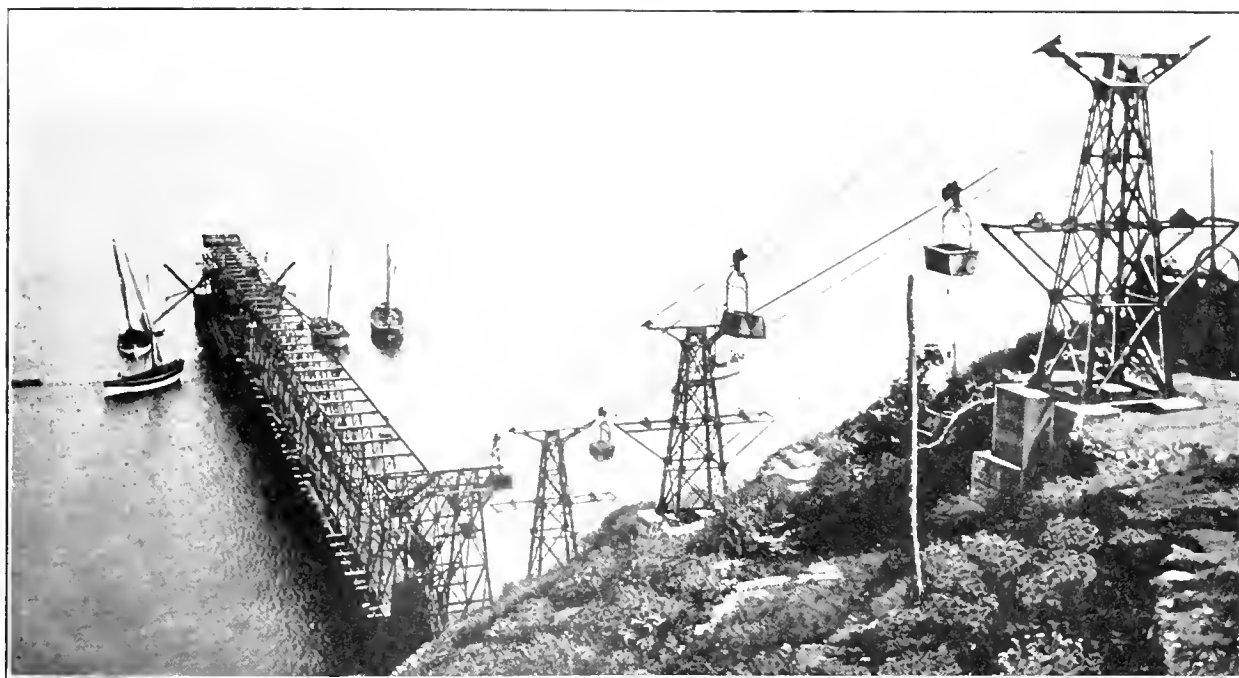

FIG. 1. LOADING PIER IN THE SEA, RIO ALBANO MINE, ISLAND OF ELBA

The main deposits are situated on the precipitous east coast in the mountains north of Rio Marina where the promontory of Pero rises nearly vertically from the sea with the peak of Callendozio on the summit in which are found the important Rio Albano ore deposits. To the north of Callendozio is the Giogo, another ore producing hill, which is popularly called Giove (Jupiter), it being supposed that some ruins there found are those of a Jupiter temple. This deposit is worked in the two mines of Zuccoleto and Rosseto. The most extensive deposits, however, are near Rio, on the same coast. It is estimated that these contain some 11,000,000 tons, and they are worked in a number of mines. Other important deposits are found at Calanita.

men are employed. The inhabitants of this district formerly were fishermen or else peasants who cultivated figs; in view, however, of the progress made in the Italian mining industry, the fishing boats have been abandoned and the fields left untilled, the work in the mines being so much more lucrative.

The ore is hauled over narrow-gauge railways, by horses or locomotives. Difficulties were experienced in transporting the ore to the coast and in loading the richer ores into steamers of 3,000 to 4,000 tons capacity for shipment to Naples and Piombino, the lower grade ores going by the shorter route to Portoferraio in sailing vessels of 150 to 600 tons capacity. These difficulties are due not only to the transference of the ore from the shore to barges

and their conveyance to vessels in the open sea, but to the fact that the sea on this exposed coast is only sufficiently smooth for about 150 days in the year for the ores to be loaded in deep water. This is why the ores had to be loaded in as large quantities as possible in a minimum time, for which, as a rule, empty ships in sufficient numbers were available. In fact, serious difficulties in the service were not anti-

ated before the Bagnoli blast furnaces, near Naples, approached their completion, the first two being started in 1910. The mining company therefore was compelled in 1909 to consider the question of loading the ships by mechanical means. The most important condition to be accounted for in this connection was the necessity for an output of about 200 tons per hour, thus allowing the few days with favorable weather to be taken full advantage of. As the vessels cannot approach nearer to the shallow coast than from 100 to 200 yards, it was further necessary to carry the loading plant to a considerable distance into the open sea.

The first solution suggested was the construction of a masonry mole on which the mine cars could run. This would, how-

ever, have acted as a breakwater on such an exposed coast and a construction of unusual strength would have been necessary. It is also questionable whether a structure of this kind could have been completed in

Giove Portello, and both have proved a simple and economical solution of the loading problem. The ore arriving in mine cars is dumped at the mine into the hopper bins shown in Fig. 2 from which the rope-

in the suspension railway sections of each loading station, after which they are pushed from the station on to the open track, where they are coupled automatically to the traction rope which is in continuous motion.

The open track consists of steel wire ropes on which the carriages of the buckets run. These ropes are anchored in the loading station, and as will be seen in Fig. 1, the carrying ropes are supported by iron towers. The line has heavy gradients on which the Bleichert coupling apparatus grips the traction rope with absolute safety. On the shore are erected several supports between which the deflection of the carrying ropes is compensated by means of heavy tension weights. In this manner it is quite impossible to overload the ropes. The tension appliance is shown in Fig. 1, near the shore, also the construction of the pier of railway rails. Fig. 1 also shows the whole plant in the sea for the Rio Albano line. The supports carrying the fixed suspension rails which form the continuation of the carrying ropes over the sea are arranged on the pier. The traction rope is also guided along this section, and is deflected at the end of the pier construction by a deflection sheave. The height of the suspension line is $42\frac{1}{2}$ feet above sea level, so that vessels can be conveniently loaded from above at any stage of the tide. The loading pier for the ships is 10 feet in width, expanding 100 feet from the end to a platform 30 feet wide. Here the ships are loaded by hoppers and chutes into which the tramway buckets are tipped automatically.



FIG. 2. ORE HOPPER AND LOADING STATION FOR TRAMWAY

the course of a year. Such a mole would, moreover, have acted as a sand catcher, gradually extending the shallows to the extremity of the mole. A pier resting on piles would doubtless have been a more satisfactory arrangement as the thin driven piles would not act as sand catchers and would afford the additional advantage of offering a comparatively small resisting surface to the action of the waves. Another alternative for loading the ships was the construction of a wire-rope tramway. In spite of the high capacity of 200 tons per hour there was in fact, the possibility of connecting Rio Albano and Giove Portello with a ship-loading station out at sea, in a single span of 350 to 650 feet. An isolated ship-loading station in the sea would, however, have necessitated a foundation on caissons which would have involved a very considerable additional outlay, whereas a pier built of railway rails—in accordance with the local practice—would have been far less expensive. These considerations led to the adoption of a loading pier.

Relative to handling the ore on the pier, there were two possibilities, according to whether a surface railway or an aerial line was chosen. The former would have necessitated various intermediate appliances such as gravity planes, and the automatic return of the empty cars which would have caused difficulties, and the construction of the pier would have been comparatively heavy and expensive. This is why a Bleichert aerial tramway was finally adopted.

The plan as adopted and completed, provided for two smaller aerial tramway lines, one for Rio Albano and another for

way buckets are loaded. These hopper ore bins are of masonry, with inclined floors for the pockets, 12 being installed at Rio Albano with a length of 167 feet, and 24 at Giove Portello with a total length of 265 feet, from six of which the ropeway buckets are simultaneously loaded by means

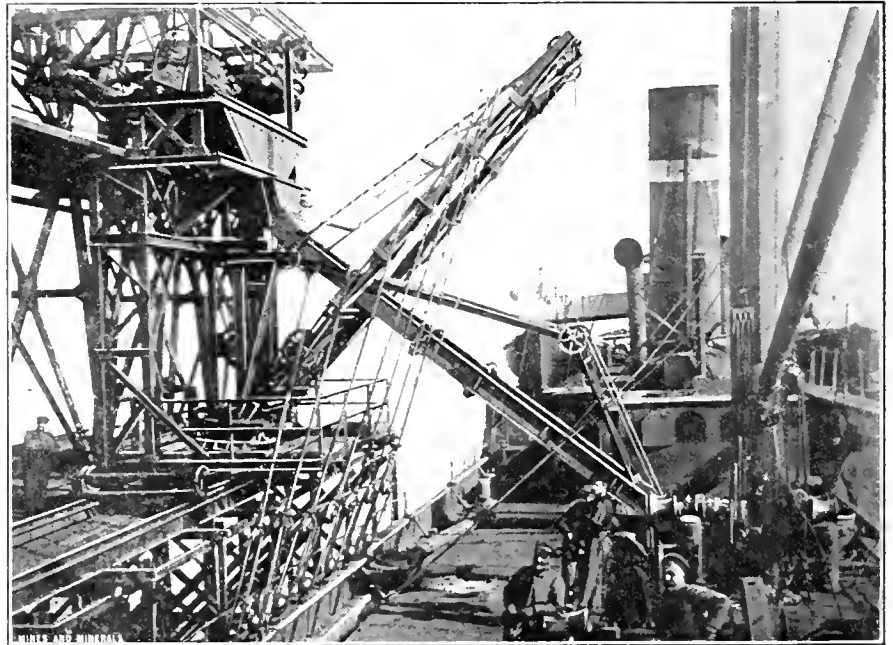

FIG. 3. MOVABLE LOADING CHUTES AT END OF PIER

of gates. The buckets, which are designed for a load of 20 hundredweight of ore, are weighed after loading and automatically registered by three self-acting scales fitted for this purpose on three parallel branches

The hoppers for the transference of the ore are portable as shown in Fig. 3, the chutes being raised by a rotary crane and moved to one side, so that they can be easily pushed past the vessels lying at the

pier. Only one chute is fitted on each side of the pier. The buckets discharge their contents into one or other of the chutes, in accordance with the position of the hopper, so that the traffic can proceed without interruption. The passage of the buckets around the return sheave at the extremity of the pier is automatically effected without detaching them from the traction rope, therefore no men are required on the pier to attend to the line except those shifting the hopper and chute from time to time.

The Rio Albano line is 1,000 feet in length, with a fall of about 160 feet. Some 200 buckets are handled per hour, which follow one another at intervals of 18 seconds, so that with a speed of the traction rope of 4 feet per second the distance between the buckets is about 70 feet. There are therefore always 28 buckets on the rope and six in the loading station for loading and weighing. The staff required for attendance on the line, including the hauls engaged at the hoppers and the weigh scales, consists of 25 men; three men on the loading pier assist in towing the ships. As the line has a fall in favor of the traffic, an excess of 30 horsepower is produced, which is utilized to drive a pump for the ore washery, the uniformity in the speed of the line being maintained by an automatic brake regulator.

The Giove Portello plant, shown in Fig. 4, is designed exactly like the Rio Albano plant, and shows that the ships being loaded do not touch the pier, hence their movements cannot interfere in any way with the process of loading.

The line has a length of about 2,460 feet

between the loading station and the return sheave. If the distance between the buckets is small, the time intervals between buckets (18 seconds) are not the optimum. On an ore loading

American engineer would have arranged the ore bins nearer the shore and then used an endless conveyor belt for carrying the ore to the point where it is loaded into the



FIG. 5. RIO ALBANO MINE

line at Vivero, Spain, where 250 tons per hour are handled, the buckets follow one another at intervals of 14.4 seconds; but a further reduction in this direction will hardly be possible. Other measures, such as the use of double carriages or the installation of double ropeways, will therefore have to be taken, in order to further increase the capacity of aerial railways.

[The method of loading iron ore into ships at Elba differs materially from the practice followed in Cuba by the Spanish-American Iron Ore Company, where shore

ships. While the capacity of 200 tons per hour is excellent for two wire tramways, it would require 25 hours to load a 5,000 ton vessel, where the traveling belt will load such a boat in 10 hours and at a cost of one cent per ton.—EDITOR.]

來來

Gold and Tin Production of Seward Peninsula

The gold produced in Seward Peninsula, Alaska, for 1911, had a value of \$3,100,000, which was a decrease of about \$400,000 compared with the figures for 1910. This falling off, according to P. S. Smith, of the United States Geological Survey, is attributable to three main causes—first, a decrease in the amount of winter mining; second, a general decrease in the number of mining operations, except dredging; and, third, the handling of low-grade material. All these causes may be referred more or less directly to the exhaustion of the known rich bonanzas before enterprises have been established capable of handling cheaply the large amounts of low-grade material which are known to exist on the peninsula. From this statement it may be inferred that at some future time the gold production of the Seward Peninsula will increase.

Although practically all the mineral production has been derived from gold placers, interest has been renewed in the tin deposits, and a production of nearly 100 tons of concentrate, worth about \$50,000, is reported from the tin placers on Buck Creek.

Not only has dredging for placer tin been carried on, but certain lode tin mines near York have been reopened under the superintendence of a competent mining engineer. It is understood that the company intends to ship the tin concentrate to Seattle, where it will be smelted.

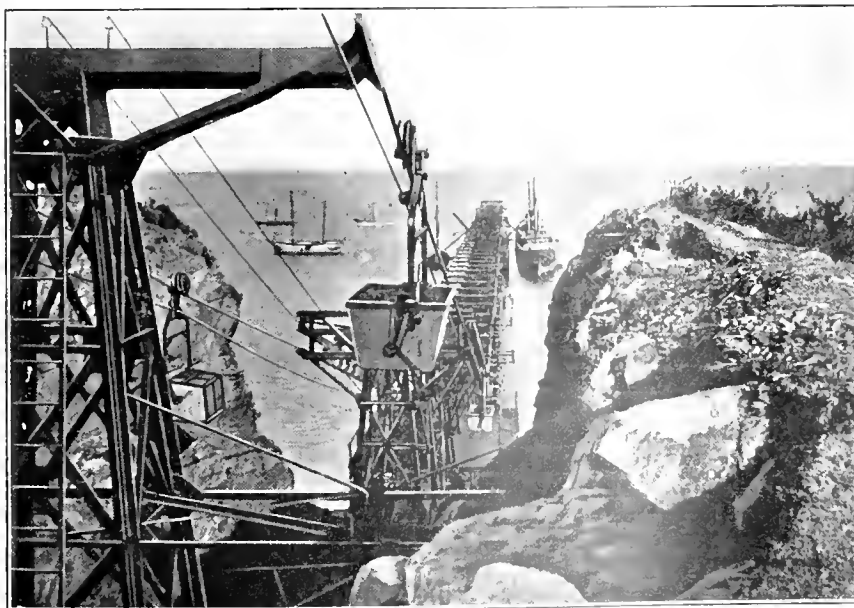

FIG. 4. GIOVE PORTELLO LOADING PIER

with a fall of 395 feet, producing a surplus power of 70 horsepower which is neutralized by a wind-sail brake.

The capacity of the two lines is 200 tons

conditions are somewhat similar. Without in the least detracting from the merits of the wire rope tramway, for it has no equal in some situations, it is probable that

Mining by Timbering and Filling

Timbering Methods and the Filling System as Employed by the Homestake Mining Co., Lead, S. Dak.

Written for *Mines and Minerals* by Albert L. Toenges, E. M.*

BEFORE describing the mining methods at the Homestake mine, it will be well to explain the geology which has, to a large extent, been responsible for the abandonment of the older methods of working and has necessitated the evolution of the present system.

The Homestake mine is situated at Lead, S. Dak., in the northern part of the Black Hills. The Black Hills consist of rocks from the Archean period to the Tertiary period. The rocks are Algonkian schists, slates, and quartzites; Cambrian quartzite; Ordovician schist; Carboniferous limestone; Jurassic and Triassic sedimentaries; and Cretaceous limestones. At the end of the Cretaceous period, the Black Hills region was slowly uplifted into a quaquaversal fold—or great dome-like, anticlinal mound—the strata of which dip away in all direc-

ized zone; while, on the east, there is a series of smaller, parallel lenses, some of which join the larger in depth. Near the surface, the ore bodies follow the rhyolite intrusions, but at depth, diverge from them and become associated with phonolites. The ore is quartzose, chlorite, and amphibole schist, carrying pyrite, pyrrhotite, arsenopyrite, and occasionally chalcopyrite. The accessory minerals are dolomite, calcite, garnet, tremolite, and asbestos. The distribution of the gold seems to be independent of the accessory minerals. In the upper levels, the gold seems to be associated with arsenopyrite, while below it is associated with pyrite. On the 100-

stulls. It became necessary, therefore, to adopt the Deidesheimer system of square-set timbering, or the style of timbering originally used in the large ore bodies of

the Comstock Lode, in Nevada. This system of timbering was revised somewhat from time to time. Ordinary square-set timbering was used until the ore bodies became of such great width that it was found impracticable. The old style of filling system, called the Homestake system, was next adopted. It was found, however, that less timber could be used, so still another system was devised and, at the present time, it is being used on all the lower levels of the Homestake mines.

Until recent years, as explained, the system of mining was that of stoping and timbering entirely with square sets. At the present time, the use of square sets is

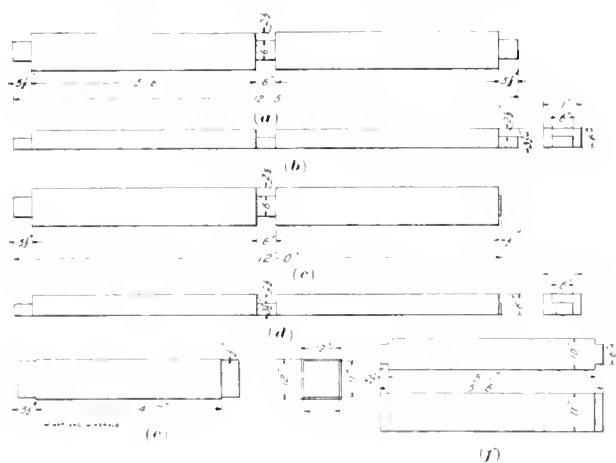

FIG. 1



FIG. 2

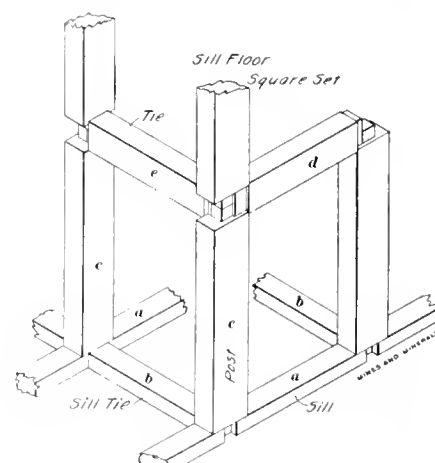

FIG. 3

tions toward the surrounding plain. Tertiary rocks were then deposited, but erosion has removed practically all of these. The older schists and those sediments deposited upon them were intruded by volcanic rocks.

The most important deposits of gold are in the crystalline schists as impregnations that appear to have taken place along two converging zones of crushing, one striking $N 10^{\circ} W$, and the other $N 30^{\circ} W$. There are evidences of several periods of mineralization, all along the same channels. The deposition of pyrite and gold was at the period of, or subsequent to, the intrusion of Tertiary flows of rhyolite-porphry. The ore-bearing zone is approximately one-half mile wide and several miles long, with a general course of $N 35^{\circ} W$.

The ore occurs in lenses of great extent. Some of the ore bodies attain a width of 500 feet. They dip to the east at steep angle, and pitch to the south. The large lens, running along the west side of the mineral-

foot level ore was found that was chiefly pyrite running comparatively high in gold. Over 60 per cent. of the gold is free milling, the remainder, associated with pyrite and arsenopyrite, must be treated in the cyanide mills. The Homestake Mining Co. has, at the present time, 1,000 stamps in its mill.

The lowest workings in the mine are on the 1,700-foot level. The Ellison shaft is, however, sunk to 2,000 feet.

The ore body was first mined by means of an open pit. The gold taken from this oxidized zone was about 72 per cent. free milling. Later on, the Star shaft was sunk in the lode and the Homestake company thereafter incurred heavy shaft maintenance expenses because of the movement of the ore body. When underground methods were first adopted, the stopes were worked by the use of stulls, for the ore bodies were not then of extensive widths.

However, as depth was gained, it was found that these ore bodies became wider and, in fact, joined together, and they became too wide to be mined by using

limited. Originally, the timbers for the square sets were all dressed, but now only rough timbers are used in stopes, and the only framing done is the making of the tenons. All shaft frames, however, are of dressed $12'' \times 12''$ timbers.

The timber-framing shop is near the Highland shaft. The timbers are usually left round and cut into the various lengths, as follows: Sills, 12 feet; ties, 5 feet 6 inches; caps, 5 feet 6 inches; sill-floor posts, 8 feet $9\frac{1}{2}$ inches; second-floor posts, 8 feet 5 inches; lagging 5 feet 10 inches.

The sills are cut as shown in Fig. 1 (a) and (b). They are framed on two sides to about 6 inches high. Sill-floor ties, Fig. 1 (c) and (d), are also framed to 6 inches high. The machine for framing the ends of the timbers was designed by a Mr. Balentine. The framing of the cap timbers (e) and the tie-timbers (f) is also shown in Fig. 1, while Fig. 2 (a) shows the sill-floor post and Fig. 2 (b) the posts above the sill floor. The framing of a post, cap, and tie costs 60 cents. Cut-

ting and sawing lagging costs 5 cents per running foot.

In the erection of a nine-post set, a gang consisting of a timberman and his helper is required. A nine-post set requires three

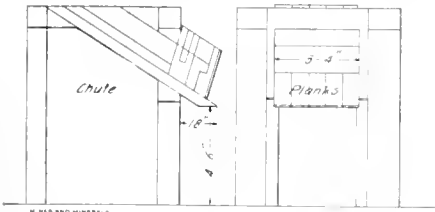

FIG. 4

sills, nine posts, six caps, six ties, six sill ties, and about 38 pieces of lagging.

The sill floor of the stope is first leveled. The sills *a* are then laid flat on lines set by surveyors, as shown in Fig. 3. These sills are leveled up and blocks placed under the end and middle of each. This gives each sill a smooth, bearing surface. The sill ties *b* are next placed in position and the sills and ties centered. The posts *c* are next stood, and after these, the caps *d* and ties *e* are joined with the upper ends of the posts.

After all timbers are in place, the entire set is trued by a plumb-line, and braces are placed from the set to the walls of the stope. The set is made rigid by means of wedges driven in between the walls of the stope and the braces. The number of braces required depends upon the condition of the walls of the stope, whether they are cracked or solid, and the ease with which the set can be braced to form a rigid structure. Each wedge used is 4 in. x 12½ in. x 2 in., tapering down to an edge.

After all the braces are in place, and before the lagging is put in, pieces of wood 2½ in. x 2½ in. x 4 ft. 6 in. are placed along the caps. These planks are known as "lagging strips." Lagging is now put into place, and held there by the lagging strips. All weight is borne by the caps.

Stoping.—The stope is now ready for further development. Drill runners will set up their machines upon the lagging and drill. They will then blast down the back on to the lagging. An 8-hour shift in a stope consists in setting up a piston rock-drilling machine, drilling two 6-foot holes, tearing down the machine, loading the holes, and blasting. Ingersoll-Rand rock drills are used. The rock is thrown through a set of lagging if no chute has been constructed. When enough rock has been taken out for another set of timbers (four posts, two caps, and two ties), a windlass is placed over the first set, and the timbers hoisted and erected. When enough rock is excavated, the set is ready for two more posts, two caps, and one tie. This will complete the second floor of the nine-post set.

By this time—or probably before this—it will be necessary to build a chute. The

details of the chute are shown in Fig. 4. Chutes are usually 3 feet 4 inches wide, and are built of either 3-inch or 4-inch planks. Some chutes are lined throughout with cast iron, one-eighth inch thick. The usual practice is, however, to place sheet iron on the bottom only of the chute. This makes the ore run considerably better than if the chute be not lined. It is the usual practice to put in a chute before starting a second floor to the stope. In regular stoping, there is usually employed a machine man, one helper, one "block holer," and two shovelers. There may be but one shoveler and no block holer, if the broken rock is not large. A "block holer" is a miner using a small "Jap" air machine to drill holes in large rocks and breaking them by means of powder.

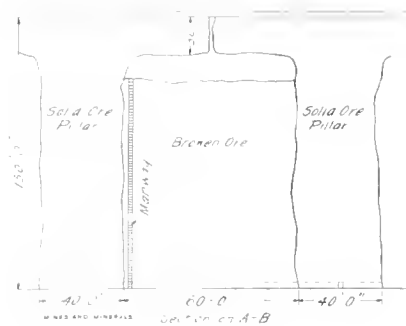
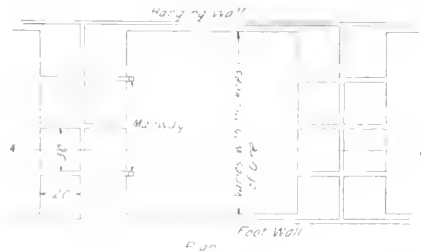

FIG. 5

Two gangs of timbermen (four men) can set up nine posts, six caps, and six ties, brace them and lag over the whole set in 8 hours. From this, the cost of one floor of square set can be figured as follows: Labor: Two timbermen, at \$3.50, \$7; two helpers, at \$3, \$6; Timber: Nine posts, at \$1.27, \$11.43; six caps, at 88 cents, \$5.28; six ties, at 92 cents, \$5.52; 38 lagging, at 25 cents, \$9.50; six lagging strips, at 4 cents, 24 cents; 30 wedges, at 1 cent, 30 cents; a total of \$45.27.

The prices on the timber may vary somewhat, but the above is a fair estimate of the cost of erecting one floor of a nine-post set. The prices given for the timbers include the labor in sawing and framing.

When a raise has reached several floors, it is desirable to build in a bin. The purpose of this bin is to keep the broken rock nearer the chute. A bin is made by lacing up three adjacent sets of timber, using 2-inch planks for the purpose. Before the lacing is put in, the caps and ties are protected by what are known as grizzlies. A grizzly is a piece of timber 6 feet 10 inches

long and usually about 12 inches in diameter and two of these are placed across the caps, parallel to the ties. A lagging is cut to fit between these two grizzlies and to act as a sprag. There are two laggings placed, one on each cap. The caps and ties of the middle set of timber only are thus prepared, and this set acts as the chute or opening through which the material will be thrown to the floor below.

A tunnel set consists of two 6' 10" timbers for posts, and a 6' 8" timber for a tie. The only tunnel sets used are in the cross-cuts through old stopes, and they are placed in the sill and between the sill-floor posts. They are placed close together, for the purpose of supporting the waste rock in filled stopes.

The writer had no experience in shaft timbering, but obtained the information contained in the accompanying figures from persons familiar with this work. One and one-eighth-inch rods are used as hanger rods in the construction of shaft sets.

The Homestake Stopping System.—The ore is low grade, averaging about \$3.86 a ton in gold. To make this material payable a large tonnage with low mining and treatment costs is necessary, and to meet these conditions the "Homestake system of stoping" was devised. This system will be explained by following its use in the development of territory tributary to the Golden Star shaft, which is sunk in country rock rather than in the lode formation.

First, a cross-cut is driven from the shaft into and through the ledge of ore. A drift is then excavated in the foot-wall north and south from the cross-cut. All stopes will be numbered from this cross-cut and "Stope No. 2, South" should thus be the second stope south of the cross-cut.

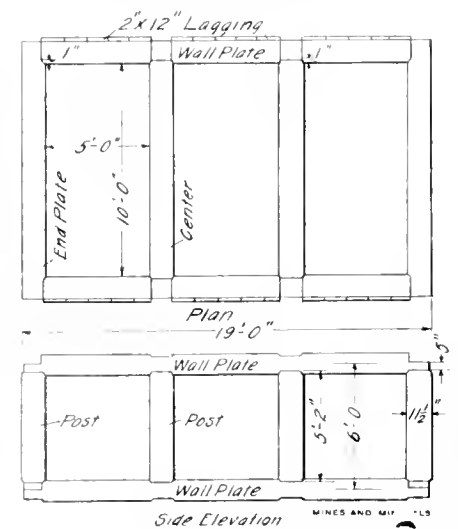

FIG. 6. ELLISON SHAFT TIMBERING

From the drift in the foot-wall, rooms or stopes are opened 60 feet wide and are spaced to leave intervening pillars of ore also 60 feet wide.

The rooms are driven from the foot-wall

to the hanging wall, irrespective of the distance, and about 10 feet high and all the ore thus broken is removed. A complete sill floor as for a timbered stope is put in and lagged over, and three lines of sets parallel to the strike of the lode are lined over doubly. One line of these sets is in the foot-wall, another line of sets is in the center, and the third line is in the hanging wall. A track is laid in each of these passageways. There are cross-connections between these trackways, placed as may seem convenient.

Ore is broken down as soon as the timber is in position. The lagging over all the sets—except the track sets—is used as temporary staging and is removed when the sets are filled with broken ore. The track sets are laced and kept intact, but the ore as broken from the roof is allowed to fill all the other sets. Some of the lacing is then removed from the sides of the trackways and ore is shoveled out. Enough ore is regularly withdrawn in this manner to make room for the miners to work on top of the broken material.

The timbers of the sill floor are the only timbers lost. The miner is not restricted as to the amount of rock he brings down at a single blast and the up-keep of the trackways may thus be a considerable amount.

Several sets of timber are carried up along the side of the stope, or room, as the work proceeds overhead. These sets are laced to be used for manways or ladderways. The stope is worked up to within 30 feet of the next level above, and the back is barred for the purpose of breaking down loose rocks. Raises are now driven along the center line of the stope to the upper level.

The ore body is of such nature that it is self-supporting, that is, the walls and back of the stope will stand during the process of withdrawal of broken ore from the bottom. When one end of the stope has been cleaned by shoveling into cars along the trackways, as explained, the sill-floor set is laced and waste rock is dropped into the stope from the level above through the raises. In this way the walls of one end of the stope are supported by the waste, while the walls of the other end are supported by broken ore. Before the waste is thrown in, a quantity of old timber is laid over the entire floor of the stope, and this timber mat is known as the "mud-sill."

The waste for filling is obtained from and through raises, which are kept filled from the surface. These are known as continuous raises. A raise is driven from one level to another. The next raise above is placed about 10 to 15 feet to one side of the lower and the two raises are then connected by an inclined by-pass. A gate is placed in the by-pass to regulate the amount of ore or waste coming from the upper raise. Each raise is also connected to a cross-cut by a small inclined raise. At the place where the small inclined raise meets the floor of the cross-cut there is placed

a grizzly, made of 12"×12" timbers placed about 10 inches apart. A rock over 9 inches thick cannot therefore pass through these grizzlies into the raise. Either waste or ore can be handled by these continuous raises; but in this present case, waste is drawn from the raises and thrown into the stope. The raises are really storage bins for either waste or ore.

The Present System.—The present system of stoping does away with all the sill floor timbers. Drifts are excavated in the hanging wall and in the foot-wall a short distance from the ledge. The ore body is then divided into stopes 60 feet wide and pillars 40 feet wide as shown in Fig. 5. A 6-foot cross-cut is driven through the center of each pillar from the hanging wall to the foot-wall. Along the cross-cuts, headings are driven about every 30 feet. These extend from the cross-cut in both directions to the stoping ground. The stope is then opened by taking out ore through the headings on either side of the stope.

On one side only of the stope timbered manways are carried upwards as the stope progresses. These manways are not in the pillar, but in the broken ore, a few feet from the pillar. As the ore is drawn out into the cross-cuts, the miners are at work on top of the broken mass. Shovelers keep the ore drawn off just sufficiently to give the miners enough room for their work. With this system, the stope can be worked about 120 feet high. When this amount of ore has been taken down, raises are driven to the level as in the Homestake system. Then the ore is drawn out completely, a mud-sill is laid down, and the waste thrown in as before. The stope is next filled with waste, nearly to the arch of ore between it and the level above. When the filling is completed, square-set timbers are put in on top of the filling and the remaining arch of ore is taken out, using the square sets for supports. As the stope approaches the upper level, great care is taken to prevent cave-ins. The arch is removed in small sections—a set at a time—while the mud-sill above the floor of the stope above prevents the running in of the waste. A stope on one level is directly below one on the upper level. As the arch is removed, waste rock is filled into the timbered part of the stope. These few square sets are the only timbers lost in this method.

After all the stopes are worked out and filled, the pillars of ore that have been left are worked by means of ordinary square-set timbering, the waste rock being prevented from running into the stope by lacing the outside sets of timber.

The features of this method that have reduced the cost of mining to a minimum are the following:

Levels may be placed at a comparatively long vertical interval. Below the 1,100-foot level, all levels are spaced 150 feet apart. The present deepest level is the 1,700-foot.

A minimum amount of timber is used.

Ore is broken at a small cost.

Stopes are easily and cheaply filled.

Nearly all of the ore can be extracted by this method.

The output is large and regular.

There are always large ore reserves, broken and in the pillars. At the present time there are about 1,000,000 tons of ore in reserve.

As a conclusion, it will be well to compare the costs of stoping with timber, by the so-called Homestake method and by the present system. The wage items will, of course, remain the same in all schemes and are as follows:

Miners and timbermen, \$3.50; helpers and shovelers, \$3.

To insure a fair comparison, take the figures resulting from the actual development of complete stopes by the three methods.

TIMBERED STOPE	
Cost of labor.....	\$ 2,057.08
Cost of timber.....	11,174.47
Incidentals (placing timber and chutes and breakage).....	5,538.97
Total.....	\$18,770.52
HOMESTAKE METHOD	
Cost of labor.....	\$ 500.34
Cost of timber.....	3,108.15
Labor, placing sill-floor timbers.....	758.16
Total.....	\$4,366.65
PRESENT METHOD	
Cost of labor.....	\$ 500.34
Cost of timber (manways).....	1,255.44
Incidentals.....	758.16
Total.....	\$2,513.94

To compare these costs on a tonnage basis, assume (as is fair) that 73,000 tons are mined from each of the three stopes. Then,

$\frac{18,770.52}{73,000} = \0.257 cost per ton of ore by timbering method

$\frac{4,366.65}{73,000} = \0.06 cost per ton by Homestake

method, or a saving of nearly 20 cents per ton

$\frac{2,513.94}{73,000} = \0.034 per ton by present system,

or a saving over the old method of 22 cents per ton, and over the Homestake method of nearly 3 cents per ton.

栗 栗

Altitude and Air Compression

The effect of altitude on the efficiency of air compressors is considerable. The calculation of the volume of compressed air delivered at sea level and at a higher altitude may be shown by the following example: If 300 cubic feet of air at an atmospheric pressure of 14.7 pounds is compressed to a gauge pressure of 80 pounds the volume will be $300 \times 14.7 \div (80 + 14.7) = 46.5$ cubic feet. If the air is at an atmospheric pressure of 10.1 then the volume would be $300 \times 10.1 \div (80 + 10.1) = 33.5$ cubic feet. The volumetric efficiency of a compressor at 10,000 feet above sea level is therefore only 72 per cent, of what it would be for the same machine at sea level.

Creep in the Panama Canal

Conditions Caused by, and the Method of Dealing With, the Large Masses of Moving Earth and Rock

By Frank G. Carpenter*

MIGHTY masses of earth and rock are sliding down into the Culebra cut of the Panama Canal. There are two places where more than 1,000,000 cubic yards of earth and rock are now moving. The material in action is equal to a solid block 300 feet square and 300 feet high. This enormous quantity of rock is advancing at the rate of almost 2 feet per day, and since the beginning of digging thirteen or fourteen times as much as that mass has been excavated, or a total of over 13,000,000 cubic yards. If there had been no slides the excavation for the canal would have been done long ago. As it is there are 11,000,000 cubic yards yet to dig and of this something like 4,000,000 are the direct result of the slides.

The Culebra cut is altogether 9 miles

The pipe line which carries the air for the drills is 10 inches in diameter, and extends from one end of the cut to the other. It is fed by three air compressors that can compress 17,000 cubic feet of air every minute. The air feeds the drills and keeps them chugging away day and night, boring the holes 6 inches in diameter and from 15 feet to 30 feet deep for the blasting. Colonel Gaillard, division engineer in charge of Culebra cut, said that last year the holes put down, if joined end to end would have equalled a pipe running all the way from Philadelphia to Chicago, or if sunk straight

ceptible. The crack is about a foot wide and it steadily grows. Another movement of the same kind is apparent at Empire, where Colonel Gaillard has his headquarters, and the workmen in pointing to it facetiously say that Mother Earth is about to take her revenge on Engineer Gaillard for the scars he is making upon her old body at Culebra.

These cracks mark the beginning of slides, and later on in the cut the earth comes down. There are several kinds of slides. The first consist of the material lying above the bed rock. These are composed of clay and other earth, and they may have a great deal of rock mixed in them. Such a slide is caused by the digging away of the material which holds it in place and also by the increased weight made by the water of the heavy rainfalls.



FIG. 1. 1ST PHOTO OF MOVING CANAL BED



FIG. 2. PHOTOGRAPH OF CANAL BED TAKEN TWO MINUTES AFTER FIG. 1

in length, and about 300 feet deep. In some places the cutting back that has been made on account of the slides is almost 2,000 feet wide at the top, and the sloping goes down in steps to the bottom of the canal, where the width is 300 feet.

It is impossible to conceive the vast amount of earth that has been taken out of the canal, since the figures convey no idea of the concrete dimensions. In 1 month enough stuff was removed to fill a ditch 3 feet wide and 3 feet deep from Boston to Chicago, and most of that was of such nature that it had to be blasted.

As one looks down into the cut he can see the mighty work everywhere going on. Trains of earth are moving this way and that. Scores of steam shovels are puffing and groaning as they drop the earth and rock on the cars, and everywhere are gangs of negroes who are drilling the ledges as shown in Fig. 3, and putting in dynamite to break up the earth for the shovels.

through the earth would have reached almost one-fourth of the way to the center. The consumption of dynamite for 12 months was over 5,000,000 pounds. Every hole requires 20 pounds. The dynamite is wrapped in pink paper to keep track of it and prevent the workmen stealing it to dynamite the waters for fishing. The loss from this source was considerable, but this pink paper can be seen a great distance, and now whenever a man is caught with dynamite so wrapped he is arrested.

Going down into the cut, cracks are seen everywhere. In some places they are so wide that one could put his foot in them, and others would hold only a finger. There are cracks all over the hills, and some of them mark out bodies of earth which will have to be moved, as they are already sliding down into the cut.

There is one great crack at Culebra which incloses 4 acres, comprising a million or more cubic yards, which are already moving, although so slowly as to be imper-

This aids in carrying the earth down into the canal.

Most of such slides occur in the rainy season, although there are some also in the dry season. One such mass seen moving comprised about a million cubic yards, equal to a block 300 feet square and 300 feet high, and was going forward at the rate of 18 inches per day. From the bed of the canal the place where the clay joined the rock could be plainly seen. It was a sort of a hollow in the hills where the rock of the cut had been blasted off sheer so that one could follow with the eye the line where the clay ended and the bed rock began. There was a 95-ton steam shovel at the foot of the rock, and it was catching the earth as it fell and loading the cars. It was working just fast enough to keep the stuff from the slide out of the way. The earth fell slowly and in great masses, continuously dropping down into the cut.

Take the Cucuracha on the east side of the canal. The word Cucuracha means

* Copyright, 1912.

"cockroach," and this cockroach is the biggest of its kind upon earth. It covers an area of 17 acres and forms a great mass of earth which has broken off 1,820 feet from the center line of the canal.

It began when the French were working, and it has caused trouble ever since digging was begun. The United States have already moved out of it a mass of earth amounting to 2,000,000 cubic yards, and it is still active. At one time it came onward at the rate of 14 feet every day. Nevertheless the steam shovels ate it up as it came, and there is no doubt but that the shovels and dredges will be able to care for it and all the other slides of the future. The ordinary slide can

into the canal. These masses do not come from the top, but from the strata of which the canal banks are made. Sometimes they come from below the canal bed and force themselves up in humps through it, overturning steam shovels and heaving the railroad tracks.

This morning, at a point just opposite Gold Hill, I saw a hump, or great hill, which had risen up in the bed of the canal during the night, moving the four railroad tracks which ran parallel across it. The rails were twisted and torn, and the ties were pulled out of the earth. Colonel Gaillard and myself stopped to watch the men who were getting ready to repair the tracks and were bringing up shovels to take out

beneath, and it has squeezed some of them out into the canal. The weaker strata are like the jelly in a layer cake. The layers above pressing on the jelly cause it to ooze. The soft strata give way to the weight above and are forced out into the canal bed, or if the stratum is under the bed of the canal it is squeezed out so that it humps up and throws the railroad as described.

Slides of strata such as described are common, but the engineers know how to control them. They have occurred so often that they are now taken as a matter of course. The hump or creep of this morning will be out of the way before night. Four hundred men are working at it and sending it down to Balboa.

Colonel Gaillard says that there has not been 1 week during the past 3 years when the bottom of the canal has not been heaving and rising, but he adds that the heaving grows less and less as the weight from the sides of the cut is removed and the upper banks properly sloped. At present the only place where the earth is creeping is right under Gold Hill. The trouble occurs within a length of perhaps 200 feet, whereas it formerly extended over 2,000 feet. The creep makes it necessary to rebuild a great deal of track, and on this account altogether more than 100 miles of track have already been shifted.

The rains here are often exceedingly heavy, retarding the work. During the wet season the clay flows down like a river and it takes time to clear the railroad of mud. As an instance of the rainfall, there are some places on the isthmus where it has spurts as heavy as anywhere in the world.

In the cut are heated areas where the chemical condition of the earth is such that it oxidizes upon exposure to the air and generates heat. In some places the cut steams, and in others the ground is so warm that you cannot put your hand in it.

These hot spots are found at various depths, and they are often of such a temperature that the dynamite would explode if put down into a hole, drilled through them. For this reason a long iron pipe is dropped down into every drill hole before it is charged. It is left there for 10 minutes and then taken out. Then, by running the hand along the pipe one can find whether there is a hot place in the hole, as this heats the pipe at that place. Some premature explosions have occurred owing to the lack of this test, and some of the material now being handled would fire dynamite if brought near it.

In one place in the cut steam was pouring forth like a geyser. The smell of sulphur was strong, and one had to get to windward to prevent being overcome by it. At this place the ground was yellow with sulphur and the steam was oozing out over an area of several square yards. A manilla

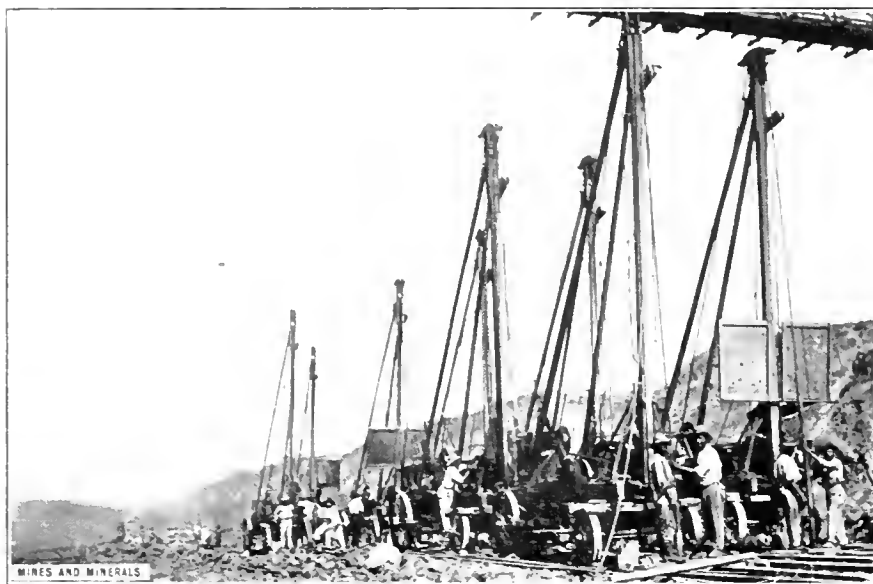

FIG. 3. CHURN DRILLS ON PANAMA CANAL

be handled by one shovel, and this is so even when the slide is a long one. At Las Cascades a shovel moved up and down a slide one hundred times, going back and forth and removing its toes as they were pushed into the cut.

There is a big slide on the west side of the cut near Culebra which covers 28 acres and another on the east side north of Gold Hill where about 17 acres have broken off, beginning 1,200 feet back from the center line of the canal. So far an area something like 157 acres of slides has been taken out, and there are many acres still in motion. Colonel Gaillard, who has seen the glaciers of Alaska, says that these slides move just like them. The earth flows down the sloping surface of the bed rock, the lateral support of the masses having been removed by the digging. It is just as though the earth were made of molasses and held back by dams at the sides. These dams were taken away by the digging of the canal.

In addition to these surface slides or flows there is another class of earth motion which is carrying great masses of rock

the hump, when lo, right under our eyes, we saw the earth rise and throw the railroad, ties and all, to one side. I had my camera ready and made photographs of the ground while it was moving. As the last picture was finished one of the tracks turned over and rolled down the side of the hill. This hump was right in the bed of the cut and almost on the bottom of what will be the permanent bed of the canal.

In another place the walls of the cut contained many different layers of rock of varying degrees of density, lying one upon the other. Here was a stratum of shale, there one of lava, and above it one of limestone or a layer of volcanic dust hardened to stone.

Before excavating began these strata lay one upon the other, and the weight of the mass was equally distributed, bed upon bed, so that it was not possible for any of the strata to move, no matter what lay above them. Then the great ditch was cut and the weight and pressure on that side were taken away. This allowed the great weight above to exert its force on the weaker strata

envelope held over one of the cracks was destroyed by the heat which even charred a piece of white pine lumber, although it did not bring it to a blaze.

In looking at the earth near the steam vents it seems cool, and, to the touch of the hand on the surface, there is no sign of heat, but when the crust is scraped away a bit the hand would almost be burned by the contact.

In loading this stuff the mass is sometimes so hot that the brakemen cannot ride on the loads, and they hang outside, holding on by the irons, as the trains move on toward the dump.

There is, however, no danger from these heated areas. The geologists of the commission have examined them, and they say they are due to the oxidation of pyrites and other materials which generate heat on exposure to air.

來 來

Characteristics of the Mexican Miner

Written for Mines and Minerals by Harold Lakes

The first 3 months an American mine manager operates in Mexico is "hell"; the next 3 months, he begins to enjoy life in his new surroundings; and thereafter it is hard to drive him out of the country. If he does leave, he will always possess an attraction for Mexico.

Mexican peons are, as a class, most ignorant. Very few of them can write their names. They are inveterate thieves, and they will stand and look a man squarely in the eye while they calmly lie out of any predicament. If it happens that a storekeeper puts in a new clerk for a day or two, every native within reach will attempt to purchase things from the clerk cheaper than usual, upon the bluff that such articles have always been sold at lower prices heretofore. If bosses are changed in a mine, the men will invariably endeavor to bluff their new taskmasters as to what may be reasonably expected of them in the matter of a day's work.

In the ignorance and shiftlessness of these people, lack of consideration for the morrow's existence plays a prominent part. They live for today, only, and have no compunctions concerning the throwing up of a job even if they have not a nickel in sight, and will calmly take chances on finding something else to do when money is needed. This mental attitude is encouraged by their ability to always partake of the food and shelter of other natives.

If it chances that a peon is invited to take a meal with an American, the Mexican will probably take his seat, fail to remove his hat, and will observe none of the rules of table etiquette. Perhaps the saddest part of his meal lies in his wrest-

ling with a spoon and fork, implements scarcely ever used by him among his own people. If a peon is requested to ascertain the time of day, he will go to a house containing a clock; but, having no idea what the clock says, he will take special notice of the sun's position and will, upon his return, report the time.

It is strange how strong some of these men are, physically, for one of them will eat about as little in two days as would make an ordinary meal for a single American. They do not possess great strength in their backs, but can carry great loads upon their shoulders if such loads are placed thereon by others.

In our country much sweet and greasy food is considered heating to one's system and hence unfit for summer diet; but in Mexico, a family of five or six members will consume a kilo (2.2 pounds) of lard per day as well as one or two kilos of sugar. This latter staple is bought in cubes, and from seven to ten of these cubes are used per cup of coffee. The Mexicans prepare their native beans in a manner that is highly acceptable to Americans, and "gringos" always ask for frijoles when arriving in a native camp.

A peon house will have one room which may, perhaps be 12 feet by 14 feet, and this will provide shelter for two or three families, comprising 12 to 15 persons. Beds consist of blankets or sacks spread on the floor. Instead of removing a stone which may be found in the way of comfort, a person will adjust his body to miss it. Pigs help to make up a family. A dog will be kicked around, but a pig never, for frequently a pig comes in for more consideration than a person. Chickens also live in the house and roost at night over the occupants of the beds. It is commonly remarked that peon women will use more water and will look dirtier than their hogs; so that women are a nuisance in those camps where water is scarce.

Mexican peons will often starve themselves to save up a few dollars, only to gamble and drink the money away in a single night. In the state of Sonora, men who refuse to work and who are drunk much of the time, are considered public nuisances. They are put into the army for 5 years and are paid 26 cents per day from which they must board themselves. A soldier of this class is a picture of forlorn humanity. He wears sandals on his feet as the only protection from the cactus and other thorns of the country. His uniform is wrongly named for it is nondescript. He lives with the feeling that he is serving time—not his country—and his fighting value is correspondingly measured. Of course, not all Mexican soldiers are of this class.

The average mine manager from the

States generally selects and takes his corps of miners with him to Mexico; for it is the case that, until the recent political disturbances in Mexico, there have always been many American miners who sought experience in this other republic. The boss will begin by putting Mexicans and Americans at work together, and there soon results the inevitable trouble, due to a difference in the customary wages paid the two classes. The native at \$2.50 per day, is expected to do the same kind and amount of work as the American who receives \$3.50 per day. The Mexican, of course, objects. Then the American soon begins to complain of the heat, the poor water, the Mexican "grub," and the difficulty of conversation with the natives. Finally, the manager realizes the incompatibility of the two classes of laborers, and he solves his problem by discharging all of his Americans except just enough to do the mine timbering and to fill a very few of the important positions. Affairs progress all right in this manner until, within a week, the manager finds his miners are driving drifts in directions directly opposite to the correct ones, and it becomes necessary for him to devote a great share of his time to personally pointing all the drill holes, telling the men just how much powder to use in each hole, which holes to shoot first and which last, and restricting the number of candles used by each man per day to a certain number.

In most parts of Mexico, miners are paid according to the inches of drilling, for in this way the men may be held up to a fair amount of work. A Mexican will undertake contracts for driving at so much per foot, but he will never agree to carry on his contract for any specified length of time, nor for any given number of feet. As long as his progress pays satisfactorily, he stays with his contract, but upon entering harder rock, he quits. The only advantage in giving such contracts lies in getting longer days from the men and thus in finishing the work quicker than it could be finished under day's pay. There is a saying that "when a Mexican is working his best, cut his wages and tell him to dig in," for if he is promoted or complimented, he believes that his services are indispensable, and he becomes useless.

An American who does not understand Spanish finds plenty of trouble; for after explaining points to his men in detail and inquiring if he has been understood, he is invariably told "yes," whereas the truth is the men are perfectly blank as to what has been told them. That same night, perhaps, the manager, finding things quite the reverse of his orders, will "fire" a poor man, replacing him with a poorer one, and the whole trouble has been due to the American's own deficiencies.

Practical Cyaniding—Part 1

History—Chemical Reactions—Solubility of Minerals—The Mill Solution and Its Constituents—Laboratory Work

Written for Mines and Minerals by John Randall*

THAT cyanogen combined as a cyanide is a solvent for gold and silver has long been known, but it was not until MacArthur and the Forrests made improvements in the method of precipitating gold from the solution by means of zinc, using zinc shavings, freshly cut, that the cyanide process for gold extraction assumed commercial importance. In the same year that the MacArthur-Forrest patents were granted in England (1858), Ernest Siemens, of Berlin, applied in the principal mining countries of the world for patents upon a method of depositing gold from cyanide solutions upon cathodes of sheet lead by means of an electric current. Owing to a meager knowledge of the chemistry of the process during its early history, zinc precipitation was somewhat imperfect and uncertain, and therefore in some fields, notably in South Africa, the Siemens method was for a while a keen rival of zinc precipitation.

The scope of the cyanide process has been so much enlarged within recent years that any gold or silver ore of moderate richness not known to contain too great quantities of substances destructive to the cyanides, should be tested with a view to cyanidation. In cases where a good recovery can be made by the simpler process of amalgamation, a profit can generally be realized by cyaniding the tailing. The fact that the field for the process is such a wide one makes many modifications necessary in its successful application to different kinds of ores.

When gold is treated with a cyanide solution, oxygen or some other element that acts as an oxidizing agent must be present. The reaction, presuming oxygen to be present, is expressed by the following equation, known as Ehsner's equation, as Ehsner advanced the theory in 1844:

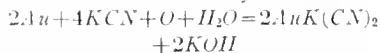

The probable reaction is that the gold unites with the cyanogen, liberating potassium. Part of the potassium immediately unites with the gold cyanide, forming the double salt, auropotassic cyanide; the remainder, uniting with the water, liberates hydrogen and forms caustic potash or potassium hydrate. When such a solution is evaporated, it yields octahedral crystals, which show on analysis to be auropotassic cyanide, $AuK(CN)_2$.

The order of solubility of the more common minerals in a .1 per cent. cyanide solution, according to Julian and Smart, is given in Table I.

In forming at the values named in this table each substance was taken alone, but when more than one of these substances are added upon in the same solution at

*Bull. U. S. G.

the same time the case is somewhat different. If the substances are in contact or near enough together to be electrically connected, they form galvanic couples, accelerating the dissolution of the more soluble substance and retarding the dissolution of the other. Sometimes this action is a hindrance to the process, as a

TABLE I. SOLUBILITY OF MINERALS

Minerals	Degree of Solubility
Marcasite, white iron pyrite, FeS_2	1.0
Mispickel, arsenopyrite, $FeAsS$	4.8
Iron rust.....	7.0
Galena, lead sulphide, PbS	11.5
Iron pyrite, FeS_2	18.0
Charcoal iron.....	22.0
Copper pyrite.....	36.0
Lead.....	43.0
Silver.....	45.5
Gold.....	82.5
Zinc.....	100.0

couple formed between copper pyrites and marcasite would accelerate the dissolution of the copper. Other couples formed, as between gold and the sulphides, would be a distinct advantage. This action undoubtedly occurs to a greater or less extent during the treatment of all ores containing base metals or their compounds.

An accumulation of hydrogen at the cathode of a galvanic couple causes a condition called polarization, in which action is greatly diminished or ceases altogether, unless this hydrogen is removed as fast as formed. In the case of an ore acted upon by a cyanide solution the oxygen dissolved in the solution plays the important part of keeping down the accumulation of hydrogen. It is almost needless to remark in this connection that a solution while moving, as in percolating, is much more efficient in this regard than while at rest. Comparatively strong solutions tend to the evolution of hydrogen faster than it can be removed, thus inducing polarization, which is a reason why such solutions are much less efficient per unit of strength. Also when the dissolution of gold is impeded or stopped from this cause, other galvanic couples are formed and base-metal compounds are brought into solution with considerable rapidity. This has given rise to the idea that weak solutions exercise some kind of selective action in their preference for dissolving gold.

Another effect of even partial polarization should receive attention. The deposit of hydrogen, tending to reverse the polarity of the couple, is extremely liable in a complex solution like a working mill solution to deposit some insoluble or difficultly soluble substance upon the gold. This

affords an explanation of the fact observed by many mill men, that if abnormally low extraction occurs upon a vat of ore from some cause known not to be attributable to the ore

itself, it is usually impossible to obtain a normal rate of extraction by subsequent treatment.

From the foregoing remarks it is easy to see why, in many early attempts at cyanidation with comparatively strong solutions, and with considerable intervals of rest between the periods of leaching, many ores were not regarded as amenable to cyanide treatment that are now considered quite docile.

Iron sulphide is but little acted upon by cyanide solutions provided they are properly applied and kept in working order, but with ores containing partly oxidized iron sulphides the case is quite different. Ferrrous sulphate, $FeSO_4$, soluble in water, reacts with the potassium cyanide solution forming potassium ferrocyanide as follows:

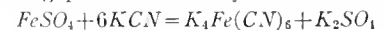

Soluble sulphates can be removed by a preliminary water wash with an alkali added near the end of the operation to neutralize acidity, but unless the ore is well oxidized complex reactions are likely to occur resulting in a loss of cyanide.

Copper compounds in some quantity, are generally found in gold ores. Whether a small quantity of copper sulphide is objectionable might depend on the presence of other elements, and could best be determined by experiment. Copper oxides and carbonates are readily attacked by cyanide solutions and their presence generally renders the cyanide process inapplicable.

Antimony, as stibnite Sb_2S_3 , is not objectionable unless occurring in considerable amount. The sulphur combines with the alkalis in the solution forming alkaline sulphides which must be kept from accumulating.

Blende ZnS , is but very little affected by cyanide solution.

Tellurium. Ores containing compounds of tellurium are generally difficult and often impossible to treat with cyanide solutions until oxidized, the tellurium seems to coat the gold with a more or less insoluble film.

Coarse gold, owing to the time required to dissolve it, should be removed before treatment with cyanide. This is generally done by amalgamation or concentration.

Silver chloride is readily soluble in cyanide solutions, but other silver compounds are much more slowly dissolved, metallic silver being less soluble than gold. The dissolution of silver sulphide Ag_2S , is generally accounted for according to the following equation:

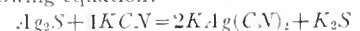

If very much potassium sulphide K_2S is formed in the solution the action is liable to be reversed and dissolved silver is precipitated as Ag_2S . Cyanide is also destroyed by the formation of thiocyanate KCN_2S .

It has been customary to add acetate of lead to silver ores to form lead sulphide with any free sulphate or soluble sulphide, thus rendering the sulphur harmless. Sodium cyanide $NaCN$, in solution, seems to have the preference over potassium cyanide in cyaniding silver sulphide ores. By grinding silver ore very fine and then agitating, an excellent recovery may be effected with cyanide solutions.

The addition of a lead compound should only be made when the silver exists as argentite Ag_2S , and then it is more economical to use litharge than lead acetate. However, air perseveringly and judiciously applied costs much less than chemicals and can generally be made to answer every requirement as an oxidizer.

Slime.—While clayey, or talcose, ores produce the most slime, any ore will form some slime when ground with water. A substance having something of the characteristic of gelatine is developed when pure feldspar is ground in water. This substance, termed a "colloid," absorbs water which greatly increases its bulk. When a solid is dissolved in water, a force called cohesion exists between the molecules of water and the soluble substance that tends to keep it in solution. But in this case the molecules of the solid are so separated that there is no cohesion between them, so that they are free to move among themselves and through the dissolving medium. This force of adhesion is stronger than the original cohesion of the molecules of the solid among themselves, else the solid would not dissolve. The strength of this adhesive force is illustrated in a strong solution of common salt that will not freeze, as the adhesion of the salt molecules prevents the water from separating from them to form ice crystals. This only partly explains the action of colloids in water or watery solutions, for the reason that colloids do not form true solutions with water, but owing, probably, to the shape of their molecules, exhibit a considerable amount of cohesion, forming with water a jelly or semisolid. The point to be particularly considered is that neither the colloid particles nor the entrained water is entirely free to move by diffusion as in the case of true solutions. Thus diffusion, so necessary to the dissolution of solids, is greatly retarded or entirely stopped by the presence of slime. This gelatinous matter coats the granular particles of ore in much the same manner as the gelatinous perisperm of some seeds surrounds them when moistened, this preventing diffusion between the solution in contact with the ore granule and the solution outside. But if a solution of a considerably different density

is brought in contact with this coating of slime, the tendency toward diffusion will overcome the adhesion of the slime for its entrained liquid, osmosis taking place through the colloid, as illustrated in the pressure diagram by the tendency of salts in solution to diffuse through membranes. After partial diffusion takes place the osmotic pressure becomes too low to break down the adhesion of the colloid for its entrained liquid, and diffusion and consequent dissolution cease until another considerable change of density occurs in the surrounding solution. Thus it is found that in treating slime by the cyanide process agitation is imperatively necessary, while a number of changes in the strength of the solution can be made with a beneficial effect on the extraction.

Flocculation.—Ore slime can generally be flocculated, or caused to shrink somewhat and break into flakes, by the addition of a small amount of caustic lime. This is of great service in thickening slime, but does not prevent the slime retarding diffusion.

THE MILL SOLUTION AND ITS PRINCIPAL CONSTITUENTS

Water, the great natural solvent makes up the entire bulk of the working solution in a cyanide plant. The solid constituents of many mill solutions comprise only about one-thousandth of their entire weight and do not appreciably increase their volume. A general knowledge of the properties of this solvent is necessary to the cyanide operator.

Natural surface waters, found in springs, rivers, and lakes, contain air in a state of solution. 1,000 cubic centimeters of pure water, at sea-level pressure and temperature of greatest density, contain when saturated 17.95 cubic centimeters of air of the following composition: Oxygen, 31.91, and nitrogen, 65.09 per cent. by volume. Atmospheric air contains considerably less oxygen.

Stagnant waters from swamps and ponds and from old mine workings usually contain organic matter undergoing decomposition. These impurities act as reducers, i. e., deprive other bodies of oxygen. These waters also usually contain organic and mineral acids. They can generally be rendered fit for use in mill solutions by aeration and by treatment with an alkali.

The affinity of water for carbon dioxide CO_2 is considerable, one volume of water being capable of dissolving several volumes of this gas. The capacity of water to absorb carbon dioxide is partly accounted for from the fact that the two form a definite compound, carbonic acid H_2CO_3 . Water containing H_2CO_3 is capable of dissolving large quantities of calcium carbonate, which is practically insoluble in pure water.

Waters containing carbonates in solution should never be used in making up a fresh quantity of mill solution until these impuri-

ties are removed. What is called "liming," treating with freshly slaked lime $Ca(OH)_2$ is the most efficient method of purifying such water. The calcium hydrate removes the carbonic acid according to the following equation:

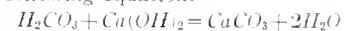

The calcium carbonate formed, as well as that in solution, is precipitated. Should the water contain carbonates of the alkalies, they are decomposed by the lime, the alkalies becoming free and the CO_2 being locked up with the lime and removed from the solution.

Waters containing chlorides are not particularly objectionable, sea water having been successfully used in cyanide solutions. Such waters, however, have a lower absorption coefficient for oxygen.

The cyanides, potassium cyanide KCN , sodium cyanide $NaCN$, and calcium cyanide $Ca(CN)_2$, are the principal cyanides found in mill solutions. Cyanogen CN composed of carbon and nitrogen is classed as a compound radical for the reason that it exhibits many of the characteristics of a single element. It is sometimes denoted by the symbol Cy , particularly in foreign countries. Combined with alkaline bases it forms cyanides. When freed from this combination it takes one atom of hydrogen, forming hydrocyanic acid HCN , a gas having a smell not unlike that of peach kernels, and one of the most deadly poisons known.

The strength of cyanides is computed according to the amount of contained cyanogen; a cyanide having the amount of cyanogen contained in pure KCN being called 100 per cent.

The alkalies, caustic soda $NaOH$, and caustic potash KOH , if not introduced directly into a mill solution find their way there by the decomposition of their cyanides. They are useful in making up the amount of free alkali required in the solution.

Protective alkali. Free alkali in a cyanide solution is termed "protective" because it protects the cyanide from decomposition. Acidity in the ore, that would otherwise cause cyanide loss, is neutralized and rendered innocuous by this protective alkali.

Lime, not classed as an alkali but as an alkaline earth, is a much more energetic base than either potash or soda. Its properties and the points of difference between it and other alkaline elements merit the special study of the cyanide operator. Calcium is bivalent, therefore a molecule of calcium oxide CaO having the molecular weight 55.87 is equivalent to two molecules of sodium hydrate $NaOH$, the molecular weight of $2NaOH$ being 79.92. Bearing in mind that the caustic soda of commerce usually contains only 70 per cent. $NaOH$, an interesting comparison can be made as to the comparative efficiency of the two substances, taking into consideration the difference in cost.

The sparing solubility of calcium hydrate $Ca(OH)_2$, one in 530 parts of water, makes

it practicable to mix lime CaO directly with the ores as it comes to the mill, thus getting the benefit to some extent of a preliminary alkaline treatment, without complications which might occur from a too strong alkaline solution if a more soluble alkali were thus used. In many cases the lime combines with enough moisture from the ore in slacking to make the ore work materially better in the feeders and the conveyers.

Lime combines with CO_2 with great avidity. In the presence of potassium or sodium carbonate it robs these elements of their CO_2 , the calcium carbonate thus formed being insoluble. The lime, at first sparingly soluble as $Ca(OH)_2$, then goes out of solution entirely. The small amount of CO_2 always present in the air has a marked effect in removing lime from a cyanide solution. Some free calcium hydrate should always be formed in a working cyanide solution.

Lime with arsenic forms an insoluble compound and will decompose alkaline arsenites, forming insoluble calcium arsenite, thus removing arsenic from a solution.

Reducing Agents.—Alkaline sulphides, principally as potassium sulphide K_2S and sodium sulphide Na_2S , are formed in working solutions and seriously impair their efficiency. Various chemicals have been used to oxidize these sulphides but nothing has been found to be as economical and efficient, generally speaking, as atmospheric air properly and persistently applied. Skey, in 1888, proved by experiment that K_2S and hydrogen sulphide H_2S cause the deposit of an exceedingly thin film of sulphur upon particles of gold, that interferes with cyanidation as well as amalgamation, and that a small quantity of H_2S is usually formed during the wet crushing of pyritous ores, but metallurgists generally seem to have been rather slow to appreciate the full significance of his discoveries.

Oxygen.—By reference to the Elsner equation it will be seen that the presence of oxygen in a working mill solution is a necessity.

In any dilute solution of a solid in a liquid the molecules of the solid tend to separate until they are equally diffused through every portion of the liquid. This property of solutions in general plays an important part in the cyanide process. For example, a particle of porous ore one-fourth inch in diameter becomes saturated with cyanide solution. The minute particles of gold within these pores form with the solution a soluble gold compound $KAu(CN)_2$, at the surface of the gold particles, but if no diffusion occurred to carry away the dissolved gold as well as to bring fresh cyanide in contact with the gold, dissolution would cease. Further, diffusion must occur between the solution contained in the pores of this ore particle and the solution outside, or the dissolved gold could not be recovered from the

particle of ore. As might be expected, this distribution of the molecules takes place more slowly as the liquid more nearly approaches complete balance or diffusion. If the first solution should be removed from around the ore particle in question and a solution substituted having an appreciably different strength, diffusion would be materially accelerated.

LABORATORY WORK IN CONNECTION WITH CYANIDE SOLUTIONS

There is some diversity in practice among chemists in the use of standard solutions, some adhering in part at least to the normal system. The following test solutions shown in Table 2 do not require any computations, and are recommended as being convenient for determining volumetrically the different important components of a working cyanide solution.

Silver Nitrate Test Solution.—Weigh out 6.6 grams of chemically pure silver nitrate and dissolve in sufficient pure water to make one liter. Keep the solution protected from the light.

TABLE 2. TEST SOLUTIONS

Name of Solution	Grams of Reagent in One Liter		Standard	Used in Determining
	Theoretical	Practical		
Silver nitrate $AgNO_3$	6.5201	6.6*	1 cc. .005 gm. KCN	Total cyanides as KCN
Sulphuric acid H_2SO_4	8.7558		1 cc. .005 gm. CaO	Free alkalis as CaO
Potassium permanganate $KMnO_4$	3.9516	4.0	1 cc. .001 gm. available oxygen	Reducing Agents

*NOTE.—It may seem that this excess of silver nitrate, amounting to nearly 2 per cent, is unnecessarily large, but it is believed to be within the requirements of usual mill practice. With a test solution containing exactly the theoretical amount the end point would be at the point of saturation and before any permanent turbidity. In mill practice titrations are often required by artificial light, sometimes of poor quality, and sometimes upon slightly turbid solutions, which makes it necessary to carry the titration somewhat beyond the end point in order to get an unmistakable indication. The test solution is made stronger in order to balance this source of error. For instance, a 2-pound solution requires 2 cubic centimeters or 32 drops of a theoretically correct $AgNO_3$ test solution. One-half to one drop additional in order to make the end point discernible would introduce an error amounting to 1½ to 3 per cent. The figures "six point six" (6.6) have also the advantage of being easily remembered.

Sulphuric Acid Test Solutions.—Weigh into a beaker 9 grams of chemically pure sulphuric acid, place 1 liter of water in a bottle, add the sulphuric acid and mix. This solution is too strong and must be standardized in the following manner: Prepare a standard solution of oxalic acid by dissolving 1.126 grams of chemically pure oxalic acid free from moisture in enough pure water to make 100 cubic centimeters. Fill a burette with the oxalic acid $C_2H_2O_4$ in solution and fill another burette with the sulphuric-acid solution to be standardized. Next prepare an alkaline solution of any convenient strength but the strength need not be known. Lime water made clear by filtering will do. Put 20 cubic centimeters of this alkaline solution in a beaker, add two or three drops of phenolphthalein solution and titrate with the oxalic-acid solution. Next titrate a like portion of the alkaline solution with the sulphuric-acid solution to be standardized. It is required that the sulphuric-acid solution remaining in the bottle shall be so diluted that on further trial the amount to be run in to the alkaline

solution from each burette will exactly correspond.

EXAMPLE.—Suppose that 6.3 cubic centimeters of the oxalic-acid solution and but 5.8 cubic centimeters of the sulphuric-acid solution were required at the first trial. Then every 5.8 cubic centimeters of the stronger solution must be diluted with water until it attains a volume of 6.3 cubic centimeters. Suppose further that 982 cubic centimeters of the sulphuric-acid solution still remains in the bottle. The problem can then be stated by proportion, thus:

$$5.8 : 6.3 :: 982 : (x)$$

Whence $x=1,066$, the required volume, and $1,066-982=88$, the number of cubic centimeters of water to be added. After the water has been added, the titration should be repeated and a further adjustment made if found necessary. Standardizing this solution is quite necessary on account of the fact that the concentrated acid cannot be depended upon to be of uniform strength on account of the avidity with which it absorbs moisture from the air.

Potassium Permanganate Test Solution. Dissolve 4 grams of potassium permanganate $KMnO_4$, in 1 liter of water recently boiled and filtered and keep in an amber-colored glass-stoppered bottle. For use in testing mill solutions it is not necessary that this solution should be standardized.

Phenolphthalein Test Solution.—Dissolve 2 grams of phenolphthalein ($C_{20}H_{14}O_4$), in 100 cubic centimeters of grain alcohol. Then carefully add from the end of a glass stirring rod a dilute solution of any fixed alkali until the test solution acquires a pale pink color, but is not yet reddened by the alkali. This solution is used as an indicator.

Potassium Iodide Test Solution.—Dissolve 10 grams of potassium iodide in 100 cubic centimeters of water. This solution is used as an indicator. After the iodide is dissolved, place a drop of the solution on the spot plate, test with phenolphthalein test solution and, if alkaline, carefully add sulphuric-acid test solution to the iodide solution in the bottle until by further test it is found to be neutral.

Apparatus.—A burette stand should be

provided, capable of holding at least three burettes and it is best to have the burette always occupy the same position on the stand, for instance, beginning at the left, $AgNO_3$, H_2SO_4 , and lastly $KMnO_4$. After being filled, the burettes should be covered by loosely fitting caps. This is imperatively necessary if used in a mill or where exposed to lime dust. The usual precaution of always rinsing a presumably clean burette with a little of its test solution just before filling should never be neglected. Muddy solutions sometimes require filtering. Filter papers and funnels should be provided, care being exercised to see that these are not contaminated by acid fumes which might render the determinations utterly valueless. A small portion of each indicator is conveniently kept near the burette stand in bottles of about 25-cubic-centimeter capacity, provided with a perforated stopper in which is placed a piece of glass tubing so drawn as to make a small nozzle. Solution samples are conveniently brought into the laboratory in tin cups holding about one-half liter. It is presumed that the operator is somewhat acquainted with volumetric methods and will provide himself with such other apparatus as he may deem convenient. He will also be habitually careful in his work when he recollects that he is dealing with very dilute solutions, mill solutions sometimes carrying as little as one part of solids to five thousand parts of water, and negligence in some seemingly unimportant particular is liable to produce grave results.

Determination of Cyanide.—By means of a pipette, transfer 10 cubic centimeters of the solution to be tested to a small flask or beaker. If the solution contains more than 5 pounds of cyanide per ton it is best to dilute it with an equal volume of water before proceeding with the titration. Add two or three drops of the potassium iodide solution and begin running in the $AgNO_3$ solution from the burette, shaking the flask or beaker to redissolve the precipitate formed. In case a mill solution is under examination a white, flocculent precipitate may form which cannot be redissolved by shaking. This should be disregarded, as it is not silver, but probably zinc, the silver iodide being distinguishable by its yellowish color. Proceed with the titration until after shaking a yellowish opalescence remains, due to undissolved silver iodide. This is most readily observed by transmitted light, that is, by holding the liquid between the eye and the light. This end point should be so sufficiently pronounced as to be distinguished with certainty from a slight original turbidity of the solution. Each cubic centimeter of the silver-nitrate solution run in from the burette indicates the presence of 1 pound of KCN or its equivalent in other available cyanides in a ton of solution.

The use of the iodide indicator causes the estimation of the cyanogen in the

double zinc cyanide as if it existed in free cyanide, but not the corresponding salt of copper. As the zinc compound is known to be a solvent for gold, no material error is thereby introduced. Without the iodide indicator, a part of the cyanogen of the copper double cyanides is indicated. As the copper salt is entirely useless, the iodide indicator should be used to eliminate error due to possible presence of copper, if for no other reason.

In testing weak solutions or when greater accuracy is required, from 20 to 50 cubic centimeters of the solution may be taken for titration and the reading divided by the required number.

Determination of Free or Protective Alkali. To the same portion of solution that has already been tested for cyanides, add one or two drops of the phenolphthalein indicator. If free alkali is present the liquid will assume a deep red color. Titrate with the sulphuric acid solution until the red color is discharged. Each cubic centimeter of the acid test solution used indicates the presence of 1 pound of lime CaO , or its equivalent in alkalies, in a ton of solution.

Determination of Reducing Agents.—To the same portion of solution that has already been tested add $1\frac{1}{2}$ to 2 cubic centimeters of a 10-per-cent. sulphuric-acid solution. This acid solution is made by mixing one part by volume of sulphuric acid with nine parts of water. Titrate the acidified solution with the permanganate solution until the reddish color of the permanganate remains permanent for about 10 seconds. This is generally sufficiently accurate for mill work. When greater accuracy is required, the permanganate solution should be accurately standardized, a larger quantity of the solution to be tested should be taken, and at least an hour of time allowed for the color of the permanganate to be discharged. It is not necessary that the cyanide solution be first tested for cyanide and alkali. When 10 cubic centimeters of the solution to be tested are taken, each cubic centimeter of the permanganate solution used indicates that approximately one-tenth of a gram per liter (two-tenths of a pound per ton) of oxygen must be combined in the solution to oxidize alkaline sulphides or other reducing agents. Ferrocyanides, generally present in mill solutions, discharge the color of permanganate, but their quantity is generally so small as not to materially affect results when the rapid method above outlined is used.

Determination of Gold and Silver.—A fairly good method, and one in common use, is to evaporate 10 assay tons of the solution on litharge, and making up the litharge into a half-assay-ton crucible charge with silica and fluxes, put it through the regular routine of a fire assay. The solutions are measured into shallow tin or graniteware plates and the litharge added by means of a small measure. The solution may boil

quite rapidly until nearly dry when the heat should be moderated. When dry the litharge is scraped out upon a mixing cloth, the silica put into the pan and by means of it the remaining litharge scoured off, which together with the flux is transferred to the cloth and rolled. The mixture is next put into a crucible, inquartered with silver if necessary, a cover of salt added and it is ready for the furnace. If this method is used it is best to estimate 30 cubic centimeters for an assay ton.

An accurate method of assay requiring less labor than the last is as follows: Procure some tall-form beakers that will conveniently hold 10 assay tons. Have a 10 per cent. solution of lead acetate prepared in a large bottle. Have on hand a quantity of commercial hydrochloric acid as its action is generally more rapid. Fine zinc shavings, or zinc dust, will also be required. Measure into a beaker 10 assay tons of the solution to be assayed. Add 1 to $1\frac{1}{2}$ grams of zinc dust by means of a measure of the required size, mixing the zinc dust by means of a stirring rod. Then add 15 cubic centimeters of the lead-acetate solution and set on the hot plate. When the temperature is about half way to the boiling point add 15 cubic centimeters of the crude hydrochloric acid, adding the acid in two separate portions if the action is too violent. The assays are then left on the hot plate until the zinc is dissolved, which usually occurs in about 15 minutes, but they may be left a much longer time if it is not convenient to give them immediate attention. The solution will be clear and contain a quantity of spongy lead, mostly in the bottom of the beaker. The gold and silver is in the lead. Decant off the solution, collecting the lead if necessary by means of a glass rod. Add about 100 cubic centimeters of water and again decant. Place the spongy lead upon a small square of lead foil, fold, squeezing in the fingers, dry for a minute on the hot plate and the assays are ready for cupellation. If inquartering is necessary this is best done by adding silver nitrate solution from a burette as soon as the solution is measured into the beaker. Some use a $1\frac{1}{2}$ -inch square of aluminum foil instead of the zinc. If the foil is one-sixteenth inch in thickness it will last a long time, as but little of it is dissolved. The spongy lead is easily separated from the foil.

Solution Tests Without Reagents.—The presence of caustic lime can be detected by breathing upon the solution. If the amount of lime is considerable, say, 2 pounds per ton, the solution will be at once covered with a pellicle of $CaCO_3$. If only a trace of lime is present the pellicle will form slowly and only in small patches. Absence of protective alkali is evidenced by the evolution of HCN , plainly discerned by its smell. This state of affairs anywhere about a mill calls for prompt action.

(To be continued)

THE ocher mines of Georgia are in the vicinity of Cartersville, Bartow County, about 50 miles northwest of Atlanta. The deposits are confined to a narrow belt some 8 miles long and less than 2 miles in width. The associated rocks are chiefly quartzites of Cambrian age, which have been closely folded and also faulted.

The Ocher Deposits of Georgia

Where the Ocher Is Found, Its Method of Occurrence, and the Manner in Which It Is Prepared

*Written for Mines and Minerals by S. W. McCallie**

as mining developments have progressed at present, there seems to be nearly an equal occurrence in the broken quartzite and in the residual clays. In the quartzite the

the ocher and the clay is never distinct, there being a gradual blending of the one with the other.

Mining is carried on largely by tunnels, drifts, and slopes,

similar to coal mining. None of the ocher is marketed in the crude state. To obtain the merchantable product, the only preparation necessary is the separation of the ocher from its mechanically admixed impurities, and otherwise preparing it for market by washing, drying, pulverizing, and packing.

After the ocher has been mined it is carried on a tramway to the washer and dumped into a long trough or box filled with running water. A central shaft armed with iron blades arranged in the shape of a broken helix, revolves lengthwise in the box and violently agitates the ore. The very finely divided particles of ocher remain in suspension in the water and are floated off through an opening near the top of the box into a race or flume which empties into a series of vats some distance away, where the ocher is allowed to settle. The water is in large part siphoned from the vats by means of rubber hose, and the ocher is allowed to partly dry. It is then removed from the vats in the form of a stiff mud to the drying racks under a shed, where the drying process is completed. Artificial drying is in vats or tanks arranged in series, and in which iron pipes are run at close intervals along the sides and bottoms for steam heating. Drying by this method requires usually not longer



DRYING SHED, RIVERSIDE OCHER CO., BARTOW COUNTY, GA.

Ocher mining had its beginning in the Cartersville district in 1877. A year later a small plant for drying ocher was erected and put in operation within the corporate limits of Cartersville. In 1890 the Peruvian Ocher Co. began operations on a large scale, and during the following year made its first shipment of ocher to European markets. Subsequent to the last-named date three other large ocher plants were put in operation, all of which have been operated more or less continually. The four plants have a total maximum output of about 800 tons of washed ocher per year. The most extensive workings are those of the Georgia-Peruvian Ocher Co., on the left bank of the Etowah River, 2½ miles east of Cartersville.

The Georgia ocher is a pulverulent, yellowish earthy material consisting largely of iron oxide intermixed with more or less clay and sand. In addition to the minerals here named some of the deposits carry a small amount of manganese, which gives to the refined ocher a greenish tint. Barytes is also often met with in the form of beautiful crystals, and, strange to say, these crystals are frequently almost perfectly transparent and free from iron stain. Barytes crystals are especially abundant at the mine of the Georgia-Peruvian Ocher Co., which has become a well-known locality to mineral collectors.

The ocher occurs in greatest abundance along the shattered zones of what is known as the Weisbach quartzite and in the residual clays derived from the quartzite. So far

ocher forms irregular branching and intersecting veins, which often expand and enlarge into bodies of ocher 10 feet or more across. When the ocher is taken from these irregular veins and pockets, the quartzite is left completely honeycombed with irregular passages and rooms, not



PLANT OF GEORGIA-PERUVIAN OCHER CO.

unlike the labyrinthine passages often met with in limestone caverns. In the residual clays, the ocher is likewise irregular in occurrence, both in its vertical and longitudinal extent, but at the same time its occurrence is not so variable as in quartzite. Here, as in the quartzite, the contact of

than 1 or 2 days, when the ocher is ready to be removed to the racks and the drying continued for the usual time, 8 to 12 days, before the ocher is dry enough to pulverize. After being thoroughly dried on the racks, the ocher is removed to a room where it is pulverized and packed under steam

* State Geologist.

pressure. Packing is in barrels and bags of uniform size. Capacity of the barrels is from 350 to 400 pounds, and that of the bags 210 to 250 pounds.

The principal use made of the yellow ocher mined in Bartow County, up to the present time, is in the manufacture of linoleums and oilcloths. For this consumption the markets are in England and Scotland, to which the bulk of the Cartersville product is exported. Some of the ocher is used for a similar purpose in the plants manufacturing linoleums and oilcloths in the United States. It is used also to a limited extent in the manufacture of paints.

Until recently, the American ochers have been considered inferior to the imported ochers from other countries for the manufacture of paints. Gradually, however, the excellent qualities of the Georgia ochers for paint purposes are beginning to be recognized, and it may be confidently predicted that in the future an increasing demand will be made for this product in paint manufacture. By reason of its high grade, containing proportionately a smaller amount of impurities and a larger amount of iron oxide than most of the yellow ochers produced in the United States, the Georgia ocher yields on calcining a rather desirable red pigment, which must eventually make its way into the markets. The Georgia ocher is further used in a variety of minor ways, the demand for which, however, is very limited.

The principal markets at present for the Georgia product are foreign, and they include points in England, Scotland, Ireland, and to some extent, Germany. It is also shipped for use to many of the larger towns both in the North and in the South.

來 來

"Curie," the Standard for Radium

A conference of all civilized nations requested Mrs. Curie, the well-known radium scientist, to establish a standard for the measurement of radium and radioactivity. Mrs. Curie took up this work with great zeal and brought it to a successful finish. She established a standard by which the radioactivity will be uniformly measured throughout the world, and through which in future all radioactivity may be determined. In honor of the famous scientist the standard measurement is called "curie." It is very interesting to get acquainted with the full particulars of this "curie."

The "curie" consists of pure radium which has been produced by Mrs. Curie herself in her own laboratory. It has the form of a tube, is 30 millimeters long, 3 millimeters thick, and weighs .2 gram. But in medical use there are only quantities of .001 gram since larger quantities are not supplied. The quantity of the emanation from .001 gram of radium is called one "millicurie." This measure-

ment probably will be, before long, the standard for radium measurements. The governments of Germany, England, and Italy have already taken steps to secure for their respective countries standard measurements for radioactivity. The "normalcurie," created by Mrs. Curie, will be preserved at Brno and near Paris and deposited there at the "Bureau International," in which is also a standard meter measurement that can be affected neither by heat nor cold. The weights and measures preserved in this "Bureau International" will therefore be enriched by the most modern of all measurements, the "normalcurie." It took Mrs. Curie more than 2 years to finish her work.

來 來

Asphalt Minerals

There are several asphalt minerals. Albertite differs from ordinary asphaltum in being only partly soluble in oil of turpentine and its very imperfect fusion when heated. It emits a bituminous odor and when rubbed becomes electric. It is brittle with a conchoidal fracture. Its luster is brilliant and pitchlike, its color jet black, and its streak black to brownish black. It softens a little in boiling water and intumesces in the flame of the spirit lamp, emitting gas, but it does not melt like asphalt. In the closed tube, however, it can be melted with some intumescence. It is soluble to the extent of 4 per cent. in ether, 30 per cent. in oil of turpentine, but is practically insoluble in alcohol.

Grahamite resembles albertite in its pitch black lustrous appearance, but is distinguished from it by its action with various solvents. It is brittle and has a sub-conchoidal fracture. Its streak and powder are a dark chocolate brown, it has the hardness of 2 and a specific gravity of 1.145. Heated to 400° F. it softens so that it can be melted and drawn out into threads, but it melts only imperfectly and with a decomposition of the surface. On heating it decrepitates and behaves very much like caking coal. It is dissolved rapidly by chloroform and carbon bisulphide; it is slowly but mostly dissolved by oil of turpentine and coal tar benzole, and partly by ether, naphtha, benzene, and gasoline. It is insoluble in alcohol and is unacted upon by caustic alkalis and nitric or chlorhydric acid. Strong sulphuric acid is colored brown by it. It consists essentially of 79 per cent. carbon, 6.5 per cent. hydrogen, 14 per cent. oxygen. It is one of the indicators of petroleum. Gilsonite is considered to be a variety of grahamite. It has a brilliant and lustrous black color, gives a rich brown streak with a shade of red. It is very brittle, showing a conchoidal fracture and is easily crushed to powder. It has a hardness varying from 2 to 2.5 and specific gravity of 1. It is a non-conductor of electricity and is elec-

trically excited by friction. It fuses easily in the candle flame and burns brilliantly, much like sealing wax, and like sealing wax it will take a clean sharp impression from a seal, but unless the melted mineral is very hot it does not adhere to cold paper. It has considerable plasticity when warm and is not sticky, but retains after melting its lustrous black and smooth surface, and can be melted and cooled rapidly without any apparent change in composition, although it doubtless loses some of its volatile matter. Upon distillation a very small quantity of clear white dense oil is driven off and a little gas or vapor. It dissolves readily in melted wax, ozokerite, spermaceti, and stearine; it also dissolves readily in crude petroleum and heavy lubricating oil, but the white distillates from petroleum have little or no effect upon it at ordinary temperature. It dissolves freely in oil of turpentine when warm, but does not dissolve readily in cold spirits of turpentine. It is soluble in ordinary alcohol. Ether does not attack fragments, but slowly dissolves the powder. Its composition is about 80.5 per cent. C, 10 per cent. H, 3.3 per cent. N, and 6 per cent. O.

Ozokerite is a mineral of the simple hydrocarbon group which consists chiefly of members of the paraffin series. In appearance and consistency it resembles wax or spermaceti. When pure it is colorless to white, often leek green, yellowish, brownish yellow, and brown, translucent, and greasy to the touch. Fusing point about 56° C. Specific gravity .85. It is soluble in ether, carbon bisulphide, oil of turpentine, benzene, and naphtha. Slightly soluble in boiling alcohol.

Wurtzilite is a solid black mineral with brilliant conchoidal fracture and a general resemblance to jet or some of the cannel coals. It is sectile and the shavings are somewhat elastic, and if bent too suddenly when cooled they snap like glass, but when slowly pressed and warmed, a flake may be bent nearly double. The mineral in very thin plates is of a deep red color and by reflected light is jet black. Its hardness varies from 2 to 3 and its specific gravity is .03. It does not melt in boiling water but becomes softer, tougher, and more plastic. In the flame of a candle it melts, takes fire, and burns with a bright luminous flame with very little smoke, giving off a strong bituminous odor. Fused in a glass tube, it emits a dense cloud of white and yellow smoke and a distillate of a thick brown tarry oil with a strong odor, leaving a small residue of fixed carbon. Fragments warmed in the hand emit a strong odor, rather offensive, like that of some of the crude petroleum.

There are two classes of bitumen rocks, known as bituminous limestone and bituminous shale. The color of these rocks is usually greenish. The shale will take fire and burn, giving off the peculiar odor of bitumen somewhat similar to that of

burning rubber. The limestone will not burn as readily.

Refining With Boiling Water.—Asphalt, such as is found in asphaltic sandstone, is extracted by boiling the asphalt-bearing rock in water, the cooled rock is crushed and deposited in iron kettles which previously have been about half filled with water. As soon as the temperature of the water and rock reach the melting point of the asphalt, the latter separates from the rock and floats to the surface from whence it is collected. The mineral tar thus obtained contains water and earthy substances which must be removed, and to accomplish this the pure bitumen is again heated in proper vessels until the water is evaporated and the larger part of the impurities separated and settled, and the bitumen is placed in barrels. The residuum of the second operation is utilized in the manufacture of mastic blocks. The heavier asphaltum cannot be refined by the boiling process, on account of its high specific gravity and because of the nature and occurrence of the impurities, which are mixed through the asphaltum in a state of so fine division that they cannot be separated without effecting a solution of the asphaltum. This is accomplished in a crude way by melting the asphaltum and keeping it at a temperature sufficiently high to evaporate the water and light hydrocarbons, while at the same time part of the heavier impurities settle out. Rock asphalt and more especially asphaltic limestone, is beyond doubt the most suitable for paving purposes.

For the recovery of the bitumen of very asphaltic rock, the oldest process consists in subjecting the rock to a temperature above the melting point of the bitumen and collecting whatever drains from the heated rock. This process is carried out in reverberatory furnaces and yields from 25 to 75 per cent. of the asphalt, according to the density of the rock. It is very difficult by this means to obtain a uniform product, and it is, therefore, considered better to extract the asphalt by means of a solvent such as benzene, petroleum, naphtha, and carbon bisulphide. In selecting a solvent, however, to extract asphalt, it is to be borne in mind that the solubility of both petrolene and asphaltene is unlimited in carbon bisulphide, while petroleum naphtha will only dissolve a fixed amount of asphaltene at a given temperature, though it dissolves petrolene in all proportions. This property of petroleum naphtha offers excellent means to control the constituents of asphaltum, and, in the process of extraction, to adjust the desired proportions of asphaltene and petroleum to purity. The process is to crush the rock and put it in a large iron cylinder which has steam jacket surrounding it, then to add naphtha; the distillate which arises is carried off in a tube and deposited by condensers. The carbon bisulphide process differs somewhat from this and there is a

complete extraction, which is more rapid than that of naphtha. The use of carbon bisulphide as a solvent requires the same amount of labor and about 10 per cent. less steam. For the extraction of asphalt from rock with carbon bisulphide the same apparatus may be used as for naphtha.

來 來

Great Alaskan Earthquake

The United States Geological Survey has just published an account of one of the 10 greatest earthquakes of historic times—that in the Yakutat Bay region of Alaska. Although there is no especial relation between earthquakes and volcanic eruptions, the recently reported earthquake at Fairbanks as well as the activity among Alaskan volcanoes gives perhaps added interest to this account of a natural phenomenon of another class.

The Yakutat Bay earthquake occurred on September 3, 1899, and was followed during the next 3 weeks by many less violent shocks. The area of greatest intensity lay along the flanks of the St. Elias Range, in a region of high mountains and superb glaciers, and the movement was accompanied by enormous avalanches and rock slides. This is a vivid demonstration that the growth of mountains is still in progress. At some places in the region the land subsided and forests were submerged. At most places, however, the land rose, and many points which before had lain below sea level were elevated above it. Barnacles which had lived in sea water were found 47 feet above sea level. The study of the effects of this earth movement was undertaken by the late Ralph S. Tarr, of Cornell University, and Lawrence Martin, of the University of Wisconsin, and their report of the work has been published as Professional Paper 69 of the United States Geological Survey, with a preface by G. K. Gilbert.

In addition to making an exhaustive study of the movements of the land which took place in the Yakutat Bay region and of the effects of the earthquake upon the many glaciers of the region, the writers amassed a great fund of information in regard to the intensity of the quake throughout the whole area within which it was sensible and recorded the testimony of many witnesses. The shock was felt at distances of 670 and 1,200 miles in opposite directions from Yakutat Bay, and the area of the region over which the tremblings were felt is more than 1,500,000 square miles. This gives the Yakutat Bay earthquake a place among the very greatest earthquakes of historic times. The other great shocks, without exception, resulted in heavy loss of life, the number of persons killed reaching in one of them the enormous total of over 60,000. The Yakutat Bay shock was fortunately free from fatalities, not because it was less severe

than the others, but on account of the sparsely settled character of the region in which it occurred.

This report—"The earthquakes at Yakutat Bay, Alaska, in September, 1899"—is illustrated with half-tone views showing the effects of the earthquake, maps, and seismograms of the shock as recorded at places as far distant as Batavia, Java; Cape Town, South Africa; and Catania, Italy. A copy of the report may be obtained free on application to the Director of the Geological Survey, Washington, D. C.

來 來

Once More the "Dowser"

The "bob stick" is not American exclusively, nor is it an article that has passed from interest, for we are told in a recent issue of the *Mining Journal* (London, England), that it has recently been so seriously held in the Cornwall mining region as to have been the subject for a public lecture. The inventor of this new "dowsing rod" has combined just enough mysticism with an appearance of scientific investigation to have influenced the credulity of the correspondent, and we abstract from his write-up as follows:

"The instrument employed by Mr. Fosdick bears no resemblance to the hazelfork branch, its form being that of a truncated octagonal cone of Jarrah wood, about 1½ inches in diameter at the top end, ¾ of an inch in diameter at the bottom, and 3½ inches long. There is a groove in each of the eight facets into which to slide various slips of metal. This cone is attached by a supple piece of twine about 18 inches long to the middle of a bar of the same kind of wood about 5 inches long, ¾ of an inch wide, and ¾ of an inch thick. The operator takes the bar of wood in the right hand, letting it rest on the thumb and little finger, the other three fingers being above and not touching the bar, the cone being allowed free play and hanging from the bar by the twine. When hanging vertically over any metal-bearing substance, the Jarrah wood cone oscillates with a good swing in the direction of the greatest length of the substance. In this tracing of lodes, the direction of the swing denotes the strike; whereas, if there is no metal-bearing substance underneath, the cone remains stationary. As with the hazel twig, not everybody can operate it. In some hands, the cone remains stationary whatever there may be underneath. With an adept, a certain qualitative analysis of an ore can be discovered, for if there is a tin lode underneath, the cone will vibrate freely, but if strips of tin are inserted into the grooves of the cone, the instrument will not vibrate. The same obtains with the other metals, so that the insertion of any metal strip causing the cone to cease vibrating, points to the fact that the stone contains that metal."

REFERENCE has often been made to the development of the electric hoist abroad; and with the increasing use of this kind of hoist for hoisting from mines, it

may be of interest to discuss the question of economy of the various types of electric hoists compared with steam and compressed-air hoists. It is useless to give specific figures of the cost, as these will depend upon local conditions; but it is believed that some test results may be of interest as indicating the basis on which to estimate the cost of operation.

The economy of electric hoists is affected so much by operating conditions that to properly appreciate the subject a very close examination of local requirements is necessary. The great flexibility of electric-power transmission and distribution renders it possible to locate electrically driven hoists in situations where steam would be impossible, and where it would be necessary to use compressed air.

The ease of control of the electric hoist, and also the possibility of making it more or less automatic, is, for a great many locations, of the utmost importance. The ease with which distribution lines can be insulated, eliminates any question of loss except that due to voltage drop.

In case of steam hoists, it is necessary to have steam pipes connecting the engine to the boiler house, which generally are a source of considerable loss. Even comparatively short lengths of piping cause considerable condensation, and seriously affect the over-all efficiency of the equipment.

The steam hoist, because of the conditions under which it operates cannot compare with the electric hoist for underground service, owing to the heat from steam pipes and the troubles arising from the exhaust. The steam plant also has the disadvantage of requiring generation of the steam close to the hoist, and this eliminates the possibility of purchasing power from any central generating equipment. In the case of small hoists, the burden of a boiler plant, with its attendant labor and up-keep, adds considerably to the cost of hoisting.

When electric power can be purchased, it is economical to pay even as much as the full cost of the fuel for a steam hoist, on account of the saving of labor and maintenance. The economy of the small steam hoist is, however, generally very low, and the fuel cost is, as a rule, considerably more than cost of current; and it can generally be stated that the difference in favor of the electric hoist increases as the size of the plant decreases.

Power Consumption of Hoisting Plants

Relative Economies of Steam, Air, and Electric Hoists—Tests of Electric Hoists Under Varying Conditions

Written for Mines and Minerals by S. W. Sikes

The only other competitor of the electric hoist is the air hoist, which has been used to a limited extent in certain localities. The air hoist suffers from the disadvantage of the steam plant, as far as the trouble of handling pipe is concerned, but it is possible to transmit air over considerable distance with very little loss, if the lines are in perfect condition. This is seldom the case, and one of the causes for the low efficiency of air hoists, is the leakage that invariably takes place. By reheating the air, the loss of efficiency due to the air cooling during transmission can be considerably improved, but this requires either a steam supply or a furnace close to the hoist.

The air hoist has the same limitations as the steam hoist, as far as control is concerned, and does not lend itself readily to the use of automatic devices. The limitations of the steam and air hoists are more evident the larger the equipment; and owing to the difficulty of operation only the highest class of labor can be used.

Electric Hoists.—In the case of small electric hoists, the power consumption is generally of minor importance, although such hoists are as a rule naturally efficient. The advantage the small hoist has over any other system for mining, is so great that the cost of current is a secondary matter. In case of large hoists, however, where the power consumption may be considerable, more attention must be given to the question of economy, although this may not be by any means the controlling feature. Where power is purchased and the rate is based upon load factor, or where the generating capacity available for supplying the hoist is limited, the peak load may be of greater importance than the power consumption, and it will pay to use some system of equalization, although the kilowatt hours required to perform a certain amount of work may be increased. In such cases it is necessary to carefully consider the local conditions existing, as it is not always obvious which is the best system to adopt. For instance, some power companies charge for power on a certain percentage of the instantaneous peak load or upon the 5-minute average load, at their option. Under certain conditions it may happen that the rate of charging is determined, not by the peak load, but by the average input to the hoist. In such a case there would be no advantage in equalizing the load although

at first sight it would appear that this would reduce the cost. The system of charging is of primary importance in determining the kind of hoisting equipment when power is purchased and should always be given the first consideration.

In comparing different hoists designed for different duties, it is difficult to find a proper basis, on account of the various features entering into the design of such equipments. From a standpoint of power consumption, however, we are concerned only with the input to the hoist required to perform a certain amount of useful work. Useful work performed is that necessary to hoist the net load the required distance, and this is the same whether the hoist is working balanced or unbalanced, as with 100 per cent. efficiency the amount of power required to lift the unbalanced weight of cage and rope would be returned when lowering. In general, the over-all efficiency is expressed in terms of input to shaft horsepower or

Net load, in pounds \times vertical height in feet

550

= shaft H. P. seconds

The economy of electric hoisting depends partly upon the system used, but to a certain extent cannot be controlled by any system of driving, as there are certain losses which are independent of the motor or engine. The principal of these are:

The shaft friction which is generated by the movement of the cage on the guides, and the resistance of the air to the cage movement. In vertical hoists, the air friction is considerably more than the friction of guides, especially for high-speed hoists. With two-tracked incline hoists, the friction of the car on the rails or guides is generally more than the air friction.

Sheave friction is as a rule very small except in certain cases where a number are used for guiding and supporting a rope when the shaft is not vertical. In case of vertical shafts, it is practically negligible.

Friction of hoist and gear: This item is generally the greatest loss that is independent of a system of driving, although with modern equipment, using direct-connected motors or engines, the loss may be very small. Where gearing is used, the loss is greatly increased, unless considerable care is taken in the manufacture of the gear and in the alinement of the equipment.

Rope friction. There is some loss involved in bending ropes due to the internal friction of the strands, and this may be considerable where the rope is

wrapped around several sheaves, such as in the Whiting system of hoisting. As a rule, however, this loss is very small and can be neglected.

The losses due to the electric drive depend upon the system of control. Where a simple rheostatic control is used either for a direct-current or alternating-current motor, the losses will be:

1. The motor loss consisting of copper, iron, windage, and bearing losses.
2. Loss in rheostat.

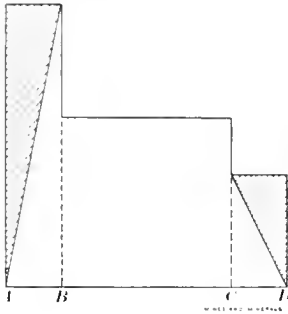

Fig. 1

When the voltage control system is used and a special generator supplied, the field of the generator being varied so as to vary the voltage applied at the motor terminals, the losses are as follows:

1. Motor losses consisting of copper, iron, windage, and bearing losses.
2. Losses in motor-generator set, due to the individual losses in the machine. The loss in the motor-generator set may be divided into two parts: (a) the constant loss, due to the set running light, and (b) the variable loss which is caused by the operation of the hoist. The vari-

tem except that the constant losses are increased by the amount necessary to drive the flywheel and these losses may be considerable, under unfavorable conditions. There is also the loss due to the slip regulator, if the hoist is operating on an alternating-current system, which may be from 5 per cent. to 10 per cent. under normal conditions.

Rheostatic Control.—In order to understand properly the losses due to rheostatic control, it is necessary to refer to a characteristic load diagram.

In Fig. 1 is shown a load diagram for a balanced hoist with a tail-rope. *AB* represents the acceleration, *BC* the period of running at full speed, and *CD* the period of retardation.

The energy absorbed in the resistance is made up of two parts, one being equivalent to the amount of energy stored in the moving parts and the other being equal to the power required to move the static load through the distance traveled during the period of acceleration.

It will be seen that this is equal to half the energy put into the hoist during the period of acceleration and retardation, which will be readily understood when it is considered that the average speed during these periods is half the full speed if the rate of acceleration and retardation is constant. It is obvious that the time of acceleration and retardation influence considerably the rheostatic loss, as the energy absorbed during the acceleration of the moving parts remains the same, independent of the time; but if it is increased, the period during which the motor must overcome the static load at a reduced speed, is greater, and the difference in output, when working at the

braking. This is not always practical and it is sometimes necessary to sacrifice economy to meet operating conditions. This diagram illustrates a simple case where the static load is that due to the material to be hoisted and it is constant during the whole of the hoisting period,

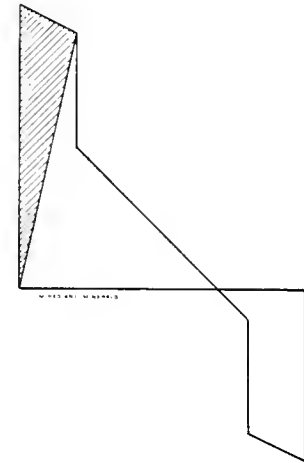

Fig. 2

as the other moving parts are balanced. With the ordinary cylindrical drum without a tail-rope, but with the cages balanced, the static load during starting may be very much greater than that due to the net load alone, on account of the fact that the rope is not balanced. The static load in such a case is made up of that due to the net load, rope, and friction. At the end of the trip there is no unbalanced rope on the loaded side, but on the empty side there is the full weight of the rope suspended, and if the rope weighs more than the load, the diagram will show the load driving the drum.

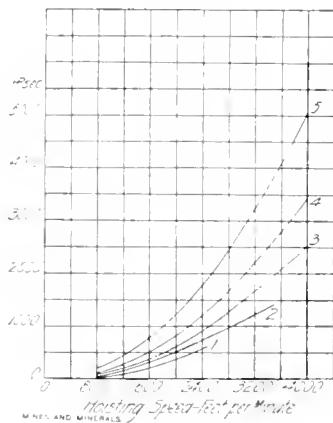

Fig. 3

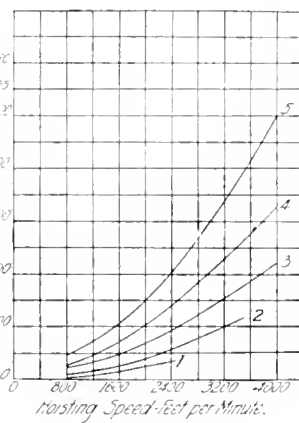

Fig. 4

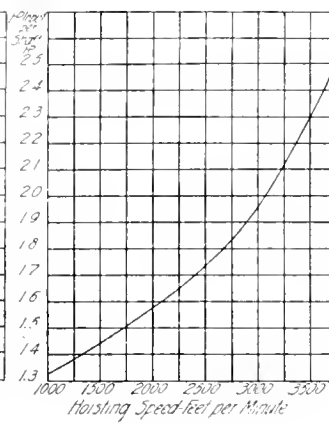

Fig. 5

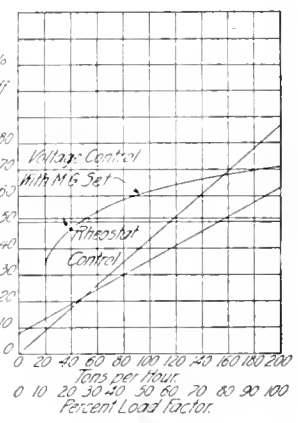

Fig. 6

able losses are made up of the iron and copper losses of the generator and copper loss of the motor. The constant loss is the windage and bearing friction, as well as the iron loss of the motor. When a flywheel is used with a motor-generator set for equalizing the input, the losses are the same as the voltage-control sys-

tem reduced speed compared with the full speed, must be absorbed in the rheostat. Considered solely from the standpoint of minimum power consumption, the acceleration should be as short as possible and the retardation so arranged that when the current is cut off, the hoist comes to rest at the landing stage without any

In Fig. 2 is shown a characteristic load diagram hoist without tail-rope, for a deep shaft. In this case, the weight of the rope is more than that of the load lifted, so that there will be a negative torque before the load reaches the surface. This acts against economy in two ways; in the first case, the total torque at starting

is very great in relation to the load lifted, and consequently, the rheostatic loss due to the static load at starting is very great. When there is negative torque, it is not possible to regain some of the energy during retardation, and consequently the whole of the area below the zero point represents lost energy, which must be absorbed in the brakes under ordinary conditions. If the hoist is stopped by reversing the motor, the losses will be further increased by an amount represented by the area below the zero line.

In Fig. 3 is shown some curves based upon average results with double-drum hoists working balanced without tail-ropes. Curves have been drawn for hoists designed for 500 to 4,000 feet total depth, and it will be seen that with the increase in the depth for which the hoist is designed the power required for acceleration increases very rapidly, owing to the fact that the weight of the rope and all the parts of the hoist increases at a greater rate than the depth.

These curves show the horsepower seconds required for each ton of net load for which the hoist is designed. For instance, a hoist built for 3,000 feet, running at the speed of 4,000 feet maximum, requires about 3,500 horsepower seconds per ton, so that for a 5-ton hoist the power required for acceleration would be about 17,500 horsepower seconds. These curves are based on average hoists, and are representative of normal conditions. It will be understood that the power required per ton of load will decrease as the load increases, as the weight of the parts does not increase in proportion to the net load; but for average loads these curves are approximately correct.

Fig. 4 shows the results of a considerable number of tests giving loss in the rheostat for various conditions. It will be seen that in general these curves are similar to those in Fig. 3. The hoists built for the greater depths, on account of the greater mass to be accelerated and the greater static load at starting, require considerably more power per ton.

It is not intended that these curves should be taken as representing absolute conditions, as a considerable variation may be caused by local conditions, but they indicate the relation between the loss and the depth of mine and the speed.

Figs. 3 and 4 show very clearly the price that must be paid for high speed, and it is clear that in order to obtain the best economy, the hoisting speed should be as low as possible. As the depth increases, the rheostatic loss is also increased on account of the greater weight of the moving parts required to handle the load; but the net load is also

generally increased for the greater depths, so the loss in power remains about the same. With the increasing speed, the loss naturally increases on account of the greater time the rheostat is in circuit; and an examination of a number of tests shows that the efficiency is practically controlled by the maximum speed of hoisting in the case of the cylindrical-drum hoist.

In Fig. 5 is shown the average of some test results, which indicate that for high speeds hoists with rheostatic control are not particularly economical. It is seldom, however, that rheostatic control is used for such hoists, as generally high-speed hoists are only used for great depths and the size usually warrants a more economical arrangement.

The results given in the three preceding curves, it should be understood, apply only to balanced, cylindrical-drum hoists without tail-ropes. In the case of conical or cylindrical-conical drums or reels, the starting conditions are more favorable to

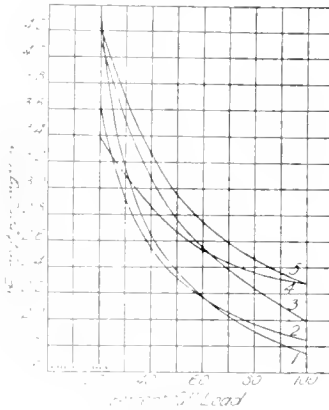

FIG. 7

rheostatic control, but these types of hoists are only used to a very limited extent.

The curve shown in Fig. 5, indicates that where high speed is required some type of control other than rheostatic should be adopted. In case power input equalization is not required, an ordinary motor generator can be used with a direct-current hoist motor, the speed of the latter being controlled by varying the field of the generator. With this type of control, which has been used for some very large installations; the rheostatic losses are eliminated; and under conditions where there is a negative torque, or in other words where the hoist tends to drive the motor, energy can be returned to the line. The losses in the motor-generator set, however, tend to offset to some extent these savings, and the over-all efficiency depends upon the degree to which the hoist is utilized. If the hoist is running almost continuously, the losses due to the motor-generator set will be com-

paratively small, whereas, if the operations are infrequent, and the motor-generator set is kept running continuously, the losses will represent a very much greater percentage.

In Fig. 6 are shown some comparative figures for a hoist operating from a depth of 3,000 feet at a maximum speed of 3,000 feet per minute. These curves show the total power required when hoisting at various rates, and it will be seen that the over-all efficiency of the motor-generator equipment is appreciably higher than the rheostatic control, when the hoist is working fairly well loaded; whereas at the light loads, the rheostatic control is more economical. They are equal at about 25 per cent. of the maximum capacity.

In cases where it is required to equalize the power input to the hoist, by mounting a flywheel on the shaft of the motor-generator set, causing this flywheel to deliver energy as required, the losses are naturally increased. This increase is due to the extra friction and windage of the flywheel, which may be considerable; and in case the motor-generator set is driven by the alternating-current motor, there is a certain loss due to the resistance, which it is necessary to insert in the motor in order to obtain the required speed variation. The resistance loss varies with the amount of work that the hoist performs, but the loss due to the flywheel is practically constant, independent of the rate of operation. It is therefore obvious that the over-all efficiency will vary according to the rate at which the hoist is used. This is a very important feature and it is common practice to determine the capacity of the hoist more upon its capacity for a short period than upon the average daily capacity required, it not being generally appreciated that this increase in the capacity for short periods, means a considerable reduction in the all-day efficiency.

In Fig. 7 is shown the result of a number of tests on such equipments, operating both in this country and in Europe. These curves show that the power consumption increases rapidly for the lower capacities.

In the case of the curves 3 and 5, it should be noted that these tests were made when the hoists were operating from approximately half the depth for which they were designed, so that the flywheels are very much larger than required and the machines also have a far greater capacity than necessary, hence the operating conditions are decidedly unfavorable. Curve 4 indicates that the losses in the machine are a great percentage of the total loss, as from the shape it is obvious that the fixed losses are not very great. The high transformation losses are due to the rapid accelera-

tion and retardation necessary with the comparatively high speed for this depth.

In order to improve the efficiency of this hoist, it is necessary to make a careful study of the distribution of losses. In case the hoist is used near its full capacity regularly, it will be generally more economical to use a comparatively large flywheel and reduce the rheostatic losses in the slip regulator in the case of motor-generator sets driven by induction motors. When the average work is considerably below the maximum capacity, it will be found advantageous to decrease the size of the flywheel, allowing a greater slip, and increase the rheostatic losses.

The bearing friction may be appreciably reduced by decreasing the number of bearings and their size, providing, if necessary, forced lubrication with suitable oil cooling arrangements. The excitation should be reduced as much as possible, and when the hoist is at a standstill, means should be taken to either reduce the current flowing in the hoist-motor fields or to cut them off altogether. Comparatively little improvement in economy can be obtained by increasing the efficiency of the machine above ordinary commercial values, as it is the constant losses that mainly effect the all-day efficiency.

(To be continued)

采 采

Turquoise in Arizona

The turquoise mining district is situated on the east flank of the Dragoon Mountains, in Cochise County, Ariz., about 14 miles east of Tombstone. The district is reached by a branch of the El Paso & Southwestern Railroad from Douglas. As described by F. L. Ransome in Bulletin 530-C, United States Geological Survey, it contains two small settlements, Courtland and Gleason. The turquoise mines, from which the district gets its name, are on the west side of Turquoise Hill, northwest from Courtland. They are said to have been fairly productive, but are now idle and very little could be learned of their history.

The turquoise occurs in joints and small irregular fractures in a bed of Cambrian quartzite that outcrops along the west side of Turquoise Hill a few feet above the contact with decomposed granitic rock. At the opening examined the bed had been stoped to a width of 4 feet and a depth of 75 feet or more, the bottom of the shaft being now filled with water. A short distance north of this opening and near the western boundary of the area mapped, other workings, perhaps a little more extensive than those visited, have been opened on the same bed of quartzite.

According to a report by A. B. Frenzel, part of which appeared in the *Mineral Industry* in 1899, there was considerable

activity in turquoise mining at Turquoise Mountain in 1898. This mountain is 18 miles from Kingman in Mohave County, where Aztec or Indian workings were reopened. Veins of turquoise showed from the commencement of operations, increasing in width as the work progressed. Near the surface the stone was of poor color and quality, but as depth was gained the rock became firm and the turquoise solid and of better color.

采 采

The Leasing of Metal Mines

An abstract from a recent editorial in the *Salt Lake Mining Review* needs some qualification. While admitting some of the good points made in favor of leasing mining properties, still serious objections may be raised against the system. The *Review* says:

"A great many mining men—men who work in the mines and who know how to polish off the head of a drill—could make a great deal more than regular wages if they would take a working lease on some property of known value; and more than one mining company, if it could be brought to believe it, would derive a greater revenue by leasing its properties than by working them.

"Lessees can often accomplish more than a mining company. The lessee is working for himself, individually, and knows no hours.

"The mining company has fixed charges to meet, such as office rent, and salaries to secretary, manager, and office boy. The lessee works hard all the time, because he is working for himself. The pick-and-shovel miner, in the employ of a company, has no interest at stake but to put in his time, and this often at an actual loss to the company. The lessee has but few wants and demands no luxuries. He can live and carry on his work at half the expense that a company can. A lessee will get along with less equipment than a company, with its big ideas. His automobile is often nothing but a burro, and his champagne merely good spring water. Therefore his expense account is not padded, and he has no need to tear his hair and wonder what his manager is doing that so much money is needed in outputting a few tons of ore.

"The leasing system is good for any camp. A miner who is fortunate in securing a good lease is much better off than if he were working in a company mine for so much per day. He is a benefactor to his camp, for he buys his supplies of local merchants and the men he employs spend the major portion of their earnings among the business men of the district. The lessee is oftentimes more successful and independent than a mining company, and perchance may develop a small mine into a great producer."

We do not believe it to be universally advisable for a company to let out its ground under leases. There are, as stated, very peculiar features of economy attaching to the system of leasing. But, on the other

hand, the very fact that a lessee gives little heed to many of the things that would give a company superintendent or manager serious concern, introduces a weak point. A lessee will spend just as little as possible in timbering, in tracklaying, and in ventilating. He will not exert himself nor spend his money in making the mine workings safe or workable longer than he is required to occupy them. His work is therefore not of the standard most large mining companies are obliged to maintain. He will take chances on his life or health that our very worthy laws will not sanction in the wage practise. He will submit to adverse conditions and to inconveniences that he would not stand were he working under day's pay in the same property. Naturally, he is straining every point to get the largest returns with the very minimum of cost, and he is not devoting any consideration to the wreckage that may prove a sequel to his operations. Therefore many companies, while realizing and appreciating the arguments set forth by the advocates of the leasing system, prefer to keep on the "company" basis until they have exhausted all the known available ore bodies. When a mine has reached this point, and the owners are sure that they, themselves, shall never wish to work it again, then it may be advisable to give the lessee a chance to gouge and rob the mine all he can. In this manner the life of many a mine has been materially prolonged.

Very often, mines are bonded and leased. When this is the case, the holders of leases have intentions of purchasing the property and they will accordingly conduct their operations in a manner to retain the mines in good condition.

It has been said that the Cripple Creek District has had two periods in its history. During the early years of the district's activity, it was known as a high-grade camp. As depth was gained the kind and grade of the ore changed, and this was simultaneous with a general business depression pervading the whole nation, so that stagnation faced the district.

Many well-known mines closed down. But, soon, there set about a very general request, from miners and prospectors, for leases on blocks of patented ground and in developed mines. These being granted, the hard-working miners set to work upon economical scales and actually accomplished the profitable mining and treatment of the refractory and low-grade stuff that had not been "ore" when these mines had been on company basis. Thus the district, as a whole, was tided over this critical period during which metallurgists wrought out the solution of profitably treating the low-grade telluride and sulphide ores.

Therefore, while hearty recognition of the value of the leasing system should be given, still there are always conditions to be considered in each individual instance in which leasing is suggested.

Gold Dredging Up to Date

The Characteristics of a Gold-Dredging Field—Conditions to be Noted in Examining, and Their Influence on Costs

Written for Mines and Minerals by Arthur Lakes

IN selecting a field for gold-dredging there are several considerations, amongst which are:

1. Obviously, the assurance of the presence of gold in the ground of sufficient value to warrant dredging.
2. The surface contour of the land, liability or not to freshets or floods.
3. Nature of gravels.
4. Depth of gravels.
5. Character and contour of bed rock.
6. Water and power facilities.
7. Climatic conditions.

The first is determined by intelligent examination and prospecting.

The surface contour should be comparatively regular and gentle.

the buckets to a severe test. Hitherto unknown quartz leads carrying ore have sometimes been discovered on dredging and have led to profitable mining, or the decomposed outcrop of the continuation of a known vein has been uncovered and resulted for a space in rich dredging ground. When an abnormally large boulder or a high reef of hard rock is met with, it is usually possible for the dredge to pass over it and resume operations on the other side. A fairly even soft bed rock is much preferred to the

near sea level, malaria and other tropical diseases are a hindrance to dredging by white labor, natives then may learn the business and take their place efficiently.

TESTING GROUND

Besides surface shallow placer gravels and hydraulic workings, with possibly some known gold veins and gold-bearing rocks and working gold mines affording a reasonable presumption that the area is generally gold bearing and a probability that the deep gravels will be found likewise auriferous, it is customary for a company contemplating dredging to prove positively the gold-bearing character of the gravels to be dredged by putting down test shafts and test drill holes to

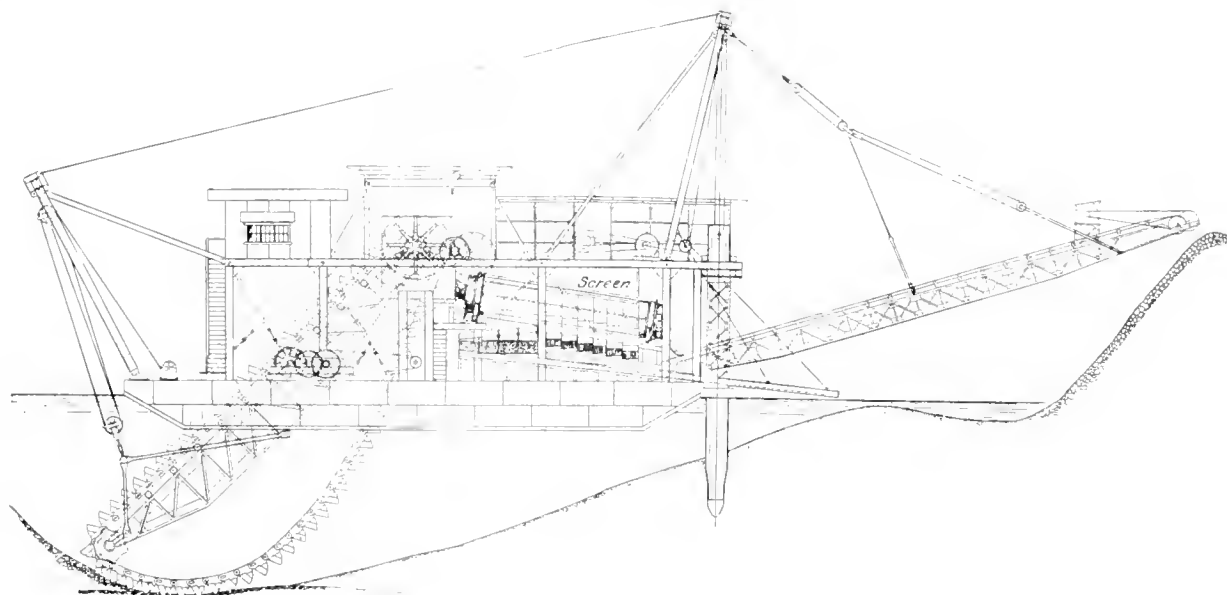

FIG. 1. SECTIONAL VIEW OF DREDGE

The depth of gravels to bed rock is limited from 10 to 70 feet. A superabundance of large boulders such as would be difficult for ordinary buckets to handle has resulted in the failure of many dredges, owing to their build and machinery being inadequate. A large amount of clay or fine material in the gravels tends to clog the gold-saving tables and by rolling up into balls "steals" the gold and prevents its amalgamation.

The character of bed rock is important as the largest proportion of gold generally settles on it or penetrates it a little way. Hence it should be soft enough to be easily scraped or dug into by the buckets. Bed rock is commonly a decomposed igneous rock, such as granite or porphyry, a soft volcanic tufa, or a shale.

Occasionally a hard quartz vein or a reef of quartzite or some other very hard rock may be met with and temporarily put

contrary. Preliminary testing will show the nature of bed rock prior to dredging.

Sufficient water is necessary to float the dredge, also to wash and winnow the material. Dredging areas being usually along the courses of or in the vicinity of rivers, water is easily obtainable for dredging purposes as well as for supplying electric power used in the present day in place of steam used formerly. Areas of gold-bearing gravels called "dry placers" in regions totally inaccessible to water could not be dredged.

Climatic conditions in some regions may, in the winter season, affect the period of active work by freezing the gravels, cutting off the flowing water and obstructing the machinery. These natural obstacles are being overcome by artificial means and in many cases dredging is being carried through the severest winters and the year through without cessation. In some tropical countries in swampy areas

bed rock systematically over the field, on an average one hole to every 2 acres. In this way a reasonable approximation of the prospective value of the entire area can be attained before any steps are taken in actual dredging or before a dredge is built.

In this respect dredging for gold is far more certain and sure than ordinary lode mining. Values can be figured up and approximated before any costly operations are undertaken. The cost of building and installing the dredge can be estimated exactly. The amortization factor is known, and approximately the gold values, together with the reasonable profits. Thus the gravels by testing are known to contain so many cents to the cubic yard and the cost of working them can be estimated to a reasonable certainty. Hence, when an investor goes into dredging he knows more than in most lines of business what he going into,

and what will be his expenditure and profit. In the case of ordinary precious-metal mining no man can see but a few feet ahead of the actual workings; but in dredging, by careful testing, it is

monly over 100 feet long by 30 or 40 feet wide and 8 to 10 feet deep. It is built very strongly of thick heavy timbers firmly bolted together and strengthened by trusses and steel work to support and



FIG. 2. DREDGE, SHOWING TAILING STACKER AND DISCHARGE LAUNDER

known for many square miles what the field will produce and the element of speculation is reduced to a minimum. The gold value may be of less importance than various physical and other conditions in the ground to be prospected. Such may be a hard uneven bed rock with a great depth of gravel to reach it, many large boulders, much clay, a rough surface contour, dikes and ridges of hard rock crossing the field, gold contents small and unevenly distributed, and a severe winter climate, against the opposite and more favorable conditions.

To learn the value and character of gravel, depth to, and nature of bed rock, if the gravels are not too deep, pits may be sunk to bed rock, at intervals systematically arranged. This is often done as preliminary. If the depth exceeds 20 feet or thereabouts to bed rock, prospecting by churn drills is expedient and cheapest.

The following are the commonly accepted conditions for examining ground for dredging.

1. Value, character, and distribution of gold content.
2. Depth, character, quantity of ground to be worked.
3. Contour and character of bed rock.
4. Water level and available supply.
5. Labor, transportation, supplies, etc.
6. Surface contour of property.
7. Operating costs.
8. Labor, transportation, supplies, etc.
9. Climatic conditions.
10. Recovery by the dredge is generally less than the gold content indicated by prospecting.

A common gold dredge of Californian type is a long boat, hull, or pontoon com-

withstand the strain of its powerful machinery and the heavy work. Its complement consists principally of a digging ladder with an endless chain of buckets, screening apparatus, gold-saving tables and devices, pumps, and stacker. It floats in a pond of its own excavating of convenient size for it to turn around in and deploy. As it advances upon the bank in front of its bow it leaves at a safe distance behind its stern a train of boulders and debris from 20 to 40 feet high, sometimes several miles in length.

A gold dredge has been described as a floating mill with apparatus for excavating and elevating the gold-bearing gravels and winnowing them of their values. The power plant, usually run by electricity, is aboard the boat. The hull is built in scow form with the forward part divided in the middle so as to form a well in which the ladder and bucket chain can be raised and lowered. Taking the gold-dredging boats at Breckenridge, Colo., and the California pattern as a type, the hull is 115 feet long 40 feet 6 inches wide and 9 feet deep. The sides are curved at the forward, or bow, and the well is about 6½ feet wide extending back from the bow about half the length of the hull.

The dredge is anchored, or held to its work if excavating, by means of spuds. These are beams firmly held in a vertical position in casings on the stern gantry and attached to the stern of the boat. In these they are raised by winding on a winch drum and dropped by releasing the same. The steel point of the spud is driven by its weight into the bottom of the pond. One spud is called the "digging," the other the "walking" spud. The walking spud, which may be of wood or

steel, is used in advancing the dredge. This is accomplished by winding the starboard side line and dropping the starboard spud, then by loosening the starboard line and winding the other side. The dredge is swung from side to side by side lines attached to the shore by "deadmen" or buried logs and passing through sheaves on the dredge to winches winding the rope on the side to where the dredge is swung. The "digging" spud, usually of steel, is used to anchor the dredge whilst digging, and answers as a pivot around which the boat is swung in an arc.

As the machinery is constantly renewed the hull should be built strong enough to outlast all parts. Strength and stiffness to withstand the machinery vibrations are essentials. Timbers, as far as possible, should be in one piece without jointing or splicing, especially the main trusses and frame timbers. Oregon pine is commonly used.

The sides of the hull are extended from midships to the stern of the boat and from bulkheads aft.

There are also two bulkheads running the length of the boat, tied together by drift bolts some 30 inches long driven through the edge of the planking and binding the whole hull as a unit.

Lateral trusses prevent the boat from sagging, whilst the back guy connections prevent torsion. Three frames or gentries, strongly built of thick timber strengthened by steel plates, are erected

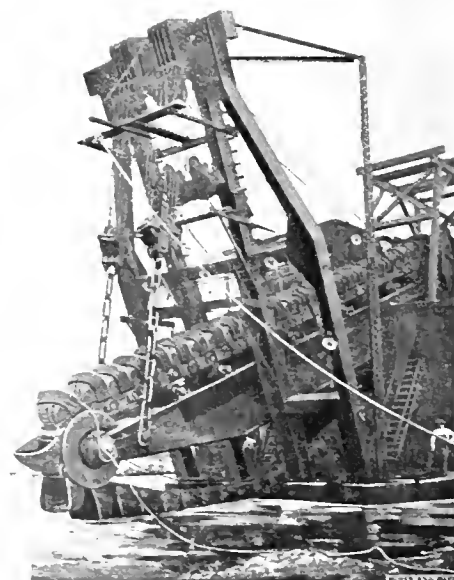

FIG. 3. LOWER TUMBLER AND BUCKET LINE, 13-FOOT DREDGE

on the hull to support the machinery. The middle gantry supports the upper tumbler and upper end of the digging ladder. The chain of revolving buckets passes from the upper tumbler round the lower tumb-

ler at the bottom end of the digging ladder. The bow gantry hoists and lowers the digging or bucket ladder. The stern gantry suspends the stacker ladder, hoists and lowers spuds, and provides guides for them. Gantries may be of wood or steel or of both combined.

The digging apparatus includes ladder, buckets, rollers, and tumblers. The ladder and bucket line varies in length, size, and capacity according to depth and nature of the ground worked. The ladder may be from 60 to over 100 feet. It is made of structural steel angles and plates. Angle-iron braces are used. Truss rods are fastened from each end on the bottom to give extra strength. Steel rollers on the upper side of the ladder reduce the friction of bucket line and prevent excessive wear on the ladder.

Tumblers are massive revolving castings of open-hearth steel one at the top, the other at the bottom of the ladder around which the chain of buckets revolves. They may be square, pentagonal, or hexagonal. They are protected by wearing plates. Their shafts are 10 to 12 inches diameter of the hardest manganese or nickel steel. The bucket line is the most destructible and costly part of the dredge, subject to the greatest wear and tear, and needing constant repair. The bucket line of modern dredges is close connected. The bottom is of solid casting. The size of a bucket as well as the dredge to which it belongs is estimated by its cubic capacity, this may be from 3 to 15 cubic feet. Buckets from 3 to 13 cubic feet vary in weight from 500 to 2,150 pounds.

The buckets dump over the upper tumbler into a hopper where jets of water assist emptying and dissipate clay. Thence the material passes to the revolving screen which disintegrates and classifies it. The stacker receives the oversize from the screen, and carrying it along over a rubber belt conveyer dumps it well behind the boat. The length of the stacker varies with the depth of the ground dug and the amount of gravel to be handled. The motive power is nowadays commonly electricity in place of steam formerly used. Electric current at Folsom, Cal., is taken aboard the dredges at 2,000 volts for motors of 50 horsepower and stepped down by transformers to secondary 440 voltage. Transformers are sometimes on shore with a cable to the boat. The digging face of the pit is kept from 150 to 250 feet wide and the boat passed from side to side of the pond by sidelines. The bank is cut in terraces or a sloping face. The whole width of the cut in alternate sections is carried forward to the limit of the property. The dredge is then turned around and in return makes a similar cut. When the ground is very hard, frozen, or

cemented, steam points, blasting and monitors may be used ahead of the dredge. Property to be dredged is sometimes laid off in lettered squares. The yardage is periodically measured or surveyed as the dredge advances.

Gold-saving appliances used on a dredge are revolving screens, tables, and sluices.

The revolving screen disintegrates the material so that particles of gold may not be carried off over the stacker in lumps of clay or cemented gravel. These screens may be 6 feet wide by 32 to 35 feet long; the diameter of perforations vary from 5-16 inch to $\frac{1}{2}$ inch inside the

sand, and "quick" are scraped into buckets and emptied into a tank of water. 90 per cent. of amalgam is caught above the stop and mercury trap. Material is further treated by Long Tom sluices. A "clean-up" is usually completed in two or three hours and may occur every 6 or 8 days. At Oroville, Cal., there are two products for the melting room. One consists of amalgam with some mercury; the other of black sand containing also nails, lead, and sometimes Chinese coins, with much shot lead from generations of sportsmen. Some of this second product passing over the tables acts as "sluice robber." With the black sand

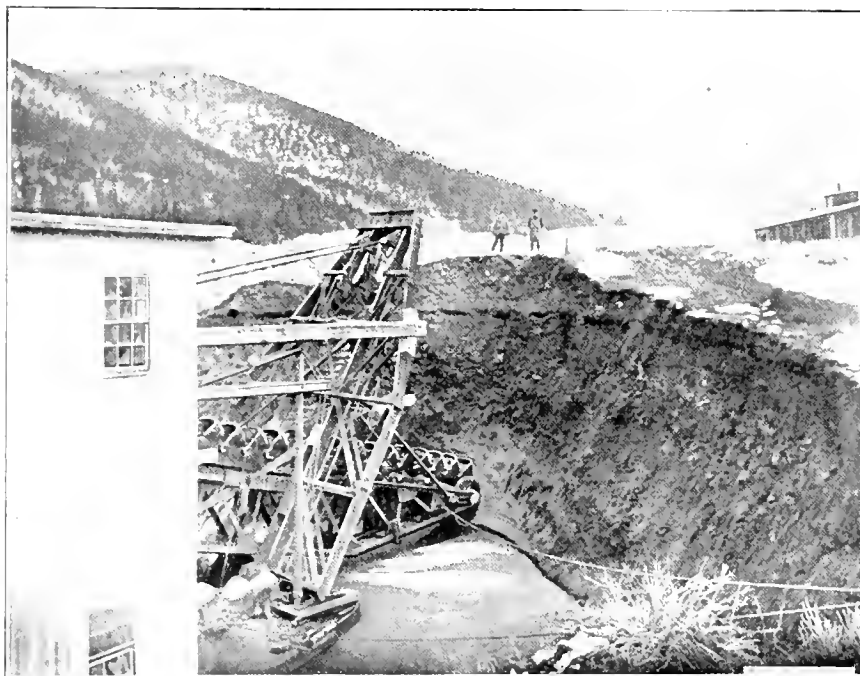

FIG. 4. DREDGE ATTACKING HIGH BANK ON FRENCH CREEK

upper part of the screen and from $\frac{1}{2}$ inch to $\frac{5}{8}$ inch at the lower end.

Wooden bar riffles capped with iron or angle irons are used accompanied by quicksilver. The gold-saving tables slope toward each side of the boat at right angles to the slope of the screens. Cocoa matting is sometimes used for catching fine gold, only coarse gold settles behind the metal or wood riffles; $1\frac{1}{2}$ inches per foot is a good slope for tables and sluices. Too much and too swift water may carry off and lose fine gold. Too flat a grade is apt to cover the mercury with sand. Gold may be coated with a film of iron oxide or be influenced by arsenic from arsenical pyrites and fail to amalgamate. Tailings are periodically tested. "Clean-ups" are made at intervals by a gang of three experts or gold men on both sides of the boat simultaneously. Riffles are loosened with a bar and washed on the table, each man takes a section above the stops till all side tables are finished. Amalgam, black

are traces of platinum, osmium, and iridium. Amalgam is placed in an iron vessel and retorted, smelted, and poured into iron molds. Mercury is cleaned at intervals by retorting, it may leave a white residue carrying \$16 per ounce of gold. Black sand is separated with nails, etc., from second product by a magnet. Black sand is sometimes said to be worth \$140 per ton. It may be barren magnetite or may carry a small per cent. of gold.

Dredges aim to obtain the greatest output in a given time, to maintain the highest per cent. of working time and secure the highest extraction. The cost of dredges is from \$40,000 or \$50,000 to \$225,000, according to the gauge of the buckets. Boats with buckets of 3-cubic-foot capacity dig about 40,000 cubic yards monthly, larger ones up to 200,000 or more. Fixed costs of dredging form a large per cent. of the total operating costs, hence a large relative output is desirable. Production is limited by mechan-

ical difficulties and increasing percentage of gold lost in the boats digging more than a certain yardage. Screens cannot treat and prepare for gold-saving tables more than a certain quantity per day irrespective of the digging capacity of the boat and if this ratio is exceeded there follows an increasing loss in gold per yard dredged. Though a certain amount of gold is lost, by increasing the output more net profit may be made. Among factors of loss is when expenses are going on, but temporarily no gold is being produced. The constant need of repairs and stoppages of the buckets is a chief cost and loser of time. A dredge at Oroville, replaced all buckets on a dredge in 12 months. Wearing of pins is another loss of time and cost. Wearing plates or tumblers, a set costing \$600, may be needed in a few months. Tumblers as well as spuds are not unfrequently cracked or broken by the intense strain to which they are exposed and have to be repaired or discarded.

The costs of dredging again depend on various local circumstances and conditions, such as:

Average depth of ground and character of gravels.

Favorable or unfavorable conditions on rich or poor ground.

Number of cubic yards excavated and average daily yardage. Number of acres dredged.

Whether working by headlines on easy ground or by spuds on difficult ground.

Whether land is subject to overflows or not at high water.

Whether gravel is a compact clean gravel with little clay and few large boulders, or the opposite.

Gravel shallow, deep, or medium.

Character of bed rock, hard, soft or decomposed, granite, shale, or volcanic tufa with even or uneven contours.

Whether dredge is an old-fashioned double-lift or a modern single-lift, whether with open or close-connected bucket line.

Surface of ground covered or not by thick growth of small timber which must be cleaned before dredging. Whether fired trees or large stumps abound or not.

Much clay and fine stuff with heavy overburden of sandy loam or light soil.

Expenses connected with installing machinery, repairing, or remodeling old ones.

Difficulties from working against a high bank above the surface of the pond and from raising bed rock and cemented gravel, the former sometimes requiring cutting through if it rises above water level, to a sufficient depth to float the dredge and enable it to maintain its course.

In costs and expenditure are included: operating, material, and labor; electricity;

repairs; general expenses; taxes and insurance.

Under the above conditions the costs of dredging around Oroville appear to lie between 3 cents per cubic yard as a minimum and 10 cents as a maximum with an average of from 5 to 6 or 7 cents. Dredging expenses there are

reduced by putting many boats under one management and not duplicating departments. Three shifts are employed, the crew consists of dredge master, winchman, and two oilers.

Wages at Oroville are: Foreman, \$125 monthly; winchman, \$3 per day; oilers, \$2.50 per day; other labor, \$2 per day.

Improvements in the Caving System

A Few Suggestions Looking to the More Economical Mining and Treatment of the Brown Ores of Virginia

*Written for Mines and Minerals by Charlton Dixon**

IN previous articles† the writer endeavored to make plain the methods of mining Virginia brown ores, as practiced above and below ground. In this article attempt is made to show how practice may be altered and modified to produce larger profits, more particularly from the under ground operations.

The caving system is, and always has been, applied as inflexibly as the laws of the Medes and Persians, often inflicting an avoidable expense on the operators. As practiced, the upper level is always driven to the boundary before any robbing can be done. This is not necessary in 90 per cent. of the cases.

In coal mining, as soon as a room is driven its pillars may be extracted. The effect of letting all of them stand until the last room is finished can easily be imagined. This is exactly the procedure in the ore field today. It is no more necessary in the one case than the other.

The custom of retarding the car levels in a shaft opening or drift, on account of the supposed impossibility of robbing, is wrong in every way. From the commencement of a shaft operation, all help required to handle a full capacity on top is employed. On this account, and the retardation process practiced, development cost is high.

What should and can be done is to rush the car level, the 12-foot or 24-foot levels, incessantly by three 8-hour shifts, three men to a turn, having always plenty of cars ready for them to load direct, thus avoiding casting the fall back from the face in order to hasten the drilling. Planks or sheet iron should be laid at the face before blasting. This facilitates the shoveling.

In the meantime, the upraises should be started as soon as the proper distance is obtained. When the boundary or other limit is reached, the last two should be rushed to the outcrop, using the three shifts until this is done. One of them, even if the ore does not reach to daylight, should be worked out to daylight for temporary ventilation, timber, etc. The upper levels may now be driven back toward the opening, meeting those being worked from the

upraises behind. Just as soon as connection is made to the nearest chute, robbing can be commenced at once, precisely where it would and does after say 2 years of procrastination. This method would shorten the life of the ordinary mine at least 2 years out of 5, which is about their average life. In other words, as much ore would be won by the above method in 3 years as can be done in 5 by the present one. This means 2 years' salaries and wages, and 2 years' pumping, besides hundreds of dollars in timber, etc., saved. An objection might be offered to this double-end method, as it may be named, on account of the difficulty of elevating the necessary timbers at the "in end." That is more imaginary than real, because, as has been said in a previous article, if there are six levels to begin with, in a distance of 2,000 feet two of them will be pinched out. The reason is, the ore is never so accommodating as to rise in the same ratio as the car level. Considerable timber may be brought down the temporary air hole and stowed in the lower levels for use in the first robbing.

Another variation, or modification, to the caving system can be applied, which would also reduce the cost of timber changing, besides that of developing. That is, to rob each alternate block down to the 24-foot level, leaving the other as a barrier pillar. This would give a large amount of cheap ore at an early stage and would alleviate the hardship of development to a very considerable extent.

The barrier pillar can be mined in retreat, thus maintaining a good output to the end.

These two modifications might be combined—there is nothing to prevent it—and they would form an ideal plan of operation in this ore. There is no doubt about the caving system being an expensive one as practiced, but if the plans suggested are applied profitable results will be produced.

The upraises are driven every 50 feet and these add very much to the cost of operation. The object of such a short distance between them is to accommodate the wheelbarrow, to save time in pushing it back and forward.

Were the levels straighter, a 2-foot gauge

* Pittsburg, Pa.

† MINES AND MINERALS, Vol. 32, pages 483 and 553

track and a car of 1,000 pounds capacity could be used on all of them. This would obviate the necessity of one-half of the upraises, besides saving much of the time now wasted in traveling to and fro with an insignificant load. By substituting cars for the wheelbarrows the cost of mining will inevitably drop. The truth of the foregoing has been sufficiently demonstrated at some of the operations during the last 4 years. Wherever the change was effected the men preferred the cars to the more primitive vehicle.

Generally speaking, the ventilation is very deficient. The fans are invariably small, antiquated, and necessarily very inefficient. Air-courses are contracted, besides being extremely crooked; in fact the whole question does not receive much attention. The necessity of it is manifest; the temperature of the robbing rooms is nearly always far above that in which a human being should be required to exert himself. Much black damp (CO_2) is also generated, which, owing to poor ventilation, is an important factor of expense, as lamps will not burn and men are not efficient in semidarkness, not to mention headaches, etc. Better fans should be used by all means, air-courses might, with very little extra cost, be kept in better condition. Not a fan in the district is cased to reverse the current; although the shafts and slopes accumulate ice very rapidly during cold weather. This also adds an avoidable cost. Dynamite being the only explosive used to any extent underground, the amount of time lost waiting until the fumes are carried off after a blast, is almost incredible. Of course, the better the ventilation, the less this loss becomes.

The custom of sinking shafts and steep slopes in the ore is uneconomical, as thousands of tons of what should be the cheapest ore are lost. Textbooks give no instructions concerning robbing shafts. Openings should be made in the waste; by so doing all the ore is recovered.

Another saving can be effected by connecting some of the upper levels to the shaft as intermediate hoisting stations. At present the ore is chuted from the top levels to the car level, then hauled back again. This congests traffic to the detriment of all concerned.

In many instances an arrangement of this sort would pay if for no other purpose than to handle the timber. It is costly, besides being very laborious, to elevate this material through a narrow manway to a height varying from 40 to 90 feet. Were this distance halved, the cost would also be cut in two.

Large two-compartment shafts are the rule, which is an outlay not justified by the conditions; not one of them has an output to exceed the capacity of a single hoist. A single shaft with room for a counterbalance would satisfy the requirements. A self-dumping cage would add to the profits.

At the shaft bottom only one track would be necessary, the roads running direct to the cage, the engine to a kick-back, thence to a side track parallel to the loaded one, but with a pillar between. A shaft of the above description is now in operation. It is very satisfactory.

Owing to the inclination being insufficient to chute the ore from the upper to the lower levels at many places, transferring must be resorted to. This is probably responsible for more extra cost than any other single cause. It often requires the employment of three to four men to handle the ore ordinarily taken care of by one where the pitch is favorable. To elucidate, ore from the 48-foot level is wheeled to the chute connecting it with the 36-foot level; at the bottom of this it is caught in another wheelbarrow. This is repeated on the 24-foot and 12-foot levels.

To avoid this trouble the territory should be closely drilled, every hole going to the flint, and the levels figured closely. If found too flat for a gravity flow, where the vein comes to within a reasonable distance of the surface a slope should be sunk in the foot-wall at an angle sufficient to keep it from touching the ore until the required depth is reached. This where the pitch of slope is between 10 degrees and 30 degrees; where less than 10 degrees, the slope should go down on the ore, as the ordinary mine car can be used, in conjunction with side-tracks at the mouth of the different levels. On the steeper pitches a 2-ton dump car should be used, drawing its load from the chutes at the different levels. Where the depth from the surface precludes the adoption of this method, transferring may still be avoided by driving a heading straight up the pitch in the foot-wall, using a counterbalance or small winze engine to take care of the ore; a surface engine with the rope running in one of the bore holes could also do the work.

Concerning the method generally practiced in surface operations, there is not much to be suggested by way of change. These are mostly all confined to the outcrop ore running with the strike. After the ore has been extracted the trench left acts as receiver general for the drainage from the mountains above them. The water caught in it is subsequently pumped from the lower levels.

Occasionally a serious loss is brought about by this feature, as a stratum of loose sand is often found between the ore and flint from 3 inches to 12 inches thick. This is washed out, causing the whole hill to settle down. In one shaft operation, one side of the mine was ruined entirely. Much money was wasted in attempts to counteract it, and it was finally abandoned.

This can also be avoided by driving drainage drifts from the hillside when the cuts are exhausted.

Only after a thorough drilling and most careful leveling combined with ore of good

quality, and where the stripping does not exceed 2 feet to every foot of ore, should open work be indulged in.

The preparation of the ore for the furnace is in many cases susceptible of much improvement. A large percentage of it occurs in hemispherical form, the cavity nearly always containing sand, either loose or solidified, generally the latter. The ore encloses it like the tentacles of an octopus. Apparently there is no cure for this but to crush the whole of the product to pig size, the largest not to exceed $1\frac{1}{4}$ inch. There is nothing impossible about this from a mechanical standpoint, for the cost would be largely compensated for by the reduction of the number of handpickers needed, and by the higher percentage of ore recovered.

Rubber picking belts are responsible for much waste reaching the furnace. They are too narrow and channel too easily when carrying a full burden; only the waste seen on the surface can be picked off. At one washer, steel conveyers $2\frac{1}{2}$ feet wide were installed; these provided spreading space for the load, exposing all sand, etc. Being of large capacity, they necessarily travel much slower, thus giving the pickers time to eliminate all extraneous matter. Washers should be arranged in a way to permit washing and concentrating to be carried on independently, with at least one-half day's storage for each.

The largest and by far the most costly washer in the district is built on the continuous plan, a derangement of any of its multitudinous parts affects the whole. Much loss has been entailed thereby.

來 來

Bleaching Powder

Bleaching powder is also commonly known as chloride of lime. It is soluble in about 20 parts of water. When brought into contact with sulphuric or hydrochloric acid it gives up its chlorine. With the sulphuric acid, the sulphur unites with the lime to form calcium sulphate, leaving the chlorine free. It is used in the barrel chlorination process. In making the charge it is customary to first charge the "bleach," as it is called, which is followed by the ore, which completely covers the bleaching powder. Then the water and acid are introduced, the barrel is quickly closed and the cover secured. The barrel is then rotated, which results in a thorough admixture of the several ingredients of the charge. The chlorine is liberated, as above indicated, and attacks the gold present in the ore. The process was quite extensively employed some years since at Deadwood, S. Dak., in the treatment of the telluride gold ores of that district, but has since been superseded by the less expensive cyanide process. There are ores, however, which may be successfully treated by the barrel chlorination process which are not readily amenable to cyanide treatment.

Random Thoughts on Prospecting

Written for Mines and Minerals by A. J. Hoskins

Persons who take an interest in metal mining are occasionally asked by friends why it is that there are not more Mother Lodes, Leadvilles, Comstock Lodes, or Cripple Creeks being found. They also are requested to admit that it is probably true that there remain no great undiscovered mining regions in our great West.

It is true that very little of the public domain has been absolutely overlooked by prospectors. Such pioneers have pretty well traversed the earth. But the fact should be recognized that there are large sections of country that have been either too casually investigated or that have been so radically different in character from previously known mineralized regions as to have deceived the seekers for mineral wealth.

The Cripple Creek district was for years utilized only as a cattle-grazing and ranching country. During the occupancy of the region, there were two distinct excitements in quest of gold, but no real finds were made for a number of years thereafter. One of the rushes was founded upon an actually fraudulent attempt, on the part of a notorious character, to sell a salted gravel bed to gullible gold seekers. The other rush, however, was inspired by a report of ore discovered in place, but this was proved to be false rumor. These unfortunate incidents combined to discourage investigation in that region to such an extent that prospectors were wary of following their calling therein for fear of being discredited. In fact, so pronounced became the stigma on this area, that men of science denounced the country, declaring the formations were such that nothing good could emanate therefrom. So, when one or two honest prospectors finally reported good luck, wise heads were shaken and the district condemned as being absolutely "impossible" from a mineralogical standpoint. Purely because of preconceived prejudice concerning geological occurrences, this area was shunned; but the discoveries just mentioned could not be denied, and the rest is history.

Our knowledge of natural conditions has reached such a stage that it is almost permissible to paraphrase the old phrase into "metals and valuable minerals are where one finds them," not restricting the statement to the single metal, gold. Prospecting has come to be a scientific pursuit rather than the gambling game of chance that it formerly assumed. Whereas the miner of today appreciates the environments in which past discoveries have been made and is thereby encouraged to seek minerals or metals in similar places, he will not allow himself to confine his search to such formations or regions alone, but he will investigate possibilities that are presented in any geological structures that may, so far as he is aware, never have produced ore bodies.

Prospecting is going on all over the world; the United States is not excepted from this assertion. It must, however, be realized that there are areas in which climatic conditions seriously impede the prospector. Some areas seem always to remain invulnerable to his search, while others may be investigated during only certain, and often brief, seasons. One might imagine that those sections of the West that are arid, because they have almost no precipitation, summer nor winter, would be absolutely forbidding to the prospector; but such is not true, for this ubiquitous individual is usually thereby permitted to ply his vocation ceaselessly. On the other hand, we think of regions that never have dry seasons—places with heavy falls of snow or rain the year through—and we find it hard to conceive how a mine could ever be disclosed under such adversity. The past winter and spring have been unusually severe as regards the fall of snow in the mountains of the West and Northwest.

Much has been said by the press of the High Grade district, in the northeastern corner of California. Opinions vary as to the virtue of the area, but the present season will probably settle the question. Still, erroneous conceptions might be arrived at, and the prospectors there must be ready to investigate formations which, to them, may seem quite forbidding.

Among the areas to come in for attention from prospectors this season, is the northwestern portion of Colorado. The three large counties of Grand, Jackson, and Routt are said to contain over 1,000 square miles of unclaimed, mineralized, government land. The winters here are always long, and prospecting has always been more or less restricted on that account. The greatest handicap, however, has, until within the past 2 or 3 years, been the absence of any railway lines in this domain. The so-called Moffat road is now constructed and operated from Denver over the Continental Divide to Steamboat Springs, the metropolis of this region. Hunters, a few ranchmen, and straggling prospectors have roamed this wilderness for many years and have, from time to time found "mineral"; but as time went by with no improvement in the transportation conditions, all such finds were of necessity abandoned. During past years there have been numerous rumors of gold discoveries in the vicinity of Hahn's Peak, and well-posted mining engineers have frequently made favorable estimates of this region's mineral wealth in many of the metals. There is a very great variety of rocks and they are so mutually related, physically, as to offer inducement to the prospector. The coal resources of this section have been well exploited and good coal mines are in operation along the new railroad; but as yet, there is very little known, generally, concerning the other natural resources.

It must be admitted that there has been a rather general depression in some of the metal-mining lines during the past few years, but there are now unmistakable signs of an awakening interest in the industry, and there are being sent forth numerous inquiries for desirable mining properties by persons who never before have been known to possess such interests. This is creating work for not only the prospector but the mining engineer, who usually follows on the trail of the prospector. During the past 12 months, many old-time mines have been revived throughout the West, while many prospects that were never before exploited are being developed into mines.

One feature of this search for mines is the present-day practice of financially large concerns in maintaining staffs of skilled men who devote practically their entire time to the investigation of finds reported by the common prospector. As a general thing, mineral finds are made by men who lack money to develop mines. The only hope for such men, therefore, lies in selling out all or part of their rights to others who can provide the required capital to equip and develop these properties into productive mines. Perhaps this fact has been accentuated too strongly at times, with the resulting discouragement of prospecting, temporarily. We have been passing through such an unfortunate period. In but one country of the world, so far as known, has legislation ever been sought on this economic problem. At present, there is some agitation being carried on in New South Wales whereby the State Minister of Mines is urged to offer prospectors protection from the unscrupulous schemes of investors who combine to control prices of prospects.

We, in this country, do not face such monopolistic control of the selling prices of new mining property. Instead, our prospectors have a good chance to sell or finance their projects, providing they are reasonable in their demands. A decade or two ago, American capital could be enlisted in new mining enterprises in return for small fractional interests, but the man who now puts his money into such a deal feels that this money is just as essential to the success of the mines as was the discovery of the ore. He reasons that the two prerequisites in the establishment of any mine lie in the finding and in the financing, and that therefore these two factors should be granted practically equal importance in the apportionment of interests. The prospector of today is obliged to bring himself so far out from his naturally selfish instincts as to deny himself the right to a lion's share in his discoveries. Possibly he can settle each particular instance to his own satisfaction by pondering upon the query as to which is the more valuable: all, or most, of an undeveloped, non-producing prospect; or one-half, or less, of a real, dividend-earning mine.

Mines and Minerals

Vol. XXXIII.—No. 2.

SCRANTON, PA.—SEPTEMBER, 1912—DENVER, COLO.

Price, 25 Cents

PUBLISHED MONTHLY AT SCRANTON, PA.

ESTABLISHED 1891

INTERNATIONAL TEXTBOOK CO., PUBLISHERS

T. J. FOSTER, President S. P. ALLEN, Secretary E. H. LAWALL, Treasurer
RUFUS J. FOSTER, Vice-President and Manager

EUGENE B. WILSON, Editor ARTHUR J. HOSKIN, Associate Editor

WESTERN EDITORIAL OFFICE: 1221-1222 First Nat'l Bank Bldg., Denver, Colo.
CHICAGO OFFICE: 1006 Michigan Ave.

Entered at the Post Office at Scranton, Pa., as second-class matter
Address all business communications to MINES AND MINERALS, Scranton, Pa.
CABLE ADDRESS, "RETSOF, SCRANTON"

LONDON OFFICE: INTERNATIONAL BUILDINGS, KINGSWAY, LONDON, W. C.
SOUTH AFRICAN OFFICE: MANSION HOUSE CHAMBERS, ALDERLEY STREET, CAPE TOWN.

NEW ZEALAND OFFICE: 63 DIXON STREET, WELLINGTON.

AUSTRALIAN OFFICE: 83 PITT STREET, SYDNEY.

SUBSCRIPTION RATES

Single Copies.....25 cents
Yearly Subscription, including postage:
To United States, Mexico, Cuba, Porto Rico, Hawaii, and Philippines, \$2.00
To Canada.....2.50
To all other countries.....3.00
The date after your name on the wrapper is that of the month to which your subscription has been paid. If you do not want to continue your subscription after that time, kindly notify us.
Notice to discontinue or change of address should be sent to the Scranton office.
When notifying us of a change of address always give your FORMER as well as your present address.

TABLE OF CONTENTS

Editorial—	
Editorial Notes—Krebs, Indian Territory, Explosion—Uniformity in Mine Inspectors' Reports—"Laying Up Treasures" The Scientific Management of Mines—The Civil Service Idea of a "Mine Technologist"—Convict-Mined Coal.....	59
Premiums for Yards and Gardens.....	62
Personals.....	62
Manager for Illinois Mine Rescue Station.....	62
COAL MINING AND PREPARATION	
Southern Kentucky Coal Field.....	63
Barometric Pressure and Mine Gas.....	66
First-Aid Contest at Gary, W. Va.....	68
Cadeby Mine Explosion.....	68
The Flooding of Superba Mine.....	69
The Horsepower and the Kilowatt.....	71
Fires in Mines and Some of Their Causes.....	72
A New English Coal Field, by J. J. Baines.....	72
Trade Notices.....	73
Gasoline Motors in Mines, by A. F. King.....	75
Obituary—	
George Maxwell Jessup.....	78
A Colorado First-Aid Contest, by G. F. Whitesid.....	78
Lake Commerce for June, 1912.....	79
Answers to Examination Questions—	
Pennsylvania Bituminous Fire Bosses, April, 1912.....	80
Preservation of Mine Timbers.....	83
Correspondence—	
Wind Blasts—Treatment of Broken Hill Ores—An Air Blast, or Earth Movement—Allowable Error in Closing Survey—Humidifying Mine Air.....	87
Catalogs Received.....	88
ORE MINING AND METALLURGY	
Tin Ore Dressing and Metallurgy.....	92
Cburn-Drill Examination of Placers, by James E. Dick.....	95
Barytes in Missouri, by Lucius L. Wittich.....	97
The Pelton Waterwheel.....	99
Sand Filling on the Rand, by Edgar Pam.....	103
To Find Capacity of Cylindrical Tanks.....	103
The Market for Joplin Ores, by A. J. Hoskin.....	104
Sealing Off a Loading Place, by John T. Fuller.....	105
The Calculation of Areas, by H. G. Henderson.....	107
Concrete Shaft Lining, by E. R. Jones.....	107
Practical Cyaniding—Part 2, by John Randall.....	109
Power Consumption of Hoisting Plants, by S. W. Sykes.....	114
Formation of Magmas, by E. B. Wilson.....	115
New University Mining Laboratory.....	116
Society Meetings.....	116
Books Received.....	116
Squibs—	
Power and Quantity of Air, 67—New Jersey Mineral Production, 86—Single Shaft Guide, 98—No Reward for Tin Discovery, 104—Monel Metal's Resistance to Corrosive Action, 108—Eucalyptus Oil for Ore Dressing.....	113

THE poet who wrote "Hope springs eternal in the human heart" must have had a wide acquaintance among prospectors.

來 來

A WITTY old Irishman once said: "The world's not much to a man whin his wife is a widdy." If mine workers who jeopardize their lives by inattention to the condition of the roof in their working places would remember that witty remark, the number of accidents due to "falls of coal or roof" reported annually by the mine inspectors would not comprise the greater portion of deaths reported.

來 來

THERE is a vast difference between a mine surveyor and a mining engineer. Every man who possesses the degree of Engineer of Mines conferred by some college or university because he completed a certain course of study, is not necessarily a mining engineer. This is not the fault of the institution which conferred the degree. Sometimes it is due to nature, but in most cases it is due to lack of application, and an appreciation of the fact that it takes study and mental effort to apply principles learned in a general way to detailed conditions met with in actual practice.

來 來

A CORRESPONDENT sends us a clipping from a journal whose name we have not been able to ascertain. We should be very glad to give due credit to this paper in copying this remarkable paragraph; but our readers may agree with us that it is merciful to not divulge its identity. This is the paragraph:

"The geological formation is briefly described by stating that the Permian limestones have intruded and overlapped the Mezozoic. The Carboniferous formation covers the entire field. The metallic deposition is in the crystallized limestones and usually accompanied upon the hanging wall with porphyritic dikes."

來 來

PROF. H. H. STOEK, head of the mining department of the University of Illinois, and formerly editor of MINES AND MINERALS, at the close of the last term of the University took some examination papers home for inspection. Seated in his library, busy with the work, Mrs. Stoek, who was present, suddenly heard him break the silence with a hearty laugh. When she inquired the cause of it, the Professor said: "Listen to the answer to this question—'After the hole is tamped

and the squib is inserted, what should the miner do next?' 'Yell *fire!* light the squib and git—the powder will do the rest.'" In answer to Mrs. Stoek's query as to what credit he would give for such an answer, the Professor said: "One hundred per cent. The answer, while laconic, is absolutely correct." The student who made that answer, after acquiring a mining education under Professor Stoek, will undoubtedly know how to practically apply his knowledge.

采 采

Krebs, Indian Territory, Explosion

WE are indebted to Mr. E. W. Parker for the following information to be added to the list of explosions printed in the July issue of MINES AND MINERALS. The Krebs, Indian Territory, explosion was attributed to dust. It occurred at 5:03 P. M., January 7, 1892, and 67 were killed. Over 100 of the injured ultimately recovered and some of those who lost their lives might have been saved had it not been for lack of proper care and sanitation in their homes, and the unusual severity of the weather at the time of the accident.

采 采

Uniformity in Mine Inspectors' Reports

THE Mine Inspectors Institute is an organization with which every State Coal Mine Inspector in the United States should be affiliated. As an organization of inspectors it should not in any way encroach on the field covered by the several institutes composed of mine officials and mining engineers, as it has a broad enough field in originating and discussing plans to make the inspection service of each state most efficient. As an important preliminary to a proper consideration of the relative conditions existing in each state, MINES AND MINERALS respectfully suggests that the tabulated information in each state's annual reports be made uniform in arrangement, and be made to cover the same calendar months of each year. By this means the value of the reports will be greatly enhanced and both inspectors and mine officials will be better able to determine the relative efficiency of the methods employed to conserve life and property under conditions met with in the various coal fields. We trust the suggestion will meet the approval of the membership, and that the Institute will see the wisdom of using its knowledge and influence to bring about such uniformity. MINES AND MINERALS will be pleased to publish the opinions of both inspectors and mine officials on the advisability of such a system of reports.

采 采

"Laying Up Treasures"

ACCORDING to the *Goldfield (Nev.) News*, the Mother Lode Mining Co. is operating its 340 acres of mineralized lands at Cherry Creek, in White Pine County, Nev. What distinguishes this from the ordinary mining company is the fact that it is owned and controlled by ministers. The president is the Rev.

A. F. Dotterer, of Philadelphia, Pa. Eight of the ten directors are, or have been, active preachers. These men have been managing the company's affairs for over 3 years, and five of the men have personally visited and inspected the property.

There can be no reasonable objection to doctors of divinity extracting zinc from the bowels of the earth, but when they attempt to extract gold from the bowels of the ocean as did the dominie in Maine it is unfair to their parishoners.

If ministers are entirely dependent on salaries, they are not to be blamed for trying to lay up treasures in some other way; and what offers greater opportunities than metal mining if you use judgment before investing?

采 采

The Scientific Management of Mines

MINING is not a haphazard undertaking, and at scientifically managed mines the business and the work move forward with regularity and smoothness unsurpassed in any industry that requires the physical exertion of men. To scientifically manage mines the manager must be technically educated, broad gauged, and experienced in the many phases of the business. The manager who depends on the education of others to carry on the work, or who holds in supreme contempt the educated engineer and will state that he can hire all the college engineers he wants for \$60 per month, can never develop into a scientific manager, no matter how practical he may be. Scientifically educated managers are those who have learned the theory of mining and who have by experience developed into practical men, or vice versa. The scientific mine manager does not hesitate to call in the consulting engineer, whenever a problem involving considerable expense arises, not to ascertain what is to be done but how best to do it. This policy is based on the broad-gauged man's belief that two good heads are better than one good one.

The new doctor who proclaims his calling as "efficiency engineer" might find some employment in mining, provided he can induce the practical manager to believe he is an expert in mining. It is doubtful, however, if the scientific manager will ever have need for him, for in order to be of any use he must determine, by systemic observation and analysis, conditions as they are, and study how to improve them. The question then arises, is the "efficiency engineer" as capable of improving matters as the scientific engineer who is continually advocating improvements as the changing conditions arise and warrant.

Systematic arrangement of the departments originates with the manager, but each is improved by departmental heads, provided they are inclined to receive suggestions from their men and are in sympathy with the management's policy. For example, many economic ideas have originated with miners, who have discussed them with foremen, and the latter with the managers. There is scarcely a large or small colliery where there is not some

labor-saving device that originated with the workmen. It is quite true that where there is one valuable idea advanced there are many worthless ones; however, the intent of the men should be encouraged. It does not follow that all educated mining engineers will make scientific managers; there is an inherent quality about the successful man which conforms to the conditions with which he is surrounded and to the kind of men with whom he is obliged to work. This is a branch of scientific management which, if overlooked, is fairly sure to result in failure.

Mr. S. A. Taylor, who is connected with the University of Pittsburg, has prevailed upon the Faculty to consent to a course of instruction in the Scientific Management of Mines. This course is only open to graduates in mining after 2 years' experience in the field.

來 來

The Civil Service Idea of a "Mine Technologist"

THE United States Civil Service Commission announces an examination to fill a vacancy in the position of mine technologist in the Bureau of Mines, field service, at a salary ranging from \$1,800 to \$2,400 per annum, and vacancies requiring similar qualifications as they may occur, unless it is found to be in the interest of the service to fill the vacancy by reinstatement, transfer, or promotion.

The duties of the person appointed to this position will be a general study of mine conditions with reference to economic problems with a view to the improvement of these conditions, especially in the coal fields of the United States, and a study of these conditions as affecting the welfare of the miners.

The applicants for the position must have had graduate work in economics in some college of good standing, especially along the line of industrial economics.

Competitors will not be required to appear at any place for examination.

The examination will consist of the subjects mentioned below, weighted as indicated:

<i>Subjects</i>	<i>Weights</i>
1. General education and scientific training.....	35
2. Professional experience along industrial lines, and fitness	30
3. Publications, theses, etc.....	35
Total.....	100

In furnishing material under Subject 3 any published works, unpublished manuscripts, or theses may be submitted. Letters of recommendation from teachers or colleagues may also be submitted under this subject.

All statements relating to training, experience, and fitness are subject to verification.

Age limit, 24 to 40 years, inclusive, on date of examination.

The above circular issued by the United States Civil Service Commission was no doubt penned as a serious production by its author, but to practical educated mining men, and to those who have been eminently successful notwithstanding a lack of college training, it is a very humorous production.

In the first place the larger mining corporations and many of the larger individual mine owners will pay more money than our respected "Uncle Samuel" offers for approved talent.

In the second place the man who can pass the examination in Subjects 1 and 3, and who has had any successful extended "experience along industrial lines" is not looking for a job paying \$1,800 to \$2,400 per annum.

It looks to an outsider, as if the United States Bureau of Mines considered a higher education in the "ologies" of greater importance than broad practical mining knowledge in the personnel of its force.

If the Bureau of Mines is to command the respect and cooperation of the managements of large mining interests, it will have to employ men who, by experience as well as education, have at least as much practical knowledge of mining methods and mining conditions as the subordinate officials of the companies engaged in the industry. Many an eminently successful mine manager cannot spell correctly with a pen, but as a rule he has in his mental storehouse a fund of information that is of greatest value; and if he could dictate what he knows and what he learns by observation to a clerk with sufficient education to put it in proper English for publication, it would be of greater value than improved theories suggested by men of greater education but less knowledge. We do not want to be understood, in this connection, as believing that a technical collegiate education is not of value, for we know that it is, and that when possessed by an active industrious man who knows how to apply it, it makes him of superior ability. What we do want to emphasize is the fact that the Bureau of Mines will never be of real service till its officers recognize the fact that "book education" alone is not the prime requisite in a man to enable him to study mining conditions and to work out economic problems connected therewith.

來 來

Convict-Mined Coal

THE Southern Appalachian Coal Operators Association has decided to take an active part in the coming election of governor and members of the legislature of Tennessee, in an effort to secure the abolishment of state mines worked by convicts. The state mine has been a political asset, and the large tonnage which it produced has been thrown on the market at prices far under the market ruling, thus completely demoralizing the market, especially when in its worst condition.

The state of Tennessee has a Railroad Commission, and it is claimed that whenever a shortage of cars is noted at the state mine there is little delay in correcting it. The operators of course do not enjoy such privileges. It is also stated that a coal broker who is handling convict-mined coal and compelled to take the coal according to contract, as the mine works every day, sold screened coal at 45 cents, and in fact gave away some coal on the payment of freight and demurrage.

The operators have decided to secure from every candidate for the offices above mentioned an expression of their opinion in the matter of doing away with the state mine.

Premiums for Yards and Gardens

In accordance with notices published under date of April 15, 1912, premiums for the best kept yards and gardens at the plants of the United States Coal and Coke Co., Gary, W. Va., were awarded to householders on July 23 and 24. The awards were made by a committee consisting of Prof. C. R. Titloc, Director of Agricultural Extension, College of Agriculture, West Virginia University, Morgantown, W. Va.; Dr. E. A. Schubert, traveling agent of the Agricultural and Industrial Department of the Norfolk & Western Railway Co., Roanoke, Va.; and Professor Hanifan, State Superintendent of Rural Schools, Charleston, W. Va. Colonel and Mrs. Swepe, of Welch, accompanied the party.

The prize given was \$10 for the best kept garden and \$5 for the best kept yard at each plant, with an additional prize of a fine lawn swing, which was awarded by the Agricultural Department of the Norfolk & Western Railway Co. for the best kept garden and premises generally at all the plants, which was awarded to John Wolfe (German) at No. 9 plant.

Premiums were awarded by the committee as follows:

Works No.	Yard			Garden		
	House No.	Name	Nationality	House No.	Name	Nationality
2	62	Jim Marcelli	Italian	84	Rufus Tatum	Colored
3	23	Mike Wasso	Slavish	210	Each Socosh	Hungarian
4	7	P. L. Gillespie	American	50	Paul Conchia	Slavish
5	44	Hugh Jennings	American	2	Andy Saxon	Hungarian
6	126	Jacob Brown	Colored	77	Arthur Gray	Colored
7	36	Jim Rose	American	52	Wm. Deush	German
8	40	W. A. Graham	American	48	Mike Dutsie	Polish
9	147	M. Grobelink	German	142	John Wolfe	German
10	61	H. C. Mann	American	76	Joe Wassus	Hungarian
11	114	J. W. Lester	American	110	A. P. Mitchell	American
12	76	J. E. Money	American	26	S. T. Spencer	American

Honorable mention was also made of 21 others.

House No. 142, at No. 9 works, was awarded special premium of lawn swing, given by the Agricultural Department of the Norfolk & Western Railway Co.

In making the awards, the location and natural conditions were taken into consideration, as well as the general appearance of the yards and gardens.

The interest and pride taken by the householders in their yards and gardens proved a revelation to the entire committee, and aside from a monetary standpoint, it gives the householder fresh vegetables throughout the greater part of the year. After seeing the gardens, the committee estimated that from a monetary view alone, the gardens will average at least \$100 per garden, while a number of them will greatly exceed this amount, and an estimate of the gardens as a whole was placed at from \$15,000 to \$20,000. The manner in which the gardens and yards are kept at the various works shows that the householders are becoming awakened and getting to know

what good gardens mean to them. Improvements in the yards and gardens also lead to sanitary improvements, and great benefit is derived from this source.

Doctor Schubert, who served on the committee last year, said that in his opinion the sanitation had improved and that the gardens had improved at least 200 per cent.

These premiums will be awarded from year to year, as improvements in the yards and gardens will be of vast benefit to the householders, the company, and the surrounding community.

Personal

Personal

C. W. Purington, of London, is now in Alaska.

D. C. Jackling, of Salt Lake City, is in Alaska.

B. J. Latimer is with the Buena Tierra Mining Co., at Santa Eulalia, Chi., Mex.

E. P. Earle is a director of the Tribullion Smelting and Development Co.

Alfred L. Johns has left Victor, Colo., and is now located at Guadalajara, Jalisco, Mex.

R. H. Elliott has recently become super-

July to take charge of the Ingersoll-Rand office at El Paso, Tex.

Prof. Frank D. Adams, D. Sc., F. R. S., Dean of the Faculty of Applied Science, and Logan Professor of Geology at McGill University, Montreal, has been appointed president of the executive committee of the twelfth session of the International Geological Congress, to be held in Canada in August, 1913.

J. W. Merritt, assistant in mineralogy at Northwestern University, has been appointed instructor in geology at Dartmouth College.

R. E. Garrett, of the University of Oklahoma, and the Oklahoma Geological Survey, has been appointed assistant in mineralogy at Northwestern University.

Alexander N. Winchell has resigned from the United States Geological Survey to resume work as a consulting mining geologist. He has recently returned to his office in Madison, Wis., after spending several weeks in Nevada in connection with litigation regarding the ownership of the remarkable ore deposits of the National mine in that state.

Manager for Illinois Mine Rescue Station

Manager for Illinois Mine Rescue Station

The position of Manager of Mine Rescue Stations, for the State of Illinois, made vacant by the resignation of Mr. Richard Newsam, will be filled by means of an examination to be conducted at Springfield by the State Civil Service Commission, on October 3 and 4, 1912. This examination will include a statement of the applicant's experience in mining, and will cover a knowledge of first aid and mine rescue apparatus, general mine operations, including mine maps, ventilation, mine gases, safety lamps and general methods of work, the organization and administration of mine rescue work, and a knowledge of the State laws relating to this work. This position, which is open to residents of Illinois, has a salary of \$3,000 per year, all necessary traveling expenses being allowed in addition. Applicants must be between the ages of 30 and 60 years. In order to qualify, a candidate must not only be familiar with rescue apparatus and methods, but must have ability as an organizer, for while the actual work of training is mainly in the hands of the men living at each station, the manager must coordinate all the work and must have power to interest both operators and miners in mine rescue and first aid work.

Illinois is the only State having a thoroughly organized service of this kind. Up to the present time, about 1,500 men have taken rescue and first aid training in Illinois. Applicants for the position should write immediately to the State Civil Service Commission, Springfield, Ill.

intendent of the Liberty Bell mine at Telluride, Colo.

Edward Meents, of Battle Creek, Iowa, has been visiting mining properties in Colorado.

Geo. L. Crawford has opened an office at 315 Ideal Building, Denver, Colo., as a consulting engineer.

J. M. Bovee is manager of the Shawnee Copper Co., instituting operations in Carbon County, Wyo.

E. C. Van Diest, of Colorado Springs, Colo., is now a member of the board of trustees of the Colorado School of Mines.

Arthur H. Carpenter, Denver, is a new member of the technical staff of The American Vanadium Co., of Pittsburg, Pa.

Walter L. Reid, mill superintendent for the Smuggler-Union Mining Co., of Telluride, Colo., has been in Oregon on business.

J. B. Carman is with the American Smelting and Refining Co., at Velardena, Durango.

John V. Harvey is engineer for the Peregrina Mining Co., at Guanajuato, Mex.

W. A. Townsend left Denver, Colo., in

COAL MINING & PREPARATION

Southern Kentucky Coal Field

IN the progress report of the Geological Survey of Kentucky, 1906 and 1907, A. R. Crandall has written a meager account of the southern central coal field of Kentucky or, as some might call it, the southeastern coal field, which extends into northern Tennessee.

With this exception, one of the most interesting coal fields in the United States, from a geological standpoint, has been

Geology—Description of the Coal Beds, Mining Methods, and Surface Plant of the Stearns Coal Co.

Written for Mines and Minerals

tions are exposed, both by the railroad cuts and the creek erosion.

At Barthell the Lea conglomerate begins to rise in high cliffs above the railroad, while rocks the size of houses have fallen from them in places so as to choke up the creek. In addition to these

iferous series; further, it contains large rounded quartz pebbles, thus forming the closest approximation to the structure of

its counterpart in northeastern Pennsylvania the writer has observed in any bituminous coal field. Owing to the natural advantages offered for observation and the railroad cuts, the bedding planes or parting lines between the strata are clearly shown; particularly is this so be-

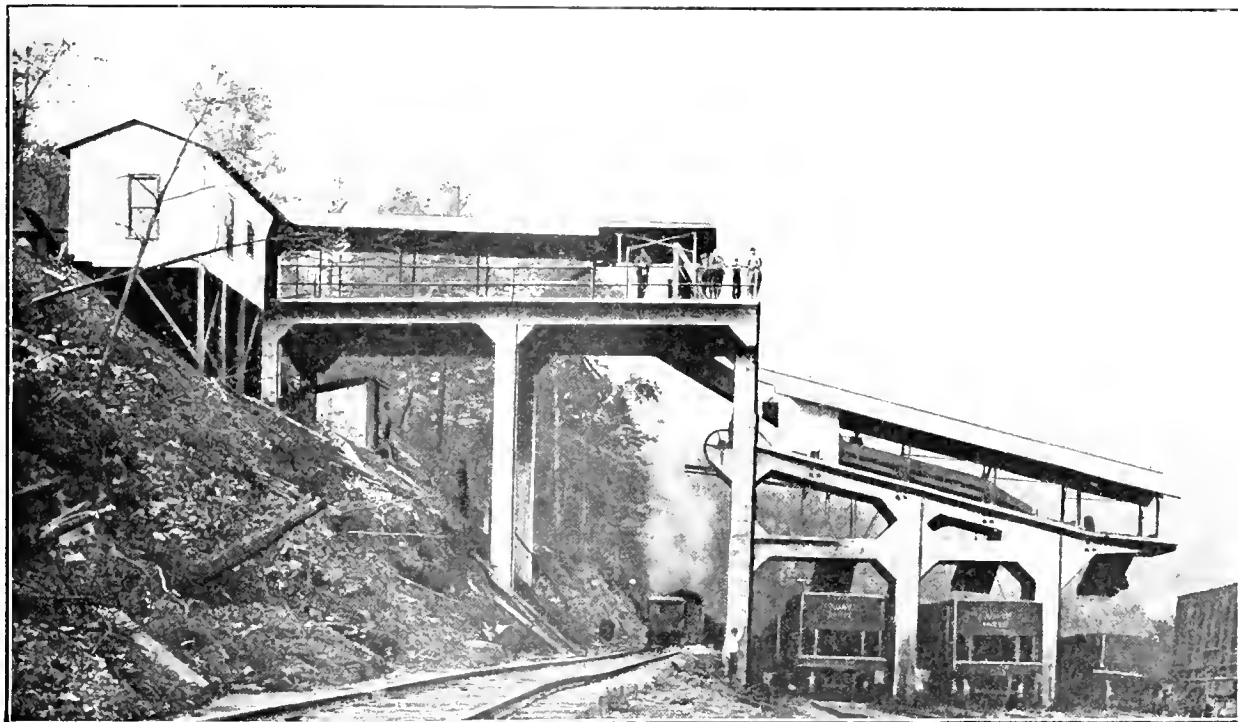

FIG. 1. CONCRETE TIPPIL AT MINE OF STEARNS COAL CO.

neglected. It seems to have been separated from the Jellico field by the upheaval which formed the Pine and Log Mountains.

Starting from the town of Stearns, which is virtually located on the top of the mountain, the Kentucky and Tennessee Railroad goes slightly southwest on the hillside to Paunch Creek, which it follows to the Big South Fork of the Cumberland River, whence it turns and follows the river almost due north to Yamacraw. The descending grade of the railroad is steeper than the pitch of the strata, consequently the geological sec-

exposures, the old streams made deep undercuts here and there in the cliffs that almost resemble caves. At Yamacraw the railroad crosses the Big South Fork on a \$75,000 concrete bridge and follows Rock Creek toward the southwest to Rock Creek station. Between Yamacraw and Oz, beyond No. 10 mine, the Subcarboniferous strata are represented by the variegated Mauch Chnuk or Chester shales and below them is the Subcarboniferous or St. Louis limestone. The Lea conglomerate corresponds geologically to the Pottsville conglomerate, it being the lowest member of the Carbon-

tween the conglomerate, red shales, and limestone where railroad cuts have been recently made and weathering has not obliterated these marks. The coal seams, three in number, are found in the Lea conglomerate.

It seems somewhat peculiar that coal beds existing in the Pottsville conglomerate should have exceptional qualities that make them in some particulars more valuable than the general run of bituminous coal beds. In the counties of Whitley, Wayne, and Pulaski in Kentucky, and in Scott, Pickett, and Fentress counties, Tennessee, the three coal beds vary in

thickness from 2.5 feet to 7 feet, averaging, however, between 4 and 5½ feet. Numbering from the base of the conglomerate upwards, No. 1 coal bed occurs about 20 feet above the Chester formation, and according to Crandall has the following analysis:

Moisture, 3 per cent.; volatile matter, 36 per cent.; fixed carbon, 57 per cent.; ash, 5 per cent.; sulphur, .79 per cent.

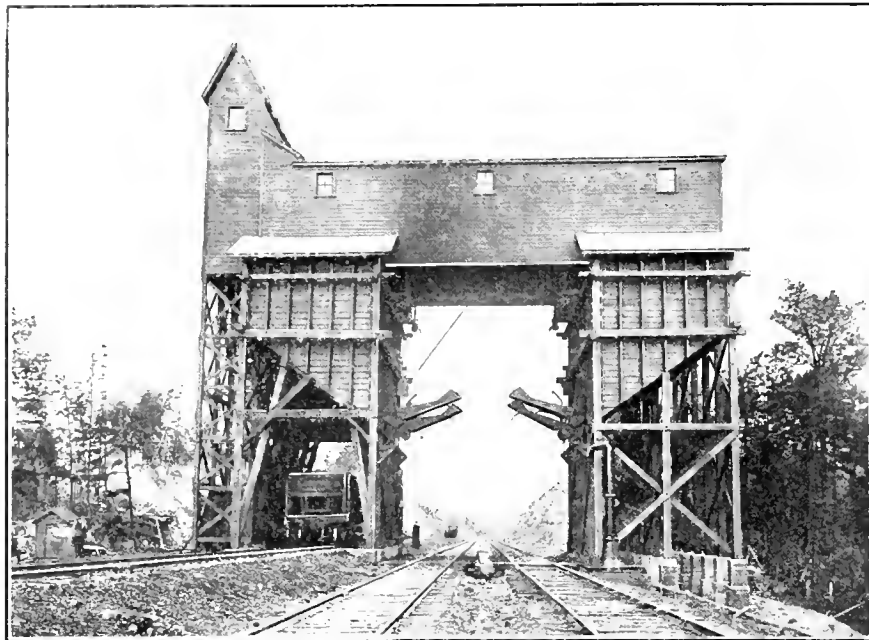

FIG. 2. COALING STATION AT STEARNS, KY.

This coal bed at Worley varies from 4 feet to 7 feet in thickness, and is particularly interesting because, without any reason so far discovered, soft coal will suddenly change to cannel coal, and vice versa. Sometimes there will be soft coal above the cannel coal, which may increase from nothing to almost the entire thickness of the seam and then decrease. There is no parting between the two varieties; they merge into each other, and consequently no endeavor is made to separate them for shipping purposes. No. 4 mine is worked by Sullivan punchers and chain machines and has electric haulage. The rooms are made 40 feet wide with 20-foot pillars where the roof is good; where it is soft, however, the rooms are made single, 24 feet wide with 16-foot pillars. The entries are driven 12 feet wide; cross-entries are turned every 400 feet. The mine contains some gas but no explosion has yet resulted.

Mine No. 3 has been driven so as to connect with Mine No. 4, 1,000 feet away, and thus has lost its identity. It was assumed when driving the two mines toward each other that they would meet; it happened, however, in this case, that a horse of rock split the two beds, as shown in Fig. 3, slightly upsetting the nicely prognosticated plans.

The top coal so far as followed is 3 feet thick, while the rock between the beds increases from nothing up to 12 feet. This mine ships 600 tons daily, but the development is such that the quantity can be greatly increased. Analysis of coke made from the nut and slack of No. 1 seam by the Dayton (Tennessee) Coal and Iron Co. is as follows: Moisture and volatile matter, .54; fixed carbon, 87.06;

sulphur, .91; specific gravity, 1.88; pore space, 45.10; ash, 11.39.

From this it is assumed that the coal should produce an excellent coke in retort ovens, and furnish a good amount of by-products owing to its richness in oily hydrocarbons.

So many irregularities in thickness and so many local "raises" and "swags" were found that in many cases it was not possible to gather with motors. The combination of mules and motors was then

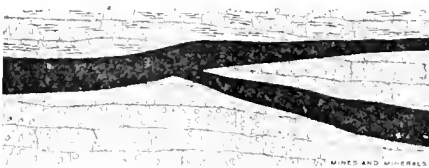

FIG. 3. SPLIT IN COAL SEAM

tried and the plan works tolerably well. The coal is gathered from the room partings with mules and delivered to sidings on the main entries, where it is picked up in trips and taken to the tippie. Previous to introducing the motors every effort consistent with economy was made to reduce gradients to a minimum and to ease curves and straighten roads. The track was then relaid with 25-foot and 35-foot

steel on white oak ties 5 inches by 6 inches by 5½ feet, spaced 18-inch centers. The compressed terminal bond, consisting of a head on the end of a copper conductor, is used. This head is compressed in a drill hole in the rail by means of a screw jack, which exerts a pressure of from 10 to 20 tons on the head of the bond, causing the copper to expand in the hole and form an intimate contact. These bonds have thus far eliminated the troubles arising from poor bond contacts. The trolley wire is 4-0 V grooved; the machine wire is No. 4; the clamps are the "Sure Grip" of the Electric Railway Equipment Co. On the outside hauls the trolley wire is strung on 8-inch round chestnut poles set 30 feet apart with 3" x 5" white oak cross-arms. Power is obtained from a Jeffrey 150-kilowatt generator, to which is directly connected an induction motor, forming a motor generator set. Three haulage motors are used, one 8-ton and two 5-ton, all Jeffrey equipment. The plant, while small and compact, is built in a substantial manner and has to date fulfilled requirements.

When constructing the Kentucky and Tennessee Railroad in 1903, the No. 2 coal bed, which is 90 feet above No. 1 coal bed, was found at suitable tippie height above the railroad to commence mining operations, at the place called Barthell. Here mines No. 1 and No. 2 are opened. No. 1 mine being the more extensive, it is probable the No. 2 mine will be merged in No. 1 when the two excavations meet. The No. 2 coal seam is not so free burning as No. 1 coal seam, but for steam locomotive purposes it is preferable. About 130,000 tons of coal from No. 2 bed is sold yearly to the Cincinnati, New Orleans and Texas Pacific Railroad, which has one of Roberts & Schaefer's coaling stations at Stearns, shown in Fig. 2. The elevating capacity of this two-track coaling station is 125 tons of coal per hour, with storage capacity of 500 tons in two equal sized bins. The machinery, driven by electric power obtained from the Stearns Coal Co.'s power plant, includes not only the elevating and distributing coal system, but an electric compressor and machinery for sand house. This plant also has complete fire protection equipment, consisting of fire pump, hydrants, fire hose, and sprinkling devices above the bins.

The mines are worked double entry, with double and single rooms as explained for Nos. 3 and 4 mines. At present coal is shot off the solid and haulage is accomplished by mules and electric locomotives.

Mine openings Nos. 5, 6, 7, 8, and 9 of the Stearns Coal Co. are merely prospects on Rock Creek and will not be developed for some time, as a long spur track will need to be built to connect them

with the Kentucky and Tennessee Railroad; besides, the operating mines are capable of producing more than twice the coal being shipped, which in 1912 will amount to over 400,000 tons.

Mine No. 10 is a short distance beyond Yamacraw on Rock Creek, and is destined to be a mine of large capacity. It has two openings some distance apart but at such height above railroad track that when the cars come from the main entry they are run directly on the tippie and dumped. The tippie, which is shown in Fig. 1, is probably the pioneer concrete tippie; and if not, it is the pioneer of its kind. The Stearns Coal Co. have abundance of the best white oak and long-leaf yellow pine for tippie construction, yet it was believed that a concrete tippie if properly constructed would last enough longer than a wooden tippie to pay for the difference in first cost, and in any circumstance it would not burn and so interfere with coal shipments. The construction of the tippie was an experimental venture, because there were no all-concrete tipples to use as patterns and to develop weak points for improvement, besides the anthracite breakers were partly concrete and wood or concrete and steel, the all-concrete breaker of the D. L. & W. Co. at Taylor, Pa., not having been finished. The No. 10 tippie, which has been in use over 1 year and 4 months, has not so far developed any weakness and has given general satisfaction. The tippie was constructed and the screens furnished by the Associated Engineering Co.

The tippie is a remarkably neat looking structure, braces and housing being reduced to a minimum, thus making its simplicity more glaring. If a tippie is to last, it must have solid foundations, with every part of the superstructure bound together to form a rigid mass. In testing for foundations, it was found that the ground under the shaking screens and loading chutes was yellow clay, making it necessary to enlarge the foundation piers for the tippie columns and keep the pressure on them under 1,000 pounds per square foot. The reinforced-concrete columns have 4 square feet sectional area and necessarily differ in length; the third or longest pair are 44 feet high and are reinforced with extra steel rods in order to bind them to the tippie floor above the screen floor below. The columns are braced at all corners and junction points, to add stiffness, and the three lower bents are tied with a beam and braced in order to furnish mass and resist the strains produced by vibration of the shaking screens.

All concrete beams on the tippie and shaker frame floors are 2 feet deep and 1 foot thick. The tippie floor is of concrete 4 inches thick. This has a grade of 1.5 per cent. for the loaded cars going to the dump and 1.7 per cent. for the empty

cars going away from the dump. In the tippie floorbeams regular trussed reinforcing was used. The shaker-frame beams were specially reinforced for concentrated loads at points where the screen pedestals were fastened. The floors were reinforced with $\frac{3}{4}$ -inch round bars placed 6 inches apart and bent in truss form to reach from beam to beam. Special steel

loaded car pushes in place so as to cross the return tracks *e* at the frog point. The track *a* has a higher elevation and the removable rail, which in place forms part of it, swings over and rests on the return track at *f*; but so soon as the loaded car has passed over the movable rail, a weight fastened to it by a chain swings it back and holds it in the position shown. At *g*

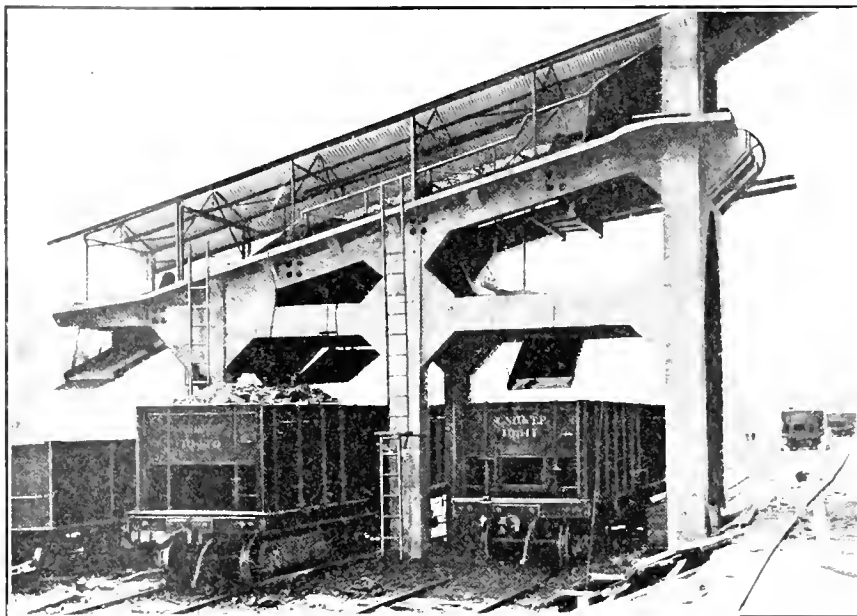

FIG. 5. STEARNS TIPPIE, CHUTE END

chairs placed 2.5 feet apart were embedded in the concrete tippie floor to hold the track rails in place. The arrangement of the tracks on the tippie floor is shown in Fig. 4.

The loaded cars come from the weigh scales on track *a*; at *b* there is a switch thrown by hand to direct the cars to one of the two Phillips kick-back dumps at *c*; at *d* there is a movable rail which the

there is a spring switch which is always set for directing the empty cars on the track *e*.

The shaker screen is of new design, and does away with the long suspension rods, and spring boards of the old style; there is also an absence of long reach rods between the screen and eccentric, thus economizing considerably in space. In the new screen the suspension rods are links 6 inches long and on these the screen swings full stroke without the attendant vibration that accompanies other shaking screens. The screen at Stearns No. 10 mine is 72 inches wide, and effectively separates the coal into 4 or 5 grades if desired at the rate of 200 tons per hour with a consumption of 6 horsepower. The little building shown beneath the tippie floor in Fig. 1 contains the motor which drives the shaker screens by a belt that passes over the delivery main railway track to the eccentric shaft pulley shown on the third bent of the tippie. The screen frames are of steel, and the screens are two-decked, consequently it requires only the opening or closing of valves to make a number of different coal sizes, a matter which is accomplished quickly. The upper screen plate is of sheet steel .25 inch thick, perforated with 2-inch diameter holes; all coal which passes over this screen can be separated into sizes by passing it over bars. The

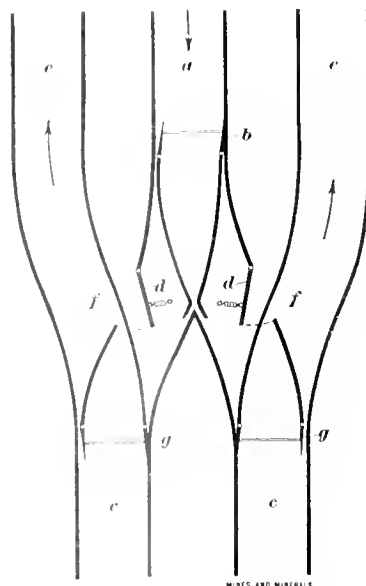

FIG. 4

Barometric Pressure and Mine Gas

Observations Showing the Effect of Variations of Barometric Pressure on the Composition of Return Air

under screen plate, made of the same thickness of steel, is punched with 1-inch diameter holes, the oversize going to bar screen which separates any coal over 1 inch. The screen is run at about 110 revolutions of the eccentric per minute, which is equivalent to 220 shakes; at the same time it is accomplishing more work with less horsepower and less vibration than shakers having larger area.

About 2 years ago the mine designated as No. 11 was opened at Yamacraw on the west bank of the South Fork of the Cumberland River. As the railroad is on the east bank, it became necessary to provide means for transporting the coal across the river temporarily for the development and construction period, and later for the regular operation of the mine.

Temporarily an old steam log-loading machine was set up near the railroad, and a 1 1/4-inch plow-steel cable was strung over the river and anchored in solid rock on either side. To this was suspended from a trolley, a sheet-iron bucket of 2 tons capacity. The coal was dumped from the mine car through a short chute directly into the bucket, pulled across the river by means of the log loader, dropped

IN volume XXVIII, No. 2 of the Proceedings of The South Wales Institute of Engineers, J. W. Hutchinson and Edgar C. Evans have a joint paper on "Analyses of Mine Air," which will prove interesting reading. We have abstracted parts of this paper relative to the fire-bosses test for firedamp and to the effect which variation in barometric pressure has on the flow of gas into a mine. —EDITOR.]

The new English Mine Act of 1911 stated for the first time that definite percentages of various gases in the ventilating current must not be exceeded. Previous provisions with regard to ventilation stated that "an adequate amount of ventilation shall be constantly produced in every mine to dilute and render harmless noxious gases." The law now is that, "a place shall not be deemed to be in a fit state for working or passing through if the air contains less than 19 per cent. oxygen or more than 1 1/4 per

and we believe even so low as 1 per cent. We have been training a number of firemen in the detection of low percentages of methane. They have, by means of hundreds of analyses made, become familiar with the caps showing the various percentages. Each fireman after making a cap test in the mine notes down the percentage which he thinks is present. He then immediately takes a sample of the air which is afterwards analyzed in his presence. The notes he has made are collected previous to the analysis, so that there can be no question as to the fairness of his observations.

The tests are made with an ordinary bonneted Clanny lamp fitted with round wick. In making a test the fireman lowers his flame until the luminous tip is barely visible; he then bases his estimate on the appearance of the cap, the height, density, and condition of tip all being taken into account. The firemen in their reports rarely state the height of a cap,

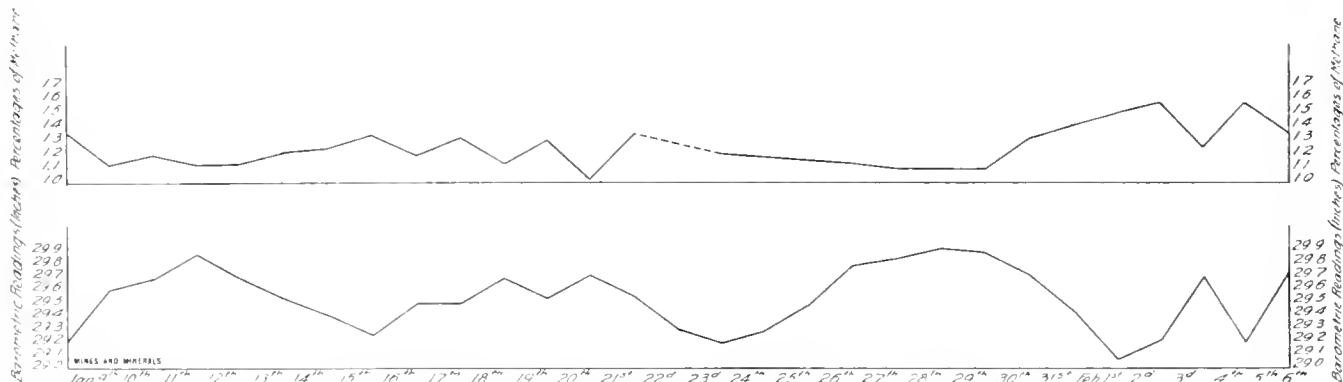

FIG. 1. INFLUENCE OF BAROMETRIC PRESSURE ON PERCENTAGE OF METHANE

into railway cars and shipped as run-of-mine. With this equipment a capacity of 150 tons in 9 hours was obtained at a cost of not to exceed 10 cents per ton, and the wasteful practice of stocking the development coal in the mine yard was avoided.

The permanent equipment consists of a reciprocating aerial tramway of 550-foot clear span operated by a 35-horsepower General Electric variable-speed motor, geared to the main driving wheel of the tramway. The 1 1/4-inch lock coil track rope cables reach from cliff to cliff across the river, and are anchored in solid rock and concrete. The traction cables are 5/8-inch plow steel. The buckets are 52 cubic feet capacity and travel at a speed of 800 feet per minute.

The writer is indebted to Mr. J. E. Butler, Manager of the Stearns Coal Co., for the material in this article.

cent. carbon dioxide; and an intake airway shall not be deemed to be normally kept free from inflammable gas if the average percentage of inflammable gas found in six samples of air taken by an inspector in the air-current in that airway at intervals of not less than a fortnight exceeds 1 1/4 per cent." The Act also states that "workmen must be withdrawn and a place shall be deemed to be dangerous if the percentage of inflammable gas in the general body of the air in that place is found to be 2 1/2 and upwards—or if in a part of the mine worked with naked lights 1 1/4 or upwards." With the statutory limit of 2 1/2 per cent. of methane it has become absolutely necessary that the fireman should be able to detect the presence of low percentages of firedamp by means of the safety lamp. With careful training it is possible for skilled men to detect as low as 1 1/2 per cent. of methane

but definitely state that a place contains a certain percentage of gas, and in most cases with considerable accuracy.

The chemical analysis of the return air-course is of the highest importance, since this airway is the main sewer, as it were, and contains the gases from the various working districts and places ventilated. Systematic analysis of the return air is also a check on the ventilation, and calls the manager's attention to any increase in the quantity of gas, such as may be due to increased blowers of gas or decreased speed and efficiency of the fan; and if the analyses are combined with anemometer readings the quantity of gas produced by a colliery can be directly ascertained. The original clause in the Mines Bill stated that the percentage of methane in return airways used for hauling coal should not exceed .5 per cent. Had this clause been persisted in, it

would have closed a large number of collieries in South Wales, with a consequent loss of coal output of enormous dimensions.

The results of our analyses were interesting, and systematic analyses were continued with a view to accounting for the variations which were found taking

the coal, with the consequent variation in the percentage of gas found in the return air.

The results on the whole are exceedingly consistent. A drop in the barometric pressure is accompanied by a rise in the methane percentage, and a barometric rise with a corresponding fall

throughout the period of the working shift until the end at 3 p. m.; then it falls gradually throughout the night to a minimum on the following morning. This is repeated periodically day by day throughout the period taken. Thus the peaks of the curves all represent the methane percentage at the end of the working shift; the troughs—the minima—represent the periods when no coal was being worked. The influence of the barometer is also plainly marked. Corresponding with the sudden fall in the barometer the methane curve, as a whole, takes an upward tendency, fluctuates on Thursday in accordance with the fluctuating barometer and rises again on Saturday in agreement with the falling barometer.

采 采

Power and Quantity Air

The relative amounts of power required to pass equal quantities of air through air-courses of the same length but different areas and perimeters are found by the

Perimeter
formula: Power varies as $\frac{\text{Perimeter}}{\text{Cube of Area}}$

The following table shows the results of using different sizes of airways:

Size of Airway	P	A	Relative Power, Making the Road 6x6=1
6x6	24	36	1.00
5x5	20	25	2.29
4x4	16	1	7.59
3x3	12	9	32.00

It will be noted from above that while the area of the airway 3 x 3 is one-fourth of the 6 x 6, yet it requires 32 times as

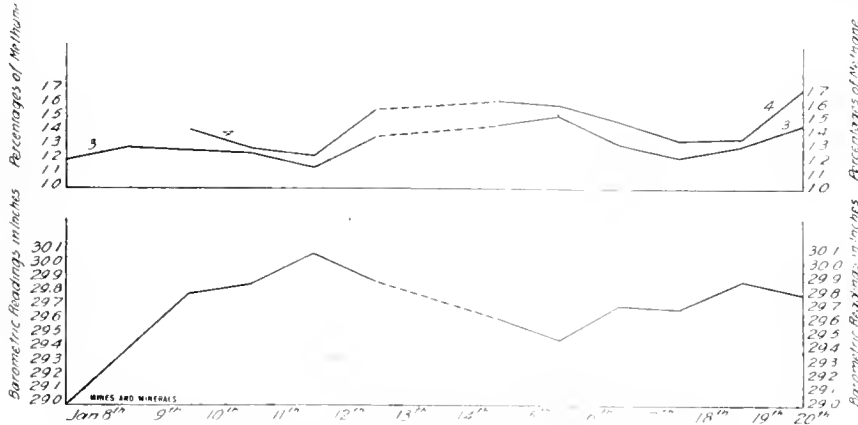

FIG. 2. INFLUENCE OF BAROMETRIC PRESSURE ON PERCENTAGE OF METHANE

place. The first and most obvious influence to be looked for was the variation in barometric pressure. Daily examinations of the air were made in the main returns of two mines, with a view to finding how far barometric variation affected the amount of methane given off from coal. To this end samples were taken daily at four places and the barometric pressure noted. The results showing the influence of barometric pressure on the percentage of methane in the return airways are given in Fig. 2. It will be noted that, a substantial rise in the barometer is accompanied by a drop in the percentage of methane and vice versa, but a close examination will show several local variations which cannot be accounted for by barometric variations. The amount of gas released is influenced by the rate at which the coal is worked, and thus varies at different periods of the shift. Again, variation in the speed of the fan causes a variation in the quantity of air passing along an air-course and consequently a distinct influence on the percentage of methane.

In Fig. 1 is shown the curves of variations of methane relative to variations of the barometer, at the second mine, and which confirm the influence of barometric pressure on the percentage of methane in the return airways. The seam at this colliery gives off large quantities of gas wherever it is worked. Samples of the return air were taken daily with extreme care by the colliery surveyor. The samples were taken at the same spot each day at the same time, the barometric pressure being recorded simultaneously. This curve shows in an unmistakable manner the enormous influence the barometer has on the quantity of methane given off by

in percentage throughout the period observed. There is no doubt in this case but that the fan was working at a regular fixed speed and a constant water gauge. While the experiments shown in Fig. 1 were going on an attempt was made to find whether the time at which the return air was sampled had any effect on the percentage of methane, apart from that due to barometric changes in pressure but due to the working shift. These experiments were carried on in another colliery. Samples were taken four times daily at 6 and 10 A. M. and 3 and 10 P. M., readings of the barometer being made simultaneously. During the first two days the barometer remained prac-

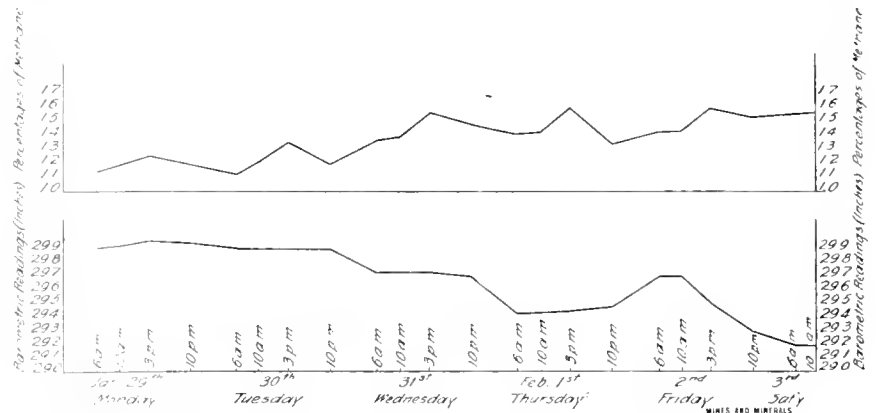

FIG. 3. INFLUENCE OF WORKING AND BAROMETRIC PRESSURE ON PERCENTAGE OF METHANE

tically stationary and its influence was practically eliminated. Thus any variation in the methane percentage, assuming of course that other factors remained constant, was due to mining the coal. It will be seen in Fig. 3 that the percentage of methane is at a minimum at 6 A. M., before the day shift starts, but increases

much power to force the same quantity of air through it. This illustrates the great importance of keeping the airways large and explains why ventilation is often poor or an excessive amount of power is required to furnish sufficient air for the needs of the men and animals in the mine.

First-Aid Contest at Gary, W. Va.

The first-aid contest held on the Athletic Grounds, at Gary, W. Va., on July 4, under the auspices of the United States Coal and Coke Co., was a brilliant success. While the contest was open for all first-aid teams in the Pocahontas coal field, only three teams reported, as follows:

Team No. 1, from the plants of the United States Coal and Coke Co., on Tug River, above Gary; team No. 2, from plants on Sand Lick Creek, above Gary; and team No. 3, from Gary and Wilcoe.

The contestants were very fortunate in being able to procure the services of Dr. J. J. Rutledge, Mining Engineer of the National Bureau of Mines, Pittsburg, Pa., and Dr. J. Howard Anderson, of Marytown W. Va., to act as judges. Before the opening of the contest, Doctor Rutledge made a short address in which he outlined the great progress being made in first-aid work throughout the country, particularly in the soft-coal districts. He also stated that in all first-aid contests it was customary to penalize each contestant by giving certain discounts for failure to observe certain precautions necessary to first-aid work. The discounts decided upon for the contest were as follows:

	<i>Per Cent.</i>
For improper control of team.....	15
For failure to reduce shock.....	15
For failure to stop bleeding.....	15
Failure to observe aseptic precautions.....	5
Appearance of team.....	5
Not observing proper sequence in rendering first aid.....	10
For careless handling of fractured bones.....	15
Time.....	5
Failure of rescuer to protect self.....	5
Improper application of splints, tourniquets, and bandages.....	10

The schedule of contests was as follows, which were performed by each team in turn:

1. Man unconscious from electric shock or gas. Remove from wire; perform artificial respiration for 1 minute.

2. Small injuries. Dress wound of right temple; dress wound on back of left hand. Apply tourniquet for severe hemorrhage of leg below knee and arm.

3. Compound fracture of right arm below elbow. Control bleeding, dress wound, apply splints, and dress complete.

4. Man injured, simple fracture of left leg below knee. Apply splints. Make stretcher with two coats and two mine drills. Place injured man on stretcher and carry 50 feet.

The manner in which the contesting teams went through the different events showed the efficient training they had received, and Doctor Rutledge said that they would compare favorably with contesting teams in the various state contests. The points made by the different teams were as follows: Team No. 2, 83½; team No. 1, 82½; team No. 3, 77½.

The following prizes were awarded: First prize, \$40 in gold; second prize, \$30 in gold; third prize, \$20 in gold. Each contestant also received a solid-gold first-

aid button. Fully 500 persons were present and enjoyed the contest.

The contesting teams, as well as everybody present, were very much pleased by the efficient manner in which the judges rendered their decisions, and their knowledge of first-aid work, as they took particular interest in observing each and every point in favor or against the different teams, and they were judged by individual points scored for or against them, instead of being judged as a whole; and everybody connected with the contest expressed their thanks to Doctors Rutledge and Anderson for the very capable manner in which they officiated.

來 來

Cadeby Mine Explosion

The Cadeby mine, in which an explosion occurred on July 9, is one of the two large collieries owned by the Denaby & Cadeby Colliery Co. The Cadeby shaft is sunk to the Barnsley coal seam, which at Conisborough, in Yorkshire, has a depth of 2,250 feet from the surface. At the time of the explosion about 200 men were in the mine, and in the district which exploded about 35 men, instead of the usual 136, when the explosion occurred at 4:30 A. M. while the night shift was at work. Only two of the men in the first explosion escaped. When the mine began to clear, rescuers went into the pit and were searching for the bodies when a second explosion occurred, much more severe than the first. Other rescuers were summoned and made their way as far as possible and by 8 o'clock six bodies had been recovered. These bore evidence of the severity of the blast. Coal dust was burned on them and it was apparent that in most instances death had been almost instantaneous. The work of the rescue parties was seriously hampered by the heavy fall of coal and stone which followed the explosion.

Mr. W. H. Pickering, Chief Inspector of Mines for Yorkshire and the North Midlands, and Mr. Hewitt and Mr. Pickle, two other mine inspectors, went down into the mine. In the absence of the managing director of the company, Mr. Douglas Chambers, of the Denaby mine, joined the party, as did Mr. Douglas Pickering, son of the Government Inspector. These men were superintending the operations below when another explosion occurred followed by two others. These men were soon brought up in a state of collapse, overcome by the fumes. From these it was learned that most of the rescue party, the mine inspectors and the officials had been caught by one of the last two explosions and many of them had perished.

Despite the tragic sequence of events, men were still ready to descend as res-

cues, and later in the afternoon the work of rescue was resumed. By 5 o'clock 31 bodies had been recovered. Percy Murgatroyd, who was the last man to see Mr. Pickering and the other members of the rescue party alive, wore a helmet. He stated that it was about 11:30 o'clock when the exploring party undertook to find out what had been the cause of the explosion. He was the only one who wore a respirator because the air seemed good and there was no need of one, but it was his business to penetrate into any part of the workings that the others might direct him to go. He was talking quite casually when all at once there was a trembling of the air. There was no time to seek a place of safety, there was a fearful crash, then clouds of dust and smoke all around. He remembered seeing Mr. Pickering and Mr. Hewitt lying on the ground as if asleep, and did not think they could have lived more than two minutes in that atmosphere. He staggered about in the darkness and tried to find his way out, but suddenly realized that he was lost. He came to a great fall and was so exhausted that he collapsed. After a minute or two it occurred to him that he might find a telephone. He found one and rang up and suddenly heard footsteps approaching and two rescuers came upon him and brought him out.

Two surveyors who escaped were a mile and a half away from the shaft and carried the first news of the explosion through the shaft. Edward Humphries, one of them, stated that his first impression of the explosion was a puff of air in his face and a moment later the place was filled with dust. He with two others went steadily on an investigating tour, doing all they could to locate the mischief, but it was not until they came to level known as 14 that they found any serious marks of the disaster. Cars were smashed, girders twisted in all shapes, and everything scattered about showing the force of the explosion. Word was sent to the pit manager and it was about 5 o'clock after the first puff of air that the real trouble was located. Foul air prevented further investigation for a while and then the men traveled some distance and came across the body of a man half buried in dirt. In all it is thought that 87 men lost their lives in this disaster. The seat of explosion was sealed in order to prevent further explosions, which are supposed to originate from gob fires that are prevalent in Yorkshire mines.

The coroner's jury returned a verdict of "accidental death," caused by two gas explosions on July 9. Fourteen bodies were sealed in the affected area and the coroner intimated that a formal inquiry was to be held by the Home Office.

**Colliery Guardian*, London, Eng.

ON July 24 a tremendous downpour of rain occurred in the vicinity of Uniontown, Pa., that found its way into the Superba mine and trapped 14 men. At about the same time the flood found its way into the Lemont mine about 1 mile away, drowning three men.

Through the kindness of Joseph S. Hagans, a photographer of Uniontown, it has been possible to obtain illustrations which show one of the difficulties the entrapped men had to overcome to escape.

Both the operations are in Fayette County, a few miles northeast from Uniontown, Pa. Superba, the smaller mine, is at Evans Station, and is purely a coal-shipping proposition working on one of the upper measures known as the Sewickley coal, a bed about 5 feet in average thickness and separated from the Pittsburg, or Connellsville coking seam by some 90 feet of intervening strata.

The mine has not been in operation long enough to be rated among the older plants and probably 50 acres have been developed up to date. The Lemont mine, however, has been in operation a number of years, and operates solely in the Pittsburg seam. Both these plants occupy in part, the same superficial outlines; the Lemont workings on the western end, partly exhausted, lying directly beneath those of the smaller mine. The dip or inclination of both seams in this particular location is to the westward, and the general trend of both operations is practically in the same direction; odd as it may appear, the main openings of each plant are more than a mile apart and are on opposite sides of the same main valley. The Lemont openings enter direct on the outcrop and with the inclination of the seam; the Superba inlets, in the opposite hillside, swing around in several consecutive angles until they get the natural bearing and follow the same inclinations as the Lemont workings. The dip on the main slope of the Superba mine is about 7 per cent.; the Lemont opening is more on a local "backbone" in the basin, consequently somewhat flatter.

The conformity of the surface area covered by the recent flood is not one that would naturally cause apprehension or anticipation of this unusual disaster, save in the fact that the coal outcrops along the bottom of the foot-hills defining the valley; but the latter is one of ample width and extent, with several miles of gently rolling or undulating country to the base of the regular mountain chain on the east (Laurel Ridge). It is well cleared and has been cultivated in the past; and while the watershed exposure

The Flooding of Superba Mine

Tremendous Downpour of Water Wrecking Surface Structures and Bursting Into the Mines

Written for Mines and Minerals

is considerable, there is ordinarily ample clearance for the spread of excessive rainfalls.

It is a well-populated section with the inhabitants located so as to be at any time quickly notified of and protected against impending dangers from floods. Yet all the misfortune took place in mid-day, when all were in position to realize and see for themselves; which proves how entirely unusual the occurrence was and how little it was apprehended. While ample assistance of all sorts was

around were covered and impassable, indicating the suddenness and extent of the storm.

The northeastern corner and high point of the Superba operations crops in the valley close to the railroads' right of way; both the Pennsylvania and the Baltimore & Ohio Railroads traverse this valley in parallel lines and near together; the mine workings stop at the boundary of the right of way, and the coal at this point has only 6 feet of cover. But previous to the day of the accident, no indication

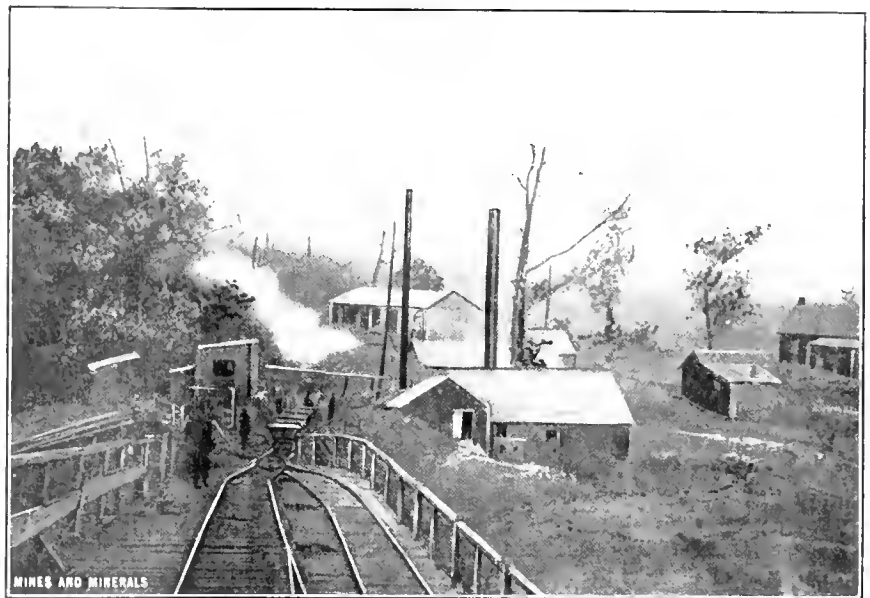

SUPERBA MINE SURFACE PLANT

readily available for an ordinary outbreak, the community was overwhelmed and helpless before the suddenness and power of such volume of water as descended during the few hours covering the period of disaster. It has been stated by good authority that the rainfall during these few hours amounted to more than 2 inches.

Further confirmation of the helplessness and horror of those involved lay in the fact that the waters did not enter either mine through the natural or expected sources, the regular mine openings, but in each place broke through the surface in the low places of the main valley and where the old workings had been driven up almost to the crop of the coal, leaving but a few feet of surface to cover these excavations. Flowing into these old excavations, it sought its own course, spread in all directions, and was simply beyond human control for the time being.

of fracture or settling of this surface had been noted, although for some years heavy train traffic with its vibrations and pressures had been constantly passing this point. At Lemont, the same condition applied—differing only in the fact that the railroad actually crossed the excavated portion and the thin cover was on the opposite side of it, a mile further eastward than the break at Superba; nor had there been any indication of break or settling at this second hole.

The first sign of serious trouble took place about 1 P. M. in the sudden disappearance of a heavy stream of water that flowed along the western ditch of the railroad; immediate investigation showed the water to have broken through the surface at the point above referred to at the Superba mine; and from all reports a similar break occurred at the Lemont mine at about the same hour. Sixty odd men were at work in the Su-



SUPERBA SLOPE MOUTH

perba mine and a full quota of employes at the adjoining plant.

Messengers acquainted with the workings were at once dispatched to notify the men of their danger and to hurry them out as rapidly as possible; and after strenuous effort on the part of the messengers and many narrow escapes, all but 14 of the total in Superba and 3 in Lemont made their way to safety. That effective and very rapid work was done by the messengers is illustrated in one case where a Superba trackman, working in the extreme dip and farthest point in the mine, was rescued along with many others. Of the other 14 men lost, several were within rescue distance, but the rush of the water carrying with it timber and heavy debris, finally battered and beat them back until they were totally exhausted and lost. Much of this final overpowering was due to the additional stream flowing into the traveling way shortly after the messengers started on their journey to notify the men; this new stream caught even the messengers on their return trip and in their then exhausted condition, their escape was only short of miraculous. Also, in this mine, with only 5 feet of height in which to travel, all the men were handicapped, due to the crouched position necessarily maintained; and as the water continued to rise, their space for air supply became rapidly contracted, and all the way through they suffered many physical disadvantages in the strenuous endeavor to make their way to safety through the strong current of water, laden with debris, and with the usual passageways blocked with foreign matter.

The manways in each case were several feet higher in elevation than the ordinary storm stages of water; and also in wide

parts of the valley barriers or covers built around the openings were swept away by the sudden rise; the ventilation regulating and controlling doors and stoppings were burst open by the inrush of water; timbers dislodged, mine tracks thrown out of place and pushed up to the roof, and all loose timbers, materials, and other debris were swept along the main outlets and escape ways. At this most crucial moment, while most heroic endeavors were being made to dam back the flow of water in the mines, on the surface and within a few miles on both sides of the plants, bridges and standard railroad track and work were being swept away; heavy stone abatments were battered and damaged, house foundations washed out and the buildings dislodged and several of the larger towns suffered

great loss of property; traffic was entirely suspended; even the highways were impassable and a complete demoralization of the whole district for a length of 12 miles lasted until the following day.

While a dip of 7 per cent. is rather heavy in the usually flat beds of coal in this section, such pitch does not afford, as has frequently been the case in the heavy pitching anthracite seams, highly elevated places to which men can retreat in case of flooding, and where for a limited time they will likewise find air storage sufficient to maintain life, if quick rescue can be accomplished. But in the present case, as the water flowed in the main openings or even the new breaks, it would rapidly fill up all the excavations, and those who could not keep ahead of this rise, would be trapped and covered. As the men were all probably on their way out from the various parts of the mine, where those who became victims met their end it would be difficult to state; many of them would likely be floated off to other parts from where they met the water until they lodged on some obstruction. The only definite statement that can be made is that most of them were employed in the most recently developed part of the mine. This is on the southern side of the slope, away from the old workings in which the break originally took place. Two new main flats are being pushed in this lower section, and there is not much difference in elevation at these points between the slope dip and the headings mentioned; the greater body of the coal lies in this part of the mine and it was the endeavor of the management to get ample development in this solid portion to take care of their shipments without having to depend on the old section near the crop.



VIEW OF MANWAY, SUPERBA MINE, AFTER FLOOD

While two adjoining mines have been unfortunate at the same time in losing employes through the same means, what happened at each plant was by no means effected through the mishap to its neighbor. The water into Superba followed a westward course; and while directly over the western end of the Lemont operations, even had the breaks and fissures of the intervening strata been sufficient to allow this water to pass down into the workings of the latter mine, very little damage would have been done to Lemont; but there is little indication that the water followed such a direction, as after subsiding on the surface the volume in the Superba remained about stationary, indicating very little leakage or subdrainage. On the contrary at Lemont, its body of water appears to have taken the eastern course due to the "backbone" referred to, and other operations along the main axis of the same basin, but in the opposite direction from the Superba and operating in the Pittsburg seam, were getting high water through this source.

There are several small valleys, laterals they might be called, branching out at almost right angles from this main valley and extending back to the Laurel Ridge; these valleys are the natural water courses for the mountain streams and are about 2 miles apart; one of them is just west of Evans Station; the other nearly opposite Lemont. It was at first thought and so reported that one of the large storage reservoirs at the foot of the mountain had given way, but afterwards was found not to be the case; the forces of several storms circling around the affected district must have suddenly concentrated and fallen in a deluge; the meeting of the waters through the two lateral valleys into the main valley then caused the sudden rise. Something worthy of note is the fact that in the lateral at Evans Station, and about a mile southward from it (much nearer to the base of the mountain) is another mine operation with a manway opened within a hundred feet of the creek bed and its own small reservoir. This manway is not much elevated above the surface and only a railroad fill intervenes between it and the flow of water; yet the water rushed by this point, tore its way through huge ash dumps from the ovens, upset tracks and bridges, and very little of it eventually reached the manway to do any serious damage. This miracle simply kept down the list of the storm's victims and even looks providential.

Many harrowing tales are told by the survivors; of course they vary widely in their narratives, due mainly to the disconnected events occurring in rapid succession and as they remember them in fleeting space; but the full horror of this unusual accident can be somewhat

realized by one who is experienced in mining practice and posted in the lore of the man who works underground.

In the Superba mine there are probably 40 acres of exhausted territory now full of water, and the length of time required to pump it out is problematic, depending on the success with which persistent endeavor will be met, and the amount of repair work to be done as the work advances. While one might figure out the cubic feet of water to be discharged per day to eventually displace the quantity involved, the unforeseen features cannot be estimated; however, this work of pumping and eventual recovery of the bodies was put under way as quickly as the conditions would allow.

The inundated portion is one of much commercial activity; several railroads, a street railway, and numerous mines and industries, as well as the homes of the employes, are strung along the valley for some miles. Moreover, while excessively high waters are not necessarily apprehended, the clear spaces through its length have been somewhat blocked with such industries and by the deposit of much refuse matter. Some attempt has been made to retain the natural water courses, but in an indifferent way; much of the refuse, light in character, is easily disturbed or washed into the streams during heavy rainfalls and liable in this case to add to the blockade. Bridges are numerous both on highway and rail, indicating the tortuous course of the streams; and the stoppage of water through a few of these at a critical time becomes a serious matter. It would appear to the casual observer that it might be good policy for the numerous industries to come to some arrangement for establishing of definite water channels, and this must be done with a full cognizance of what has been done under the surface in the way of mining operations as well as the exterior or surface arrangements. While the possibilities of a similar flood are equally for and against its occurrence, an investment of the kind here referred to will be of much smaller moment than the many thousand dollars lost in a few hours during this recent downpour; and the guarantee of safety to the men working underground will be a feature far more commendable and of greater moment than any monetary consideration. The importance of such water courses must necessarily rank with efficiency, conservation, safety, and good roads.

柔 柔

Dr. Holmes says that during the past year in producing 500,000,000 tons of coal in the United States, there were wasted or left underground in such condition that it probably will not be recovered in the future, 250,000,000 tons of coal.

The Horsepower and Kilowatt

There was, before 1911, no precise definition of the horsepower that was generally accepted and authoritative, and different equivalents of this unit in watts are given by various books. The most frequently used equivalent in watts, both in the United States and England, has been the round number, 746 watts; and in 1911 the American Institute of Electrical Engineers adopted this as the exact value of the horsepower. It is obviously desirable that a unit of power should not vary from place to place, and the horsepower thus defined as a fixed number of watts does indeed represent the same rate of work at all places. Inasmuch as the "pound" weight, as a unit of force, varies in value as g the acceleration of gravity varies, the number of foot-pounds per second in a horsepower accordingly varies with the latitude and altitude. It is equal to 550 foot-pounds per second at 50 degrees latitude and sea level, approximately the location of London.

The "continental horsepower," which is used on the continent of Europe, differs from the English and American horsepower by more than 1 per cent., its usual equivalent in watts being 736. This difference is historically due to the confusion existing in weights and measures about 100 years ago. After the metric system had come into use in Europe, the various values of the horsepower in terms of local feet and pounds were reduced to metric units and were rounded off to 75 kilogram-meters per second, although the original English value was equivalent to 76.041 kilogram-meters per second. Since a unit of power should represent the same rate of work at all places, the "continental horsepower" is best defined as 736 watts; this is equivalent to 75 kilogram-meters per second at latitude $52^{\circ} 30'$, or Berlin. Circular of the Bureau of Standards, No. 34, June 1, 1912, gives tables showing the variation with latitude and altitude of the number of foot-pounds per second and of kilogram-meters per second in the two different horsepowers.

These values, 746 and 736 watts, were adopted as early as 1873 by a committee of the British Association for the Advancement of Science. The value, 746 kilowatt, will be used in future publications of the Bureau of Standards as the exact equivalent of the English and American horsepower. It is recognized, however, that modern engineering practice is constantly tending away from the horsepower and toward the kilowatt. The Bureau of Standards of the Department of Commerce and Labor and the Standards Committee of the American Institute of Electrical Engineers recommend the kilowatt for use generally instead of the horsepower.

Fires in Mines and Some of Their Causes

The following non-technical address by Prof. W. H. Minor, of the Department of Mining Engineering, Ohio State University, was delivered to the Sugar Creek, Ohio, Mining Institute:

A mine fire is sometimes a very serious matter. The importance of a mine fire depends upon its position in the mine to a considerable extent, and if steps are not taken at once to dam it off or put it out it will spread over a large area in a short time. Frequently it is very difficult to get to the fire because of the poisonous gases evolved together with the high heat generated. While mine fires do not usually result in a large loss of life, they frequently reduce the output of a mine, because they contract the area which is in a workable condition. Each fire must be dealt with according to the circumstances which surround it, consequently there is no set of rules which will apply to every mine fire.

Of the many causes for mine fires probably the chief one is the firing of coal, timber, or other combustible material in the mine, which may happen in ordinary working or by accident. Fires have been started by furnaces or boilers in the mine, used for pumping or ventilation. Timber may be fired by naked lights, gas ignited by an open light, heat generated by steam pipes, oxidation of coal, or some other material. Coal may take fire spontaneously through oxidation; it may be fired by coming in contact with an electric cable; or in firing a shot. An explosion may start a fire by lighting the gas when present. Firing shots at quitting time and then not going back to the face to see if the gas is burning sometimes leads to mine fires, particularly in the anthracite field. Probably the greatest cause of fires in the bituminous coal mines is spontaneous combustion due to the oxidation of fine coal, or to the oxidation of pyrite. Associated with the oxidation of coal, the sulphur in connection with the coal also oxidizes. Moisture favors the oxidation of sulphur, but it impedes the oxidation of coal. The part which the sulphur plays seems to be to increase its volume, thereby creating a pressure in the coal which tends to break it up. This chemical action creates heat, causing gas to be given off, which, with its lower temperature of ignition, aids in the start of a fire at any given point. Associated with the oxidation of coal and sulphur in a pillar of coal, is pressure due to the weight of the overlying mass which tends to crack and fissure the pillar, exposing large surfaces to oxidation. The last condition would probably never start a fire directly. The coals which are most liable to spontaneous combustion are the lignites and closely associated bituminous coals which carry oxygen and volatile constituents. A fire would be preceded by a rise in temperature, a sort of musty smell,

a sweating of the coal, gas will be given off in quantities until finally explosions of gas would be noticed after the fire has started.

Prevention is usually a matter of care and foresight, but in case a given seam is liable to fires, they may be avoided by removing all fine coal from the mine, or sometimes by excluding the air from the gob or adopting a special system of working.

A fire of small extent, especially in entries, may be put out by applying water and pulling down the burning mass, loading it into cars and taking it to the surface when it has been thoroughly quenched. The air in this case may require the erection of partitions or some especially designed ventilating apparatus. Oftentimes a road may be driven above the seam, and having erected dams previously the fire area may be flooded. The most efficient method is by stopping off the fire. This is, of course, to prevent air from reaching the fire. Considerable argument goes on from time to time as to which end should be closed first. Fires have been handled by closing either end, but the outlet should be closed first, because in so doing the gas given off from the fire is bottled and a mixture is formed containing more than 10 to 12 per cent. of blackdamp, which would not permit of an explosion taking place. After the outlet has been closed there is no great hurry in sealing the inlet until the smoke or gas is detected rolling back from the fire. The first partitions erected may be of canvas, or bags filled with sand. If these seem to suffice, a masonry dam seated in the walls on all sides should be erected. In this dam should be placed a large pipe which may or may not contain a valve. The end of this pipe should be placed in a barrel filled with water and gas allowed to bubble up through the water at such times as seem to suit the working conditions. As the fire gradually dies out the water will be drawn back into the fire area and more water will have to be supplied to the barrel. This avoids any air reaching the fire area. Sometimes instead of using this trap a flap valve is placed over the end of the pipe and this works fairly well under certain conditions.

The fire may be extinguished by chemical methods; either the use of blackdamp or sulphur dioxide is recommended, but the method is a costly one. Finally a fire may be put out by flooding the entire mine, but the cure is almost as bad as the ailment, and this heroic treatment should only be applied as a last resort. Chemical fire extinguishers may be employed effectively in a mine at the very start of the fire. It is to be remembered that a fire generates explosive gases and oftentimes small explosions occur at regular intervals provided conditions remain constant. Having observed the intervals when these explosions occur, it is possible to work at the fire between explosions. This does not always take place, but it is well to note the fact that it is the usual occurrence. In reopening a

fire territory the outlet should be opened first. When there is a fan which is easily reversible, advantage may be taken of this condition in connection with the fire oftentimes to great advantage.

The various rescue appliances and helmets may be used in connection with fire fighting and in opening fire territory. It is advisable in this connection that five men wearing the equipment should always travel in a body. This necessary precaution should be taken so that if any accident should happen there would be plenty of help for the one who met with the accident or otherwise.

In quenching a gob fire a piece of canvas should be placed over the material and water thrown on the bagging. It is dangerous to throw water from buckets on such a fire unless the fire-fighters are protected with oxygen helmets. Water from a hose may be used effectively if the fire-fighters are on the intake side of the fire, in fact at the present time water is better for all mine fires, large or small, unless it be a chemical fire engine. Those mine fires which are most difficult to extinguish are near the crop and consequently are fed by oxygen to a limited extent. The oxygen keeps the coal glowing and the carbon dioxide is split up into oxygen and carbon monoxide, thus continuing the fire indefinitely.

* * *

A New English Coal Field

By J. J. Baines, Manchester, England

The first output of coal from a completely new coal field, the existence of which was entirely unknown some years ago, is an event both of importance and interest. There are no indications on the surface, or in the surroundings to suggest coal-measure rocks in the southeast of England; their existence at a considerable depth was surmised by reasoning, on the faith of which a large amount of capital has been raised and invested. Bore holes were sunk, and the expected seams ultimately found. England, Wales, and Scotland, considered as one large island, is made up, toward the west and north of primary rocks, and toward the east and south, of secondary and tertiary rock formations. The existing coal fields are in the west and north, in Wales, around Bristol, in the Midlands, Lancashire, Yorkshire, the northeast, and in Scotland. Many of these coal fields are detached areas, which were probably once continuous, the intervening portions having been removed by erosion. In Belgium and the north of France, about the same latitude as the south of England, there are extensive coal fields and it was suggested some 12 or 15 years ago that the Continental fields continued in a great saucer-like formation below the sea, below the secondary rocks of the south of

England, and cropped up in the known coal fields of the west of England, the distance between the Belgian and French outcrop on the east, and the English outcrop in the west being approximately 200 miles. It was suggested that if in the southeast corner of England, now covered with chalk, shafts were sunk, this supposed great trough of coal-measure rocks would be pierced. Now a first train of 12 trucks carrying 120 tons of coal has just been dispatched to London. It is the commencement of a great industry, which will convert a hitherto agricultural district into a mining center, with the greatest market of the world within 50 miles. London is now supplied with coal partly by water from the Newcastle district, in the extreme north of England, and from the great Midland coal fields; now coal can be obtained almost at its gates. Bore holes were sunk through the chalk near Dover about 1901 at the foot of the Shakespeare Cliffs; this chalk covers not only a considerable area of the southeast of England, it occurs also on the French coast and is probably continuous below the shallow sea forming the Straits, and has been deposited on a continuous sheet of Carboniferous rocks. The problem experts had to solve was to select a locality where these newer beds could be pierced with the greatest possibility of reaching the older rocks. The discovery of coal has shown the skill with which the problem was considered and solved. Other bore holes were sunk further inland and control was obtained over large areas of land.

Coal was not the only mineral found, for about 600 feet down an iron ore deposit was found 16 feet thick, which is also to be developed, so that two industries may be developed in an area where the last generation would have considered them impossible. The shaft from which coal is now being obtained is in mid Kent, about 15 miles or so east of Canterbury. For several years following 1901 the work was limited to bore holes; there were difficulties with regard to capital; during the last two years or so shaft sinking has been in progress and now the harvest has commenced. The first mine is known as the Shakespeare colliery, situated beside the main line of the Southeastern and Chatham Railway. Two shafts have been sunk, and a bore hole at Ropersole, 7 miles away. The deepest shaft extends to 1,632 feet and taps six seams of coal, four of which are workable; the shallowest seam is said to produce highly bituminous coal of good general commercial value and two deeper seams yield a bright house coal of good quality. Still deeper borings beneath the second shaft have revealed a seam of coal suitable for steam raising purposes.

There are two separate areas where bore holes and shafts have been sunk; the first, from which the coal supply mentioned above has been obtained is near the seashore, at the foot of the great chalk cliff, and the other at a place inland called Waddershare, where the first bore hole was commenced during 1906 and at least five seams of coal of high quality, at workable depths and of workable thickness have been discovered. Another bore hole at a place called Fredville has also been sunk, in all at least six bore holes have been made and coal proved in all cases. One shaft at Tilmanstone colliery is 14 feet in diameter; considerable difficulties occurred, not so much from the quantity of water as with the strata, which almost dissolved in water and ran at the sides whenever given the least opportunity.

The extent to which the new coal field is being developed may be realized from the fact that there are at least 10 companies interested of which four are so-called mother companies, whose business it is to take up the mineral areas and lease them to tenants; three of the others are colliery companies, which act as tenants. The reason that there are four of the former is due to the very large area under which coal has been proved. One company limits itself to boring; and another to sinking shafts. The largest seam found has a thickness of 6 feet and the area of the coal field fully proved is 70 square miles. Outside the known limits the accumulations of secondary and tertiary rocks may render the coal seams too deep to be reached, and there may of course be areas not at present known where these thin out. It has been estimated that there are 1,000 million tons of coal in the proved area. Many of the underlying fireclays are stated to be suitable for industrial purposes. An important and interesting point is that some of the coal is suitable for navigation, equal to the best South Wales navigation smokeless coal and there has been hitherto no coal found anywhere similar to the South Wales coal, except in New Zealand. Now a third source of supply will become available.

The saucer-like trough formed by the coal-measure rocks, extending from Belgium and France to the west of England, is not an isolated phenomenon. The coal field of South Wales is a precisely similar formation, rendered more interesting as the lip of the saucer can be traced all round. Further north a precisely similar basin occurs, the coal-measure rocks cropping up in North Wales on the west and in Derbyshire in the east, the trough being filled up with secondary new red sandstone containing salt deposits, representing an inland sea. The reverse formation also occurs.

Trade Notices

New Storage Battery Mine Locomotive.

A new type of storage-battery locomotive has been recently put on the market by The Atlas Car & Mfg. Co., of Cleveland, Ohio. It has a narrow frame, and is especially well adapted for use in low veins without the cutting away of the roof. It is built in various lengths, widths, and heights to meet requirements, the minimum height being about 36 inches. The frame is of steel, thoroughly braced, and is carried on four ground tread wheels which are of either chilled cast iron or rolled steel. The machinery and batteries are protected by steel plates; the top plate is removable, thus giving immediate access to all parts of the mechanism. The wiring is carried in conduit and attached to the frame to prevent injury. Four sizes are made, weighing 2, 2½, 3, and 4 tons each, and in track gauges ranging from 24 inches to 48 inches. However, the 2- and 2½-ton sizes can be furnished to accommodate 18-inch and 22-inch if required. A controller and hand brake are placed at either end, permitting of operation from either end, the speed being the same in either direction. The battery capacity is sufficient to run the locomotive through a 10-hour day with one charging on ordinary service with usual shut-downs for switching, etc. A special type of motor is used, so that no current is wasted in overcoming resistance while running, and the full draw-bar pull can be secured at the start with only the normal current from the battery. An ampere-hour meter is furnished with the locomotive; by its use in connection with the circuit breaker, the storage battery cannot be injured by overcharging. At the zero point on the dial there is a platinum-tipped insulated contact pin, connected to one side of an auxiliary circuit leading from the meter, the other side of this circuit is connected with the indicating hand. When the hand goes back on charging the battery and touches the point at zero, this action operates a shunt trip coil circuit breaker, which opens the circuit with which it is connected. The meter also shows the condition of the battery in regard to charge and discharge. If desired, a combination volt ammeter is furnished in place of the ampere-hour meter. A headlight is placed at each end of the locomotive and an electric gong is included in the equipment. This company is also prepared to furnish a portable charging outfit complete with generator, engine, switchboard, and fuel tank. This charging outfit does away with the purchase of a large amount of expensive machinery, which is usually thought necessary for the charging of storage batteries. When not in use for charging the batteries, this outfit can be used for other purposes such as running motors, mine lighting, etc.

The Atlas Car & Mfg. Co. also manufactures a full line of mine cars and surface

hauling locomotives of various kinds. Catalogs of the various lines will be sent upon request.

The Hyatt Way is the title of a booklet issued by the Hyatt Roller Bearing Co., of Newark, N. J. This is the first number of a series which will appear monthly, and contains principally reprints of advertisements used by that company in different papers. The advertising of the Hyatt Roller Bearing Co. has been a good example of the "reason why" style, and the assembled advertisements therefore tell an interesting story and give a good idea of the varied purposes for which their roller bearings may be used.

New Branch Office.—The Taylor Iron and Steel Co., of High Bridge, N. J., announces the opening of an office in Pittsburg, Pa., at 301 Oliver Building. The office will be in charge of Mr. James S. Morrison. In order to handle matters expeditiously, they request that all inquiries and orders for Tisco manganese steel castings from customers in the immediate vicinity be sent through the Pittsburg office.

A Section Insulator Switch.—The Electric Service Supplies Co. has placed upon the market a section insulator switch which has a valuable additional patented feature by which the closing of the switch closes the dead section of the breaker. In this way the switch protects the breaker, because the closing of the dead section prevents arcing. Consequently, injury and strain to the motors when the trolley wheel breaks and removes the circuit is eliminated. The switches not only protect the breaker by closing the dead section simultaneously with the closing of the switch, but they save the time of the motorman because he does not have to stop or leave his position to close the switch, and the switch is mounted so that the motion in closing is in the direction of the traffic. A saving in expenditure for unnecessary power is also affected, as the section of the line which it is desired to insulate is dead when it is not in use, and hence there is no danger in the section, as there are no live wires. The motorman can throw the switch when he again desires to enter the section without stopping or leaving his position. The switches are made for currents up to 1,000 amperes, are tapped for $\frac{3}{4}$ -inch stud, and are provided with feeder connections at each end.

New House Organ.—*The Keystone Traveler* is the bimonthly house organ published by the Electric Service Supplies Co. The July number is devoted to an illustrative description of the new building now occupied by that company, explanation of the various departments, their work and method of carrying it out, and a detailed résumé of the organization and growth of The Electric Service Supplies Co. The theme of the little introductory talk on this issue is "service," the title being "Service is Success." This theme is dealt with briefly but neatly, some of the suggestions

and statements made being extremely good ones. "The story of any success is service," is the concluding and summarizing sentence of the article.

Universal Mine Hanger.—A new trolley wire hanger, made by the Ohio Brass Co., of Mansfield, Ohio, is designed to be installed either directly to the mine roof by means of an expansion bolt or to the roof timbers by means of a hanger screw. It has an especially broad top which bears directly against the surface from which it is supported, a feature which is desirable at all times and particularly so on curves where a heavy side strain is thrown upon the hanger. The shell of the hanger is made of sherardized malleable iron and is provided with a hole for draining off moisture which may collect at the bottom of the expansion bolt. The stud is insulated from the body by heavy layers of mica and is molded into the Dirigo insulation which is formed into a triple petticoat to minimize surface leakage in wet mines. The use of this hanger obviates the necessity of carrying two kinds of hangers in stock at the mines and also simplifies installation, since all hangers can be put in place by screwing them on to the bolt or screw. A portion of the body is made hexagonal, so that a wrench may be used for this purpose.

Transportation in Industrial Plants. Large manufacturing plants often present a difficult transportation problem, due to their unsymmetrical growth, owing to expansion not being provided for in the original conception. The Jeffrey Mfg. Co., of Columbus, Ohio, is spread out over an area of approximately 26 acres, with 18 acres of floor space, and manufactures a large line of electrical locomotives, electric storage-battery trucks, coal-mining, elevating, and conveying machinery of all descriptions, structural-steel work, etc. Formerly the raw and finished material was transported to and from cars in and about the shops and the departments by two-wheeled warehouse trucks, four-wheeled trucks, and industrial cars. Also, part of the territory was served by a Jeffrey storage-battery truck working on a 36-inch gauge industrial track. A study of conditions made it plain that a material saving could be effected by a more efficient transportation system. Accordingly, the industrial railway was extended to take in all departments, a systematic method of car dispatching was established, and instructions were issued that no material was to be transported by other means than by the storage-battery trucks and industrial cars. It was immediately found possible to dispense with the services of a two-horse team, 28 two-wheeled warehouse trucks, 13 four-wheeled trucks, eight wheelbarrows, and 18 men whose whole time had been devoted to this purpose, effecting a saving of more than \$600 per month. The Jeffrey storage-battery truck does not require the service

of skilled operators, and the maintenance and operating costs are extremely low. Full descriptions and information will be furnished on request.

Largest Electric Mine Hoist in America. In the mine of the Christopher Coal Mining Co., at Christopher, Franklin County, Ill., will be installed the largest electric mine hoist in America. The mine, including 32 locomotives for haulage, is to be operated entirely by electric power, and about half the capacity of the plant will be required for the hoist. Power for the several operations will be generated at the mine by two 750-kilowatt, three-phase, 60-cycle, 2,300-volt Curtis turbogenerators. Above ground practically all the machinery, except the hoist, will be operated by alternating current; while all the underground equipment is to be operated by 250- to 275-volt direct current. The hoist operates on the Ilgner system and is of the double-drum type, having 7-foot drums designed for an effective load of 9,000 pounds in a car and cage, the combined weight of which is 11,000 pounds. Wire hoisting rope $1\frac{3}{4}$ -inch diameter is used. The equipment is designed to make 1,000 trips from 600 feet depth in 7 hours, with a maximum rope speed of 2,400 feet per minute. A 1,150-horsepower, 550-volt, direct-current motor drives the hoist and is direct connected to the drum shaft by a flexible coupling. This motor is designed especially for hoisting service and has large overload capacity. Power will be supplied to the motor by a flywheel motor-generator set. The speed and direction of rotation of the hoist will be governed by a controller at the operating platform, by means of which the voltage and polarity of the generator will be governed. The efficiency of this form of control, called the Leonard control, is very high, as there are no rheostatic losses except the comparatively small ones in the field circuit of the generator. The torque of the regulating motor varies with the line current and when this current tends to exceed a predetermined value, the torque of the regulating motor will overcome the weight of the moving parts of the rheostat, introducing resistance into the rotor circuits of the main induction motor, thereby causing the motor to slow down and allowing the flywheel to give up its energy. When the current falls below the predetermined value, the weight of the moving parts of the rheostat will exceed the torque of the motor and the resistance will be cut out automatically. In the control equipment are also devices to guard against damage from overwinding, failure of alternating-current supply, loss of exciter voltage, loss of air pressure for the brakes, as well as extreme overloads. Both service and emergency air brakes are provided. The hoist is to be of the Ottumwa Iron Works make, and all the electrical apparatus, including the mine locomotives, is being furnished by the General Electric Co.

Gasoline Motors in Mines

With Special Reference to the Advantages and Disadvantages of Gasoline Locomotives for Mine Haulage Work

By A. F. King, E. M., Charleston, W. Va.*

FOR possibly 30 years gasoline motors have been used for various purposes on the Pacific Coast and in the metal mines of the West, this development being brought about by the high cost of steam generation and, in many cases, scarcity of water in arid regions.

Stationary gasoline motors were first used in the mines of West Virginia about 15 years ago, and at about the same time the Prouty Company, of Chicago, was advertising its manufacture of gasoline haulage motors of different capacities for mine work.

It has been since the advent of the automobile, and during the past 6 years, that manufacturers have seriously tried to develop a gasoline haulage motor that would satisfactorily meet mining conditions; and,

equipped with an electric igniting device, which is so connected as to operate from a storage battery when the motor is starting, and thereafter from a magneto.

Some manufacturers also equip the motors with absorption chambers, the types and capacities of which differ with the size of the motor. The absorption chambers are intended to absorb the carbon dioxide (CO_2) generated, and to cool the gases given off. It is also claimed that this absorption chamber is a protection against the ignition of explosive mine gas or coal dust in case the engine "back fires."

4. No trolley lines, hangers, bonds, or cables are required, thus saving the labor for their installation, their cost, and maintenance.

5. It aids in the humidification of the mine air.

6. It is safer than a trolley-wire equipment; that is, the mine employes are less liable to meet with injury through contact with the motor or its transmission lines.

7. No time is lost in handling the trolley pole or wires; and in gathering it is unnecessary to attach and detach either transmission or haulage cables.

The disadvantages of the gasoline motor are:

1. In the use of gasoline in the mines there is an element of danger, from the fact that it readily volatilizes, and when

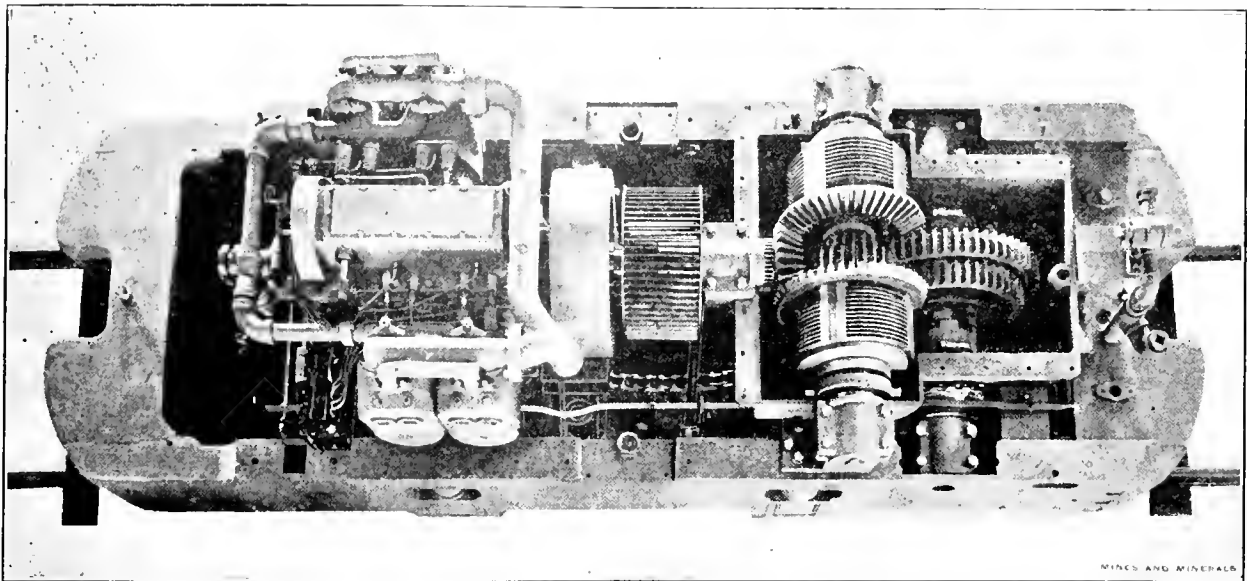

FIG. 1. TOP VIEW OF GASOLINE LOCOMOTIVE, STRIPPED

I am now given to understand that there are about 300 in actual service.

In shape and appearance the gasoline locomotive closely resembles the electric locomotive, except that it has no trolley pole. The larger types of the gasoline motor require more height than an electric motor of the same weight.

The cylinders, or combustion chambers, are water-jacketted, to prevent undue heating and consequent sticking or binding of the piston. Excessive cooling of the cylinders, however, reduces the efficiency.

Rotation is always in one direction, so that the reversing is done by means of clutches and miter gears. They are usually constructed so as to run on full and on half speed.

Each motor is equipped with a carbureter whose office is to properly mix the air and the gasoline in the cylinder. They are also

The gasoline storage tanks are placed, in some makes, in the side of the frame of the motor, Fig. 1, while in other types they are suspended within the frame of the motor or placed in a more or less exposed position.

The repairs are said to cost about the same as for electric motors of the same power, but, on account of the gasoline motor having reciprocating parts, the writer is inclined to believe that they cost more.

The advantages of the gasoline motor are:

1. No power plant is needed to operate them, the power-generating apparatus being a part of the motor. This means that power-plant fuel, labor in operating, and maintenance of the same, are not required.

2. There are no transmission-wire lines or pipe lines needed, and line losses and line maintenance are dispensed with.

3. The use of the motor is not affected or interrupted by short circuits, bursted pipe lines, or drains upon the transmission lines by other motors.

mixed with air forms a very explosive gas.

2. The combustion of gasoline in the combustion chamber extracts oxygen from the mine air.

3. Carbon dioxide and free nitrogen are the products of the perfect combustion of gasoline.

4. The carbureter is usually adjusted to furnish, as nearly as possible, the proper mixture of gasoline vapor and air when the motor is doing its heaviest work, and if it is assumed that, under these conditions, perfect combustion is obtained, it is evident that when the engine is running with the motor standing, or when it is doing light work, there is a more or less imperfect combustion, which means that carbon monoxide (CO) is given off.

5. I am of the opinion that the absorption chambers do not eliminate all of the carbon dioxide which is produced, nor do they prevent the carbon monoxide or free nitrogen from being given off.

*Paper read before the Coal Mining Institute of West Virginia.
33-2-4

6. When the coal must be cut by mining machines, a power plant, though not necessarily so large, must be operated and maintained, and transmission lines, both outside and inside the mines, must be erected and maintained.

7. The gasoline motor costs from 25 per cent. to 50 per cent. more than an electric motor of the same power.

8. It is also said that, due to its having but two speeds, the gasoline motor will not start as large a trip as the electric motor.

9. One complaint heard is that it will not take an overload, as do electric motors; but it seems to me that the tractive effort in either case is dependent upon the weight of the motor, and in the case of the gasoline motor, it is simply a question of designing the engines large enough to produce the effect.

10. At the present time the gasoline

consumption of gasoline per day is $2\frac{1}{2}$ gallons per ton weight of motor; this motor would consume $12\frac{1}{2}$ gallons, or 73.1 pounds.

This motor would then produce 225 pounds, or 1,921 cubic feet, of CO_2 , 861.4 pounds, or 11,570 cubic feet, of nitrogen, and 105.26 pounds of H_2O . It would rob the mine air of 257.3 pounds, or 3,026 cubic feet, of oxygen.

Doctor Haldane has found that what we know as blackdamp does not entirely consist of carbon dioxide, but that the greater part of it is composed of nitrogen. There would, therefore, be produced 1,086 pounds, or 13,491 cubic feet per 8-hour day, 1,686 cubic feet per hour, or 28.1 cubic feet of blackdamp per minute.

To keep the percentage of blackdamp below 1 would require a volume of 3,000 cubic feet of air passing per minute.

If, however, there is incomplete com-

more assurance that the gasoline mine motor has come to stay.

DISCUSSION BY E. B. WILSON

Mr. A. F. King's paper on the "Use of Gasoline Motors in Coal Mines" is of particular importance at this time, when many mine managers are considering seriously their introduction. It is also of as much importance to metal as to coal miners, because of the poorer systems of ventilation in metal mines and the greater need for some system of comparatively cheap haulage. The Institute is to be congratulated on having what is probably the first impartial article on this subject presented to its members; and what is here added is not in the way of criticism, so much as to furnish further information on the subject. In Fig. 1 is shown one make of gasoline locomotive, stripped so as to show engine, cooling fan, and transmission gear. It is a four-cylinder engine, with two sets of gears, one for a speed of 4 miles an hour and one for a speed of 8 miles an hour. These gears are thrown in and out of mesh by levers.

In Fig. 2 is shown the locomotive with the engine door and the gasoline tank door removed on one side for inspection. Fig. 3 shows the driver's end of the Whitcomb gasoline locomotive and the carbureter. With an occasional glance at these three illustrations it will be possible for the uninitiated to follow the discussion.

The idea of the introduction of such volatile and highly inflammable liquid as gasoline into coal mines is rather startling at first, but the difficulties and dangers have been so far overcome that they are used in the deep mines of Westphalia and elsewhere, and almost daily their number is increasing. In Austria they are allowed in fiery mines if their construction complies with certain regulations relative to ignition. Some German machines are made without carbureters, the vaporizing and ignition of the fuel taking place in the cylinder.*

Attempts have been made to prevent the carbon dioxide resulting from the combustion of gasoline escaping into the mine atmosphere. It can be accomplished provided sufficient lime water is carried on the locomotive, but if the solution is not changed often, or is allowed to reach the boiling point, 1 gallon of lime water will absorb but approximately 3.2 cubic feet of carbon dioxide, and any additional quantity will be expelled by the heat. The chemical reactions taking place are as follows:

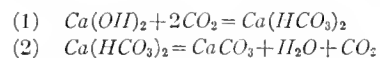

In equation (1) calcium hydrate and carbon dioxide form acid calcium carbonate, which is broken up as shown in equation (2) so soon as heat is added from the exhaust. It, of course, is understood that

*MINES AND MINERALS, Vol. XXXI, page 30.

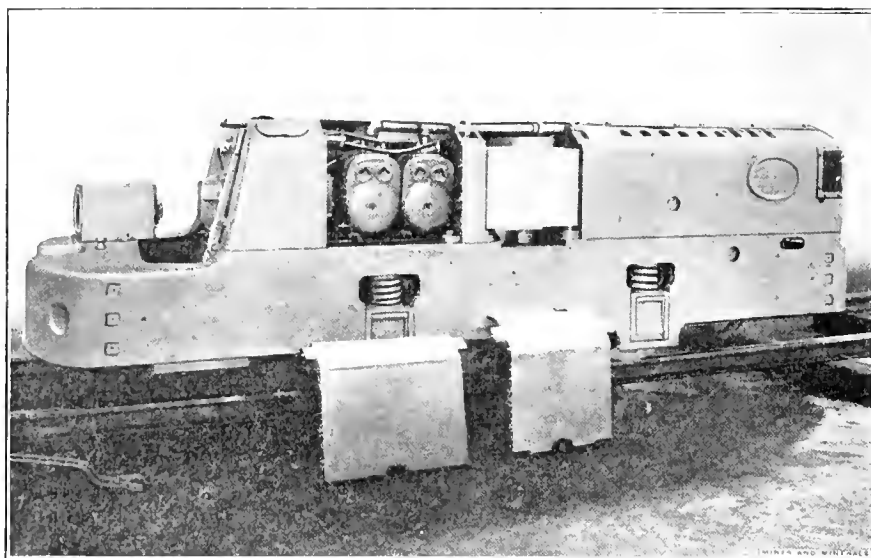
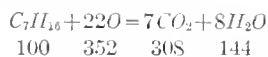

FIG. 2. LOCOMOTIVE WITH GASOLINE TANK DOORS REMOVED

motor cannot safely be used in a gaseous mine.

Gasoline is of the hydrocarbon series, whose typical formula is C_nH_{2n+2} . Assuming a specific gravity of .70 at zero, centigrade, its formula would approximately be C_7H_{16} , which is called heptane. A gallon of this oil will weigh about 5.85 pounds.

Assuming that there is perfect combustion in the engine, the following chemical changes would take place:



which means that for every 100 pounds of gasoline used there are produced 308 pounds of CO_2 ; that 352 pounds of oxygen are abstracted from the mine air, and that 1,178.4 pounds of free nitrogen are given off; neglecting other constituents of mine air, and assuming that oxygen and nitrogen exist in the proportion of 23 per cent. and 77 per cent., respectively, by weight.

Let us further assume that a 5-ton gathering motor is used, and that the con-

sumption in the engine, carbon monoxide (CO) is produced, and the very dangerous character of this gas, even .1 of 1 per cent. being very injurious and poisonous if breathed for any length of time, makes it imperative that additional air be provided to make ventilation exceptionally good, and it is suggested that the quantity of air to be provided for the particular motor under consideration be made 5,000 cubic feet per minute, say, 1,000 cubic feet per ton of motor.

There are conditions in the mines under which the gasoline motor will operate satisfactorily, but its many advantages should not cause us to neglect or overlook the dangers incident to its use.

When manufacturers practically eliminate any danger from carbon monoxide poisoning by building an engine that will have perfect combustion under varying loads, and when the mine operator using them realizes that he must provide ample ventilation to carry away and dilute the noxious gases generated, then it may be said with

gasoline locomotives are unsafe in dead entries or in an entry where insufficient air is stirring; and Mr. King is right in his contention that 1,000 cubic feet of air per minute should be supplied per ton weight of motor, for this is abundantly on the safe side. D. H. Trowbridge* in March, 1911, made some careful experiments to ascertain the number of cubic feet of carbon dioxide in 1 pound of gasoline. He found that 26.5 cubic feet of carbon dioxide was evolved when there was complete combustion, which is 8 per cent. more than the volume given by Mr. King. However, Mr. King's figures for gasoline consumption, 2½ pounds per ton, are somewhat high, about 2 pounds being a fair average. There is no fixed rule in regard to fuel consumption, which necessarily varies with the grade, the speed of the motor, and the intelligence of the operator. With a gasoline engine there is a medium where just sufficient gasoline gives the most power, and if less or more is used the power is reduced.

It is a comparatively simple matter to adjust the carbureter to obtain this result and if the same attention is bestowed on points of this kind as is given the adjustment of electric motors, the results will be at least equal. Again, with the regulation of the fuel the carbureter is adjusted to provide for a fair range of speed of the engine. The gasoline locomotive engine has a uniform speed and the size of the engine is proportioned to the weight of the motor, so that the engine has power at even lower speeds than normal, which is 500 to 550 revolutions per minute. In the majority of motors the engine has ample power at speeds ranging from 300 to 350 revolutions per minute up. The range of speed is from 200 revolutions per minute, when the engine is running light and not pulling, up to 800 to 1,000 revolutions per minute, depending upon the size of the engine. Again, with the modern carbureter the throttle valve in the carbureter is opened and closed just the same as the steam valve on a steam locomotive, and when the engine is running light or pulling a light load the throttle valve is not wide open; therefore, more air is drawn in, less gasoline is consumed, and the volume of carbon dioxide and nitrogen will vary almost directly with the quantity of gasoline used.

The Whitcomb company had the question of carbon dioxide fully investigated and had between 30 and 40 different analyses made of the mine air in which the locomotive was hauling. In all of them the percentage of carbon dioxide was so low that the ventilating current was little vitiated.

Various authorities, among them Doctor Haldane, quoted by Mr. King, affirm that there could be quite a percentage of carbon dioxide in air and not be injurious to the health of the men working in the air. In fact, some authorities claim that there

could be 3 per cent. or 4 per cent. of carbon dioxide in the air without being dangerous, while, according to the analyses made by Mr. Trowbridge, the percentage of carbon dioxide in the air was as a rule only a small portion of 1 per cent. However, as Mr. King states, .1 of 1 per cent. of carbon monoxide would be dangerous.

Recently, from one of the 10-ton gasoline locomotives in operation in the mines of the Jamison Coal and Coke Co., a test sample was taken directly from the exhaust pipe of the engine. This engine is a machine of the four-cylinder, four-cycle type, with cylinders 8 inches in diameter. The engine was running 600 revolutions per minute and the motor was hooked to a trip of cars whose wheels were spragged so that the engine was slipping its wheels, although the rail was sanded; therefore, the engine was working up to its full capacity. This

If a ruling could be made that these gasoline motors were permissible in any mine or any entry, provided there was a volume of air of say 500 to 750 cubic feet per minute to each ton of weight of motor, it would make a safe regulation and would put the gasoline motors on a better understood basis. In fact, it would not be any particular hardship if a provision was made even as high as 1,000 cubic feet per ton of weight, as suggested by Mr. King, provided that for a gathering motor due consideration be given to the fact that in many cases a motor would only be in any given air-current for a very few minutes. For instance, with a motor running up into a room the motor would probably not be in that room over 3 or 4 minutes out of an hour, and in a good many cases an hour and a half. The average "turn" will run probably not over five to seven cars per day;

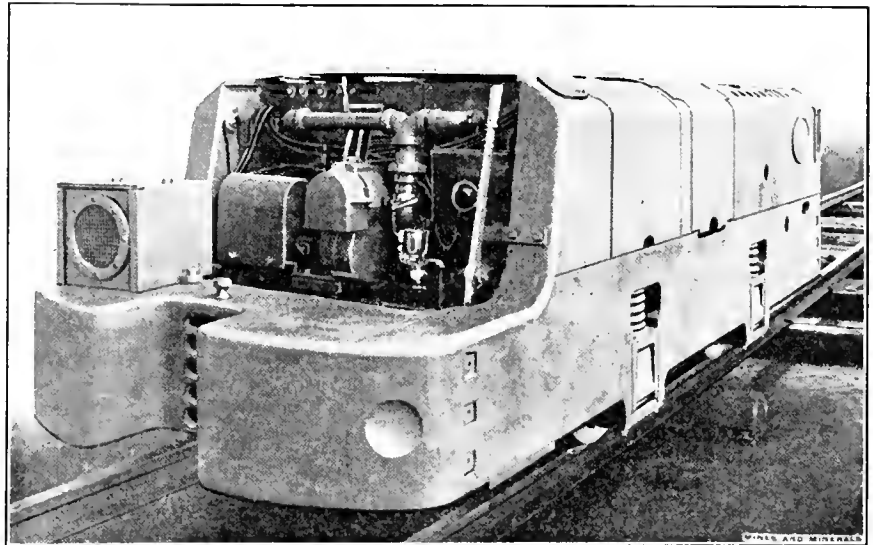

FIG. 3. REAR VIEW OF GASOLINE LOCOMOTIVE, CARBURETER ALONGSIDE BRAKE LEVER

engine has a double exhaust, the exhaust from two cylinders going off one side and the exhaust from the other two cylinders going off the other side. On one side the exhaust showed about 7 per cent. of carbon dioxide with about .1 of 1 per cent. of carbon monoxide. The exhaust from the other two cylinders showed about 4½ per cent. of carbon dioxide and about .2 of 1 per cent. of carbon monoxide. This engine would throw off a total volume of about 214 cubic feet of exhaust per minute when running 600 revolutions per minute; therefore, if the rule suggested by Mr. King is followed, there would be 10,000 cubic feet of air passing in this entry and into this air there would be an exhaust of 17 cubic feet of carbon dioxide and .49 cubic foot of carbon monoxide per minute. The carbon dioxide given off under such conditions is hardly worth considering from a toxic standpoint, and the percentage of carbon monoxide would be so small that it would not be detectable by any ordinary analysis.

therefore, a motor would only enter a working place from five to seven times in a day of 8 hours.

In regard to the hauling capacity of the gasoline locomotive, any machines should have engine power enough to slip the wheels without stalling the engine, when in low gear. With any locomotive the hauling capacity is governed by the traction on the rail, and this in turn is governed to a very large extent by the weight on the drive wheels. Therefore, a gasoline locomotive will pull as much as it is possible for any locomotive of the same weight; it will also pick up a load with less jerk and jar than any other traction motor.

In Fig. 2 it will be seen that the gasoline tanks are housed within the frames of the motor, remote from the carbureter, and thoroughly protected in every way. In a number of cases the carbureter, through the carelessness of the operator, has gotten to leaking and on fire. On each side of the carbureter there is a shut-off valve, one from each gasoline tank, and there is a

*Lewis Institute, Chicago, Ill.

shut-off valve on each tank, therefore, there is a double shut-off on each side. In case the carbureter gets on fire, the operator can shut off the gasoline either at the shut-off valves each side of the carbureter, or if the fire is too hot at this point, he can shut off the gasoline at the tanks, and the only damage that can be done is possibly to burn the cork float in the carbureter. However, there is a very small quantity of gasoline in the carbureter at any one time, and the pipes leading from the tanks to the carbureter are small; therefore, even in case it should happen from any cause that the carbureter did get on fire, it would be unlikely to cause any considerable damage.

Attention is directed to the fact that there is no universal system of mine haulage, but that one system is better adapted to certain governing conditions than some of the others. The gasoline locomotive is no exception to the rule, consequently it has its limitations; with conditions favorable, it is one of the great strides made in recent mining improvements. That this is so is attested by the number of mine-supply machine shops which are experimenting in its construction.

來 來 Obituary

GEORGE MAXWELL JESSUP

George Maxwell Jessup, a young mining engineer, of Wilkes-Barre, Pa., and a younger brother of Albert Jessup, E. M., general manager of the G. B. Markle & Co. collieries, at Jeddo, Pa., died of ptomaine poisoning at the Hahnemann Hospital, in Scranton, on August 1, aged 27 years. "Max" Jessup was a young man of much promise, and was prominent socially in the northern anthracite field. After graduating from the Scranton High School he entered Lehigh University, leaving that institution before graduating to take up practical work in his chosen profession.

A Colorado First-Aid Contest

First Annual Contest of the Colorado Division of the Victor American Fuel Co.'s First-Aid Team

Written for Mines and Minerals by G. F. Whitside*

The first-aid work attempted under the auspices of the company had its beginning in May, 1910. Like any work of this nature, there was considerable enthusiasm manifested at the start among those who more fully realized the benefits to be obtained. It soon became evident that it was a more difficult matter to arouse and retain the interest of the miners and company men, who were the most greatly to be benefited by this instruction. But the faithful persevered, however, and a gradual but certain gain in attendance and proficiency was attained, so that when the Government Rescue Car made its appearance in November of that year, the work was established upon a permanent basis.

To further stimulate the interest in the first-aid classes, the officials of the company decided to hold an annual contest for picked teams representing the various company properties. The first Colorado contest was scheduled to take place in the baseball park at Walsenburg, on June 22, of this year. On account of the unfortunate accident at Hastings mine on June 18, the contest was postponed until July 13.

Great interest was manifested by the many people who packed the grandstand and entirely surrounded the roped enclosure in which the events were held. Dr. John R. Espy, chief surgeon for the company, prepared the program and was in direct charge. The judges were Capt. C. L. Cole, Medical Corps, U. S. A., Dr. John W. Amesse, and Dr. Harold G. Garwood, both of the Colorado National Guard. Mr. E. P. Linskey was announcer of events.

*Chief Engineer Victor American Fuel Co., Denver, Colo.

Past experiences in other gatherings of this character have demonstrated that the proper handling of the audience, especially that portion which is on its feet and moving about, is of prime importance. Unless people can be kept back of certain fixed lines, they will crowd about the subjects, interfering with the work of the teams, and obstructing the view of others in the audience. By referring to Fig. 3, it will be seen how the people were handled so that at no time during the progress of the work was there the least difficulty for any one to obtain a full view of any one of the teams.

The following is the list of events. Owing to the lateness of the hour, the sixth and seventh events were omitted when their time came:

First Event.—(a) One man. Man partially overcome by gas. Can stand but cannot walk. Carry 100 feet to good air. This event is shown in Fig. 1.

(b) Two men. Left hand caught by drilling machine. Bones of hand broken and palm lacerated. Sharp hemorrhage, blood bright red and spurting. Dress and carry 50 feet to stretcher.

Second Event.—Four men. Rock fall. Right arm nearly severed in arm pit by sharp rock. Pectoral muscles, chest to arm, cut off, but no bones broken. Top of shoulder uninjured. No serious hemorrhage, vessels escaped or lacerated and clotted. Simple fracture of both bones of left forearm. Dress and carry 50 feet on stretcher.

Third Event.—Two men. Man lying unconscious, right leg over live wire, not grounded, but dry. Remove man from



FIG. 1. CARRYING DISABLED MAN



FIG. 2. MAITLAND TEAM, WINNERS OF FIRST PRIZE

wire and attempt to restore him. Three minutes for efforts.

Fourth Event.—Full team. Premature explosion. Compound fracture of lower jaw. Chest crushed, with probable simple fracture of several ribs on both sides. Shock considerable. Dress and carry 50 feet.

Fifth Event.—Full team. Man squeezed between pit car and rib of tunnel. Compound fracture of left femur in middle third. No serious hemorrhage. Pelvic bones broken, simple fracture. Dress and carry on stretcher over obstacles.

Sixth Event.—Three men. Rock fall. Compound fracture of both bones of right leg. Severe hemorrhage. Tissues about right eye lacerated and swollen; possible injury to eye. Dress and carry 50 feet.

Seventh Event.—Full team. Face, arms, hands, and chest burned by powder explosion. Dress and carry 50 feet.

With a view of making possible suggestions to others interested in this work, the following taken from the report of the judges to Doctor Espey is given to show in what particulars the greater number of mistakes and imperfections occurred: Artificial respiration faulty, first and third events; seven cases. The treatment was usually too rapid.

Not doing the most important thing first, all events, 15 cases.

Awkward handling of patient, all events, seven cases.

Captain's failure to command, all events, eight cases.

Not treating shock, all events, 10 cases.

Not stopping hemorrhage, second event, four cases.

Failure to be aseptic, second event, two cases.

A few other minor criticisms were noted, but the foregoing cover the most important ones. While the events were timed, this was done as a check rather than with an idea of making or breaking speed records. When, in the opinion of the judges, a team was unnecessarily slow, it was discounted. However, when the work done was first class and showed proficiency and skill, the fact that this particular team did not call first for inspection did not lower its percentage.

The following scores were made: Maitland, 94½; Delagua, 92½; Gray Creek, 88½; Hastings, 88; Chandler, 87½; Radiant, 86½; Bowen, 85½; Ravenwood, 82½.

In keeping these scores, the following discounts governed in each event where they were applicable: For not stopping bleeding, 10; for not treating shock, 10; for not doing the most important thing first, 5; for a loose or "granny" knot, 5; for a loose bandage, 5; for a loose splint, 5; for wrong artificial respiration, 5; for slowness in work, 5; for captain's failure to properly command, 5; for awkward handling of patient or stretcher, 5; for failure to be aseptic, 5; for failure to entirely cover

wound, 5, for unfairness or for outside coaching, a forfeiture of all credit for that event.

The specifications for each event were typewritten upon eight separate sheets, each in a sealed envelope. As each event was called, the envelopes were distributed to the captains of the teams, who then read the statement of the work to be performed for the first time. When all captains had declared themselves ready, the word was given to proceed with the event.

In the fifth event, after all the subjects were prepared to be carried over and through the obstacles, all teams but the first to make the trial were retired from the field, that they might in no way profit by the experience of those going before them. As each team passed through the curtain at the left of Fig. 3, the next in order was admitted to carry its subject through the passage representing an entry.

Lake Commerce for June 1912

The iron ore shipments from Lake Superior and Lake Michigan ports during June, 1912, amounted to 7,274,732 long tons, an increase of 58 per cent. when compared with the shipments in June, 1911. Iron ore shipments since the beginning of the year, 13,394,964 long tons, were about 54½ per cent. greater than during the corresponding period of 1911. Increases in shipments were reported at all the important iron ore shipping ports, namely, Duluth-Superior, Two Harbors, Escanaba, Ashland, and Marquette.

The receipts of iron ore show a corresponding increase from 4,460,764 long tons in June, 1911, to 7,219,093 long tons in June, 1912, or nearly 62 per cent. The receipts since the beginning of the year show an increase from 7,959,822 long tons in 1911 to 12,343,667 long tons, or 55 per

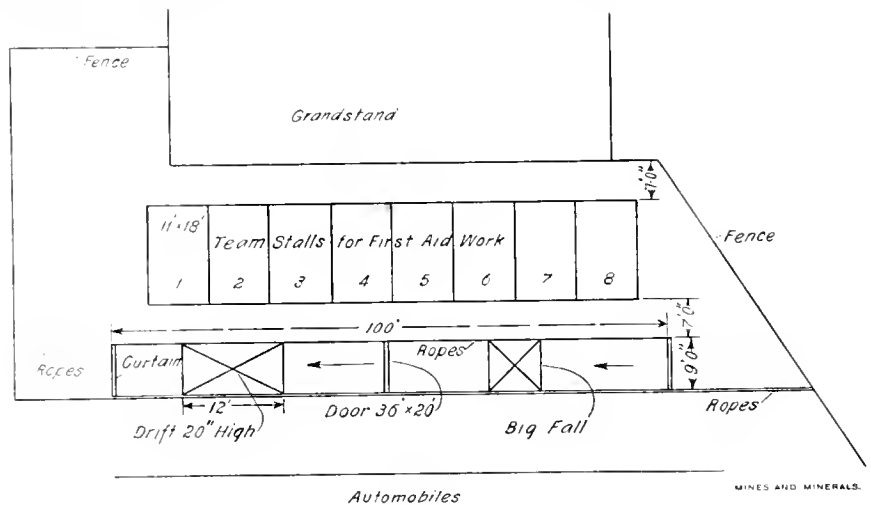

FIG. 3. DIAGRAM FOR FIELD FOR FIRST-AID CONTEST

The prizes consisted of a handsome silver loving cup, presented by the company, which is to remain in permanent possession of the team which shall take first place three times; a handsome cut-glass punch bowl, with ladle and set of cups, given by the First National Bank of Walsenburg, which remains in permanent possession of the Delagua team; and as a third prize, the Baxter Hardware Co. presented each member of the Gray Creek team with a handsome pocket knife.

The judges acted with absolute impartiality and marked with no leniency whatever. The high scores made by all the teams, therefore, indicate the greatness of their proficiency in the work. The most disinterested spectator could not fail to be interested in, and impressed with the value of instruction of this character. It should be taken up by all the mines, all the railroads, and rapid-transit companies; indeed, we may live to see it taught in all our public schools, for lives are frequently lost for lack of proper treatment in case of accidents due to everyday causes.

cent. Over 80 per cent. of the iron ore receipts are credited to Lake Erie ports, the remainder to Lake Michigan ports.

The June shipments of coal, 3,623,745 short tons, show an increase of 13½ per cent. over the shipments in June a year ago. Of the June, 1912, shipments, 2,836,934 short tons were soft coal and 491,941 short tons hard coal, the remainder being bunker coal supplied to vessels engaged in the domestic trade. The shipments of soft coal showed an increase of 27 per cent., while those of hard coal showed a decrease of over 32 per cent., when compared with the June shipments in 1911. Over 97 per cent. of the soft coal was shipped from Lake Erie ports. Of the domestic soft coal shipments on the Great Lakes in June, 1912, 1,521,490 tons were received at Lake Superior ports; 1,084,644 tons at Lake Michigan ports; and 89,119 tons at Lake Huron ports. The total domestic shipments on the Great Lakes during the present year (including hard and soft coal and bunker coal) were 6,765,173 tons.

QUES. A.—Are you a citizen of the U. S. of A.?

Ans.—While this may be answered by a simple "yes," or "no," it is well to qualify by saying "yes, native born," or "yes, naturalized," or "no, but first papers applied for," etc.

QUES. B.—What is your age?

Ans.—This had better be answered by giving the date and place of birth, if known, thus: Age, 32; born, July 16, 1880, in McKeesport, Pa.

QUES. C.—If a naturalized citizen, produce proof of your citizenship.

Ans.—Either the final or the declaration papers should be handed to the Examining Board.

QUES. D.—Have you testimonials of character?

Ans.—These should be obtained from former employers, superintendents, and the like for whom the candidate has worked, or from well-known and reliable business men, and should be handed to some member of the Examining Board if asked for. These testimonials are meant to show more particularly the fact that the candidate is sober, honest, hard working, and ambitious, rather than that he was a good tracklayer, driver, or machine runner, and the like.

QUES. E.—How many years practical experience have you had in the bituminous mines of this state and other states and countries? State fully when, where, and by whom employed, and the length of time of such employment in each case.

Ans.—This should be answered similarly to the following: "Worked as trapper at the Rolling Mill mine of the Cambria Steel Co., Johnstown, Pa., from August, 1894, to December, 1898; employed as driver at the same mine from December, 1898, to January, 1900; tracklayer and timberman, Lick Branch mine, Norfolk Coal and Coke Co., Lick Branch, W. Va., February, 1900, to April, 1906; machine runner, Pittsburg-Buffalo Co., Marianna, Pa., August, 1907, until the present time." The candidate is not supposed to account for every month of his time, as it is probable that at intervals he has been out of work, sick, or the like. If the month of beginning or ending employment at any place is not known, give the total number of months or years worked and the date as near as possible.

QUES. F.—Have you ever obtained a fire-boss certificate prior to this examination?

Ans.—To be answered by "no," or if you have a certificate by stating what kind (mine foreman's, fire boss, or the like), and where and when secured. It would be well to have the certificate with you to show the Examining Board.

QUES. G.—What are the legal duties of a fire boss?

Ans.—These are set out in Article V of the mine law approved June 9, 1911, copies

Answers to Examination Questions

Examinations for Fire Boss Held in the Bituminous Regions of Pennsylvania, April 12, 1912

of which may be obtained from the Department of Mines, Harrisburg, Pa. The article is not very long and as it is of prime importance it would be well for the candidate, although not at all necessary, to commit its contents to memory. Briefly stated, its provisions are:

SECTION 1. In mines generating explosive gas in sufficient quantities to be detected by an "approved safety lamp" the mine foreman must employ one or more fire bosses whose competency is evidenced by a "certificate of qualification" from the Department of Mines upon recommendation of the Examining Board. This certificate is granted after successfully passing an examination, such as the one supposed to be before the candidate. The fire bosses' daily examination must begin within 3 hours of the time the shift is due to enter the mine and no light must be used for this purpose "other than that enclosed in an approved safety lamp." Before beginning the examination the fire boss must first see that the air-current is traveling in its proper, regular course. This determined, he must "examine carefully every working place without exception, all places adjacent to live workings, every roadway, and every unfenced road to abandoned workings and falls in the mine." He must not only examine for gas but "for all dangers in all portions of the mine under his charge," and "shall leave at the face and side of every place examined, the date of the examination." He must also "examine the entrance or entrances of all worked-out and abandoned portions adjacent to the roadways and working places where explosive gas is likely to accumulate"; and across the mouth of any place, whether working or not, where explosive gas or any other "immediate danger" is discovered, he shall place a danger signal which "shall be sufficient warning for persons not to enter." He, the mine foreman, or the assistant mine foreman, "through an interpreter," shall explain to "the non-English speaking employes of the mine," and in his or their own language, the meaning of all danger signals.

SECTION 2.—Immediately after making an examination of all, or any part, of the mine the results of this examination must be entered in ink and signed in the permanent record book at the mine office on the surface. The record must show the time taken in making the examination and must state clearly the nature and location of any and all dangers found in any part of the mine, which dangers must be

reported at once to the mine foreman. If an inside station has been established in the mine a second record book must be kept there which the fire boss must fill up and sign

in addition to the one at the office on the surface, and these record books must be open during working hours to the inspector or to any employe of the mine. No person shall be allowed to enter the mine until the fire boss has returned to the office on the surface, or to the underground station (if there is one) on the intake entry of the mine, and has reported to the mine foreman, or assistant mine foreman, "that the mine is in safe condition for the men to enter."

SECTION 3.—This provides for a second examination during working hours of "every working place" by the first fire boss or another acting in his place.

SECTION 4.—"The mine foreman and the fire boss" must maintain a permanent station at or near the main entrance to the mine, with a proper danger signal, designated by suitable letters and colors placed thereon." When the working places are "1 mile or more" from the drift mouth or from the foot of the shaft or slope, a permanent station may (it is not compulsory) be erected by the mine foreman (provided the location is approved by the mine inspector) for the use of the fire bosses, in which "a fireproof vault of ample strength shall be erected of brick, stone, or concrete, in which the temporary record book of the fire bosses (as described in Section 2) shall be kept." It is unlawful for any person except the mine foreman and "in case of necessity such other persons as may be designated by him, to pass beyond said permanent station and danger signal until the mine has been examined by a fire boss, and the mine, or certain portions thereof, reported by him to be safe." The fire boss shall not allow any one "to enter or remain in any portion of the mine through which a dangerous accumulation of gas is being passed by the ventilating current from any other part of the mine," and any violation of this rule must at once be reported to the mine foreman.

SECTION 5.—Any person, except those in real or delegated authority, who passes a danger signal into the mine, or who, when inside goes past a danger signal into any other portion of the mine, or who removes a danger signal before the mine has been examined and reported safe, or any person who passes a danger signal placed at the entrance of a place, whether the place is working or not, or removes the danger signal without permission of the mine foreman, assistant mine foreman, or fire boss, is guilty of a misdemeanor. The mine foreman shall notify the inspector for the district, and the inspector shall enter pro-

ceedings against the guilty party. If the mine foreman fails to report violations of the law which he has seen or which have been reported to him, he is guilty of a misdemeanor, and is liable to punishment.

SECTION 6. A fire boss who neglects any or all of his duties or who makes a false report as to the conditions of any portion of the mine examined by him is guilty of a misdemeanor and shall be suspended by the mine foreman and his name given to the mine inspector that he may be prosecuted. If found guilty, his certificate must be returned to the Department of Mines. At the end of 6 months, during which time he cannot act as fire boss, he may be granted a new certificate after passing another regular examination. If found guilty a second time, his certificate is again surrendered to the Department of Mines, but in such a case he is not allowed to take another examination. This will prevent him forever from serving as a fire boss in the state of Pennsylvania.

SECTION 7. In an emergency a regularly employed fire boss may act as a first-grade assistant mine foreman.

QUES. 2.—If a portion of the mine was worked with locked safety lamps and approved powder used for blasting, how would you light the shots, and what precautions would you take if called upon to perform this duty?

ANS.—Sec. 14, Art. IV, which describes the method of firing shots in gaseous mines is not at all clear. After authorizing the employment of shot firers in mines generating explosive gases and defining their duties and stating how shots may be fired, it proceeds to state "no shot firer or any other person shall fire a shot in any working place or *in any mine* if his safety lamp can detect explosive gas at the roof." After thus prohibiting the firing of shots in working places or *in mines* in which explosive gases may be detected, the section again sets forth how shots may be fired in gaseous and *dusty* mines. The authors of the law presumably meant that in mines generating explosive gases shot firers must be employed, but that a shot firer should not shoot a hole in a room or other place where his safety lamp showed gas at the roof, but must first remove the gas. With this understanding the fire boss' duties, if called upon to take the place of a shot firer, would be:

To test the roof for gas and if any was found to remove the same by bratticing up to the face or otherwise. Whether the coal be undercut, or sheared, or shot off the solid, he must see that the holes are properly placed so that they will do the work expected of them and not result in blown-out or windy shots. If the holes are not properly placed, he must decline to fire them. The holes are to be charged with permissible powder and tamped with some incombustible material, such as clay, of which a supply must be kept at con-

venient places underground. "Under no condition shall the shot firer use coal dust or other combustible material for tamping." If the mine is dusty as well as gaseous, the entry or room where a shot is about to be fired must be "so thoroughly wetted as to prevent the existence of any dry dust for a distance of at least 80 feet from the hole to be fired." All shots must be fired by electrical apparatus (the kind is provided by law), and "no person other than the shot firer shall connect the wires of or operate said apparatus." After firing one or more shots, he must return to the place or places before leaving the mine "to see that there is no fire or any other danger existing." If the coal is shot from the solid he must see that all men are out of the mine except the shot firers and those "delegated by the mine foreman to safeguard property." A record must be kept and a report made to the mine foreman of every hole that he has refused to charge, every blown-out shot, and every hole that has missed fire.

QUES. 3.—Give the names, symbols, and specific gravities of explosive and other gases found in coal mines; where is each found; where and how produced, and what effect has each on the health and safety of the workmen, and how can they be removed?

ANS.—Nitrogen, symbol *N*, specific gravity .9713, is the chief constituent of the atmosphere and, consequently, the most abundant gas in mines. It is also found to a small extent occluded in the pores of coal and is sometimes produced by the explosion of certain classes of powder. The gas is not actively poisonous, but as an increase in its amount is accompanied by a decrease in the amount of oxygen present in the air, it eventually causes death by suffocation. Oxygen, symbol *O*, specific gravity 1.1056, is the second most common gas in the air and, naturally, in mines. It is the great supporter of life and combustion and occurs occluded in the pores of some coals. Carbon dioxide, at one time called carbonic acid, and some times known as blackdamp, symbol CO_2 , specific gravity 1.529, results from the complete combustion of carbon. It is formed in mines from the breathing of men and animals, from the burning of lamps, and the explosion of powder, and from gob and other mine fires, and more or less is occluded in the pores of the coal and in the rocks overlying and underlying the coal seam. It is an inert and non-poisonous gas and, as does nitrogen, causes death by suffocation by reducing the oxygen content of the air below the amount that will support life. As it is heavier than air, it is generally found near the floor and in dip workings. Methane, formerly called light carbureted hydrogen, or marsh gas, symbol CH_4 , specific gravity .559, occurs as an occluded gas in coal and in the overlying and underlying rocks, from which it is given off as the coal is

mined. It is also given off by both active and abandoned gas or oil wells which have not been properly cased off below the coal. As it is much lighter than air it is generally found near the roof, on tops of falls, and the like. It is a non-poisonous gas, and like nitrogen and carbon dioxide, may cause death by suffocation through diminishing the proportion of oxygen in the air. It and carbon monoxide are the explosive gases common to mines. Carbon monoxide, formerly called carbonic oxide or whitedamp, symbol CO , specific gravity .967, is formed through the slow combustion of carbonaceous material in the gob or abandoned parts of the mine; by the imperfect combustion of carbon in mine fires; by the explosion of most kinds of blasting powder, and by explosions of coal dust. Carbon monoxide is unquestionably the most dangerous gas met in mines, not only because it is highly explosive, but also and more particularly because it is highly poisonous even in very small amounts. Under any circumstances .2 per cent. is fatal in a short time and much smaller amounts if a man is exposed for a greater period of time. The oxygen of the air forms with the red corpuscles of the blood an unstable chemical compound which is conveyed through the arteries and veins to all parts of the body for the needs of the various tissues. It appears that these red corpuscles have about 250 times the affinity for CO as for O and, consequently, if any of the former gas is present it is absorbed instead of oxygen with fatal results; the patient really dying from the substitution of carbon monoxide for oxygen in the blood. As this gas is a little lighter than air it has a tendency to collect near the roof, but its specific gravity is so nearly that of the atmosphere that it is readily diffused. All the gases just described are common in afterdamp of all kinds. Sulphureted hydrogen, symbol H_2S , specific gravity 1.191, is one of the rare gases met in coal mines, and results from the decomposition of iron pyrites (sulphide of iron) in the presence of moisture, and from the explosion of some classes of powder, especially if the charge is damp. It is explosive and far more poisonous than carbon monoxide. Owing to its weight it is apt to be found near the floor.

The above are the more common gases met in mines. In addition, there are certain rare gases always present in the air, such as argon, xenon, etc.; a number of gases consisting of carbon and hydrogen in the same series as methane given off by the coal, and some compounds of nitrogen and oxygen formed by the explosion of powder.

The method of removing these and any other gases from mine workings is to supply a sufficient quantity of fresh air moving at sufficient speed to dilute them to a point where they are no longer dangerous and remove them from the mine.

QUES. 4.—If there is 5,000 cubic feet of air, containing 5 per cent. of marsh gas, measured at the last cut-through in an entry, how much more air should be added to reduce the amount of gas to 1 per cent.?

ANS.—The amount of marsh gas in the air is $5,000 \times .05 = 250$ cubic feet. That this total amount (250 cubic feet) of gas may make but 1 per cent., the volume of gas and air must be $\frac{250}{.01} = 25,000$ cubic feet. As there are already 5,000 cubic feet of air and gas present, the amount to be added is $25,000 - 5,000 = 20,000$ cubic feet of air.

QUES. 5.—What is the principle of the safety lamp? Describe its construction.

ANS.—The principle of the safety lamp is the isolation of the flame from the outer air by means of a wire gauze. The mixture of gas and air passes through the gauze and (if enough gas is present) burns within the lamp. The products of combustion pass out through the gauze and being split up by the holes (meshes) therein, are cooled below the temperature at which they would ignite a dangerous mixture of gas and air outside the lamp. In its principal features the lamp consists of a metal receptacle to hold oil or other illuminating fluid, which constitutes the lamp. Above this is the wire gauze, the lower portion of which in all modern lamps is replaced with heavy glass to increase the amount of light. The upper portion of the gauze is surrounded by a sheet-metal covering, known as the bonnet, intended to prevent the flame being blown through the gauze (and thus igniting the firedamp) when the lamp is carried in an air-current of high velocity. Some lamps, such as the Wolf, in common use in Pennsylvania, are provided with a device by which they may be relighted if extinguished in the mine, as well as with magnetic locks so that they may not be opened except by the lamp tender at the lamp house, where a powerful magnet is kept.

QUES. 6.—How would you prepare your safety lamp before commencing your examination of the mine, and what kind of a lamp would you use, and in what direction would you travel through the mine? If a door was found open by you in a section of the mine known to generate explosive gas, what would you do in such a case?

ANS.—The lamp should be cleaned, filled, and trimmed. The gauze should be examined for any possible flaws and holes or for grease or dirt that may have lodged upon it. Extreme care should be taken to see that it is put together properly and, if possible, it should be tested in a box containing explosive gas before it is carried into the mine. In event of more than one fire boss going on shift at the same time it would be well for each to examine the others' lamp, thus affording a check upon any possible mistakes. The kind of lamp used should be according to law "an approved safety lamp," the Wolf being

probably the most common type in use in Pennsylvania. Lamps used for testing for gas are usually more delicate than those used for working purposes. There are many types, some provided with indicators that tell approximately the percentage of gas present. The inspection should be made "with the air," that is, in the same direction the air travels.

In the event of a door being found open it has probably been left in that position by the shift of the previous day, in which event the particular section of the mine may have been without air for 9 or more hours. In any case, the door should be closed and a warning or danger signal posted. If the mine makes a great deal of gas it may be necessary to speed up the fan in order to remove it. If the mine makes some gas it would be well to defer the examination of this section until the last, that the gas may be as far as possible removed, or a special examination should be made after the first one and just before the shift goes on. Extra precautions should always be taken in testing and examining after a district has been cut off from air for some time, and no one should be allowed to enter until absolutely sure that no more than the usual amount of gas is present.

QUES. 7.—Are there any conditions under which the flame will pass through the gauze of a safety lamp? Explain fully.

ANS.—Yes. If the lamp is held too long in a gaseous atmosphere the gauze will become heated and pass the flame; or if the lamp be held in an air-current the flame may be blown through; or holding the lamp in a slanting position causing the flame to heat the gauze, will communicate flame to the outside; or if there is grease or soot on the gauze it will, being a good conductor, permit the wires to be more rapidly heated, destroying their power to cool the flame of the burning gas below its point of ignition. Other ways by which flame may be passed are by breaking the glass as the result of a fall or by water falling upon it when hot, or by an explosion of gas within the lamp suddenly forcing the flame through.

QUES. 8.—If 20,000 cubic feet of gas at the greatest explosive point is passing through the mine, what is the quantity of gas given off and what quantity of air should be added to make it non-explosive?

ANS.—The percentage of gas at the maximum explosive point is 9.46. Hence, the 20,000 cubic feet of mixed air and gas contains $20,000 \times .0946 = 1,892$ cubic feet of gas, and $20,000 - 1,892 = 18,108$ cubic feet of air. The lower explosive limit is reached when the mixture of gas and air contains 7.14 per cent. of gas. We may assume that the mixture contains .01 per cent. less, or 7.13 per cent. The total volume of mixed gas and air should then amount to $\frac{1,892}{.0713} = 26,536$ cubic feet. As the original volume of mixed gas and air was 20,000

cubic feet, it will be necessary to add $26,536 - 20,000 = 6,536$ cubic feet of air.

It is understood, of course, that these figures are intensely theoretical. No one would consider a mine with 7.13 per cent. of gas in the air at all safe, as this mixture, while theoretically non-explosive, would burn. In the presence of the explosive dust found in practically all the bituminous coal mines of Pennsylvania, the allowable percentage of marsh gas in the air should be well under 1 per cent. Assuming, however, that with all precautions, such as undercutting the coal, using permissible powder, systematic sprinkling, the employment of skilled shot firers, and the like, that 1 per cent. of marsh gas is allowable, the total volume of gas and air would then be $\frac{1,892}{.01} = 189,200$ cubic feet, and the amount of air to be added would be $189,200 - 20,000 = 169,200$ cubic feet.

QUES. 9.—What qualifications other than those required by law, should a man possess in order to make an efficient fire boss?

ANS.—If he possesses what is wrongly called "common sense," combined with a realization that upon his skill and watchfulness may depend the lives of all in the mine, he should make a good fire boss. If he possesses common sense, he will be a good observer and close reasoner, cool in the presence of danger, and will almost unconsciously "do the right thing at the right time." If he fully realizes all the responsibilities of his position, he will be sober, industrious, and willing to learn.

QUES. 10.—Explain why some safety lamps are more sensitive to gas than others?

ANS.—Any lamp that admits air freely below the flame and has a good draft that at once carries away the products of combustion is more sensitive than one where the air is admitted above the flame and the draft is poor, as the circulation within the lamp is poor and it is apt to go out when most needed. Lamps burning naphtha, or any substance giving a flame with the least amount of light, and when they have no reflecting surface behind the flame, will show a smaller percentage of gas and that more plainly than lamps using the heavy, light-giving oils, and particularly so when the lamp is provided with a reflector.

QUES. 11.—How would you proceed to enter a place supposed to contain firedamp, and where and how would you hold your lamp to find it?

ANS.—The place should be entered cautiously and slowly to avoid walking under, or into, or disturbing a large body of gas. In making tests the lamp should be held upright, and, beginning near the floor, should be slowly raised toward the roof until gas, if present, shows a cap on the flame of the lamp. If there are holes in the roof or "high" places between timbers, etc., the lamp should be raised into them.

Preservation of Mine Timbers

AT the 1909 summer meeting of the Coal Mining Institute of America, John M. Nelson, Jr., read a paper on the "Preservation of Mine Timbers," and recently the United States Department of Agriculture issued Forest Service Bulletin 107, having the same title. The latter is by E. W. Peters, and both are herewith abstracted ad libitum to bring out the valuable suggestions incorporated therein.

Relative Life of Treated and Untreated Timbers—Different Methods and Cost of Plant for Treating

off the bark; seasoning, and preservative treatment. While under certain conditions peeling and seasoning increase the durability of timber, chemical preservatives give the best results.

Before timber is treated with preservatives it must be peeled and seasoned, and

that there are two general methods of timber treatment, besides the brush treatment.

The brush treatment is fairly effective and consists in

applying two or three coats of hot creosote or other preservative to timbers, care being taken to get the preservative into all checks and knot holes, so that fermentation cannot set up decay. The amount of preservative for this kind of treatment is relatively small and no special equipment is needed.

Brush treatment is advisable at small operations where the quantity of timber used will not warrant the erection of a treatment plant. The main disadvantage to brush treatment is that the slight penetration of the antiseptic material does not secure the protection of the interior of the timber for a considerable period, and the thin coating may be broken so as to leave the interior exposed to fungus spores.

Fig. 1 shows graphically the comparative cost of untreated and of brush-treated loblolly pine gangway sets after various periods of service. The charge includes the cost of installation and maintenance, plus simple interest at 5 per cent. on the investment; and was derived from the cost data given in Table 1; and the figures for average life were secured from the experimental sets placed in the mines of the Philadelphia & Reading Coal and Iron Co., as shown in Fig. 2. The broken lines show the actual expenditures for a gangway set of average life.

Thus, the original cost of a green, unpeeled, and untreated loblolly pine gangway set, including removal of old timber

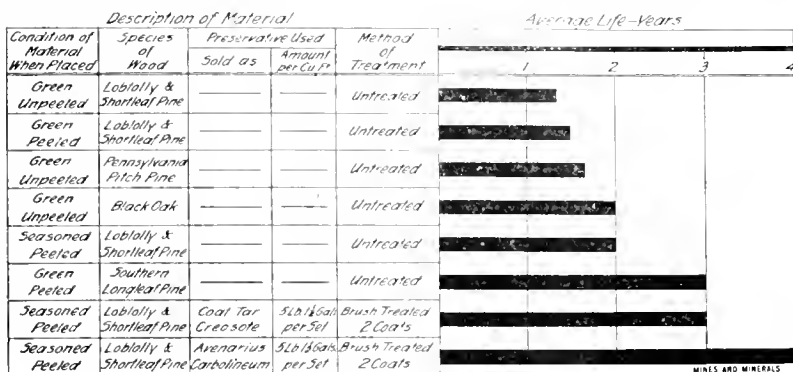

FIG. 1. SHOWING LIFE OF TREATED AND UNTREATED GANGWAY SETS

In 1907 mining operations the cost of round prop timber alone was \$10,000,000, while additional expenditures were necessary for lagging, planks, ties, and other lumber extensively used in mines. It is not stated whether this included the timber used in metal mines, but it is assumed that it does.

Concrete and steel have to some extent taken the place of timber in mines, but their high cost and the difficulty of installing them will restrict their use to work that is permanent.

The Philadelphia & Reading Coal and Iron Co., the coal mining department of the Delaware, Lackawanna & Western Railroad Co., in Pennsylvania; the Tennessee Coal, Iron, and Railroad Co. in Alabama; the Bunker Hill & Sullivan Mining and Concentrating Co. in Idaho; the Homestake Mining Co. in South Dakota; and the Anaconda Copper Mining Co. in Montana, have installed wood-treatment plants to secure authentic data on the efficiency of various methods of preserving mine timbers from decay.

The Forest Service is obtaining data from these companies with the object of determining suitable methods for treating timber used in mines, and to determine the durability of treated and untreated timber.* In mines, 5 per cent. of the timber used is destroyed by wear; 20 per cent. by breakage and fire; 50 per cent. by decay and insects; 25 per cent. is wasted from all causes.

The practical methods of increasing the durability of timbers in mines are: Peeling

all timbers should be cut and framed to their final dimensions and form before treatment.

There are three questions which every mine manager will ask as soon as the subject of wood preservation is mentioned: (a) What will the treatment plant cost? (b) What will it cost to treat timbers? (c) What will be the economy in treating timbers?

To answer (a) it must be understood

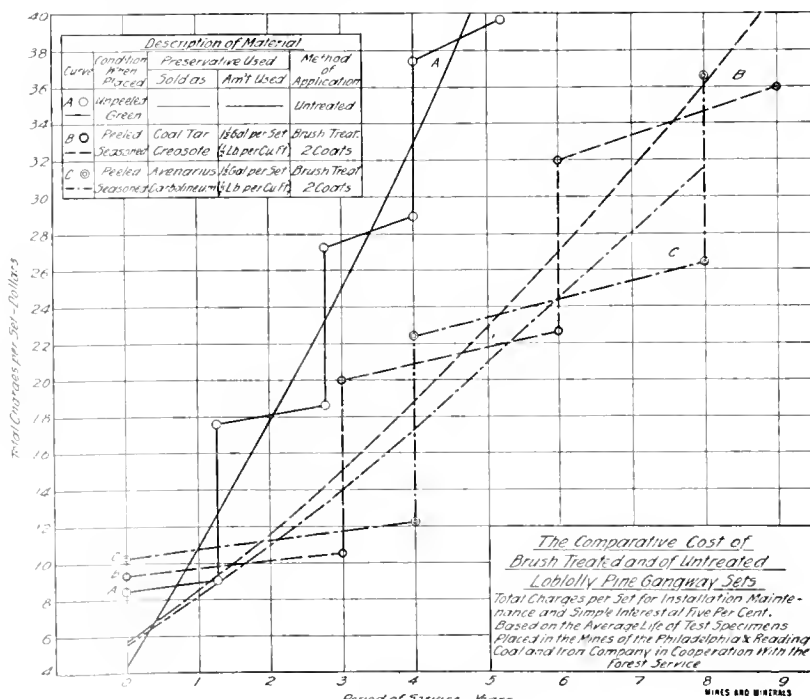

FIG. 2

*Vol. XXXII, p. 706, MINES AND MINERALS.

and placement of new one, amounts to about \$8.50. The average life of such a set is about 1 year and 4 months. At the end of this period the simple interest charges on the expenditure amount to 57 cents, making the total cost up to that time \$9.07, as indicated on line A. To this must be added a replacement charge of

\$18.10. With a set brush-treated with creosote, on the other hand, the charges amount to \$11.60, a saving of \$6.50 due to the treatment. In 4 years this saving amounts to \$13.80, which represents the difference between \$33, the total cost of the untreated sets, and \$19.20, the total cost of the brush-treated sets, for that

very conservative, since the price of mine timbers will unquestionably continue to rise. On the other hand, a certain salvage might have been allowed for removed props, which may be utilized for fuel or sawed into lagging. Since, under the conditions of the experiment, failure from mechanical causes, such as crush and squeeze, was more common in treated than untreated props, the former would have a greater salvage value, and the relative saving resulting from their use would be greater than that shown in the diagram.

Concerning the comparative life of brush-treated timber and untreated timber, the following is given:

All of the untreated material failed within from 1 to 3 years, while brush-treated timber remained serviceable for from 3 to 4 years.

The life of untreated peeled loblolly and short-leaf pine was from 10 to 15 per cent. greater than that of similar unpeeled material.*

In dry, well-ventilated workings the average life of untreated seasoned loblolly pine was approximately 25 per cent. greater than that of similar green material. In wet locations seasoned timber did not appear to outlast unseasoned material.

Loblolly and short-leaf pine, brush-treated with coal-tar creosote and *Avenarius carbolineum*, proved to be from 50 to 100 per cent. more durable than similar untreated material. Moreover, brush-treated loblolly and short-leaf pine proved more serviceable than untreated long-leaf pine, pitch pine, and red and black oak. Brush treatment with *Avenarius carbolineum* was somewhat more effective than similar treatment with coal-tar creosote.

Another process of applying preservatives to mine timbers is known as the open-tank process, where the atmosphere is the

*Most of the timbers were placed in fairly dry situations.

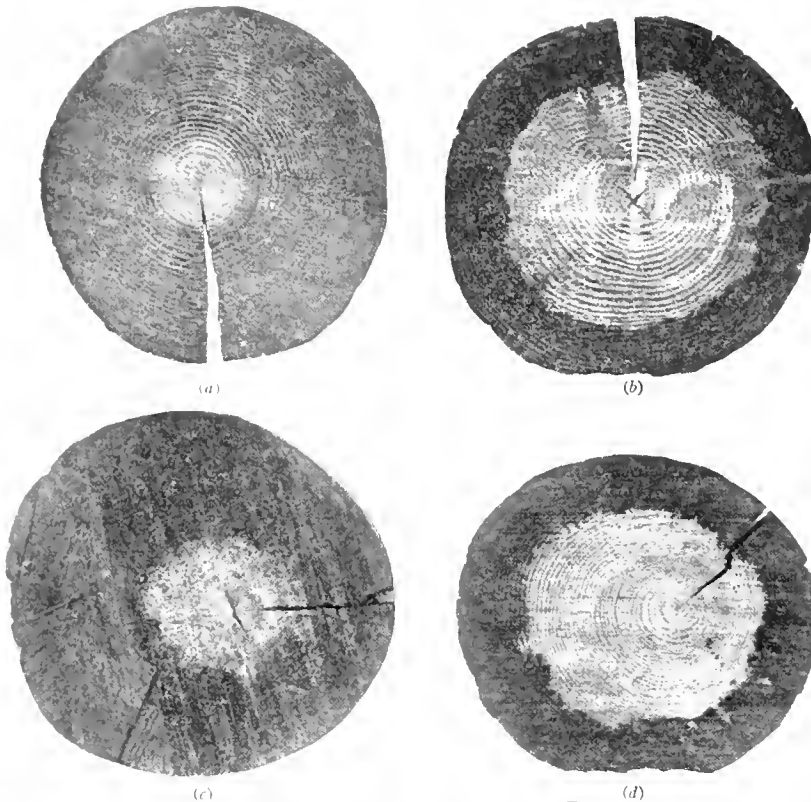

FIG. 3. SECTIONS FROM ROUND TIMBER AFTER TREATMENT

\$8.50, which is represented by the vertical rise in this line, the total charges for the two installations and the maintenance and simple interest on the first installation up to this time amounting to \$17.57. After a period of 2 years and 8 months the interest charges on the cost of the first installation amount to \$1.14, and on the first replacement to 57 cents, making the total cost up to this time \$18.71. A second replacement is then necessary, the cost of which is again shown by the second vertical rise in the line. Thus the increased interest charges are represented by the increase in the slope of the lines connecting the vertical rises in the broken line, while the vertical rises represent the successive replacement charges. Lines B and C, showing the cost of brush-treated sets, are derived in a similar manner.

If a number of sets are considered, it is unlikely that all of them will fail at the same time, and for this reason the average expenditures are better represented by the smooth curves shown in the diagram. These also show better the saving which may be realized by the use of brush-treated timber. Thus in 2 years the average total charges against the untreated set, as read from the curve, amount to about

period. The curves further indicate that brush treatment with carbolineum proved more economical than brush treatment with creosote. The fact that the initial cost of the timber at different periods is considered to be the same makes the curves

TABLE 1. COST OF UNTREATED AND TREATED LOBLOLLY PINE GANGWAY AND ENTRY SETS PLACED BY THE PHILADELPHIA & READING COAL AND IRON CO.

Condition of Material Before Treatment	Method of Treatment	Preservatives Used, Sold as—	Unit Cost of Preservative	Amount of Preservative Used Per Set	Cost Preservative Per Set	Cost Per Set of Peeling, Seasoning, and Treating Timber*	Total Cost of Set in Workings
Green unpeeled.	Untreated						\$8.50
Green peeled....	Untreated					\$.28	8.78
Seasoned peeled.	Brush treated, two coats	Coal-tar creosote	8 cents per gallon†	1½ gallons per set, .5 pound per cubic foot (same as above)	\$.12	.65	9.27
Seasoned peeled. (same as above)		<i>Avenarius carbolineum</i>	70 cents per gallon†	(same as above)	1.05	.65	10.20
Seasoned peeled.	Impregnated	Water-gas-tar creosote	7 cents per gallon†	10 pounds per cubic foot or 30 gallons per set	2.10	.94	11.54
Seasoned peeled.	Impregnated	Coal-tar creosote	8 cents per gallon†	(same as above)	2.40	.94	11.84
Seasoned peeled.	Impregnated	Zinc chloride	4 cents per pound dry salt	½ pound dry salt per cubic foot or 13 pounds per set	.52	.94	9.96

* Cost of treating includes cost of labor, fuel, and interest and depreciation on plant.

† Unit cost of creosote based on price of tank car lots of from 8,000 to 10,000 gallons.

‡ Unit cost of carbolineum based on price of barrel lots.

pressure used to force the preservative into the pores of the timber. This differs materially from the process where artificial pressure is used for penetrating the pores. The non-pressure, or open-tank process, is much simpler and less expensive than the pressure process, but it is not so well suited for the treatment of a variety of species and forms of timber. The process is as follows: After seasoning, the wood structure becomes more porous, and in this condition is placed in a bath of the preservative. The heat causes the air in the wood structure to expand and much of it is expelled. After a time the hot liquid is run out of the treating tank and cooler preservative admitted; or the timber is removed from the hot bath and quickly plunged in a cooler one; or the heat may be shut off and the timber allowed to cool with the preservative. These operations cause a contraction of the air and a condensation of moisture to take place within the timber; a partial vacuum is consequently created and the preservative is forced into the timber under atmospheric pressure.

The preservative process best suited for the treatment of round timber by mining companies depends upon the form and species of timber handled and the proportion of sapwood it contains. A porous wood, such as sap pine or red oak, is more easily impregnated with a preservative than is a dense species, such as white oak or chestnut. A less expensive non-pressure treatment is therefore more suitable for the treatment of these porous woods. Moreover, sapwood is more easily treated than heartwood. When the timber to be treated is round there is always a well-defined band of porous sapwood encircling and enclosing the interior dense heartwood. The presence of the surrounding sapwood insures a satisfactory and even penetration of the preservative fluid applied by either method of treatment, inasmuch as the sapwood of almost any species of timber may be penetrated without the application of artificial pressure. However, when the timber to be treated is partly square or rectangular, as a railroad tie, both sapwood and heartwood surfaces may be exposed. As a rule, this dense heartwood can be treated more thoroughly by the application of artificial pressure. When treated, the sides of the tie covered with layers of sapwood may be thoroughly impregnated, with the other two sides barely penetrated with the preservative liquid. The side of the tie on which the rails rest and into which the spikes are driven, is usually heartwood, and it is here that a preservative treatment is most desired. Moisture collects beneath the base of the rail and around the spikes, forming an excellent opportunity for the development of decay. If such a tie is not treated uniformly on all sides, the money invested in the treatment of the sap portion may be partial loss. Of course some species of wood contain a much larger pro-

portion of sapwood than do others. For instance, southern pine contains a great deal of sapwood, while white oak and chestnut contain a very small proportion. In consequence, a non-pressure method of application may be suitable for the treatment of the former species and not desirable for the treatment of the latter. Numer-

at 230° F. and cooled to 170° F. The preservative penetrated 3.7 inches and was absorbed at the rate of 18 pounds per cubic foot. Fig. 3 (d) is loblolly pine seasoned 3 months, treated 2 hours in preservative at 215° F., cooled to 175° F., and then heated 2 hours longer at 230° F. The stick absorbed 3.7 pounds of preserva-

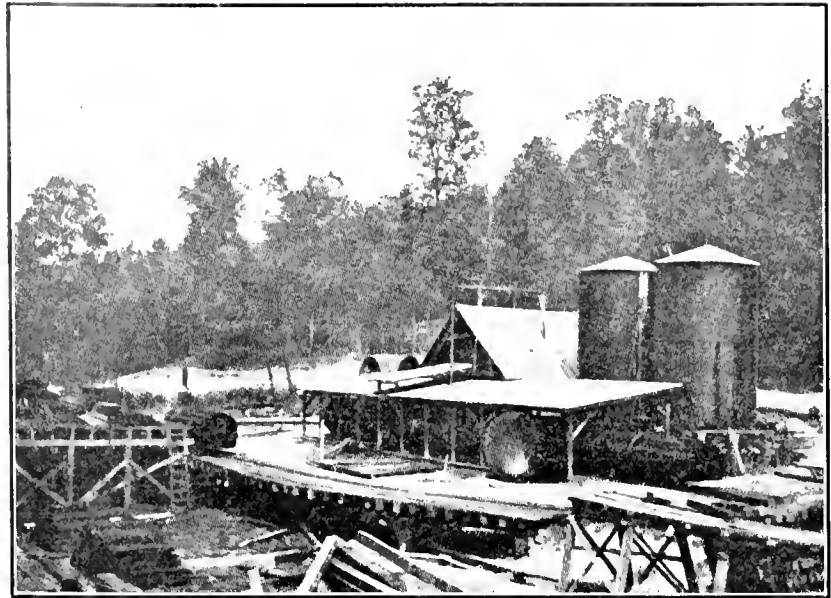

FIG. 4. WOOD-PRESERVING PLANT AT McADORY, ALA.

ous variations in the kind and form of timber should influence the consumer in selecting a method of treatment, but space will not permit of giving them in detail.

For the treatment of round mine timbers a non-pressure method of application may be the better.

A non-pressure plant with a daily capacity of 30 sets of collar timber or 800 linear feet of 12-inch timber may be installed complete for about \$6,000. This plant could treat about 400 flat ties in a day of 12 hours, and a proportionate number of standard-gauge railroad ties. An open-tank plant, having a capacity of 100,000 cubic feet per year of 250 days, may be erected at a cost of from \$1,500 to \$2,500.

The low cost of an open-tank plant places it within the reach of many mine operators. Fig. 3 shows sections of round mine timber sawed from the center of sticks 10 feet long. Fig. 3 (a) is loblolly pine seasoned 3 months. It was treated in an open tank for 2 hours, at 185° to 195° F., cooled to 160° F., then heated for 3 hours at 210° F. It absorbed 6.2 pounds of preservative per cubic foot, and had a penetration of 3.5 inches. Fig. 3 (b) is loblolly pine that was seasoned 2 months and then subjected to 3 hours at 180° F., cooled to 140° F., and then heated for 2 hours at 215° F. The absorption of preservative was 3.1 pounds per cubic foot and the penetration 1.5 inches. Fig. 3 (c) is seasoned pitch pine that has been treated 5 hours

tive per cubic foot, and was penetrated 1.5 inches.

The unit cost of handling timber at open-tank plants is from 3 to 4 cents per cubic foot. In Table 1 is shown the cost of the open-tank treated and the untreated loblolly pine gangway and entry sets. Each set in this table consists of one 7-foot collar, one 9-foot leg, and one 10-foot leg. Each member of the set was 13 inches in diameter and approximately, there are 26 cubic feet in a set.

The condition of timber treated by the open-tank process with sodium and magnesium chloride, although not comparing favorably with that of timber similarly treated with other preservatives, was better than that of the brush-treated timbers.

Open-tank treatment of green timber with zinc chloride proved fairly effective, but the tests indicate that better results will be secured with seasoned material, since about 13 per cent. of the green timber treated with zinc chloride by the open-tank process showed marked signs of decay after 4 years, while no decay was found after the same period of service in seasoned material similarly treated.

With many species of wood a satisfactory treatment can be secured only by the pressure process. The essential difference between the open-tank process and the pressure process is that in the former atmospheric pressure is relied upon to secure the penetration of the wood, while in the latter the preservative is forced into the timber pores by artificial means.

Pressure processes may be employed for either full-cell or empty-cell treatment; the former leaves the treated portion of the wood completely filled with preservative, while the latter aims to inject the preservative as deep into the timber, but leave no free antiseptic in the wood cells. The oldest process of full-cell treatment with creosote is termed "Bethellizing." A similar treatment with zinc-chloride solution is called "Birnettizing." Fig. 4 shows the plant of the Tennessee Coal, Iron, and Railroad Co., at McAdory, Ala. Its capacity is 830 cubic feet of timber per run; it being possible to make three runs daily if necessary. The total cost of the plant, including the necessary yard construction, was

Since the impregnated timbers have not been in service long enough to enable their average life to be determined, most of them being still sound when last inspected, it is impossible to show the ultimate saving in money resulting from their use. Even for the period since their installation, however, they have proved more economical than untreated or brush-treated material.

Below is given in detail the cost of the untreated and creosoted 16'x8" Douglas fir shaft sets placed in the mines of the Anaconda Copper Mining Co. These sets contain 1,127 feet board measure of Douglas fir squared timbers from the Pacific Coast, and 393 feet board measure of lagging. The average absorption

the above information has been abstracted.

From what has been stated it may be inferred that not only will proper preservative treatment result in a direct saving in money, but it will make less timber necessary for any given working. Furthermore, the use of treated timber makes it possible to utilize many of the interior and more rapid-growing species, which, though possessing most of the requirements of high-grade structural timber, lack durability. Treated timber of these species has in many cases proved more serviceable than high-grade untreated material. Thus, in the eastern and southern states, treated loblolly and short-leaf pines may take the place of untreated long-leaf

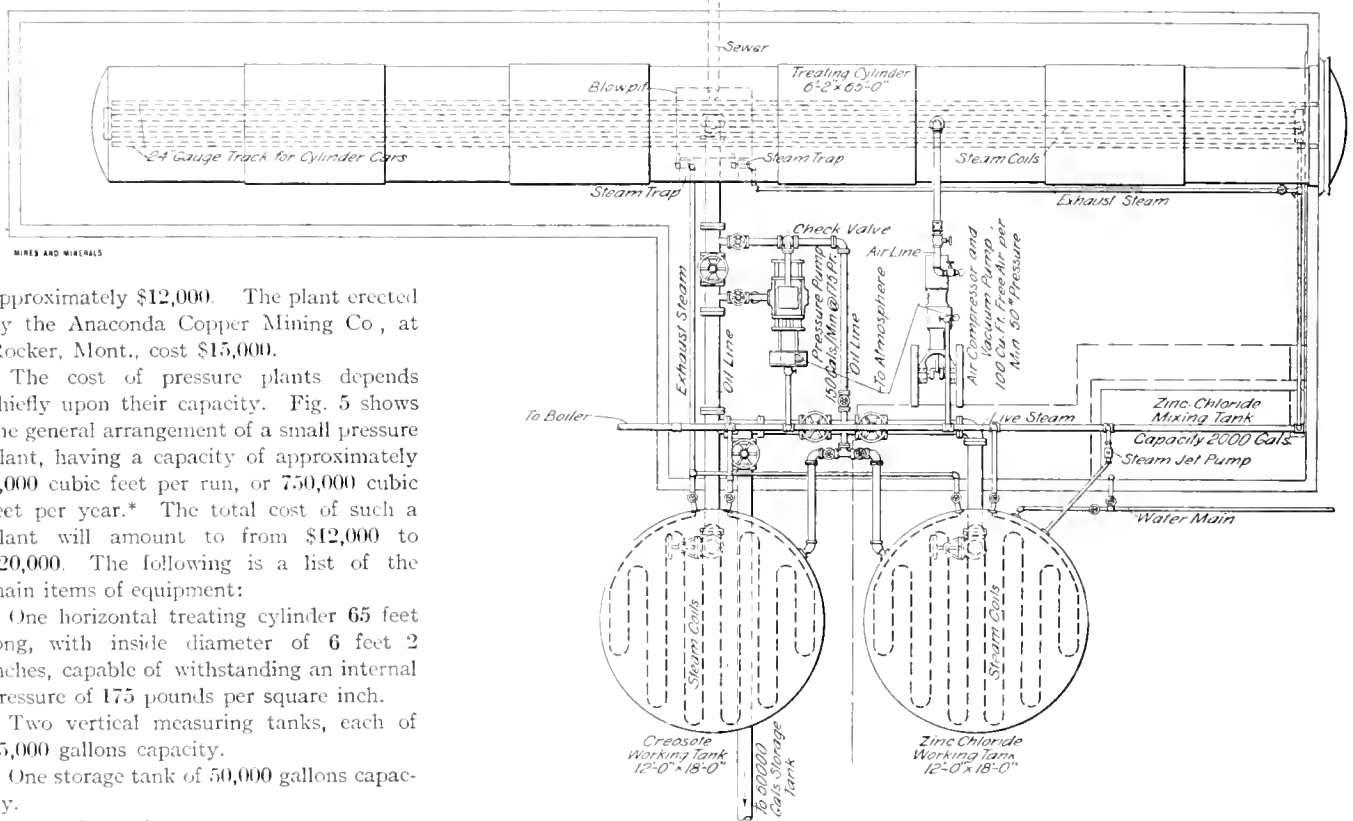

FIG. 5. PLAN OF PRESSURE PLANT FOR TREATING TIMBERS

approximately \$12,000. The plant erected by the Anaconda Copper Mining Co., at Rocker, Mont., cost \$15,000.

The cost of pressure plants depends chiefly upon their capacity. Fig. 5 shows the general arrangement of a small pressure plant, having a capacity of approximately 1,000 cubic feet per run, or 750,000 cubic feet per year.* The total cost of such a plant will amount to from \$12,000 to \$20,000. The following is a list of the main items of equipment:

One horizontal treating cylinder 65 feet long, with inside diameter of 6 feet 2 inches, capable of withstanding an internal pressure of 175 pounds per square inch.

Two vertical measuring tanks, each of 15,000 gallons capacity.

One storage tank of 50,000 gallons capacity.

One hoist engine.

One pressure pump, capacity 150 gallons per minute at 175 pounds pressure per square inch.

One air compressor, capacity 460 cubic feet of free air per minute at 20 pounds pressure per square inch.

Sixteen cylinder cars.

One zinc-chloride mixing tank of 2,000 gallons capacity.

Special attention should be given to the design and construction of a storage yard of adequate capacity for both treated and untreated material, since handling the timber before and after treatment is an important factor in the cost of operation. It is also important to locate the plant at a convenient point in the mining district, so that treated timber may be readily distributed to points where it is to be used

*Annual capacity based on three runs per day for 250 days.

secured in the treatment of these timbers amounted to 4.5 pounds of creosote per cubic foot:

Cost of untreated sets:	
1,127 feet b. m. squared timbers, at \$20.50	
per M b. m.	\$25.36
Framing timbers.	13.50
Cost of lagging, at \$15 per M b. m.	5.90
Switching and unloading charges.	8.85
Cost of placing set.	18.00
Total cost of untreated set in place.	\$63.61
Cost of treatment:	
Cost of treating, including interest, depreciation, fuel, and labor charges.	\$ 3.34
Cost of creosote, at 15.6 cents per gallon; absorption 4.5 pounds per cubic foot.	8.03
Loading and unloading charges.	1.23
Total cost of treatment.	\$12.60
Total cost of treated set in place.	\$76.21

In concluding, attention is called to the article on the antiseptic treatment of mine timber in the July, 1912, issue of MINES AND MINERALS, as the points raised have not been covered in the sources from which

pine, while treated red and black oaks may be substituted for untreated white oak. Douglas fir, which is now extensively used in the West, may in turn be replaced by treated hemlock, larch, or western yellow pine. Inferior grades of timber can usually be bought for less than higher grades, and an additional saving thus realized.

來 來

New Jersey Mineral Production

The total value of the mineral products of New Jersey in 1911 amounted to \$37,716,411. Of this amount 23.4 per cent. was zinc; 3.7 per cent. was iron ore; 5.7 per cent. was mineral paints, coke, and by-products; and 8.6 was Portland cement. The average value of the iron ore was \$3.22 per ton.

Correspondence

Wind Blasts

Editor Mines and Minerals:

SIR:—I would like to have you explain to me the cause of these so-called wind blasts that occur here. I have been employed by the Federal Mining and Smelting Co. at the Standard mine. Within the last month these wind blasts have killed two men and crippled four. The cause no one knows. The level they occur on is the 18th, which is fairly dry. If they were dust explosions, to my idea they would wreck the timbers. If they were created by carbon dioxide the men could not work because the candles would not stay lighted. I have talked with most of the men that worked on the level and they all agree that the explosion sounds like some one shooting before time, and the explosion is on the inside of the wall or the force is behind the walls or roof, which forces slabs of rock out with considerable force, enough to wreck timbers, etc. The foot-wall or the hanging is not of limestone. I have talked with the superintendent and foreman. They think that there is a cavity formed by the slipping of the ground and gas accumulates which causes the explosion. These are lead-silver mines located in the Coeur d'Alene district. Can you enlighten me on this subject?

HENRY HOARD

Kellogg, Idaho

Treatment of Broken Hill Ores

Editor Mines and Minerals:

SIR:—My paper on the "Treatment of Broken Hill Ores" which you published in your issues of November, 1911, to March, 1912, was written early in 1908. Many important processes have materially altered since that date. Unfortunately I have not visited Broken Hill and Port Pirie since then, but so far as I can gather from private information and published statements the following have been the chief alterations in practice:

Sizing.—Revolving trommels have in part or whole been superseded by various types of shaking and moving screens. Screen sizing has also been much more extensively used in connection with concentration on jigs, tables, and runners.

Grinding.—The grinding pan superseded other types of fine grinding; e. g., rolls, Heberli mills, and ball mills, and the grinding pans are in turn being superseded by tube mills. In order to prevent overgrinding of galena and blende, which are more friable and heavier than silicious gold ores, it was found necessary to reduce the height of discharge of the

grinding pans and shorten the length of the tube mills, compared with those commonly used in gold fields.

Flotation Processes.—Despite the wide initial difference of modus operandi of the various patented processes, they have rapidly approached a common usage in emulsifying and aerating the pulp, using very small amounts of sulphuric acid and oil. The methods employed to separate the "mineral sum" from the rest of the pulp still differ considerably, owing to patent rights. Owing to the large amount of litigation respecting flotation processes that has taken place and is still considered probable, it is difficult to obtain authentic details of the workings of the various plants. It has just been announced that the rights of the Potter, De Bavay, Sulman-Pickard, Cattermole, and Bellot patents have been consolidated. This will probably be followed by the processes in several plants being made more uniform in practice.

Roasting Concentrates.—Since the above-mentioned paper was written, the Kopp roasting furnaces at Port Pirie were heated by producer gas instead of by direct coal firing. More recently a Dwight-Lloyd blast roasting plant has been installed, superseding in whole or in part the Huntington-Heberlein pot roasting plant previously in use.

Zinc Smelting.—A zinc roasting and smelting plant has been erected at Port Pirie, where Broken Hill zinc concentrates are being successfully treated.

The importance of Broken Hill should not be overlooked. It is the largest producer in the world of both lead and zinc and one of the largest, if not the largest, producer of silver.

WILLIAM POOLE

An Air Blast, or Earth Movement

Editor Mines and Minerals:

SIR:—Last December, while engaged in the examination of a mine, near Wallace, in the Coeur d'Alene district, Idaho, it was my fortune to experience the shock of an "air blast" and to observe, thereafter its effect on the underground workings of the mine. I am writing the experience with the expectation that some readers of MINES AND MINERALS will be able to describe and explain the phenomenon.

The mine in question is opened by a tunnel and, from a point about one-half mile in from the mouth, a main working shaft 1,800 feet in depth has been sunk. The level on which I was at the time is at a depth of about 2,000 feet from the surface and I was more than 1,500 feet away from the shaft station.

About 3 o'clock in the afternoon, a time when we knew there was no blasting in the mine, we heard a dull, heavy

loom, like a distant blast but not preceded by the usual "knock" of shots.

Our lights were blown and we felt the rush of air. Going to a point some distance out in the same drift we met the assistant engineer who was cutting down samples and he stated that he had felt the strong outward rush of air. To him the sound had appeared near, so that his first thought was to go in and see if anything had happened at the face of the drift where miners were working.

Half an hour later, one of the shift bosses came in and stated that the force of air had been strong enough to put out the candles of himself and another man who was with him, knocking the latter down. The apparent explosion, as we learned later, had occurred 200 feet above these men and 400 feet above the level on which my assistants and I were working.

Later we learned that a good many men working in places above and below the level on which the plainest evidence of the earth movement was visible, had experienced about the same shock.

A visit to the level, 400 feet above our working point, showed three broken posts and a pile of dirt 2 feet high along the drift for 2 sets. This dirt had come from the sides, not above, and the lagging overhead was not broken. It was apparently a settlement of a large rock mass, not a giving way of the timbering nor a distortion of the level.

When we left the mine, at the end of shift, I met State Mine Inspector Bell who, with Superintendent Davis, had been at the shaft station on the tunnel level, half a mile underground from the tunnel mouth. Neither of them (nor any one else at that point) had noticed any noise or air movement. However, on going to the mine office, about 300 yards from the tunnel mouth, I was asked by the book-keeper as to what had happened. He stated that he had felt the building shaking and rocking in a manner similar to a slight earthquake, but the movement lasted only a few seconds. He also had had a telephone message immediately from another mine office more than a mile away, where about as much of a shock had been felt, and where it was believed at first that it must be an earthquake.

If it had been entirely an air movement, one would suppose that the force of it would have been felt at all points in and around the shaft and particularly at the collar of shaft where some of the many men stationed could not have failed to observe it.

While talking the matter over, I learned that a similar "air blast" had occurred 17 days previously in the same mine. The strongest evidences had been noted by the superintendent at nearly the same place in the level, but they did not

extend into the stopes over the level nor was there any material settlement of timbers.

F. L. SIZER, M. E.
San Francisco, Cal.

Allowable Error in Closing Survey

Editor Mines and Minerals:

SIR:—In the matter of the inquiry of C. G. O. in your February issue concerning the allowable error of closure in a mine survey, it seems to me that the care with which any survey, whether surface or underground, is made, depends entirely upon circumstances; that is, each survey must be considered as a separate problem. Where land is worth, as it is in some parts of the Connellsville region, as high as \$3,000 an acre, or where mining operations have been extended under a large city as at, say, Scranton, Pa., vastly more care must be taken both above and below ground than where the land in fee is worth \$50 an acre and the value of the surface improvements is insignificant.

I do not consider that error in closure is to be measured by the number of minutes the survey is "out" upon occupying the first station, but rather by the failure of the survey to close, when calculated, in latitudes and departures. I have been advised by engineers from the anthracite region of Pennsylvania that it is their custom to allow an error of 1 minute in a closure of 12 stations. This seems to me all wrong, as there are instances where an error of 4 or 6 minutes in this number of stations will have no effect upon the practical value of the survey, and there are other cases where even an error of 1 minute is not allowable. A survey of 12 stations may extend but 1,000 feet in flat workings or it may cover 5,000 feet in pitching ones. While an error of 1 minute might mean very good work in the second case, it would not be extraordinary in the first. On the other hand, in the first case, there should be no error of distance measurement between stations to exceed .01 foot, while in the second, errors of .05 foot may reasonably be expected. For these reasons and because stations are located by linear as well as angular measurements, failure to balance in latitude and departure is the only test as to the accuracy of a survey.

In my own work in the rolling, submountainous districts of the Appalachian region, I find no difficulty in securing a closure of 1 in 5,000. That is, in running a traverse of one mile (practically), the initial stake is missed by 1 foot, which, if platted on the ordinary mine scale of 100 feet to the inch, is but .01 inch. If the error in closure was, say, 1 in 4,000 or even as high as 1 in 2,500, whether the survey should be rerun is a matter of judgment. If the land is low-

priced or if discovering the error involved transporting the corps a long distance at a considerable outlay, I would not consider the gain in accuracy offset by the increased expense. On the other hand, were the land valuable or were other and extensive surveys to be based upon the one in question, then the work should be rerun.

In the matter of inside surveys the same reasoning applies. In the nearly horizontal, well-conditioned mines of Pennsylvania and West Virginia, with thick coal, any underground survey should close within 1 foot in 10,000 feet and in many instances the error will be but 1 foot in 20,000 or 25,000 feet. Personally I always rerun a mine survey (under the above conditions) when the error exceeds 1 in 10,000; that is, I rerun the survey if of the main heading or of any workings that will be greatly extended. For short butt headings driven to the line, with a 10-foot, or more, barrier pillar to the next operating property, an error of 1 in 2,500 is allowable.

In other words, surveying is a business proposition in which it is poor policy to spend \$25 worth of time to save \$5 worth of land. To my mind nothing so plainly shows the skill, experience, and judgment of the engineer as a knowledge as to when his work is sufficiently well done.

FRANCIS G. WELLES

Chicago, Ill.

Humidifying Mine Air

Editor Mines and Minerals:

SIR:—In answer to James Ashworth's article on humidifying mine air, and in contradiction to a letter of mine published in MINES AND MINERALS, in April issue, where he claims it is misleading to state the humidity of a mine in percentage of humidity, I do not see anything misleading, because it is not the actual weight of water contained in a given quantity of air that determines its humidity, or hygrometric condition, but its approach to saturation, or its capacity to hold moisture.

Percentage of humidity is used by the United States Weather Bureau, the Bureau of Mines, and other authorities.

In reference to Mr. Ashworth taking my temperatures and grains of water contained per cubic foot, to prove his assertion, I wish to say that such results are to be expected, because the first temperature was the outside temperature, the second temperature was underground, outside of radiator, but close enough to it so that there was an increase in temperature; the third temperature was taken inside of radiator, but outside of steam pipes, and at this point the temperature had been raised from 26 degrees to 61 degrees, and

being outside of the steam pipes, the decrease in the degree of saturation was to be expected.

He also claims that water vapor has no value as a restrainer of an explosive flame until after the air contains 25 grains of water per cubic foot of the mixture. The temperature of air capable of carrying this amount of moisture would be such as to prevent a person from performing hard labor.

I believe that moisture in the form of water vapor is a restrainer of dust explosions, or of dust taking part in a gas explosion, to the extent of the moisture present, because the greater the degree of saturation of the mine atmosphere, the more damp the surrounding and there is no danger from dust until raised into suspension. The more damp the dust is, the more difficult it is to raise it, also to ignite it, as the moisture contained has to be extracted before distillation takes place.

JAMES DALRYMPLE,
State Inspector of Coal Mines

Denver, Colo.

Catalogs Received

Allis-Chalmers Co., Milwaukee, Wis. Bulletin No. 1627, Hydraulic Turbines, Vertical Single—Twin—Triplex Open Flume, 20 pages; Bulletin No. 1630, Hydraulic Turbines, Spiral-Plate Steel Casings, 24 pages; Bulletin No. 1802, Sampling Machinery and Equipment, 48 pages.

The Crestline Mfg. Co., Crestline, Ohio. Catalog "C," Pumps, Sinks, Hose, Water Supplies, 135 pages.

E. I. duPont de Nemours Powder Co., Wilmington, Del. Vol. 1, No. 5, The Agricultural Blaster, 16 pages.

The Green Fuel Economizer Co., Matteawan, N. Y. Catalog No. 142, Green's Economizer, 104 pages.

General Electric Co., Schenectady, N. Y. Bulletin No. 4963, Small Direct and Alternating-Current Motors, Drawn Shell Type, 20 pages.

Hyatt Roller Bearing Co., Newark, N. J. The Hyatt Way, 8 pages.

Industrial Instrument Co., Foxboro, Mass. Bulletin No. 65, Recording Gauges for All Purposes, 24 pages; Bulletin No. 67, Differential Recording Gauges, 8 pages.

Ingersoll-Rand Co., 11 Broadway, New York, N. Y. "Little David" Pneumatic Drills, 16 pages.

Jeffrey Mfg. Co., Columbus, Ohio. Bulletin No. 13-B, Storage Battery Trucks, 8 pages.

J. M. and O. R. Johnson, Ishpeming, Mich. Recording Machines for Mines and Elevators, 4 pages.

Spencer Heater Co., Scranton, Pa. Catalog No. 10, The Spencer Heater, 40 pages.

E. Keeler Co., Williamsport, Pa. Water-Tube Boilers, 46 pages.

ORE MINING & METALLURGY

Tin Ore Dressing and Metallurgy



AS assistant geologist of New South Wales, Mr. Carne has made a study of the tin deposits and metallurgy of that country. His researches have been incorporated in "Mineral Resources No. 14," published by the Department of Mines, Geological Survey of New South Wales, Australia, and constitute a classic on the mineralogy, geology, dressing, and metallurgy of tin. According to more than one authority, tin ore occurs in acid granite. In the United States it has been found in coarse pegmatite, termed "greisen." Unless petrological evidence is at fault the acid granite of the Tingha district coincides with those of Cornwall, England, South Dakota, and North Carolina, where tin is found. These are considered to be the ore bearers.—EDITOR.]

A typical Middle Creek Tingha, New South Wales, acid granite carrying tin is medium to coarse grained. Orthoclase is the predominant mineral, and gives the granite a pink color. A lesser amount of white feldspar is also present; a little biotite, and patches of a yellowish alteration product cause a speckled appearance. An analysis by H. P. White furnishes the following composition:

	Per Cent.
Silica.....	76.28
Alumina.....	11.41
Ferric oxide.....	1.60
Ferrous oxide.....	.72
Manganous oxide.....	.06
Magnesia.....	.15
Lime.....	.62
Soda.....	3.97
Potash.....	4.54
Carbon dioxide.....	.04
Titanium dioxide.....	.20
Phosphoric anhydride.....	.17

The norm is determined by Mr. Card as follows: Quartz, 34.9; orthoclase, 26.7; albite, 33.0; anorthite, .3; diopside, .8; akermanite, .4; iron oxide, 2.5; apatite, .3.

A Description of the Mining, Concentrating, and Smelting Processes in Use in Australia and Tasmania

Written for Mines and Minerals

Mining tin in New South Wales is confined to stream mining by sluicing or dredging alluvial deposits; to mining old stream beds covered with basalt by shafts and drifts; and to tin-vein mining. The dressing

worked by means of a spring pole. In some instances horsepower gearing was attached. To the spring dollies are sometimes added small hand-power rolls for fine crushing. At one place adjustable rolls with flywheel geared for hand power are in use. The tin material is returned for recrushing through closer adjustment, and finally sieved.

The most favored crushing machine is the stamp mill, although rock breakers, rolls, Huntington mills, Fig. 3, and Chilian mills, Fig. 2, have been tried. Fig. 5 shows an ingenious local adaptation of the Chilian mill principle, in which granite wheels take the place of steel wheels for grinders, and the rock floor takes the place of the pan and die. Breakers and rolls with jigs and concentrating tables do not always prove satisfactory, owing to the large tough mica plates in the greisen.

In a paper read before the Scientific Society, Broken Hill, New South Wales, R. H. Couran states: "The method of treatment at the mill taking the ores from

the Clitters group is practically the last word in Cornish milling practice. The ore contains cassiterite, wolfram, and copper sulphides. After passing over grizzlies, it is broken by rock crushers and fed by suspended automatic Challenge ore feeders, to a battery of twenty-five 1,100-pound California stamps, and crushed through 20-mesh gunmetal woven screens. It is then classified in spitzluten, giving three spigot products and an overflow. Each of the spigot products is taken to a concentrating table, the middling from which is ground and afterwards treated on a vanner.

"The overflow from the spitzluten goes to a 10 compartment condensing and classifying spitzkasten. The various spigot products from the spitzkasten are taken to the

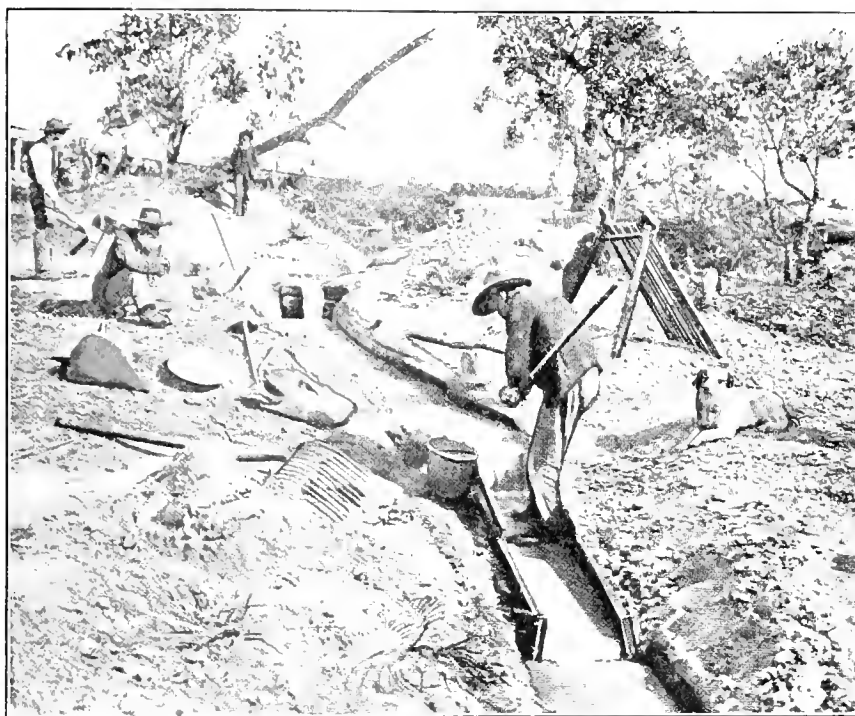

FIG. 1. TIN SLUICING

of tin-bearing rock is confined chiefly to material obtained from vein mines. Fortunately for the miner of small means, tin ore is of such value it is salable in small quantities; therefore, pockets can be worked and the material treated in primitive ways. In some pockets the material is so rich as to need no dressing, others produce material that is dressed with spalling and bucking hammers on a flat-rock surface after preliminary roasting if the material is hard and tough. Improvements on this method take the form of raised bucking tables built of rough-dressed stone and capped by a single slab or iron plate.

Intermediate between these primary forms and the modern stamp battery is the "spring dolly," an iron-shod wooden stamp

distributing boxes of double vanners, the product of the first three pairs of compartments going to three double vanners, and the last two to one double vanner. The middlings from these four machines are

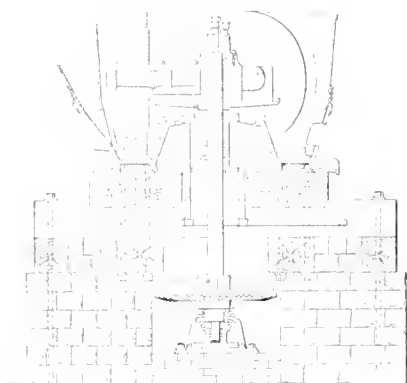
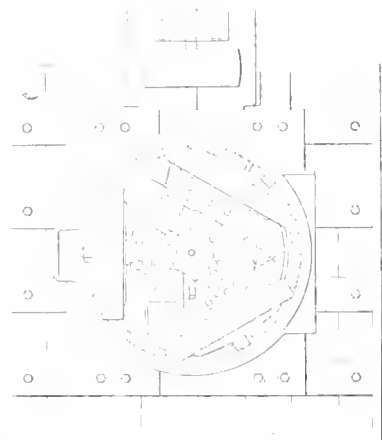

FIG. 2. CHILIAN MILL

treated on a fifth one, after some of the water has been eliminated in a spitzkasten. All the tailing passes to an eight-compartment spitzkasten 40 feet long, where a quantity of lime is added. A large quantity of the water is removed and pumped back to the storage tanks. The tailing passes on to dams where it is settled; it being illegal to run solids into the neighboring river.

"The concentrate from the table being coarser than that from the vanners, is roasted separately, and then passes to a magnetic separator of the cross-belt type, which gives five products. In the first and weakest field, magnetic oxide of iron is removed; in the second field, oxide of iron with adhering oxide of copper; in the third, oxide of iron and wolfram; in the fourth, wolfram; the non-magnetic product is oxide of tin and some silica. The copper and iron product is sold to copper smelters. It contains 10 per cent. copper and a high percentage of iron oxide, thus commanding a good price. If there is too much tin and wolfram in the first two products they are crushed dry in a ball mill and then retreated.

"The wolfram products are finished in kieves or tossing tubs and sold. The vanner concentrates are roasted and treated

in buddles, then dried in a reverberatory furnace, and treated on the magnetic separator, giving a similar product to the table concentrates. The preliminary "buddling" or washing is necessary owing to the limited capacity of the magnetic separator. The secret of the success of magnetic separation is in the roasting, it being desirable to produce the greatest possible quantity of the higher oxides of iron and at the same time eliminate the arsenic and sulphur. If the ore is rich in copper, the iron and copper products of the separator are treated with hot sulphuric acid in a lead-lined vat, and the copper in the solution is precipitated on scrap iron. All the water used in treating the roasted products is passed through precipitation tanks."

The following notes on the treatment of Mt. Bischoff tin mine, Tasmania, have been supplied by J. D. Millen, G. M.:

"The flow sheet, Fig. 4, is of the plant under erection, and embodies the results of numerous experiments that have been carried out during the past 3 years.

"The present mill treats 19,000 tons of ore per month, containing .56 per cent. of tin oxide; and of this, 82 per cent. is saved by concentration. In the two adjoining mills there are 25 and 60 stamps, respectively. These stamps crush surface ore, but also a large quantity that comes from underground, where the vein varies from 18 inches to 18 feet, with an average width of 3 feet.

"The process of recovering alluvial tin ore from channel drifts, surfacing, etc., is

when the rush for the mineral ensued in 1872. Altered conditions and greater experience led to modifications in the size of sluice boxes, but the main features of mining and dressing remained unchanged.

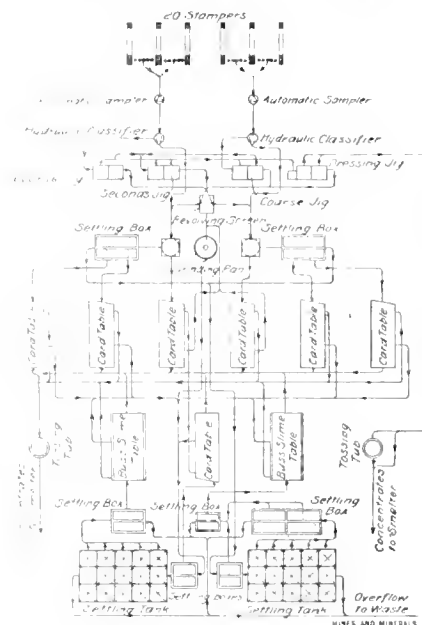

FIG. 4

The advent of the modern systems of sluicing and dredging led to new methods of maintaining efficient hydraulic pressure head for breaking down, and the development of power for excavating and elevating,

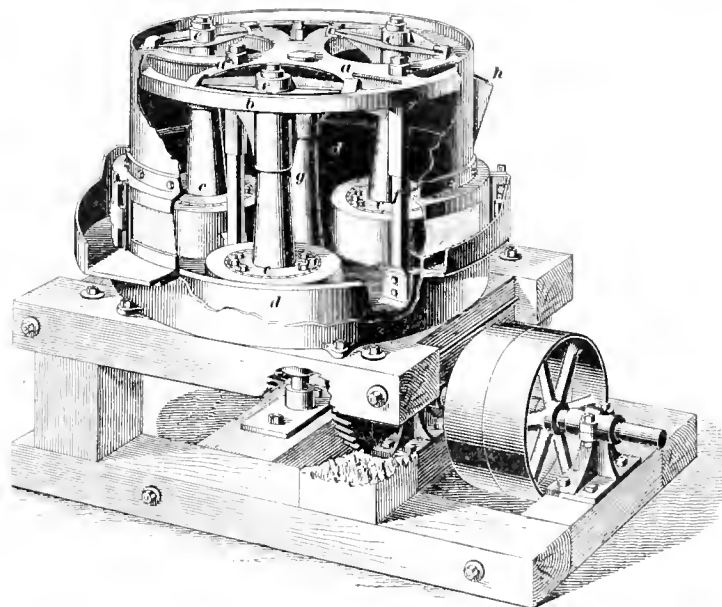

FIG. 3 HUNTINGTON MILL

a simple one, owing to the specific gravity of the mineral, which is from 6.4 to 7.1, and yet it requires considerable skill in the final cleaning stage. All the methods of ground and box sluicing, puddling, etc., in vogue in alluvial gold mining, were naturally applied to alluvial tin mining,

the dressing and concentration of the mineral being effected as before, but on a scale proportionate to the increased power. Fig. 1 shows men actively engaged in tin sluicing. The introduction of steam pumps to force water, instead of the rare and seldom continuous head of water from a

natural flow, revolutionized tin mining in the principal tin centers and led to the recovery of not only a large percentage of the tin lost in previous working, but of much ore thinly scattered through the overburden, the channel banks, and adjacent flats, which could not be remuneratively recovered by other means

"The efficiency of a powerful stream of water issuing from a nozzle, in breaking down and thoroughly disintegrating the wash and overburden, even when explosives are necessary to burst cemented layers, has rendered suction or pump dredges most favored by the miners, 31 being in operation during 1909, and but two bucket dredges. In gold mining the order is reversed, bucket dredges being the favorites. Bucket dredges are not so efficient against the high bars in a channel and clay wash. The presence of high bars in a channel would be equally objectionable in the case of a floating suction dredge, but the nature of the conditions allows choice between a floating or stationary plant. The absence of any puddling power in the bucket type of dredge is a marked disadvantage compared with the suction."

Smelting Tin Ores.—The smelting practice at the Glen Smelting Works, Tem Hill, in 1887, was described by David as follows:*

"The reduction of the ore is effected in three reverberatory furnaces. These are constructed on the usual plan of an ore chamber, separated from the fireplace by a fire-bridge, 1 foot high. The ore chambers, which have oval-shaped hearths, are from 14 to 16 feet long, and from 6 to 8 feet in width. Their floors sink slightly toward the center, and the arch, which is 2 feet high near the fire-bridge, slopes downwards toward the far end of the chamber, the object of this being to keep the flames from the furnace as close down upon the ore as possible. A flue at the far end of the chamber communicates with one of two brick chimneys, which are respectively 50 and 60 feet high. The outer walls of the furnaces are built of common brick, the sides, crown, bottom, flues, and all exposed parts, being firebrick. Owing to the greater wear and tear of the bottoms and sides, the former are so placed upon iron supports as to be easily removed. The charge for each furnace is 4 tons, 3 tons of ore being mixed with 1 ton of ground charcoal. The charge, having been previously moistened with water, is shoveled into the ore chamber, in which heat is maintained by burning wood in the fireplace. The ore is then spread over the bottom of the furnace with a large iron rake or rabble, until it acquires a thickness of about 12 inches at the center. The heat of the furnace is then gradually raised, the flames from the fireplace playing upon the surface of the ore, and passing through the flue at the far end up the chimney. The charge is stirred from time

to time with a rake, especially during the latter part of the smelting, and in 12 hours is thoroughly smelted. At the expiration of that time the furnace is tapped, the contents running into a cauldron or float of firebrick, which is large enough to hold all the metal and a small quantity of slag. The furnace, having drained, is ready for another charge, and by the time that has

drays, and forwarded to Glen Innes. The load taken by each dray varies, of course, according to the state of the roads; the average load being 5 tons, drawn by eight horses."

"Since the year 1875, these works have been under the management of Mr. J. Reid, to whom I am indebted for much of the above information."

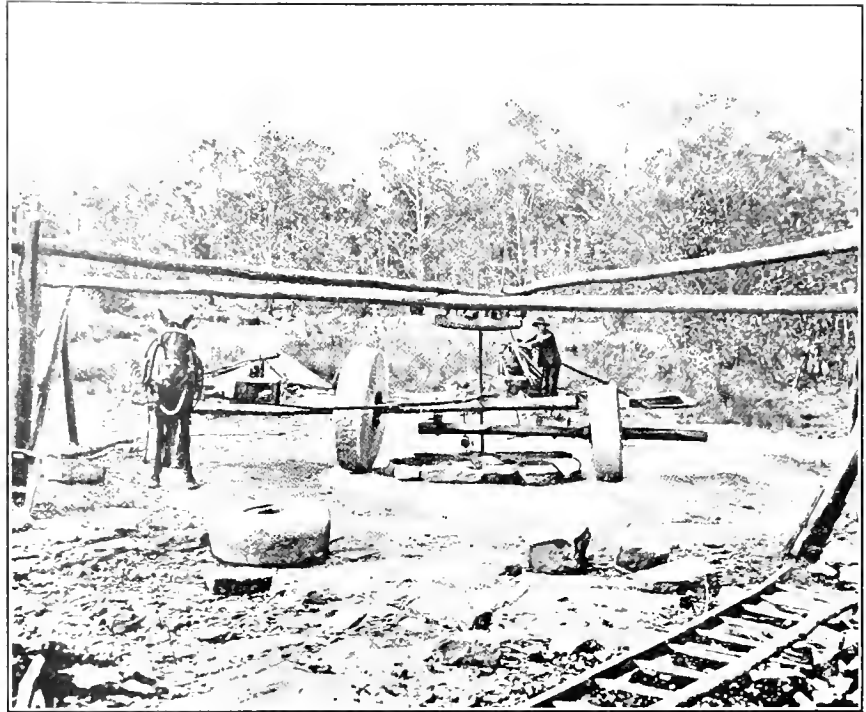

FIG. 5. HOME-MADE CHILEAN MILL

been attended to the temperature of the molten metal has decreased to a point that will admit of removing the slight covering of the slag, without the risk of extensive oxidation. From this it is conveyed in iron ladles direct to the refining pots. These are cauldrons of cast iron, three in number, capable of holding 5 tons of molten tin. The highly heated metal (previously placed in the 2½-ton cauldron) is allowed to settle for some 2 hours, after which the upper portion of the metal is ladled into two smaller cauldrons, where, the temperature being lowered, boiling by the immersion of green billets of stringy bark is resorted to. The green billets are kept immersed by an iron lever, and the steam escapes and causes a violent ebullition of the metal, thus oxidizing any impurities, as also a large percentage of tin, which is afterwards recovered by furnace treatment. The metal, after having been boiled for 4 hours, is, when cold, generally soft enough to stand the bending test—this being always taken as the standard of quality. It is then ladled into cast-iron molds, giving it the ingot shape. Each ingot so cast weighs 50 pounds, and assays 99.5 to 99.8 per cent. of metallic tin. The ingots, having been carefully weighed, are packed, placed on

Sulphur Mines in Mexico

The great bulk of Mexican sulphur is obtained from the mines near Cerritos, in the State of San Luis Potosi, about 50 miles east of the capital. The deposit is one of the largest and richest in the world. Other Mexican deposits have been worked to some extent; but until political matters become more settled the output is likely to be irregular.

As stated in a recent U. S. Consular Report, the production of the mines is about 800 metric tons (metric ton = 2,204.6 pounds) of refined sulphur per month. The sulphur is encountered at a depth of 20 feet below the surface, and the lowest present workings are 190 feet deep. The mines are at an elevation of about 5,800 feet above sea level. The indications are that the sulphur extends downward in chimney form. The ore runs 37 to 90 per cent. pure and is smelted by the steaming process.

The mines employ some 700 men. The property is owned by the Virginia-Carolina Chemical Co., an American concern, but is under lease to German interests. The excess over home-market demands is shipped to Germany.

*Geol. Mag. Ck., 1887, pp. 154, 155.

TESTING or prospecting placer deposits is accomplished by the use of churn drills, by sinking shafts, or by test runs which involve small operations. This paper is descriptive of the churn-drill method, as it is generally conceded to be the most desirable and, at present, the most universally used.

Churn drilling is subdivided into hand drilling and steam drilling; however, the hand drill has, as yet, not received the universal indorsement of placer miners, and for this reason, it will not be considered in this article.

All American percussive drill rigs are practically the same in principle, their only differences being in the minor features of construction. They depend for drilling on reciprocating up-and-down motion furnished by attaching the drills and rods to machines operated by steam power.

The object of drilling placer ground is, primarily, to determine its average gold value. However, there are other important features of any deposit that must be determined, which the drilling will reveal, if properly interpreted. To know these conditions is fully as important as to know the quantity of gold, since certain of them may increase operating costs to such an extent as to make the ground worthless. Or, they might make it unworkable by ordinary methods and, in extreme cases, by any method. From the data obtained by drilling, the anticipated profits may be calculated.

The following are some of the important features to be ascertained by the drill: Value of gold per cubic yard or per square foot of bed rock; distribution of gold—laterally and vertically; depth of gravel to bed rock; position of the level of ground water; nature of the bed rock; slope of the bed rock; amount of clay in the gravel; presence, size, and distribution of boulders; whether or not the gravel is frozen (in northern countries).

For ordinary ground, up to 50 feet in depth, the drilling tools (or, as they are commonly called, "the string of tools") consist of a rope socket, stem, and bit. For ground deeper than this, it is customary to insert a set of jars between the rope socket and stem.

All of these tools have tapered joints and are cylindrical, except where squared for the tool wrenches. The rope is attached to the rope socket by forcing it into the hole at one end and then driving soft iron pins through the holes on the side and through the rope. These pins are then clinched at both ends. The

*Akron, Ohio.

Churn-Drill Examination of Placers

Description of Drill and Tools, Method of Setting Up, Driving Casing, Pumping, Sampling, and Calculations

By James E. Dick, E. M.*

other end of the socket has a box into which is screwed the pin on one end of the stem.

The function of the stem is to add weight to the string of tools, and forms a connecting link between the bit and the socket. It is 4 inches in diameter and 10 feet long, but may be purchased in a greater or less length if a different weight is desired. On the lower end of



FIG. 1. DRIVING CASING

the stem is a box into which the pin of the bit screws.

When prospecting placer ground with a traction driller three different kinds of bits are used; the placer bit, the fluted rock bit, and the Mother Hubbard bit. Each is for a different purpose. The placer bit is designed especially for placer prospecting and is used almost continually. For this reason, it is always well to have two on hand so that one may be sharpened while the other is being used. It has a thin long blade and is made to cut rather than to crush, as is the case with each of the other two types.

The rock bit is used for breaking up large rocks and boulders and for drilling into bed rock or hard pan. It is heavy and blunt and strikes a crushing blow. The Mother Hubbard bit may be used in

place of the rock bit, but it is lighter and is used only at times when there is a possibility of the thin placer bit slipping off sideways and thus causing a crooked hole. This cannot take place with the Mother Hubbard bit, since it is so thick as to nearly fill up the hole.

The pulling jars are for the purpose of pulling up the casing when a hole has been completed or abandoned. The cap screws on to the top of the casing in the place of the drive head. The device works like a piston; the hammer or piston part, on its upward motion inside the casing, striking the cap a heavy blow that loosens the casing and pulls it up a little at each blow.

A vacuum sand pump is used for removing the cuttings from the hole. This is a simple suction or sludge pump, and consists of a 4-inch steel cylinder, 8 feet long, in which a piston works. The piston is drawn up rapidly, producing a vacuum inside the pump. This causes the cuttings at the bottom of the drill hole to be drawn in, and the valve is then closed by the weight of material in the pump.

A special casing is made for use in churn-drill holes, it differing from ordinary merchant pipe in that it is made with straight threads and the ends are cut off square so as to meet in the center of each coupling. It can be obtained in lengths of from 5 to 7 feet. Except in soft ground, where the drilling and driving are very rapid, the short lengths are found to be the most convenient. Casing is made in two different weights, light and extra heavy. Under ordinary conditions, the light is always used. Its thickness of 5-16 inch is sufficient to withstand the ordinary stress placed upon it. The extra heavy is used only where the conditions are the most severe and additional strength is required. It has a thickness of 1/2 inch. The inside diameter of the light weight is 6 inches, and the outside diameter of the extra heavy is the same as that of the light weight. This makes its inside diameter 5 5/8 inches.

The drive shoe is attached to the bottom of the casing to protect it from the wear and tear of driving. It is made of wrought steel and is 7 1/2 inches in diameter at the cutting edge. It has a shoulder against which the end of the pipe is screwed to protect the threads from the jar of driving.

The drive heads are made of solid steel and they also have shoulders against which the pipe is screwed. Each has two holes in its side and at points directly opposite one another, so that the head may be turned on or off by means of a steel bar.

Setting Up.—When the location of the hole has been decided, the drilling machine is moved by its own power to this point and “set up.” A proper setting up is essential from the standpoints of economy and accuracy. A poor set-up

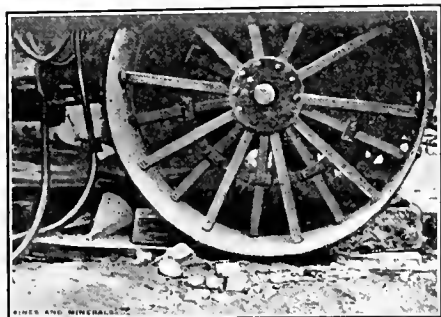

FIG. 2. REAR WHEEL CHOCKED

usually results in a crooked hole and crooked casing must often be pulled up before the hole is completed, thus necessarily incurring a considerable loss of time. If the hole is very crooked, the tools and pump will fitcher or bind, and this may result in the loss of them and the hole as well. If a deep hole is crooked, the apparent location of the hole on the surface may not be its actual location at bed rock, and this may cause a material error in estimates where a rich narrow pay streak is being blocked out. For these reasons, it is well to set up the machine properly in the first place. It will have to be done, sooner or later.

Fig. 2 shows the method used in chocking rear wheels of the driller. They rest on 4-inch planks and are chocked by wooden, wedge-shaped blocks. These blocks are driven with a sledge, after the machine has been run on to the planks, and are then nailed to the planks to prevent their slipping from the vibrations of the engine. The ground must be leveled before these planks are laid in position.

In Fig. 3 is shown the manner in which the front or derrick end of the machine is braced. A number of planks of length slightly less than the distance between the inside of the two front wheels are placed in the position shown and are built up to such a height that jack-screws may be placed between them and the bottom of the derrick ladder, and the machine raised so high that the front wheels are free to revolve. By raising one jack-screw and lowering the other, the top of the ladder is moved to the right or left until the rope hangs in the middle and over the point at which the hole is to be placed. By raising or lowering both of them simultaneously, the rope may be made to hang closer to, or farther from, the machine, as desired. The customary position is such that the machine tips slightly forward. The casing should

stand at least a foot away from the front end of the wagon bed. Wedge-shaped blocks are driven between the axle and the wagon bed to take weight off the ball and socket of the axle and to steady the front wheels.

Starting Hole and Driving.—After setting up the machine, a hole is dug a couple of feet deep and the tools then let down to get the exact location of the center of the proposed drill hole. A joint of casing, with a shoe on one end and a drive head on the other, is then placed directly over this point with the shoe down, is plumbed, and the dirt filled around it.

The next operation depends somewhat upon the nature of the ground. Where there is no overburden, the method of first drilling immediately beneath the shoe is used. The casing settles as the drilling proceeds; if it does not, it is driven afterwards.

However, the usual method is to drive first. This is done in almost every kind of ground, and always when the overburden is deep. The driving blocks are

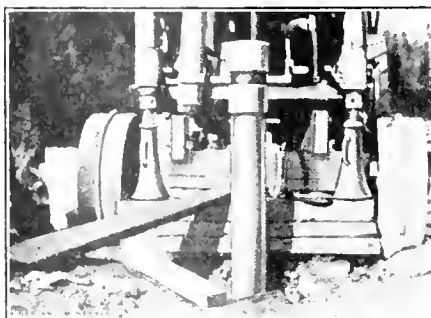

FIG. 3. BRACING FOR FRONT OF DERRICK

clamped to the lowest square on the stem and the stem lowered to such a point that, when the walking beam is up, the blocks come about 3 or 4 inches above the top of the drive head. The walking beam is thrown into gear and driving begins. The casing is steadied by two or three men on different sides, and by means of a level, the direction in which it leans, (if not plumb) can be determined. By a little pressure on the proper side, the casing may be brought into a vertical position. While this is going on, it is well to have a man on the ladder steadying the stem, as shown in Fig. 1. After the first length is down, it is usually unnecessary to steady the stem but, occasionally, the level should be applied, and if the casing is found to be out of plumb, the various methods described later may be used to straighten it.

In order to get the fastest results in driving, the length of the rope must be correct. The clamps should strike the head with a sharp blow while coming down on the spring of the rope. The clamps should rest only a fraction of a second

on the head, and should immediately spring back after striking the blow. If this rule is carefully observed, the fastest driving will result. The drill rope is let out, from time to time, as the casing descends, and is kept at the proper length. Under ordinary conditions, driving is done 1 foot at a time. After the casing has been driven a foot, the core is drilled and pumped; and then the driving repeated. When the first joint has been driven down to the head, the head is removed, the threads of the casing cleaned and greased, and the second joint screwed on, and the driving continued. Since there should always be at least one length of casing ready, this means that the threads should be cleaned and greased and that a coupling should be on one end.

Drilling.—Each time, after the casing has been driven as far as desired, the driving clamps are removed, the stem and bit are lowered into the casing, and drilling is begun. In starting the drilling, or at any time, if the hole is dry, water should be poured down the casing.

The proper length of rope for drilling is about the same as for driving. The blow must be struck, as before, while the tools are taking up the spring in the rope, and the bit must rest on the bottom for the smallest fraction of a second only. This cannot be seen, of course, and the drill man must tell by the “feel” of the rope. This ability to know by the sense of feeling, whether the drill is working properly, distinguishes a good drill man from a poor one. There are certain times when a longer rope is used, as when drilling through rocks or boulders with the rock bit. In these cases, a crushing, rather than a cutting, effect is desired.

Drilling is always done inside the casing, that is, the bit never gets below the bottom of the shoe—except when clearing a way for the casing, in drilling through boulders, in exceedingly tight

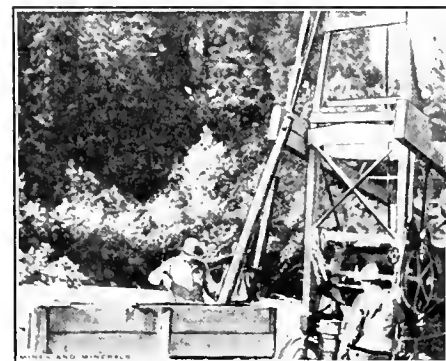

FIG. 4. DUMPING SLUDGE

or cemented gravel, or into bed rock. Drilling is more important than driving, or pumping, since, upon its proper execution, depends the accuracy and speed of the work.

Pumping.—The sand or sludge pump works on the vacuum principle. When the plunger is suddenly raised, the vacuum formed within the pump barrel draws the cuttings in through the valve at the bottom. It naturally follows that the greater the speed at which the plunger is raised, the greater will be the vacuum produced. It usually requires three or four pumpings to get all the material out when the pump is operated slowly, so the object of bringing up the plunger rapidly is apparent. Therefore, when the pump is lowered and reaches the bottom, 6 to 8 feet more of rope is let out and allowed to hang loosely over the top of the casing. The engine is speeded up and the pump reel thrown into gear. The taking up of this slack rope gives the engine time to get under full speed, and when the plunger comes up in the pump it does so with considerable speed.

It is customary to raise the pump a few feet from the bottom of the hole and to then lower it, repeating this operation two or three times before pulling up and dumping. In this way, the pump will be full each time that it is brought to the surface.

The contents of the pump are dumped into a box, the valve is washed out by water thrown into it, and the pumping operation is continued, or the pump is hung up, depending upon the conditions of the work.

Dumping.—There are various methods of handling the sample, after it is recovered from the hole. The usual method is to empty the pump sludge directly into a box. This box is from 10 to 12 feet long, made of 12-inch smooth planks, open at the top and with a gate at one end. The joints should be calked. The box is set on a couple of saw horses conveniently close for dumping from the pump, and with the gate end away from the machine. As shown in Fig. 4, the box should be set to slope slightly toward the gate end.

Rocking, Panning, and Cleaning Up. From the dump box, the material passes to the rocker, which may be either directly under the gate end of the dump box or to one side. If placed to one side, the material must be moved to it with a shovel or a pan. A pan may be so placed under the gate end of the box that the rocked material will drain into it while the water is allowed to drain over its side. If the rocker is placed directly under the end of the box, it must necessarily be built on a low, broad plan.

The rocker should be constructed with two trays, each having two, and preferably three, pockets which are best made by using a piece of canvas on the frame and by lapping it back. It is always advisable to use amalgamating plates at the ends of the rockers.

The concentrate from each foot of pump sludge is washed from the trays into a pan, but is screened to approximately $\frac{1}{8}$ -inch size before panning. The screening cuts down the work of the panner, enabling him to keep ahead of the work during fast drilling, and to use his spare time assisting the helper. The screening is best done under water in a tub and the screened material should be carefully examined before discarding, especially when it is obtained near, or on, bed rock.

All rejected stuff, both from the rocker and the pan, should be preserved and put through a small sluice at the completion of each hole. All the black sand recovered is amalgamated by any convenient thorough method, and a sample taken for assay. These sands sometimes run very high in gold and where this is true they are saved and shipped, or are worked over by other methods.

The gold resulting from the panning is dried, annealed, weighed, placed in a phial, labeled, and filed for future reference.

Calculations for Single Hole.—The inside diameter of the casing is $5\frac{7}{8}$ inches. The outside diameter is $6\frac{1}{2}$ inches. Some engineers hold that it is the displacement of the pipe rather than its cubical content that ought to be used in calculating. Others believe vice versa. However, when the cubical content is taken, it is found to be much too small and this gives a calculated value that is too high. The cubic content, per foot of $6\frac{1}{2}$ -inch pipe, is .23 cubic foot. To make allowance for the observed discrepancies, .25 to .27 cubic foot is used. The latter, .27, is called Radford's factor, it having been determined by a mining engineer of wide experience in this kind of work and who compared results from drill holes and shafts.

This factor is generally accepted as the most convenient and accurate. With .27 as a factor, 100 cubic feet of core make 1 cubic yard, so that 100 divided by the length of the core and multiplied by the value, in cents, of gold recovered from the hole, gives the value of the gravel per cubic yard. As an example take a hole $29\frac{1}{2}$ feet deep, yielding 8.79 cents in gold.

$$\frac{100 \times 8.79}{29.5} = 29.8 \text{ cents per cubic yard}$$

A system of factors is sometimes used by samplers when accuracy is desired. Different factors are selected for varying conditions of ground; and when passing from one stratum to another of a different texture the factor is changed. The following are the factors: For compact gravel, .010; for medium gravel, .011; for loose gravel, .012; for loose gravel and sand, much water, .013.

To calculate with the above factors,

multiply feet drilled by the factor selected, and divide the value (in cents) of the gold derived from the sample by the result. Thus for compact gravel:

$$\frac{8.79}{29.5 \times .01} = 29.4 \text{ cents per cubic yard}$$

By the use of a different factor, as .012, for a layer of loose gravel, the result is arrived at:

$$\frac{8.79}{29.5 \times .012} = 24.6 \text{ cents per cubic yard}$$

In other words, as the compactness of the gravel decreases, the amount of the sample or core increases but the value decreases.

Although this method has much merit, and seems to be used successfully in the California dredging areas where it originated, conditions in other districts are so varied that a more universally applicable method is described later, under the heading of "Records." By this method, simple calculation is used, but the actual amount of sample is used rather than the depth of the casing, as in the foregoing cases and therefore the results are usually considered to be of greater accuracy.

Calculations for an Area.—To estimate the value of an entire area under examination, the value per cubic yard, as found above at each hole, is multiplied by the depth of the hole in feet. The sum of products from all the holes, in "foot cents", is divided by the sum of the depths of all the holes, in feet. This will give a unit value, in cents per cubic yard, relative to the whole mass.

Sometimes it is possible to segregate certain desirable sections of the property. Again it may be possible to cut out certain portions at the ends or sides, so that the remainder will be of sufficient area and value to warrant operations, whereas the total value shown might not be attractive. This applies especially to deposits suited to hydraulic treatment and where only the pay streak is worked. An instance is known wherein a portion of a property under examination was proved to be apparently a dredging proposition, but the necessity of securing this payable portion only, made it undesirable as a dredging investment.

In estimating the value of the gravel in a dredging area, it is necessary to consider only a certain percentage of the calculated value. The reason for this is that all the gold is not saved in actual operations. In the case of dredging, some of the gold never even reaches the gold-saving tables or sluices. Hence it is seen that the percentage adopted in calculations must depend upon the methods of handling and upon the nature of the gold. With fine, flaky gold, the loss in the sluices will be much higher than with the coarse.

(To be continued)

BARIUM was discovered by Sir Humphrey Davy when testing the mineral barite, which is found as gangue in the lead mines of Lancashire, England.

Barium is a pale-yellowish silvery metal; malleable, very hard to fuse, and having a specific gravity of about 4. Merck, of New York, quotes the metal obtained by electrolysis, probably from



FIG. 1. BARYTE READY TO SHIP

smelting some of the barium salts, such as the chloride. Barium, one of the three alkaline earth metals, decomposes water rapidly at common temperatures and oxidizes in the air readily. Its principal value is for the preparation of barium chemicals.

The ores of barium are barite or barium sulphate, $BaSO_4$, also called "heavy spar"; and witherite, or barium carbonate, $BaCO_3$.

Barytes, or barite, the chief ore is insoluble in water and most acids, and consequently has survived disintegration, while the original minerals and rocks with which it was associated have weathered and dissolved. Since it is found in clay and sandy deposits, its origin was doubtful until it was afterwards found associated with the lead ore, galena, in veins. Frequently crystals of galena are found encased in barite and not infrequently some blende. The mineral may be known by the following peculiarities: Color, white, gray, green, blue, or pink; when white it looks like calcite; it may be transparent or colorless; its specific gravity (4.5) will distinguish it from calcite and gypsum. Hardness, $3\frac{1}{2}$; cleavage, basal and perfect. It colors the flame green, while

Barytes in Missouri

Description of the Mineral and the Conditions Under Which It Is Found—Methods of Mining and Preparing for Market

By Lucius L. Wittich

strontium carbonate, or celestite, colors the flame red. Barite crystallizes in the rhombic system in diversified forms.

In Missouri barite occurs in the northwestern part of the Bonne Terre sheet and in the area which is underlain with the Potosi formation. This formation is a member of the Upper Cambrian. It is in or just beneath the residual red clay that the barite is found. Beneath the red clay, speaking generally for the entire barite district, residual material, consisting of drusy quartz, fragments of dense chert, and masses of barite occur. Both hematite and galena sometimes are associated with the barite. Where hematite is found it usually occurs as a thin layer, coating the drusy quartz. When lead is found it usually occurs in cubes disseminated through the barite. Where it occurs on the surface of the barite masses it is oxidized and usually covered with a thin coating of lead carbonate. When barite is found in conjunction with the calcite of zinc-bearing ground, separation is almost impossible unless expensive methods are adopted, and in such cases the barite is looked upon as a detriment. Instances have been reported where the presence of barite in zinc mines made milling impossible and operations were suspended through necessity.

In some portions of southern Missouri the zinc mining industry is materially handicapped through the presence of the mineral; and when an effectual method of separation is found, the zinc production from about ten counties may be materially increased. In the southwestern portion of the state, operators have been fortunate in finding the zinc and lead ores free from the troublesome barite, but in one instance at least, that of the Blue Jay mine on the Mexico-Joplin land, at Joplin, a big producer was short lived because an enormous pocket of the mineral was encountered and its association with the blende made it impossible to clean the latter.

Sulphate of barium ($BaSO_4$) occurs in several portions of the United States, but the principal district from which a commercial product is obtained lies 65 to 70 miles south, and slightly west, of St. Louis. The chief towns through which barite is handled are Mineral Point and Potosi, both in Washington County, Missouri. The output from Washington County represents more than 95 per cent. of the production of the United States; in fact, statistics show that virtually all

of the yearly production of the United States, 35,000 to 40,000 short tons, comes from the district mentioned. The largest companies are the Potosi Lead, Ba-

rytes and Mercantile Co., of Potosi, represented by Mr. A. O. Nichols, to whom the writer is indebted for much of the information contained in this article; and the Point Milling and Mfg. Co., of Mineral Point.

From the lands of the Potosi company the monthly output of barite is about 1,000 tons; from the Point company about 200 tons. From other lands the monthly output ranges down to less than 10 tons. The value of the crude barite, as sold by the miner to the land-owning company, is from \$2 to \$3 a ton, depending on the distance from the railroad. The land-owning company pays the expense of hauling. The barite, in turn, is sold to grinding companies for approximately \$4.50 a ton, meaning that the miner pays to the land-owning company about 40 per cent. royalty for the privilege of gouging out the product. A hard-working miner can clear \$2 to \$3 a day, while members of his family, his wife and children, can all aid in the work, and through their assistance the income to a single family sometimes reaches \$5, or even more, depending largely on the size of the family and the diligence of the toilers.

There are about 50 localities in the Potosi-Mineral Point district where barite



FIG. 2. WINDLASS AND ROCKER

has been mined or is being mined. In a few of these galena occurs with the barite. Separation is easy by hand cobbing, one mine known as the Star shaft, in the Potosi field, having entered an

unexpected pocket of galena which produced \$10,000 worth of ore in a few weeks' time. The hope of encountering lead in large quantities is one of the never-fading dreams of the barite gougers, who toil day after day at their tedious work ever in the belief that sometime they may encounter the deposit that will make them independent.

The mining methods are crude in the extreme; the writer has visited many of the gouges on the 25,000 acres owned by the Potosi company and at no place did he find a mine greater than 30 feet in depth, save in a few isolated cases where greater depth had been attained in sinking into pockets of galena. Fig. 1 shows about a ton of cleaned barite, termed "tiff" by the gougers, while Fig. 2 gives an idea of the crude hand windlass employed. Often the windlass is even more crude than that shown, being merely a piece of tree trunk passed across supports made by placing cross sticks at either side of the shaft.

The visitor is impressed forcibly with the fact that the rule of the survival of the fittest is the law of the land where barite is mined. No leases of any specific size are given to the miners. They merely make application to "go to work," and, obtaining permission, proceed to mine whenever and wherever they please.

"Have you no system of blocking out claims or leases?" the writer asked of Joseph Deguna, one of the "old timers," who had gouged here and there in every direction from Potosi. At the time he and his wife and one son were busy at a "tiff" mine on a pretty hillside to the south of Potosi. Not 10 feet away, Anthony Declue and son, William Alonzo Declue, were producing "tiff" from a shallow gouge.

In broken English (most of the miners are of French descent) Mr. Deguna replied that no such system had ever been devised.

"If I get a good run of 'tiff,'" he explained, "I can set up some little stakes in the ground where I think the boundaries of the deposit may be. There isn't any law here saying that my neighbor can't sink a hole into the heart of my 'tiff' if he wants to, but"—Deguna grinned as he clenched his fist and threw the muscles of his arm into play—"I don't think he will want to."

"But if you were a smaller man who couldn't defend himself, then the big, husky gouger could come along and steal your claim, is that it?" Deguna was asked.

"Yes," was the thoughtful reply, after a pause, "he might; but you don't hear of much of that. In fact, it is so easy to find the 'tiff' that when one of us gets a good thing we look upon it as a matter of course. We don't have to gouge very long before finding pay dirt."

Storekeepers in Potosi and other small towns of the eastern Missouri barite belt accept the "tiff" as currency much the same as merchants in a gold mining camp might take gold dust. It is not uncommon to see a barite miner trudging into town with a canvas sack of mineral which he trades for a pound or two of tobacco or possibly a sack of flour.

No fixed rules regulate the size of shafts that are sunk into the barite masses. They are almost invariably round and no effort is made at timbering. After the shaft has penetrated the barite horizon from 3 to 4 feet, the gouger digs out in every direction from the circumference

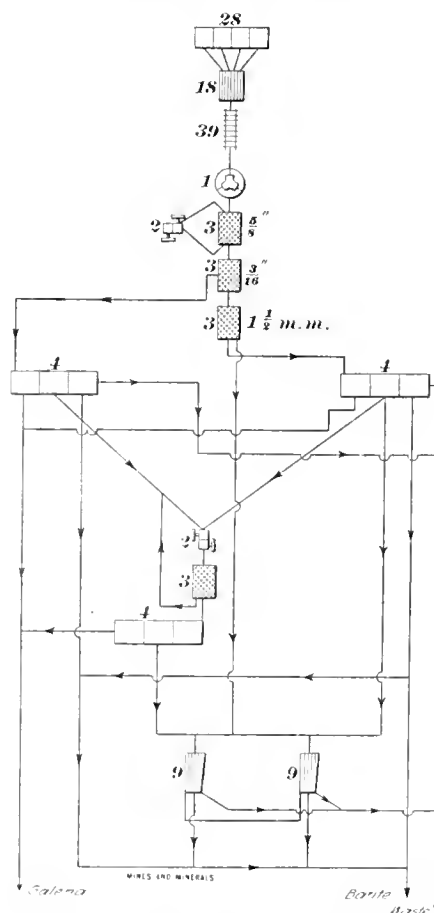

FIG. 3

1, Crusher; 2, Rolls; 3, Trommel; 4, Jigs; 9, Concentrating Tables; 14, Shaking Screen; 28, Ore Bin; 39, Picking Belt

of the shaft, thus leaving a great, rounded room into which the circular opening descends. The shafts vary in circumference from $3\frac{1}{2}$ to 5 feet. The gouging process continues only so long as there is little danger from caving ground. It is considered wiser to abandon a shaft and sink a new one a few yards distant rather than carry the drifts too far and stand the risk of caving ground.

Sometimes a solitary miner will conduct all his own operations. He will dig his own shaft, tossing the dirt out with a shovel and when the shaft becomes too deep for this he will construct a flimsy ladder on which to descend and ascend,

and will install a crude windlass. Going into the ground he will fill his bucket, then climb out by the ladder and hoist the dirt. Sometimes the product is almost pure barites; again it will be thickly coated with a gummy red clay, which must be dried to a crisp by the sun before it can be removed. No explosives are used in mining the barite, and because of the shallow workings no pumps are employed, although, at times, following heavy rains, the shallow gouges will become filled with water.

The clay-laden barite, after being taken from the ground, is scattered in thin layers over board platforms and thoroughly dried, after which the stuff is placed in shakers, also called cradles and rockers, Fig. 2, the average capacity of which is 150 pounds each. A shaker is built along no stereotyped lines; it may consist of a barrel, punched thoroughly with 1-inch holes, and so hung that it can be jerked backward and forward; or it may consist of a box with a metal bottom, in which holes have been cut, and which has been placed on rockers. Ten minutes to half an hour is required to shake the dried clay loose from the pieces of barite, which vary in size, some being as small as grains of rice while others may be as large as a man's head. Heaped into large, white piles, the barite is then ready to be loaded into wagons and transported to the nearest railroad, from which it is shipped to the grinding plants, when sufficient has accumulated.

At the property of the Wrisberg Mining and Milling Co., in Franklin County, Missouri, mill treatment of barite is being tried, a new plant having just been completed by the American Concentrator Co., a flow sheet of which is shown in Fig. 3.

At this property the chief mineral product is galena, PbS , the specific gravity of which is 7.4, compared to 4.5 for barite. Where this combination is encountered it is self-evident that the galena recovery must be made first.

The ore occurs in fissure veins and galena predominates. There is enough barite, however, to make the marketing of this product profitable; enough so at least to pay for the extra cost of milling. After the ore leaves the shaking grizzly, it is hand sorted before passing to the crusher. Oversize from the $\frac{5}{8}$ -inch screen goes back to the rolls; the undersize goes to the $\frac{3}{16}$ -inch screen, the oversize in turn passing to a $30'' \times 42''$ jig while the undersize goes to $1\frac{1}{2}$ -millimeter screen; the oversize goes to a $24'' \times 36''$ jig while the undersize goes to tables. Middlings from both jigs mentioned go to 24-inch rolls, thence to $\frac{5}{8}$ -inch screen, the oversize returning to rolls and the undersize going to the $24'' \times 36''$ jig.

Where barite is found with zinc blende, the specific gravity of which is 3.9-4.1, the separation is, however, not so simple.

The treatment of blende carrying barite along elaborate lines has been tried at the Tahoma mine, in Benton County, Missouri, and has proved satisfactory, although the same principle adopted at an other property has, strangely enough, failed signally.

At the Tahoma mine, a mill of 400 tons daily capacity is operated. Here the barite is separated from blende by a process requiring intense heat, the separator being comprised of a tube, 12 feet long by 8 inches in diameter, set in an oil-burning brick furnace. This tube is inclined slightly toward the end from which the discharge comes. A series of screens is at the discharge end, and a loose ring hopper is installed at the feed end. Although still finer screens may be utilized, the plan of using 20-, 30-, and 40-mesh screens, arranged concentrically,

The bulk of the barite produced from the Washington County, Missouri, district, is reduced to a fine powder and utilized as an adulterant in white-lead paints. It is used also as a source of barium products.

At the grinding plants the barite is first run through crushers and rolls and

reduced to a fine sand, then treated to a sulphuric-acid bath to remove all foreign coloring matter, after which it goes onto the 200-mesh screens for final separation, the undersize passing to the grinders which reduce it to a powder, ready for the acid bath and then the market, while the oversize returns to the rolls

The Pelton Waterwheel

Principles of Construction of the Impulse Waterwheel—Methods of Calculating the Power and Speed

Written for Mines and Minerals

THE Pelton waterwheel, shown in Fig. 1, is an impulse wheel that is used for very high heads and comparatively small volumes of water. The jet from the nozzle *A*, which im-

revolutions is such that the actual velocity of the cups corresponds nearly to the theoretical velocity.

The loss of efficiency is due to the friction of the water in the cups and the

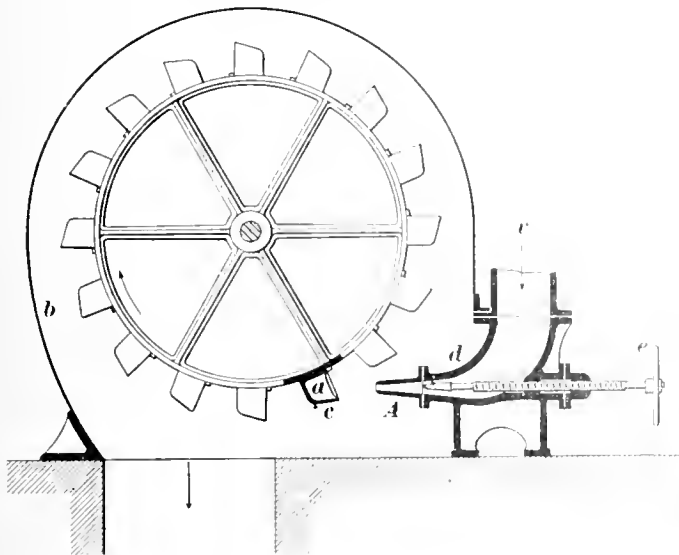

FIG. 1

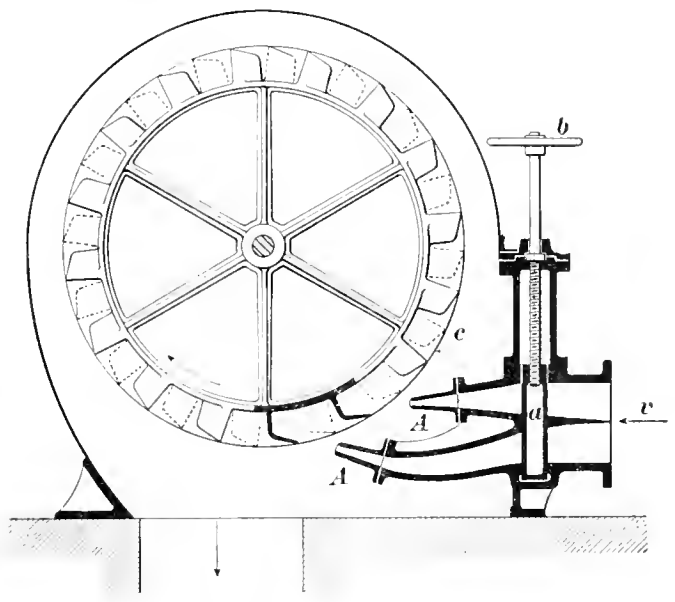

FIG. 3

with the coarser one on the inside, has proven satisfactory. The barite will readily pass the 40-mesh screen, although little of the blende will do so. Before being dumped into the tube, which revolves slowly, the concentrate is dried partly. As the concentrate works down through the tube, the barite, coming in contact with the red-hot metal, explodes and this causes it to become decrepitated. Passing from the tube to the screens, very little of the blende will go through a 40-mesh screen, although the barite, now almost as fine as powder, would pass through a 200-mesh screen. From the 20- and 30-mesh screens the oversize goes to the bins; from the third screen an oversize middling product is procured. The undersize from the 40-mesh screen goes to a concrete vat where it passes over a 200-mesh screen, the blende being recovered as an oversize.

pings on the raised center *a* of the cups *c*, is deflected to both sides, and finally leaves the cups in a direction tangent to their outer edges. In this way, the direction of the motion of the jet is changed nearly 180 degrees; and when the velocity of the cup is equal to one-half the velocity of the jet, the theoretical efficiency of the wheel is 100 per cent. Experiments have shown that the actual efficiency is sometimes nearly 90 per cent and that the best efficiency is obtained when the number of

energy that is lost in the absolute velocity the water has when it leaves them.

Fig. 2 shows two sections of the cups and the common method of fastening them to the rim of a cast-iron wheel. The inclination of the edge *a* is such that the water as it leaves the cup flows clear off the wheel and offers no resistance to its motion. The faces of the cups are also inclined to the radius of the wheel, as shown, in order to give the water a slight tendency to flow from the center of the wheel as it reacts from the cups. The outer edges of the cups are made sharp, so as to offer as little resistance to the water as possible, and the inside surface is sometimes finished for the purpose of reducing the loss by friction.

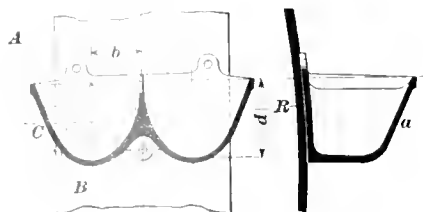

FIG. 2

The wheel must be provided with a cover or casing *b*, Fig. 1, to prevent splattering of the water.

The water for impulse wheels is dis-

charged through nozzles, and in order to secure a high efficiency, it is necessary that the pressure head in the pipe be converted into velocity in the issuing jet with as little loss as possible. The ordinary method of reducing the flow of water by means of a valve in the pipe necessarily causes extra resistances and reduces the head. Fig. 1 shows a nozzle applied to a Pelton wheel, in which the flow of water is regulated by a conical plug *d* operated by the hand wheel *e*.

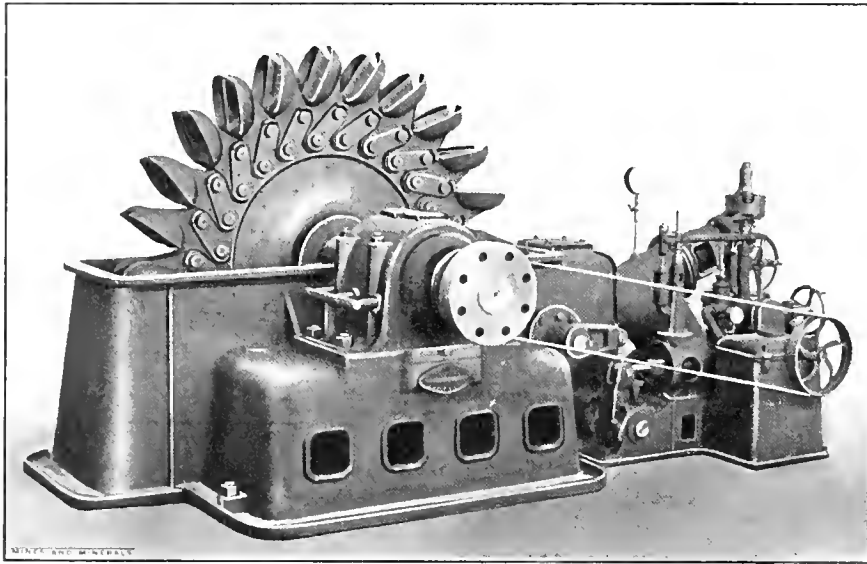

FIG. 4. PELTON WHEEL FOR 2,395-FOOT HEAD

This has the practical effect of varying the size of the nozzle and, hence, the quantity of water without a corresponding change in the velocity.

The power of a given size of impulse wheel may be increased by increasing the number of nozzles. This increases the amount of water used and gives the same efficiency for all the nozzles that would be obtained if only one were used. Fig. 3 shows a double nozzle *A, A* applied to a Leffel cascade impulse wheel, in which a gate valve *a*, operated by the hand wheel *b*, opens the orifices to the nozzle successively. By this means, as many of the nozzles may be opened as are required to furnish the necessary power and the water will be used without loss of head.

Another method, which is used when the supply of water is variable, is to have a number of nozzles of different sizes to correspond with the supply of water. When the water supply is small, a small nozzle can be used, and in this way the greatest efficiency can be obtained; and when the supply is increased, a larger nozzle enables the full power to be obtained without loss.

The circumferential velocity of an impulse wheel, i. e., the actual velocity of the cups, depends on the head, and hence the velocity of the jet. With a properly

designed nozzle, the velocity of the jet will be nearly that due to the pressure head in the end of the pipe, and the best efficiency is obtained when the velocity of the cups is about one-half the velocity of the jet.

The number of revolutions, with a given velocity at the circumference, varies inversely as the diameter of the wheel; it is, therefore, possible to make the number of revolutions correspond to the speed of the machinery to be driven within cer-

tain limits. In accordance with this principle, wheels are often designed so as to run at a speed that enables them to be connected directly to the shafts of dynamos, centrifugal pumps, or similar machinery, without the use of belts or gearing. The Pelton wheels are seldom used for heads of less than 50 feet, but are applicable to falls of any greater height. A number of wheels are in use under heads of more than 2,000 feet.

EXAMPLE.—What should be the diameter of an impulse wheel that is to be directly connected to the shaft of a dynamo, if the pressure head is 275 feet? The dynamo is required to make 850 revolutions per minute and the coefficient of velocity of the jet is .98.

SOLUTION.—The velocity of the jet is $.98 \times 8.02 \sqrt{275} = 130.34$ feet per second. The circumferential velocity of the wheel is, therefore, $130.34 \div 2 = 65.17$ feet per second, and the diameter required for 850 revolutions per minute is

$$d = \frac{65.17 \times 60}{850 \times 3.1416} = 1.464 \text{ feet, say 18 inches.}$$

In Fig. 4 is shown a Pelton waterwheel designed for operating under a head of 2,395 feet. This waterwheel was constructed at Geneva, Switzerland, to drive electric generators, and its speed is governed by the regulator shown to the rear

of the wheel. This regulator is operated from the main shaft of the waterwheel by belt transmission, and by means of suitable mechanism controls the impinging stream of water striking the Pelton buckets. By this means the speed of the wheel and generators is held at 500 revolutions per minute, even under considerable variations of load. This Pelton wheel develops 5,500 horsepower and is in service at the hydro-electric plant, Vierge Be Saas at Valais, in Switzerland. The special construction of the bucket on this steel impact waterwheel is of interest because of the cutting away of a portion of the bucket in order to increase the efficiency and satisfactory operation at this high head and consequent speed. This bucket construction was designed by a Swiss engineer.

In the West two mining companies were situated so as to use the same stream to generate power. In one instance the lower company brought suit to restrain the upper company from discharging mill tailing into the stream as it cut the buckets.

來 來

Single Shaft Guide

The accompanying sketch of a shaft guide, used at one of the mines of the Amalgamated Copper Co., Butte, Mont., is applicable where space does not permit of the use of the ordinary end, two-guide arrangement. It consists of a plank spiked to the shaft timbers to which is bolted a piece of heavy sheet iron. These form the guide which, of course, is continuous from the top to the bottom of the shaft. To the floor of the cage are bolted two **Z** bars which engage

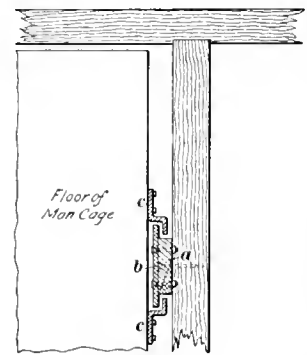
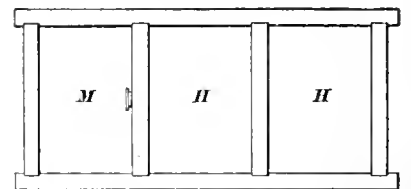

SHAFT GUIDE

the guide as shown. The arrangement is best adapted to slow-hoisting speeds, as in a manway, and gives excellent satisfaction.

THE following article, abstracted from the Journal of the Chemical, Metallurgical, and Mining Society of South Africa, is of considerable interest at this time to inhabitants in Northeastern Pennsylvania. It will be remembered that Engineers William Griffiths and Eli Conner suggested the use of sand to prevent mine

Sand Filling on the Rand

Methods in Use on the Rand for Flushing Sand From Stamp Mills and Cyanide Works Into Mines

By Edgar Pam, A. R. S. M

fall of 10 per cent. or more from the foot of the dump to the shaft, or where the ground can be readily excavated to obtain this fall, hydraulic sluicing is undoubtedly the best. More usually, how-

ever, the inclination cannot be obtained without great expense, and either conveyer belts or mechanical haulage would necessarily have to be used. With either of these two methods of transportation, the sand is dumped into a brick-lined bin excavated near the shaft, and connected to it by a tunnel. The bins at present in use are 40 feet long, 30 feet deep, and 10 feet wide, and hold from 500 to 600 tons of sand. Parallel to the long axis of the bin, and divided from it by a brick wall, is a tunnel 6 feet wide and 8 feet high. The bottom of the bin is built with a 25-per-cent. fall toward the tunnel, as shown in Fig. 1. Through the dividing wall are four openings 10 inches high and 6 inches broad into which water is sprayed, as shown in the plan. A mixture of sand and water comes out through the openings and falls into a launder which has a grade of from 12½ to 15 per cent. The sluice water, which is supplied under a pressure of 50 pounds per square inch, is forced through four one-half-inch nozzles and washes 200 tons of sand per hour down the mine. The mixture running into the launder is, by volume, equal parts of sand and water, or by weight, 60 parts of sand and 40 of water.

In addition to the four nozzles above mentioned there is one more which leads clean water direct into the launder. This is used for washing out the pipes before and after use and is an essential precaution against the pipes choking. The mixture of sand and water flows to the shaft and falls through a hopper into a

pipe from 5 inches to 6 inches in diameter. Pipes without lining have been used so far, but owing to the combined action of sand and water are not expected to last

long. Some special pipes have been ordered with 5-16-inch walls. These will be 7 inches in diameter and lined with Jarrah wood 1 inch thick. The lining will be inserted in lengths of about 8 inches, so that should even a section of the lining get loose it will not stick in the bends and cause a choke but go down the pipe and out with the sand. The pipes have loose flanges and are of such lengths that they can be turned or replaced easily. They will be turned at frequent intervals in order to equalize wear.

In inclined shafts and stopes the pipes may be replaced by launders, which are cheaper and less liable to be choked.

When debating the route of the pipe line, there was at first considerable discussion as to whether horizontal lengths could be used. The only objection to them was that a greater quantity of water must be used for washing out the line. The length of a horizontal pipe line must bear some ratio to the pressure in the column pipe. Mr. Waller says that the custom in Silesia is to allow 300 feet of horizontal pipes for every 100 feet of vertical head. For the installation so far planned it has not been necessary to approach this allowance, but 600 feet of horizontal pipes are working well at the 2,000-foot level. So far we have had no experience with up grades, but they are undoubtedly possible, although it is a question if they will prove expedient. The only valves on the pipe line are for diverting the stream of filling from one branch pipe to another, and one valve is always opened before the other is closed.

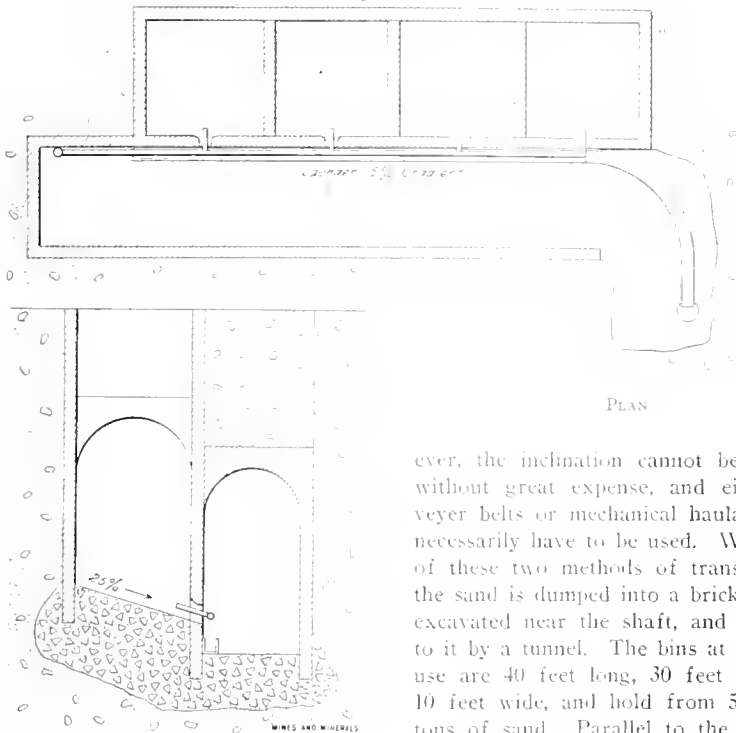

FIG. 1. PLAN AND END ELEVATION OF BINS

caves. The paper is a good one and contains information on flushing the sand from stamp mills and from cyanide works into mines, and no doubt will be of interest to all metal miners where timber is expensive and conditions do not favor the caving system of mining. A second article on the same subject will cover the discussion on Mr. Pam's paper and will be found equally as important and interesting as the original.—EDITOR.

Sand filling has been carried on for over a year at the Robinson Gold Mining Co.'s mine, but only on a small scale; and before commencing to lower large tonnages it was decided to secure the services of an engineer who had previous experience in this work. Mr. Waller, of Kaltowitz, Silesia, accepted the appointment, and the following is an account of the system recommended by him modified to suit local conditions:

The method of transporting the sand from the dump to the shaft is purely a mechanical question. Where there is a

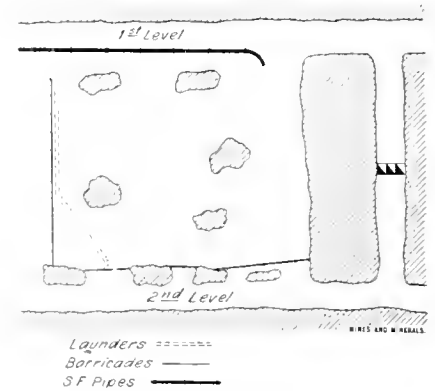

FIG. 2. STOPE READY FOR FILLING

The flow of sand can only be started or stopped from the surface, and it is therefore necessary to install a reliable system of telephones so that instructions can be given from below.

To prepare a stope for filling, all box holes must be closed above the pillars by means of uprights well hitched and lagged with 1½-inch planks. The planks are of course nailed on from inside the stope and must be fitted closely on the pillars, foot-wall, and hanging wall. Any crevices are filled with grass, which is rammed in

tight and kept in place by a piece of wood. Where possible the sand rests against a shaft or boundary pillar on one side, but the other is usually built similarly to the box holes, the uprights being 3 to 4 feet apart.

The chief point to keep in mind in filling a stope is to allow as little pressure

as possible on the barricades, and for this reason the area to be filled should be as long as possible and the water should have a free flow. The outflow is usually through openings in the side barricade. These are 12 inches wide and the full height of the stope. As the sand rises, the openings are closed from the bottom so that only the water lying on the sand can get away. These openings are so placed on the barricade that water is flowing out at the bottom of one before the lower one is closed. This outflow is always as far as possible from the inflow, so that as much sand as possible settles along the bottom of the stope, but even when this length is considerable, even up to 500 feet, it is necessary to clear the overflow water by a series of weirs and settling sumps before it is allowed to reach the mine pump.

Filling is at present proceeding in old stopes only, but it is intended as soon as possible to fill directly behind the present stopes. It is possible that this method of packing may induce the miners to alter their present method of stoping, starting off from the drive. In this case a stope would be started by cutting away 50 or 60 feet up the dip, building a timber barricade, filling the area stoped with sand, laying rails on the sand, and then stoping up again and so on to the top of the drive.

Sand filling would be equally applicable to our present method of stoping, but the scheme mentioned would have the advantage that drive pillars would be saved and shoveling and tramming cheapened. However this is a matter for the future, and only experience will prove whether it is practicable or not. At present only sand from old dumps which contain no trace of cyanide is being sent into the mine. As an additional safeguard recommended by Doctor Moir the dumps are sampled ahead of that work, the idea being that by the time the sands have become acid all traces of cyanide will have disappeared. The chemical treatment at present is the addition of lime to save the pipes and pumps, but it is hoped that in the near future some process will enable the use of current sands with absolute safety.

The experiments made in concentration and gold recovery have not yet given results worth discussing, but it is hoped to pay some of the expenses by this means. Owing to the short time the work has been in progress no details as to the probable cost of the process are available, but the following are some of the advantages resulting from sand filling, even if it proves more expensive than the present method of supporting the excavation:

1. Sand filling greatly increases safety of the miners.

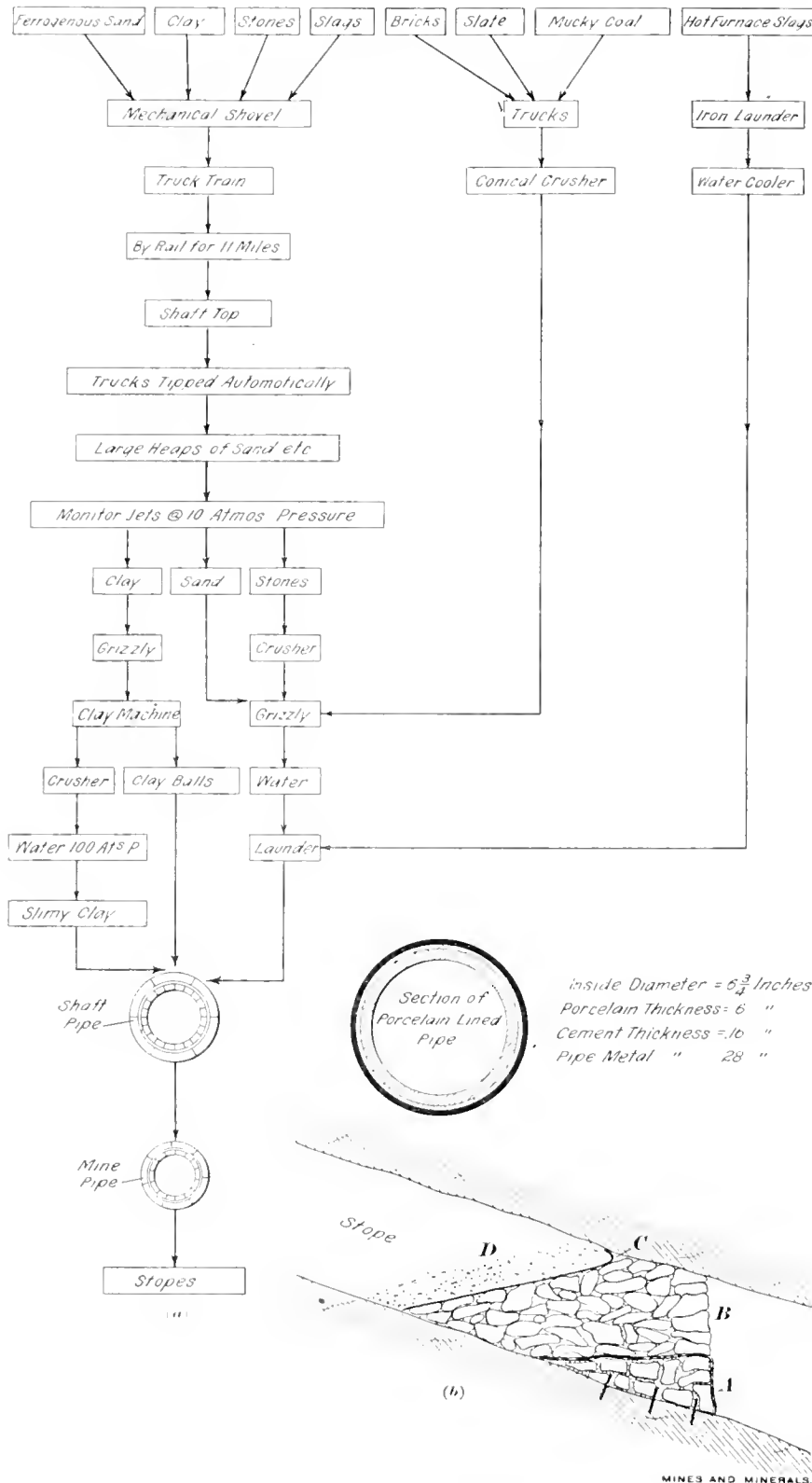

FIG. 3. FLOW SHEET AND SECTION OF BARRICADE

2. It increases the security of shafts and mine workings, which are among the biggest assets in South Africa.

3. It improves ventilation underground; for since practically the same amount of air will pass through a smaller area, its velocity must increase. The air can be guided into the places where men are working and will not be dissipated in worked-out areas.

4. Increase of ore reserves, as fewer or no pillars will be left, and this feature becomes an asset to the country and to the shareholders.

5. Reclaiming old pillars and foot-walls, which is impossible without a sound method of supporting the hanging walls.

6. Removal of dumps from the surface, thus diminishing the dust nuisance, improving the aspect of the town, and setting free large areas of ground for useful purposes.

7. Possibility of mining at great depths. When getting near the maximum crushing strength of quartzite, supporting ground by pillars, waste packs, and sticks is almost absurd except as a temporary measure.

DISCUSSION

Charles E. Saner said that at the Village Deep mine they have been running sand underground and at present can handle 1,200 tons per day. The pipe line goes down an old shaft through old stopes and drives, down the main incline, and along the top level. The pipe line has numerous twists, bends, and curves, yet the sand flows well to its destination. The secret is to first flow clear water through the pipe for 3 or 4 minutes before sending down sand, and always run clear water through the pipe for a similar period after shutting off the sand, otherwise the sand soon settles in any horizontal part of the pipe line and chokes it and so causes trouble.

Another essential for successful and smooth work is to have at least two separate places to fill into, so as to have continuous running. In old stopes the great trouble was found in making the pillars over the drives water and sand tight, as they have taken weight; and it will probably be found quicker and cheaper to go up the stope 15 or 20 feet and erect a barricade along the stope, continuously, ignoring all pillars. The drive pillars can be taken away and if practicable the barricade could be taken down and used again, the sand either remaining solid and vertical, or taking the natural angle of repose without falling into the drive, this of course depending upon the dip of the stope. The sand after 24 hours does not become solid, for as soon as water is put on again it becomes saturated and is like a quicksand or jelly. It is surprising the quantity of hay used to fill up old cracks in the foot and

hanging walls, thus making one more instance of the mining industry materially benefiting the farmers.

It is believed that silting will benefit mining in several ways in the near future when it can be filled close behind the working faces. It will be possible then to guide the air to the working places instead of losing it in disused and worked-out stopes. The hanging wall will be supported throughout and everything will be excavated, and few, if any, pillars will be left, much less timber. Probably before long it will be possible to run the sand from the cyanide tanks, after treatment, by belts or other means, direct to the sluicing bins.

J. D. Marquard said: Much of the future good and safe mining on the Rand will depend greatly upon successful sand filling. Having spent some little time at Kaltowitz, in Silesia, where sand filling is largely in vogue, it will be just as well to remind you that sand filling has done much for Silesia. It was started there some 6 years ago by one of the cleverest engineers in the district. His ideas were largely criticized; however, he persevered under trying circumstances, for some of the difficulties were great. Most of these difficulties have now been practically overcome with the result that today one mine is putting down 7,500 tons of filling per day. The ultimate result is that his mines are working cheaper and are safer than others in the neighborhood. His critics are convinced and are now sand filling also. Numerous advantages have been gained in Germany by this system that do not directly affect us; however, the diagram Fig. 3 (a) shows the different stages of the system as there carried out, and is useful for reference.

The problems on the Rand are more complicated and present more difficulties and dangers than those of Silesia.

Surface transportation of filling material will vary at different mines, depending largely upon the respective elevations of the cyanide tanks and dumps above the shaft collars; however, the surface work on the whole will present no great difficulties. There is no reason why the sand cannot be sluiced with monitor jets from the old dumps into launders, and so transported to the shaft collars; or the current sand treated against cyanide may be lifted with water from a sump near the cyanide tank by means of elevator buckets, or centrifugal pumps. In some cases by starting up the disused tailing wheels the sand may be lifted to sufficient height to give it a drop to the shaft. It is very essential that the slush should be as thick as possible; a good mixture is 60 per cent. sand and 40 per cent. water by volume. A launder with 20-per-cent. grade will allow of this mixture flowing freely. At the Robinson

mine these launders are lined with cement castings, a very good protection. These are made on the property comparatively cheaply. The chemical destruction of cyanide must be left to the cyanide managers, whose duty it will be to see that the slush is in a safe state for the mines.

From Fig. 3 it will be seen that the Silesian sand is sent down with various mixtures, such as clay, slags, stones, bricks, etc. These mixtures have beneficial and detrimental effects.

The beneficial effects are:

1. The clay lubricates the pipes, aiding transportation.

2. The clay with fine slags has a binding effect underground; and after 1 year the sand is as solid and compact as sandstone, requiring a hammer to break a piece off.

3. Slags and other materials give a certain amount of porosity to the mass, aiding drainage.

4. The sand particles are rounded, unlike Rand sand, which is angular.

5. The ferruginous mixtures also give binding effects, for some little chemical action takes place.

The detrimental effects are:

1. The clay causes trouble on the surface, sticking to the mechanical shovels and choking the crushers, grizzlies, etc.

2. Slags, bricks, etc., scour the pipes.

The material on the Rand is nearly pure silica with cyanide and cyanide compounds. It is not ferruginous, and there are no mixtures for binding or cohesion. On tunneling into the dumps, although the sand is subject to good pressure, there is found absolutely no cohesion. This non-cohesive difficulty is one of the greatest to be overcome. The sand packs very well, which can be seen at the mines now filling, and while moist it appears to have some cohesive power. Once it dries there will be no cohesion, and a portion of the resulting pressure of the overlying strata will be transmitted to the supporting barriers on highly inclined stopes. It certainly will be beneficial to get the sand as cohesive as possible behind the barriers. Around the mines there is a good thickness of red clayey soil. This is often used for brick making, and the following mixtures have been tried on the surface with fair success:

90 per cent. sand, 10 per cent. red soil plus water. Some cohesion and porosity.

80 per cent. sand, 10 per cent. red soil plus water plus 10 per cent. fine ash. Some cohesion and porosity.

80 per cent. sand, 20 per cent. red soil plus water. Good cohesion and porosity.

70 per cent. sand, 20 per cent. red soil plus water plus 10 per cent. rough ash. Good cohesion and good porosity.

Probably future experiments will find a good cohesive mixture. The red soil can be shoveled mechanically on sites

where the excavations may be finally used for retaining slime.

The choice of suitable pipes for the transportation of material in the shafts and elsewhere is an important matter. The wood lined pipes described by Mr. Pam are similar to those used in Silesia. In some mines there is a tendency to condemn these pipes. It would be well to give them a good trial, however, for they have been used quite successfully abroad. In the pipes in Silesia they have clay for lubrication, good inside diameter to lessen velocity, the sand is rounded, water is pure and not acid, and experience has shown that slags, bricks, etc., remain somewhat in the center of the pipes, while the sand is nearer the wood lining.

On the Rand the sand is angular and it has a greater scouring effect on pipes than the rounded sand would have. Porcelain-lined pipes are used in the shafts in Silesia; they last a fair time. It may be that Rand sand will not scour porcelain pipes too fast, therefore even if expensive they should be given a trial. A good sized pipe in the shaft is an important matter, for then the velocity of flow will not be too swift, thus obviating wear to some extent. An important point is that the pipes in shafts and elsewhere should remain reasonably full. The contents must be taken away below at the same rate as supplied at the top. For this purpose there must be a regulation valve in the mine pipe to which the shaft pipe line is directly connected. The hopper must hold a fair amount of slush, so as to keep the pipe full if there is a temporary hitch in the surface supply. Telephone communications allow of proper regulation by the operator below. Disregard of this precaution is one of the greatest causes of wear and tear in pipes, especially the shaft pipe. Often a sucking noise is heard at the top of the column and at the delivery end into the stope the slush comes out with spurts under high pressure. This is largely due to air being drawn into the pipe and causing alternately cushioning and releasing, with resultant excessive velocities and jerks or hammering in the pipe line, which results in the wear of the pipes and the loosening of the wood lining. The hopper will in a great measure prevent the sucking in of air. An important point to remember in connection with silting is to flush the pipes with water before and after use, and another point is never close the regulation valve.

The pipes in the shafts in Germany are always in duplicate. The system of sending the sand down in a paste through 8-inch bore holes, as at the Simmer and Jack, has many advantages for it saves pumping, but unless this bore hole is used as a pressure column there will be some difficulty in getting the material to the

far east and west portions of the mine. Very deep bore holes will cost a good deal, the expense increasing fast after the first 400 feet. There is also the disadvantage of passing through faulted ground or dykes which may cause future blocking of the bore hole. It may be that the pipes, etc., will be so costly eventually that bore holes will be the more economical for sand transportation. In the mine, wooden launders should be used wherever practicable.

Until it is certain that Rand sand coheres, or a proper cohesive mixture for filling purposes is devised, wooden barriers are not recommended; they serve in Silesia, but there the conditions are different. The barriers in Silesia are not nearly so extensive as those on the Rand will be; besides the filling coheres and hardens long before the barriers have time to rot. The Silesian stopes are flat, causing the resultant pressure on the barriers to be small. On the Rand the sand has to remain indefinitely, and if the lagging is wet on one side and dry on the other, two conditions arise which will rot timber soon. The overlying rock will crush, with the resultant pressure transmitted in part at least on the barrier, and this slope dripping water will permit much of the water to collect behind the barrier, another cause for anxiety. As a suggestion the barrier shown in Fig. 3 (*b*) might do well in service.

The masonry *A* is held with binding jumpers to the foot-wall. This will have a wedging effect on the overlying waste *B*, which must be packed well, the cavities being filled with ashes. If the ashes act as good filters then the matting *C* is not necessary. A 2-foot layer of the rough ash is represented by *D*. It is essential that all water be drained from the filling, therefore the barrier must be porous.

Much must be learned from future experience relative to stope filling and dewatering. In the mines which are now sand filling good progress has been made. It seems, however, that the more places there are to fill the better the filtering and dewatering of the sand can be regulated. There must be at least two stopes to work consecutively, day by day, each stope having a full day in which to prepare it for the next supply. It is an advantage to have a period between each filling, for then the sand can settle properly, and the water percolate through the sand, or clear above the sand.

It is best and cheapest to have no side barriers, but to keep boys heaping the free end up and letting it lie at its natural angle of repose, or less. The clear water is removed through old disused 3-inch pipes. These pipes have 1-inch holes drilled every 9 inches along their lengths. The pipes are laid on the foot-wall from bottom to top of the stope, and the holes

have wooden plugs in them which are pulled out to let the clear water off. The following are some of the points to watch in stope filling and dewatering of sand:

1. Fill at the farthest point away from the drainage pipe.

2. Have no side barriers. The sand will lie at its natural angle of repose at the free end.

3. Where wooden side barriers are preferred, it would be best to have the filling pipe nearest to, and the discharge pipe farthest away from, the barrier; because all the coarse sand remains nearer the former pipe. This would make a better packing against the barrier. The other way will leave slimy sand against the barrier which often forces its way through during filling operations, generally slushing the drives, etc.

4. The sand must be so arranged in the stope that the water flows off at the junction of the foot-wall and the sand, and by no means against the hanging.

5. The supply launder should drop the slush from the hanging wall or as high as possible, and must be led right up to the sand. The slush must not be allowed to run in from the top of the stope on the foot-wall.

6. When starting a stope see that the first sands are well packed against the barrier. This is an important point and will prevent much slime, etc. getting into the drives at the commencement.

7. The length of the filling face must be as long as possible; the longer the better.

8. The discharge or drainage pipe can have more than one hole every 9 inches, say 3. This will allow of quick dewatering. After the clear water is off, the holes are again plugged and filling can be restarted.

9. Between the supply and discharge pipe, arrange small paddocks with bits of board. This will retard the flow, causing the sand to settle and the water to arrive reasonably clear at the discharge pipe.

In Australia stopes are being filled successfully with dry sand at a fairly low cost. Distribution takes place underground with chutes, traveling belts, etc. It will certainly do no harm to study their system. With the electrification of many mines power can be had cheaply and easily underground. Some of this power can be used for transporting appliances for sand. It would not be a bad idea to get the sand down the shaft pipe dry; it can be fed by means of a screw conveyor if near the dump, or otherwise into a strong square wooden pipe, 12 in. x 12 in., fixed in the corner of the pump compartment. Then dry sand may be sent down this square pipe into a funnel-shaped bin into which jets of water are playing. The funnel-shaped bin can be placed in such

a position in the shaft as the mine distributing pipes demand. The mine pipes would be attached directly to the bin. This arrangement would have the extra length of piping in a shaft, which is so subject to wear, and pumping of sand filling water to the surface, the actual amount coming to the surface being what the mine makes.

Most of the remarks made here are suggestions only, and it is hoped that more will be heard in the society on sand filling. The subject is still partly in the experimental stage. It has to get out of that stage soon, for it is important that the overlying strata should be kept up. It is also important to fulfil all the advantages mentioned by Mr. Pam. There are many other advantages as well which will come up as soon as practical sand filling is an accomplished fact on the Rand. Practical knowledge is the outcome of experience; and with practical knowledge, sand filling will be successful, and with that success it will be possible to alter many of the present mining arrangements underground for the benefit of the Rand.

采采

To Find Capacity of Cylindrical Tanks

Written for Mines and Minerals

Assume that the tank is 72 inches in diameter and 13 feet long with flat ends. On a piece of "squared" paper draw to scale a quarter of a circle 72 inches in diameter to represent one-half of the lower half of the head. If no "squared" paper is at hand the sheet may be ruled in squares. Each small space on a line in the figure represents 2 inches; consequently, each small square represents an area of 4 square inches of the head.

Consider that the tank is divided into 72 horizontal layers, or sections, each 1 inch in thickness. First take the lowest section, that is the one directly above the line *OX*. The matter may seem clearer by considering that the tank is filled to a depth of 1 inch. By the eye determine as nearly as possible where the sharp end of the lowest section of the head may be cut off and the end made square, without altering the area. This point is at *A*. *OA* is 5½ inches, or one-half the width of the lowest section. The entire width is twice as great and the area of the lowest section is therefore 11 square inches. The tank is 13 feet, or 156 inches, in length. Then for each square inch of the head the tank has a capacity of 156 cubic inches, or $156 \div 231 = .675$ gallon. The quantity at the depth of 1 inch is therefore $11 \times .675 = 7.4$ gallons. The right-hand end of the second section after being squared off, is at *B*, 10 inches from the center line. Hence, the entire width is

20 inches, and the volume included between the lines of 1 and 2 inches is $20 \times 7.4 = 148$ gallons. In the same way the contents of each additional inch can be determined. The contents of any depth will be found by adding together the contents of the sections in that depth. It will be seen that the capacity of any section in the lower half of the tank will equal that of the corresponding section in the lower half. After the contents of the tank for which has been determined the quantity may be properly marked off on a measuring stick.

If the plan just given considerable multiplication is involved. This may be obviated by a simple graphical method. Choose any vertical line, say the one at 40 inches to the right, and lay off on it, starting at the horizontal line *OX*, a scale of gallons. Draw the number of gallons in a section, extending to this line. If the width of the half section is 40 inches, the whole width of the section is

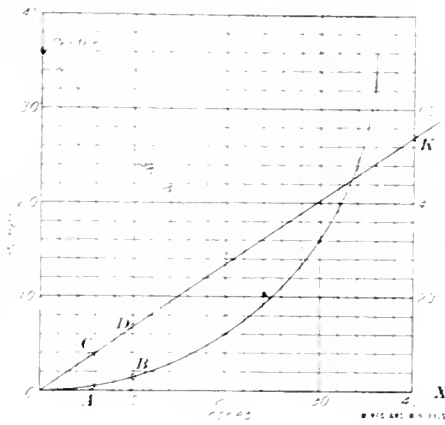

FIG. 1

80 inches and the corresponding capacity is $80 \times .675 = 54$ gallons. Mark *K* the point corresponding to 54 gallons, and join *O* to *K* by a straight line. Any scale that will be convenient may be chosen, but it is well to have *OK* make an angle of 45 degrees, approximately, with *OX*. In the figure each division represents 2 gallons.

To determine the number of gallons in any section, proceed as follows: *A* is the right-hand end of the first section. Directly above it locate *C*. Measuring the line from *C* to the base line *OX* according to the scale of gallons, we find it to be equal to 7 gallons. In a similar manner locate *E* above *B*, and observe that the corresponding capacity is about 13.5 gallons. In exactly the same way the capacity of each section can be readily determined. The correctness of this graphical method is easily seen because the capacity of any section is proportional to its width. It is suggested that the "top" and "bottom" of each section be marked with a small nail, and by the aid of a strip of paper the corresponding point in *OK* lo-

ated. Should a scale be made for the imperial gallon, one must not forget that this measure contains 277.3 cubic inches.

In making the calculations for the matter in this article, no attempt has been made to be exact. However, if the drawing is carefully made, reasonably accurate results can be obtained. For illustration, suppose that an error should equal one-fourth of a small square, then the corresponding error would be one-fourth of .675 gallon, .17 gallon, or about two-thirds of a quart. The method here described brings to mind the fact that problems in mensuration may be solved with ease on "squared paper" or by means of a drawing. Should, for example, the tank have bumped ends, the volume of the ends could be found section by section by following the method given here.

采采

The Markets for Joplin Ores

By A. J. Hoskins

The zinc-lead region surrounding the common point in the state boundaries of Missouri, Kansas, and Oklahoma is usually referred to as the Joplin district, the city of Joplin being about centrally situated in this area.

The bulk of the production of the mines in this region comes from the Missouri portion of the area. While outsiders may think of this output as originating "around Joplin," the local operators have a practice of subdividing the country into small districts that are respectively tributary to numerous little towns or railroad stations, in each of the three states. In the Missouri portion of the region, for instance, there are some 25 or more such imaginary districts, each holding a friendly rivalry with its neighbors along figures of production.

In these "camps," the ore as mined, must undergo concentration before it is marketable, and this is therefore always attended to at the mouths of the mines. Thus, every mine is found to possess its mill at the collar of one of its shafts, and this plant will contain the necessary crushers, rolls, and jigs. The flow sheet of such a mill is exceedingly simple.

The region contains two types of ore bodies that are locally termed "soft ground" and "sheet ground." The former type of ore body is usually the richer, and it was through the discovery and working of this kind of ore that the district became famed. The sheet ground is geologically deeper. During recent years, this formation has been extensively explored, and the production from it has been increasing so rapidly that it has surpassed the output from the soft ground. Thus, during 1911, the production of crude ore from these formations was 3,217,000 tons from the soft ground and 4,945,000 tons from the sheet ground.

As the ore comes from the soft ground, it averages about 4½ per cent. content in the sulphides of lead and zinc. In this content, the zinc mineral is about ten times as abundant as the lead mineral. In other words, according to Mr. J. P. Dunlop, of the U. S. Geological Survey, the crude ore from this formation carries about 4.1 per cent. sphalerite and .4 per cent. galena. After the concentration of this ore, the two mill products will average, respectively, 58.9 per cent. metallic zinc, and 79.9 per cent. metallic lead. From this, one will notice that the treatment given the run of mine, while exceedingly simple, is really very efficient.

The sheet ground carries, on the average, 2.1 per cent. of sphalerite, tersely termed "jack," and .5 per cent. of galena. After milling this ore, the two concentrated products average 79.8 per cent. metallic lead and 58.6 per cent. metallic zinc. These two figures compare closely with the averages of concentrates from the soft ground. Statistics covering a year show a small difference in the average prices paid for the corresponding products derived from the two kinds of ground, but the reason is not obvious.

Concentrate is purchased at the mill of the mining company by agents of the smelting companies and is loaded into the railroad cars by employees of the purchasers. The price paid for the concentrate is net to the mine operator, in the sense that there are no freight nor smelting charges to be deducted. The miners all agree, nevertheless, that "Jones pays the freight."

During 1911, the average price per ton paid for galena concentrate from the soft ground was \$54.41. Taking 79.9 per cent. as the average grade of this product, the sellers received about 3.4 cents per pound for the lead contained in their ore, whereas the average market price for that metal during the same year was 4.4 cents. The difference, therefore, provided for the costs and profits in smelting and marketing.

Similarly, on the sphalerite concentrate from the soft ground, the average price paid last year was \$40.80 per ton. Using the average figures for the grade of this material, it appears that about 3.46 cents was paid for a pound of zinc, although the average quotation on spelter for the year was 5.76 cents. It is generally admitted that zinc smelting is more expensive than lead smelting, but the differential in this case seems excessive. It appears from these figures that, although zinc was actually worth 30 per cent. more per pound than lead, the producers accepted practically the same price for both metals.

For the galena concentrate derived from sheet ground, the average price during 1911 was equivalent to 3.54 cents per

pound of lead; while the jack concentrate from the same formation sold at prices that averaged 3.39 cents per pound of zinc.

來 來

Sealing Off a Loading Place

By John T. Fuller, E. M.*

The simple device illustrated was used by the writer to seal off condemned "loading places," in the diamond mines at Kimberley, South Africa.

In these mines it is often necessary or advisable to temporarily stop the loading out of certain stopes or parts of stopes, either because waste rock has "come in" to the loading places or to prevent too much blue ground being removed from the stopes during the stoping operations.

A form of "shrinkage stopes" is used in these mines, the miners standing on the broken ore to reach and drill the "backs."

When the extraction of the "blue" is

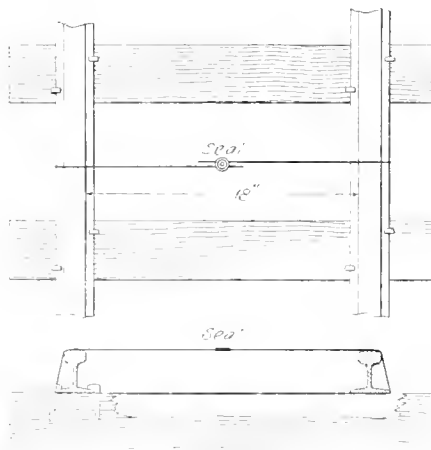

TRACK SEAL

let by contract at a certain price per load (16 cubic feet) dumped into the "passes," everything that can be loaded into a truck is "good ore" from the contractor's point of view.

The "roof inspector," "shift boss," or other official on his rounds, may order loading places stopped, and even place a "barricade" at such points; but nine times out of ten loading would be resumed as soon as the official's back was turned.

Material once dumped in the "passes" was safe, so far as the contractor was concerned; because in most cases, though the waste was easily distinguishable from the "blue," it was impossible to trace it back to the level from which it had been dumped, owing to the fact that a number of different levels dumped into the same "passes."

It was very difficult to catch a contractor "red handed" loading waste, as they kept "natives" on the lookout for the "boss" and were generally warned in plenty of time to stop all illegal work.

*Consulting Engineer, Honesdale, Pa.

In spite of the heavy penalties imposed on detection of such work it seemed impossible to stop it until the method of "sealing off" was tried.

Each "reef inspector" was supplied with a pocket reel of steel wire about 16 or 17 gauge, a pocketful of lead seals such as are used by the railroads for sealing freight cars, and special "pliers" that formed a combined wire cutter and seal stamp.

Whenever for any reason a loading place was condemned the inspector would wrap a wire around the rails just inside of the loading place, and after drawing it tight through the holes in the lead seal, would clamp it down tight on the wire with his pliers, at the same time leaving the imprint of the stamp on the lead.

All places thus sealed were reported to the inspector and shift boss of the succeeding shift, who inspected the seals and removed same if for any reason it had become advisable to resume loading.

It was soon found by the contractors that they could not tamper with these wires and seals in any way without leaving traces of such tampering and, of course, if a car was run in such a place the wire was broken.

All broken wires or tampered seals were considered as direct evidence of illegal loading and the maximum penalty immediately imposed.

In a very short time the practice of loading from condemned places was entirely eliminated.

來 來

No Reward for Tin Discovery

The United States uses between 40 and 50 per cent. of the world's production of tin but mines only a small quantity. In 1911 the output of tin ore in this country was equivalent to 63 tons of metallic tin, valued at \$54,013.

For some unknown reason there is a widely prevalent idea that the United States offers a reward for the discovery of a tin mine that can be worked at a profit. Where the rumor started is unknown, but it seems to be fostered by unscrupulous or ignorant persons who have mining stock to sell. The Geological Survey's officials state that the United States does not offer and so far as known to them never has offered a reward for the discovery of a tin mine, or any other mine.

So many letters are received by the Geological Survey asking where tin deposits can be found in the United States that a brief outline of the occurrences of the metal have been published in a report on the production of tin in 1911 by Frank L. Hess, a copy of which may be obtained free on application to the Director of the Geological Survey at Washington, D. C.

The Calculation of Areas

Short Methods of Determining Areas from Maps, with Special Reference to Areas of Irregular Outline

By H. G. Henderson*

A VERY important portion of the office work of the mining engineer or surveyor is the calculation of areas as displayed on the mining map, and although the general principles underlying such calculations are understood by mining engineers, there are one or two special notes and ideas for facilitating work which may not be known generally. These are stated briefly for the purpose of assisting the mining surveyor in shortening and simplifying what is often a laborious undertaking.

For example, there is an interesting feature which does not appear to be generally known regarding what is called the 25-inch map, which makes it particularly fitted for the calculation of the areas, and this is that each square inch upon the map represents so approximately as to be practically true, 1 acre. For this reason the average breadth and length in inches of a mine claim which has been delineated on a 25-inch map may be taken with an ordinary 2-foot rule, and the product of these measurements will give the required area in acres. The reason for this is as follows:

The 25-inch map is laid down on a scale of $\frac{1}{2500}$, that is to say, every linear measurement on the map would, if made on the actual ground itself, be 2,500 times as long. Suppose now that a square inch is drawn on the map as at (a) Fig. 1; the real length from A to B would, of course, be 2,500 inches, and similarly the real length from A to C would be 2,500 inches. Now, 2,500" multiplied by 2,500" equals 6,250,000 square inches, and this number of square inches is practically equal to 1 acre. In reality, however, 6,272,640 inches make an acre, but the difference is almost negligible, as will be seen if a square inch is accurately drawn out on a piece of paper, and an acre is then put down on a piece of transparent paper on the $\frac{1}{2500}$ scale. If these are superimposed, the latter upon the former, the eye can detect no difference, and the above is a safe rule to form a guide to the mining surveyor.

Arising out of this, it may be of interest to mention a useful rough approximation for the calculation of areas which may not be known to all mine surveyors, and which may be noted in connection with plans and models. This consists in the measurement of such areas by the means of an ordinary 2-foot rule. If a representative fraction (R. F.) of the plan be given, any required area on such a plan can be approximately calculated by the eye, or at any rate by taking the average length and average breadth with the ordinary 2-foot rule. For example, sup-

posing a mining claim is laid down on a scale of 100 feet to the inch. In this case the representative fraction would of course be $\frac{1}{1200}$. Now the number of square inches in the plan that are equal to 1 acre will be $(\frac{2500}{1200})^2$ which equals 4.34, and in order to obtain the acreage of the claim the number of square inches contained in the plan must be divided by 4.34. The reason of this can best be seen by taking an area on a $\frac{1}{2500}$ scale plan.

It is evident that if the area of the land occupying 1 square inch on the $\frac{1}{2500}$ plan be laid down to the same plan drawn to $\frac{1}{500}$ scale, 1 acre will occupy a square in the map of 25 square inches. That is to say, the number of square inches found by the 2-foot rule on the $\frac{1}{2500}$ plan must be divided by 25 to give

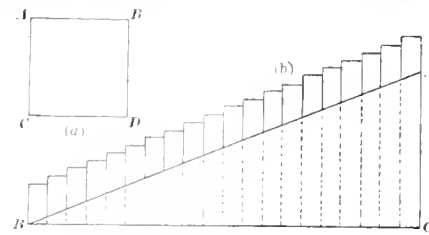

FIG. 1

the approximate acreage; but 25 equals $(\frac{2500}{500})^2$; hence the rule will be found to be as follows:

Take the square of the denominator of $\frac{1}{2500}$ and divide it by the square of the denominator of the representative fraction of the plan before you and the result will be the number of square inches on that plan equivalent to 1 acre.

EXAMPLE 1.—A mining claim is marked out on a plan drawn to the scale of 3 chains or 198 feet to the inch

$$(R. F. = \frac{1}{2376})$$

How many square inches go to the acre?

$$(\frac{2500}{2376})^2 = \frac{6250000}{5645376} = 1.11. \text{ Ans.}$$

Suppose the concession to give under the 2-foot rule 437 square inches, its area would be $\frac{437}{1.11} = 394$ acres.

EXAMPLE 2.—A mining concession is laid down on a map the scale of which is 24 inches to the mile. How many square inches go to the acre?

Here the representative fraction is of course $\frac{24}{1760 \times 3 \times 12} = \frac{1}{2640}$, and the answer

$$\text{is } (\frac{2500}{2640})^2 = \frac{6250000}{6969600} = .896; \text{ and if the}$$

concession under the 2-foot rule yielded 437 square inches, the area would be $\frac{437}{.896} = 499$ acres.

It will be evident to those who carefully

consider the question that the formula to be perfectly true should be

$$(\frac{6272650}{D. R. F.})^2, \text{ or } (\frac{2504.524}{D. R. F.})^2$$

But 2,500 is more easily remembered than 2504.524, and the result will be practically the same.

An interesting point arises in connection with the measurement of areas which on the actual surface formation are upon a slope. One of the cases in which a surface survey, for example, is rendered necessary is when a mining company has, as a result of its operations, to pay an amount as compensation to the owners or occupiers of the surface of the land under which their workings run, or more usually, of such sections of land as are required for the surface operations of the mine. In such cases, where the damage is computed in terms of the value of growing crops, it becomes necessary to survey the land and to calculate the area of the enclosure affected. This is a comparatively simple matter where the land is approximately horizontal, inasmuch as a survey is, of course, plotted on the flat, and the area is calculated in accordance with this.

More than one case of dispute has, however, arisen where the land lies on a hillside; and when it is agreed that compensation shall be paid for the growing crops, the mine surveyor should be careful to see that his company is not unjustly treated in the matter. In Fig. 1 (b), for example, the farmer may argue that if angle A B C is the slope of his field, the survey will show one side say of the area as length B C as on the plan, whereas the actual area of his field in which say turnips are growing, should be calculated in terms of A B as more turnips can be grown in an area bounded by A B than in one of similar width bounded by B C.

If this principle were admitted, endless difficulties would be incurred in dealing with undulatory ground, as a surface plan would be valueless. That such complications need not occur, and that the surveyed plan must be accepted literally in such cases, may be seen by imagining for the sake of illustration that pine trees grow over the area as closely as they can be packed as shown by the vertical rectangles. If their number be counted it will be seen that quite as many can be grown on the level B C as on the slope A B, and this argument applies in full force where timber, corn, and practically

*Mining Engineer, London, England.

all cereals are concerned. There is a slight increase where flat growing crops such as turnips, cabbages, etc., are concerned, but the difference is negligible and does not correspond to the difference between A B and B C, inasmuch as the crop is not absolutely flat on the ground like a coat of paint, but has an appreciable depth vertically. Moreover, no

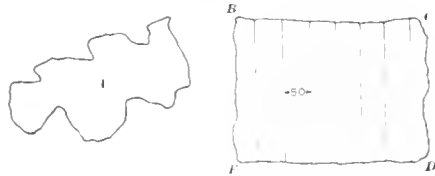

FIG. 2

more rain falls on the sloping surface than would impinge on it if the surface were flat, so that the value of a slope is no greater from a farmer's point of view than that of its corresponding projection on the horizontal. That this view is correct is borne out by the fact that farm leases are based on acreages calculated on the flat, so that it is manifestly unfair to claim compensation for surfaces on the slope on any other basis than on the level survey. A young surveyor, however, might easily be hoodwinked by the specious nature of the opposite argument.

If it becomes necessary to calculate in a rapid but accurate manner the area of a mining concession, deposit, stope, etc., as marked on a plan, there are, of course, many ways of doing this; but as a matter of experience it will probably be found that for simplicity and accuracy the method to be described is by far the best. Consider an irregular area such as A, Fig. 2 to be the boundaries of an ore deposit, as outlined on the map. A piece of tracing paper similar to B, C, D, E, should now be taken and upon the same should be ruled in red ink, parallel lines as shown, at convenient distances. By way of illustration the lines are shown in the diagram as drawn at distances apart corresponding to 50 feet on the ground to the scale of the plan. The tracing paper should then be placed over the plan of concession A, as shown in Fig. 3 (a) and a long strip of tracing paper should be marked off on some suitable round number or integer on the scale. The strip should then be taken and with it the distance from A to B, B to C, C to D, and so on should be marked off, and such distances should be marked and numbered on the strip as shown in Fig. 3 (b). It will then be found that sooner or later the 2,000-foot mark will fall upon the plan at X. From X the measurements should be recommenced and another 2,000-foot mark made, this process being continued until the whole of the concession area has been covered. Eventually the measurements will finish with a cer-

tain number of 2,000-foot distances and be either a trifle long or short, as the case may be. All that is necessary to do in order to start the computation is to count the number of 2,000-foot marks. For example, call these three in number. Then 2,000 multiplied by three, plus the trifle over, which is measured along the scale, multiplied again by 50, gives the area of the deposit in square feet.

The reason for numbering the marks on the edge of the strip of tracing paper is to prevent any mistake in the act of measuring and also to enable the strip to be used over and over again. Of course, with stopes and similar plan drawings, the parallel lines should be so many definite feet apart and in such a case the strip measurements are taken in feet also, giving the result in square feet. Although this method is so simple and quickly effected, it is surprising how accurate the results will be. The only trouble which may occur, apart from errors in measurements of computation which should be easily guarded against, is to be found where the outline of the deposit is very irregular. In such instances a "give and take" method must be adopted to compensate what may be termed the jagged ends of the widths to be measured.

It is, of course, a fundamental rule that measurements and computations connected with mining plans such as that described in the previous paragraphs should be most carefully checked, and in order to avoid the possibility of falling twice into the same error which might have occurred in the first computation, it is advisable that, wherever possible, the check should be carried out by a method or manner different from the one which was originally adopted. There are several ways of checking a computation of the area, and two or three of the most useful of these may be briefly described.

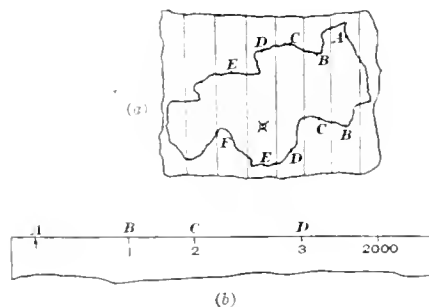

FIG. 3

With areas, the checking may be performed by using over again the lined tracing paper described in the previous paragraph, but in the second computation placing the lines at right angles to their previous position as indicated in Fig. 4. By computing the area by measurement of the strips so formed taken at right

angles to the previous strips, it may be found that there is a slight difference in the result, more especially if, as pointed out above, the ends of the strips are irregular, and some means has to be taken of estimating the area of the jagged ends.

Another method of checking, and one that is very simple in application, is to transfer the area of the concession or deposit to a sheet of tracing paper, and

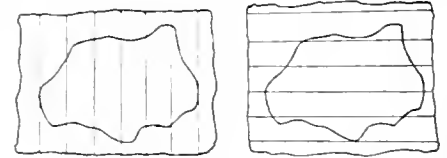

FIG. 4

by its side on the same sheet of paper to lay down according to the scale of the plan, a rectangle containing a whole number of acres, say, 10, 20, 50, as may be convenient. If, after doing this, the two outlines are carefully cut out from the tracing paper by means of a sharp knife or a pair of scissors, and then carefully weighed each in a very delicate balance, a simple rule of proportion will give the required answer. For example, if the tracing paper of the outline of the concession weighed $\frac{1}{4}$ ounce and the rectangle representing to scale 50 acres weighed, say, $\frac{1}{2}$ ounce, it follows, assuming the specific gravity of the two pieces of paper to be the same, that the area of the concession will be 25 acres.

It very often occurs, however, that a mining engineer finds himself in a locality where he has no tracing paper, no balance, and, in short, nothing suitable for the purpose. He simply has his plan before him, and is required to calculate the area of a concession marked upon it. It may be presumed, however, that the plan has a scale upon it or attached to it. The best way to go to work under these conditions will be as follows: The engineer or surveyor should affix the plan and a sheet of paper on a board or table, and should construct a rectangle on the paper containing any given number of acres. He should then obtain from his cook a little dough and proceed to build a wall of this material round the concession and also round the rectangle, taking care that the dough accurately corresponds with the two outlines. Within these two enclosures dried peas or buckshot should be placed until there is a single layer all over each enclosure. The peas or buckshot contained in each of the two areas should then be carefully counted and the ratio of the two areas should correspond to a very near approximation to the numbers of peas or buckshot contained in each. As the area of the rectangle is accurately known, a simple application of the rule of three will give the area of the concession.

The foregoing observations do not include anything which is radically new or startling, but they have, it is hoped, a certain merit from the point of view that simplicity in operation always tends to success in surveying, whether this rule is applied to field or office work. Such simplifications tend to the elimination of

those mechanical errors, which although they so easily creep in, are yet so difficult to detect, and which oftentimes throw work out of balance and lead to erroneous conclusions, and it is therefore hoped that the above practical hints may be of some value to mining engineers and surveyors.

Concrete Shaft Lining

Materials and Properties Used in Making Reinforced Concrete Sets Tests Showing Relative Strength of Concrete and Timber

By E. R. Jones*

FOR a number of years solid concrete and reinforced concrete shaft collars and shafts have been in vogue where the conditions warranted a shaft of any degree of permanence, but not until 1909 was reinforced concrete tried as a substitute to take the form and similar methods of installation as the long-used timber sets for shaft purposes; namely, at the Nos. 3 and 4 shafts of the Ahmeek Mining Co.

In the beginning, two distinct kinds of material were used; a good grade of gravel and natural sand from a local pit; and the trap rock, through which the shafts were sinking, together with clean conglomerate sand from the C. & H. mill. Sets were molded from these two classes of material and installed with equal partiality, and subsequent service has proved both to be equal to the demands made upon them. Pieces set aside for the purpose were allowed to season sufficiently that they might be given a fair competitive test, and it was found, on comparing the fractures in the two combinations of material, that the sand and cement filling the spaces between the rounded pebbles broke away from them, while the fracture in the trap-conglomerate same combination continued through the larger elements of the mixture. The gravel mixture could doubtless be improved considerably by careful washing, but the cost of preparation, compared with the trap rock and conglomerate sand, prohibited its use in this particular case.

The materials finally used were as follows:

No. 1 Portland cement. Conglomerate sand. Trap rock trommeled over $\frac{3}{4}$ -inch through screens.

The proportions used were 1-3-5 in wall plates, end plates, and dividings, and 1-2-4 in studdles. The reinforcement in wall and end plates consisted of three $\frac{3}{4}$ -inch Monolith steel bars with $\frac{1}{4}$ -inch webs, crimped on to them, together with two straight $\frac{3}{4}$ -inch Monolith bars. The dividings were reinforced by four $\frac{1}{2}$ -inch Monolith steel bars wound spirally with $\frac{1}{4}$ -inch steel wire, the

whole presenting a column with square cross-section. Studdles were reinforced with two pieces of old wire rope $1\frac{1}{4}$ -inch in diameter. Reinforced concrete slabs were molded for the shaft lining, the material used being fines of trap rock under $\frac{3}{4}$ inch, conglomerate sand, and Kahn expanded metal as reinforcement. The mixture used for slabs was 1-2-4. By way of experiment, the writer selected a piece of No. 1 hemlock plank of the same length, width, and thickness of a concrete slab, which had seasoned for 1 year, supported them at either end, and placed them side by side, and then applied an equal pressure across the center of each. Three failure cracks appeared in the concrete slab just previous to the breaking of the hemlock plank, although total collapse of the concrete slab did not occur until the pressure was considerably increased. While the method of the test employed was crude, it proved to the satisfaction of the writer that the concrete slab was much superior in strength. Considering the rapid decay of timber used as shaft lining, no further comparison of the two is necessary.

In the molding of the concrete sets, 2-inch No. 1 white pine was used in the construction of the forms. These were soaked in a wood preservative, and repainted with preservative on the interior each time before setting up, thus insuring them against warping and prolonging their lives indefinitely, as well as securing a smooth and easy parting from the concrete when removed. A barrel-type mixer was employed in preparing the charge for the forms. The amount of water used in the mix was such that, when the batch was piled, it settled rapidly without agitation. A drier mix was attempted by way of experiment, but due to the amount of reinforcement employed, it was found impossible to ram the drier mix into place.

The labor involved in the making consisted of two carpenters setting up forms and keeping them in repair; one man wheeling forms on to skidways ready for filling, returning used forms to shop and cleaning the same; one man feeding mixer from stock piles of rock, sand, and cement; one man

delivering mix to forms and shoveling material into place; and one mason tamping charge into final position. With this combination of men as many as four complete sets, consisting of 64 separate pieces, have been molded in 1 day of 9 hours. In ordinary weather, the sides of the forms were allowed to remain in position over night, and then removed, while the bottoms were left in place another 24 hours. The bottoms were removed by turning the pieces on their sides, where they were left to harden 1 day longer before removal to the stock pile. All through the process of removal, the sets were handled with the greatest care in order to preserve the appearance of the set and prevent cracking, which might not develop to the eye until weathered. All skidways used in making and storing were brought to a level to prevent warping and bending while the sets were green, to insure a perfect fit under ground; for, unlike timber, the concrete set cannot be brought to place unless perfectly true. Sets should not have been used under 60 days after removing forms, although we, through the reduction of the stock piles, have been forced to install pieces of 14 days set, but the greatest care was observed in handling and putting in place underground. Concrete sets 1 year old, which have been subjected to all manner of weather, can be abused somewhat and handled almost as carelessly as timber.

As before stated, the above-mentioned sets were made for the Nos. 3 and 4 shafts of the Ahmeek Mining Co. The shafts are of the three-compartment variety—two skipways and one manway, dipping at an angle of 80 degrees. The outside dimensions of the compartments are:

Skipways, 7 feet 6 inches high, 6 feet 10 inches wide.

Manway, 7 feet 6 inches high, 3 feet wide, with the end plates and dividings, making the greatest span of 7 feet 6 inches. Offsets were molded in all plates 5 inches from the inside face to accommodate lining slabs. Also, holes were cored for the use of hanging bolts and bracket bolts. The wall plates, end plates, and studdles have a cross-section of 80 square inches; dividings, 81 square inches. The percentages of reinforcement are approximately as follows:

	<i>Per Cent.</i>
Wall and end plates.....	5
Dividings.....	5
Studdles.....	3

It was found advisable from the beginning, because of the great weight of the wall plates, to mold them in two sections, one section spanning the ladderway, and one skipway, and the other section spanning the remaining skip compartment. These two sections were connected when in place by two bolts passing through holes cored for the purpose, and two straps of iron spanning the splice. Studdles were made for 4-foot, 5-foot, and 6-foot sets, to accommodate the ground passed through.

*Read before the association of mining engineers of the copper country, The Michigan College of Mines Club at Houghton, Mich., February 25, 1912.

The weights of the different pieces comprising the set are as follows:

	<i>Pounds</i>
Long section of wall plate.....	1,035
Short section of wall plate.....	700
End plate.....	600
Divider.....	645
3-foot 3-inch studdles.....	268

Complete set of 16 pieces..... 8,104

Taking the weight of No. 1 western fir, which has been exposed to the weather in stock piles, as 33 pounds per cubic foot, the above concrete set weighs almost three times that of a 12"×12" timber set which the concrete set is intended to replace. Because of this additional weight of the concrete set, it was found necessary to increase the usual five or six men on the timber gang to seven in number. In a vertical shaft, to which the concrete sets are especially adapted, the number of men per gang might again be reduced. The sets are hung or built as the ordinary timber sets, only requiring an additional rope and block to swing the pieces in place. After the sets are wedged to line, bottoms are put in between the plates and the surrounding shaft wall, and the set is then tied to the shaft wall by means of concrete in the proportion of 1-3-5. The concrete slabs are then put in place and loose rock thrown behind them, filling up what space still remains between the set and the wall of the shaft.

After the set is in place, it is extremely important that it be well protected from the blast, for, unlike the timber set, concrete will not stand the blast. For this purpose, the writer used flat timber and steel plates chained to the under side of the plates and dividings, and even this precaution was at times inadequate. Where the ground was breaking easily, the sets have been as near as 12 feet to the miners, and again, when the ground was especially refractory, sets 40 feet from the blast have been cut out. It is obvious that it is well to keep as far behind the mining as the ground will permit. In dangerous ground, which required timbering close up to the sinking, timber sets were used, but, had not time played an important part in the sinking, no ground was met in which concrete sets could not have been installed. With a gang of seven men, one complete set can be installed in a 9-hour shift. This permits a sinking rate of better than 100 feet per month, which was accomplished at the Nos. 3 and 4 shafts.

The comparative cost of the concrete set and timber set, delivered at the shaft collar, is striking. The concrete set was delivered for \$22.50, the timber set for \$37.60. These figures are based on:

Western fir, \$28 per 1,000 feet, f. o. b. car; crushed rock, 35 cents per yard, f. o. b. shaft; conglomerate sand, 60 cents per yard, f. o. b. shaft; No. 1 Portland cement, \$1.15 per barrel, f. o. b. works; reinforcement, \$12 per set, f. o. b. factory.

The Ahmeek Mining Co., I believe, was the first to adopt the concrete stringers,

and the Mohawk Mining Co. soon followed with their use. At the Ahmeek, these stringers have been in continuous use since the beginning of operations and have required no repairs. Superintendent Smith, of the Mohawk, has informed me that soon after the stringers were installed, skip repairs increased about 100 per cent. The stringer being entirely rigid, and the skip also of rigid construction, the axles of the skips were found to be crystallized and the rivets working loose. This feature was overcome by molding 2-inch pine strips, after treating them with wood preservative to prevent decay, into the stringers at intervals of 3 feet, allowing them to project ½ inch above the face of the stringer, and resting the rail thereon. The pine strips have been in place 4 years, and none have been replaced to date, and skip repairs have been reduced to normal. Possibly because of a differently constructed skip, Ahmeek repairs were not abnormally high, but the same racking of the skip body occurred and the Ahmeek company has adopted the Mohawk feature and expects to profit accordingly.

Concrete plats, or stations, have been in use at both the Ahmeek and the Mohawk for some time. They differ from the timber plat in outward design only in the cross-section of the members, which are 9 in. × 12 in., and are reinforced with old rail and wire rope, and replace the 12"×12" and 12"×14" timber formerly used. Holes are cored to accommodate gates for skip and dump doors and tram rails are imbedded in the concrete, making the use of spikes unnecessary. When turntables are used on the back of the plat, the rigidity furnished by the concrete insures the trammers against derailed cars, resulting from a tilted table.

At the present time, our company is installing reinforced-concrete dividings to replace the practice of putting in 10-inch flat timber. In cross-section they are 9 in. × 12 in., and are reinforced by old rail. On the ladder road, they are placed 6 feet from center to center, and between the skip compartments are put in as often as the hanging requires. Since the casing along the ladder road performs no other office than the protection of the men while on the ladder, or in case of a fall, plank is used for the purpose, and a 3-inch hemlock strip is molded into the dividings to facilitate the fastening of this casing.

Quite often in the placing of concrete and reinforced concrete, both above and below ground, not enough attention is paid to the character of the men employed in charge of the mix and actual distribution of the material. It is not enough that the work shall look finished and neat on the removal of the mold boards, which any gang of men can accomplish with only this end in view. The placing of concrete where strength is desired, as well as weight and finish, requires care and judgment. Men

should be selected who will see that the fines are uniformly distributed with the coarser material, for, unless the rock of the mixture is made to well overlap, congregation of coarse material and fines will accumulate which will result in a weakness, which often cannot be detected after the work is completed. The ideal method of placing the mix is by hand with shovel, but in shaft work this method is slow and requires extra labor where the work is situated some distance from the place of mixing. Where chutes are used to convey the mix to its destination, the larger material arrives in advance of the fines, making an even distribution difficult and at times impossible. The writer has eliminated this feature by placing traps at regular intervals in the conducting launders, for the purpose of retarding the larger particles, thus securing a more even mix at the end of the launders than at the beginning.

Concrete has long been used underground for bulkheads, forks, open gutters, and casings for firedoors, and cannot be surpassed for these purposes. As applied to shafts, the material is comparatively new, but each succeeding year marks its advance, and in the end timber will have been entirely superseded. For much of the underground construction, timber is still the rival of concrete, but, due to the increasing scarcity of the timber suitable for mine use, it cannot long remain as such, and must soon make way for the more plentiful materials, concrete and steel.

I wish to thank Mr. S. R. Smith, of the Ahmeek Mining Co., and Mr. Will Smith, of the Mohawk Mining Co., for information furnished me.



Monel Metal's Resistance to Corrosive Action

Recent experiment made at the laboratory of the Board of Water Supply, New York City, indicate that Monel metal possesses about the same resistance to corrosive action as the better known bronzes, while it had the additional advantage that it presented the least change in appearance as a result of the corrosive action. Specimens of several bronzes, Monel metal, and steel, were weighed and embedded in rich earth, which was kept wet for 6 months by periodical additions of very dilute solutions of corrosive salts. At the end of the test period all of the specimens were taken out, scrubbed, dried, and weighed to ascertain the comparative loss from corrosion. The results were as follows:

	<i>Per Cent. Loss</i>
Phosphor bronze.....	.09
Tobin bronze.....	.11
Monel metal.....	.12
Parsons manganese bronze.....	.12
Muntz metal.....	.33
Steel.....	1.04

Another test of the same kind under somewhat different conditions, but the same period, gave about the same relative results.

Practical Cyaniding—Part 2

Laboratory Equipment Apparatus for Ore Testing and Methods of Operation—Roasting and Treatment of Concentrate

By John Randall*

SINCE writing paragraph on "Determination of Reducing Agents," which appeared on page 45 in the August number, I have been using a better and more convenient method of determining reducing agents in cyanide solutions as follows:

Determination of Reducing Agents. By means of a pipette, transfer 10 cubic centimeters of the solution to be tested to a small flask or beaker and add 4 or 5 cubic centimeters of a 10-per-cent. solution of sulphuric acid. This acid solution is made by mixing 1 part by volume of

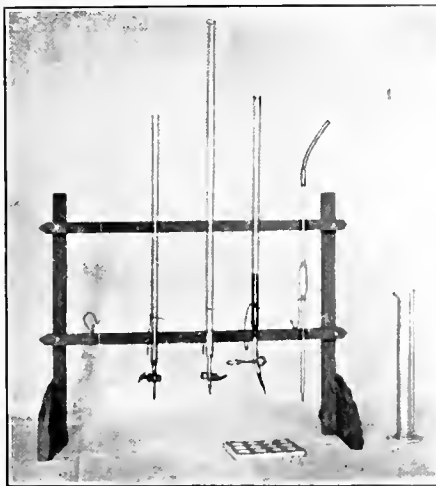

FIG. 1. BURETTE STAND

sulphuric acid with 9 parts of water. Run the potassium permanganate test solution from a burette into the solution under examination until the reddish color of the permanganate just fails to be discharged. Next heat the solution in the flask or beaker over a spirit lamp until it is near the boiling point when the reddish color will probably be discharged. Carefully run in more of the permanganate test solution drop by drop, reheating the cyanide solution at intervals over the spirit lamp, until a pinkish tint of the permanganate remains. Each cubic centimeter of the permanganate solution used indicates that one-tenth of a gram per liter (two-tenths of a pound per ton) of oxygen must be combined in the solution to oxidize alkaline sulphides or other reducing agents. Ferrocyanides and thiocyanates discharge the color of permanganate, but their quantity in mill solutions is generally small and may be disregarded. If a bright piece of silver foil or a silver coin is placed in a cyanide solution containing a considerable amount of alkaline sulphides, the silver will be blackened.

*Boulder, Colo. Part 1 appeared in August MINES AND MINERALS.

In addition to the apparatus needed for fire assaying, the laboratory should be equipped with burettes graduated to $\frac{1}{10}$ cubic centimeter, measuring pipettes, graduated cylinders, funnels, filters, etc., also a mixing flask (liter flask). A burette stand more convenient than those usually found on the market can be made on the premises. As many burettes as required are supported in notches cut in two horizontal bars, being held in their places by wire springs, the end of the spring being bent into a hook, as shown in Fig. 1.

In case the light is not good and it is necessary to set the burettes directly in front of a window, the cross-bars may be attached directly to the window frame.

The gold pan is an indispensable article. It is stamped from a single piece of sheet steel, and the diameter of the bottom should be four times the horizontal width of the flaring side.

A smaller pan made of sheet aluminum, 12 inches in diameter at the top and of the same proportions as the iron or steel pan, can be found on the market, and is very convenient on account of the ease with which sulphides can be seen against the white bottom. A large dishpan will answer for a panning tub.

The Hot Plate.—If the laboratory is not already equipped with a hot plate one can be made by fitting a two-burner gasoline stove into a small table, the top of the stove being flush with the table top. A piece of $\frac{1}{8}$ -inch sheet steel 10 inches square is placed over each burner. A hole near the edge of each sheet to fit a stove-griddle lifter is convenient. To make it of a proper working height while standing, the table should be set on a platform 10 inches high. A hood leading to a flue to carry off fumes should be placed over the apparatus. If very much work is to be done the hot plate is quite indispensable in getting out the fire assays.

Scales.—An even-balance scale having a capacity of about 1 pounds should be provided, together with a set of brass metric weights, 1 gram to 1,000 grams.

Sieves.—A nest of 8-inch assayers sieves, brass wire cloth in tin frames, of the following mesh, will be found useful: 10, 20, 30, 40, 60, 80, 100, 150, and 200. Coarser ones with wooden frames can be made as needed. Very serviceable round-hole sieves can be punched from tin pans on a block of end wood by carefully fitting a flat-faced steel punch to the required size. Sieves coarser than $\frac{5}{8}$ -inch round hole will be seldom required.

Apparatus for Ore Testing.—Even after

the method of treatment has been decided upon and the cyanide mill is in operation, ore-testing work should not be altogether abandoned, and in case the mill treats

custom ore, testing work will be continually required. A room connected with the laboratory, and fitted up with appliances for ore testing, is one of the most important adjuncts of the milling plant. An agitator like the one shown in Fig. 2 can be made on the premises. The wood disk supporting the jars is mounted on a bicycle hub. A hexagonal block is secured to the center of the disk on which is mounted the sheet-metal clips that hold the 2-quart jars snugly in place. The plane in which the disk rotates is at an angle of about 27 degrees from the vertical, or a slope represented by the hypotenuse of a right-angled triangle having an altitude equal to twice its base.

The apparatus should turn at a speed of five to eight revolutions per minute. A small electric or water motor will furnish the power required.

After questions connected with the chemistry of the process have been decided by agitation tests, it is generally desirable to make tests on larger quantities of ore and under conditions more nearly approaching mill practice, at the same time ascertaining if there are any obstacles to zinc precipitation.

In Fig. 3 is shown an arrangement for a small testing plant composed of tubs *a* and *b*, a precipitating box *c*, and a sump *d* for receiving the filtrate. The top tub *a* will hold 100 pounds of ore and sufficient cyanide solution to leach out the gold. The gold cyanide solution is drawn from this tub *a* to the tub *b* below it, from which it passes into the precipitating box *c* that

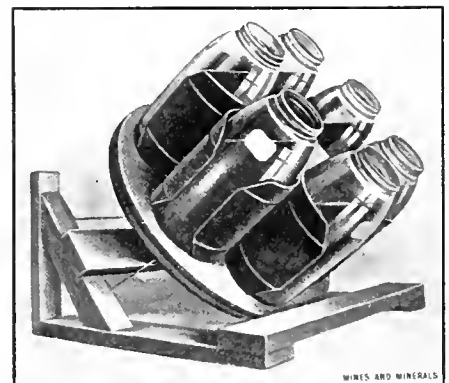

FIG. 2. AGITATOR

contains zinc shavings. After the gold is precipitated, the filtered liquor passes into the sump *d*, where it is tested for cyanide loss, then strengthened or standardized by the addition of cyanide, and, if needed, pumped back to the tub *a*. Sometimes two

or more sets of these tubs may be arranged to drain into a precipitating box *c*, as shown.

Filters.—A good filter bottom can be made for small testing plants by placing slats 1 inch apart across a hoop. These slats do not reach down the entire width of the hoop, but stop about 1 inch above the bottom to allow a free circulation of the liquor. The upper surfaces of the slats

is now manufactured which obviates this difficulty by giving the movable jaw a downward motion immediately after each crushing stroke, thus rubbing the packed ore from the face of the jaw. This machine will crush to about $\frac{1}{4}$ -inch size, and the laboratory size machine is rated at 600 pounds of ore per hour.

In the laboratory pulverizer, or sample

result in percentage of lime actually dissolved. The portion titrated must be clear and contain no undissolved lime in suspension.

Computing Results.—All weighings are made by the metric system on account of its convenience and the saving of time. The chemist's glassware is graduated to this system. In order to become fluent in its use, it is merely necessary to forget a considerable number of long names applied to the useless number of units and thus boil the system down into workable form. The practical weights and measures of capacity are: 1,000 milligrams=1 gram=1 cubic centimeter of water; 1,000 grams=1 kilo (about 2 pounds)=1 liter of water (about a quart); 1,000 kilos (or liters of water)=1 metric ton (2,204 pounds avoirdupois).

It will be seen from the above that the kilo bears the same relation to the metric ton that 2 pounds does to the short ton of 2,000 pounds.

EXAMPLE.—It is desired to add to 100 grams of ore enough lime to make 2 pounds to the ton. Without stopping to "figure," weigh out 100 milligrams of lime. It is desired to make 5 liters of a 2-pound cyanide solution. Weigh out 5 grams of cyanide and add the water.

ORE TESTING WORK

The methods used by cyanide operators in making cyanide extraction tests vary considerably. Those herein suggested have stood the test of practice and when

are covered with a false bottom and canvas, and a strip of canvas should be tacked between the circumference of the hoop and the inside of the tub to prevent sand from washing under the false bottom.

If it is desired to test the rate at which an ore will leach, this can be accomplished in a percolator made of 6-inch wrought-iron pipe of sufficient height to hold the depth of ore that it is desired to charge into the mill vats. Ore charges for leaching are from 5 to 8 feet in depth, and occasionally as much as 10 feet, where large tonnage is required. The pipe percolator is rigidly secured to the wall by brackets, the bottom being closed by an ordinary pipe flange and plug, the plug being tapped for an outlet nipple and valve. The filter cloth is placed between the halves of the flange coupling and the edges are made tight by the flange bolts. The tailing is discharged by separating the flange.

Crusher and Grinder.—A laboratory crusher and also a grinder should be provided, even if for no other use than the ordinary assay work. When a busy assayer is obliged to get along without such conveniences, poor sampling is not an uncommon result. Laboratory crushers of either the Blake or Dodge type are used, but these machines when built in laboratory sizes have small capacity. In the mill sizes, the comparatively heavy pieces of ore usually fall from the jaws as soon as crushed, but the laboratory size has a tendency to choke, even on dry ore. The question of capacity is not of great importance in dealing with hand samples in ordinary work about a mine; but in testing ores, considerable quantities are required to be handled, and the case is quite different. A machine

grinder, shown in Fig. 4, the ore is ground by a rubbing between two flat disks. The moving disk revolves upon an axis that is given a gyratory motion to assist in the grinding and promote even wear of the disks. These machines will grind to 200 mesh, can be opened for cleaning without changing the set for fineness of grinding, and require very little space.

The Jones ore sampler will be found quite indispensable in ore-testing work.

Lime Water.—Take 200 grams of lime, slack in water by the aid of heat, add about 2 liters of water and mix. The clear solution is used, leaving the undissolved lime in the bottom. More of the solution may be obtained by adding water. This solution is useful in making up cyanide solutions for ore tests.

Prepared Lime.—Crush 500 grams of lime of good quality on the bucking board and pass it through an 80-mesh sieve. Roll it on the sample cloth and transfer to a salt-mouth (wide mouth) bottle that must be kept tightly corked. The alkaline strength of this lime should be determined, as lime often contains varying amounts of silica and other inert substances.

Alkaline Strength of Lime.—By the method about to be described, all the soluble alkalies and alkaline earths in the sample are reckoned as lime. Slack 1 gram of lime in a casserole by the aid of heat and mix it with 1 liter of distilled water. (Natural water of good quality may be made to answer the purpose by neutralizing with lime water until it strikes a pale pink color with phenolphthalein.) As 2 pounds of lime per ton of water has been added to the water, it is only necessary to titrate the mixture with H_2SO_4 test solution and compute the

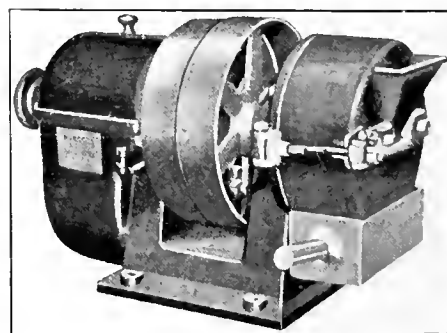

CLOSED

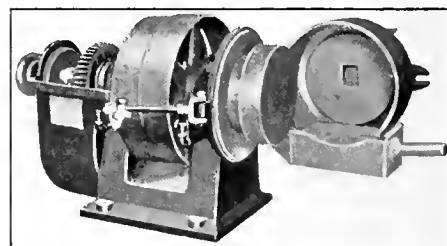

FIG. 4. PULVERIZER CLOSED AND OPEN

run alongside of mill work have been found to check quite closely. Some have a preference for percolation tests run in glass percolators of 1 pint to 1 quart capacity. These require more attention than agitation tests, but give good results on easily-treated ores. However, percolation tests

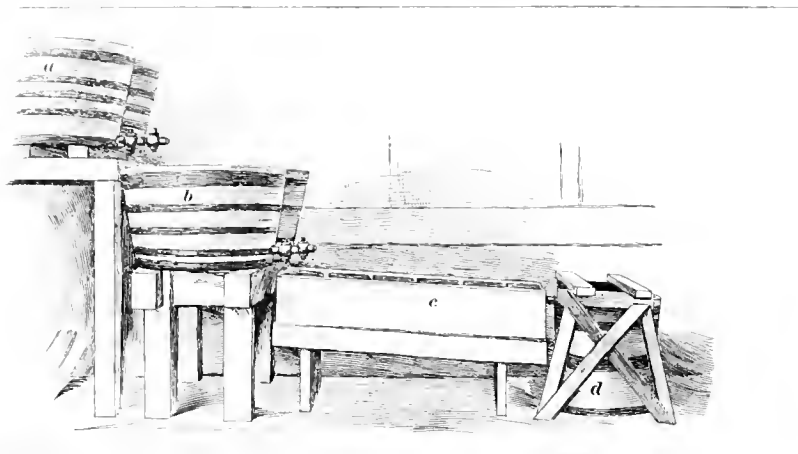

FIG. 3. TESTING PLANT

on some pyritous ores would be vitiated by allowing them to stand idle during the night, as of necessity one is obliged to do. Agitation tests require less time than percolation tests. They may be placed on the agitator near the close of the work period of the day, allowed to run 16 to 18 hours, and be ready for assay the next morning.

The Sample.—In preparing ore samples for testing, the ore should be kept as nearly as possible in the same condition in which it would be received at the mill. Drying is necessary in order to correctly estimate weights, but if the ore is to be crushed wet this may be omitted and the weight obtained from the moisture sample.

Artificial heat used in drying, even if quite moderate, is liable to cause marked changes in both pyritous and oxidized ores. Under the influence of warmth and moisture the pyrite is rapidly decomposed, ferrous compounds are oxidized to ferric, clayey material is partly dehydrated at quite a moderate dry heat, and in some cases the ore is changed so greatly as to render a test misleading. Samples may be thoroughly dried, and in mountain regions quite expeditiously, by exposing them in thin layers to air-currents of any ordinary temperature. Preliminary tests should be made on samples crushed moderately fine, say, to 40 mesh.

Making the Test.—Break 40 pounds of the ore to $\frac{1}{2}$ -inch size. With the sampler cut out 10 pounds and break to 10 mesh. From this cut $2\frac{1}{2}$ pounds and break this cut to 40 mesh, cutting from the 40-mesh ore a liberal sample for assay. The assay will determine the value of the entire lot. Assays in connection with ore testing should receive the same care and attention as bestowed on controls. The $\frac{1}{2}$ -inch and 10-mesh lots will be reserved for future consideration and attention will now be directed to the 40-mesh ore.

Test for Soluble Acidity.—Place 10 grams of the ore on a filter in a 3-inch funnel, wash with distilled water, adding the water a little at a time from a wash bottle, collecting the filtrate in a beaker. Titrate the filtrate with decinormal (one-tenth normal strength) $NaOH$ test solution, using phenolphthalein indicator. One cubic centimeter of decinormal $NaOH$ test solution is equivalent to .004891 gram of H_2SO_4 . The result of the titration may be computed thus:

Example. Suppose that 1.3 cubic centimeters of the $NaOH$ test solution was used. $1.3 \times .004891 \text{ gram} = .0063583 \text{ gram}$, the amount of acid (as H_2SO_4) washed out of the 10-gram sample by the water. Ten grams is $\frac{1}{100000}$ of a metric ton. The amount of acid in a ton of ore is therefore 100,000 times .0063583 gram, equal in round numbers to .6 kilo. A kilo per metric ton is the same as 2 pounds per short ton; therefore, if one desires to do his thinking in pounds he doubles the .6, making 1.2 pounds.

Ores do not usually contain enough

soluble acidity to make a preliminary water wash advisable, but this condition occurs when treating old tailing.

Test for Total Acidity.—Ores not yielding acidity to water often contain substances easily decomposed by an alkaline solution, thus containing considerable quantities of alkali. This is termed latent acidity. It is of little use to proceed with a cyanide test until these factors are determined. To determine total acidity, take two samples, 100 grams each, of the 40-mesh ore, and place each in a jar of the agitator. Prepare a clear solution of lime hydrate containing about 3 pounds of lime (CaO) per ton, and ascertain its strength by titrating 20 cubic centimeters. Place 500 cubic centimeters of this solution on one portion of the ore, and in the same manner prepare and place upon the other portion of ore a solution of about one-half the strength of the former. The reason for using five times as much solution as ore is to guard against any material drop in the strength of the solution during the test. At the end of 10 minutes titrate 20 cubic centimeters from each jar, also titrate at the end of 12 hours. In computing results, it must be remembered that, as there is five times as much solution as ore, the drop in the strength of the solution must be multiplied by five in order to indicate the amount of lime consumed per ton of ore. Fifty cubic centimeters may be used for the first and last titrations if greater accuracy is desired. The carbon dioxide in the air will consume some lime, but as that would occur in mill practice, no error is thereby introduced. If it is desired to know how much lime consumption is due to the air, the tests may be made in duplicate, one of the duplicates to be covered by the jar cap. It may be that the sample tested with the weaker solution will show a considerably lower lime consumption. This will give valuable information as to the total alkaline strength of cyanide solution to use.

Extraction Tests.—A test for gold extraction and cyanide consumption may now be made. Cut out and weigh into each of the six jars of the agitator 100 grams of the 40-mesh ore. Add a weighed amount of prepared lime to each charge. The lime consumption already determined will be a guide as to the amount of lime to add; but a different amount may be added to each charge, in order to note the effect of various amounts on the extraction. After the lime, add 500 cubic centimeters of cyanide solution varying in strength from 1 to 5 pounds of cyanide per ton, with protective alkalinity varying from $\frac{1}{2}$ to 2 pounds of lime per ton. Start the agitator and carefully record all the particulars of each test. After the agitator has been running 16 to 18 hours, decant the solutions from the jars, carefully titrate them, and record results, examining the solutions for reducing agents. Transfer the ore to filters in 6-inch

ribbed funnels and wash with water added in small portions, putting the washings into the solutions. Assay the solutions and dry and assay the several tailings. Study the record of each test. If the solution comes off with more protective alkali than it had at the beginning, it indicates that too much lime was added. If less, the reverse. Study the extraction and cyanide consumption; and if there is a material difference in the amount of cyanide consumed by the different tests, look for the probable cause and endeavor to make an improvement in the next series of tests.

After deciding the question of lime and solution strength, the matter of crushing may be gone into by means of samples crushed to various sizes from 10 to 150 mesh. Tests may be made on coarser material, if the appearance of the ore should warrant. The time of treatment beyond which no appreciable extraction occurs can be easily ascertained by putting on a number of like tests and taking them off after different intervals of time, up to 24 hours, remembering that the solution must be kept in proper condition. Do not be hasty in forming conclusions, but endeavor to verify the work by further experiment before accepting results. If there is reason to believe that reducing agents are interfering with extraction, a larger amount of solution may be used in the test and the jar may be tightly closed at intervals and vigorously shaken to incorporate air with the solution. At the end of the test note the effect when the solution is examined with $KMnO_4$. Air may be introduced into the solution during the entire time of the test in the following manner:

Aerating Device.—Procure a 60-gallon cask, set it on end, calk into the head a piece of $\frac{1}{2}$ -inch iron pipe reaching to the bottom head, having cut a notch across the bottom end of the pipe so that the cask bottom will not obstruct the opening. Insert a funnel in the top of the pipe and place it under a water supply. Screw a $\frac{1}{2}$ -inch gas-pipe nipple into the upper head of the cask. Water let into the cask through the funnel will force air through the nipple. Next, draw the end of a 3-foot piece of glass tubing to a fine point, placing the point of the tube in a jar of the agitator and reaching nearly to the bottom. By means of a flexible connection, secure the tubing near its other end so that the tube will be in line with the axis of rotation of the agitator. The pointed end of the tube will then easily follow the rotary movement of the jar. By means of a piece of rubber tubing, connect the glass tubing with the nipple in the head of the cask. To adjust the water coming into the cask so that the apparatus will run for a given length of time, hold a graduated cylinder under the stream above the funnel for 8.64 seconds ($\frac{1}{10000}$ of a day). Each 100 cubic centimeters of water caught in the cylinder represents a flow of 1 metric ton per 24-hour day.

Larger Tests.—After the agitation tests are concluded, leaching tests may be made in the tub plant, these tests to include precipitation of the gold upon the zinc shavings. Mechanical questions, such as the leachability of the ore, may be decided by the leaching tests. If there is doubt as to a fair leaching rate, the iron-pipe percolator may be used, being careful to fill the percolator in the same manner as the vat is proposed to be filled in mill practice—wet, semidry, or dry—to the end that the charge may have the same permeability. If the character of the ore is found to require separate treatment for sand and slime, the sand may be separated by panning. Pan in cyanide solution if it is proposed to crush in solution.

Concentration and Sizing Tests.—Ore may contain heavy minerals deleterious to cyanide, but become amenable to treatment after this mineral has been removed by concentration. Concentration tests are made by means of the miner's gold pan. As it is necessary to use the gold pan in order to make rapid and accurate sizing tests, concentrating and sizing will be described together. Weigh out 1 to 2 kilos of ore crushed to the proper mesh. Fill the panning tub about two-thirds full of water to which a little milk of lime has been added in order to settle slime. Place a convenient amount of ore in the pan, and with the pan dip some water from the tub and thoroughly wet the ore, breaking up lumps and slime with the fingers. Support the 200-mesh sieve across the top of the tub by means of two sticks, or, better, by a frame made for the purpose. Have plenty of water in the pan, holding it level and shaking it from side to side. Do not be in a hurry to begin panning off the lighter material. After the pan has been at rest for a few seconds it will be noticed that the sand has packed. Shake the pan vigorously from side to side and note the effect. The sand is partly in suspension under the water and the heavy mineral is working its way to the bottom. Note the difference in the feel of the pan when in motion. It is more easily moved, the sand not moving with the pan. If there is too much water in the pan the sand will be broken up and mix with the water, and the concentrate raised from the bottom of the pan. Repeat these operations until you have become a little familiar with them. You are not losing any time, as the grains of sand are being rubbed and scoured from adhering slime and fine particles of sulphide. If the ore is very slimy, use extreme care to prevent wasting away sulphides with the slime, as the slime has the effect of buoying up the finer particles of sulphides. After shaking the pan, hold it stationary for 2 or 3 seconds and then slowly pour the slimy water through the screen. If quite slimy, leave from one-half to one-third of the water in the pan above the sand. Dip more water into the pan and repeat these operations,

which may proceed more rapidly as the amount of slime in the pan decreases. The water in the tub will generally be sufficiently clear for panning, as the lime will flocculate the slime and cause it to settle rapidly to the bottom. The mineral is soon down under the sand and all the water above the sand may be drained from the pan each time the slime is poured into the sieve. Finally the water poured from the pan will be practically clear. The sieve is then lowered into the tub so that the wire cloth will be a little under the water, the side of the sieve is tapped by the hand, and all the 200-mesh material remaining in the sieve is made to pass through. The oversize remaining on the sieve is returned to the gold pan. The slime in the tub is poured into a bucket, where it rapidly subsides, and a considerable portion of the water may, by means of a rubber tube, be decanted back to the tub for reuse. After further decantation the slime is transferred to a pan and dried.

If it is desired to separate the concentrate it will be best to size the sand into two portions. To do this, place in another gold pan a sieve of such mesh as will divide the sand into two nearly equal portions.

SIZING OF M. H. NO. 54, JANUARY 24, 19—FROM PUZZLER MINE
Stamped to 12 mesh wire screen, No. 19 wire, the opening being approximately 20-mesh assayers sieve

Size of Mesh		Per Cent.	Assay	Total
	+ 20	1.8	\$14.00	\$.252
-- 20	+ 40	22.2	12.40	2.753
-- 40	+ 80	24.0	12.40	2.976
-- 80	+100	7.0	11.60	.812
--100	+200	8.0	12.80	1.024
--200		31.0	14.40	4.464
Concentrate		6.0	96.80	5.808
Heading assay, \$18.40		100.0		\$18.089

Pour water into the second pan to a depth of 1½ inches; place the sand upon the sieve a portion at a time, and by tapping and moving the sieve under the water, cause the finer sand to pass through. The two portions of sand are then separately panned, the operation being somewhat different from that described for the slime. The pan is shaken from side to side with a convenient amount of water, the operator tilting the pan from himself near the end of the operation so that the water nearly escapes over the edge of the pan. In panning off the sand the pan is more slowly moved from side to side while the water and lighter sand is running over the edge, the operation being assisted by the wave-like motion of the water from side to side, while the greater portion of the sand settles or "packs" in the pan. More water is added, and the shaking repeated until the sand is again in suspension and more of the gangue is panned off. No attempt should be made to separate the last portion of the gangue, as it will result in loss of mineral. The mineral remaining in the gold pan is washed into a small drying pan, and the sand again panned to make sure that no considerable

amount of mineral has been panned over. After both sizes of sand have been panned, the sand and the mineral are separately dried. Only a very moderate degree of heat should be used in drying sulphides. The nest of sieves is arranged with the coarsest uppermost and the dried sand screened. A small scorifier placed in the uppermost sieve causes the wire cloth to vibrate as the sieve is shaken and greatly assists the operation. The sieves are taken off one by one and the scorifier transferred to the next lower as the operation proceeds. The material passing the last sieve and found in the pan bottom is added to the dried slime unless it is desired that it should be weighed separately. The concentrates and the different sizes are weighed and the percentage of each calculated. If it is attempted to size without first separating the slime, it will be found that a large amount of clayey material will adhere to the coarser particles, besides the passing of the finer particles through the 200-mesh sieve after drying will be extremely laborious. The following example from actual practice illustrates a good method of tabulating the results of a sizing or concentration test:

The column headed "total" is derived by multiplying the assay by the per cent. The assay of the different sizes shows that the ore was crushed to the right screen. A very little mineral was seen embedded in the +20 sand, which accounts for its slightly higher assay, \$14. The remaining sand appeared white and clean. The higher assay of the -200 is accounted for by a little sulphide being panned off with the slime. As such losses always occur in concentrating mills, this does not introduce any error. A concentrate assaying \$96.80 per ton was obtained, making a recovery of \$5.80 from an \$18-ore by concentration. Before methods were found for the treatment of ore after the free gold and concentrate had been recovered, large amounts of gold were allowed to go to waste in the tailing.

Separate Treatment.—Tests on comparatively large lots may be made by panning off the slime and leaching the sand, while the slime may be treated by repeated agitation and decantation with fresh portions of solution that may afterwards be passed through the sand. In making percolation tests it is best to keep the solution moving

during the greater part of the time. To this end there should be sufficient solution above the leaching vessel at the end of the day and the leaching rate so regulated that it will run for a greater portion of the night. The ore should be kept covered with solution during the leaching. A good method of accomplishing this is to fill a 10-gallon tin can with solution and support it in an inverted position over the leaching tub, with its mouth just below the surface of the solution covering the ore, the can being partly closed by a stopper having a hole in it. As soon as the solution falls below the opening, air will enter the can, allowing a small portion of solution to run out. More than one of these cans may be used in the same vat if necessary. The rapidity of leaching is regulated by means of the valve outlet of the leaching tub.

Coarse Crushing.—If the ore is amenable to treatment at a coarse mesh, say, $\frac{1}{2}$ - to $\frac{1}{2}$ -inch size, it will not be necessary to separate the slime, provided the ore is crushed dry, but it need not be dried artificially. Some ore is successfully treated in this manner as it comes from the mine, containing quite an amount of moisture. The first solution is always put on from the bottom, which generally flocculates the slime-forming material so that no slime afterwards comes down upon the canvas filter. After preliminary agitation tests, it is always best to make leaching tests on coarsely-crushed ore, taking sufficiently large tailing samples to be certain of the percentage of extraction.

Modifications.—Laboratory extraction tests may be modified in a great variety of ways to suit special requirements. The operator must, to a considerable extent, decide for himself on these modifications; and in order to be successful he must have some originality and a knack for investigation and research. The outline here given is not expected to be followed in every detail, but as a general guide to a practical knowledge of the subject, which can only be gained by experience.

ROASTING TREATMENT OF CONCENTRATE

Ores containing gold in combination with tellurium and antimony are benefited by a preliminary roasting operation, as the loss of cyanide is thereby reduced and the extraction of gold is increased. In the Cripple Creek district, Colo., most of the telluride ores are unsuitable for cyaniding until after roasting, when a high extraction of gold has been obtained with a small consumption of cyanide. In some places, concentrates and pyritic ores that could not be treated economically in the raw state have been successfully treated after a dead roast. Roasting has the effect of decreasing the cyanicides in the ore by volatilization and oxidation. It seems also to break up refractory ore particles by freeing the gold, and to render the material more permeable to cyanide solutions.

As this method has been tested, by the method described, for total extraction and consumption of cyanide, if the extraction is low, further roasting is tried; and, if the result is not satisfactory, the difficulty may be corrected by roasting. The sulphur-bearing ores of Kalgoorlie, West Australia, are first roasted and then ground in Wheeler pans.

Treatment of Concentrate.—Concentrate containing pyrite should be ground to slime and treated by agitation, if it will yield extraction without roasting. If the concentrate contains amalgam or coarse gold, this should be removed by means of a small amalgamating plate or like device, placed between the regrinding machine and the agitator. Some concentrate requires roasting in order to prepare it for cyanidation. The economy of doing this in preference to roasting the entire bulk of the ore is apparent.

Vacuum Filter Tests.—The leaf about to be described is of standard construction and will be found to answer general laboratory requirements. Make a frame of wood 12 in. \times 12 in. inside. The top strip of the frame should be $1\frac{1}{2}$ in. \times $\frac{3}{4}$ in., and the sides and bottom $\frac{3}{4}$ in. \times $\frac{3}{4}$ in. Cover this frame on both sides with No. 8 cotton duck, stitching the two thicknesses of duck together by eight vertical seams $1\frac{1}{2}$ inches apart, reaching to within $\frac{1}{4}$ inch of the inner edges of the frame. The two outermost seams will be about $\frac{3}{4}$ inch from the side pieces of the frame. In the pockets between these stitchings, slip $\frac{3}{8}$ " \times $\frac{3}{8}$ " square sticks short enough to easily go inside the frame, leaving the stick out of the center pocket. Pass through the top frame and center pocket a piece of $\frac{1}{2}$ -inch wrought-iron gas pipe, cutting some notches in the lower open end of the pipe so that it will not choke where it rests on the lower frame strip. Make an air-tight joint where the pipe passes through the upper frame strip, by means of lock-nuts and packing. Securely tack the canvas to the frame, lapping the two pieces on the outside of the frame. Cover and saturate the canvas with paraffin paint or shellac varnish where it comes in contact with the frame so that no cake will form on that portion. The filtering area will then be exactly 2 square feet. To the top of the pipe attach a small hose capable of withstanding a vacuum and attach to a receiver and air pump. If an accurate vacuum gauge is not at hand, attach a glass mercury tube to the suction hose and count the vacuum in inches of mercury. Have three vessels, one for the slime pulp provided with agitation, one for cyanide solution, and one for wash water. Run the pulp from the agitator into the first vessel and put in the filter leaf, keeping it all the time under the pulp and the vacuum in operation, and keep up enough agitation to prevent settling. Record the time and vacuum required to build a cake 1 inch in thick-

ness. Remove to the cyanide solution, and draw through the cake twice as much solution as its contained moisture. Remove to the wash water, and draw through it half as much water as was drawn off the cyanide solution. If the leaf is kept entirely submerged the amount of wash drawn through can be known by measuring the fall of liquid in the vessel. If compressed air is not convenient, the cake may be blown off with water, using a pressure of not more than 10 pounds per square inch. On drying the discharged cake, its weight will give a basis on which to compute tonnage capacity. Diffusion loss in the wash water can be approximately determined by boiling down all the wash water left in the vessel after several cakes are washed and assaying as a solution assay, computing the result to the amount of dry slime washed. In order to more closely approach mill conditions, the solution wash may contain about 10 cents gold per ton. Diffusion into the wash solution is not serious, if known and the losses are guarded against by occasionally pumping out the wash vats and changing the solution. Experience seems to indicate that different ores present quite a wide difference in this respect.

(To be continued)

采 采

Eucalyptus Oil for Ore Dressing

According to the United States Consul at Hobart, Tasmania, local prices for eucalyptus oil have lately shown an advancing tendency, due, it is understood, to the demand which has arisen for the lower grades of such oil in concentrating sulphides of lead and zinc in Australia.

Eucalyptus-oil distillers are selling all the lower grades of oil to ore mills. Tasmanian eucalyptus oil utilized in milling may be obtained easily from all kinds of eucalyptus leaves, but the leaves of the peppermint gum are at present the chief source of supply. This oil is selling for 16 to 20 cents per pound. It seems possible that its preparation may become an important by-product of the Tasmanian timber industry, and it is already announced that a mill for its extraction is to be erected at Scotsdale in northern Tasmania. The December (1911) issue of the *Australian Journal of Pharmacy* makes the following reference to this interesting use of eucalyptus oil:

"Enormous quantities of oil have been consumed in the mining districts in the processes of preparing sulphides of zinc and lead. About one-half pound of oil is emulsified by vigorously shaking it up with 100 gallons of water, and with this mixture the moistened or powdered ore is stirred up. The eucalyptus oil floats the sulphide particles and carries them to the surface, together with the gold and silver contained in them."

Power Consumption of Hoisting Plants

Relative Economies of Steam, Air, and Electric Hoists—Tests of Electric Hoists Under Varying Conditions

By S. W. Sykes. (Concluded from August)

IN the case of electrically driven hoists, the efficiency is not as a rule very much affected by the method of operation, especially in the case of large hoists with voltage control. It is therefore more or less immaterial whether the operator is highly trained or not, so long as he has sufficient intelligence to op-

erate the hoist in such a way as to obtain output and avoid accidents. This is due to steam leakage and condensation in the engine, brakes, etc., and also to the method of handling.

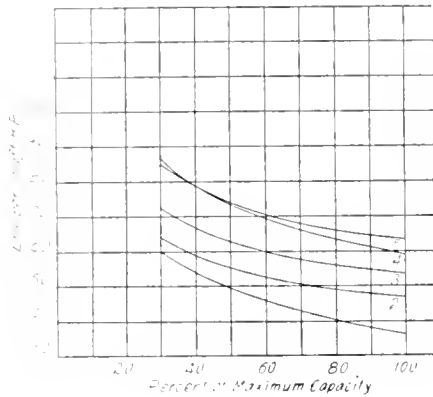

FIG. 8

erate the hoist in such a way as to obtain output and avoid accidents. In the case of steam hoists conditions are different, as it is possible by unskilled operation to very materially affect the economy. As already pointed out, the economy of a steam hoist is affected to a great extent by the steam pipe, which, for all practical purposes, should be considered as part of the hoist. The economy of a steam hoist is, as a rule, affected more by the proportion between the average duty and maximum capacity than electric hoists, even when the flywheel motor-generator system is used. This is due to the conditions limiting the design of steam hoists and the economical operation while running.

An essential condition of a steam hoist is that it must start with the most unfavorable crank position. It is therefore necessary to use two cranks at 90 degrees to avoid dead centers, and generally the cylinders must be designed so that each is capable of exerting the maximum torque required to start. The consequence is that the engine is very large for the average work it must perform, and were it not for the starting conditions the result would be the equivalent of running an engine on very light load. At starting it is necessary to admit steam practically the whole of the stroke, and if the accelerating period is a large percentage of the time that steam is on the engine, it is obvious that the consumption will be high.

The steam hoist for main shaft hoisting has been greatly improved during the

last few years, and with modern valve arrangements and favorable steam conditions, reasonable steam consumptions are obtainable. The great majority of hoists, however, are very uneconomical, owing to the lack of refinement in design, and they cannot be taken as representative of what can be accomplished. In Fig. 8 is shown the results of a number of tests on engines working under different conditions, these tests being made on engines which may be taken as representations of modern practice.

Curve 4 shows a test on a double tandem-compound hoisting engine, working with steam at 135 pounds per square inch non-condensing. In this case, the mine was not operating at the full depth and the engine was, consequently, somewhat too large.

Curve 1 shows an engine operating with considerable superheat and a moderate vacuum. The engine is working at about the conditions for which it was designed, and this is probably as low a steam consumption as can be obtained under working conditions.

Curve 2 shows a hoist working non-condensing, with saturated steam, at about the conditions for which it was designed; and it should be noted that this hoist has only a simple engine, but its economy is better than that of the double tandem-compound engine, shown by curve 4. This is due to the load being nearer to the designed capacity, and it shows the waste caused by a hoist that is too large for the work.

The result shown in curve 5 represent very closely the average steam consumption of the usual type of simple hoist engine with a Corliss valve gear. This hoist was working at its designed capacity and is considered a first-class equipment, although it is about 6 years old. The curves 1 and 2 show considerably better results than usually obtained, and could be only duplicated under very favorable conditions with the latest design of engines.

Curves 1, 2, 4, and 5 show steam actually used by the engine.

Curve 3 shows the steam consumption of the machine covered by curve 2, including the loss in a pipe line 340 feet long, 12 inches in diameter, protected with ordinary insulating materials, and it will be seen that this loss is very considerable. It will be noticed that all of the curves show an increased consumption when the hoist is worked

below full capacity. This is due to steam leakage and condensation in the engine, brakes, etc., and also to the method of handling. Under the conditions shown in curve 1, which indicates the steam consumption of 37 pounds per shaft horsepower at full capacity, an electric hoist of the flywheel motor-generator type, could be operated with a steam consumption at the generating plant of about 25 pounds per shaft horsepower hour.

Air Hoists.—The number of installations of air hoists is not very great, nor is it possible to obtain very much information regarding them. In Fig. 9, however, is shown some test results for an air hoist, operated by an electrically driven compressor, the compressor being provided with unloading devices and suitable receivers. It will be seen that the loss is very considerable and at the lower loads, the power consumption is very much in excess of the figures shown in the flywheel motor-generator set, Fig. 7. Very extravagant claims have been made for various systems of air hoists, but no information has been published that would justify the statements. It is quite possible to show that under certain conditions such hoists are economical, but practical results do not confirm these statements.

Summary.—It is impossible to draw any general conclusion as to the comparative cost of hoisting with different systems, as it is altogether controlled by local conditions, but the curves that have been given indicate to some extent

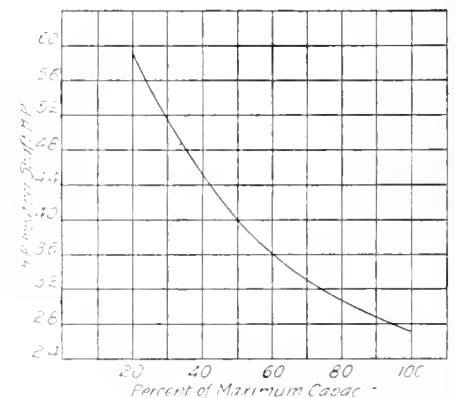

FIG. 9

the bases on which such comparisons can be made. The features affecting the economy of electric hoists have been considered in some detail so as to show the lines along which new installations should be designed to obtain best results.

There is one characteristic of the electric hoist that is of considerable importance from an operating standpoint; that is, the efficiency does not change with

the age of the installation, except, perhaps, a little on account of wear of gears, etc. This is not the case with steam and air hoists, as constant attention is necessary to prevent leakage in pipes, valves, etc., and as a rule there is always more or less loss in this way. After a plant has been in operation for a few years, it is usually found that the economy has been materially reduced, except in a few cases where very great attention is given to maintenance, which is not the rule. Where air hoists are used it is practically impossible to maintain the piping free from leaks, and unless the leak is a bad one it is not discovered. The same applies to steam pipes to a lesser degree, but it must be remembered that each joint is a potential if not actual point of leakage. With steam lines, each foot of pipe is a source of loss due to condensation. The question of maintenance has not been discussed, as this is usually a matter of local conditions, but the figures given will indicate, in general, the bases on which cost estimates may be made.

來 來

Formation of Magmas

By Eugene B. Wilson

About 13 years ago one of the best geologists of our time stated that it was almost criminal to advance the ideas submitted in this paper. However pre-conception is as difficult to eradicate in this instance as in the case of observers who have absorbed ideas to which they endeavor to make the genesis of ore deposits conform.

Both Moses and David use the word Heaven before the word earth and as the fourth commandment was given direct to Moses, many accept the nebular hypothesis as the origin of the earth. This supposes that our planet in conjunction with the whole solar system originated in the separation and condensation of a small part of an enormous nebula or cloudy mass of vapors and gases, like the faint luminous star clouds which may be observed on clear dark nights. It also presumes that when any portion of those vapors and gases was thrown off or detached from the whole mass it began to arrange and consolidate as a globe.

Geologists, as a rule, have assumed that in the beginning the earth was a molten mass that cooled gradually until it became fit for the habitation of man. It is difficult to reconcile this assumption with the nebular hypothesis, or with the rocks that compose the basement complex. Vapors would not condense in burning material and certainly granite shows no sign of vulcanism, while it does show that it was a comparatively cool plastic magma to which the word plutonic has

been assigned to distinguish it from slag or dry-heat formation.

This argument is apparently strengthened by the chemical law that the heat of formation is equivalent to the heat of separation, and from the fact that the minerals composing granite retain their water of crystallization, which, had vulcanism played a part, would have been impossible. Evidently the chemical heat of formation was gradually dissipated after the reactions ceased and then the earth formed a gigantic plastic magma. At the time the earth was forming there must have been moisture in abundance, and undoubtedly the mother liquor of the magma was hot, owing entirely, however, to wet chemical reactions.

Astronomers state that the sun shows indications of dry heat, also that it contains metals similar to those on the earth. However, our planet shows no past indications of heat other than can be duplicated by dynamic and chemical forces. The volcanic appearance of some rocks influenced the early geologists to assume as a starting point that the earth was originally a fiery mass, and this assumption was strengthened by active volcanoes erupting fluid material that glowed on reaching the atmosphere. It is believed that geologists now discredit this theory, because similar phenomena can be reproduced on a small scale by chemical reactions, which with pressure will superheat a mass; and further, active volcanoes and eruptions discredit vulcanism or dry heat.

A close examination of the so-called igneous rocks of the eruptive class will disclose that their surfaces are glassy or slaggy where they have been exposed to the atmosphere, while their interiors show them to have been formed by wet heat. If the theory of vulcanism or dry-heat formation of the earth be rejected, and aqueo-igneous fusion as it is observed in natural eruptions substituted, it is possible to establish the hypothetical formation of magmas as herein outlined.

Geologists state that granite is the basement complex or primary rock from which other rocks were formed. They call it plutonic, meaning thereby it was deep seated and cooled slowly under pressure. That granite was formed by aqueo-igneous fusion is evident from the water of crystallization in the minerals composing it. Fissures in sedimentary rocks sometimes show intrinsic granites with angular pieces of the sedimentaries engulfed in it.

If the foregoing enunciation coincides with observed geological conditions, then the theory of formation of magmas depends for synthetical explanation upon the basement complex being the parent magma from which two other magmas were formed under widely varying con-

ditions. These three magmas are named and defined as follows:

1. *Aqueo-Igneous Magma*.—This kind of magma formed rocks through the heat produced by chemical reactions augmented by pressure. Magmatic solution or mother liquor was a strong factor in the operation. Magmas of this kind produced the basement complex and later eruptive rocks.

According to J. D. Dana, all rock crystals contain on an average of 2.5 per cent. of water of crystallization, and, in addition, rocks in the zone of fracture contain quarry water. It is reasonable to presume that the heated magmatic solutions which were capable of forming and segregating rock minerals were equally capable of forming and separating metallic minerals and disseminating them through the magma as individual crystals. This segregation is typical of aqueo-igneous magmas whether of the basement complex or the Tertiary eruptive rocks, and will be noticed to some extent in aqueo-organic magmas; in fact it is "first concentration."

2. *Aqueo-Organic Magma*.—This magma had its origin in organisms that lived in water, and which afterwards were made plastic and consolidated by pressure. In the crystalline limestones of the early series, heat and magmatic solutions played their part. The oldest limestone, probably Cambrian (locally known as MacAfee limestone in New Jersey), is white and crystalline with scales of graphite here and there. It is found in juxtaposition with a magmatic deposit of Franklinite, a mineral that is magnetic and composed of iron, manganese, and zinc oxides. Daubrée states that Franklinite can be produced artificially by the action of perchloride of iron and chloride of zinc on lime, with heat as an adjunct.

Knox dolomite, a Cambrio-Silurian limestone, contains disseminated crystals of galena, sphalerite, and pyrite, and sometimes segregated crystals. From the similarity in which the metallic minerals are found in the aqueo-igneous and aqueo-organic magmas they are considered as minerals of first concentration, although metallic minerals of second concentration are found in connection with aqueo-organic magmas that have weathered.

3. *Aqueo-Magma*.—This kind of magma includes sedimentary deposits such as salt and gypsum, sandstone and slate. The former two were formed from supersaturation of aqueous solutions. The latter are fragmentary, yet evidently laid down by water, consolidated by pressure, and cemented by colloidal substances that afterwards hardened. Rocks of the aqueo-magmatic class carry ore deposits of second concentration and sometimes of third concentration.

New University Mining Laboratory

It is stated by H. H. Stock, Professor of Mining Engineering, that the University of Illinois is just completing a mining laboratory 100 feet long by 42 feet wide, divided into two equal sections; one for the treatment of ores and one for the washing of coal. The building also includes sample crushers and screens and two steel sampling floors, one for ore, and one for coal.

The crushed material is elevated in a 15"×20" continuous carrier equipped to dump automatically along the upper run into any one of a row of steel bins, each holding 5 tons. Beneath these bins is an automatic traveling scale through which the material is delivered to any one of the screens or the washing or concentrating appliances. On the coal side there is a Holmes Brothers shaking screen and a Webster revolving screen, each fitted to separate four sizes and each about 13 feet long. On the ore side is a vibrating screen. Beneath each of these screens is a set of bins from which the screened material is taken in wheelbarrows to a dormant scale and then delivered to the lower run of the carrier which elevates it to the upper tier of bins. Through the automatic traveling scale the coal is delivered to an American Concentrator jig or to a Stewart jig. A Luhrig jig and a Jeffrey-Robinson cone washer will be added later. The washed coal is delivered into a 1,300-gallon settling tank, from which it is elevated by a Webster bucket elevator to an overhead bin and from thence by carrier delivered to a bin outside the building, from which it is carted away to the boiler plant. The coal side of the laboratory has a capacity of 5 tons per hour.

On the ore side the material may also be crushed in a stamp battery. The fine screened ore is mixed with water and delivered by a centrifugal sand pump to a three-compartment classifier, the products from which go to a 6-foot vanner, an 11-foot concentrating table, and a buddle. These three machines deliver to four pointed tanks, beneath which are drying tables.

In an adjoining room is a completely equipped chemical laboratory and assay room for carrying on such tests as are required in the concentration of ores and the washing of coal. The equipment also includes an assortment of hand jigs, classifiers, a spiral separator, a small Jeffrey-Robinson tub, and a small laboratory concentrating plant.

The Mining Department is also equipping a new blasting and explosives laboratory, a rock drilling and coal cutting laboratory, and is building a new rescue station for giving training with oxygen helmets and other rescue appliances.

The offices, drafting rooms, library, and recitation rooms of the Mining Department are located in the new Engineering Building, which will be ready for occupancy September 15. In this building there is also a completely equipped laboratory for the study of mine gases and safety lamps.

Beginning with the collegiate year the Mining Department of the University of Illinois will have a complete equipment for teaching all branches of mining engineering.

來 來

Society Meetings

The International Geological Congress, on the joint invitation of the Government of Canada, the Provincial Governments, the Department of Mines, and the Canadian Mining Institute, will hold its twelfth meeting in Canada during the summer of 1913. It is proposed to hold the meeting of the Congress in Toronto, beginning on or about August 21, and continuing the session 8 days. Prior to and after the session there will be excursions to various parts of Canada. For further information address W. Stanley Lecky, A. R. S. M., Victoria Memorial Museum, Ottawa, Can.

The opening meeting of the Eighth International Congress of Applied Chemistry will occur in Washington, D. C., September 4, the other meetings, business and scientific, in New York, beginning Friday, September 6, 1912, and ending September 13, 1912. Visiting members will register at Chemists' Club, 52 East Forty-first Street, New York City.

Canadian Mining Institute will hold a meeting in Victoria, B. C., on September 18 and 19. The main object of this meeting is to afford Western members the opportunity of expressing their views on a number of questions relating to the business affairs of the Institute, including proposed amendments to the by-laws and other questions of present importance. One or more sessions will be devoted to the reading and discussion of papers; and members proposing to contribute to the program are invited to communicate at once either with Mr. E. Jacobs, secretary of the Western Branch, Victoria, B. C., or with the secretary of the Institute. Arrangements are also being made for a meeting at Lethbridge, Alberta, of which further particulars will be issued later.

James F. Callbreath, Secretary of the American Mining Congress, has opened offices at 602-3 Munsey Building, Washington, D. C., where members of the Congress and mining men generally may always feel welcome. The headquarters of the Congress will remain, as heretofore, in Denver, Colo. Subsidiary or-

ganizations, known as Chapters, are now operating in Alaska, Arizona, Colorado, Oregon, Utah, and Washington, while there are also the Southwestern Lead and Zinc Chapter and the Wisconsin-Illinois Zinc Chapter.

來 · 來

Books Received

UNITED STATES GEOLOGICAL SURVEY PUBLICATIONS, Washington, D. C. Bulletin No. 506, Geology and Mineral Resources of the Peoria Quadrangle, Illinois, by J. A. Udden; Bulletin No. 516, Results of Spirit Leveling in Florida, 1911, by R. B. Marshall, Chief Geographer; Bulletin No. 520-C, The Lower Copper River Basin, Alaska, The Taral and Bremner Districts, The Chitna District, by Fred H. Moffit; Bulletin No. 520-D, Gold Deposits Near Valdez, Alaska, by Alfred H. Brooks; Bulletin No. 520-E, Gold Deposits of the Seward-Sunrise Region, Kenai Peninsula, Alaska, by Bertrand L. Johnson; Bulletin No. 520-F, Gold Placers of the Yentna District, Alaska, by Stephen R. Capps; Bulletin No. 520-H, Mining and Water Supply of Forty-mile, Seventy-mile, Circle, and Fairbanks Districts, Alaska, in 1911, by E. A. Porter and C. E. Ellsworth; Bulletin No. 520-I, Rampart and Hot Springs Regions, Alaska, by H. M. Eakin; Bulletin No. 520-J, The Ruby Placer District, Alaska, by A. G. Maddren; Bulletin No. 520-L, The Alatna-Noatak Region, Alaska, by Philip S. Smith; Bulletin No. 530-C, The Turquoise Copper Mining District, Arizona, by F. L. Ransome; Bulletin No. 530-I, Notes on the Clays of Delaware, by G. C. Matson; Clay in the Portland Region, Maine, by F. J. Katz; Bulletin No. 530-K, Vanadium Deposits in Colorado, Utah, and New Mexico, by Frank L. Hess; The Production of Salt and Bromine in 1911, by W. C. Phalen; The Production of Antimony, Arsenic, Bismuth, and Selenium in 1911, by Frank L. Hess; The Production of Manganese and Manganiferous Ores in 1911, by Ernest F. Burchard; The Production of Borax in 1911, by Charles G. Yale and Hoyt S. Gale; The Production of Barytes in 1911, with a note on Strontium Ore and Salts, by W. C. Phalen; The Production of Mineral Paints in 1911, by W. C. Phalen; The Cement Industry in the United States in 1911, by Ernest F. Burchard.

UNITED STATES DEPARTMENT OF AGRICULTURE, Washington, D. C. Bulletin No. 107, The Preservation of Mine Timbers, by E. W. Peters.

DEPARTMENT OF MINES, Mines Branch, Eugene Haanel, Ph. D., Director, Ottawa, Can. Bulletin No. 6, Diamond Drilling at Point Mainainc, Province of Ontario, by Alfred C. Lane, Ph. D.; Mica, Its Occurrence, Exploitation, and Uses, Second Edition, by Hugh S. De Schmid, M. E.

Mines and Minerals

Vol. XXXIII.—No. 3.

SCRANTON, PA.—OCTOBER, 1912—DENVER, COLO.

Price, 25 Cents

PUBLISHED MONTHLY AT SCRANTON, PA.

ESTABLISHED 1881

INTERNATIONAL TEXTBOOK CO., PUBLISHERS

T. J. FOSTER, President S. P. ALLEN, Secretary E. H. LAWALL, Treasurer

RUFUS J. FOSTER, Vice-President and Manager

EUGENE B. WILSON, Editor ARTHUR J. HOSKIN, Associate Editor

WESTERN EDITORIAL OFFICE: 1221-1222 First Nat'l Bank Bldg., Denver, Colo.

CHICAGO OFFICE: 1006 Michigan Ave.

Entered at the Post Office at Scranton, Pa., as second-class matter

Address all business communications to MINES AND MINERALS, Scranton, Pa.

CABLE ADDRESS, "RETSOF, SCRANTON"

LONDON OFFICE: INTERNATIONAL BUILDINGS, KINGSWAY, LONDON, W. C.

SOUTH AFRICAN OFFICE: MANSION HOUSE CHAMBERS, ALDERLEY STREET, CAPE TOWN.

NEW ZEALAND OFFICE: 63 DIXON STREET, WELLINGTON.

AUSTRALIAN OFFICE: 83 PITT STREET, SYDNEY.

SUBSCRIPTION RATES

Single Copies.....25 cents

Yearly Subscription, including postage:

To United States, Mexico, Cuba, Porto Rico, Hawaii, and Philippines.....\$2.00

To Canada.....2.50

To all other countries.....3.00

The date after your name on the wrapper is that of the month to which your subscription has been paid. If you do not want to continue your subscription after that time, kindly notify us.

Notice to discontinue or change of address should be sent to the Scranton office.

When notifying us of a change of address always give your FORMER as well as your present address.

TABLE OF CONTENTS

Editorial—	
Editorial Notes—Car Shortage Likely—The Cause and Prevention of Mine Accidents—Bulletin No. 47—Coke, Oil, and Patriotism—Dust Explosions	117
Personals	120
Kentucky Coal Mines, 1911.....	120
COAL MINING AND PREPARATION	
Buckner No. 2 Mine, by Warrent Roberts and Oscar Cartledge.....	121
Correction	125
Early Dust Explosions	126
Gas Ignition by Tungsten Filament Electric Lamp.....	126
Lake Superior Mining Institute	127
Illinois State Inspectors of Mines.....	129
Fireproof Shaft, Vermillion Mine, by A. F. Allard.....	130
Answers to Examination Questions—	
Utah Mine Foremen's, 1911 (Continued).....	132
Waste Heat Coke Ovens, by Sim Reynolds.....	135
Air-Compressor Cylinder Lubrication, by A. L. Christian.....	136
Publications on Mine Accidents and Tests of Explosives.....	138
Automatic Blocks for Inclines, by Simon H. Ash.....	138
The Classification of Coal, by Leonard V. Newton.....	139
Moistening Mine Ventilating Currents, by A. A. Steel.....	141
Production of Coke in Kentucky.....	143
Correspondence—	
Rock Dump Wanted—Conveyer System for Mining Coal—British Electric Mining Lamp Contest—Personal Views Re Affairs American Institute of Mining Engineers	144
Increasing the Efficiency of the Fire Boss, by Bert Lloyd.....	145
Coal Mine Accidents in Pennsylvania.....	146
ORE MINING AND METALLURGY	
Revival of Mining at Red Cliff, by A. J. Hoskin.....	147
Economical Shaft Sinking, by Mark B. Kerr.....	151
Tennessee Phosphate Practice, by James Allen Barr.....	152
Brakpan Mines, Ltd., by H. S. Güler.....	156
The Smoke Problem	158
Shaft Upraising Profitable, by L. L. Wittich.....	159
Concentration at the Butte and Superior Mill.....	160
Churn Drill Examination of Placers, by James E. Dick.....	161
A Field Inkstand, by E. J. Henkhe.....	164
Obituary—	
Thomas Lane Carter—George W. McClure—W. W. Tweedale	164
Practical Cyaniding—Part 3, by John Randall.....	165
Domestic Camp Science	168
Notes on Mine Surveying, by H. G. Henderson.....	169
Recent Jig Design, by Roy Reddie.....	170
Direct Current Turbo-Generators, by J. C. McQuiston.....	172
Trade Notices	173
Book Review	173
The National Forests	173
Sapphire Mines of Northern Kashmir, by J. Godwin.....	174
Squibs—	
Lord Kelvin's Memorial, 120—State Coal Mine, 134—Adiabatic and Isothermal Air Compression, 134—Receivers of Air Compressors, 137—Michigan Coal Statistics, 140—American Red Cross, 140—First Permissible Explosives, 145—Bessemer Iron Ore, 151—Normal Volumetric Solutions, 155—Antimony Ores, 155—Antimony, 160—First Test of Gatun Lock Gate, 164—Zinc and Lead, 168—California Oil in Peru, 171—New Calendar	173

OUR cover design shows one of the richest placer deposits ever found in Alaska, on Little Creek near Nome, on Seward Peninsula. The frozen ground was mined below the surface during the winter by the aid of steam, after which it was hoisted and stacked in the piles shown. When the sun commenced to thaw the piles in summer, and so furnish water, scrapers and horses were used to carry the gold-bearing dirt to the sluice boxes, in which dirt and gold were separated.

來 來

THE price of silver, which has reached 62.5 cents per ounce, has created a revival of prospecting in the Cobalt district. Several prospects are being opened with a view to bringing them to the producing stage, among which are the John Black, Ophir, Columbus, Cochrane, Airgold, King Edward, and the 20th Century. The Cobalt-Central is now being worked under the name of the Penn-Canadian Mining Co., a number of Pennsylvania shareholders having purchased the old company and incorporated under a new name.

來 來

IF the United States Bureau of Mines will close its "Press Agency," cease making spectacular exhibitions at Bruceton to prove what practical mining men know, and will make some effort to get at facts regarding waste in mining by other means than by relying on ancient history, and will be fair enough to concede that American mine managers and mining engineers are possessed of a modicum of sense which impels them to true conservation in both life and property, it may in the course of time live down the reputation it has earned during the past two years, and begin to be of some real value.

來 來

WITH a limited area from which to mine it, and a possible production that will be from 10,000,000 to 12,000,000 tons less than the probable demand for this year, plus higher wages paid the mine workers, and yearly increasing cost of production due to the gradual exhaustion of the most cheaply mined coal, prices of anthracite are bound to increase. Notwithstanding the opinions of editors who have never seen an anthracite mining plant and political demagogues who talk for effect, the price of anthracite coal as fixed by the producers is based on cost of production plus a fair profit. If based entirely on the law of supply and demand profits could be greatly increased this year. Years ago when the supply exceeded the demand and operators and mining corporations were bankrupted by the low prices

at which coal was sold, uninformed and sometimes venal newspaper and magazine writers were just as persistent in their abuse of the mine operators as they are today. It would certainly be a sign of the near approach of the millenium if the truth regarding the commercial side of the anthracite industry was occasionally published in periodicals other than those specifically devoted to mining matters.

來 來

Car Shortage Likely

MINES AND MINERALS has been requested by officials of the Pennsylvania Railroad to state that railroad facilities are taxed to the utmost, and to request shippers of mineral products to cooperate with railroads to prevent car shortage and congestion of traffic. This can be accomplished if there is prompt loading and unloading of cars.

W. A. Garrett, Chairman of the Association of Western Railways, also requests cooperation from shippers.

來 來

The Cause and Prevention of Mine Accidents

THERE is always a cause for every mine accident, and competent mine officials continuously endeavor to remove such causes. They are unsuccessful when the cause does not become evident until immediately preceding the accident or after it has occurred. American coal mine officials are often unjustly blamed for permitting accidents to occur. There no doubt have been numerous accidents in American mines that could have been prevented by a little extra precaution that would have been an economy rather than an expense, but such instances are becoming fewer each year. That mine disasters cannot be entirely prevented, even by the use of the utmost care, is proved by the occasional large disasters in European countries, where the governmental control of mining operations is much more rigid than in America. In Germany, for instance, the government inspection of mines is most rigid, and the government has for years had able commissioners studying mining conditions and methods, reporting on causes of accidents, and suggesting remedial measures. The same may be said of France, Belgium, and Great Britain. Yet in all these countries large disasters occasionally occur, the recent German disaster being an example.

The occurrence of these disasters does not mean that the governmental work is ineffective, for such is not the case. The investigations and conclusions drawn therefrom have been of great value in lessening the dangers of coal mining. That great mining disasters will be entirely prevented is beyond the hope of the ablest practical mining men, but there will always be room for improvement, and from both a humanitarian and economic standpoint, rational investigation and study of the causes and prevention of accidents should be encouraged by every mining nation and state. Sometimes investigations are discouraged by mine managers, but in almost every instance the lack of cooperation on the part of mine

managers is due to the foolish assumption of superior knowledge on the part of investigators, who, while highly educated in the technicalities of mining, are woefully lacking in the practical experience so essential in recognizing local details which often are of prime importance. If the work of the United States Bureau of Mines, in this respect, is to be of equal value to that of the commissions entrusted by other governments with similar work, the men employed in the Bureau must be good practical mining men, as well as men of superior technical education. In addition, to secure such men, the appropriation available for the support of the Bureau must be large enough to enable its director to pay for such talent fully as much as mining corporations pay for equal ability, and its continuance should be so certain as to enable the men engaged to be sure of their positions as long as they are efficient and active in the work.

來 來

Bulletin No. 47

DURING the past year the "Press Agent" of the United States Bureau of Mines has on numerous occasions made the Bureau ridiculous by certain claims of results achieved. In some cases the Bureau was given credit for establishing facts that were known to intelligent mining men for fifty or more years.

In a recent report, Mr. Charles L. Parsons, chief mineral chemist of the Bureau, says:

"In mining coal in this country, probably one-third of the bituminous coal and one-half of the anthracite is left behind in the mine. Fully 80,000,000 tons of anthracite is now being left behind in the mine each year, and it is estimated that since mining began in this country fully two billion tons of anthracite and three billion tons of bituminous coal have been left in the ground under conditions which make future recovery highly impossible."

If Mr. Parsons was writing of 30 years ago, his statement of proportionate waste in mining would be nearly correct, but it is absolutely at variance with facts today, and if it were not ridiculous it would be an unpardonable reflection on the ability of American mine officials.

As the annual production of anthracite in Pennsylvania is now approximately 90,000,000 tons, and the entire anthracite production of the United States is approximately 100,000,000 tons, Mr. Parsons' inference that the annual waste of anthracite is now 80,000,000 tons or 44.4 per cent. of the coal in the ground is absolutely incorrect.

來 來

Coke, Oil, and Patriotism

ENGLAND is abundantly supplied with citizens who are ever forecasting what might happen in case of war. If her statesmen are doubtful of securing an appropriation for oil to lubricate her internal or external machinery they invent a war scare. There

is no question but that this plan promotes patriotism and makes her people cling to each other for mutual protection; but it also has another good effect, it sharpens our cousins' wits and under the excitement of war produces results that are useful in times of peace. Gilbert R. Redgrave with other Englishmen views with alarm the fact that England is at present without a native oil supply, but must depend on foreigners for this commodity. Doctor Diesel greatly relieves his anxiety by stating that England has in her coal beds sufficient oil for all her requirements, because it is becoming generally recognized that the new era in dealing with coking coal about to arise will prove profitable alike to colliery owners and manufacturers of coking plants. The present method of manufacturing coke in by-product ovens yields a tar oil too much loaded with pitch for ordinary purposes and is correspondingly deficient in the lighter and more valuable oils. This can be remedied by the distillation of coal at a lower temperature than is usual with coke makers, and this also has the effect of reducing the output of gas by 50 per cent. If a high yield of gas is not desirable the volume of tar oils will be increased from 7 to 35 per cent. of the weight of the coal coked.

The oil produced in this way resembles petroleum rather than pitch tar oil, and after the removal of the more volatile constituents leaves a good fuel residuum.

While in the past the coke made by slow distillation of coal has been of poor quality, that difficulty has been overcome, and coke as good as ordinary gas-house coke is prepared. Thus England shall be free to lubricate with native oils, and run her internal combustion engines with gasoline.

柔 柔

Dust Explosions

AT the Liverpool (England) section of the Society of Chemical Industry meeting on February 14, Dr. J. Harger read a paper on "Dust Explosions and Their Prevention," which exploited a new theory for the prevention of such explosions, worked out in the chemical laboratory of the Liverpool University. Briefly stated Doctor Harger's theory is to prevent the ignition of coal dust, and, in a measure, the ignition of firedamp, by reducing the amount of oxygen in the air-currents flowing through the mine. He stated that while a lamp would not burn in air in which the oxygen had been reduced to 17 per cent., a man could do continuous hard work in such an atmosphere and not notice that it differed from ordinary air containing 21 per cent. oxygen. He stated that a man would not notice or feel any bad effect until the oxygen was reduced to below 14 per cent. At 12 per cent. the shortage was noticeable, and a danger point was reached when the percentage of oxygen in the air was reduced to 7½ per cent. He drew attention to some work of Professor Haldane, F. R. S., Dr. Leonard Hill, and Prof. Benjamin Moore, F. R. S., all great English authorities on respiration, who agreed that air containing from 17 to 18 per cent. oxygen with a moderate amount of carbon dioxide, up to 1 per cent., was perfectly suitable

for human requirements, and was in fact just as good as ordinary air. Dr. Leonard Hill had made this the subject of special research for 15 years, and his opinion therefore was worthy of credence. He quoted from Doctor Hill as follows:

"A reduction of oxygen to 17 or 18 per cent. of an atmosphere would have no influence on the work done. Mining operations are conducted, railways, etc., are built and big towns exist, at altitudes where the partial pressures of oxygen are much less than this. An increased percentage of carbon dioxide, say up to 1 per cent., will slightly increase the breathing; otherwise it will have no effect."

Doctor Harger stated as the result of his own experiments and the researches and experiments of others, that the reduction of oxygen necessary in the mine air varied with different coals, and with the method of working. In most mines a reduction of 1 per cent. in the oxygen, and the addition of ½ per cent. of carbon dioxide is sufficient. With others a reduction of nearly 2 per cent. in the oxygen, and an addition of ¾ per cent. of carbon dioxide, is necessary to render them safe. This diminution in the oxygen in the mine air is recommended in addition to the amount absorbed by the coal dust, loose coal, and coal faces and ribs. He further stated that absolute safety is secured if the reduction in oxygen is made to 17½ per cent. with ½ to 1 per cent. of carbon dioxide, not only from coal-dust explosions, but from firedamp explosions, also from fires of wood or coal in the roads, and from gob fires. For respiration such an atmosphere is as good as ordinary air, and for people predisposed to consumption it is better. This he stated has been proved by many investigators.

Doctor Harger suggested, as a means to reduce the oxygen in the air, that flue gases, purified from harmful gases and smoke, be mixed with the fresh air entering the mine—1 part to 30 of fresh air, or 1 part to 15 for the more dangerous mines. This he states can be done with very simple appliances.

The plan suggested does not appear feasible. In the first place lights do not burn brightly in air from hydraulic compressors carrying 18 per cent. oxygen. Flue gases even if purified from harmful gases will contain some feature that is not beneficial to the miner; besides, a small quantity additional of CO_2 due to lights absorbing the lessened quantity of the oxygen will create an atmosphere that will extinguish safety lamps. For instance in the Burrill experiments (see Vol. 32, MINES AND MINERALS, page 650) at the Pittsburg Testing Stations a candle went out when carbon dioxide reached 2.95 per cent. and oxygen 16.24 per cent.

As the United States Bureau of Mines is equipped for such air investigation, there is no reason why Doctor Harger's plan should not be proved either practical or impractical. If practical, even through modification, Doctor Harger will have been proved a benefactor to coal mine owners and workers. If impractical, the absolute knowledge that it is so will be of value.

Personals

Ivan De Lashmutt is superintendent for the Hobson Silver-Lead Co., at Ymir, B. C. N. F. Drake has accepted the chair of geology at the University of Arkansas, Fayetteville, Ark.

C. M. Eye was recently appointed manager of the Corrigan-McKinney Co.'s operations in Chihuahua.

Albert L. Toenges, whose article on methods employed in the Homestake mine appeared in our August number, has moved to Hibbing, Minn., where he is on the engineering staff of the Oliver Mining Co. Walter W. Barnett, of Golden, Colo., has returned to his work at the Wellington Mine, Breckenridge, Colo., after a year of recuperation from an accident sustained in this mine.

Rensallaer H. Toll has returned to Denver after spending several months starting up the once active Mineral Farm Mine at Ouray.

J. F. Callbreath, secretary of the American Mining Congress, has returned to his main office at Denver after his long stay in Washington during the recent session of Congress. He has issued a call for the fifteenth annual session, which will be held at Spokane, Wash., November 25 to 28.

Henry D. Milton is secretary-treasurer of the El Paso Gold Mining Co., in the company's new offices, 214 Equitable Building, Denver, Colo.

H. N. Herrick recently resigned his position as assistant professor of mining in the University of California and has gone into practical mining work.

Robert S. Lewis, of Stanford University, has been appointed assistant professor of mining in the University of Utah.

George McNaughton is now manager of the St. Anthony mine, at Sturgeon Lake, Ont.

Carl Scholz, manager mining department of the Rock Island Lines, issued a circular on September 2 stating that H. S. Mikesell has been appointed assistant to the manager.

Leroy A. Kling, who has been connected for some time past with two well-known crusher companies in Cedar Rapids, Iowa, has just accepted a position with the Wheeling Mold and Foundry Co., of Wheeling, W. Va., as sales manager of the road machinery department.

W. H. Cunningham, of the firm of Cunningham & Conner, consulting engineers, with offices in the Robson-Prichard Building, Huntington, W. Va., and the Blackstone Building, Ashland, Ky., has been appointed Assistant State Geologist of Kentucky. Mr. Cunningham is also secretary-treasurer of the Mine Owners' Association of Kentucky.

M. C. Reed, of Scranton, representative of the Sullivan Machinery Co., has persuaded the Hillside Coal and Iron Co., the Delaware, Lackawanna & Western Co., the Pennsylvania Coal Co., and some

other anthracite companies to adopt coal cutters in their mines.

John E. McCarthy, recently of Denver, Colo., but now of Las Vegas, N. Mex., was recently married to Miss Hazel Shipman of Houghton, Mich.

W. H. Tangye has been appointed superintendent of the Calumet and Sonora properties, at Cananea, Sonora, Mex.

R. C. Glazier has been appointed manager of the Cambria Steel Co.'s blast furnaces at Johnstown, Pa.

Marshall G. Moore has been appointed mining engineer of the Cambria Steel Co. This position places Mr. Moore in general charge of mining operations.

L. F. Miller, Professor of Physics and Electrometallurgy at the Colorado School of Mines, recently visited many of the mining districts of his state, becoming familiar with their activities.

Dr. Karl Oestreich, of the University of Utrecht; Dr. Guster W. v. Zahn, of the University of Jena; Dr. Clinton Marinelli, of Florence, Italy; Dr. Joseph Partsch, of the University of Leipzig; Prof. Emile Chaix Du Bois, of Geneva University; with twenty other geographers of Europe visited Scranton recently. The visitors seemed to take great interest in everything shown them, which of course pleased those who escorted them to interesting places in Scranton. Colonel Phillips and Manager Tobey invited them to visit the Hampton power and water-hoisting plants of the D., L. & W.

A. P. Cameron, superintendent of the Penn Gas Coal Co., has been made superintendent of the Westmoreland Coal Co., succeeding E. G. Smith, who becomes consulting engineer of both companies.

John G. Hayes has resigned as general manager of the People's Coal Co., of Scranton. He will take charge of the Southern Sulphur Co.'s mines near Dallas, S. C. A. G. Bennett, a division superintendent of the mining department of the Delaware & Hudson Co., is Mr. Hayes' successor. Mr. Hayes has been superintendent of the People's Coal Co., for more than a decade, serving under the ownerships of J. L. Crawford and J. G. Shepherd, and was retained when the company passed into the control of New York interests about a year ago.



Lord Kelvin's Memorial

The Institution of Civil Engineers of Great Britain has invited the various British and American national engineering societies to cooperate with it in the erection of a memorial window in Westminster Abbey to the honor of the late distinguished scientist and engineer, Lord Kelvin. The American Institute of Mining Engineers' committee appointed to receive contributions for this fund consists of Prof. James F. Kemp, Samuel B. Christy, Dr. James Douglas, and Dr. Joseph Struthers, secretary of the Institute.

Kentucky Coal Mines, 1911

*By C. J. Norwood**

There was a decrease in the production of coal in Kentucky during 1911, amounting to 795,200 tons from 1910.

The production by districts was as follows:

District	Tons
Western, 11 counties.....	6,959,541
Southeastern, 7 counties.....	4,448,383
Northeastern, 9 counties.....	2,516,887

Total..... 13,924,811

The disposition of the coal mined was as follows:

	Tons
Sold locally.....	367,413
Used at mines.....	373,164
Coked.....	112,292
Shipped from mines.....	13,071,742

Total..... 13,924,811

The average value of the bituminous alone, at the mines, for the respective districts was as follows:

Western.....	\$.8632
Southeastern.....	1.1248
Northeastern.....	1.0584

Average for the state..... \$.9816

The cannel (67,782 tons) was produced by three mines in Morgan County and one in Johnson. The average selling value at the mine was about \$2.51 per ton.

The tonnage of coal mined by machine in each district, together with the percentage of the total product of the district represented by such tonnage, was as follows:

District	Machine Cut	Per Cent.
Western.....	5,490,274	78.86
Southeastern.....	1,437,718	32.32
Northeastern.....	1,870,375	74.31
Total.....	8,798,367	63.18

In 1910 the outward shipments amounted to 63.04 per cent. of the total production. The reported outbound shipments for 1911, together with the percentage of the total output represented by such shipments, for each district, were as follows:

District	Tons	Per Cent.
Western.....	4,337,736	62.23
Southeastern.....	1,867,253	41.97
Northeastern.....	1,753,979	69.68
Total.....	7,958,968	57.16

The average number of persons employed immediately at the coal mines in Kentucky was 23,018, of whom 18,161 were engaged underground.

The average number of employes and the average number of 10-hour days worked per operation, according to districts, were as follows:

District	Total Empls.	Inside	Days
Western.....	10,367	9,002	138
Southeastern.....	8,934	6,329	193
Northeastern.....	3,717	2,830	195
Total.....	23,018	18,161	

*Chief Inspector of Mines.

COAL MINING & PREPARATION

Buckner No. 2 Mine

Surface and Underground Arrangements, Showing Most Advanced Practice in the Illinois Coal Field

By Warren Roberts and Oscar Cartlidge

THE Franklin County, Illinois, coal field is attracting more attention at this particular time than any other in the United States. The operators going into this field erect the most modern and up-to-date surface plants that will care for a large tonnage of coal. Mr. Warren Roberts, of Roberts & Schaefer, of Chicago, has described the surface arrangements in this article, and Mr. Oscar Cartlidge, of Marion, Ill., State Inspector of the 12th Illinois District, the underground

be in a central position on the property, and because railroad connections could be made with the Illinois Central and the Chicago, Burlington & Quincy railroads.

The railroad tracks forming the working yard extend east and west from the tippie, with the empty storage tracks to the west. The connection from the Illinois Central is made by a spur coming in from the north which forms into a Y

underground arrangements were planned to produce, prepare for market, and load on to railroad cars 4,000 tons of coal daily.

The surface arrangements consist of a four-track steel tippie; combined power plant, hoisting engines, electrical equipment, boiler house with steel coal storage tanks; blacksmith, machine, and car-repair shop; supply house; an auxiliary hoisting engine; steel fan and concrete fan-engine house; a double compartment fireproof and weather-proof engine house; a complete water system; electric

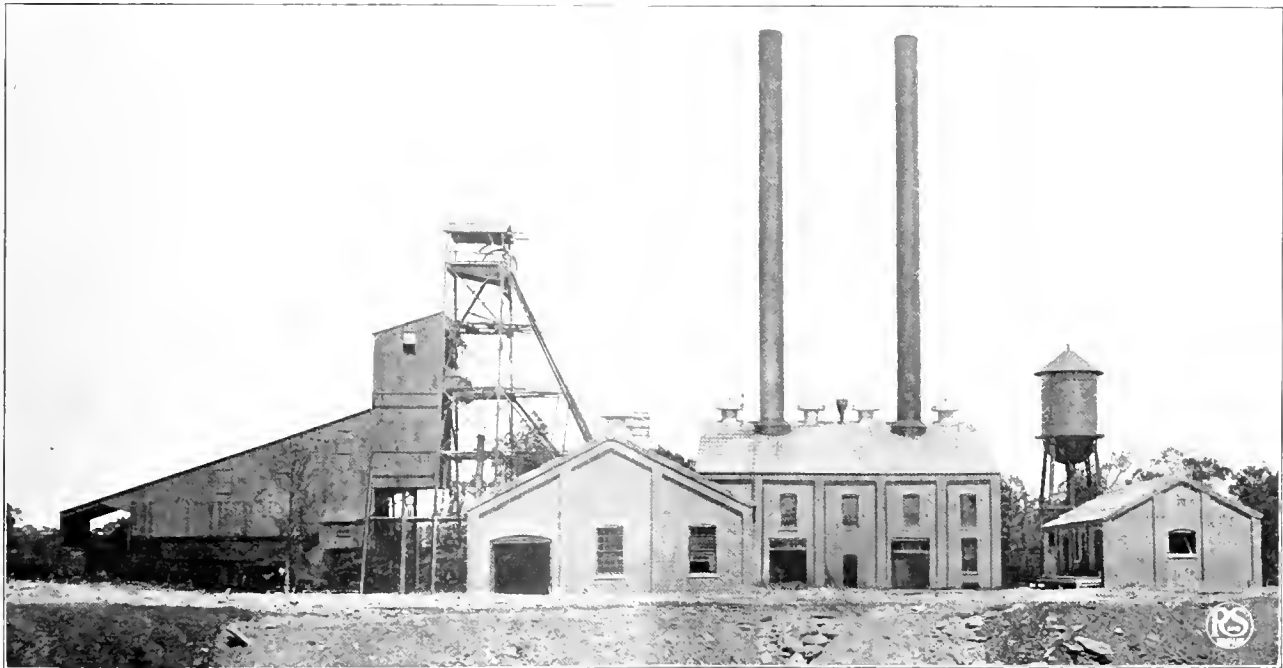

FIG. 1. BUCKNER NO. 2 MINE TIPPIE AND POWER PLANT

arrangements. The editor considers he is fortunate in obtaining one of the firm of engineers and contractors who designed the entire surface arrangements of the plant to describe it; and doubly fortunate to have Mr. Cartlidge, who followed the work from the breaking of ground at the surface to almost the present stage of the working.—EDITOR.]

SURFACE ARRANGEMENTS

The Buckner No. 2 mine of the United Coal Mining Co. is about 2 miles east and south of their No. 1 mine, which is 1 mile east of Christopher, Ill. This location was selected so the shafts would

connecting both to the empty and the loaded tracks. The C., B. & Q. comes in from the south and connects in the same manner, thus forming a double Y. The surface plant is within this double Y and therefore is arranged not only to receive empty cars but also to receive mine supplies.

Empty cars from the yard tracks pass over the railroad track scale and are weighed before being placed under the tippie. After being loaded, they are passed over another railroad track scale and are weighed before being delivered to the loaded track. The surface and

lighting system, and a small office for the mine superintendent. This entire surface plant, excepting the office, is of concrete, steel, and brick construction and is practically fireproof and permanent.

The head-frame and tippie, Fig. 1, are of steel, the latter being covered on sides and roof with corrugated galvanized-steel sheathing. It is also provided with stairs and walks to give access to all parts of the machinery. The only woodwork in this structure is the stair treads and the 2-inch plank floors and walk.

The agreement between the miners and operators is that all coal in a mine car

shall be paid for by weight. Fortunately the coal at this mine is clean and there can be no friction between the miners and operators on the score of dirty coal as is frequently the case in other mining districts.

man operates the weigh hopper door *c*, by means of a steam cylinder *d*, which enables him to open and close the heavy steel door by simply turning a valve stem. The contents of the weighing hopper slide by gravity, as soon as the door is opened,

arrangement was adopted to allow an even distribution of the coal on the screens and to prevent any hindrance in the hoisting and dumping when working to full capacity. The two counterbalanced shaker screens rest on rollers and are driven by an eccentric shaft connected by belt with a double engine placed on the ground underneath the tippie between the mine shaft mouth and the first loading track. These screens are 10 feet wide and of a length sufficient to span four railroad tracks. They are designed so that run-of-mine coal can be shipped from the lump-coal track without the use of cover plates. The upper screen has a double deck for making slack and nut coal and the lower screen has a single deck for taking the egg out of the lump coal. A small hopper *h* is placed beneath the screens over each track to receive a small amount of coal, which enables the railroad cars to be changed beneath the tippie without the necessity of interrupting hoisting.

The slack and screenings from the nut, egg, and lump coal are delivered by shaking chute to the slack car.

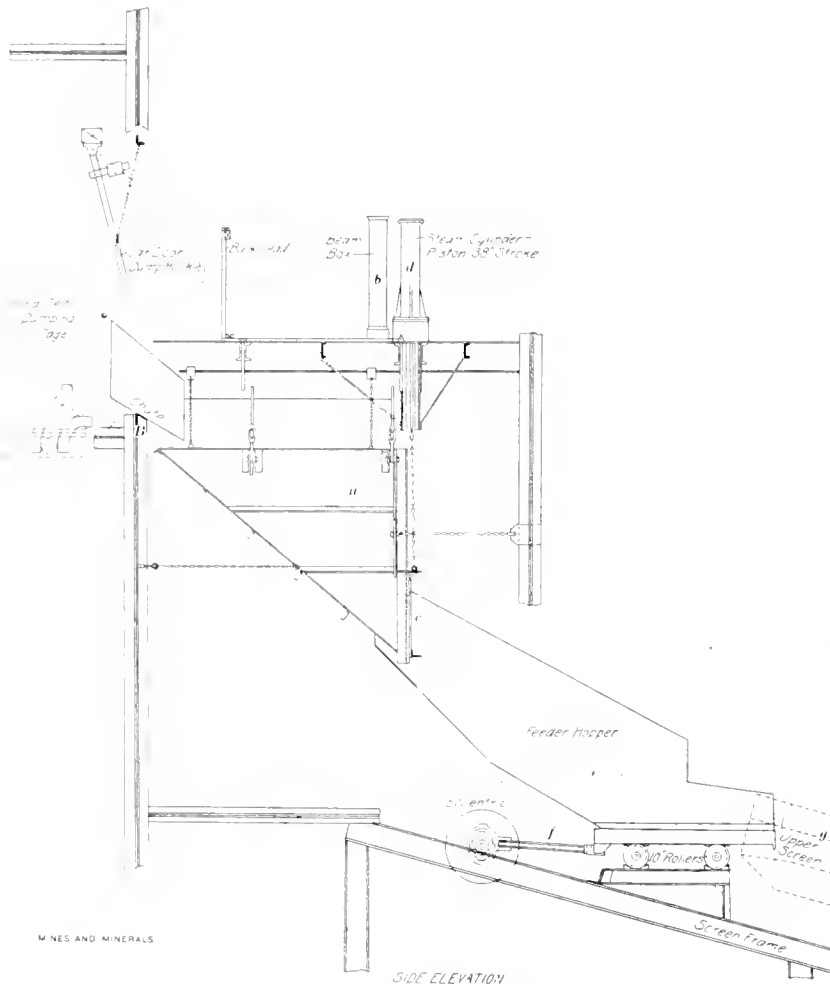

FIG. 2. FEEDER AND WEIGH HOPPER

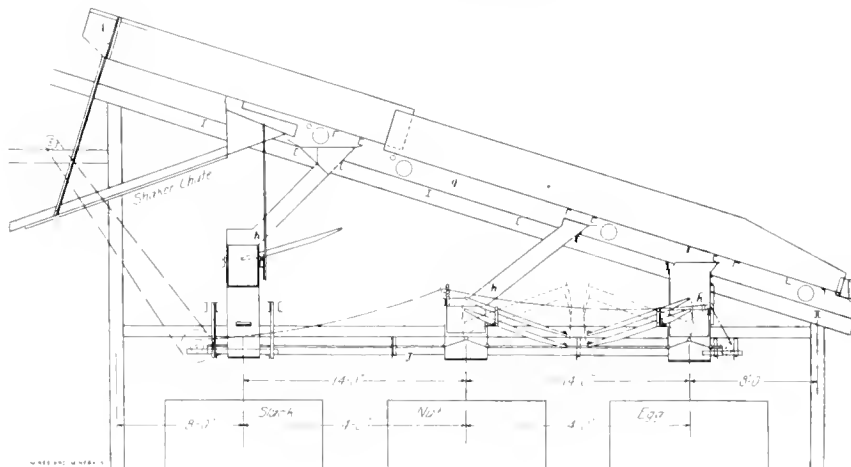

FIG. 3. SHAKING SCREENS

Mine cars in this field are large and hold from 4 to 4½ tons of coal. They are raised to the top of the tippie on self-dumping cages and dumped into a weighing hopper *a*, shown in Fig. 2, attached to a suspended tippie scale *b*. The weigh-

into a receiving hopper *e* capable of holding the contents of two or three mine cars.

From this latter hopper the coal is fed gradually by the reciprocating feeder *f* on to the shaking screens *g*, Fig. 3. This

The nut and egg sizes pass from the shaker screens into small pockets beneath the screen and above their respective loading tracks. The nut and egg coals pass from the hopper to the railroad cars by way of an end loading chute, which is of sufficient length to admit of considerable adjustment, that is, raising and lowering, to prevent breaking the coal with a high fall into an empty or partly loaded car. Each of these chutes is provided with a short lip screen for rescreening the coal just before it is loaded into the car. The slack from these lip screens is carried by a small conveyer *j* to the slack car, which is being loaded by the slack chute.

The lump coal passes off the end of the shaker screens and is loaded into a railroad car by means of a curved-end loading chute, which is also of a length to allow adjustment so as to raise and lower the outer end and deliver the coal into the car with the least breakage possible.

The loading chutes are raised and lowered by means of cables and windlasses. As this coal is practically free from impurities no further preparation is neces-

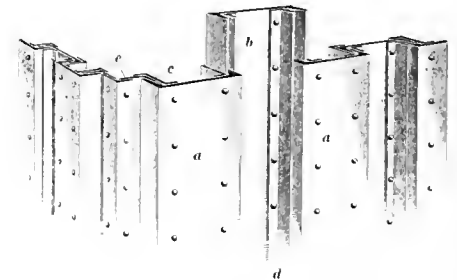

FIG. 4. CHANNEL BAR PILING

sary, but it is evident from the description given that sizing and keeping the prepared sizes free from slack is of considerable importance.

Another interesting feature of these screens consists in an arrangement whereby different combinations of the various sizes can be made, or mine-run placed in the car on the lump track without use of cover plates on the screens. This is accomplished by making the screens double decked and by having a system of valves which, when closed for any particular size of coal, enables this coal to be carried forward and placed with coal of larger size.

The upper shaker screen is also provided with a small auxiliary screen which takes out a certain portion of the $\frac{3}{4}$ -inch coal from the screenings and delivers it to a side chute to a boiler house conveyer, which in turn carries the coal to the bunkers above the boilers; and, from the bunkers, the coal is delivered by steel spouts into the automatic stokers.

The buildings in which boiler, hoisting engines, and electrical equipment are installed are to the right of the head-frame shown in Fig. 1. The boilers are in one room and the machinery in another. In the boiler room there are four water-tube boilers, arranged in batteries of two each, each battery having a steel smokestack, 54 inches in diameter and 150 feet high. The boilers are supplied with Murphy stokers and beneath the fireboxes there are small hoppers into which the ashes drop. Below the hopper there is a concrete tunnel in which an ash car travels, receives the ashes from the hopper, and carries them outside the tunnel to the yard. This ash car is moved by means of a small hoisting engine and rope placed in the corner of the boiler house and operated by the fireman as occasion demands.

Boiler feed-pumps made by the Platt Iron Works, of Dayton, Ohio, are installed in duplicate and cross-connected, each being of sufficient capacity to supply all four boilers with water. The engine room contains a Danville Foundry and Machine Co.'s duplex 28" x 48" first-motion hoisting engine that operates two 8-foot diameter drums; a 250 kilowatt generator direct-connected to a four-valve engine; also a small direct-connected generator for use in lighting the mine and plant when the large generator is not running. One noteworthy feature is the auxiliary hoisting plant at the air-shaft. One of the three compartments of this shaft contains a steel stairway, and in another a small platform cage is operated on which materials are taken into the mine, and men hoisted and lowered during working hours. This arrangement avoids any interference with hoisting, which must be carried on at the

rate of one car per minute if a capacity of 4,000 tons in an 8-hour day is to be maintained. The auxiliary hoisting equipment consists of a pair of small first-motion drums operating a drum to which the cage and hoisting rope are attached. A small steel head frame carries the customary rope sheave that is centered over the shaft compartment in which the cage plays.

SINKING AND UNDERGROUND DEVELOPMENT

The work of sinking the No. 2 main and escapement shafts, known as the

quired, and excavations made to within about 3 feet of the sand.

Interlocking steel sheet piling was then driven around the shaft through the sand; but when an attempt was made to remove the sand it was found that the piling would not turn the water and sand, and it was withdrawn and the Friedsted interlocking channel bar piling shown in Fig. 4, which is a combination of channel and Z bars, was used.

These bars were furnished by the Carnegie Steel Co. and were driven with a

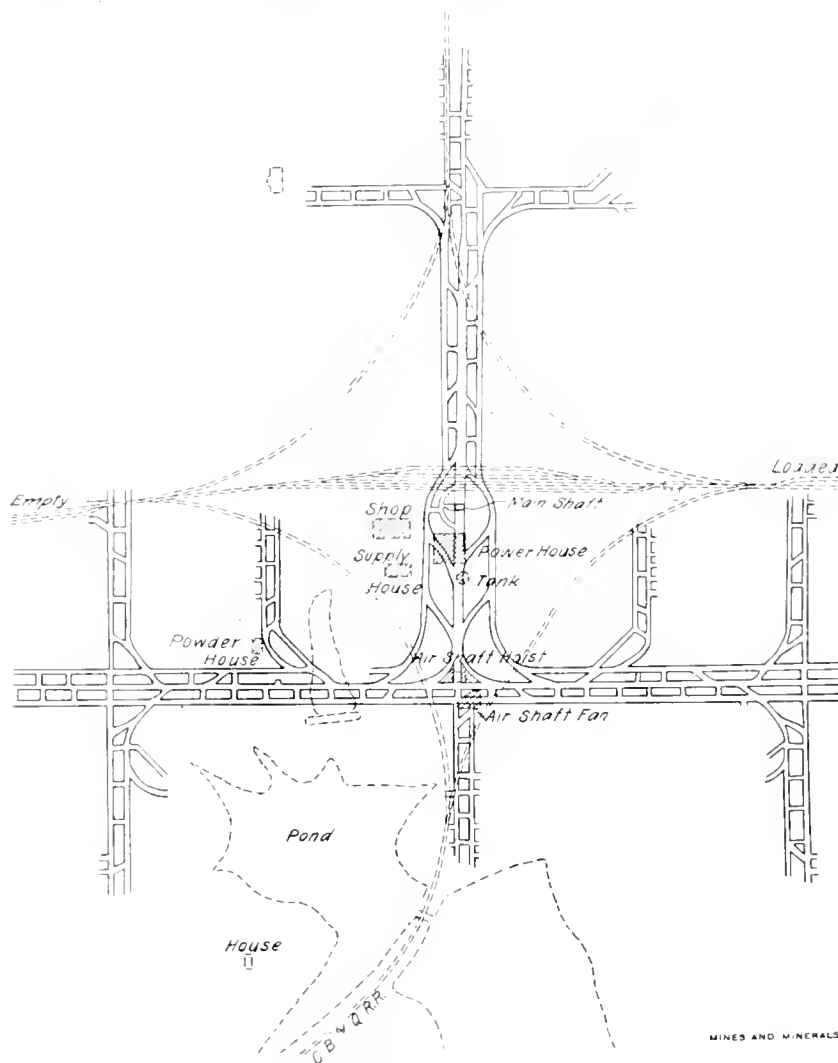

FIG. 5. SURFACE AND UNDERGROUND PLAN, SURFACE WORKS SHOWN DOTTED

Buckner mine, was begun October 25, 1910, and coal was reached at a depth of 447 feet, May 28, 1911.

Unusual difficulty was experienced in sinking these shafts by reason of the fact that at a depth of 25 feet, 18 feet of very free running quicksand was encountered.

Previous drilling having shown the strata to be, surface, 25 feet; quicksand, 18 feet; with alternate layers of shale, sandstone, and limestone down to the coal, the shafts were laid off about 4 feet larger in each dimension than was re-

quired, and excavations made to within about 3 feet of the sand. The total depth to which the piling was driven was 40 feet, in two sections of 25 feet and 15 feet and 28 feet and 12 feet, and they were driven about 7 feet into the shale below the sand.

This type of piling proved to be perfectly water-tight, and the sand inside was easily shoveled out, the timbering with 12-inch yellow pine being carried down with the excavation. After getting down to the solid strata, forms were made to bring the main shaft to an inside clearance of 11 ft. x 19 ft. and it was



FIG. 6. PHILLIPS AUTOMATIC CAGER AND SHAFT BOTTOM

concreted. The remaining distance was timbered with 3-inch yellow pine, and the entire surface was then fireproofed with galvanized iron, which was nailed to the wood in overlapping sections. Steel buntons, 4 feet apart, divide the shaft into three compartments.

The escapement shaft was sunk in the same way, and is equipped with a man and material hoist, the cage being 4 ft. 6 in. x 4 ft. 2 in. There is also an air compartment 10 ft. 6 in. x 11 ft., and a stairway of solid steel so constructed that water cannot accumulate thereon.

The hoisting and stair compartments are separated from the air compartment by a solid reinforced-concrete dividing wall 6 inches thick.

The shaft bottom shown in Fig. 5 is laid out to cage the coal from one side as shown in Fig. 6, while the empty cars from the other are delivered to wings at either side, Fig. 8, by gravity after being elevated to a height of 7 feet by a Phillips drag shown in Fig. 9. Phillips mechanical cagers automatically place the loaded cars on the cage, releasing one car at a time as the cage touches the bottom. Recently, as an experiment, 136 tons were caged and hoisted in 12 minutes.

The coal, which is the Illinois No. 6 bed, is about 10 feet thick at this mine. It is of excellent quality, being very free from impurities of every kind, and lies comparatively level. The method of development is shown in Fig. 5. Three main entries are driven east and west, with cross-entries turned at right angles every 1,370 feet. From these cross-entries stub entries are turned in pairs every 350 feet. Pillars between main entries are 30 feet, with 150-foot barrier pillars on each side. The cross-entries have a dividing pillar of 20 feet with

flanking pillars of 125 feet, while the stub or room entries have 20-foot pillars between them, with 32 rooms on each entry. Room necks are turned 10 feet wide, with 35-foot centers, and are widened out at an angle of 45 degrees to a width of 21 feet after the first 7-foot cut is taken out. The rooms are not advanced until one-half of the panel, or 16 rooms on each stub entry, are turned, when the 16 rooms are advanced concurrently a distance of 175 feet and the pillars are withdrawn retreating from No. 16 to No. 1. At the same time the stub entries are being driven for another 16 rooms, and after the stub entries hole into the next cross-entry this series of rooms is advanced and the pillars recovered retreating from No. 17 to No. 32, the coal being delivered to the cross-entry which has been holed.

When a panel of 64 rooms is worked out the stub entries will be sealed up at each end and abandoned. This method will be pursued with each succeeding panel; and as the company has tried this method to a limited extent in their No. 1 mine, they are assured of getting the maximum amount of coal with the least yardage cost.

The anticipated output of this mine is 4,000 tons in a day of 8 hours. Mine cars of 4 tons capacity will run on 50-pound steel in the main entries; 40-pound in the cross-entries, and 20-pound in the rooms. Electric haulage is used exclusively, no animals having ever been in the mine, and eventually there will be about 15 motors and 30 chain breast machines of the Goodman manufacture in operation. No hauling will be done on the middle main entry, so that it will be unobstructed for the free passage of air.



FIG. 7. FIRE-FIGHTING STATION



FIG. 8. TIMBERING AND CONCRETE WALLS AT TRACK INTERSECTION

All overcasts are of steel and concrete, while all stoppings between air-courses are of brick plastered over with cement; and at each intersection of a branch road concrete walls are constructed to support the roof. The walls at such an intersection are shown in Fig. 8, which also shows the substantial construction for supporting the roof.

Prominent above all other things is the precaution taken by this company to protect its employes from injury. Upon landing from the cage at the shaft bottom one is confronted by large signs of a warning nature, such as "Remember the Law"; "Danger"; "A little Caution on Your Part Will Avoid Many Accidents," etc., and at intervals along each entry similar signs call attention to the fact that the mine worker's occupation is a continual hazard.

Just off the shaft bottom is a combination office and emergency hospital of concrete, consisting of two rooms each 12 ft. x 12 ft. fitted up with desks, stretchers, first-aid outfits, etc., where the seriously injured can be given temporary aid. On the wall of the office room is a map of the workings which is extended monthly, and shows the actual development at a glance.

On the other side of the shaft is a concrete fire-fighting station, shown in Fig. 7, provided with hose, hand pump, buckets, chemical fire extinguishers, etc. In Fig. 7 Mr. F. J. Urbain is at the left; Edward Laughron, County Mine Inspector, is standing in the door; while Frank Rosbottom, 11th District State Mine Inspector, is sitting down.

A complete system of sprinkling pipes, having a 75-pound head from the water ring in the shaft, and which maintains a constant supply of 12,000 gallons, ramifies to every part of the mine, with hose connections every 100 feet; and the dust is kept thoroughly washed down. Permissible explosives are used exclusively; and it is the boast of the general manager that a pound of black powder has never been fired in the mine.

The writer wishes to acknowledge his indebtedness to President C. M. Modernwell and to General Manager F. J. Urbain for courtesies extended him while preparing this article.

采 采

Correction

On page 11 of MINES AND MINERALS for August appeared an interesting article by C. H. Thompson under the title which the author wrote as "Coal Cost and Coal Loading Machines." Through a typographical error this was incorrectly printed "Coal Dust and Coal Loading Machines." This will explain the evident lack of relation between the title and the article.

Clinkering of Coal Ash

By E. B. Wilson

Coal briquet slag formed by the fusing together of the various ingredients composing the ash in coal. Ash derived from coal contains silica, SiO_2 ; lime, CaO ; alumina, Al_2O_3 ; ferrous oxide, FeO ; ferrous sulphide, FeS ; magnesia, MgO ; and small amounts of other chemical combinations.

If an analysis is made of the ash, it is possible to calculate whether a slag will form under the ordinary conditions that prevail in boiler furnaces.

In order to form slag there must be "acid silica" to unite with the "basic oxides," and although silica makes a number of combinations with bases, the heat required to bring about fusion to form the slags varies greatly, according to the relative proportions of the oxides and silica.

with the silica, a fluid slag forms at comparatively low temperature. If there is a predominance of lime, the slag will be gray, but as the percentage of ferrous silicate increases it passes from bottle green to black. One of the most readily fusible combinations with silica is termed a "monosilicate"; that is, the ratio of oxygen in the base is to the ratio of oxygen in the acid (silica) as 1 : 1.

To show the method to be followed in determining whether an ash will form clinkers, the ash analyses from two coals are used, one being semibituminous and the other bituminous.

The semibituminous coal formed slag above and below the fire bed proper, thus causing considerable trouble. As the following analyses show, the coal is an excellent fuel aside from its slagging properties: Moisture, .496; volatile hydrocarbons,

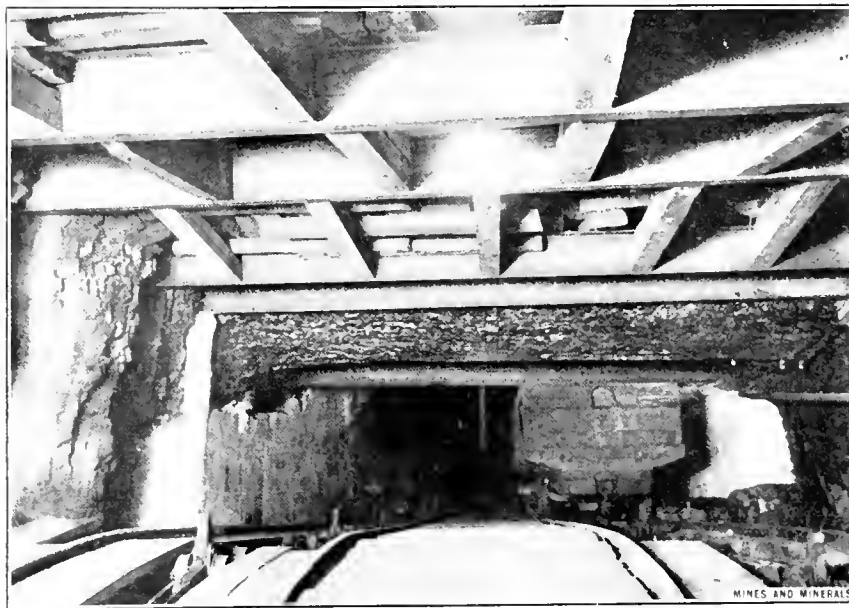

FIG. 9. CAR HAUL HANDLING EMPRIES AT FOOT OF SHAFT

The oxides, when taken alone, are quite infusible, and are termed refractory materials; but when two or three are brought together with silica in indefinite proportions, a given heat will cause them to fuse and form a silicate, which is the slag called elinker. If there is a large proportion of the less fusible materials, lime, magnesia, and alumina, in the ash compared with the less fusible base, such as ferrous oxide, it will require an exceedingly high temperature to form slag, more in fact than the boiler furnace will produce. However, it requires less heat to fuse two oxides with silica than one, and three than two. In case there is a large excess of silica in the ash it will also require an exceedingly high heat to form slag, and if formed it will be pasty and probably give little if any trouble under a boiler. When there is a goodly proportion of ferrous oxide in ash and the proper proportions of other bases to unite

19.139; fixed carbon, 75.530; sulphur, .480; ash, 6.360. Analysis of the ash was as follows: Silica, 39.02; alumina, 23.52; ferrous oxide, 11.14; lime, 19.97; magnesia, 3.265; undetermined, 3.085.

For the benefit of those unfamiliar with slag calculations and the derivation of the factors used for determining the silica necessary to satisfy a given oxide and form a silicate, the following explanation is given:

The formula for calcium monosilicate is $2CaO \cdot SiO_2$ and results from the following chemical combination that requires 471,300 heat units:

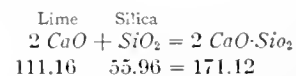

From this equation it requires $\frac{59.96}{171.12} = .539$ part of silica to combine with 1 part of lime to form a calcium monosilicate. The molecular weights of the lime and

silica are used to obtain the factor .539, which is known as Ballinger's factor. Factors for other oxides are obtained in the same way. Using these factors and multiplying the percentages of the various bases in the slag by them, it will be found that there is enough silica and iron in the ash to form a monosilicate.

$$\begin{aligned} 23.52 \text{ Al}_2\text{O}_3 \times .886 &= 20.839 \\ 11.14 \text{ FeO} \times .419 &= 4.668 \\ 19.97 \text{ CaO} \times .539 &= 10.764 \\ 3.265 \text{ MgO} \times .758 &= 2.477 \\ \hline &38.748 \end{aligned}$$

It will be seen from this that the mixture was just right, there being sufficient silica to satisfy the bases and form a fluid slag.

It will be noticed also that the coal is low in sulphur and no sulphur is given in the ash analysis. The sulphur in coal is a very important feature in slag formation. Ordinarily it exists as pyrite, FeS_2 , but while one molecule is driven off by heat, forming SO_2 gas, the other molecule is extremely difficult to oxidize even in an oxidizing furnace, which a boiler furnace, from a metallurgical standpoint, is not. When ferrous sulphide, FeS , is formed, silica will not combine with the iron, consequently no fusible slag is formed. The following illustration will show this, as well as the difficulty of forming fusible slag without an easily fusible base for flux. The bituminous coal under consideration contained 2.54 per cent. sulphur, but gave no trouble from clinker, the sulphur being in sufficient quantity to unite with the iron and prevent its slagging with the other ingredients of the ash. In this case the ash had the following analysis: Silica, 29.14; alumina, 15.56; lime, 20.73; magnesia, 1.91; ferrous oxide, 13.42; sulphur, 6.

The iron in the ash is reported as ferrous oxide, consequently there was $\frac{56 \times 100}{72} = 78$ per cent. metallic iron in the oxide, or $13.42 \times .78 = 10.46$ per cent. iron in the ash. The formula for ferrous sulphide is FeS , and to satisfy the sulphur will require $\frac{56 \times 6}{32} = 10.5$ parts of iron; therefore, in this case there is no iron left to be converted into oxide to form a fusible slag. If 5 per cent. had been left, the amount would be so inconsequential in comparison with the other basic oxides that only a little slag would be formed, and that at extremely high temperature. In the first example, 19.2 per cent. of the total basic oxides was ferrous oxide, a matter which is called to the reader's attention to emphasize that unless more than 10 per cent. of the various oxides in ash is ferrous oxide available for slag, there will be little clinkering under boilers. Should a fuel have a tendency to slag, the formation temperature may be raised by spreading pieces of limestone or oyster shells, if convenient, on the fire, and thus making the ash material more refractory. When the silica in the ash is considerably lower than the bases, there will be little

clinker formed, if any, since the effect is the converse of adding refractory oxides when sufficient silica is present.

The impression prevails that sulphur is a slag-forming material, which is not the case; on the contrary, it will prevent the formation of slag.

來 來

Early Dust Explosions

The Savanna, Indian Territory, mine explosion is of special interest because it brought on the first discussions of dust explosions in this country; was instrumental in introducing sprinkling to keep down dust; and did introduce shot firers in this country. Mr. E. W. Parker, of the United States Geological Survey, kindly furnished us with letters from Mr. William Cameron, of McAlester, Okla., giving authentic details of the Savanna and Krebs explosions in Indian Territory. His dates do not agree with those given on page 713, July, 1912, MINES AND MINERALS; however, the latter were given from memory and were slightly confused except in regard to the years in which the explosions occurred.

Mr. Cameron writes: "There were two explosions at Savanna, the first was in mine No. 1, February 2, 1885, whereby 33 men and boys were more or less injured, six of whom died from their injuries (four men and two boys). This explosion brought about the appointment of special shot firers to blast the coal after all miners and others had left the mine. These were the first shot firers appointed to fire shots in America, and I claim whatever credit, if any is due, for the initiation of shot firers into this country; I had to have the cooperation of Major McDowell, General Manager of the company, who gave it his hearty indorsement.

"The second explosion occurred in mine No. 2 on the night of April 4, 1887. There were four shot firers in the mine and two men sprinkling the slope when the explosion occurred, all of whom lost their lives. In the excitement and rush, 12 of the rescuers rushed ahead of the air and lost their lives, making a total of 18 lives lost in all. The explosion blew the timber out of the mouth of the slope for about 100 feet back from the portal, which allowed the entrance to cave for that distance, and made it impossible to enter the mine through original passage. The flame passed out of the slope and set fire to the tippie which was totally destroyed. The dust explosion at Krebs, Indian Territory, in which 67 men were killed, occurred at 5:03 P. M., January 7, 1892. Over 100 of the injured ultimately recovered, and some of those who died might have been saved had it not been for the lack of proper care and sanitation in their homes, and the unusual severity of the weather at the time of the accident"

Gas Ignition by Tungsten Filament Electric Lamp

The Bureau of Mines has been asked a number of times whether firedamp can be ignited by breaking the bulb of a miniature incandescent lamp in a body of it.

This question is of more importance now than at any previous time because of the increasing use of portable electric lamps for mine service. Portable electric lamps are often used where gas is known to be present, and some times, as in rescue work, such lamps must be used where gas (methane) may be present in dangerous amounts. Tests were made with miniature incandescent-lamp bulbs containing tungsten filaments. The bulbs were supplied to the bureau without cost by the General Electric Co., the Federal Miniature Lamp Co., and the National Electric Lamp Association. In all tests the filaments were glowing at the moment when the bulbs were broken. One hundred and thirty-one bulbs were broken in a mixture of natural gas (that used in Pittsburg) and air combined in the proportion of 8.6 per cent. gas to 91.4 per cent. air, the most explosive mixture.

Forty-five tests were made in gas-and-air mixtures other than the most explosive. These mixtures contained from 3 per cent. to 12.4 per cent. of gas. Mixtures containing as little as 5 per cent. of gas and others containing as much as 12.4 per cent. of gas were ignited by 1.5-candlepower, 3.5-volt, .3-ampere bulbs that were smashed while burning at rated voltage as follows:

TABLE 1. BULBS CAUSING IGNITION AT OR BELOW RATED VOLTAGE

Manufacturer's Rating			No. of Tests	No. of Ignitions	Percentage of Rated Voltage Causing Ignition*
C. P.	Volts	Amprs.			
1.0	2.5	.3	11	7	100.0
1.5	3.5	.3	23	16	100.0
2.0	5.5	.3	9	6	98.7
1.0	2.0	0	9	7	100.0
1.0	2.5	0	10	3	100.0
2.0	4.0	0	10	7	82.2
2.0	4.5	0	10	7	85.3
	2.0	.73	5	3	94.5
	4.0	.53	5	5	94.9
	6.0	.30	5	5	88.2

TABLE 2. BULBS CAUSING IGNITION AT MORE THAN RATED VOLTAGE

Manufacturer's Rating			No. of Tests	No. of Ignitions	Percentage of Rated Voltage Causing Ignition*
C. P.	Volts	Amprs.			
.5	1.5	.4	10	1	132.7
	2.0	.23	9	3	120.0
	2.0	.40	9	3	106.0
	2.0	.53	6	5	102.0

* The values given in this column are the average percentages of the voltages impressed upon such bulbs as caused ignition.

Lake Superior Mining Institute

An Account of the Proceedings and Excursions of the Meeting Held August 28, 29, and 30

Written for Mines and Minerals

ON August 28, 29, and 30, about 300 out of the 600 members of the Lake Superior Mining Institute gathered at Houghton, Mich., to attend the seventeenth annual meeting.

In addition to the attractive itinerary prepared by the committees, the weather was such that it harmonized with the good fellowship that prevailed. Politics was tabooed and none would signify his favorite animal, which permitted all hands to enjoy the outing.

On Wednesday afternoon the first excursion train conveyed the members to the Michigan smelter, at Coles Creek, where, on disembarking they entered the top of the sampling mill and descended to the furnace-charging floor. As it was casting time the visitors were able to see the molten copper flow from the furnace to the ladle and then see it poured into small ingot molds. The Walker machine, shown in Fig. 2, is a photograph of a machine in the works of the Electrolytic Refining and Smelting Co., Ltd., Port Kembla, N. S. W. The furnace spout and ladle are shown to the left; the molds, which are for 135-pound wire bars, dump into a water tank at the foot of the elevator shown to the right. Another furnace and casting machine is shown to the rear of Fig. 2. At the Michigan smelter the visitors saw the method followed for making copper-molds for the casting machines.

The party next embarked on the special Copper Range train and were conveyed to the Champion mine, which they reached in time to see the ore skip changed for a man-hoisting skip. This occupied about 10 minutes, after which a number waited to see the skip bring up the men from a depth of 2,420 feet. Fig. 1 shows the customary man-hoisting car used at inclined shafts in the Lake Superior region, with its load of human freight. The hoisting rope and car connections are carefully examined before the men are either hoisted or lowered in the shaft. On remarking that the miners were husky looking chaps, an iron miner said they were not as healthy looking as his men, in fact, lacked color in their faces, which would be natural now we come to think of hematite being a fairly good red mineral pigment.

From the Champion mine the members were conveyed by trains to the Baltic mine where the miners' wash and change house were examined and the concrete oil house was visited.

At the Baltic mine the lubricating oils received in tank cars flow by gravity to storage tanks in the basement of the oil house. From these tanks they are lifted by pumps and measured prior to consumption. To those unfamiliar with the conditions and the surface works at these mines, the time allotted for their inspection

was inadequate; however, this could not be avoided and was in a great measure compensated by the pamphlet of information prepared especially for this meeting by Arthur L. Carnahan, in which there was also a poem by Allan Tyrrell, two verses of which slightly changed, appealed to those who are lovers of nature:

I stood on the hills of Houghton
As the sun sank slowly down
With a farewell glance of gladness
O'er the grim old northern town
And the north winds drifted softly
With perfume strangely sweet
And toyed with the crimsoned maple
Leaves that fluttered to my feet.

The ride back to Houghton just before dusk furnished an excellent view of Portage

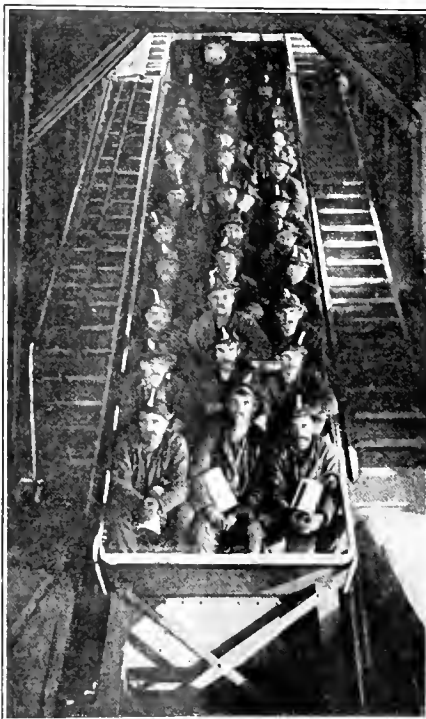

FIG. 1. MAN CAR, LAKE SUPERIOR COPPER MINE

Lake, flanked by hills, with Hancock and Quincy shaft houses looming high above the city of Hancock. Probably it was this sight that inspired Allan Tyrrell to paraphrase Longfellow, at any rate it recalls that peculiar state of mind which those who have camped by some lake deep in the woods are likely to have in the evening when there is nothing doing and it is too early to retire:

And out from Hancock city
As the deeper shadows fell
There rang o'er the murky waters
The tones of a silvery bell
And the echoes, oh! the echoes
Rolled gloriously and free
As o'er the lake to Houghton
They noated up to me.

At a Lake Superior Mining Institute meeting the tired feeling, due to an all-day excursion, is not allowed to interfere with the business end, consequently a session was

held in the Masonic Building. President F. W. Denton opened with an address of welcome, after which several papers were read and discussed. Much interest is shown in the iron and copper regions relative to decrease in accidents, and William Conibear's paper on "System of Safety Inspection of the Cleveland Cliffs Iron Co." was ably discussed by Messrs. Cole, Duncan, Sperr, Lawton, Grierson, Kelly, and Denton.

Early Thursday morning the members boarded a special Mineral Range train for points north of Houghton, where they inspected a small part of the largest mining machinery in the world. At Lake Linden there are two mills, one called the Calumet, with 17 steam stamps, and the other called the Hecla, with 11 steam stamps. The combination is capable of crushing about 10,000 tons of rock daily. The rock crushed at these mills carries an average of 25.47 pounds of copper per ton, and during the last fiscal year 2,909,972 tons were crushed. The latest wrinkle in ore dressing at these mills is the regrinding plant for the tailing coming from the mill tables. It has been the practice to use Chilean mills for this purpose; recently, however, one Hardinge and one cylindrical tube mill have been successfully used, and it is probable that others will be installed. In the electrical power house the five generating units with a combined capacity of 8,000 kilowatts were admired. This power drives 240 motors for various purposes about the company's works, ranging in capacity up to 700 electrical horsepower. The foundation for a new mixed-flow turbine generator, one unit of 10,000 kilowatts, is completed, and there already exists a demand throughout the various works of the Calumet & Hecla which will absorb all this power.

After leaving Lake Linden the Ahmeek mine was visited, where on one car were two masses of copper which comprised a car load. This kind of copper ore requires the roof to be taken from the reverberatory furnace in order to place it on the hearth. After this is accomplished the roof is repaired and the furnace heat raised. Owing to the large lumps of mass ore having some rock attached they are more infusible than copper concentrate, and because of their size they melt but slowly above the bath of molten metal and more slowly below.

On the surface at this plant there was a set of reinforced-concrete shaft lining for inspection. It is said to cost less than timber, lasts longer in these mines, which are practically free from acid water, and has the further advantage of being fire-

proof. The Ahmeek management was the first to adopt concrete timbering in the copper country.

After luncheon at Electric Park the party went by trolley cars to the Franklin mine, where a new and interesting duplex hoisting engine is coupled to air-compressing cylinders and the skip when going down the shaft is made to compress sufficient air to help hoist the next load one-third the way up the shaft. This is termed an air-balanced hoisting engine and was origi-

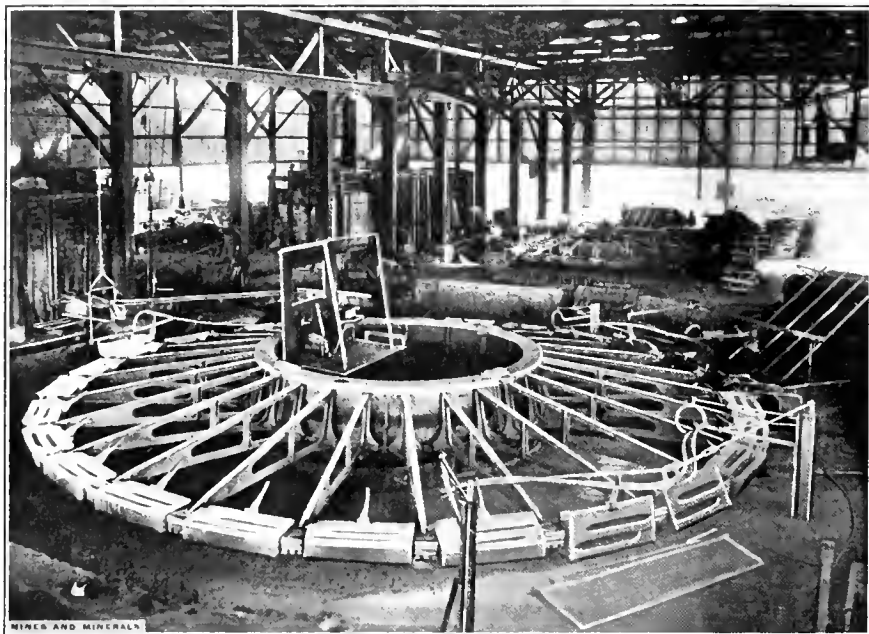

FIG. 2. WALKER CASTING MACHINE

inated by General Manager R. M. Edwards. MINES AND MINERALS will, if permitted by the Institute, publish Mr. R. H. Corbett's paper on this hoister and compressor, in a future issue.

From the Franklin mine the members returned by trolley cars to Houghton, where they got a "hoot" if they wanted one, after which they embarked on a barge and were towed down the lake to the Oniganing Yacht Club House. Here a dinner was served. Doctor Holmes explained the functions and aims of the United States Bureau of Mines, and then a concert was given by the Calumet & Hecla Band. Friday was devoted to reading papers and demonstrations at the Houghton School of Mines.

The following is a partial list of papers presented at the meeting: "Methods of Sampling at Lake Superior Iron Mines," by Benedict Crowell, Cleveland, Ohio, "System of Safety Inspection of the Cleveland-Cliffs Iron Co.," by William Conibear, Ishpeming, Mich.; "Raising Shaft at Rolling Mill Mine, Negaunee, Mich.," by Edwin N. Cory, Negaunee, Mich.; "Mine Sanitation," by E. B. Wilson, Scranton, Pa.; "Raising, Sinking, and Concreting, No. 3 Shaft, Negaunee Mine," by E. R. Elliott, Negaunee, Mich.; "The Unex-

plored Parts of the Copper Range of Keweenaw Point," by Alfred C. Lane, Tufts College, Mass.; "Foot-wall Shafts in Lake Superior Copper Mines," by Dr. L. L. Hubbard, Houghton, Mich.; "Some Applications of Concrete Underground," by H. T. Mercer; "Rock-House Practice of the Quincy Mining Co.," by T. C. DeSoller; "Construction of Intakes at the Mills of the Champion and Tri-Mountain Companies," by Edward Koepel, Beacon Hill, Mich.; "Balancing Rock Crushers," by

Beacon Hill, Mich., Charles Champion, C. L. Adams, Ed. Koepel.

Baraboo, Wis., A. W. Rahn.

Beaver Dam, Wis., J. R. Gish.

Crystal Falls, Mich., S. J. Goodney, W. J. Richards.

Cleveland, Ohio, S. L. Mather, M. T. Hearley, A. C. Bittchopsky, H. A. Raymond.

Calumet, Mich., John Knox, W. M. Gibson.

Crosby, Minn., T. H. Martin.

Commonwealth, Wis., E. W. Hopkins.

Chicago, Ill., W. A. Mitchell, H. C. Hampton, A. B. Conover, N. P. Mowatt, F. W. Mowatt, C. G. Strong, C. R. Silver, L. A. Sisley, J. W. Holman, H. M. Scott, B. W. Goodsell, M. W. Sherwood, R. D. Hunter, H. Cole Estep, P. J. Woolf, L. B. Armstrong, W. D. Cantillon, C. Jackson, E. D. Brigham.

Derby, Conn., W. H. Keefe.

Denver, Colo., H. C. Parmelee.

Dollar Bay, Mich., R. H. McDonald, E. J. Foley.

Dayton, Ohio, J. Franklin Ware.

Duluth, Minn., J. H. Harding, J. G. Vivian, R. J. Raley, A. N. Gow, T. H. Lang, W. G. LaRue, T. F. Cole, S. H. Witherbee, F. J. Webb.

Easton, Pa., John M. Sherrerd.

Escanaba, Mich., J. N. Clifford, H. J. Robertson, W. B. Lindsley, C. E. Helmer, C. E. Andrews.

Green Bay, Mich., E. T. Hastings.

Hibbing, Minn., William Wearne, Joseph Shields, W. J. West, G. E. Harrison.

Hubbell, Mich., G. L. Heath, J. B. Cooper

Houghton, Mich., A. H. Meuche, F. W. Sperr, F. W. Paine, M. J. Carroll, N. J. Wright, R. J. Wirtz, H. W. Fesing, F. J. Rawden, F. W. Nichols, I. J. Shields, John Grigg, J. W. Shields, W. D. Calverly, James R. Dee, S. E. Byrnes, S. T. Harris, T. J. Kitts, F. W. McNair, Thomas Mullen, A. T. Pryor, George Williams, J. B. McNamara, J. C. Mann, D. R. Wallace, L. L. Hubbard, R. H. Maurer, R. H. Corbett, G. S. Goodale, F. R. Bolles, F. L. Van Orden, J. M. Broan, R. H. Shields, R. Skiff Shelden, H. F. Nickerson, J. H. Reeder, H. L. Swift, J. H. Rice, C. H. Cooper, E. A. Seaman, C. J. Webb, Enoch Henderson, Phillip Carroll, Richard Carroll, James B. Carroll, W. J. Criez, L. P. Cook, W. C. Douglas, J. T. Healy, John C. Pryor, William B. Hoar, W. J. Uren, B. F. Sparks, H. E. Stewart, James Fisher, Jr., George L. Christiansen, R. C. Pryor, W. R. Hodge, S. S. Lang, C. H. Moss, R. B. Lang, H. W. McNair, W. A. McNair, H. P. Hood, W. J. Keast, L. La Rochelle, Ocha Potter, W. J. Whinens, J. A. Seifert.

Hancock, Mich., R. D. Blackburn, John M. Wagner, C. L. Lawton, T. F. Lynch, George P. Schubert, J. L. Harris, H. L. Baer, E. P. Leach, T. C. DeSollar.

Ishpeming, Mich., E. E. White, W. H. Johnstone, William Conibear, Lucien Eaton, M. F. LaCroix, W. T. Cole, Allen F.

O. P. Hood, Pittsburg, Pa.; "In the Lake Superior Area—What Influences if Any, Did the Ancient Topography of Foot-Wall Beds Have Upon the Subsequent Deposition and Distribution of Copper in Overlying Beds," by L. L. Hubbard, Houghton, Mich.; "The New Franklin Hoist," by R. H. Corbett, "Notes of Methods of Mining Iron Ore in the Lake Superior District," by F. W. Sperr, Houghton, Mich.; "Failures of the Rule of Following the Hanging in the Development of Lake Superior Copper Mines," by F. W. Sperr, Houghton, Mich.

To judge of the esteem in which a technical society is held by its members, it is only necessary to note the attendance at its meetings. Members of the Lake Superior Institute are widely scattered, yet 50 per cent. of its membership were probably present. The following list does not include all, for some came late after the list had been taken from the secretary's book.

Atlantic Mine, Mich., A. D. Edwards.

Ashland, Wis., W. F. Walker, G. J. Quickly.

Appleton, Wis., T. W. Orbison.

Boston, Mass., W. A. Paine, A. L. Carnahan, Thomas S. Dee, Alton L. Dickerman.

Bessemer, Mich., G. S. Barker, W. G. Trevarthen.

Rogers, R. I. Nilas, William Jory, Ed. N. Corey, J. T. Quinne, C. J. Stakel, H. G. Halt, C. D. Cole, M. M. Duncan, A. J. Youngbluth, H. L. Smythe, Howard Heyn, H. O. Young, C. T. Rice, J. P. Jopling, George A. Newett, W. G. Imhoff, W. C. Rowe, A. B. Miner.

Ironwood, Mich., B. W. Vallet, L. C. Brewer, George H. Abcel, D. Sutherland, F. B. Goodman, William Bond, O. W. Johnstone, Pearson Wills, C. E. Stevens, Carl Brewer, Dan Nolan, J. A. Rupp, J. M. Bush.

Iron Mountain, Mich., W. J. Davidson, Frank Carbis.

Iron River, Mich., D. H. Campbell.

Kearsarge, Mich., C. G. Smith.

Lansing, Mich., R. C. Allen.

Laurium, Mich., W. R. Jewett.

Lake Linden, Mich., C. H. Benedict.

La Crosse, Wis., L. I. Rehfuss.

Milwaukee, Wis., E. F. Fishwick, J.

F. Letz, F. M. Prescott, E. C. Hingston.

G. L. Tifts, Irving Reynolds.

McKinley, Mich., W. P. Chinn, R. J.

Chinn.

Menominee, Mich., C. W. Mott, L. L.

Prescott.

Marysville, Mich., D. W. Powell, Joseph Fay, N. P. E. John, F. L. Pearce, J. M. Longyear.

Mesa City, Mex., E. E. Ryan.

Mohawk, Mich., W. J. Smith.

Negaunee, Mich., J. H. Rough, W. H.

Yates, Fred Ward.

New York, N. Y., J. R. Stanton, F. P.

Bumall.

New Britain, Conn., Ferdinand Ritter.

Oshkosh, Wis., J. H. Whitney, A. B.

Whitney.

Pittsburg, Pa., Doctor Holmes, F. F.

Morris, O. P. Hood.

Palatka, Mich., W. H. Bengey.

Point Mills, Mich., R. L. Oliver.

Painesdale, Mich., W. J. Richards, W.

A. Rankin, P. P. Daume, H. S. Goodell, F.

W. Denton.

Republic, Mich., W. A. Sieenthal, P.

W. Pascoe.

Rockland, Mich., Samuel Brady.

Redridge, Mich., A. H. Sawyer, O. D.

Fellows, Jr.

Ramsay, Mich., T. S. Williams.

Scranton, Pa., E. B. Wilson.

St. Louis, Mo., W. B. Gotch.

San Antonio, Tex., J. C. McTyre.

Tuft's College, Mass., Prof. A. C. Lane.

Trinountain, Mich., B. D. Noetzel,

Richard Bowlen.

Virginia, Minn., John H. Burt.

Verona, Mich., W. J. Davis.

Vulcan, Mich., William Kelley, F. H.

Armstrong, F. L. Burr.

Watertown, Mass., Prof. Henry L.

Smyth.

The following officers were elected:

President, Pentecost Mitchell, Duluth,

Minn. Vice-Presidents, Geo. H. Abeel,

Ironwood, Mich.; W. P. Chinn, McKin-

ley, Minn.; W. H. Jobe, Palatka, Mich;

Francis J. Webb, Duluth, Minn.; A. D.

Edwards, Atlantic Mine, Mich. Treas-

urer, E. W. Hopkins, Commonwealth,

Wis. Secretary, A. J. Yungbluth, Ish-

peping, Mich. Representatives from five of

the leading mining and metallurgical jour-

nals attended the meeting which shows the

importance attached to the institute.

The various committees are to be con-

gratulated for the systematic way in which

every part of the program was carried to

completion, and the reception committee

for the generous treatment accorded the

visitors.



ILLINOIS STATE INSPECTORS OF MINES

Reading from left to right—First row (sitting down)—Frank Rosb, Benton; Thomas Hndson, Galva; Walter Rutledge, Alton; Hector McAllister, Streator; W. W. Williams, Litchfield. Second row.—James Taylor, Peoria; Thomas Little, Murphysboro; Oscar Cartlidge, Marion; John Dunlop, Peoria. Third row.—W. L. Morgan, East St. Louis, Thomas Park, Canton, W. S. Burris, Danville. Above:—Thomas Weeks (Deceased)

THE Bunsen Coal Co., of Westville,

Ill., a subsidiary of the United States Steel Corporation, broke ground on October 5, 1911, for the construction of a concrete-lined shaft combining an escapeway for the men and an upcast airway for ventilating purposes. The Vermillion mine has a daily output of 2,750 tons. The development at the present time comprises

Fireproof Shaft, Vermillion Mine

Concrete Construction of Shaft Lining and Bottom—Description of Steel Sinking Shoe

By A. F. Allard*

sinking and design adopted combined the new features of a rectangular designed shaft of concrete and the sinking of same through the soft strata by means of a steel shoe and the weight of the concrete lining walls.

width of 4 feet 10 inches and extends the length of the shaft; the pattern is of open design and only a small percentage of the space taken up would affect the ventilation and upcast of which a portion of the air goes through the stairway openings. Fig. 3 shows the plan and elevation of the shaft.

Two reinforced concrete archways are provided at the shaft bottom, one for the upcast air from the mine and the other from manway entrance to the stairway. Each arch has a span of 7 feet and a height of 9 feet from landing to the top of crown, both arches extend a distance of 6 feet from the shaft lining. The sump is floored over and supported on 3-inch I beams. Fig. 2 shows the arrangement at the bottom openings.

The steel shoe for the sinking of the shaft, from the surface of ground to the solid strata, was of rectangular design, forming an open caisson, and measured when set up ready for sinking 11 ft. 6 in. \times 16 ft. 6 in. The side and end plates are $\frac{1}{2}$ inch thick. Fig. 1 shows plan and section of shoe with details showing method of construction at the corners and splice connections.

The shoe before riveting together comprised six sections connected with $\frac{1}{2}$ " \times 12" \times 26" splice plates thoroughly riveted. The rivet heads were all countersunk on the back of the shoe to lessen the friction when sinking. The four rectangular corners were all stiffened with the same size plates. The shoe has a vertical depth on the back line of the lining of 26 inches and an angle of 45 degrees from the cutting edge to the inner side of the lining at top of shoe. The two side pieces between splice connections are each 10 feet long and the four corner sections measure each 5 feet 9 inches on the end, and 3 feet 3 inches on the side. The opening at top of the shoe provides for a concrete lining wall of 15 inches thickness. The side and end plates at the top between the splice connections are all stiffened with 3" \times 3" \times $\frac{1}{2}$ " angles. To prevent the top from buckling or spreading 1" \times 15" bolts are placed every 3 feet around the entire shoe, these bolts have countersunk heads on the back of the shoe. Between the horizontal bolts and extending around the entire shoe, and spaced 3 feet apart, 1 inch diameter by 6 feet in length vertical rods were used to tie in the shoe to the first section of concrete lining, the top of these rods were bent in U form to receive similar rods which were placed as each section of lining wall was poured, and extended to the top of coping. The shoe when completed had a total weight of 7,000 pounds.

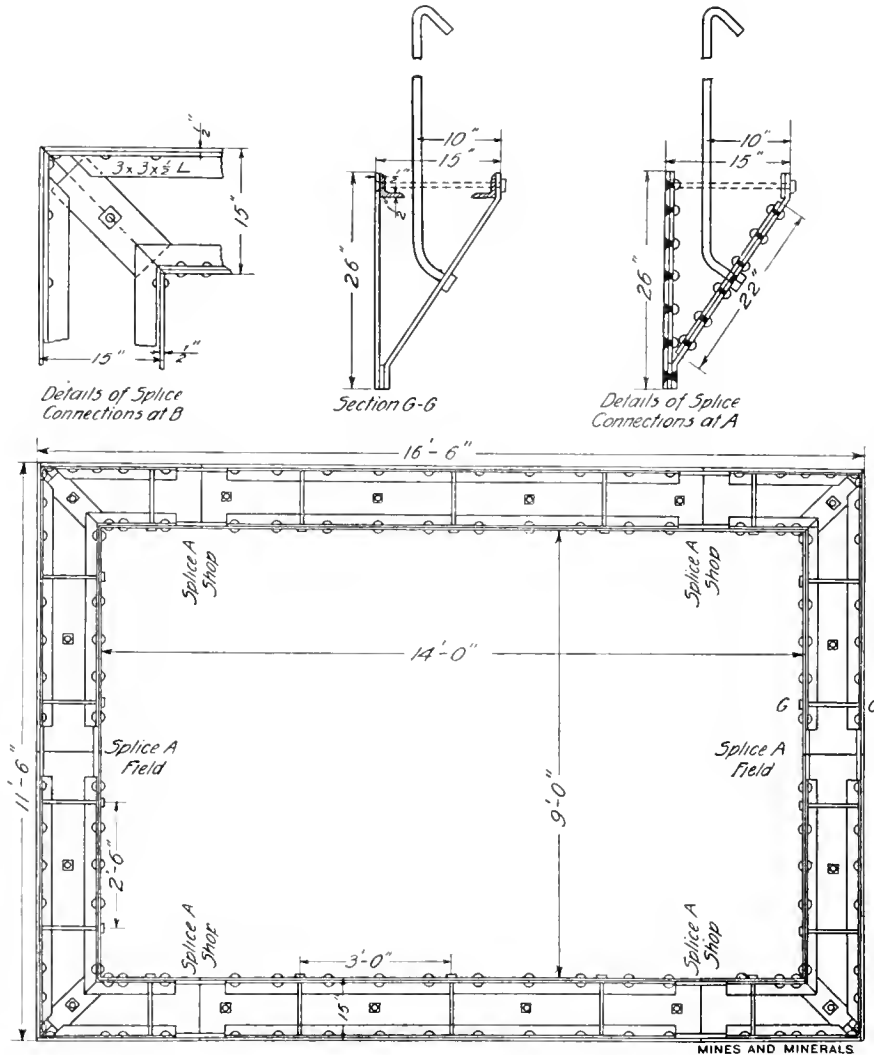

FIG. 1. PLAN AND DETAILS OF STEEL SHOE

about 500 acres of the Grape Creek coal seam. The point chosen for the shaft location is 3,500 feet from the hoisting shaft. Departing from the ordinary procedure of contracting the work, and in order to obtain the experience during construction, the Bunsen Coal Co. purchased all equipment necessary and completed the work with their own forces. Work was stopped during the winter months and started again during April, 1912, the shaft lining walls being completed on June 1 of same year. The method of

The shaft is of rectangular design and measures 8 feet in width by 13 feet in length in the clear between the concrete lining walls. The concrete walls have a thickness of 21 inches from the top of coping to the steel shoe, a distance of 52 feet, from this point to the bottom of shaft the walls have an average thickness of 12 inches. The total depth of shaft is 205 feet to the archway landings at the bottom. A sump with a depth of 3 feet 6 inches is provided. The shaft has an opening area of 104 square feet. The steel stairway and landings occupy a

* Chief Engineer, Bunsen Coal Co.

Wooden forms were used for all of the concrete lining work and were made up of 2" x 10" surfaced plank carefully put together and stiffened vertically with 4" x 6" strips. The forms were 6 feet high, two side and two end pieces formed the units for the entire section. An inside and outside form was necessary for the placing of the concrete until the shoe was landed on solid strata. These forms remained in position at the top of the shaft until this portion of the work was completed. To readily release the concrete when set and remove the forms when necessary, all of the connecting joints had beveled edges and were brought into position by wedging. The sides and ends were well braced to hold in the correct position.

From the shoe to the shaft bottom an inside form only was necessary, the concrete filling into the sides of the rock excavation or against the 2-inch curbing timbers. No forms were removed from the concrete until it had set for at least two days.

Steel Stairway.—The steel stairway is of zigzag pattern and together with the landings occupies a space longitudinally in the shaft for a width of 4 feet 10 inches. Each flight rises on a 38-degree angle from the vertical, and is 11 feet long. The separate flights, including the landings, are supported on 8-inch channels weighing 11¼ pounds per foot placed crosswise in the shaft, and are secured in the concrete side walls by placing in pockets and grouting the ends, which have a bearing of 6 inches in the wall. These channels are placed 2 feet from the end walls and are spaced vertically 6 feet apart, alternating for each flight.

The stair stringers are ¼ in. x 7 in. deep. The treads are ¼ in. x 11 in. x 27 in. with checkered surfaces and are supported on 1½" x 1½" x ¼" angles riveted to the stringers. The rise between treads is 8 inches. The landing plates are ¼ in. x 25 in. x 58 in. and are also checkered on the surface. Three lugs of 3½" x 5" x ¾" angle iron are riveted to the plate and fastened to the concrete wall by means of ⅝" x 5" expansion bolts well drawn up. The hand railing is made up of two lines of 1½-inch pipe, the uprights are bolted to the stair stringers and connected to each line of railing. The total weight per vertical foot of stairway and landings, not including the channel supports, was 95 pounds.

Before placing any steel work, two coats of paint were applied on the surface and again another coat in the shaft upon completion of the work.

The cutting of the pocket holes in the concrete and the drilling of same for the bolt holes was all done by hand. The men erecting temporary scaffolds as each flight was placed, working from the bot-

tom upwards. This stairway is easy for the men to walk on and is of economical design, making the shaft absolutely fire-proof. Fig. 3 shows the plan and part elevation of the stairway.

Method of Sinking and Concreting. For sinking work, a steel shoe to penetrate the soft strata was used and carried the concrete caisson from the surface of ground to a point 52 feet below the top of the coping.

To give the shoe a good start, excavation was first made, giving ample clearance for a depth of 3 feet when the forms were placed in position at the surface and the first section of concrete lining wall poured to a depth of 6 feet.

Mucking was then started, and as the sides of the excavation were cleared the

was added to each batch. The concrete was mixed in a cubical mixer located near the top of the shaft, poured into a bucket, lowered, and the mix distributed in the several forms by means of a movable chute supported on a temporary platform at the top of each section in the shaft. No supporting buntoms for the side walls were used in this shaft.

From shoe to the shaft bottom the usual method of sinking was employed; namely, drilling and shooting the sump holes and benches, carrying down the excavation as far as possible to permit the placing of from 20 to 60 feet of concrete lining wall, when the sinking and concreting process was repeated.

When soft strata and fireclay seams were encountered in the excavation,

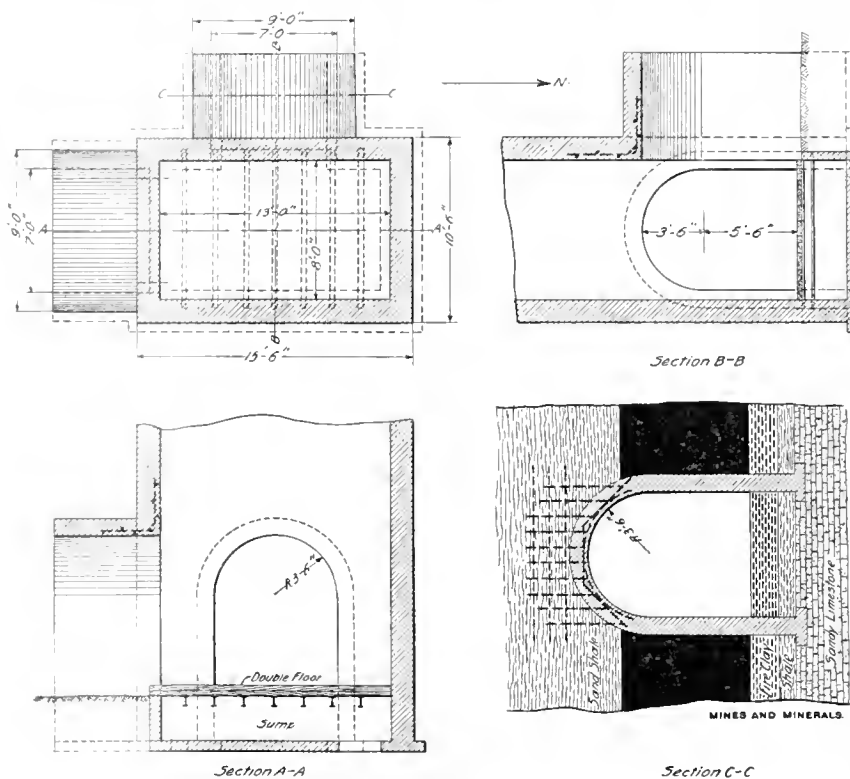

FIG. 2. CONSTRUCTION AT SHAFT BOTTOM

weight of the concrete started the cutting edge and penetration of the shoe, until sufficient depth was made for the placing of another 6-foot section of concrete wall. This same process was repeated until shoe and concrete walls were landed on the solid strata at a depth of 52 feet from top of coping. For this depth the walls were 21 inches thick, and the entire section sunk by the weight of the concrete through the surface soil, sand, gravel, and clay strata. To tie together each vertical 6-foot section of concrete lining wall, 1 inch diameter by 6 feet rods were placed around the entire section and spaced 3 feet apart. The concrete mix was composed of 1 part "Universal Portland Cement," 2 parts sand, and 5 parts gravel. For the closing-in section an extra bag of cement

2" x 10" curbing timbers were placed to protect the sides from caving.

When the shoe was landed, several cracks appeared in the concrete walls mainly due to the pressures exerted because of the weight of the concrete not settling evenly; at times one end was much higher than the other, and mucking at the lower end had to be stopped and continued at the high end until both came to the same level. When the shoe was landed the shaft section for a depth of 52 feet was found to be about 9 inches out of plumb, this was equalized and the cracks grouted by placing a concrete veneer over the entire top section, the concrete was adhered to the original walls by the use of ¾-inch lag screws staggered every 3 feet and firmly placed

in the original concrete, making a good appearing and efficient job when the work was completed. The advantage of sinking by this method, through soft ground, over that of using curbing timber and jacking the shoe down by hand, was not only in progress, but also the saving in cost by eliminating any heavy timber that might be necessary, and by pouring the concrete for the heavier wall sections and erecting the forms on the surface. Very little water was met with during the work and little trouble was experienced taking care of it. During the sinking and con-

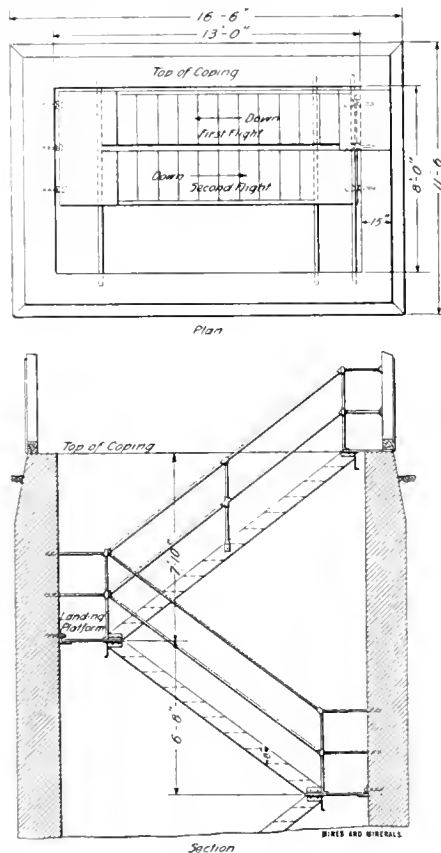

FIG. 3. SHAFT AND STAIRWAY

creting work, two 8-hour shifts were employed consisting of 7 men on each shift. One shift only was used of 5 men when the stairway was erected.

The equipment consisted of a straight mast derrick with swinging gear attachment and a 50-foot boom handling all of the muck and conveying the concrete; one double-drum hoisting engine with $6\frac{1}{2}$ " \times 10" cylinders, and attached to the engine was a 20-horsepower vertical boiler; one 50-horsepower portable fire-tube boiler; one duplex feedwater pump, size 6 in. \times 4 in. \times 6 in.; two side dump trucks; two dump buckets each of 1 cubic yard capacity; and one cubical concrete mixer with engine attached. The mixer had one-half cubic yard capacity. Electric lights for the work were furnished from the Vermilion mine, and water for boiler use was pumped from the same place.

Answers to Examination Questions

Answers to Questions Asked at the Examination for Mine Foremen, Held in Utah, 1911

(Continued from August)

QUES. 15.—What should a miner be made to know about a safety lamp?
ANS.—A miner should know that in the hands of ignorant, careless, or uninstructed men, the safety lamp instead of insuring freedom from gas explosions may be a positive source of danger through a false sense of security created by its presence and use. The miner should be able to know when the lamp has been properly cleaned and put together and when the gauze is in good condition; he should know that the lamp should not be opened under any circumstances except by those authorized to do so and in a place where such opening cannot ignite gas; that the flame should not be too high nor should the lamp be kept in a gaseous atmosphere too long; he should know that the lamp must be kept upright, must not be allowed to fall, must not be directly exposed to strong currents of air or, what is the same thing, must not be swung to and fro while being carried. He should be especially instructed that if anything goes wrong with his lamp, or if he even suspects that it is not working properly, to take the lamp carefully from his working place to the entry where gas is but rarely found and report to the fire boss or mine foreman.

QUES. 16.—Explain the difference, in method of producing an air-current, between a force and exhaust fan?

ANS.—As the power required to force a given amount of air through the same mine is the same with either an exhaust or blowing fan, the difference in the systems consists practically in the different arrangement of the fan casing. In exhaust fans the air is commonly discharged upward through a chimney-like extension which widens toward the outer end. In blowing fans the discharge is usually in a horizontal direction into the airway with only enough enlargement to accommodate it to the size of the mine heading.

However, the underground conditions produced by the use of the two systems are markedly different. With the exhaust fan the atmospheric pressure in the mine is always a little less than that outside, the result being that if the fan stops there is a tendency for any gas to be driven back into the coal or the gob, while with a blowing fan, the pressure in the mine being greater than that outside, a stoppage of the ventilating machinery has a tendency to permit the escape of gas from the coal and abandoned workings. In a mine making much gas the percentage of firedamp thus released from or forced back into the workings is insignificant, but the advantage,

such as it is, is in favor of the exhaust fan. Under the exhaust system of ventilation, the hoisting shaft is the downcast and, if wet, much trouble may result in winter from water freezing on the guides, etc. With the blowing system the hoisting shaft is, of course, the return and the escaping air-current, being warm, there is rarely any danger from freezing. On the other hand, with a blowing fan the intake may freeze, and as the effect upon the ventilation is the same whichever shaft is clogged, from this standpoint it is immaterial which system is adopted, although it will be admitted that a hoisting shaft by reason of its greater accessibility is more easily kept clear of ice than an ordinary ventilating shaft. However, with modern methods of construction there is rarely any excuse for any great amount of water dropping in the shaft.

In regard to working conditions at the foot of the shaft; under the exhaust system the shaft parting is constantly supplied with fresh air and while relatively cool in summer is absolutely cold in winter. In the blowing system, the air on the shaft parting is always foul and is warm both winter and summer, as mine temperatures vary but little from season to season. With the exhaust system, the shaft parting is clear and free from fog or haze, except upon unusually warm and humid days in summer when there may be some slight condensation of moisture, whereas with the blowing system the shaft bottom is always more or less hazy from powder and lamp smoke and possibly some watery vapor. From the standpoint of health, proper working conditions, etc., at the shaft bottom, the exhaust system is to be preferred.

As regards conditions at the working face, the advantage is with the blowing system, because the haulage road being the return the foul air and dust are immediately conveyed away from the miners instead of toward them as is the case under the exhaust system when the haulage road is the intake. It should be remembered, however, if the seam is gaseous it may not be safe to make the haulage the return (blowing system) on account of danger from driver's lamps, sparks from the trolleys of electric locomotives and the like.

From the standpoint of humidification and dust treatment the advantage appears to be with the blowing system. If the air-shaft is the downcast, the incoming air may be heated at the entrance to any desired temperature and humidified to any degree of saturation so that it reaches the face in

the best possible condition to keep the dust moist; and this may be done without the highly objectionable clouding of the haulage way with steam which is practically unavoidable under the exhaust system. As mine entrances are placed where there is least cover, it follows that there is a drop in the rock, or normal mine, temperature from the working face to the drift mouth or shaft bottom. Under the blowing system, this regular drop in temperature is favorable to a uniform deposition of moisture from the face outby, so that the haulage roads, where a large percentage of dangerous dust is made, are in a better and safer condition than under the exhaust system where the haulage roads are the intake, and where the entering air, except for a few months in summer, is below the normal mine temperature and hence tends to absorb moisture from the mine.

In general it may be stated that in non-gaseous mines, or in mines giving off but small amounts of explosive gas, but troubled with inflammable dust, the blowing system is to be preferred, because it permits of a very perfect handling of the dust. If the mine is very gaseous, unless compressed air or storage battery electric haulage is used, together with storage battery portable lamps, it would seem better to use the exhaust system because of danger of igniting the gas by open lights or sparks from a trolley. If the mine is both gaseous and dusty, hauling should be done on a separate heading and a 3-, 4-, or 5-entry system of mining be adopted.

QUES. 17.—Upon making your rounds of inspection in the morning, say in No. 3 entry and in Nos. 1, 2, 3, and 4 pillars, you found the gas down to the edge of the roof on the caves, these pillars being worked with safety lamps while other rooms and entries on the same split were worked with open lights, (a) What would you do? (b) Do you think that the above method can be made a safe practice?

ANS.—(a) While attention should be paid to the situation of the pillars and rooms with respect to the direction of the air-current, safety would demand the immediate withdrawing of the men until such a time, at least, as all have been provided with safety lamps. (b) Whether working the pillars with safeties and rooms and entries with open lights can be made a safe practice will, as stated, depend in some measure upon the direction of the air-current. If, in the line of motion of the air, the pillars are outside the rooms, most superintendents would work the rooms, or all except the one or two nearest the pillars with open lights, as the gas is being pulled away from the rooms. On the other hand, if the rooms were inside the pillars, that is, if the air entered the pillars first, ordinary prudence would indicate the use of safety lamps in the rooms beyond. It would seem better practice to use safeties in both rooms and pillars under any cir-

cumstances, as a heavy fall might force the gas in any direction back upon the open lights. A higher degree of safety would be obtained by using electric storage battery lamps in place of open lights as they are absolutely safe unless the bulb be broken in a mixture of air containing a quite large proportion of explosive gas.

QUES. 18. What are the principal things to be looked after in haulage ways in mines to insure safety to men and animals and economical haulage?

ANS.—The headings should be driven "on points," or sights set by the mining engineer with a transit, or if an engineer and a transit are not available sights may be set by the foreman with a compass. It is advisable to so place the line of sight with respect to the ribs of the entry that one rail may be laid on this line. This will insure, due care being taken by the tracklayer to bring the other rail to gauge, that the track is absolutely straight, and no one thing does more to prevent derailments and consequent loss of time and possibly of life and property, than having a straight track. Grades should be made as uniform as possible by taking up the bottom on the rises and filling in the swags. Also the track should be properly lined so that there are no vertical kinks in the rails, and surfaced to prevent local low places or "low joints." The rails should be of good size, 45 pounds per yard or larger where high-speed electric haulage is employed, some mines employing 60- and 65-pound rails on main headings. Ties should be large, sound, and evenly spaced on 2-foot centers or sufficient in number to prevent the rails bending between them upon the passage of a heavy trip. Track should be well ballasted to insure proper drainage to the ditch, which should be carried on one side of the entry in all wet mines, and which ditch should be kept clean so that water may not back up under the road bed. The regular split switch of the surface railroad type should be used in preference to the old style stub, or blunt, switch. There should be at least 2 feet clearance between the widest part of the body of the mine car and the rib, which distance should be maintained on one side of the entry so that men using the haulage way as a traveling road instinctively turn in the proper direction to pass an approaching trip. This is easily possible, if the heading is straight and the rails laid on points, but difficult of accomplishment otherwise. It is also advisable to have refuge, safety, or man, holes cut in the rib at regular intervals on the same side of the heading as the widening used as a traveling way or path. These places of refuge should be whitewashed or painted to indicate their location, and it is advisable to have an electric light burning in front of each. Unquestionably many of our readers have at one time or another dropped their lamps and been in the dark and thus in serious

danger when traveling on the main road. An electric lamp every 60 or 100 feet affords sufficient light for one to reach a place of safety where he can wait until some one with a lamp comes or even may proceed with perfect safety to the parting. The above applies to permanent main haulage ways which are to be used throughout the life of the mine; and large operators now realize that the increased investment for first-class track and rolling stock is returned many times over in less cost of haulage and maintenance. On cross-entries such precautions are not needed, as the life of the entry is relatively short and the speed of haulage not so great. In any case, however, the track should be straight, or good weight of rail, properly surfaced, etc. The amount of money spent upon cross-entry tracks should be proportioned to the amount of coal to "come off" them. Poor room switches probably cause more trouble on cross-entries than anything else. It is by no means unusual to see a fine piece of entry track disfigured on the room side with a series of cheap cast-iron frogs. It is almost impossible to set these frogs properly, or if set properly, they soon get out of line and are a continual source of derailment, with its attendant loss of time and labor, both of which mean money. Room frogs should be of the same general type as those used for entry turnouts from the main haulage road, only smaller. If properly cared for they may be taken up and relaid until the mine is exhausted. In pitching seams the entries generally follow the water level or are driven with a slightly rising gradient to insure proper drainage. The curves should be as regular as possible and the rails should be bent by machine to the shape of the curve and not sprung into place. An elevation dependent upon the degree of curvature and the speed of the trip should be given to the outer rail. In other particulars the handling of track and haulage roads is the same in pitching as in flat seams.

QUES. 19.—How much more resistance does an air-current encounter when traveling 600 feet per minute than at 500 feet per minute? If the water gauge is .8 inch at the lower speed what would it be at the higher?

ANS.—If P and V are the pressure and velocity at a speed of 600 feet a minute and p and v those at 500 feet per minute, the formula for the resistance (pressure) is in the first case, $P = \frac{k s V^2}{a}$ and in the

second, $p = \frac{k s v^2}{a}$. The ratio between them

$$\text{is } \frac{P}{p} = \frac{\frac{k s V^2}{a}}{\frac{k s v^2}{a}} = \frac{k s V^2}{k s v^2} = \frac{V^2}{v^2}, \text{ since } k, s, \text{ and } a$$

are the same in either case; or the resistance, which is measured by the pressure, p , is proportional to the square of the

respective velocities. If the pressure at the lower velocity is called l , we have by substituting the values of V and v , $\frac{P}{l} = \frac{600^2}{500^2}$
 $= \frac{360,000}{250,000} = \frac{36}{25} = 1.44$. That is, the resistance at 600 feet per minute is 1.44 times as much or 44 per cent. greater than at 500 feet per minute.

If I equals the water gauge at the greater velocity and i the water gauge at the lower velocity, we have the two formulas, $I = \frac{P}{5.2}$

and $i = \frac{p}{5.2}$ and the water gauge ratio

is $\frac{I}{i} = \frac{P}{p}$. But, since $\frac{P}{p} = \frac{V^2}{v^2}$, we have by

substitution, $\frac{I}{i} = \frac{V^2}{v^2}$, that is, the water gauge

ratio and the pressure ratio are the same, which is to be expected, since the water gauge is used to measure directly the drag, or resistance. Since we have found the ratio $\frac{P}{p} = 1.44$, the ratio $\frac{I}{i} = 1.44$ as well,

Since the water gauge, i , at the lower velocity is equal to .8 inch, we have by substitution, $\frac{I}{.8} = 1.44$. From this $I = .8 \times 1.44 = 1.152$ inches.

QUES. 20.—(a) What precautions would you take to prevent a squeeze in a coal mine? (b) What are the main dangers attendant on a squeeze?

Ans.—As a squeeze is due to too great a weight being thrown upon the pillars the best means of prevention is, naturally, to proportion the width of the pillars and rooms to the thickness of the overlying rock; the thicker the superincumbent rocks, the wider the pillars and the narrower the rooms and entries. For the proportioning of pillars according to the depth of the workings beneath the surface, various more or less satisfactory formulas are given. It is obvious that a single room even of unusual width, say as much as 50 feet, when driven in a solid block of coal will not bring about a squeeze, whereas the working of a 20-acre tract with rooms of this width separated by 20-foot pillars will result in one. From this it follows that too large an area of coal should not be opened and left standing. The use of almost any retreating system of mining lends itself to the prevention of squeezes because the headings are driven narrow to the boundary, the rooms turned at the far end of the workings, and the pillars drawn as soon as the rooms reach the limit of their length. Squeezes are apt to occur in mines where the pillars and rooms are not of uniform width or where the pillars are improperly drawn. Spacing the rooms a regular distance apart and driving them on rights will eliminate danger from pillars of variable width, and systematic pillaring

carefully watched should prevent squeezes during robbing.

A squeeze once started is a very difficult thing to control and no set rules can be laid down for the purpose. In handling a squeeze the object is to remove the weight from the pillars of coal as rapidly as possible. In the early stages this may sometimes be done, in part, by shooting down the roof to a height as great as it is possible to drill a round of holes. In some cases it is possible to flush slaek through bore holes drilled from the surface into the openings made by the entries and rooms. Usually, however, an attempt is made to secure a break of the overlying rocks to the surface. Sometimes this may be done by a rapid drawing of the pillars, but usually it is attempted by building a series of masonry or timber eribs in a line across a number of rooms. If the squeeze is found to be beyond control and it is seen that the district in which it occurs is destined to be closed, efforts should at once be made to recover all the timber, rails, and other property within its boundaries. A district in which a squeeze has developed should be surrounded by ample barrier pillars or solid coal, so that the crushing action may not "ride over" into what would otherwise be good ground.

(b) Squeezes generally begin and extend slowly, giving ample warning for the retreat of the workers. Should the action be violent, men may be caught by falls of roof or imprisoned by the closing of a portion of the workings; gas may be forced out upon open lights, resulting in an explosion; or the sudden closing of a large area may force out a volume of air with the velocity and violence of an explosion, tearing down timbers, destroying brattices and doors and even propelling cars up the hoisting slope.

QUES. 21.—If you are operating a mine in which firedamp was generated freely, using a locked safety lamp, the coal in the gaseous zone becoming exhausted, and you decided to develop another portion of the mine in which no gas had been discovered, what restriction would you enforce to prevent naked lights being taken into the fire zone?

Ans.—The question is not quite clear, in that it fails to state the situation of the proposed new and non-gaseous working with reference to the about to be abandoned and gaseous workings. If, as is not infrequently the case, the gaseous workings consist of a pair of cross-entries with the accompanying rooms, the entries being connected with the main haulage road and intake, respectively, it would be advisable to seal off the mouths of the entries and air-course with masonry stoppings provided with a small man door which should be kept locked. This will prevent any but those in authority from entering the dangerous workings.

However, if it is necessary to use the

entries in the fiery zone to reach the new workings, the above course cannot be followed. If the pillars therein have not been drawn it would be advisable to brattice off the room necks as close to the entry as possible. This will prevent any one entering the old workings; and if these old workings be ventilated by a separate split and the brattices be properly built, there should be no danger of leakage of explosive gas into the entries. If bratticing is not possible, an ordinary lamp station should be established at the entrance to the gaseous workings and no one allowed to enter and pass through them unless provided with a locked safety lamp in good condition obtained from some one in authority at the station. The customary rules and regulations prevailing in gaseous mines should be posted and enforced.

Notwithstanding that gas has not been discovered in the advanced workings, it would seem good policy to work them with safety lamps. The fact that the old workings have developed large quantities of gas is strong indication that the new ones will do so at some time, and perhaps unexpectedly. It is by many considered the best practice to use safety lamps exclusively in all parts of a mine when the existence of gas compels their use in one part thereof; that is, either use all open or all safety lamps. Whatever objections may be raised to this view, it will be admitted that it tends to insure safety.

來 來

State Coal Mine

In Victoria, Australia, there is a state coal mine in the control of the Railway Commissioners. Prospecting with drills has proved that there are 22 million tons of coal in a bed 2 feet 6 inches thick covering 3,500 acres.

Eleven shafts have been sunk ranging in depth from 177 to 283 feet, but all are not producers, only 3, 5, and 11 being used for that purpose at the time of writing.

In 1911, 710,058 tons of coal were mined, but with the exception of slack coal, which averages 42 per cent. of the output, no coal was sold to the public. Evidently public utilities are run by the Government or else they have to buy this coal from the Government, for the prices given at the mine are \$2.75 for screened coal, \$2.50 for second grade, \$2.12 for run-of-mine, and \$1.62 for slack. The total number of men employed at the mines near Wonthaggi are 1,200; these averaged \$3.47 per shift during 1911 when working on contract.

來 來

Adiabatic differs from isothermal compression in not having the air cooled during compression. Most compressors, if not all, are constructed on isothermal lines.

Waste Heat Coke Ovens

At Marianna, Pa.— A Plant Using Heat from 75 Ovens at a Large Saving Over Coal Firing

*By Sim Reynolds**

THE Marianna waste-heat system consists of four Stirling boilers of 500 horsepower each, fired by the gases given off from a block of 75 beehive coke ovens; and it has been demonstrated that these boilers are delivering 90 per cent. efficiency. The four boilers were originally installed with automatic chain-grate stokers, and it is interesting to note that with the present waste-heat system in use there is an actual saving of over \$60 per day, as shown by the following:

COST OF OPERATING AUTOMATIC STOKERS		
2 firemen (also tending water)	\$2.25 per day	\$ 4.50
4 ashmen.....	2.00 per day	8.00
68 tons coal at 75 cents per ton.....		51.00
Total.....		\$63.50

The cost of getting coal to stokers has not been included in the above, yet with these same boilers fired with the waste heat the cost of operation does not exceed \$2.50 per 24 hours, or a daily saving of \$61 in the operation of a batch of 75 coke ovens.

To those who are more or less familiar with waste-heat systems, as applied to coke making in the United States, it is a generally understood fact that one of the most annoying features of the ordinary, or earlier systems, was the burning out of the connecting flues which carry the gases from the individual ovens to the main conduit. These flues are of course subjected to a great heat, that burns them out more or less completely, in the ordinary waste-heat apparatus. In the ordinary construction this destruction occurs 4 or 5 feet below the top of the oven, or in a line with the top of the coke, and considerable time must elapse before workmen can enter the oven to repair the damage.

In the Kearns waste-heat system, used at the Marianna mine, the oven gases pass to the main conduit by means of a flue set on a line with the top of the oven as shown in Fig. 1. This flue, placed as it is, can be opened in a few minutes after the coke is drawn, and any repairs necessary made. It will also be noted that the flues of this system are built with an air cooling arrangement under and around them, cold air entering at an opening in front of the oven, and out by the way of a small brick stack at the rear. With this method the burning out of a flue is of rare occurrence, and, should the flue need attention at any time in the process of making coke, it is readily accessible, a point not to be overlooked during a busy season. Another of the advantages of having the waste-heat flue connected at or near the top of the oven is that the gases rise naturally from the burning coal, thus giving a uniform draft throughout the oven, and, consequently, a more uniform combustion and quality of coke. This is a decided advantage over

having the gas flue lower down in the oven, from the fact that the coal near the entrance to the waste-heat flue as ordinarily constructed, gets a draft out of proportion with the balance of the charge, which has a decided effect on the quality and structure of the product.

The results obtained at the Marianna

conduit. When this is necessary a small sheet-iron damper is placed in position to shut off the oven from the main conduit, and so isolate the faulty oven from the rest of the block, when the repairs can then be accomplished without further interference.

The coke manufactured in these ovens is unusually free from black butts, which is due to the uniform rate of coking, a constant draft being maintained direct from the ovens to the boilers. The percentage of sulphur is also lower than the ordinary

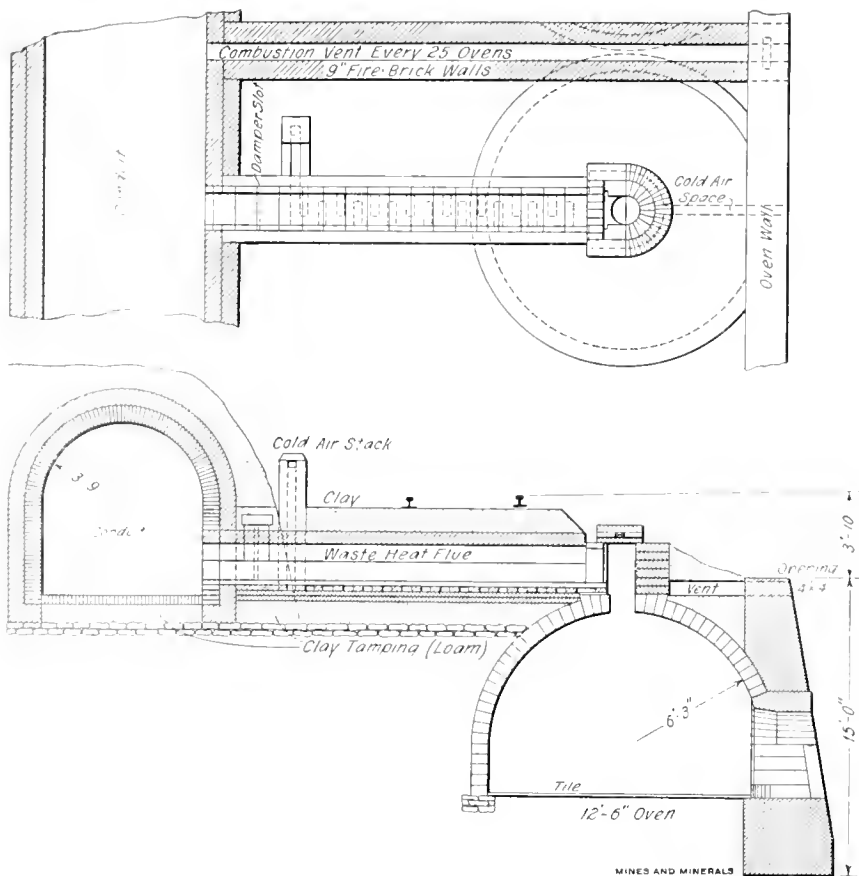

FIG. 1. PLAN AND ELEVATION OF WASTE HEAT COKE OVENS

plant have certainly been gratifying, both to the inventor and the Pittsburg-Buffalo Co. Over 90 per cent. of the fullest possible efficiency is obtained (something the reader will readily agree is far from common in heating or power departments of our industrial plants), and a block of 75 ovens requires only the services of one man to watch the water in the boilers, etc., and who has ample time to give to other duties besides.

The system at Marianna has been in operation over 2 years, certainly a sufficient time to give it a thorough test, and so far the cost of upkeep has been hardly worth mentioning; in fact, the only expense in the whole system has been that of slight repairs to the waste-heat flues from ovens to main

beehive coke, being below the 1 per cent. mark. Wind storms and other climatic conditions have no effect whatever on the coking process, which cannot be said of the old beehive ovens. Draft is regulated at the boiler room for the entire system. Each boiler can be disconnected when necessary from the main conduit by means of a damper through which water circulates. The matter of cleaning boilers is more simple and convenient than with any other style of firing, to say nothing of the absence of dirt under the boilers.

The cost of a waste-heat plant, such as is installed at Marianna, varies according to local conditions, but for a plant say of 50 to 75 ovens, the cost will be approximately \$250 per oven over and above the

* Inspector for W. J. Rainey Co., Uniontown, Pa.

beehive oven, or say an initial cost of \$20,000 for a block of 75 ovens, which should supply something like 2,000 boiler horsepower. It is safe to say that the Marianna waste-heat plant on this block of coke ovens paid for itself during the first year of its operation. The construction of 300 additional ovens is under consideration by the Pittsburg-Buffalo Co., and enough of these will be put on waste heat to furnish power for the entire plant.

Another point worth considering in

regard to waste-heat ovens is the fact that it has been found by actual test that it is possible to burn from 10 to 15 bushels more coal per oven in the waste-heat than in any other style of oven operation.

At the Marianna plant 48-hour and 72-hour coke are the principal grades made, and the demand for the furnace coke has been greater than could be supplied.

Coal is fed to the ovens by electrically-driven larries over a 90-pound track laid on I beams.

the pipes becoming red hot at the joint. The ignition has been known to extend into the air receivers, and the flames to be carried down into the mines by the compressed air.

A lubricant which is of a high flash point, 625° F., and comparatively free from unnecessary volatile carbon, is best suited for air compressing cylinders. One explosion took place where the flash point of the oil was 554° F. and the ignition point 606° F. In another case an explosion occurred with oil which had a flash point of 575° F. and an ignition point of 625° F. Conditions were similar, the air was compressed to about 60 pounds per square inch. If the temperature of the air before its admission to the compressors is 60° F. and it is compressed to 58.8 pounds absolute pressure the final temperature where no cooling is used during the compression will be *317.4 degrees. If the air which is admitted at 60° F. is compressed without cooling to 73.5 pounds absolute pressure, the final temperature will be 369.4° F. These figures are also based on dry air, which increases in temperature during compression to a greater degree than moist air, and it is known that the compressed air is never very dry. The additional frictional resistance may raise the temperature of the compressed air to the ignition point of the oil.

Too small a discharge pipe or too many angles in a discharge pipe might also tend to produce an explosion, although they occur in well-designed systems. An explosion occurred about 6 years ago, where the temperature of the incoming air was normal, the discharge passages and pipes were free and of ample area, hence the only possible explanation that could be advanced was that the temperature of the compressed air was made excessive by the sticking of the discharge valves, thus letting some of the compressed air back into the cylinder to influence the temperature before compression.

When the piston of an air compressor has forced a cylinder volume of air through the discharge valves, and when this piston has its direction of movement reversed, there will immediately be a tendency of the compressed air to return to the cylinder. In this it is checked by the valves; but the discharge valves are liable to become incrustated with carbon scale and not seat properly.

At the Mammoth mine in the Tintic district, Utah, an explosion occurred in the air-compressor cylinder of a duplex Corliss air compressor which resulted in the death of an assistant engineer and injury to the chief engineer. The cause of the explosion has been attributed to the oil used in the cylinders. The explosion shattered the back head; the back

*Peel, "Compressed Air Plants for Mines," p. 46.

Air-Compressor Cylinder Lubrication

Influence of Heat Upon Oils—Dangers Resulting From Caking and Carbonizing of Improper Lubricants

By L. A. Christian

THE following is an abstract from the paper entitled: "Lubrication," read before the West Virginia Mining Institute:

In the last 15 years the use of compressed air has become so general that a knowledge concerning the lubrication of air compressing cylinders is of importance.

The compression of air results in the conversion of energy into heat, and the temperature of the air increases with the pressure to which it is subjected. From time to time trouble arises with the discharge and intake valves of air-compressor cylinders, much of which is caused by the use of heavy and gummy oil.

Experience has shown that the occasional non-seating of valves in air compressing cylinders and the occurrence of fire in discharge pipes and air receivers, is due to the oil used. These difficulties cannot be laid to the oil alone, although it is a well-known fact that an inferior oil, which contains a large amount of easily volatilized carbon, can readily cause an explosion, because structural features of a machine may facilitate the volatilization of the oil and the ignition of the vapors.

The fact that an air compressor frequently pollutes the air in a mine indicates that some foreign substance is in the atmosphere. For instance, at those mines where there is an unusual amount of dusty substances in the atmosphere, which can be drawn in the air cylinder and mixed with the oil, there is formed a substance which, on heating, cakes and may take fire.

Experience has shown that the greatest heating takes place at the point where the air passes from the cylinder into the discharge pipes. At this place the mixed oil and dust gathers and decreases the size of the aperture into the discharge pipe, and more air is compressed in the

cylinders than can pass through the valves. This results in recompressing the air and increasing friction, also an abnormal heat. If the discharge valves be incrustated with carbon scale deposited from oil, a portion of the compressed air passes back through the valves and decreases the air pressure in the cylinder, but does not decrease the temperature.

It is important that the temperature of the compressed air be kept as low as possible, and to that end all the standard makes of air-compressor cylinders are provided with jackets through which cold water is kept circulating. The flash point of oil used in air compressing cylinders should be as high as good lubricating qualities will permit. By flash point is meant that degree of heat at which some part of the oil passes off as vapor, which being inflammable, will ignite if brought into contact with fire. The mere raising of the temperature of an oil to the flash point will not produce ignition of the vapors; indeed ignition may occur before the flash point is reached, as in the case of sawdust saturated with linseed oil. Combustion is the rapid chemical combination, of a substance with oxygen. This combination called rapid oxidation generates sufficient heat to set the substance on fire. If a considerable quantity of inflammable vapor be present, an explosion follows. In the air cylinder of a compressor an oil should be used which will resist the relatively large quantity of highly heated oxygen.

Ignition in the compressor air cylinders, discharge pipes, and passages, is not uncommon, and at times is in the nature of an explosion. Two air receivers were blown up during the construction of the New York aqueduct. In one case the engine room was destroyed by fire resulting from the explosion. Other instances have occurred where ignition has taken place near the air compressor,

flange of the cylinder was torn off at several points, particularly at the top, where a portion of the cylinder was blown away. Such explosions, while rare, serve to emphasize the importance of using only the best grades of oil for air-cylinder lubricant.

Cheap oil is not advisable in air cylinders, for with the best of oil explosions occur if too much oil is used, or if the valves and ports are not kept clean and free from deposits. If the oil is of low flash test, on reaching the interior of the heated cylinder it will vaporize and pass out with the air without affording any lubrication to the wearing surfaces.

If the oil be too dense, or is compounded with animal or vegetable oils, as is the case with many steam cylinder oils, it will have a tendency to adhere to the discharge valves and passages, and, being subjected to the dry heat of the compressed air, will gradually change to a hard, brittle crust, which in time will completely choke up the air passages or prevent the valves seating.

It has been found by numerous experiments that petroleum oil of a high flash test is the best lubricant for air compressing cylinders. Some engineers presume that an air cylinder requires the same amount of oil as a steam cylinder. This is a mistake.

In lubricating the interior of an air-compressor cylinder the conditions are different from those found in a steam engine cylinder. In the air cylinder the heat is a dry heat and the oil has a tendency to stick to the surface, consequently less is needed than in a steam cylinder where moisture is always present and has a tendency to wash the oil away from the surface.

The amount of oil to be fed into the air cylinder should be, if the machine makes less than 120 revolutions per minute, about 1 drop every 3 minutes.

Some engineers find that a carbon deposit is easily cut away by kerosene oil, and in their anxiety to remedy the difficulty throw kerosene oil into the inlet valves. Kerosene should never be used in air cylinders. It has a flash point of 120° F., and it is not difficult to understand that there will be an explosion under circumstances when the temperature in the air cylinder may be from 300 degrees to 450 degrees.

A high-grade non-carbonizing lubricant will cost a few cents more per gallon, but when the time it takes to clean the intake and discharge valves is taken into consideration, the high-grade oil will be found the cheaper.

To clean the air cylinders or air passage, use soapsuds, made of 1 part soft soap to 15 parts water. Feed this into the cylinder and let the machine work with a liberal solution instead of

oil for a few hours or a day; then open the blow-off valve of the receiver and drain off the accumulation of oil and water. This cleaning process if repeated about once in 2 months where a good lubricant is used will be sufficient; but bear in mind that oil is to be fed into the cylinder for an hour or so before shutting the machine down, in order that the valves and the parts connected with the cylinder may be coated with oil; for if this is not done the inside of the cylinder will rust.

At a plant in W. Va. there was an air compressor with one cylinder 24" x 20½" x 40", guaranteed to compress 1,444 cubic feet of free air per minute with 90 revolutions per minute. This machine worked satisfactorily for about 11 months, then the capacity fell to about 900 cubic feet of free air per minute. On examination it was found that 11 out of 28 discharge valves were incrustated with carbon scale, and that they were stuck and partly open. When the valve caps were taken off the valves were found stuck so fast it was necessary to take off the cylinder head. Then by taking a round piece of hard wood large enough to cover the face of the valve they were driven out of the valve seats. It took four men over four days to get this machine in proper working order.

The manager was anxious to know what caused the valves to stick and where the carbon scale came from. When asked what kind of air-cylinder lubricant was being used, his answer was that he was using an 18 cents per gallon engine oil. To get a proper lubrication, that oil was fed through a sight-feed lubricator at the rate of from 5 to 10 drops per minute. It was thought any kind of oil would do. If this company had used a good non-carbonizing oil from the time the machine was put in operation it would have saved nearly a hundred dollars.

來 來

Receivers of Air Compressors

The purpose of a compressed-air receiver is to reduce the pulsations of the air from the compressor, to collect water and grease carried by the air in the pipes. The receiver is not intended as an air reservoir of power, though to a limited extent it may be employed for this purpose, as in the event of sudden stoppage of the compressor for any cause the air in the receiver may have sufficient volume and pressure to accomplish some work, such as hoisting a skip that has already been started by the engines which are run by compressed air. The extent to which the receiver may be used for this purpose depends upon the volume of air and its pressure. The principle is exemplified in the compressed-air motors.

Publications on Mine Accidents and Tests of Explosives

The following Bureau of Mines publications may be obtained free by applying to the Director, Bureau of Mines, Washington, D. C.:

Bulletin 10. The use of permissible explosives, by J. J. Rutledge and Clarence Hall. 34 pages, 5 plates.

Bulletin 15. Investigations of explosives used in coal mines, by Clarence Hall, W. O. Snelling, and S. P. Howell, with a chapter on the natural gas used at Pittsburg, by G. A. Burrell, and an introduction by C. E. Munroe. 1911. 197 pages, 7 plates.

Bulletin 17. A primer on explosives for coal miners, by C. E. Munroe and Clarence Hall. 61 pages, 10 plates. Reprint of United States Geological Survey Bulletin 423.

Bulletin 20. The explosibility of coal dust, by G. S. Rice, with chapters by J. C. W. Frazer, Axel Larsen, Frank Haas, and Carl Scholz. 204 pages, 14 plates. Reprint of United States Geological Survey Bulletin 425.

Bulletin 26. Notes on explosive mine gases and dusts, by R. T. Chamberlin. 67 pages. Reprint of United States Geological Survey Bulletin 383.

Technical Paper 4. The electrical section of the Bureau of Mines, its purpose and equipment, by H. H. Clark. 1911. 12 pages.

Technical Paper 6. The rate of burning of fuse as influenced by temperature and pressure, by W. O. Snelling and W. C. Cope. 1912. 28 pages.

Technical Paper 7. Investigations of fuse and miners' squibs, by Clarence Hall and S. P. Howell. 1912. 19 pages.

Technical Paper 11. The use of mice and birds for detecting carbon monoxide after mine fires and explosions, by G. A. Burrell. 1912. 15 pages.

Technical Paper 12. The behavior of nitroglycerin when heated, by W. O. Snelling and C. G. Storm. 1912. 14 pages, 1 plate.

Technical Paper 13. Gas analysis as an aid in fighting mine fires, by G. A. Burrell and F. M. Seibert. 1912. 16 pages.

Miners' Circular 2. Permissible explosives tested prior to January 1, 1911, and precautions to be taken in their use, by Clarence Hall. 1911. 12 pages.

Miners' Circular 3. Coal-dust explosions, by G. S. Rice. 1911. 22 pages.

Miners' Circular 4. The use and care of mine-rescue breathing apparatus, by J. W. Paul. 1911. 24 pages.

Miners' Circular 5. Electrical accidents in mines, their causes and prevention, by H. H. Clark. 1911. 10 pages, 3 plates.

Miners' Circular 6. Permissible explosives tested prior to January 1, 1912, and precautions to be observed in their use, by Clarence Hall. 1912. 20 pages.

Automatic Blocks for Inclines

By Simon H. Ash*

Most of the coal mines in the Roslyn district of the state of Washington are worked at a considerable distance above the railroads along which the tipples must be located. This necessitates the haulage

ropes are in tension and in contact with the pulleys *a* and *b*, the blocks *c* and *d* are up and will block any cars above them. They are held in this position by means of the balance weights *e* attached as shown to the levers *f* and *g*; the balance weight counterbalances the weight of the pulley and truck, and the weight of the

tension of the rope on the empty-car track takes place the rope pushes down on the pulley on which it rests at *a*. As this end of the lever *f* moves downwards the other end moves upwards. This lever in turn is connected with the lever *h*, as shown, by means of a pointed strap passing through the hole *i*; this causes this end of the lever *h* to move upwards while the other end which is connected to the block *c* moves downwards, thus moving the block *c* downwards level with the tops of the rope guide *j* and allows the loaded trip to pass. As soon as the loaded trip reaches the knuckle, the rope resting on the pulley *b*, the tension of the loaded trip rope causes *b* to move downwards, which in the same manner as described above causes the block *d* to move downwards allowing the empty trip to pass as it comes up the plane into the yard. As soon as the empty-trip rope passes *a* the block *c* goes up. As soon as the trips are landed the tension in the loaded trip rope on the pulley *b* is released and the block *d* goes up, thus blocking the empty trip above the knuckle. When both ropes are below the knuckle both blocks are down. If for any reason whatsoever when the trips are in motion below the knuckle the block on the empty-car track should fail to go down, instead of the empty cars running into the block and being wrecked, the front car of the trip would ride on the 1"×1" irons *k*, which are hinged as shown, and push the blocks down to their necessary position.

The time that accidents are most likely to occur, and which has frequently been the case is when the cars are being transferred to or from the gravity-plane ropes at the top of the plane. The device described is simple, easy to keep in working order, costs little to construct, and has proven itself practical.

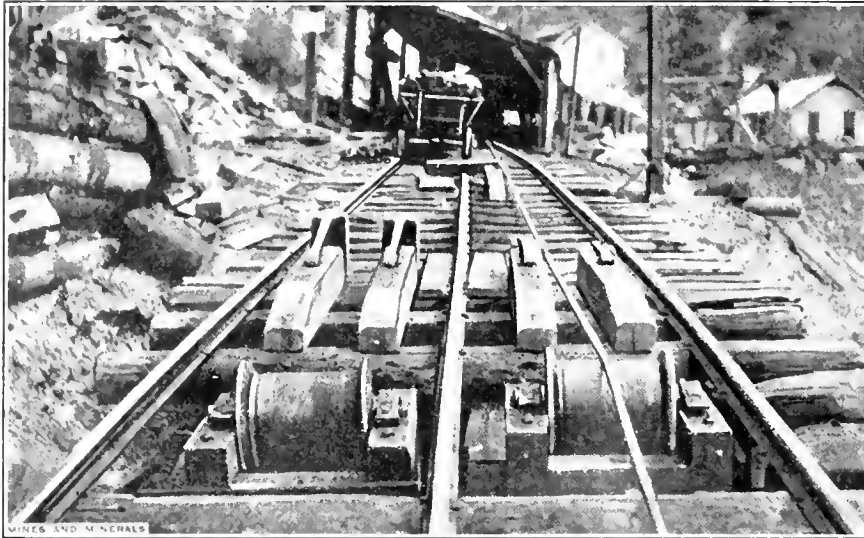

FIG. 1. AUTOMATIC SAFETY BLOCKS AT HEAD OF PLANE

of the coal being carried on in two distinct stages, namely: the gathering of the trips at the mouth of the mine or at a parting inside; and the conveying of the coal from the top of the plane, incline, or parting to the tipple. This requires the trips to be blocked between the two stages.

At the No. 1 mine of the Roslyn Cascade Coal Co., William Mackay, general manager, the trips are gathered at the mine mouth and then lowered over a gravity plane to the tipple by means of a set of gravity-plane sheaves. The cars are handled in trips of 10. The weight of the average empty car is 850 pounds; the weight of the average loaded car is 2,400 pounds; the size of the rope is 7/8 inch. The gravity plane, which is 3,400 feet long, has an average grade of 14 1/2 per cent., and crosses three ravines on timber trestles. As shown in Fig. 1, the plane has three rails from the knuckle at the mine mouth to the midway point. The by-pass is here, and below this point a single track runs to the tipple. The rails are of 25-pound steel. The track gauge is 30 inches.

To hold the cars at the head of the plane, a pair of automatic blocks have been installed and these are working perfectly. The blocks which are operated automatically by the ropes on the gravity plane are made of 4"×6" timbers, and can be raised or lowered to any height desired above or below the level of the tracks. At all times except when the

rope not in tension which rests on either pulley when the trips are not in motion, one standing on the tipple the other in the yard.

As soon as a loaded trip is run out of the mine it is spragged in the yard and the mine rope disconnected. The rope of the gravity plane is then connected to the rear of the loaded trip. At a signal from the tipple that an empty trip is ready, the sprags are withdrawn and the loaded trip moves toward the tipple. Up to this point the blocks are both up, but as soon as the

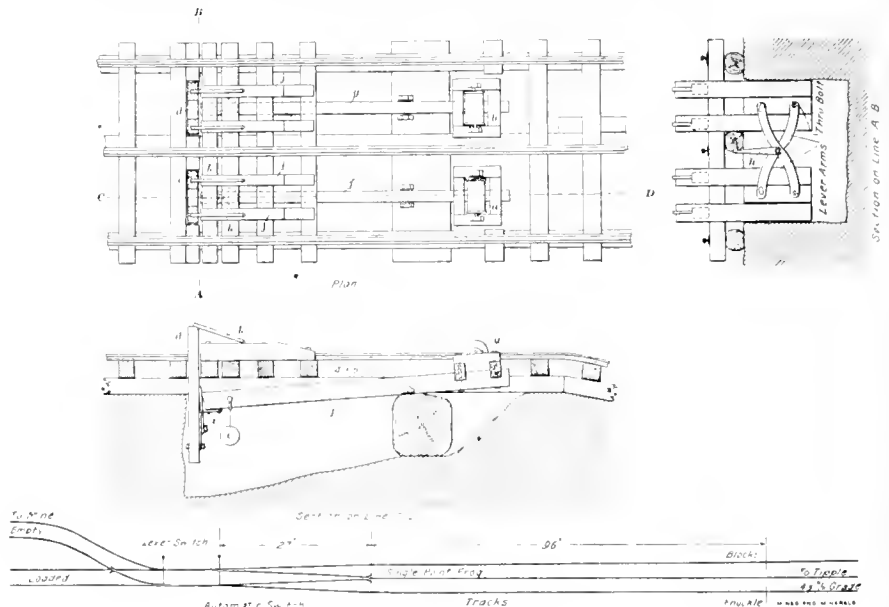

FIG. 2. PLANS AND DETAILS

*Mining Engineer, Roslyn, Wash.

The Classification of Coal

A Study of the Classifications Proposed by Different Investigators—British Thermal Units

By Leonard V. Newton

A CLASSIFICATION of a natural object is usually based on some fundamental and permanent attribute of the thing itself.

The earliest classification of which there is available authentic records is Uray's Dictionary of Chemistry, published in 1845. Uray classified coal according to physical properties, and his classification was as follows:

1. Cubical coal.
2. Splint or slate coal.
3. Cannel coal.
4. G lance coal.

This classification, it is readily seen, is very rudimentary and crude. No coal could even be approximately classified, because in the determination of physical properties, personal equation plays a very great part.

Uray's classification was followed by Watt's. Watt's method was still physical in its character, but was good in that he grouped the coal under more substantial headings, as may be seen from the following:

1. Lignite, or lean coal, 30 to 40 per cent. H_2O .
2. Bituminous, or caking coal:
 - (a) Caking coal.
 - (b) Cherry coal.
 - (c) Splint coal.
 - (d) Cannel coal.
3. Anthracite coal.

Prof. H. D. Rogers was the next man to take the step that Watt started, and he offered a classification in which coal was classified according to diminishing carbon and augmenting hydrogen. His classification was as follows:

Anthracite, volatile matter below 6 per cent.; semianthracite, volatile matter below 10 per cent.; semibituminous, volatile matter, 12 to 18 per cent.; bituminous, volatile matter above 18 per cent.

Commercially, Professor Rogers' classification may be all right, but from a theoretical standpoint, no coal can be classified according to volatile matter, as it is a variable too great to be considered alone. Furthermore, volatile matter includes both combustible and non-combustible matter; hence, one coal might be high in CO_2 , due to a piece of calcium carbonate in the sample, and it could not possibly fall in the same place in the classification with a piece of the same coal without the calcite.

In 1844, Prof. W. R. Johnson, in his report to the United States Government on American coals, advanced the following classification: "Coal shall be classified according to the ratio of the volatile matter to the fixed combustible matter." Thus, we have $C : VHC : H = \text{fixed carbon} : \text{Vol. Hydrocarbons} : \text{Water}$.

Coal classified thus would vary between proportions as follows:

BETWEEN PROPORTIONS
 Anthracite coal: 99 C : 1 VHC and 89 C : 11 VHC.
 Semianthracite: 94 C : 7 VHC and 84 C : 16 VHC.
 Semibituminous: 84 C : 16 VHC and 81 C : 19 VHC.
 Bituminous: 80 C : 20 VHC and 47 C : 53 VHC.

Mr. P. Frazer proposed his first classification while engaged in work as assistant geologist of the Second Geological Survey of Pennsylvania. His classification is based on the fuel ratio, which was described as the quotient of the fixed carbon divided by the volatile combustible matter. Coals classified thus would be as follows:

CLASSES OF COAL	C	
	VHC	H
Hard dry anthracite from	67.02 to 8.64	
Semianthracite from	12.75 to 5.41	
Semibituminous from	11.41 to 4.52	
Bituminous from	3.93 to .68	

This classification is poor because of overlapping of values, which makes the classification of coals not only difficult, but incorrect.

Campbell said this classification was poor because of the uneven values, and because of overlapping. He suggested that coal be classified as follows:

CLASSES OF COAL	C	
	VHC	H
Anthracite from	100 to 12	
Semianthracite from	12 to 8	
Semibituminous from	8 to 5	
Bituminous from	5 to 0	

This classification failed because in grouping all the coals under a ratio of 5, for instance, as in the case of bituminous coals, the range is too wide; furthermore, no provision is made for lignite, which is one of the most important coals of the West.

Collier, in the "Coal Resources of Yukon," proposed a classification to care for lignite coal, by making all coals with a moisture content of 10 per cent. or over, lignite coal. This is incorrect, because by

is small, this is all right, otherwise it is not. The calorific value of the coal is unsatisfactory, as many bituminous coals are higher in British thermal units than anthracite, due probably to higher percentage of H, or much sulphur. The hydrogen of the coal does not classify it, as low-grade coals sometimes have as large a hydrogen content as high-grade coals.

Mr. Campbell, in 1905, proposed a classification by means of a carbon-hydrogen ratio, which he claimed was very satisfactory. His data are based upon the works of Prof. N. W. Lord, in charge of the chemical laboratory of the United States Geological Survey of the Louisiana Exposition. His classification is as follows:

Group	C/H Ratio	
	D to ?	D to ?
Group A (Graphite)	?	30?
Group B Anthracite	30?	26?
Group C Semianthracite	26?	23?
Group E Semianthracite	23?	20
Group F	20	17
Group G Bituminous	17	14.4
Group H	14.4	12.5
Group I	12.5	11.2
Group J Lignite	11.2	9.3?
Group K Peat	9.3?	7
Group L Wood	7	2

The trouble with this classification is, first, an ultimate analysis is necessary to determine the carbon and hydrogen; second, the determination of the hydrogen is very difficult, and therefore the classification is made worthless for commercial purposes. It may be said, however, that Campbell's ranges are limited.

If Mr. Campbell had excluded both H_2O and ash, in his arrangement based on total carbon, he would have had an excellent separation of coal, and would have also separated the lignites and peats.

Prof. S. W. Parr, in his paper of July 3, 1906, says: "A good classification must have correct analytical facts, and scientific data." He claimed that Campbell's classification is poor because hydrogen is a variable, and Campbell failed to use the

TABLE I

Laboratory No.	Date	County	Proximate Analysis						
			Total H_2O	Fixed C	Volume Matter	Ash	Sulphur	B. T. U.	Unit Coal B. T. U.
1786	8-08	Sangamon	14.18	37.84	35.39	12.59	4.29	10,396	14,574
1790	9-08	Sangamon	16.41	40.85	33.80	8.94	3.95	10,603	14,477
2622	7-09	Bureau	17.31	39.11	34.81	8.77	3.38	10,502	14,480
1843	9-08	Vermilion	13.23	39.41	37.44	9.92	2.75	11,143	14,761
1129	2-08	St. Clair	15.91	37.43	37.33	9.33	3.95	10,685	14,593

analysis many bituminous coals have a moisture content of over 10 per cent.; for instance, samples taken from laboratory tests run are in Table I.

The proximate analyses just given clearly show that Collier's classification is radically wrong.

Thus we see that the full ratio is unsatisfactory; the classification by carbon content is wrong. Where combustible matter

ratio of the volatile hydrocarbons to total carbonaceous matter. The constituent lost sight of in differentiating the lignites and bituminous coals is the water of hydration, which, according to Dulong = $H - \frac{O}{8}$.

The ratio employed by Professor Parr is the ratio existing between the forms of carbon; namely, $V C \times \frac{100}{C}$.

V C = volatile carbon unassociated with H.
C = total carbon by analysis.

In classifying coals, the anthracites are those in which the carbon ratio is not greater than 15 per cent.

In bituminous coals, the ratio is not below 20 per cent.

The chemical nature of coal is becoming better known, and Mr. Grout, seeing how well Mr. Iddings represented the composition of coal by graphic methods, decided to do likewise with coal. In this work, the works of the United States Geological Survey and Professor Parr have been used; also the work of Prof. C. N. Gould.

The value of a diagram depends on clearness and readiness with which its meaning can be grasped, and, second, its purpose. No arrangement can be found in which distances being made proportional to analysis, the areas will be intelligible.

Equilateral triangles, Fig. 1 (a), are used such that the areas are proportional to the four constituents of the coal, as shown by proximate analysis.

Fixed carbon: Central white triangle.
Volatile matter: Black triangle placed just above.

Ash: Black triangle below to left.

Moisture: Black triangle below to the right.

To further show the chemical composition of coal, it is instructive to arrange them in a multiple diagram, Fig. 1 (b), based on the ultimate analysis. Essential parts are C, H, and O. N and S are subordinate and not considered.

According to the diagram, coals may be classified according to their position

for air-dried coal analysis. He suggested that it would be well to start with the weathered coal and trace it back into the seam until the maximum is found, and so determine the depths at which coal is subject to the loss from air exposure, as well as finding the maximum loss to which the coal is liable. He says that were it not for weathering effects, a curve could be platted, and the calorific efficiency of any coal found

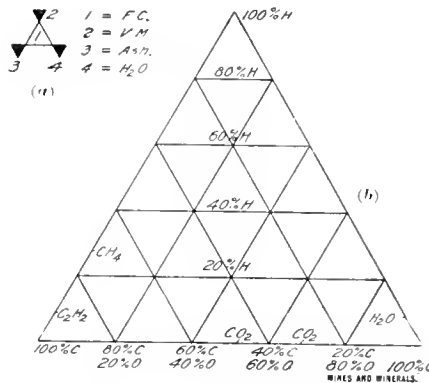

FIG. 1. HYDROCARBON COMPOUNDS

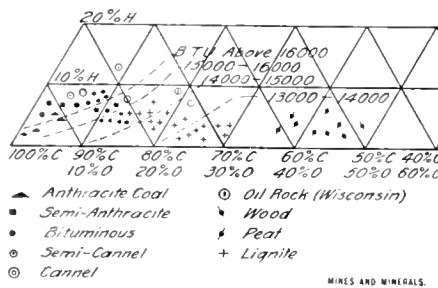

FIG. 2

PROFESSOR PARR'S CLASSIFICATION OF COAL

Coals	Anthracite	Anthracite:	$V C \times \frac{100}{C}$ below 4 per cent.	
		Semianthracite:	$V C \times \frac{100}{C}$ between 4 and 8 per cent.	
Bituminous	Semibituminous	Semibituminous:	$V C \times \frac{100}{C}$ from 10 to 15 per cent.	
		Bituminous proper	A	$V C \times \frac{100}{C}$ from 20 to 32 per cent. Inert volatile 5 to 10 per cent.
			B	$V C \times \frac{100}{C}$ from 20 to 27 per cent. Inert volatile 10 to 15 per cent.
	C		$V C \times \frac{100}{C}$ from 32 to 44 per cent. Inert volatile 5 to 10 per cent.	
	Black lignite	D	$V C \times \frac{100}{C}$ from 27 to 44 per cent. Inert volatile 15 to 15 per cent.	
		Black lignite	$V C \times \frac{100}{C}$ from 27 per cent. up. Inert volatile 16 to 20 per cent.	
			Brown lignite	$V C \times \frac{100}{C}$ from 27 per cent. up. Inert volatile 20 to 30 per cent.

in the coal series, and by their British thermal unit values, Fig. 2. However, I believe that the classification according to the position in the series is poor, because of the fact that the semianthracites have a higher British thermal unit value than anthracite; furthermore, the series is very confusing.

Dowling used

$$FC + \frac{1}{2} \text{ vol. combustible}$$

$$\text{Moisture} + \frac{1}{2} \text{ vol. combustible}$$

directly by reference to the curve. Dowling's ratio arranges coals much the same as the old fuel ratio does for the eastern coals, but a better arrangement is given for the western lower-grade coals.

The phrase unit coal is used to represent the organic material which is involved in combustion, as apart from the mineral constituents which are the extraneous and variable accompaniments of the actual or unit coal. A number of men have worked

along these lines; namely, Lord and Haas, Noyes, Parr, and Wheeler.

The various statements made are:

(a) According to Bement:

$$\text{British thermal unit as indicated}$$

$$1.00 - (\text{moisture} + \text{ash as weighed})$$

(b) According to Lord and Haas:

$$\text{British thermal units} - 4050 S$$

$$1.00 - (\text{moisture} + \text{ash as weighed} + S)$$

(c) According to Noyes:

$$\text{British thermal units as indicated}$$

$$1.00 - (\text{moisture} + \text{ash as weighed} + \frac{1}{2} S)$$

(d) According to Parr and Wheeler:

$$\text{British thermal units} - 5000 S$$

$$1.00 - [\text{moist. and ash} + \frac{1}{2} S + .08 (\text{ash} - \frac{1}{2} S)]$$

The idea in getting the British thermal unit value of the coal is to find the actual heat produced by the coal, disregarding the heat produced by S, H, etc.

By means of this British thermal unit value coal may be classified. The classification of fuel types by heat values for unit or actual organic substances is as follows:

	British Thermal Units
Cellulose and wood.....	6,500-7,800
Peat.....	7,800-11,500
Lignite, brown.....	11,500-12,500
Lignite, black.....	12,500-13,500
Subbituminous.....	13,500-14,200
Bituminous coal—(Mid-continental).....	14,200-15,000
Bituminous coal—(Eastern field).....	15,000-16,000
Semianthracite.....	15,500-16,000
Semibituminous.....	15,500-16,000
Anthracite.....	15,000-15,500

Regarding the various classifications, I consider that the classification of coal according to British thermal units, said British thermal units being determined by unit coal, is best. It is fit for a commercial usage, and being easily handled, when approximate analysis is given, it is theoretically and commercially good.



Michigan Coal Statistics, 1911

Andrew Stevenson, Inspector, Saginaw, Mich., reports the following for the mines of Michigan in 1911.

Number mines.....	27
Average employed monthly.....	2,550
Average daily wages.....	\$3.39
Tons pick mined.....	758,626
Tons machine mined.....	636,737
Total tons mined.....	1,395,363
Cost per ton.....	\$1.80
Number days worked.....	220.8
Tons per man.....	546
Pounds powder per ton.....	.827
Number fatal accidents.....	7
Fatal accidents per 1,000 men.....	2.73



American Red Cross

The First-Aid Department of The American Red Cross has issued a catalog of first-aid books and supplies.

With a view to conserving human life by rendering immediate aid to the injured in mines, the Red Cross has established a First-Aid Department. In this work the Red Cross is assisted by Mayor Charles Lynch, Medical Corps, United States Army, and Dr. M. J. Shields, one of the pioneer teachers of first aid among miners in this country.

Moistening Mine Ventilating Currents

Use of Steam Jets and Water Sprays—Methods of Avoiding Fog and Undue Dampness

By A. A. Steel*

EXPERIMENTS have shown that only dry fine dust explodes and that plenty of water furnishes the simplest method of preventing the spread of a dust explosion. But it is necessary to wet the dust thoroughly in all parts of the mine. After the dust has been thoroughly dried, it cannot be quickly moistened. Therefore, the water should be applied continuously and the air-current of the mine prevented from drying it. These results are most readily obtained by keeping the air-current so moist that it will not absorb the natural water of the mine.

When air is cooled, the amount of invisible water vapor it can carry is diminished. If therefore the outside air in summer time is sufficiently supplied with moisture, some of this moisture is deposited in drops upon all parts of the walls of the mine with which warm air comes in contact, because the temperature of the coal and rocks in the mine does not change much during the year and so cools this air. In the winter time, the cold outside air contains very little moisture and it rapidly dries out the mine dust as it warms up on entering the mine. These facts explain why the mines sweat in summer and are so dry in winter.

Whenever the outside air does not contain substantially as much water as it will hold at the mine temperature, water should be added to it. In order that the air can carry enough water, it must be at least as warm as the rocks of the mine. It may be raised to the mine temperature and at the same time moistened by a sufficient number of sprays of warm water. In severe weather, there will be trouble from the freezing of the pipes and the spray, and a great deal of water will be needed. A few jets will not be sufficient, and the fact that a certain mine has suffered from a dust explosion, even though there were a few water sprays in the intake, cannot be taken as proof that wet dust is explosive. Rather it proves that water sprays do not immediately warm the air to mine temperatures.

The fact that the new mines in Kansas are more likely to explode is not due to the fact that more air is supplied but to the fact that the air reaches the actual working places in less time and dries them out more completely than it does the actual working places of the more extensive mines.

Steam Jets.—It is cheaper and easier to use jets of exhaust steam, which will both warm and moisten the air. No more steam will be used than that needed to raise the air to a little above mine temperature and the steam jets will cause no uncomfortable heat if they are small and not pointed directly at a passer-by. If a number of

small jets are used, the air will mix with the steam before it has a chance to heat the roof unduly. If the steam is turned toward the roof or wall, this can be protected by light lagging.

It should be noted that the drying effect of the current will extend throughout a mine as rapidly as the moisture nearer the intake is absorbed. On the other hand, air deposits moisture only while cooling and as soon as the warm air of summer reaches the temperature of the mine, it ceases to deposit water. The sweating only extends into the mine as the dripping coal near the intake gets warmer, and this change is slight. Therefore, to quickly dampen the mine by means of the air-current, steam jets must be placed at more than one place in the path of a long ventilating current. The writer has noticed, however, that coal dust gets very wet if

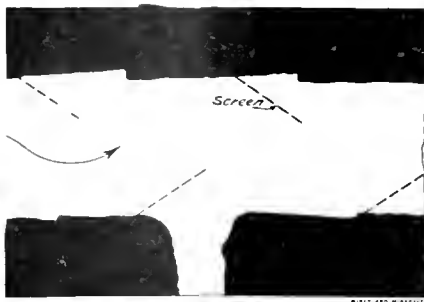

FIG. 1

stored in cellars, the bottom of piles of coal, abandoned mine workings, or other damp places free from a current of drying air; therefore, jets near the face will not be necessary unless the dust is made very rapidly as by heavy shooting in a dry mine. This point can be determined by experience at each mine.

The heating effect of steam is not great unless it is condensed to water, consequently except under exceptional conditions, more steam will be needed to heat the air than is required to moisten it. The condensed steam remains as a thick mist until it settles upon the walls of the mine workings. This will make the hauling of the coal past the steam jets both disagreeable and dangerous, if, as in some states, the law requires the haulage road to carry the intake air, and some means must then be taken to prevent the mist from interfering with the hauling of coal.

Mr. Rice suggests using water jets to slightly moisten the air during the day time, and steam jets at night, in case the coal must be hauled past the jets. Warm water will make some mist as well as steam,

and at best as much water will be taken up by the air as it will hold at that temperature. Since even a little steam will warm the air slightly, more water can be intro-

duced by steam jets without a fog than by water. In very cold weather, water jets would freeze unless far from the mouth of the mine with expensive pipes. For these reasons, it seems better to omit water sprays in winter, and merely cut down the amount of steam in the day time when necessary until the mist is not objectionable.

Where there are steam pipes in one compartment of the downcast shaft, they warm the air considerably and quite a little steam can be added at the top of the shaft without causing a mist at the bottom. During the night, an excess of steam can be used to make up for the shortage during the day. This can be obtained from the exhaust of the fan engine supplemented by some steam direct from the boilers if necessary. A sufficient quantity of steam will of course melt all accumulations of ice and make it unnecessary to reverse the fan at night. The mine will not dry out too much in a single day.

The mist may be eliminated by the plan of first warming the air by passing it over steam pipes until the steam jets will just saturate the air and finish warming it without condensation. At a large mine, however, this will require several thousand dollars worth of radiators. This mist can also be avoided by superheating the steam, until the steam needed to supply moisture to the air will bring in enough heat to warm the air to mine temperature. For outside air at 10° F. with a humidity of 80 per cent. this would require 1,200 degrees of superheat which is also impracticable.

The suspended drops of water can be thrown out by centrifugal force, by driving the air at high velocity through a spiral passage. This is done in some forms of steam separators, but the velocity there used is 6,000 feet per minute or more, and it is quite impracticable to give the entire ventilating current of the mine this velocity. Other steam separators cause the drops of water to cling to metal surfaces by causing the steam to pass projecting points. B. N. Wilson, Professor of Mechanical Engineering, University of Arkansas, has suggested that this principle might be used in the mine by stretching wire screens from the roof to the floor on alternate sides of the air-course as shown in Fig. 1. The air-current will be sufficiently stirred so that all parts of it will soon come into contact with the screens, and pass through them without much extra resistance. As the mist passes through the screen, some drops of water cling to the metal, other drops unite with each other and so become heavy enough to quickly settle. Light galvan-

*Professor of Mining, University of Arkansas, Fayetteville.

and wire screen (hardware cloth) of about four mesh is recommended. It is regretted that no funds are available for the purpose of determining the efficiency of this apparatus and affording data as to the number of screens necessary. They are cheap and screens can easily be added in the mine until the air is cleared. This is the most feasible method for quickly settling the mist.

Objection to the mist can be avoided by placing the steam jets where the fog will not be objectionable. If the air is to be moistened at the main intake, some intake may be provided in addition to the main outlet for coal. If the mine is large, additional intakes will be necessary anyway and the problem presents little difficulty. If the mine is ventilated by a separate split for each entry, the air generally first passes through the old working of the entry. A few steam jets could then be placed at the entrance to the old rooms of each entry. By the time the air-current of such a mine reaches those entries having no old workings, it would be so warm that the air could be moistened sufficiently with little or no condensation of the steam to a mist. Piping for such steam jets will be expensive, but this system is much cheaper as well as more effective than that of piping all parts of the mine for sprinkling with a hose. This is required by law in Oklahoma. The pipes could also be left bare to partly warm the air by radiation and so reduce the mist. The small slope mines ventilated by coursing can be moistened by the exhaust from the steam pump. This can be distributed along the air-courses leading to the two lower entries and so throughout the mine. It is thus seen that objectionable mist can be avoided at little expense.

As yet none of the American coal mines are so deep that they are uncomfortably warm. Therefore, the miners will not be inconvenienced by the humidity of sprayed air. At the worst, the conditions will be the same as they now are in the summer time. Some of the recently published lurid rhetoric about saving the miners from the dire disaster of working in a moist mine is no argument against steam jets. As the mines get warmer, stone dust will have to be substituted for water to check dust explosions.

The most common objection to spraying the air is that it causes the roof to fall. This is unquestionably true if the roof is such a pure clay that it will absorb water indefinitely. Even then, it is doubtful if the number of accidents will be increased, because in any case the rooms will become moist in the summer time and the same amount of rock will fall. All of this is likely to fall on the miners except that in the few working places finished before the roof becomes wet.

Most of the falls of rock in old entries and traveling ways are caused by the wetting of roof that has dried out from its naturally moist condition and so cracked

open to let moisture get behind the slabs. These falls, which are the heavy and dangerous ones, will be largely reduced by keeping the mine constantly moist. It is believed that falls are also caused by the changes in temperature of the mine workings. The fact that a uniformly moist air-current does not injure the mine roof was demonstrated by the experiments of Frank Haas, Consulting Engineer for the Consolidation Coal Co., of West Virginia, and this argument against sprays has little weight.

It seems, therefore, that steam jets should be installed in most of our mines. If experience proves that they do not injure the roof, their universal adoption should be required by a law in each state, requiring that the ventilating current of the mine shall be so warmed and moistened that it is within 5 degrees of the temperature of the return air and shall have a humidity of over 90 per cent. of saturation before it reaches the first active working place upon each split of the air.

On warm and very dry days, the air of a mine should be moistened only, and the extra heating caused by steam will be objectionable. For this purpose, a few sprays of water will be sufficient. They can be used to rapidly cool the air even when it is wet. The same apparatus can be used for the steam jets in winter. As a preliminary arrangement, a line of pipe may be installed along each side of the main intake slope or shaft bottom about opposite the center of the coal seam. To prevent spoiling the pipe for other use, two or three holes for the jets, say one-sixteenth inch in diameter, can be drilled in each coupling of the pipe. These may be placed as far apart as the ordinary length of pipe, and the sprays received upon bits of sheet iron fastened to the coal. Valves should be placed at intervals to cut off as much of the end of the pipe as may be necessary when using water. A valve at the exhaust of the pump or fan will regulate the amount of steam to be used. Experience will show how much the pipe must be extended or how many holes should be plugged with wood. Special nozzles for mine sprays are now on the market.

To illustrate the amount of water and steam needed to warm and moisten the incoming air to saturated air at mine temperature, consider the case of a medium-sized mine with an output of 1,400 tons of coal in 8 hours and requiring 50,000 cubic feet of air per minute. Assume the mine temperature to be 60° F. which is about the Arkansas mine temperature.

If the moisture is supplied in the form of a water spray, a good deal of heat will be required to evaporate the water so that it can enter the air as vapor. If the incoming air is warm, it can supply this heat in cooling to 60° F. provided that it is not so dry that too much water will be required. If the warm incoming air at any given

temperature has just the right humidity, it can be both cooled and moistened to saturated air at 60° F. by the evaporation of a certain amount of water. Table 1 gives in round numbers this humidity and the weight of water required for several temperatures.

TABLE 1.—HUMIDITY OF OUTSIDE AIR AT GIVEN TEMPERATURE AND POUNDS OF WATER AT 60° F. NEEDED TO PRODUCE 50,000 CUBIC FEET OF SATURATED AIR AT 60°

Outside Temperature	Per Cent. of Humidity	Water Needed	
		Pounds	Gallons
65	79.2	2.3	.239
70	63.8	4.2	5.13
80	39.8	8.5	1.019
90	24.6	12.6	1.510
100	15.2	16.5	1.978
110	9.5	20.5	2.458

The humidity of this air at the higher temperature is so low that this condition will seldom if ever occur except in the Far West. The table shows however, that the amount of water required to saturate the air is in the extreme case only 2.5 gallons per minute. This can be supplied by a 1-inch pipe with a fall of 3 feet in 100 feet. Under a 50-foot head, this will require only nine jets one-sixteenth inch in diameter.

If the air contains more water than the amounts given in this table, it will become saturated before it is cooled to mine temperature by the evaporation of the water of the jets. It can only be cooled further by warming the water of the jets. In practice,

TABLE 2.—POUNDS OF WATER AT 60° F. REQUIRED TO COOL 50,000 CUBIC FEET OF AIR (MEASURED AT 65° F.) TO 65° F.

Outside Air Temperature Degrees	Humidity Per Cent.	Cooling Water Required		
		If Heated to 65° F.	Each Spray Heated to Temperature of Passing Air	Each Spray Heated to Temperature of Incoming Air
70	85	830	700	450
	90	1,450	1,225	750
	100	2,750	1,950	1,375
80	70	4,450	2,200	1,125
	80	6,250	3,150	1,575
	90	8,000	3,850	2,025
90	100	9,800	4,350	2,475
	70	11,400	4,650	1,900
	80	13,900	5,200	2,325
100	90	16,450	5,725	2,750
	100	18,950	6,200	3,150
	70	70	20,000	6,300
80		23,550	6,900	2,950
90		27,050	7,400	3,375
100	100	30,500	7,850	3,800

it can therefore not be cooled quite to mine temperature; assume, therefore, that it is to be cooled to 65° F. and that sufficient air will be used to make 50,000 cubic feet when saturated with moisture and at a temperature of 65° F. If the water is introduced as a fine spray, it can be assumed that the water is warmed and the air

cooled until both reach the same temperature. If enough water is sprayed into the air to cool it at once, no part of the water will remain heated above 65° F. The quantity of water at 60° F. required by this plan to cool the air entering the mine at various temperatures and humidities is given in column 3 of Table 2

If the particles of water could be made to travel against the air-current, they would continue to cool the air and warm themselves until they all reached the temperature of the incoming air. The amount of cooling water so required is given in column 5 of Table 2

It is quite impracticable to apply cooling water in this way, but by applying it slowly to the incoming air by a number of jets some distance apart, the water of the first spray can be raised to nearly the temperature of the incoming air and that of only the last to the temperature of the cooled air. The minimum quantities of water required by this method are given in column 4 of Table 2. Actually a little more than this amount of water will be needed even if the jets are small and far apart, and directed against the air-current.

The outside conditions will be seldom worse than 70 per cent. humidity at a temperature of 100 degrees. This may be assumed to take about 7,500 pounds of water per minute. This will require about 750 jets one-eighth inch in diameter under a 50-foot head, and will require about a 5-inch pipe. It seems therefore commercially impossible to so cool the air that there will be no sweating in the mine at all. Even a small amount of water will be beneficial and at least the amount given in Table 1 should be used to start the sweating immediately.

The difference in the amount of water required to cool wet air and dry air arises from the fact that the evaporation of a pound of water spray has a greater cooling effect than 200 pounds of water heated 5 degrees, and because the moisture of warm air has such a large proportion of its total heat.

If the outside air at any given temperature is dryer than the figures given in Table 1, heat in addition to the water spray will have to be added to bring it to the condition of saturated air at 60° F. If heat is furnished by dry steam, the amount needed is given in Table 3. The third column gives the pounds of steam needed to saturate the air with moisture. This is merely cooled from the boiling point to 60° F. The next column gives the additional steam which will be condensed to mist at 60° F. For any given temperature, the steam required increases as the humidity decreases, and the amount for any other humidity can be readily figured by noticing the rate of change for the humidities given. For low temperatures the amount of moisture in saturated air is so small that the influence of humidity is almost negligible.

Dry air at 60° F. or warmer can be brought to the condition of saturated air by adding warm water or a mixture of mine water and steam. There will then be no mist. The last column of the table gives the negligible amount of water required in connection with steam for dry air at 60° F. Dry air at higher temperatures will need very little steam in addition to the water given in Table 2.

TABLE 3.—POUNDS OF DRY STEAM NEEDED TO WARM 50,000 CUBIC FEET OF AIR TO 60 DEGREES AND SATURATE IT WITH MOISTURE

Temperature	Humidity	Steam as Vapor	Steam as Mist	Total Steam	Water
60	100				
60	90	1.0		4.0	.2
60	80	7.5		7.5	.3
60	70	12.0		12.0	.5
60	60	16.0		16.0	.7
60	50	19.5		19.5	.8
50	100	12.2	8.0	19.7	
50	90	15.1	7.5	22.6	
50	80	17.9	7.0	24.9	
50	70	23.7	7.0	30.7	
50	60	29.5	6.5	36.0	
40	100	21.5	15.0	36.5	
40	90	23.5	15.0	38.5	
40	80	25.5	14.5	40.0	
40	70	29.5	11.5	44.9	
40	60	33.5	14.0	47.5	
30	100	28.0	22.0	50.0	
30	80	30.5	22.0	52.5	
30	60	33.0	22.0	55.0	
20	100	32.5	30.0	62.5	
20	80	34.0	30.0	64.0	
20	60	35.5	30.0	65.5	
10	100	35.0	38.0	73.0	
10	80	36.0	38.0	74.0	
10	60	37.0	38.0	75.0	
0	100	37.0	46.0	83.0	
0	80	38.0	46.0	84.0	
0	60	39.0	46.0	85.0	
-10	100	39.0	54.0	93.0	
-10	80	39.5	54.0	93.5	
-10	60	40.0	54.0	94.0	
-20	100	39.5	62.0	101.5	
-20	80	40.0	62.0	102.0	
-20	60	40.6	62.0	102.5	

At the low temperatures, the amount of mist is not exact. This is due to the fact that no information could be obtained as to the heat required to evaporate water at temperatures below freezing. It was necessary to assume that it increased with lower temperatures at the same rate below freezing, as it did above, although this is not the case. The error is trifling because at these temperatures, the amount of moisture in air is very small.

All computations are for mines at sea level. The temperature alone determines the amount of steam in a cubic foot of air. As a result, column 3 of Table 3 does not vary with the altitude of the mine. The weight of dry air in a cubic foot decreases at high elevations. As a result, less steam will be required to warm it.

The exhaust of a common slide-valve engine may be assumed to contain 25 pounds of dry steam for each horsepower for each hour it runs. A temperature of 10° F. above 60° with a humidity of 60 per cent. saturation as may be expected for a mine may be run day or two at a time.

This would then require all the exhaust steam of 180 horsepower of engines. This is available at any mine of this size which in addition to the fan should have a good plant for power haulage and mining machines. If exhaust steam is used, a good steam separator must be placed just before the first jet to take out the water condensed in the engine, otherwise it will increase the amount of mist. This water can be drawn off continuously into the air along with a little steam, if the pipe is large so it will not be sprayed. It will then heat the air slightly.

Assuming 30 pounds of steam per hour as a boiler horsepower, the same air would require at night 150 boiler horsepower if all engines were stopped. One pound of good slack coal should evaporate 6.5 pounds of water. This would then require, in an extreme case, the burning of about 700 pounds of coal per hour. At large mines, a fireman is now employed each shift anyway and the coal would cost about \$4.50 a day, 16 hours a day. The night temperature will seldom average below 40 degrees any month. This will require only 40 to 45 pounds of steam per minute which should be largely supplied by a fan engine. If made especially, it will cost about \$2.50 per winter night at the larger mines, or \$150 a year. This is a small price to pay for freedom from dust explosions.

來 來

Production of Coke in Kentucky

The output of coke in Kentucky for 1911 shows a gain of 15,534 tons over that for 1910, but the total production is still comparatively small. The increase was due to the output of ovens in Pike County, together with a small tonnage made at the close of the year in Harlan County. Following are the tonnages of coke reported:

Company	County	Coke	Ovens
St. Bernard Mfg.	Hopkins	35,336	155
Ohio Valley C. & M.	Union	1,555	20
Wisconsin Steel	Harlan	120	60
Elkhorn Con. C. & C.	Pike	10,252	50
Marrowbone C. & C.	Pike	12,814	32
Totals.....		60,077	317

The Wisconsin Steel Co., which is expected to become a large producer, was still constructing ovens at the close of the year; it is expected to have 300 ovens burning by the end of 1912. The Marrowbone Coal and Coke Co. reported only 463 tons for 1910. This company will finish 68 ovens in 1912, making a total of 100. The Elkhorn Consolidated Coal and Coke Co. reported no coke for 1910. The Straight Creek ovens (now owned by the Continental Coal Corporation), in Bell County, which produced 215 tons in 1910, were idle in 1911, and are expected to so remain during 1912.

Correspondence

Rock Dump Wanted

Editor Mines and Minerals:

SIR:—I noticed in MINES AND MINERALS sometime ago a description of an apparatus for tipping rock that comes out of a coal mine. The mine that I have charge of is a slope (not a shaft), and I have a large quantity of rock coming out of the mine. Now I would like more information of this apparatus, or even the maker's address or any hint from your readers who have had to handle quantities of dirt or rock from a mine. A wooden apparatus is no use, because the rock heap is on fire, and to unload the rock cars with shovels takes too many men and ties up the cars too long.

ANXIOUS

Conveyor System for Mining Coal

Editor Mines and Minerals:

SIR:—I know of a coal mine 4 feet in height, with a very bad roof (some call it soapstone roof), that must be machine cut. Would it be practical to introduce the Blacketts conveyer system to work the blocks out by the retreating method? How long are the Blacketts conveyers, or what is the most economical length to work it. Which is recommended, to work by electricity, or compressed air? How many men or boys does it generally take to handle this conveyer system to give satisfactory result? I may say that I prefer to cut, with electric longwall chain cutter, such as the Jeffrey or Sullivan chain cutters. An answer will greatly oblige

BLACKETT

British Electric Mining Lamp Contest

Editor Mines and Minerals:

SIR:—As readers of MINES AND MINERALS are aware, a British mine owner, something over a year ago offered a prize £1,000 or \$5,000 for the most practical and best portable electric mine lamp.

The judges of the contest were Mr. Charles Rhodes, former president of the Institute of Mining Engineers, and Chas. H. Merz, member of the British home department committee on the use of electricity in mines. The conditions of the competition were:

1. The competition open to persons of any nationality.
 2. The judges empowered to award the whole of the prize, to divide it, or to make no award if no lamp appeared to them to be of sufficient merit.
 3. The competition was open for 6 months, closing on December 31, 1911.
- The requirements which all the lamps submitted in competition were asked to fulfil were as follows:

1. Each lamp to be of sound mechanical

construction so as to withstand rough usage.

2. It was to be of simple construction and easy to maintain in good order and repair.

3. It was to be so constructed as to render impossible the ignition of inflammable gas, either within or without the lamp.

4. The lamp battery was to be so constructed that any liquid it might contain could not be spilled with the lamp in use.

5. The lamp was to be so constructed as not to be liable to deterioration by corrosion as a result of the action of the electrolyte.

6. It was to be effectively locked.

7. It was to be capable of giving an amount of light not less than 2 candlepower continuously for 10 hours

8. The light was to be well distributed outside the lamp.

In addition to the above, regard was directed to be paid to: (a) The first cost of the lamp; (b) the cost of maintenance; (c) convenience in handling; and (d) the weight of the lamp when charged and ready for use.

In issuing their award the judges said:

"We have had submitted to us 195 lamps, varying very considerably in design and construction.

"We have awarded the first prize to the C. E. A. G. lamp, sent in by F. Farber, Beurhausstrasse 3, Dortmund, Germany. Inasmuch as a number of other lamps possess considerable merits, we have apportioned the amount offered for the competition as follows:

Farber, F., Beurhausstrasse 3, Dortmund, Germany.....	£600
Attwater, Thomas, 22, Pelham square, Brighton.....	50
Bohres, Adolf, Zietenstrasse 12, Hannover, Germany.....	50
Bristol Electric Safety Lamp Works, 40, Gt. Smith St., Westminster....	50
Electrical Company, Ltd, The, 122-124, Charing Cross road, London, W. C.....	50
Gray, W. E., 19, Archer St., Camden Town, London, N. W.....	50
Joel, H. F., 134B, Kingsland road, London, N. E.....	50
Oldham & Son, Denton, Manchester.	50
Tudor Accumulator Company, 119 Victoria St., Westminster, S. W....	50

Of all the different lamps submitted I know from good authority that there was but one outfit that not only met the necessary requirements, but had the advantage of having the lamp attached to the cap (adjustable to all angles), while all the others were hand lanterns. The disadvantage of a hand lantern as compared with a light on the cap is so obvious that it seems incredible that prizes should have been awarded to so many lamps of that type, even if, in construction and principle they may have been most excellent.

This award carries with it an implied indorsement of the British Government, which seems to me to be at variance with that government's usual conservatism and traditional practicability in commending mechanical appliances. I am most heartily in favor of competition among the world's inventions, and of course commend the spirit and generosity of the colliery owner who gave the prize, but I think that a practical and economical electric light outfit embracing the feature of the lamp worn on the cap, with a small battery carried on the belt, more nearly meets the requirement of the working miner than a hand lamp, since the lamp worn on the cap gives the miner the use of both hands, and furthermore throws the light in whichever direction he turns his face. I cannot understand why awards should be made to lamps built on an old principle and of inconvenient type.

ELECTRICIAN

Personal Views Re Affairs American Institute Mining Engineers

Editor Mines and Minerals:

SIR:—The Institute has labored for some years under three separate difficulties:

1. Ill-defined division of responsibility, in the dual control of its activities, between the Board of Directors and the Council.
2. The independence of the Secretary of the Council, because of his election by the Institute at large, of the body he is supposed to serve: an illogical situation.
3. The possibility afforded, by the present form of Constitution and By-Laws of placing the management of the entire affairs of the Institute in the hands of a single individual.

The Directors are made solely responsible for the funds and property of the Institute by the incorporation laws of the State of New York. The Constitution places the management of all its professional and social affairs in the hands of the Council who may, and who have in the past, in arranging them incurred indebtedness for which the Directors are responsible; but in which they have frequently had no voice. This should be changed so that no expenditures can be incurred except on previous appropriation by the Board of Directors.

The Secretary has been the executive officer and has the power, under the Constitution, of incurring debts in the name of the Institute, auditing the bills and paying them without consulting either of the governing bodies.

As shown in the report of the Committee of Five, the Institute has for some years been short of funds. Its annual income has not sufficed to meet all of its financial obligations.

The main reasons for this are:

1. The expense incurred by the interest in the United Engineering Society building.

2. High salaries and inefficiency in the office work.

3. The large proportion of life members whose commutation of dues has been spent for current expenses as fast as received, while the obligations of the Institute to them are continuous.

4. The large number of delinquent members carried on the books and supplied with publications.

Together the life members and delinquents are about one-fourth of the total, so that the entire expenses are paid by about three-fourths of the membership.

It is generally admitted the Constitution should be amended, and in so doing we believe the difficulties mentioned above should be borne in mind and every effort made to remove them.

It is hardly possible to do away with the dual control of Directors and Council without putting the control entirely in the hands of the New York members, which they do not desire, and which would not be for the good of the Institute. The incorporation laws place the responsibility so entirely in the hands of the Directors that in order to have meetings most of them must be residents of New York or vicinity, or the power be delegated to an Executive Committee of such residents, which amounts to the same thing. For this reason the dual control will have to be continued.

The undue influence of the Secretary of the Council should, and can be, obviated by abolishing his election by the membership at the annual meeting and by letting the Council elect their own Secretary subject to their own pleasure. A one-man management can be prevented by changes in the Constitution and By-Laws precluding the occupancy of certain offices by the same individual.

Two policies have been in mind for the future management of the Institute. One is a continuance of the present predominating influence on the part of a single individual; the other a practical divorce of the business management and the professional activities so that they will not come in contact except at a single point.

In the past the Institute has had an especially versatile and energetic Secretary; but even in this case the number of those who have not agreed with his policy has increased until they now probably constitute a considerable majority of the Institute. Even if it were desired to continue what is practically a one-man management, and if an individual combining all of the necessary qualifications could be found it is doubtful whether the Institute, with its present obligations and

comparatively small membership could afford to pay sufficient to obtain him.

We believe it would be better, at least for the moment, to have a Business Manager selected by and responsible to the Directors and have the editorial work, so far at least as the selection of material goes, performed by a Committee on Papers and Publications, as is done by most similar societies who attempt to manage their affairs economically; the papers so selected to be turned over to an Editor and the Business Manager, who would attend to the details of publication and distribution.

The expenses of the United Engineering Society building have been incurred and must be provided for. It is therefore either necessary to increase the income of the Institute, decrease its expenditures, or both. The former result can be obtained by making the Institute of greater value to its members which would probably result in increasing the membership, the latter result by more efficient management at the head office and by eliminating various subsidiary activities not strictly a part of the Institute's business.

We believe that the membership can be largely increased, as other societies of similar aims and scope have grown largely in the past few years, while the Institute has stood still. An increase in the membership beyond the present number will increase the income much more rapidly than the expense, so that a comparatively small number of additional members would place the Institute in an easy financial position.

We believe this to be a better and surer way of providing the needed funds than to increase the dues, which would undoubtedly cause enough resignations to make the financial result uncertain. When a large proportion of the members are dissatisfied and are asking themselves whether they are getting a proper return for their money it is a bad time to ask them to pay more unless they can be clearly shown that they are to receive an adequate return.

We believe that by lopping off some unnecessary expenditures, by still closer supervision on the part of the Board of Directors considerable economies can be effected without in any way curtailing the work which the Institute was called into existence to do.

GEO. C. STONE
C. R. CORNING

New York, N. Y.

采 采

The DuPont Powder Co. state that the permissible explosives now made by them were first put on the market late in 1907. Before that there were two others, one made by the Dupont Company and the other by the Mastrite Explosive Co., which were introduced late in 1904 or early in 1905.

Increasing the Efficiency of the Fire Boss

By Bert Lloud

When Joseph Smith became general superintendent of the Stag Cañon Fuel Co., at Dawson, N. Mex., the slogan "Safety First" was immediately adopted, and many new systems of inspection, looking to the prevention of accidents were inaugurated, the most important of which is the one that governs the fire bosses.

Each fire boss is provided with a small, detachable-leaf notebook, in which he records all faulty or dangerous conditions that he discovers on his morning tour of inspection, and upon his return to his station these notes are amplified in a larger book, on the inside of the front cover of which the following notice is pasted:

NOTICE

The object of this book is to prevent accidents as much as possible and if the proper attention is given to the different conditions as reported, no doubt some accidents will be avoided.

There are few accidents that could not have been prevented had proper precautions been taken in time; however, it is the duty of every one who is employed by this company, such as fire bosses, shot inspectors, foremen, capmen, etc., to report any bad conditions that come under their notice, so that accidents can be prevented.

Fire bosses and shot inspectors are employed principally on account of the safety of the men and mines, and have greater responsibility than most people realize. Pit bosses should give them all the support they can, and also the fire bosses should and can greatly assist the pit bosses. If places are reported in dangerous condition and are too numerous for the pit boss to get around to in any reasonable time, he can authorize the fire boss to revisit such places and see that they are being properly fixed up and men prevented from working in dangerous places or under dangerous conditions.

If any places are without sufficient timber, either in place or loose, it should be noted and men not allowed to work or go in the place until they secure sufficient timber.

If stumps have been left behind in pillars, the fire bosses should stop the men from taking too much of the pillars back from such stumps, and report on the book anything they consider dangerous.

The information referred to in this book is considered the private property of this company for the benefit of the officials concerned in the safety of the mines and is not for public inspection, and should be treated as such.

When men refuse to properly timber their places or take down loose and dangerous rock or coal, this should be reported, and it is the duty of the pit bosses to see that they are not allowed to work until the place is put in a safe condition.

The original sheet from this book will be returned to the General Office with the time of day that bad conditions have been remedied stated thereon.

(Signed) STAG CAÑON FUEL CO.

The original report is written on a leaf that is perforated, a carbon copy being made on a duplicate leaf that remains in the book. The fire boss then signs the original and duplicate, and upon the arrival of the pit boss the original is detached and given to him. This official now becomes responsible for the remedying of the conditions as noted by his subordinate, so taking this report with him, he proceeds, according to his convenience or the exigencies, to personally investigate the extent of each unfavorable condition reported, giving necessary orders for their correction, at the same time noting in a proper column of the report the time he made the inspection. After each item has been checked he signs the report and submits it to the superintendent, who checks it and forwards it in turn to the desk of the general superintendent.

The accompanying is the copy of a report as it is received by the last-named official. This is an ideal report made up to show some of the various matters that are to be noted, consequently, the time given is not for any one day, and this brings up the old subject of how many places can the fire boss visit in a given time.

The many great advantages of this system are obvious. In the first place nothing is left to memory. The transcript of the fire boss' report is a constant reminder to

It is possible that the value of the system would be increased by requiring a notation regarding the condition of every working place in the mine. A fire boss would absolutely satisfy himself that no dangerous conditions existed before he would write the word "good" after the number of a room if he knew that his comment would hold against him if it were incorrect. To not mention a place at all and to report it as being in a good condition are two very different things.

years for which statistics are obtainable there has been a decrease in the number of fatalities amounting to 25 per cent."

Frederick L. Hoffman, in refutation, said: "The fatality rate for 1910 was 4.18 per 1,000 persons against 3.39 for 1909. This comparison of the record for 1910 and 1909 is upon the basis of the official returns furnished by the mine inspectors of the different states. The facts derived from trustworthy sources, therefore contradict the statement made in the program of the National Mine Safety Demonstration under the auspices of the United States Department of Mines...."

Mr. Roderick in commenting on this controversy says: "It may be said here that it is not surprising that there should be a decrease in accidents since 1907 as that was the most disastrous year in the history of the coal industry in this state, the fatalities numbering 4.40 for every 1,000 persons employed. There is unfortunately no evidence to show that there has been any material decrease from the years immediately preceding 1907. In fact the 4 years since that date and the 4 years immediately preceding show about an equal number of fatalities. It is gratifying of course to know that the number of accidents during the latter period has decreased even slightly, but the percentage is so small that there is little cause for congratulation over the results of the widely heralded preventive measures that have been introduced in recent years. In the former period 1903-1906 for every 1,000 persons employed 2.93 lives were lost; during the latter period 1908-1911, 2.87 lives were lost, a decrease of .06 per cent. The average number of lives lost per 1,000 persons employed for the entire period of 9 years was 3.07. During the 9 years the great catastrophes at the Harwick, Naomi, Darr, and Marianna mines occurred by which 604 lives were lost. The Harwick explosion occurred in January, 1904; the Naomi and Darr in December, 1907, and the Marianna in December, 1908. The total lives lost inside all the mines during that time by explosions of gas and dust was 792, deducting 604, there are left 188, an average of about 20 a year from these causes or only 4 per cent.

"The total number of all the fatal accidents in the bituminous mines during the 9 years was 4,832. The number of lives lost by falls was 2,552, or 52.82 per cent.; by cars 709, or 14.67 per cent.; by gas and dust, 792, or 16.39 per cent.; by electricity, 191, or 3.95 per cent.; by explosions and blasts 88, or 1.82 per cent.; by miscellaneous causes 500, or 10.35 per cent. The general average loss from gas and dust omitting the four explosions referred to was less than 4 per cent., while the average loss from falls was about 60 per cent., or 15 times as great."

STAG CAÑON FUEL CO.
FIRE BOSSES' DAILY REPORT OF CONDITIONS, MINE No. 3
Date

Time	Entry	Room No.	Remarks
	3rd North	Entry	Small cap of gas at face.
8:40 A. M.	4th North	Entry	Lagging on timbers near face loose.
9:05 A. M.	4th North	14	Shots not fired. Not mined deep enough.
9:15 A. M.	5th Cross	Entry	Door won't close. Damaged by car.
9:20 A. M.	6th Cross	Entry	Canvas down near face.
10:15 A. M.	5th North	2	Bad piece of rock at face.
10:30 A. M.	5th North	14	Timber near face loosened by shot.
10:35 A. M.	5th North	19	Standing shot. Not enough powder.
11:10 A. M.	6th North	3	Blown-out shot.
11:25 A. M.	6th North	24	Not enough props placed in room.
11:30 A. M.	6th North	27	Roof at cross-cut very loose.
11:35 A. M.	6th North	28	Small quantity of gas, right hand. Face.
1:10 P. M.	9th West	Entry	Cross-cut blocked with timbers.
1:15 P. M.	10th West	Entry	Shots not fired. No dobe dummies.
1:40 P. M.	10th West	7	Roof in cross-cut very bad.
2:05 P. M.	10th West	19	Three sets of timber at mouth of room are broken. Mule can't pass under.
2:10 P. M.	10th West	24	Pillar working. Hold men out.
2:15 P. M.	10th West	30	Not enough props in place.
7:50 A. M.	12th West	Entry	Stopping in 2nd X cut from face is in bad order.
8:00 A. M.	11th West	Entry	Board off top.
8:10 A. M.	11th West	Entry	Small fall of rock at mouth of 25 room. 1 set timbers broken.
7:10 A. M.	Main Motor Road		Trolley wire loosened from hangers near 9 West overcast.
	Main Motor Road		Timbers near 5 West too close to track.

J. G. T., Supt.

O. K., RICH HARRIS, Pit Boss

JOHNNY FRANKS, Fire Boss

the pit boss, and the pit boss is enabled to systematically check the observations of the fire boss.

Should a dangerous condition be overlooked and an accident occur in consequence, the pit boss is responsible if the fire boss reported the danger; and the fire boss is held responsible if he failed to include it in his report. The fire boss soon learns to omit nothing from the report regarding conditions that the pit boss should know.

A tremendous advantage is gained through the knowledge the fire boss has that the general superintendent is in close touch with him; that his reports are criterions of his energy, interest, and intelligence. His main effort, therefore, is to discover and report all the existing adverse conditions, knowing that he will be commended for his diligence. The pit boss in turn is speeded up, as he must either provide remedies for the troubles as reported or answer the "whys" that come from the man above. Again, the man above speedily gauges the value of his subordinates by noting what the fire bosses report, and the interest shown by the pit boss as denoted by the time it takes him to get around.

Should there be a lack of cooperation on the part of the pit boss and the fire bosses, due to personal differences, this dangerous condition may be quickly detected from the spirit of the reports.

Red tape and system are synonymous terms to a great many people. In this case there is just enough red tape used to enable the general officers to be in continual close touch with the underground conditions of all their mines.

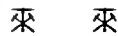

Coal-Mine Accidents in Pennsylvania

James E. Roderick, chief of the Department of Mines of Pennsylvania, in commenting on accidents states: "Much is written on the subject, and the people have their imaginations and sympathies worked upon to such an extent by the oftentimes thrilling and exaggerated accounts of accidents, the suffering of the victims and their families and the many attendant horrors natural to such catastrophes, that they form erroneous opinions not only regarding the number of accidents and the suffering they entail but also regarding the physical and social conditions that surround the miner, his compensation, and his welfare generally." He then quotes a statement which had been circulated as follows: "The most important problem before the Bureau of Mines (Federal) is an attempt to reduce the number of deaths in the mines, and it is gratifying to note that in the last 3

ORE MINING & METALLURGY

Revival of Mining at Red Cliff

Old Colorado Mines Formerly Abandoned on Reaching Sulphide Ores, Now Successfully Operated

By A. J. Hoskin

HERE is a small mining district in Colorado that is almost unobserved as such by the persons who compose an almost constant tide of overland travel through this area. Eagle River heads in the Continental Divide at Tennessee Pass, on the Denver & Rio Grande Railroad, a few miles north of Leadville, and starting on its way down the Pacific Slope, quickly



FIG. 1. EAGLE CANYON, ROCK CREEK

assumes a volume that, in a less precipitous country, would spread out into a very pretentious river. Here, however, it is admired only as a beautiful mountain torrent of clear snow water and is a haunt of trout fishermen. Within a very short distance from its head, this stream swirls through one of the most picturesque spots in the world and it is right here that one may find the very interesting mining district that forms the topic of this article.

The geology of this district is comparatively simple. In Fig. 1, one may discern the characteristic weathering surfaces of the three principal kinds of rocks that occur in this region. Extending up some distance from the bed of the river, we find Archean granite with its surfaces

exposed in large, irregular blocks and its detached portions in large, angular boulders. The railroad tunnel shown in the view penetrates this granite. Upon this fundamental formation, we find Cambrian quartzite beds whose aggregate thickness varies between 200 and 300 feet. In the picture, these beds comprise the cliff in the middle distance. These strata can be seen to dip away from the observer into the distant mountain. This quartzite presents very beautiful cliffs all along this region and its surfaces are always beautifully marked with the striae corresponding to the planes of sedimentation. Upon the quartzite beds are conformably laid the water-limed beds of Silurian age. The limestone in places, appears as cliffs somewhat similar to those of the quartzite, but as the series is much higher on the mountain and comprises their tops, the disintegration has usually produced a fine wash and soil that sustains the major part of the flora of this area. This is shown on the distant peak, Battle Mountain, where the foliage is principally spruce and aspen. The planes of sedimentation are easily visible.

The sedimentary rocks have all been quite uniformly tilted from their original position so that they now dip about 10 degrees to 15 degrees northeasterly. In portions of this district, sheets of porphyry have intruded the strata of limestone and it is probable that these intrusive masses were the ultimate sources of the metallic minerals that compose the ores. All these formations are considered as extending into the corresponding series at Leadville.

The district does not appear to have been seriously disturbed by faulting as are most of the Battle Mountain mining districts. It is, however, to be sure, but they are of minor displacement. In the Eagle River region, whose buildings appear in the foreground, a vertical fault fracture has been observed. Generalized silver-lead veins are the result of the movement of the rocks, and they are about 3 feet. In other portions of the district, veins have been, and are being, discovered. Faults extend through all these formations and hence the resulting

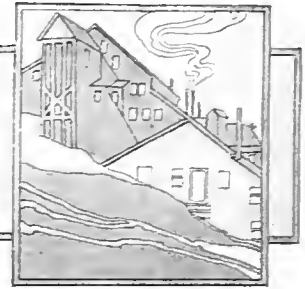

veins may be classified as true. Such veins present very attractive outcrops in the several formations, but their ex-

ploration has proved their best contents to lie between walls of quartzite. These fissures, in general, strike northeasterly or in the direction of the dip of the sedimentaries.

Years ago, Eagle County, Colo., was famous through the production from its many small gold, silver and lead mines.



FIG. 2. ROCKY POINT MINE

The region is usually spoken of as the Battle Mountain mining district from the name of the mountain upon which most of the mines are located. At one time, a little camp known as Gilman, situated high up on the ridge of the mountain (Fig. 3) did a flourishing business; but this town, handicapped by its location, could not compete in permanency with Red Cliff, which is on the main line of the Denver & Rio Grande Railroad. Just now, however, Gilman is enjoying a slight renewal of life through the resumption of mining in the Iron Mask and Rocky Point mines.

The discoveries of mineral wealth were made here contemporaneously with, or shortly after, those of the neighboring

districts of Leadville, Alma, Kokomo, Robinson, Aspen, and Breckenridge. Many remarkably rich bodies were excavated by the pioneers. The first finds were of the rich gold and silver ore bodies filling what appeared to be peculiar irregular caves in the quartzite, the metals occurring in their metallic or free state, frequently in the forms of beautiful nuggets. It is believed that these bodies were replacements of the country rock rather than the filling of preexisting cavities. The outcrops of these masses were

solution was redeposited in its typical crystal forms.

In the pioneer days, much mining was conducted in the limestone beds high up on Battle Mountain, but here the operations were short lived, just as were those in the quartzite, for the operators soon reached the obnoxious sulphide zone that always terminated their bodies of lead, copper, gold, and silver ores.

The metallurgy of precious metals was then in its fundamentals and only the simplest or least complex ores could be

mining districts is why so many gold camps suffered along with the typical silver camps during the depression of the early nineties. To explain this seeming paradox, one must reflect upon the status of metallurgy in those days. As already suggested, it was of a primitive sort and there was a striking similarity in the treatments applied to both sorts of ore. The ores of the two metals were usually subjected to practically the very same treatments; they were classified as either "free milling" or "smelting." Very often, the ore bodies were valuable for both the precious metals, and success in their exploitation and excavation depended upon good market prices for each. At one time, a small copper smelting plant operated at Red Cliff, but the producers of the copper ore soon learned that it was economy to ship their output over the range to Leadville, and the Red Cliff plant was obliged to discontinue operations.

For the moment disregarding the unjust dishonest practices charged against the smelting companies of those days, and assuming that the smelting of custom ores was done at fair rates, we must admit that the closing down of many silver mines had the indirect effect of curtailing the output of lead ores which were depended upon by most smelteries to effect the separation of the silver and gold from the gangue of the ores. This flux being thus hard to obtain, smelting rates were raised at the most inopportune time, and none but the very high-grade mines could endure the adverse costs thus imposed.

However, when operations in this district closed, nearly a score of years ago, probably the main cause was the one already suggested; viz., the encountering of low grades of silver and gold ore in which so-called refractory sulphides existed in abundance. In this instance, the trouble was accentuated in the fact that the sulphide stuff was principally sphalerite. Zinc was then despised by the Western miner, for a very heavy penalty was imposed—with more or less fairness—by smelting companies in their charges for treating ores carrying appreciable percentages of this metal.

The intervening years have wrought changes in the worth of zinciferous ores and science has been evolving methods whereby the base metal in such ores may be recovered at much less cost than formerly. Pronounced economies in mining methods have also been developed and, as a sequel to all these changes, miners now entertain new opinions relative to such ores and, in place of mining primarily for the gold and silver that may be contained in the low grades of these complex ores, they are actually sedulously seeking and mining crude materials that were formerly thoroughly obnoxious to them. Further than this, they now con-



FIG. 3. IRON MASK MINE AND TOWN OF GILMAN

indicated on the cliffs by rusty iron stains that resulted from the oxidation of pyrite, an original component of these ores. The miners generally found that their ore shoots were thus oxidized for not more than 200 feet from the outcrops and that their bonanzas gave out when the unaltered or sulphide ground was encountered. At such points, the ore was always found to be so low grade and refractory to existing methods of treatment that profitable operations ceased.

These shoots of ore were limited to particular strata, so that both the roofs and floors of the stopes were unusually smooth, firm, and readily followed. The Ground Hog mine was one of the early-day producers from this type of ore body. In this mine, most beautiful nuggets and crystals of gold were found cemented or united with both native silver and horn silver (cerargyrite). The crystalline gold probably resulted through a secondary deposition, the metal being originally in minute particles disseminated through the ore and associated with pyrite. The oxidation of pyrite produced the persulphate of iron (one of the few solvents of gold), and the gold, after being brought into

treated at profit. Prospectors, therefore, sought only the rich oxidized ores. They were heartily disgusted whenever their developments led them into the unaltered or sulphide zone. The miners of this district were obliged to acknowledge the fact that their treasures occupied only a comparatively shallow zone along the outcrops and accordingly, when they had skimmed off this cream, as it were, they moved on to other fields. And yet, as is always true of any old mining camp of the West, a few men have retained their faith in this district to such an extent that they have steadfastly remained with it through all its period of desuetude and they are now "on the ground" to participate in what promises to be a notable revival of activity.

About the time that the Red Cliff miners were exhausting their bonanzas, the entire mining industry of the state received a staggering blow through a sudden and pronounced decline in the market price of silver. This particular district, being in a weakened condition, naturally succumbed along with numerous other pioneer mining districts. A very common inquiry made by visitors to the Colorado

sider any recovery of the precious metals from such ores as but adventitious, or "velvet."

Typical Red Cliff veins are being worked now in a number of properties, among them being the Star of the West and the Bleak House mines.

Bleak House Mine.—This property comprises a group of claims lying on Battle Mountain. It is developed and operated through an adit whose portal is along the bed of Rock Creek (Fig. 1) so that it is probably not more than 10 to 12 feet above the granite. This tunnel was driven as a cross-cut for 300 feet and, at that distance, intercepted the Bleak House vein. As the bore advanced, it reached continually higher geological zones. Upon reaching the vein, the adit was deflected and became a drift northeasterly along this vein. This work was done years ago, and we are told that the operators removed very rich silver-lead ore from the stopes above this level. The vein is far from uniform in thickness, but it will be fair to assume its average as about 4 inches. As already mentioned, this is a fault plane. The ore in this vein is argentiferous galena and is very easily distinguished from the quartz gangue. This galena varies in silver from 50 ounces to 700 ounces per ton. Minor cross-faults have been encountered, and while the vein has been somewhat displaced by them, the disturbances have never seriously interrupted ordinary procedure of mining.

During the drifting and stoping in this vein, there was disclosed a large so-called "contact" of zinc ore, which, of course, proved objectionable in those days. Some desultory exploitation of this ground was performed, but it remained practically virgin until recently. The ore shoots of zinc have been attacked, within the past couple of years, and a very notable tonnage has been removed, if one may judge from the sizes of the resulting chambers. These stopes have smooth roofs and floors that conform absolutely with the bedding planes of the quartzite and hence have a slope that is not at all troublesome in mining.

The surface plant at the Bleak House is very primitive in its layout and equipment. Its site is a precarious one in times of Rock Creek's heavy flow. Ore coming from the tunnel is trammed into the small ore house where it undergoes washing with water from a hose, and hand sorting. Two grades of ore are thus selected. A small gasoline engine drives a correspondingly small compressor that supplies air enough to operate one hammer drill; most of the drilling underground is by hand. About twenty men are employed in the mine and on top. The property is leased to R. V. and J. M. Dismant, brothers, who have undertaken to make it suc-

ceed despite the numerous failures of predecessors. The mine could be operated to produce two distinct types of ore; viz., the silver-lead, from the vein; and the zinciferous, from the masses. The property appears to possess mineralogical and geological features that warrant the installation of a much better mining plant. There can never be a large, systematic production of the mine's zinc ore until such an improvement is made, and this suggested plant should include a mill adequate to effect a local concentration

cipitous height of the walls prevented. This view is from a high point on the opposite wall of the cañon but it does not show either the foot or the top of the cliffs. There is a light aerial tramway extending from the building at the mouth of the Rocky Point slope (near top of Fig. 2), down to the railroad at the foot of the cliff. This is now used to handle the ore being mined. Near the middle of the picture may be seen the portal of an adit driven in the granite, years ago, to develop the same formation as the slope.

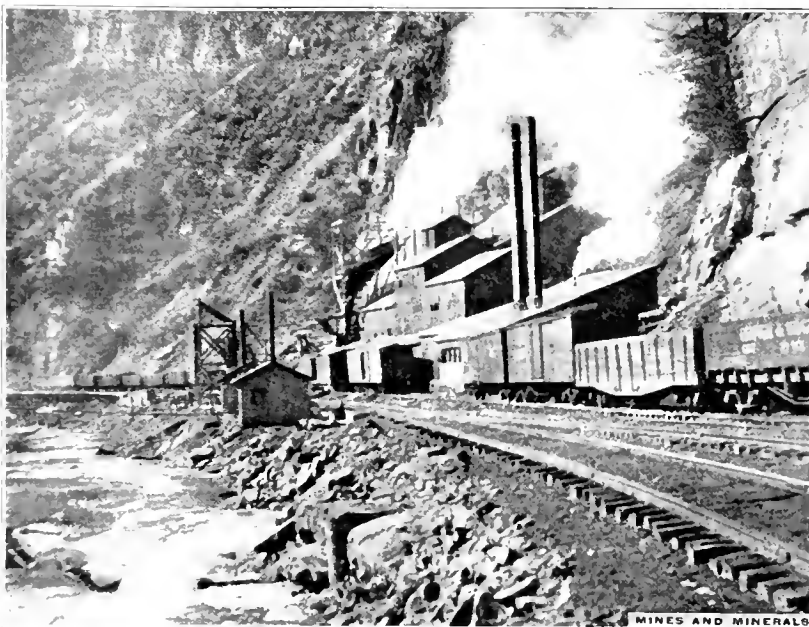

FIG. 4. IRON MASK MILL, EAGLE CAÑON

of the ore. The zinc is found here as two minerals, sphalerite and smithsonite. With an up-to-date equipment, the costs, instead of being necessarily excessive as they now are, could be reduced so materially that the mine would enter upon an entirely new lease of life.

Eagle Mining and Milling Co.—Interest has lately centered in the operations of the Eagle Mining and Milling Co., for it is conducting its work on the greatest scale and according to strictly modern ideas. Some 3 or 4 years ago, this company acquired title to two groups of mining property which, though contiguous and actually conflicting, had theretofore been owned by distinct interests.

Rocky Point Mine.—One of these groups 2 miles from Red Cliff was known as the Rocky Point mine. Its ore was confined to a zone in the quartzite outcropping about half-way up the steep side of the mountain.

Fig. 2 shows that this mine was well named, and it also exhibits the contrast in the appearance of the granite and the quartzite. The writer endeavored to secure a picture of this property that would show all the details, but the restricted width of the gorge together with the pre-

Production from this mine is limited to sulphide ore averaging 8½ per cent. copper and which is shipped in its crude form to the Arkansas Valley smeltery at Leadville. This ore will eventually come through the Newhouse adit.

Iron Mask Mine.—The other mining group mentioned as having been purchased by the Eagle company is the Iron Mask mine that, during the early nineties, produced a large tonnage of ore from the limestone beds. This mine is shown in Fig. 3 and lies above the Rocky Point mine. The aerial tramway is shown leading down from this mine to the mill in the bottom of the gulch and better shown in Fig. 2. This mine, too, is developed through a slope practically parallel to the Rocky Point slope, but in a different geological series. The workings of both the original mining companies followed the stratification; they were both mining the replacement bodies. When the companies reached such a stage that they were both extracting ore from ground bounded by the same surface lines, litigation was inevitable. The controversy was but one of the very many that have arisen through the application of the American doctrine of extra-lateral rights. The

Rocky Point mine owners, having an unquestioned outcrop, claimed the right to follow their ore bodies on their dip; but the Iron Mask owners resented this and instituted legal obstruction that resulted in the cessation of operations. About the time of this legal entanglement, the ore bodies in both mines had changed from bonanzas of gold and silver into shoots rich in zinc. In a way, therefore, the shutting down of these mines was not solely attributable to litigation; but the prolonged inactivity of these properties may be justly ascribed to the failure of the principals to reach a compromise or to arbitrate.

Recognizing the new value that changing metallurgical, mining, and industrial conditions had meanwhile set upon ground such as was owned by the two litigants, Mr. S. N. Hicks, of Denver, bought both pieces of property and thus silenced the controversy. With the able assistance of Mr. R. M. Henderson and Mr. Charles H. Hanington, also of Denver, exhaustive experimentation in the milling of the ore was performed, numerous natural obstacles were overcome, and a very complete plant both for mining and for concentration was finally completed. This company, a close corporation, is now operating its property with the smoothness of an old, time-worn concern and the adventurers mentioned are enjoying the merited success that their perseverance made possible.

Zinc Deposits.—The Iron Mask mine is being worked now exclusively for zinc ore. The masses of sphalerite within the limestone beds are really marvelous in both size and richness. Drifts lead away from the slope, the main artery of the mine, into these ore bodies which are practically solid "mineral." The ore carries a fair percentage of pyrite but practically no quartz. The sphalerite, which accounts for about 17 per cent. zinc in the crude ore, is of the black variety and is generally in small crystals. Galena occurs pretty uniformly associated with the sphalerite, but is so much less abundant that the crude ore will average not over 1½ per cent. lead. One component of this ore is siderite which occurs frequently in most beautiful forms, among them being the botryoidal. However, even this material occurs in limited amounts. A person visiting these stopes wonders how Nature could have produced such a concentration of zinc sulphide. Gold and silver occur in very small amounts in the crude ore, but their value is appreciable in the subsequent concentration products.

Stoping.—Great chambers of irregular shapes spread out and crook about, branching and reuniting around pillars, with numerous instances of stoping being conducted by men working upon shelves of ore, and for hundreds of feet,

in all directions, there is no country rock to be found. A very interesting feature of the excavation of this stuff is the fact that it drills easily, but the blasting of it cannot be depended upon to break down large blocks, because of the peculiar, fine, loose, crystalline structure. Absolutely no sorting is required either in the stopes or on the surface. Every pound of material shot down is ore and is elevated to the surface, in ordinary ore cars through the slope, by a duplex, self-contained steam hoisting engine. Here the only treatment before loading into the buckets of the aerial tram is crushing of this crude ore so that it will pass ⅞-inch apertures.

The ground stands up wonderfully. Whereas these mine chambers are very wide and often quite high, no timbers are used to support the roofs. Indeed, it seems that natural conditions have been multiplied for rendering the mining cheap. The early-day operations produced many passages connecting with the surface, and these now accomplish the natural ventilation of the mine.

The attention of the writer was called to a very peculiar odor that may be noted in freshly broken specimens of the sphalerite. When the miners are shoveling this material, the same odor is noticeable. It is not at all unpleasant, it being comparable both in kind and in strength to that of fresh, warm, cow's milk. This may not be a novelty to some readers of this article who have worked similar deposits, but the author has wondered how many persons will accuse him of nature faking.

Steam, generated in coal-fired boilers, propels the hoisting engine and the air compressor that sends air to the drills. The only other use of power at this mine is for running the crushers in the head-house and these are driven by electricity generated in the mill at the foot of the mountain, Fig. 4.

The mine is worked but one shift per day, for with such tremendous ore reserves it is an extremely easy matter to produce, in a single shift, many times the mill's capacity per 24 hours. As fast as hoisted, the ore is trammed to the head-house, put through a 9"×15" Blake crusher, thence through a ¾-inch trommel into a 9"×16" Samson crusher, and thence to the storage bin.

From this bin, the crushed ore is loaded directly into the buckets of the tram. This tramway is a Bleichert, two-bucket affair in which a descending bucket loaded with 1,200 pounds of ore serves to pull up the empty one on the opposite cable. The standing cables are of the locked-coil type, 1½-inch diameter. The running rope is ½ inch and is wrapped but once around the brake drum in the head-house. One man attends to loading

the buckets and operating the brake. No attention is required in dumping the buckets at the lower terminals, this step being performed automatically, the ore dropping into a commodious bin, vaguely discernible behind the clouds of sulphur and coal smoke.

The receiving bin at the mill will hold a 24-hour supply. From this bin, automatic feeders pass the ore to stationary, slotted, inclined screens (of the Edison type), the apertures being 16 mesh and ⅝ inch. The particles of the ore over ⅝ inch go directly to a set of coarse rolls, while the stuff of intermediate size is delivered to fine rolls. The feed to both these sets of rolls is by means of shaking chutes hung at a very small inclination, these chutes being really conveyers. All the rolled products are returned to the slotted screens.

The screen products drop into a hopper-shaped bin from which they are continuously delivered to a belt conveyer that discharges into another bin from which, in turn, the ore is discharged by two plunger-type feeders to two six-hearth Dewey roasters whose combined capacity is rated at 70 tons per 24 hours, but which are easily taking care of about 85 tons. In these roasters, which are performing exactly duplicate duty, the ore is not given a dead roast, but the temperatures and speed of ore travel are so closely regulated that but a part of the sulphur is removed from each molecule of pyrite, while the siderite is converted into magnetic iron oxide. All the iron is thus put into such forms that it is subsequently removable by magnetism. From the discharge of these roasters, the product, while still hot, is elevated through a revolving, inclined, cylindrical, steel cooler having spirally set interior riffles for tumbling the ore. Upon emerging from this, the ore is quite cool and goes directly to a second storage bin.

The roasted and cooled material is next fed automatically to the belt of a re-modeled Ball-Norton magnetic separator, the alternating polarity magnets of which were constructed especially for this installation. The two products of this treatment are, (a) silica and the sulphides of lead and zinc; (b) magnetic oxide of iron, carrying some structurally entangled galena and sphalerite.

The (a) product is elevated and passed into a Bunker Hill screen, where it is, for the first time, brought into contact with water. The oversize and undersize go to different Card tables, where a separation is made into concentrates of galena and blende. The (b) product from the Ball-Norton separator is passed through a grinder of the coffee-mill style, and then is elevated and delivered to a Cleveland-Knowles magnetic machine which effects the separation of an iron

product and a lead-zinc-silica product. The iron material is discharged into a launder to waste, while the preserved material is delivered to the same Bunker Hill screen and put through the same treatment as product (a).

With ordinary attention to feed and operation, the millman is now able to keep his respective products practically uniform. It is his aim to make a zinc concentrate running about 48 per cent. metal. His galena concentrate runs about 75 per cent. lead.

The proportion of lead to zinc is small, the comparative tonnages of shipped concentrates being about 10 to 1. The mill being on the right of way of the railroad, the shipping products are loaded directly into box cars. The lead concentrates are sold to the American Smelting and Refining Co., while the zinc concentrates are shipped to the American Metals Co.'s plants in Oklahoma.

A very important part of the installation has thus far been overlooked. High upon the opposite mountain, the company impounded a small mountain stream and directed this into a 10-inch, sheet-steel pipe that conveys the water down the mountainside and across the river into the mill. In a total length of 3,200 feet, this pipe gives a head to the water of nearly 600 feet, or a pressure in the mill of practically 250 pounds per square inch. This water, passing a 3/4-inch nozzle, drives a 24-inch Pelton wheel that ordinarily delivers about 120 horsepower, and this power is conveyed by belting to various generators and the mill's line shafts. It is from one of these generators that the current to operate the crusher up at the Iron Mask mine is taken. The mill contains a set of coal-fired boilers and an engine for use whenever a shortage of water may occur through drought or freezing. The photos show the boilers in use, the exhaust steam issuing from a Norwalk compressor furnishing air to the mines. The power plant occupies a very limited space in the right end of the mill building and is so planned that steam and water-power may be utilized separately or together.

There has been nothing to conceal, but the owners have been opposed to any public announcements of their operations; indeed, during the days of tribulation in equipping and adjusting their plant, they did not care for the attention of outsiders. There has been no ulterior motive back of this reticence, for the property was purchased and equipped as a permanent investment, there being no notion of promotion or of selling out. The writer recently accepted an invitation to visit this property and he was more than elated, later, when he was granted the privilege of writing it up. He, therefore, desires to express his appreciation of the assistance

and courtesies of both Mr. Hicks and Mr. Hanington.

來 來

Economical Shaft Sinking

By Mark B. Kerr*

The mines of the Grass Valley and Nevada City district, in California have long been noted as among the permanent and paying in that state. One pay zone after another is encountered on the strike and dip, connected along the fracture planes in the diabase by what are locally known as crossings. As a rule, this crossing or fault merely throws the vein from the foot-wall to the hanging wall, or vice versa

In the Pittsburg mine, near Nevada City, a very strong, well-defined crossing threw the vein about 40 feet and was the principal cause for closing down this promising property some 12 or 15 years ago.

When the present holders recently took hold of this mine, they found the shaft down 1,000 feet and the vein flattened off in the hanging wall, even beyond where the south segment of the vein should be by projection. The problem was then to sink the shaft through the crossing and pick up the south segment of the vein and sink on it.

In sinking to the 1,100 level, and then driving on the vein and picking up the south segment of it, it was found that the main shaft had been flattened so much that both segments, north and south, were back of the shaft, or in other words, in the foot-wall (see Fig. 1).

A gradual curve below the 1,100 level was made, increasing the dip of the shaft from 25 degrees to 53 degrees. At the 1,300 level a station was cut and the vein developed both sides. The country rock is a close-grained diabase, so it was decided to sink a winze 200 feet on the vein, then drift back north to a point under the shaft and raise up with stoping drills to connect with the bottom of the shaft.

The result of the survey for this work (the last distance up the raise to point of beginning being calculated) was as follows:

Station	North	South	East	West
0-1	15 56	10 47		
1-2			42 76	22.41
2-3	55 16	32 68		
3-4			56.94	15.64
4-5	18 48	18 21		
5-6			51.55	65.50
6-7	23 68	47 89		
7-8			27.72	15.25
8-9	9 89	65 65		
9-10			24 98	14.72
10-0	47 40			70.55
	170 17	174 90	203.95	204.07

Eastings and westings checked within .12 foot and a possible error of 4.73 feet was found in the northings and southings. Distributing this error, the upraise was made on this line, the dip calculating between 52 degrees and 53 degrees, to correspond with the shaft above.

* Mining Engineer, San Francisco, Cal.

The vein at the 1,500 level was found to dip 52 degrees, but, after going up 20 feet, it flattened, so the raise, the rest of the way, was made in the wall, thus saving time and expense; for sinking in this hard ground is very tedious. The slope distance up this raise was 153 feet, and 30 feet per week was made with two shifts, performing the work in 5 weeks. The work was delayed a week in order to trim the sides and corners. From now on the shaft can be sunk deeper on the vein, with only a slight divergence now and then from the theoretical dip adopted from the course in the shaft below the 1,100 level.

The drills used were the Ingersoll and the Shaw stoping. The total cost of this work, including all hoisting, supplies, labor, and supervising, and electric power throughout, was \$3,950, or \$20.57 per foot. When it is realized that to sink this shaft the same distance would have taken just twice as long and would have doubled the

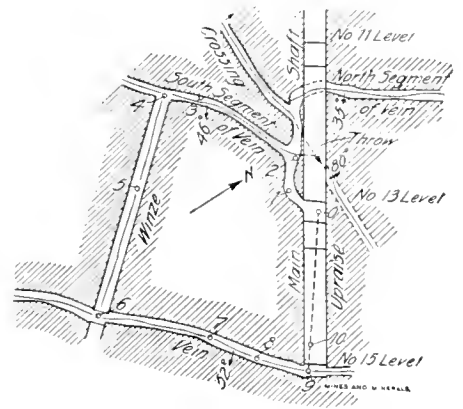

FIG. 1

cost, the justification for the engineering work is obvious; and again, the company had the advantage of exploring the vein and knowing its peculiarities in advance.

Such a piece of work, although novel, is not difficult to lay out; but the greatest care should be taken in the surveys, especially to obtain the proper alinement. If any other superintendent cares to follow this up, it is best to do as was done in this case; that is, explore ahead sufficiently to be sure that the practical conditions are favorable when the work is complete, for the saving accomplished is a tremendous factor in favor of its adoption.

來 來

In Bessemer pig iron the greatest allowable quantity of phosphorus is 1 per cent. To obtain allowable percentage of P in ore divide its per cent. in iron by 1,000, thus:

$$\frac{62\% \text{ Fe}}{1,000} = .062 \text{ per cent. } P, \text{ allowable.}$$

If over this amount the ore is classed as non-Bessemer. Some insist that limit is .05 per cent. P. The ore must be so low in P as to allow for the P in fuel and flux and yield pig iron not over 1 per cent. P. Phosphorus is wanted for white iron and in iron that is to be machined.

PHOSPHATE rock is tricalcium phosphate, $Ca_3P_2O_8$, combined with various impurities, both mechanically and chemically, the former being represented by silica, some free iron and clay, and the latter by alumina in the form of aluminum phosphate $Al_2(PO_4)_3$, iron phosphate $Fe_2(PO_4)_3$, calcium carbonate, fluorine as CaF_2 , and traces of arsenic.

Brown phosphate rock varies from shale rock resembling half-burnt clay to the more common cellular brown rock occurring in irregular plates, and the gray rock, much harder, and presenting a vitreous-looking fracture, though still somewhat cellular. The percentage of iron and alumina is largest in the first variety and lowest in the last. The mechanically combined impurities, chiefly clay, are removed by washing. Silica, which is of very nearly the same specific gravity, has not as yet been eliminated successfully except when it occurs in a very fine state and floats off with the wash water.

The brown rock occurs in the Lower Silurian, more commonly known as the Ordovician horizon, resting on the Bigby limestone.

Blue phosphate rock resembles blue limestone, into which it sometimes grades by imperceptible stages. It occurs in the Devonian series, and ordinarily below the Chattanooga shale, unless the latter is missing by reason of erosion. The grade runs from 50 per cent. to 75 per cent. bone phosphate of lime, with occasional analyses showing 80 per cent. The lowest commercial limit is about 65 per cent.

The color of the blue rock also indicates its grade, ordinarily the gray rock being the highest and the darker color indicating a lower grade.

Above the blue rock occurs a thin stratum of Kidney, which is of still lower grade, though there is an exception to this.

White phosphate rock is the highest grade occurring in Tennessee, and has been known to run over 90 per cent. bone phosphate of lime. The known deposits are so far from transportation that they are not being mined to any extent at present.

Brown rock prospecting should be conducted in a systematic manner, as unless the person in charge of the work has had a very large experience in the occurrence of the phosphate he is more than liable to so place the prospect holes or pits as to obtain results which are not the average. To be on the safe side, the ground should be laid off in from 100-foot to 200-foot squares, according to the uniformity of the deposits, and holes sunk with post-hole diggers and augers. In this way the outcrops are determined and barren spots traced. When the rock runs out between two holes, it can be,

*Engineering Association of the South.

Tennessee Phosphate Practice

Kinds of Rock Mined—Prospecting, Sampling, Handling, and Mining—Organization and Management

By James Allen Bar[®]

if necessary, more exactly determined by additional boring. Each hole should be numbered, and a sample of the rock taken, placed in a cloth bag, marked with the number of the hole, and sent immediately to the testing place. It is said that a man selling land at one time switched good samples for bad ones; another lined the prospect holes with high-grade rock. In the West this is commonly called "salting." It might be well to observe precautions to prevent anything like this.

The depth of the overburden and rock should be taken from each hole and the proper record made of the same, so that it can be transferred to a prospect map. When the deposit occurs in the ribbon or hat-band formation, the holes should run across the deposit.

About in every acre a pit should be dug to verify the results of the auger holes and obtain a proper sample for washing tests. The fine-cut samples from the auger holes would not fairly represent the rock coming from the mine. The samples are also liable to be contaminated by flint and dirt, scraped down from the overburden.

In case of very irregular deposits, where there are many cutters in the limestone, it would be well to use the pit method in prospecting entirely, it being almost impossible to gain even an idea of the rock between cutters by auger holes alone. This latter amount will run from one-fourth to one-half of the total volume as represented by the average depth of the rock below the top of the lime.

In blue rock prospecting, ordinarily the outcrop may be uncovered easily on a hillside. If possible, this should be done at intervals of 100 to 200 feet, the thickness of the rock determined, and samples taken for analysis. The outcrop will run lower in bone phosphate of lime than farther in, and the joints will have a brown-colored border, due to oxidation. Back in the hill a diamond or core drill will have to be employed or shafts sunk to determine the thickness of the rock, its grade, and continuity.

The blue rock is by no means a uniform deposit. It will be broken by low-grade "horses," and will very often "pinch out" farther in the hill, or at least be uniform only in one direction as to thickness and grade.

In Tennessee the grade of blue rock is practically the only consideration, and hence analysis is the ultimate test.

The impurities in brown rock, which are removed by washing, are principally clay with an inappreciable amount of fine silica.

The object of all the washing tests is to determine to what grade the sample will wash under actual conditions of operation and how much will be recovered. In general, hand washing will be slightly more thorough—say, to the extent of $\frac{1}{2}$ per cent. to 1 per cent. bone phosphate of lime, and the recovery 10 per cent. to 20 per cent. higher. This is true in any testing on a small scale, as has been demonstrated in western practice, where some disastrous failures have resulted in erecting reduction plants and purchasing properties on the results of laboratory tests.

The sample to be tested is soaked in a tub of water until fairly soft. The tub is then dumped into the top screen of a washing apparatus, which is easily described as two superimposed screens, set in some watertight basin, such as an iron wheelbarrow. The top screen should have about 1-inch holes, and the other slightly smaller than 16-mesh holes. The sample is then washed by a stream of water, with a piece of $\frac{3}{8}$ -inch pipe bent in an angle for a nozzle. About 20 pounds pressure is sufficient. The operation is continued until all of the rock is cleaned of the clay. The lumps of muck should be broken by stirring with the hand paddle, using a motion similar to the action of a log washer. The screens are now removed, the muddy water decanted from the sand, and fresh water added until it runs off almost clear.

The resulting products are separately dried, weighed, and sampled for analysis. The ratio of the original to the final weights will give the recovery, which may be either figured on a wet or dry recovery; or if moisture samples are taken of the original, the recovery on a dry basis may be calculated. The weight of the rock occurring in the field, per cubic foot, should also be determined at intervals for computing the recovery of the rock in tons from an area represented by the sample. The specific gravity of the rock in Mount Pleasant field varies from 10 per cent. to 20 per cent.

The results of these recovery tests should show the total tonnage of sand, rock, and screenings from each acre of ground as selected, the average analysis of each size, and thus give the all-important information as to the commercial value of the rock.

Careful account should be kept by an experienced person of the behavior of the sample in washing, for it is by observing the action of the rock in a test that valuable data can be gathered for the design of the prospective plant. The percentages of the rock screenings and sand also bear an important part in the plant design, so that the sand washer may bear the proper ratio to the total capacity of the plant.

It is evident that the more difficult the

washing of the sample and the greater the amount of impurities to be removed, the more thorough must be the washing in the plant designed to handle this material.

The commercial value of the prospecting data for blue rock is as follows: The grades should run on an average of 68 per cent. with some 70 per cent. to 72 per cent. bone phosphate of lime, $Ca_3(PO_4)_2$. Below 60 per cent. it is practically impossible to handle at the present market quotations. The 60 per cent. to 67 per cent. grade is largely ground for the raw-rock trade.

The thickness of the deposit should not be less than 28 inches in order that mining can be done economically. Providing the mine is developed systematically, the cost of mining should not be over \$1.25 per ton.

The roof should be of good, firm shale, unless the overburden is light—that is, not over 20 feet—so that it can be removed economically.

From the results of the prospecting for brown rock the tonnages are computed, and thus knowing the market price for the respective grades, and also the cost of handling the rock, the commercial value per acre of ground is obtained.

The overburden is an important item, and is charged against the washed rock at so much per ton. This is obtained by figuring the removal of the overburden at 14 cents per yard.

In the valuation of the property there are on the credit side so many tons of the various grades, with a given value at the present market quotations, and, if the land is also owned, its value after the mining operations have been completed, together with any rents which may accrue during the life of the operations. Any other sources of revenue should also be included, of which timber is the chief.

On the debit side are the following costs, figured from the total price of the land and other purchases, such as right of way, all figured on a tonnage basis, plus the estimated working costs.

The following figures are representative of the present-day practice and show the effects of grades on the valuation of property, viz.:

Price of property.....	\$400,000.00
Brokerage and prospecting.....	25,000.00
Erection of plant and mining equipment.....	125,000.00
Total.....	\$550,000.00
Tons of rock on property.....	1,250,000
Cost per ton initial expenditure.....	\$.44
Removing overburden.....	.50
Mining.....	.40
Washing.....	.35
Drying.....	.16
Screening, stocking, and loading.....	.15
Overhead expense.....	.50
Total.....	\$2.50

At the rate of 60,000 tons per year, the property will have a life of 21 years.

	73%	75%
Average selling price of rock \$	3.50	\$ 4.00
Net profit.....	1.00	1.50
Profit per year.....	60,000.00	90,000.00
Per cent. profit per year....	12%	18%

Considering the risks of the business, not less than 20 per cent. per year should be

considered justifiable. The above procedure should be carefully studied to arrive at the proper value of the rock.

From the experience gained in washing the samples, a very good idea may be formed as to the elaborateness of the washing plant necessary. Comparatively clean material may be obtained by the use of a single set of logs; but if much clay be present, a tandem set is much better, especially when capacity is a figure. The log washer consists of a box about 25 feet long, 7 feet wide, and 4 feet deep, in which are made to revolve, in the case of a double log, two shafts constructed of angle irons, in which are fastened chilled cast-iron paddles. The rock is dumped in the lower or tail-end and pushed forward by the paddles, which are set at an angle to form a screw when revolving. At the same time the water and material are agitated so as to put the clay in mechanical suspension. The tail-end of the logs being the lowest, an overflow gate is provided through which the muddy water and considerable phosphate sand flow, the coarser sand and rock being pushed to the higher or discharge end, where it should issue from the logs with very little water. The log washers should work with as little water as possible, and the contents of the box should be of creamy consistency to give the best results. The function of the second set of logs is to receive the material from the first, and with the addition of fresh water, again elutriate the clay in a more thorough manner than could be done in one set in the presence of so much of the contaminating substance.

It is the general procedure of the present-day practice to prepare the material for the logs by crushing much finer than formerly, the last three plants being built to reduce the phosphate rock to 1 inch and smaller. This not only permits a thorough washing of the rock, but reduces the power necessary to operate the logs compared with what is required when working lump rock. However, fine crushing is productive of a larger percentage of sand. By employing fine crushing, 150 to 400 tons, figured on a washed basis, may be put through a set of logs, providing the grade will permit, in 1 day's time.

Following the log washers, a revolving screen, with an internal spray, eliminates the remaining clay and the smaller sand from the rock. The screens have jackets ranging from $\frac{1}{8}$ -inch to $\frac{1}{16}$ -inch mesh. In former days the screen holes were anywhere between $\frac{1}{2}$ -inch to 2 inches in diameter, the resulting undersize often being wasted.

Following the rock department comes the sand washer, which is the most important part of the entire plant, but which is today the least perfected. The system known as the "tank process," was introduced by Mr. Granbery Jackson. In this system the sand is run into large square or round tanks, where it settles out as much as is permitted by the overflow velocity and eddy current.

The surplus water flows to a discharge launder. This system has two methods of transferring the sand to the next washing tank. In one it is continuously removed by a jet of water operating in a pipe and pumping into a second tank, where the operation is again repeated until the sand has received five washings. From the last tank it is run into a bin, where it is drained and discharged on to a conveyer from the bottom dump door.

In the second-mentioned system of transferring, the sand is washed by hand hose from the tank to a steam pump, where it is elevated to a second washing system, and so on.

While these tanks wash the sand perfectly, the inherent defect is that the fine material is still wasted and the water used is unnecessarily large in volume. The perfect sand washer should embody the following principles:

1. The velocity of the water in the final overflow should not be greater than .4 of a foot per second, which will just carry off 150- to 200-mesh phosphate sand and all the elutriated clay. Any greater velocity will carry off a correspondingly larger grain of sand, viz., .17 of a foot per second will float 100-mesh material.

2. The clay must be elutriated and caused to rise and travel in one direction by reason of its fineness and properties of suspension in a colloidal solution, and the sand to settle out or travel in an opposite direction by reason of its greater settling power. The clayey water must be thoroughly eliminated from the sand by the addition of fresh water, as in the operation of decanting. It must also be remembered that in some steps of the process, either in the logs or sand washer, the sticky clay must be scoured from the sand particles.

3. The sand must be dewatered and placed in condition for handling or drying.

The coarse and fine sand should be treated separately. In western cyanide plants the slime is effectively separated from the coarse sand in various forms of classifiers. The practice of dewatering, or eliminating the large volume of water coming from the washer might be well improved upon by noting the use of the Dorr mechanical dewaterer in the majority of the modern cyaniding plants, which operates under very similar conditions to those required in this field.

In designing equipment to handle the sand from the washers, valuable information can be obtained in Mexico and the West, where the Blaisdell excavating system automatically handles thousands of tons daily.

The rock and sand issuing from the washer should be stored in piles where it will drain and eliminate the excess moisture before drying. The storage piles should be large enough to supply the dryers during stoppages of the washer and bad weather, which prohibits mining. Probably the best

machine adapted for storage purposes is a modification of a traveling crane equipped with a 54-cubic-foot clam-shell bucket.

The two systems of drying in use in the Mount Pleasant field are feeding at the cold end and discharging at the hot end; and reversing the above operation.

It is evident that the fuel economy in the first system will be higher on account of the low-stack temperatures possible. The importance of this item will be clearly seen upon studying the percentage of heat lost from this source in a furnace test.

In the first system one can put his hand on the cold end of the dryer, which ranges between 150° F. and 200° F. In the second system the temperature of the flue gases will range between 400° F. and 600° F. The first system was formerly operated entirely with natural draft, with the exception of a steam jet, which furnished the necessary volume of air by induction through the grate and forced the gases through the shells, at the same time insuring complete combustion, but, at a considerable loss of steam. With this method of firing, wood is also used with coal to obtain the necessary openness of fire, the ratio being about 2 cords of wood to 1 ton of coal. Later the system was changed to coal entirely by using the following modifications: To burn the coal, a slight air pressure was introduced in the ash pit, the latter being preferably kept filled with water to keep down the formation of clinkers and cool off the grates. Only sufficient air is forced through the grates to balance the vacuum due to the stack draft. This not only lengthened the life of the furnace, but eliminated any objectionable feature of smoke being forced out of the fire-door and dryer opening. The combustion in this case is almost perfect, only a white feather of steam appearing at the stack.

The second system relies entirely upon the forced draft to obtain its results, and, in general, uses a much smaller furnace and grate area than the first system. The combustion is not complete, and a very high percentage of the fines is carried through the cylinder by the high velocity of air, which is unnecessary waste and requires additional handling to save. In roasting fine ores metallurgists aim to keep down the velocity of air through the ore bed to 200 feet per minute. Adequate dust chambers should be provided to reduce the velocity of the flue gases and to precipitate the fine dust.

The rock from the dryer is elevated to a storage tower, preferably of steel construction on account of the hot rock issuing from the dryers occasionally at almost a red heat. Probably the best form of elevator for this service is a malleable bucket, continuous pattern, single-strand type, with plain idlers and traction head and tail-sprockets, operating at a speed of 60 to 100 feet per minute. The use of sprockets in the elevator greatly increases the wear and jar,

especially on the chain. The most commonly used chain is a combination malleable and steel link. The dry rock may be either screened or run directly to the storage bin. By using a separate wet storage pile there is no use for this screening, as the rock and sand may be kept apart all through the operation.

The distribution of the dry rock is best effected by man-operated motor car. A belt conveyer might be used, but an occasional rush of red-hot rock would preclude the use of any ordinary-priced belt and also tend to increase the cost of maintenance. One attendant would be necessary to look after it, which is enough for the operation of a motor car handling 400 tons per day.

The dry rock may be stored the same as the wet rock. If the life of the property and the magnitude of the operations warrant, a more elaborate system of storage bins of reinforced concrete or steel might be installed; but it is doubtful whether the present condition of phosphate mining industry in this state would warrant such an expenditure for the slight reduction in cost obtained.

The rock from the elevator may be spouted direct to a car and conveyed back from the doors to the end either by hand or a short belt conveyer. Care should be taken to prevent burning up the car from an occasional rush of red-hot rock or cinder.

MINING AND STRIPPING

The overburden to be removed is generally clay, with occasional flint boulders. The ground works very well during dry weather, but in rainy weather becomes too miry for a scraper outfit.

At present the majority of stripping is done by wheel scraper outfits under contract price of 14 cents per yard. One company pays 15 cents, but does not advance any money ahead of the engineer's estimate.

Steam shovels have been little used. The drawback to their use is the manner in which the scraping has been done in scattered pits with long hauls for dirt. The pockety nature of the deposits partly accounts for this, but mostly the lack of system in mining.

A long-boom revolving shovel, equipped with either drag-line bucket or extra long dipper stick, makes about the best outfit for removing dirt by mechanical means. The radius of this operation enables a pit 50 feet wide to be stripped and the overburden piled up in a previously made cut which has been mined out. There are offers to do this work for 10 cents per yard where sufficiently large area for scraping warrants continuous operation for the shovel without moving.

Grab buckets have been tried, but it is a common experience that they will not handle anything economically that a man cannot dig with a shovel.

The work of the wheel scraper is too well known to warrant description. Scraping by this method is usually done in pits 40 to 60 feet wide and 150 to 300 feet long.

The depth of the overburden removed in this field will average about 9 feet.

At the Ward mines, near Centerville, the overburden is being taken off by a hydraulic giant, water under 150-pound pressure being used through a 1½-inch nozzle. The flow back is ditched to a sump with the aid of a ditching hose, where it is pumped out by an 8-inch centrifugal pump to the waste. In some cases this is done entirely by gravity.

Whenever stiff yellow clay is encountered, the progress is slow and costly, it being possible to remove about 100 yards in 1 day, costing 17 cents to 20 cents. However, this material is so hard and stiff that it is difficult to handle with pick and shovel. While working in the best of conditions, removing loose sand with little clay and boulders, it is possible to move at least 1,000 yards of material in 1 day at a cost of 5 cents per yard. It will be safer to figure the average cost at 8 cents to 10 cents.

The flow back from the working face will not handle any material larger than ordinary gravel, about 3 inches in diameter; the larger size must be washed back with the ditching hose and the hydraulic giant. The centrifugal pump will handle pieces 2 inches smaller in size than the diameter of the suction, though, of course, this is very hard on the pump linings and impeller.

Around the outcrop of a blue-rock deposit, where the overburden and slate roof is light, this may be removed, and the rock quarried. The underground mining is ordinarily done on the room-and-pillar system, the pillars being recovered by drawing back. With a good roof, the only timbering necessary is a few posts near the working face, the gob being thrown behind and to one side to provide additional support.

The following precautions should always be observed in laying out and operating underground workings of this kind:

- 1 The room should be so directed as to run parallel with the joints of the rock in order to fire the shots to the best advantage. If a miner can locate two joints, he can then place his hole so as to obtain the maximum effect of the powder; but if the room runs at right angles with the joints, he cannot then tell where the next one occurs, and is liable to lose a part of his shot.

- 2 The entries should be so located as to block out the maximum amount of rock with the minimum of drifting in the direction in which the phosphate rock pinches out.

- 3 The mine must be worked according to a system and kept to this by a competent surveyor.

- 4 Drainage must be provided and kept open.

- 5 Main line tracks should be laid with not less than 30-pound rail, properly lined and surfaced.

- 6 The entries should be driven and kept in shape by a competent foreman.

7. Rooms should not be over 200 feet long and 40 feet apart, being staggered on each side of the main drift to facilitate trackage.

In brown-rock mining the prospect map should be carefully studied, a plan laid down and thereafter followed as closely as practical. Before beginning operations formulate a plan and decide how to obtain the rock cheaply, not only in one particular pit, but on a general average. Always keep the mine in condition so that it will not have to be cleaned up with attendant high cost.

Material which only brings on an average of \$4 per ton f. o. b. the cars requires large tonnages and strictly economical methods to produce profits, especially when the prices are based on a 50-per-cent. recovery, bringing down the price to about \$2 in the field.

In laying out the future plans of mining operations, the following points must be considered:

1. How can the overburden be disposed of without covering up rock and without long hauls or rehandling? This may be done by starting in on the outcrop and working in; or if no outcrop is available, then the first cut must be hauled away to a barren spot or rehandled. As soon as the first cut is available and mined out, it may be used for dirt room.

2. Open the mines so that the track may be thrown continually without tearing up and so that the entire deposit may be reached with a minimum amount of trackage.

3. Sufficient rock must be opened to permit placing of enough cars to supply the plant. It will take from 100 to 150 cars per day to take care of a 200-ton plant.

4. Always provide for drainage. This must be done, or every rain will mean a shut-down of the mines.

5. Provide a good main-line track from mines to plant, laid with not less than 40-pound rails on a good road bed, laid out by an engineer who knows his business. This will enable one locomotive to haul twice as much as it could on a poor road bed. A 12-ton locomotive makes a good size for the main-line service, while a 7-ton locomotive is large enough for switching around the mines and plant.

Hydraulic mining is to be tried shortly in this field. Judging from its work in Florida and the operation at the Ward mines, it will prove successful as far as the mining is concerned. The only objection to this method is that it will send so much water to the washer as to make the problem of sand handling a difficult one. In getting around this objection, valuable information might be obtained by observing the operations of the Washoe smelter at Anaconda, Mont., for saving the very fine slime from their concentrating plant. The material is run into one of three large ponds—one for filling, one for draining, one for excavating.

The latter is done by grab bucket, operated on the Lidgerwood cableway system. The excavated and dewatered material can then be handled by ordinary methods.

There are not many deposits of rock in the Mount Pleasant field which will permit other than hand mining. This is because the rock often runs in deep cutters between the limestone. Flint and other waste material also occurs in irregular deposits, and at times even a whole stratum of low-grade flinty material will separate two good layers of phosphate rock, all of which makes a close selection by hand mining imperative to maintain the proper grade.

Where it is possible to obtain a good block of rock free from flint and clay seams and unobstructed by lime boulders, then a steam shovel will remove the rock economically and be cheaper than hand mining. It has often occurred to the writer that a locomotive crane adapted to a narrow-gauge track could be used to advantage for mining rock in the deep cutters by dropping buckets down to the working face, where they would be filled by hand, raised and unloaded into the cars. It costs 20 cents per mine car to load from the face of the rock up to 40 cents and 50 cents from deep cutters.

There should be one superintendent over all the field work, mines, and plants; all orders for the operations to go through him. Do not pay him superintendent's wages and make a foreman out of him by having the higher officials issue orders direct to the men, with its attendant demoralizing effect on the system. The plants and mines should each have a foreman, responsible to the superintendent only. The master mechanic should be in charge of all mechanical operations, being in full authority in his department and over his assistants, but under order of the superintendent or plant superintendent in the same manner as a locomotive engineer is governed by the conductor. Above all, there must be harmony in the working quarters and a loyal spirit among the men.

All requisitions for supplies should come from the heads of the respective departments, O. K'd by the superintendent, and, if necessary, passed by the engineer. Spare parts should be kept in stock along with supplies, which requires that a storehouse be kept and regulated by a stores and supplies account, showing each day the balance of any item on hand. The supplies as taken out should be charged to the proper account, with allowance for freight and handling.

Repairs are not charged directly against the separate accounts on the cost sheet, but are provided for by a set charge against each ton of output. At the beginning of the year the master mechanic or engineer should prepare an estimate of the amount required for the maintenance of each machine and building. These charges are then prorated among the proper accounts to obtain the above-mentioned fixed charge.

The object of this is to eliminate the violent fluctuations of the cost sheet due to a breakdown, which may occur only once a year. Of course the charges per ton for repairs and maintenance may require changing if the output does not come up to expectations.

Time cards should be turned into the office each morning by the head of the department. On the back of each card should be a distribution of the time to the proper accounts, this to be used in making up the cost sheet.

The cost sheet is the vital part and chief consideration of the elaborate system of accounting. It enables the superintendent to keep an accurate check on the work and shows him each day how to improve the next one. The cost sheet should by all means be a daily one. The older an event is, the less interest it holds and the less meaning it has. The actual operating cost should be separately shown in an itemized statement, giving for mining, washing, drying, etc., the cost today, amounts forward, and totals to date, of labor, supplies, fuel, and maintenance, all of which are totaled and the average cost for each item figured. A separate part of the sheet may in like manner contain a statement of other costs charged against the production, but not included in the actual working cost. The above two items are then recapitulated to show the total cost today and the average cost to date from the first of the month. This sheet should also show the mine cars dumped, tons washed and recovered, percentage of recovery, and tons dried. A separate account should be kept of the number of tons in wet and dry storage, with the probable grades.

來 來

Normal Volumetric Solutions

In wet assaying a normal solution is one which contains in 1 liter, in any stated reaction, the chemical equivalent of 1 gram of hydrogen. If the molecule of the reagent be univalent 1 liter will contain the weight in grams equal to the molecular weight of the reagent; if bivalent, a weight in grams equal to one-half its molecular weight; if trivalent, a weight in grams equal to one-third its molecular weight, etc.

來 來

Antimony Ores

The following shows the percentage of antimony in various minerals:

	Per Cent. Sb		Per Cent. Sb	
Stibnite	71.80	(3) Senarmontite	83.56	
Chalcostibnite	48.90	(4) Valentinite	83.56	
Berthierite	57.00	(5) Cervantite	79.20	
Zinkinite	42.60		Kermesite	75.30
(1) Stibonite	74.90	(6) Volgerite	58.91	
Durfeldite	30.52		Livingstonite	53.12
(2) Burunite	50.11		Guejarite	58.50

Those numbered are oxides. The others contain sulphur.

Brakpan Mines, Limited

Description of a Large Modern Electrically Operated Cyanide Plant on the Rand, South Africa

By H. S. Gilser*

THE property of the Brakpan Mines, Ltd., is situated on the far East Rand, 21 miles from Johannesburg. It consists of 1,150½ (=1,691 acres) deep level claims and is opened by two seven-compartment shafts, 4,400 feet apart. No. 1, or the north shaft, is 3,100 feet deep vertically. Shaft No. 2, or the south shaft, is

vided with a steel head-frame and is served by two electric hoists. One has parallel drums 11 feet diameter by 8 feet long, grooved for ropes 1½ inches in diameter.

plished during the year amounted to 10,675 feet, of which 9,701 linear feet were in reef, with an average value of 10.07 pennyweights of gold, in a stopping width of 32.89 inches. The ore reserves were recalculated on the first of the year 1912 and gave 1,925,346 tons of ore carrying 6.73 pennyweights over a stopping width of 58 inches. The reduced tonnage is partly due to the elimination of certain low-grade blocks of material about which more information has been gained since the beginning of milling. Recent reports show the lowest level carries 12 pennyweights of gold over a width of 60 inches of reef.

It is interesting to note in the cost of developing and equipping the property an item of £38,644 spent on bore holes, also the original estimated total cost was to be £1,135,700, whilst the cash provided by the issue of shares, interest received, and sundry revenue totaled £1,078,734, or a shortage of £56,956. But the complete equipment cost £1,185,283, or an original underestimation of £49,583. Therefore, it cost to equip the mine £106,548 more than the total sum provided, which is more than balanced by the profits gained up to the end of the year.

The reduction works are situated near No. 2 shaft, as are the machine shops, offices, and staff quarters. The ore leaving the mine is dumped from 5-ton skips on to a 1½-inch grizzly, the undersize going to a fine bin of 1,300 tons capacity, and the oversize to a coarse bin of 1,250 tons capacity. The coarse ore from No. 1 shaft is hauled by a locomotive in 40-ton hopper-bottom cars to a coarse bin, and the fine to a separate fine bin. Five belts convey the coarse ore to the five trommels shown in Fig. 2, where further fine ore is separated and the remainder sprayed with water. It passes to five sorting belts 32 inches wide and 72 feet long, where 16 per cent. waste is picked out and placed on waste belts on either side and sent to the waste dump. Tube-mill pebbles are picked off the discharge end of the sorting belts and thrown into small bins from whence they are trammed to the tube mills. Each sorting belt, together with its waste belt, is driven by a 5-horsepower motor. The trommels and five belts feeding them are driven by a 50-horsepower motor. The remaining ore on the belts is delivered to five Blake-type crushers, each driven by a 50-horsepower motor and having a capacity of 40 tons per hour. At the base of each crusher is the intake of a dust flue connected to an exhaust fan which delivers to a dust chamber outside the building. Space is provided for a sixth unit, consisting of a trommel, sorting belt, and crusher. The crushed ore and fines are conveyed by cross-belts to a main-incline belt 32 inches wide,



FIG. 1. SURFACE PLANT, BRAKPAN MINES, SHOWING SHAFT NO. 2

3,700 feet deep, at which point the reef was intersected. An incline with an average grade of 7½ degrees connects the two shafts underground, and from this six levels are driven off in both directions. Underground haulage in the incline is effected by means of an endless rope.

Electric power purchased from the Victoria Falls and Transvaal Power Co. is used throughout the plant, the 10,000 horsepower taken being distributed in part as follows: Main hoisting engines, 4,500 horsepower; nine pumps, 1,500 horsepower; battery and tube mills, 1,950 horsepower; reduction works, 1,000 horsepower.

The balance is used on the surface and for underground ventilation and haulage. All transmitting cables are paper insulated, lead covered, and armored, upwards of 30,000 feet having been placed underground. To a large extent, they are laid on the ring system, thus preventing serious stoppage due to cable failure, or damage. Power is metered to show the consumption for pumping, hoisting, milling, etc., and also each pair of feeders is separately metered, enabling the supply to different departments to be closely checked.

No. 2 shaft has seven compartments, measuring 42 ft. × 9 ft. over all. It is pro-

*Johannesburg, South Africa.

Tooth clutches are provided for adjustment and also the standard type of liquid starter and automatic overwinding-prevention devices. The post brakes are applied by dead weight, relieved by air-operated cylinders with the ordinary cataract-cylinder attachments. The hoist is direct-connected to a three-phase alternating-current motor. The second hoist, the main dimensions of which are the same as the others, uses direct current, the motor-generator set being located in a subdivision of the hoist room. No. 1 shaft has seven compartments, is equipped with a steel head-frame and a hoist similar to that erected at No. 2 shaft. All three hoists are 1,500 horsepower each and have a capacity of 100 tons per hour from a vertical depth of 3,800 feet. The maximum hoisting speed is 3,500 feet per minute, and the average time for a complete trip is about 2 minutes.

The reduction plant started up toward the end of May, 1911, and up to the first of the year 241,204 tons of ore had been treated, yielding a working profit of £110,977, or 9s. 2.42d. per ton crushed. The ore reserves at the time of starting up the plant were 2,035,108 mine tons, carrying 6.62 pennyweights of gold, with a stopping width of 52 5 inches. According to the annual report, the development accom-

which ascends at an angle of 18 degrees and delivers at right angles on to a shuttle belt which discharges the ore where wanted in the battery bin, holding 6,000 tons.

The battery comprises 160 stamps, 2,000 pounds each, 94 drops per minute, with a 9-inch drop. The following are the details of the stamp parts:

	Diameter Inches	Length Feet. Inches	Weight Pounds
Heads...	9½	42	770
Stems...	4½	14 6	696
Tappets...			232
Shoes...	9½	14	288
Dies...	9½	8	163
Cam-shaft	7½	16 3	

The cam-shaft pulleys are 7 feet in diameter by 22 inches wide, with 21-inch belts.

The mortar boxes are of the open-front type, placed on concrete foundations with anchor bolts accessible for inspection and replacement. Ordinary rubber sheeting is placed between the foundation and mortar box. The foundation also carries cast-iron shoes for the timber kingposts, timber cushions being provided between the shoes and the concrete. Of the 160 stamps, 140 are driven in sets of 10 by 50 horsepower motors placed on the screen floor, and the remaining 20 stamps, 10 at each end of the mill, are driven in sets of five with the idea of enabling broken cam-shafts to be utilized. Tighteners of the rigid type are provided for the battery belts. Twin Challenge feeders serve 140 stamps, the remaining 20 being fed by those of the New Comet type. The mill-water service pipe is 8 inches in diameter and the back of each box is served by two branches, discharging between stamps 1 and 2 and 4 and 5. Four storage tanks 30 feet in diameter by 10 feet and 16 feet deep, mounted on steel lattice framework, having a total capacity of 240,000 gallons, are provided. Each stamp is at present crushing 14 tons per 24 hours through an eight mesh screen, but 20 tons per 24 hours through a three-mesh screen have been crushed. The pulp leaving the mortar boxes passes direct to launders leading to one of two 10-inch coarse-sand pumps driven by a 75-horsepower motor. They have a lift of 45 feet, and when running at 440 revolutions per minute either one can handle 14 tons of pulp per minute. An overflow pit having a capacity of 150 tons is provided.

The elevated pulp is distributed by launders to six Caldecott diaphragm tube-mill cones 6 feet in diameter by 8 feet deep. The underflow from the cones, with added clear water, is fed to six tube mills, each 22 feet long by 5 feet 6 inches in diameter, fitted with patent spiral feeders and lined with rib-type lining made of bar iron set in cement. Tube pebbles are fed by hand, an ammeter indicating when there are enough present, and the tube is driven by a 125-horsepower motor. A portion of the

overflow from the cones joins the product from the tube mills and flows over the amalgamating tables shown in Fig. 3, a group of five being provided for each mill. The 30 tables are stationary, set at an angle of 18 degrees, and are 5 ft. × 12 ft. Each table and the tail-launders are provided with amalgam traps.

The pulp from the tables is elevated by one of two 10-inch fine-sand pumps, driven by a 75-horsepower motor, to a launder placed at an angle of 9 degrees, which delivers it to four primary diaphragm cones 8 feet in diameter by 8 feet deep, which are kept filled with sand. The underflow from the cones is returned with clear water to the two center tube-mill cones by a 10-degree launder. The overflow goes to four

holding about 1 ton and automatically dumped by the Bleichert system of aerial sand haulage from the top of a cantilever 210 feet high, rising at an angle of 32 degrees, and driven by a 75-horsepower motor. Ad. Bleichert & Co. installed this system, shown in Fig. 4, under a guarantee to dump sand at a cost not to exceed 3 cents per ton. The buckets run on a monorail automatically attached to an endless rope and can be dumped at any point on the circuit. The cantilever can be extended when the dump reaches the present top.

In the slime plant there are four cone-bottom slime collectors 65 feet in diameter by 12 feet to 17 feet deep, with a column to start pumping and a hose for cleaning. Three are collecting while the fourth is

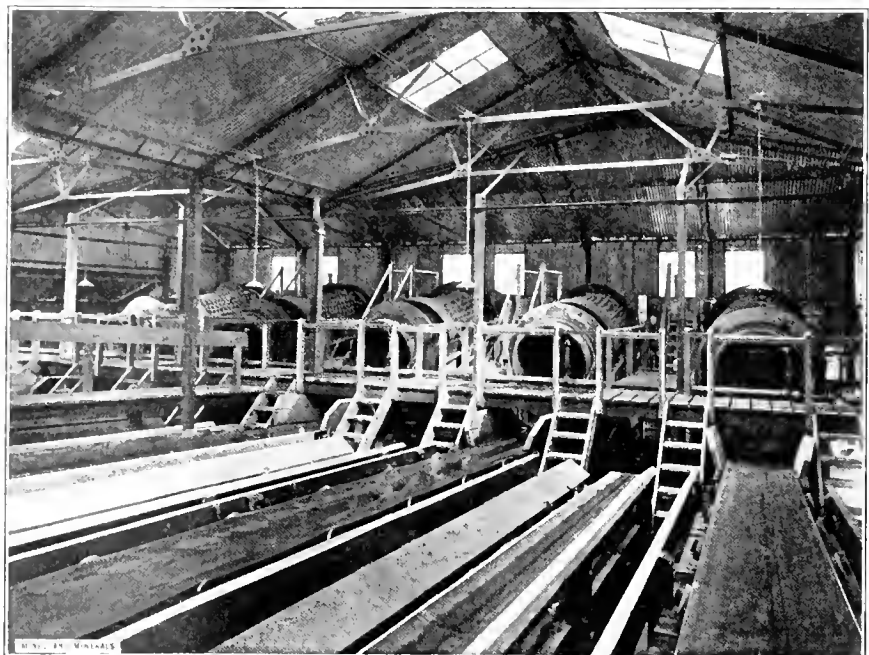

FIG. 2. TROMMELS AND SORTING BELTS

secondary diaphragm cones 8 feet in diameter by 10 feet deep; these are kept filled to within 3 feet of the top with sand. The underflow from the cones with clear water goes to four sand-collecting tanks 60 feet in diameter by 10 feet deep, the pulp discharging to the center by launder and overflow gates at periphery. The overflow from the collecting tanks, together with the overflow from the secondary cones goes to four small cones 5 feet in diameter by 5 feet deep, the underflow of which is returned to the fine-sand pump. Lime is added to the overflow from a ball mill, and it passes to the slime-collecting tanks.

The collected sand is shoveled on to belts and then delivered from a double balanced distributor to eight sand-treatment tanks 60 feet in diameter by 11 feet 3 inches deep, holding 1,180 tons. A 6-day treatment is allowed, the tanks being pumped dry several times by vacuum. The treated sand is discharged by hand into buckets underneath the tank of 22 cubic feet capacity,

being decanted and transferred. The clear-water overflow goes to two cone-bottom water tanks 65 feet in diameter by 6 feet to 11 feet deep, and is pumped to the battery, the excess rising in the mill-water tanks. The slime is transferred with weak solution to six Pachuca tanks, 15 feet in diameter by 45 feet deep, by one of two 12-inch sludge pumps driven by a 100-horsepower motor. The charged pulp contains about 1.25 parts solution to 1 of pulp, and cyanide is added to make the strength of solution equal .02 KCN. It is agitated 4 hours and then transferred to the stock-pulp tank from which it gravitates to the vacuum filter boxes. Thirty to 40 minutes is taken to make a slime cake 1½ inches thick, after which it is washed 30 minutes with barren solution, dropped into a V-shaped concrete sump, agitated with compressed air, and pumped to the dam. The vacuum slime plant consists of two boxes 70 feet long each, having six hoppers. There are 168 filter leaves in each box,

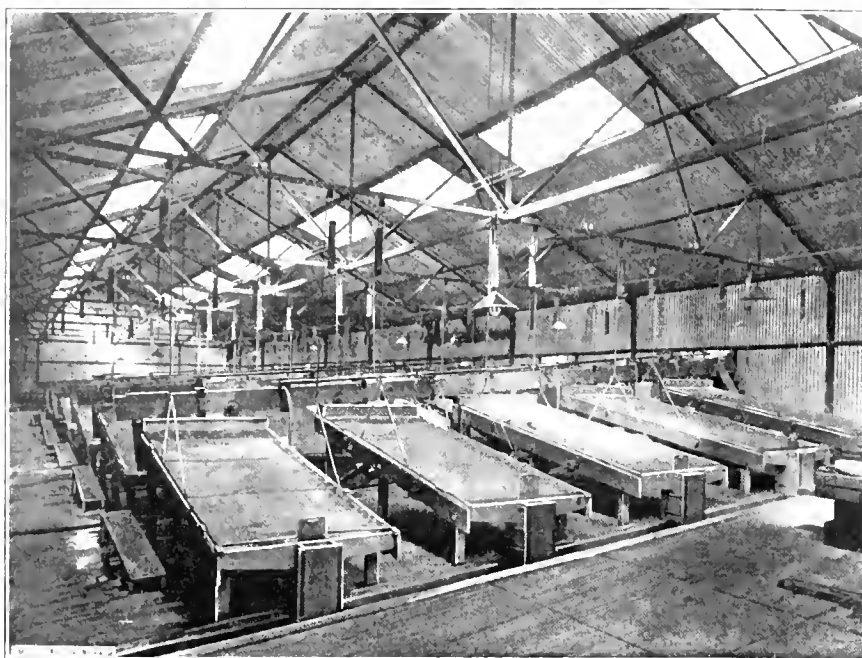

FIG. 3. AMALGAMATING TABLES

each leaf having a filtering area of 80 square feet, or a total area of about 27,000 square feet. The stock pulp tank is provided with a paddle agitator and is 60 feet in diameter by 10 feet deep. The stock-solution tank has the same dimensions and holds 1,000 tons. There are cone bottom excess-pulp and excess-solution tanks each 65 feet in diameter by 6 feet to 11 feet deep, also a weak-solution tank of the same dimensions, and two sand-bottom classifiers, 50 feet in diameter by 8 feet deep taking the solution from the filter leaves. The sump tanks are as follows: One slime gold-solution tank, 65 feet in diameter by 6 feet deep; three sand gold-solution tanks, 50 feet in diameter by 6 feet deep; one slime barren-solution tank, 20 feet in diameter by 8 feet deep; two sand barren-solution tanks, 60 feet in diameter by 10 feet deep; and another one 65 feet in diameter by 6 feet deep.

For precipitation, weighed amounts of zinc in proportion to the amount of solution to be precipitated are fed by three belts, with barren solution, to the suction of three triplex pumps driven by 10-horsepower motors and then to three 52-inch Merrill presses, capacity 1,000 tons of solution per day each, the precipitated solution passing to the barren solution sumps. The Merrill presses are situated in the extractor house, along with the amalgamating plates and refining furnaces, enabling all the gold-recovery processes to take place under one roof under the supervision of one operating staff.

A small elevator is provided to raise the gold slime to the acid tank, which, after being acid treated is collected in a small filter press. There is a reverberatory furnace holding 20 No. 100 pots, a drying oven for eight 3' x 2' x 6" pans, a ball mill for

grinding slag, etc., three amalgamating barrels for black sand, with batea, amalgamating plates, and settling tanks, two $\frac{1}{2}$ -inch amalgam presses, and two amalgam retorts.

Space has been provided for the addition of 40 stamps, four tube mills, the necessary amalgamating plates, and cyanide tanks. The plant was designed for 60,000 tons a month, but recent experience has shown that the capacity of the battery was underestimated.

The returns for the month of May, 1912, show that 130 stamps and six tube mills crushed 53,650 tons of ore, yielding 20,821 ounces of gold valued at £88,442, giving a working profit of £40,317, at a cost of 17s. 11d. per ton treated.

The Smoke Problem

In the fall of 1911 the Department of Industrial Research of the University of Pittsburg was provided by a Pittsburg business man with funds for a thorough investigation of the smoke nuisance. At the present time the investigation is being conducted by a staff of 25 specialists, of which seven are giving their entire attention to this task. Some of these men are studying the effect of smoke and soot on the atmosphere, on the weather, on plant life, on buildings, on the public health; some are investigating the economic damage done by smoke and soot; others are making a detailed study of the mechanical devices for preventing or abating smoke; and still others are inquiring into the chemistry and physics of smoke and soot, into the laws concerning the smoke nuisance, and into the history of the subject as a whole.

Recognizing the interest in the smoke problem manifested by a large number of American cities, and in response to inquiries that have been made, the Department announces that the members of its staff are prepared to lecture on the following phases of this problem:

1. The Smoke Nuisance (A general presentation of the subject.)
2. Smoke and the Public Health.
3. Smoke and the Cost of Living.
4. Smoke and Plant Life.
5. Methods and Means of Smoke Abatement.
6. The Effect of Smoke on Buildings and Building Materials.
7. The Psychology of Smoke.
8. The Smoke Nuisance and the Housekeeper.

For further particulars apply to Dr. R. C. Benner, Department of Industrial Research, University of Pittsburg, Pittsburg.

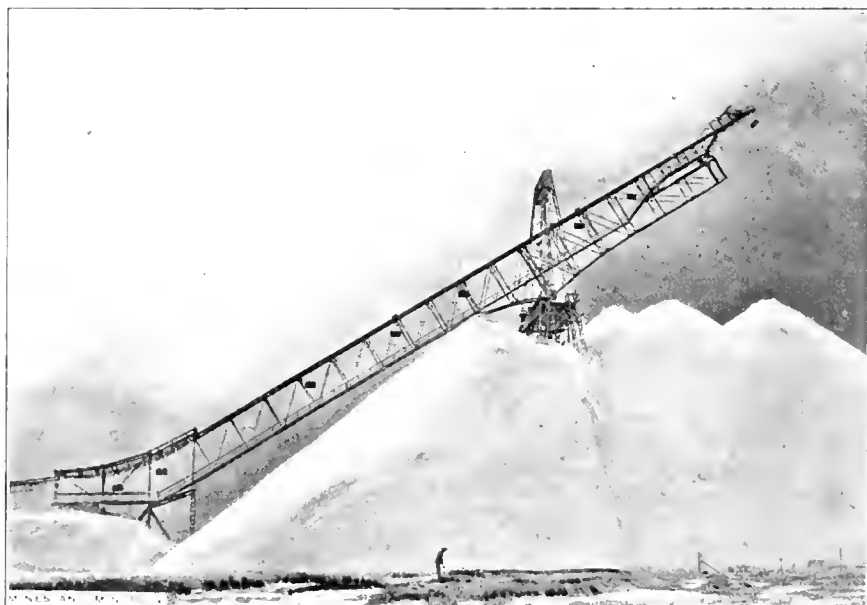

FIG. 4. AERIAL SAND DUMP

Shaft Upraising Profitable

Driving a Raise to Surface by Use of a Swinging Platform Hanging from a Cable Through a Bore Hole

By Lucius L. Wittich

BOTH in point of time and money a great saving was accomplished at the property of the Nowata Lead and Zinc Co. at Duenweg, Mo., when

a new shaft was made by driving an upraise to the surface. H. Correll, manager of the company, undertook the work of upraising on his own responsibility after having received bids for sinking the shaft by contract. The lowest contract bid received was \$15.50 per foot, for a shaft 5 ft. x 7 ft. in the clear, put down to a depth of 210 feet. This would have meant an expenditure of \$3,255, to say nothing of the greater time required. Although the upraising was purely an experiment, the first instance of the kind in the Missouri-Kansas-Oklahoma district, and although many unforeseen difficulties arose which can be remedied in subsequent operations of a similar nature, the aggregate cost of upraising the shaft was only \$1,273.58, or \$6.06 per foot. This saving of \$1,981.42 has convinced the company that where it is possible to start at the bottom, that is the wise course to pursue. The company has started a second upraise for a shaft, and it is safe to prophesy that the cost figures will show a still greater saving.

The existence of a 6-inch drill hole at a point where his company desired to sink a new shaft caused Mr. Correll to consider the advisability of using the hole as a medium through which a cable could be passed, to support a working platform at the lower end. Fig. 1 shows the plan adopted in upraising the shaft. At the top, near the drill hole opening, was stationed a hoister, which was operated so little of the time that an expenditure of 50 cents a day for natural gas for fuel defrayed the cost. As this was a minimum flat rate it was in excess of what would have been charged had only the gas really used been paid for. The drill hole extended into the drifts of the mine, the distance from the surface to the roof of the drift where the drill broke through being 210 feet. Through the drill hole was lowered a 5/8-inch cable, which passed over a pulley in a derrick and thence to the hoister.

At the lower end, the cable was attached to a specially constructed platform, built of 2" x 4" and 4" x 4" oak lumber, the size of the platform being 4 ft. 8 in. x 6 ft. 8 in., thus leaving 2 inches in the clear, all around, when the platform was hoisted into the upraise. The aggregate weight of the platform, operators, and equipment was 800 pounds, divided as follows: stoping drill, 110 pounds; steel, 50 pounds; two operators, 300 pounds; platform, 340 pounds.

Starting the shaft in the roof of the

drift was much the same as starting it in solid ground at the surface. The 5' x 7' space was marked out, with the drill hole as its center, and the work of shooting

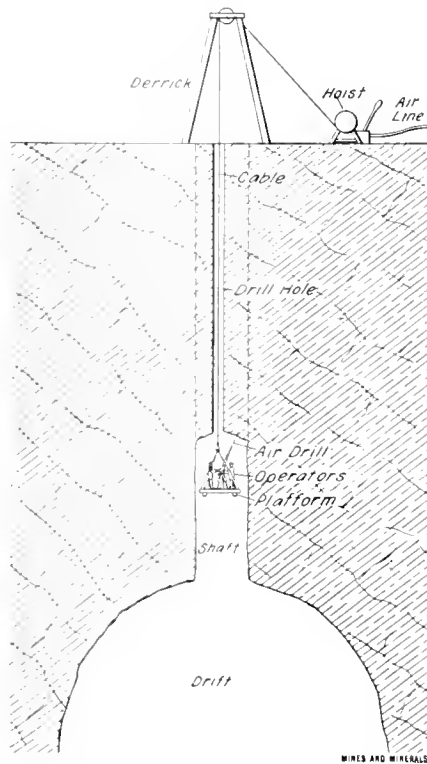

FIG. 1. METHOD OF UPRISING

down the rock started. The platform was supported by four iron bars, fastened at the corners of the platform, and meeting at a point above the center, high enough

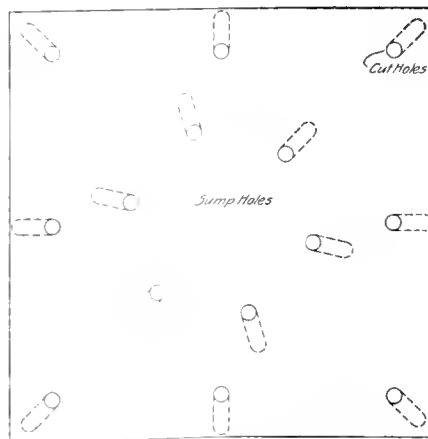

FIG. 2

to permit the operators to work freely. A hook permitted the cable to be detached from the platform; thus when shots were fired the platform was lowered

to the floor of the drift and pulled to a point of safety to be out of the way of falling rock, while the detachable cable was hoisted up the drill hole in order

that it might not be damaged by the blast.

From the time the first round of shots was placed in the roof of the upraise until the shaft was completed, cribbing being included, fifty-two 8-hour shifts were required. This was about a third of the time usually required for sinking a shaft of similar dimensions. The cribbing was installed from the bottom up.

In upraising, 14 holes were driven to a depth of 5 feet in the roof, as shown in Fig. 2. Six of these corresponded to the ordinary sump holes used in sinking a shaft from the top down, while eight corresponded to the cut holes, four of these being driven near the corners and four along the edges, midway between the corner holes. Each hole was loaded with four sticks of dynamite, a total of 56 sticks for one charge. Forty-per-cent. dynamite was used. During the upraising of the first 100 feet the shots were fired from below, the electrical shot firer being stationed in a drift. During the remainder of the work, the shots were fired from the surface. A signal cord down the drill hole enabled the operators to signal to the hoisting engineer.

The 18 feet of surface soil was shot down at a single blast, the drill hole being plugged at the bottom and loaded with dynamite. The result of the blast was an opening more than large enough to accommodate an ordinary mine bucket, and in this bucket workmen were lowered and the edges blasted out and trimmed. It was this final step that Mr. Correll considers his one big mistake. He believes matters could have been expedited by first sinking from the surface down to the hard limestone, then beginning the upraise. As it was, an enormous mass of surface dirt was shot into the drifts when the surface was blasted down, and this became a sticky mass following a heavy rain. It was almost impossible to remove it, and as a result much valuable time was lost. The surface caved, also, to some extent, but heavy concrete walls were built down to the limestone, thus making it secure.

The upraising method has many advantages over the former methods of shaft excavating employed in the district. Ordinarily in shaft sinking the necessity of removing the pumps before each blast, or the necessity of at least covering them with heavy timbers, is of greatest importance. Repairs are constantly being made to the pumps as the result of damage from the shots. Water is invariably

rising in the sump and the workmen have an unsanitary place in which to toil. As virtually all of the larger mines of the district frequently used from one to half a dozen extra shafts, exclusive of the mill shaft, and as the underground workings usually connect, the possibility of making an upraise is found on every hand.

The cost item of \$1,273.58 includes the fuel, wages, powder, timbering, every feature in fact of the work; it even includes the purchase price of the stope drill, \$135. However, it does not include the cost of sinking the 6-inch drill hole, which was already at hand. If it had been necessary to sink such a hole, the added cost would have been 80 cents per foot, including the casing, meaning a total of \$168 to be added to the figures already given. Many mines, however, have their drill holes already sunk, that can be used as was the one at the Nowata company.

At all times the ventilation was good, as the fumes quickly lifted through the drill hole. In this respect the method is even better than the methods of upraising employed in many of the western mines, where pens are built to hold the working platforms. In such cases, the air may become foul at the highest point of operation.

采 采

Concentration at the Butte and Superior Mill

The following description of the very interesting practice being conducted in the new mill at the Black Rock mine, north of Butte, Mont., was written by Prof. George W. Schneider, of the Colorado School of Mines, after a recent visit to this plant, and was published in the *Rocky Mountain News*, Denver, Colo.

What may be considered the last word in zinc concentration is the new Butte and Superior mill, at Butte, built for the treatment of the zinc ores which are the principal product of the Butte and Superior Co. operating the Black Rock property in North Butte. The ore is practically a clear zinc sulphide, with little or no iron sulphide, a little galena, and some rhodochrosite (carbonate of manganese), occurring in the Butte granite. A simple problem presents itself so far as a separation is concerned, as the usually troublesome iron sulphides are conspicuous by their absence. But the point to be desired, and which has been obtained, is the recovery of a large percentage of the zinc from the gangue material. The ore fed carries about 23.3 per cent. of zinc, the concentrate, 51.4 per cent., and the tailing 3.2 per cent., indicating a 91-per-cent. recovery, which is expected to be increased.

The following is a brief description of

the treatment: The ore is hoisted and dumped from mine cars (to be replaced later by skips) to ore bins, thence to 18" x 30" Blake crusher for preliminary crushing—thence by belt conveyer to 500-ton circular steel bin, thence to two apron feeders over Berthlett screens, 1½-inch mesh, to two gyratory crushers. Thence over Berthlett screens to two sets of 20" x 54" rolls set to one-half inch, and thence on belt conveyer to 1,500-ton bin at head of mill. The preliminary crushing is done in a building at the shaft, and the gyratory and roll crushing is done in a separate building located between the shaft and mill building and connected with same by belt conveyer.

The main mill bin discharges to apron feeders thence to 10-millimeter impact screens—thence to No. 1 elevator, the oversize going to 16" x 42" rolls, to No. 1 elevator to 5-millimeter impact screen, after which water is added and the product sent to first set of Janney classifiers, the oversize going to second set of rolls, thence back to No. 1 elevator. The products from the Janney classifiers go to the coarse jigs, the side draw from the same going direct to mineral bin, hutch product to cleaner jigs, and the tail to 6-foot Akron Chilian mill reducing to one-half millimeter, then to second set Janney classifiers, the product from which goes to sand jigs giving a hutch product which goes to No. 5 elevator to No. 3 Janney classifiers to the cleaner jig, and the tail which goes to 4½' x 20' tube mill. The cleaner jigs make a first hutch product going to 16" x 30" rolls to No. 4 Janney classifier, to Wilfley table, making a lead product which goes to lead bin and a zinc product which goes to zinc bin. No tail is made by the Wilfley. Nos. 2 and 3 hutch products from the cleaner jigs go direct to mineral bin. Tailing from cleaner jig goes to 5-foot Huntington mill, screen 4.5 millimeters, thence to No. 5 elevator and returns to cleaner jigs, making a closed circuit for this product.

The tube mill product goes to mill sump, from which it is raised by two pumps to Dorr classifiers, and the slime going to settling tanks, together with slimes from all the Janney classifiers. Sands are returned to tube mill for further grinding, the fineness required being 150 mesh.

To the settling tanks is added about 8 ounces of copper for each 1,000 gallons of pulp, which, when made slightly acid with sulphuric acid (one-quarter to one-half pound per ton of ore) gives a crystal water and a four to one pulp in about 2 hours. It is this last pulp which is given the oil-flotation treatment, and consists in running same to a chamber where it is heated to 40 degrees centigrade with live steam. Oil commonly known as "candle maker's red oil" is then added in

the proportion of about 1 pound per ton of ore. The steam in heating the sulphide expands the gas bubbles, and facilitates the coating of the sulphide particles with the oil. The rhodochrosite in the ore is sufficient to supply the necessary carbon dioxide needed for its flotation. After emulsifying, the product is pumped to the first treatment tank where the entire mass is agitated. A float concentrate is then taken off from the top of the tank and the remaining pulp goes to the second treatment tank where the process is repeated, and thence to the third tank where the pulp is again agitated and the third concentrate taken off. From the third tank the pulp discharge is a final tailing. There is considerable silica mixed with the first concentrates, so they are all cleaned in a second set of tanks, the concentrates from which are the final product, while the tailing is sent back to the first treatment tank for further treatment. The zinc concentrate is shipped to the zinc smelters of Oklahoma and Ohio.

The above treatment was determined upon only after a long series of experiments, starting on a small scale and finally resulting in the renting of the plant of the United Copper Co. at Basin, some 30 miles distant, which was fitted up for the commercial treatment of several thousand tons of ore along the lines here considered. The oil-flotation end of the plant, which is a slime treatment for sulphides, largely employed at the present time in Australia, was worked out by James M. Hyde after experience in that locality.

The new mill has a capacity of 1,000 tons for 24 hours, the size of the main building being 94 ft. x 332 ft. Electric power is used, 1,000 horsepower being required. A new departure is afforded in the operation of all the large shaft clutches which are controlled by compressed air, and 250 gallons of water are required for each ton of ore.

All of the primary concentration is effected by well-known methods, the best standard machinery being employed. The oil flotation, as stated above, is not new, so that no new or radical departures have been adopted, but a sound conservative employment of the best and most recent successful methods to the solution of the problem at hand.

采 采

Antimony

Antimonial ores carrying gold and silver are difficult to treat, for the reason that roasting is usually required, and the fact that antimony fuses at a comparatively low temperature renders this difficult. Successful roasting of antimonial ores can be accomplished by treating the ore several times at moderate heat between 400° and 700° F. This gradually volatilizes the antimony and sulphur.

Churn Drill Examination of Placers

Forms of Keeping Records—Cost of Drilling—Remedies for Drilling Troubles—Sources of Error

By James E. Dick, E. M.*
(Concluded from September)

THE object of recording is to keep a section of each hole so that, later, when the series of holes is completed, the strata—gold bearing, cemented, clayey, or otherwise—of each hole may be correlated with those strata of the other holes. Things which may not appear to be of importance in the record of an individual hole, may, when read from the accumulated records of all the holes, have considerable bearing.

the superintendent is not required to be continually about the machine. The time record tells whether or not the work is moving along at a proper rate. But, aside from this advantage, the time record has very little in its favor.

and the formations and the gold by the panner. It will be noticed that the sizes of the gold "colors" are recorded by numbers. This is a method used considerably in California, where the meaning of the sizes is generally known. However, it is not advisable to use it generally, as it means nothing to those who are not familiar with the ground or to those for whom the information may be obtained. By using "nuggets," "colors," "dust," and "flour," the records will be better understood, and more easily explained.

Under the heading "formations," are seen such symbols as *L*, *C*, *St*, etc. These are abbreviations and, properly, a key should be printed on the bottom of the record blanks as follows: *C*=coarse; *S*=sand; *Md*=medium; *G*=gravel; *St*=sticky; *M*=much; *Cl*=clay; *F*=fine; *Li*=little; *L*=loose; *V*=very; *Sm*=some.

It is also advisable to use a key at the bottom of the drill man's record as follows: *P*=pipe; *Pul*=pulling; *Pmp*=pumping; *T*=times; *Be*=began; *Stp*=stopped; *drv*=drive; *D*=drilled.

The third sheet in Set 2 is a summing up in condensed form of the calculated results and all other information obtained from each hole. It constitutes a report on the hole.

Set No. 3 contains no record of the time consumed in the various operations, and when such time record is not desired, this makes an ideal set. The manner of keeping the core permits an accurate record of the amount of material taken out. In the case of running ground, the actual length of core and not the depth of hole is used in calculating the value for the hole.

Sometimes it may be better to have the panner keep the record of the formations, and, if so, the headings may be shifted from the drill man's to the panner's sheet. It is best, however, to have this record kept by

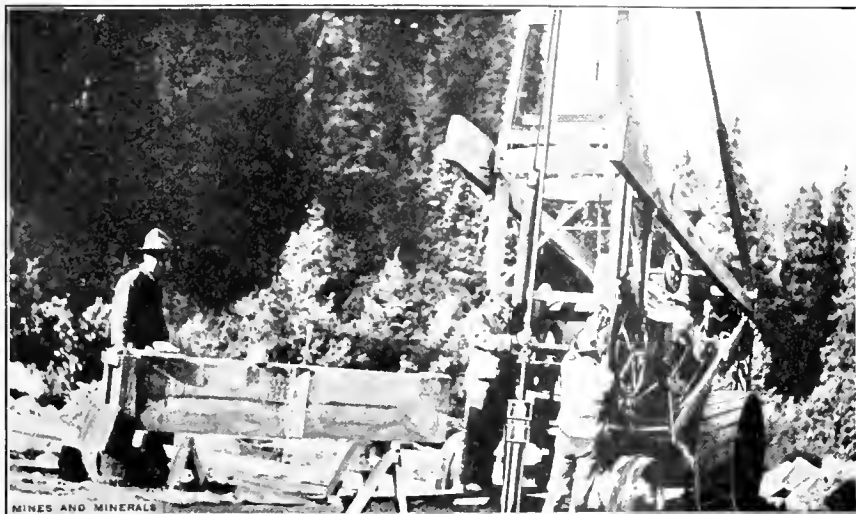

FIG. 5. HOISTING THE TOOLS

The vertical distribution of the gold (i. e., the horizons of the pay streak or pay streaks); the zones of cemented gravel (false bed rock) or of clays; or the thicknesses of beds of coarse and fine gravel, are all determined from the records. From these same rocks, the contour of the bed rock and the course of the channel may be plotted into comprehensive maps and sections.

In addition to the records of the holes, it is often desirable to keep time records in order to determine the amount of time consumed in each operation, and thus assist in working out cost sheets.

The record of a hole usually consists of a set of sheets—often two and sometimes three. The drill man always keeps a record. In the case of a two-sheet record, the panner also keeps one; and when three sheets are used, one is prepared by the rocker. The accompanying are different types of records that have been used. The type for each individual case will depend upon the nature of the ground and the desire of the operator.

Set No. 1 is the usual type of record. One sheet is kept by the drill man, and the other by the panner. The drill man records the time consumed in each operation, while the panner records the results of his panning, together with the formations encountered and the depths. This kind of record has its main advantage in that

Sometimes a single sheet, like the "Panner's Record," Sheet 2, is used. The drill man records the depths and formations, and the panner fills in the heading under "gold." The third sheet of the set is merely a summing up of the results of all the holes. In this set, the drill man's sheet and the right-hand side of the panner's sheet are kept by using lines as indicated.

Set No. 2 shows a very thorough and convenient type of record. Like Set No. 1, the time sheet is kept by the drill man,

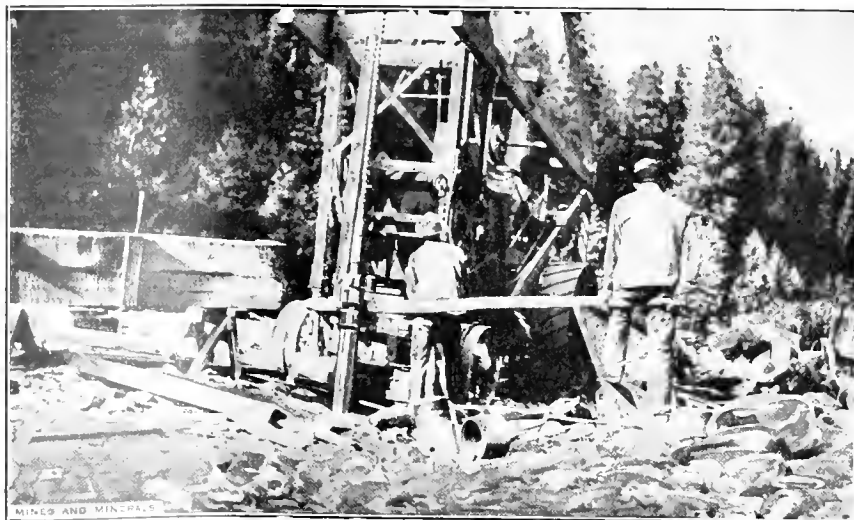

FIG. 6. STRAIGHTENING THE CASING

* Akron, Ohio

both men for, in this way, each will act as a check on the other.

Cost of Drilling.—The cost of churn drilling naturally varies between wide limits, and will depend on the following factors: Price of labor—skilled and unskilled; price of fuel; accessibility to a base of supplies; coarseness of gravel; compactness of gravel; depth of gravel; climate—arid or wet; ease or difficulty of moving machine.

Perhaps the most suitable conditions for this drilling are in California, while the most difficult conditions are probably in Alaska and South America. In California, all of the above conditions are favorable; but in Alaska they are all unfavorable, except, perhaps, the items of coarseness, compactness, and depth, which are liable to vary even within a single locality. In southern countries, where the rainfall is heavy, great difficulty may be experienced in moving a machine because of the soft and swampy soil. This adversity applies also in many sections of Alaska, where the drill must be moved over the "tundra," or soft swampy overburden of decomposed moss and vegetable matter. In some cases, the time consumed in moving a machine is twice or thrice as long as that required in sinking a hole, and consequently, such a condition materially increases the cost of drilling.

If the country is arid, water for drilling may have to be hauled long distances. If the country is wet, high water may interfere with the work. If a deposit is coarse and compact, the speed of drilling is slow with the cost correspondingly great. If a base of supplies is not within reasonable distance, or if the cost of fuel is excessive, the cost of drilling is high.

The following are actual costs of drilling per day in different states:

CALIFORNIA	
Machine man.....	\$3.00
Panner.....	3.00
Fireman.....	2.50
Roustabout and team.....	\$ 4.00 to 5.00
Superintendent.....	3.00 to 7.00
Wood.....	3.00 to 5.00
Repairs.....	3.00
Rental of machine.....	5.00
Total.....	\$27.00 to \$33.00

COLORADO	
Machine man.....	\$ 5.00
Panner.....	3.00
Helper.....	3.00
Team.....	\$ 2.50 to 5.00
Superintendent.....	3.00 to 7.00
Fuel.....	1.25 to 5.25
Repairs.....	1.00 to 2.00
Rental of machine.....	5.00
Total.....	\$23.75 to \$35.25

ALASKA	
Machine man.....	\$ 5.00
Panner.....	\$ 3.00 to 4.00
Fireman.....	3.00 to 4.00
Helper.....	3.00 to 4.00
Team.....	7.00 to 10.00
Superintendent.....	7.00
Wood.....	4.00 to 5.00
Repairs.....	3.00
Rental.....	7.00
Total.....	\$42.00 to \$49.00

These figures are the operating costs per day rather than the cost of drilling (as usually expressed) per foot drilled; and they may vary greatly even within a given

district. It is evident that, if a drill is making but 10 feet per day, the cost per foot will be three times as much as when it is making 30 feet each day. However, in California, the deposits are pretty uniform, and the average cost of drilling per foot is about \$2.50. This means that the rate of drilling is 11 to 14 feet per day. The cost in the Breckenridge district of Colorado will average about as in California. In the interior of Alaska, the costs are about \$3.50 or \$4 per foot, while along

ground. In many districts, it is hard to get men who are willing to work in this fashion.

DRILLING TROUBLES AND THEIR REMEDIES

The difficulties encountered in drilling vary in number and magnitude with the character of the ground. Coarse and deep gravels present the greatest troubles, which arise from the difficulty in driving casing and in keeping the casing straight.

When the casing becomes crooked before the hole reaches a depth of 15 to 20 feet,

SET NO. 1

Sheet 1.

Exploration or Property: _____

Daily Record on Hole No. _____

Date, _____

Diam. of Shoe, _____

Name of Machine, _____ Size, _____

Name of Drill Runner, _____

Name of Helper, _____

Time	Drilling	Driving	Pumping	Pulling	Moving	Repairing	Depth

Sheet 2.

Panners Record of Drill Hole No. _____

Date, _____

Depth of Hole	Gold				Formation				
	Nuggets	Colors	Dust	Flour	Loam	Sand	Gravel	Rocks	Bedrock

Sheet 3.

Record of Drill Holes on Claim _____

No. of Hole	Time	Bedrock			Gold			Valuation			
		Yes or No.	Depth	Formation	Nuggets	Colors	Dust	Flour	Weight Gold	Value Gold	Value Cu. Yd.

the coast, the costs vary between \$4 and \$8 per foot. This difference between costs in Alaskan districts is explained in the fact that the streams of the coast regions are rapid and consequently have coarse deposits; whereas, the streams of the interior districts have opposite characteristics.

Also, the coast placers are often more isolated and actually more difficult of access.

The division of labor has considerable bearing on the cost of drilling. The most ideal conditions exist when the superintendent does the panning and the helper does the fring. This is impracticable in some cases on account of the extra amount of work caused during the drilling of hard

it is usually an easy matter to straighten it, either by driving wedges alongside of it or by bringing slight pressure against it in some other way. But when greater depths are reached, it is not an easy matter to get the casing back into alinement. The following method will often prove a remedy: Have a long, straight pole, and a sling made of a 6-foot piece of manila rope, doubled. By the use of these, leverage may be had against the casing in any desired direction. Figs. 1 and 6 show the method of using the lever without the sling. This is done while driving, and the helper operates the pole, throwing his weight against it. If the drive head is near the ground, the method shown in Fig. 6 is best. The leverage is obtained

Sheet 1. SET NO. 2
DRILL RECORD

No. of Hole, 10 _____ In. Runner _____

Time		Nature of Work	Pipe		Pump		Core		Remarks
Hrs.	Min.		Ft.	In.	Ft.	In.	Ft.	In.	
1	15	Arrived Hole 10.							Nov. 11
1	30	Put on pipe....							
1	32	Begun drive.....							
1	12	Stopped drive.....	7	0					

Sheet 2. FIELD LOG

No. of Hole _____

Date Commenced _____ Date Finished _____

Depth		No. of Colors			Formation	Core		Remarks
Ft.	In.	Size	Size	Size		Ft.	In.	
3	1				S. C. L.....	3	11	All gold flat
4				3	M. L. F.....	3		
4	10			3	St. Ch.....	2	2	
5	8	1	2		S.....	1	1	
6								

Sheet 3. PROSPECTING LOG-BOOK

No. of Hole _____ Date _____

Contract or Option _____

Tract or Claim _____

ft. Prospected _____

Employees

Name	Occupation
	Panner
	Drillman
	Helper
	Fireman
	Laborer

Description

ft.	Size of shaft _____
	Weight of gold _____
	Value of gold _____
	Value per cu. yd. _____
5	Cubic ft. in Test _____
	Water level _____
10	Total depth _____
	Bedrock _____
	Location _____
15	Remarks _____

20	_____

25	_____

	Total _____
	Prospector _____

with crowbars. The sling is used when a pressure is desired in such a direction as cannot be obtained with the pole alone. It is fastened to the machine frame and over the end of the pole. The direction of pressure can be adjusted and the length of the rope may be changed by looping it over the end of the pole as many times as necessary.

Occasionally, the casing may be straightened when crooked by turning it half-way around with the heavy chain tongs. When this is done, care should be taken to turn in the direction of screw-threading on the casing. This method seems to be most successful when the entire string of casing is bent throughout; that is, not merely at one or two of the joints, but a little at each joint. The exact condition of the casing can be seen by throwing a light down into it with a mirror, after the water has been pumped out, and by noticing just where the bend is. The cause of the trouble itself can often be discovered in this way. For instance, if the last one or two joints are the only ones at which the bending occurs, this might indicate that the casing has been deflected by the sloping side of a large boulder. In such a case, it will be well to pull up until the casing is again straight and to then drill ahead of the casing.

If the casing has a tendency to dip directly away from the front of the machine, this can be remedied by the simple method of placing a 2" x 6" piece of wood of proper length between the casing and the blocks upon which the jack-screws set.

When the casing cannot be driven, it is usually because the shoe is on a boulder or perhaps is wedged between boulders. In either case, it will be necessary to drill with the rock bit ahead of the casing, and clear the way for it. If the boulder is of extreme thickness or toughness, blasting is resorted to. The casing must be pulled up a couple of feet and all the water pumped out before shooting. When the cause of hard driving is tight ground rather than boulders, the speed of the work will be increased by turning the casing around a few times with the chain tongs. This also applies to hard pulling.

Sources of Error.—The sources of error in sampling by this method are numerous and difficult to determine. However, with a thorough knowledge of them and their causes, they can usually be avoided.

The greatest source of error is getting too large or too small a sample. Evidently if the sample is too large the content will be high, while if it is too small, the content will be correspondingly low. The length of core left in the casing after pumping should be such as to prevent an inrush of water. If the water does rush in from hydrostatic pressure on the outside, some gold may be carried from the surrounding ground and the sample will show a value in excess of the truth. Therefore, when possible, the level of water in the casing

THE SOLUTION MAN.—The solutions as

well as the leaching vats and zinc boxes are in charge of the solution man who acts under the general direction of the mill superintendent or chemist. His shift is either 8 or 12 hours, according to the custom of the camp, and he is not permitted to leave the mill until relieved by the next shift. As soon as practicable after coming on shift he should go over the whole department to ascertain the exact conditions of affairs, particularly noting whether valves have been left open or otherwise misplaced. At the end of the shift he should report to the man relieving him any unusual circumstances or conditions. A card is usually kept showing the stage of progress of each leaching vat and where leaching to, but he should check the correctness of these records by actual observation. He makes titrations of such solutions as are required for his guidance in performing his duties and is expected to keep the standard solution to the proper strength by the addition of cyanide. Should he find any abnormal change in the amount of protective alkali in the solution at any part of the mill he will at once report his discovery to the proper authority. He will keep his solution pumps in order except when needing extraordinary repairs, carefully avoid overflows of solution, see that the vats are properly filled and discharged, and in a mill of moderate capacity is expected to do all the work in the leaching and precipitation departments. The work of packing the zinc boxes is generally done only during the day shift. He assists with the clean-up which generally occurs at the first and middle of each month. If he be active, faithful, and intelligent he he earns better wages than the average workman about a mill. The position is a good post-graduate school for a man having the necessary theoretical knowledge and desirous of fitting himself to take charge of a mill. While there is plenty of hard labor for the solution man to do, he should not always be required to "keep busy" as is the rule with laborers. The superintendent in making his rounds of the mill should be well satisfied if he finds everything in good order, even though he should find his solution man sitting down and calmly surveying the flow of the solutions. But when a good solution man begins any task he moves as if he meant to "do it now."

Standardizing the Solution.—The telltale boards of the solution tanks are graduated in tons. If not, a properly graduated board should be put up either at the side or in place of the old one. Table 1 gives

*Boulder, Colo. Article began in August, 1912, number.

Practical Cyaniding—Part 3

Mill Solutions and Leaching—Standardizing Solutions—Electric Current—Mill Treatment of Ores

By John Randall*

the depth of 1 ton of water in tanks of even sizes from 8 to 32 feet in diameter.

Observe by the telltale board the number

TABLE 1.—DEPTH OF 1 TON OF WATER IN CIRCULAR TANKS, THE VOLUME OF 1 TON OF WATER BEING TAKEN AT 32 CUBIC FEET

Diameter in Feet	Area in Square Feet	Depth of Water in Feet
8	50.27	.636
10	78.54	.408
12	113.10	.282
14	153.94	.208
16	201.06	.159
18	254.47	.126
20	314.16	.102
22	380.13	.084
24	452.39	.071
26	530.93	.060
28	615.75	.052
30	706.86	.045
32	804.25	.040

of tons of solution to be standardized, and by a titration of the solution observe how many tenths of a pound the solution is below the standard. As this amount is required to be added to each ton, the total amount of cyanide required is found by multiplying this amount by the number of tons.

EXAMPLE—There are 80 tons of solution to be standardized and the solution is found to be .2 of a pound below standard. $80 \times .2 = 16$. the number of pounds of cyanide required

As the cyanide is very poisonous it should be handled in a manner involving as little risk as possible. Convenience is also a prime requisite, as the solution man generally has plenty to do. The dissolving box, a wooden box with holes in its bottom, is located over the sump and just below the floor of the precipitating room. The stream of solution continually entering the sump passes through this box. A case of cyanide is brought around and laid on its side. The boards are ripped from the side uppermost and the tin cut around three sides. Lumps of cyanide too large to handle with a miner's shovel are broken with an ax or pick. The amount of cyanide that the dissolving box will hold is known. If it will hold 30 pounds the 16 pounds required in the example is shoveled in, filling it to about half full. The shovel is put back in the opened case of cyanide and never used for any other purpose. The solution man then starts the pump and goes about other work. As in the example noted it would require 8 pounds of cyanide to change the titre of the solution a single point, it will be seen that weighing the cyanide is a needless refinement.

Introducing Oxygen Into Cyanide Solutions.—Air or even pure oxygen in the form

of bubbles mixed with a solution has no effect upon it unless actually absorbed (i. e., dissolved) by the solution. High temperature and the presence of dissolved solids re-

duce the amount of gases a liquid will absorb. Agitation under pressure promotes such absorption.

A theoretically correct method of introducing atmospheric oxygen would require the absorption of all the air admitted to the solution. In this case the amount of air admitted need not be large.

A reciprocating solution pump running sufficiently fast to cause a little water hammer in the pipes is extremely efficient, provided a little air is admitted at some point in the tail pipe. If the opening in the tail-pipe for drawing in the air is small it will not interfere with the pump in picking up its load on starting. The small quantity of finely divided air thus admitted to the solution and the enormous rise in pressure caused by the stroke at the instant of impact promotes the absorption of the air. Aerating solutions by means of a centrifugal pump with a small inlet at the intake is efficient, and less objectionable than the foregoing from a mechanical standpoint. Raising solutions by means of the air lift is efficient, but would convert caustic lime into carbonate of lime on account of the comparatively large amount of air used and the carbon dioxide it contains.

Showering the solution into the storage tank in the form of a spray, particularly if allowed to fall from a considerable height, is helpful but is open to the same objection as the air lift.

Chemical oxidizers are little used as they are expensive and consume cyanide to some extent. Litharge, PbO , is used with good commercial results in treating some ores which give rise to large amounts of alkaline sulphides in the solution. The lead parts with its oxygen and locks up sulphur by forming the practically insoluble sulphate.

Electric Current.—A method of destroying some reducing agents in a cyanide solution is by passing through it an alternating electric current. The 60-cycle current supplied to many mills as a source of power is said to answer the purpose, but its cost might place it at a disadvantage unless the mining company has its own hydroelectric plant with current to spare. This method is used in a few special cases, but its success depends upon the nature of the reducing agents in the solution. Its efficiency should be determined by laboratory experiment on the mill solution before the apparatus is installed. The alternating current has no effect upon alkaline sulphides, hydrogen sulphide, or ferrocyanides, when added to a laboratory solution. The operator desiring to use this method could suspend in the barren sump

two or more $\frac{1}{2}$ -inch lead pipes with the bottom ends closed to serve as electrodes, their distance apart to be somewhat greater than half the diameter of the sump. If the sump tank is of wood the electrodes might be placed quite close to opposite sides. The electrodes should be attached to the 110-volt lighting circuit by means of insulated wires controlled by a switch. The resistance of the circuit should be approximately determined before the current is turned on and the probable amperage of the current thus estimated. The current will be found to pervade the entire volume of solution in the tank. A better plan than using the current direct from the lighting circuit would probably be to step the current down to about 10 volts by means of a transformer and correspondingly increase the size of the electrodes, making them of heavy sheet lead.

The cyanide chemist should use every means at his disposal to keep reducing agents in his mill solution down to a reasonably low limit.

Mill Treatment of Ore.—The treatment as well as the kind of mill required for a given ore depends upon the facts brought out in the laboratory tests. If there is much ground for doubt, these tests should be verified by sending a quantity of the ore to a custom mill before the construction of a mill is decided.

While varying widely in detail, all ore treatment by the cyanide process must of necessity consist of the following steps:

- (a) Crushing or grinding.
- (b) Leaching or agitating with cyanide solution, in order to dissolve the precious metals.
- (c) Washing the solution and the dissolved metals from the ore.
- (d) Precipitating the metals from the solution, usually by means of finely divided zinc.
- (e) Refining the precipitate and melting it into bullion.

In detail the principal methods of treatment are as follows:

Coarse, Dry Crushing—If in order to secure a fair extraction the ore is only required to be crushed to $\frac{1}{4}$ -inch or $\frac{1}{2}$ -inch size, it may be treated at a low cost, which sometimes more than compensates for the lower extraction obtained. Presuming that the ore does not require a preliminary water wash to remove soluble acidity, a supply of unslacked lime is provided at the place where the ore is dumped at the top of the mill. With a shovel of the proper size the dumpman places one shovelful of lime on each car before dumping. An ore breaker and two sets of crushing rolls with their usual accompaniment of screens and elevators will be found sufficient. After passing these the ore falls into the bin, from which it is ready to be charged into the leaching vats. The finish bin should be large enough to hold a comfortable surplus of ore so that a tem-

porary stoppage of the crushing machinery will not interfere with the regular routine of work in the leaching department. Ore of this kind is best sent to the vats by means of a belt conveyer combined with an automatic tripper that can be placed at any vat desired. It is best to have the ore distributed evenly in the vat by some automatic device, as the Blaisdell distributor. If allowed to fall into the vat in conical piles the ore is liable to classify, the coarser particles rolling to the bottom of the pile. This may in part be prevented by spraying cyanide solution upon the stream of ore as it leaves the tripper. It is always best to arrange the work of filling and discharging vats as well as other intermittent operations so that they will come at a specified time of the day.

Preliminary Treatment.—When ore contains a considerable quantity of soluble sulphates a preliminary wash may be advisable before percolating with a cyanide solution. This more generally applies to the treatment of old tailing. The wash may consist of water only or a solution of sodium hydrate. In any event alkali should be added toward the end of this preliminary treatment. Whenever pyritic ore is kiln dried previous to dry crushing, soluble sulphates that are destructive to cyanide are formed. The proper remedy for this is wet crushing, preferably in cyanide solution, thus avoiding the cost of drying, as well as the large mechanical loss of cyanide in displacing the preliminary wash with solution. Cases are quite rare in which an ore contains sufficient soluble sulphates to make a preliminary wash advisable with its attendant loss of cyanide that must occur by the dilution of the solution in displacing the moisture left by the wash. If a preliminary wash is used it should not be introduced below the filter, but be put on from the top. If introduced at the bottom, a little cyanide solution left under the filter will be brought up into the ore and occasion a loss of gold.

Putting on the Solution.—Some mills have facilities for circulating two solutions, a standard and a weak solution, but in any event the ore should be first treated with solution of standard strength, the weak solution, if used, serving as a preliminary wash near the end of the leaching period and before the wash water is put on. Sometimes a weak solution is very serviceable in washing out dissolved gold that barren solution of standard strength fails to dislodge from the ore particles. The first solution is put on from the bottom of the vat through a pipe communicating with the space below the filter cloth, and allowed to run on so slowly as not to make channels in the ore charge. The best way to accomplish this is to bush the pipe down to the proper sized opening at some convenient point so that the valve may be opened to its full extent without danger. As soon as the solution has risen to within 18 inches

of the top it may be started on from the top also in order to expedite the operation. After the ore is covered to a depth of 6 inches the solution is shut off and the vat allowed to stand 1 or 2 hours before leaching begins. Generally speaking, leaching with standard solution should be continued during the time required for extraction, regulating the flow of the solution at the valve so that about 5 tons of solution shall be used per ton of ore during the treatment. More solution than this would require a needless amount to be passed through the zinc boxes. This rule is of a general character only, and might in special cases be exceeded.

Special Method of Treating Coarsely Crushed Ore.—In treating the ore under present consideration it is generally found best to repeatedly drain the charge, all the applications, of solutions after the first being put on from top, the leaching valve being closed for, say 2 hours, after the application of each quantity of solution, after which the vat may be allowed to slowly percolate, the ore being in the meantime kept covered with solution slowly added at the top. When it is desired to drain the charge, the leaching valve is opened wider and the solution rapidly run off, a sufficient interval of draining being allowed to filter off all the solution that will readily come away, bearing in mind that the ore is under treatment and gold is being dissolved during this draining process, with access of air to the charge. Assays of the solution at the end of the draining process are instructive in this regard, but in order to assign a practical value to these high assays the smaller flow of solution must be taken into consideration. The process applied to this coarse ore becomes one of maceration rather than percolation and its success is more marked in cases where the charge is not entirely homogeneous on account of poor distribution while filling. After a number of applications of the standard solution one or at the most two applications of the weak solution may be made in the same manner, the first weak solution being sent to the strong gold solution tank. At last the wash water is applied in the same manner, but no time for slow percolation need be allowed, the wash being rapidly run off to the weak gold tank. The rate at which the solutions are run off has some influence on the amount which can be taken off, which should be as great as possible within a reasonable time. Under some conditions too rapid draining causes solution to be entrapped in the ore by air coming in below it, thus making a much less complete draining possible. The operator will ascertain the proper rate at which the charge should be drained by careful and intelligent observation, sparing no pains in arriving at the best obtainable result. This maceration method is of doubtful advantage in the treatment of finely crushed and less permeable ore charges.

Discharging the Tailing.—If sufficient water is available and the tailing can be allowed to run into an adjacent stream or to a flat piece of ground of considerable extent, sluicing by means of water delivered at a hose nozzle under considerable pressure is by far the cheapest method of emptying the vat. The vat should be full of water, the hose made ready, then the bottom discharge gates dropped. In the case of the coarsely crushed ore, the tailing will rush out as soon as a gate is opened. In discharging finely crushed tailing the charge should be first saturated with water but the ore not covered. The pipeman walks out to a point above the open discharge gate, directs the stream down into the sand and pushes the hose pipe straight down until the sand begins to cave and run through the gate. The sand is then broken down by the stream as rapidly as possible. The greater part of the sand can be removed by undercutting the bank with the stream and allowing it to fall toward the discharge gate. The bottom is cleaned up with a smaller stream of water at a lower pressure in order to avoid damage to the filter cloth. The filter is then examined and if necessary holes are patched, bits of canvas, sail needles and waxed thread being on hand for that purpose. The practice of nailing patches to the filter rack should not be countenanced. Sand will work through between the nails while sluicing, and if it is necessary to afterwards take up the filter the cloth is ruined. When the discharge gates are closed they should be tested with a little water to see that they are tight. This may be the duty of the solution man, but after the next charge of ore is in and the solution has been put on, the mill superintendent should go under the vat to see that the gate is not leaking.

In case water cannot be used for discharging the tailing, a belt-conveyer system may be installed. This in connection with the Blaisdell excavator leaves nothing to be desired, provided the enterprise warrants a considerable expenditure for equipment. Where the Blaisdell system is used, good distribution of the charge is secured at a low cost. In a small plant the tailing may be shoveled into cars running on tracks under the vats. When vats are discharged by shoveling, cocoa matting should be laid on the filter to protect the canvas.

Leaching Finely Crushed Ore.—If the ore has been roasted it can generally be leached without separating the dust. The heat used in roasting dehydrates the clayey matter that would otherwise form slime and impede or prevent leaching. The first solution is put on as directed for coarsely crushed ore. Then leaching is begun and continued throughout the time allotted for treatment. The charge is in some cases drained once or twice to admit air, but draining generally has the effect of packing the charge. It is not generally considered

best to drain between the application of different solutions as the following solution will mix less with the preceding one if put on as soon as the first has disappeared from the surface. The percolation then proceeds continuously.

A vat charge of finely crushed ore, after draining, contains a large amount of moisture held by capillary attraction. The next solution put on runs down into the charge at once and is mixed with this moisture. Air is also entrapped which for a time impedes percolation.

Weak Solution.—After putting on weak solution the vat is left leaching to the strong gold tank for a specified period or until a titration shows the effluent to be sufficiently weak. This point is determined by the necessity of keeping a convenient amount of each solution in circulation.

Wash Water.—No definite rule can be laid down for applying the wash water. The practice will vary according to the kind of the ore. Sometimes good results are obtained by using the same method for the wash water as has been recommended for the weak solution. In other cases it has been found quite beneficial to first drain the vat and then run on the water in small amounts, not more than 3 inches in depth at a time, with an interval allowed for draining between each application of water. The amount of water used is of necessity determined by the question of keeping a convenient quantity of mill solution in circulation.

Shortage or excess of solution. If the mill is short of solution the leaching vats may be more thoroughly washed with water. On no account should any fresh solution be made up to supply such deficiency. In a carefully operated mill there is little or no necessity of ever running solution to waste in order to reduce the stock. If sufficient time is allowed for extraction in the vats, the last solutions are in reality a wash, and the very large amount of moisture unavoidably discharged with the tailing keeps the quantity of solution within convenient limits.

Two solutions vs. one. With the increasing use of weaker standard solutions the necessity for a second solution is much less apparent than formerly. It is often not regarded worth while to run the extra set of zinc boxes required by the second solution.

Fine Crushing.—Millmen in most cyanide plants try to crush the ore only sufficiently fine to liberate the gold, knowing that in so doing a large percentage of the crushed material will be much finer. When crushing to a 40-mesh screen, it may be that 86 per cent. of the product will pass through a 100-mesh screen and 46 per cent. of the remainder will pass through a 150-mesh screen. In fact when crushing to a 30-mesh screen, over 50 per cent. may pass through a 200-mesh screen and be considered slime. The quantity of material finer than the

screen crushed through depends on the kind of ore and the machine used in crushing. If the stamp mill, Huntington mill, or Chilian mill is used, the fineness of the material will be influenced by the height of the discharge above the die. The quantity of water used in crushing also has considerable bearing on the amount of fine ore made. In one instance, when the ratio of ore to water was $\frac{1}{6.39}$, 43.57 per cent. of the ore passed through a 100-mesh screen, while, when the ratio was $\frac{1}{4.2}$, 56.15 per cent. of the ore passed the same screen. When dry crushing was attempted, 22.6 per cent. of the ore passed the screen in the same period of time, but 45 per cent. of the ore in the mortar box was finer than 120 mesh. In Table 2 are shown the results of tests made with ore after flowing over an amalgamating plate. These tests show that the coarser ore contains the greatest values, and that while 54.6 per cent. of the ore was finer than 150 mesh it contained but \$1.24 to the ton; under such circumstances, the coarser ore must be crushed finer if cyaniding is to be effective. The signs + and - indicate the ore remaining on or passing through the screens. Thus -60 +90 means passing through 60 and remaining on 90.

TABLE 2.—PULP SIZED AND ASSAYED AFTER AMALGAMATION

Mesh	Per Cent.	Assay Value	Total
+ 60	14.6	\$9.09	\$1.327
- 60+ 90	16.5	8.16	1.346
- 90+100	5.8	4.65	.270
-100+150	8.5	3.00	.255
-150	54.6	1.24	.677
	100.0		\$3.875

Wet fine crushing for cyanide treatment is almost invariably done in solution. The solution circulated through the grinding or crushing machinery is called the battery or mill solution to distinguish it from the barren and wash solutions. Unless the ore is all ground to slime it is necessary to classify the product of the grinding or crushing machinery into sand and slime.

Before wet crushed ore can be made leachable, the slime, which for convenience is classed as all material finer than 150 or 200 mesh, must be removed. Hydraulic sizers and classifiers such as are used in concentrating mills have not been found satisfactory when operated by cyanide solution, and the Dorr classifier is almost exclusively used for this purpose. These machines separate the sand by dragging or scraping it up an inclined plane while washing it with a spray of solution. It is best to have the sand clean, as a little coating of slime over the grains of sand materially hinders extraction. Experiments have demonstrated that each per cent. of slime contained in a sand charge lowers

the extraction about 1 per cent. This applies to the colloidal slime formed during the wet crushing of an ore.

Manner of Filling.—When sand is washed into a vat by means of water or solution it tends to classify, the coarser and finer grains becoming separated, also a little motion of the pulp in the solution causes the sand to pack, the smaller grains filling the voids between the larger, thus hindering leaching. No matter how free from slime the sand is when it starts on its journey to the leaching vat, if the ore is somewhat soft the grinding of its particles in the launders and distributing pipes will produce some slime. Under the constant movement of the solution this slime will classify in the vat to some extent. On examining a charge filled by means of a Butters distributor the trace of the distributor jets can often be discerned in the annular rings of partly classified material. The fault is not in the distributor but in distributing with solution. For these reasons wet filling is not so much in vogue as formerly.

A better method is to take the dewatered sand as it comes from the Dorr classifier and transport it directly to the leaching vat by a belt conveyer. The charge may be automatically leveled as the filling proceeds, by the Blaisdell system, or in a smaller plant, where the cost of distributing machinery is not warranted, the conveyer system may be placed sufficiently high to admit of leveling by hand labor. If the leaching valve is kept open during the filling and leveling, there will be no danger of packing the charge. In some mills the sand is run into receiving vats by means of Butters distributors, and after draining is transferred to the leaching vats. This secures equally good results, but has no advantages over direct filling provided the filling is properly done. The dewatering of the sand is beneficial in case it is necessary to give the charge more air than can be carried by the solution.

A method of filling to keep up protective alkalinity is to feed a small quantity of crushed lime to the sand as it travels in the launder or on the belt conveyer. Some ores consume alkali during the entire time of treatment and if the charge is deep or the percolation slow the free alkali is liable to become exhausted from the solution before it reaches the filter. Small granules of unslacked lime distributed through the charge dissolve slowly and give out alkali to the solution during the entire leaching period. The lime should be crushed to an 8-mesh screen and may be fed to the belt conveyer by means of a mechanical feeder. The feeder should be belt driven. The hopper may be of the same size as used for stamp mill feeders but the shaking tray should be only about 3 inches wide. The tray is pulled backward by means of a cam and a spring throws it forward striking a stop which jars down a small portion

of lime at each stroke. The position of the stop is adjusted by means of a screw which regulates the length of the stroke. One filling of the hopper may answer for several hundred tons of ore, but in some cases it is extremely important to have this small portion of lime fed into the vat in this way.

All-Sliming.—Whenever it is necessary to reduce all of the ore to slime, it is most economical to put a coarse screen (3 or 4 mesh) on the stamp batteries and send the battery product to a tube mill. It is necessary to dewater and classify the material between the stamps and tube mill, as either slime or an excess of water in the tube mill will greatly reduce capacity. A Dorr classifier is used to fill both these requirements. The tube mill discharge contains some coarse sand and this discharge is therefore returned to the classifier, the oversize passing through the mill a second time. In mills of low capacity, a slowly running Chilean mill with a high discharge is sometimes placed below the stamps for sliming, but this plan is not recommended where low milling cost is of first importance.

In mills of considerable size, three-stage grinding is practiced with a considerable saving in cost of equipment as it very greatly increases the capacity of the different machines. Four-mesh screens are put on the stamp batteries, this product is sent to Chilean mills crushing to an 8-mesh screen, and the Chilean mill product sent to tube mills, the slime being separated after leaving the Chilean mills. By this arrangement it would be quite easy to slime 150 tons of ore per day with twenty 1,000-pound stamps, one 6-foot Chilean mill and two 5'×22' tube mills. This allows for a stamp duty of 7½ tons per stamp, which is rather low when crushing to a 4-mesh screen. A considerable portion of the ore would be slimed in the Chilean mill, thus relieving the tube mills. In any arrangement for stage crushing the sizes of screen openings are adjusted to balance up the work done at the different stages, regard being had to the hardness of the ore and the efficiency of each machine.

Experiments in tube milling show that, with possibly slight variations for different ores and makes of mills, the moisture in the feed should be kept at 38 to 40 per cent., and in any event regulated within very narrow limits. A little variation from this "critical point" causes a serious falling off in efficiency. In one series of experiments it was found that with a feed containing 39-per-cent. moisture three 5-foot tube mills would do the same work as four of the same mills working on a feed containing either 36 or 48 per-cent. moisture.

(To be Continued)

來 來

Zinc mixes with lead when heated but separates when cooled. The amount that will remain permanently alloyed depends upon the temperature of lead.

Domestic Camp Science

Oregon Agricultural College, Corvallis, Ore., has issued a bulletin on "Camp Cookery." It contains 31 pages of practical and useful information for those who spread their table under the greenwood bough. It was prepared by the school of domestic science and art for the special use of forest rangers, campers, mining prospectors, and sportsmen. It follows somewhat the lines of instruction in the course in camp cookery given at the college for the forestry, mining, and surveying students.

Believing that they could relieve some of the "blue days" in camp consequent upon "sad" biscuits, half-cooked "spuds," and monotonously greasy fried things, the domestic science teachers obtained from the forestry department of the college and the Forest Service a ration list and camp equipment selected by men of many years field experience, and prepared a list of 65 carefully selected recipes. These are so simply explained that it takes no initial culinary skill to use them. They are also conveniently indexed at the back of the book.

The ration list, sufficient for one man for 100 days, or 100 men for 1 day, as given, may be used as a basis for making up supplies for camping parties. It includes the following: 100 pounds fresh meat, including fish and poultry; 50 pounds of cured meat, canned meat or cheese; 15 pounds lard; 80 pounds flour, bread, or crackers; 15 pounds corn meal, cereals, macaroni, sago, or corn starch; 5 pounds baking powder or yeast cakes; 40 pounds sugar; 1 gallon molasses; 12 pounds coffee; 2 pounds tea, chocolate or cocoa; 2 cans condensed milk; 10 pounds butter; 20 pounds dried fruit; 20 pounds rice or beans; 100 pounds potatoes or other fresh vegetables; 30 cans canned vegetables or fruit; 4 ounces spices; 4 ounces flavoring extracts; 8 ounces pepper or mustard; 3 quarts pickles; 1 quart vinegar; and 4 pounds salt.

Eggs may be substituted for fresh meat at the rate of 8 eggs to a pound of meat. Fresh and cured meats may be interchanged at the rate of 5 pounds of the fresh or 2 pounds of cured. A substitution of fresh milk may also be made for condensed, at the rate of 5 quarts of fresh to a can of the other. Likewise fresh fruit may take the place of the dried in the ratio of 5 pounds of fresh to 1 pound of dried. A ration, as the word is commonly used, is the food estimated to be necessary for one man for one day. The amount in this list is designed to be sufficiently liberal and varied for all circumstances, and is the maximum which should not be exceeded.

On the basis of this list a party of six may be comfortably fed for 17 days. The

cost will vary, necessarily, with the location, being from 45 to 55 cents a man for a day if near large markets and convenient to railways. Where pack horses must be used, or transportation is otherwise difficult, the omission of the heavier provisions, such as canned goods containing much water, and the substitution of more flour, beans, and dried fruits is advised. Where fresh meat cannot be obtained additional bacon and corned beef must be included. Where the campers pack their own food on their backs a still further cut must be made in the heavy things. Under favorable conditions

plenty of flour, bacon, rice, beans, oatmeal, cornmeal, tea, sugar, dried fruit, and salt must be taken. As much soap and matches as seems necessary must also be carried.

The pamphlet also explains how to build camp fires, and what should be included in the camp equipment. Among the interesting recipes are those for "army bread," "emergency biscuits," "dough boys," "pulled fire bread," ranchman's bread, flap-jacks, "fried quois," "Mulligan," "hunter's pudding," and Johnnie cake. This information has long been needed and little has been written before.

Notes on Mine Surveying

Devices for Identifying Stations Underground—Method of Correcting Traverse that Fails to Tie

By H. G. Henderson

THE practice of mine surveying from time to time reveals practical points, not only worthy of record by the mine surveyor for his own use on future occasions, but also possessing a larger interest as affecting the general practice in connection with this branch of the industry. Many of these are simple, but if neglected, the surveyor probably will adopt some roundabout method that will possibly tend toward mistakes. For this reason it is thought advisable to put on record one or two brief notes concerning metal mine surveying, which may be of interest to surveyors and engineers engaged in this work. Nothing new or original is claimed in connection with these points, but as they do not appear to have been specifically recorded and made available for public use, they have value.

It is important in mine surveying that the surface and underground measurements tally with each other. To a large extent the accuracy of the plans depends upon the accuracy of the instrument used, and the proverb that "No chain is stronger than its weakest link" holds good in surveying work. There is a temptation in mine practice to reserve the newest and most up-to-date instruments for the surface work, while the older and inferior instruments are used for the underground work. Probably this arises from the mistaken idea that the chief thing to remember is to keep the good instruments from injury as much as possible, and the reluctance to subject them to rough work underground. It is far better, as a practical matter, to use the inferior instruments both at the surface and underground; as any errors inherent in the instrument would manifest themselves in both cases, and on the principle that some-

times two wrongs may make a right, the surface errors would tend to cut out the errors underground, and vice versa. If necessary, the better instrument can then

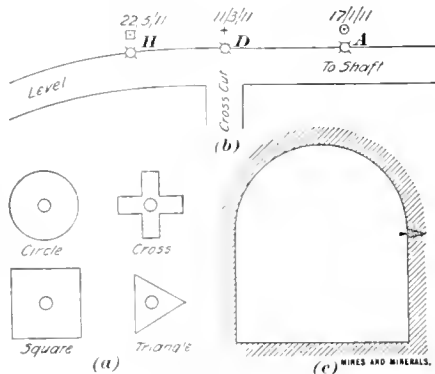

FIG. 1

be used on the surface work to check the readings of the inferior one. As an illustration in point, there was a dispute between two mining companies regarding a question of encroachment. The whole matter turned on the question of the reliability of the plans, and one party as evidence produced a most costly theodolite, and argued that with the use of such an instrument a mistake was practically impossible. This argument, would of course, only hold good if the same instruments were used both on the surface and underground.

One of the greatest difficulties which a surveyor encounters in work carried on underground is the location and identification of the pegs put in at the finish of the last survey in order to form a basis for the commencement of further work. It is often found that these pegs become in course of time covered with slime and dirt and generally must be searched for in order to commence a fresh piece of

survey work. The surveyor could easily mistake some other peg put in by the machine drillers or by a miner to hang his jacket on, for the peg which he himself put in at the last survey. The miners who are attendant on the surveyor are generally ready in order to save themselves trouble in the search to assert that the first peg they come across in the neighborhood, is the very one that they put in at his previous visit. Hence it sometimes occurs that the unfortunate surveyor starts his work underground from the wrong peg and then plots it on the mine plan as from the correct peg, with dire results. It is therefore necessary that the surveyor should have distinguishing marks for his own pegs; and a convenient system is for the surveyor to keep in his pockets what may be called "tokens" of different shapes cut out of sheet lead, as illustrated in Fig. 1 (a). It will be observed that the names of these tokens, "circles," "crosses," "squares," "triangles," run in what may be termed "dictionary" or alphabetical sequence, and hence the order in which they occur is easily remembered. In order to illustrate their practical use it may be supposed that Fig. 1 (b) represents, in plan, a level which is in process of survey. On July 14, 1911, the surveyor went underground with the intention of starting from the peg D put in on March 11, 1911, in order to survey a new cross-cut which had been driven. The attendant miners, having scraped away the dirt discovered the peg A and are prepared to swear that it is the very peg that they put in on March 11, and the one that the surveyor wants. The distinguishing mark, however, proclaims to the surveyor that this is not the right peg, and he tells them that the proper one is ahead of them, further to the west. The miners next unearth peg H, and are confident that now they have the right one. The surveyor, however, sees by the distinguishing mark that they are again wrong, and that since the word "cross" in dictionary sequence lies between the words "circle" and "square," the real peg must be between the two already discovered, and after further search this peg is found.

In practice these tokens are placed as shown in Fig. 1 (c). After the necessary hole has been bored, the wooden peg is driven into the wall of the level and the usual nail is hammered into the peg, the token having been strung on to the nail before use. It will, of course, be remembered that in the majority of mines two pegs are left as a base for a further start, and a careful measurement of the distance between these will settle any doubt which might exist. There are, however, many mines where the levels are so narrow and tortuous that only one peg can be left as a base, and therefore the

system previously described has been found to be of immense practical benefit and the means of saving much time.

It occasionally happens that, in spite of every care taken by the surveyor to secure accurate results, the measurements taken in the field, when plotted in the office fail to "tie." This may be due either to inaccuracies in the instruments and means of measurement used, or to the unavoidable errors of observation that occasionally fall to the lot of even the most careful operator. It will, of course, be a harassing and sometimes expensive and time-wasting thing to have to go back and resurvey the whole area or that portion which is affected by inaccuracies, and therefore it will be interesting to give a simple method of making the necessary corrections for a closed traverse that on plotting fails to "tie." The method may be followed by reference to Fig. 2 (a). Assume that AB , BC , CD , and DE are the lines of the survey as plotted and which fail to tie by the distance EA . The error may be corrected by assuming that the discrepancy is divided equally over the whole of the series of operations, and in order to make the necessary corrections, a drawing such as is shown in Fig. 2 (b), is made.

On a sheet of paper then a straight line is drawn, on which is marked off the successive lengths AB , BC , CD , and DE corresponding to the same lines shown in Fig. 2 (a). They should, of course, be marked off on the same scale as plotted on the mine map. A perpendicular should then be set at A on the line AE and the distance AF should be marked off on it representing on a magnified scale the length AE on the plan. The points EF should then be joined by a straight line. At points B , C , and D perpendiculars are

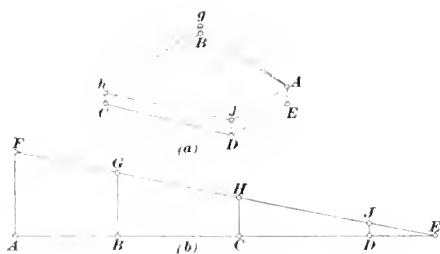

FIG. 2

drawn from AE to the line EF . Comparing these perpendicular heights with the distance AF the length, by scale on the plan, of BG , CH , and DJ should be marked upon them.

With a parallel ruler, lines should then be marked off parallel to line AE , Fig. 2 (a) running through the points B , C , and D , respectively. On these lines the lengths of the respective perpendiculars should be marked off to scale from the perpendiculars in the triangle AEF , Fig. 2 (b), and

when the points g , h , j , have been obtained, lines should be drawn to join the points $A g$, $g h$, $h i$ and $j A$. These will represent the closed traverse corrected so as to "tie," distributing the error over the various points in a proportional manner. It will usually be found that this method of correction leads to results which are accurate within any practical limit of error, providing that no gross mistake has been made in one or more of the measurements.

Recent Jig Design

Form of Jig Containing Some Improvements that Give Increased Efficiency and Capacity

By Roy Reddie

THE jig equipment illustrated in Fig. 2 was designed to replace six "Hartz" jigs of the following dimensions: Four 3-cell 18 in. \times 40 in., and two 4-cell 18 in. \times 30 in. These jigs were working on a carbonate of zinc ore (Smithsonite) in a decomposed dolomite gangue, which was crushed, sized, and fed to the jigs as follows: $-\frac{1}{2}$ in. $+\frac{3}{8}$ in. to two 3-cell 18 in. \times 40 in. jigs; $-\frac{3}{8}$ in. $+\frac{3}{16}$ in. to two 4-cell, 18 in. \times 30 in. jigs; $-\frac{3}{16}$ in. $+\frac{3}{32}$ in. to one 3-cell, 18 in. \times 40 in. jig; and $-\frac{3}{32}$ and through the spigot of classifier to one 3-cell, 18 in. \times 40 in. jig.

The four jigs handling material over $\frac{3}{16}$ inch in size made screen and hutch concentrate, sending the tailing to a set of rolls for finer crushing, the crushed material being returned to the system. The jigs treating material through $\frac{3}{16}$ -inch screen, made screen and hutch concentrate; tailing from these jigs went to the dump.

The concentrate was drawn intermittently from the "bed" through the usual side-draw Heberle gate, Fig. 1. A fairly good grade of shipping concentrate was produced, but to do so required considerable reworking of the hutch concentrate.

The problem was to increase capacity, improve the grade of concentrate, and to decrease working costs.

A simplification of the screening system seemed desirable, so it was decided to adopt one limiting size of trommel screen for admission of jig feed to the system; a $\frac{3}{8}$ -inch round hole was fixed upon as the maximum size, and the concentration of this practically unsized feed is effected by jig adjustment rather than by a refinement of sizing.

The equipment designed to meet these conditions consists of a 5-cell rougher jig and a 6-cell cleaner jig, the salient points in the construction of which are

It will be seen from the foregoing that nothing very new has been enunciated and that all of the points raised can be solved by a little common sense. As, however, there is no advantage in each surveyor having to rediscover the best methods of going to work in any particular instance, it is possibly the case that the above notes may serve their turn in facilitating the work of other mining engineers and for this reason they have been written.

shown in the accompanying illustrations. The framing consists of 6" \times 6" scantling; the posts are gained into, and bolted to the sills by brackets and lag screws, and the bridge trees are gained to receive the posts and bolted to them by means of $1\frac{1}{8}$ -inch holding-down bolts. The rigidity of the bridge trees is still further insured by bolting them down to the center partition by an expansion bolt, the center partition having been built up to the bridge trees for this purpose.

The jig tank is built up inside the framing, by spiking together 2" \times 4" sized timber, the compartments being then lined with 1-inch tongued-and-grooved flooring. A strip of soft cotton wicking should be placed between the 2 \times 4's to make them water-tight.

The design seeks to reduce the risk of

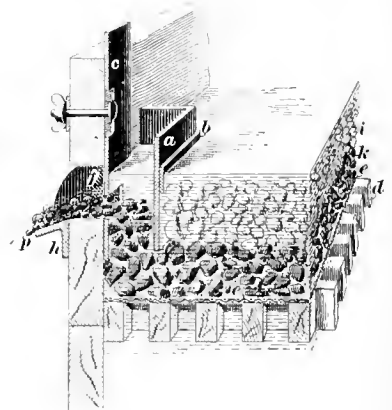

FIG. 1. THE HEBERLE GATE

lost motion during the life of the jig, by providing heavy transmission gear. The $3\frac{5}{16}$ -inch shafting runs in heavy plain pillow boxes. The eccentrics are of the readily removable "Clark patent" type. These are massive, readily adjusted, and work without any differential motion. The cleaner-jig shaft is cut on the middle bridge tree to allow a variation of plunger

speed between the first three and the last three plungers. Cast-iron grates are used, the openings of the bars running at right angles to the flow of jig feed. These grates are easily "spudded," or cleaned, while the jig is working.

The bottom of the plunger compartment was designed with several ends in view. It will be noted that it is a body of solid concrete, faced with sheet iron, in the form of a paraboloid. This mass of concrete, and the form of it, fulfils the following functions: it increases the rigidity of the structure as a whole; reduces the volume of water to be moved at each stroke of the plunger; reduces the frictional resistance to the flow of water through the throat of the jig; so changes the direction of flow of the jiggling water, passing through the throat of the jig, that a comparatively uniform impulse

passes upward through the whole screen area: it provides a comparatively still well below the jiggling currents, which is favorable to the settlement of fines. It will be noted that the form as well as the depth of the center board influences the pulsion and suction strokes.

The use of a gate and dam at the center of the tail-board will be found to insure a more even bed than the old side-draw gate and dam of the Heberle type can maintain, and the tailings will also discharge more evenly over the tail-board. This tail-board gate will be found equally serviceable for drawing off concentrates or "chats" and it can be worked automatically or intermittently, as desired.

These jigs have met the conditions for which they were designed. Working on a feed which varies from $\frac{1}{8}$ inch to 60 mesh, they are doing much better work

than the jigs which they replaced, despite the fact that they are handling a large proportion of fine feed, from 20 mesh to 60 mesh, that was formerly concentrated on tables.

采采

California Oil in Peru

In the mining section of *Peru To-Day*, it is stated that "Peruvian producers of petroleum, after distilling out the gasoline and kerosene, find a ready market for the residuum in the nitrate fields of Chili. In several places it has displaced coal, but California fuel oil is used in greater quantities, because the Peruvian producers cannot supply the demand. It has been found in the nitrate fields that oil is cheaper, easier to transport, load and unload, requiring no labor or lighterage, and it reduces the cost in the fireroom.

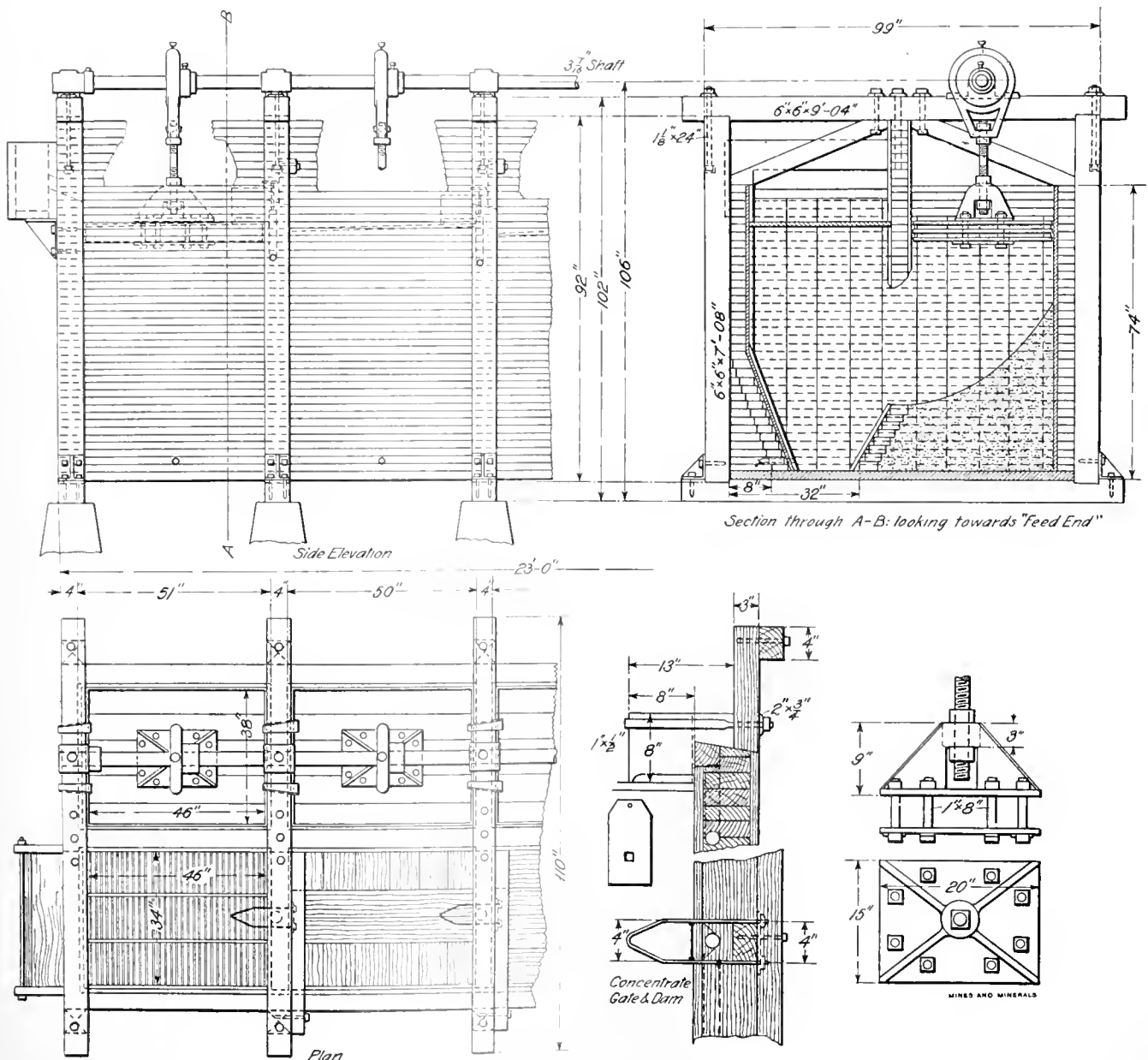

FIG. 2. ROUGHER JIG

NEW MINING MACHINERY

Direct-Current Turbo-generators

By J. C. McQuiston*

Turbogenerators are being so generally introduced in mining it is believed the following information will be of interest to readers of MINES AND MINERALS.

Many are used for exciter sets in alternating-current generating stations, for lighting, pumping, and for storage battery charging. They are particularly applicable for exciter service in modern generating stations where the steam pressure exceeds 125 pounds per square inch, because small reciprocating engines ordinarily used for

pounds per square inch. Either shunt- or compound-wound generators can be furnished. Standard compounding is 118 volts, no load, and 125 volts, full load, or 235 no load, and 250 full load. Compounding can be varied by adjusting the shunt.

The Westinghouse Electrical and Mfg. Co., East Pittsburg, Pa., manufacture machines of this type. Fig. 1 shows a turbine of the single wheel impulse type with the upper half of the cylinder and casing removed. The rotor is mounted directly on the end of the generator shaft. Although only one impulse wheel is used, an unusually high efficiency is obtained by using the steam two or more times on

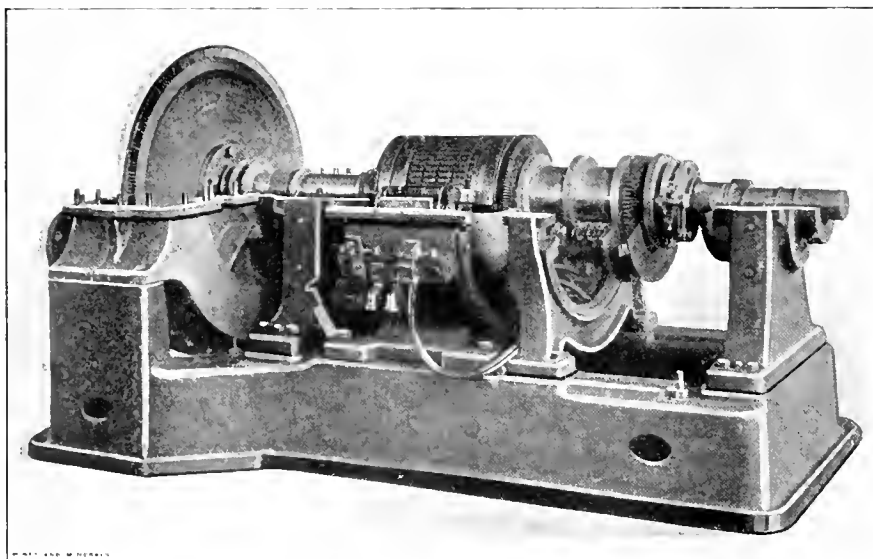

FIG. 1. DIRECT-CURRENT TURBO GENERATOR WITH CASING REMOVED

driving exciters are usually designed for pressures not greater than 125 pounds per square inch. Where the boiler pressure exceeds 125 pounds per square inch, a reducing valve must be used with such engines. Turbines operate directly on pressures up to 200 pounds and with steam superheated to 150° F.

As compared with reciprocating engine sets the features in favor of the turbo-generator set are: Simplicity; reliability; few-moving hence wearing parts; few bearings to oil; compactness and less floor space; less cost for installation; and less oil used.

The line of turbogenerator sets now being manufactured includes machines of the capacities most in demand of from 10 kilowatts to 200 kilowatts. Standard voltages are 125 and 250. Three-wire generators—125 and 250 volts—can be supplied. The steam pressure range is from 75 to 200

* East Pittsburg, Pa.

the one wheel. The governor is of the flyball kind. In case of overspeeding, the automatic, safety-stop, throttle valve is tripped, thereby immediately shutting off the steam supply.

All parts of the turbine are readily accessible for inspection or repair. The upper half of the cylinder and casing may be removed as shown in Fig. 1, without interfering with the valve or governor mechanism, and, if necessary, the whirl or rotor may be entirely removed from the casing.

Generally speaking, the steam consumption of turbines of small powers compares favorably with the performance of automatic high-speed engines of similar capacity. As the turbines are carefully tested in the shop before shipment, there can be no uncertainty as to their performance. The guarantees of steam consumption are based on an average of actual test results plus a comfortable margin.

Trade Notices

Pipe Line Pumping Equipment.—William Schwashauser, chief engineer of the International Steam Pump Co., has returned from a 3 months trip to Europe, visiting England, Germany, and Russia. While in London he closed a contract with S. Pierson & Son for the entire pumping equipment required for a new oil pipe line now under construction in Mexico. The pumping engines will be furnished by the Fred. N. Prescott Steam Pump Co., of Milwaukee, Wis., and the condensers and auxiliaries by Henry R. Worthington.

New Catalog.—An especially fine catalog (No. 45) has been recently issued by the Ludlow-Saylor Wire Co., of St. Louis, showing the various lines of products made by the company. They report that business is extremely good in all lines, with an exceptionally heavy demand for mining cloth, cement cloth, and other weaving products.

Notice.—John Davis & Son (Derby), Limited, of All Saints' Works, Derby, England, announce that on and after August 29, their house at 110 West Fayette Street, Baltimore, Md., will be closed. All orders for new instruments and for repairs should be addressed to All Saints' Works, Derby, England, where they will be promptly executed.

Covering Steam Pipes.—A neat booklet issued by the Armstrong Cork Co., of Pittsburg, Pa., describes the Nonpareil high-pressure pipe coverings, the methods of applying, together with tests of this and other coverings. It also describes Nonpareil cork covering for use in refrigeration work. The book will be sent free on application.

New Buildings.—Plans have been made by the Western Electric Co. for new buildings to be erected at Hawthorne, Ill., near Chicago, which will cost approximately \$750,000, to take care of increases in business in the future. This construction follows out the company's general policy of concentration of the manufacturing part of the business at Hawthorne, where upwards of 11,000 people are now employed. Business during the summer has been increasing rapidly and the conditions are exceedingly satisfactory.

Prospectors' Supplies.—On account of increasing sales and the probable big resumption of prospecting and development this fall and early winter, the Way's Pocket Smelter Co. has found it advisable to separate the manufacturing and selling organizations. In the future, the Way's Pocket Smelter Co. will devote its entire time to making smelters and to experimental work

along new lines. The selling organization will be J. W. Swaren & Co., 112 Market Street, San Francisco, Cal., to whom all orders for Way's Smelters and supplies should be addressed. This new company will also handle a complete line of machinery and supplies ordinarily used by prospectors and new properties. Mr. Swaren has been a prospector himself, and appreciates the difficulties met in getting equipment and supplies while out on the hills or on the desert, and his personal attention will be given to securing for customers the best materials on the market.

Coaling Stations.—A contract has recently been awarded the Roberts & Schaefer Co., of Chicago, by the Queen & Crescent Route, for a 500-ton reinforced-concrete Holmen counterbalanced-bucket locomotive coaling station for installation at Ludlow, Ky., near Cincinnati. Contract price is \$17,500. The Louisville & Nashville Railroad have also awarded a contract for a 400-ton frame-constructed, counterbalanced-bucket coaling station for installation on their line at Livingston, Ky. The Roberts & Schaefer Co. have also recently secured a contract for a large complete coal-mining plant for the Calgary Coal Syndicate, to be installed at Mitford, Alberta, Can.

Technical Advertisers.—An evidence of the increasing attention being given to the most efficient methods of advertising engineering and technical products appears in the announcement of Wightman & Richards, forming the Technical Department of Jos. A. Richards & Staff, general advertising agents, Tribune Building, New York City, representing the association of Joseph A. Richards, Lucius I. Wightman and Paul Morse Richards. Joseph A. Richards is the head of the agency founded by Joseph H. Richards in 1872, and since identified with conspicuous national successes in advertising salesmanship. Mr. Wightman is an engineer who has for many years specialized in the advertising and marketing of machinery and engineering products. Paul Morse Richards is a publisher, sales manager and advertising man of wide experience. Messrs. Wightman and Richards bring to the field served by the technical press a much needed combination of agency facilities with specialized technical and engineering skill. The new organization guarantees, through specialized service, a judicious administration of any account, combining, as it does, an experienced advertising manager, an engineer, and a sales manager, with a complete corps of trained assistants.

來 來 New Calendar

The British Parliament has been weighing the importance of a bill providing for the establishment of a simple and symmetrical business calendar. This bill, as at present

prepared, does not propose to alter the ordinary succession of the days of the week. The chief objects to be attained in the enactment are as follows: Each business year will be of four quarters of exactly 91 days, or 13 weeks, each. Any period of 3 successive months will contain this same number of days or of weeks. There must be some plan devised for the absorption of the one extra day in the year, but this can be readily done by the declaration of a holiday. In the event of a leap year, the plan must provide for two such extra days. The adoption of this as a law will effect great simplification of commercial accounting in every line. Americans will be interested in following up this plan in its actual practice.

來 來 Book Review

THE EXAMINATION OF PROSPECTS, by C. Godfrey Gunther, E. M., 222 pages, illustrated. McGraw Book Co. Price \$2 net. This little volume, in its limp leather binding, fits one's coat pocket, so, no doubt, the author's intention will be fulfilled in the practical use to which the book is put during the field work of examining engineers. As explained in the preface, the book aims to concisely present economic geology in a practical manner and to emphasize the applications of accepted modern views. The writer dwells on the difficulties presented in the valuation of undeveloped mining properties. He devotes the first chapter to a discussion of examinations by going into the very practical methods employed by leading engineers and covering a number of precautions to be exercised. The balance of the book is pure science, as the following chapter headings will indicate: Structural Geology; Structural Features of Ore Deposits; Primary Ores and Their Distribution; Types of Primary Ore Deposits; Primary Ore Shoots; Primary Alteration of Wall Rocks; Alterations by Surface Agencies; Residual Ores and Their Distribution; Secondary Ores and Ore Shoots; Outcrops. The book is profusely illustrated by reproductions of figures that appear classical to readers of the United States Geological Survey publications. Throughout the book, the reader notes the brevity with which each topic is handled, but realizing that he receives the meat of the nut, he experiences a satisfaction that is oftentimes lacking in the perusal of books along similar lines.

HENDRICKS' COMMERCIAL REGISTER. S. E. Hendricks Co., publishers, 74 Lafayette Street, New York. 1,574 pages; price \$10. The twenty-fifth annual revised edition of Hendricks' Commercial Register of the United States for Buyers and Sellers has just been issued. Its aim is to furnish complete classified lists of manufacturers for the benefit of those who want to buy as well as for those who have something to sell. It covers very completely the architectural,

engineering, electrical, mechanical, railroad, mining, manufacturing and kindred trades and professions. The present is by far the most complete edition of this work so far published. The total number of classifications in this book is over 50,000, each representing the manufacturers or dealers of some machine, tool, specialty, or material required in the architectural, engineering, mechanical, electrical, railroad, mine, and kindred industries, representing upwards of 385,000 names and addresses. An important feature of Commercial Register is the simplicity of its classifications. They are so arranged that the book can be used for either purchasing or mailing purposes. It gives much information following the names of thousands of firms that is of great assistance to the buyer. It also includes the trade names of all articles classified in the book as far as they can be secured. The book is revised, improved, and issued annually.

來 來 The National Forests

Secretary Wilson, of the United States Department of Agriculture, has decided to establish an experiment station on the Manti National Forest near Ephraim, Utah, for the study of grazing and water protection problems. Already the gathering of observations on the relations of erosion and run-off to the forest cover have begun.

It has already been proved conclusively that the overgrazed condition of areas on which the natural vegetative cover has been seriously altered is responsible for the formation of torrents and the rapid discharge of debris-laden flood waters. In a recent destructive storm the water ran clear from a part of the watershed which was within the National Forest, and in good condition as a result of well-regulated grazing, while from other areas it swept down sand and boulders.

The National Forests provide range during a part or all of the year for a considerable part of the stock produced in the Western States. Approximately one, and one-half million head of cattle and horses and seven and one-half million head of sheep and goats occupy the forest lands each year. These figures do not include nearly three hundred thousand calves and over four million lambs and kids for which permits are not required.

The experts of the Department believe that when the ranges which were denuded by many years of improper use are restored to a normal condition of productivity it will be possible to provide feed for a much larger number of stock without injury to forest growths or watersheds, and both the stock grower and the consumer of meat products will thus be benefited.

THE sapphire mines of Northern

Sapphire Mines of Northern Kashmir

Kashmir, India, are at about longitude $76^{\circ} 55'$ E and latitude $33^{\circ} 30'$ N. They were discovered through a landslip which brought down the precious stones from the face of a precipitous cliff to the narrow valley below. The beautiful blue color of the crystals and their adamantine luster attracted the curiosity of some Bhootian

Valuable Gems Discovered by Wandering Natives in a Wild and Desolate Country

By J. Godwin*



A BOMBAY REKA

shepherds who frequent these solitary hills during the summer months of July, August, and September. Although these people were ignorant of the value of the stones scattered about the place, they had the common sense to pick up some of the best crystals, which were perfect in color and without flaws, with the hope of exchanging them for salt and sugar. These commodities are very scarce in the hills and can only be procured at a very high price from the traders of Pangi, Chamba, Kulu, and the Simla hills. Finding that the traders eagerly gave them salt, sugar, iron, and other necessities of life for the stones, the shepherds began a regular exchange with them. The traders reaped a good harvest through the ignorance of these uncivilized people and the Kashmir State lost much wealth.

His Highness the late Maharajah of Jammu and Kashmir, on hearing of the discovery of sapphire mines in his territory, immediately deputed some of his trusted officers to proceed to the mines and collect all the stones procurable and to put guards on the mines to stop further plunder. The sapphires which were brought down from the mines by the officers were worth several thousands of pounds. The journey from the scene of the sapphire mines to Jammu, a distance of over 160 miles, has to be made over dangerous mountain paths and over difficult mountain passes. During the journey some of the sapphires changed hands, but the majority were brought down safely and deposited in the state treasury of

Jammu. Thus after many years the illicit trade was stopped.

Some years after the death of the Maharajah the mines were leased to a company for a couple of years. More sapphires worth several thousands of pounds were recovered from the alluvial workings. The company to which the mines were given had a short lease and the difficulties they encountered in carrying out the work were great. The working period was but three months out of the twelve, for the mines were situated at an altitude of 15,000 feet and were in the region of perpetual glaciers and snow. There is small wonder that the company was obliged to retire and abandon the mines.

On my visit to the mines in 1909 to demarcate the boundary, I first turned my attention to the washing of the alluvium to find whether there were any sapphires left from previous washings, but found that not a speck of sapphire worth washing for had been overlooked.

My attention was next drawn to the original mines, 14,500 feet above sea level, but before I traveled up the narrow zig-zag path leading to the mines I examined the local geological formation of the hills, and this I found to be mostly plutonic rocks of aqueo-igneous origin, and in some places small laccolites were also observed. In going higher up the slope by the narrow path I looked very closely in order to see whether any veins or even streaks could be found traversing the rocks. I was successful in finding a good many small white streaks of decomposed feldspar running through the rocks. These contained minute specks of sapphires and the most prominent among them were found to be on the face of the cliff some distance below the original mines. This vein had been worked by the company to whom the lease was given, but unfortunately it was unable to follow the vein more than 6 or 8 feet during the working season of 6 months in 2 years. The sapphires which were obtained, although small and not of good color, were encouraging. I examined the veins closely, and it seemed as if these small veins were mere branches emanating from a central source or pocket. It is not improbable that my inference is correct, because those laccolites which were observed distinctly show that the rocks underwent great disturbance at the time when they were intruded by molten magma which not only caused large fissures and fractured the overlying strata, but

many small fissures and minute cracks in the surrounding rocks. These fissures were subsequently filled by mineral solutions and crystallized into the valuable gems found. To prove that the inference is correct and that pockets of sapphire still exist in these rocks requires money, patience, and courage.

The original sapphire mines were first discovered through the landslip some 32 years ago. I found the place, but the adjoining rocks had been blasted so that no trace of the original pocket was left for further exploitation. After the landslip some of the most valuable of the sapphires had been picked up by the Bhootian shepherds, but subsequently gems to the value of more than a million pounds were discovered by washing.

From this mine I climbed 500 feet higher and there found a natural pit covered with ice, from which according to the natives many valuable stones were extracted and taken away by robbers from Kulu and the Bashar Hills. Unfortunately I had not been authorized by the Kashmir Government to dig trenches or to examine the mines; hence, after placing a landmark on the spot, I left reluctantly.

During this trip I traced other valuable minerals such as galena, blende, chalcopyrite, extensive beds of sulphur, magnetite, hematite, bauxite, coal, and recently some quartz veins containing gold and silver, but in small quantities. From this it must not be surmised that gold in paying quantities cannot be found in the Jammu and Kashmir Himalayas.

Exploration and prospecting require wealth, courage, and patience. There are few in India who will risk even a mite out of their millions unless they can see



CAMEL COACH, BHOPAL, INDIA

a ready and sure return. As a consequence, industries which are the true source of wealth are neglected. In spite of her great natural resources and aspirations, India will not rise to the level of the other enterprising nations unless the Indians learn to be active and intelligent and to enrich themselves by hard work, perseverance, and definite training.

*Mining and Exploring Officer, Jammu and Kashmir State.

Mines and Minerals

Vol. XXXIII.—No. 4.

NOVEMBER, 1912—SCRANTON, PA.

Price, 25 Cents

PUBLISHED MONTHLY AT SCRANTON, PA.

ESTABLISHED 1881

INTERNATIONAL TEXTBOOK CO., PUBLISHERS

T. J. FOSTER, President S. P. ALLEN, Secretary E. H. LAWALL, Treasurer

RUFUS J. FOSTER, Vice-President and Manager

EUGENE B. WILSON, Editor HUGH ARCHBALD, E. M., Asst. Editor

CHICAGO OFFICE: 1006 Michigan Ave.

Entered at the Post Office at Scranton, Pa., as second-class matter

Address all business communications to MINES AND MINERALS, Scranton, Pa.

CABLE ADDRESS, "RETSOF, SCRANTON"

LONDON OFFICE: INTERNATIONAL BUILDINGS, KINGSWAY, LONDON, W. C.

SOUTH AFRICAN OFFICE: MANSION HOUSE CHAMBERS, ALDERLEY STREET, CAPE TOWN.

NEW ZEALAND OFFICE: 63 DINON STREET, WELLINGTON.

AUSTRALIAN OFFICE: 83 PITT STREET, SYDNEY.

SUBSCRIPTION RATES

Single Copies..... 25 cent-

Yearly Subscription, including postage:

To United States, Mexico, Cuba, Porto Rico, Hawaii, and Philippines \$2.00

To Canada..... 2.50

To all other countries..... 3.00

The date after your name on the wrapper is that of the month to which your

subscription has been paid. If you do not want to continue your subscription

after that time, kindly notify us.

Notice to discontinue or change of address should be sent to the Scranton

office.

When notifying us of a change of address always give your FORMER as well

as your present address.

TABLE OF CONTENTS

Editorial—	
Editorial Notes—Correction—Notice—Statement—Proper Mining	
Terms—Putting Money into the Ground.....	175
Personals.....	178
Correction.....	178

COAL MINING AND PREPARATION

The Lathrop Coal Co., by J. Harvey Williams.....	179
Testing Texas Lump Lignite, by D. C. Earnest.....	180
A Preventable Shaft-Sinking Accident.....	181
The Panther Valley Mining Institute.....	182
Annual First-Aid Contests.....	183
Trade Notices.....	188
Correspondence—	
Anxious Answered—Gases from Acetylene Lamp.....	189
Societies.....	189
Why Is a Stopping? by Oscar Cartledge.....	190
Determining Coal Values, by E. G. Bailey.....	191
Coal Washing and Briquetting.....	193
A Method of Socketing or Capping Winding Ropes.....	195
Derailing Switches for Slopes, by Simon E. Ash.....	196
Hogan on the Bureau of Mines.....	197
Commercial Sampling of Coal, by C. E. Scott.....	199
New Steel Mine Support.....	201
Self-Burning Limestone in Syria.....	201
Facts About Anthracite Mining, by E. W. Parker.....	202
Book Review.....	203

Answers to Examination Questions—	
Mine Foremen, Second Grade, Pennsylvania Bituminous, 1912.....	204
Carbon Monoxide in Illuminating Gas.....	206

ORE MINING AND METALLURGY

Rock Phosphate in Kentucky, by James H. Gardner.....	207
Authentic Petroleum Lore.....	209
Deep Mining in California, by Al. H. Martin.....	210
Economic Efficiency in Lead Concentration, by R. S. Hurd.....	211
Manganese in Gold Amalgamation.....	212
Practical Cyaniding—Part 4, by John Randall.....	213
Causes of Fires in Metal Mines, by T. A. Teft.....	218
Sand Filling on the Rand, by Edgar Pam.....	219
South African Shaft Sinking Practice.....	220
Air-Balanced Hoisting Engine, by R. H. Corbin.....	221
Gulch Mining in Gilpin County, by Arthur J. Hoskin.....	223
Rhigolene.....	224
Some Problems in Mine Surveying, by C. R. Forbes.....	226
Iron Mining in Missouri, by Lucius L. Wittich.....	227
Asbestos, by Warren W. Currens.....	229
Diseases of Metals.....	230
New Mining Machinery—	
New Electric Mine Pump—Fuses for Electric Lines Nonpareil.....	231
High-Pressure Covering—Sectional Unit Switchboard.....	231
Catalogs Received.....	232
Illinois Coal Statistics.....	232
Squibs—	
An Early Instance of First Aid, 195—Track Drainage, 196—Capacity	
of Rolls, 197—Reduction of Accidents in French Mines, 197—Mine	
Superintendent's Responsibility, 203—The Mining Industry of	
Formosa, 211—Bismuth, 212—Bureau of Mines Examinations, 217	
—Blister Plates for Sampling, 219—Nova Scotia Gold Production,	
220—Difficulties, 222—Assay of Cyanide Solutions, 225—Two	
Kinds of Sulphur Mining, 228—Homestake Electric Plant.....	230

IN selecting a mine manager, or a mine foreman, it is just as essential to know under what conditions he made his record as to know the record. An inferior man in charge of a mine where all natural conditions are favorable to economical and safe mining may acquire a better reputation than a superior man in charge of a mine where the natural conditions are not nearly so favorable.

來 來

ON another page, Malachi Hogan, an old Irish coal miner and philosopher, discusses with his friend Reilly the work of the Federal Bureau of Mines, from the standpoint of the mine worker. Mr. Hogan expresses himself emphatically on some of the vagaries of the Bureau, and the truths so quaintly expressed in his native brogue will be appreciated by all practical coal-mining men, from miners to general managers.

來 來

IN September many of the numerous First-aid corps held competitive contests; and in this issue of MINES AND MINERALS, will be found an account of several. The Wadesville No. 3 First-aid team, one of the 72 which took part in the Philadelphia & Reading Coal and Iron Co.'s contest is shown on the front cover. The subject has left eye bandaged because of an injury and the right arm in splints, because the hand has been crushed. This shows the neat work which first-aid teams perform.

來 來

Correction

IN our October issue we entitled the article descriptive of the Christopher No. 2 Mine of the United Coal Mining Co. "Buckner No. 2 Mine" instead of "Christopher No. 2 Mine." The name we used is a local designation, and is not the correct name by which the mine and its product are so favorably known.

來 來

Notice

THE Denver editorial office of MINES AND MINERALS was closed on November 1, and all business heretofore transacted there has been transferred to the main offices at Scranton. The editorial force at Scranton has been augmented so that plans for the constant improvement of the journal may be more conveniently and quickly carried out. All mail heretofore sent to Denver should from this date be addressed to Scranton, Pa.

In this connection the management desires to emphatically state that the change and consequent retirement of Prof. A. J. Hoskin as Western Editor is not due in any way

to lack of ability or loyalty on his part. On the contrary, if Professor Hoskin's personal affairs permitted his locating in the East, we would have been pleased to retain his services. As it is, he will be an occasional contributor and from time to time will very probably be called on for special service in line with the plans decided on.

柔 柔
Statement

MINES AND MINERALS, and similar publications are now required, by the Post Office Department, to file, with the Postmaster General, a sworn statement giving the names of the publishers, owners, editors, business managers and, if owned by a corporation, the names of the holders of at least 1 per cent. of the stock, twice each year, and to publish the same in its reading columns. In just what way this information will be of service to the Government we are at loss to understand, but the statement required will be found in this column.

Our readers probably know that MINES AND MINERALS is one of the properties of the International Textbook Co., whose stock is very widely held, so that while we would gladly do so were it practical, it would be impossible to give a complete list of the stockholders without crowding out of our reading columns, matter of vastly more interest to our subscribers. We have, therefore, taken advantage of the clause which permits us to give only the names of those whose holdings amount to more than 1 per cent. of the stock of the corporation.

Statement of the Ownership, Management, Circulation, etc., of MINES AND MINERALS, published monthly at Scranton, Pa., required by the Act of August 24, 1912.

NAME OF	POST-OFFICE ADDRESS
Editor, E. B. Wilson.....	Scranton, Pa.
Managing Editor, Rufus J. Foster.....	Scranton, Pa.
Business Manager, Rufus J. Foster.....	Scranton, Pa.
Publisher, International Textbook Co.....	Scranton, Pa.

Owners: (If a corporation, give names and addresses of stockholders holding 1 per cent. or more of total amount of stock.)

T. J. Foster.....	Scranton, Pa.
Rufus J. Foster.....	Scranton, Pa.
J. K. Griffith.....	Pittston, Pa.
Elmer H. Lawall.....	Wilkes-Barre, Pa.

Known bondholders, mortgagees, and other security holders, holding 1 per cent. or more of total amount of bonds, mortgages, or other securities:

NONE.

RUFUS J. FOSTER,
Business Manager

Sworn to and subscribed before me this 30th day of September, 1912.

FRANK LAMBADER,
Notary Public

[Seal]

(My commission expires February 8, 1913.)

柔 柔

Proper Mining Terms

MINING ENGINEERS who are editors have persistently advocated the proper use of mining terms. So early as 1880 Dr. Rossiter W. Raymond compiled a "Glossary of Mining and Metallurgical Terms," which was printed in Vol. IX of the Transactions of American Institute of Mining Engineers, and he has frequently urged engineers to carefully consider their expressions when writing.

The erroneous impression prevails that if a judge,

ignorant of a technical meaning, constructs a definition to suit his case, that he has forever defined the word. Mr. D. W. Kuhn, of Pittsburg, Pa., in his remarks on the Sherman anti-trust law said: "A judge in Tennessee held in an elaborate opinion that a mule was a horse, and the court has ever since stuck to that decision." He also commits "lese majeste" and says "the Supreme Court has sometimes as much as said that a mule was a horse and at other times that a mule was not a horse"; but in the face of this the Attorney General "believes every horse is a mule."

The legal fraternity are not the only sinners; young mining engineers and many older ones use colloquialisms, which amount to the use of slang to those not intimately acquainted with the district, and usually leave a doubt in the reader's mind as to the writer's meaning. Take for instance the word "killas," a Cornish term which is used to express a series of more or less fissile sedimentary rocks in the West of England mining region, but not elsewhere. As another example, take the word "elvans," a term which has been applied to almost every kind of rock which occurs in dikes or distinct beds, other than granite, limestone, slate, or shale, and consequently has to be defined to mean anything. This term is also local and confined to Cornwall unless a Cornishman gets away from his native land. While the use of colloquialisms in technical writing tends to spread illiteracy, the misuse of words by those who pose as mining experts is inexcusable. Frequently they will write on anthracite coal, zinc-blende, veins of coal, butt-headings, cross-cuts in coal veins, and numerous other monstrosities. Doctor Chance defined the word heading as "the face where work is being done in driving a horizontal passage."

Miller's definition of heading is "the breast or face of a working."

W. S. Gresley states a "heading is any subterranean passage driven for the purpose of proving or working the mine." The Standard Dictionary gives the following definition of heading: "A driftway in the line of a tunnel or adit in which men work; also any place where work is being done in driving a horizontal passage."

Coal and Metal Miners' Pocketbook: (1) A continuous passage for air or for use as a manway; a gangway or entry. (2) A connecting passage between two rooms or other working places. The word "heading" is derived from the word "head," meaning a leader. Doctor Chance is right for coal, and Mr. Miller is right for ore; the other definitions are wrong or partly so. An expert must have written the Standard definition to make use of the term *driftway*, and then getting mixed used the Doctor Chance definition.

Many of the so-called "butt entries" are "face entries" in which case the main entry is a butt entry, and some one is going to become mixed. If there is any necessity for using the word "butt," which signifies the short cleat in coal, it should be used correctly. The term "cross-entry" should be given the preference, as it means an entry turned at right angles to the "main entries."

The Institute of Mining and Metallurgy, England, is now trying to standardize mining terms; they should consult our friend T. A. Rickard if in doubt on the proper word to use.

采 采

Putting Money into the Ground

ONE hears many caustic remarks about the money that has been wasted—actually thrown away—in mining. There is a very common statement, taken by most people as fact, to the effect that more money has been put into, than has ever been taken out of, the ground. Many people accept this in the same way that they assent to many other popular remarks, giving no considerable amount of thought to the matter but assuming that this epigram must have been coined by somebody who had authority to speak.

It cannot be denied that vast sums of money have been actually thrown away in men's aspirations for mineral wealth. But can anybody deny that just as great sums have been wasted in the pursuit of other forms of wealth? Why has nobody coined the remark that more money has been lost in mercantile lines than has been won from them?

Acknowledging that money has really been lost "in mining," let us consider the manner of its losing. There are certain ways in which this money could be lost that would appeal to us as strictly legitimate; but there are more numerous and unqualifiedly illegitimate ways of unprofitably dispersing capital.

People, as we all know, possess an innate gambling tendency. This has often induced people of small as well as large means to undertake ventures, pure and simple, in mining. Without perhaps a single worthy indication, they have spent good money in the exploitation of ground, in driving long cross-cuts, or in sinking deep shafts or inclines. Is it any wonder that the majority of such undertakings have proved failures? Not at all; nor is it fair to charge such pure speculations against mining proper.

Other people are prone to be induced by the most unwarrantable excuses to prosecute operations in unproved ground. Many persons have spent large amounts in ground exploitation merely in pursuance of dreams, or because they have been advised by spirits, or the more tangible, but no more reliable, fortune tellers, who are always ready to pervert this industry to their illegitimate ends. Such losses of money should not be placed on the debit side of mining.

Then, too, we must award the wild-catters and mine sharks their just credit for the ill repute into which the mining industry has fallen among their many dupes. Such victims are made to feel that they have really had a taste of mining, but the fact remains that they were never directly concerned with any actual mining. They were no more associated with the business of mining than if they had bought "green goods" or "gold bricks." Consequently, it is only justice to exclude such money losses from the account books of the mining industry.

We can now pass to slightly different sorts of capital expenditure that have almost invariably proved losses. We recognize numerous ways in which persons have unwisely placed money that was presumed to develop mining property.

One very familiar method of parting with money upon the assumption that it is going into mining is to listen to, then believe, and finally to follow, the advice of "practical miners," prospectors, and other persons who lack technical knowledge along geological or mineralogical lines. When anybody has lived in mining communities long enough, he will understand the force of this argument against heeding the advice of all such individuals. This is not meant to imply that all such persons are actually deceitful. It is perhaps true that there is not another class of individuals more absolutely honest at heart than prospectors. Genuine prospectors always expect to win their fortunes from Mother Earth and they have no thought of cheating. They finally become imbued with the idea that they have succeeded in finding their coveted bonanzas; but they usually fail in the culmination of their quests only because they have exhausted their resources. Hence they must find persons of means who will assist them financially to their goals. Their stories are beguiling and they ring with sincerity: sometimes they may prove just as true as they sound; but, more often, these men are so misled by their hopes that realities are unintentionally distorted. Persons who yield to the lure of such tales and eventually regret their steps have no logical reason for placing any censure upon the industry of mining. On the other hand, they should blame themselves roundly and learn the lesson that such a mistake presents.

A certain class of imposters, omnipresent in every new (if not in every old) mining district or camp, stands responsible for a large percentage of the losses incurred by inexperienced mining investors. These men are pretenders pure and simple. They pose as either mining engineers or "practical miners." They are sometimes known among the legitimate engineers as "sidewalk experts." They frequent hotel lobbies and ingratiate themselves with the new arrivals in camp until they overcome their deficiency by a superabundance of cleverly contrived conversation that quite disarms the victims. Whether or not such fakers have any mining propositions worthy of consideration, the chance of success in mining under their guidance is, indeed, precarious. Assuming that such a person really has the right to promote and to develop a given piece of worthy mining property, how much chance does the capitalist have of getting value received for his money if such investment be administered by one ignorant of mining economics? Quite often, these self-styled mining engineers believe themselves to be sincere in their promotions, but they finally come to the miserable terminations of their efforts with absolutely no benefit to their clients and with very little permanent benefit to themselves. Of course, they always see to it that they receive commissions or salaries so long as the funds last.

Personals

John T. Fuller, E. M., formerly with the DeBeers company, South Africa, is now Superintendent of Mines for the Canadian Copper Co., Copper Cliff, Ontario.

Charles L. Fay, mining secretary of the Y. M. C. A., resigned his position October 1, to enter the manufacturing and sale of oils and oil products at Wilkes-Barre, Pa. Mr. Fay will continue as Secretary-Treasurer of the Coal Mining Institute of America.

John P. Reese has been appointed general superintendent of the coal mining operations of the Chicago & Northwestern road. The operations are the Superior Coal Co., of Illinois, and the Consolidation Coal Co., of Iowa.

W. R. Brasher, of St. Charles, Ky., has been appointed assistant mine inspector by Prof. C. J. Norwood, chief inspector of Kentucky, to succeed T. O. Long, whose time has expired.

Old Freibergers in America are arranging for a dinner in New York City around the Christmas holidays. Secretary, C. L. Bryden, 1015 Myrtle St., Scranton, Pa.

Archibald A. C. Dickson, Metallurgist and Mining Engineer, announces the removal of his office from Rejauli P. O., India, to Kodarma, E. I. R., India, where facilities exist for conducting his professional work economically and efficiently.

Robert S. Lewis, Salt Lake City, has been appointed Associate Professor of Mining, State University, Salt Lake City, Utah.

V. H. Hughes, E. M., has been appointed Assistant State Geologist of Missouri.

F. L. Sizer has taken the position of general superintendent of the Mascot Copper Co., at Dos Cabezas, Arizona.

James H. Gardner, formerly Assistant Geologist on the U. S. Geological Survey and recently doing work on the clays, coals, and oil fields for the State Geological Survey of Kentucky, has been engaged by the Topographic and Geologic Survey of Pennsylvania and given charge of the mapping and general study of the Broad Top coal field, with field headquarters at Hopewell, Pa.

Samuel M. McMahon, has been promoted to the position of Superintendent of the La Belle mine, of Wellsburg, West Virginia, belonging to the West Virginia-Pittsburg Coal Co., of Pittsburg.

William O'Conner, F. G. S., Mining Engineer, Argoed, Monmouthshire, England, attended the first-aid contest for the "Muckle Cup" at Inkerman, Pa.

John J. Tierney, Vice-President and General Sales Manager of the Cooser-Pocahontas Sales Co., sailed for Europe October 8, for a well-earned rest. He expects to return in November.

W. E. Fohl, J. Aarons, and R. N. Hosler, Membership Committee of the Coal Mining Institute of America, hereby serve notice that each member is to secure one new member before December 10, 1912.

George Watkin Evans, Mining Engineer, of Seattle, Washington, who has been examining the Ground Hog Coal Field, Hazleton District, British Columbia, was injured while in the field, but is now recovering. He had planned to return but has decided to remain in Seattle for the winter.

Dr. Henry M. Payne, has returned from the Yukon Gold Fields in Alaska, where he spent the summer in consultation work. He is associated with S. T. Williams and staff, 346 Broadway, New York City.

Robert M. Black, formerly engineer with mining companies in Oklahoma, Illinois, and West Virginia, has been chosen for the assistant professorship of mining in the University of Pittsburg, succeeding E. N. Zern, now of the West Virginia University.

Prof. Arthur J. Hoskins, late western editor of MINES AND MINERALS, has established an office in Room 1221, First National Bank Building, Denver, Colo., to resume the practice of his profession as a mining and metallurgical engineer, giving special attention to examinations, equipment, operation, management, and consultation. Professor Hoskins is eminently qualified to succeed in such work through a diversified experience of nearly 20 years, in which he has combined practical work with close study of the methods applied in successful operations throughout the Rocky Mountain region.

Frank Koester, Consulting Engineer, has removed his office from 115 Broadway to larger quarters at 50 Church Street (Hudson Terminal Bldg.), New York. Mr. Koester is principally engaged in steam and hydroelectric power plant work and electric transmission.

Rush T. Sill, Mining Engineer, and Harley A. Sill, Metallurgist, have opened an office in Los Angeles, California, to carry on work in their specialties. They were formerly located at Culiacan, Mexico.

Prof. J. F. Kemp, of New York, has returned from an inspection of geological conditions in Panama.

C. E. Coolidge and C. S. Johnson, have been appointed assistant professors in mechanical engineering at the Colorado School of Mines.

Dr. F. H. Newell, director of the U. S. Reclamation Service, on September 20, addressed the Colorado Scientific Society, Denver, on "Reclamation."

Chester T. Kennan, Eagle, Colorado, is active in a movement on the part of prospectors and miners to have mineral lands above timber line withdrawn from national forest reserves.

Thomas Thomas, of Dorranceton, Pa., was recently promoted to be General Superintendent of the Lehigh Valley Coal Co., with headquarters at Wilkes-Barre, Pa. Mr. Thomas is a man who has successfully devoted himself to one company. He started to work in 1877, when he was 9 years old, for the same company of which he is now general superintendent, and except for the years when he was attending school and college, he has always worked for the Lehigh Valley Coal Co. His first work in the mines was tending door, an occupation at which a good many of the competent men of the anthracite region started. With that beginning, he has done every kind of work around the mines. Mr. Thomas is also a college man, having been a member of the class of 1886 at Lehigh. Shortly after leaving college, in 1891, he was made outside foreman at the Exeter colliery and then inside foreman in 1894. In 1901 he was made superintendent of the Lackawanna Division of the Lehigh Valley Coal Co., which comprised several collieries near Pittston, Pa., among them being the one in which he had started to work as a boy. Then, successively, Mr. Thomas was put in charge of the Hazleton district in 1905, and the Wyoming district in 1907, until he is now General Superintendent.

J. H. Hearter, of Wilkes-Barre, has been appointed to the position which Mr. Thomas formerly held.

The Denver & Rio Grande Railroad has provided J. C. Roberts, of the United States Bureau of Mines, a coach for use in traveling throughout the portions of Colorado traversed only by narrow-gauge roads. This car has been fitted up with the apparatus from the regular standard-gauge rescue car, and on September 5 started on its first trip. Professor Roberts, K. H. Chisholm, foreman miner, and W. D. Scofield, first-aid miner, will have charge of the work and will give instruction in both first-aid and rescue work in all of the metal mining camps of southwestern Colorado.

At the examination for Managers of Mine Rescue Stations, held by the State Civil Service Commission of Illinois on October 3, 1912, the following candidates successfully passed: Oscar Cartledge, Marion, Ill.; Evan D. John, Carbondale, Ill.; John Dunlop, Peoria, Ill.

Correction

The flow sheet, which appeared on page 96 of the September issue of MINES AND MINERALS, shows a recovery of the barite from the tables and no galena, whereas it should show a recovery of galena and no barite at this point. The middling is returned to the table feed and the barite rejected with the tailing, as the recovery of this fine material is unprofitable.

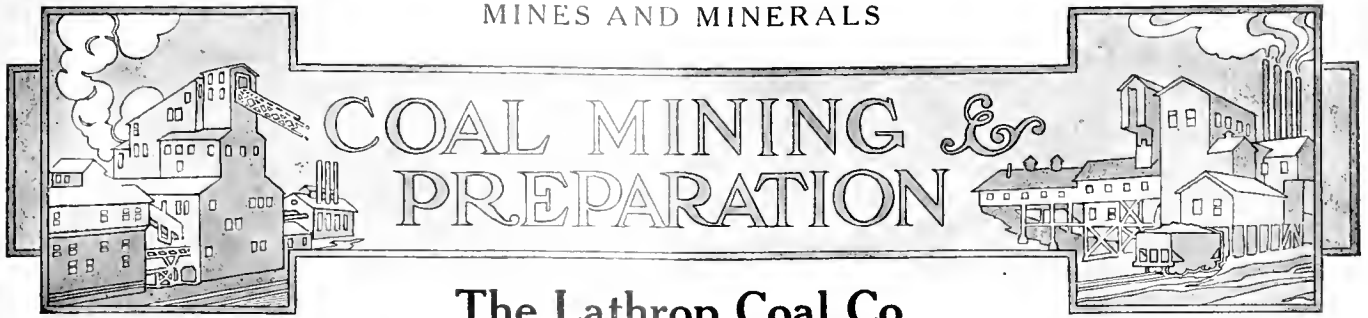

The Lathrop Coal Co.

A Description of the New Plant at Panther, W. Va., and the Method Employed in Mining

By J. Harvey Williams, E. M.*

A FEW years ago, Panther (a small town situated on Tug Fork of the Big Sandy, in McDowell County, W. Va., and about midway between Welch and Williamson) was known as a lumber manufacturing town, but the stately poplar and the brave old oak could not stand the mighty onslaught of the axman, so the lumber mills are no more.

Fifteen months ago, however, the town took on a new life, and its inhabitants

north of west on a grade of about $1\frac{1}{2}$ per cent.; the roof is of solid sandstone and is prominent all around the outcrop, thereby preserving the quality of the outcrop coal.

The present projection for the development of this mine was made with the view of securing a maximum efficiency of the ventilating current, safety to the employes

so doing, overcasts will be constructed in order to furnish a separate split of air for these sections, regulators being installed at proper

places to govern the flow of air to various parts of the mine.

The method as adopted for mining the coal, which is shown in Fig. 2, is to drive the cross-entries out, then drive out the four rooms nearest the outcrop and start retreating with these four pillars as soon as the rooms are finished. While the pillars

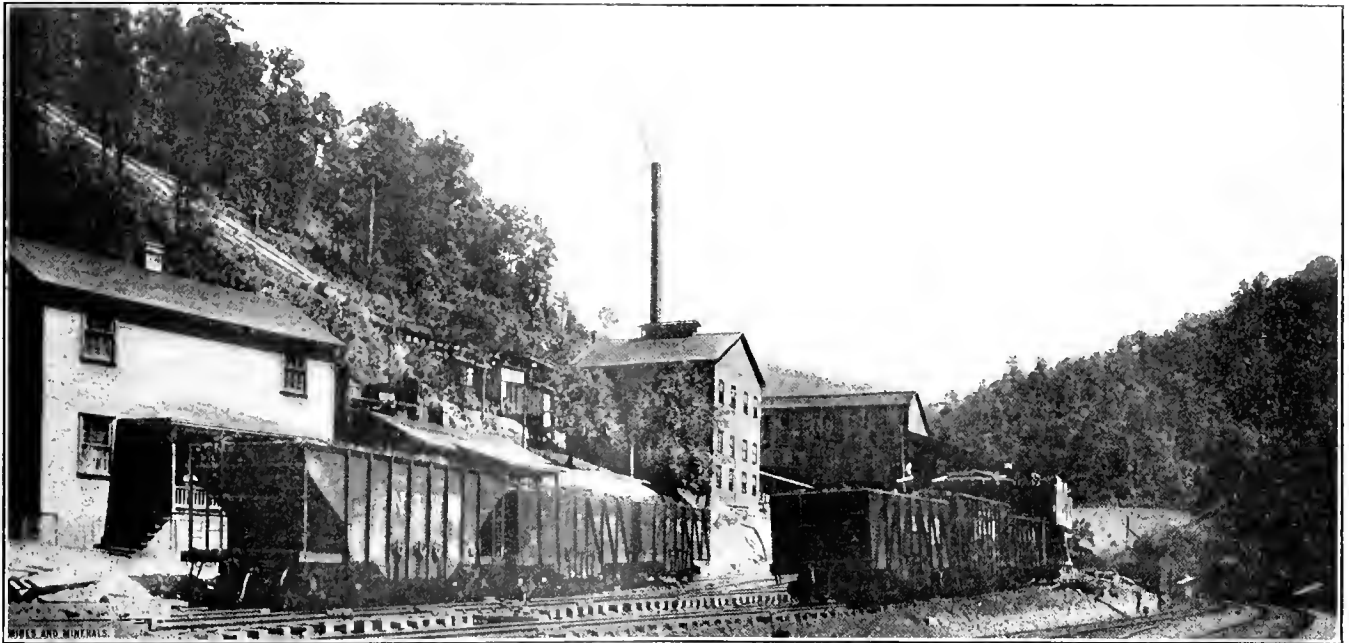

FIG. 1. PLANT OF THE LATHROP COAL CO.

together with those of the surrounding community were glad to see the hillside being leveled off for storage tracks and work in general going on toward installing a large coal operation. Today many of them find employment with the Lathrop Coal Co., while others till the soil and find a ready market and a good price for their products.

There are several veins of coal underlying the hills around Panther, but the one nearest the hilltop is being operated by the Lathrop Coal Co. and is 700 feet vertical height above the railroad. The vein is from $6\frac{1}{2}$ to 7 feet thick and the coal is of excellent quality, being high in carbon and low in ash. The dip of the strata at this point is approximately 45 degrees

*Welch, W. Va.

inside of the mine, and the total extraction of the coal, together with a minimum cost to the operators.

Owing to the fact that there is a long line of outcrop and necessarily will be many breaks to the outside, the management favored a force fan, therefore a $5' \times 7'$ Jeffrey electric force fan was installed in the center entry or airway, the entries on either side forming the return airways as well as being the haulage ways, thus forming a three-entry system. All cut-throughs are built up with stone stoppings as fast as the work advances, in order to force the intake air directly to the face of the main entries and allowing it to return along the rooms, cross-entries, etc. Where cross-entries have sufficient territory to warrant

are being drawn the next four rooms are driven up and so on until the cross-entry is finished.

The writer is of the opinion that this method of mining will obtain a minimum cost for track work and from falls of roof and eliminate all possibilities of a squeeze.

All entries are driven 70 feet on centers and 14 feet wide. Rooms are 70 feet on centers and 30 feet wide, with two tracks in each room; the motor delivers an empty on one track and takes the load from the other, thus giving the miner a chance to keep busy loading and saves labor for him by reducing the distance from the coal to the car.

The coal is all cut with electric machines of the Goodman short-wall type, and is

hauled to the top of the plane with Good-man motors, where it is dumped into a receiving bin; from this bin it is conveyed to the lower tippie by 10-ton monitors and a 14-foot diameter drum, over a plane 1,450 feet long. This is without exception the best plane of its character that I have ever seen, being laid of 60-pound steel on well hewn and sawed ties. When the coal reaches the foot of the plane, it is dumped into a receiving bin, which is equipped with an oscillating feeder that delivers the coal on to a shaker with $\frac{7}{8}$ -inch spaces between bars, which takes out all of the slack and delivers the over sizes on to a picking table where the coal is cleaned; and when making run of mine, the slack and over sizes are reassembled after clean-

one for egg, one for lump, and one for box-car loading. The blacksmith and machine shop are conveniently arranged.

The power plant consists of one 275-horsepower upright boiler, with a water heater, and one 150-kilowatt, 250-volt, Ridgway generator. The coal is delivered to the power house from the tippie by a conveyer, and the ashes are flushed from the power plant through a 12-inch pipe; this enables one man to easily take care of the power plant and the deep-well pump, which pumps water into a 30,000-gallon tank for the town supply, and a 40,000-gallon tank for the power plant.

An electric hoist and a separate plane, laid with 40-pound rails conveys the men to and from the mine, and hauls supplies.

Testing Texas Lump Lignite

By D. C. Earnest

On page 3 of the August edition of MINES AND MINERALS there is an article entitled "The Status of the Gas Producer," and we take exception to the statement that for steaming purposes lignite is practically valueless. This statement has been made by the United States Bureau of Mines many times, and up to this time it has not been challenged by this company because we had an idea that the investigations made by the Bureau of Mines would show that lignite was not valueless for steaming purposes.

During the last seven years our company alone has produced and sold for

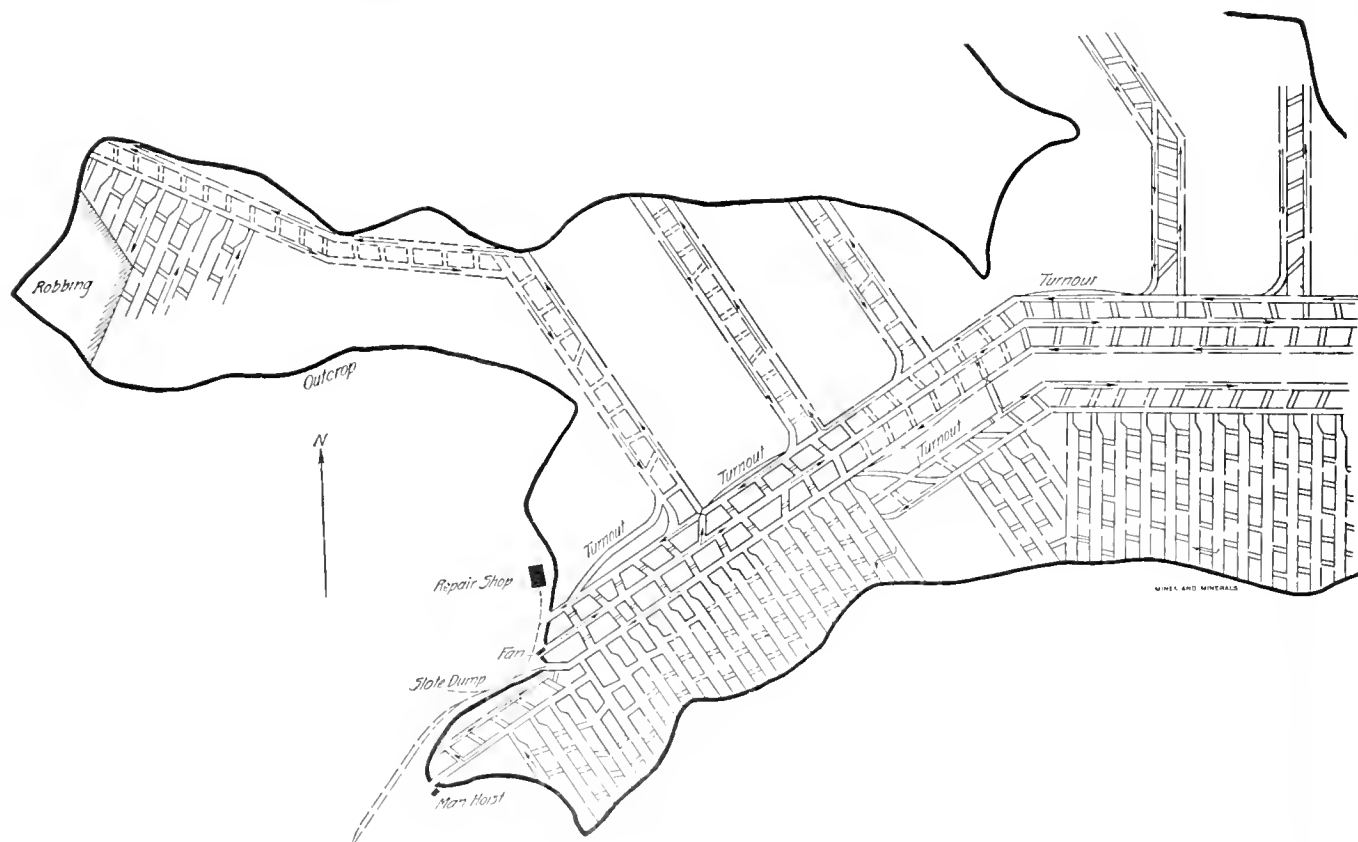

FIG. 2. METHOD OF MINING, LATHROP COAL CO.

ing. When making prepared coal, it is delivered from the picking table on to a second slack screen with $\frac{7}{8}$ -inch openings and from this to a screen with $1\frac{1}{2}$ -inch openings which makes nut coal, the over sizes going on to a screen with $3\frac{1}{2}$ -inch openings making egg coal. All of the coal that passes over this latter screen is conveyed to the lump car by an electric traveling table which can be raised or lowered, thereby saving the breakage of the coal. The screens are all of shaker type and the tippie in every respect is up to date. Slack and all other sizes can be loaded together; or nut and egg, or egg and lump together, all of the machinery being run by electric motors. There are five loading tracks, one for mine run and slack, one for nut,

All houses are built single, with two, three, and four rooms, as the miners like these much better than double houses. The houses are plastered inside and are neatly furnished, giving a good appearance to the town in general. The company store has ample room for offices outside the store department. There are two churches, one for white and one for colored, and Mr. Leckie who is president and general manager of the company has constructed a building for the different secret orders at this place. He is very much concerned as to the welfare of his employes and is always ready to encourage them along social and educational lines, and one can safely say that he will spare no pains to keep the operation and the town up to date.

steam purposes in Texas more than 40,000 cars of lignite coal, and this coal has been sold in a territory where fuel oil and slack coal were abundant at low prices. Now if lignite was valueless as a steam producer, it would be impossible for this company to sell 40,000 cars of coal in seven years. During the same period of time we believe that other lignite companies in Texas have sold as many as 60,000 cars.

As evidence that lignite coal properly burned has some value, we refer you to an evaporative test made at the plant of the Columbia Mfg. Co., at Dallas, Tex., and lignite is now being fur-

*President of Consumers Lignite Co., Dallas, Tex.

nished to this plant notwithstanding natural gas is here in abundance, fuel oil, until the last few weeks, has been sold at a very low price, and large quantities of coal from Oklahoma and Arkansas are offered in this market at reasonable prices.

The United States Bureau of Mines has accomplished a great deal for the lignite industry of the United States by calling attention to the value of lignite when converted into producer gas, but this Bureau has invariably done the lignite industry a great injustice by always stating that the lignite has no value as a steam producer.

The following is a report of the test:
REPORT OF A BOILER TEST AT THE PLANT OF
COLUMBIA MFG. CO., DALLAS, TEX.

Object of test: To determine the difference in evaporation of lump lignite and black lignite.

Fuel used: Hoyt lump lignite coal screened over a $\frac{3}{4}$ -inch screen, mined at Hoyt, Texas, and sold by Consumers Lignite Co., Dallas, Tex.

Equipment consisted of two O'Brien horizontal return tubular boilers, set in brick, with a 4-inch air-chamber wall vented to the outside. Each boiler is 72 inches in diameter by 22 feet long, with twenty-six 6-inch tubes, and has a common furnace with 84 square feet of surface. The stack is 4 feet in diameter and 100 feet high, set on a twin uptake over the two boilers. In the uptake is placed a bank of 2-inch pipes to further increase the feedwater temperature.

The grates, built for lignite, are 4 inches wide, 6 feet long, and the width of the furnace is 14 feet. Each linear foot has twenty-five $\frac{3}{8}$ -inch round holes, and the air surface is 20 per cent. of the grate surface.

The furnace draft doors are bricked up solid, and in the center of each furnace is located an Argand steam blower, the center ring of which has eighteen 32-inch holes.

The lignite tested was weighed by Mr. J. A. Shortess. The weights for each hour were recorded on the data sheets. A sample of lignite was secured each hour at random from the pile, and placed in a box; and after the tests were completed an average sample was taken and sent to the laboratory for analysis.

All feedwater was measured by a turbine wheel meter, and read each hour.

Thermometers of the Schaffer & Budenburg type were used to take the feedwater and stack temperatures.

Analyses of the furnace gases were taken every 15 minutes and analyzed for carbon dioxide.

The test was started exactly at 11 A. M., May 16, 1912, and continued until 9 P. M. the same day, 10 hours' run.

The fireman had no special instruction as to how to fire the coal, and all asked

was to keep the water in the gauge glasses on the strings which were placed at the beginning of the test.

The boiler tubes were blown an hour before the test, but not during the test at any time. The blow-off pipe was not opened any time during the test.

There are six furnace doors, and each door was alternately fired every few minutes by one fireman. The average length of time the doors were open during operation for firing each hour was 24 per cent. of the time. This observation was taken by a stop watch. The CO in the flue gases during the time doors were open was never over 3 per cent., which shows a fuel loss during that time of 60 per cent. and proves the necessity of opening and closing doors just as quickly as possible, which so far as the engineer knows is never given any attention anywhere in Texas.

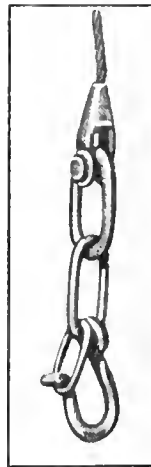

FIG. 1

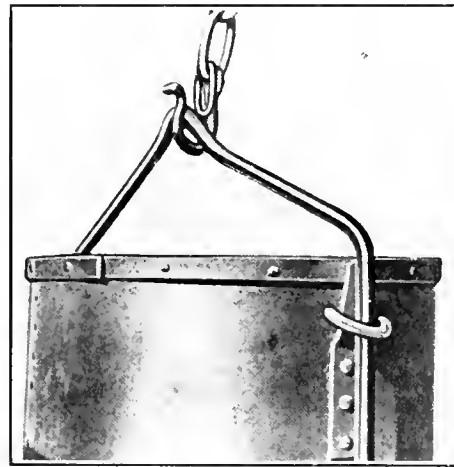

FIG. 2

The sample of lignite was analyzed by Landon C. Moore, and a certificate issued for 8,030 B. T. U. per pound. The moisture was 23.52 per cent., which is below the average moisture content of lignite throughout the state.

From the log the average for 10 hours was as follows: Steam pressure, 105 pounds; air temperature, 80° F.; uptake, 563° F.; feedwater, 192° F.; total fuel, 30,302 pounds; total water, 133,301 pounds; boiler horsepower, 410; fuel per square foot grate per hour, 36 pounds; average evaporation per pound of lignite per hour, 4.44 pounds.

The combined efficiency of the furnace and boiler on the average was 54 per cent., we should expect 60 per cent. at least.

The cost to evaporate 1,000 pounds of water at this plant with lignite delivered for \$1.50 per ton, is 16.9 cents; or \$1.50 worth of lignite will evaporate 8,880 pounds of water.

The test and the above report were made by J. F. Greenwood, M. E., of Dallas, Texas.

A Preventable Shaft Sinking Accident

Mr. Oscar Cartlidge, State Mine Inspector for the Ninth District of Illinois, gives the following account of an accident that goes to show how necessary it is to have top men and bottom men who will refuse to allow men to run risks:

On February 13, 1911, a deplorable accident occurred at the No. 3 mine of the Saline County Coal Co., Harrisburg, in which four men lost their lives.

This is a new mine, the shaft having just been sunk, and the sinking buckets were still in use. The afternoon shift were timbering and had come on top to eat supper. They had a platform built in the shaft about 80 feet down, the shaft being about 200 feet deep.

The bucket was not allowed to swing in the shaft, being held in place by a follower and guides, and was attached to the rope by a hook and safety link. The rope was hooked to the bucket by one of the men who failed to fasten the safety link attached to the hook.

One bucket load of men was lowered to the bottom platform, the second load was in the bucket ready to be lowered, when the top man noticed that the safety link was not in place, and so informed the men. One of them said "let it go at that." The top man gave the signal to lower. Two men were standing on the south of the bucket to one on the north side, which caused the bucket to tip and catch on the edge of the platform. The hook became detached from the rope and the three men and bucket were precipitated to the platform below, killing them and one other who had preceded them.

The risk taken caused the death of four men, and left three widows and eight children without providers. The safety link used is shown in Fig. 1 in place, in Fig. 2 as detached.

The Panther Valley Mining Institute

(Written for *Mines and Minerals*)

The officials and employes of the Lehigh Coal and Navigation Co., whose operations are located between Mauch Chunk and Tamaqua, Pa., held a first meeting and a dinner, preparatory to beginning institute work, in the Opera House at Lansford, Pa., on the evening of October 5.

Three hundred and seventy-five men, officials, and employes, were present, and the guests at the speakers' table, all of whom had attended many gatherings of a similar nature, voluntarily and freely expressed the opinion that in the apparent character and natural intelligence of the men present, it was equal to any, and excelled many gatherings, of men in mining or other vocations, they had attended.

The large room was neatly decorated, the tables were conveniently and tastily arranged, and back of the speakers' table under an electrical design, partly hidden by ferns, was an excellent orchestra, which discoursed appropriate music during the dinner, and accompaniments to popular songs between the addresses.

After an excellent dinner, coffee and cigars were served, and the real business of the evening began. Mr. W. G. Whildin, General Inside Superintendent of the Lehigh Coal and Navigation Co.'s collieries, presided, and seated with Mr. Whildin, and Mr. Edwin Ludlow, Vice-President and Manager of the Lehigh Coal and Navigation Co., at the same table as guests, were S. D. Warriner, President of the company; Rev. J. J. Curran, of Wilkes-Barre, Pa.; E. W. Parker, Chief Statistician of the United States Geological Survey; Thomas Thomas, General Superintendent of the Lehigh Valley Coal Co., and President of the Wilkes-Barre Mining Institute; C. L. Fay, formerly Mining Secretary of the Y. M. C. A., and Organizer of Institutes; Rufus J. Foster, Vice-President of the International Textbook Co. and Manager of MINES AND MINERALS; E. R. Jones, a coal mine superintendent from the state of Coahuila, Mexico; Dr. L. E. Rollet, of West Virginia; and Isaac M. Davies, State Inspector of Mines, of Lansford.

In a brief speech outlining in a most general way the objects of the meeting, and expressing his hopes for the success of the movement, Mr. Whildin introduced as the first speaker Rev. Father Curran. In his address, which called attention to his sympathy with mine workers and his personal assistance given them during the strike of 1902 and since then, he emphatically stated that he was as much in sympathy with educational movements, which tended to make the mine workers

more efficient, more intelligent, and to raise their standard of life, as he was to see them get a maximum wage. He commented on the real interest the leading officials of the present were taking in the uplift of the mine workers, as compared with the lack of interest of 35 years ago, when, as a young man, he worked in the mines. He clearly showed that there was an interdependence on the part of the workmen and the officials. That this interdependence should be recognized and encouraged by both sides. This meeting, he said, arranged by the officials, showed their interest, and he hoped the men would do their share to not only obtain the advantages in an educational way themselves, but to urge others, and particularly those of the non-English speaking races, to take advantage of them also. With a heartfelt wish for the success of the Panther Valley Mining Institute, Father Curran had to leave the hall hurriedly to catch a train that would enable him to be at home the next morning to officiate at his church services.

Mr. Thomas followed Father Curran with a sketch of the history of the Wilkes-Barre Institute, showing its growth from a small beginning of less than 150 members to a membership of over 1,400. He also, in a forceful manner, told of the success of the movement from an educational and efficiency standpoint. Mr. Parker followed Mr. Thomas with an interesting address in which he spoke of the advantages to be derived from such organizations by both employer and employe. In addition he presented some very interesting statistics regarding coal mining which are of such a nature that they are presented separately on another page.

Mr. Parker was followed by President Warriner of the Lehigh Coal and Navigation Co., who in a brief address expressed his great interest in the movement and his own desire to forward it by every means in his power. He spoke of the need of greater knowledge and consequently greater efficiency in not only officials but mine workers also, and his determination, if possible, to make all promotions to official positions from among the ranks of the company's own employes. He called attention to the fact that while the "foot of the ladder was crowded, there was room on the upper rungs for those who had the ambition to acquire the ability to hold places thereon."

Mr. Warriner was followed by Mr. R. J. Foster, who briefly sketched the difference in the attitude of the heads of the large companies today, in the matter of education and uplift of the employes, to that of 30 or 40 years ago. He showed how improvements in the conditions in anthracite mines commenced in

earnest as soon as they were taken over by the large companies, and that constant improvement had been going on ever since. While it was true accidents still occurred, and probably always would, that if the extent of the workings and other conditions in the mine were the same today as they were 40 years ago, the results would be wonderfully in favor of those of today. Even with more adverse conditions, there is a great improvement. In contrasting the old policy of the heads of the companies regarding the education of the employes, he related a personal experience with one of the most prominent engineers and managers of 20 years ago. This gentleman, he said, was a most estimable man in many ways, and was at one time his superior officer. In speaking of the International Correspondence Schools, which at that time were beginning to show results, he said: "I have no sympathy whatever with your undertaking. You may not realize it, but you are sowing the seed for great trouble in the future. By educating these men you are putting false notions in their heads, making them dissatisfied with their positions in life and encouraging them to demand more than the employers will concede to them." This narrow view, Mr. Foster said, was not held by the higher officials today. In every case, in the anthracite field, and as far as he knew in the various bituminous fields, the managers of the larger companies were encouraging the education of their employes, and assisting by every legitimate means in the social uplift of the men. He briefly expressed the hope that Mr. Whildin's expectations of the growth of the Panther Valley Institute would be more than realized.

Mr. Foster was followed by Mr. C. L. Fay, who reviewed the origin and history of the mining institute work, and in a somewhat detailed manner explained the objects and results obtained. As an enthusiast in the work he covered the field in a thorough manner and gave much advice as to what the aims should be, and how they were to be accomplished. At the close of his address, Mr. Whildin stated that owing to the lateness of the hour, and the fact that many of those present had to catch the last cars for home, he would refrain from calling on Mr. Ludlow and one or two others qualified to speak on the subject, and adjourned the meeting.

A unique feature of the dinner was the parodies on popular songs composed by Mr. Whildin and which were sung by the entire company accompanied by the orchestra. In each case the parodies had either a local significance or had reference to the institute.

The enthusiasm shown by those present, presages abundant success for the movement.

SUSQUEHANNA COAL CO.'S MEET.

The third annual competitive first-aid contest between the Susquehanna Coal Co., Mineral Railroad and Mining Co., Summit Branch Mining Co., and Lytle Coal Co., all under the management of Robert A. Quin of Wilkes-Barre, was held September 14, at Shamokin, Pa. The special train that left Wilkes-Barre at 6 A. M., carrying the officials, first-aid teams from Nanticoke,

Annual First-Aid Contests

An Account of the Contests Held by the Different Companies in Various Parts of the Country

Wadzinski and his subject, Russell Ogan from Nanticoke No. 5 Colliery, No. 2 shaft. Prize, French bronze medal.

Two-man event, was annexed by Ray Penman and Patrick McCarthy, with Frank Ramsey, subject. Prizes, French bronze medals. In the preliminaries the

attention drawn to the advisability of first-aid work, by an accident which happened at one of the latter company's collieries while he was on the ground. A short time after, at a conference of mining men, he suggested the matter of organizing first-aid work at the mines, and a few months later, when he assumed the management of the P. & R. C. and I. Co. he put his ideas in force. The outgrowth of his first experiment is the



JUDGES AND OFFICIALS AT RED CROSS CONTEST, INKERMAN, PA.

and their friends, arrived at Shamokin in time for the Nanticoke teams to reach Edgewood Park, and engage in the first contest at 9:30 A. M. The officials of the Susquehanna Coal Co. close their mines, and on this holiday and excursion, invite the operators and other mine officials in the hard coal field to be their guests. On this outing old friends meet, new friendships are formed, and in fact, the day is as enjoyable to the coal men as a county fair to the farmers. The mingling of the mine officials of the various collieries, which are widely separated, compensates for lost time, the expense for brass band, special trains, and luncheon; for the men exchange ideas to their mutual advantage and that of the company. This year 43 first-aid teams entered in the elimination contests out of which 29 qualified for the final contests. Drs. F. L. McKee, G. M. Stites, J. M. Maurer, and B. C. Guldin, all company men, were judges in the elimination contests. This arrangement proved satisfactory and caused one surgeon to say that after his experience as a judge, he would not, in the future, condemn another judge. After luncheon at which about 1,000 sat at tables, the final events were conducted, with Dr. J. B. Rogers, Pottsville; Dr. D. H. Lake, Kingston; and Dr. J. W. Geist, Wilkes-Barre, as judges.

The one-man event was won by John

Pennsylvania Outside, and No. 1 Slope team, to which these men belonged, received 100 mark in the four events.

Joseph Eyster, John Davis, James Campbell, and Charles Weaver, subject, all from Lake Fidler Outside, won the three-man event, receiving French bronze medals as prizes. Their score was 98.

The full-team event was won by Hickory Swamp Outside, composed of P. H. McGinnis, Captain; Ralph B. Platt, William Dockey, Clyde Castetter, Thomas Elliott; John Anderson, subject. Prize, silver cup and gold bronze medals. The cup must be won three times to be held permanently. The Glen Lyon team, won it at the second annual contest.

The prizes were presented to the winners of the one-man event and two-man event by A. L. Williams, Esq., Wilkes-Barre, Pa.; in the three-man event and full-team event, by Hon. F. B. Moser, Shamokin, Pa.

The surgeon who coached the winning team received a silver medal. The field was arranged exactly as the year before, as was shown in November, 1911.

PHILADELPHIA & READING FIELD DAY

Some 10 years ago W. J. Richards, vice-president and general manager of the Philadelphia & Reading Coal and Iron Co., at that time general manager of the Lehigh & Wilkes-Barre Coal Co., had his

splendid force of 76 first-aid corps, numbering nearly 500 trained men, recruited from the ranks of the mine workers, that held their eighth annual competitive drill at Lakeside Park, East Mahanoy Junction, Schuylkill County, Pa., on September 21.

The first-aid corps, mine officials, and invited guests, numbering between 1,600 and 1,700, were conveyed to the park from the various localities in special trains, which arrived on the ground shortly after 8 o'clock. Accompanying the corps were three brass bands, behind which the first-aid men and mine officials marched to the park, in review before Mr. Richards and the invited guests.

Dr. George H. Halberstadt, of Pottsville, Pa., the superintendent of first-aid work for the company, directed the competition, and Dr. J. B. Rogers, of the Pottsville Hospital, acted as judge.

Everything on the field being in readiness, the competition began very promptly. The first contests were by districts, of which there were ten. Ten preliminary contests were first held. The corps of each district drew, by lot, a number, and all the corps of that district competed in the same numbered contest as shown in the following list:

1. Compound fracture of skull and jaw.
2. (a) Foreign body imbedded in left cornea. (b) Crush of right hand.
3. Dress burns of head, neck, body, and arms.

4. Crush of pelvis and laceration of hips. Dress hip with spica. 5. Handling by one, two, three, and four bearers—cross obstruction. 6. Rescue patient from electrical contact—carry 10 feet. Artificial respiration. 7. Crushed foot, laceration of leg to middle third. Spiral reverse

cust Gap (inside corps), St. Nicholas (inside corps), West Shenandoah (inside corps), Henry Clay (inside corps), Otto, Good Spring, and Potts (Mammoth section). The closeness of the contest and the efficiency of the various corps is evidenced by the fact that with a rating of

Wilkes-Barre and Nanticoke, Pa. All the collieries of this company were represented by first-aid teams. Hollenback sent two; Empire, one; South Wilkes-Barre, three; Stanton, two; Sugar Notch, two; Lance, two; Nottingham, two; Reynolds, one; Wanamie, three; Maxwell,



PACKER NO. 5 TEAM, LEHIGH VALLEY COAL CO.

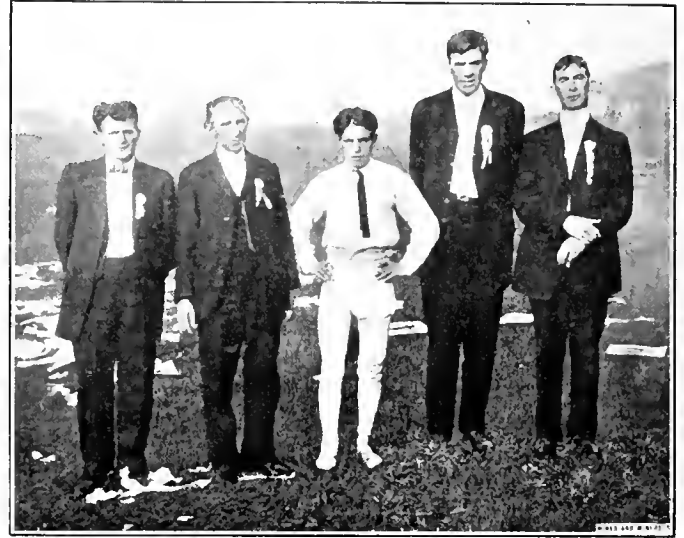

BEAR RIDGE COLLIERY TEAM, P. & R. C. & I. CO.

bandage. 8. Compound fracture of forearm with laceration of hand and fingers. Dress hand and fingers with spica. 9. Compound fracture of leg with dislocated thigh. 10. Fracture of spinal column.

The winning teams in the preliminary contests were as follows:

Event No. 1, Otto Colliery, Minersville District. Event No. 2, Wadesville Colliery and Bridgeport Transfer, St. Clair District. Event No. 3, Bear Ridge Colliery, Gilberton District. Event No. 4, Good Spring Colliery, Tremont District. Event No. 5, Henry Clay Colliery (inside corps), Shamokin District. Event No. 6, Potts Colliery (Mammoth Section Corps), Ashland District. Event No. 7, West Shenandoah Colliery (inside corps), Shenandoah District. Event No. 8, St. Nicholas Colliery (inside corps), St. Nicholas District. Event No. 9, Locust Gap Colliery (outside corps), Mt. Carmel District. Event No. 10, Tunnel Ridge Colliery (inside corps), Mahanoy District.

These 10 corps then competed in the final contest, which was to dress injury to foot, leg, thigh, and hip; spiral reverse leg and thigh; figure of 8 of knee, and spica of groin.

In this final contest the Bear Ridge Colliery corps, consisting of Peter Shoppie, leader, Thomas Hobin, subject, John T. Thomas, Dennis Sheehan, and Thomas McGrue, were declared the winners. The second place was won by the Tunnel Ridge Colliery (inside corps). The other district winners in order of grade were Wadesville and Bridgeport Transfer, Lo-

100 points for perfection, the lowest team had a credit of 94. The blue ribbons, the prizes, for the winning corps, after introductory remarks by Mr. Richards, were presented by Morris Williams, of Philadelphia, president of the Susquehanna Coal Co. Hon. O. P. Bechtel, of Pottsville; Dr. Herbert M. Wilson, engineer of the U. S. Bureau of Mines; Rev. W. H. Lindermath, of Pottsville; Dr. J. C. Biddle, superintendent of the Ashland Hospital; and Hon. J. R. Jones, presented the red ribbons to the other corps who had won places in the final competition.

Owing to the number of competing teams, the work occupied the entire day until nearly 6 p. m., except for about an hour, during which an excellent course dinner was simultaneously served to 1,670 persons at tables erected in the grove, by a Philadelphia caterer, who had a large corps of competent waiters.

Previous to the presentation of the prizes, the nearly 500 members of the various corps, under command of Doctor Halberstadt, to the music of the three bands marched in review before Mr. Richards and the guests.

In addition to the competitions, one of the company's new and improved ambulances was on exhibition. It attracted attention on account of its convenience and the comfortable provisions it contained for the transportation of the injured.

LEHIGH AND WILKES-BARRE MEET

The third annual field day of the first-aid teams connected with the Lehigh & Wilkes-Barre Coal Co. was held September 21, at Sans Souci Park, between

three; Audenreid, two; Honey Brook, four; making in all 27 teams, or 162 men. There were six events; the full teams rating first and second in events 4 and 5, competed in two difficult problems. This eliminated all but Sugar Notch Outside, Lance Outside, Lance Inside, and Nottingham Inside.

The one-man event was won by Stanton Colliery; the two-man event by Nottingham Colliery Inside. This team was in the final events and for neat, quick work, had no superiors, but they lost through inattention to small but important details.

The three-man event was captured by four men from the Lance Colliery Outside. The colliery's full team, composed of Edward Collins, David Cummings, Charles Wilkinson, Charles Atwell, Charles Meyers, and Charles Kostruzna, won the first prize at the meet.

Dr. F. L. McKee, company surgeon, is to be congratulated on the excellent work of his pupils. The young men are also to be congratulated on their uniformly good work. The members of one or two teams were more nervous than if they had been engaged in an accident. This is not a bad sign, as it shows self-consciousness coupled with a desire to excel.

Dr. J. W. Geist, of Wilkes-Barre, was the judge, and as he did not know the men and they did not know him, everything was entirely satisfactory. Those in charge of the demonstration say it was a vast improvement over the second annual field day, and the writer does not see how teams could look better and work more neatly.

LEHIGH VALLEY COAL CO. CONTESTS

The Lehigh Valley Coal Co. held a successful first-aid contest at Hazle Park, Hazleton, Pa., September 21, that being a central point for the different divisions of the company. Each of the six divisions was represented by one team selected at preliminary contests held prior to the general meet.

The teams selected to compete for their respective divisions and their ratings were as follows:

Lackawanna Division, Stevens Colliery, West Pittston, 95 per cent.; Wyoming Division, Westmoreland Colliery, Wyoming, 98 per cent.; Lehigh-Coxe Division, Drifton Colliery, Drifton, 94 per cent.; Delano Division, Primrose Colliery, Mahanoy City, 95 per cent.; Mahanoy-Schulkill Division, Packer No. 5 Colliery, Lost Creek, 99 per cent.; Pottsville Division, Blackwood Tunnel, Blackwood, 82.5 per cent.

The Packer No. 5 team, composed of John McLean, captain; Joseph Curvin, John Sheridan, Charles Calbert, Henry Carey, and Thomas Brown, won the contest, the Westmoreland team being a close second.

None of the teams knew what problems they were to solve until they were handed to the captains on slips of paper.

In the one-man event Thomas G. Evans, Stevens; Anthony Gludding, Primrose; John McLean, Packer No. 5, and James Morris, Westmoreland, tied. An

their subject is well as to the particular method of bandaging. They complimented every team for their work, which was right because the proficiency of these men in this work has saved, and will no doubt continue to save, the lives of underground workers. After the third event the teams and their guests were served with a dinner.

Mr. Atherton Bowen, who has trained the teams, was complimented on the uniformity with which the teams worked; and Mr. John Lloyd, inspector of equipment, for the arrangements of the contest and the comfort of the guests and spectators.

PENNSYLVANIA COAL CO. CONTESTS

The seventh annual first-aid meet of the Pennsylvania Coal Co. and the Hillside Coal and Iron Co. was held at Inkerman, Pa., September 21. Those in attendance were given a spectacular and clever exhibition by the six teams representing the various districts in which the above companies have collieries. To make the conditions more nearly similar to those in the mines, obstacles were erected on the field and the space in which the men worked was curtailed, thus adding materially to the difficulty in dressing, yet at the same time increasing the interest of the spectators, as it disclosed the ingenuity of the men in overcoming obstacles. As an illustration, the fifth event for full teams had the following problem to contend with: Severe

and D. A. Capwell, of Scranton, awarded the first prize, the "Captain May Loving Cup," to the Law Shaft team, Central Colliery, Avoca District. The team consisted of G. Kellum, S. Bernard, Thomas Edwards, J. Lewis, J. Colburn, and T. McDermott. The average number of points scored by each district team is as follows: Avoca, 97½; Mayfield, 95; Forest City, 94½; North Pittston, 94¾; Dunmore, 94¾; South Pittston, 93¾.

All of the men competing were awarded gold badges or buttons, while those who had been perfect in attendance at first-aid instruction were surprised with \$10 gold pieces. Mr. Reese, mine inspector of the Fourth Anthracite District, presented the Mayfield District team, who won second prize, with a box of cigars. Captain W. A. May, president of the companies, addressed the teams on first-aid work, after which Hon. C. C. Bowman presented the prizes. This was the second elimination contest of the Pennsylvania and Hillside first-aid corps, and the first five teams were entered in the Red Cross meet for the "Muckle Cup," which was won last year by the Erishin team of the D., L. & W. Coal Co.

D., L. & W. FIRST-AID CONTEST

A first-aid contest between teams representing the various departments of the Lackawanna Railroad was held at the Central Y. M. C. A. building at Scranton, Pa., on September 21. Twenty-four teams from the coal-mining department and five

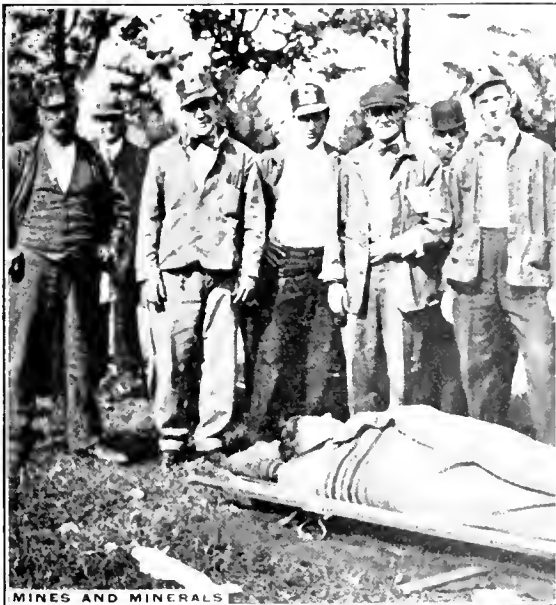

LANCE NO. 11, OUTSIDE TEAM, L. & W. COAL CO.



LAW SHAFT TEAM, PENNA. COAL CO.

extra event was then ordered, which was won by T. G. Evans with 99 points, A. Gludding coming second with 95 points to his credit.

The judges, Dr. E. G. Heyer, of Hazleton State Hospital, and Dr. A. G. Fell, of Wilkes-Barre, paid particular attention to the manner in which the corps handled

scalp wound on top of head, compound fracture of the left thigh at middle with injury to the large artery; dislocation to right hip, toes turning outward; treat, place on stretcher, and transport up and down steps, over loaded car, and load into ambulance standing on ground. The judges, Drs. V. S. Fulton, F. J. Bishop,

teams from the railroad department, competed against one another for the honor of holding the President's cup, which was presented this year, for the first time, to the best team in the whole Lackawanna system. There was also at the same time a contest between the teams from the coal-mining department, for the Superintend-

ent's cup, which was won last year by the team from the Brisbin mine.

In the contest for the President's cup the team from the foundry connected with the railroad shops, at Scranton, was victorious, being Thomas Harding, captain; John Cullen, Michael Walsh, Walter Moore, John Landuskie, and John Healy, subject. The team from the Central mine was runner up for the President's cup,

ability. After the contest a dinner was served by the company to all the contestants, and each member of a team was presented with a gold bronze medal on which was a red cross pendant from a blue enameled pin on which was printed "Lackawanna Company."

ANTHRACITE RED CROSS CONTEST

The fourth annual first-aid contest for the Muckle cup, was witnessed by a large

will act as judges in some future contest they will agree with one of the surgeons at the Shamokin meet, who stated that never again would he claim a judge had ruled against his team unfairly. As this contest is an open event it should be patronized by more than six coal companies for several good reasons: The cup was presented by the president of the Red Cross Society of Pennsylvania to



BRISBIN MINE TEAM, D. L. & W.



PINE BROOK TEAM, SCRANTON COAL CO.

as it had already won the superintendent's cup. This team was composed of the following men: Joseph Taylor, captain; Anthony Tierney, David Davis, Ivor Jones, Caradoc Thomas, and William Lascomb, subject.

The contest was ably managed by Dr. J. M. Wainwright, 15 events being run off between 1 o'clock and 5:30 in the afternoon. The teams were divided into four sections, each section having one judge in the first series of five events, in which each team competed.

The winners in this contest were the teams from the Brisbin, Central, Holden, and Truesdale mines, and the Railroad and Foundry teams. These then competed in a second series of events in which the Central and Foundry teams were chosen to compete in the final events to determine the winner of the president's cup. Drs. Fulton, Henry Smith, R. G. Wall, and W. E. Keller, acted as judges.

After the contest, T. E. Clark, general manager of the railroad, made the speech presenting the president's cup and delivered the Red Cross diplomas to those who had studied for them. C. E. Tobey, superintendent of the coal-mining department, made the speech presenting the superintendent's cup to the Central team. A third cup was given by the Y. M. C. A. for the best team trained under its supervision, and it was won by the Foundry team.

All the teams in the contest proved that they could do remarkably competent first-aid work, the problems given being such as would test practical first-aid

number of men and women spectators at Inkerman, September 28. The cup was presented in the name of the Red Cross Society by Mrs. John Muckle, of Philadelphia, president of the Pennsylvania Red Cross Society. In order to hold the cup it must be won three times by the same team, but so far the same team has not won it twice; however, it is considerable honor to hold it once. In 1909 the Avoca team, of the Pennsylvania Coal Co., was successful; in 1910 the Woodward Colliery team, of the D., L. & W. Co., captured the trophy, and this year, 1912, the Pine Brook Colliery team, of the Scranton Coal Co., composed of the following men, was successful: Arthur Young, captain; John W. Jones, Nathaniel Thomas, Samuel Thomas, Dennis Duffy, and William Morgan.

The Temple Iron Co.'s Mt. Lookout Colliery team, Harry Sax, captain, was awarded second place, and the Fernwood Colliery team, Jas. R. Pollard, captain, of the Hillside Coal and Iron Co., took third place. The teams entering this contest were representative of the various companies, and being coached by company surgeons do their work differently. Great rivalry exists between the teams and surgeons, but that professionalism will enter into the contests as some have suggested is unlikely, the managers and surgeons of the coal companies being opposed to any such featuring of strictly humanitarian work. In the judging, some doctors have thought their teams were not given full credit. It is possible that if these doctors

stimulate good-natured rivalry in this kind of work; it is the first public prize offered to first-aid mine teams in the United States, and since the contests are judged by army surgeons sent to the meet by the Government, they are virtually both national and state affairs.

The judges at this meet were Captain William H. Moncrief and Lieutenant H. J. Hallet, army surgeons, from Governor's Island, New York, and Captain P. W. Huntington, army surgeon, from Philadelphia, Pa. One at least of these men had never attended or acted at a miners' first-aid contest, and not knowing one team from another except by number, their judgment was determined by what they considered the best team work.

The affair was under the management of Dr. F. F. Arndt, of Scranton, with Mr. Kosman I. Vail of the Railroad Department of the Y. M. C. A. Secretary.

The Delaware, Lackawanna & Western Co. entered the four district teams which won at the company contests on the previous Saturday. These were from Holden, Central, Truesdale, and Brisbin collieries. The Pennsylvania Coal Co. entered the Avoca Shaft team. The Hillside Coal and Iron Co. entered teams from Forest City, Dunmore, Fernwood and Mayfield; Scranton Coal Co. entered their Pine Brook and Raymond collieries teams; the Temple Iron Co. sent their Mt. Lookout and Lackawanna collieries teams; the Parrish Coal Co., Plymouth, sent one team, as did the Price-Pancoast Coal Co.

We are of the opinion that if the other coal companies sent teams they would not have regretted the experience. The winners of second and third place were awarded Red Cross bronze medals. It is probable that the suspension of mining operations during the first part of this year had considerable to do in keeping some teams from entering this contest, for the companies are now bending every

the anthracite fields, at least, much attention is paid by the judges to the way the men handle the bandages with supposed dirty hands and the way they handle the patient while performing their work.

FIRST AID AND HELMET CONTEST AT TRINIDAD

There are within a few miles of Trinidad, Colo., large coal mines operated by

panies had been furnished sets of the rules that would govern, and had been invited to send teams. For weeks, accordingly, teams worked in nearly every camp, training for this meet. There were thirteen entries and these all participated.

Each first-aid team consisted of six men—a captain, a patient, and four operators—and every man was required to be a bona fide employe about the mine

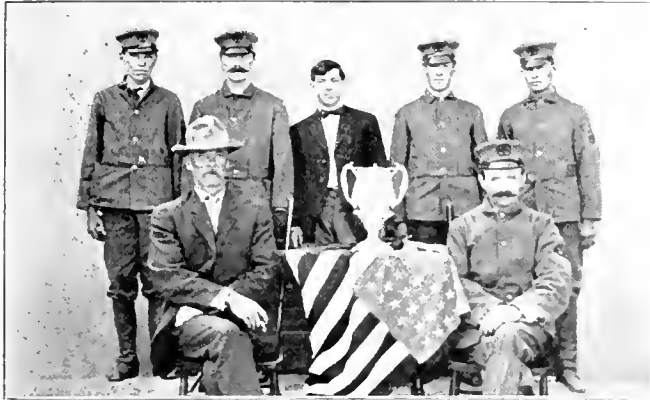

MAITLAND TEAM, WINNERS AT TRINIDAD, COLO



HICKORY SWAMP, OUTSIDE, TEAM, MINERAL R. R. & MINING CO.

endeavor to make up the shortage of coal brought about by the stoppage of mining.

At the Pittsburg First-Aid Conference the triangular bandage was adopted as the one to use for first-aid work. This will in a measure cause a number of first-aid teams, who have used the roll bandage, to commence work over again; there are, however, so many things in favor of the triangular bandage, that its use will not be difficult to learn, in fact, its manipulation is easier for the team and less painful to the injured man.

SCRANTON COAL CO. MEET

The Price-Pancoast Coal Co. of Throop, has one colliery which is under the management of John R. Bryden, who is also manager of the Scranton Coal Co. Dr. J. F. Jacobs, who is surgeon of both companies, offered a silver loving cup for competition, and on October 2, the best of the teams met at Guernsey Hall, Scranton. Doctor Arndt, of Scranton, and Doctor Van Sickle, of Olyphant, acted as judges and were compelled to go over some of the problems twice and see the patient unbound before they could render their decisions; in the end, however, the Price-Pancoast team won the cup, beating the Scranton Coal Co.'s Pine Brook team, which won the Muckle Cup at the Red Cross contest held at Inkerman on September 28. From this it is evident that an injured person would be equally safe in the hands of either team; since in a close contest a very slight act must be counted, by a careful judge either for or against a team, even though in practice it is comparatively unimportant, and such matters being largely matters of personal preference might affect different judges differently. In

the Colorado Fuel and Iron Co., the Victor-American Fuel Co., the Cedar Hill Coal and Coke Co., the Chicosa Fuel Co., and the Rocky Mountain Fuel Co.

Beginning September 25, 1912, there was held, at Trinidad, the Las Animas County Fair. In some respects, this was an old-fashioned, annual county fair, but this year the region's two main industries, agriculture and coal mining, were given equal prominence. The program for the Fair therefore brought into town not only ranchers and cowboys, but miners and mining engineers from that part of the state.

The program of miners' events had been prepared under the direction of H. H. Sanderson, mining engineer, who has devoted much time and attention to first-aid and helmet work instruction. Thursday was "Miners' Day" and there was a large attendance.

Previous to this meet, the various com-

represented by his team. It was further stipulated that not more than three men on a team should have participated in the similar contests of the preceding year. Each helmet team comprised five men—a captain and four miners—and the same restriction was made concerning engagement in the contests of 1911. In all other respects, the rules were substantially the same as are adopted elsewhere in such contests.

The participants in the first-aid events were the following teams, who took places in line according to numbers drawn by lot: 1. Segundo; 2. Berwind; 3. Piedmont; 4. Starkville; 5. Walsen-Robinson, second team; 6. Frederick; 7. Sopris; 8. Primero; 9. Maitland; 10. Walsen-Robinson, first team; 11. Tercio; 12. Morley; 13. Tabasco.

Four events took place on the race course in front of a large grand stand. The judges were four surgeons, of whom two are stationed at Fort Logan, Colo., on the medical staff of the Regular Army. All four judges were unprejudiced by any company connections and were total strangers to every man on the teams.

The specifications of the events had been withheld from everybody (except the committee in charge) until the contests started, when the judges were each supplied with complete copies. Immediately preceding each event, a sealed envelope was handed to the captain of each team, and this contained the specifications for that particular event only, in typewritten form. These were then read by each captain to his team and, simultaneously, by megaphone, the same were announced to the spectators and to the teams, so that there might be no mis-



H. H. SANDERSON WITH RESCUE APPARATUS

interpretations. After a few moments allowed for questions, signals were given and the work begun. Thereafter there could be no explanations nor suggestions offered by anybody.

It would be difficult to conceive better system than was displayed throughout these events. It was almost military in its quiet and smoothness. For each event, each of the four judges selected four or five of the teams for his special attention, and it was so mutually arranged among them that each judge inspected each of the teams at least once during the contest. The teams proved to be so well matched that the arrival at final averages required careful deliberation on the part of the surgeons. The winners were: First, Maitland team, grade 95 per cent.; second, Morley team, grade 93 $\frac{3}{4}$ per cent.; third, Walsen-Robinson, first team, grade 90 per cent. The Maitland team represented the Victor-American Fuel Co., while the Morley and the Walsen-Robinson teams were from the Colorado Fuel and Iron Co. The men on the Maitland team were: David Aitkens, captain; Alex. McBurnie, Robert Shaw, William McLennon and Alex. Wilson, operators; Arthur Quinn, patient.

All the teams, with the exception of the winning team, were in neat Red Cross regulation uniforms. The Maitland team was uniformed in neat white soft shirts and blue overalls.

To the winning team was voted a silver cup that, a year before, had been captured by the Primero team, with the stipulation that its permanent possession depended upon being won thrice. In addition to this, six polished aluminum Wolf safety lamps were presented to this team. The second prize consisted of six automatic lighters.

Helmet Contest.—There were but three entries in the helmet contest, the winners being declared in the following order: First, Primero team, grade 90 per cent.; second, Frederick team, grade 87 per cent.; third, Morley team. The Primero team comprised: Thomas Warburton, captain; Robert Scott, George Fortune, John Jurcheck, and M. J. Green, miners. The judges were H. H. Sanderson, Thomas C. Harvey, and Bert Lloyd.

For this contest, a temporary structure had been erected and arranged to represent entries in a mine. Instructions to the teams stated that a man had been overcome by gas at the extreme end of these workings, and to reach him it would be necessary to pass over a bridge (overcast), over a rock fall, through a low breakthrough and a brattice. The building was filled with noxious fumes from burning manure and sulphur. The air was so heavy therefrom that the spectators peering into the windows could scarcely follow the movements of the men who were obliged to use their elec-

tric lamps, the safety lamps, with which they were also equipped being useless in the foul atmosphere.

The task involved the removal of a dummy, representing the victim, as far as the entrance, where the dummy was exchanged for a live patient upon whom the balance of the work was performed. The helmets used were of the Draeger type. The contest elicited unusual interest among the spectators.

The prizes were the same as for the first-aid contest with the exception that there was no silver cup. Each participant in both contests was presented with a beautiful bronze medal.

FIRST-AID CONFERENCE

A conference was called by the Bureau of Mines to discuss mine rescue and first-aid work at Pittsburg, Pa., September 23 to 25. On the first day of the conference, committees were appointed to consider and report upon certain questions in regard to first-aid and mine rescue work. These committees reported on September 25, and the recommendations were adopted as submitted. Finally the Committee on Organization reported and made the work of the others void by the following resolution:

Resolved, that this Conference be made a permanent organization; that the presiding chairman, Mr. H. M. Wilson, be elected the President of a Temporary Committee to be composed of seven members; that there be elected a Vice-President; that Mr. C. S. Stevenson be elected Secretary, and that the other members of the Committee be appointed by the President; that the purpose of the Temporary Committee shall be to draw up a constitution and by-laws, and otherwise complete the organization; and, that until there be such permanent organization, all details in connection with first-aid and other matters be passed over.

The above resolution was discussed in detail and finally adopted by unanimous vote.



Trade Notices

Change of Address.—Notice is given by John Davis & Son (Derby), Ltd., of All Saints' Works, Derby, England, that their address in the United States has been changed from Baltimore to care of J. F. McCoy Co., 157 Chambers St., New York, who are now sole representatives for the United States.

Change of Chicago Office.—The Jeffrey Mfg. Co. has moved its Chicago headquarters to offices on the seventeenth floor of the recently completed McCormick Building, one of the most up-to-date fire-proof office buildings in Chicago. S. S. Shive, sales engineer, is the district manager in charge. The Jeffrey Mfg. Co. maintain fourteen branch offices in the United States and over one hundred

agents in the leading commercial centers of the world.

The Western Electric in Cleveland. The Western Electric Co. has taken over the business of the Cleveland Electrical Supply Co., of Cleveland, retaining the entire personnel of the supply company which it supersedes, with the exception of R. F. La Ganke, vice-president and manager, who is retiring from active business. H. A. Speh, of the Buffalo house succeeds to the post of manager. Louis Griesser, sales manager, has been twenty years in the electrical business at Cleveland. The Cleveland house has, in Mrs. H. L. Hausman, the only saleswoman in the company's employ. A telephone sales department has also been organized under the supervision of F. E. Triebner, formerly of the electric company's Nashville office.

Steam Turbine Driven Centrifugal Pump of 100,000,000 gallons per day capacity is to be installed in the Ross Pumping Station of the Pittsburg Water Works, by the DeLaval Steam Turbine Co., of Trenton, N. J. This pump will be the largest steam turbine-driven centrifugal pump ever built in this country, the rated capacity of 100,000,000 gallons per day against a total head of 56 feet amounting to over 980 water horsepower. The pump is guaranteed to show a duty of 115,000,000 foot-pounds per thousand pounds of dry steam, all steam used by the condensing equipment being charged to the main unit.

Crushed Coke Plant.—The Alicia crusher is located at the plant of W. Harry Brown at Alicia, Fayette County, Pa. The plant, consisting of 400 rectangular ovens, began operations October 1. The coke production is about 25,000 tons per month, of which 6,000 tons will be crushed and screened into egg, stove, chestnut, pea, and dust sizes.

Chicago Office.—For the convenience of middle western customers, J. H. Williams & Co., makers of drop-forgings, Brooklyn, N. Y., have opened an office and warehouse at 40 South Clinton St., Chicago, Ill., where a stock of their many drop-forged specialties will be carried on hand.

Consolidation.—The Taylor Iron & Steel Co. announces the acquisition of the Wm. Wharton, Jr. & Co., Inc., of Philadelphia, Pa., with works at Philadelphia and Jenkintown, Pa., and its subsidiary corporation, The Philadelphia Roll & Machine Co. The Taylor Iron & Steel Co. has in recent years devoted itself to the manufacture of steel castings of a special high-grade nature, Tisco manganese steel being the principal one. Tisco manganese steel castings are particularly applicable for use in railway track parts, safes, vaults, conveyer chain, sprockets, special wheels, the wearing parts of rock crushing and cement grind-

ing machinery, centrifugal pumps, the wearing parts of steam shovels and dredges and other parts of heavy-duty machinery subject to wear, abrasion, or shock. The Wharton company manufactures switches, crossings, special rails, and track parts for steam and street railways. Their specialty is the application of Tisco manganese steel to these parts.

On October 1, 1912, the Taylor Iron & Steel Co. changed their corporate title to the Taylor-Wharton Iron & Steel Co. The organization of the Taylor Iron & Steel Co. will become the organization of the Taylor-Wharton Iron & Steel Co., namely: President, Knox Taylor, Vice-Presidents, A. B. Borie, Prof. H. M. Howe, V. A. Angerer; Secretary and Treasurer, W. A. Ingram.

A New Canadian Company.—The C. O. Bartlett & Snow Co. of Canada, Limited, has been granted a Dominion charter to deal in, manufacture, and install, elevating and conveying machinery, power transmission machinery, engines, boilers, hoisting machinery, brick machinery, garbage reduction and destroying machinery, paint machinery, grain and cereal machinery, and to carry on a general line of engineering, manufacturing, and construction work. The head office of the company has been opened at 282 St. Catherine St., Montreal, with Herbert S. Hersey, General Manager. This company is the outgrowth of the extensive Canadian business of the C. O. Bartlett & Snow Co. of Cleveland, Ohio, and although the connection between the Ohio company and the Canadian company will be very close for some time, the organization and management are entirely independent. The Canadian company has been granted Canadian rights to all patents and licenses owned by the Ohio company and this, taken in connection with the vast engineering data and designs of the original company coupled with the wide acquaintance and engineering experience of Mr. Hersey and the engineers associated with him in handling the Canadian business, places the new company on the basis of an old established concern with years of business experience behind it and with a business reputation of the highest standard as well as a large clientele from which to draw a substantial amount of business from the start. The C. O. Bartlett & Snow Co. has installed a number of the best and most up-to-date coal-mine equipments during the past few years in the Crow's Nest Pass District as well as having done a large business in connection with the cement interests of Canada and with the coal, gypsum, and asbestos interests of the Eastern Provinces. Therefore, on account of the increasing business of Canada and the development in mining, lumbering, etc., a wide field is open for the new company.

Correspondence

"Anxious" Answered

Editor Mines and Minerals:

SIR: In the last issue of MINES AND MINERALS I notice a request by "Anxious" for information regarding a rock dump that had been described in MINES AND MINERALS some time ago. If he referred to the dump now in use at the Cokedale mine, Colorado, I wish to advise that there is but one rock dump of this type in existence. We had great quantities of rock to handle and a great deal of shallow ground to fill up, so I designed the dump in question and had it built in our local shop. It was designed to fit our type of pit car and while it worked very successfully it might not be as satisfactory with another type of car. The description of this dump is in the May, 1910, issue of MINES AND MINERALS, page 592.

If after reading this description your correspondent is satisfied that a dump of this kind would answer his purpose, I shall be glad to give him any assistance I can, in designing a truck for the kind of pit cars he is operating.

Trinidad, Colo.

W. B. LLOYD

Gases from Acetylene Lamp

Editor Mines and Minerals:

SIR:—Please publish the following questions in your Correspondence Column.

(1) What effect (if any) do the gases given off from the "acetylene pit lamp" have on the miner? (2) What are the elements of the gases given off by the carbide, and what is "carbide" made of?

Tasker, N. Dak.

T. S. ALMOND

來 來 Societies

The winter meeting of the Coal Mining Institute of America will be held in Pittsburg, Pa., December 18 and 19. The following tentative program has been arranged by the Executive Committee:

Forenoon, the first day, December 18: President's address. Paper—"A Brief History of the Coal Mining Institute of America," by Wm. Seddon, first Secretary of the Institute. Paper—by Eugene B. Wilson, Scranton (subject announced later).

Afternoon, the first day, December 18: Paper—"Roof Action," R. D. Hall, New York. Paper—to be presented by representative of the Pittsburg Testing Station, U. S. Bureau of Mines (subject announced later).

Evening, the first day, December 18: Institute dinner and social session, probably to be held in the Fort Pitt Hotel. Name of special speaker to be announced later.

Forenoon, the second day, December 19: Discussion—"Rib Drawing by Machinery," led by W. L. Affelder.

Business session.

Luncheon, at School of Mines Building

Afternoon, the second day, December 19: Paper—"Gas Producers from the Mining Man's Standpoint," name of writer to be announced later. Paper "Coal Crushers," by G. R. Delamater, Philadelphia. Discussion—"Oil and Gas Wells in the Bituminous Coal Fields," led by A. P. Cameron.

Committee appointed on Local Arrangements for the December meeting: W. E. Fohl, S. A. Taylor, and J. B. Johnston.

AMERICAN MINING CONGRESS

The 15th Annual Convention of the American Mining Congress will be held in Spokane, Washington, November 25 to 28, inclusive.

The serious work of the Convention is done by its Resolution Committee, composed of one member from each state selected by the delegation from such state. Any member of the Convention may introduce in writing any resolution upon matters pertaining to mining and in this way secure its consideration. The chairmen of the different committees are as follows: General Revision of Mineral Land Laws, E. B. Kirby, St. Louis, Mo.; Smelter and Freight Rates, E. A. Colburn, Denver, Colo.; Federal Legislation and Metal Mining Affairs, D. W. Brunton, Denver, Colo.; Alaskan Affairs, Falcon Joslin, Fairbanks, Alaska; Coal Mining Affairs, Walter M. Bogle, Fisher Building, Chicago; Prevention of Mine Accidents, W. R. Ingalls, New York; Workmen's Compensation, John H. Jones, Pittsburg, Pa.; Standardization of Electrical Equipment, in Coal Mines, George R. Wood, Pittsburg, Pa.; in Metal Mines, H. S. Sands, Denver, Colo.; Mineral Statistics, George W. Ritter, Salt Lake City, Utah; Forestry Relations, T. J. Grier, Lead, South Dakota; Bureau of Mines, Seely W. Mudd, Los Angeles, Cal.; U. S. Geological Survey, Dr. H. Foster Bain, San Francisco, Cal.

TRADE PRESS ASSOCIATION

At the Niagara Falls meeting of the Federation of Trade Press Associations of the United States, a resolution was passed extending greetings to the National Federation of Retail Merchants, whose convention is to be held in St. Louis, November 19 to 21, and recommending that the Trade Press Association be represented at the meeting, the purpose of the two organizations being similar.

來 來

A recent French report shows that for 1910, the output of coal per man increased, the wages also being slightly higher. It is referred to in the report as a "phenomenon," the previous experience having been that higher wages have resulted in diminished output per man.

FROM the way some mine managers build them, one would think stoppings are a necessary evil imposed by law, and to be disposed of in the quickest and cheapest possible way, without regard to efficiency.

Now the sole purpose of a stopping is to prevent the air-current from short-circuiting. If the stopping leaks and part of the air returns to the upcast shaft before reaching its ultimate destination, labor, material, and horsepower are wasted in proportion to the amount of leakage.

The kinds of material generally used in stoppings in coal mines, and the method of construction, are: ship-lap or rough oak boards, plastered; ship-lap or rough oak boards, not plastered; slate walls, plastered; slate walls, not plastered; concrete monolith walls; concrete blocks; blocks made of cement and cinders, and brick.

Actual measurements, where some of the different kinds of stoppings are used, gave the following results, and indicate clearly that not all mine managers are devoting their best thought to the important subject of mine ventilation.

In a certain mine there was a door in the return between the eleventh and twelfth southwest entries. Just below the twelfth southwest in the return was a regulator. With the door open, 5,000 cubic feet of air per minute was passing through the regulator, and 4,920 through the door. At the last open cross-cut between these two entries—a distance of 900 feet from the door—no reading was to be had with the door open. With it

Why Is a Stopping?

Results of Improperly Built Stoppings—Different Methods of Effective Construction

By Oscar Cartledge

9,040 cubic feet per minute; the last cross-cut 7,200 cubic feet. There were seven ship-lap stoppings plastered with wood fiber, showing an efficiency of 80 per cent. The cost for a stopping of this kind, with an area of 70 square feet,

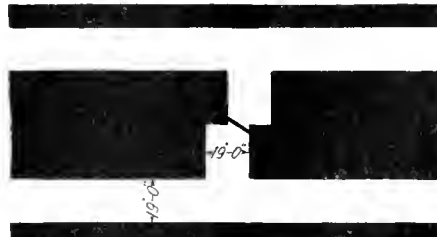

FIG. 1

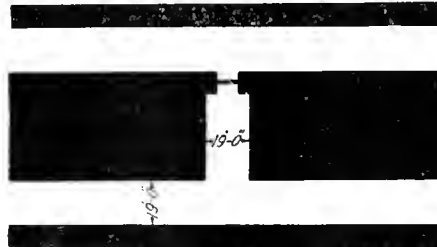

FIG. 2

counting labor and material, is about \$7; and its average life is about 3 years. It will have to be replastered every 6 months at a cost per year of \$1.50.

In another mine the intake of the fourth southwest had 4,860 cubic feet. At the last cross-cut no reading could be obtained. There were 30 rough board stop-

Efficiency 15 per cent. The cost of rough board stoppings for an area of 70 square feet, including labor, is \$5.50; and the average life is 3 years.

At another mine the second southwest intake had 21,560 cubic feet, the last cross-cut 13,860 cubic feet. There were 10 stoppings made of patent lath, and one door made to swing both ways. Five of these stoppings were plastered with wood fiber, and five were not. Efficiency 64 per cent. Cost and life same as ship-lap.

Another mine measured 9,940 cubic feet at the intake of the first southwest, and at the last cross-cut there was 8,151 cubic feet. Between this pair of entries were 30 cinder block stoppings, two temporary ship-lap stoppings, not plastered, and one door. Efficiency 82 per cent.

COST FOR AN AREA OF 70 SQUARE FEET	
63 blocks 6 in. x 9 in. x 18 in. at 9 cents.....	\$5.67
Cement	1.00
Labor, 2 men, one day at \$2.84.....	5.68

Total\$12.35

As to the life of this kind of stopping, no reliable data could be secured; but some two years old are still apparently as good as ever.

In another mine where the slate which falls from the roof is utilized there was a reading at the west intake of 25,810 cubic feet. At a distance of 1,030 feet there was 22,100 cubic feet, an efficiency of 92 per cent.

These slate walls are built double at a distance apart of 2 to 6 feet and filled between with loose material. After letting stand a sufficient time to settle, one wall is plastered with a mixture of wood fiber and sand.

The cost of a stopping of 70 square



FIG. 3. SHIP-LAP PLASTERED STOPPING



FIG. 4. PATENT LATH PLASTERED STOPPING



FIG. 5. BOARD STOPPING, PLASTERED

closed a reading of 4,488 cubic feet was obtained. Between the door and the open cross-cut, were 12 ship-lap stoppings, plastered with wood fiber. This shows an efficiency of 91 per cent.

In this same mine an intake registered

stoppings, not plastered, and two doors. Efficiency nil.

In this same mine the main west entry showed 6,825 cubic feet with 1,000 cubic feet at the last cross-cut. There were 19 rough board stoppings, and two doors.

feet area will be, at the prevailing rates:

Three sacks fiber at 30 cents.....	\$.90
Hauling slate and building stopping, two men, 8 hours, at \$2.84.....	5.68
Two men, 8 hours, at \$2.61 (drivers).....	5.22
Two men, 2 hours, plastering.....	1.42

Total\$12.32

Stoppings in this mine over 2 years old are perfectly good.

The concrete monolith, brick, and concrete block stoppings, from the standpoint of efficiency, cannot, of course, be improved upon. Those made of cinders and cement, while they have the advantage of being of light weight and cheap, may not last so well; for the acids from the cinders will probably in time have a disintegrating effect on the cement.

Many advocate the plastered wood, because it offers but slight resistance to an explosive force; but when we consider that a 6-inch wall made of concrete blocks, if laid in lime, would readily blow out if an explosion should occur, and that such a wall is practically permanent; that the cost through a period of years, is less; and that if blown out, the blocks would not be destroyed as lumber would be; it is apparent that the advantage lies

cuts must be made not more than 60 feet apart. To avoid paying yardage, cross-cuts are often made more than 18 feet wide where the roof is strong enough to permit it; but when this is done the cost of the stopping almost equals the yardage saved.

To overcome this, some operators have adopted the plan of offsetting the cross-cuts one-half, or more, of their width, as shown in Fig. 1. Others drive the cross-cut wide from one side and take one or two cuts narrow from the other, as shown in Fig. 2.

Both are good plans to follow in stub or cross-entries in machine mines (with a possible advantage for No. 2); for if the stopping is narrow it not only costs less, but the chances for leakage are lessened.

If a series of stoppings is so constructed that most of the air is lost before

Determining Coal Values

By E. G. Bailey*

Manifestly the value of coal, as measured by its heating and evaporative powers, must be determined by actual experiment. The fundamental question is, shall the experiment be conducted on a large scale, as in the case of a boiler test, or on a small scale, but with great refinement, as in the method pursued by the chemist. In truth the methods are not so different as they appear.

The chemist in the laboratory conducts a miniature boiler test as truly as does the engineer in the power plant. The latter always expresses his results in "equivalent evaporation from and at 212° F. per pound of coal." His feedwater is not necessarily at 212 degrees, and it is an unusual case if his steam is at the same temperature. Suppose a case where the temperature of the feedwater is 110° F. and the gauge



FIG. 6. SLATE STOPPING, WOOD-FIBER PLASTERED



FIG. 7. SLATE STOPPING NOT PLASTERED

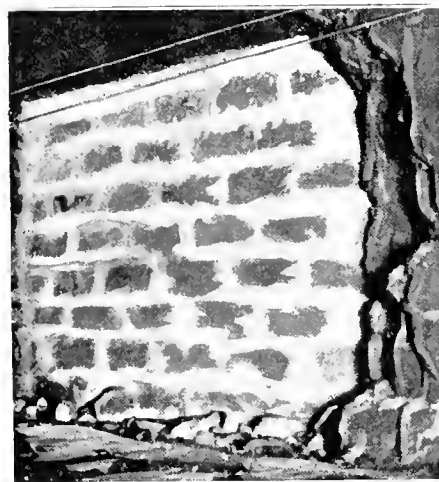

FIG. 8. STOPPING OF CINDER BLOCKS AND CEMENT

with the block stoppings. Stoppings made of lumber also have this disadvantage, that they cannot be plastered close to the face of the entries on account of vibration from the shots knocking the plaster off.

The slate wall, if left unplastered, is practically worthless, and in Illinois is not permitted. But if it is plastered with cement or wood fiber, it makes a fine and permanent stopping, if care is used in the construction of the walls.

Ship-lap and patent lath, if plastered, makes a tight stopping; but is a mere makeshift if the plaster is omitted.

In the case of ship-lap, the fiber will adhere much longer if the surface of the boards is "roughed up" with a pick or other pointed instrument.

The cost of a stopping depends on the area of the cross-cut; and a little head work will sometimes be the means of reducing the cost on this important item of mine ventilation.

In Illinois, yardage must be paid on all work less than 18 feet wide; and cross-

it reaches the working faces, the health of the workmen is menaced by reason of the deleterious air in which they are compelled to labor; their efficiency is reduced and money lost to the company in horsepower consumed in producing a ventilating current that does not ventilate. The inspector is compelled to show up the mine manager in a bad light; and frequently has to withdraw men from the working places, causing an additional loss to the company and a loss to the men who are deprived of the work. And, in addition to all these, there is also the ever-present danger of explosion and fire which may result from gas by reason of bad ventilation.

All of us have seen many a good over-cast that was nearly useless because of leaky stoppings, and many a fine fan throwing great volumes of air into a mine, and which was lost before it ever reached a miner.

What excuse can there be for a poor stopping?

pressure is 150 pounds. From a steam table we find that there were 1,115.6 British thermal units used in evaporating each pound of water fed to the boiler into dry steam. Had the water been fed to the boiler at 212 degrees and evaporated at atmospheric pressure, the heat used would have been only 965.8 British thermal units per pound. Dividing 1,115.6 by 965.8 gives 1.155, which is the factor of evaporation. Multiplying the weight of water fed to the boiler by this factor, gives the "equivalent evaporation." This calculation makes the results obtained under various conditions comparable. Take another illustration of a boiler in a central hot-water heating system plant, where the return water is all pumped into the blow-off connection of a boiler and passes out the steam pipe after having been heated and not evaporated into steam. If the water enters the boiler at a temperature of 120 degrees and leaves at 175 degrees, it will have absorbed 55.4 British thermal units per pound, and divid-

*Chief of Coal Department of the Arthur D. Little Laboratory, Boston, Mass.

ing this by 965.8 gives .05736 as a "factor of evaporation." No engineer is going to say he cannot make a boiler test under such conditions, and in such a test, if there were 169.6 pounds of water pumped through the boiler per pound of coal fired, the equivalent evaporation in pounds of water evaporated from and at 212° F. per pound of coal would be 9.73.

The determination of the calorific value of a coal in the laboratory by means of a bomb calorimeter is so similar to this last illustration that it, too, is simply a boiler test. The bomb is nothing more than a perfectly tight steel boiler, but instead of having the water in the boiler and the heat applied from the outside, the conditions are just reversed; the fuel is burned in the bomb, or boiler, and the water completely surrounds it, so that all of the heat is absorbed and indicated by the rise in temperature of the water. If 1 pound of coal was burned and the surrounding water, including the equivalent of the bomb and other metal parts, weighed 2,000 pounds, and the temperature rose 7.250° F., we would have as the factor of evaporation 7.250 divided by 965.8, or .007507. Multiplying the pounds of water per pound of coal, which in this case is 2,000, by this factor, gives 15.014 as the equivalent evaporation from and at 212° F. per pound of coal. However, instead of reporting the results in terms of equivalent evaporation, as the chemist used to do and as is still common in England, he calculates results in British thermal units. From the above figures, one readily sees that the heat developed by the burning of the pound of coal was 2,000×7.250, or 14,500 British thermal units. If we take the results as calculated on the evaporation basis, we have 15.014 pounds water evaporated from and at 212° F., multiplied by 965.8 (the number of British thermal units required to evaporate 1 pound of water under these conditions), giving 14,500 British thermal units developed per pound of coal. So that with the calorimeter the chemist really conducts a boiler test and obtains 100 per cent. efficiency. As a matter of fact, the chemist uses but 1 gram of coal and 2,000 grams of water in the calorimeter test, but the same results are obtained as if proportionally larger quantities of each had been taken. All through the work of the chemist, accuracy replaces quantity. He can weigh $\frac{1}{2000}$ part of an ounce as accurately as the engineer weighs pounds, and with his thermometer he reads thousandths of a degree instead of degrees.

The disagreement between the evaporation as determined on the boiler test and the British thermal units from the calorimeter are more frequently due to errors or variations in conditions in one or both tests. How closely can the engineer check the results on different tests from the same lot of coal, and likewise what is the variation between the British thermal units deter-

mined from different samples taken from the same cargo?

A competent engineer, who has made a large number of evaporative tests, found a variation of 17 per cent. between different tests on the same coal. These tests, however, were of only 4 hours' duration, which was the most probable reason for such a large error. Evaporative tests made at the fuel-testing plant of the United States Geological Survey show variations of 3 to 5 per cent. on coal from one car burned under as nearly identical conditions as is possible to obtain. Variations in the rate of evaporation seriously affect the efficiency. The thickness of the fire, intensity of draft, and evenness of the bed of fuel are so closely related to boiler efficiency that in making a test it should be made so thorough that a heat balance can be calculated showing the distribution of heat as it escapes in the various sources of loss, as well as that used for evaporation. Such data add weight to an evaporative test and show whether or not the coal, the load, the fireman, or the grates should be credited with the good or poor results. If an engineer obtains only 65 per cent. efficiency he should determine whether the excessive losses are due to high flue temperature, incomplete combustion, or an excessive air supply. The more important data of a couple of tests given in Table 1 will illustrate this point. The coal used was from the same car.

TABLE 1

Analysis of Coal	1		2		
	Per Cent.		Per Cent.		
Moisture	1.08		.88		
Volatile	17.93		17.87		
Fixed carbon	73.84		73.32		
Ash	7.15		7.93		
Sulphur	.83		.84		
British thermal units	14,240		14,168		
Temperature of flue gases, degrees F.	575		520		
Evaporation from and at 212 degrees F.	9.47		10.13		
Gas Analysis		Per Cent.		Per Cent.	
Carbon dioxide, CO ₂		11.50		10.12	
Oxygen, O ₂		6.71		9.12	
Carbon monoxide, CO		1.38		.04	
Nitrogen, N ₂		80.41		80.72	
Air excess		47.00		76.00	
Heat Balance		B. T. U.		Per Cent.	
Heat used in evaporation	9,142	64.2	9,791	69.1	
Latent heat of water in coal	365	2.6	355	2.5	
Products of combustion	1,160	8.1	1,340	9.5	
Air excess	480	3.4	775	5.5	
Unburned CO	865	6.1	35	.2	
Unburned coal in ashes	490	3.4	120	.8	
Radiation, etc. (by difference)	1,738	12.2	1,752	12.4	
Total	14,240	100.0	14,168	100.0	

TABLE 2

	1		2	
	Per Cent.		Per Cent.	
Loss due to air excess	3.4		5.5	
Loss due to unburned CO	6.1		.2	
Loss due to unburned coal	3.4		.8	
	12.9		6.5	

The coal was not at all responsible for this difference of 5 per cent. in the boiler efficiency, but it was practically all up to the fireman. Table 2 gives the losses which may largely be controlled by him.

There are certain features in coals that the chemist has as yet been unable to determine with accuracy from the analysis. The most important one is the kind and amount of clinker formed. This varies so much with the conditions under which the coal is burned that a practical test is necessary. But when the engineer does make a test, how often does he determine the per cent. of clinker formed? This item is frequently of great importance, but it affects the capacity of a plant much more than it does the efficiency. The coking properties of a coal may also affect the capacity of a plant, while the efficiency might not be affected in the least. What the engineer should determine is what coals he can burn without being in danger of a shut-down with the heaviest load, and leave it to the analysis to determine which of these coals will develop the most heat units per dollar. This does not mean that the British thermal units alone should be considered, but the volatile and ash would be considered as affecting the boiler efficiency, and comparisons made in this manner are more accurate and less expensive to obtain than if determined by a long series of evaporative tests.

Coal Washing and Briquetting

THE Alstaden Colliery Co., Limited, has two mines near Oberhausen, Germany. At the No. 2 Hibernia mine anthracite is mined, and the plant described in this article was designed to treat this kind of coal.

The Plant of the Alstaden Colliery Co., Ltd., at No. 2 Hibernia Mine, Germany

Before the engineers undertook the design of this plant, they conducted a series of exhaustive experiments to ascertain the physical properties of the coal and its peculiarities during the usual methods employed in washing, after which they decided on the best system to follow for its treatment.

The quantity of coal to be treated was 900 tons in 16 hours. The system decided on was to break the coal into small pieces and then subject it to a washing operation. In order to produce a marketable briquet, it was found necessary to wash only the coarse grains contained in the fine coal and to mix the unwashed dry dust with it after it had passed through the washing process. The dirt mixed with the coal as it comes from the mine is removed by the process employed, and enables briquets of high grade to be made from the fine coal.

The material as it comes from the mine is conveyed in mine cars from the shaft cage and fed to a shaking screen by means of a mechanically driven revolving tippie. The screen plate is perforated with 3.15-inch diameter round holes; and material below this size falls direct into the receiving hopper *A* shown in plan and elevation, Fig. 1. The coal which passes over the screen is delivered on to a picking belt, where the coarse dirt is removed by hand. From the picking belt the coal goes to a pair of rolls, which reduce it to nut size and smaller, after which it falls into the hopper and is raised by an elevator to a shaking screen punched with 1.97-inch diameter holes. The coal passing through the screen falls into hopper *A*; that which passes over the screen is delivered to a jaw crusher by which it is broken into pieces below 1.97-inch size and is discharged into hopper *A*. In order that the large coal may be stocked in the summer, a chute is provided at the end of the picking belt, by which the coal can be delivered into tram cars. The rock picked from coal is loaded into rock cars on the picking belt platform. The rock cars are raised by an elevator *C* to the level of the cage landing and hauled to the waste heap, where they are dumped. A second steam elevator *D* is provided for raising the coal stored in the stock yard to the tippie platform. From the hopper *A* the coal is raised by means of elevator *E* to the washery shown in Fig. 2, where it is delivered to

and divided by two shaking screens *F*, shown also in Fig. 4, and furnished with screen plates having perforations 1.57 inches, .59 inch, and .12 inch. The classified products from 3.15 inches to 1.57 inches, 1.57 inches to .59 inch, and .59 inch

1.18-inch diameter are delivered on a picking band which is provided to enable a light bituminous shale, which it is impossible to separate by washing, to be eliminated by hand. The belt delivers the coal into the two outer compartments of the storage tower. The nut coal from 1.18-inch to .59-inch diameter and from .59-inch to .315-inch diameter is dis-

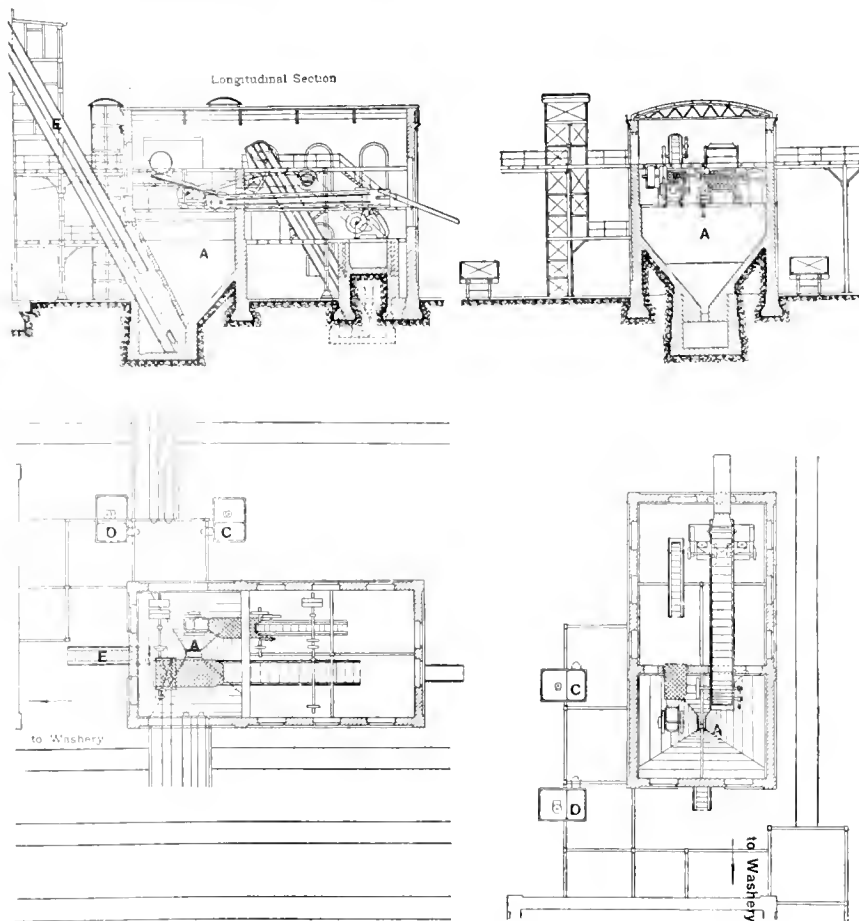

FIG. 1. SCREENING AND CRUSHING PLANT

to .12 inch are delivered into separate troughs, along which they are flushed by a stream of water to the six compartment washer *G*, shown also in Fig. 5. The largest size is treated in the first compartment, the intermediate size in the next two compartments, and the smallest size in the three remaining divisions. The largest and intermediate sizes are discharged from the jigs into two troughs along which they are flushed by the overflowing water to two draining and classifying screens *H*, Fig. 2, which are above the nut coal bins. These screens are furnished with plates having 1.97-inch 1.18-inch, .59-inch, and .315-inch diameter perforations, into which sizes the coal is separated. The two sizes, 3.15-inch to 1.97-inch diameter and the 1.97-inch to

charged into two bins as these sizes are too small for hand picking. To prevent this coal from being broken as it is being deposited in the bins, an anti-breakage spiral chute is fitted to each division of the loading bins. The discharge gates in the bottom of the bins are arranged in combination with draining screens and sprinkling devices, by means of which the coal is rinsed with fresh water before passing down automatic anti-breakage chutes into the broad gauge cars. The fine coal below .31 inch removed with water from the nut coal at the top of the bins by the drainage screens, is conveyed along the troughs to the sump *I* of the drainage elevator *K*. This elevator, which is furnished with perforated buckets, lifts the coal and delivers it into either of two

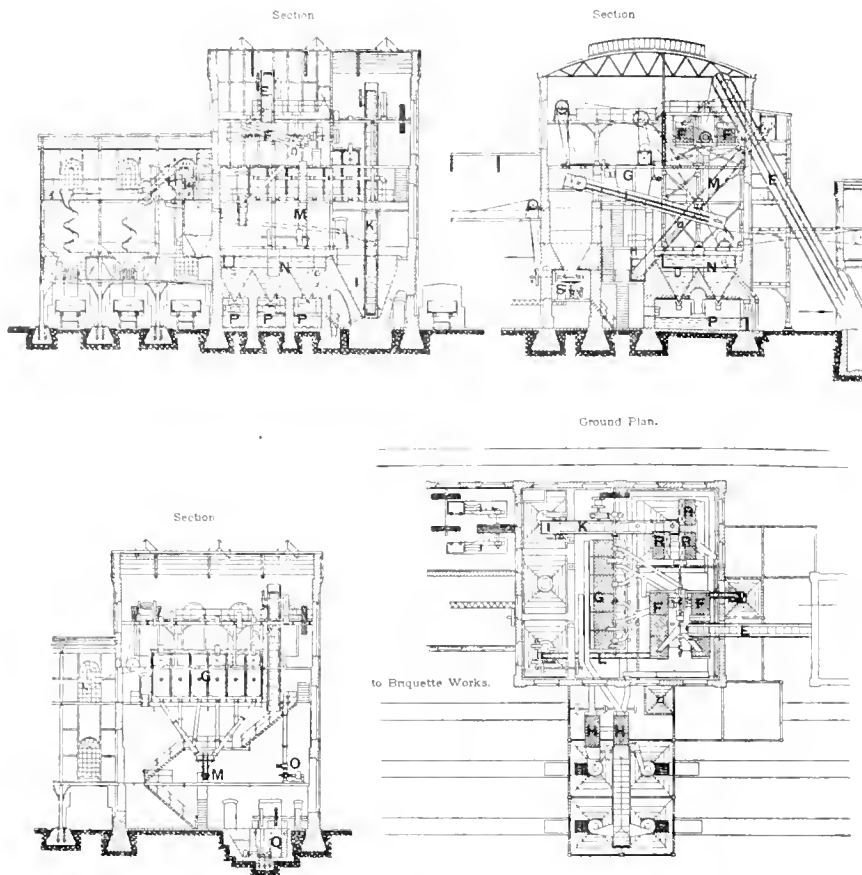

FIG. 2 COAL WASHERY

compartments provided for storing the fine washed coal. The hopper divisions are fitted with drainage devices and the coal becomes relieved of most of its moisture. The fine dust coal below .12-inch diameter eliminated by the main classifying screens passes down a chute leading to a scraper conveyer *L* and is carried to a third compartment in the fine coal tower. The dirt eliminated by the jigs in washing passes down through pipes leading from the bottom of each division of the jig hutch to the boot of the dirt elevator *M*, by which it is drained and delivered to the dirt collecting hopper. The dirt hopper is so placed that the material can be discharged into cars on the cage level. All water used in the system is returned to the fine coal draining elevator sump *I*, where the fine coal accompanying it settles down and is removed by the elevator *K*. The surplus water containing fine material in suspension passes over a sill into the pointed settling tanks *N*. In these tanks the suspended particles settle, while the clarified water passes down a pipe leading to a large centrifugal pump *O*, by which it is raised and reused. The fine material collected in the spitzkasten *N* is drawn off at the bottom by opening suitable valves, and flows to one of the three sludge sumps *P*, where it is drained. The sludge is subsequently loaded into tram cars and

taken to the boiler house, where it is mixed with the boiler coal and used for firing purposes.

The water which overflows from the

sludge sumps, together with the water employed for rinsing the nut coal, carrying with it any fine coal which may have been produced in the loading and discharging operations, is conducted to the centrifugal pump *Q* by which it is delivered into the elevator sump *I* and is subsequently used over again in the washing process after undergoing clarification in the spitzkasten, so that no water escapes from the plant with the exception of that contained in the washed products in the form of moisture.

As there is a probability that at some later date it may be considered advisable to wash the fine coal below .12-inch diameter, the plant is arranged so that three additional fine coal washers *R* can be subsequently installed.

The washing and screening plants are driven by one horizontal compound steam engine. The engine is connected to a central condensing plant, but it is arranged so that it can be worked non-condensing if required.

Briquet Plant.—The briquet plant is designed to produce 30 tons per hour of briquets weighing 6.6 pounds each. It is arranged in duplicate, each section consisting of one oven and three presses with all subsidiary apparatus. Only one section of the plant has been erected but a second section will be added.

The fine washed coal and dust coal upon being discharged from the storage towers is received upon revolving tables, which enable the coal to be drawn off regularly and in any desired quantity and also in any desired proportion of washed

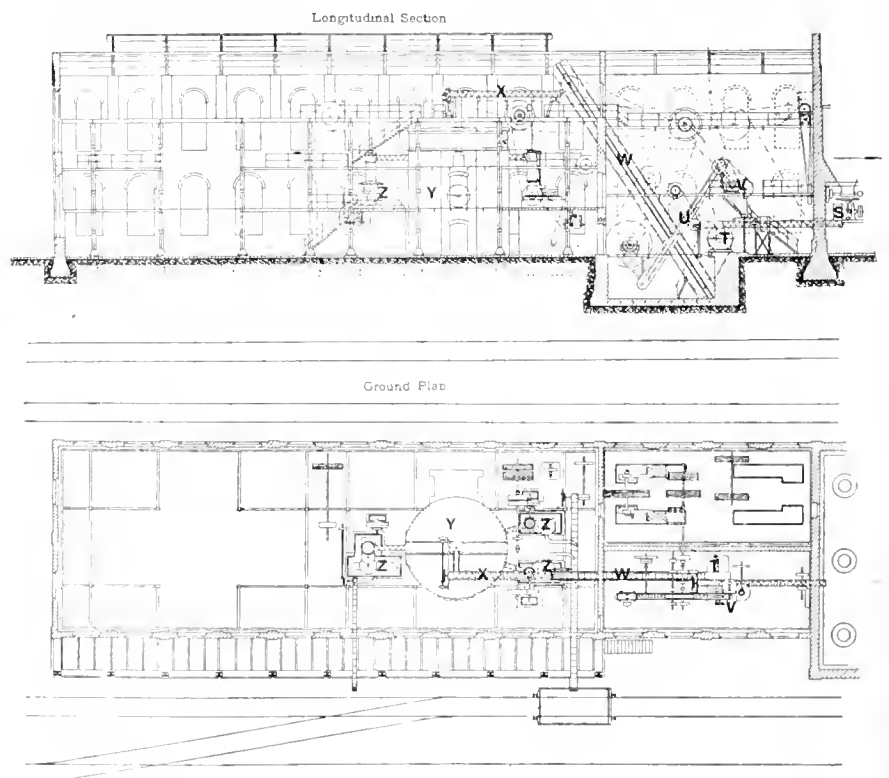

FIG. 3. BRIQUET PLANT

and dust coal. The coal is deflected from the revolving tables by means of a diverting plate and falls into the trough of a scraper conveyer *S*, Fig. 3. The scraper conveyer takes it to a screw conveyer by which it is delivered to the disintegrator *T* where the dust and washed fine coal become intimately mixed and reduced to a fine state.

The pitch is brought to the plant in railway cars and is stored in a chamber running along the whole length of the building. From the storage chamber the pitch is conveyed to the jaw breaker from whence the crushed product is raised by the elevator *U* and delivered to the small disintegrator *V* by which it is reduced to a fine state. Beneath the disintegrator there is a small storage hopper out of which the pitch is withdrawn in regular quantities by means of the revolving table which is arranged with a deflecting plate. The pitch falls into the trough of the screw conveyer

agency of the screw conveyers. Before reaching the presses *Z* the material first undergoes a kneading process in the steam heated vertical kneading arrangements. After passing through this process the material is delivered on to the molding plates of the press and is subsequently compressed into briquets of the size required. The briquets then pass automatically on to conveyer belts of the wire woven description and are conveyed to a chute from whence they are taken off by hand and loaded into railway cars.

The whole of the machinery in the briquet plant is driven by a horizontal compound steam engine of the same size and type as that provided for actuating the screening and washing apparatus. Both engines are placed in one engine room which permits of their being easily and conveniently attended to.

The buildings of the screening plant, washery, and briquet manufactory are all built of substantial brickwork with the

A Method of Socketing or Capping Winding Ropes

In an article in Transactions of the Institution of Mining Engineers, Douglas Jackson says:

The socketing of winding ropes has always been a subject of deep interest to colliery managers, and is now even more so, seeing that the new Mine Act (English) stipulates that ropes must be recapped at intervals of not more than 6 months.

The ordinary methods of capping ropes have given good results in the past, and in the majority of cases have held firm during the whole life of the rope. It is generally known, however that the attachment of the socket to the rope is the weakest part, and would be most likely to give way before the breaking strain of the rope is reached. With deeper pits and increased loads raised at a much higher speed, the risk of the socket slipping is undoubtedly greater.

This fact has led the writer to devise and

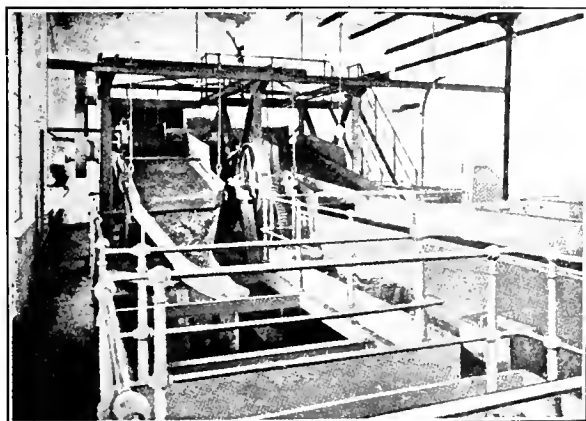

FIG. 4

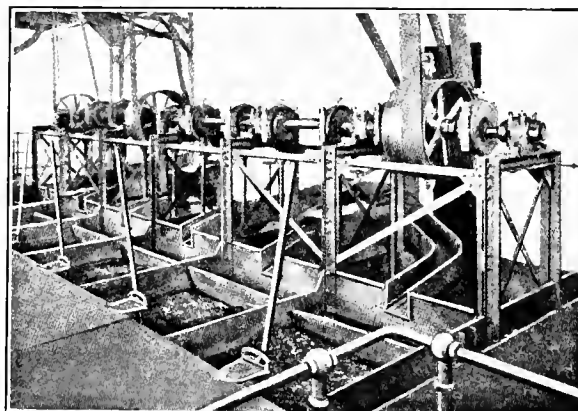

FIG. 5

previously referred to, which conveys the washed and dust coals from the coal storage hoppers to the plant. The coal and pitch are conveyed to the disintegrator *T* by which they are intimately mixed together. The mixed product falls into the boot of the elevator and is raised by this elevator and delivered to the screw conveyer *X* by which it is fed evenly and continuously into the oven *Y*. The oven consists of a circular brick chamber having a revolving floor. Beneath the floor a series of heating fires are kept continually burning, which keeps the oven at the required temperature. The heat is sufficiently intense to dispel the remaining moisture in the coal and to heat the coal and pitch to the degree required. The mixture is deposited in the center of the floor and as the floor revolves the material is continually turned over by fixed stirring plates, which at the same time gradually deflect the charge to the periphery of the floor. The heated mass is discharged by means of fixed scraper plates and passes to the three presses by the

inner fittings for supporting the various apparatus, shafting, etc., made of structural iron work. The roofs are made of iron work and are covered over with cement composition; and the floors are partly made of plates and partly of concrete, so that the whole plant is composed solely of masonry and iron.

We are indebted to the Coal Department of the Humbolt Engineering Works Co., of Cologne-Kalk, Germany, for information in this article.

采 采

An Early Instance of First Aid

Some years ago a witty Irish miner working a breast in the Mammoth Seam in the pitching measures of the Hecksher-ville Valley, Schuylkill County, Pa., having favorable conditions for a heavy shot, fired it. After he and his laborer had waited a short time in the safety of a cross-heading for the smoke to clear away, he said, "Moike, g' up now an' thrim off the sides an' top, an' I'll g' out fur th' ambulance."

adopt a simple method of capping, which can be applied by the colliery blacksmith, with no risk whatever of the socket slipping. The tools used in preparing the rope for the cap are shown in the accompanying illustration (Figs. 1 to 6). In Fig. 1, a socket is shown fixed at one end of a piece of rope, while the other end shows the white-metal cone completed and ready to receive the cap. Each size of rope requires its own set of tools, made in proportion to the diameter. The length of the cap should be equal to 22 times the diameter of the rope, and the large diameter of the cone should be equal to twice the diameter of the rope.

The socket for a winding rope is generally made of soft steel, or of Low Moor iron, with a breaking strain of about 40 tons per square inch; but it is better to err on the safe side, and assume the breaking strain at, say, a quarter less, or 30 tons per square inch. Fig. 2 shows the mandril, which is made of hard steel and turned in the lathe to the desired diameter and taper. This mandril is used by the blacksmith as the

pattern or block on which to fit and finish the completed socket. Fig. 3 is the spike, with rings about 2 inches apart, and is turned in the lathe to the same taper as the mandril, but is less in diameter by the thickness of two strands of the rope and rings. The rings are sawn through lengthwise, in order to give them an easy hold on the spike. The twister (Fig. 4) is used to twist the strands of the rope round the spike and rings back to their natural lay or original position. The hole in the center

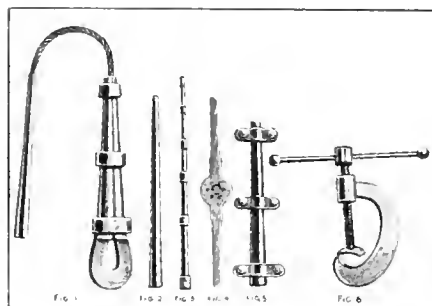

TOOLS FOR SOCKETING WINDING ROPE

is large enough to allow of the rings on the spike passing through, and the six smaller holes, spaced equally apart, receive the strands of the rope. The clamp (Fig. 5) is made in two halves, with three half glands riveted on each half, the inside head of the rivets being countersunk. The two halves, when bolted together, fit on the mandril.

To prepare the rope for socketing, the strands at the end of the rope must be sawn to an equal surface, the socket rings passed on to the rope in their order, the length of the socket measured off, and the rope lapped round for a few inches with soft wire. The rope is then fixed in the vise, the strands unfolded, and the central core cut out. Each strand is then put through one of the small holes in the twister; the spike with its rings is placed in the position of the central core of the rope, and the strands are gradually twisted around it: when the twister reaches the top of the

drawn, leaving the rings inside a properly tapered cavity ready to receive the metal. A hot rod should next be put down the center so as to heat the small ring at the bottom, and the white metal then poured in at the top. Should a leak take place at the bottom of the clamp, a touch with wet waste will stop it at once. When sufficiently cooled, the clamp should be taken off and the short ends of the strands dressed off. The finished cone will now be exactly of the same dimensions as the mandril. The socket should now be heated at the bend, the cone put into its position, and the socket closed gently down with the screw clamp (Fig. 6). The socket rings are then driven into position, and the operation is complete.

In the system here described, the cone is well formed and solid, so that there can be no corrosion of the wires, and, in addition, the strands of the rope have their natural twist.

The writer had six tests made with short lengths of rope, and not one of them broke under the breaking strain given in the rope-maker's tables.

Another test was made with a short length of rope. One end was socketed by the rope maker, the other in the manner already described. The result was that the rope broke inside the rope-maker's socket with a strain of 75 tons, or 78 per cent. of the breaking strain of the rope, which was stated in the maker's tables as 96 tons. After examination the cause of the breakage was seen to be that the rope maker in socketing his end of the rope had adopted the method of turning back the strands over an iron ferrule, and interweaving the ends into the rope again. The taper made was therefore imperfect, and no two strands were subjected to the same strain.

Richard's self-tinning plastic white metal was used for the socketing of all the ropes tested, its melting point being as low as 500° F., and its contraction in cooling almost nil.

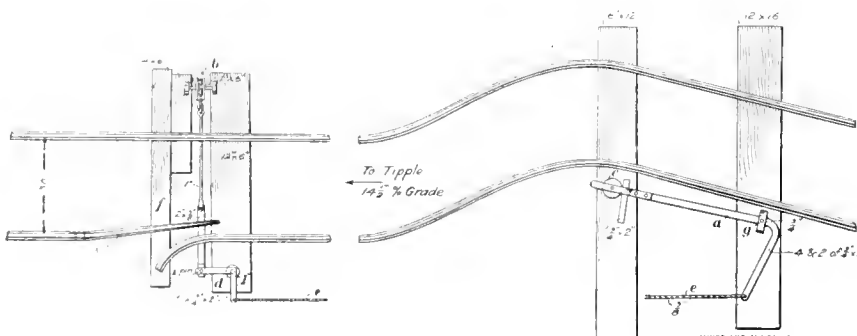

FIG. 2. DETAILS OF DERAILING SWITCH

spike, the top ring will be a little below the end of the strands. The clamp (Fig. 5) is put on and screwed tight; this presses the strands firmly against the rings of the spike, and so holds them in position. The spike can now be turned round and with-

In a paper read before the Alabama Coal Operators' Association, J. B. McIntyre says: "Probably no one item works so much injury to mine tracks as acid mine water, so that proper drainage becomes a matter of prime importance.

Derailing Switches for Slopes

By Simon H. Ash, E. M.*

It has been stated that the only reliable method of derailing a runaway car or trip on a slope is by means of the automatic safety switch that is always set to run the cars off the track, except when the operator closes it for the cars to pass down the incline. This kind of switch is closed by the ascending car or trip and is opened automatically after the cars have passed.

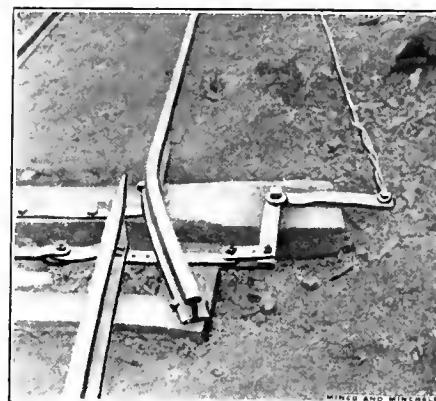
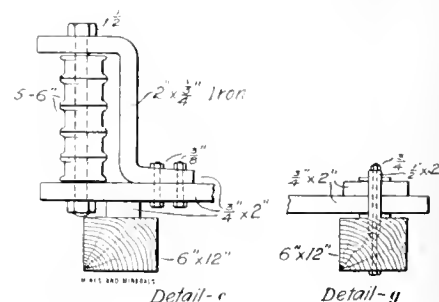

FIG. 1

It is thus always set to run a descending trip off the track, and depends upon the man at the top of the incline to see that the switch is closed at the proper time.

If the headman makes no mistake the trip will reach the bottom in case there is no other accident before or after it has reached the switch; however, there is always an element of uncertainty when man must be depended on in such cases; and this, with numerous other considerations, have been factors in condemning inclines where they could be avoided. While in some cases it has been considered advisable to build from 1 to 2 miles of tramway in order to avoid inclines, even with such expensive means they at times are necessary; therefore, improvements along the lines of safety are eagerly sought.



Owing to the increased danger arising from the long gravity planes necessary to handle the coal in the Roslyn district of the state of Washington, various devices were tried to derail runaway cars and pre-

*Engineer for R. C. C. Co.

vent the excessive damage done, as well as to protect the lives of men on the tippel. At the No. 1 mine of the Roslyn Cascade Coal Co., William Mackay, general manager, the gravity plane is 3,400 feet long, averages 14½ per cent. grade, and is almost a perfect tangent with the exception of two small curves, the location of one of which was taken as the position for the safety switch described. A plan and elevation of the derailing switch, which is working most excellently, is shown in Figs. 1, 2, and 3. The switch is operated automatically by the hoisting rope, which, by means of pulleys and a connecting rope operates the two levers that throw the switches, shown in Figs. 1 and 3. The switch is always held open to derail the trip until the hoisting rope has passed below the lever *a*, Fig. 2. This lever is held in position by means of the weight *b* suspended by a chain over the pulley, as shown. As soon as the hoisting rope passes below the lever *a* it engages the pulley *c*, Figs. 2 and 3, which moves the lever *a*, which in turn operates lever *d*, Figs. 1 and 2, by means of the tiller rope *e*, which is 160 feet long, sufficient to allow a 15-car trip to be a safe distance from the switch. The lever *d* on moving closes the latch *f*, thus throwing the switch for the main line. Should any cars break loose above the lever *a* the switch would fail to operate and the cars would be derailed.

The above device is at work on an outside engine plane, but a somewhat similar device, shown in Fig. 4, is in operation in the slope of No. 2 mine, which is sinking on an average grade of 28 per cent.

There are so many chances for cars running down a slope that the sinking operations are always a cause of anxiety; therefore, the installation of this device near the slope bottom is a source of relief to the men and the management. The plan of operating the slope device is the same as for

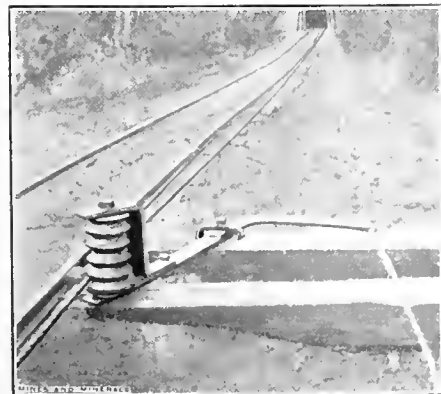
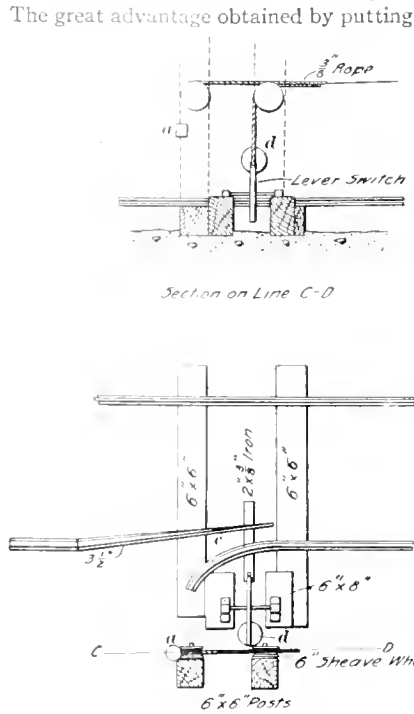

FIG. 3

the engine plane; that is, by means of hoisting rope, levers, reach rope, and weights, except a different method is used for obtaining the desired leverage by placing the pulleys in the center of the track and using a different method of keeping the derailing switch thrown.

The device in Fig. 4 is to balance the weight *a* in Fig. 4 is to balance the weight of the pulleys and lever *b*, and to always return the pulleys to their normal position. The lever switch *c* by means of the weight *d* serves the same purpose as the weight *b* in Fig. 2 in keeping the derailing switch thrown open.



Hogan on the Bureau of Mines

Written for Mines and Minerals

Say, Reilly, this Bureau of Mines makes me tired. Here they are spindin' money and makin' a great hullabaloo out near Pittsburg explodin' coal dust in an ixpirimintal mine, and provin' to the minin' public fwhat we all know, and fwhat the *Minin' Hur-rl'd* and the *Colliery Engineer* printed twenty-five or thirty years ago.

Av coorse they pay some attintion to

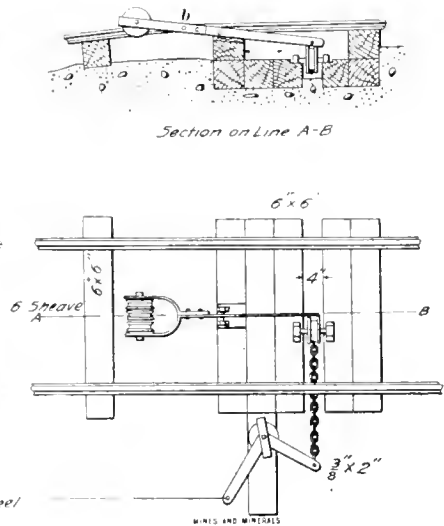

FIG. 4

the pulleys in the center of the track, as shown in Fig. 4, is the doing away of any curves in the track and only necessitates the track being slightly elevated.

來 來

Capacity of Rolls

The capacity of a set of rolls for ore crushing depends largely on the evenness of its surfaces. If the rolls are worn so as to become grooved, and so that they do not meet except in spots, their efficiency is reduced, often as much as 50 per cent. A set of well-constructed 14" x 27" rolls, with even surfaces, and running at 100 revolutions (700 feet peripheral speed) per minute, and taking ordinary quartz ore from the crusher at .5-inch size, will reduce it approximately as follows: To pass 8-mesh screen, 3,500 to 4,000 pounds per hour; to pass 12-mesh screen, 2,500 to 3,000 pounds per hour; to pass 15-mesh screen, 2,000 to 2,500 pounds per hour; to pass 20-mesh screen, 1,500 to 1,800 pounds per hour.

來 來

In a recent French report, reference is made to a reduction in the number of fatal accidents in French coal mines, which fell from 1.17 per 1,000 men employed in 1909, to 1.08 in 1910, and although the figures for 1911 are not yet published, it is believed they are equally satisfactory.

gas too, an' they have a laboratory where they tesht the gas, an' powdher an' safety lamps. I'm not sayin' that they don't do some good things, but whin they tell the results of their teshts they put it in words that you an' I can't understand. Sure if it's gas they're talkin' about they give it a name be which few ould miners (and many of them are well acquainted wid mine gases mind ye), wouldn't know it. Sure they spake of ould fashioned fire damp as methane; black damp, be the same token, they call carbon dioxide, and white damp they call carbon monoxide. But whisper, Reilly, the fire damp is jist as hot, the white damp as deadly, and the black damp as chokin' be the big names as be the names be which you know them. I wuz talkin' to Father McGovern about it the other day, an' sez he, "Hogan, don't let the names bother ye. The names the min in the Bureau give the gases don't change them a bit. You know them be wan name, an' they bein' eddicated call them be the chimical or scientific names." But Reilly, it does bother me. Sure whin I wuz a bye the hedge schoolmaster niver taught me chemistry, if he knew it himself; an' most av the min in the mines are no bether. I've no objections to the high choned names, if whin they call the gas by them, they'd interdooce them to us by sayin', "this is Carbon Dioxide *nee* Black Damp" as the Chicago society reporters

say whin they spake of me rich daughter Mary Ann as Mrs. Patricius Monaghan, *nee* Hogan, the lasht bein' her name before she married Pat. But, lave thim call the gas fwat they will, I'll have no hard kick if they'll find some way to make it less harmful than it's been in the pasht.

Will they do it? Well, Reilly, I don't know will they. There are some min in the Bureau that know something about minin'; but there are more av thim that have a lot to larn, and 'tis thim that seem to have the most to say. Sure if ye'd belave what they tell the newspaper min, and all they print in the bulletins, ye'd think the shuperintindints an' bosses, let alone the miners, who have spint their lives in the mines, know nawthin' av minin'; an' that a few min in the Bureau who know bether how to get a government appropriation than they do to dhrill a hole an' fire it, or set a prop, know it all.

Begorra, the more I rade about the Bureau in the newspapers an' the bulletins, the more I think it wuz organized for three purposes: First to get an appropriation, second to sphind it, and third to make the wurrk of the miner aisier an' safer, and to taich the minin' companies how to consarve the coal resoorces av the country. Av coorse the laiste important objicts av the Bureau, as I see it, are mentionted lasht.

Ye're right, Reilly. The minin' companies are doin' a lot to make the mines safer, an' they've larned how to mine the coal bether than they did whin you got yer first job as a miner after laborin' wid Davy Evans. Av coorse the savin' av the coal is good business, Reilly, an' ye can thrust the coal companies to look out fer number wan. There are times, as you well know, whin I'm not willin' to spake many good words fer the companies, but there are others whin I musht, iv I want to be fair. Look at the first aid work. That's a grand thing, and it wuz the Big Boss of the Readin' company that set an example in it, that was soon follyed be all the others. The companies furnish all the appliances, pay the docthors for taichin' the byes, an' give thim opportunities to learn the wurrk, which is all for the good of the min. Be this manes, and the inthrest the officials take in the wurrk, the min and the companies are partners, an' aich larns to know an' respect the other. An' whin aich Fall they have the competitive dhrills av the different crews, it's a great sight to see the officials, from the big boss down, matin' the min on an aqual footin', an' good feelin' an' respect prevailin' on both sides. Besides the first aid work, many iv the companies are doin' a great dale more. Look at fwat Tom Lynch is doin' in the coke regions. I wuz out there on Christmas to see Pat Tormey, an' he wuz

tellin' me av all the pains the bosses at the Frick Coke Company's mines had to take to prevint accidents. Ivery place around the mines where there is anny danger, there's a sign of warnin' an' the words "Safety the First Consideration" are stuck up everywhere so that both the bosses an' mn are always reminded that the savin' av a life or a limb is av more importance than a big production. In the ould days, Reilly, there wuzn't much consideration given to the safety of the miners, an' it's only be good luck an' the blessin' of God that the two av us are here now. It's different now wid most of the companies, an' if the extint of the mines and the production wuz the same, wid the same coal to mine that we dug forty years ago, there wouldn't be half the accidents there were thim. But conditions have changed in the hard coal regions, as you know, Reilly. The mines are deeper, more machinery is used, an' the minin' requires more judgment an' skill on the part of the min' than it did forty years ago. This accounts in a large missure for many of the accidents. Av coorse most of thim that do happen might be previnted, either be more care on the part av the min or the officials. But, Reilly, it's always aisier to see how to prevint an accident after it's happened than before.

Now, as I've been argyin, Reilly, the companies are workin' hard to prevint accidents, an' be minin' institoots an' other manes, they're taichin' the foreigners English, an' all av us simple rules to make the work safer. If the lads dhravin' pay from the Government would larn just fwat is being done, and thry be workin' in harmony wid the mine officials to improve things, insthead of claimin' credit for provin' things we all know, and av sayin' other things we know are wrong belittlin' the repytashuns of the bosses, they wouldn't be the laughin' stock av both the bosses an' the miners.

Sure they have some lad in Washington that dishes out all kinds av sthories to the reporters, till ye'd think the hid of the Bureau wuz lookin' fer a job as ladin' lady in a burlesque throup. The latest thing they've brought out is a sthory that the companies are wastin' 80,000,000 tons av hard coal ivery year. Whin ye think, Reilly, av how the companies are minin' coal that was abandoned thirty, forty, and fifty years ago, an' in the fresh ground they are workin' they're takin' out about two-thirds av the coal, at first work, an' thim robbin' back until they lave but little av the pillars, how the devil can they be wastin' almost as much as they mine? I see by the papers that a lad named Parsons workin' fer the Bureau diskivered this, and Docthor Holmes has been tellin' the people about it, and how the soft coal miners are wasting over three times as much ivery year. I'm thinkin', Reilly,

that Parsons has been asleep for the past thirty years. Begorra, if he wuz writin' history, instead of sayin' "Home Rule wuz at hand for Ireland," he'd tell about the battle of the Boyne, and make ye belave it happened yestherday.

Why is it that hard coal dusht don't explhode? Well, Reilly, afther forty years workin' in hard coal, you know it don't explhode, don't yeh? Well, if you know it, lave it go at that. I know that soft coal dusht does explhode, and you know hard coal dusht don't. Bechune the two of us we *know* what the Bureau of Mines is larnin'. Av coorse, whin yeh come down to the raison av it, all I can tell yeh is that the soft coal has more gas in it than hard coal, and a bit of hate warmin' the flyin' dusht makes it give off the gas, an' if it's lighted there's the devil to pay. What kind av gas is it? Well, Reilly, it's gas all right, and be the same token I'd call it fire damp, but the larned min av the Bureau call it somethin' that sounds like "fol de rol highbrow carbons." Ye ask, did I rade about the canary burds? Av coorse I did, an' though I've no use for the color of the little things, the poor burds can't help that, and it's a shame to be killin' thim be experimints in the mines whin English sparrows are so plintiful, an' nobody wantin' thim: Mebbe it's because canary burds cost more than the Bureau uses thim, fer there's nawthin' chape about the Bureau irect the salaries it pays to the few lads in it who do know something about minin'.

Do I think anny good thing will come from the Bureau? Av coorse I do. Some of these days, if they live long enough, the min at the head of it 'll larn a little about minin', an' whin they do, they'll thry to larn more from the min who have spint their lives in the mines. Sure it isn't much you or I know, Reilly, about the fol de rol highbrow carbons an' such things, but we do know how to dhrill a hole and fire a shot, and how to set a prop, an' a few things like that. We might be able to taich thim a little, an' thim whin it comes to the bosses, big an' little, that know all we know, an' more too, and have eddication as well, they can taich the lads in the Bureau as much as their heads 'll hould. Besides, Reilly, the Bureau has done some good work in thrainin' Rescue Corps, an' in testin' powdher an' ile an' things like that, an' I'm hopin' that in the coorse av the nixt tin or twinty years, the boss av the Bureau will realize that the min at the head av the minin' companies have at laiste a little knowledge av minin', an' that the harder his press agent at Washington works the less respect the min at the mines have for his Bureau. Well, Reilly, it's gettin' late, so I'll take the full av me pipe and lave ye, so ye'll be gettin' a good night's slape. Good night, to ye, me bye.

Commercial Sampling of Coal

Precautions Necessary that the Sample May Accurately Represent the Lot When Selling by Analyses

By C. F. Scott*

AMONG consumers of bituminous coal there is an increasing tendency toward the chemical analysis, as a measure of quality. This is true in cases where the coal is not bought on analysis basis, as well as in contracts where the analysis is specified. The large users of steam coal are well informed on the quality of the various coals available to them, many having chemical laboratories sufficiently well equipped to make thorough tests, while the small consumers are aware of the fact that there is a very wide variation in the quality of different coals, and even they are awake to the importance of knowing the actual quality of the coal they buy. Consequently, it is now quite common for the coal company to be asked to furnish an analysis of the coal it expects to deliver on a certain contract. The consumer keeps this analysis and makes arrangements with some laboratory to take samples at certain periods, and send him the results. These results are then compared with those furnished by the coal company, and should any of them show higher ash or lower British thermal units, a complaint is immediately registered, and often an allowance asked for.

Whether this particular analysis or sample represents the coal is rarely questioned by the consumer; check analyses are occasionally requested, but duplicate sampling rarely.

In handling the complaints arising from the shipments of some 20,000,000 tons, in the past 2 years, it has been found that over 50 per cent. of such complaints as were covered by analysis specifications, were caused by inaccurate sampling. In the chemical analysis there is little chance for error, providing the work is done by a reasonably intelligent analyst; and in many investigations no case is recalled where the analytical work was at fault. There is as yet no uniformity in the method for the determination of the heat value of a coal; however, a bomb calorimeter, such as the Mahler or Atwater, where the coal is burned in oxygen, under pressure, is the type that has proven most accurate, and is the commonly accepted standard.

The weakest point in the present system of testing coal, as delivered at the plant, is the method of taking the sample and preparing it for analysis. The improper sampling of a lot of coal, such as a pile, a car, or a barge load, is so evident that it has finally become the subject of much discussion, and is now realized to be a very important feature of coal testing. Poor sampling is so general that it has been found in plants that consume thousands of tons monthly, in plants where coal has been bought on specification basis for several

years, and in plants where skilled chemists are employed.

It is evident that the fact has been overlooked, that an analysis of coal is merely an approximation, and the value of the opinion based on the analysis depends on the approximation of the results determined. Where the interpreter of the analyses available on certain coals is not familiar, by previous experience, with the coal under discussion, it will be necessary for him to take more than ordinary precaution in passing an opinion on the commercial value of a coal. It seems that analyses heretofore have been considered of equal value, and no consideration of weight has been placed on the care and the quantity of the material handled.

Those who have considered their work well done, by sending samples to the best chemist available, have failed in their object, unless they have employed equal skill in the interpretation of the results so received. This interpretation depends on the knowledge of coal in general, together with a knowledge of the particular coal under examination, and the detailed facts of preparation of the sample.

The size of the sample used in the laboratory is of necessity limited to a few grams of coal, pulverized to 80 or 100 mesh. This laboratory sample may represent 50 or even 500 tons. When originally taken it should contain large pieces and fine coal in their respective proportions. The limits of variation permissible in a coal analysis are narrow, and where the chances of error are so manifold as in the sampling of coal, the greatest care should be exercised.

The most common error, such as taking only the lumps, or the discarding of everything above a certain size, will produce different effects on different coals, and this is a fact heretofore almost entirely overlooked by those in fuel-testing work.

In the case of low volatile, friable, columnar structure coals, an excess of fine coal in the sample will have a tendency to reduce the ash. It has been known to cause an error of 20 per cent. of the total ash. As an illustration, the following results are given:

Size of Coal	Per Cent. of Ash
Over No. 6 mesh and under No. 10 mesh	12.88
Under No. 6 mesh and over No. 10 mesh	10.48
Under No. 10 mesh and over No. 20 mesh	9.34
Under No. 20 mesh	8.86

The analysis of a properly taken sample

of this coal is as follows: Moisture, .70; volatile, 17.08; fixed carbon, 71.28; ash, 10.94.

The effect of this error (excess of fine coal in the sample),

with a high volatile, harder structure coal, is directly the opposite, and the ash is increased to several per cent. above the normal.

In the following results, column No. 1 shows the ash percentage in samples where that portion of the sample that remained on top of a 60-mesh sieve was discarded, while column No. 2 shows the ash in the same samples with the entire sample put through the 80-mesh sieve.

	No. 1	No. 2
	12.76	10.60
	13.36	10.59
	18.11	14.63
	12.59	11.33
	12.49	10.70
	11.13	9.42
	11.21	8.25
	10.88	9.87
Average	12.82	10.67

This is a coal that runs about 37 per cent. volatile matter.

In the former case the difference in the analysis of the different sizes of coal is due to the position of the impurities in the seam, as well as their character and that of the coal in which they exist. The shale is found in a finely divided state in the seam and is hardly perceptible. It acts as a sort of binder, holding together enough coal to form large lumps, and it is almost invariably true, that the parts of the seam which break down into the smaller sizes are free from this impurity. In addition to this, the coal is softer and more friable than the shale.

In the latter case, the coal is free from shale in the seam proper, and the shale entering the product of the mine comes from the floor or roof. The coal is harder than the impurity; and in handling, the greater percentage of shale is reduced to the smaller sizes and carried into the slack or fine coal, the ash in these sizes thereby being increased.

Errors in sampling not only occur in the taking and making up of the original sample, but are often found in the crusher house or sampling room. The man usually designated to take the sample is a fireman or laborer about the plant; or, if a man especially detailed or employed to do this work, he is paid little more than day-labor wages, and after receiving his first instructions is left to do the sampling without being watched. He is not aware of the effect on the sample, of even the slightest variation from the rules he was told to follow. A case is recalled where a sampler of more than 15 years' experience in the sample house of a large consumer of coal and coke was found to be the cause of serious trouble. The laboratory results on coal began to show excessively high ash.

*Chief of testing department of the Consolidation Coal Co., Fairmont, W. Va.

Complaint was made to the coal company furnishing the coal. Investigations followed and the methods used in the laboratory of the consumer were found to be unquestionable, the manner in which the sample was taken was above criticism, each step being carefully carried out, but in the final operation of making up the laboratory sample, this man was rubbing the samples until about half went through the 80-mesh sieve, and throwing away that which remained on top. By a series of tests to determine the effect of this error, it was proven to have increased the ash in the samples from 2 to 8 per cent. above normal. This was with a coal of about 38 per cent. volatile matter and of hard structure. The time at which this man began throwing away part of the sample checked the date upon which the laboratory results began to show excessive ash.

Heretofore, whether coal has been sold on an analysis basis or not, the collecting of the sample has been left entirely with the purchaser, and little attention has been paid to this part of the work, and even today there seems to be no rule or system followed in collecting samples. In some cases a sample is taken for each car load delivered, another company may take one sample for a certain number of tons delivered, still another, one sample for every cargo received, regardless of the number of tons it contains, while we find another, one of the largest and most important consumers of soft coal in the United States, taking one 5-pound sample to represent a cargo of approximately 5,000 tons. It can readily be seen that there is a limit to the number of tons one sample may fairly represent; also it is evident that the size of the original sample should be in some definite proportion to the number of tons it represents. The variation in two samples of coal, from the same pile, is often quite largely due to the difference in the analysis of the lump and the fine coal, and it is difficult to obtain proportionate parts of these different sizes in each sample; especially is this true if the sample is small. Since variation in different samples does occur, the average of the greatest number of carefully taken samples gives the most accurate figure as to the quality of the coal being sampled. If one sample only is taken, then the larger the original sample the more likely it is to be representative, as the chance of error decreases as the size of the sample is increased, likewise does the chance of error decrease as the number of samples is increased, even though the coal being sampled is uniform in quality.

Recently 100 cars of run-of-mine coal were sampled for sulphur determinations. The average of the 100 samples was 1.196 sulphur. These 100 results were divided into two sets of 50 each, by putting every alternate one in the same set; one set averaged 1.198, the other 1.195; then in the same manner into three sets of 33 each,

with the following averages: 1.192, 1.182, 1.214; then into four sets of 25 each with the averages as follows: 1.201, 1.221, 1.191, 1.168. Then into five sets with the following averages: 1.153, 1.211, 1.094, 1.215, 1.276. Then into 10 sets with these averages: 1.113, 1.145, 1.037, 1.203, 1.193, 1.338, 1.152, 1.228, 1.281, 1.272. The maximum variation from the average of the 100 samples is .142, in the 10-sample set, which is approximately 12 per cent. of the total sulphur; in the 20-sample set the maximum variation is .102 or 8.5 per cent. of the total sulphur. On individual analyses $\frac{1}{10}$ of a per cent. is a slight variation, but in a coal that runs 1.20 on the average, it is hardly permissible in the majority of cases where accurate averages are desired, consequently 20 samples would not have been a sufficient number to give the desired results on these 100 cars of coal. From the 25-sample set the maximum variation is .028, and this is probably the smallest number of samples that would represent these 100 cars with desired commercial accuracy for this class of coal.

One hundred ash analyses were averaged and divided in the same manner, and even though the coal used is very uniform in ash content, nevertheless the difference in the average of the 20-sample set and the 100-sample set, was too great to allow the 20 samples to be considered sufficient for the determination of the ash in the 100 cars of coal.

In deciding the number of samples necessary to be taken from any one consignment of coal it would be unsafe to draw definite conclusions unless several hundred analyses had been made of the coal in question, and its uniformity or lack of uniformity determined, and its accurate average established. In the sampling of coal delivered at the plant this is rarely ever done, and the conclusions drawn from individual analyses, or sets of five and ten analyses, are given too much consideration and weight and are often erroneous.

Few contracts, if any, have been made, which stipulate in detail rules to govern the method to be pursued in collecting and preparing samples for analysis. It is now self-evident, however, to many shippers, that a sampling clause, which will compel the taking of representative samples must be inserted in all contracts, where coal is sold on an analysis basis, or where the purchaser expects to have analyses made of his deliveries; and it is the purpose of this paper to set forth, in part, rules which may aid in the adoption of standard methods for coal sampling.

The methods given below are, in a general way, those used by the testing department of the Fairmont Coal Co., Somerset Coal Co., and the Consolidation Coal Co.

Where samples can be taken mechanically, such as taking a definite quantity from a hopper or chute, at regular intervals, by the means of a slot or door which is opened

and closed automatically and dropped into a crusher and quartering machine, it is advisable to do so, as it eliminates the personal element and the danger of chance samples. At plants where the annual consumption of coal is large, the advantages of mechanical sampling are many and the saving would more than offset the cost of installation and operation.

Local conditions and facilities to some extent govern sampling, but the principal points may be followed out at any plant, whether the coal is received by barge, railroad, car, or wagon.

"The size of the sample shall not be less than the proportion of one part in one thousand, and the minimum size of any one sample shall be 100 pounds, the maximum number of tons one sample shall represent shall be 1,000, and preferably much smaller than this, 250 tons. All the impurities, such as slate and pyrites, should be broken down in the original sample, and if this is done as each shovelful is taken, it makes the work much easier. In collecting the original sample from a railroad car it should be taken as the coal is being discharged; where the coal is delivered to the point of sampling in wagons, one large shovelful should be taken from each wagon; where it is delivered in a barge, the sample shall be taken as the barge is discharging (if the discharging is accomplished by the aid of a bucket or belt conveyer it is advisable to take advantage of this and obtain a small shovelful from the buckets or off the belt at regular intervals); where the sampling must be taken from a pile, a shovelful shall be taken from all accessible parts of the pile, and the shovel shall be filled from the coal underneath the surface. As the coal is collected it must be placed in a box, barrel, or can, of sufficient size, which has been thoroughly cleaned out before using. A lid should be kept on the container at all times to prevent dust, ashes, etc., from collecting on the sample.

"When the total sample is completed it shall be put through a crusher or dumped on to a clean wood or cement floor, or on a canvas cloth, and crushed down by means of a hammer until no pieces larger than 1 inch remain. The sample shall then be mixed by shoveling it over itself into a conical pile and divided into four equal quarters, the two diagonally opposite quarters being discarded and the two remaining mixed together in the manner just stated. After quartering twice, the sample shall be crushed down to $\frac{1}{2}$ inch and mixed and quartered until it is reduced to about 10 pounds, when it shall be crushed to $\frac{1}{4}$ inch and quartered down to about 2 pounds. This 2-pound sample should not contain any pieces over $\frac{1}{4}$ inch in size. The sample is then placed in a can or jar with a tightly fitting lid and labeled, and sent to the sampling room."

The methods in the laboratory sampling room where the samples receive their final

preparation have, within the last few years been materially simplified by the introduction of crushers, quartering machines, and pulverizers, which have done away with the bucking board, hand-power crushers, and quartering by means of a spatula. In a modern sampling room where power is used to do the crushing and pulverizing,

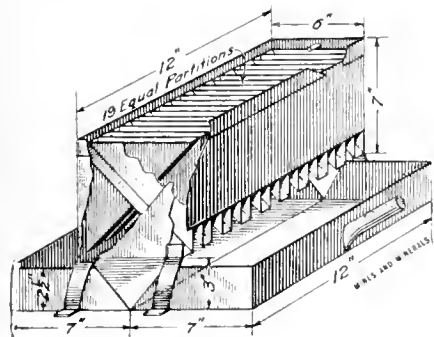

FIG. 1

the number of samples that can be put through in a day's time is almost unlimited, and the accuracy with which these machines do the work has been proven, and has helped to make this part of the work more reliable and simple. Nevertheless, there are some machines on the market, both for pulverizing and the quartering which are both inefficient and unreliable.

Samples, other than regular ones, come to the Fairmont laboratory in money bags, fruit jars, cans, and mailing cases of every description. They are at once turned over to the sampler, whose first duty it is to take note of the mark or label (if a sample has no mark or label to indicate its origin, it is put aside until a letter or advice bearing on it is received). The sample is then put through a jaw crusher, which crushes it down to a No. 8 mesh size, and if the weight of the whole sample does not exceed 1/2 pound it is next put through a disk pulverizer and crushed down to No. 20 mesh size. If the sample weighs 2 or 3 pounds it is quartered down to about 1/2 pound after leaving the crusher, and then put through the pulverizer. After it has been crushed to No. 20 mesh it is finally quartered to 2 ounces and placed in a laboratory sample bottle, in which has already been placed a ticket showing the marking of the sample as it came to the laboratory. From the bottle it is put through the disk pulverizer and pulverized so that the entire portion of it will pass through a No. 80 mesh sieve, and rebottled. It is then entered in the record book and given its laboratory number.

The crusher and pulverizer are belted to a line shaft, which is run by a small motor. Quartering is accomplished by passing the sample through a riffle sampler, which is a box of small diagonal chutes, which open at the bottom, alternately on opposite sides of the box, as shown in Fig. 1.

Passing the sample through once, halves it and does it very accurately. By test it

has been determined that it cuts the sample into two halves, within 1/100 of 1 per cent. when the samples do not contain anything larger than No. 10 mesh size. The analysis of the two halves will check within a tenth of 1 per cent. in ash, sulphur, and British thermal units.

In addition to the riffle sampler there is a quartering machine known as the Forest-Coolidge automatic sampler, designed for the purpose of handling large samples of ore, coal, and coke.

There are small crushing machines for the first crushing, while for pulverizing samples to 100 mesh a power disk pulverizer is a very efficient machine. It does the work of a bucking board, with the aid of a very small motor. Its capacity is equal to that of the crushers, so that while one sample is being put through a crusher another may be working through the pulverizer.

For cleaning machines, tables, plates, etc., in the sampling room, an air blast with a sufficient length of rubber tubing to reach all machines is a great improvement over a hand bellows and brush.

采 采

The New Steel Mine Support

At a recent visit to the Penn-Mary coal mines attention was called to a new steel mine support. It consists of rails both for legs and for cap pieces. The cap and legs are bolted together at their intersection by two steel plates as shown in Fig. 1. These plates are formed in dies under a steam hammer, so as to grip the rails tight and give a simple and rigid construction. While the method of joining is simple, nevertheless the plates must be forged to conform to the size of the rail. When properly made this set of timbers is strong and serviceable.



FIG. 1

FIG. 2. STEEL MINE SUPPORT

Fig. 2 shows a set of three timbers joined together and set up for the purpose of photographing. As will be noticed they are tied together at the top by means of steel rods, and if necessary can be tied on the sides as well. Foundations for all steel timbers should be of concrete, strong stone, or have an iron base plate.

Self-Burning Limestone in Syria

While making a trip through the Hauran district of Syria, south of Damascus, east of the upper Jordan, United States Deputy Consul John D. Whiting states his attention was attracted to a curious stone which might be described as a self-burning limestone. Some natives were burning it and he was enabled to see the operation.

At this place the rock lay in a stratum between ordinary limestone; it was of a grayish black color, and when freshly broken had an odor of petroleum. Nearby were outcrops of what looked like the same material many rods long and 20 to 30 feet thick.

The quarrying is easily done with primitive picks and other tools, as the rock is quite soft and full of seams. The stone is broken into small pieces with hammers and piled up against the bank of rock. A wall of the same material about 2 feet high is roughly laid up around the pile on three sides, making a pile of small stone 8 to 10 feet long and nearly as wide, and 2 feet at the front, rising to nearly three times that height at the back where it lies against the bank.

In building the wall around the pile small holes are left for draft and in which to start the fire. When the kiln is ready to burn, a few small bunches of straw are placed in the holes mentioned, lit with a flint and steel, and in a short time the whole pile has ignited. The men then begin working on a new kiln while the other burns and cools.

After about 12 hours of burning the stone has all become converted into lime, except the stones in the wall and the very top layer, which are only about half burned. When cool, the lime is air slacked and sifted to remove any pieces not

thoroughly burned, which are thrown into a new pile to be fired again.

While there he saw four kilns in all stages of the process except the firing. The workmen said that it made a very black smoke with a bad odor like kerosene burning. The lime is white and said to make a very strong plaster, superior to the ordinary lime burned with brush.

Facts About Anthracite Mining

History of the Growth of the Industry Which Also Shows Increased Economy in Production

By E. W. Parker

AT THE initial meeting and dinner of the Panther Creek Valley Mining Institute, at Lansford, Pa., E. W. Parker, Statistician of the U. S. Geological Survey, in his address presented the following interesting historical facts, suggestions, and statistics:

We are just about at the hundredth anniversary of the birth of the anthracite mining industry. Historians generally consider that the industry began in 1820, when 365 tons, one ton for every day of the year, were shipped from the Lehigh region to Philadelphia. Prior to that, however (in 1807), 55 tons are reported to have been shipped to Columbia, Pa. For the purposes of this meeting—not as a statistical or historical fact—we can split the difference and consider that it began in 1813, and that we are now in the hundredth year of the anthracite industry. From the small beginning of one ton a day, the production of anthracite has grown to such an extent that at the present time the production is as much every 2½ minutes as the total production was in 1820. Then you produced 1 ton a day. Now you produce 2½ tons every second of the 24 hours for 365 days in the year. Anthracite production has not gone ahead by leaps and bounds during the last few decades as has the production of bituminous coal. The increase in anthracite has been somewhat more rapid than the increase in population, for in 1880 the anthracite consumption was about one-half ton for each inhabitant, in 1890 and 1900 it was about two-thirds of a ton, and in 1910 it was about four-fifths of a ton. In 1880 the per capita consumption of bituminous coal was less than 1 ton, and today it exceeds 4 tons. The production of Pennsylvania anthracite exceeds the entire coal production of any country in the world outside of the United States, with the exception of Great Britain and Germany (and of course the United States), and represents a total value, in 1911, of approximately \$175,000,000. It employs an army of nearly 175,000 men. From the earliest time to the close of 1911 the total production of anthracite has amounted to about two billion long tons.

To the credit of the mining men of the anthracite region be it said that whereas, a few years back, but 40 per cent. of recovery was accomplished, and 60 per cent. of the coal lost, now these percentages are practically reversed. Formerly 1½ tons were lost for every ton marketed, now at least 2 tons are marketed for every ton lost. This practical conservation put into effect in the anthracite region of Pennsylvania, has

probably extended the life of the fields, or the expectancy, as they say in life insurance circles, fully 100 per cent. To still greater accomplishments along these lines, to the maintenance of a proper relationship between the cost sheet and the returns from the sales department, and above all to the safeguarding of the lives and health of the army of employes, are the purposes, I believe, to which this mining institute of the Lehigh region is to be devoted.

I am sincerely in earnest when I say that some of our professors of conservation might learn some valuable lessons in practical conservation by a study of conditions in the anthracite region of Pennsylvania. It was here that real conservation in the United States had its birth, in the work of such men as Eckley B. Coxe, P. W. Sheafer, Franklin B. Gowen, William Griffith and others whose investigations into the waste in mining, preparing, and utilizing of anthracite, and suggestions made for lessening it, showed what might be and has been accomplished in real conservation. History will write along with these, as men equally entitled to places in this hall of fame, the names of May, of Phillips, of Richards, of Wariner, of others of their class and of our late and deeply lamented friends, Luther and Lathrop.

Not the least of the reforms put into practice in recent years is that of conserving the efficiency of the miner that has been brought about through the spring reductions in price. This plan was put into effect in 1901. One of the effects of this is seen in your monthly record of shipments. For instance, in 1911 the shipments of the six months from April to September averaged 5,734,070 long tons per month. The average shipment for the first and last three months of the year were 5,924,980 tons, a difference between the winter and summer months of less than 200,000 tons. How it has benefited the miner is shown in the fact that in the five years from 1895 to 1900 the average working time in the anthracite region ranged from 150 to 174 days, with a mean average of 163 days. In the five years from 1906 to 1911, inclusive (leaving out 1909), the average working time ranged from 195 to 246 days with a mean average of 218. The shortest year in the later period contained 21 more working days than the longest year of the earlier period, and the average for the later period was 33.7 per cent. more than

the earlier. With these figures and with the knowledge of the advance in wages in 1903 and 1912, the prosperous condition among the mine workers in the anthra-

cite region is not difficult to understand.

In forming this Institute the men of the Lehigh region are taking a long step in the right direction. During the last few years the establishment of local organizations of this kind has made considerable progress and they are meeting with marked success. The Geological Survey desires to cooperate with and lend all the aid it may to this and sister societies of the same character; for, as I said at the start, we get more than we give, in association with men who make up such organizations. It has been my pleasure and my privilege to attend meetings of the Coal Mining Institute of America, the West Virginia Mining Institute, the Lake Superior Mining Institute, and others, and I have been deeply impressed with the excellence of the ideas brought out in the discussions at the sessions. Frequently men who would balk at preparing a set paper will be induced to get on their feet and "have at 'em" in the meetings, in consequence of which much good stuff is brought to light. Moreover, the local character of associations of this kind makes them all the more helpful. Organizations whose membership is scattered over wide areas always have difficulty in getting a representative collection at their meetings. On the other hand, at the meetings of the Lake Superior Mining Institute, for instance, from 70 to 80 per cent. of the membership will be present, and the same percentage will apply to other local associations. The West Virginia Mining Institute has accomplished a world of usefulness in the bituminous regions of that state. Its membership is composed largely of mine superintendents, foremen, and other practical workers on whom a great part of the responsibility for the safety of the mines and miners as well as the economical production of coal depends. The opportunities afforded by the sessions of the Institute to discuss, not only in open meeting but in informal talks with their fellows, local problems in which all are more or less interested, are of immense benefit.

During the last year, the bituminous coal-mining men of Kentucky have organized an institute among themselves, and I note that a movement is well under way for the organization of the Western Coal Mining Institute, which will embrace the states of Colorado, Wyoming, New Mexico, and Utah.

No other branch of the mining industry offers such scope in possible

usefulness to these local institutes as does coal mining. We are all doing what we can to ameliorate both the hazardous and exacting life of the miner. In doing this, however, the greatest obstacle to be overcome is the miner's opposition to any restriction of his personal liberty. What is needed here, as in the bituminous region, is concerted action to secure legislation for the enforcement of discipline in the mines and the imposition of severe penalties for infractions of laws and regulations. The miner has to be protected more against himself, his own worst enemy, than against any other source of danger. I do not know of any case, however, where legal penalties are imposed upon a miner for disobedience of rules, even though such disobedience might place in jeopardy the lives of hundreds of coworkers. The miner's callousness to the danger to which he is exposed, from the time he enters the pit mouth, is the greatest difficulty with which the management of the mine has to contend. Concerted action by organizations such as yours will be most effective in securing reforms.

I have been somewhat impressed by the recently published report of the Bureau of the Census, on Mines and Quarries, covering 1909, in which it appears that the value of the anthracite product in that year was \$149,180,471 (the Survey's figures for the same year were \$149,181,587) and the expenses amounted to \$139,324,467, showing that in a production of 72,384,249 long tons, the difference between the outlay for expenses and the income from sales was less than \$10,000,000, or about 13 cents a long ton. The bituminous production was valued at \$427,962,464, and the cost sheets showed a total expense of \$395,907,026, a difference of \$32,000,000. As the output was approximately 380,000,000 short tons (379,744,257 short tons, to be exact), the margin to allow for losses incidental to explosions, fires, and other accidents, and for profit on the business, is 8.4 cents a ton. The margin on anthracite per ton is about 40 per cent. more than that of bituminous, but I doubt if any one contemplating investing his savings would consider either an attractive proposition. It is certainly not sufficient to secure the maximum degree of safety, nor the maximum recovery of coal, for it is an axiomatic proposition that every ton of coal extracted, above a certain percentage, costs so much more per ton. It is in the solution of such problems that the local institute may find a field of great usefulness.

來 來

A mine superintendent should be responsible to his superiors for results only. A competent man takes pride in accomplishment, and anything that injures that pride detracts from his efficiency.

Book Review

ENERGY AND VELOCITY, DIAGRAMS OF LARGE GAS ENGINES: THEIR USE AND LAYOUT, by Paul L. Joslyn. 70 pages, 62 diagrams, cloth bound, price \$2. The Gas Engine Publishing Co., publishers, Cincinnati, Ohio.

With small gas engines, it is not so expensive nor so difficult to change some points, and it frequently happens that very radical changes in construction are so effected. But with the gas engine of several thousand horsepower, it is impossible to do this, so everything must be worked out in advance. In this book, the author gives the methods of laying out energy and velocity diagrams for large engines operating on blast furnace, producer, or natural gas, with instructions as to their use, etc. The data given are the result of actual designing on some of the largest engines built.

PRACTICAL FIELD GEOLOGY, by J. H. Farrell and Alfred J. Moses. 273 pages including index; 62 illustrations. McGraw-Hill Book Co., publishers; price \$2.50. Professor Moses is one of the first mineralogists of our times, as was his predecessor in ancient times, therefore his guide to the sight recognition of 120 common but important minerals must be worth investigating. J. H. Farrell, E. M., is not so well known as a mining geologist, however, his company is good; his preface rings truthfully; and his book reads as if he knew his subject. He opens his preface as follows:

"When 'Omer smote 'is bloomin' lyre,
He'd 'eard men sing by land an' sea;
An' what he thought 'e might require,
'E went an' took—the same as me."
—Kipling.

He gives credit to those whose assistance he has invoked, but not credit to those his assistants invoked, owing no doubt to the intricacy of the curve.

VIRGINIA GEOLOGICAL SURVEY, MORGANTOWN, W. VA. A new volume is described in the following extract from the printed circular of the Geological Survey:

DETAILED COUNTY REPORT ON DODDRIDGE AND HARRISON COUNTIES, under date of September 1, 1912, 712 pages +XVI, with 29 plates of illustrations and 5 figures in the text, and a case of 3 maps (soil, geologic, and topographic) of the entire area. In addition to the detailed study and description of all the rocks, streams, and industries, with hundreds of oil and gas well records within the area, the geologic map gives the structural contours on the Pittsburg coal, showing all the anticlines, synclines, and structural terraces. The line where the Pittsburg coal disappears in Doddridge County is shown on these maps with scale of one inch to the mile, as are all roads, streams, houses, etc. Price, with

case of maps, \$2. Extra copies of geologic, or topographic map, 50 cents each.

THE MINERAL INDUSTRY, VOL. XX. This book of 997 pages contains the statistics, technology, and trade items of the mineral industry, and supplements previous volumes. It has been edited by Charles O. O., assisted by 78 writers who have made a study of some specialty. All the important elements are reviewed statistics and advances made in their recovery are recorded, and in addition the economic geology of a number of non-metallic, yet important, minerals is treated. There are special chapters on Placer Mining; Ore Dressing and Coal Washing; A Review on Mining Decisions in 1911; Assaying and Sampling; and Mineral Statistics covering imports and exports and productions in this and other countries. Price \$10. Publishers McGraw-Hill Book Co., New York City.

THE BUSINESS OF MINING. This book by Arthur J. Hoskins, M. E., is published by J. B. Lippincott Co., Philadelphia. It comprises 224 pages, including index, and is illustrated with half-tones on special pages. There are 23 chapters devoted to advising mine investors how to safeguard their money, and in endeavoring to establish mining as a legitimate business. Similar pleas have appeared in all technical journals for many years, but this is the first time, it is believed, where they have been placed in book form, and so made accessible to the general public. Mr. Hoskins has written a concise non-technical exposition of the principles involved in profitable mine investments, and if his advice is followed there will be fewer "soreheads." It may be stated without much fear of contradiction that before a real man dies he has invested in some phase of mining. Some invest a little money so that others will invest a good deal and develop the country for them; others, with a gambling instinct, make their investments bets, kissing their money good-bye; again others with "cupidity lust" invest more than they can afford to lose, and usually without any precaution; finally there are mining stock investors, who, working on the stock exchange, do not help mining enterprises at all.

CONCRETE COSTS. This book was gotten up for engineers, architects, contractors, superintendents, and foremen, to promote the introduction of scientific management. It is by Fredrick W. Taylor and Sanford E. Thompson, the authors of "Concrete Plain and Reinforced," has 700 pages, 8 vo; 81 illustrations, and 23 chapters. John Wiley & Sons, publishers, New York City. Price \$5. The book contains much useful data and will be appreciated by all who use concrete. Most of the text will be learned in practice, but the tables will be valuable to both the experienced and the inexperienced.

Answers to Examination Questions

Examinations for Second Grade Mine Foremen Held in the Bituminous Regions of Pennsylvania, 1912

QUES. 1.—What are the duties of a mine foreman relative to his daily visits to each working place; what should he observe, and what instructions should he give the workmen?

ANS.—The mine foreman must employ a sufficient number of assistants so that he or some one of them may visit each working place at least once a day while the men are actually at work. Particular attention must be paid and, if need be, more frequent visits must be made to pillar workings, particularly if a fall is expected. While at the face, he should see that the coal has been properly mined, that is, has been under-cut, center-cut, top-cut, or sheared (side-cut) to a depth at least as great as the depth of the shot hole to be used. Should the mine generate explosive gas and the coal be 5 feet 6 inches, or more, in thickness, the seam, in addition to the ordinary under-cut, must be sheared to the depth of the shot holes in all places 10 feet or less in width.

He shall direct the miner, while making a cut, to set sprags under the breast of coal so that it may not fall upon him; and these sprags shall not be more than 7 feet apart. He shall direct the miner to either take down or properly secure any loose pieces of slate or coal; shall see that the holes for blasting are properly placed, and shall designate the angle and depth of the holes, which shall not be greater than the mining, and shall direct the greatest amount of explosive that may be used in each hole as well as the method of charging and tamping, and "in a general way," shall instruct the workmen "how to mine coal with safety to themselves and others."

At the end of the shift the assistant foreman must enter in the record the conditions as to safety of all the working places visited by him, making a separate note of any unusual occurrence he may have noted; which report the mine foreman must read and sign in ink not later than the next day.

QUES. 2.—What are the legal requirements as to cut-throughs in rooms and entries; and the supplying of the workmen with timbers?

ANS.—The distance apart of cut-throughs in room pillars is determined by the district mine inspector, but in no case shall it exceed 35 yards (105 feet) or be less than 16 yards (48 feet). The distance apart of entry cut-throughs is not given, but a reference in Section 2 of Article 4, indicates that it is the same as for rooms. In all mines all new stoppings between the main intake and its return shall be built of masonry, concrete, or other incombustible material, and

"shall be of ample strength." In addition, if the mine generates explosive gas, new stoppings and old ones which are being replaced in cross-entries shall be constructed of incombustible material. In non-gaseous mines, stoppings on cross-entries may be made of wood. Stoppings are required in room cut-throughs and they may be built of wood, or brattice cloth. All stoppings shall be kept in good condition.

Props and cap pieces, the former cut with square ends and as near as practicable to the proper length for the thickness of the seam, shall be delivered to the working faces or as near them as they can be hauled in mine cars. In order to secure timber the miner must notify the person in authority one day in advance, "giving the number, size, and length of props and cap pieces required." In event of emergency, the props may be ordered at once, and if not to be had on short notice, the place must be vacated until they are supplied. The place and manner of leaving orders for timber shall be specified in the mine rules and will naturally be different at different mines.

QUES. 3.—What does the law require for the protection of workmen along haulage ways, where different systems of haulage are used?

ANS.—Except in entries where rooms are turned at regular intervals of not more than 90 feet, and the room necks are kept clear for at least 3 feet back from the rib, it is necessary on animal and mechanical haulage roads to cut shelter holes at least every 90 feet; such holes shall be at least 2½ feet deep by 4 feet wide and shall be whitewashed and kept clear of obstructions. The regulations are the same on main haulage roads where machinery is used, except that shelter holes must not be more than 15 yards (45 feet) apart, and may be dispensed with if rooms are turned at regular intervals of not over 45 feet and kept clear of obstructions for 3 feet back from the rib. All shelter holes shall be driven level with the floor and on one side of the entry only. If, in the judgment of the district mine inspector, the roof is strong enough, there must be maintained along one side of the entry a continuous clear and clean space 2½ feet wide from the side of the car to the rib.

Like other parts of the law of 1911, this section is confusing. There is a distinction made between "mechanical hauling" and "hauling done by machinery," which is hard to understand. Further,

while Section 8 of Article IV permits traveling on main haulage roads, provides for shelter holes, etc., the last part of Section 4 of

Article VI as clearly prohibits this if the main entry be used as an intake. As perhaps more than 90 per cent. of the main entries in the state are intakes on which haulage is done, traveling on haulage-ways is practically prohibited in one section of the act and permitted in the other.

QUES. 4.—What means are necessary in order to properly conduct the air-current to the face of the workings? Mention, also, the essential points necessary to be observed with respect to each of them.

ANS.—The principal means are doors, stoppings (brattices or curtains), and air bridges (overcasts or undercasts).

Doors, except of a temporary nature such as when made of canvas, should be as air-tight as it is possible to make them. Main doors should be built in pairs so that one may be closed when the other is open. As far as possible they should be set where the roof is sound. The frame, when of timber, should be heavy, set well in both roof and floor and should be well caulked between the side frames and the rib. All important doors should be built of heavy timber and together with the frame should be covered with sheet iron to prevent danger from fire. Modern practice requires that door frames be of concrete or of timber set in concrete and the ribs for some distance on each side thereof be coated with this material. In some mines the doors are made of a uniform size, so that, in event of one being broken or otherwise destroyed, it may be immediately replaced by one taken from a stock kept on hand for the purpose. Canvas doors, consisting of cotton duck or brattice cloth nailed to a light frame of scantling, are frequently used for temporary needs and in emergencies, but should be replaced by substantial and permanent doors as soon as possible.

Stoppings of canvas are frequently used to convey the current from the last breakthrough to the face in gaseous workings. Such stoppings, as well as canvas curtains hung across an entry to deflect the air-current up a room, are only temporary and are removed when the occasion for their use has passed. In large mines, permanent stoppings on the main entries are commonly made of concrete, masonry, hollow tile, or brick, from 9 to 18 inches or more in thickness, and not infrequently are reinforced with steel rods, old rails, or the like. Brattices of plank are used in breakthroughs between rooms universally, and frequently on entries. In the latter case they do not give satisfaction, as

it is almost impossible to prevent their leaking.

In the matter of air bridges, overcasts are preferable to undercasts, as they are easier and cheaper to drive and generally cheaper to maintain. In wet mines undercasts are generally out of the question as they would be flooded with water and their area thus diminished. While overcasts in many mines are still leaky wooden boxes, in the better class of mines all main air crossings at least display great skill and care in their construction

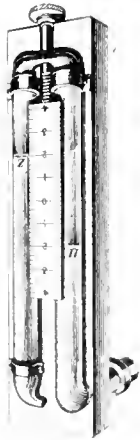

FIG. 1

They are not infrequently regular arches of brick, masonry, or reinforced concrete, or may be built of heavy rails or I beams covered with cement. As they are intended to last throughout the life of the mine which may be from 20 to 50 or more years, it is apparent that a permanent overcast which requires no repairs and does not leak and waste air-current, and consequently power, is, in the end, vastly cheaper than the short-lived, leaky wooden air box which has to be constantly repaired and frequently renewed.

QUES. 5.—A dam in an entry supports a vertical head of water of 80 feet, sectional area of dam is 70 feet. Find the total pressure (in short tons) on the dam.

ANS.—Taking the weight of a cubic foot of water at 62° Fahrenheit and under a barometric pressure of 30 inches of mercury to be 62.29 pounds, the pressure per square foot upon the dam is $80 \times 62.29 = 4,983.2$ pounds. As the dam has an area of 70 square feet, the total pressure in pounds is $4,983.2 \times 70 = 348,824$; and dividing by 2,000 (the number of pounds in a short ton), the total pressure $= 348,824 \div 2,000 = 174.412$ short tons.

QUES. 6.—Name and describe the different instruments used by the mine foreman to examine the condition of the ventilation of a non-gaseous mine. Explain the principle and application of each.

ANS.—The principal instruments are an anemometer, together with a tape to measure the area of the airway, for measuring the velocity of the air-current;

and a water gauge to measure the resistance, due to friction, to the passage of the air through the mine. The best modern practice requires, in addition to these, a thermometer and a psychrometer or hygrometer to determine the humidity of the mine air, that it may be learned if it is sufficiently dry to absorb moisture from the workings and thus render the coal dust liable to explosion if opportunity is afforded. This instrument is described in detail on page 722 of the July issue of MINES AND MINERALS where will be found as well a description of the barometer, safety lamp, the use of canary birds, etc., commonly employed in gaseous mines.

The anemometer consists of a series of blades or vanes fixed upon an axis, which may revolve, the whole enclosed in a metal frame. The blades are so arranged that one revolution of the anemometer corresponds to 1 foot of travel of the air-current, the number of revolutions being recorded on a dial or series of dials. The anemometer is held in the air-current for any convenient number of minutes (usually 2 or 3) which is determined by a watch, when the reading of the dials will give the number of feet traveled by the air in this length of time. The total distance divided by the number of minutes the anemometer was in motion will give the number of feet traveled by the air in 1 minute, in other words, the velocity; as 1 minute is the unit of time in estimating velocities in problems concerned with ventilation. The area of the airway in square feet is determined by measuring its height and width with a tape, and this area multiplied by the velocity, as recorded by the anemometer, gives the volume of the air-current in cubic feet per minute.

The water gauge is a glass tube bent in U shape as shown in Fig. 1 with both ends open. One end of the tube is bent at right angles and is fitted with a brass extension tube which is inserted in a small hole bored in the brattice separating two airways as shown in Fig. 2. The purpose of the instrument is to measure the difference in pressure between two airways. Water is poured in the tube and, when there is no difference in pressure, is level in both arms. When the pressure in one airway exceeds that in the other, the water will sink in one arm, the intake, and rise in the other, the return. The difference in levels between the water in the two arms is read on the scale shown in Fig. 1. Any difference in water level as read from the scale on the water gauge represents a ventilating pressure necessary to overcome the friction due to passage of air under conditions prevailing. Each inch of water represents a drag of 5.2 pounds per square foot or a ventilating pressure of 5.2 pounds per square foot. The con-

stant 5.2 is derived from the weight of water, 1 cubic inch of which weighs .036 pound, hence a square foot would exert a pressure of $.036 \times 144 = 5.184$ or practically 5.2 pounds to the square foot.

QUES. 7.—What precautions should be taken in a dry and dusty non-gaseous mine to insure the safety of the workmen?

ANS.—Dry and dusty mines are far more dangerous than gassy and very wet ones owing to the liability of the fine dust to explode through the agency of

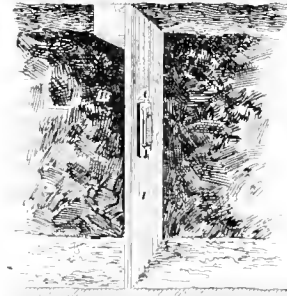

FIG. 2

a blown-out shot, a mine fire, or the arc produced by the short-circuiting of an electric current, the effects of what otherwise would be of trifling damage to life or property being spread throughout the mine by the burning fine dust everywhere present.

Naturally, the first step is to reduce the amount of dust made in the work of mining and hauling to daylight. The amount of dust made at the face may be greatly reduced by undercutting the seam by hand or machinery; by drilling no hole of greater depth than that of the mining; by placing the holes and charging them with permissible, short-flame powder so that they will do the work required of them and no more; by firing the holes by electricity, or otherwise, after the men have left the mine, shot firers being employed who, before firing the shot or shots, have thoroughly wetted down the roof, floor, ribs and all dust for from 60 to 80 feet back from the face; and by seeing to it that the loaders clean up and load out all slack and more particularly the fine bug dust made in machine mining.

Mine cars should be as tight as possible so that they may not leak slack on the headings while being hauled from the room to the parting, some companies using sheet-steel cars without gates, that are dumped in rotary dumps. Cars should not be loaded with too much topping or in such a way that lumps may roll off and be ground into powder by mules or motors. In some mines, near the mouth of each room entry is arranged a spraying device under which

the loaded cars pass and where their contents are thoroughly wetted.

Despite all efforts more or less dust is made, which is carried and deposited through the mine by the air-currents, and the handling of this is a serious problem, the best means to this end being in dispute. All old and abandoned workings should be tightly sealed at the mouth of the entry going into them, to prevent dust being carried into them; then an explosion otherwise started cannot gather force by sweeping up the dust that may be in them. All entries should be cleaned up at regular intervals and the dirt carried out and dumped at the surface, and not loaded into breakthroughs and room necks as is too frequently done.

At this point ideas as to the proper method of treatment differ. The common method of dust treatment in the United States is to wet down all the entries, roof, floor, and ribs, often enough to insure that all the dust is so moist that its explosion is impossible. This is the most satisfactory way, but is very expensive owing not only to the cost of the pipe lines for conveying the water, but more particularly to the wages of the men employed. To overcome the expense of this method, many mines heat the air at the drift mouth and there saturate it with moisture by means of steam jets, the idea being that the air-currents upon cooling will deposit moisture throughout the mine and do away with the necessity of sprinkling by hand. It is now generally admitted that this "preheating and pre-moistening" are not satisfactory, as the current soon deposits its water and unless recharged will begin to absorb moisture from, and thus dry out, the dust the same as an ordinary air-current. In view of this, most mines where preheating and moistening are used wet down a greater or less amount of entry by hand sprinkling, water cars, etc.

Chemicals which absorb moisture have been, without much success, used on the floor of haulageways, and very recent experiments in England indicate that if the proportion of oxygen in the air is kept down to 17 per cent., dust explosions will not occur, but a satisfactory method of reducing the content of oxygen to this amount has not yet been devised.

At many mines in England, and at one in this country, what may be called the rock-dust method of treatment is in successful operation. This consists in spreading very finely ground clay or shale over the floors, throwing it upon the roof and ribs, and depositing it upon shelves made for the purpose. It has been shown that clay dust, when mixed with coal dust, will render the latter inert and non-explosive.

Ques. 8.—Name the inexplusive gases found in the mines of this state, giving their composition and specific gravities.

What effect have these gases on the workmen and what methods would you adopt to remove them?

Ans.—The inexplusive gases met in mines are nitrogen, oxygen, and carbon dioxide, formerly called blackdamp. Nitrogen constitutes 79.3 per cent., by volume, of the air and has a specific gravity of .9713. It is odorless, colorless, tasteless, and not poisonous. Its province is to dilute the oxygen. Should its proportion be increased, which, of course is accompanied by a decrease in the proportion of oxygen, death from suffocation will follow. Oxygen, specific gravity 1.1056, constitutes 20.7 per cent. by volume of the air. Like nitrogen it is odorless, colorless, tasteless, and non-poisonous, and is the supporter of life and combustion. About 1 per cent. of the air is composed of certain inert gases similar to nitrogen, such as argon, xenon, etc. It is not desired to remove any of these atmospheric gases and the aim is to keep the mine air of the same composition as that outside. A slight change in the proportion of nitrogen to oxygen does not result in any ill effects upon the men, but if the proportion of oxygen is lowered too far by increasing the amount of inert gas, through the introduction of carbon dioxide, methane, etc., or by the addition of slight amounts of such highly poisonous gases as carbon monoxide or sulphuretted hydrogen, death will occur by suffocation in the one case and by poisoning in the other. The other inexplusive gas common in mine air is carbon dioxide, blackdamp, or CO_2 . It has a specific gravity of 1.529 and is therefore found near the floor, in dip workings, and the like. It is odorless and colorless but has a peculiar sweet taste. It is not poisonous, but causes death by suffocation, if in large amount, by reducing the proportion of oxygen in the air below that necessary to support life. It may be removed by carrying brattices up to the place where it is found, the gas being diluted and swept away by the air-current.

The question as submitted to us requires a description of the inexplusive gases. A very full description of all the gases met in mines, explosive as well as inexplusive, will be found on page 81 of the September issue of MINES AND MINERALS.

Ques. 9.—If, in a mine employing 200 persons, it was necessary to double the minimum quantity of air for persons, as required by law, how many splits of air would be required? If the main intake airway was 42 square feet area, what would be the velocity of the air-current?

Ans.—The law specifies that not more than 70 persons shall work in any one split unless the state mine inspector decides that this is impracticable, in which case as many as 90 may be allowed. In

either case there would be three splits; in the first, two of them might have 70 men each and the third, 60 men ($70 + 70 + 60 = 200$); and in the second case, there might be two splits with 90 men each and one with 20 men ($90 + 90 + 20 = 200$). The minimum amount of air would be 150 cubic feet per man per minute in non-gaseous mines, and 200 cubic feet per minute in gaseous mines. In the first case 200 men would require $200 \times 150 = 30,000$ cubic feet of air a minute, and in the second case, $200 \times 200 = 40,000$ cubic feet of air a minute. Doubling the quantity of air per man will not increase the number of splits required by law. The quantity of air in the one case will be, however, $30,000 \times 2 = 60,000$ cubic feet per minute, and in the other $40,000 \times 2 = 80,000$ cubic feet.

The velocity of the air-current in the intake would be either $30,000 \div 42 = 714$ feet per minute, or $40,000 \div 42 = 952$ feet per minute, depending upon whether each man received 150 or 200 cubic feet of air a minute. If the quantity of air be doubled, the size of the airway remaining the same, the velocity would be doubled and would be, respectively, 1,428 and 1,904 feet per minute.

(To be continued in December)

來 來

Carbon Monoxide in Illuminating Gas

Existing legislation shows no tendency to limit the carbon monoxide content of gas, although it is the only constituent of illuminating gas, which, in the amounts ordinarily found, is poisonous. Coal gas contains from 5 to 10 per cent. of carbon monoxide; water gas 25 to 30 per cent. To limit the amount of carbon monoxide in the gas sold might limit the amount of water gas made. Such regulations as would prevent the operation of water-gas plants now in existence would be very severe, but the extension of present plants should not be directed toward increasing the use of coal gas rather than of water gas. The use of water gas may possibly not be much more dangerous than coal gas. A large proportion of the cases of death or illness by gas poisoning are suicidal; and the character of the gas would have only a small influence upon the result. A large number of deaths and cases of poisoning called "gas poisoning" are due not to the gas itself, but to the carbon monoxide formed by combustion of the gas with insufficient supply of air, due to faulty appliances. It is possible that the protection of the public from danger will be found rather by regulation of appliances, and the general education of gas users as to proper precautions, than in the limitation of the carbon monoxide content of the gas itself.

ORE MINING & METALLURGY

Rock Phosphate in Kentucky

The Geological Formations in Which Phosphate Is Found—Deposits That Are Worked—Manner of Formation

By James H. Gardner

THE occurrence, in commercial quantities, of rock phosphate in Kentucky has recently been demonstrated near Midway, in Woodford County, by the Central Kentucky Phosphate Co. For more than 40 years, the phosphatic rock beds in the Ordovician limestone of central Kentucky have attracted the attention of stratigraphers and local chemists but no attempt was made to investigate their economic value.

ation of the overlying beds, where thin plates of this phosphate cannot be found, and recently samples were collected from a locality in Woodland County that indicated a deposit there of phosphate of very promising character. They ran as high as 33 per cent. phosphoric acid (72 per cent. calcium phosphate). The samples

in Scott, and extending in the same direction to where the land begins to fall off to the level of North Elkhorn. Fayette County also offers a very promising field. The soil at the phosphate horizon is a very deep red, and is characterized by the presence of a 'honey-comb' coral of the genus *Columnaria*," Fig. 3.

During the interval from 1905 to 1911, there were periods of excitement with reference to the possibilities of the Ken-



FIG. 1. CONTACT OF PHOSPHATE DEPOSIT WITH LIMESTONE FLOOR



FIG. 2. SUDDEN DEEPENING OF PHOSPHATE, ALSO LIMESTONE EXTENDING INTO PHOSPHATE BED

In 1877, Dr. Robert Peter, stated that strongly phosphatic rock was associated with the limestone beds in the north-central counties of the state, but it is reported that a negro was the first to bring to light the fact that rock phosphate occurred in commercial quantities in Kentucky. In the summer of 1905 while digging post-holes on the farm of Mr. H. L. Martin near Midway, he discovered what he considered phosphate rock similar to the brown rock phosphate in Tennessee. Mr. Martin verified the negro's opinion, and from that time prospecting has continued. Prof. C. J. Norwood, called attention in the Geological Survey Report of Progress for the years 1904-5, to the apparent practicability of using the phosphatic limestone and rock phosphate in the untreated form as "agricultural lime." In the same report, page 26, he quotes from a memorandum by Professor Miller as follows: "There is hardly a locality where the top of the Lexington limestone (Ordovician) has been exposed in upland situations, as the result of slow denud-

ation of the overlying beds, where thin plates of this phosphate cannot be found, and recently samples were collected from a locality in Woodland County that indicated a deposit there of phosphate of very promising character. They ran as high as 33 per cent. phosphoric acid (72 per cent. calcium phosphate). The samples

first collected consisted of plates of leached limestone from half an inch to an inch and a half in thickness and weighing from 1 to 3 pounds. These lay scattered very thickly over the surface of a roadside slope, and on digging down were found disseminated through the soil nearly to the bed rock—here from 1 to 2 feet below the surface. In the light of all that is known at present, the most favorable district for prospecting is in that comparatively level and very fertile belt of country extending northward from Versailles to Midway, and again beginning on the other side of South Elkhorn.

tucky field. Three or four companies secured options on land; large bonuses were paid farmers for options running a short time and some of these were allowed to lapse, thus giving an exaggerated idea of values, and to some extent retarding development. None of the companies have begun developments, with the exception of the Central Kentucky Phosphate Co. that started the erection of a plant in 1911 which has been in operation since November of the same year.

Until the present time, rock-phosphate developments have been confined to the area near Midway but notable exposures are reported from Scott, Mercer, and Jessamine counties. The lands containing the rock-phosphate beds are fertile and possess high value for farming purposes, constituting the best there is of the far-famed Blue-grass Region, and being worth \$200 per acre for farming and grazing purposes alone. To what extent the Kentucky field may be broadened will be determined only by thorough prospecting, and the attitude assumed by the

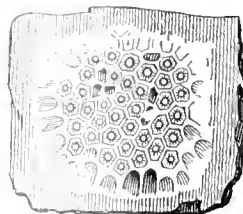

FIG. 3. COLUMNARIA

farmers. The Lexington limestone comes to the surface over a large area in central Kentucky, and the outcrop of the base of the overlying Winchester follows a meandering course for a long distance around the Lexington, making an inlier of the latter on the Jessamine Dome of the Cincinnati geanticline. It seems highly probable that the deposits of rock phosphate will be confined to the western and southern portions of this inlier.

The phosphate deposits of the Kentucky field belong to the class known as brown rock phosphate, the essential base of which is tricalcium phosphate $Ca_3(PO_4)_2$. The phosphate is in the form of loose rock, consisting of thin plates and finely comminuted material mixed with some clay, the whole being of a dark-brown color. The hard rock plates vary from light-gray to dark-brown in color and are usually rather dense. In specific gravity they average about 3. They are more resistant to weathering than limestone, although occasional pieces in

idea of the phosphate value of the better grade of rock.

The specimens analyzed consisted of plates of rock phosphate free from any considerable amount of clay.

Waggaman also gives in the same bulletin (page 28) the complete chemical composition of three different varieties of rock that occur in the same deposit near Midway as shown in Table 2.

The brown rock phosphate in Kentucky occurs as elsewhere, in the form of loose-rock deposits that lie near the surface. The commercial deposits occur in blanket form on limestone and are covered by clay and soil. The workable deposits vary from 1 to 6 feet in thickness and are very irregular; both the bottom and top of the beds are limited by inconstant factors in their origin. The rock phosphate deposit originates from secondary concentration in the process of weathering of phosphatic limestone, consequently the mantle which it forms over the uneven surface of the limestone is simi-

only at the one horizon near the contact of the Lexington and the Winchester limestone formations; as a result, the deposits are possible only in districts where this particular stratigraphic horizon forms the surface of the country, or at least lies well above drainage. In regard to the two forms of brown rock-phosphate in the Mount Pleasant field of Tennessee, Waggaman† states: "The blanket deposits sometimes cover wide areas. They usually lie near the surface of gently undulating hills where the under drainage is favorable to their formation. Almost ideal conditions existed in the Mount Pleasant for the production of such deposits. In this section the highly phosphatic Bigby limestone lies very near the surface and is underlain by an easily soluble fine-grained limestone through which the percolating waters readily drain. The leaching began where the surface water gained access to the beds along the joint planes, but gradually worked through the entire mass, carrying away the carbonate of lime in solution, leaving the less soluble phosphate of lime. The blanket deposits are always more or less wavy; owing to the irregularity of the leaching. Large columns, boulders, and cones of unaltered phosphatic limestone occur throughout the deposits."

It is apparent that in the origin of the brown rock phosphate in the Kentucky field, chiefly two processes have been at work. In the first place, percolating ground water carrying carbon dioxide converts limestone into the soluble bicarbonate of calcium and carries it away. It does not so readily dissolve the calcium phosphate constituents of the limestone, and consequently the thin layers or plates of phosphate that are evident in the fresh rock are left as inherited products from the stone's decay, just as pieces of chert are left. Furthermore it appears that thick porous pieces in certain instances may have resulted simply as the left-over matrices of stone layers running high in their content of phosphate. The second important process is the one that has been of chief value in the building up of deposits of sufficient grade to be commercially worked at the present time. This is simply the process of secondary enrichment so common in the origin of ore deposits. The phosphate is concentrated near bed rock by being leached from the higher portions of the bed and carried down by descending solutions; here the process of replacement of limestone takes place, phosphate being substituted for carbonate. The clay as well becomes highly charged with phosphate and the richest portion of the deposit is thus built up directly on top of the limestone bed rock.

The ultimate origin of the phosphatic material in the fresh limestone is an

TABLE 1. PHOSPHATE PERCENTAGES OF HIGH-GRADE KENTUCKY ROCK

Location	Analyses	
	P_2O_5	$Ca_3(PO_4)_2$
Farm of M. D. Steel, 2½ miles south of Midway, Ky.....	34.02	73.35
Cogar farm, ½ mile south of Midway, Ky.....	33.75	73.74
Slack's farm, 3 miles northwest of Midway, Ky.....	37.10	81.08
Outside State University grounds, Lexington, Ky.....	26.13	57.10
Smith's farm, 2½ miles east of Georgetown, Ky.....	27.14	59.43
Cut, 6 miles south of Lexington, Ky.....	34.10	74.52

TABLE 2. COMPOSITION OF DIFFERENT VARIETIES OF KENTUCKY PHOSPHATE

Description	SiO_2	$Fe_2O_3-Al_2O_3$	P_2O_5	$Ca_3(PO_4)_2$
Light yellowish-brown.....	24.29	17.18	21.34	46.71
Brown, chocolate, close-grained, thin-bedded.....	2.63	2.75	35.71	78.17
Brown, chocolate, porous, hard.....	4.88	3.67	34.00	74.43

freshly exposed workings are very porous and soft. These plates vary in size from the granular form up to pieces that weigh several pounds. In the mine of the Central Kentucky Phosphate Co., pieces have been found that measured 6 inches in thickness and were 3 or 4 feet long. Along the east and southeast areas of the outcrop of the Lexington limestone, a considerable distance from the phosphate field, very large deposits of chert are found at about the phosphate horizon, but in that territory there is a notable absence of commercial phosphate, though some of the chert is highly phosphatic.

In chemical composition, the rock phosphate of Kentucky varies in "bone phosphate of lime" or tricalcium phosphate, from about 40 to more than 80 per cent. The analyses in Table 1, taken from a report by W. H. Waggaman* present an

*Bureau of Soils, U. S. Department of Agriculture, Bull. No. 81, page 25.

†Ibid., pages 7 and 8.

lar to that of any deposit of red limestone clay. The level of unweathered rock is irregular and naturally the bottom of the phosphate conforms with it: at places it suddenly deepens and at others "rock horses" rise into the phosphate beds. The top of the phosphate bed is more regular than the bottom, and more nearly parallels the surface topography; but it is by no means constant. The cover of clay and soil varies from about 2 to more than 10 feet, being thicker on the tops than on the sides of hills and ridges.

The Ordovician limestone, from which the deposits have originated by denudation and decomposition, is only slightly phosphatic in its fresh state. The phosphate is at first in the form of rich but very thin, dark-colored layers along the bedding of the limestone and in the form of disseminated material throughout the stone. So far as is known, this condition prevails to a sufficient extent for the formation of commercial deposits

interesting question for scientific discussion. It is evident that the phosphate has not been deposited secondarily, but is innate with the stone; it was lain down as a part of the limestone beds. Inasmuch as the limestone is of marine origin, carrying a marine fossil fauna, we are necessarily forced to conclude that the phosphatic content came also from the sea. In the fresh limestone as seen in a new quarry face the intercalated phosphatic layers are dark colored, due to carbonaceous material; thus we have the element carbon in the free state, associated with the phosphate, as would be expected if it had been produced by organic life. It is generally concluded among geologists that organic life is the original source of the phosphorus segregation. Probably the conditions under which life existed in the sea are as important as the nature of the species. The remains of shell life are evident in great prominence and the very small gasteropod "Cyclora minuta" is especially abundant at the phosphate horizon.

The Ordovician sea in which the phosphatic material of the limestone originated was probably rather shallow. It was an epicontinental body of water extending over a large geographic province. What may have been the local conditions in this broad and long sheet of marine and brackish water wherein the phosphorus element was secreted to such an extent, is as yet unknown. The ripple-marked and cross-bedded character of the limestone strata and the phosphate lenses indicate that wave action affected the sediment as it was deposited; this fact would indicate that the water was not deep in which the phosphate-producing life brought about such important results along with the forms of life that secreted calcium carbonate in building up the deposits of limestone. At this mine the deposit of phosphate rock varies in thickness from 18 inches to 6 feet and is covered by from 2 to 6 feet of clay and soil. Stripping is done by means of ordinary horse scrapers and an acre or more of covering is removed in advance of mining. The raw product goes through the plant without washing, and no acid phosphate, or super-phosphate, is produced. The rock is merely dried, screened, and ground. By means of pick and shovel, the rock is loaded at the mine into dump wagons and hauled to the plant. A chain conveyer carries it to the top of an inclined rotary cylinder heated by direct firing with coal. The dry cylinder is carried by a continuous bucket elevator to the screen of about three-quarter inch mesh. The plates of phosphate passing over the screen fall into a storage room; this is the highest grade rock, and is guaranteed to run 76 per cent. bone phosphate of lime; it is sold to the

American Agricultural Chemical Co. for the manufacture of acid phosphate.

The rock passing through the screen goes to the grinder and is reduced to a powder 90 per cent. of which will pass a 100-mesh screen. This material runs about 63 per cent. bone phosphate of lime; it is carried to the storage room and from there is loaded into cars for shipment and direct application to the soil. At the present time the plant has a storage capacity of 1,500 tons and a daily output of 30 tons, but it is expected that the

the oil as a cure-all and giving directions about its use.

Among other things it was recommended for cholera morbus, liver complaint, bronchitis, consumption, and other ills too numerous to mention. The dose was three teaspoonfuls, three times a day.

In 1858, this man Kier sold some refined petroleum to a Joseph Coffin, of New York, for 62½ cents a gallon, to be used for illuminating—but no great trade was developed prior to the operations of "Colonel" Drake, of Titusville fame.



DRAKE OIL WELL AS IT APPEARED IN 1864

output will soon be increased to 100 tons per day. The ground rock is sold direct to farmers. In the finely ground form the phosphoric acid soon becomes available to plant life, especially if the phosphate is used in connection with manure.

來 來

Authentic Petroleum Lore

Back of 1859, people looked upon petroleum as a sort of freak of nature a little bit like Ponce de Leon's famous Spring of Perpetual Youth. What little petroleum was obtainable was secured from the surface of various streams in the oil districts, or by digging pits and scooping out the oil which seeped in from the surrounding soil.

About 1850, a demand for salt induced a number of prospectors to sink wells, from which they expected to get brine, and thus to make salt by the evaporation process. In sinking these wells, very often oil was brought up with the brine and one man in particular, a certain Samuel M. Kier, built up quite a business in petroleum, or "Rock Oil," as a medicine.

This crude oil he put up in 8-ounce bottles with a good old patent medicine circular attached, lauding the virtues of

The Seneca Oil Co. sent Colonel Drake to Titusville, in 1859, to secure petroleum oil in quantities, for refining. They had been encouraged by Professor Silliman of Yale College, to believe that fortunes could be made out of this oil if properly refined.

After a great deal of difficulty, Drake put down a well that eventually reached the enormous depth of 69½ feet, in August, 1859. Coming to the well one morning, he and his assistants were amazed to find their dry hole filled to the brim with oil. The next day a pump was installed and some 25 barrels of the precious liquid was taken out.

The success of this well, and the fact that crude oil was then selling for about a dollar a gallon, induced others to sink wells, and soon a veritable boom was on.

Land that formerly could be purchased for a song jumped to fabulous figures, one farm of 50 acres had been originally purchased for a yoke of oxen, but now sold for over four million dollars.

Drake's derrick was only 34 feet high—a very crude affair. His tools were not of the best, and drilling went on at the rate of 1 or 2 feet a day. Modern derricks are usually above 80 feet high, which allows for handling long lengths of tubing.—*Leschen's Hercules*.

Results of Deep Mining in California

The Deepest Gold Mines in America, Showing the Persistent Nature of the Gold Deposits of the Mother Lode

By *Al. H. Martin*

DEEP quartz mining in California has progressed to an extent unapproached in most American commonwealths. This is due largely to the excellent results generally attending deep explorations, the free-milling character of ore, and the fact that California mining was firmly established before the industry was foreshadowed in many other states. Deep mining has made particular progress in late years, with the northerly portion of the Mother Lode and the Grass Valley district claiming paramount attention. The splendid results attending the operations of the Kennedy and South Eureka in Amador County, and of the North Star and Empire at Grass Valley, have been principally effective in encouraging mining to great depths. The greatest energy along these lines has been

the Argonaut has attained an incline depth of 3,600 feet. The South Eureka is down 2,800 feet on the incline, and the Eagle-Shawmut has been developed to an incline distance of 2,700 feet. Numerous properties have been opened to a depth exceeding 1,500 vertical feet. The North Star, Grass Valley district, has been developed to an incline depth of 5,400 feet, and the Empire, same district, has an incline shaft 3,500 feet deep. The Kennedy and other companies are planning to sink deeper, the ore showing in the lower levels being particularly encouraging for deeper activities.

Of all the mines in California that

gained; and from that point to the present lowest working level (3,450 feet), ore conditions have proven exceptionally satisfactory. The veins occur in a slaty formation, with considerable free gold and sulphurets showing. North of the shaft the shoots have an average width of 11 feet and have been developed about 500 feet. The southerly shoots range from 5 to 6 feet wide, with average lengths of 700 feet. On the 3,450-foot level the main vein displays a width of 15 feet. Values throughout range from \$5 to \$10 per ton, with the average around \$6.50. Occasional rich streaks of quartz are encountered. This ore is carefully guarded and mixed with the lower grade to maintain a fairly uniform monthly standard. The three-compartment shaft is 3,550 feet deep and will be eventually sent down to intersect the hanging-wall and foot-wall veins. It is expected to tap the former at an approximate depth of 3,900 feet and the latter near the 4,400-foot point. Two compartments are used for ore, the third for water. A 1,200-horsepower engine operates the hoist. Skips with a capacity of 3½ tons are operated, the trip from the 3,450-foot level to surface being made in 1¼ minutes. The skips handle the small amount of water without difficulty. The ore is broken by piston drills, four air compressors furnishing energy to the machines. The ore is shoveled direct from the various levels into mule trains and sent to the 100-stamp mill. The annual production approximates 180,000 tons, valued at about \$1,000,000. Mining and milling costs average around \$3 per ton. The demonstration of strong and rich auriferous deposits below the 2,300-foot level by this company, and the subsequent favorable results, have resulted in the opening of numerous old properties, and the inception of a new era of progress throughout the northern portion of the Mother Lode. It has also had a benignant influence in deeper work in other portions of the belt, and in adjacent fields.

The South Eureka probably ranks after the Kennedy as the property that has given the greatest impetus to deep work on the Lode. This property was developed to a depth of 2,600 feet, and was on the point of being abandoned when an 80-foot drift from the 2,500-foot level intersected a 50-foot vein averaging \$6.50 per ton. This was subsequently opened at the 2,600-foot point and upper levels, and a tottering prospect was converted into one of the best mines in the state. The three-compartment shaft has an incline depth of 2,800 feet and is provided with

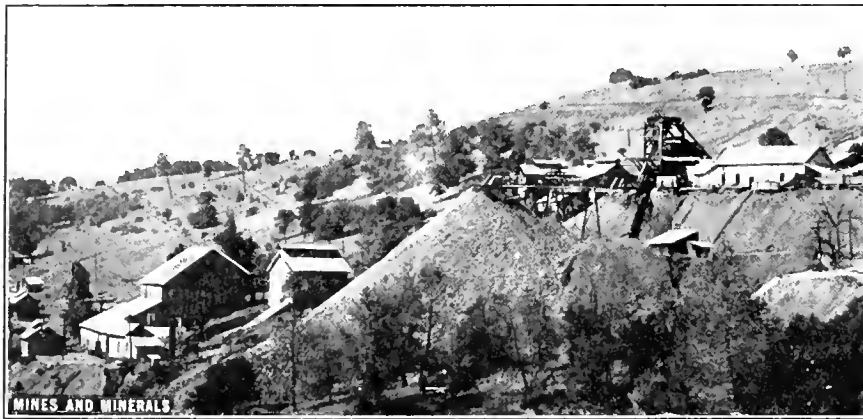

ARGONAUT MINE AND MILL

recorded in the Amador County portion of the Mother Lode. This mammoth auriferous gold zone embraces Amador, Calaveras, Placer, Tuolumne, and Mariposa counties, with Amador and Calaveras the principal producers. Amador is particularly deserving of attention, as within her confines are found the deepest gold mines in America. The general formation of the Mother Lode is clay-slate, at times altering to greenstone-schist. Veins also occur in a serpentine belt, but while larger they usually lack the values contained by the slate and schist deposits. Some of these veins range 50 to 150 feet wide, with numerous ledges exceeding a width of 20 feet. The average value of mined ore on the Lode approximates \$3.80 per ton, but in the large deep mines values are considerably higher.

Among the principal mines of the Lode are the Kennedy, South Eureka, Argonaut, Eagle-Shawmut, and Utica group. The Kennedy has been developed to a vertical depth exceeding 3,550 feet, and

have stimulated deep operations, the Kennedy unquestionably claims the premier honors. As the deepest gold mine in America this property has demonstrated the remarkably persistent nature of the Mother Lode gold deposits, and given an impetus to developments throughout the affected region. Previous to the opening of commercial ore at the 1,200-foot point the Kennedy was considered practically a failure, having been condemned in 1880 after several years of fair production, and lying idle until 1885. In the upper workings the veins were found badly broken, with values constantly varying, and the deposits showing indications of terrible compression during the formative period. Faulting was frequent, and the ore values frequently vanished. Experience gathered in the Keystone, Oneida, and other properties, encouraged the reopening of the Kennedy in 1885, after the shaft had attained a depth of 900 feet. The greatest improvement in character and strength of ore developed after the 2,300-foot level was

4-ton skips traveling at the rate of 1,250 feet per minute. The two main veins occur in a slate formation, with soft gouge dividing the quartz from walls. The ledges are gradually converging toward each other and are expected to meet near the 3,000-foot point. A considerable percentage of sulphureted ore occurs, and this is shipped to the Selby smelter at Vallejo Junction. The free-milling quartz is treated by an 80-stamp mill. 12,000 tons are crushed per month, mining and milling costs averaging \$2.63 per ton.

The deepest incline mine on the Lode is the Argonaut, developed to a depth of 3,600 feet. This property encountered commercial ore near the 600-foot level, but the first important discoveries were made at the 1,600-foot point. The vein on the 3,450-foot level shows a width of 20 feet. On the recently opened 3,600-foot level the vein is reported 30 feet wide. The deposits occur in slate, and the ledges are less broken than in neighboring properties. Operations are handicapped by distance of shaft from main ore points, and its unsatisfactory pitch. The shaft is three compartment and equipped with an electric hoist operated by a 500-horsepower Westinghouse motor. The 40-stamp mill crushes 200 tons per day.

The North Star mine, at Grass Valley, has been developed to an approximate depth of 5,400 feet with the 5,300-foot the deepest working level. The vertical depth of the workings is about 2,066 feet. In the upper levels, now exhausted, the vein averaged about 18 inches wide, with values running about \$18 per ton. Below the 2,500-foot point the vein widened out to 6 feet with the crushed country rock persistently mingling with quartz. This necessitates the breaking down of the whole mass to obtain best results. Values for the entire width average \$10.745 per ton, and 95,401 tons were treated in 1911 at an operating cost of \$509,925, with \$46,481 additional for developments. Net earnings for the year were \$468,681. This company has conclusively demonstrated the persistent nature of the Grass Valley ore bodies, and it is likely the veins will be found persisting as far as economic conditions will permit following. The vein occurs in a fine-grained dark-green rock composed of uralite-diabase and uralite-porphyrite, with the walls strong and generally well marked. The company operates two 40-stamp mills and a cyanide plant. Of the total extraction, 77.1 per cent. is obtained by amalgamation and 22.9 per cent. by cyanidation. It is stated 98 per cent. of the total ore content is recovered. For years the North Star has ranked as the foremost quartz gold producer of California, its annual yield surpassing \$1,025,000.

The Empire, developed to an incline depth of 3,500 feet, is controlled by a private corporation, and little of value has been given out by the management. The ore occurs in diabase and granodiorite and has an average width of 10 to 18 inches. Values are stated to range \$15 to \$40 per ton, with occasional streaks of remarkably rich quartz encountered. The shaft is three-compartment. The mill comprises 40 stamps, and the annual yield is estimated at about \$750,000. Like the North Star vein, the Empire ore bodies have proved remarkably persistent, and the results obtained have stimulated deep workings by other companies in the district. A detailed account of this remarkable property appeared in the September, 1911, issue of MINES AND MINERALS.

The instances cited indicate the great interest manifested in deep quartz mining in the northerly districts of California. It has been found necessary to handle the generally low-grade ore on a large scale to insure successful results, as the \$3 a day and 8-hour shift means a somewhat high labor cost. Electricity is gradually superseding water-power, with a corresponding cost reduction. As most California ores, particularly along the Mother Lode, yield readily to simple milling, there is no need for erection of costly and complicated reduction plants, such as are required in reducing refractory material. Among the noted old mines on the Mother Lode, that have been recently rehabilitated and are being sent to pronounced depth, are the

Economic Efficiency in Lead Concentration

By R. S. Handy*

While running a series of efficiency tests on frue vanners in the new unit of the Bunker Hill & Sullivan west mill, I included a few tests to determine the economic effects of various speeds in the forward motion of the belt, all of the other mechanical conditions being constant. The tests

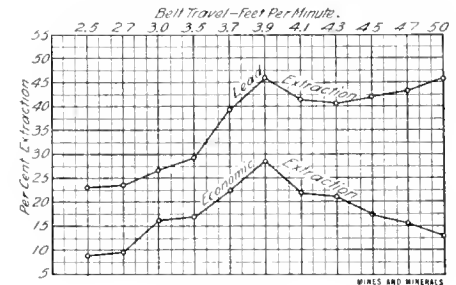

FIG. 1

produced some interesting results, as shown in the accompanying table and graphic representations.

The tests were run on a Chalmers & Williams 6-foot Frue vanner, with a slope of 1/4-inch per foot, fed with thickened overflow from an Esperanza drag classifier, all through 200 mesh. The dilution of the feed was one part solids to 7.8 parts water; wash water, 3.57 gallons per minute; speed, 200 revolutions per minute. One test per day was made at intervals covering a period of a month, which accounts for the variations in the feed assays of the different tests.

The results are tabulated in Table 1

TABLE 1

Test No.	Belt Travel Feet Per Minute	Tons Feed Per 24 Hours	Assay Feed Per Cent. Pb	Tons Lead in Feed Per 24 Hours	Tons Concs. Per 24 Hours	Assay Concs. Per Cent. Pb	Tons Lead Concs. Per 24 Hours	Per Cent. Extraction Lead	Per Cent. Extraction Economic	Ratio Lead to Economic Extraction
1	2.5	4.94	8.72	.430	.155	63.8	.099	23.1	8.7	.376
2	2.7	6.46	8.31	.537	.187	66.9	.125	23.3	9.7	.416
3	3.0	5.89	11.07	.652	.247	71.5	.176	26.9	16.5	.613
4	3.5	5.70	11.18	.638	.292	64.2	.187	29.3	17.1	.583
5	3.7	5.46	10.58	.573	.367	61.2	.225	39.2	22.3	.569
6	3.9	6.58	9.30	.612	.507	56.0	.284	46.4	28.6	.616
7	4.1	6.70	9.61	.644	.600	45.0	.270	41.9	22.0	.525
8	4.3	6.06	9.63	.583	.498	47.2	.235	40.3	21.4	.531
9	4.5	6.94	8.81	.611	.887	29.0	.257	42.1	17.4	.413
10	4.7	7.04	9.53	.671	1.180	24.5	.289	43.0	15.6	.362
11	5.0	4.96	8.69	.431	1.040	19.0	.197	45.7	12.4	.271

Plymouth Consolidated, Keystone, Oneida, Central Eureka, Lightner, and many others. And most of this activity is traceable directly to the results obtained by the Kennedy, South Eureka, and other progressive operators.

乘 乘

The mining industry of Formosa for 1911 was as follows: Number of mines—gold, 9; gold-copper, 1; gold dust, 27; copper, 2; mercury, 1; coal, 270; petroleum, 39; sulphur, 16. Production—Gold, \$1,065,400; gold dust, \$48,882; silver, \$32,525; copper, \$264,513; coal, \$468,317; petroleum, \$3,243; sulphur, \$22,950.

(which is self-explanatory) and are shown graphically in Figs. 1 and 2. The economic extraction referred to is the ratio of the value of the feed—figured at the full price for the lead and silver contents—to the net value of the concentrates as they are sold to the smelters, using the same base prices. The idea was to determine under what conditions the most money is extracted from a given quantity of metals in the feed, and whether the relationship of the lead extraction to the net returns would be somewhere nearly constant.

* Mill Superintendent, Bunker Hill & Sullivan M. & C. Co., Kellogg, Idaho.

It developed that the lead extraction and the economic extraction increased steadily with increasing belt speed (Fig. 1) until a travel of 3.9 feet per minute was reached, after which the lead extraction remained fairly constant, while the economic extraction decreased rapidly with increasing belt speed.

The test No. 6, which produced the best economic extraction, was a fair average of

experiments with concentrating machines on this character of feed, and indicates, I think, that the content of free, crystalline lead particles is about 55 per cent. (since 20 per cent. extraction can be obtained in retreating the tailings), and that the remainder of the lead is mechanically included in the flocculent matter that flows with the surface water off the vanner.

The main point brought out in these tests is that in concentrating lead ores, where the cost of transporting and refining the product is such an important economic factor, there is a point in each concentrating process at which the adjustment of the lead extraction to the grade of concentrates gives the highest economic recovery. This is well illustrated in Fig. 2, in which the two important factors are represented graphically. The highest economic point seems here to be very sharply defined.

It may be well to explain that with the Bunker Hill ores it is not necessary to consider the silver in making tests, as the ratio of the silver to the lead is, for all practical purposes, a constant.

來 來

Manganese in Gold Amalgamation

Manganese oxide (MnO_2) is often found associated with ores of gold and silver, particularly the former. Noted instances are Butte, Mont., Leadville, Colo., and Tombstone, Ariz. The action of manganese dioxide on mercury is not well understood and its evil effects are often the cause of much annoyance, notably in pan mills. It is thought by many that in some manner nascent oxygen is given off from the black manganese oxide, and this in some manner affects the mercury. In pan mills caustic lime is often added with good effect, and it may be that a similar result might be obtained by adding quicklime to the mercury in a plate mill. In some mills concentration before amalgamation has been found to give better results than are obtained in the usual practice. In concentration before amalgamation much of the deleterious mineral present—usually manganese oxide, molybdenite or graphite—is washed away with the gangue, and the precious metal, relieved of these substances, amalgamates more readily. In other cases concentration alone has been found to result in a saving of a higher percentage of the gold than could be obtained by amalgamation alone in the presence of manganese, graphite, or molybdenite. In the treatment of some silver ores by the pan amalgamation process, where much base metal is present, the addition of a small amount of manganese oxide has been found to have a beneficial effect, producing a higher-grade bullion than was otherwise obtainable.

來 來

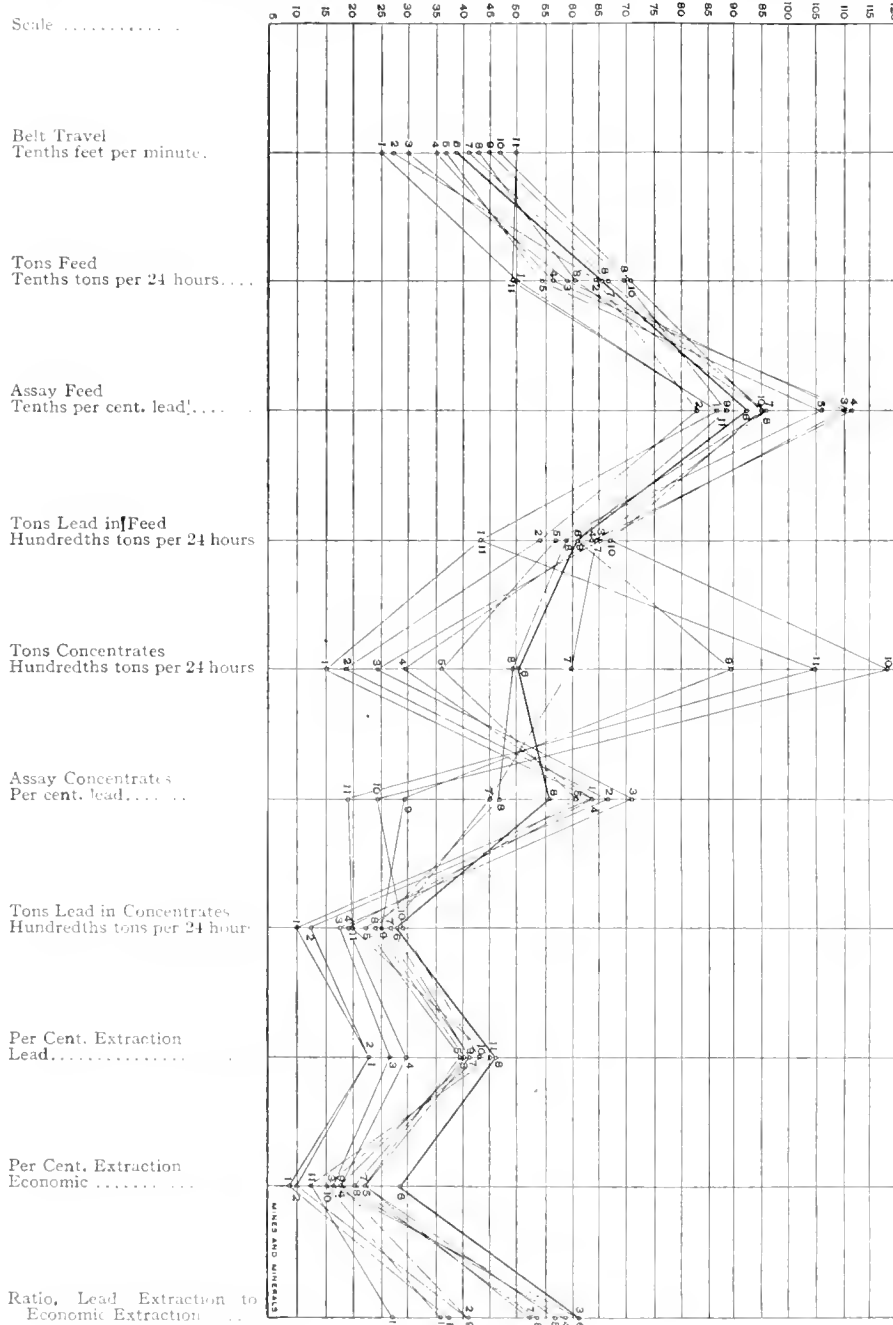

FIG. 2

all the tests so far as feed and tonnage were concerned. The vanner was running at practically the adjustment shown in test No. 6 when the tests were started.

An interesting point to note is that the excess sand pulled over in the concentrates after the sixth test did not increase the lead extraction. This is in line with other

To demonstrate this, roughly, I screened some of the tailings on a fine, silk cloth and washed the muddy water through with clear water. Thirty per cent., by weight, in the form of clean sand was left on the cloth and assayed 1 per cent. lead, while the light, flocculent matter through the cloth assayed 6.14 per cent. lead.

Bismuth is a reddish-white metal and is very brittle. Its specific gravity is 9.83, and it melts at 264° C. or 507° F. Like water, it may be cooled 6 degrees or 7 degrees below its freezing point, but when solidification sets in, the temperature rises to 480° F. and continues to rise until mass is solid. It expands .03 of its volume on solidifying, a property which it communicates to its alloys.

Practical Cyaniding—Part 4

Slime and Its Treatment—Intermittent and Continuous Decantations—Thickeners—Filter Presses

By John Randall*

AS used in mill practice the term slime includes all material passing through a 200-mesh sieve, and often sand as coarse as 150 mesh is allowed to go into the slime, as it assists filtration by making the cake more permeable. When ore is crushed to impalpable powder, the fine gold and fine silver will go quickly into solution. As lime will absorb its weight in water, it has been a problem in the past to separate the gold cyanide solution from the slime; however, in recent practice this is accomplished.

From the very commencement of the cyanide process, slime, or colloidal hydrates, in the ore gave trouble. Efforts were made to prevent the formation of slime by crushing the ore comparatively coarse, that is, to 20-mesh screen. But this did not free the gold in some ores, so that the extraction was imperfect. Besides, in some cases, when crushing to a 20-mesh, from 30 to 60 per cent. of the ore would slime, which made percolation and drainage difficult. Finer crushing was then adopted and the pulp was separated into sand and slime, each of which was subjected to separate treatment.

The gold and silver are dissolved from slime generally by agitation in Pachuca tanks, Fig. 1, or mechanical agitators, and as a rule present no difficulties; but it must be borne in mind that when slime and solution are lying at rest in a tank no extraction is taking place. Changes of solution are necessary, especially so in case of silver ores, and air must be persistently applied if reducing agents are present.

Gold and silver are recovered from slime by decantation, vacuum filtration, or filter pressing. Decantation is the oldest method, and may be classed as intermittent and continuous, the successful application of the latter is quite recent. Vacuum filters are of two kinds, the thin cake, such as the Ridgeway and the Oliver; and the thick cake, such as the Moore and Butters. Filter presses are of two kinds, as the plate and frame type used for a long time in many industries, and another type in which the filter leaves are enclosed in a chamber or cylinder. They are more properly called pressure filters. The Swetland and Kelley are widely different forms of this type.

Intermittent decantation was the first method practiced for recovering the gold cyanide solution, the slime being alternately agitated with barren solution and then allowed to settle or thicken at the bottom of the tank when the clear solution containing a considerable part of the

gold was decanted to the zinc boxes. This operation was repeated several times with a fresh portion of solution, water being added with the last wash to make up for the moisture sent to waste in the tailing after the last decantation. From three to four decantations were generally made, making it necessary to pass a very large amount of solution through the zinc boxes as well as requiring large storage capacity for the wash solutions. Intermittent decantation also required that the

series of thickeners and is alternately thickened and washed, the same wash solution being successively used for the several washes by being passed through the series in a direction opposite to that of the ore. The first work done upon series decantation in America, as far as adapting the method to mill practice is concerned, was done in the Black Hills of South Dakota in 1901, in which four washes were given the slimed ore, and the work resulted in patents taken out in 1902 by John Randall

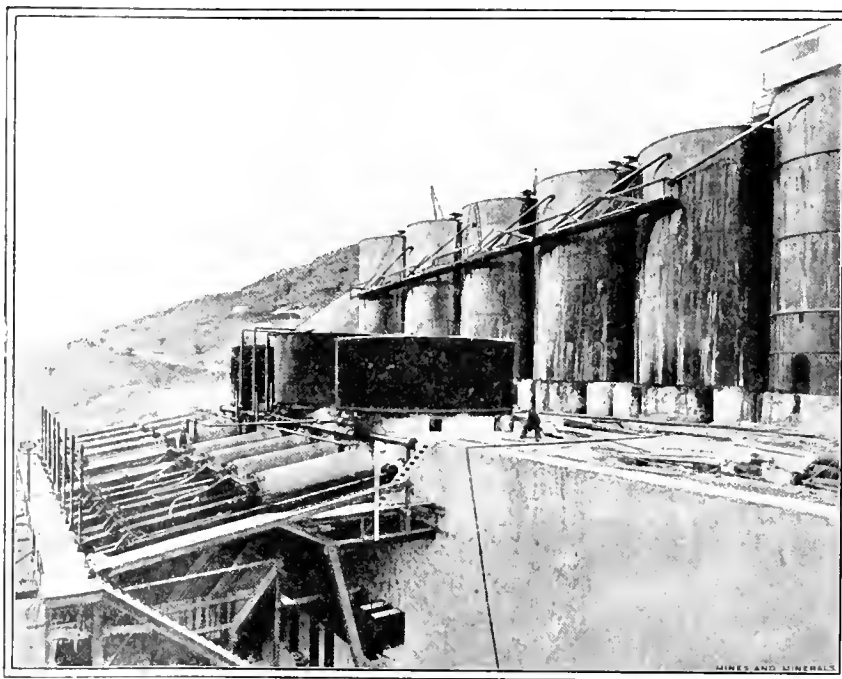

FIG. 1. PACHUCA TANKS, AT RIGHT

tanks should be large compared with the tonnage, as the pulp while thickening occupied but an inconsiderable portion of the tank near the bottom. These intermittent operations also involved considerable labor cost, but the process is still practiced on a large scale in South Africa in the older mills, the agitation being effected by drawing the material from the bottom of the tank and pumping it to the top with centrifugal pumps. The only reason for continuing the practice is the cost of changing the equipment. No new mills are being built on this plan.

Continuous decantation has been used and a moderate degree of success achieved by thickening continuously in large cone-shaped tanks. If a considerable degree of thickening is attempted it is likely to give trouble on account of the talcose material building up on the slopes

for an apparatus to carry out the method in a series of thickener cones. The inherent difficulties in thickening in cones and the fact that vacuum filtration was then beginning to attract attention away from other methods, caused series decantation to attract little attention in this country until the introduction of the Dorr thickener.

At about the same time that Mr. Randall was installing his series decantation plant in the Black Hills, the Denny brothers worked out the same method in South Africa, their apparatus differing considerably from his in detail. The Denny apparatus provides for three operations: first, dewatering the battery slime, next cyanide treatment for securing extraction, and lastly two series washes for recovering the gold-bearing solution.

The Dorr thickener having come into

*Boulder, Colo. Part I appeared in August MINES AND MINERALS.

extensive use, series decantation is thereby made convenient and practicable and is receiving the attention it deserves. This thickener removes the settled slime by means of slowly moving scrapers, obviating the trouble caused by the slime building up on the slopes of the cones and sliding down at irregular intervals. Changes of solution necessary either for

per ton in the following thickener of the series.

EXAMPLE.—Three thickeners, *l*, *m*, and *n*, are operating in series, one part of the solution passing through the series from *l* to *n* in the thickened slime issuing from the underflow of each and finally leaving the series as underflow from *n*. The overflow passes up the series from *n* to *l*, one

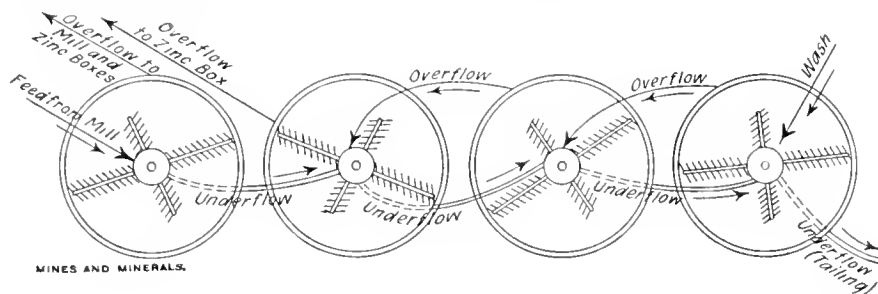

FIG. 2. THICKENERS IN SERIES

securing extraction or for recovery of metal-bearing solution are effected by running thickeners in series either with or without agitators between them. In some plants where the solution is quite low in cyanide, this method is displacing filters. The system greatly reduces the amount of solution required to be passed through the zinc boxes over that required by other methods of decantation.

In computing results for any ratio of wash to ore or for any method of applying the wash, only the solution is taken into account. If it is assumed that the slime is thickened to 50 per cent. moisture, then an amount of solution equal to the ore is moving down the series, toward the right in diagram Fig. 2. If we denote the ratio of solution to ore by *r*, the amount of solution moving down the series will be $\frac{1}{r}$ and the amount moving

part of water being added at the last thickener, *n*, and one part of half-strength solution added at the next to the last thickener, *m*. All the overflow leaves the series at the first thickener, *l*. The feed of slime coming into the series at *l* contains two parts of standard solution to one part of ore. What is the strength of the solutions in each of the three thickeners, regarding the strength of the standard solution as unity?

In thickener *l* two parts of solution are entering with the feed and two parts are entering it as overflow from *m*. In thickener *m* one part of solution is entering from the underflow of *l*, one part of half-strength solution is entering it from the mill, and one part is entering it from *n*. As to the last thickener *n*, one part of solution is entering it as underflow from *m* and one part of water is being added.

Solving for *x*, *y*, and *z* we have the values $\frac{3}{4}$, $\frac{1}{2}$, and $\frac{1}{4}$, or expressed in percentage, 75, 50, and 25 per cent. of standard strength of the solutions in the thickeners *l*, *m*, and *n*.

EXAMPLE 2.—(a) Four thickeners, *k*, *l*, *m*, and *n*, are operating in series under the same conditions as in the last example, the half-strength solution being added to the next to the last, and the water to the last. What is the strength of the solution in each? (b) What is the value for the last of a series of five thickeners operating in the same manner? Ans. For last thickeners. (a) 20 $\frac{1}{17}$ %, (b) 18 $\frac{1}{7}$ %.

The above results are instructive, showing as they do that increasing the number of thickeners does not materially affect the value in the last one after the third. However, increasing the ratio of wash has a very marked effect. This is illustrated by the following example, which might be met in mill practice, the gold value instead of the solution strength being computed:

Four thickeners are operating in series on the same principle as outlined in Example 2 under the following conditions:

1. The value dissolved is \$5 per ton of ore, the dissolution of value being completed before the pulp enters the first thickener. The entire battery product, consisting of 6 tons of solution to 1 ton of ore is sent to the first thickener. From the overflow of this thickener 1 ton of solution is returned to the batteries to every 4 tons sent to the zinc boxes. Of course 1 ton of solution per ton of ore passes out at the underflow with the thickened slime. It will therefore be seen that no washing occurs in the first thickener, it being in the battery circuit only.

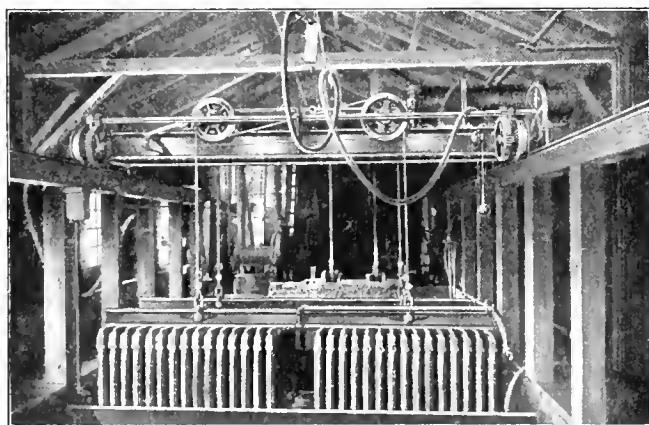

FIG. 3. THE MOORE FILTER

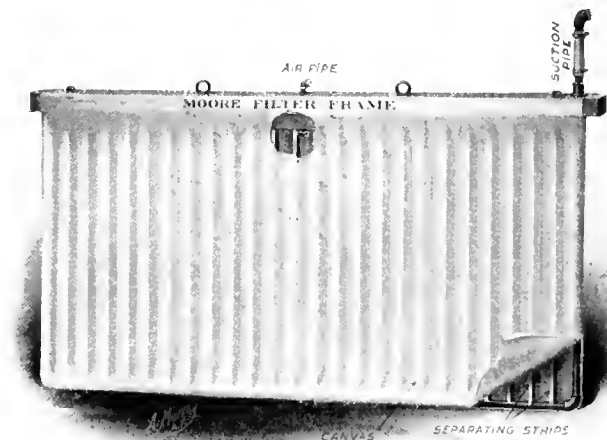

FIG. 4. MOORE FILTER FRAME

in the opposite direction will be *r*-1 and the value *r* per ton for the contents of any thickener is

$$v = \frac{p + f(r-1)}{r}$$

In which *p* represents the value per ton in the preceding thickener and *f* the value

From these conditions we derive the following equations:

$$x = \frac{2+2y}{4} \tag{1}$$

$$y = \frac{x + \frac{1}{2} + z}{3} \tag{2}$$

$$z = \frac{y}{2} \tag{3}$$

2. One ton of water to each ton of ore is added at the last thickener to balance the moisture loss in the discharged tailing.

3. Four tons of wash solution containing \$.50 gold per ton is added at the third thickener for each ton of ore. The overflow solution leaves the series from

the second thickener and is returned to the batteries.

Let w , x , y , and z , respectively, equal the values in gold per ton of the solutions leaving the first, second, third, and fourth thickeners. Then will

$$w = \frac{5x + w + \$5}{6}$$

$$x = \frac{5y + w}{6}$$

$$y = \frac{x + 2 + 4(.05)}{6}$$

$$z = \frac{y}{2}$$

Solving for the values of w , x , y , and z , $w = \$1.29$; $x = \$.29$; $y = \$.089$; $z = \$.044$; making a recovery of a little over 99 per cent. by washing in three thickeners.

The above example is from a flow sheet worked out for an all-sliming mill crushing in solution and having a capacity of 100 tons of ore per day. Through the courtesy of the Dorr Cyanide Machinery Co. the following flow sheet is given:

SOLUTION FLOW SHEET. FOR 100-TON MILL USING DORR THICKENERS FOR RECOVERY OF GOLD SOLUTION

	Tons Debit	Tons Credit
First thickener		
Coming from batteries.....	600	
Going to zinc boxes.....		400
Returned to batteries.....		100
Underflow with pulp to second thickener.....		100
	600	600
Second thickener		
From third thickener overflow...	500	
From first thickener underflow...	100	
Overflow through batteries.....		500
Underflow with pulp to third thickener.....		100
	600	600
Third thickener		
Barren solution from zinc boxes.	400	
From fourth thickener overflow.	100	
From second thickener underflow	100	
Overflow to second thickener...		500
Underflow to fourth thickener...		100
	600	600
Fourth thickener		
From third thickener underflow.	100	
Water.....	100	
Overflow to third thickener.....		100
Underflow to waste.....		100
	200	200

It will be noted that in this arrangement only 4 tons of solution per ton of ore is required to go to the zinc boxes. A mill constructed on this principle is being operated by the United States Reduction and Refining Co., at Florence, Colo., on a large accumulation of tailing. This method of recovery is applicable where a quite weak cyanide solution can be used, where the gold is readily brought into solution, and where it is desired to equip a mill at a moderate expense.

A very attractive field for the practice of series decantation in thickeners is where changes in solution strength are required in order to secure extraction. This condition is quite commonly met in ores yielding colloidal slime in wet crushing.

Filter presses of the ordinary Dehne.

or plate and frame, type have for some time been successfully used in the treatment of high-grade gold slime, principally in Australia, but the labor involved in opening the press and separating the frames each time the tailing is discharged has prevented its adoption in the United States, where low operating cost is of primary importance. The success of the Dehne press, however, has stimulated invention, and presses are now built that do not require to be opened in discharging and which give good results on fairly permeable slime cakes.

Pressure filters of various makes are used with success and are economical in operation. A fair knowledge of how to operate them may be gained from a description of each.

Vacuum filters of the thick-cake type as the Moore, Fig. 3, and the Butters, Fig. 5, came rapidly into use over the entire mining world as soon as they were placed upon the market, which was about the

Telluride, Colorado, which has a daily capacity of 300 tons of dry slime. This is equivalent to a filter area of 6,336 square feet, or 15 times that of a tank filter having the same capacity.

Vacuum filter plants are constructed with movable and stationary filter leaves; that is, in one case the filter leaves are moved from tank to tank during the process, while in the other case the filter leaves remain in the same tank while the solutions are changed.

There are two kinds of filter leaves that may be used in vacuum filters. The one shown in Fig. 4 consists of a pipe frame attached to a wooden rail. The upper part of the pipe composing the lower rail of the frame is cut away to form a trough in which the filtrate collects. In this trough are placed the vertical wooden separating strips, after which the entire frame is enclosed in 8-ounce duck. The canvas is stitched between the separating strips in order to

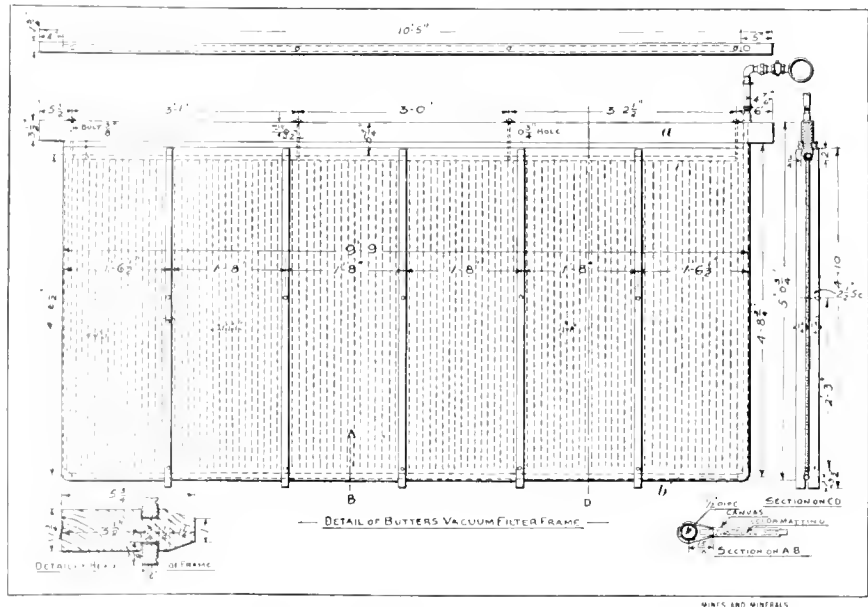

FIG. 5. BUTTERS VACUUM FILTER FRAME

year 1902. Their extensive use merits a general discussion and description apart from each make of filter.

Pressure filters require air-tight tanks, while vacuum filters are operated in open tanks. Vacuum filters are constructed to make use of the difference in pressure between the weight of the atmosphere and a partial vacuum produced by a pump connected with the interior of a submerged filter leaf. Owing to the limited pressure at command, less than 14.7 pounds per square inch, the time required to build a cake is more than is required by either the filter press or the pressure filter. This difference in time, however, is more than compensated by the number and size of the filter leaves that are handled in open tanks. For example, 66 filter leaves, each 6 feet wide and 8 feet long, make up a filter basket at the Liberty Bell mine in

give the frame stiffness and strength. To one upright side pipe, is fastened a nipple, and to this is attached a flexible hose terminating in an elbow, which joins a vacuum pipe, not shown. Filter leaves of this description are usually 5 feet wide by 10 feet long, and are arranged in baskets; that is, a number of leaves are fastened to steel I beams so that they may be lifted at one time.

In Fig. 5 is shown the other vacuum filter leaf. The frame consists of a 1 3/4" x 5 3/4" wooden top rail *a* with the remaining three sides made of 1/2-inch pipe *b*. The top of the lower pipe is perforated with 5/16-inch holes through which the filtrate enters the pipe. The filter mat consists of a layer of cocoa matting, covered with an envelope of 8-ounce duck, stitched at intervals of 1 inch as shown by the dotted lines. The canvas is rein-

forced by wooden strips on each side of the frame, as shown. There is a horizontal line of stitching below the top rail where the matting ends, and above this the canvas is made impervious by being coated with waterproof paint. The canvas over the pipes is also painted to prevent slime adhering to any part of the filter except the mat. The strips of wood that hold the canvas to the top rail are grooved and made to project as shown in the section, the object being to prevent the liquor from the top frame trickling over the surface of the slime cake when the filter is removed from the bath of slime pulp. To show the relation of the bottom rail pipe *b* to the matting and canvas, a section through line *AB* is given. The filter area on each frame shown is 80 square feet, and each filter, when bare, will occupy a space of 2.68 cubic feet; when loaded with 1 inch of slime cake it will require a space of 9.34 cubic feet. Owing to the projection of the slats, the distance between the centers of two consecutive filter leaves is $4\frac{1}{2}$ inches, which furnishes sufficient space for the accumulation of a cake 1 inch thick. The top rail of the filter frame projects at each end beyond the filter, so that it may rest on brackets in the tank. The filter leaves shown in Fig. 5 are bolted together in baskets of four each, and are used in the stationary vacuum filter process.

Specific Gravity of Slime Pulp.—Before the size of the apparatus needed in a cyaniding plant can be determined, the number of cubic feet that the pulp mixture and the filtrate will occupy must be definitely known. The volume of these mixtures varies with their specific gravity, which, therefore, must always be determined. While the specific gravity of slime pulp may be ascertained by means of the hydrometer, this method is not satisfactory owing to the difficulty experienced in keeping slime uniformly suspended in the pulp. A better method of finding the specific gravity is to weigh the mixture.

RULE.—To determine the specific gravity of slime pulp, place a measuring flask graduated to 100 cubic centimeters upon the scales and counterbalance it. Then fill the flask to the 100-cubic-centimeter mark with the slime pulp and weigh. The weight of this pulp is the difference in weight between the empty and the charged vessel, and this divided by 100 will be the specific gravity of the pulp.

This rule is based on the fact that 100 cubic centimeters of distilled water weighs 100 grams, for water is the unit in specific gravity calculations.

EXAMPLE.—What is the specific gravity of a slime pulp 100 cubic centimeters of which weighs 122.9 grams?

SOLUTION.—From the rule just given, if 100 cubic centimeters of the slime weighs

122.9 grams, the specific gravity is $122.9 \div 100 = 1.229$. Ans.

The specific gravity of *dry slime* varies. If the slime is wet and then dried to a hard mass, the specific gravity may be found by applying the following rule:

RULE.—To determine the specific gravity of dry slime, weigh the slime in air and then in water. The weight of the slime in air divided by the difference of the weights in air and in water will be the specific gravity.

EXAMPLE.—A mass of dry slime weighs 480 grams in air, but when submerged in distilled water shows a loss of 380 grams; what is its specific gravity?

SOLUTION.—Applying the rule just given, the specific gravity of the slime is $480 \div 380 = 1.263$. Ans.

Another method of determining the specific gravity of dry slime, and the only method available when the slime is in a loose pulverized state, is as follows: Having weighed a quantity of the dry slime, place it in a 100-cubic-centimeter flask and thoroughly mix with water. Then fill the flask up to the 100-cubic-centimeter mark with water from a burette. The weight of the slime in air divided by the difference between 100 cubic centimeters and the total amount of water that flowed into the flask will then be the specific gravity of the slime.

EXAMPLE.—What is the specific gravity of a dry slime that weighs 48 grams, if 50 cubic centimeters of water is required to mix it thoroughly, and 12 cubic centimeters more is required to bring it up to the 100-cubic-centimeter mark?

SOLUTION.—From the statement just made, the specific gravity of this slime is

$$\frac{48}{100 - (50 + 12)} = 1.263. \text{ Ans}$$

It is possible to find the number of cubic feet in 1 ton of slime pulp if the specific gravity of the slime pulp or the specific gravity of the dry slime and the required dilution are known.

RULE 1.—To find the number of cubic feet in 1 ton of slime pulp, divide the number of pounds in 1 ton by the number of pounds in 1 cubic foot of the pulp.

RULE 2.—To find the number of cubic feet in 1 ton of slime pulp, multiply the number of pounds in 1 ton, divided by the weight of 1 cubic foot of water, by the proportion of solution in the pulp. To this add the product of the proportion of slime in the pulp and the number of pounds in 1 ton divided by the weight of 1 cubic foot of water multiplied by the specific gravity of the dry slime.

EXAMPLE 1.—How many cubic feet are there in 1 ton of a slime pulp that has a specific gravity of 1.205?

SOLUTION.—Since 1 cubic foot of water weighs 62.5 pounds, 1 cubic foot of the pulp will weigh $62.5 \times 1.205 = 75.312$ pounds. Therefore, 1 ton of the slime

will contain $2,000 \div 75.312 = 26.556$ cubic feet. Ans.

EXAMPLE 2.—How many cubic feet will there be in 1 ton of slime pulp that consists of 3 parts of solution to 1 part of slime, if the specific gravity of the dry slime is 2?

SOLUTION.—Applying Rule 2, 1 ton of the pulp will contain

$$\left(\frac{2,000 \times 3}{62.5 \times 4} \right) + \left(\frac{2,000 \times 1}{62.5 \times 2 \times 4} \right) = 24 + 4 = 28 \text{ cu. ft. Ans.}$$

To find the dilution from the number of cubic feet of pulp mixture in 1 ton, first find the specific gravity of the dry slime, and then the specific gravity of the pulp mixture, and assume that the cyanide solution has a specific gravity of 1. The dilution may also be found by applying the formula

$$D = \frac{1(a-b)}{a(b-1)}$$

in which

D = dilution;

a = specific gravity of dry slime;

b = specific gravity of pulp mixture.

EXAMPLE 1.—What is the dilution of a pulp mixture that has a specific gravity of 1.125, if the specific gravity of the dry slime is 2?

SOLUTION.—Applying the formula just given,

$$D = \frac{1 \times (2 - 1.125)}{2 \times (1.125 - 1)} = 3.5 \text{ to } 1. \text{ Ans.}$$

EXAMPLE 2.—What is the dilution of a pulp mixture, if the specific gravity of the dry slime is 2.5 and there are 26.5 cubic feet of the solution in 1 ton?

SOLUTION.—As there are 32 cubic feet of water in 1 ton, the specific gravity of the mixture is $\frac{32}{26.5} = 1.208$. Then, from the formula, the dilution is

$$\frac{1 \times (2.5 - 1.208)}{2.5 \times (1.208 - 1)} = 2.5 \text{ to } 1. \text{ Ans.}$$

Cyanide solutions never approach a strength of 1 per cent., or 20 pounds to the ton of water; that is, $\frac{1}{100}$ more than the unit of measurement taken, or $\frac{2,020}{62.5} = 32.32$,

and $\frac{32.32}{32} = 1.01$, is the specific gravity of a 1 per cent. cyanide solution; 1.02 is that of a 2 per cent. solution; etc. The calculation given above is therefore near enough for all practical purposes.

If the specific gravity of a dry slime is known, the weight may be readily found.

RULE.—To find the weight of dry slime, multiply the weight of 1 cubic foot of water by the specific gravity of the slime.

EXAMPLE.—What is the weight of 1 cubic foot of dry slime that has a specific gravity of 2.4?

SOLUTION.—From the rule just given, 1 cubic foot of the slime will weigh $62.5 \times 2.4 = 150$ pounds. Ans.

Weight of Slime on Filter Leaves.
When the area of the filter leaves, the thickness of the cake, the specific gravity of the dry slime, and the moisture in the cake are known, the weight of the slime on the leaves may be obtained.

RULE.—To find the weight of slime on the filter leaves, find the amount of slime in cubic feet. Multiply this amount by the percentage of moisture present to find the quantity of water in the slime. Then multiply the cubical contents of the slime by the difference between 100 per cent. and the percentage of moisture in the slime, to obtain the amount of dry slime. Each of these products is then multiplied by the weight of 1 cubic foot of water and the specific gravity of the water and slime, respectively, and then divided by the number of pounds in 1 ton. The sum of the weights thus obtained is the weight of the slime on the leaves.

EXAMPLE.—Find the number of tons of slime cake on 410 square feet of filter, when the specific gravity of the dry slime is 2.4 and the cake 1.75 inches thick contains 20 per cent. moisture.

SOLUTION.—Since the slime cake contains $410 \times 1.75 \times 144 = 59.79$ cubic feet, it contains
 $59.79 \times .20 = 11.958$ cubic feet of water and
 $100 - 20 = 80$
 $\frac{80}{100} \times 59.79 = 47.832$ cubic feet of dry slime. Therefore the slime cake contains
 $\frac{11.958 \times 1 \times 62.5}{2,000} = .3736$ ton of water and
 $\frac{47.832 \times 2.4 \times 62.5}{2,000} = 3.5874$ tons of slime.

The weight of the cake is, therefore,
 $.3736 + 3.5874 = 3.961$ tons. Ans.

By carrying out a series of calculations with dry slime of different specific gravities, the number of cubic feet of pulp in 1 ton and the specific gravity of the pulp for different dilutions are obtained. These may be tabulated for ready reference in the mill as shown in Table 1.

EXAMPLES FOR PRACTICE

1. When a slime pulp has a specific gravity of 1.4, how many cubic feet of the pulp will equal 1 ton?

Ans. 22.857 cu. ft.

2. How many cubic feet will there be in 1 ton of slime that, when dry, has a specific gravity of 2, and, when filter pressed, retains 30 per cent. of moisture?

Ans. 20.8 cu. ft.

3. What will be the volume in cubic feet of a ton of slime pulp solution, diluted 2 to 1, the specific gravity of the slime being 2.25 when dry?

Ans. 26.073 cu. ft.

4. The available part of a filter-press frame has an area of 3 ft. x 5 ft. There are 91 such frames, and the cakes are made 1¼ inches thick. What will be the number of tons of slime that a press of this size can treat at one charge, assuming that the slime when dry has a specific gravity of 2 when it retains 30 per cent.

moisture in the press?

Ans. 6.83+ tons per charge.

5. When dry slime has a specific gravity of 2.6, and is mixed with 4 parts by volume of solution, what will be the specific gravity of the mixture?

Ans. 1.32

Weight of Slime Cake.—Slime cake varies slightly in weight, but on a vacuum filter a cake 1 inch thick will weigh about 8 pounds per square foot. A filter leaf having an area of 80 square feet, or two sides 5 ft. x 8 ft. each, will carry 640 pounds of slime cake. On an average, the cake will contain 35 per cent. of moisture, which leaves 416 pounds of dry slime per 80 square feet. Assuming that the original slime pulp contained 3 parts of solution to 1 of dry slime and that the filtering plant contained 60 leaves, the quantity of solution that will pass through the filter when forming a 1-inch slime cake

TABLE 1. DILUTION, VOLUME, AND SPECIFIC GRAVITY OF SLIME PULP MIXTURE

Ratio of Solution to Slime	Specific Gravity of Dry Slime											
	2		2.25		2.3		2.4		2.5		2.6	
	Cubic Feet of Pulp	Specific Gravity of Pulp	Cubic Feet of Pulp	Specific Gravity of Pulp	Cubic Feet of Pulp	Specific Gravity of Pulp	Cubic Feet of Pulp	Specific Gravity of Pulp	Cubic Feet of Pulp	Specific Gravity of Pulp	Cubic Feet of Pulp	Specific Gravity of Pulp
1.0:1	24.00	1.333	23.11	1.381	22.96	1.394	22.67	1.411	22.4	1.428	22.15	1.444
1.5:1	25.60	1.250	24.89	1.286	24.77	1.291	24.53	1.304	24.4	1.311	24.12	1.326
2.0:1	26.56	1.205	26.05	1.229	25.84	1.237	25.78	1.241	25.6	1.250	25.43	1.258
2.5:1	27.42	1.167	27.00	1.185	26.81	1.193	26.58	1.204	26.5	1.208	26.34	1.215
3.0:1	28.00	1.142	27.55	1.160	27.48	1.164	27.33	1.170	27.2	1.176	27.08	1.182
3.5:1	28.43	1.125	28.05	1.141	27.98	1.143	27.85	1.149	27.7	1.154	27.62	1.158
4.0:1	28.80	1.111	28.44	1.121	28.38	1.128	28.26	1.132	28.2	1.136	28.06	1.140
4.5:1	29.09	1.100	28.76	1.113	28.71	1.111	28.59	1.119	28.5	1.123	28.42	1.126

may be calculated as follows: The total load on the frames $\frac{640 \times 60}{2,000} = 19.2$ tons, 35 per cent, or 6.72 tons of which is moisture. The dry slime will weigh $\frac{416 \times 60}{2,000}$

12.48 tons, and as each ton of dry slime was diluted with 3 tons of solution, there were $12.48 \times 3 = 37.44$ tons of solution. Subtracting 35 per cent., or 6.72 tons, of the total load for moisture, there remains 30.72 tons of solution as the quantity that passed through the filter. The quantity of filtrate that passes through any number of filters for any dilution can be obtained from the formula

$$Q = a n \times \frac{d c - (b - c)}{2,000}$$

in which

- a = area of filter leaf, in square feet;
- b = weight per square foot of slime cake 1 inch thick;
- c = weight per square foot of dry slime cake 1 inch thick;
- d = number of parts of solution to one part of slime;
- n = number of filter leaves;
- Q = quantity of filtrate, in tons.

In this formula the weight per square foot of a slime cake 1 inch thick is usually

taken as 8 pounds; the weight per square foot of a dry slime cake 1 inch thick is taken as 5.2 pounds.

EXAMPLE.—A tank 22 feet long, 10¼ feet wide, and 7 feet deep, accommodates 60 filter leaves ¾ inch thick, having an area of 60 square feet. (a) When the filter leaves are in the tank and spaced 4½ inches between centers, what will be the capacity in tons, for pulp solution having a specific gravity of 1.25? (b) What will be the capacity of the tank for the pulp solution when the slime cake on the filter leaves is 1 inch thick?

SOLUTION.—(a) Total capacity of the tank is $22 \times 10\frac{1}{4} \times 7 = 1,578.5$ cubic feet. The space occupied by the filter leaves is $72 \times 120 \times \frac{3}{4} \times 60 = 388,800$ cubic inches, or 225 cubic feet. The space that the slime pulp may fill, therefore, is $1,578.5 - 225 = 1,353.5$ cubic feet.

Having a specific gravity of 1.25, the

pulp will weigh $62.5 \times 1.25 = 78.125$ pounds per cubic foot. The pulp solution in the tank will therefore weigh

$$\frac{1,353.5 \times 78.125}{2,000} = 52.87 \text{ tons. Ans.}$$

(b) Since the filter leaves are ¾ inch thick, the total thickness of the leaf and the cake on each side of it will be 2¾ inches. Therefore, the space filled by the coated leaves, in cubic inches, will be $72 \times 120 \times 2\frac{3}{4} \times 60 = 1,425,600$, which is 825 cubic feet. As the tank contains 1,578.5 cubic feet the space that the slime pulp may fill is $1,578.5 - 825 = 753.5$ cubic feet. Since 1 cubic foot of slime pulp weighs 78.125 pounds the tank will contain

$$\frac{753.5 \times 78.125}{2,000} = 29.43 \text{ tons. Ans.}$$

栗 栗

The Bureau of Mines announces two examinations to fill vacancies; one for a mine sanitary engineer at a salary ranging from \$1,800 to \$2,400 per annum; the other for a mineral technologist at a salary of \$3,000 per annum. The applications for these positions close on Nov. 9 and 8, 1912, respectively.

Causes of Fires in Metal Mines

Extensive Use of Timber Furnishing Conditions Favorable to the Starting of Dangerous Conflagrations

By T. A. Tefft

FIRES in coal mines arise from numerous sources, as there is fuel for consumption; but it would seem that among the barren rocks and non-combustible ores of the metal mines there is nothing to burn, and that a fire in such a mine would be impossible; and if, in spite of seeming reason, a fire therein did occur, it would be not alone a phenomenon, but a paradox.

And yet in a metalliferous mine a fuel body exists in the timbering.

In a coal mine the layer of mineral is dug out, except the pillars and props which are left standing to support the roof. When the stratum is excavated and there are no like deposits above in the members of the formation, then most of the pillars are dug away and the roof is allowed to cave. In such mining, timbering is a science but slightly called into play. It is different in a mine in which shafts are sunk 2,000, even 3,000, feet into the earth, and where tunnels are miles long; in which caving is never allowed, and drifts, stopes, and winzes are kept open, even after all the ore is taken from them. In such mines, with their many levels and galleries, the art of timbering to sustain the sides and roof rises to the highest forms of mechanical study. This is intensified by the various degrees of integrity of the formations through which the workings are run. When this is solid rock, the subject is comparatively simple. But when, as is often the case, one or both walls are of friable rock or loose conglomerate containing boulders, or when it is serpentine or talc, often wet, and sometimes with water that is scalding hot, when the foot- or hanging wall may swell with an irresistible pressure after the drift is dug, then timbering is a problem worthy of the keenest intellect.

While the mines of the West were yet new and small, timbering consisted of mere "stulls" or sticks of wood braced into an opening immediately against that part of the wall which showed a bulge, and there was no system in their disposition. This method is used even now in some small mines or prospecting drifts where timber is scarce, the wood employed being tamarack, juniper, or cottonwood; when this is unobtainable, green yucca is pressed into service with favorable results.

But in large mines, timbering has come to be one of the most important branches of engineering, and into their labyrinthine recesses is driven, stick by stick, whole forests of logs. The wood most used is the sugar pine, but for no other reason than that it is generally the wood most

abundant on the mountains near the mines.

From one plan and method of supports to another, timbering has advanced to what is called the "square-set" system, an admirable arrangement of frames and braces, but which requires an immense quantity of wood; so that these subterranean galleries, which ramify through miles and miles of the earth in a single locality, are really great cities of wooden buildings. As such, a fire in them, when it manages to communicate from one level to another, becomes a dangerous and serious matter.

Thus it can be seen that there is abundance of material in a metalliferous mine with which to support a fire, and this material is frequently in a condition very readily to invite combustion. The air forced through all parts of a mine, with the high temperature which is generally present in deep mines, soon seasons the greenest wood and makes it dry as tinder; then a lighted candle, held too close to a post or cap, may ignite some fibers of old bark and so carry the flame behind the sprags or lagging, subsiding there in a smoldering fire which eats and chars but does not blaze.

This manner of burning was strikingly exemplified some years ago in a fire at the Green Mountain mine in Plumas County, California. They had an engine on one of the levels fed by steam pipes into the mine from a boiler above ground. The heat of the steam chest so carbonized the wood of several posts on the side of the level that a candle flame, touching one of them, flashed into ignition, and before the men could get out of the mine, the fire, through a "dry" process, had spread so that two of the men were caught below and were asphyxiated.

Nor is wood the only combustible substance found in metalliferous mines. Some years ago it was given out that bituminous shale was burning in a certain silver mine in the West. This was received with an incredulous laugh by mining engineers and mineralogists all over the West, but the statement is probably true. It is certainly not without precedent that bituminous shale should form a foot-wall of a metalliferous vein, even though the impregnation of bitumen might not be detectable in the rock with the naked eye. Bennett H. Brough, in the "Transactions of the North of England Institute of Mining and Mechanical Engineers," mentions that such shale exists

in a lead mine in Derbyshire, and that explosive gas emanating from it collects in fissures of the lime rock wall; and at the Silver Islet mine, an argentiferous de-

posit on the north shore of Lake Superior, gas shot forth from a drill hole and threw a flame nearly 40 feet long. Some men were drilling in the foot-wall when gas began to escape from the drill hole. It did not flow copiously, but they withdrew the drill, and one of the men for purposes of inspection held a lighted candle close to the hole. Instantly there sprang from the orifice a jet of fire which, as the hole inclined obliquely, blew with a furnace roar far down the level. When the first burst of ignition was over, which momentarily filled the entire opening with flame, the men hurried out of the shaft. They returned shortly after without a candle, and drove a wooden plug into the hole. When the gas had been forced out of the workings by pumped air they held a candle to the spot again, and again the gas ignited, there being a leakage notwithstanding the plug.

Marsh gas is quite common in iron mines, which often lie contiguous to beds of lignite. It occurs, too, in salt mines, generated through decomposition of vegetable substances, and lodges in the crevices as firedamp.

And there are other inflammable gases besides light carburetted hydrogen which are sometimes found in mines and cause fires. No mineral is more commonly distributed through the masses of metalliferous veins than iron pyrite, a chemical combination of iron and sulphur. The oxidation of this, which may occur through contact with water and air, evolves sulphuretted hydrogen, an inflammable gas; and as the process of its generation is attended with great heat, it might be possible for ignition to be started through this process, and combustion spontaneously to ensue. Fires starting from decomposing pyrite are common enough in coal mines, and there is no reason to suppose that, with a chamber densely filled with sulphuretted hydrogen emitted from such a source, it might not be lighted from the retort that produced it. Decayed wet wood in a moist atmosphere will engender an inflammable gas similar to marsh gas; this has frequently been found in abandoned parts of metalliferous mines where the timbers have rotted and the air is foul.

Divers phenomena are noticeable in connection with deep-mine fires, and among the most prominent are those affecting ventilation. It is well known that a fire above the opening of a mine, as the burning of a shaft house, will draw all the air out of the lower recesses, and will

at once smother all the life there is below. And the fact that fire above will draw the life-sustaining air from below, even when the air is abundantly pumped into the apartments beneath the fire, was fully and with fatal results demonstrated in the great conflagration which occurred on the Comstock lode in 1869.

The methods of extinguishing fires in deep ore mines are much the same as those employed in coal mines, though the damaging results from such operations are usually much greater in the former than in the latter. The most common way to suppress a fire in a mine is to flood it. In a coal mine this can be done with but little injury to the future working of the property; but in a metalliferous mine it is very different. The timbers become saturated, swell, and burst, allowing serious caves where such would otherwise not occur. And then, though water will unquestionably put out a fire wherever it reaches it, there are parts of a metalliferous mine which may still be dry and burning when the mine is filled with water so that it will run over the top of the shaft. These are the stopes and winzes, those perpendicular cul-de-sacs or inverted wells rising from a level into the vein from which the ore is dug. These being filled with air and their timbers burning, the water will rise in them only as far as it is permitted by the resisting air; and so a portion of them remains dry while the oxygen in the volume of atmosphere which they contain will sustain the slow and stubborn fire until the water is removed, and so continue as a source of foul gas generation and communication for future spreadings of the fire.

The use of carbon dioxide as an extinguisher affects combustion in a mine much the same as water: the fire is quenched where the gas reaches, but being a heavy fluid, it moves and rises much the same as water, and is in like manner repressed by the confined air in the stopes. It does not, however, damage the timber as does water, neither does it moisten it, and as soon as the gas is driven out of the mine the timbering is left dry as before, ready to rekindle almost upon the touch of a spark.

Steam as an extinguisher was exhaustively tested as long ago as the Comstock fire. All shafts were sealed, and for 71 hours steam was forced into the mine. At the end of that time water was thrown down the shafts to clear the atmosphere, and men were sent below. The fire was found to be still burning, and as soon as the air reached it, it began to blaze. The hatches were thereupon replaced and steam was again turned on for nearly 4 days longer. Men then entered the mine with hose and a hand-to-hand fight commenced. The hose party advanced and put out the fire, while gangs followed who cut out the burnt timber

and replaced it with new. There was some caving, but the debris of this was removed and the cavities timbered up. It was in this way that the fire was gotten under control; but 3 weeks after so much was done and the men had resumed regular work in taking out ore, the fire again took head and it was necessary once more to close the shafts, turn on steam, and proceed to do the battle with the hose as before. And when this had been continued long enough to show its inadequacy as a method of fighting fire, it was finally decided to set apart the worst of the fire districts in the several mines and wall them up, cement them air tight, and leave the coals to extinguish themselves with the fumes which their combustion exhaled, a phenomenon which will take place if the air is entirely excluded. The fire in other parts of the mine was finally suppressed; yet 6 months after the burning was supposed to have been wholly quenched, men working in the upper levels of the mines would drive their picks where fire still smoldered.

The losses occasioned by fires in deep mines may be little short of the full sum invested in the underground improvements of the property. Not only must the timbering be replaced, but even the excavating must, to a large extent, be done anew. The vein, too, may, whenever it is exposed, be spalled and disintegrated, its sulphides burnt out, the ore melted into matte, that it may be difficult to mine. In short, a fire in a deep mine may be a ruinous calamity; and that they do not oftener occur may be adjudged, under present system, more a matter of good fortune than care. In some mines, however, wise adaptation to the advances of science has removed nearly every element of risk from this source. The lighting of the workings with incandescent lamps has abolished the smoky and danger-breeding candle, and the replacing of sawdust with infusorial earth in the manufacture of giant powders allows no chance of ignition from explosives.

Articles describing fires in metal and other mines will be found in MINES AND MINERALS, Vol. 32, pages 19, 253, 340, 342, 435.

栗 栗

Blister Plates for Sampling

R. Baggaley states in *Metal Industry* that segregation may cause one part of a bar of blister copper to contain even twice as much silver or gold as another. In casting the blister as it comes from the converters, plates $17 \times 24 \times 2$ inches are cast in a mold, which has 240 small projecting buttons, this leaving 240 dots in the plate. The plates are then drilled through at these dots. As 240 plates form a carload, the sample will represent 57,600 drillings in the shipment of such a quantity.

Sand Filling on the Rand

By Edgar Pam, A. R. S. M.
(Concluded from September)

Mr. A. R. Hughes in discussing Mr. Pam's paper says: As the filling of worked-out stopes with sand has provided quite a new experience for underground men on the Simmer and Jack mine, it is with considerable diffidence that I venture to give my experience and a short description of the methods employed in connection with the work.

The stope is admirably situated for this purpose as it is enclosed by a dike on the east and south sides and by a block of ground on the west, which is being worked toward the east. From the main drive on the south side of the dike a cross-cut extends north. From this a box-hole rise has been put up about 18 feet entering the bottom of the stope, and on the west side of the dike there is an intermediate drive leading through to No. 1 shaft, as shown in Fig. 4.

A bulkhead made of $3'' \times 9''$ deal, supported by $8'' \times 8''$ upright timbers was placed across the intermediate to the east

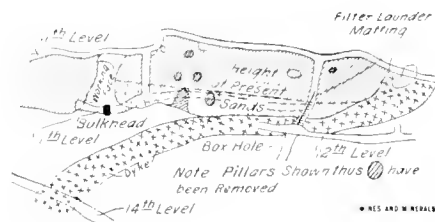

FIG. 4

of the working face, the $3'' \times 9''$ deals being perforated and covered with coconut matting on the face next to the sand, thus forming an outlet for drainage on the west side of the stope. It will now be apparent that an enclosed space has been provided with the exception of the box hole entering the stope on the south or bottom side. This box hole is used as the main outlet for drainage. A dry wall was built across it through which a 6-inch pipe projects into the stope. A filter frame 12 inches square covered with coconut matting and extending up the stope above the level of the sand was placed over the 6-inch pipe, thus forming an efficient filter through which all the drainage must percolate before escaping into the level below, as shown in Fig. 5. The square filter is made in 12-foot-6-inch lengths, one end being made 14 inches square for about 2 feet to fit over the length previously fixed, so that when the sand rises to about 2 feet from the top of the filter the next one can be placed over it, and by this means the filter is always kept above the level of the sand, as shown in Fig. 6. Inside this frame a covered wooden launder is placed to maintain an opening should the filter frame collapse. The drainage from the

sand is a small stream of about one-third of a ton of clear water free from cyanide to every ton of sand deposited, and although about 200 tons of current residue is lowered daily, men are still at work in the stope taking out pillars, etc., and suf-

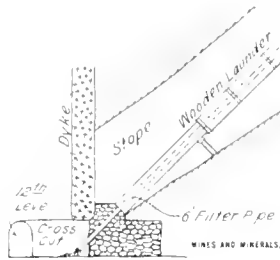

FIG. 5

fer no inconvenience from cyanide or any of its products.

The sand is conveyed from the bottom of the bore hole in wooden launders 9 inches wide and 7 inches deep and a grade of 15 degrees over which the pulp flows freely when diluted with a small spray of mine water. The sand forms a compact mass on which men can walk comfortably in from 2 to 4 hours after filling has stopped. The cleaner and more freely leachable the sand the better, as slime tends to retard drainage and pockets water between the points where the launders deliver sand.

It is pointed out here that there should be several stopes ready for filling when it is proposed that the whole of the current sand residue be sent underground, as the removal of pillars, etc., takes time, and when dealing with the daily production of sand from the cyanide works, filling must go on without interruption. For a stope less favorably situated for sand filling than that described, I would suggest that stulls be made of stout mine poles hitched at the top and bottom, lagged over with old pipes and rails, and packed with waste rock to a thickness of about 4 feet, the inner face being covered

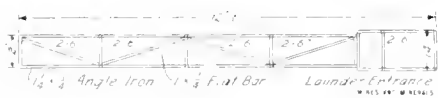

FIG. 6. FRAMEWORK OF LAUNDER

with cocoanut matting. This would afford perfect drainage and the sand being in a dry state would exert very little pressure against the stulls, and there would be no uncontrollable mass of sand and slime saturated with water to become a real source of danger in the mine.

乘 乘

Since 1862, Nova Scotia gold mines and prospects have yielded about \$20,000,000 in gold. The recorded production for the year 1862 is just about equal to that of 1911.

South African Shaft Sinking Practice

Our readers are no doubt aware that the government of the Transvaal has undertaken mining, and has, for some time, been sinking four very large shafts with a view to operating mines along the most up-to-date, economic lines. These different shafts are being sunk according to one plan, and therefore the description of the practice at any one shaft will convey a comprehensive idea of what can be accomplished by federal management and ownership. The State's mines are operated, for sufficient reasons, under the title of The Government Gold Mining Areas Consolidated.

What is perhaps a world record in rapidity of shaft sinking is described at some length in the *South African Mining Journal*, from which the following material has been abstracted.

Mr. Martin H. Coombe is manager of the work at the "Southeast" plant, and he is ably assisted by three "sinkers," Messrs. Robar, Lowson, and Readhead, who deserve equal mention with him in having established the remarkable record that occurred recently. The previous record for similar work on the Rand was 213 feet, at the Modder Deep. The Southeast shaft went down 233 feet in the month of March, this year.

This shaft has seven compartments and the overall dimension of excavation is 10 ft. x 45 ft. The actual tonnage of rock hoisted during the sinking of the 233 feet was 8,155, or an average of 35 tons per foot of sinking. The sinking was done through 78 feet of shale and 155 feet of quartzite, one-third thus being in the shale that is recognized as the more favorable rock for rapid penetration, and in which previous records have been established. The record run began at a depth of 1,738 feet from the collar of the shaft.

All of the drilling is performed by hand, native laborers being exclusively employed for this work and for mucking. The crew comprises 82 "boys" (as the natives are called) with one overseer or "sinker" and one white assistant. Three 8-hour shifts are worked every day in the week. The shaft having been laid out with its long axis parallel to the dip of the strata, advantage of the bedding planes is taken in the placing and pointing of the drill holes. The natives drill double-handed, throughout the greater section of the shaft, using 7-pound hammers. Single-hand holes are drilled only along the ends.

Timbering is performed by four timbermen and eleven "boys." Two men and six boys are known as the "bottom set" men; one man and four boys put in the hitches, bearers, and permanent guides; and one man and one boy work on the

brattices. All of this work is performed on the morning shift, which is from 7 A. M. to 3 P. M., and only for unusual reasons is any overtime permitted. After the sinking shift is in the bottom, and the hoisting of men has commenced, the two bottom set men go down with their lines, stage planks, blocks, wedges, and "boys." Their first duty is to block the next to the bottom set, using the bottom set to carry their stage planks. Once they have reached their place of work, they are not allowed to interfere with the skips until the "sinker" has finished cleaning up, has his drills sent down and his boys drilling. Then the engines are handed over to the timbermen who use them to hang the next set. From the time the first pair of wall plates is shackled until after the set is hung, filled in, tightened up, and temporarily blocked, and the timbermen are again on the surface with their equipment, is one hour to one and one-half hours. The timbermen are not allowed to take down any ground within the neat lines for the timbers, as the sinker is solely responsible for all such excavation.

During a single shift, 57 skips (114 tons) of rock have been hoisted from the bottom, one set of timbers has been blocked while another has been hung and filled in, four 30-foot guides have been hung and bolted to place, and the entire round of holes has been drilled, loaded, and blasted. During this time, all the hitches were cut, bearers were installed, and all timbers lowered, and with no interruption to the steady work of every man. On each of the three compartments not used for hoisting, there are substantial pentices.

All timber used is pitch pine. The wall plates and end plates are 9" x 9" timbers. The wall plates are framed in two pieces, respectively, 22 ft. 9 1/2 in. and 20 ft. 8 1/2 in. in length, and these are simply butt jointed on a divider, making a total length of 43 ft. 6 in. The dividers are 7" x 9" sticks and are 6 ft. 6 in. long, the outside width of the shaft frame thus being 8 feet. Sets are placed at 7-foot centers. The skip guides are 4" x 8" pitch pine carried on channel brackets bolted to the dividers. Bearer sets are placed approximately every 120 feet, hitches never being less than 4 inches deep. The framing of guides, ladders, rings and other timbers for the four different shafts is done by three men, by hand. No particular care is given to maintaining a sink (sump), nor is there any pump in use at the bottom; since no water is allowed to get to the bottom of the shaft, it being caught in a number of "rings" above the 600-foot mark and is discharged into, and hoisted in, the regular skips used for rock. It is desirable, when using skips for hoisting in balance during sinking, to have the bottom as level as possible. In this instance, there

are two hoisting engines, each handling two skips occupying respective pairs of compartments between the middle compartment and the two end compartments. Effort is therefore made to shoot the benches in such a manner that the two skips of each pair will have practically the same landing level. This facilitates the loading of the rock and obviates any of the troubles that would arise if either skip were necessarily lowered more than its mate, such as kinking of the rope, running one skip light, or taxing the men unduly by high shoveling.

Blasting takes place every 8 hours, and from 40 to 45 holes complete a round for each shift and square the shafts. These holes are from 3 ft. 6 in. to 5 ft. deep. Four are drilled abreast, the length of the shaft, the side holes always being placed according to plumb-lines hung from the last set of timbers. The ventilation is accomplished without resort to machinery, a wooden chimney being constructed up through the headgear and down the entire length of the pump compartment. This provides a natural draft of from 20,000 to 25,000 cubic feet of air per minute, so that, 10 minutes after blasting, the bottom is clear of smoke and fumes. All illumination is by acetylene lamp.

The shaft is equipped with a modern steel head-frame, 110 feet high from shaft collar to platform, covering all the compartments. Two double-drum hoists are installed, one a geared engine with $10\frac{1}{2} \times 33$ " cylinders, the other a first-motion engine with 22×48 " cylinders. All the drums are 8 feet in diameter and use $1\frac{1}{2}$ -inch cables. The skips are of 45 cubic feet capacity. The shaft collar is of massive concrete extending down to solid rock and built up 5 feet above the surface.

Six of the compartments are of the same dimensions, viz., 6 ft. 6 in. \times 5 ft. in the clear. The pump compartment, occupying one end of the shaft, is 6 ft. 6 in. \times 8 ft. 6 in. in the clear. This section contains a ladderway 2 ft. 8 in. wide, while spaces are reserved for pipes and columns and for repairing cages.

Once a month, wire plumb-lines are dropped to check the lines of timbering. One point of special note is the remarkable progress maintained in timbering; for during 61 consecutive days (2 months) 64 sets of timber were put into place as above described.

No shift bosses or timber foremen are employed, the opinion being held that such persons are superfluous and, in fact, are really hindrances. The men work upon a bonus system and efficiency is of the highest order. The state mines are therefore said to be breaking, hoisting, and dumping rock from these shafts at a cost per ton less than that of many neighboring mines in their stoping and hoisting of ore.

Air-Balanced Hoisting Engine

Device by Which the Power Developed by the Descending Skip Compresses Air to be Used in Hoisting

By R. H. Corbett*

DURING one of the excursions of the August meeting of the Lake Superior Mining Institute the Franklin Jr. copper mine was visited. The works at this mine are comparatively new as is evidenced by the modern head-frame and ore bin shown in Fig. 1. On the incline just outside of the covered portion of the head-frame, the 7-ton skip which carries 10 tons of ore at one trip is shown. The photograph was taken just after the skip had discharged into the circular ore bin or rock house.

To the right may be seen the tower for carrying the rope from the head-sheave

single skip or cage and he considered that the simplicity of a single-compartment shaft and its equipment would warrant any complication of the hoisting engine which would produce the desired result. It was apparent to him that if the power developed by the descending skip could be applied to compressing air, it would furnish a solution of the problem.

When the time arrived for ordering a hoist, the matter was placed in the hands of Mr. Bruno V. Nordberg to design an engine and work out the details of an air-balanced hoist to meet the requirements. Following this the hoisting



FIG. 1. ROCK HOUSE AT FRANKLIN, JR., MINE

to the drum of the hoisting engine. This explanation and illustration will give those engineers who have not had an opportunity to visit the copper mines of Michigan an idea of the progressiveness of the copper men, and their willingness to adopt any improvements, or when not to be found, to devise their own. This is clearly shown in the following article which was written for this meeting—EDITOR.

An air-balanced hoisting engine was built in conformity with the ideas of R. M. Edwards, General Manager of the Franklin Mining Co., and the other Dow properties in the Lake Superior copper district. Mr. Edwards long held the opinion that for deep mining operations a single-compartment shaft would be desirable, provided that a balanced hoisting engine could be built to operate a

engine under discussion was built. This is a horizontal duplex machine with the steam cylinders attached to the frames. The air-compressing cylinders are located immediately back of the steam cylinders. The air pistons are attached to extensions of the steam piston rods, the whole forming a complete hoisting engine and air compressor combined. Means are provided for allowing the steam to run free while lowering the skip, and the air pistons run free while hoisting. The engineer regulates the speed of the descending skip by controlling the quantity of air compressed. By means of the operating lever on the platform he absolutely governs the work done in the air cylinders between the limits of full cylinder capacity and no load.

The air-compressing cylinders have four Corliss valves. The two lower ones admit free air to the cylinders in the

*Houghton, Michigan.

usual way. The two upper valves are provided especially for regulating the capacity and are the ones controlled by the engineer while lowering. The air delivered under pressure passes through spring-loaded discharge valves located in the cylinder heads. The regulating valves are fitted with releasing mechanism and dashpots like a Corliss steam engine. When they are open they afford a direct passage between the bore of the cylinder and the air-inlet pipes through the channel on top of the cylinder casting; therefore no air can be compressed while they are open.

To illustrate their valve action, suppose the air piston is moving toward the end of the cylinder while lowering the skip. If the regulating valve is open, the air in front of the piston will be forced back

for this purpose. The operating valve of this cylinder is attached to the reversing gear of the hoisting engine; therefore when the engineer reverses his engine the exhaust valves are either released or booked up again, as the case may be, without further attention on his part.

While compressed air is usually in demand around a mine, it was decided in the present instance, that it would be best to mix it directly with steam from the boilers and use the mixture in the steam cylinders for hoisting the load. Three cylindrical air receivers each 10 feet in diameter and 32 feet long were installed for storing the compressed-air mixture with the steam. They furnish ample storage space at the present time for both steam and air.

Fig. 2 is a diagram of the general

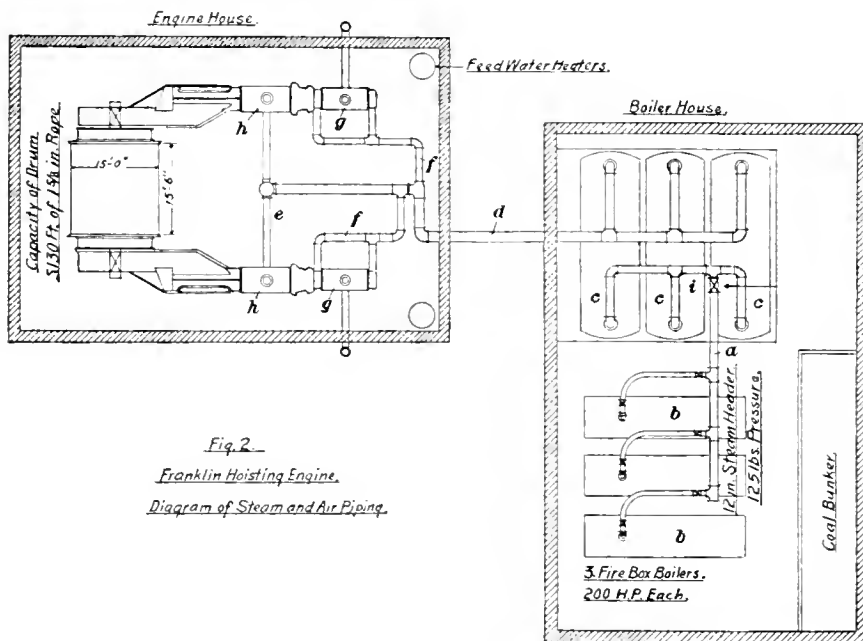

FIG. 2

into the inlet pipe. If, however, the engineer trips the valve and the dashpot closes it at any desired point in the stroke, then the air left in the cylinder will begin to compress until it finally passes out through the discharge valves. The arrangement is such, that the further the engineer moves his lever the more air will be compressed and the more the resistance will be increased on the air pistons. The air cylinders are only used for regulating the speed while lowering. The usual steam-operated brakes are provided for landing the skip.

To enable the steam pistons to run free while the engine is lowering, the exhaust valves on the steam cylinders are arranged to be released from their connections and remain wide open and stationary until they are hooked up again when the engine is reversed for hoisting. The releasing and hooking up mechanism is connected to a small steam-operated thrust cylinder provided to furnish power

arrangement showing how these receivers are connected with the boilers, air compressors, and steam cylinders. A 12-inch steam pipe *a* connects the boilers *b* with one end of the receivers *c*. A 16-inch pipe *d* from the opposite end of the receivers is carried to the throttle valve *e*. The 12-inch discharge pipes *f* from the air compressors are connected to this same 16-inch line. This forms a convenient way for the compressed air to reach the receivers when lowering and also to supply the steam cylinders *h* with pressure for hoisting. A reducing valve *i* is placed in the 12-inch steam pipe between the receivers and boilers. It is set to maintain about 75 pounds pressure on the receivers. The boiler pressure is usually about 125 pounds.

In explaining the operation of this feature of the hoisting engine, we will say that in the first place the receivers are filled with steam at 75 pounds pressure. The skip is then lowered into the

mine and the air compressors begin to discharge compressed air into the receivers to mix with the steam they already contain. By the time the skip reaches the bottom of the mine the pressure in the receivers will rise to 95 pounds, the increase being due to the compressed air forced in by the descending skip. When, therefore, the hoisting commences there is the 95 pounds pressure to start with. As the skip moves upward the pressure in the receivers gradually drops to below 75 pounds as the engine is now using the air stored in the receivers by the previous trip downward; however, the reducing valve opens after the pressure drops and steam is taken directly from the boilers to complete the trip upward. When the hoist stops, the pressure in the receivers will rise to 75 pounds in the receivers through the reducing valve connected with the boilers and be in readiness for the next trip down.

The engineer handles three levers in controlling this hoist, the throttle lever, reverse lever and brake lever, the same number as on other hoists in this section. The throttle lever, however, usually stands in a vertical position when the hoist is stopped. If the engineer pushes it forwards it operates the throttle valve, if he pulls it backwards it acts on the regulating valves on the air cylinders. With this exception the hoist handles about the same as other hoists in the copper country.

The following are the principal details: Diameter of steam cylinders, 46 inches; diameter of air cylinders, 36 inches; stroke of all cylinders, 72 inches; diameter of piston rods, 7½ inches; size of crankpins, 12 in. × 12 in.; size of crosshead pins, 8½ in. × 12 in.; size of main bearings, 20 in. × 40 in.; diameter of hoisting drum, 15 feet; length of hoisting drum, 15.5 feet; capacity of drums, 5,130 feet of 1½-inch rope; weight of skip, 14,000 pounds; weight of rock, 20,000 pounds; weight of rope per foot, 4.15 pounds; number of boilers required, 2; capacity of each boiler, 200 horsepower; number of feed-water heaters, 2.

The boilers are the Lake Superior fire-box type with crown and arch tubes.

Shaft dips 47 degrees from horizontal.

采 采

Difficulties

The following letter has been received by a well-known contractor in town from a man who is sinking a shaft in South Lorrain:

"Dear Friend:—The men arrived all right with boots and oil clothes. We start the 8-hour shift today. There is seven pair of them boots 11 by 12. Can't get them down the shaft, so I send them out."—*Cobalt Nugget.*

Gulch Mining in Gilpin County

History and Description of Some Old Colorado Placers that Are Now Being Reworked by Hand

By Arthur J. Hoskins

It is probably generally known among metal mining men that the first lode mining in the Rocky Mountain region is credited to Gilpin County, a very small part of central Colorado. Sixty years ago, this whole, great, western area was spoken of as the Pike's Peak Region. Expeditions of pioneers, geographers, and geologists had traversed the country previous to that time, but no settlement took place until gold was discovered and mined. As is often the case, civilization followed in the wake of mineral discovery.

The discovery of gold in California, in 1849, created a notable overland travel of adventurous persons from the eastern states. Georgia, it would seem, contributed a large quota of these sturdy, pioneering gold seekers. They sought the Californian fields, and the most difficult part of their task lay in the wearisome cross-country travel. Some went to the Pacific Coast by ship via the Horn, but probably the majority of these miners occupied berths in prairie schooners.

It is no wonder that these prospectors would give attention to the first mountainous country encountered by them in their long tedious travels, for they were probably well aware that rough areas are more productive of precious metal bodies than are the plains. So, when parties of these men reached and sought suitable points for passage across the front range of the Rockies, they selected and traversed stream beds as affording the easiest grades. Also, quite naturally, they tested the "dirt" as they proceeded.

It is said that one party consisting of seven Georgians, en route for California in 1849, established winter camp on the South Platte River, it being decided in-

ceeded on their way westward before accomplishing much in Colorado.

Nine years later (1858), it happened that a party of Georgians entered the cañon of Clear Creek and, finding "colors" in the gravel of the stream, they combined their progress toward California with an investigation of the merits of what is now Colorado. Their prospecting along the channel of this stream gradually led them to the forking of the stream, and separate parties proceeded thence up the respective branches. According to present nomenclature, these two forks traverse different counties, the north fork being in Gilpin County, while the south or main fork is entirely within Clear Creek County.

Good results were obtained by these prospectors in both branches. The methods and devices used in this prospecting were necessarily of the most primitive kind; but they were effective if not highly efficient, for the research of these men culminated in the discoveries of some of the mother lodes in both branches. It thus appears that the first locations of lode claims were nearly contemporaneous, although it is conceded that the North Fork obtained first results. History states that placer gold was discovered at Jackson's Bar (now Idaho Springs), in January, 1859, by G. A. Jackson, and that during the same year, numerous lodes were located in that vicinity. The prospectors who proceeded up the North Fork of Clear Creek met with especially good results washing along the channel of a dry gulch branching from the creek about 3 miles above the forks, and, in honor of one of their number, they named this Russell Gulch. This has subsequently become well known for its many lode mines as well as placers. Among the arrivals in this area, was a John Hamilton Gregory, from Georgia. He and two companions prospected the main channel of the North Fork, and in May, 1859, their search brought them to the outcrop of a splendid vein where the town of Black Hawk now stands, and which was taken up as the Gregory Lode. This was undoubtedly the first lode claim ever taken up and worked in Colorado. Accordingly, just as California tells of its "forty-niners," so Colorado remembers its "fifty-niners."

Since the discovery days, placer mining has been carried on along both forks of Clear Creek. Of late years, naturally, the operations are on a very small scale since the ground has been pretty thor-

oughly turned over and washed, and there remain very few patches of virgin gravel. Much of the gravel has been handled repeatedly, each time in an effort at recovering the very fine particles of gold. The many mills that were built in and around Black Hawk for the local treatment of ores were far from efficient in their saving of the yellow metal; a very



FIG. 2. WASHING BY HAND AT BLACK HAWK

considerable portion of the gold originally in the ores entering the mills was discharged with the tailing into the channel of the creek. The North Fork is not a large stream and when the hundreds of stamps in the camp were working on ore, the water was turned to a very thick mud. Much of the failure in amalgamating the gold was probably due to the viscous condition of the feed-water, for often the shortage of this supply necessitated its conservation and reuse.

The gold losses in the mills have been recognized by Nature and the bed of the creek has constituted a sluice for the recovery of the metal that eluded Man. Just how far we may explain the more recent enrichments of this channel on the theories of gold precipitation from solutions is doubtful. Some persons assert that gold is "growing" in this channel all the time by a process of enrichment, the metal being transported thither in the acid waters from the mineralized veins and precipitated by ordinary chemical reactions. If we may believe this, we have two explanations why gulch miners find it profitable to rewash the bed of this stream at intervals of about a decade.

There were no railroad facilities in this region until the year 1872 when a narrow-gauge road was completed from Golden (at the mouth of the cañon) to Black Hawk. This same year a 4-mile branch was built up the other fork. Below the

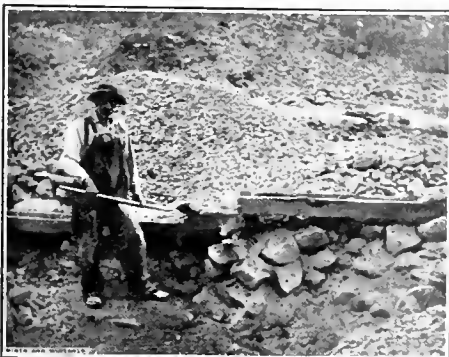

FIG. 1. GOLD WASHING AT RUSSELL GULCH

advisable to attempt crossing the mountains before the next spring. These men are reported to have washed a small amount of gold from the channel of the river, but the following spring, they pro-

forks, a few miles down stream, the creek occupies a veritable cañon, but above the forks, both branches are in open valleys. The average width of the North Fork is not over 10 feet, whereas the South Fork carries, probably, ten times as much water.

During the earlier decades of this country's activities, a few expensive installations of ditches, flumes, and giants were in use, and these turned over comparatively large areas of the channel. But, at present, placer mining is confined to the slow, arduous accomplishments of a few scattered men who handle very limited quantities of gravel in a season, but who appear to make their living in this manner. Figs. 1 and 2 are typical of the scenes passed while traveling in a train to Black Hawk during the season from April to October.

As observed in these views, the gulch miner nowadays is satisfied with a very simple, inexpensive outfit. One wonders if such apparatus is really of any account. It would seem that the physical labor involved in digging and handling this dirt would warrant the use of apparatus that would assure a more nearly perfect efficiency. These men, however, use a simple sort of a "tom" into which is conducted a small stream of water from an old pipe or wooden V-shaped trough. Gravel and sand are shoveled into a screen occupying a horizontal position about half way from the bottom of the "tom." On this screen, by means of the shovel, the materials are turned over and subjected to the action of the water that carries the finer stones and the sand into the lower compartment where they start flowing down the inclined and carpeted sluiceway to the tailing pile.

No quicksilver is used in most of these affairs, Brussels carpet being relied upon to catch and to hold the heaviest particles, such as gold and the sulphides of iron, lead, and copper. Once or twice a day, each miner must cease his shoveling long enough to remove and rinse his carpets in a tub of water. The material thus collected in the tub constitutes his shipping product and is expected to contain any gold that went into his device.

There are doubts as to the efficiency of these devices. In the first place, the water flowing in the creek is usually very muddy and its mixture with the treated sand gives to the whole pulp a rather slimy consistency that is adverse to the settling of any light particles, especially flaky ones such as gold "colors." Then, again, there is a continual scouring action going on against the surface of the carpet that would appear to prevent the accumulation of gold in the nap. Finally, the length of any one of these sluices is so short that gold would be given little show to work its way down through the stream even were the water clear.

The writer was unable to secure figures

from any of these men stating their recoveries and profits, but all conceded that they were "making wages." At one place, a woman acts as assistant to her spouse and performs the lighter portions of the work.

Some of these persons have lived in this gulch for 30 years or more, and it is almost beyond belief that they can subsist upon the meager profits that seem possible in the handling of ground that has been washed repeatedly. Of course, living in the simple manner in which they do is very inexpensive. Besides, they probably utilize the winter months, when

gulch mining is not possible, in other activities.

These persevering people perform acts in our industrial conditions that are generally supposed to belong to the past. They are remnants of a former period. They are interesting figures for tourists who travel between Denver and Central City; but very few persons leave the train and hold conversation with these miners. These gulch miners, however, deserve attention, for they are most cordial in their manners and are possessed of much interesting history relative to this section of our western mining country.

Rhigolene

Fancy and Fact Concerning a Newly Discovered Product of Oil Wells Which Is a Gas in Liquid Form

AN admiring optimistic California friend sends the following Chapter I on Rhigolene. The Editor is not responsible for the statements in Chapter I, which were so unique he requested F. W. Brady to write Chapter II on the same subject.]

CHAPTER I

A marvelous discovery, which scientists claim will prove to be one of the greatest of the age, has been made by W. C. Cutler of Sawtelle, Cal., whereby it will be possible to hereafter utilize a rich natural resource which has been going to waste for centuries. The result of this development will be to provide a cheap gas for fuel and illumination and at the same time to manufacture ice and supply cold air for purposes of refrigeration. The process is so simple that every household may be equipped at small expense with its individual plant for this quadruple service. The expense of installation and operation is so small that the innovation will prove a boon to desert as well as cold climes, to farm houses and city residents, to all people everywhere. These things are made possible through the conservation of rhigolene, a little known magical liquid or gas which has heretofore been permitted to escape in endless quantity from wet gas wells throughout the country.

The story of the discovery of rhigolene and its economic application to these manifold uses is interesting, and followed the unsuccessful efforts of Mr. Cutler to secure a quantity of the mysterious fluid, although having searched the world over for a small quantity of it. Government chemists could throw but little light on the subject and the quest ended where it started, the sum total of information gained being that rhigolene was gasoline of high quality, used in rare cases as a local anesthetic and producing a low tempera-

ture through evaporation. The inability of the experimenter to secure a quantity of this fluid caused him to employ the highest grade of gasoline obtainable in his tests. These demonstrated that through a system of coils he was enabled to produce hoar frost. Still searching for rhigolene, he went into the oil fields in the hope that he might hit upon a process whereby the much coveted liquid gas might be obtained. By placing a large hood over the top of a wet gas well and confining the escaping gas, he succeeded through the medium of a vacuum pump in compressing the gas so that it was deposited as a liquid in a steel tank. Held here under pressure it remained in liquid form. His next move was to introduce the liquid into pipes, thus harnessing the volatile power that had previously been latent. Released under pressure as a spray, ice was formed in any shape or thickness required; the released rhigolene, being still cold, serving as a refrigerating agency while winding through coils to a tank. Here, held as gas and with pipes leading from the tank, it may be utilized for either heating or illuminating purposes. Tests of the gas have demonstrated that for both heat units and for purposes of illumination it is superior to the ordinary carbon gas.

Mr. Cutler has recently secured method patents covering both process of utilizing the rhigolene in the manner stated and reaching into the sky and catching a valuable product that is today escaping from every wet gas well in the world.

The process by which rhigolene is induced to yield heat, light, and cold at the will of man is not difficult to understand. Like all great inventions, the simplicity by which results are attained strikes the mind with gratifying effect.

The domestic plant, which the inventor says will banish a swarm of household worries, is compact and may be made

small enough to suit almost any purse or cottage and large enough for any fortune or castle. In brief, the production of heat and cold from rhigolene is described in the two words compression and expansion. First lessons in physics taught us all that a given amount of air or gas, at atmospheric temperature, contains a certain amount of heat, and that if compressed into a much smaller space the gas, while still holding the same amount of heat, will show a higher temperature. If expanded into greater space the temperature is lowered. If a liquid occupying a cubic inch of space evaporates into a gas which occupies 400 cubic inches of space, it can readily be seen how cold each of the 400 cubic inches will become. With rhigolene, which is liquid only under high pressure, the construction of a refrigerator was delightfully easy. The liquid is confined in a high-pressure steel tube, connected with a coil for refrigeration, into which the rhigolene is allowed to expand slowly, and down goes the temperature as though the wand of the frost god had touched it. The coils are covered with the white testimony of freezing and the gas passes into a larger chamber, where under less pressure it assumes its original state of natural gas and may be piped thence for heat, cooking, and light. With these facts in mind the imagination leaps at once to visions of freedom from the coal, light, and ice trust. What legislation has failed to do, invention promises. While monopoly and government wrestle and strive, the inventor in the seclusion of his laboratory turns their warfare into a bootless farce.

The cost of conservation is merely a nominal one, so low that the producer and dealer can be assured of a fair profit while the price to the consumer is kept within the reach of any income that can buy ice or fuel. The great saving of other products that goes with the gathering of rhigolene from the escaping wet gas is expected to prove a powerful factor in keeping down the commodity price of the liquid that yields the secret of light, heat, and cold.

Mr. Cutler, the discoverer of this method of capturing and conserving to the world this long lost resource, is an interesting though unassuming character. He is the inventor of more than two dozen useful or scientific devices, a number of which he freely gave to the world without patenting. From others he is receiving royalties that made it possible for him to become the most extensive date planter of the Colorado desert.

CHAPTER II

When a brand-new patent that proposes to change the established order of things and emancipate mankind from a "swarm of worries" explodes in our midst, we are bound to "sit up and take notice."

No matter what the "life" of such patents may be, we cannot overlook the fact that all of them contain at least a milligram of truth, and in this case for conserving rhigolene, there is a good measure of ballast.

Rhigolene is a very light product from the fractional distillation of crude petroleum. Its specific gravity is about 62, or the Baumé scale from 90 to 95. Ordinarily it is lost with the wet gas escaping from oil wells. However, it can be said with both pleasure and satisfaction that the lighter vapors, or gases, from oil wells can be and are being compressed and liquefied. Also, this new industry, though only two or three years old, is growing very rapidly. While the imagination of the inventor of a process for harnessing rhigolene "leaps to visions of freedom from the coal, ice, and light trusts," it would be well for us common mortals to keep under cover and try to find other means of making a salary of fifteen dollars per week pay living expenses of \$17.26.

The status of the "natural gasoline" industry today is about as follows: The first attempts to make gasoline from natural gas consisted simply in compressing the gas from oil wells to some 150 to 300 pounds and cooling it. This process resulted in liquefying some of the gas which was collected in a tank. The portion of the gas not liquefied was turned into the supply mains and sold for fuel; that is, this was done where such lines were installed, otherwise the gas was wasted. Also there was a considerable loss from the lighter gases that "weathered" from the liquid that had been made. As much as one-half of the gasoline would pass off and be wasted. By using a higher compression, a greater amount of gas would be "fixed," and by blending this light gasoline with kerosene, the heavier oil could be made more volatile and more specially suited for gas-engine service. Another plan was to collect the high-grade gasoline first and then to compress the gas from this and produce a "wild" product to be used for blending with heavier oils.

There was considerable loss of gas, just the same, and the proposed plan to make the entire gas supply available, as based on experiments conducted by experts in the employ of the Government is as follows:

First, by light compression take out the ordinary gasoline, which can be stored and transported in the usual way. Second, by higher compression and cooling of the remaining gas, there will be an extraction of a light high-grade gasoline used for blending with the heavy naphthas made at the refineries. It must be understood that these gas products are made in plants located in the oil fields, while the oil refineries are at a consider-

able distance from them. Also, the companies are independent of each other. Hence, the blending products must be sold to the refineries, or the heavier oils must be purchased from them by the liquid-gas people and the blending and selling of the product done in the field. At any rate the method requires some business management. Third, a higher compression with greater cooling of the remaining gas, this producing a liquid gas that must be stored in strong tubes or tanks and handled as a gas and not as an oil. This liquid could be transported with safety and used for heating and lighting purposes. Fourth, by a very high compression of the remaining fraction of the gas, a lighter liquid than from the third compression may be obtained. It is entirely practical to handle this product; as the Government experiments show that the maximum pressure was 755 pounds at 133° F., which is much higher in temperature than would be expected from any climate where the gas would be used. Steel tanks are now in common use for transporting gases at 2,000 pounds pressure. These tanks of liquid gas would be used to operate stationary gas engines, and also automobiles and aeroplanes. The gas from the liquid requires three times or so more air than ordinary natural gas, and hence the burners and mixers have to be modified for its combustion.

This liquid gas produced by a compression of from 250 to 755 pounds, depending upon the temperature, begins to boil at about 40° F., and hence it is something of a cooling agent.

However, before discarding our ice chests and giving the coal man the go-by, it might be well for us to find out whether or not a steel tank of this liquid gas will give all the refrigeration wanted when we are using the necessary amount of the gas for light and fuel. One gallon of the liquid will yield about 50 cubic feet of gas at 32° F. at sea-level pressure. With a specific gravity of .58 at 60° F., the gallon would weigh about 5 pounds, hence there will be 10 cubic feet of gas per pound of the liquid gas. We do not know the latent heat of the liquefied gas, but there are some problems involved in carrying out these dreams of the inventor that make more than one big "if" in the way of our emancipation from the high price of oil and the drudgeries of life.

來 來

Assay of Cyanide Solutions

Assay of KCN solutions (Lindemar). Ten assay tons of solution is heated until hot, and ammonical copper nitrate added until permanent blue color, H_2SO_4 is then carefully added in excess, the solution stirred and immediately filtered. The paper is folded and carbonized in a scorifier, transferred to a crucible, fused, and cupelled.

Some Problems in Mine Surveying

A Formula for the Determination of a Plane, the Direction and Slope of Two Lines Therein Being Known

By C. R. Forbes*

THE mine surveyor is often called upon to solve problems involving the determination of a plane, knowing the direction and slope of two lines therein, or problems involving the intersection of two planes.

The ease with which such problems can be solved by use of the following formula is not generally recognized, although the formula could be given frequent application and is one of value to the engineer.

The formula referred to is derived from

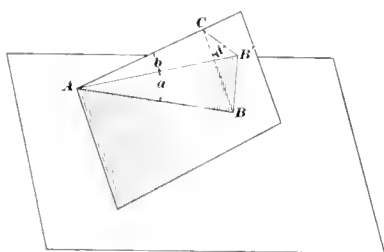

FIG. 1

the relation existing between an inclined line and a horizontal line in the same plane and the dip of the plane, and is as follows:

$$\tan a = \sin b \cdot \tan d$$

Where a is the angle of slope of any line in the plane, b is the horizontal angle or difference in bearings between this line and a horizontal line in the plane, and d is the angle of dip of the plane. The derivation of the formula is readily seen by reference to Fig. 1, and is as follows:

$$(1) \tan a = \frac{B B'}{A B'}$$

$$(2) \tan d = \frac{B B'}{C B'}$$

Eliminating $B B'$ from 1 and 2.

$$\tan a \cdot A B' = C B' \tan d.$$

$$\tan a = \frac{C B'}{A B'} \cdot \tan d.$$

$$\frac{C B'}{A B'} = \sin b.$$

$$\tan a = \sin b \cdot \tan d.$$

In the following problems, which are given to illustrate application of this formula, a vein or seam is represented, theoretically, by the plane. Mine openings (such as inclines and slopes), or sloping lines of outcrop are shown as inclined lines in this plane. Any horizontal line in a seam of coal or vein of ore will determine the strike.

PROBLEM 1.—A coal seam strikes N 20° W, Fig. 3, and dips 10 degrees to the westward. Find the direction of an incline to be driven in the seam on a -5-per-cent. grade.

Formula: $\tan a = \sin b \cdot \tan d.$
 $\tan a = .05.$
 $d = 10^\circ.$

* Professor of Mining, School of Mines and Metallurgy, Rolla, Mo.

To find b . Substituting in formula:
 $.05 = \sin b \cdot \tan 10^\circ.$

Solving:

$$b = 16^\circ 28'.$$

Direction of incline, N 36° 28' W, or S 3° 32' E.

PROBLEM 2.—The outcrop of a vein on a hillside runs N 60° E and slopes 20 degrees

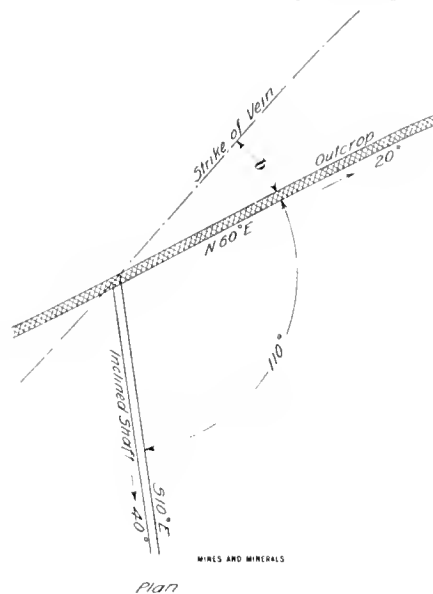

FIG. 2

to the eastward. An inclined shaft sunk on the vein dips 40 degrees to the southward and runs S 10° E. Find the dip and strike of the vein, Fig. 2.

Formula:
 $\tan a = \sin b \cdot \tan d,$ for any line in a plane;

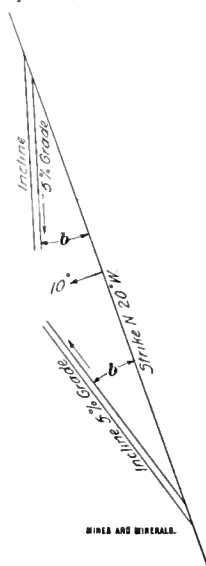

FIG. 3

$a = 20^\circ$ for line of outcrop;

$a = 40^\circ$ for line of shaft.

Since the two lines lie in the same plane, whose dip is d , we may write the following two equations:

$$(1) \tan 20^\circ = \sin b \cdot \tan d.$$

$$(2) \tan 40^\circ = \sin (b + 110^\circ) \cdot \tan d.$$

Solving for b :

$$\frac{\tan 20^\circ}{\sin b} = \frac{\tan 40^\circ}{\sin (110^\circ + b)}$$

$$\tan 20^\circ \cdot \sin 110^\circ \cdot \cos b + \tan 20^\circ \cdot \cos 110^\circ \cdot \sin b = \tan 40^\circ \cdot \sin b$$

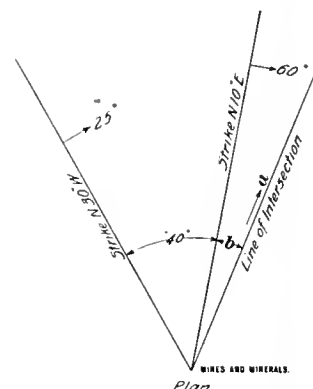

FIG. 4

$$\cot b = \frac{\tan 40^\circ}{\tan 20^\circ \cdot \sin 110^\circ} - \cot 110^\circ.$$

$$\cot b = 2.4534 - (-.36397) = 2.81737.$$

$$(\cot 110^\circ = -\tan 20^\circ)$$

$$b = 19^\circ 28'. \quad 60^\circ - (19^\circ 28') = 40^\circ 32'.$$

Substituting value of b in (1),
 $\tan 20^\circ = \sin 19^\circ 28' \cdot \tan d.$
 $d = 47^\circ 31'.$

The vein strikes N 40° 32' E and dips 47° 31' to the eastward.

PROBLEM 3.—Find the direction and slope of the line of intersection of two veins, one of which strikes N 10° E and dips 60 degrees to the eastward, the other strikes N 30° W and dips 25 degrees to the eastward, Fig. 4.

Formula: $\tan a = \sin b \cdot \tan d.$ a = slope of line of intersection; b = horizontal angle between line of intersection and strike of one vein; $(b + 40^\circ)$ = horizontal angle between line of intersection and strike of other vein. Since the line of intersection lies in both planes, we may write the following two equations:

$$(1) \tan a = \sin b \cdot \tan 60^\circ.$$

$$(2) \tan a = \sin (40^\circ + b) \tan 25^\circ.$$

Solving for a and b :

$$a = 20^\circ 15'; \quad b = 12^\circ 18'.$$

The direction of the line of intersection of the two veins is N 22° 18' E and its slope is 20° 15' to the eastward.

The above problems are intended to illustrate some of the applications of this formula and its great convenience in solving problems of this kind. Readers will be able to recognize its usefulness in very many modifications of the data here assumed.

Iron Mining in Missouri

Revival of Work on Deposits Formerly Extensively Mined and Still Capable of Large Production

*By Lucius L. Wittich**

MISSOURI no longer occupies the important position it once did in the production of iron ores, but recent activities in new districts and the resumption of operations in regions formerly worked extensively, may increase the output materially in the course of the next year or so. The eastern portion of the Ozark uplift, which includes the major portion of the state south of the Missouri River, is where the largest iron ore mines are located. The production of specular hematite com-

district became more or less famous throughout the country, the chief deposit being looked upon as a mountain of almost solid iron ore.

At Shepherd Mountain, in Iron County, south of St. Louis, where the first iron mining in Missouri was undertaken, operations are still in progress, although the mine was idle for many years. The Puxico Iron Co. is working the magnetite ores of this mountain in addition to mining at Pilot Knob, 1¼ miles to the northeast, and also at Puxico in Stoddard County, farther to the south.

The Shepherd Mountain deposits were worked as early as 1815, but the production was limited. Operations were conducted at various times up to the civil war and were not resumed again until the present company took a lease on the property. Deep diamond drilling in 1888 showed a formation much more extensive than any that had been worked.

The iron mining boom resulted in the construction of the St. Louis, Iron Mountain & Southern Railroad to Pilot Knob, thus affording shipping facilities to other furnaces. Prior to this the output was sent overland to Ste. Genevieve on the Mississippi River and transported by boat.

The opening of the deposits at Iron Mountain and Pilot Knob marked the beginning of a 30-year epoch of great activity in iron mining in Missouri, and the state was considered an important center in the production of this ore. The annual production ran close to the half-million ton mark at times until 1888, when the output declined precipitously, due to the working out of the more extensive ore bodies. About this time also discoveries of large deposits of high grade Bessemer ore were made in the Lake Superior region and a resultant slump in the price of iron ore and iron products materialized, discouraging operators in the Missouri districts, who had

received as high as \$10 a ton for their product on several different occasions, this high figure having been attained in 1866, 1867, and 1873, the latter year, in

fact, seeing the price go to \$12 a ton.

The one iron furnace in blast in the state at the present time is in Dent County and is owned by the Sligo Furnace Co., of St. Louis. The output of the central Ozark district is taken at this furnace. The mines to the east face the



FIG. 1. IRON MINES AT PILOT KNOB

prises the greater portion of the output, although some brown ore and a small amount of magnetite is mined. The average annual iron-ore production from the state is about 100,000 tons. Much of this ore is hand picked and shipped to furnaces in Ohio, where it now brings approximately \$4 a ton for grades carrying close to 60 per cent. metallic iron.

Discoveries of iron, according to history, were made by Marquette in 1673. The Ashebran furnace at the Shut-in, not far from the Shepherd Mountain mines, was built in 1815. Missouri was thus the first state west of Ohio in which iron was mined and smelted. At many points throughout the state ruins of the early-day furnaces may be seen. Fig. 3 shows the remains of the furnace operated by the Big Muddy Iron & Coal Co., on the slope of Pilot Knob.

Mining was started at Iron Mountain, St. Francis County, in 1844. Two years after this a blast furnace was erected, and two years later, in 1848, another furnace was blown in. The Valley Forge, started in 1851, ran until 1866, iron blooms being produced. A third furnace was started in 1855, and the Iron Mountain



FIG. 3. RUINS OF FURNACE AT PILOT KNOB

necessity of paying a heavy freight rate in shipping to eastern furnaces.

Iron Mountain, in St. Francis County, is a low, conical hill, rising barely 230 feet above the level of the surrounding country. Its base covers about 300 acres. In 1872, this property produced 269,480 tons of iron ore, and during recent years varies from 7,000 to 60,000 tons. Three kinds of ore are found: Boulder ore embedded in the surface clay; ore in veins extending to a considerable depth in the porphyry; and the conglomerate ore occurring in beds between the porphyry and the overlying Cambrian limestones.

It was because the boulder ore so completely covered the mountain that the early idea pictured the place as a body of solid iron, and it was not until after the early mining had resulted in the crust of boulder ore being removed that the true nature of the formation was made clear. Veins were next encountered, after which diamond drilling was conducted to locate the masses of conglomerate.

Pilot Knob, like Iron Mountain, rises like a peak from the surrounding plain,



FIG. 2. LOADING CHUTE AT PILOT KNOB

but is much higher, attaining an altitude of 600 feet, the main mining operations having been conducted at the apex of the hill. These have been abandoned many years, however, and the present operations are being conducted in an open cut on the north slope of the mountain. Here the

fully hand picking the surface ore the iron is brought to 53 per cent. To the north of the open cut the company has a winze into 40 feet of ore, which shows a higher percentage of metallic iron and a higher percentage of silica.

Extensive drilling operations indicate

been done, black iron ore is found at a depth of 600 to 617 feet. At present, mining is confined to a deposit near the top of the mountain, where a dull blue specular hematite, mixed with magnetite, occurs. The company is working deposits occurring adjacent to the open cut extending down the southwest slope of the mountain, which was worked years ago and which is almost 1,300 feet in length.

On the south slope of the mountain, small deposits of ore have been mined in open pits, but the chief deposits consist of the fissure veins at the top, the stratified veins at the north base of the mountain, and the residual deposits of boulder ore.

In Stoddard County, in the extreme southeastern corner of the state, low-grade iron ores have been mined since 1901, and since 1905 shipments have been steady. The largest producing mine in this county is the Pico, shown in Fig. 4.

The Pico mine lies on the southeastern rim of the Ozarks, where the Cambrian limestones outcrop in the foot-hills, and is about 1 mile north of the town of Puxico. Toward the top of one of these foot-hills an area of several acres is covered with an outcrop of cherty brown ore. Open pits afford the best method of development and a number of these have been excavated, the largest being about 50 feet deep, 200 feet long, and 100 feet in width. Here the ore has been found to extend beneath the strata of residual surface chert and clay, and reaches the Cambrian limestone, although in the smaller pits the ore deposits were comparatively small, being pockety and very irregular.

The iron content is comparatively low, rarely reaching 50 per cent. and often dropping to 44 per cent. The silica content ranges from 10 to 20 per cent.

G. W. Crane, assistant state geologist, in his 1912 report on iron ores of Missouri, dwells at length on the origin of ores. Condensed, his theory is that the brown ores, in their present formation, are the result of sedimentation from descending waters, while the specular hematites, he believes, owe their origin to igneous action. He cites the fact that the bulk of these ores lie within a radius of 5 miles of Pilot Knob, a region of early volcanic eruptions.

來 來

Two Kinds of Sulphur Mining

In the sulphur mines of Sicily young boys climb for 400 feet bearing in a stifling atmosphere 40-pound loads of sulphur ore upon their backs. In Louisiana a bore hole containing two concentric pipes is driven to the ore; a hot solution of calcium chloride is forced through one pipe to melt the sulphur, which is then pumped to the surface through the other.

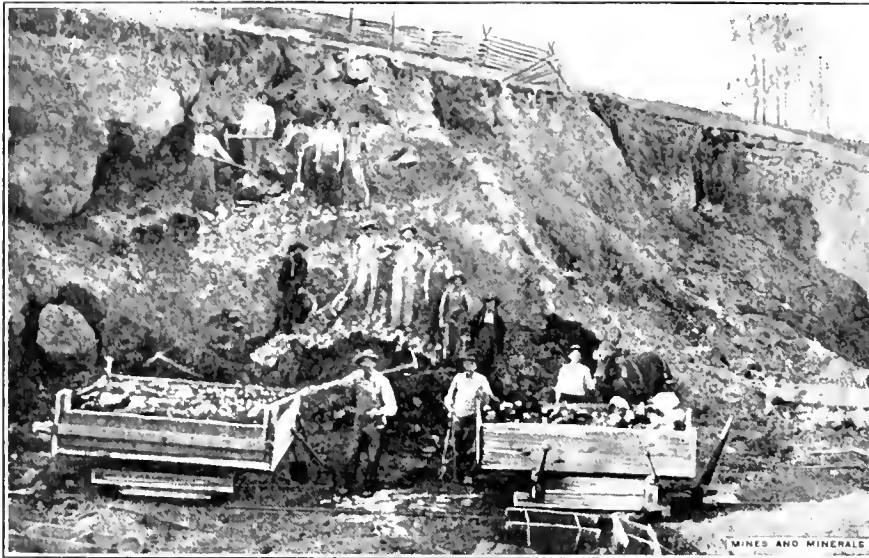

FIG. 4. PICO IRON MINE, PUXICO, MO

conglomerate, consists of a matted mass of ore and porphyry boulders; the ore being weathered crumbles readily beneath a pick. Fig. 1 shows this formation and the long chutes down which the ore is sent, a distance of 100 feet, in boxes holding 350 pounds each, to be emptied into tram cars with a capacity of 3 tons each. The loaded box in sliding down the chute, Fig. 2, is the motive power for pulling up an empty box, the two passing on a switch half way up the incline. The tram car is pushed a distance of 1,000 feet and emptied into a freight car for transportation to the East.

The ore from this mine is sold on a basis of 50 per cent. metallic iron, a premium or deduction of 8 to 10 cents a unit prevailing for ores carrying above or below this basis. The cars carry from 60,000 to 90,000 pounds.

Because of the complexity of the formation in the 60-foot face being worked, careful hand sorting is required. The ore will average 56 per cent. iron, 10.15 per cent. silica, 4.37 per cent. alumina, and .021 per cent. phosphorus.

Embedded in the surface clays, over the north slope of the mountain, indicating the long weathering of the main ore bodies, are numerous boulders of iron ore and porphyry which occur in commercial quantities. This area is smaller than the underlying conglomerate, and to the present time little effort has been made to mine this boulder ore. The iron content is lower than in the conglomerate, barely exceeding 50 per cent., while the silica is as high as 30 per cent. By care-

the presence of other ore bodies, one of which is on the northwest slope of the mountain. The deposit is large, and drilling has indicated that it is almost vertical. Development of this ore body will in no wise retard work in the conglomerate body farther to the east, nor will it replace this latter development, as there is enough of the conglomerate blocked out to insure steady operations for a number of years. Ore is known to exist beneath the southern slope, but the deposits are small, and, according to drill records, are at greater depth than those on the north slope, the best deposits occurring at a depth of 600 feet. Ore was encountered in other holes at a depth of 400 feet, the deposits, in places, being 50 feet in thickness and ranging in richness from 51.8 per cent. to 21 per cent. ore.

From its workings on Shepherd Mountain, a short distance southwest of Pilot Knob, the Puxico Company procures a higher grade of ore, an average assay showing 60.83 per cent. iron; .07 phosphorus; silica, 8.23; and sulphur, .02. The mountain is somewhat higher than Pilot Knob, reaching an elevation of about 700 feet above the surrounding country. Development here is of especial interest because no iron production from this mountain, prior to the recent activities, has been reported since the civil war. Much of the ore is highly magnetic and commands a higher price than the product from Pilot Knob. The ore is of Bessemer grade and is ranked as the best of Missouri iron ores. At the north base of the mountain, where much drilling has

ASBESTOS is described in the writings and records of the ancient civilizations. The Romans were familiar with a cloth woven from asbestos

fiber and used to wrap around human corpses during preparation for cremation. Several specimens of this ancient cremation cloth are preserved in the Vatican Museum. Marco Polo, when traveling through Siberia, in the thirteenth century, was shown some cloth which withstood fire. The ancient process of manufacture involved crushing in mortars, fiberizing, and spinning. The lamps of the "Vestal Virgins" were supplied with asbestos wicks. In the year 1720, asbestos was found in the Ural Mountains. During the reign of Peter the Great, a factory for the manufacture of asbestos articles was established but it was not successful because the uses for such goods at that time, were limited.

The value of the non-combustible properties of the mineral was not realized until about 40 years ago. Since 1860, enormous exploitation and development have made the asbestos industry commercially prominent. The progress made in the invention of mechanical methods for utilizing the raw material has been wonderful.

In 1877, asbestos was found in the Province of Quebec in the serpentine hills of Thetford and Coleraine. Large fires had cleared away the timber and exposed the rock to weathering. This surface weathering simplified prospecting in the district and large areas were taken up near Thetford and Black Lake.

Since 1890, the old crude methods of hand cobbing the ore have been replaced by mechanical plants. These plants are more economical and have brought about a prolonged life for the industry. New fields for the mining of fiber have been discovered but the Canadian fields rank first the world over.

The name asbestos is derived from the Greek and signifies incombustible. The French Canadians call the mineral "pierre a cotton"—cotton stone. It has been referred to as a mineralogical vegetable and a "physical paradox."

In mineralogy, three minerals are classified under the name asbestos; namely, antophyllite, amphibole, and serpentine. The first two resemble each other chemically, being silicates of lime, magnesia and alumina. The third, serpentine, is a hydrated silicate of magnesia and may be represented by the formula,

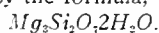

Antophyllite has no commercial im-

Asbestos

Examples of Its Early Use—Derivation of the Mineral—Different Varieties and Their Values

By Warren W. Currens*

portance. There are five varieties of the amphibole mineral, viz., tremolite, actinolite, asbestos, mountain leather (also called mountain wood and mountain cork), and crocidolite.

The first three of these are similar in external appearance and chemical composition, but the asbestos is readily distinguished by its easily separated, long, silky fibers. Tremolite occurs in long, stout crystals of dark gray color and in columnar masses. Its use commercially is limited. It is sometimes used in manufacturing mineral wool. Actinolite is a lime-magnesian silicate with iron. It occurs in magnesian rocks, such as talc. It is used in weighting paper, in roofing, and in various forms of adulteration.

Asbestos, tremolite, actinolite, and other varieties of amphibole pass into fibrous varieties, the fibers of which are sometimes long and flexible. These varieties are called asbestos, hornblende asbestos, or amphibole asbestos. The name chrysolite is applied to the superior serpentine fiber mined in Canada. The Italian asbestos is properly so called, but is often confused with the better chrysolite.

Mountain leather and cork are not asbestos and are easily distinguished therefrom.

Crocidolite is sometimes called blue asbestos. The fibers are long, flexible, and easily separated by the fingers. Large quantities are found in Gringualand, South Africa. The mineral has a silky luster and a dull lavender-blue color. An attempt was once made to substitute crocidolite for chrysolite on the market but failed. Crocidolite has the composition of 50 per cent. silica and about 40 per cent. oxide of iron. Good asbestos fiber carries 50 per cent. silica and only ½ per cent. iron oxide. The crocidolite fiber, because of its high iron content, disintegrates with heat and becomes rotten, the iron salts disintegrating by weathering.

Serpentine has three distinct fibrous forms, viz., picrolite, soapstone (talc) and chrysolite. Serpentine, as a rule, is found in massive form. It also occurs with a banded, schistose, and slaty structure. Its color varies from black, through the different shades of green, to light green. The luster is resinous to pearly or wax-like, but is seldom earthy. The rock surface in some places has a greasy feel similar to talc, but it is readily distinguished by its greater hardness. Picrolite

and chrysolite have similar chemical compositions, but their physical properties are entirely different.

Serpentine is derived from olivene or peridotite and is

hence sometimes classed as a hydrated peridotite or olivene. By the action of carbonated water on olivene, the iron and some magnesia are carried off, the resulting rock being serpentine. Olivene contains fissures, the alteration occurring along them; and the alteration product appears as a fringe of crystals with fibers lying at right angles to the olivene faces.

Picrolite resembles coarse asbestos. The fibres are 8 to 12 inches long, rough to touch, brittle and not easily separated. The color is dark to light green, sometimes gray or white. Picrolite is not a substitute for asbestos and finds little commercial use.

Chrysolite is, as stated above, a variety of serpentine but it has a lower specific gravity and is distinctly fibrous. The hardness varies from 3 to 3.5; the specific gravity is 2.2 to 2.3. The luster is usually silky and the color is green or greenish yellow. The fiber, to be of commercial importance, must be long, fine, infusible, flexible, and must have some tensile strength. Chrysolite easily withstands temperatures of from 2,000 to 3,000 degrees Fahrenheit.

The spinning qualities of asbestos are of importance and these vary with different fibers. Good fiber carries a percentage of water, varying between 13.5 and 14.5 per cent. This content bears a close relation to the flexibility of the fiber. If the fiber be subjected to great heat and some water be expelled, the fiber becomes brittle. Good fiber may be distinguished from bad by subjecting the fibers to tearing, twisting, and bending between the fingers. A good grade of asbestos will give white, silky fibers that may be twisted into threads. Poor asbestos splits up and breaks when rubbed between the fingers. Hornblende and chrysolite have the common property of resisting heat, but only chrysolite offers superior spinning and working properties.

"Vein fiber," or "cross-fiber," are terms applied to fibers which are found to lie at right angles to the vein walls. Veins intersect portions of the serpentine in every direction and with no definite arrangement, sometimes crossing each other. The thickness of veins varies up to several inches. The length most profitably mined varies from one-fourth to one-half inch. In many places, the fiber is divided by a seam of serpentine, carrying magnetite or chromic iron ore. The veins are sometimes displaced by faults, and the fibers are then drawn out along the fractures

*Mining Engineer, Denver, Colo.

and may appear long because of the overlapping. Hornblende asbestos never occurs as vein or cross-fiber.

Slip fiber is usually white. It fills slickensided fault-planes in serpentine resulting from slipping of one rock portion along the contact with another portion. The fiber is bedded on the slipping plane in a flat position, there being a definite parallelism in the arrangement of the fibers. The slip fiber, when mined and separated from the rock, is in no way different from the vein fiber.

Origin of Asbestos Fiber.—The steps in probable origin of asbestos as worked out by Fritz Cirkel*, are outlined as follows:

1. The intrusion of olivene through the earth's crust from below.

2. A gradual alteration of the rock to serpentine through hydration with perhaps a loss of silica and an accompanying increase in volume.

3. A slow readjustment of the rock masses, resulting in the formation of joints and slickensides.

4. A subsequent formation of fissures as receptacles for asbestos fiber. These fractures could occur through the shrinkage of the rock or the injection of granite dykes.

5. Infiltration of serpentinous solution from the side walls, by a process of segregation and subsequent slow crystallization of chrysolite.

6. A second slow readjustment of the magmatic rock mass and the formation of "slip fiber."

The first five steps will account for formation of "vein fiber," while the sixth explains the derivation of "slip fiber" from vein fiber.

柔 柔

Diseases of Metals

Not only mankind, animals, and plants, but also inorganic bodies, have their diseases which slowly but surely lead to their destruction if help is not extended to them in time. The similarity goes even so far that, just as there is in the organic bodies a bacillus, the carrier and disseminator of diseases, an infection may take place in inorganic bodies, especially metals, through contact with a diseased metal.

A German scientist, Prof. L. Erdmann, was the first to make searching observations of organ pipes made of tin; however, Erdmann attributed those changes in the structure of the metal observed by him to the vibration of the pipes. Similar observations were made by Fritsche in St. Petersburg, in 1868, on the same metal in the form of large blocks. The phenomenon in this case was that those tin blocks gradually crumbled to pieces. The same scientist observed a similar change on metal buttons of Russian mili-

tary uniforms which had been transformed during the long time they were stored at the quartermaster's depot, into an amorphous mass, very much to the astonishment of the inspecting officers. Fritsche produced a solid basis for this hypothesis by unquestionable experiments with Banca tin blocks. According to the minute description of the chemist, these diseased tin blocks showed sometimes a crumbled surface and sometimes warty bubbles or deep cavities, similar to pocks in animal organism. In most cases the metal blocks were tarnished and the surface showed faint, radiating formations. While Fritsche exposed a tin block to artificial cold, he could observe that the disease attacked the object at different places at the same time and caused striated or bubble-like wounds.

Since then many other scientists have tried to better explain this phenomenon. The best progress in this attempt was made by E. Cohen, Professor at the University of Utrecht, whose experiments were published in the *Revue Generale des Sciences*, a short time ago, which led to conclusive results. Cohen took as object of observation also a tin block of about 25 kilograms which had already begun to crumble. He found in this block two tin species, physically entirely different from each other, but whose chemical qualities were the same: one a white, bright tin, which was sound and could be put to practical use; the other a gray amorphous tin which covered the center of infection of the block. Through physical-chemical experiments Cohen came to the conclusion that this transformation from white to gray tin takes place at 18° C. and that the contact of sound tin with infected tin mutually favors this transformation, just as the inoculation of certain microbes causes a specific metamorphosis in animal organism. The formation of small warts was predominant in this transformation into gray tin and they covered the entire surface of the block within 3 weeks. Cohen rather cleverly called this disease which is contagious, the Zinnpest (tin pest). At the transformation of white into gray tin the specific volume of the metal increases by about 25 per cent. which causes these small wart-like formations. After the disease is further advanced these swellings finally crumble into an extremely fine-grained powder. Cohen did not hesitate to draw a practical conclusion from these results. Heretofore, only collections of costly tinware or valuable tin medals or coins had to suffer from tin pest without the conservators of the museums or the numismatologists being able to put a stop to it. A large number of medals and utensils, especially tin dishes and plates, perished through this disease, as any close observer will notice when he visits a large museum.

Cohen claims that there is only one remedy: the rooms and glass show cases in which the tin objects are exhibited, should always be above 18° C.

The tin pest is not the only disease of metals. The famous scientist A. von Hasslinger a long time ago called attention to another kind of metal disease which was also contagious, but he did not devote his time to a searching examination. Cohen undertook to also solve this problem and named this phenomenon "Verhaertungskrankheit" (hardening disease). It would probably have been better named "Verdichtungskrankheit" (thickening disease). As object of observation, tin was used at first, and later on, tin plate. Cohen placed several tin-foils that were infected with this disease, upon the tin plate, and ascertained the fact that the surface which was covered by the tin-foil, became dull and crystalline. He explained this to be recrystallization, which is also caused by low temperature. This disease is not limited to tin and iron but extends also to other metals. Cohen diagnosed it especially on petroleum receptacles in brass lamps which had become leaky after 3 years' use. Although the chemical quality of the metal remained unchanged, its cohesion had disappeared and there were crevices and holes in it. The microscopic analysis proved that on account of the recrystallization the metamorphosis of the metal from a meta-stable to a more stable condition had produced these effects. Finally also lead is subject to this disease, which may be observed especially in the lead chambers of sulphuric acid factories. Cohen occupies himself at present with what he calls the "pathology" of iron. Highly interesting results may also be expected from this. The above-mentioned researches do not only interest chemists and engineers but also laymen and the housewives to whom they explain many disagreeable facts and thus aid them to prevent the latter.—K. K.

柔 柔

Homestake Electric Plant

The Homestake Mining Co., Lead, S. Dak., has completed its great hydroelectric generating plant. The water of Spearfish River has been diverted for a distance of 5 miles through tunnels driven most of the way through solid rock. The plant has been tested and found to generate upwards of 6,000 horsepower. The mills and other works of the company are now undergoing modification that will dispense with steam power, and it is expected that before fall all the works will be electrically driven. The mills will be arranged in units of 10 stamps, each having its separate 25-horsepower driving motor. The whole project is costing considerably over \$1,000,000.

*Canadian Department of Mines.

NEW MINING MACHINERY

New Electric Mine Pump

Pumping conditions at mines in one locality vary so widely from those in another that many kinds of pumps have been designed with a view to meet some of the requirements of all. To accomplish this, mine pumps must cover a wide range of capacities and working heads, and be constructed also to withstand the action of different kinds of water, which may be gritty in one case and corrosive in another or both. The large power mine pump shown in Figs. 1 and 2 was designed by the Deane Steam Pump Co. of Holyoke, Mass., to meet the requirements of the Baltimore No. 5 colliery of the Delaware & Hudson Coal Co., at Parsons, Pa., which involve muddy and acid water and high lift, in a shaft. The noteworthy features in connection with

damage due to breakage. The valve seats are made easily removable by the use of special flanges that also are arranged so as to hold seats firmly in place. The valves are double ported of large area; rubber is used for the facing. A by-pass equipment makes it possible to start the pump with practically no load on the motor, and priming piping, and valves permit prompt and reliable starting. One large vacuum chamber and three air chambers insure smooth operation. The object of three air chambers is to obtain less headroom than would be required by one of an equivalent volume. Swing bolts and slotted flanges, or flanged joints subject to frequent disconnection, expedite removal of parts.

The power end of this pump possesses features worthy of examination. The crank-shaft is fitted with cast-steel crank-

12 inches; speed of pump, revolutions per minute, 48; speed of motor, revolutions per minute, 375; capacity of pump, gallons per minute, 825; working lift, 400 feet; motor, 125 horsepower, 440 volts, three-phase, 25 cycles.

The motor for this pump was furnished by the General Electric Co.

來 來

Fuses for Electric Lines

Fuses are regulated in size to carry a certain number of amperes, and to melt and open the circuit when it carries an overload. A common form of fuse metal is the fuse wire or fuse strip, made of lead composition and commonly sold by electrical supply houses. The Board of Fire Underwriters recommends the use of enclosed fuses to avoid possibility of damage or fire from the melted metal.

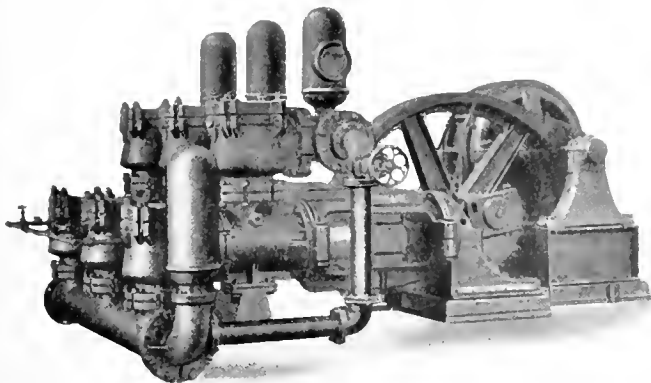

FIG 1 FRONT VIEW OF ELECTRIC PUMP

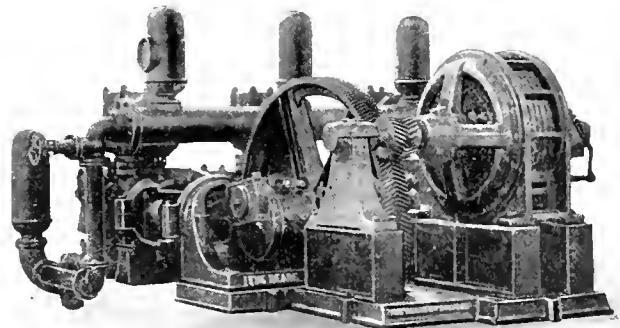

FIG 2 REAR VIEW OF ELECTRIC PUMP

this pump are that it is electrically driven with plungers moving horizontally, instead of vertically, and in some other respects adopts the good points that have been reached by years of effort on the part of steam pump manufacturers. The stuffingboxes of the plungers can be packed from outside; the water cylinders are lined with wood to prevent the destruction of the metal through the corrosive action of the water; and the water end is supplied with pot valves. The pump is triplex single acting and constructed with an extra allowance of metal to compensate any loss that might occur from corrosion either inside or outside.

The valves and by-pass pipes are of acid-resisting bronze, and the same metal is used for lining throats and glands and for capping the ends of the plungers, which are specially subject to corrosion.

The water end is sectionalized with separate cylinders and valve pots, rendering it easy to inspect and repair any

disks, with the crankpins pressed on and also keyed to the shaft. Each yoke that connects the cylinder to the frame is split in a horizontal plane to facilitate replacement of these heavy castings without completely removing others. The design of the yoke and the large diameter of the crosshead and guides renders the gland studs accessible and permits the adjustment of shoes and connecting-rods. The connecting-rods are interchangeable, with solid crosshead and forked crank-ends, that have wedge adjustments.

The gear-wheels have the herring-bone face and are supported between two frames, which with the heavy motor base and an outboard bearing for the motor shaft insure alinement. The method of mounting the motor, and the height of the base, will permit continued operation of the pump with even a considerable depth of water on the pump-room floor. The dimensions and capacities of the pump are as follows: Diameter of plungers, 12 inches; length of stroke,

To enable the user to know just what he is using and to buy it as cheaply as possible, the Daum refillable fuse shells were invented. They are made with heavy cast-brass, carefully machined, removable caps, screwed onto heavy vulcanized fiber tubes. In these can be connected any suitable size fuse wire. One size shell is designed for any number of amperes from 1 to 30, and larger ones have similar variations. It is only necessary to insert the proper size wire, and if it burns out put in another. The A. F. Daum Co., Pittsburg, Pa., will send particulars or sample shells on request.

來 來

Nonpareil High Pressure Covering

The Armstrong Cork Co., of Pittsburg, one of the largest manufacturers of cork in the world, utilizes waste cork for the manufacture of Nonpareil cork-board insulation and Nonpareil cork covering for brine, ammonia, and ice-

water lines, and has added to its line a new type of high-pressure and superheated steam-pipe and boiler covering, known as Nonpareil high-pressure covering. This contains no cork, but consists of diatomaceous earth and asbestos fiber. Diatomaceous earth, sometimes called infusorial earth, is of very low specific gravity, and is made up of the skeletons or shells of microscopic plants known as diatoms, which existed in the sea bottoms ages ago. These minute bodies, which are practically pure silica, are hollow and contain air, therefore, diatomaceous earth is an excellent non-conductor of heat.

In the form of plastic cement it has been used for years in Europe for heat insulating purposes, and the Armstrong company has perfected a process by which it is successfully bonded together in sectional form so as to produce a strong, efficient pipe covering for high-pressure work.

It is claimed by the makers that this material is from 10 per cent. to 15 per cent. more efficient as a non-conductor of heat, than material previously in use, and in their catalog this claim is substantiated by tests made by several well-known authorities. The material also resists temperatures at which the older coverings calcine and disintegrate, thus making it particularly well suited for the insulation of superheated steam lines, breechings, etc.; also it is not affected by moisture or steam, and after being submerged in water for weeks, it will after drying, be found to be just as strong and efficient as it was in the first place. The covering is easy to apply, and the price, it is understood, compares favorably with that of any other high-pressure coverings on the market. It is made in sections 36 inches long for pipes of standard sizes up to 14 inches. For pipes of larger diameter, boilers, breechings, etc. it is furnished in block form, and for irregular surfaces the cement is furnished. Users of steam are invited to write for catalog, samples, and prices.

來 來

Sectional Unit Switchboard

Private telephone systems in homes, business offices, factories, and institutions have become necessities, and intercommunication is looked upon as the most efficient way in which to get results within an organization. The Western Electric Co. has placed upon the market an intercommunicating switchboard that follows out the sectional unit idea as used in filing systems and libraries. The purchaser need only buy as much equipment as his present needs demand; when the necessity for additional extension arises, he can buy another section of switchboard which will fit in with those already installed. This switchboard is for use when the number of telephones exceeds twenty

or is likely to exceed twenty in a short time. The units fit together like those of a sectional bookcase; and, by adding units, it is possible to make a switchboard of 20, 40, 60, 80, or 100 lines capacity, which will be reliable, while inexpensive enough to fit a modest appropriation. A valuable feature of this switchboard is its arrangement for sounding a general alarm. This is a means of ringing and talking to all stations simultaneously, thus providing a fire or general alarm system without extra cost. Four systems, to give four different classes of service, may be furnished, and two of them provide means of connecting into the public telephone system.

來 來

Catalogs Received

KEUFFEL & ESSER Co., New York, N. Y. Pocket Magnetic Compasses, 18 pages; Unique Measuring Tapes, 11 pages.

THE RICHARDSON-PHENIX Co., Milwaukee, Wis. Bulletin No. 53, The Richardson Model "M" Mechanical Lubricator 16 pages; Bulletin No. 54, The Phenix Lubricator Oil Pump, 16 pages; Bulletin No. 55, Scientific Lubrication of Machinery.

CHICAGO PNEUMATIC TOOL Co., Chicago, Ill. Bulletin No. 118, Chicago Giant Rock Drills Auxiliary Valve Type, 8 pages; Booklet 119, Operation and Upkeep of "Rockford" Railway Motor Cars, 24 pages; Bulletin 120, Instructions for Setting Up and Operating Chicago Giant Rock Drills, 8 pages.

INGERSOLL-RAND Co., 11 Broadway New York, N. Y. "Butterfly" Hand Hammer Drills, 8 pages. Catalog No. 75 Water Lifted by Compressed Air.

NORDBERG MANUFACTURING Co., Milwaukee, Wis. Bulletin No. 20, "S. C." Compressors—Belted Type, 8 pages; Bulletin No. 21, Nordberg Uniflow Engine, Corliss Type, 8 pages.

POWER AND MINING MACHINERY Co., Milwaukee, Wis. Catalog Especial. Maquinaria y aparatos para la Reduccion De Piedro, Y Minerales, Fabricacion de Cementos y Fundicion, 112 pages.

INDEPENDENT POWDER Co., Joplin, Mo. Dynamite, The Various Kinds, When, Where, and How to Use them, 156 pages

FOOT BROS. GEAR AND MACHINE Co., Chicago, U. S. A. Catalog No. R, The IXL Speed Reducers, Price Book, 24 pages.

JEFFREY MFG. Co., Columbus, Ohio. Bulletin No. 74, Jeffrey Freight and Package Handling Machinery, 28 pages.

W. S. ROCKWELL Co., 50 Church St., New York City. Catalog 15, Rotary Annealing and Hardening Furnaces, 16 pages.

GENERAL ELECTRIC Co., Schenectady New York. Bulletin No. 4995, Direct Current Switchboards, 16 pages; Bulletin No. 4996, Alternating Current Switch-

board Panels, 48 pages; Bulletin No. 4968, Electric Automobile Appliances, 38 pages; Bulletin No. 4998, Thomson Direct Current Test Meter, Type C B-4, 4 pages; Bulletin No. A 4001, Oil Switches for Small and Isolated Plant, Type F Form K 13, 8 pages; Bulletin No. A 4002, Polyphase Maximum Watt Demand Indicator, Type W, 8 pages.

THE BALDWIN LOCOMOTIVE WORKS, Philadelphia, Pa. Record No. 72, Mallet Articulated Locomotives, 44 pages.

J. A. BRENNAN DRILLING Co., 304 Peoples Bank Building, Scranton, Pa. Folder, You Can't Look Into the Earth But We Can.

ELECTRIC RAILWAY EQUIPMENT Co., Cincinnati, Ohio. Bulletin "A" Ornamental Street Lamp Posts, Combination Railway and Lighting Poles, Mast Arms, Brackets, 32 pages.

LINK-BELT Co., Chicago, Ill. Book No. 124, Steel Chains, 50 pages.

PULSOMETER STEAM PUMP Co., 17 Battery Place, New York, N. Y. Catalog 18, The Pulsometer, Its Construction, Operation and Field of Application, 48 pages.

S. FLORY MFG. Co., Bangor, Pa. Catalog 1912, Hoisting and Cableway Machinery, 180 pages.

來 來

Illinois Coal Statistics

Number of counties producing coal.....	52
Number of mines and openings of all kinds	879
New mines or old mines reopened during the year.....	176
Mines closed or abandoned since last report.....	142
Total output of all mines, in tons of 2,000 pounds.....	57,514,240
Number of shipping or commercial mines	380
Output of shipping mines, tons.....	56,096,695
Number of mines in local trade only.....	499
Output of local mines, tons.....	1,417,545
Total tons of mine-run coal.....	13,366,509
Total tons of lump coal.....	21,793,527
Total tons of egg coal.....	4,940,431
Total tons of nut coal.....	3,193,956
Total tons of pea coal.....	11,109,191
Total tons of slack coal.....	3,108,626
Tons shipped.....	51,502,382
Tons supplied to locomotives at the mines	924,854
Tons sold to local trade.....	2,615,678
Tons consumed (or wasted) at the plant..	2,471,326
Average days of active operation for shipping mines.....	172
Average days of active operation for all mines.....	160
Number of motors in use.....	371
Number of mines in which mining machines are used.....	137
Number of mining machines in use.....	1,599
Number of tons undercut by machines....	25,455,059
Number of tons mined by hand.....	32,059,181
Average number of miners employed during the year.....	39,149
Average number of other employes underground, men.....	31,687
Average number of boys employed underground.....	1,526
Average number of employes above ground.....	7,049
Total number of employes.....	79,411
Number of persons at work underground.	72,362
Average price paid per gross ton for hand mining, shipping mines.....	\$.636
Average price paid for gross tons for machine mining.....	\$.496
Number of kegs of powder used for blasting coal.....	1,313,448
Number of kegs of powder used for other purposes.....	3,040
Number of pounds permissible explosive.	328,075
Number of men accidentally killed.....	180
Number of men injured so as to lose a month or more of time.....	800
Number of gross tons mined to each life lost.....	319,524
Number of employes to each life lost....	441
Number of deaths per 1,000 employed....	2.26
Number of gross tons mined to each man injured.....	71,893
Number of employes to each man injured	99

Mines *and* Minerals

Vol. XXXIII.—No. 5.

DECEMBER, 1912—SCRANTON, PA.

Price, 25 Cents

PUBLISHED MONTHLY AT SCRANTON, PA.

ESTABLISHED 1881

INTERNATIONAL TEXTBOOK CO., PUBLISHERS

T. J. FOSTER, President S. P. ALLEN, Secretary E. H. LAWALL, Treasurer

RUFUS J. FOSTER, Vice-President and Manager

EUGENE B. WILSON, Editor HUGH ARCHBOLD, E. M., Asst. Editor

CHICAGO OFFICE: 1006 Michigan Ave.

Entered at the Post Office at Scranton, Pa., as second-class matter

Address all business communications to MINES AND MINERALS, Scranton, Pa.

CABLE ADDRESS, "RETSOF, SCRANTON"

LONDON OFFICE: INTERNATIONAL BUILDINGS, KINGSWAY, LONDON, W. C.

SOUTH AFRICAN OFFICE: MANSION HOUSE CHAMBERS, ALDERLEY STREET,

CAPE TOWN.

NEW ZEALAND OFFICE: 63 DIXON STREET, WELLINGTON.

AUSTRALIAN OFFICE: 53 PITT STREET, SYDNEY.

SUBSCRIPTION RATES

Single Copies..... 25 cents

Yearly Subscription, including postage:

To United States, Mexico, Cuba, Porto Rico, Hawaii, and Philippines... \$2.00

To Canada..... 2.50

To all other countries..... 3.00

The date after your name on the wrapper is that of the month to which your subscription has been paid. If you do not want to continue your subscription after that time, kindly notify us.

Notice to discontinue or change of address should be sent to the Scranton office.

When notifying us of a change of address always give your FORMER as well as your present address.

TABLE OF CONTENTS

Editorial—	
Editorial Notes—Everybody Happy—Safety Lamps for Pennsylvania—The Protection of the Surface Over Coal Mines.....	233
Personals.....	236
Oxone—Sodium Peroxide.....	236

COAL MINING AND PREPARATION

Battle Creek Mine, Tenn., by Wm. McIntyre, Jr.....	237
Spring Frog Latches.....	239
Mine Supports in Germany.....	240
Danger Signals in Pennsylvania.....	242
Electric Shot Firing, by L. L. Wittich.....	243
United States Coal Exports.....	244
The Coal Dust Question, by Samuel Dean.....	245
Old Wire Ropes for Return Circuit in Mines.....	248
Mining Society Notes.....	248
Horizontal Mine Boring Under Pressure, by Frank C. Perkins.....	250
Illinois Civil Service Examination.....	251
Monobel and Carhonite.....	252
Prize Contest for Safety Lamp.....	253

The Letter Box—

Gases—Centrifugal Pumps—Handling Stacked Carhide—Gases from Acetylene Mine Lamp—Calcium Carbide—Scientific Management.....	254
The Hamilton No. 8 Mine, by L. L. Wittich.....	255
Book Review.....	256
Temporary Shaft Head.....	257
Mine Accidents, 1911.....	257
Dust Explosion, by C. M. Young.....	258
The Value of Study to Mining Men, by Samuel McMahon.....	260
Answers to Examination Questions—	
Mine Foremen, Second Grade, Pennsylvania Bituminous.....	261
Coal Mining Notes.....	263
Prize Contest.....	264
Florida Phosphate Practice, by John Allen Barr.....	265
The Billy White Cut, by William J. Crocker.....	269
Practical Cyaniding—Part 5, by John Randall.....	270
The Magdalena Mining District, N. Mex., by Edgar G. Tuttle.....	275
Men vs. Machines, by Josiah Bond.....	277
Princeton, B. C., Mining Notes, by Frank Bailey.....	278
Standard Silver Mine, by William Fleet Robertson.....	279
Cost of Milling in South Africa.....	280
Low Costs at Wasp No. 2 Mine, by Leroy A. Palmer.....	281
Lithium, by Amil A. Anderson.....	283
Calumet and Hecla.....	284
Mill Feed Sampler, by L. M. Banks.....	284
Mineral Pigments in Pennsylvania.....	285
The Use of the Pantagraph, by H. G. Henderson.....	286
Colorado Mineral Production, 1911.....	286
Russian Platinum Industry.....	287
Platinum Near Princeton, B. C.....	287
Raising Shaft at Rolling Mill Mine.....	288
New Mining Machinery—	
Manganese Steel for Economy—Motor for Stamp Mill Drive—Ready-Made Houses.....	289
Trade Notices.....	289
Catalogs Received.....	290
Squibs—	
Motor Truck, 239—Air Compression, 242—Briquetting Lignite, 242—American Exports of Coal, 249—Action of Acids on Concrete, 254—Coke from Coal, 257—Fast Tunnel Driving, 260—Care of Tools, 263—Sapphires of Siam.....	282

THE number of miners engaged in bituminous and lignite mining in 1911 was 549,750 and those in anthracite mining, 172,585, a total of 722,335. The average production per man was 738 tons for the year in the bituminous and lignite mines and 524 tons in the anthracite mines. In 1910 the corresponding averages were 751 and 498 tons.

采采

THE cheapness of gold is probably the cause for the high price of platinum, although it has an unprecedented demand in the manufacture of jewelry. While it is a necessary metal in some industrial applications, in a large number of others substitutes have been found which have proved eminently satisfactory. While the average price of platinum was \$28.87 per ounce in 1911, it has now risen to about \$48.

采采

Everybody Happy

THE Presidential election is a thing of the past and everybody is happy. All parties can rejoice over the fact that the daily papers have resumed the publication of news other than that of a partisan nature. The Democrats rejoice over the success of their party. The conservative Taft Republicans rejoice that inasmuch as Mr. Taft could not be elected, President-elect Wilson received a tremendous plurality over Colonel Roosevelt. The Bull Moose adherents rejoice because their candidate received a much larger vote than Mr. Taft. We are all happy. Until March 4, we are unanimously for President Taft. After that date we will be unanimously for President Wilson. The United States of America is the only great nation on earth that can conduct a revolution whose decisive battle is fought on one day and ballots instead of bullets are used for missiles. The administration will change on March 4, but our respected Uncle Samuel will continue to do business at the old stand with a new general manager.

采采

Safety Lamps for Pennsylvania

JAMES E. RODERICK, Chief of Department of Mines in Pennsylvania, has issued the following notice to the bituminous coal operators of Pennsylvania: "The Act of June, 1911, provides for the use of approved safety lamps in all mines generating explosive gas. The term 'approved safety lamp' means any bonneted safety lamp approved by the Department of Mines.

"Section 8, Article 10, of that Act reads:

"Whenever safety lamps are used in a mine by fire bosses or other persons, they shall be so constructed that they may be safely carried against the air-current ordinarily prevailing in that portion of the mine in which the lamps are being used."

"A test of safety lamps was made at the National Bureau of Mines, at Pittsburg, and upon receipt of a report of the tests I have approved the following bonneted safety lamps for general use in the mines of this Commonwealth, to wit: Clanny, Davis Deputy, Wolf, Schenk (new type), Seippel, and Ackroyd & Best, where the velocity of the air ranges from 600 to 1,500 feet per minute. You will therefore govern yourself accordingly. No other safety lamps shall, for the present, be used in the bituminous mines of this Commonwealth."

采 采

The Protection of the Surface Over Coal Mines

IF coal in seams comparatively near the surface is mined there must be a great loss in coal left as pillars or the surface and improvements thereon will be damaged. When the coal and surface are both owned by the same parties the question resolves itself into which is of the greater value, and it is easy of solution. When the surface is owned by one party and the coal by another, with no specified release for damages due to the mining, the owner of the surface is amply protected by law. But when, as is the case in the city of Scranton and its environments, most of the surface owners have deeds in which is incorporated a paragraph which not only reserves the coal to the original owner but provides that it may be mined regardless of damage to the surface, there is a state of affairs that is both troublesome and unfortunate. Most deeds for lots in the city of Scranton and neighboring towns, excepting in some few localities, have embodied in them the following paragraph:

"Excepting and reserving, however, to the said party of the first part, its successors and assigns, all coal and minerals beneath the surface of and belonging to said lot, with the sole right to mine and remove the same, by any subterranean process incident to the business of mining, and also the sole right of passage through or under the said lot, to mine and remove the coal and minerals from any other lands by any subterranean process, without thereby incurring, in any event whatever, any liability for injury caused or damage done to the surface of said lot, or the buildings or improvements which now are or hereafter may be put thereon; and the party of the second part, for himself, his heirs, executors, administrators and assigns, does hereby expressly release and discharge forever the said party of the first part, its successors and assigns, and all persons who may have derived title to said coal or other minerals from said party of the first part, of and from any liability for any injury that may result to the surface of said premises, or anything erected or placed thereon, from the mining or removal of said coal or other minerals; Provided that no mine or air shafts shall be

intentionally opened, or any mining fixture established on the surface of said premises."

Owing to this reserve and release in deeds there has been some damage done lots and buildings in certain sections in the city of Scranton, as well as to streets, water and gas pipes, sewers, etc. So far, except in one or two cases, this damage has been inflicted on comparatively inexpensive property; and the aggregate of all the damage so far done is very small when the extent of the city, its assessed valuation, and the extent of the business due to the mining industry is considered. There is no question but that the wide publicity given this damage due to mine workings and the exaggerated statements regarding it in metropolitan papers have caused a great deal more financial damage to the city than the actual loss to the individual property owners. However, the loss of but a few hundred dollars to an individual, if it is his all, or is the value of a modest home for which he toiled for years, is a great loss if considered by itself. Such loss should, if possible, be prevented, and a future element of danger to large sections of the city should be removed, if it can be, by rational legal means and cooperation on the part of the mining companies, the property owners, and the city as a corporation.

As is well known, the Governor of Pennsylvania has appointed an able Commission which is giving a great deal of time and thought to measures which will remedy the existing state of affairs. One remedy suggested by a former Mayor of the city and a member of the Commission in a paper read before the Commission and published in full in the Scranton daily papers, is so impractical that it did not receive serious consideration from the majority of the Commission or from any one familiar with the coal mining industry. His plan of having the "release for damage" portion of deeds abrogated by legal enactment is unconstitutional, as it would be a forfeiture of the property and rights of the coal owners distinctly specified by voluntary and legal contract. This is the opinion of prominent attorneys and jurists whom we have consulted.

To even attempt to secure the enactment of such a measure would not only result in failure, but it would also delay rational action, if it did not prevent it entirely. The scheme is impractical from other points of view. If, as proposed by former Mayor Dinmick, the legislature should enact a bill making null and void such contracts, even if its constitutionality was not questioned, it would cause a decadence of the city of Scranton and a shrinkage of property valuation to a ruinous extent. It would seriously retract the volume of production and the life of the mining industry. None of the coal under property owned by others than the mining companies could be mined unless the operator actually purchased all the lots and improvements overlying coal seams. If such purchase could be made at the assessed valuation of the properties affected, it would require many millions of dollars—more than the coal is worth. If the mining companies had to pay the present market price, or the exorbitant prices some property

owners would naturally demand, the cost would run anywhere from \$50,000,000 to \$100,000,000.

In the territory tributary to Scranton, in a business sense, there is an annual production of about 20,000,000 tons of anthracite coal. Each ton represents the bringing into the territory of from \$2 to \$3 or say \$50,000,000 per year. The circulation of this money represents the greatest portion of Scranton's commercial activity. If such legislation was enacted as Mr. Dimmick proposes it would be illegal and impossible for any lot owner to sell the coal under his lot. The whole valley from Forest City on the north to Pittston on the south is almost one town with many thousands of lot owners. All the coal under their lots would be tied up. There would be no certainty that this would afford sure protection, because coal surrounding these lots or in the neighborhood of such lots belonging to the mining companies could be entirely mined out and squeezes or side thrusts would probably affect buildings, even if they were located directly over comparatively large pillars. There are other reasons that might be cited for the impracticability of Mayor Dimmick's scheme but there is no use wasting space on them as the unconstitutionality of the proposed measure is objection enough.

There is, however, a practical way in which the question of surface protection in the city of Scranton can probably be solved. We say *probably*, because we have no right to speak for the coal mining companies who own the coal and have a legal right to mine it regardless of consequences to the surface. We believe that the mining companies will meet the surface owners in any rational plan that may be proposed.

There is only one way in which a maximum amount of the coal can be mined and the surface be protected, that is, by flushing from 50 per cent. to 60 per cent. of the mined area full of culm, sand, ashes or other suitable material in the shape of well-distributed artificial pillars. Nearly 30 years ago this plan was used at Shenandoah, Pa., with good results and it has been used at other points in the anthracite region. It has been adopted in Europe, and is now being used by the Philadelphia & Reading Coal and Iron Co., at Shenandoah, and Mt. Carmel, Pa. It is the plan suggested by Messrs. Griffith and Conner who examined the mine workings under the city of Scranton and made an able and voluminous report to the original committee appointed to investigate the matter.

At Shenandoah and Mt. Carmel the flushing is being done entirely at the expense of the mining company, because while it owns the coal it does not enjoy the privilege of a release from damages to the surface. In these instances the size of the seams mined and the superior quality of the coal warrant the expense that the company is voluntarily incurring. As the mining companies operating in Scranton and vicinity not only own the coal but have legal right to mine it regardless of damage to the surface, it cannot be expected that they will do the same. We believe, however, that they will do their share,

and we offer the following as a general plan for the solution of the question:

Have appointed a reliable local board of commissioners, consisting of one general mine manager, one competent mining engineer, one practical miner, and two public-spirited business or professional men—three to represent the city and the lot owners, the mine manager and mining engineer to represent the mining company. Then have this board obtain an arrangement by which the cost of sufficient flushing to insure the stability of the surface should be borne proportionately by each of the three parties at interest; namely, the mining company, the lot owners, and the city at large as a corporation. The cost of the flushing might be divided, say, in the following proportions, as might be deemed fairest:

One-half of the cost to be borne by the mining company; one-fourth by the lot owners and one-fourth by the city at large, or possibly the proportion might be one-third by the mining company; one-third by the lot owners and one-third by the city at large. The one-fourth or one-third to be paid by the lot owners should be divided among the lot owners of the section being treated in proportion to the assessed valuation of their properties. This assessment against the lot owners might be paid in five annual instalments with interest, as is the case with paving and sewer assessments in Scranton. The idea of having the city pay a portion of the cost is to require property owners, whose lots are not and will not be undermined, to pay a portion of the expense in the shape of taxes. They are vitally interested in the prosperity of the city, and anything affecting the city, either beneficially or adversely, naturally affects the value of their real estate. The mining companies should pay their share, as by means of the proposed flushing it will be possible for them to recover a greater percentage of the coal remaining in the ground than otherwise. The work of flushing should be done by the mining companies, as they can do it better and cheaper than any one else.

The details of such a plan of operation would have to be worked out by the commissioners. A rational plan would be to lay the city out in sections, take each section in turn, as necessity requires, finish the work in that section and make the charges for that section separately from those of other sections.

On first thought we know that this plan will not be a popular one with real-estate owners. No man likes to pay out money if it can be avoided, but the real-estate owners of Scranton are up against a condition that must be met. The expenditure of comparatively small sums by each, to protect their real-estate holdings, which are worth many times their share of the cost of flushing, is good business.

As stated before, we have no authority from the mining companies to commit them to such a plan or to any proportionate division of the expense, but we believe from our knowledge of the managements of the companies that they will give favorable consideration to any rational plan and, we think, will be liberal in assuming some part of the cost.

Personals

Under an act of the legislature the office of the Kentucky Geological Survey has been removed to Frankfort, Ky. All communications should be addressed to J. B. Hoeing, Director of the Kentucky Geological Survey, Frankfort, Ky.

A. H. Elliott, Chemical Engineer; Louis D. Huntoon, Mining Engineer; and Bradley Stoughton have associated for the general practice of their overlapping professions, with offices at 165 Broadway, New York City.

Professor C. L. Bryden, 1015 Myrtle Street, Seranton, Pa., has a list of 98 men in America who have attended Freiberg, Germany.

E. B. Day, Vice-President of the *Coal and Coke Operator*, has resigned from that paper and is now on the staff of *Engineering Magazine*.

E. G. Bailey, M. E., is not now with the A. D. Little Co., but with the Fuel Testing Co., 220 Devonshire Street, Boston, Mass.

Sam. T. Long and Weed Smith, of Webb City, Mo., victors in 1911, again won the drilling championship of that district on October 20, drilling 35 and 13-16 inches in the allowed time and using 908 strokes.

James F. Beattie, formerly Division Superintendent of the Shawmut Mining Co., at Byrnedale, Pa., has been appointed General Superintendent of the Williams Mining Co., with headquarters at Oakridge, Pa.

Rush N. Hosler has been appointed Chief Engineer of the Rochester & Pittsburg Coal and Iron Co., Jefferson & Clearfield Coal and Iron Co., and Pittsburg Gas Coal Co., with headquarters at Indiana, Pa.

G. R. Delamater, of the Pennsylvania Crusher Co., will present a paper on "Coal Washing," at the December meeting of the Coal Mining Institute of America, to be held at Pittsburg, December 18.

Oscar Cartledge, of Marion, Ill., has been appointed Manager of the Illinois Rescue Stations to succeed Mr. Richard Newsam who resigned last spring on account of ill health. Mr. Cartledge is qualified in every way for this position and will undoubtedly be of great assistance to the mining industry of his state. Illinois is the only state having state rescue stations and cars.

The following men received degree of Mining Engineer from the Michigan College of Mines, August 31, 1912: Everett L. Booth, Chicago, Ill.; Raymond Aloysius Case, Sault Ste. Marie, Mich.; Marion Gilbert Donk, Washington, D. C.; Gordon Elliott, Globe, Ariz.; Jesus Jose Falomir, Mexico City, Mex.; John Percy Francis, Ishpeming, Mich.; Adelbert John Gleason, Biwabik, Minn.; Myron Henry Greve, Grand Rapids, Mich.; Fred Beaby Hanchett, Jr., Niles, Mich.; Kedzie Karl Hood, Houghton, Mich.; Prescott Samuel Huntington, Mason, Mich.; Frederick Edward Kurz, Green Bay, Wis.; Victor John Lanigan, Duluth, Minn.; John Munro Long-

year, Jr., Marquette, Mich.; Samuel Lowenstein, Negaunee, Mich.; Lynn Sterritt McDonald, Sycamore, Ohio; Cyril James McKie, Bessemer, Mich.; Niel Stanley Mackie, Sault Ste. Marie, Mich.; Raymond C. Mahon, Iron River, Mich.; Theodore William Molthen, Hubbell, Mich.; Daniel Leighton Newkirk, Detroit, Mich.; Jose Antonio Paredes, Mazatlan, Sinaloa, Mex.; Isak Partanen, Hancock, Mich.; Louis Procissi, Calumet, Mich.; William Arthur Rigby, Norway, Mich.; William Andrew Robins, Jackson, Mich.; Eark Williston Stuart, Chesaning, Mich.; James Elmer Waterman Swent, Oakland, Cal.; Frederick Thomas Teddy, Ishpeming, Mich.; Frank Emmett Thurber, Holland, Mich.; Roy Lesstie Wahl, Houghton, Mich.; Harold Whittingham, Market Rasen, Lincolnshire, Eng.

David White has been appointed Chief Geologist of the United States Geological Survey to succeed Waldemar Lindgren who becomes Rogers' Professor of Geology at the Massachusetts Institute of Technology. Mr. White, who is a graduate of Cornell University, has been connected with the Geological Survey since 1886, his first appointment being to the position of assistant paleontologist. Later he was assistant to Prof. Lester F. Ward, under whom Mr. White specialized in the study of fossil floras of the older geologic formations. Mr. White is also Associate Curator of the National Museum and is president of the Paleontological Society, vice-president of the Geological Society of America, and a member of the National Academy of Sciences, as well as several other scientific societies.

Dr. F. L. Ransome will take up the work of Mr. Lindgren as chief economic geologist of metalliferous deposits. Mr. Lindgren will not sever his connection entirely with the Geological Survey, but expects to do some work in the West during the coming summer.

來 來

Oxone—Sodium Peroxide

Oxone generators are coming into use in most mine hospitals for the immediate generation of pure oxygen. As an anæsthetic or reliever of pain, oxygen is exceedingly useful to surgeons, and the oxone generator can be used for the immediate resuscitation of persons suffering from shock, insensibility from smoke or gases, or where it is deemed necessary to stimulate a person who has sustained an internal injury, such as a broken rib which would prevent artificial respiration being practiced.

Oxone is electrically fused sodium peroxide Na_2O_2 with a small percentage of a catalytic substance. It forms on cooling a grayish substance, hard and dense, which keeps indefinitely in sealed tins, thus making it handy for transportation.

When brought in contact with water or water vapor the "oxone" is decomposed,

yielding oxygen and caustic soda as shown in the following equation:

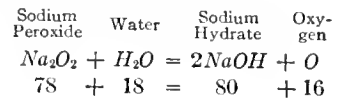

From this equation 1 pound sodium peroxide yields .205 pound oxygen, thus $.78 : 1 = 16 : .205$.

The weight of 1 cubic foot of air at 60° F. and 30 inches of mercury is .0766 pound and since the specific gravity of oxygen is 1.105, 1 cubic foot of oxygen weighs $.0766 \times 1.105 = .084643$ pound and .205 pound will occupy 2.42 cubic feet or 4,181.76 cubic inches.

Foster in his "Textbook of Physiology," gives the following differences between inhaled and exhaled air:

	Inhaled Air	Exhaled Air
Oxygen.....	20.81	16.003
Nitrogen.....	79.15	79.589
Carbon dioxide.....	.04	4.380

According to this table, oxygen decreases at the rate of 23 per cent. and carbon dioxide increases in volume 109 times. Soper, in his book on "Air and Ventilation of Subways," states that "the average adult takes into his lungs 396 cubic inches of air per minute, 20.81 per cent. of which is oxygen; therefore, he requires 82.4 cubic inches of oxygen per minute, but 77 per cent. of this can be used again; therefore, he will consume 18.95 cubic inches of oxygen per minute. Since 1 pound of oxone will furnish 2.42 cubic feet of oxygen or 4,181.76 cubic inches, it would theoretically furnish sufficient oxygen to support life $\frac{4,181.76}{18.95}$

$= 225$ minutes. When oxone is supplying oxygen for the breath in an enclosed space the carbon dioxide which increases rapidly must be cared for and this is done by the sodium hydrate formed, as follows:

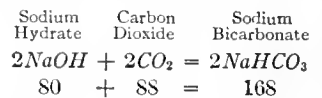

From 1 pound of oxone .8 pound sodium hydroxide is obtained; according to the equation, 52.4 per cent. of the sodium bicarbonate is composed of sodium hydrate; therefore, .8 pound sodium hydrate will require .4192 pound carbon dioxide to form sodium bicarbonate. The specific gravity of carbon dioxide is 1.529 and 1 cubic foot will weigh $.0766 \times 1.529 = .177$ pound; therefore, $\frac{.4192}{.177} = 2.37$ cubic feet of

carbon dioxide. At each exhalation 4.38 per cent. of 396 cubic inches is carbon dioxide, or 17.35 cubic inches in 1 minute, at which rate it would require $\frac{2.37 \times 1,728}{17.35} = 237$

minutes before the sodium hydrate became converted into bicarbonate.

COAL MINING & PREPARATION

Battle Creek Mine, Tenn.

Methods of Handling the Coal Outside—Mining Methods Determined by Peculiar Geological Conditions

By Wm. McInture, Jr.*

THE Battle Creek mine is 1 mile from Orme, Marion County, Tennessee. Orme is reached by a branch line of the Nashville, Chattanooga & St. Louis R. R. from Bridgeport, Alabama, although it is but a short distance west of South Pittsburg, where are the Thomas mines of the Tennessee Coal and Iron Co.



FIG. 1. OPENING AT NO. 1 MINE, ORME, TENN.

The Battle Creek Coal and Coke Co. has four drift mines situated on the eastern escarpment of the Cumberland Mountains, which are noteworthy mostly for good coal, inaccessibility, irregular stratification, and consequently difficult mining. The coal worked is termed the Battle Creek seam, and varies in thickness from 14 feet to 14 inches, but will as a whole average about 54 inches. The roof is slate and stratified sand rock and the floor is sand rock; it is not therefore the Swansea seam at Whitwell, that having a slate roof and fireclay floor with average thickness of 37 inches of coal.

The No. 1 mine, shown in Fig. 1, was

*Mine Foreman, B. C. C. & C. Co., Orme, Tenn.

opened in July, 1902, at an elevation of 1,540 feet above sea level. To get the coal down to the railroad at Orme, it was necessary to build a gravity plane 2,957 feet long from the upper to the lower tippie level. No. 1 opening is about 300 feet from the brow of the incline, but to reach the coal and continue in it through the mountain, it was necessary to make an 18-foot deep rock cut for about 180 feet. At this point the entry coal pinched, and work was stopped for a number of years; then, by driving through the squeeze about 30 feet, from 16 feet to 18 feet of coal was tapped. Originally the coal was dumped from mine cars into the top tippie and then into 10-ton skips which alternated on the three-rail gravity plane; owing to excessive breakage of the coal by these two extra dumpings, the plan was changed, and 11 loaded mine cars are sent down the plane in one trip, while 11 empty mine cars are pulled up the plane by their weight.

Mining was started on the double-entry system, with rooms on each entry, so that two large rooms were opened on the left and three rooms to the right-hand entry going in, and these are in high coal. The entry dipped so fast that it required a large heavy mule to pull one mine car to where the coal was found, and then the grade to the tippie is in favor of the loaded car.

The entries in Nos. 1, 2, and 3 openings are driven due west, and the rooms turned north and south as a rule. In this locality, while the coal bed has not been faulted to any great extent, the coal was formed on an uneven floor which causes it to pinch in one place and swell at another, as shown in Fig. 4 (a); further, the floor is rounded as if it was originally a pile of sand and this makes it necessary to give rooms the snakelike appearance shown in plan, Fig. 4 (b). The rooms are driven in the swags *a*, which run mostly north and south, consequently it is necessary to turn the track to avoid taking up floor; but sometimes it is possible to obtain easier haulage by taking up

a little of the floor. The rolls or hogbacks are sometimes from 30 feet to 40 feet long and coal lasts from 100 feet to 300 feet; then, again, coal will last a day or two and then rock for a day or two. The roof of the coal bed is practically level sand rock and hard slate, which shows that the uneven floor conditions occurred before it was laid down. The

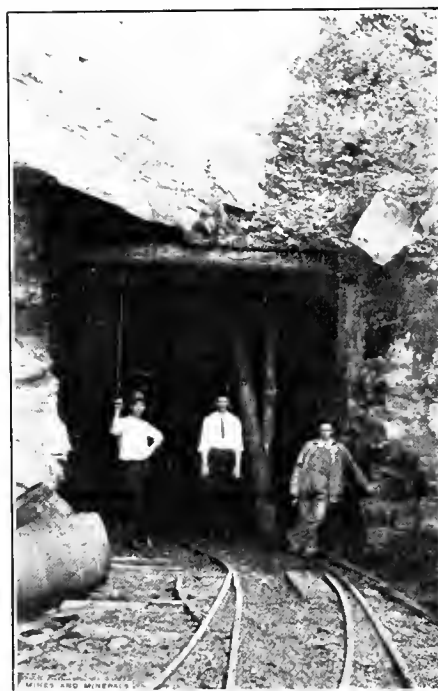

FIG. 2. NO. 2 OPENING, ORME, TENN.

roof is strong in some places and so weak in others that it will fall for 5 or 6 feet high in an 8-foot entry.

Another opening, No. 2, shown in Fig. 2 is adjacent to No. 1, but about 800 feet away. This fine little mine is worked on the room-and-pillar system as are all other mines of the company where the rock does not cut out the pillars. Sometimes good rooms are in a swag. In No. 2 mine the coal runs from 3 to 10 feet high, with most of it between 5 and 6 feet. At present the mine is worked with four mules and 25 men, but rooms are being opened to increase the output. Mines Nos. 2, 3, and 4 are connected so that the 7-foot Stine exhaust fan pulls the air into No. 2, then to No. 3, and after it passes through the workings of No. 4

mine it is discharged outside the mine. The coal bed in No. 3 mine is very irregular, owing to squeezes and faults which make its working uncertain and difficult for both the miner and the company. This mine had high coal to start with for about

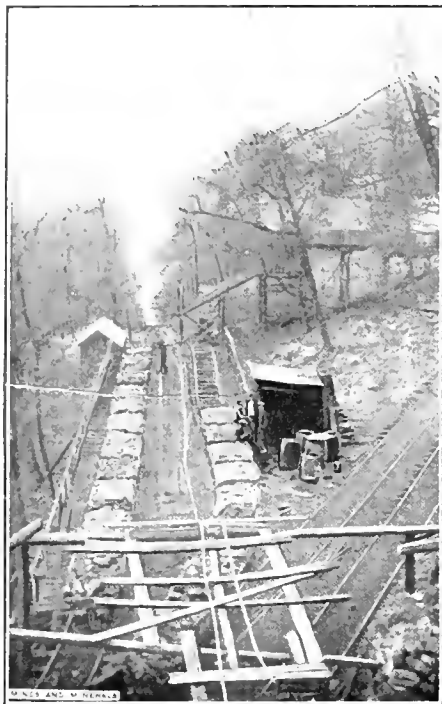

FIG. 3. UPPER TIPPLE, ORME, TENN.

105 feet; then it pinched out quickly; next came a long stretch of rock with a little swag of coal every now and then, sometimes sufficiently high for a breakthrough into the air-course, and then possibly it would be necessary to drive from 70 feet to 80 feet before another pocket of coal was found. The manager and superintendent became almost discouraged over this, but continued through the irregular ground and reached some of the finest coal in the South. On this entry there are 12 rooms. Each one of them is separated from the other by a rock squeeze. The coal in some places is almost entirely cut out, and in one place it was necessary to go through a squeeze to get out about 200 tons of coal on the opposite side.

Waves in the ocean give an idea of about how the coal and rock lie in this mine. In the morning the miner may have good coal. When he is visited in the evening he will pass you and say "she is going to squeeze," or else he has "struck a hole and cannot find the bottom." In this mine three squeezes have been worked through in the last 4 years; one took about 2 years to cut through, and then a large pocket of fine coal was struck on the left side of the entry, and a small one to the right side of the entry, which went up so steep that a jig road had to be put in to hoist the empty cars and lower the loaded cars. After going about 80 feet the coal took a

dip in the other direction, so that the miner had to shoot the coal in a hole and load the car above his head. There is a small Stine booster fan in the return air-course to assist the larger fan which is at mine No. 4.

The No. 4 mine was opened in 1902, and is the original Battle Mountain mine, from which the greater part of the coal has been obtained. It is 3,700 feet from the knuckle of the gravity plane and is connected by a narrow-gauge railroad over which the mine cars are hauled by a steam locomotive.

The main entries in No. 4 mine are driven on the three-entry system with cross-entries turned to the left and right, numbered up to 19 and 20 left and 11 and 12 right. The haulage inside this mine is accomplished by the tail-rope system which starts from the 16 left entry. Mules haul the coal to this entry. The main entries stop at this point because here the first squeeze in this mine was encountered. The right-hand air course was stopped, but finally it was cut around the squeeze in the coal, and strange to say the left air-course had coal all the way, never less than 4 feet until entries No. 15 and 16 were passed, where they encountered a roll at the end of the side track. About 1,600 feet from the main entry, right-hand entries were turned to the north in the same direction as the main entry before the roll was met. Some good coal was found here but squeezed in cross-entries 17 and 19; then it pinched out and in cross-entries 19 and 20 there is 2 feet of coal, which is about the same as a squeeze out, for that thickness of coal is not economical to work. The entry going north is in about 9 feet of coal, but the swag is only about 80 feet wide, with a rock squeeze on both sides. These entries are being driven as wide as rooms; all slate is gogged; and the machine slack, which hurts the sale of coal, is loaded into mine cars and sent to the boilers at the mouth of this opening.

In No. 4 mine, entries Nos. 9, 10, 11, and 12 left are having the entry stumps

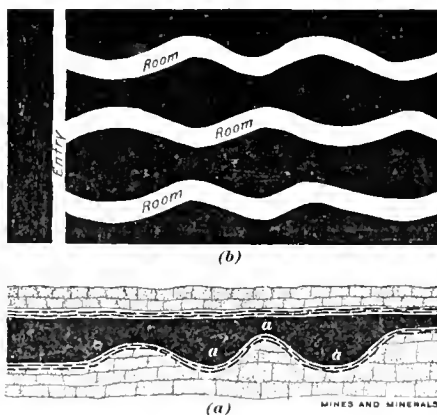

FIG. 4

drawn. New entries Nos. 9 and 10 are being driven west. The main entry squeeze took about 15 months to cut through, as there was a lack of air power to drive the rock drills. On reaching the coal, Nos. 9 and 10 right entries going



FIG. 5. LOWER TIPPLE

northeast furnished coal for about 800 feet and then played out. These were driven about 1,500 feet further, sometimes in hard material, and sometimes in soft material; nothing was found, however, but a small streak of coal. Entries Nos. 11 and 12 right were then turned off at right angles from these entries, and still there was not enough coal found to work, but they were continued about 500 feet, then stopped and all the track taken out.

The company has never used diamond drills, but it is probable that they will make use of them to prospect the field in the future. As may be seen, conditions in this coal field are peculiar, it being uncertain whether the coal will be in a large or small pocket, as the floor of the mine rolls in serpentine courses. The main entry stayed in coal longer than any entry that was ever driven, and all the left-hand entries have been driven through from 1 to 4 squeezes, and worked until they came to solid rock. Sometimes it was possible to work around some of these pinches and thus save rock work.

To undercut coal seven Ingersoll-Sergeant punching machines are used. These give satisfaction, as they are flexible enough to cut coal on the many ups and downs in the floors. In some places the coal is faulted from 4 feet to 6 feet up or down but this is unusual. There is a very good slate or rock tippie that has been dumped over for 5 years. Oc-

asionally it slides away with a part of the mountainside under it, but is brought back. For the outside haulage there is a 10-ton steam mine locomotive; and a gasoline motor that has given a good deal of trouble. No gases have been found in this mine, probably because of its height above water level; however, no chances are taken on this score, and

Some of the miners ride down on "horses" made of a few pieces of 2-inch plank as illustrated on page 70 of MINES AND MINERALS for September, 1909.

來 來

Spring Frog and Latches

The following description of an automatic frog and latches has been furnished by James Stewart, superintendent for the St. Louis, Rocky Mountain and Pacific Co., at Van Houten, N. Mex. The incline on which it is used is double tracked and is on a pitch of 35 degrees, the tracks coming together at the bottom as indicated in Fig. 1. The idea of the frog is to do away with the guard rails in which the hoisting rope so often catches, sometimes resulting in wrecking the trip. The tongue of the frog, *A*, is dovetailed and bolted into the frog rails as shown in Fig. 2. One end of the piece *B* works in a slot in the toe of the frog *A*, and the other end is connected with the lever *C*. One end of this lever *C*, is pivoted by means of the arrangement *D*, the outer end carrying a roller. The arm *C* is held in place by the fluted spring *E*, as shown in the drawing. The frog is shown set for the left-hand track, No. 1. When the next trip comes down on the right side of the incline, the wheel of the car throws the tongue *A* into the proper position and the lever *C* assumes the position of the dotted line, where it is held by the spring *E*. The mechanism

is covered by a steel plate with holes through which it can be oiled. The top of this plate is below the top of the head of the rail and is intended to remove any possibility of the rope being caught.

The mechanism operating the latches is also covered with a plate of the same dimensions as that upon which it is fixed, and is shown in its several details in Fig.

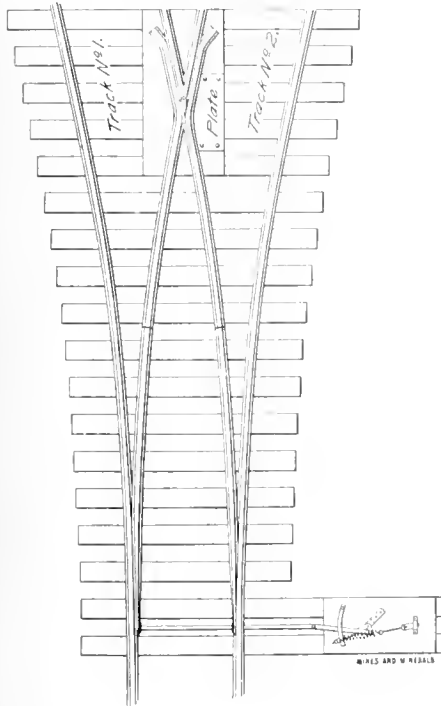

FIG. 1

ventilation is made to comply with demands for the "C" class of mines of Tennessee.

Class "C" mines include every coal or other mine employing over 20 men and 3 mules, that does not at present or may in the future liberate sufficient firedamp to be detected on the flame of a modern test lamp and has not been classed as a dry and dusty mine by the chief inspector of mines. The minimum quantity of fresh air that must be supplied to each person employed in the mine is 85 cubic feet per minute, and for each animal 500 cubic feet per minute. The inspector may demand more air than the above for each person, and has the power, if conditions warrant, to take the mine from one class and place it in another.

At the head of the incline there are two large rope drums, one in front of the other. The rope goes around both drums; five times over the rear and four and one-half times over the front drum. One-inch steel rope is being used for the 11 cars and the load that goes down an incline. Near the shipping tippie at the bottom there are two large rooms, which contain the air-compressor and a shaker screen engine. The mule stables are also at the bottom of the incline. Most of the miners ride on the incline trip to go to or from their work,

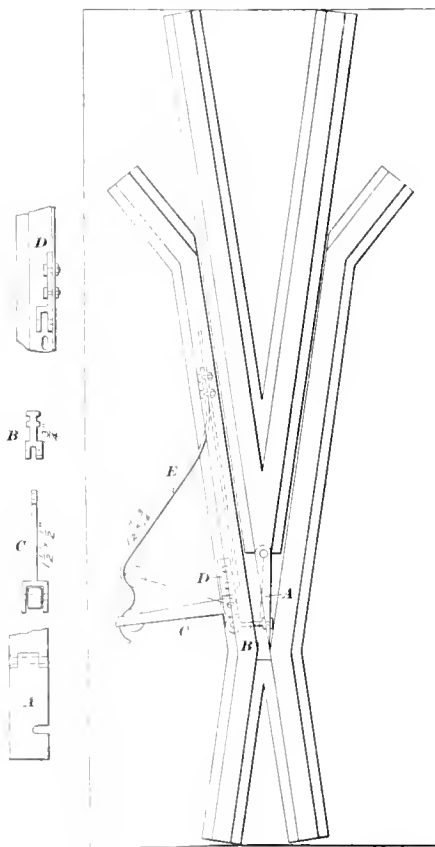

FIG. 2

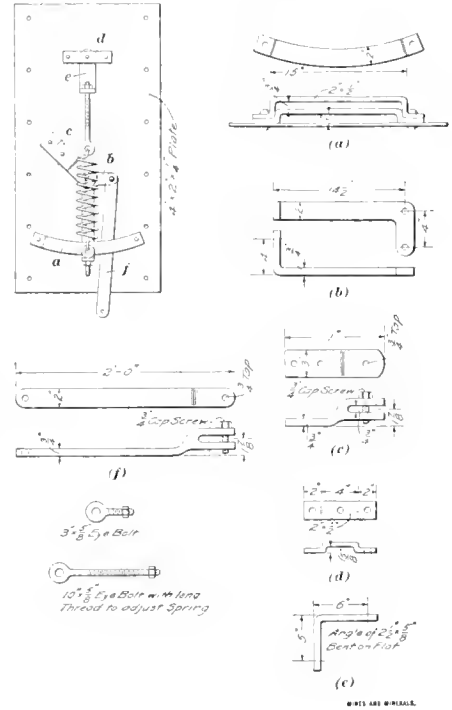

FIG. 3

3. In Fig. 1, the latches are shown set for the left-hand track No. 1. When the following trip descends on track No. 2, the latches are thrown. The lever carrying the springs is thrown over to the opposite side of the sector from that shown in Fig. 1, in which position it is held by the spring until set by another trip on the opposite track. Mr. Stewart uses a spring from an old automatic tippie.

來 來

The motor truck is now a real factor in mining. In the prairie and desert regions, the introduction of automobile traction haulage has had a pronounced effect in stimulating mining. Not only does it render a new camp more independent of railway facilities in getting started, but, having decent wagon roads, both mining and milling plants are able to operate successfully. Recognizing this modern idea, the county commissioners of many of the western states pay attention to the building of splendid roads. Throughout Utah, Nevada, and California, the citizens have awakened to this "good roads" sentiment. There is one highway now completed clear across the state of Nevada, and this has been built with the idea of boosting the mining industry.

Mine Supports in Germany

Various Forms of Timber, Steel, and Concrete Supports. Use of Rails, Pipe, and Flat Iron

Translated for Mines and Minerals

IN the Schwallbach mine in the Saar district, Germany, the greatest pressure comes on the timbers from the floor and sides of the excavations, owing to the strong roof. Three-stick timbering only lasted a short time, and in addition there was considerable difficulty and expense incurred in keeping the galleries free from creep. The timbering shown in Fig. 1 (a), (b), (c), (d), (e), and (f) represents the various methods adopted to brace the three-piece sets. When using the bracing shown, the customary scarfing between the collar and legs of the set is omitted, and at first the somewhat cheaper form of arranging the braces as in (a) was selected. This proved unsatisfactory on haulage roads, and the forms of bracing shown in (b), (c), and (e) were

shortest, while the upper and lower braces have the same lengths. Round sticks about 6 inches in diameter are used for braces, and, as shown, are separated from each other by longitudinal timbers, which makes a compact and solid frame. In this case the haulage road does not rest on the lower braces, but on ties, which are supported by sills made from the legs of old timber sets. The cost of three-piece timber sets was \$2.26 per linear foot, and they lasted on an average about 3 months before they were replaced. The sets with the present method of reinforcing cost about \$4.86 per foot, but they last 1 year,

and this particular form of collar has been adopted with great success where those made of rails alone have failed. The collar consists of two iron rails curved as shown, bound together at the ends and bolted to a flat iron tie piece. The pressure acting downwards on the rails is transmitted to the flat iron straining piece, which receives the tensile strain through bolts and the turned up ends shown. It has been proven that these truss beams have five times the bearing capacity of straight iron rails. They have been in use over 1 year, exposed to exceptionally heavy pressure, where for-

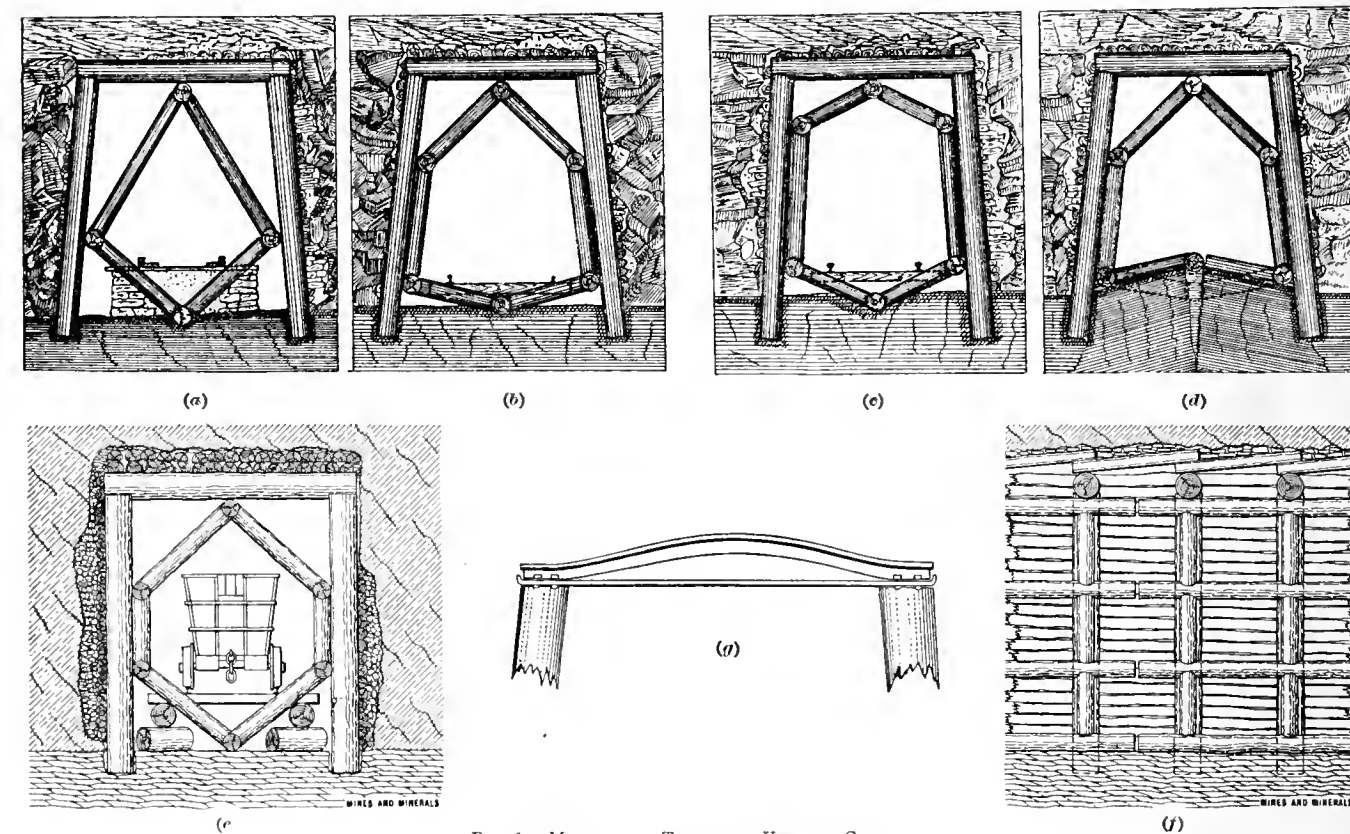

FIG. 1. METHODS OF TIMBERING USED IN GERMANY

chosen. The effect of floor pressure is shown in (d), where creep has caused the floor braces to buckle, owing to their being inserted too flat, and thus assisting in causing the legs of the timber set to be moved by the pressure. After this experience, the floor braces were pitched at greater angles, as in (e), and the legs of the sets were placed almost vertically. The braces then took the form of an irregular hexagon in which the two side pieces parallel with the legs are the

or four times as long as the three-stick set alone, which means that they are only one-half as expensive.

The cost of the first braced structure was \$2.69 per foot, and lasted about 6 months, while the second design (e) promises to last over a year, which means that it is considerably cheaper than the three-set timbering without braces. The distance of the sets apart will depend entirely on the kind of material in the walls of the excavation and the pressure coming on the timber sets.

At the tunnel of the Consolidated

merly five iron rails bound together were either bent or broken within 3 to 5 months and had to be renewed. The collar or truss, consisting of two iron rails with flat iron ties underneath, costs \$21.25 for material and labor in Germany.

In the Essen-syndicate mine, "King Wilhelm," in the South Essen mining district, iron and concrete posts are used as mine supports. This mine is worked "longwall" and the traveling roads are kept open by pack walls. At the angle formed by the junction of two roads, "the lye," it is necessary to use extra care

*Zeitschrift für das Berg-Hütten-U. Salinenwesen.

with the walls, and usually timber, to make the supports sufficiently strong to prevent the roof settling. The iron and cement post introduced in Germany is shown in section, Fig. 3. The iron posts consist of old cast-iron or wrought-iron pipes flanged at the ends as shown. These are set up at the junction of two roads and the

This kind of support has proved successful so far, but has not been in place over 1 year.

In the Bülten-Adenstedt iron mines belonging to the Ilseder Smelting Works, in the Goslar mining district, the ore bed is about 16.5 feet in height. The posts are therefore long and the collars, which are

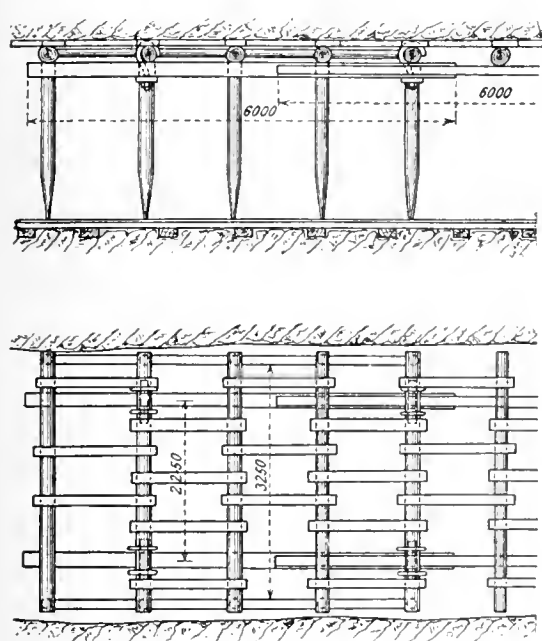

FIG. 2

pack wall partly built about them. The foot-rest is of plank and a sufficient number of wooden cap pieces are placed on the upper end to furnish the proper height for the roadway. The cap pieces at the base of the post are sunk in the floor, those at the top are strapped, as

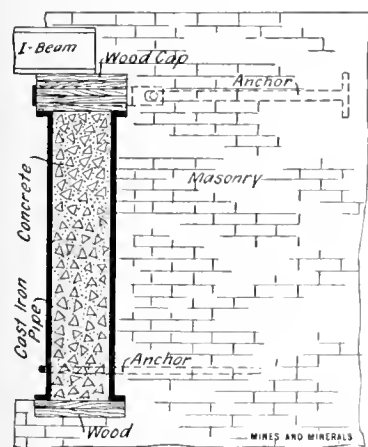

FIG. 3

shown, with an iron band and anchored in the pack wall. The lower part of the post is anchored in the same way in order to insure its remaining perpendicular and not being moved by a local movement of the pack wall near the road, the pressure of course at this place having a tendency to push the wall out into the empty space.

about 14 feet long, are supported by three posts fastened to the roof by an iron hoop (Fig. 2) and a wedge screw. The object of these hoops is to prevent the posts from being completely knocked out, as frequently happened when blasting before they were introduced. The hook arrangement facilitated work, as the props could be reset without great difficulty. In the Kings mine in the Königshutte coal mining district somewhat similar conditions prevail, and in order to save the posts from being knocked out through rock pressure or fall of rock or coal, the device shown in Fig. 4 is used instead of the hoop. It consists of an iron chain with a large ring at *a*, a smaller ring at *b* and a hook at *c*. The chain is wrapped about the post by drawing it through the large ring; it is then carried up over the collar, brought back, and the hook fastened in the ring *b*. In case a shot or rock fall knocks out the lower end of the post, the chain holds the post from falling and it can be put in place quite readily. This contrivance, which is made in the blacksmith shop, has stood the test wonderfully well.

The Reinhard system of movable props has been changed somewhat since 1910, and the new form shown in Fig. 5 has been adopted in the Reden mine in the Saar district, to some extent.

The post shown in section (a), Fig. 5,

consists of a pipe flanged at the bottom for a wooden foot-piece, and a jack-screw and nut, with a movable head surmounting the jack-screw. The head is constructed so as to receive a rail upside down, and with a slot in which a wedge is driven and which when keyed tight will force the rail up against the roof.

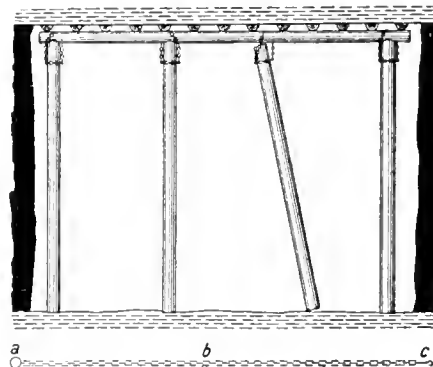

FIG. 4

The nut fits loosely into the upper part of the pipe. When making use of the portable prop a piece of plank is placed between the top of the head and the roof. The jack-screw is then worked and the

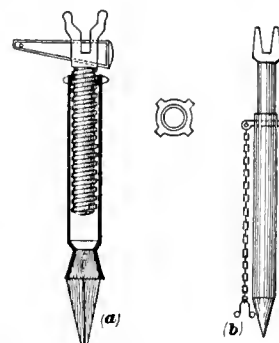

FIG. 5

post fastened rigidly in place. An old mine rail is lifted and placed in the head; one part being carried by the auxiliary prop (b), after which it is wedged in position. Lagging or wooden blocks are next driven above the rail.

The auxiliary post (b) consists of pipe,

chisel shaped at the lower end and containing a movable shaft that projects from the upper end, and which can be fastened in almost any place by a pin as shown. The upper part of the shaft has a grooved head for taking the rail and holding it near the roof. The post is securely connected to the rail collar

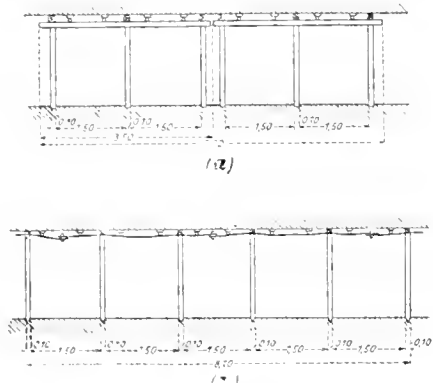

FIG. 6

by a chain. As the heading is advanced the rail collar is released and moved forward by knocking back the wedge in the movable prop. When the rail has been advanced sufficiently it is again wedged without the necessity of moving the main prop; however, the auxiliary prop is moved forward a distance corresponding with the movement of the rail. When the rail has been advanced to nearly its length, a new main post is placed under the center before any further advance is undertaken. The released main post is controlled by the jack-screw and can be used for another rail collar which has been advanced nearly its entire length. The distance from one rail collar to another depends upon the condition of the roof, but is generally from 2½ feet to 3½ feet. The principal advantage derived from the portable props, as compared with others, is that the roof is always supported during the moving ahead of the rail collars, because the main post remains in position and is not loosened. This avoids the danger generally present when placing timbers in a heading having poor roof. The system is recommended where the roof is traversed by vertical cracks and joints without being fissured so it has to be held up by special timbering.

When the collars are crushed above the posts so as to render them useless when recovered, as in the Heinitz mine in the Saar district, flat iron has been adopted with success. The flat iron bars as shown in Fig. 6 are placed exactly like wooden roof beams upon posts and held tightly in place by wedges driven between them and the roof. After several experiments, flat iron bars ¾ inch thick by 2 inches wide proved most suitable. They are punched with holes in the ends in order that they may be tied together

successively. One disadvantage due to the flexibility of the iron under heavy pressure and which caused the posts to crack, is overcome by tapering the lower ends of the posts so they will broom and permit the roof to settle without breaking the props. Through the use of the flat iron construction an economy in props is accomplished, as may readily be seen by comparing (a) and (b) Fig. 6. The prescribed distance between props, 5 feet, is maintained when flat iron roof beams are used, while where wooden posts are in use the adjoining ends of two beams require one post each. The weight of the flat iron having a section 2×¼ in. is about 1.69 pounds per foot which, with bar iron at 2 cents per pound, would cost 3.38 cents per foot. Provided the flat iron is in use 1 year and lengthened five times each month, the management estimates that about 95 per cent. of the money heretofore expended on wooden beams will be saved. Those parts of the flat iron which have been bent by the pressure of the wedges and posts are straightened out by hammering.

來 來

Air Compression

The efficiency of compressed air can be greatly increased by reheating. The gains are both direct and indirect. The chief direct gain is in the greatly increased efficiency of fuel used in the heating stoves as compared with the effect when coal is burned under boilers. It is commonly stated, and the statement is fairly correct, that when 1 pound of coal is burned in a reheater stove the commercial effect is as great as when 3 pounds are burned under a boiler. The increase in commercial efficiency when reheating air from 60° F. to 400° F. may be put at 35 per cent. The indirect gains are better lubrication of the compressed-air engine; less investment required, as a smaller plant will be needed; reduction of compressor engine friction as compared with the useful work done.

來 來

Briqueting Lignite

A number of tests have been made by the fuel-testing plant of the United States Geological Survey, and later by the Bureau of Mines, to determine the best methods of briquetting North Dakota lignite. It has been found that the lignite can be briquetted, some of it without a binder, and that its efficiency is thereby materially increased. The briquetted product also stands weathering and handling much better than the raw material.

Steaming tests have also been made with specially constructed fireboxes and grates and the results are highly satisfactory, as the efficiency of this lignite when properly fired is so increased as to

compare very favorably with that of fuel of higher grades.

The following statement has been made concerning the efficiency of North Dakota lignite in the gas producer and gas engine:

"The result of the steam test was so unsatisfactory that there is nothing by which a direct comparison can be made of the efficiency of the fuel used in the producer-gas plant as compared with the efficiency developed in the steam plant. Nevertheless, a comparison of the results obtained on other coals under the steam boiler is instructive. It shows that to produce one electrical horsepower hour in the producer-gas plant required 2.29 pounds of dry North Dakota lignite, whereas to produce the same result in the steam plant, required 3.39 pounds of the best West Virginia coal. This means that the North Dakota lignite, with the moisture eliminated, will do more work when used in a producer-gas plant than the best coal of the country will do in a steam plant."

來 來

Danger Signals in Pennsylvania

In accordance with Section 3 of Pennsylvania Bituminous Mine Code enacted June 9, 1911, danger signals in all mines must be uniform and of a design approved by the Chief of the Department of Mines. This law was enacted because fire bosses used whatever seemed to be handy as danger signals. Some would place a piece of board across the track; others wrote the word "Danger" on a piece of sheet iron or an old shovel. Jas. E. Roderick, Chief of Department of Mines, approved the following signal. The size of the signal



is 10 in.×30 in. with an oval in the center 10 in.×14 in. The color inside the oval is red and the color outside is black. A signal 24 in.×30 in. with the other dimensions as described will be satisfactory. The last paragraph of Section 1 of Article 5, reads: "The meaning of all danger signals shall be explained to the non-English speaking employes of the mines in their several languages by the mine foreman, assistant mine foreman, or fire boss through an interpreter." A sample signal should be placed on the surface so that the non-English speaking employes can see it and be taught what it means when placed in any entry or at the entrance to a room or the entrance to any place in the mine where such signals are likely to be found.

EXPERIMENTS

with the new electric shot firing system conducted by Erich Schietzel, the inventor, convinced those who witnessed them at Arma, Kan., that the invention is practical. The object of the invention is to eliminate the loss of life of shot firers, as all shots are fired from the surface and the mine may be vacated before the first blast is exploded.

Although Mine No. 8, of the Hamilton company, at Arma, is a new producer, having been placed on a tonnage basis November 7, 1911, some trouble has already been experienced from dust explosions, a serious accident of this kind having resulted from a windy shot early in October. On this occasion the two shot firers in the mine at the time narrowly escaped injury, and ventilation doors in the entries were blown from their hinges and more or less damage was done to mine equipment throughout the underground workings. Other mines in the southern Kansas district have experienced much trouble from dust explosions, and the operators of the Hamilton mines concluded that it was only a question of time until their new No. 8 property likewise would become subject to such disasters. As a rule the explosions have been bad enough only to damage the mine equipment, but occasionally a life is lost, and the annual death toll includes a number who have died in this manner. The pay of shot firers is high throughout the district, the rate ranging from \$4 to \$6 for an hour or two's work in the afternoon after the regular miners have quit their labors.

Mr. Schietzel, the inventor, formerly was employed by a German firm manufacturing electric shot-firing devices. The great drawback to the firer manufactured by this firm was the necessity of running two wires from the surface to each room, or group of rooms, to be shot. Where it was desired to shoot 40 or 50, or even more, rooms it can be realized that an intricate tangle of wires would of necessity be run down the shaft, and in such installation there would be serious danger of the wires becoming crossed. For years Schietzel worked on a device by which the rooms could be fired at intervals and at the same time do away with the necessity of running so many wires from the surface into the workings. The result was the invention of his sparker box which makes it necessary to run only two wires into the mine. It is claimed for this invention that it is the only one in existence requiring only two wires operated from a switchboard on the surface.

Fig. 1, an enlarged diagram of a portion of the mine workings of the Hamilton No. 8 property, shows the idea of installation of the wiring system, the safety switch boxes, and the sparker boxes.

The main wires are run down the shaft

Electric Shot Firing

Apparatus Designed to Permit Shots to Be Fired From the Surface at Will in Any Part of the Mine

By Lucius L. Wittich

to the safety switch box *a*. When workmen are in the mine this switch is thrown out, and consequently all wires beyond this box, in the mine workings, are dead. Only the firer is to be equipped with the key to the safety boxes, and by a simple little device, a metal rod attached to the inside of the

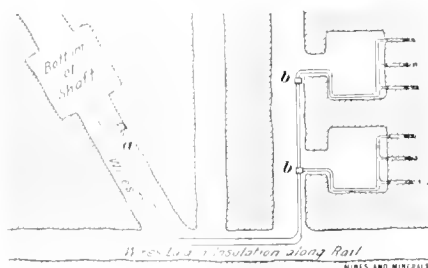

FIG. 1. WIRING FOR ELECTRIC SHOT FIRING

door, the switch must be thrown out when the door to the box is closed, as the rod will not permit of the door being closed when the current is on.

From the safety switch box *a* wires are run in both directions in the mine, connecting with the sparker boxes *b* which are placed at convenient and safe places on the entry at the necks of the rooms. Where it is desired to shoot more than one room at once, one box may answer for two or three or any number of rooms; but as the disadvantages connected with firing more than one room at a time are many, it is considered advisable to employ one box for each room to be fired.

From each sparker box, two leading wires extend into the room and are attached to the fuses.

The sparker box is 5½ inches in width, 6 inches long and 2¼ inches in thickness. It is composed of metal. The front is removed by taking out four corner screws. Packing is used in setting the front in place in order that it will be water-tight. In Fig. 2

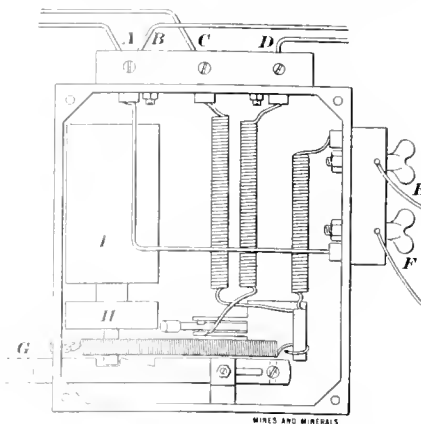

FIG. 2. INTERIOR OF SPARKER BOX

is seen the interior view of the sparker box, the front being removed. The two-wire system and connections at the top of the box are the main wires through which comes

the current from the batteries or other power sources on the surface. Three of these wires, *A*, *B* and *C* are live wires. The wire *D*, in all sparker boxes, is a dead wire until after the room has been fired when the mechanism of the box throws the current into wire *D*, thus completing the circuit to the next box in which the wire *D* likewise is dead until after the room has been fired and everything is in readiness for the current to continue to the next box.

At the side of the box, the wires *E* and *F* are the leading wires and extend into the room. The miner uses his own judgment about placing these wires. It is policy to fasten them securely at the opening to the room, but they may be hung loosely on the wall, out of the way, in the main body of the apartment or tacked loosely to the timbers by the side of the road up to a safe distance from the face of the working place. The button *G* at the lower left-hand corner of the sparker box must be pressed in before the shots in the room are connected with the switchboard on the surface. The fact that the safety switch at the bottom of the shaft has not yet been turned and that there is no current in the mine eliminates the possibility of danger from this proceeding. Failure to press this button in disconnects the shots in this particular room from the switchboard and the shots, as a result, will not be fired, but the circuit will be left open in this box and in all other boxes where the miner has neglected to push the button and the current will pass on until it comes to a box that is connected with the shots. Even were the safety switch thrown on, and even though connections were completed with the surface, there would be no chance of an explosion until all was in readiness, as the discharge of the blasts is regulated by the operator at the switchboard.

After all is in readiness for firing the last step taken underground is the throwing of the switch to place the underground wiring in connection with the switchboard. Should lightning strike the wires somewhere above at this time, the result would be the firing of possibly two rooms, but such a circumstance would be rare. Even should it occur there would be comparatively little danger to the one remaining man in the mine as he would be at the bottom of the shaft awaiting to be hoisted, and even should a fire result from the blast, which would not be likely in view of the small amount of powder discharged, he would have a reasonable length of time in which to reach the surface before the force of the explosion would overtake him.

Connections from the sparker boxes to the blasts in each room are made to obtain

a complete circuit. The method is simple, and even the miners who have never had experience in electric shot firing soon learn the method. Whoever is placed in charge of the firing has ample time during working hours to go from room to room and instruct the miners in making their connections properly.

A Kansas law provides that no more than three shots be placed in one room. At the Hamilton mine the workmen are generous with their powder. They use a cartridge about 4 or 5 feet in length. FF powder is in most common use. Each cartridge holds from 4 to 5 pounds of powder.

The switchboard was stationed in the engine room of the mine, the current being obtained from a dry battery. The inventor demonstrated his ability to fire rooms in either side of the mine at will. By switching the current he could fire shots in first one side of the mine and then the other, or he could first complete the firing of one entire side; then switch over to the other side. However, it is desirable to alternate, as this method permits the dust and gas created by the shots to clear away in each instance before firing the next room or entry.

Schietzel maintains that it is policy to fire the rooms nearest the shaft first in order that the smoke and dust may more rapidly lift should it be found necessary to go into the workings for any reason after one or two rooms have been fired.

The arrangement at the Hamilton mine enabled the inventor to begin firing the rooms nearest the shaft, thus winding up with the firing of the shots in the entries. The east and west entries had separate wiring. He could fire one, two, three, or as many rooms as he desired on the east side; then switch and fire as many as desired on the west side.

Two wires lead from the switchboard down into the mine. It is necessary that they be run through conduit or lead-covered cable down the shaft, and it is advisable to have them so protected throughout the mine.

At the top of the switchboard, Fig. 3, are three instruments, each equipped with a dial, the instrument to the left being an ammeter, the one in the center an ohmmeter and the one to the right a voltmeter. Beneath the ammeter dial is a switch, in a box which cannot be closed if the switch is connected with the battery. This is merely a safety precaution insuring a dead wire into the mine workings as long as this switch box is closed. In beginning the firing test, the inventor threw the switch to the ohmmeter, which tested the wires and connections. A correct reading on the ohmmeter is required in order to insure perfect connections. When the ohmmeter registers correctly the operator throws the switch downward, which connects the board with the batteries. At the right of the board, beneath the voltmeter is a second switch which throws the current into either side of the mine desired.

As rapidly as the battery or dynamo switch can be thrown out and replaced again just so rapidly can the rooms be fired. In case of a short-circuit a fuse plug in the center of the board will be blown out. The firing of the shots is registered by the ammeter. Should the switchboard be installed at a mine where the electrical equipment furnishes a current of 300 volts or more it would be stepped down with the rheostat located beneath the fuse plug. Only 75 to 100 volts and $2\frac{1}{2}$ amperes are required to operate the firing system. With this power the inventor claims shots may be fired to any distance. As the firing of the rooms is done consecutively, the operator knows at all times which room is being fired. A diagram of the mine workings can be utilized to advantage in the operation of the switchboard, and should any room fail to respond to the current the operator knows at a glance where to go to make an investigation of the trouble.

When the current reaches the first box, it exerts a magnetic influence on the disk *H*,

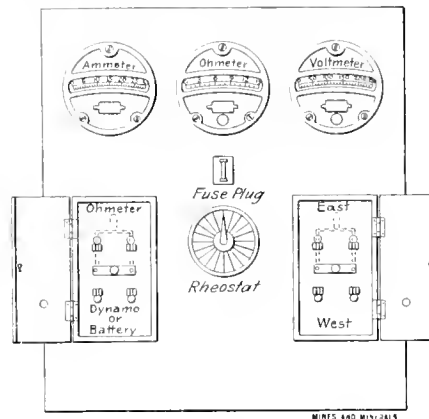

FIG. 3. SWITCHBOARD

which is drawn upward to the magnet *I*, thus releasing the rod *G*, which of necessity must be pushed in before the current can carry into the room where the shots have been prepared. The rod, thus released, returns to its original position, permitting the current to travel to the next sparker box. If this rod is not pushed in the first place, the current goes through this box to the next box. When the rod is pushed in, the current to the next box is disconnected and the only way the rod can be thrown out is for the room to be fired or for the lid of the box to be removed and the disk *H* lifted. This device prevents any one meddling with the box after the button has been pushed in and it has been placed in readiness for firing. Under ordinary circumstances it does not become necessary to remove the lid of the box, as the firing of the room springs the button back into original position and the current into that room is dead until the button is again pushed in.

As it is often found advisable to cause the shots in a room to be fired in quick succession, rather than simultaneously, a delay-action fuse can be used in connection with

the shot-firing device herein described. One shot may be fired by a direct-action fuse, which ignites instantaneously and is sensitive to the electric current. The delay-action fuse receives the current at the same instant as the direct-action fuse and ignites a tape fuse which extends from the tube connecting with electric wires. The tape fuse may be timed to ignite the powder from 5 to 10 seconds later than the instantaneous fuse.

Several interesting demonstrations were made by the inventor. He did not have the entire mine wired when he started on his experiments, but eventually the entire workings were equipped and the necessity of a shot firer going under ground was eliminated. Some trouble was experienced with the union laborers before they would look favorably on the invention. They had complained that the possibility of serious accident from shot firing was great, yet they hesitated before giving sanction to a device which would eliminate the necessity of a man being in the ground when the blasts were fired. The shot firers who had been getting high wages for a few hours work were the ones who opposed the installation of the system. The demonstration was under the management of the Schietzel Electric Shot Firing Co., of Des Moines, Iowa.



United States Coal Exports

The value of the coal sent to foreign countries last year was \$52,500,000, against \$21,000,000 in 1902 and \$8,333,000 in 1892, having increased over 500 per cent. in 20 years and 150 per cent. in the last decade.

Even these large figures of more than \$50,000,000 worth of coal sent to foreign countries in the fiscal year 1912 do not include the value of that passing out of the country in the form of "bunker," or fuel coal laden on vessels engaged in the foreign trade, which aggregated nearly \$23,000,000 in value, making a total of over \$75,000,000 as the value of the coal passing out of the United States during the fiscal year.

The quantity sent to foreign countries was, according to figures compiled by the Statistical Division of the Bureau of Foreign and Domestic Commerce, 17,500,000 tons, against 7,000,000 in 1902 and 2,500,000 in 1892. Thus the quantity exported in 1912 is seven times as much as in 1892, and the value over six times as much in 1912 as in 1892. Coke exports also show a decided growth, the value in 1892 having been but \$112,000 and in 1912, virtually \$3,000,000.

A comparison of the quantity and value of coal placed for fuel purposes on board vessels engaged in foreign trade in 1912 can only be made with comparatively recent years, the figures of bunker coal laden on vessels in 1912 being 7,093,212 tons, valued at \$22,802,876, against 6,003,794 tons, valued at \$19,671,778 in the fiscal year 1909, the earliest date for which complete figures of bunker coal movements are available.

The Coal Dust Question

A "Wet Mine" Not Necessarily a Safe Mine—Practical Methods of Applying Stone Dust Described

*By Samuel Dean**

THE following is taken from Section 18 of the Colorado Coal Mine Regulations: "That in all coal mines known to generate explosive gas that the owner or agent shall provide and adopt a system by which water under pressure or otherwise shall be sprinkled and make damp all accumulations of fine coal dust from time to time that may accumulate on any haulage road, rooms, stopes, or other working places."

There is often a scarcity of water in the vicinity of the mines in the Rocky Mountain region, and should the law be revised at any time it would appear that this part of it should be given careful consideration.

Where stone dust is distributed through a mine in such a manner that small coal, or coal dust would become thickly mixed

*Delagua, Colo.

with, or diluted by the stone dust at the initial stage of an explosion caused in any manner, the mixture cannot come under the head of "coal dust," having regard to the view of the coal-dust danger as it exists today.

At Hastings, a Colorado coking coal mine, where an explosion occurred in June last, there is no shortage of water. The explosion traveled through naturally damp workings, which are being driven to the dip. A stream of water flows down the back slope, or intake airway, and water drips from the roof in places in the main slope, or haulageway, which is also the return airway.

Everything pointed to a quantity of gas near the face of a heading off the third south having been ignited by a defective Wolf lamp in the hands of a fire boss (about

five-eighths of an inch of the gasket on the top of the glass was found bent over, and the lamp ignited explosive mixtures on the surface during tests made after the explosion). The condition of the body of a miner found in the third north heading about 650 feet from the point of origin, gave valuable information. This man was evidently standing with his back to the face of the north heading when he was met by the blast. From head to feet his body was punctured with small coal. In the pioneering cloud of the explosion there was not dust alone; the unfortunate man had been struck in the chest by a piece of coal or rock which left a deep wound 4 inches in diam-

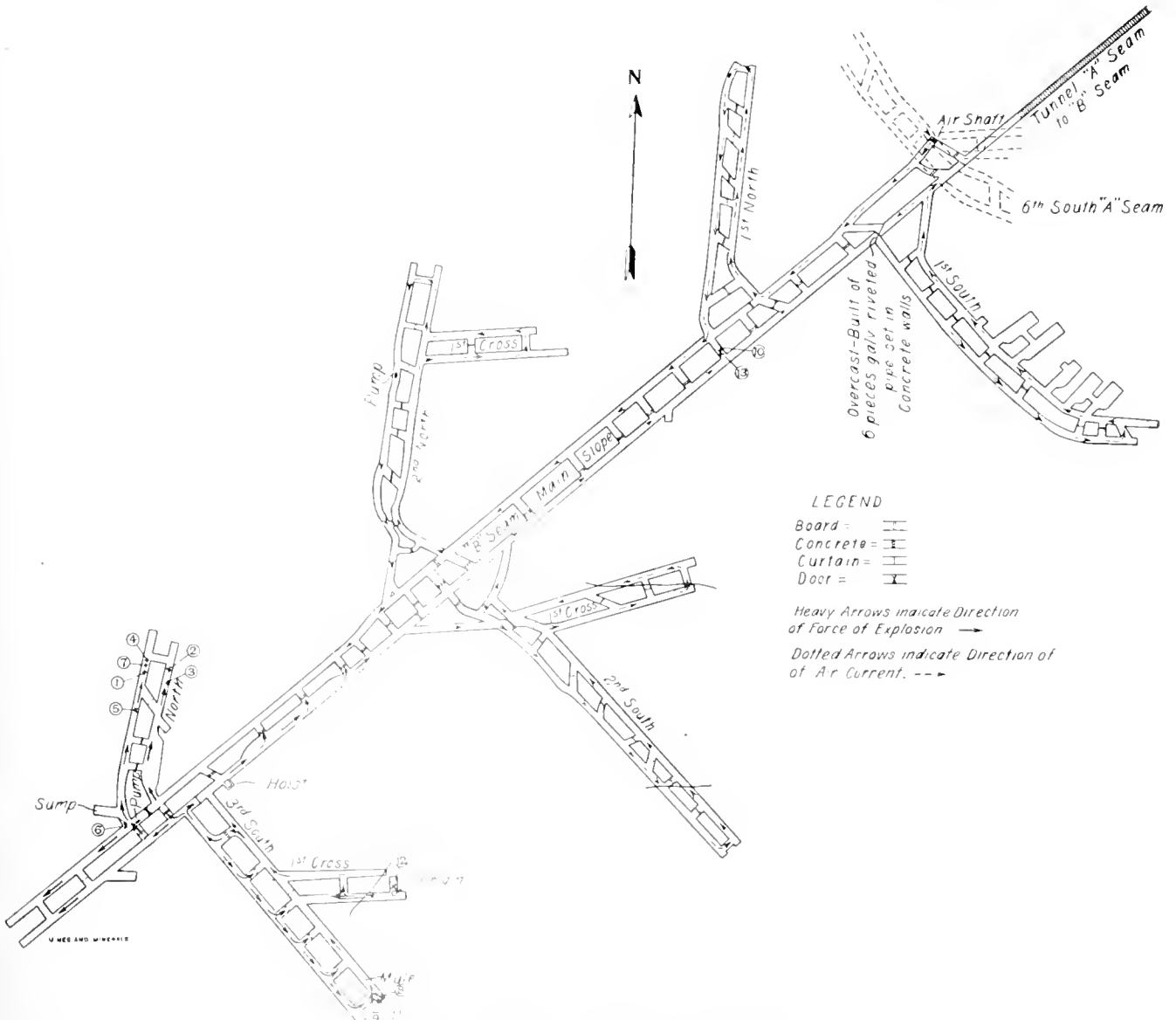

FIG. 1. PLAN OF WORKINGS IN B SEAM, HASTINGS MINE

eter, and there were other wounds from 1-inch diameter down to the size of a pin head. His hair was singed. The flame did not strike him first, otherwise he would not have been standing erect facing the onrushing small coal. The flame and the "cloud" may have been traveling together, but it is a reasonable conclusion that the flame obtained its fuel from the cloud of damp dust and coal assisted by a small percentage of methane in the air-current, and

The origin or the cause of the explosion was gas, but any suggestion that gas alone was responsible for the propagation of the flame for a distance of over half a mile will not bear investigation and can be dismissed. Before the accident the quantity of air entering the back slope was 20,000 cubic feet per minute, and the amount of methane traveling with the return air up the main slope has never been found to be as much as 1 per cent. of the mixture; three-tenths

sary for propagation, the pressure was relieved, and the explosion ceased. Had the slope continued with a cross-sectional area similar to that of the tunnel the explosion would no doubt have traveled to the outside with terrific force.

An important change might have been revealed by comparing the results of microscopical, chemical, and distillation examinations of small coal and dust gathered from the path of the explosion, and of coal

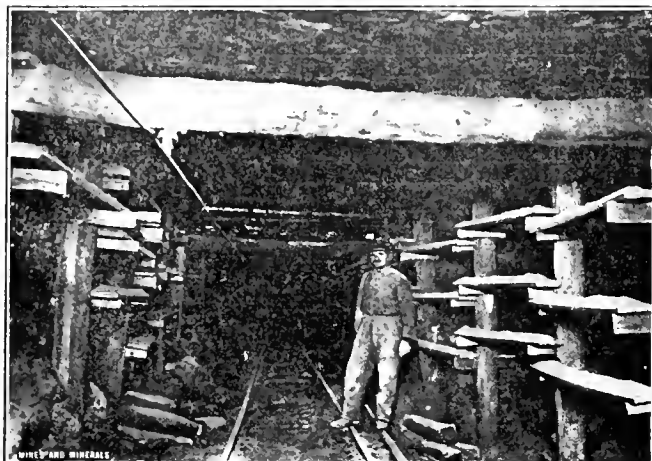

FIG. 2. ADOBE DUST ON SHELVES ON SIDES OF AIRWAY

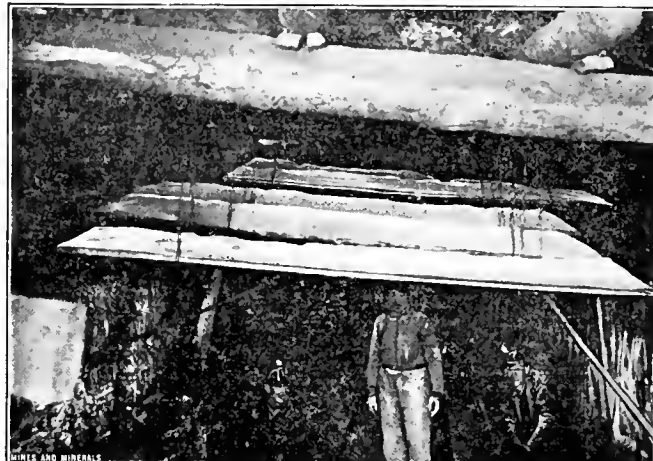

FIG. 3. ADOBE DUST ON SHELVES HANGING FROM ROOF

in that manner the explosion was propagated up the slope. Above the outby end of the rock tunnel from *A* seam to *B* seam (see plan), or over half a mile from the point of origin, beads of coke were found on the props, the coke adhering to the outby sides of the props. Coke was also found in other places nearer the point of origin.

It is important that all bias be removed when considering this explosion. The first State Inspector to enter the workings after the disaster declared that the explosion had traveled through a wet mine. Pools of water lay in the cross-entries driven north and south. Water was loaded with the coal at some of the faces and dripped from the cars as they were hauled up the slope. The wet and dry bulb readings taken before the explosion in all parts of the mine showed relative humidities which varied from 92 to 97 per cent. with an average temperature of 60° F. Yet some parts of the mine which were not touched by water, but only came in contact with the humidified air, would not be considered sufficiently wet by the critical observer. And it was possible to pick up handfuls of comparatively dry fine coal in places where it had fallen from the end-gate cars and been crushed by the traffic. But it is doubtful—and this statement is most important—if it is possible to constantly maintain, by artificial means, in a naturally dry mine, the damp condition which is general in all parts of this mine during the summer months. And it should not be forgotten that this explosion occurred in the summer time.

and one-half of 1 per cent. has been found. The explosion occurred about 9:30 P. M. on June 18 last, and the following are barometrical readings taken on the dates, and at times stated:

Date	Time	Reading
June 14	7 A. M.	23.57
June 15	7 A. M.	23.50
June 16	7 A. M.	23.70
June 17	7 A. M.	23.87
June 18	7 A. M.	23.80
June 18	9 P. M.	23.88
June 19	7 A. M.	23.88

The Hastings mine is located in the eastern foot-hills of the Rocky Mountains at an altitude of 6,450 feet above sea level. The maximum and minimum barometer readings recorded are, respectively, 23.99 and 23.00. It will be observed that the explosion occurred when there was a high and rising barometer.

Where the rock tunnel connects with the upper, or *A* seam, the height from the rail to the roof is 20 feet, tapering down for a distance of 200 feet to where the roof joins the ordinary height from rail to top of *A* seam. Wide openings also branch off in three directions at the top of the tunnel. These openings have other branches leading into worked-out areas filled with air no doubt lacking in oxygen. The explosion appeared to have gained its greatest force coming through the tunnel, every timber being swept out, but on getting expansion in the high and wide places the pioneering cloud split up, the flame no longer had that concentrated supply of fuel neces-

from the *B* seam which had not been in contact with flame, a change which might have convinced the most skeptical as to the cause of propagation.

At the Delagua, Colo., mines, adobe dust has been applied over 8,500 linear feet of entries. And in case of an ignition of fire-damp, or in the event of an explosion starting in any other way, reliance would be placed upon the adobe dust on shelves and projections along the entries to prevent the spreading of the flame. It is not considered possible for an explosion to be propagated, by the aid of small coal or coal dust, through the entries which are adobe dusted. Figs. 2 and 3 show the different arrangements of shelves in the fourth and fifth north entries. These two entries, with the cross-entries turned off them, are treated in this manner. The first, second, and third north main entry districts are still sprinkled with water, so that at the present day there is a good opportunity to compare the two methods in use at Delagua.

Up to the present time adobe dust has not been applied at the face of working places. Firedamp is seldom found and then only in very small quantities. The coal is undermined and blasted with permissible explosives. Special shot firers are employed who condemn all shots drilled in the solid, or drilled deeper than the undermining. The charge limit is 1½ pounds of explosive tamped with adobe. It is seldom that more than 1 pound of explosive is used per shot, but over the charge limit is sometimes used in rock shots; and the roof, floor, and sides are thickly adobe dusted for 100

feet on each side before the shots are fired. Shot firers make daily report, as shown in Fig. 4, and strict compliance with the rules is enforced. Under these circumstances it has not so far been considered necessary to apply inert dust at the face.

THE VICTOR-AMERICAN FUEL COMPANY

_____ Mine, _____ 191__
 SHOT FIRER'S DAILY REPORT
 District of mine _____
 Time first shot fired? _____ Time last shot fired? _____
 Number shots examined? _____ Number tamped? _____
 Number fired? _____ Number of shots condemned,
 reason why, and where located? _____

 Did you fire any shots on Main Haulage roads back
 from the face? _____
 Number of missed shots, where located _____

 Number of blown-out shots, where located, and cause
 of blow out? _____

 Did you use a wooden tamping bar for tamping all
 charges? _____
 Did you find any one in the mine during the time
 you were firing shots? _____

 Did you find any miners with detonators in their
 possession? _____
 Did you examine all the places again, with the aid of
 a safety lamp, after you had fired the shots, and leave
 your initials in chalk on the face where the coal had
 been shot down? _____
 Did you fence off all missed shots? _____
 Is your safety lamp clean, and in good condition? _____

 Did you find any gas in the working places? _____
 State the correct time you left the entrance to the
 mine? _____
 State here any further remarks you wish to make

 _____ Shot Firer

FIG. 4

Efforts are made to keep the main roads clean, and free from accumulations of small coal, and coal dust, but success in this direc-

accumulate between the rails and leave it in piles along the side of the road. These piles are not considered dangerous, on account of containing a high percentage of adobe, and because of the heavy supplies of adobe dust on the shelves, but they are removed whenever men are available for the work. Occasionally water has been sprinkled between the rails where the roof and sides are covered with adobe dust. In the cross-entries reliance is placed upon the adobe on the shelves, and that which has been thrown on to the roof and sides by hand, also on the crude adobe which has been scattered over the floor and mostly reduced to dust by the traffic. Small coal and dirt in cross-entries is not removed except when it impedes the traffic.

About three times a month all surfaces of the fourth and fifth north haulage roads, and the slope are given a covering or coating of adobe dust which is applied by machine. This machine is composed of a small Roots blower belt-driven from a 3-horsepower direct-connected motor taking current through a trolley pole, the whole being carried on a truck. The quantity of dust which the machine will blow or distribute is 100 pounds in 12 minutes. The finer particles of dust propelled from the blower will travel a distance of over 2,000 feet suspended in the air where the air-current is traveling at a speed of 300 feet per minute. The mechanical dust distributing train consists of a locomotive, mine car containing dust in sacks, and the machine. Two men are employed, one on the locomotive and the other feeding the machine and handling the hose. The train seldom stops, but proceeds at a slow pace with the man at the hose spraying from side to side and on the roof. In this way over 2 miles

filled with adobe dust by hand, so that such places can never again become resting places for dangerous quantities of fine coal dust. The upper sides of all roof timbers are covered with adobe dust. All shelves which have been erected recently are practically fireproof, being covered on the upper side with thin sheet iron.

The thought has been expressed that large quantities of stone dust in mines may cause pulmonary troubles. Where adobe dust is used no trouble of this kind has developed, nor have the workmen in the mine suffered any discomfort. But undoubtedly

TABLE 1. ALTOFTS SHALE DUST

Specific Gravity	Percentage of Magnetic Particles	Solubility in Distilled Water	Solubility in Dilute Hydrochloric Acid	Solubility in a Digestive Fluid
2.65	2.70	2.186	6.886	2.557
ADOBE DUST				
2.77	50	4.586	9.336	4.591

the adobe in the vicinity of Delagua is not of such a clayey nature as that found further south and in parts of New Mexico. It has been decided to install a mill for the purpose of reducing suitable shales to dust for use in the mines at a future date.

Through the kindness of Doctor Garforth the Delagua adobe has been microscopically examined by Mr. H. Crowther, who has made a comparison of the Delagua dust with the Altofts dust made from clay, or argillaceous shale, inasmuch as the latter has been favorably reported on by Dr. J. S. Haldane, the eminent physicist (see report



FIG. 5. GATHERING DUST FROM COUNTRY ROADS

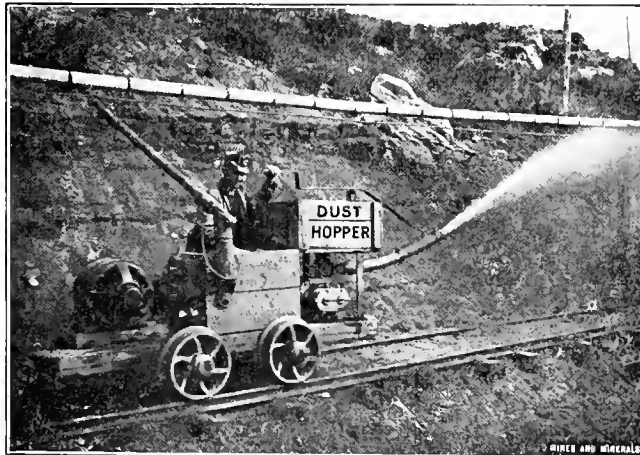

FIG. 6. DUST-BLOWING MACHINE

tion is not always attained on account of the quantity of coal which falls from the end-gate cars, and the difficulty in procuring regular labor to load out the piles of small coal at night. The two men who erect shelves and distribute adobe during the day time, scrape up the small coal which

of entries can be covered in a night. It is interesting to notice that after treatment of this kind entries driven through solid coal resemble rock tunnels.

In addition to dust placed on shelves, all ledges, holes, and natural projections along the entries are cleared of coal dust, and

of Mining Association of Great Britain, page 120): "The dust used at Altofts colliery for stopping coal-dust explosions is from soft shale, and is certainly not of such a nature as to give rise to any anxiety as to the effects produced by inhaling it, particularly as the amount inhaled would be

small It would be well to point out, however, that dust from hard stone, fireclay, sand, or any material containing free silica ought not to be employed."

In Table 1 are given the specific gravities and the solubilities in several fluids of the two kinds of dust.

It will be seen that the adobe has a high ratio of solubility, and were this point alone considered the dust would be most suitable for dusting a mine. The microscope shows that the adobe contains two kinds of siliceous particles; one consists of flakes of clay, the other of rounded grains of quartz with few cutting edges. The flakes of clay are alumina silicate. It contains also traces of oxides of iron, mica, and limestone.

The free silica is in the form of chalcedony, an amorphous form of quartz. The chalcedonic particles are more or less rounded, and few in proportion are pointed or cutting. Formerly the material has been subjected to attrition under water, hence many of the particles are smooth. It is inert and contains no substance that would give off any injurious gases or fumes. The free silica in adobe is in less irritating form, except as regards insolubility, than in any of the siliceous materials hitherto examined. At a later date the writer will deal with the matter of inert dusts suitable for use in mines in an article illustrated with drawings magnified 85 diameters, and drawn under polarized light.

The wooden end-gate car is the chief cause of the presence of coal dust on all mine roads. The small coal which falls through the bottoms, sides, and ends of the cars is quickly reduced to dust by the traffic. The removal of all dust is impossible, but with the introduction of dust-proof cars and rotary dumps, the application of the stone-dust remedy is simplified, the amount of dangerous dust to be diluted or rendered harmless being trifling compared with the quantity always in evidence where the end-gate car is in use. Where new mines are about to be opened up it is important that the proposed type of car be given more consideration than has been customary in the past.

采 采

Old Wire Ropes for Return Circuit in Mines

Written for Mines and Minerals

At the Taylor mine, belonging to the D., L. & W. R. R. Co., at Taylor, Pa., for the past 2 years old wire ropes have been used to conduct the return currents from the electric motors. At this mine the coal is brought to the shaft by means of tail-rope haulage, the mine cars being gathered and delivered to the haulage by electric locomotives. Part of the live workings are about a mile from the shaft. At first it was attempted to conduct the return currents, as the usual custom is,

through the rails, the track of the tail-rope being bonded throughout its length. But this road is crooked, as it follows the old gangways, and as there are several bad hills, the cars are more than ordinarily liable to get off the track, with the result that a good deal of work was needed to maintain the bonding. In the best laid track, bonds will work loose. For each time a joint is passed over by a car or motor there is more or less movement, even with well-blocked ties, and as solid wire bonds and channel pins were used, any movement destroyed the quality of the connection.

To overcome this difficulty, recourse was had to some old, rejected inch-and-a-quarter wire rope; this has been in use for a couple of years and no attention has to be given to that part of the return circuit. The rope is merely strung on the props along the tail-rope line, being placed at the bottom of the props on which the feed cable is strung. In making the connection between the pieces of the rope, the brightened ends are inserted into a short piece of lead pipe and then the pipe is filled with solder, so that the connection is intimate.

The use of old wire rope has been carried a step further by the Lehigh Coal and Navigation Co. In a paper read before the Panther Valley Mining Institute, Mr. Albert Loonars gave a description of the manner in which that company was using old wire ropes as auxiliary to the bonding along roadways where electric motors do the haulage.

A fact that is not always appreciated by the ordinary mine electrician or mine foreman accustomed to the use of steam, is that in the use of electricity, the return circuit must be kept in good condition if the motor is to do the work of which it is capable. In the use of steam, a leak in the exhaust pipe is of no account unless a condenser is used in connection with the engine. With electricity, not only must the feed line be maintained in good condition, but the return as well. A motor is built to do a certain amount of work at a certain voltage, using a certain current. If the voltage drops for any cause, the number of amperes, which is often indefinitely spoken of as the current, will be increased. The result of this is that the armature heats up. In fact one of the most frequent causes for the burning up of armatures is the poor condition of bonding along a track. For each bond in the best of condition will occasion a loss of voltage, though the amount is negligible. But when a gap occurs without any bond, the loss in voltage may amount to a large quantity, even sufficient to stop a motor.

From Mr. Loonars' paper and the subsequent discussion, the following information was gained:

The Lehigh Coal and Navigation Co. uses between 20,000 and 30,000 feet of rope in a year. In the past this rope has been merely thrown aside, but recently the

idea was conceived of laying it in the ground along the motor haulage roads and connecting the track by means of bonds to this old wire rope. The track is bonded as usual and every 250 to 300 feet a cross-bond is made to the wire rope, the attachment to the rope being made by soldering a clamp on to the rope, so that the connection is good. The idea is that the wire rope shall serve as an auxiliary to the bonding of the rails, so that if a bond should be broken, the motor may still have a return connection. It is best to have both rails bonded and cross-bonded, for the return from the electric locomotives passes through the wheels, and the connection is better when it is possible to use the surface of four wheels rather than two.

Along the main haulage roads, the largest size of rope is laid, and along the lateral gangways, the smaller sizes, the inch and inch and a quarter. Where the road is only to be used for a short time, dependence is placed upon the bonds alone.

Iron is not so good a conductor as copper, having a value about one-sixth that of copper. But the steel from which hoisting ropes are made is of a good quality, low in carbon and manganese, so that its conductivity is good. An 1½-inch hoisting rope is equal to a 30-pound rail in its capacity to conduct an electric current.

The results from using this old discarded rope have been excellent. It has been found that the motors can haul larger trips with less effort and with a reduction in the amount of sand used and consequent wear on wheels. Moreover, the number of armatures which are burnt up has been decreased.

采 采

Mining Society Notes

Notice of society meetings should be sent to MINES AND MINERALS to arrive not later than the 15th of the month prior to the month in which the meeting is to be held.

A meeting of the old students of the Freiberg Bergakademie will be held on Friday evening, December 20, at 7:00 o'clock in the "Hofbrann Haus," Broadway and Thirtieth Street, New York City. Dinner will be served in one of the private rooms, price per plate, \$1.50 or \$1.75.

The West Virginia Mining Institute will hold its next annual meeting at Parkersburg, W. Va., December 11 and 12. E. B. Day, secretary, 108 Smithfield Street, Pittsburg, Pa.

The Coal Mining Institute of America will hold its annual meeting in Pittsburg, Pa., December 18 and 19. C. L. Fay, Wilkes-Barre, Pa., Secretary.

The New York Section of the American Institute of Mining Engineers held its annual meeting at the Engineering Societies Building, 29 West 39th Street, New York, on Friday, November 22, 1912, at which Nelson Horatio Darton, of Washington, D. C., presented a paper on "The

Structure of the Modern Anthracite Basin Relative to Forms of Folds." The principal feature was a map showing the structure of the basin by 100-foot contours on the lowest notable coal beds. The map comprised all available mine map data and results of studies of sections and outcrops. It was prepared mainly as a basis for the investigation of the occurrence of methane in the coal. There were also shown details of flexures revealed by mining, illustrating the unreliability of ideal sections of deformed strata constructed from scattered dip observations. L. D. Huntoon, secretary, 160 Broadway, New York City.

The Secretary of the Canadian Mining Institute, H. Mortimer Lamb, Montreal, Quebec, has issued notice that nominations for president of the Institute, two vice-presidents, and ten councillors are in order, and that these nominations should reach the Secretary not later than January 1, 1913. Those that propose contributing papers should have them in the hands of the Secretary not later than January 15.

Pennsylvania State College held Pennsylvania Day, Friday, November 22, 1912. The exercises consisted in the dedication of the new Mechanic Arts building, an address by Hon. John C. Bell, Attorney-General of Pennsylvania, who was introduced by Gov. John K. Tener; a review of the regiment of 1,200 college cadets by Major-Gen'l T. J. Stewart, of N. G. of P.; inspection of buildings; football game; dances at the various fraternity houses, etc., etc.

AMERICAN INSTITUTE OF MINING ENGINEERS

The one hundred and third meeting of the American Institute of Mining Engineers was held in Cleveland, Ohio, beginning Monday, October 28, and ending Thursday, October 31. Headquarters were at the new Hotel Statler.

The afternoon of Monday was devoted to registration. Monday evening at 8:15 there was an informal gathering at the headquarters, but most of the out-of-town members did not report until the following morning.

On Tuesday at 10:00 A. M., Mr. D. T. Croxton, chairman of the local committee of arrangements, introduced Mayor Baker, of Cleveland, who greeted the Institute, and in the course of his address queried what would become of mining engineers after all of the present deposits were exhausted. In his reply, President Kemp answered this query by pointing out that what was wall rock a few years ago, has become the ore of today. Thus in his characteristic manner he epitomized the changes that are taking place in the mining of ore, and the extraction of metals. A time limit of 20 minutes for the reading of papers and 5 minutes for discussion was announced. During the forenoon the following papers were read: "Recent Developments in the Inspection of Steel Rails," by Robert W.

Hunt, Chicago, Ill.; "Notes on Titanium and the Cleansing Effect of Titanium on Cast Iron," by Bradley Stoughton, New York, N. Y.; "Cuyuna Iron Ore Range," by Walter A. Barrows, Jr., Duluth, Minn., and Carl Zapffe, Brainerd, Minn.; "The Action of Various Commercial Carbonizing Materials," by Robert R. Abbott, Cleveland, Ohio; "Measurements and Relations of Hardness and Depth of Carbonization in Case-Hardened Steel," by Mark A. Ammon, Cleveland, Ohio; "Notes on Ruff's Carbon-Iron Equilibrium Diagram," by Henry M. Howe, New York.

During the discussion, Professor Stoughton showed that 80 per cent. of the data on carbonization is at present unknown to the general profession, inasmuch as it is locked up in the archives of private corporations. A vote of appreciation was then extended to Messrs. R. R. Abbott and M. A. Ammon for the extended data that they had given in their papers noted above.

The afternoon session convened at 2 o'clock and the following papers were read during the afternoon: "Blowing In Blast Furnaces," by Ralph H. Sweetser, Columbus, Ohio; "Alloys of Cobalt with Chromium and Other Metals," by Elwood Haynes; "Manufacture of Coke," by W. H. Blauvelt, Syracuse, N. Y.; "Manufacture of Coke," by F. E. Lucas, Sydney, C. B.; "Concentration of Iron Ores," by N. V. Hansell, New York, N. Y.; "Effect of Alumina in Blast-Furnace Slags," by J. E. Johnson, Jr., Ashland, Wis.

In connection with his paper on the "Alloys of Cobalt With Chromium and Other Metals," Mr. Haynes showed some very interesting articles that were made of these alloys. These included cutting tools, razor blade, drawing knife, and a turning made with one of the cobalt chromium tools, which was very remarkable. This alloy is not only hard but resists corrosion to a very marked degree.

The papers upon coking brought out a very interesting discussion by Mr. Blauvelt, representing the Semet-Solvay Co., and Doctor Schniewind, representing the Otto-Hoffman Co., in regard to the relative value of horizontal and vertical-flue ovens.

Tuesday evening was devoted to an informal smoker, at which some remarkable moving pictures were shown, illustrating the mining of iron ores in the Mesabi field, the transportation to the docks, the loading of vessels at the docks, passage of vessels through the Sault Ste. Marie canal, the unloading of the ore at lower lake points, and most remarkable of all, pictures illustrating the various processes of the Bessemer and open-hearth methods of making steel, and the rolling of the same into rails and other shapes. Professor Kemp also gave one of his characteristic illustrated talks upon mountain climbing.

The session of Wednesday morning was devoted to a discussion of the proposed changes in the constitution of the Insti-

tute. A preliminary statement was made by President Kemp, outlining the changes in organization that had been made necessary by the incorporation of the Institute in connection with the United Engineering building of New York City. A detailed explanation of the several propositions that had been presented to the members of the Institute by letter ballot was given by Mr. Rand, Mr. Kirchoff, Mr. Olcott and others. The proposition to introduce a new form of membership as fellows, as included in Article 4 in the proposed constitution submitted by the committee consisting of J. W. Richards, Charles Kirchoff, and C. F. Rand, was not favorably received by the meeting. The discussion throughout was spirited but carried on without friction.

Wednesday afternoon, at 1:30, a special train provided for the American Steel and Iron Co., left the B. & O. station for Cuyahoga Valley, stops being made at the following plants: American Steel and Iron Co., Central plant, Cuyahoga plant, and the Newburg Steel plant. At 7:00 P. M. a subscription banquet was held for the members, ladies, and guests, in the banquet room of the Statler. The chairman of the local committee Mr. Croxton, was toastmaster, and called upon Captain Hunt, Mr. Moore, Mr. Mather, Mr. Kelly, Mr. Kirchoff, Mr. Gayley. Mr. Mather gave an interesting account of the methods being used by Cleveland-Cliffs Iron Mining Co., and other mining companies in connection with the sociology of mining, including better housing, playgrounds, institutes, etc.

The session of Thursday morning was held at the Case School of Applied Science. Of the papers that were read, the one which probably attracted the most attention, was that by Prof. Charles H. Fulton of the Case School, upon the "Constitution and Melting Points of a Series of Copper Slags." This point was debated to a considerable extent in connection with the blast furnace discussion of the previous day. Professor Fulton brought out many points, which had a direct bearing upon the previous discussion. The program also included a sightseeing tour of the C. & P. ore docks and the National Carbon Co.'s plant.

The Cleveland meeting was characterized by a new spirit of discussion and was voted by many of those present as one of the most interesting meetings that the Institute has held in years.

來 來

American Exports of Coal

According to the United States Consular Report, the exports of coal to Mediterranean countries during May and June, 1912, were as follows: Austria-Hungary, 5,400 tons valued at \$14,850; France, 11,219 tons, valued at \$33,657; Italy, 58,811 tons, valued at \$159,902; French Africa, 23,734 tons, valued at \$64,082; Egypt, 34,365 tons, valued at \$92,786.

Horizontal Mine Boring Under Pressure

By Frank C. Perkins

The apparatus shown in the accompanying drawing and photograph is said to be the most expeditious yet invented for boring long horizontal holes to drain old mine workings in which dangerous gases

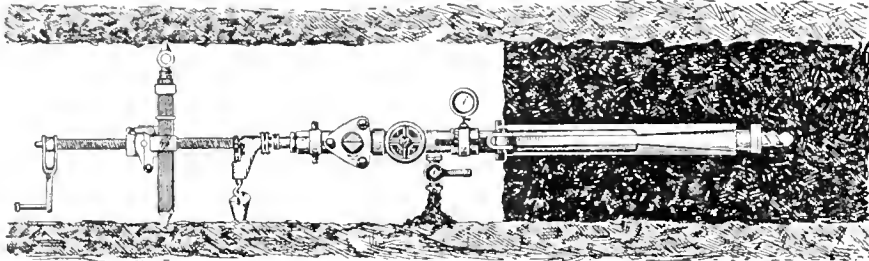

MACHINE FOR TAPPING WATER UNDER PRESSURE, IN PLACE

and water have accumulated under pressure.

It has been used successfully in collieries in tapping heavy pressures of water and gas and holding them in full control until drained.

It is maintained that with the apparatus old mine workings can be tapped under any pressure with perfect safety; that is, a water pressure can be on the bore hole at the time of holing, and with the special valves and cocks, water or gas can be shut off under any circumstances.

The tube boring rods are made with flush joints, whereby the rods are worked and inserted through the packed stuffingbox, this being watertight during the time of boring and after the water or gas is tapped the full length of the rods and the drill point can be withdrawn outside the cock which is then shut, and the stuffingbox unscrewed so that the drill point can be withdrawn; this operation being perfectly safe and without the least escape of any water or gas.

The apparatus can be readily handled by an ordinary workman and when water or gas is found it is held under control and can be either run off from the apparatus or piped away to some convenient place.

The boring rods are easily handled, and when boring to the rise several valve rods are used. The rods are kept full of water when being screwed together to avoid the inside of rods getting choked and to avoid any escape of water through the rods after the holing is made.

If it is desired, the apparatus can be firmly secured in a few minutes and tested up to 1,000 pounds pressure per square inch before commencing work; and after the water is run off, or the full length of bore hole is made, the apparatus can be withdrawn in 5 minutes and is then again ready for further use.

By means of special arrangements a small apparatus can be withdrawn under any pressure, and a larger one inserted for

the purpose of enlarging the bore hole if desired. It is said that this apparatus can be used for boring up, down, horizontal, or at any angle. The record bore hole made with it is 702 feet and still in coal. The record pressure tapped was 257 pounds per square inch, although it is stated that five equipments have been constructed to tap water at 650 pounds pressure per square

inch at the Dover colliery, in Kent, England.

The new record in horizontal boring, 702 feet, performed at Middleton colliery, near Leeds, is far beyond the record boring of 210 feet made at the Washington colliery, County Durham, some time ago, and the later record of 372 feet, made at Westerton colliery, County Durham, in both of which borings the old workings were successfully tapped under 62 and 82 pounds pressure per square inch, respectively.

The Middleton colliery hole was bored in a 4 foot 6 inch seam, dipping about

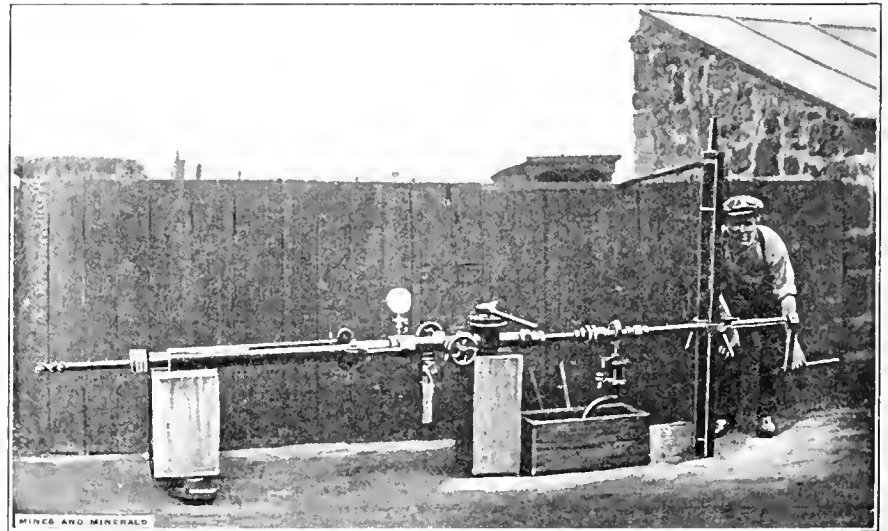

VIEW OF HORIZONTAL BORING AND TAPPING MACHINE

1 in 5 yards, and having a 4-inch slate band 22 inches from the top.

It is said that the bore hole was started above the slate band and for the full distance the hole kept in the coal between the slate and the roof. This is considered remarkable, since horizontal holes bored with diamond drills are apt to be deflected in an upward direction. During the boring operation water to wash out the cuttings is pumped through the hollow drill rods

that are attached from time to time as the hole is lengthened.

A water trough 1 ft. \times 2 ft. \times 9 in. deep is required for the pump water. At the beginning of a bore hole, drills are used with two holes in them, and in case the rods have to be withdrawn when the bore hole is some 10 yards in, then a drill rod is used with a spring valve, as the spring prevents the small holes in the bit from getting choked. This rod is fixed to the drill point, and when the rods are inserted a ball valve avoids the borings getting inside the rods and choking them up.

It is claimed that the most suitable place to start the bore hole, that is for working the pump and turning the plane handle, is about 16 inches from the bottom. The entire success of the boring depends on the pump, and it is therefore advisable to clean the valves at the beginning of each shift, also to use clean water.

來 來

Lubrication of Mine-Car Wheels

By L. A. Christian

[The following is an abstract from the paper entitled "Lubrication," which was read at the Charlestown, W. Va., meeting of the West Virginia Mining Institute.]

The lubrication of mine-car wheels is a subject which apparently has not been given sufficient consideration, either by mine-car wheel manufacturers or mine operators.

The cavity type of mine-car wheel is

ingenious, but it has never been able to satisfactorily prove its value, owing to the numerous available and unsuitable lubricants which the market affords. As a matter of fact, oil is not the proper material for cavity mine-car wheel lubrication. While the wheel may have been designed originally for the use of oil, the idea has never worked satisfactorily in practice. There is too much lost motion between the axle and the wheel

and on the end thrusts to warrant an economical use of oil. There is no exaggeration in the statement that at least 50 times more oil is wasted than is consumed in lubricating these wheels. Owing to the mechanical construction of the wheels a high grade oil will afford no better efficiency than a cheap oil, as its fluidity will cause it to waste freely, irrespective of its lubricating properties and price. Therefore, as much benefit and economy will be derived through the use of cheap black oil as from the use of high-grade oil in this kind of wheel.

A solidified grease is more inappropriate than thin oil in cavity mine-car wheels, because the grease is pushed to the outside wall of the cavity and clings there, refusing to flow by gravitation through the oil channels from the cavity to the axle. The hub may be three-fourths full of heavy lubricant and the axle run dry. The lubricant must be of a fluidity to feed through these openings when the car is at rest, but if the lubricant is too fluid it will work out rapidly when the wheel is in motion, leaving the axle and wheel dry.

A grease has been produced for mine-car wheels of the cavity type which can be used also in the roller-bearing wheels, as it possesses the proper viscosity to feed through the small opening from the reservoir to the axle when the wheel is at rest. This grease is not soluble in water. A metal surface coated with it is immune from outside chemical attack. It contains no alkaline or acid ingredient, consequently it will not injure a metal surface which has been coated with it; in fact, the lubricant is a natural preservative of mine-car wheels and axles, for no matter how corrosive the mine water may be it cannot attack a metal surface coated with this grease. When this car grease was first put on the market it was too viscous to flow freely through the hub to the axle; finally, however, a process was found which furnished a satisfactory lubricant.

When mine cars are lubricated with black oil and the car wheels submerged so that mine water gets into the cavity of the wheels, the oil is forced out and the wheels run without lubrication until they are again oiled. This grease contains such body that water cannot force it out of the wheels in case the cars stand in water over night. The grease is semi-fluid and will not change in consistency under extreme conditions of heat or cold.

Several tests were made in the extreme cold weather of January, 1912, and it never failed to develop the same lubricating efficiency in temperatures from 10 degrees to 20 degrees below zero as it developed with considerably more moderate weather. This was proved at Hazleton, Pennsylvania, where the temperature reaches 20 degrees below zero, and at

Danville, Ill., where the temperature was frequently 15 degrees below zero.

Perfect lubrication contributes enormously to the reduction of wear and tear of mine cars, and a semifluid mine-car grease contributes also to a reduction in the labor of keeping the cars oiled.

One application of mine-car grease lasts from 3 to 6 months; the time being proportional to the size of the lubricating reservoir. Reservoirs of $1\frac{1}{2}$ pounds capacity hold a sufficient supply of grease to run the wheels 3 months and longer.

Where wheels are not equipped with plugs to the cavities, the hubs should be tapped, and threaded for a screw plug before applying mine-car grease; otherwise it cannot be expected that the lubricant will stay inside and feed to the axle properly. Some consider that it is not worth while to plug these holes where oil is employed, as unscrewing and screwing in the plugs is done too often to derive any economy or benefit therefrom, owing to the frequent application of oil, but if wheels having these holes are plugged, even when oil is used, better lubrication is obtained; for when the cars are being pulled around the curves the ends of the axles push toward the outer end of the hub and force the oil out of the holes if they are not plugged. The time occupied in unscrewing and screwing in these plugs would decrease oil bills, but where grease is applied, and one application is sufficient to run a wheel from 3 to 6 months, the labor of putting in plugs cannot be considered an expensive operation.

There are wheels to be found about every mine that are apparently worn out, but which can be put into service when they are lubricated with mine-car grease instead of oil. This grease is applied to wheels by a grease gun.

The mine-car grease has been extensively tested in the laboratories of the William Cramp & Sons Ship and Engine Building Co., Philadelphia, Pa., to determine the lubricating qualities of the grease, under the direction of N. H. Schwenk, engineer of tests, and in the laboratories of the Cornell University under the direction of Prof. R. C. Carpenter, and in each instance has developed a lower frictional resistance than any lubricant tested in comparison.

來 來

Illinois Civil Service Examination

W. R. Robinson, Secretary and Chief Examiner of the State of Illinois State Civil Service Commission, sent MINES AND MINERALS the questions asked in the recent examinations for the position of manager of Mine Rescue Stations. The examination is divided into Training and Experience, eleven questions; First-Aid and Mine Rescue Appliances and Methods, sixteen questions; Organization and

Administration of Mine Work and State Laws relating to same, thirteen questions; General Line Operation, eleven questions. The questions are practical and hard for those unacquainted with the rescue practice taught. Under Training and Experience, some of the questions are as follows:

(7) What experience have you had that would assist you in planning and instructing others to keep a record of the relative value of different kinds of rescue apparatus as regards their efficiency and economy? (8) (a) Have you a certificate of proficiency in first-aid training? (b) In mine rescue training? Give names of your instructors and the place where you were trained in each. (11) What experience have you had in entering an explosion and mine after an accident?

Under First-Aid and Mine Rescue Appliances and Methods, the following questions are asked: (6) How much oxygen per minute does a normal man require? How do you determine the amount of oxygen an apparatus is furnishing? (7) Suppose you were wearing a mine rescue apparatus while hurrying into a mine to save a man and you felt suddenly as though you could not get your breath. What is probably the cause and what would you do? (12) If you found a man overcome by gas and burned about the body, and with an arm broken, what would you do? (14) Describe fully a Pulmotor and its action. (18) Name and describe the location of the principal arteries in the human body.

Under Organization and Administration of Mine Rescue Work and State Laws relating to same, the following questions are found: (2) What appliances for fighting fires and for use in case of accident and for rendering first-aid, should be found in every mine according to the Illinois mine laws? (5) If, as Manager of Rescue Stations, you lived in Springfield, and at 7 A. M. one morning you received a telegram that there had been an explosion in Saline County, what would you do before and after you reached the mine? Give reasons for your procedure.

Under head of General Line Operations, the following questions are found: (6) Under what conditions may after-damp become explosive? (9) If after an explosion you found yourself in an explosive entry of gas and air, what would you do? (10) In an abandoned part of a mine the atmosphere is practically all marsh gas and blackdamp; in another part there is only 10 per cent. marsh gas in the air. While wearing a rescue apparatus would you consider one part more dangerous than the other, to the exploring party carrying electric lamps and safety lamps?

Monobel and Carbonite

DURING the past two or three years much has been written and said about "Permissible Explosives." Long articles

concerning them have appeared in magazines and newspapers; and government representatives have lectured about them all through the coal regions. It should be remembered, however, that in this instruction but little explanation of "permissible explosives" has been made to the miner—the man who uses the explosives, for whose particular benefit they were produced, and who should be most interested in them.

With this thought in mind the Du Pont company prepared a booklet, for the benefit of the miner, who has not had information on "permissible explosives."

For many years the loss of life and damage to property, due to accidents in coal mines, has been a matter of great concern.

Investigation has shown that in bituminous coal mines the most serious accidents have been due to explosions of mine gas or coal dust, often caused by the explosives used in blasting the coal. Careful study and tests have proved that mine gas and coal dust can be ignited much more easily by some blasting explosives than by others. It was found that large charges of any explosive are more likely to ignite mine gas and coal dust than smaller charges.

Also, that it is exceedingly important that every bore hole be "tamped" with damp clay, or similar incombustible material, from the charge of explosives to the mouth of the bore hole, to obtain the full explosive force and especially if gas or dust explosions and fires are to be prevented.

Another matter, and one just as important, is that only very strong detonators (blasting caps or electric fuses) should be used with the explosives. This is because the weaker detonators, especially if they are a little damp, often ignite the explosives or set them afire instead of exploding them, and this invariably ignites mine gas, if any is present, and causes a more or less disastrous explosion or fire.

Realizing the need of explosives particularly adapted to gaseous or dusty soft-coal mines, arrangements were made about 10 years ago to test and investigate Carbonite and Monobel explosives in this country. The explosives were put on sale, about 4 years ago, with the guarantee of the Du Pont company, in all parts of the United States where coal mines are located.

Soon after this the United States Government, through a branch of the Department of the Interior, established a

"Permissible Explosives"—Different Grades, and the Circumstances to Which Each Is Suited

station at Pittsburg, Pa., for testing explosives and for investigation along other lines tending to make coal mining less dangerous. A testing gallery was built at this station, and manufacturers of explosives were requested to submit their explosives for test.

Some time before this the Du Pont company had sent representatives into many coal mines throughout the country to explain the advantages of the permissible explosives, and to show the miners how to use them, so that they would blast the coal without costing any more than the explosives used in the past.

Shortly after the completion of the Government testing station the Du Pont company installed in their eastern laboratory a gallery where explosives can be fired into gas and coal-dust mixtures exactly as is done in the Pittsburg gallery.

Almost everywhere the miners realized how much safer they were when they used these explosives. They also discovered that these "permissible explosives" gave off less smoke and fumes than anything they had used before. In most cases the miners soon learned to use these explosives, when the right kind was furnished them, so that they could mine coal at no greater, or even at less, cost than when the old explosives were used. A few men, however, who tried to use Carbonite where Monobel would have done best, or who did not have the proper grade of either Monobel or Carbonite for their work, had trouble at first. Some wanted to continue with blasting powder because they knew just how to use it. However, when they learned that blasting powder, no matter how little of it was used, always ignited the gas and coal dust in the testing galleries, and the Monobel and Carbonite, when properly loaded, never caused an explosion, even these men were glad to use Monobel or Carbonite.

Every miner knows that good judgment and experience are necessary to blast coal properly, because the coal in one mine may be harder or softer than in another mine, and may lie differently. The thickness of the seam must also be considered. All of this makes it necessary to space and point the bore holes differently in different places, and to use lighter or heavier charges of explosives.

Different kinds of permissible explosives exactly suited to almost every kind of blasting have been produced, each one intended for some particular kind of work; some of these are for soft coal, others for medium coal, and still others for hard coal. Some are better in wet

work than others, and some are specially intended for cold weather.

None of the "permissible explosives" can be depended on

to do good work if a detonator (blasting cap or electric fuse) weaker than the No. 6* is used with them. They will also fail to bring down the coal or rock properly, unless the bore hole is tamped to the mouth or collar. It takes more explosive to do the same work when only a little or no tamping is used. In hard-shooting coal or rock, each cartridge or stick, unless the work is very wet, should be slit lengthwise with a knife, and then be pressed firmly into the back of the bore hole with a wooden stick so as to leave no air space around the explosive.

"Permissible explosives" cannot be exploded with fuse alone or with a squib, but a blasting cap or electric fuse must be used and they cannot be depended on to explode with full force and minimum flame unless detonators as strong as No. 6 electric fuse or No. 6 blasting caps are used to explode them, and they are not passed by the Government as "permissible explosives" if weaker detonators are used.

Two kinds of "permissible explosives" must not be used in the same bore hole, and neither blasting powder nor dynamite must ever be used in the same bore hole with a "permissible explosive." The best way to explode "permissible explosives" in a coal mine where gas or dust exist is by electricity. To do this, electric fuses, and, unless the mine is wired for electric firing, a blasting machine and a coil of leading wire should be used. If several bore holes are fired at the same time, and they are too far apart for the electric fuse wires to join each other, connecting wire should be used between them.

Monobel is an explosive which can be used in gaseous or dusty coal mines and is classed as a nitroammonia explosive. It is made in six qualities.

No. 1 is quick acting and is intended for hard coal, hard-shooting soft coal, and soft coal which is to be coked. No. 6 is a low-freezing grade of No. 1.

No. 2 is slower acting than No. 1, and usually gives better results in blasting coal. It is as strong as the same weight of 60-per-cent. dynamite, but it is lighter than 60-per-cent. dynamite and has about one-third more cartridges to the case. On this account a cartridge of No. 2 would not do the same amount of work in rock as the same size cartridge of 60-per-cent. dynamite, but it is equal in strength to the same size cartridge of 40-per-cent. dynamite, although it is much slower in action and does not shatter the coal so much.

*No. 6 cap contains 15.43 grains of mercuric fulminate.

Monobel No. 2 is much better than blasting powder or dynamite for blasting hard coal, because it does not make any smoke or fumes that will hurt the miner; and after a little practice the miner can learn how to get out the coal cheaper than he can with blasting powder or with dynamite.

In wet work the cartridges should not be slit or broken, and should not stand in the water any longer than just time enough to load, tamp, and fire the shot.

Monobel No. 4 is the same in strength, action, and lack of fumes as No. 2, but is a low-freezing explosive.

Monobel No. 3 is adapted to mining screened coal. It is just as strong as No. 2 but so much slower acting that miners who have learned how to use it, mine the softest coal without breakage and with no more expense than with black blasting powder. It is practically without smoke or fumes, but should not remain long in wet holes before firing.

Monobel No. 5 is the same as No. 3 except it is doped to prevent freezing.

All grades of Monobel are put up in cartridges, enclosed in pasteboard cartons containing 12½ pounds each. The cartons are packed in wooden boxes containing 25 pounds or 50 pounds. Table 1 gives the size and the number of cartridges in a box containing 50 pounds and, of course, a box containing 25 pounds has just one-half as many cartridges.

TABLE 1

Weight of Monobel in Case	Number of Cartons in Case	Size of Cartridges	Number of Cartridges in Case
50 lb.	4	1 in. x 8 in.	About 205
50 lb.	4	1½ in. x 8 in.	About 165
50 lb.	4	1¾ in. x 8 in.	About 135
50 lb.	4	1⅞ in. x 8 in.	About 100
50 lb.	4	1⅞ in. x 8 in.	About 74

Monobel No. 1, No. 2, and No. 3, may freeze at from 45° F. to 50° F. Monobel No. 4, No. 5, and No. 6 will not freeze unless they have been subjected for a considerable time to the coldest weather met with in this country and often not even then.

All grades of Monobel begin to lose efficiency after they have gotten wet, so in damp or wet blasting it is better not to cut or break the paper shell of the cartridge, but to load each hole quickly and to blast it as soon as possible.

When the coal is hard and the work dry, the best results will be obtained if the cartridge shells are slit and the entire charge is pressed firmly with the wooden tamping stick into the back of the bore hole and then tamped to the mouth of the bore hole with clay. If the No. 3 or No. 5 shatter or break the coal too much, do not break or slit the cartridge shell, so that there will be air spaces about the charge. This will decrease the force of

the blast and bring down the coal in large size.

Carbonite, which has been used since before 1898 in England, contains some nitroglycerine, doped to meet the conditions demanded of permissible explosives; namely: a short flame, slow velocity of detonation, and comparatively low temperature and heat of detonation. It is made in six grades.

Carbonite No. 1 is intended for blasting hard coal, is not quite so strong, but makes a little more smoke and fumes than Monobel No. 2; however, it stands water better. Carbonite No. 2 is not quite so strong as No. 1; is also slower in action, and shatters the coal less. Carbonite No. 3 is slow in action, and is intended for soft coal. Carbonite No. 4 is the slowest acting of the carbonites, and if used in the right way will break down the coal with little, if any, more breakage than black powder or Monobel No. 3. Like the other carbonites it stands water very well and does not give off a great amount of smoke or fumes. Carbonite No. 5 is the same as No. 2, and Carbonite No. 6 is the same as No. 3, except they are adapted for low freezing. Table 2 gives the size and the number of cartridges in a case containing 50 pounds of four cartons weighing 12½ pounds.

TABLE 2

Kind of Carbonite	Size of Cartridges	Number of Cartridges to 50-Pound Case
Carbonite No. 1.....	1¼ in. x 8 in.	About 100
	1½ in. x 8 in.	About 75
	1¾ in. x 8 in.	About 50
Carbonite No. 2.....	1¼ in. x 8 in.	About 130
	1½ in. x 8 in.	About 100
	1¾ in. x 8 in.	About 75
Carbonite No. 3.....	1¼ in. x 8 in.	About 130
	1½ in. x 8 in.	About 100
	1¾ in. x 8 in.	About 75
Carbonite No. 4.....	1¼ in. x 8 in.	About 105
	1½ in. x 8 in.	About 80
	1¾ in. x 8 in.	About 55
Carbonite No. 5.....	1¼ in. x 8 in.	About 130
	1½ in. x 8 in.	About 100
	1¾ in. x 8 in.	About 75
Carbonite No. 6.....	1¼ in. x 8 in.	About 130
	1½ in. x 8 in.	About 100
	1¾ in. x 8 in.	About 75

The carbonites will not explode properly when frozen. Carbonites Nos. 1, 2, 3, and 4 may freeze at from 45° F. to 50° F. Carbonites Nos. 5 and 6 will not freeze unless they have been exposed for a considerable time to the coldest weather met with in this country and often not even then.

All grades of Carbonite resist water well, but in very wet work the cartridges should not be slit. For best and cheapest work, all bore holes should be tamped from the charge to the mouth of the bore hole. It is to be understood that no explosive is an absolutely safe explosive, but that those termed permissible are less apt to do damage by exploding gas and dust than some others.

Prize Contest for Safety Lamp

Oil and benzine safety lamps have advantages, but they contain various faults, the greatest being that they are not perfectly firedamp proof. Electric mining lamps also are not safe enough and do not indicate firedamp or chokedamp.

The Association for the Mining Interests in the District of Dortmund, has resolved to offer a prize of 25,000 marks (\$6,250) for a useful electric mining lamp provided with a trustworthy gas indicator. The lamp and gas indicator must comply with the following conditions: They must be firedamp proof, even after damage, and serviceable for at least 12 hours without interruption; they must be handy, durable, securely lockable, simply constructed, simple to attend, and economical in operation. The gas indicator must show at least—in the same degree as the benzine mining lamp—firedamp (CH₄) and chokedamp (CO₂).

After burning for 12 hours, the lamp must still show a light strength of at least one Hefner candle.*

A prize jury consisting of the following members will award the prizes: Geh. Oberbergat Bornhardt, as representative of the Chamber of Commerce; Geh. Bergat Kaltheuner, as representative of the Royal Mining Chamber at Dortmund; Bergat Gerlach, as Mining Officer; Bergat O. Mueller, as representative of the Miners' Association; Bergassessor a D. Winkhaus, as representative of the Miners' Association, Section 2; Professor Heise, as representative of the Mining Bank of Westphalia; General Director Lüthgen, General Director Janssen, Bergat Johow, Director Meyer, Director Pattberg, as representatives of the Association for the Mining Interests in the District of Dortmund.

The prize jury reserves the right to name additional members. Its decision will be final and it may divide the prize if several useful solutions are submitted. If none of the applications is in entire accordance with the given conditions, the next best solution will receive part amounts of the prize.

The applications must comply with the following demands:

1. Three lamps must be sent to the Verein für die bergbaulichen Interessen im Ober Bergamtsbezirk Dortmund, in Essen-Ruhr, Germany.
2. Three copies of the descriptions, drawings, and particular instructions for operation must be submitted.
3. The documents must be written in the German language.
4. Applications must be received not later than October 1, 1913.

The results of the contest will be published in *Glückauf, Der Bergbau*, and *Der Kompass, Colliery Guardian* and MINES AND MINERALS.

*The British standard candlepower is obtained from a sperm candle weighing six to the pound and burning at the rate of 120 grains per hour. The Hefner candlepower is .92 of the standard British candlepower.

The Letter Box

Readers are invited to ask or answer any question pertaining to mining, or to express their views on mining subjects in this department. All communications must be accompanied by the name and address of the writer—not necessarily for publication. The editors are not responsible for views expressed by correspondents.

Gases

Editor Mines and Minerals:

SIR:—Will some reader of MINES AND MINERALS advise me as to the difference between methane, light carburetted hydrogen, marsh gas, and firedamp? Do these names mean the same gas or do they apply to different mixtures of other gases?

Nanaimo, B. C. COAL MINER

Centrifugal Pumps

Editor Mines and Minerals:

SIR:—I have read considerable during the past year on the use of "multiple-stage centrifugal pumps" in shaft mines. Will some reader familiar with their use advise me as to whether they possess any advantage in efficiency or economy over duplex direct-acting steam pumps? MANAGER

Springfield, Ill.

Handling Slacked Carbide

Editor Mines and Minerals:

SIR:—I would like to know for my own benefit if calcium carbide is injurious to the system and if so in what way and how a slacked carbide should be handled. The carbide light is the best the miner has ever had and I would like to see it stay if there are no injurious drawbacks. J. W. G.

Wilgus, Pa.

Gases From Acetylene Lamp

Editor Mines and Minerals:

SIR:—On page 189 of your issue for November, I see an inquiry signed "T. S. Almond," which interests me. As secretary of the International Acetylene Association, it has been necessary for me to go into the safety of acetylene in connection with mines as well as its other many fields of usefulness.

The first question, "What effect (if any) do the gases given off from the acetylene pit lamp have on the miner?" can be answered briefly: "No effect whatever." The gases given off are simply carbon dioxide and water vapor. Far less of these gases are given off by the acetylene lamp than any other. No other gases are given off.

Second, "What are the elements of the gas given off by carbide and what is carbide made of?" Only one substance is given off by carbide and that is acetylene. Acetylene is a combination of hydrogen and carbon in the relation of two atoms of hydrogen to two atoms of carbon. There are no poisonous or detrimental elements. An unlighted acetylene lamp would only give off one-third of a foot of acetylene if all of the carbide was exhausted, without ignition.

This would take over 2 hours. There could be no possible accumulation of gas from miners' lamps under any circumstances. Calcium carbide is made from a combination of lime and coke melted together in the electric furnace. It will not burn, it cannot explode, it is unaffected by any substance except water. When it is brought in contact with water, it gives off acetylene. Acetylene miner's lamps are used throughout the world in numbers approximating a million and nothing but benefit has come to the miner from their use. No accidents have been reported.

A. CRESSY MORRISON

79 Wall St., New York

Calcium Carbide

Editor Mines and Minerals:

SIR:—Replying to T. S. Almond's questions regarding acetylene in the November issue:

Carbide, or more properly calcium carbide, C_2Ca , has been known since 1862 and was first made by heating a zinc-calcium alloy together with carbon. It is commercially prepared today by heating coal, or coke, mixed with limestone, in an electric furnace to a high temperature. When water is brought into contact with it the result is as follows:

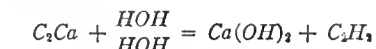

(Carbide of calcium) (2 atoms water) (Calcium hydroxide, slacked lime) (Acetylene gas)

Therefore, the "elements of the gases" given off from carbide are carbon and hydrogen.

The acetylene pit lamp is probably less injurious to the miner than the oil lamp, as the former does not form nearly the same amount of soot and smoke as the latter, which soot is irritating and harmful to the lungs. ODIN DORR

Cannelton, W. Va.

Calcium Carbide

Editor Mines and Minerals:

SIR:—I submit the following in answer to question of T. S. Almond relative to gases from calcium carbide:

Calcium carbide is prepared by heating lime (CaO) with carbon in the electric furnace. Under the influence of the high temperature the calcium is liberated to a certain extent by the action of the carbon on the lime, and unites with the excess of the carbon, part of the carbon going off as CO (carbon monoxide) and the excess of carbon

united with the Ca forms CaC_2 (calcium carbide).

The reaction taking place when water is added is, viz., $= CaC_2 + 2H_2O = Ca(OH)_2 + C_2H_2$. The gas thus prepared sometimes contains small amounts of sulphuretted hydrogen (H_2S) which gives it its disagreeable odor, but it does not occur in sufficient quantities to have any deleterious effect on the user.

It will explode when combined with air, but the limits of explosion are much wider than for coal or any other gas, and I know of no case on record of its ever having caused any ill effects on the miner in any way.

F. S. JOHNSON, Chemist

Scientific Management

Editor Mines and Minerals:

SIR:—I have read a good deal about scientific management and efficiency, but it always seems to be applied to factories where the class of work is constant. I would like to know if it has ever been applied to mining, even in a modified form. And if it has been applied, I would like to know the manner of its application and whether it was successful.

Scientific management is given credit for the ability to reduce costs. Any one who can reduce costs has the right to talk and I would like to listen to him.

Pittsburg, Pa. SUPERINTENDENT

采 采

Action of Acids on Concrete

Concrete drains have suffered more or less damage, some of them in comparatively short periods from the time of their construction. In every case the destructive action was traced to the presence of acid in the water which reached the drains either internally or externally. In one case the swampy soil surrounding the drain contained iron pyrites, and the water became charged with sulphuric acid; in the other cases, the air in the drains was heavily laden with hydrogen sulphide, which slowly oxidized to sulphur and sulphuric acid. Other mineral and organic acids, such as hydrochloric, oleic, acetic acids, and carbon dioxide were found almost as noxious. It is concluded that the destructive action of acids is due to two causes: The formation of certain calcium and aluminum compounds, especially calcium sulphate, which is accompanied by a large increase in volumes; and the formation of soluble compounds, especially calcium bicarbonate, which dissolve and cause the concrete to collapse. The chief remedies proposed are: To provide adequate ventilation inside the drains; to use dense, non-porous clinker, poor in lime, as basis for the concrete; and to cover the exposed surfaces of the concrete with a coat of tar, or, best of all, to protect the foundations of the drains with tar felt or asphalt.

The Hamilton No. 8 Mine

Geology of the Region Around Arma, Kan.—Description of the Coal and Methods of Working

By L. L. Wittich

THE Hamilton Coal and Mercantile Co. has recently developed a new coal mine on land leased from ex-Congressman Edward Ridley, 1 mile north of Arma, Crawford County, Kansas.

Crawford County is the banner coal producer in Kansas, and has been for many years; but most of the coal has come from the vicinity of Pittsburg and not from as far north as Arma. In southeastern Kansas the producing mines work coal beds found in the Cherokee shales, which correspond to the lower coal measures of Pennsylvania,



FIG. 1. ENGINE AND HOIST HOUSE, HAMILTON NO. 8 MINE

including the Pottsville conglomerate, as the shales rest on the Subcarboniferous limestone here known as "Mississippian limestone."

Above the Cherokee shales comes the Oswego limestone, and above that the La-bette shales, Pawnee limestone, Altamont limestone and shales, all in the Marmaton formation, which with the Cherokee shales are included in the Lower Coal Measures of Kansas, as shown in Table 1.

As little mining has been done so far north as Arma, three drill holes were put down to test the lease, and the same general formation was found in each hole. Seven coal beds were passed through at depths ranging from 238 feet to 241 feet, six of which varied from 3 inches to 8 inches in thickness, while the seventh averages 3 feet 2 inches in thickness and is exceedingly uniform.

The workable coal bed is the lowest one in the Cherokee and it is proposed by Mr. James Hamilton, president of the company, to mine all the coal possible and allow the upper beds to be conserved.

In the anthracite fields of northeastern Pennsylvania the Pottsville conglomerate is the lowest measure of the Carboniferous series. In it is found the Lykens Valley coal bed, which as a fuel has no superior in that region. In West Virginia the millstone grit that corresponds to the Pottsville conglomerate contains the Pocahontas coal, which is an excellent semibituminous coal.

Further to the south, on the border of Tennessee and Kentucky, some of the best bituminous and cannel coal in these two states is found in the Lea conglomerate,

which in physical structure approaches the Pottsville conglomerate, it having water-rounded quartz pebbles.

In Kansas the Cherokee shales correspond to the Pottsville conglomerate, millstone grit, and Lea conglomerate, being the lowest member of the Carboniferous formation. In the anthracite fields, Mauch Chunk red shales and Pocono sandstone represent the Subcarboniferous strata; west of the Alleghany Mountains what is known as mountain limestone forms the Subcarboniferous, and this in the Mississippi Valley is termed the Mississippian or Subcarboniferous limestone.

The quality of the coal in the bed worked is exceptionally good, and throughout the greater part of the area mined there is no trace of slate in the coal. It is clean coal between layers of slate, except where there is an occasional "horseback"; then it is poor in quality.

What are termed "horsebacks" in Kansas are clay-filled fissures formed after the coal was consolidated.

The fissures or "clay veins" usually are narrow, averaging perhaps less than 5 feet thick as they are found in the coal. They generally pass through the coal and into the shale above, often reaching almost to the surface, but sometimes thinning to a mere fissure with no apparent thickness only a few feet above the coal, as shown in Fig. 2 (a). At other times they do not pass through the coal from below and again they penetrate the coal from above as shown in Fig. 2 (b).

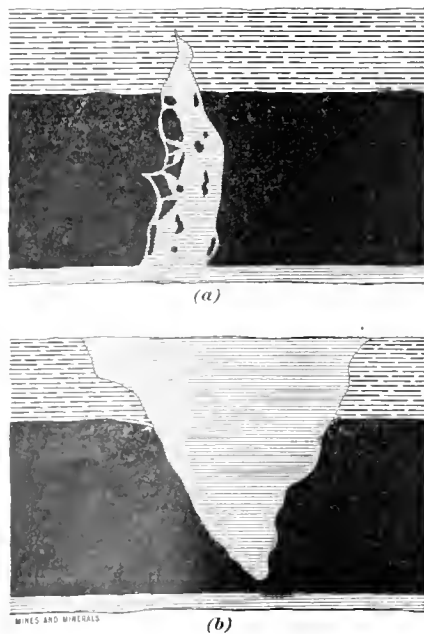

FIG. 2. "HORSEBACKS."

In other fields fissures in the coal that have been filled with clay seeping in from above are called "clay veins" while "horsebacks" are rolls in the floor of a coal bed evidently

formed before the coal had hardened.

Owing to the thickness of the bed, it is necessary in order to make headroom for the mules to brush the roof in entries, but it has been found advisable to make the height barely sufficient for the mules; for by cutting

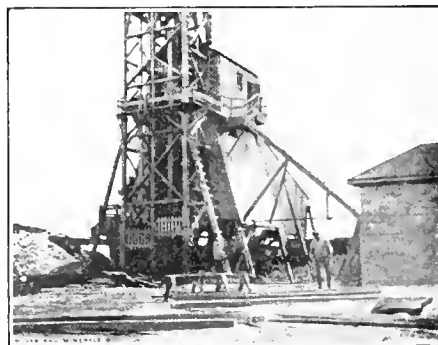

FIG. 3. DERRICK AND TIPPLE, HAMILTON NO. 8 MINE

too high, a shale is encountered which requires constant trimming. The first few feet above the coal is a strong slate which does not show a tendency to fall in slabs.

Nearer the eastern border of the Cherokee shales where the Mississippian limestone outcrops, coal is worked by stripping the dirt from above it, but at Arma the great depth of the coal from the surface is due to land at this place being on the backbone of a divide. The elevation of the coal bed is higher than to the south, also has thicker cover, and the dip is gradually to the southwest and west away from the Ozark dome. The main shaft of the No. 8 colliery is 8 ft.×14 ft. inside and is the upcast; the downcast, a short distance away, is 8 ft.×10 ft. A blowing fan 14 feet in diameter furnishes ventilation for the mine, this system being favored because the warm air from the mine passes up the hoisting shaft and there is no accumulation of ice in the winter; the men at the bottom of the shaft are also better able to work in cold weather than would be the case were the hoisting shaft a downcast. As the fan is reversible, the change to an upcast can be made quickly if necessity warrants. The downcast is equipped with a stairway, making it an escapement shaft, to be used in case of accident or stoppage of the cages in the main shaft.

While it is customary in some parts of this coal field to work the coal longwall, in Crawford County the double-entry room-and-pillar system is generally followed.

In the rooms no roof or floor is removed and only occasionally are timbers needed to support the roof. The capacity of the colliery is about 400 tons daily, but this will

of course increase when the development is extended. The coal in mine cars is hoisted on cages and dumped into a hopper-bottomed bin of large capacity. From this bin it is passed gradually over shaker screens which size it before delivery to the railroad cars. Lump, nut, and slack are made, the mine run going over all the screens to cars on a third track. All coal that passes through a $\frac{3}{4}$ -inch space in the screen is termed slack; all that passes through a $2\frac{1}{2}$ -inch space in the screen is termed nut and all over $2\frac{1}{2}$ is lump.

The southern Kansas coal district and the coal districts of the adjoining states of

the analysis of air and comparatively simple gas mixtures. The price of the book is \$1.75.

THE INDEX OF MINING ENGINEERING LITERATURE, comprising an index of mining, metallurgical, civil, mechanical and chemical engineering, by Walter R. Crane. This is the second volume by Professor Crane along this line. It is printed by John Wiley & Sons, New York. Price, \$3.

STRENGTH OF MATERIALS. This book by Mansfield Merriman has reached its 6th edition, and has been revised and reset. The number of articles has been increased from 72 to 91, the number of illustrations from 48 to 54, and the num-

ington. It is not written so as to appeal only to people engaged in mining, but so that it might be a guide to any one interested in the coals of King County. But while the appeal is general, attention has been paid to details so that the book contains that information which is valuable to a mining man. It contains maps and cross-sections of the seams of coal, with full descriptions of the various districts into which King County is divided. Moreover, the report is well and simply written.

DAYS OF GOLD. In a pamphlet prepared for the centenary celebration at Kamloops under the direction of the Hon. Richard McBride, Premier and Minister of Mines of British Columbia, is given an excellent account of the early gold days of the '60's in British Columbia. There it is stated, in speaking of the Cariboo region, that "it was the gold rush there in 1859 that raised it from the position of a fur country to the dignity of a colony and finally a Province." The pamphlet contains quotations from various sources giving a short and succinct account that pictures the distant days. The statements given as to the richness of certain of the claims then worked show the cause for the boom that the region of the Fraser River had. The Cunningham claim is here stated to have produced \$9,050 in one day and to have averaged \$2,000 a day for the whole season. Sir Richard McBride had this book prepared primarily for the old timers, many of whom gathered at the celebration.

CHEMICAL ARITHMETIC AND FURNACE CHARGES. Stoichiometric calculations have formed part of the chemical exercises in colleges in the United States but have rarely been reduced to a systematic course. Regis Chauvenet, A. M., B. S., LL. D., has compiled a course in Chemical Arithmetic which he has put in book form under the above title. The book is an excellent one, and will be found extremely useful for the student, since answers are furnished to the examples given. The calculations of furnace charges is in Part II, and should also appeal to the engineer or student, since they are between two covers and not in several books. The book has 302 pages with index and is printed by J. B. Lippincott & Co., Philadelphia.

COAL MINING IN ARKANSAS. By A. A. Steel, Professor of Mining, University of Arkansas. Arkansas Geological Survey. A. H. Purdue, State Geologist. 632 pages, illustrated. The first eight chapters constituting Part I give a comprehensive outline of the entire coal mining industry of Arkansas, including an outline of the Arkansas mine laws and suggested modifications chiefly with a view to adequate propping and mine inspection. In Chapter VII, Professor Steel furnishes a forcible argument for the repeal of the mine-run law which compels operators to pay the miners the same price for slack coal and slate as for clean coal. Part II is purely technical, and

TABLE I. DIVISIONS OF THE KANSAS COAL MEASURES (HAWORTH)

(B) Upper Coal Measures.	7. Cottonwood formation	{ Cottonwood shales Cottonwood limestones
	6. Wabaunsee formation	{ A series of alternating limestones and shales to which individual names have not yet been given Burlingame limestone
	5. Shawnee formation	{ Osage shales Topeka limestones Calhoun shales Deer Creek limestone Tecumseh shales Lecompton limestones Lecompton shales
	4. Douglas formation	{ Oread limestones Lawrence shales
(A) Lower Coal Measures.	3. Pottawatomie formation	{ Garnett limestones Lane shales Iola limestone Thayer shales Eric limestones
	2. Marmaton formation	{ Upper Pleasanton shales Altamont limestone Lower Pleasanton shales Pawnee limestone Labette shales Oswego limestones
	1. Cherokee shales	Cherokee shales

Missouri, Oklahoma, and Arkansas are surrounded by a large and thickly populated area that produces no coal. There is always a good market for the fuel, as a result, and the recently noted tendency of the natural gas fields to fail in their supply has increased the demand.

來 來

Book Review

METHODS OF AIR ANALYSIS, by J. S. Haldane, M. D., LL. D., F. R. S. 128 pages, with index, 24 illustrations. J. B. Lippincott Co., Publishers, Philadelphia, Pa. This little book deals with a subject of importance so far as coal miners are concerned. It explains: The collection of samples for analysis; apparatus for general air analysis and gas analysis; calculation and statement of results of analysis; portable apparatus for determining small percentages of carbon dioxide, methane, or carbon monoxide at mines worked with naked lights; portable apparatus for routine fire-damp estimations; gravimetric determination of moisture and carbon dioxide in air; recognition and determination of small proportions of carbon monoxide in air; determination of dust in air. The methods described are only such as are designed to meet every-day needs in connection with

ber of problems from 140 to 230. Answers to some of the problems are given, and in these strenuous times answers to all problems given a student should be given. It is discouraging to work out problems and then ascertain in the recitation room that a mistake has been made. The book contains 166 pages and is a much better book than the earlier editions, although they were good. The price of the book is \$1. John Wiley & Sons, New York, publishers.

THE MINING WORLD INDEX OF CURRENT LITERATURE, VOL. 1, FIRST HALF YEAR 1912, compiled by Carpel L. Breger, has made its appearance. It is an international bibliography on mining and the mining sciences and is published by the *Mining World*, of Chicago, Illinois. Price, \$2. It is double indexed for authors and subject matter, and is divided into three parts, Geographic; Ores and Mineral Products; and Technology; all in 12 chapters arranged for convenience.

WASHINGTON GEOLOGICAL SURVEY. Bulletin No. 3. The Coal Fields of King County, by George Watkin Evans.

This bulletin has been written apparently with a full remembrance of the character of the readers for whom it is intended, for the people in general of the state of Wash-

includes a discussion of the best methods of protecting the miners from disease and accidents and for reducing the waste of coal and producing better coal without ultimate increase in cost. The final chapter is an interesting discussion of various plans for reducing the high cost of mining by a better adaptation of the mining methods to Arkansas conditions.

Every coal mining man in Arkansas needs this book, which can be obtained by application to A. H. Purdue, State Geologist, Fayetteville, Ark., and the payment of 22 cents in postage to cover cost of transportation.

EXPLOSION-PROOF MOTORS, H. H. Clark, of the Bureau of Mines, has been making investigations on Explosion-Proof Motors. The results of his investigations are incorporated in Bulletin 46, Bureau of Mines. This can be obtained by writing to the Director Bureau Mines, Washington, D. C.

THE DESIGN OF STEEL MILL BUILDINGS, by Milo S. Ketchum, C. E., third edition, McGraw-Hill Book Co., publishers. Price, \$4.

This book is so well known that no detailed review of the book is needed. To this, the third edition, the chapters on stresses in framed structures and in bridge trusses, as well as the specifications for steel-frame buildings, have been rewritten and enlarged. In addition, Appendix III on structural drawings, estimates, and designs, containing 78 pages, 30 tables, and 24 cuts, has been added.

采 采

Temporary Shaft Head

Written for Mines and Minerals

The illustration shows a temporary shaft head that is in use at one of the shafts of the Underwood mine, which is being opened by the Pennsylvania Coal Co., at Throop, Pa. This shaft has been sunk by contract and at present the openings in the coal seams are being driven. According to the customary practice in the region, as soon as the shaft had been sunk into solid rock, the concrete lining was put in. Solid rock is very close to the surface here. The concrete has been built above the surface level, so as to raise the level of the top of the shaft and allow filling around the cribbing. In this case, there is about 20 feet of concrete work, and upon this the temporary head-frame has been built.

This temporary head-frame is used, with slight alterations, for hoisting by means of a carriage while the gangways are being driven. The engine being used in hoisting has a plain cylindrical drum, which will accommodate two ropes. To balance the weight of the carriage, another pulley was placed on the head-frame between the back-stays as shown in Fig. 1. Over this pulley was hung a sinking bucket, which was filled with short pieces of old iron rails. As the temporary head-frame does not cover the

whole shaft, there is plenty of room for the movement of the bucket in the space between the carriage way and the end of the shaft.

The fan, a small force fan, is placed directly over the shaft at one corner of the concrete lining, so that the air is forced directly downward, avoiding any turns.

The shaft is fenced about so as to avoid

cent. coke, Morris Run coal with 20 per cent. volatile gives 60 per cent., and Connells-ville coal with 32 per cent. volatile gives 64 per cent.

采 采

Mine Accidents, 1911

The Annual Report of the Department of Mines of Pennsylvania for 1911, records 615



FIG 1 TEMPORARY SHAFT HEAD

accidents. In front of the hoisting compartment there is a gate made out of a wooden rail pivoted by a hinge at one end so that the other end may be rotated when lifted vertically. The weight of the gate is partly balanced by means of a pulley and chain so that it can be handled easily.

采 采

Coke From Coal

The percentages of coke obtained from various kinds of coal are about as follows: Cannel coal containing 44.71 per cent. volatile matter gives 55.29 per cent. of coke in gas retorts, and bituminous coal containing 34.72 per cent. volatile gives 65.28 per cent.

In Semet-Solvay retort ovens Connells-ville coal containing 32 per cent. volatile matter gives 72 per cent. coke; Morris Run coal containing 20 per cent. volatile gives 83 per cent., and Pocahontas coal containing 18 per cent. volatile gives 85 per cent.

In beehive ovens Pocahontas coal with 18 per cent. volatile matter gives 62 per

fatal accidents in the mines during the year. The causes of these accidents were as follows: Falls of coal, slate, and roof, 253 or 41.14 per cent.; by cars, 92 or 14.96 per cent.; explosions of gas, 34 or 5.53 per cent.; explosions of powder and dynamite, 21 or 3.42 per cent.; electricity, 2 or .32 per cent.; blasts, 67 or 10.89 per cent.; falling into shafts, suffocation by gas, and miscellaneous causes, 146 or 23.74 per cent.

Of these fatalities, 337 or 54.8 per cent., were due to the carelessness of the victims themselves, 45, or 7.31 per cent., were due to the carelessness of others and 233, or 37.89 per cent., were classed as unavoidable.

It is a sad commentary on the recklessness of mine workers and on the discipline in the mines when 382, or 62.11 per cent., of the lives lost were sacrificed to carelessness. In the accidents classed as unavoidable it is evident that there were many from which, while they were not due to gross carelessness, the element of carelessness was not entirely absent.

Dust Explosions

Influence of Composition and Fineness of Dust, and the Presence of Gas on the Liability of Ignition

By C. M. Young*

A CONSIDERABLE portion of the following material will appear in Volume X of the report of the Kansas State Geological Survey and is now published with the permission of the Director.]

The explosion of coal dust is a combustion so rapid that the mine air and the gases formed are violently expanded by the heat. It is necessary that there be present fuel and oxygen in proper amounts and that they be ignited.

If we assume that no combustible gas is present all the fuel must be supplied by the dust. In most cases some gas is doubtless present, but it may be in quantities too small to be detected by the safety lamp. However, it has been demonstrated that even very small amounts of gas may aid an explosion.

Assuming, however, that all the fuel is to be supplied by the dust, it becomes important that we know as much as possible of the conditions under which the dust is explosive. Some students of the subject have expressed the opinion that any combustible dust may be explosive under favorable circumstances. It is my opinion that this is not the case. Anthracite dust is certainly combustible but it seems not to be explosive. This is to be expected if we remember the method of combustion of anthracite. An isolated piece surrounded by air will not burn because the heat generated by combustion is not sufficient to maintain the reaction. If we wish to burn it we must surround it by a medium which does not readily convey away the heat generated. In practice this is accomplished by having a large number of pieces of fuel lying together. In this way only so much air is in contact with each piece as is necessary to supply oxygen and the heat is not dispersed in heating an excess of air, and loss by radiation is also diminished.

Since the heat value of anthracite is high, it might seem that the burning of each particle of dust would furnish enough heat to raise the surrounding particles to the ignition temperature if they were not too far away. That this is not the case is doubtless due to the fact that, small as may be the particles of dust, they are very far from being molecular, and combustion can take place only on the outer surface. The heat is therefore developed slowly and is at the same time carried away, so that the temperature is lower than it would be if all or a large part of each dust particle burned nearly instantaneously. The combustion does not spread to the neighboring particles and there is no explosion. If it is assumed that the particles are so close together that there is little opportunity for

the dispersal of heat, there will not be enough air for complete combustion, and the heat developed will be too little to permit the spread of the combustion.

The dusts of some bituminous coals and of many other substances are not only combustible, but in some cases they are explosive. The great distinction between bituminous and anthracite coals is the fact that the former contain combustible volatile matter. It seems to be this fact that renders them, in some cases, explosive. When the coal is heated, the volatile matter is distilled and is separated from the coal as gas or vapor. The combustible part may be ignited and burned. If it is mixed with air in proper proportion it may be exploded. The fixed carbon remains behind and may or may not be burned.

It is this possibility of the distillation of the volatile matter which makes bituminous coal easy of ignition. When heat is applied the gas is distilled, and it is this gas which burns first. If the coal is suspended in the air in the form of a fine dust the gas is set free in intimate mixture with air, and the mixture of gas and air will be explosive if the combustible matter and the oxygen exist in the proper proportion. The gas set free from the coal will have definite explosive limits, just as natural gas and other explosive gases have. There must be present in the air, then, neither too much nor too little of the gas. As will be shown more plainly later, the presence of too much gas is much more rare and improbable than the presence of too little.

Since a certain amount of gas must be present, it is evident that it can be supplied by a certain amount of coal of a given composition, and that the amount of coal necessarily decreases as the percentage of volatile combustibles increases. It will then be possible to get an explosive atmosphere by distilling the gases from a comparatively small amount of coal high in volatile combustible matter. No definite statement of the amount of volatile combustible matter necessary can be made. It evidently depends largely upon the nature of the coal and the amounts of the moisture and ash.

Recently a sample of coal was sent to me for examination from a mine in which an explosion had taken place. This was claimed by some to have been a dust explosion while others believed that it was caused by gas. The dust failed to explode without the addition of a combustible gas, methane being used. Analysis showed that the coal contained only 13.4 per cent. volatile combustible matter. It seems

impossible that the dust from such a coal should be explosive under any ordinary circumstances.

In order that the distillation and com-

bus-tion, when once initiated, may be self-sustaining, it is necessary that the dust be suspended in the air. It is apparent that the ease of suspension depends largely upon the fineness of the dust particles. Any solid substance, no matter how small, will fall through the air, but the rate of fall will depend upon the relation of weight to surface exposed. We may assume that the specific gravity of all coal particles is the same, though this is not strictly true. The rate of fall will then depend upon the surface exposed, being slower as the size of the particle is decreased. If the air is in motion with an upward velocity equal to the rate of fall of the particle in still air, the particle will remain suspended. Air in motion does not move in straight lines, but the friction against the walls of the passages causes eddies, so that there are always currents which are blowing in a more or less vertical direction and these tend to raise the dust into the air and keep it suspended. If these currents are strong enough the dust will not settle out but will remain in suspension. No practical ventilating current will be strong enough to keep the coarser sizes of dust in suspension, while no such current will be slow enough to allow the finer sizes to settle out. It is apparent then that the danger increases with the fineness of the dust, other things being equal. It has been found by experiment that only those dusts which will pass through a 200-mesh screen are kept permanently in suspension in an ordinary current.

The size of the dust also has a great influence on the ease with which the volatile matter is distilled. The dust is exposed to high temperature during only a very short time. If it is in comparatively large fragments the heat will not have time to penetrate to the interior and only the outside of the fragments will be coked; that is, not all of the combustible gases which are in the coal will be set free and mixed with the air. The probability of an explosion is therefore small because it is only in circumstances out of the ordinary that enough of this coarse dust will be suspended in the air to set free a sufficient amount of gas to make an explosive mixture with the air.

On the other hand, if the dust is fine, it will be heated through in the brief exposure to high temperature and all or nearly all of the gas will be driven out. Therefore, less fine dust than coarse is required to make an explosive mixture with air. An examination of some dusts under the micro-

* Associate Professor of Mining Engineering University of Kansas.

scope showed that, in some cases, a large part of the dust which had passed a 200-mesh screen was very much finer than the openings in the screen. The openings in such a screen are approximately .003 inch in diameter, while some of the dust particles were only .00006 inch in diameter. It was found by experiment that dusts containing these small particles in large quantities were much more explosive than those made up more entirely of larger fragments, the quality of the coal being otherwise nearly the same. It therefore appears that a chemical examination alone will not determine the explosiveness of a dust, but that a physical examination is also necessary.

Two coals may be subjected to the same grinding process and yield different amounts of the very fine particles. This difference is due to differences in physical structure. Only a microscopic examination shows the great differences between coals in this respect.

It was also found that different portions of the same sample of coal may show this peculiarity. In the case of one coal it was found that if the coal was ground in stages, the 200-mesh dust being occasionally sifted out during the process of grinding, the first dust produced had a comparatively high explosive limit, while that produced last had a much lower limit. This last dust, produced from the least friable portion of the coal, showed a much larger proportion of very fine particles than that produced by the first grinding. It is not known whether this is a general fact.

The explosiveness also depends upon the nature of the volatile combustible matter. In some cases this is so tarry that the dust is bound together and cannot be suspended in air, even though the individual particles are sufficiently fine. This condition also tends to prevent the production of the finest dust. It was found that a coal from the Kittanning seam showed this quality and its dust failed to explode. It was also found that this dust contained few very fine particles.

The fact that dusts from coals low in volatile combustible matter fail to explode suggests that the addition of a combustible gas or vapor may make them explosive. This is found to be the case, and it has been found that when methane, in quantity too small to be explosive alone, is added to a mixture of dust and air containing too little dust to be explosive, the resulting mixture may be explosive. It was found that some dusts which failed to explode alone were made explosive by the addition of as little as 1 per cent. of methane. This fact indicates that there may be great danger in the presence of a very small amount of gas in the mine air. Tests for gas, as ordinarily conducted, will not indicate the presence of less than 2 per cent. and probably most fire bosses will not detect less than 3 per cent. with certainty. Thus it is apparent

that a mine, which is not considered dangerous because of the presence of gas, may be dangerous because an undetected amount of gas renders the dust explosive. Also a disturbance of the ventilating current, allowing a slight increase in the amount of gas in the air, may be a much more serious matter than it is supposed to be.

The gas which is to be feared is not alone that natural to the mine, but the gases from explosives may have the same effect. Black powder, when fired in the presence of coal, sometimes yields gases which are combustible; * some of the safety powders always yield such gases, some never do, and probably others do so under certain conditions. It is therefore possible that the gases from explosives may render the dust with which they are mingled explosive, even if they are present in quantities too small to be explosive alone. There can be no doubt that a large number of windy shots are due to these facts. I speak of these as facts because they have been demonstrated.

When the dust distilled from the heated coal burns, the particles of coal, now partly converted to coke, are heated to a temperature at which they reduce the carbon dioxide resulting from the combustion of carbon monoxide. Since this temperature endures for a very short time it is probable that the amount of carbon monoxide thus produced depends largely upon the surface of glowing carbon exposed to the gas. It is certain that enough is sometimes produced to render the afterdamp exceedingly poisonous, as is proved by the fact that short exposure to it is frequently fatal, even though life may not be extinct when efforts at resuscitation are commenced. In some cases there is enough to render the afterdamp explosive when it is mixed with a fresh supply of air. Thus there may sometimes be a second explosion following the first.

The necessary oxygen is, of course, supplied by the mine air, and mine air commonly contains a sufficient amount. An unusually large quantity of carbon dioxide will reduce the activity of the air, and this will be especially the case if, as is usual, this gas has been formed by the consumption of a portion of the oxygen of the air. It is not often however, that mine air is in this condition.

Probably the most important variable of the air is its moisture content. The presence of water vapor renders the air less fit to support combustion, not because of the presence of less oxygen but because heat is absorbed in raising the temperature of the water vapor, and the temperature produced by combustion is therefore lower. A certain amount of fuel can produce only a certain amount of heat and if a portion

of this heat is consumed in raising the temperature of the water vapor, in addition to that used in raising the temperature of the air and dust surrounding the igniting body, the resulting temperature may be too low to coke the dust and ignite the gas produced. Therefore, the presence of water vapor may prevent the occurrence of an explosion. This fact is now quite generally understood and there are many advocates of the humidification of air in dusty mines. There are certain objections to this procedure and these have been well stated and need no discussion here.

The temperature of the air may have a considerable effect. It has been said before that a sufficiently high temperature must be reached to coke the dust and ignite the gas, and if the temperature of the air is already high the heat necessary to produce this required temperature will be less than if the air is cold. The ordinary range of temperature will have little effect, but it is conceivable that a considerable compression of the air might result in a temperature that would be important. It is even possible that a wave of compression may traverse the air which will produce a temperature sufficiently high to coke the dust and ignite the gas produced. In this way an explosion might be produced at a point which the flame of the original explosion had not reached, traversing passages free from dust and originating explosions at new points. Thus the compression of the air may have an important effect in the propagation of an explosion, though it is not necessary to the inception of the explosion or to its propagation.

In order that the dust may be ignited, it is only necessary that it be raised to a temperature sufficient to coke it and to ignite the gas given off. In order that the flame may be propagated, it is probably necessary that the source of ignition be of considerable size, otherwise combustion at any one time will be so little that it will probably be confined to the immediate neighborhood of the igniting body. It has been proved in the laboratory that a bunsen burner or an ordinary miner's lamp will easily ignite dust, but it is not often that the air of a mine will contain sufficient dust in suspension for such means to ignite it. It would seem that nothing else would be so apt to do so as the large flame of a blown-out shot. This has the necessary temperature and heats a large volume of the mine air at once. Unless the flame from the shot impinges directly upon a deposit of dust, it is doubtful whether a single shot could both stir up the dust and ignite it, because the hot gases would become cooled before they could be mingled with the dust, but if previous shots had first stirred up the dust the chance of ignition would be very favorable.

The ease of ignition will be greater if the preceding shots have furnished a combusti-

* Gaseous Decomposition—Products of Black Powder, with special reference to the Use of Black Powder in Coal Mines. C. M. Young. Transactions American Institute Mining Engineers, Vol. XLI, pages 454 to 479.

ble gas, either from the explosive itself or from the coal. Windy shots which seem to have this origin are very frequent in the mines of Kansas, where black powder is used in excessive quantities.

In recent times there has been a great increase in the production of coal. This has been accompanied by changes in the conditions of mining. Larger quantities of coal are hauled over the roads and larger quantities of dust are produced in the haulageways. The increase in the size of the workings and in the number of men employed has necessitated the use of more rapid ventilating currents. The result has been more thorough drying of the dust and the suspension of more of it in the air. The use of explosives has increased much more rapidly than the production of coal. This results in the production of more dust in the rooms and, in some cases, in the production of larger quantities of combustible gases. These changes and possibly others have been accompanied by an increase in the number of dust explosions.

The foregoing notes are offered as a small addition to our knowledge of dust explosions. We already know much of the phenomena of such explosions, but we do not know all. If we did, it would be possible to explain every explosion and to positively state the precautions necessary for the prevention of explosions in the future. We cannot do this. Indeed, it is not infrequently the mine which seems safest that offers an example of the deficiency of our knowledge. But this knowledge is constantly and rapidly increasing. The subject has many phases and there must be study of all of them before we can claim general knowledge of it. This article presents a few of the more important observations made in a study of mine explosions and is written with the purpose of adding something to our knowledge of the subject, which when collected, sometime in the future, may be found so complete as to enable us to state clearly the causes of explosions and their remedies.

采 采

The Value of Study to Mining Men

By Samuel McMahon*

Our bodies at all times perform various functions with little thought on our part. How many of us ever stop to consider what a wonderful thing it is to breathe, see, hear, taste, smell, and move from place to place? Not many of us I fear are impressed with these wonderful acts because they are going on continually, and the regularity and ease with which they are accomplished make them cease to be a matter of much moment to us. Scarcity adds value to things, but common things may be so very wonderful that scientists and philosophers are unable

*Russelton, Pa. An abstract from a paper read at a local institute of mine foremen.

to explain them, and yet from the fact of their frequent occurrence they do not arouse a sense of awe in us. Now this is the position of mining men. The fact that we go to work at a certain time, quit at a certain time, and that for this work we receive a certain salary, is clearly impressed upon our minds; but for this very reason the work to most of us is liable to become ordinary, and we lose sight of the fact that we are engaged in an interesting and educating work. We go each morning into the mine and send out coal which centuries ago an allwise Providence stored there for the use of mankind. When we enter the mines, our minds do not go back to the ages when this black mass covered the earth in vegetable form. We have all heard the theory of how coal was formed, but few of us think deeply on the subject and try to understand the conditions on which this theory is based. A doctor must be familiar with the human body, its composition and the effects of drugs; a lawyer must be on intimate terms with Blackstone, and have a knowledge of technical law points; a clergyman not only must study the Bible, but Bible history; the merchant must educate himself along lines which will make him successful; and so it is in every walk of life, the successful men are those who are full of their subject, and by being informed along the lines in which they are engaged are ready to take advantage of an opportunity. By means of study these men at the crucial moment are masters of the situation. I speak now of the successful men in all the chosen walks of life; and though we may not admit it, we all either now or at sometime past earnestly desire "success," which consists in nothing more than doing well, whatever there is to do. We are a body of successful men, mine foremen, superintendents, and inspectors, and we are all trained to manage a mine successfully. Why should we not be as well versed in our work in life as men in other callings?

I am well aware that all of us, speaking for the mine foremen, are physically tired after a day's work and the idea of study and mental effort at night is irksome, but a chapter from some book on mining would be as easily read and understood as the newspaper. Reading a good book in the evening is no more of a task, than reading a paper, an act which the majority of us perform religiously, but it must be done systematically. The trouble is, that we submit too much to the routine and monotony of life. We get into a rut—and this does not refer alone to mine foremen. We fail to see what surrounds us and to prepare ourselves to step through the door when opportunity opens it to us. We should get as much happiness from life as possible and make our lives as broad and full as it was intended they should be, but let us endeavor to educate ourselves until we excel. Men like Lincoln, Garfield, and others, whose advantages for education were

not so good as ours, were crowned with success, simply because they endeavored to be ready when the opportunity arrived.

Mining men have as interesting subjects to study as there are. To be familiar with the scientific part of our work we must study geology; then we can appreciate the principles involved. The great Scotch geologist, Hugh Miller, early in life was left to the care of his mother, the widow of a sailor; later he became a stone mason; always laboring under difficulties, he succeeded in writing the books that made him famous. Miller said: "The best schools I have attended are schools open to all; the best teachers I have had are, though severe in their discipline, always easy of access; and the form in which I was, if I may say so, most successful as a pupil, was the form to which I was drawn by a strong inclination, but at which I had less assistance from my brother men or even from books than from any of the others; there are few of the natural sciences which do not lie quite as open to the working men of America and Great Britain as geology did to me." We cannot all be authors or all famous men, but some of us will, if we read, be better fitted to take up higher positions. Some of us may be managers or called on to fill the honorable position of mine inspector. I quote Miller because he had few advantages and received his education in the woods, under the earth, from trees and brooks, and his writings were on geology principally, a subject which touches our work so closely we should all be interested. Read, study, learn, satisfy the desire of the mind for knowledge if only to enjoy life more fully. My argument is that mine foremen need to study more than any other professional men. To bring intelligence into work through judicious reading makes us better workers, better citizens, and better family providers. In this age of machinery and improved methods of doing business, practical mine foremen are in demand. Try this plan of reading for self-improvement and I am sure the habit will grow until you will have to satisfy that God-given curiosity and supply the matter to the mind.

采 采

Fast Tunnel Driving

The driving of tunnels has presented much interest of late years, for projectors and contractors have striven to establish world speed records in advancing horizontal excavations. A notable instance of this sort of rock breaking occurred in the Henrylyn tunnel, at the end of West Clear Creek, in central Colorado. In 29½ working shifts of 8 hours each, this tunnel was pushed 293 feet through solid granite, or practically at the rate of 1¼ feet per working hour. The tunnel is 8 feet by 10 feet in section; is to be 15,550 feet long; and is intended to divert water from the Pacific watershed to the plains of Eastern Colorado for irrigation.

Answers to Examination Questions

Examinations for Second Grade Mine Foremen Held in the Bituminous Regions of Pennsylvania, 1912

(Continued from November)

QUES. 10.—(a) Would there be any advantage derived in the safety to life and in economy of operation of mines if a uniform system of timbering the working places was adopted and strictly carried out, such a system to be suitable to the existing conditions in each mine?

(b) What distance would you set props apart under varied conditions of roof and bottom?
(c) State the conditions of roof and floor where you are employed.

ANS.—(a) Yes, under any circumstances, and particularly if the spacing of the props is changed from time to time as conditions of roof and floor change, as these will in any mine. Roof falls are usually caused by lines of weakness due to invisible cracks extending through the roof slate to the sandstone or other rock constituting the true roof of the seam. Sooner or later the weathering caused by the warm, moist mine air will destroy what cementing material there may be, and the pieces will fall. As these cracks are invisible and unequally spaced, it is plain that if the posts are set at a uniform and not too great a distance apart, the chances that they will hold one of these blocks are greater than if set at random and by mere guesswork. Also, under ordinary conditions, if the cracks are not visible, no posts at all will be set, and, thus, a uniform system of timbering offsets the absolute disregard for his own safety that seems characteristic of many a miner. (b) The proper distance apart for props under all the various conditions possible is difficult to give. In some mines no posts at all are needed and the roof remains standing for months and years after the coal has been worked from under it. In others, the slate falls as the coal is shot, or within a few minutes, hours, days, or weeks, according to locality. No set rule can be given for spacing props and it must be determined by experience for each mine. When the proper spacing is once determined it should be adhered to until underground conditions change, when a new spacing should be experimentally decided upon.

Mr. S. L. Goodale, quoting from Austin King, Chief Mine Inspector of the H. C. Frick Coke Co.,* says: "The stronger the roof is, the stronger the prop required; because the roof, if broken, is in much larger pieces; conversely, where the roof is broken and tender, the props set must be more numerous, and if these require to be set close enough to interfere with the carrying on of the work or the ventilation, cross-bar sets with latticework lagging must be substituted. Where there is a strong roof and bottom, the props should be set so as to

permit the roof to ease, or gradually settle down, or the bottom to heave, and thus prevent the breaking of the prop or prolong its usefulness as such. Under such conditions they should not be driven very tight, and in such cases caps of short timber should be used, otherwise the invariable result is at first a bent, and later on a broken and useless prop."

Under most methods of systematic timbering the props are set at the four corners of a series of squares, with one prop in the center at the intersection of the diagonals from the corner props, in such a way that the greatest distance between any two props is 5 feet, 6 feet, or any other distance determined by the character of the roof. (c) This should be answered by stating actual conditions, as, for example, "A strong fireclay floor and a draw-slate roof averaging 8 inches thick with overlying sandstone."

QUES. 11.—What in your opinion are the things most neglected in the operation of a mine, whereby the cost of coal is increased and the sanitary conditions of the mine impaired?

ANS.—Probably drainage and ventilation are more neglected than other features of mine work affecting both the cost of production and the sanitary, or healthful (as distinct from safe or dangerous conditions), of a mine. Poor drainage means increased cost of haulage through improperly graded and neglected roads, with consequent increased power requirements, loss of time through cars being off the track, and the like. It also affects the health of the men by compelling them to work with wet feet or in wet clothes. Poor ventilation may be due to too small a fan, too small airways, or to neglected return air-courses choked with fallen roof rock, to neglect in driving breakthroughs at proper intervals so that the air may be carried to the face, to leaky doors and brattices, and to failure to properly split the air. In any case the cost of production is increased by the physical impossibility of the men doing their best in an impure and even poisonous atmosphere. The effect of such an atmosphere upon the health of the men is apparent.

QUES. 12.—The water gauge reads 2 inches; the velocity of the air-current is 500 feet per minute and the length of air-course is 4,000 feet; what would the water gauge read if the length of air-course was extended to 8,000 feet and the velocity of air-current was increased to 800 feet per minute?

ANS.—The formula for the water gauge in terms of the velocity and length of airway

$$\text{is } i = \frac{k s v^2}{5.2 a} = \frac{k l o v^2}{5.2 a}, \text{ in}$$

which l is the length, o the perimeter, and a the area of the airway, and k and v are the coefficient of friction and the velocity of the air, respectively.

Only v and l vary, and as k , o , a and 5.2 are the same for each set of conditions, they may be dropped, and the formula for comparing the water gauge, when the velocity of the current and the length of the airway vary, may be written $i = l v^2$; that is, the water gauge varies directly as the length of the airway multiplied by the square of the velocity of the current. As the airway is twice as long, we have $l = 2$, and as the velocity is increased from 500 to 800 feet a minute, $v = 800 \div 500 = 1.6$. These are the ratios and represent the relative increases in the length of the airway and the velocity of the current. Substituting, we have $i = l v^2 = 2 \times 1.6^2 = 2 \times 2.56 = 5.12$. That is, under the new conditions the water gauge is 5.12 times what it was under the old ones. As the gauge was 2 inches under the old conditions, it is $2 \times 5.12 = 10.24$ inches under the new.

QUES. 13.—(a) In case a workman is in contact with a live electric wire, how would you release him? (b) Should a workman be rendered unconscious from electric shock, or by inhaling noxious gases, what would be your method of procedure, in each case, to revive him?

ANS.—(a) Miner's Circular No. 5, of the United States Bureau of Mines, gives most excellent directions for handling those suffering from electric shock, and from it we quote as follows: "While removing the victim from the electric circuit, be careful not to get a shock yourself. If there is a switch right at hand, cut off the current at once; but if there will be any delay in cutting off the current, remove the body from the circuit by means of a piece of dry wood, used either to roll or push the body aside or to lift from the body whatever is carrying the current to it. Tools with dry wooden handles, such as picks or axes, may be safely used for this purpose. The body of the victim can be safely grasped if your hands are protected by several thicknesses of dry cloth, or if you stand upon a piece of dry wood.

"When you can do nothing else, you may be able to short-circuit the line with which the victim is in contact, and thus blow the circuit breaker or fuses which protect that part of the electric system.

"A short circuit may be made by placing an auger or drill or a piece of pipe so that it will connect the two sides of the electric circuit. For example, in case the victim is in contact with a trolley wire, the auger, drill, or pipe should be thrown across the trolley wire and track rail, so as to be in contact with both. In doing this, be sure that the auger, drill, or pipe leaves your hand before it touches the current-carrying part

*"Safety Through Systematic Timbering," by Stephen L. Goodale, Professor of Mining and Metallurgy, University of Pittsburgh, MINES AND MINERALS, November, 1911.

of the circuit, as otherwise you will get a shock yourself."

(b) The method of restoring respiration after an electric shock is the same as after suffocation from inhaling bad air. In any case do not attempt to restore breathing in case of suffocation from impure air when the victim is in the same bad air that overcame him; first get him where the air is pure, and if possible, outside the mine, if there is the least question as to the quality of the mine air.

Quoting further from Bulletin No. 5, noted above: "When the victim has been removed from contact with the current, turn him on his back, loosen the clothing from around his neck, chest, and abdomen, and place a log, a rolled-up coat, or something of similar size and shape under his shoulders in such a way as to throw his head back and his chest up. The next thing to do is to draw out the victim's tongue, which can best be done by grasping it with a piece of dry cloth. This act clears the windpipe, and unless it is done, the victim cannot be made to breathe. If the rescuer is alone, he will have to keep the tongue in this position by tying it with a handkerchief or a bandage passed over the tongue and under the jaw. The tongue must be held in this position while giving artificial respiration.

"Kneel behind the head of the victim, grasp his forearms just below elbows and draw them slowly backward until they are extended as far as possible over his head and hold them there for about one second. Then slowly push the elbows forward and downward until the elbows are at the side and the hands folded over the stomach of the patient.

"Do not perform the operations hurriedly but take about 4 seconds for one series of movements. Usually a victim of electric shock can be made to breathe within an hour, and the movements should be kept up at least that long, even if the patient does not show any signs of being 'brought to.' The patient should be kept warm, and after he begins to breathe his limbs should be rubbed briskly and toward the heart, the hands of the rescuers being kept under the covering while this is done. This will help to restore the circulation which has been suspended for some time."

If a pulmotor, or mechanical device for restoring breathing, is available, it should be used.

QUES. 14.—What are the legal requirements for the protection of workmen in the installation of electric wires, along traveling or haulageways, and should the rails be bonded?

ANS.—"In underground roads the trolley wires shall be installed as far to one side of the passageway as practicable, and securely supported upon hangers, efficiently insulated, and placed at such intervals that the sag between points of support shall not exceed 3 inches. The sag between points of support can exceed 3 inches if the height of the trolley

wire above the rail is 5 feet or more and does not touch the roof when the trolley passes under."

"At all landings and partings where men are required to regularly work or pass under trolley or other bare power wires, which are placed less than 6½ feet above the top of the rail, a suitable protection shall be provided. This protection may consist of channeling the roof, placing boards along the wire, which shall extend below it, or the use of other improved devices that afford protection."

"It is recommended that, where air or water pipes parallel the grounded return of power circuits, the return be securely bonded to such pipes at frequent intervals, to eliminate the possibility of a difference of potential between rails and pipes and to prevent electrolysis of the pipes. The rail return shall be of sufficient capacity for the current used, independent of the capacity of the pipes. On main haulage roads both rails shall be bonded, and cross-bonds shall be placed at points not to exceed 200 feet apart."

QUES. 15.—If a workman had his leg broken, or had arteries severed, what would be your method of rendering first aid to him in both cases?

ANS.—In the case of a broken leg place the patient in a comfortable place upon his back with the injured leg upon a coat or two, or a sack filled with straw or anything soft. Cut the clothing in the seams and remove it from about the fractured part carefully. If no splints are available make one of a piece of thin wood, or even of a piece of a powder keg cut out with an axe. Pad the splint and place it, and if need be a second one opposite it, over the fracture so that it will extend above and below the break in such a way that the broken bones do not rub upon one another. Then bandage it in place. Lay the patient on one of the ordinary mine stretchers and carry him carefully to daylight, being careful to arrange the stretcher so that the broken leg is not again bent. In event of a compound fracture, before the splints are applied the bleeding must be stopped and the wound dressed, the method of treatment depending upon the nature of the hemorrhage. Splints must be applied but not bandaged too tightly.

A severed artery may be known as the blood comes out in jets. The object of the first-aid treatment is to stop the flow of blood at some convenient point between the heart and the wound. Cover the fingers with antiseptic gauze and press the wound to stop bleeding while the more permanent first aid is being administered. Artificial pressure should then be applied a short distance above the wound and at such a point as not to hurt the wound or the bones, if these be broken. For applying artificial pressure, two sticks may be placed on opposite sides of the severed artery and held together by two handkerchiefs, one about each pair of ends, or a tourniquet may be made by wrap-

ing a handkerchief or lengths of gauze about the part to be compressed, making the outer end into a loop through which a stick is passed. Any desired degree of tension may be obtained by twisting the stick, but no more should be applied than is necessary to stop the bleeding. The part should then be bandaged, arranged so that the dressing will not slip, when the patient may be carried out on a stretcher, using the same precautions to prevent pain and discomfort as in the case of fractures.

QUES. 16.—(a) Give the advantages and disadvantages of the different kinds of explosives used in blasting coal and rock, and what precautions would you enforce for the handling of them? (b) What kind of a needle and tamping bar would you use and why?

ANS.—(a) The explosive commonly used in blasting rock is dynamite, consisting of nitroglycerine held in absorption by sawdust, infusorial earth, or some similar porous substance. It detonates with extreme rapidity, that is, it is "quick acting," shattering the rock into small pieces, which is an advantage in cleaning up with shovels after a blast. Further, being far more powerful than ordinary black powder, less of it is needed to produce a desired effect than the slower acting explosive, and consequently smaller holes, drilled at less cost, may be used in connection with it. It is also better adapted to shooting in wet ground than powder, as it is supplied in practically waterproof casings.

The original black powder, now being replaced by the so-called "permissible" or "safety" powders, consists of an intimate mixture of nitrate of potash, sulphur, and charcoal. It is, compared with dynamite, slow in action and is better adapted to blasting coal than the quicker acting explosives, as it shatters it less.

The permissible powders are generally quicker acting than black powder, but much slower than dynamite. They are well adapted to blasting coal, particularly in gassy or dusty mines, where, by reason of their detonating with an extremely short flame, they will not readily ignite either of these two dangerous elements.

Explosives should not be stored underground and no more than needed for one shift should be taken into the mine at one time, except that when shot firers are employed they may, naturally, take in enough for their use. When preparing holes for blasting, the shot firer should leave on the entry all but enough explosive to charge the holes in the room. Cans containing explosives should not be opened, nor should explosives be handled or made up into cartridges, within 5 feet of a lamp, which must be placed in such a position that sparks may not be blown from it into the powder. Nor must a miner smoke when handling explosives, nor carry them in the same case with, or store them near, detonators. No explosive should be forcibly pressed into a hole too small for it, and no explosive should be

removed from a hole, nor should another hole be drilled and charged nearer than 12 inches to one that has missed fire. Clay, or some incombustible material, and not coal slack, must be used for tamping, and all holes must be tamped solid for their entire length. All powder must be carried into the mine in metal cans or in receptacles of equally safe material, which must not be allowed to come in contact with live electric wires. Powder must not be stored in a tippie or weighing office and naked lights must not be used while it is being weighed or given out.

(b) A copper needle and a tamping bar of wood, or of wood tipped with copper, must be used in charging and tamping holes. Copper does not strike a spark when coming in contact with the iron pyrites so common in coal seams, and the danger of prematurely igniting the charge is thus avoided.

(To be continued)

來 來

Coal Mining Notes

The Northwestern Improvement Co. is arranging a plan for hauling loaded and empty cars at the foot of their No. 4 shaft, at Roslyn, which greatly facilitates the work and also decreases the cost of operation at least \$18 per day.

The plan of operation is as follows: A loaded trip is dropped in until one or more cars reaches the advancer, which is then started through the clutch and the whole trip advanced until the head car reaches the knuckle. While the head car is covering the distance between the head-sheave and the knuckle it will be uncoupled, and after passing the knuckle it runs by gravity over either one of two loaded tracks to a position in front of the cage landing. Two cars should always be in position awaiting the landing of the cage, and while these two are being placed upon the cage, and while the opposite cage is descending, two other loads are fed into position on the opposite loaded track. When the cage has landed the feeder is started and the front car is fed on to the cage, bumping off the empty. The cage is then raised, bringing the lower compartment into position; then the feeder is started and the second car is fed on to the cage. Both feeders are then stopped by throwing out the clutches, and at the same operation a stop is placed over the rail to prevent the incoming loads from entering the shaft sump. Shafts are run continually, the feeder chain being started and stopped when desired by positive jaw clutches. All the feeder mechanism except the feeder chain lies below the floor line, so that the cager may walk from one cage to the other without any interference. The empty cars after being bumped off the cage run by gravity over a kick-back and on to a car haul by which they are elevated to a level sufficient to permit of their running into a slight dip, when they will be coupled, oiled, and made ready for the return trip.

This plan only necessitates the employment of one cager and a boy to operate the advancer and uncouple the cars, one boy to couple the empties, and one boy as oiler.

Princeton, B. C., Coal Mines.—Mr. Frank Bailey, of Princeton, B. C., sends the following information. The Princeton Coal and Land Co. has its mine in good shape to handle recent orders of 500 tons per day from the coast and interior cities. This company has invested some \$75,000 in an up-to-date plant, with a daily capacity of 500 tons, and the coal obtained from the large seams which underlie the Princeton coal basin is a first-class domestic coal. An office has recently been opened in Vancouver

provided at Leisenring, No. 1 plant, in the Connellsville region. This hall was opened with appropriate ceremonies on Columbus Day. After other exercises, the orchestra discoursed dance music and an opportunity was given both old and young to indulge in this pleasure during the afternoon, and until 12 o'clock midnight. The opening exercises and pleasures subsequently provided were under the direction of Mr. Chas. B. Franks, superintendent of Leisenring No. 1 plant.

The Stanton Mine, in Livingston County, Ill., belonging to Rutledge & Taylor, has made a record by hoisting 4,260 tons of coal in 1 day from a two-compartment shaft.

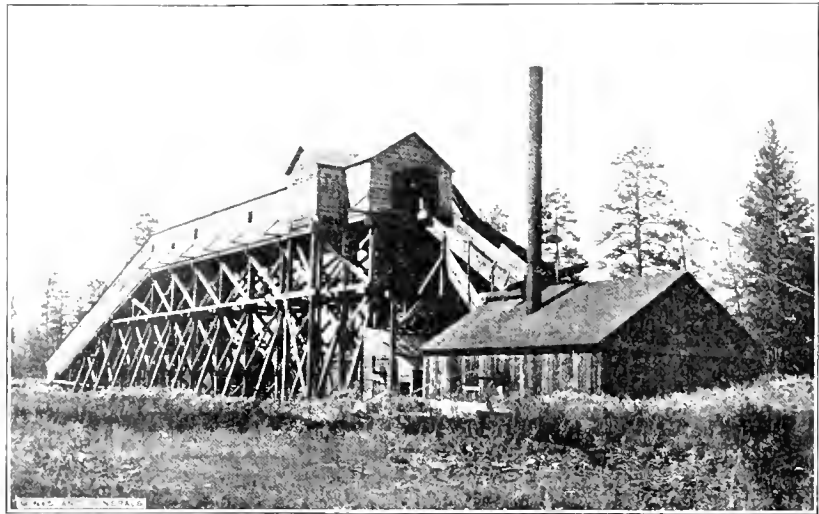

FIG. 1. COAL TIPPIE NEAR PRINCETON, B. C.

and when transportation facilities now under construction are completed to the coast, the demand will be greater.

Fig. 1. shows a tippie near Princeton, B. C. The coal is reached by a slope, and the trestle slope is housed to make it possible to work economically during the winter months.

The Columbia Coal and Coke Co., of Coalmont, lately sold to the Canadian Pacific Railway Co. \$1,000,000 worth of its bonds, and there is no doubt now that the Kettle Valley Railway (C. P. R.) will immediately build up the Tulameen Valley to tap the Tulameen coal basin at Coalmont.

The V. V. & E. Railway (Great Northern Railway) has been running trains up the Tulameen to Coalmont all summer from Princeton and Spokane, and the contracts are let to Messrs. Guthrie, McDougall & Co., for the immediate construction of 42 miles of grading from Coalmont to the summit of the Coquihalla Pass, and other contractors are working from the Fraser Valley to connect the Great Northern Railway at the summit.

Recreation Hall, Leisenring.—In addition to other rational sociological ideas adopted by the H. C. Frick Coke Co., a recreation hall for the use of the employees has been

This is at the rate of 3.5 cars per minute, each car holding 2.5 tons.

Teaching English.—Among the features of the Young Men's Christian Association work in this country is teaching English by a method which combines English with life saving and practical instruction. This is accomplished by aid of the book "Mine Accidents and Their Prevention," published by the Coal Department of the Delaware, Lackawanna & Western Railroad Co., combined with Roberts system of teaching English which has been described in MINES AND MINERALS.

來 來

Care of Tools

The care of tools is quite as important as any other detail of track work. All tools should be kept clean, sharp, and in good order. All new tools should be marked with the company's brand by the storekeeper. When tools are worn out and need replacing, the worn-out tools should be returned to the supply house.

Each track-laying gang should be provided with a strongly made tool box of sufficient size to contain the complement of tools and it should be furnished with a substantial lock.

Prize Contest

With the idea of stimulating interest in practical mining questions, and at the same time drawing out ideas from our readers who constitute a large portion of America's most progressive mining men of all classes, we offer the following prizes:

For the best answer to each of the following questions, we will give any books on mining or the sciences related thereto, now in print, to the value of \$3.

For the second best answer, similar books to the value of \$2 will be given.

Both prizes for answers to the same questions will not be awarded to any one person.

CONDITIONS

1. Competitors must be subscribers to MINES AND MINERALS.

2. The name and address in full of the contestant must be signed to each answer, and each answer must be on a separate paper.

3. Answers must be written in ink on one side of the paper only.

4. "Competition Contest" must be written on the envelope in which the answers are sent to us.

5. One person may compete in all the questions.

6. Our decision as to the merits of the answers shall be final.

7. Answers must be mailed to us not later than one month after publication of the question.

8. The publication of the answers and names of persons to whom the prizes are awarded shall be considered sufficient notification. Successful competitors are requested to notify us as soon as possible as to what disposal they wish to make of their prizes, and to mention the numbers of the questions when so doing.

9. In awarding prizes, other things being equal, a carefully written and arranged answer will be given the preference.

10. Employees of the International Textbook Company, or of MINES AND MINERALS, are not eligible to enter this contest.

Questions for Prizes

1. *Calculation of Size of Fan Required for a Given Circulation.*—What size and type of fan would you employ for the circulation of a volume of 160,000 cubic feet of air per minute against a water gauge of 2 inches? Show method of arriving at size.

2. *Diffusion of Mine Gases.*—(a) Why does marsh gas, C_2H_6 , diffuse more rapidly into the air-current than carbonic acid gas, CO_2 ? (b) In a close place, where the ventilation is poor, is there any limit to the diffusion of marsh gas into the atmosphere?

3. *Distance Between Centers.*—(a) Given a gangway driven due north and chambers turned on a course $\text{N } 75^\circ \text{ W}$ so that there will be 50 feet between centers, what is the distance on the gangway between center lines?

(b) If the course of the gangway is changed to $\text{N } 20^\circ \text{ W}$ 20 feet inside of the center line of a chamber, what will be the distance on the course of the gangway between the center lines of the chambers?

4. *Size of Pumps.*—If a mine is making 4,000 gallons of water an hour and the shaft is 260 feet deep, what is the size of a plunger pump which will be necessary to take care of this water? What is the size of a centrifugal pump?

Some Air Analyses

In the Proceedings of the South Wales Institute of Engineers for September are published "Further Notes on the Analyses of Mine Air," by J. W. Hutchinson and E. C. Evans, an abstract of whose former paper was published in the September number of MINES AND MINERALS. These notes were made to "ascertain what effect a slowly rising or falling barometer had on the quantity of methane issuing from cavities or old workings, and also what effect the varying speed or stoppages of the fan had on the quantity of methane in the air-currents." The place chosen for the sampling of the air was at the outby end of an old main return airway, which was of considerable length with a large area of goaf and old workings on each side. The outby end of this return had been stowed up some years previously, as firedamp was always more or less present, and the quantity varied considerably. A pipe, 12 inches in diameter, passes through the stopping and rubbish in order to carry off the firedamp from the inside. It had been found necessary to have a current of at least 25,000 cubic feet of air per minute always circulating in order to keep the roadway leading to the upcast from the stopping in safe condition. Samples were taken hourly, 75 yards from the end of the pipes, the barometer being read simultaneously.

Upon analysis of the samples it was found that the quantity of firedamp in the air

increased rapidly with a fall in the barometer; that a fall of half an inch in the barometer was accompanied by an increase from a trace to 3 per cent. of firedamp. But as the barometer began to rise, the quantity of firedamp given off fell rapidly; a rise of .16 inch in the barometer causing a fall of 2.48 per cent. in the quantity of firedamp.

The conclusion to be drawn from these analyses is that dangerous conditions may result from any slight fall in the barometer, where a body of gas exists in old workings.

In the tests on the stoppage of the fan, it was found that the percentage of firedamp increased steadily during the stoppage and then rose rapidly as soon as the fan was started again, the barometric pressure of the mine being lowered by the starting of the fan.

來 來

Prospectors report finding a large deposit of good anthracite coal in the foothills of the Rocky Mountains, 243 miles southwest of Edmonton, B. C. The Highwood range of mountains, which runs to Mist Mount, 10,300 feet above sea level, presents an unbroken formation for fifteen miles, in which there is a continuous ridge of coal. The seams cover an area of one and a half miles in width and extend 3,000 feet below the surface, the reported depth of the Kootenai series. The seams show dips of from 46 to 82 degrees with thin coverings of shale, slate, and sandstone. Tests show the coal is of a grade almost corresponding with Pocahtontas.

ORE MINING & METALLURGY

Florida Phosphate Practice

Steam Shovels and Hydraulic Mining—Steam and Oil Engines—Electric Power Transmission

By John Allen Barr*

FLORIDA phosphates, classed as hard rock, soft rock, land pebble, and river pebble, are found in Eocene, Miocene, and more recent geological horizons. The hard-rock phosphate occurs massive, laminated, and as boulders piled together, also in the form of pebbles where the other rocks have been broken by weathering and water movements. This kind of material possesses

this standard. This ore is mined open cut, by dredging, and by hydraulicking; it is then washed, dried, and shipped to fertilizer works, mostly abroad.

River-pebble phosphates are found as bars in the rivers of southern Florida, and

The capacity of the dipper or shovel varies from 1 to 2½ cubic yards, and the boom and dipper arm is made to conform to the depth of the alluvions. For example, a 35-foot boom will raise material 18 to 20 feet above the shovel track and make a cut 35 feet wide. The cars to carry the overburden are standard gauge of 12 cubic yards capacity. They are usually dumped by

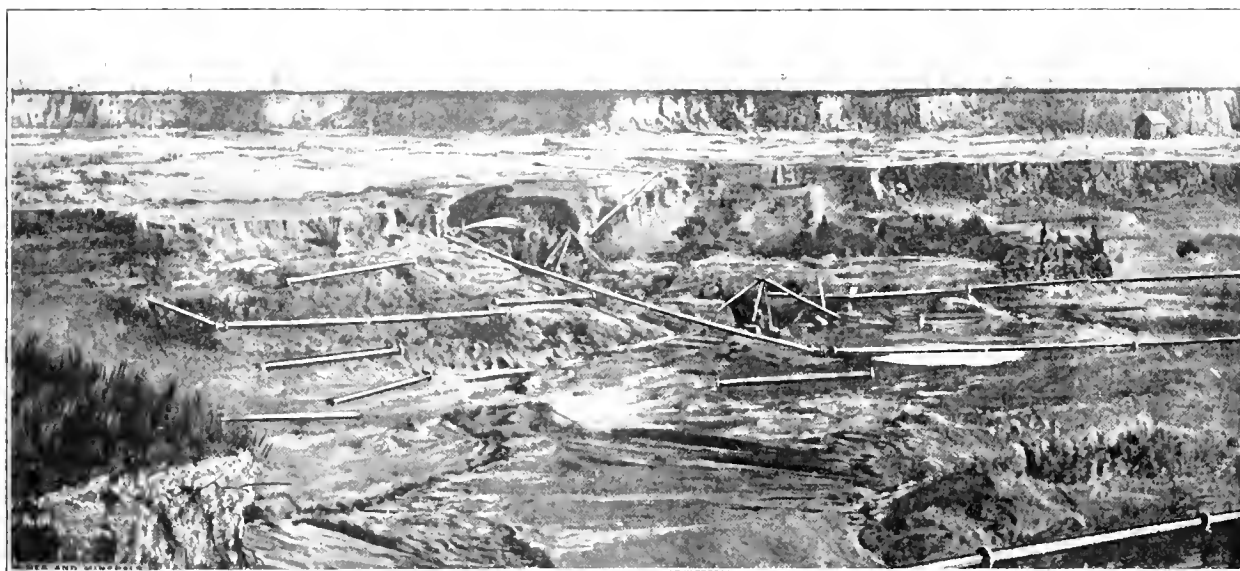

FIG. 1. HYDRAULIC PHOSPHATE MINING.

a variable structure from compact to fibrous, and while usually of a creamy color is frequently found stained with iron oxide.

The soft-rock phosphate occurs in deposits by itself and associated with hard-rock phosphate. It may be clayey or sandy and fill spaces between boulders of hard-rock phosphate. It is evidently a secondary deposit formed by the disintegration of other phosphates of lime.

It carries from 20 to 30 per cent. less phosphate of lime than hard-rock phosphate, which varies from 80 to 86 per cent.

Land-pebble phosphate is essentially a mass of whitish phosphate pebbles varying in size from grains to 1 inch in diameter, averaging possibly a little over one-quarter inch. They are hard and have usually a matrix of phosphatic clay and sand. The percentage of phosphate of lime which the pebbles contain is from 75 to 80, but the average material as mined would not reach

with them are found the fossil remains of vertebrates. The river pebble is blue or black, varying from 1 inch downward in size, and frequently occurring as the hardened casts of small molluscs.

It is presumed that river-pebble phosphates are derived from land-pebble phosphates, and also from hard-rock phosphates. The percentage of phosphate of lime in the river pebbles is between 58 and 68; at present river dredging for phosphate pebbles is not as active as the mining operations for land pebbles.

Florida phosphate beds are covered with soil to varying depths, which is removed by means of steam shovels or hydraulic nozzles. If the deposit is below water level, traction dredgers working on the land, or floating dredges, are used.

The overburden of land deposits is stripped from the ore by steam shovels, a cut being taken the full swing of the shovel boom, and the shovel moved forward a short rail length when this is finished.

hand, although some of the more recent cars have air dumping arrangements which are controlled from the engine cab. The cars are run out to the dump and handled in the usual manner, care being taken not to waste the material where it will cover future work. Steam shovel work is done by contract, the price being 20 cents per cubic yard.

Whenever conditions are favorable and space available for the disposal of material, the overburden is removed by the hydraulic method shown in Fig. 1, and pumped into an abandoned excavation from which the phosphate has been removed. The cost of stripping by the hydraulic method is from 5 to 8 cents per cubic yard. The overburden in Florida phosphate fields is favorable for this kind of work, being clean, fine sand, with some pebbles, the majority of the foreign substances being sods, stumps, and palmetto roots. Occasionally the sand is cemented and grades into a soft but tough sandstone which must be blasted before hydraulicking. Owing to the overburden

* Assistant Manager, Mt. Pleasant Phosphate Co., Tenn.

containing little clay, it can be stacked in large dumps that do not liquify and run into the streams.

In Florida where hydraulic stripping is practiced, hydraulic mining may be also, in which case the material is broken by playing one or more streams of water under a pressure of from 90 pounds to 140 pounds per square inch against the face of the deposit. This operation, which is shown in Fig. 2,



FIG. 2. BREAKING DOWN ROCK WITH HYDRAULIC NOZZLE

causes the rock containing the phosphate to crumble and flow into a ditch cut in the underlying marl. The flow is aided at times by additional water from a $\frac{1}{4}$ -inch-nozzle ditch hose, the object being to drive the material into a sump about 8 feet square also cut in the marl. From the sump the material is lifted by an 8-inch or 10-inch centrifugal pump and discharged into the washers. Since the rock material consists of firm sand and round phosphate pebbles, very little of it being over $1\frac{1}{4}$ inches in diameter, it is easily made to flow through the ditch into the sump, on a grade of 2 inches to the foot, by the use of about 10 times its weight in water.

The hydraulic nozzles are connected to the main water supply pipe which is usually 10 inches in diameter. Where two nozzles are worked each has from 200 to 500 feet of 6-inch diameter, flanged, spiral-riveted, galvanized water pipe. Asphalt roofing paper or tar board is used for flange gaskets. At one or two convenient places, in this 6-inch line, a ball-and-socket joint is applied to facilitate the lateral movement of the nozzles. This ball-and-socket joint is shown in Fig. 3(a).

When two nozzles are used they are pointed so as to wash the material to a central point, which is the ditch leading to the sump. In case the ditch clogs, an auxiliary hose is coupled just back of the nozzles and the flow of water from this is used to move the material to the sump. After the face of the rock is mined so far away from the sump that the material does not flow properly through the ditch, a new sump is

blasted 50 to 75 feet nearer the working face, and the pump is moved to it. The pressure required for hydraulic mining of this kind is not high, but the work demands a large volume of water in order to transfer the material through the ditch to the sump and not choke the pump by an excess of solids.

The outfit for transferring the ore to the washer consists of a centrifugal pump of the

sump is used owing to the difficulties arising from back flow and water hammer when operating two centrifugal pumps in series. Where the centrifugal pump discharges without much head, the end of the pipe line is elevated for a pipe length at an angle of 45 degrees in order to furnish sufficient pressure head to work against and prevent vibrations in the pump.

Some difficulty has been experienced with

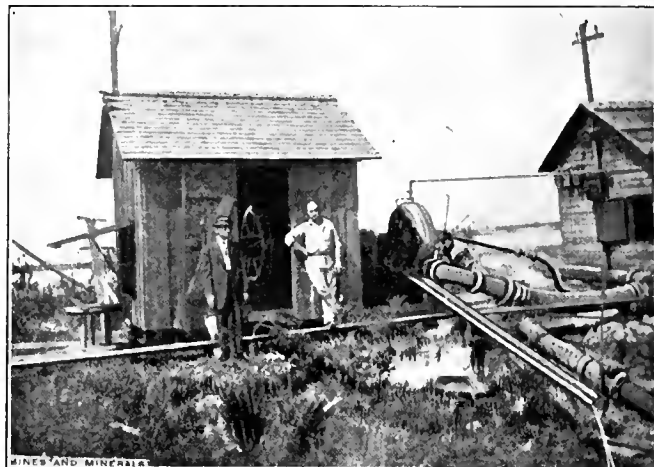

FIG. 4. RELAY PUMP

volute box type, with chilled cast-iron facing, directly connected to the slip-ring motor. The tail-piece of the pump, which must be made flexible, is raised from the sump by means of a set of triple blocks suspended from a tripod. This arrangement is necessary, because whenever the mouth of the suction pipe becomes clogged with grass, roots, etc., it must be raised out of the water for cleaning. In case the distance is more than from 800 to 900 feet between the mine pump and the washer, a relay pump is usually installed. In such cases the mine pump discharges into a sump from which the relay pump, Fig. 4, draws its material and forces it to the washer. The

heavy rubber pump suction hose reinforced by spiral wire, owing to its high cost, \$125 to \$150, and the uncertainty of its lasting more than from 2 to 6 months. Mr. Langsford, master mechanic, has invented a device which has successfully supplanted the rubber suction, at his plant, the Prairie Pebble Co. It resembles an expansion joint and being of cast iron is practically indestructible. It is supplied with water packing to prevent the admission of air into the tail-pipe, but it permits motion in one direction only, which is sufficient in the cases under consideration. Between the Langsford joint and the pump, and as near the former as possible, a flap valve shown in Fig. 3(b), is placed, to be used when priming the pump. It is a check-valve held open by a lever and a latch to prevent the valve from being closed whenever the pump loses its vacuum, and the water rushes back toward the sump. Should the valve be closed by this blow back it would create a water hammer, and burst the pump.

Mr. Blood, of the Florida Mining Co., has invented a simple flexible joint which replaces the expensive and short-lived flexible hose tail-pipe at much less cost. It is so constructed with an inner lining, as to prevent the sand and phosphate coming in contact with the rubber. It is a double diaphragm of heavy rubber sheeting with an iron thimble, flanged as shown in Fig. 6, to connect with the pipe line. An inner thimble is used to carry the material and prevent its coming in contact with the rubber.

The majority of the new phosphate plants are equipped both with steam and electri-

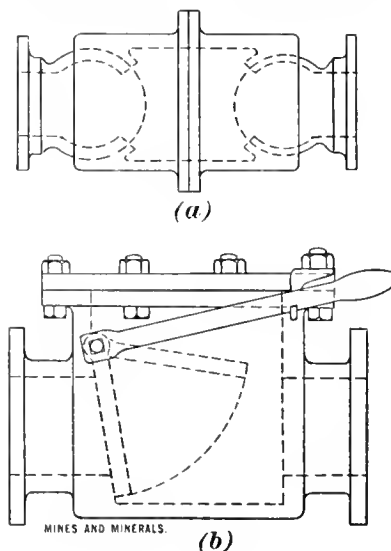

FIG. 3

city for driving the machinery. The 8-inch and 10-inch centrifugal pumps are driven by General Electric motors of the slip-ring induction type, 60-cycle, 75-horsepower, 2,000 volts, and $21\frac{1}{2}$ amperes, with street-car controller having three resistances, a Thompson ammeter, and an oil circuit breaker. The pump, motor, and other parts are mounted on skids, so as to be readily moved, and the motor is covered with a light frame house as shown in Fig. 4.

Practically all the water pipes and pump pipes used in the Florida field are of steel

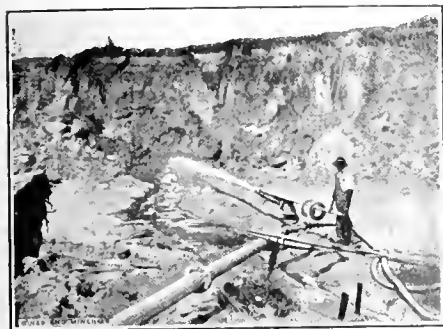

FIG. 5. HYDRAULIC NOZZLE

with peaned flanges and cardboard gaskets. The flanges, which come separated from the pipe, are generally put on by men who work on contract.

The preparation of phosphate pebble for market is comparatively simple and is practically the method described by Francis Wyatt in his book on "The Phosphates of America" which reached its fifth edition in 1894. The methods of mining and transporting the material have changed greatly, and the plants have been so enlarged that even though the preparation remains the same, the conditions are quite different and demand more engineering and executive skill.

After the material reaches the washer from the mines it is delivered to a relay pump as shown in Fig. 6 without going into a sump. This pump lifts the material to the top of the washer, where it is discharged into a launder that feeds a rotary screen, having $1\frac{1}{4}$ -inch holes. The screen makes two products: an oversize consisting of mud balls and coarse rock which is sent directly to the tailing pond, and an undersize which is discharged on to an inclined stationary screen with $\frac{3}{8}$ -inch slot openings, where some of the sand is removed, the operation being assisted by sprays of water. The oversize from this screen passes to a 16-foot double log washer which discharges the material into another 16-foot single log washer. These logs separate the particles of phosphate, sand, and pebble from the silica by reason of their grinding and mixing action. Wash water is also supplied to the logs, which assists the separation by moving the silica sand backwards and over the tail-gate of the log box. The last set of logs discharge on to a shaking screen which further elimi-

nates all but from 6 per cent. to 8 per cent. of the remaining silica and the greater part of the water. The dewatered material from this screen goes directly into a hopper-bottomed storage bin over the railroad tracks.

The Prairie company's washer is driven by a motor back geared 5 to 1, the counter-shaft running at 103 revolutions per minute with sprocket drive. This is a 60-cycle machine of about 30 horsepower, 220 volts, 75 amperes.

The Florida Mining Co.'s washer probably represents the best practice in the field. Its special feature, aside from its superiority in heavy structural work, is the idea of passing the mud balls and the coarse phosphate pebbles to a roll crusher, where they are disintegrated and discharged to the log washers in such shape that they can be cleaned. The log washers are double 20-foot logs solidly constructed and well designed, the paddles being large and heavy.

The central spindle of the log is a heavy hollow shaft to which the paddles are bolted with locknuts, a feature superior to the four separate angle irons in some other logs. The angle-iron logs, however, have one advantage in their later design, in that there are no stuffingboxes at the tailing end, these being replaced by a chilled cast-iron gudgeon and bearing supplied with fresh water to keep out the grit.

At this particular plant they are mining phosphate material containing some yellow clay such as is found intimately associated with the Tennessee phosphate, and contrary to expectations it was not entirely removed by the hydraulic mining, nor by passing it through two pumps; but when it had passed through the logs it was removed in large quantities in the first screen in the form of mud balls; some of the yellow clay passed through the second set of logs where it was loosened and removed by a second screening. It was the intention to pass these mud balls through the crusher, or rather a disintegrator, so that the entrained phosphate might be liberated by the logs.

Flat screens are very economical in repairs but in some places they might have a tendency to clog up with the clay, and it is to be noted that the French company, who are washing clayey material, employ rotary screens entirely.

Boiler Plants.—At the Prairie Pebble Co. works there are twelve 135-horsepower water-tube boilers whose flue gases pass through four economizers. At the Florida Mining Co., Scotch marine boilers are used. The objection to the Scotch boiler is the poor circulation of water, owing to an underlying circulating ring, which gives trouble by filling with scale, thus forming a constant menace to the safe running of the boiler. The boiler rooms are fitted with feedwater weighers, Bristol recording gauges for steam pressure, and also temperature gauges for the feedwater. The recording instruments together with the feedwater temperature instruments are arranged con-

veniently on a large board within the boiler room. By this means a constant check is kept on the running of the plant and pounds of water per K. W. hour at the switchboard computed at the end of each day.

The boilers are fired by hand, the coal passers getting coal from a small car which runs back and forth on the track before the boilers. Ashes are removed from the basement by a similar system.

This is the only plant in Florida visited that uses superheated steam. It is a well-known fact that, with turbines especially, economy increases with the superheat and noticeably prolongs the life of the blades by reason of the absence of moisture. The reason that superheat has met with failures in this country is due to its not being adaptable to all cases and more especially to the old type of engine which is not constructed to withstand the higher temperatures.

The boiler is fed, as a rule, by outside-packed plunger pumps designed to operate at very slow speeds, that is, not over 15 strokes per minute.

The earlier and present universal practice is to use direct-acting compound or triple-expansion pumps for furnishing water to the hydraulic nozzles at the mines and to the washer. The Florida Mining Co. has a triple-expansion pump capable of furnishing 4,000 gallons of water per minute, which it delivers at a pressure of 150 pounds per square inch. The Prairie Pebble Co. uses a somewhat similar pump made by the Worthington company. Their pumping plant consists of three triple-expansion, duplex, direct acting pumps, size 12 in. \times 19 in. and 30 in. \times 17 in. \times 21 in. These pumps have a capacity of 2,800 gallons per minute, each.

The only centrifugal pumping plant that supplies water to the pipe nozzles is installed by the new French company. This company uses a three-stage turbine pump, direct connected to the 250-horsepower induction motor, and it delivers water to the nozzles at a pressure of 140 pounds per square inch. The experience with this

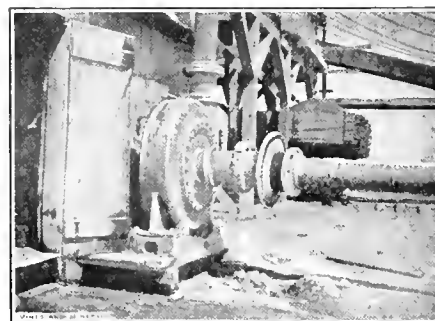

FIG. 6 FLEXIBLE JOINT

pump in the field has been that, when new it was very satisfactory, but when pumping gritty water, such as must be the case at most of the mines, the pump lining soon wears and the pump has a low efficiency.

The newest pumping stations being built

contain the Corliss flywheel condenser pump. The principal advantage of this pump for this kind of work over the direct-acting pump is principally its high duty, which often is at least one-third more. The duty of the direct-acting pump seldom goes over 90,000,000 gallons, while that of the Corliss flywheel pump approximates 120,000,000 gallons in 24 hours. The flywheel pump is less liable to become broken by failure of the governor to act, or by bursting of the pipe line.

Air compressors are installed at this plant to pump water from artesian wells, using the principle of the Pohle pump. The efficiency of this arrangement is from 30 to 40 per cent., and it would seem as if a centrifugal pump driven by a vertical shaft in a sump would increase this efficiency considerably, say, from 30 to 60 per cent.

The Prairie Pebble Co. has one Ingersoll-Rand cross-compound air compressor, with Corliss valve motion, automatic air valves, and a capacity of 2,027 cubic feet of air per minute. They also have one tandem-compound Sullivan air compressor with Corliss valve motion capable of furnishing 2,450 cubic feet of air per minute.

The Prairie Pebble engine room presents no special features, as it has been built up piece by piece and is not the main power plant. Exclusive of the pumps which have been described, there are two four-valve automatic engines direct-connected to 2,300-volt generators; there is an alternator engine of 325-horsepower capacity when running at 200 revolutions per minute, belted to a 240-kilowatt, 2,300-volt generator; one 300-horsepower Harrisburg piston-valve engine making 250 revolutions per minute and direct-connected to 240-kilowatt, 2,300-volt generator.

The Florida Mining Co. generates power with a 300-kilowatt turbine of the Parsons reaction type. This unit is direct-connected to a 300-K. V. A., 2,300-volt turbogenerator.

The Charleston Mining Co., at Fort Mead, has a 1,000 K. V. A. vertical Curtis turbine and are installing a 600-K. V. A. horizontal turbine of the same kind. For a smaller unit than 3,000 K. V. A. and less, the horizontal turbine is preferable by reason of the absence of the forced feedstep oiling system, such as is necessary in the vertical type. The chief advantage of the turbine over the reciprocating engine is its simplicity, low first cost, ease of upkeep, and the possibility of using a lower-priced operator. It is also much more compact than the reciprocating engine.

While turbines of 1,000-kilowatt capacity and larger are designed for as economical steam consumption as the ordinary reciprocating engine, still with high pressure and superheat, the poppet-valve engine holds the record for thermal efficiency, but at higher first cost, and cost of maintenance.

The Prairie Pebble Co.'s central power station is the largest in the field and consists of eight sets of tandem-connected,

three-cylinder, Deisel oil engines, direct-connected to a revolving field alternator, of 2,300 volts, 75½ amperes, three-phase, 60 cycles, 164 revolutions per minute. The Deisel engine operates on the principle of the four-cycle gas engine, the difference being that the air is compressed in the cylinder to 750 pounds, giving, thereby, temperature above the flashing point of oil. Just before the highest pressure point of the stroke, oil is injected with air, causing the explosion and generating power by the expansion of the gases on the down stroke. Crude oil, or distillate, can be used in this engine, but the Prairie Pebble Co. uses a lighter distillate, as it was found that the crude oil was detrimental to the life of the engine on account of its carbonizing the cylinders.

The one and only advantage of the Deisel engine is the low fuel consumption, it being one-half that of the steam engine; that is, a thermal efficiency of about 30 per cent. It is very much like a gas engine except that it has more troubles. Its high cost of upkeep and repairs, and its periods of trouble would soon overcome its superior advantage of fuel consumption in a country adjacent to coal mines. It is essential for the continual operation of the plant that there be one or more reserve engines available, when, as is frequently the case, it becomes necessary to make repairs, especially after the plant has run for about 5 years.

It is important for the proper operation of the Deisel plant that the chief engineer thoroughly understand his business, and one who has that requisite can command a salary from \$2,000 to \$3,000 per year. But he is cheap in the end compared with the low-priced and inefficient engineer.

The Deisel plant of the Pierce Phosphate Co. has been in operation about as long as the Prairie Pebble Co.'s plant. This plant consists of six three-cylinder Deisel engines. This company has also a gas-producer plant operating a 1,200-horsepower tandem, two-cycle gas engine, direct-connected to the revolving field alternator that is run parallel with a Deisel plant, which has five 2,300-volt alternating-current generators, and one 500-volt direct-connected generator.

The gas producer has given considerable trouble but is now in such shape that it has a thermal efficiency of from 28 to 30 per cent., and uses any fuel from peat to sawdust.

It seems to be the practice in the Florida phosphate field to use 2,300-volt, three-phase, 60-cycle alternating current for all power purposes, and 500-volt direct current for trolley work. Where the transmission lines are carried from 2 to 3 miles or more, it is the practice to step up the current to 17,000 volts and step it down to 2,300 volts at the distribution station. Direct current is generated at the Prairie Pebble central station by three synchronous motor-generator sets. The advantage of this set over

the rotary converter is that the field can be over excited to bring the power factor near unity. The synchronous motor is not satisfactory when improperly installed and operated. It is affected by line surges, change of voltage and load, requiring separate adjustment of the field for each change of load. This latter may be accomplished, however, automatically.

Frequent flooding of the pumps in the mine pits necessitates that the motors be dried. At the Florida Mining Co. this is done by connecting a General Electric transformer of 60-cycle pole type, 20,000-watt capacity, primary 2,300 voltage, which will give a normal current through the stator with the rotor stationary and all resistance cut out. The voltage to which the line current is stepped down must be sufficient only to send normal current through the winding. When drying a transformer of from 2,300 volts to 440 volts capacity the secondaries are short-circuited, and 110 volts are sent through the primary, with the result that normal current is obtained in both windings.

Heaviness of construction is noticeable in all new equipment in the Florida field. Much of the construction is reinforced concrete and steel so that almost perfect rigidity is obtained, a feature essential for the economical operation and successful working of shaft lines. In cases where supports are not entirely rigid, ball-and-socket pillow-blocks are used for the regular work. The heavy stationary rigid pillow-blocks are much used in large sizes, placed on end-adjustable base plates.

The lubrication is principally by grease cups, on account of the excessive dust which precludes the working of chain oil bearing; however, in any place where dust is not excessive the self-oiling pillow-block is not only more economical in oil but requires attention only once a month and uses a grade of oil which gives a lower coefficient of friction. On account of the excessive amount of dust and grit about drives, sprocket and chains are almost universally adopted for transmission of power. The heavy kinds of chain are used. It is noticeable with all of these drives that none exceed the proper speed for chain, viz., 500 feet per minute.

Manganese chains are being adopted with excellent results. Where the belts can be used, chains should not be given preference, for the well-designed belt drive will last for years. The only reason that belts give so much trouble and wear out so quickly is that they are over stretched, the designers not giving sufficient attention to their installations. The belt drive properly installed is from 6 to 8 per cent. more efficient than the chain drive. No rope drives are used in Florida on account of the universal employment of electric power. At the Prairie Pebble Co., the large 150-horsepower drier-shed motors are connected to the main line shaft by a Renold silent chain.

This excellent speed reducer is kept well lubricated with graphite grease free from grit.

The wet rock elevators of the Prairie Pebble mill are placed at 57-foot centers. These elevators have a pitch of $4\frac{1}{4}$ inches per foot. The elevator buckets, 8 in. X 18 in., have round bottoms. The manganese chains work on an 18-inch traction tail-pulley and a 30-inch traction head-pulley traveling at the rate of 235 feet per minute.

The dry-rock elevators are constructed along the same lines but their length is divided into two vertical lifts, to reduce the weight on each chain. These elevators have given perfect satisfaction, the use of manganese chains insuring long life, freedom from breakdowns, repairs, and frequent renewals. They are all single strand elevators which obviates any trouble with unequal wear on chains. However, unequal wear may be reduced by leaving one of the tail-sprockets loose to compensate this difference and permit ascending buckets to come parallel.

The Phosphate Mining Co. and the new French company both have double-strand elevators with 22-inch cups. This arrangement permits of a positive discharge by running over a double set of head-sprockets and allows the speed of the elevator to be reduced on account of not needing centrifugal action for bucket discharge.

Practically all of the conveying is done by flight or drag conveyors. The best conveyor of this kind in the field is in the wet bins of the Prairie Pebble Co. It has a chain with 24-inch head-and-tail sprockets on 62 $\frac{1}{2}$ -foot centers. Every third link in the chain has a flight 11 inches wide and 5 inches deep. Roller idlers 8 inches in diameter are placed every 12 feet, and the speed of the conveyer is from 60 to 100 feet per minute. The journal bearings are supplied with grease cups. The phosphate material is allowed to make its own bed in the concrete trough, thus eliminating the frequent renewal that would be necessary if the flight were allowed to drag upon iron plates as is the case in most conveyors. There is practically no trouble with this drag.

With the exception of the Prairie Pebble Co., the majority of the new dryers are of the rotary type, manufactured by the Georgia Iron Works. These are set level, the material being fed at the cold end and worked to the hot end by spiral flights on the inside of the shell. All of the dryers are fired by oil, which accounts for their large capacity and easy operation. The only objection to the use of rotary dryers is where the rock contains clay that clogs the spirals. Rotary dryers are about 50 feet long and require about 5 horsepower to run them. Their capacity is about 100 tons of well-drained sand in 10 hours or 120 tons of rock, and to dry this quantity of material requires from 5 to 6 tons of coal. One man can fire two dryers with coal, provided the coal is in front of the furnace.

The most noteworthy part of the construction is the storage bins of all the plants. The Prairie Pebble Co. has a reinforced bin, 525 feet long by 75 feet wide by 30 feet deep, not including the clearance over the tracks. It is composed of three compartments with four tracks overhead for the car haul and three tracks underneath for the railroad.

At the Prairie Pebble mill car hauls are the source of much trouble and wear and Mr. Langford heartily agrees with the suggestion that two motor-driven distributing cars would perform this work much better and at less cost.

The storage shed being built by the Phosphate Mining Co., has as a special feature an overhanging side of cantilever effect that allows the bins to project over the railroad tracks on this side. This construction does not appear to be a very desirable feature. The mill building, or that part over the dryers, is of reinforced concrete columns with slab floors having reinforced beams.

For the considerable tonnage in the Florida field these large storage bins are very desirable. For instance, the Prairie Pebble Co. work 20,000,000 tons through their plant; the Wales plant, 3,000,000 tons. On the face of this it would not seem that the Wales plant would be justified in the erection of an expensive storage bin.

The storage bin of moderate capacity, say 20,000 tons, would cost about \$80,000, representing a charge of 2 $\frac{3}{4}$ cents against 3,000,000 tons, and the ordinary storage shed with an electric crane would only represent a charge of .003 mill per ton. Judging from the above figures the ground level storage with an electric crane is cheaper for loading from the storage pile into cars. The structural work for storage house as well as for dryer shed could be of steel and last longer than the mine.

Wet storage sheds should be constructed with an electric crane on steel supports with a slope drainage floor and with no retaining walls on the side. It has been found by experience that to drain this kind of material side walls greatly interfere with the rate of drainage. The shed floor can be built of planks with cinder drain underneath and all underlain with drain tile

采采

The "Billy White" Cut

By William J. Crocker*

Much has been written relative to the wedge, the star, the sidehole, and other cuts for opening drifts and mining tunnels, but the "Billy White" cut, while good in any hard ground, is especially useful in tough rocks that have no slips, faces, or walls to which shots may break

This cut derives its name from one William White, a miner who first used it in the tin mines of Cornwall. The round of holes for this cut is drilled as shown in Fig. 1.

*Negaunee, Mich.

Three holes, 1, 2, and 3, are drilled straight into the breast, exactly in a line with one another, at a distance of 5 inches, center to center, thus making the distance over all 12 inches, assuming the holes are each 2 inches in diameter. Another hole 4, is drilled 7 inches to the right of the first three holes and in a horizontal line with hole 2. Hole 5 is drilled 12 inches to the left of hole 2 and in the same line as hole 4. These five holes complete the drilling of the cut. All are put in horizontally or looking down just enough to hold water.

The success of this cut lies mainly in drilling the holes in planes with one another and in shooting them in the proper rotation.

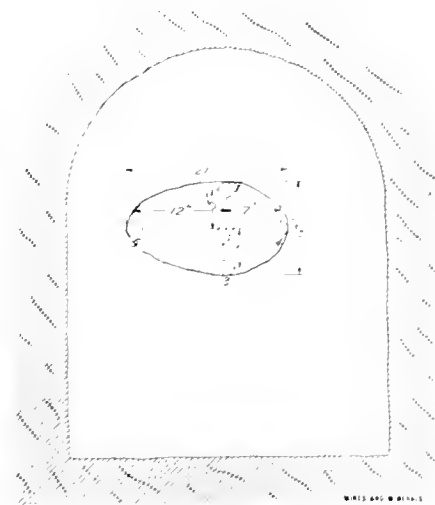

FIG. 1. THE "BILLY WHITE" CUT

Four of them are loaded in the usual manner, care being taken to cut the several fuses of slightly variable length so that the holes will go off in the following order; viz., 1, 3, 4, and 5. Hole 2 is drilled merely to provide space for hole 1 to break to, and is never loaded. Each shot creates more clear face for the following shot. After holes 1 and 3 have gone, the chamber is about 12 inches vertically by 5 inches horizontally and somewhat oval in section. After all the holes have shot, there is produced a chamber about 12 inches by 21 inches, as shown in the illustration.

A feature of this cut is that it breaks as big at the bottom as at the collar. I believe the scheme will break as deep as is ever desired. I have brought them 6 feet in the Hartford mine, Negaunee, Mich., and in the East Pool mine, Cornwall, England. I have also known this cut to be used in regular 6-foot holes in the Glen Deep and the Vogelstrieus Deep mines, of South Africa. This success may be understood by noting that hole 1 has but 3 inches of rock to break and has 2 inches of relief in hole 2. The rest of the round is obvious. I find that this cut takes no more powder than do other cuts, but on the other hand, it often accomplishes its function with less powder. The full bore of the tunnel is obtained by the usual placing of holes that will break to this initial cut.

Practical Cyaniding—Part 5

Operation of Vacuum Filters—Precipitation—Zinc Shavings and Boxes—Use of Zinc Dust

By John Randall*

THE operation of forming slime cake by means of a vacuum is the same in all cases, and as a general proposition the more vacuum the pump produces the sooner will the cake be formed with any given slime pulp. To form the slime cake, the filter leaves are submerged in the slime pulp and the vacuum pump is connected to them. To prevent the pulp solution from falling below the top of the filter leaves, a steady stream is permitted to run into the tank, while, to prevent the slime from settling, air agitation is practiced, or else the slime is pumped from the bottom and returned at the top of the tank. The time required to form the cake will depend on the slime treated and its dilution. With

refilled with wash solution in the stationary process, the vacuum is kept on the filter leaves, but the pressure is lowered until it is not more than 5 pounds per square inch. As soon as the tank is filled with wash solution, the vacuum is increased to 28 inches, or 13.72 pounds per square inch, or the normal working pressure, and continued until the gold solution has been displaced. The time required to displace the gold solution is more than the time required to form the cake. It will vary from 50 to 120 minutes, depending on the

tons, of moisture remains in a cake and that the wash solution contains 25 per cent. of cyanide. Since .25 per cent. of 1 ton is 5 pounds, this cake will contain $5 \times 6.72 = 33.6$ pounds of cyanide. At 20 cents a pound, this will amount to \$6.72. There is also a possibility that the solution in the cake will contain some gold as well. The time occupied in displacing the wash solution is reduced to one-fifth of that consumed in displacing the gold solution, and the liquor that passes through the filter is sent to the wash solution tank. The vacuum is now shut off entirely, and the wash water remaining in the tank is used to flush out the slime cake from the tank; or, if the water is scarce, part of the water is pumped to the wash-water tank and only part used for flushing purposes.

If the agitation of the slime and cyanide solution was thorough, the slime cake is now ready to be removed to the tailing heap. For this purpose, one of the following methods may be adopted:

1. Water may be admitted to the interior of the filter through the vacuum pipe at a pressure of about 8 to 10 pounds per square inch until the slime has left the filter leaves. The filter leaves not being constructed to withstand pressure from the inside, must be kept submerged while the cakes are being discharged in this way.

2. Water and air under pressure not to exceed 10 pounds per square inch are considered by some preferable to either air or water alone. Where the combination of air and water is adopted, the filter leaf is bounded on all four sides with iron pipes, and the air is admitted from the lower pipe while the water is admitted to the filter through the upper pipe. With air and water in combination, it is not necessary to keep the filter submerged, since either air or water will find a ready exit through those places in the filter cloth where the cake has been displaced.

3. Compressed air may be used to displace the cake, although it is not so effective as air and water or air and steam.

The filter leaves must be kept submerged when air alone is used. The cake drops into the hoppers of the filter tank and is sludged out if all the water is to be wasted, but if water is valuable, valves are placed in the sides of the tank just above the commencement of the hopper and the water saved to this level.

The water introduced into a filter must be free from sediment and organic matter, otherwise the pores of the cloth are liable to be closed, and in addition organic matter might precipitate the gold in solution. The water necessary for discharging filter cakes, per ton of cake will, vary from 1 to 2.5 tons for wet cake, the former being the quantity required when part of the water

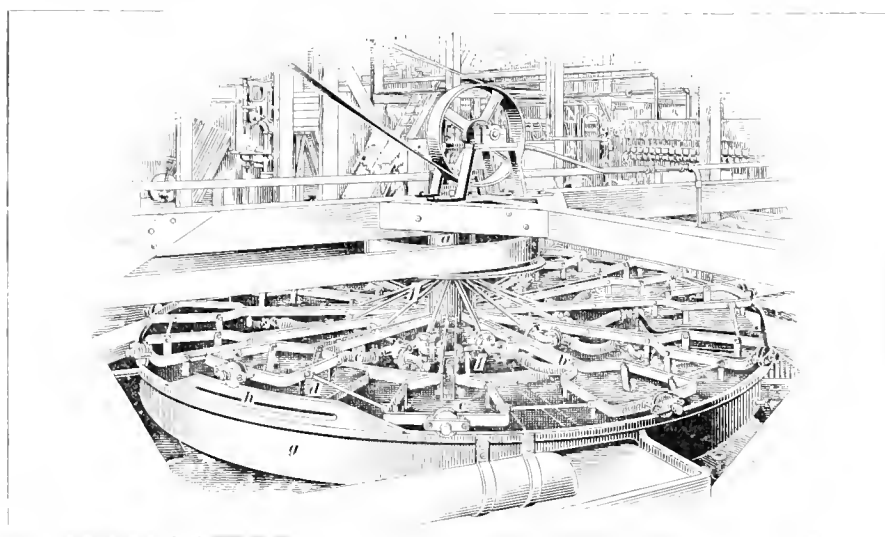

FIG. 1. OGLE-RIDGWAY FILTER

uniform pulp solution of medium settling slime, it is about as follows:

Time of Formation Minutes	Thickness of Cake Inch
5	.250
10	.375
20	.500
30	.625
40	.750
50	.875
60	1.000

After the slime has caked to a sufficient thickness, which is determined by measurement, the vacuum is lowered in order not to dry out the cakes while they are having their solutions changed. A crack in a slime cake causes a channel through which the wash solution will flow instead of through the cake, and thus the main object of the wash solution, that is, the displacement of the gold solution, will be abortive. During the time that the filter leaves are being changed from tank to tank in the movable process, or during the time the slime pulp is being drawn and the tank

kind and thickness of the cake and the pressure employed in its formation.

The quantity of wash solution necessary to completely displace the gold solution will approximate between two and three times the quantity of gold solution remaining in the cake, that is, if 35 per cent. of moisture remains in the cake, 1 ton of the cake will require from .7 ton to 1.05 tons of wash solution for its displacement. The first half of the wash solution can be sent directly to the gold solution tank, and the second half to a tank where it may be brought up to the standard used for agitating the pulp. When the washing process has continued as long as previous experiments indicate that it should for the complete displacement of the gold solution, the vacuum is again reduced, and the wash solution remaining in the filter tank is returned to the wash-solution tank.

The operation of displacing the wash solution with water is sometimes omitted, but the economy of doing this should be carefully considered. In most cases a water wash will pay for the trouble. For example, suppose that 35 per cent., or 6.72

* Metallurgist, Boulder, Colorado—Article commenced in August, 1912.

is saved and the latter when no water is saved. When dry cake is discharged by air and water or steam and water, only about one-half ton of water is required, and this is needed mostly for washing down filter leaves and sludging out the tank previous to the next operation.

An acid tank is a necessary adjunct to vacuum filters wherever lime is used. Frequently, lime is required to counteract acidity in the ore, or to settle slime. The calcium oxide becomes converted into calcium carbonate and precipitates on the filter leaves. Unless the calcium carbonate is removed, the filter in time becomes practically useless, owing to the meshes in the cloth becoming clogged. To raise the filter leaves and transfer them to the acid tank, a differential pulley is attached to an overhead crawl. The filter leaves are removed in baskets and submerged for about 6 hours in a bath of 2-per-cent. hydrochloric acid, after which they are removed and rinsed in clean water to clean them of acid and stop the action between it and the lime. It may be necessary, where much lime is used, to adopt a stronger acid solution, say a 5-per-cent. solution, and draw it through the filter by a slight vacuum, the vacuum pipes being attached to the filter basket during the cleansing operation. The filter leaves are treated in regular sequence, a certain number each day, while the frequency of the treatment depends on the quantity of lime used in the process.

Thin cake vacuum filters are rapidly gaining favor on account of the greater tonnage capacity of a given filter area, also the rapid passage of the washes through the thin cakes minimizes diffusion losses. The Ogle-Ridgeway filter, Fig. 1, was introduced at the Great Boulder Proprietary mine in Kalgoorlie, West Australia, where it was required to treat as much slime as the filter presses there use. An exhaustive trial extending over 1 year showed that it was able to treat slime for 8 cents per ton, which was 25 cents less than the filter presses could do. The filter, which is practically automatic, is capable of treating the tailing from the decantation process in South Africa, where 6,000,000 tons of slime was treated annually by the decantation process, involving a loss of \$1,000,000 per annum through incomplete extraction. The success of the Ridgeway filter depends on the use of a thick pulp that does not exceed 55 per cent. in moisture. Thickeners are now made that can be depended upon to furnish a pulp even thicker than is required for this filter.

The Oliver continuous filter shown in Fig. 2, differs from all others in washing the cake by means of a spray instead of immersing it in the wash. The automatic style of its operation is in line with the increasing tendency toward continuous methods in all stages of ore treatment. It seems to combine the good features of the

Ogle-Ridgeway with greater simplicity of design. A feature of the Oliver that is particularly important in mills of moderate capacity is that no attendant is required, the attention that the solution man has time to bestow upon it being generally sufficient. These filters are running on pulp containing as high as 66 per cent. moisture. Operating costs per ton including renewals of the filter surface range from 2.9 to 4.6 cents per ton.

Conditions Affecting Slime Filtration. Practical experience has demonstrated that slime from different ores varies so much in its physical properties as to require different kinds of filters; or speaking more definitely, a filter giving good results on one class of slime may fail when called upon to treat another class. In plants where sand and slime are separately treated, the slime may be made more permeable by adjusting

fessor of Mining and Metallurgy, Mackay School of Mines, Nev., have standardized and put in definite form a considerable amount of information on the subject of slime filtration, as well as brought to light some original discoveries. He found that the portion of the cake next the canvas is most dense and that there is a progressive decrease of density toward the outside, and that a cake when taken from the water shrinks in the direction of its thickness but regains its original thickness when again immersed in the water. He draws a parallel between some slime cakes and a mass of rubber balls, the deformation of the balls under pressure tending to close the interstitial spaces having a relation to the amount of pressure used.

Fig. 3 gives the average filtering rate deduced from Professor Young's experiments. If we assume for convenience that

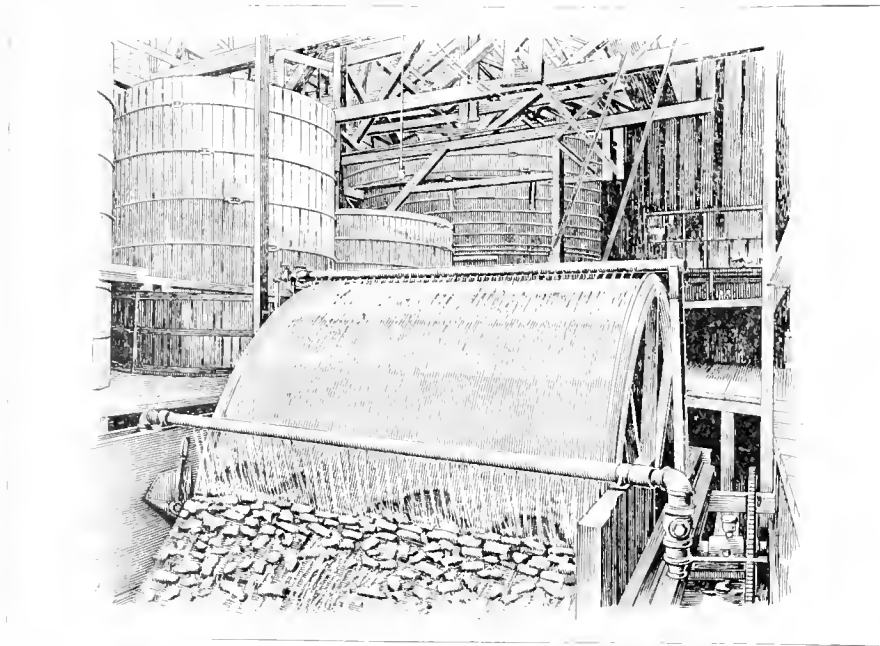

FIG. 2. OLIVER CONTINUOUS FILTER

the classifier so that a greater amount of very fine sand is mixed with the slime. Coarse sand in a very clayey slime does not help filtration and may hinder it, as the nearly impervious slime fills the voids between the coarse grains which are themselves impermeable. Even throwing all the 200 mesh sand into the slime will not make the cake more permeable unless the quantity of fine sand is great enough so that the voids between the grains will not be entirely filled by the colloidal slime. The pressure allowable in slime filtration depends upon the nature of the slime. In some attempts to use pressure filters where vacuum filters gave low filtering rates, it has been found that greater pressure decreased the filtration rate or stopped filtration entirely. Each type of filter seems to have a different range of usefulness, some being of special value only in the treatment of a given kind of slime.

Experiments by George J. Young, Pro-

the pulp in any case is thickened to 57.45 per cent. moisture before going to the filter plant, then the number of pounds of water per minute drawn through the filter will equal the dry weight of slime built up on the cake in the same time, provided the cake contains 35 per cent. moisture. It will be seen from the diagram that cake building proceeds with great rapidity at first but falls rapidly until at a cake thickness of one-third of an inch the rate of building has dropped to a comparatively low point. By measuring the diagram, disregarding fractions beyond the first decimal place, we find the time required for building each layer one-tenth inch in thickness to be as shown in Table 1.

These time computations are based on the usual assumption that a slime cake 1 inch thick weighs 8 pounds per square foot. At 35 per cent. moisture the dry weight of such cake would be 520 pounds per 100 square feet or 52 pounds for each tenth

of an inch in thickness. The time required is therefore computed as that required to deposit 52 pounds in each layer. It will be noticed that while slightly over 1 hour is required to build the 1-inch cake, the first three-tenths is built in less than 6 minutes. This serves to explain the comparatively large capacity of thin-cake filters. Another circumstance deserves notice. During washing the rate of travel of the wash solution or water through the cake 1 inch thick is only 6 pounds per minute. At 35 per cent. moisture there are 280 pounds of solution in the 100 square feet of cake. Assuming that every molecule of the water travels through the cake at the same rate of speed, $280 \div 6$ or 46.7 minutes would therefore be required for the water to move 1 inch. The rate of travel per minute would be the reciprocal of this number, which is .0214. A filtration rate of two-hundredths of an inch per minute is sometimes, but not always, less than the diffusion rate of the dissolved gold from the cake out into the wash, and accounts for the enrichment of the wash solution often observed in the operation of thick-cake vacuum filters.

Professor Young summarizes the subject as follows:

1. The proportion of clayey material in ores which are to be subjected to all-sliming and filtration should be maintained at a minimum.

2. The slime pulp should be as free as possible from sands coarser than No. 150 screen, and as large a proportion of the pulp as possible should consist of material passing a No. 200 screen.

3. The slime pulp before filtration should be settled to as thick a consistency as is possible consistent with easy circulation in pumps and in pipes.

4. The temperature of the slime pulp should be maintained between 20° and 30° C. or higher.

5. The temperature of the wash water and the pulp should be the same.

6. Vacuum pressures should be varied until the proper intensity for the given slime is obtained.

7. Where very clayey slime is to be filtered, as much fine sand should be crowded into the pulp as it will carry without undue settling and clogging.

8. No. 10 canvas supported by slats gives the best all-round service for thick cake, and No. 12 canvas on wire netting answers the requirements for thin-cake filtering machines.

9. With slime containing a large proportion of colloidal material, pressures greater than those obtainable with vacuum apparatus are of questionable advantage.

10. With slime containing a large proportion of clayey material the vacuum filter should be used.

11. With slime containing a small proportion of clayey material and much fine sand, both vacuum filters and pressure

filters could be used with perhaps equally good results.

12. With slime containing much coarse and fine sand, the chamber filters with air agitation and high pressures would perhaps give the best results.

TABLE I

Layers One-Tenth Inch in Thickness	Filtration Rate in Pounds of Water Per 100 Square Feet Per Minute	Time in Minutes Required to Build One-Tenth Inch in 57.45 Per Cent. Pulp
1	90.0	.6
2	32.0	1.6
3	15.0	3.5
4	10.0	5.2
5	8.0	6.5
6	7.0	7.4
7	6.5	8.0
8	6.0	8.7
9	5.5	9.0
10	5.0	10.4
Total time		60.9

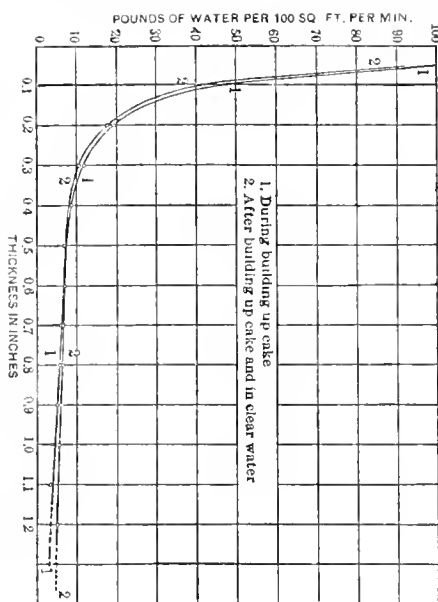

FIG. 3. AVERAGE FILTERING RATE FOR SLIME CAKES, NO. 10 CANVAS

13. Of the vacuum filters the thin-cake continuous filters are a decided improvement over the thick-cake filters.

It will be seen from this discussion that the successful treatment of ore slime means much more than mere mechanical routine and should receive the most earnest and painstaking attention from the mill superintendent.

White Precipitate.—Owing to the numerous impurities in ores many substances find their way into cyanide solutions or become associated with them. When the precipitation boxes are reached the various solutions are broken up by hydrolysis and the deposition of the gold, thus forming compounds that produce a loss of cyanide and are troublesome to handle. The conditions that govern the formation of grayish-white porous precipitate are not thoroughly understood, but as a rule when it forms on the zinc, gold is being imperfectly precipitated.

The double salt of potassium aurocyanide is precipitated from the solution by means of zinc filaments of such thickness that 1 pound exposes about 1,500 square feet of surface to the solution. The precipitation of gold takes place according to the reaction expressed by the equation

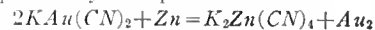

The double salt formed in the precipitation is directly decomposed into hydrated zinc oxide, $Zn(OH)_2$, potassium cyanide, and free hydrocyanic acid, according to the equation

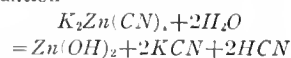

Both the potassium cyanide and hydrocyanic acid are free to form other compounds, which it is evident that they do, because ferrocyanide of zinc and potassium, $K_2Zn_3Fe_2(CN)_{12}$ and zinc cyanide, $Zn(CN)_2$, are found in the white precipitate. Zinc hydrate forms on the zinc shavings, particularly where weak cyanide solutions, from .01 per cent. to .03 per cent., have been used, thus impairing their usefulness. Strong cyanide solutions dissolve the zinc hydrate as formed, or it may be dissolved by the addition of fresh cyanide solution at the head of the precipitation boxes.

If lead salts are used in the dissolving solutions, the lead deposits on the zinc and falls off, thus keeping a surface of zinc clear for the precipitation of gold. Similarly, lead prevents copper from depositing as a layer on the zinc and interfering with the precipitation of gold. Common salt or ammonium salts in solution appear to assist precipitation owing to their slight solvent action on zinc hydrate.

If the sodium or potassium cyanide fed into the zinc box contains alkali carbonates and there is lime in the gold solution, the efficiency of the zinc is impaired, owing to its surface being partly insulated from the gold solution by a coating of calcium carbonate, which forms according to the reaction

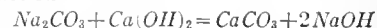

Protective alkalinity. Potassium cyanide in dilute solutions dissolves zinc cyanide in accordance with the equation



The double salts of potassium cyanide with base metals are soluble in excess of caustic alkali, and will therefore not form to a great extent if there is sufficient free alkali present. Thus zinc hydrate will not form when the following reaction can occur:

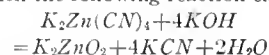

These reactions point to the necessity of a protective alkalinity to prevent the loss of cyanide, and to obtain good precipitation of gold. When the precipitation of gold occurs in the zinc box there is a loss of alkalinity that is proportional to the percentage of plus or minus alkalinity in the solution. To insure good precipitation and reduce the consumption of zinc,

there should be protective alkaline hydrate. So long as free caustic alkali is present, any carbon dioxide will be converted into carbonates, thus protecting the cyanide in the solution.

Composition of white precipitate. The residues, termed the white precipitate, in the zinc boxes at Ferreira Deep mine were found to have the bases given in Table 2. In addition to the ingredients given, the white precipitate will contain variable quantities of calcium and lead sulphates, oxides, or carbonates.

TABLE 2. COMPOSITION OF WHITE PRECIPITATE

Base	Per Cent.
Ferrocyanide of zinc and potassium, $K_2Zn_3[Fe(CN)_6]_2$	10.45
Zinc cyanide, $Zn(CN)_2$	22.73
Zinc hydrate, $Zn(OH)_2$	51.79
Copper oxide, CuO	40
Ferric oxide, Fe_2O_3	1.01
Silicon oxide, SiO_2	1.03

By comparing the analysis of a solution entering and leaving the precipitation boxes it was found that 81 per cent. of the ferrocyanide remained in the box and went into the white precipitates. There was a reduction of nearly 50 per cent. in potassium cyanide, which accounts for the formation of ferrocyanide of zinc and potassium.

If there is a certain strength of potassium cyanide in the solution, ferrocyanide of zinc and potassium will not be precipitated, but if this strength is lowered precipitation will occur.

When copper is present in the gold solution, it covers the zinc with a bright metallic copper covering. This copper deposit is observed in the lower compartments first, from which it gradually works toward the highest. The precipitation of the gold is very slow when the zinc is coated with copper.

According to Virgoe there is a higher and a lower copper potassic-cyanide salt formed. The higher salt has the formula $K_4Cu_2(CN)_6$ and is formed when a small quantity of copper is dissolved in a dilute cyanide solution containing an excess of potassium cyanide. This salt solution is said to be a fair solvent for gold and silver, but the lower copper salt, $K_2Cu_2(CN)_4$, which is formed when there is considerable copper present, has no solvent power. Copper goes readily into a solution of .1 per cent. potassium cyanide, but is only slightly dissolved by solutions containing .05 per cent. of potassium cyanide. It has been found that dissolved copper is precipitated faster from a weak cyanide solution than from a strong one. It is evident that the precipitation of copper occurs most readily from such solutions as contain the higher salt; in other words, from weak cyanide solutions.

The precipitation of copper from a weak solution may be effectively prevented if a strong cyanide solution is allowed to drop

in the first compartment of the zinc box, particularly if the protective alkalinity is preserved during precipitation. To prevent deposits of copper in the precipitation boxes from strong solutions, the zinc shavings are sometimes coated with lead by being placed in a 10-per-cent. solution of lead acetate. This lead-coated zinc will precipitate gold from weak cyanide solutions and leave the copper in solution. It is difficult to work ores containing much copper on account of their large consumption of cyanide and the difficulty of precipitating the gold in the presence of copper.

Frothing.—The presence of organic compounds will sometimes cause excessive action on the zinc, generating hydrogen so vigorously that frothing is the result. Frothing is generally accompanied by a lack of oxygen in the solution. This should be remedied at once, but frothing due to the presence of organic matter cannot be prevented. In weak solutions it does not always accompany an excessive zinc consumption.

Precipitation Obtained.—When good precipitation takes place the solution leaving

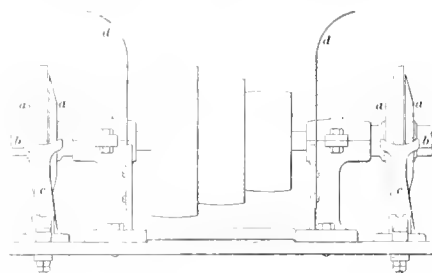
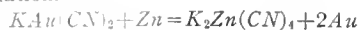

FIG. 4. ZINC SHAVING LATHE

the zinc boxes will not contain more than 8 to 12 cents gold per ton irrespective of its value on entering. Solutions poor in gold or silver do not usually admit of as clean precipitation as richer ones.

Zinc Shavings and Boxes.—In filiform, or thread-like turnings, zinc shavings are generally used for the precipitation of gold and silver from potassium cyanide solutions containing those metals. The shavings should be free from arsenic or antimony, but a little lead in their composition is an advantage, as it promotes rapid precipitation by forming a voltaic couple with the zinc. Zinc sheets and zinc amalgam have been tried, but zinc shavings are preferred, because of the ease with which cyanide solutions attack them. They also allow the free and rapid passage of the cyanide solution, and the screens through which the gold precipitate falls are not clogged by the zinc. The action of the zinc on the gold solution is a simple substitution of zinc for gold, according to the equation.



According to theory, 1 pound of zinc should precipitate about 6 pounds of gold; but in practice it requires $\frac{1}{2}$ to 1 pound of zinc for every ounce of gold precipitated.

The double salt of auro-potassic cyanide is one of the most stable of gold salts, but its decomposition by zinc is practically complete. The precipitated gold is not redissolved by potassium cyanide so long as there is zinc present. The potassium zinc cyanide remains in the solution that passes to the sump tanks.

Zinc shavings are usually cut from disks of No. 9 Brown & Sharpe gauge, 12 inches in diameter. They have a 1-inch hole in the center, weigh about $\frac{1}{2}$ pound each, and are .114 inch thick. The shavings are usually cut by a machine like that shown in Fig. 4, twenty disks being held in place between cast-iron washers *a* by means of nuts *b* at each end of the mandrel that is passed through the hole in the center of the disks. Then, as the mandrel is revolved, usually at the rate of 350 revolutions per minute, the shavings are cut from the disks by sharp steel tools steadied on iron rests *c*. Guards *d* prevent the shavings getting under the belt of the machine. Zinc shavings, as ordinarily packed in a zinc precipitating box, weigh about 6 pounds per cubic foot; they should be thin enough to burn when lighted by a match. Some machines have an automatic feed mechanism that can be arranged to cut three thicknesses of shavings automatically. The lathe will make 150 pounds of zinc shavings per day of 8 hours. The proper thickness of zinc shaving is $\frac{1}{8000}$ (.002) of an inch. Shavings from $\frac{1}{1000}$ to $\frac{1}{8000}$ inch in thickness are used.

Zinc shavings should be uniformly distributed in all compartments of the zinc box except the last one, which is left empty to collect any particles of zinc and gold that they may be carried from the others. The corners of each compartment should be well packed to prevent the solution passing through in channels. The speed with which the solution should flow through the boxes can be determined by tests on the outflowing solution for the presence of gold. Where gold precipitation takes place under proper conditions, the metallic deposit on the zinc is brownish-black, and precipitation should take place in the first compartments. In imperfect precipitation, the deposit is frequently gray or of a dull metallic color. The dry precipitate seldom contains more than 40 or 50 per cent. of gold and silver, the remainder being finely divided zinc and its impurities. The precipitation in the zinc boxes is influenced by the amount of cyanide present in the solution.

Fresh zinc shavings should be added daily to the last compartment of the precipitating boxes. The partly consumed zinc should be brought up a step so that the first chamber contains zinc partly consumed and rich in bullion, while the last chamber contains fresh zinc. Zinc on which bullion is already deposited is more active than new zinc; it is, therefore, advisable to replace the dissolved zinc in the upper compartments with zinc from the lower compart-

ments and add the fresh zinc to the last compartment. Zinc boxes should not be disturbed oftener than necessary to keep them from channeling; and then the work of rearranging the zinc should be carefully and gently done, as the gold precipitate when detached is liable to be carried past several compartments and lost in the sump.

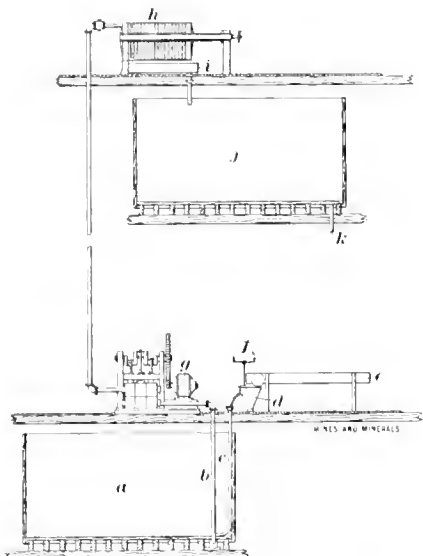

FIG. 5. MERRILL PRECIPITATION EQUIPMENT

The usual rate of flow for all zinc boxes is 1 ton of solution per day (24 hours) for each cubic foot of zinc. If the weak box does not give satisfactory results at this, it may be run more slowly. A weak zinc box should not be run unless there is a good reason for its use.

If a mill is equipped for two solutions and it is desired to use only one zinc box, proceed as follows: After a vat has been leaching for nearly half its allotted time it will be found that the effluent solution contains only about one-fourth as much gold as it did during the first day. This effluent should be turned to the weak sump which may now be called the mill sump. This solution containing some gold is standardized, all the additions of cyanide being hereafter made to this solution alone. This mill solution is used on the vats during the early portion of their leaching period, thus supplying the zinc box with a solution richer in gold than could otherwise be obtained. This rich solution after parting with its gold in the zinc box is called "barren" and goes to the barren sump to be used on the vats during the latter part of their treatment. The solutions alternately change places, the mill solution becoming barren after passing through the zinc box. The plan generally saves zinc and cyanide, as only one-half of the solution is required to pass through the zinc. The consumption of zinc is generally nearly proportional to the amount of solution passing through the box and has little relation to the amount of gold deposited.

Zinc Dust Precipitation.—The low price of zinc dust as compared with zinc shavings has led to many attempts to use it as a precipitant for gold on a milling scale. While some of these attempts have been fairly successful, the method had no advantage over the use of zinc shavings until the Merrill precipitation press was devised. These presses are particularly applicable to large mills where the trouble and expense of cleaning up so many zinc shavings would be very great. At the Homestake, where the press was first used, it is precipitating the gold from 4,000 tons of solution daily. The method is also particularly applicable in treating ores containing a large amount of silver, which makes a bulky clean-up. In using zinc dust the zinc consumption is much reduced, owing to the shorter time of contact of the zinc with the solution and the fact that the zinc dust is added to the solution only in proportion to the amount of metal to be precipitated. Another advantage in the use of zinc dust is that a complete clean-up of the mill can be made, while in the use of shavings it is necessary to carry over a large amount of bullion in the zinc boxes. Security from fire is also an advantage.

This method of precipitation can best be understood by reference to Fig. 5. The pump *g* is connected by pipe *b* to elevate the precious-metal bearing solution from the usual sump tank *a* through the filter press *h*, the barren filtered solution flowing by pipe *i* from the press to the storage tank *j* for reuse.

The precipitant of zinc dust is spread upon the belt of the automatic feeder *e*, which is arranged by means of a float and counterweight to travel at a speed proportionate to the volume of solution pumped. The dust drops into a small agitating, or mixing cone *d*, where it is pulped with air and solution from pipes *f*, and overflows into the suction of the pump. The mixed stream of solution and precipitant passes up the discharge column and into the filter press, where the precious metals and any excess of zinc remain, and the clear, barren solution flows to the storage tank.

The filter presses, Fig. 6, used for this work are of a special type. The frames or containers are triangular in section, and the feed-pipes are so arranged that the solution and zinc enter from the bottom or apex of the frame. Thus any excess of zinc remaining in the press from a previous pumping is kept in agitation by the incoming fresh solution and the maximum precipitating efficiency is obtained.

The operation of the press is as follows: Air is blown through the press until the product contains from 5 to 10 per cent. moisture. This takes from 1 to 2 hours at 6-pound to 10-pound air pressure. The contents of the precipitate containers or frames are then discharged into a box mounted on rollers, which is run on to scales and weighed. Core samples for

moisture and assay are taken if desired. Fluxes are then added, and after mixing, the product is shoveled directly into the melting pots, all these operations taking place in the original clean-up box.

With silver ores no acid treatment of the product is necessary, the raw product from the presses being from 50 to 80 per cent. metal, depending on the richness of the solution precipitated.

In the case of gold ores the product is either briquetted with litharge and cupeled, or the usual acid treatment and pot melting may be employed.

Electrical Precipitation.—This method gained considerable prominence in South Africa during the early history of cyanidation, being introduced there by the Siemens & Halske Co., of Germany, one of the ablest engineering firms in Europe. Much valuable scientific data was collected by Doctor Siemens as to the possibilities and limitations of the method. The inventor found and demonstrated that in order to precipitate the gold from 100 tons of cyanide solution per day 10,000 square feet of cathode surface were required, and also the same amount of anode surface. The cathodes were made of sheet lead and the anodes of iron. The installation cost was high and the power required for generating the electric current was a considerable item of expense.

Many other futile attempts have since been made to bring the method into practice on a milling scale, generally by men not conversant with the principles involved. However, one important improvement has been made by Mr. Charles Butters that is giving good service. It consists in making the anode of peroxidized lead, thus obviating the destruction of both the anodes and of a considerable quantity of cyanide, which occurred in the Siemens-Halske method. Some cyanide is also saved over the zinc method as no zinc potassic cyanide is formed. This advantage is believed to be more apparent than real, as a large portion of the zinc finally separates from the solution as zinc hydrate.

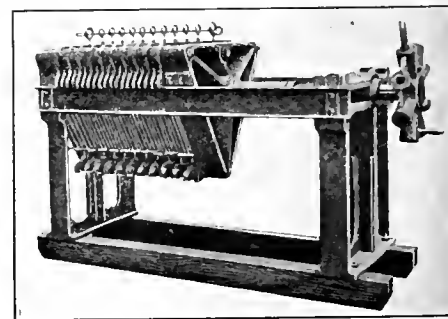

FIG. 6. ZINC DUST PRECIPITATION PRESS

Charcoal Precipitation.—The use of charcoal as a precipitant for gold has been the subject of numerous patents, and the method has been used in a few instances, but has never attained commercial importance.

THE Magdalena mining district, in Socorro

County, N. Mex., is distant about 27 miles west of the town of Socorro from which a branch line of the

Atchison, Topeka & Santa Fe Railroad runs northwesterly about 27 miles to Magdalena. The district includes a portion of the north end of the Magdalena range, also the towns of Magdalena and Kelly.

The principal mining operations are near Kelly, about 3 miles southeast of Magdalena, on the west slope of the range. A good wagon road, with a slight upgrade, connects the two towns.

The Magdalena Mountains rise to an elevation of about 9,000 feet; the summit being about a mile east of Kelly. The range is about 25 miles long, north and south, the east slope continuing to the valley of the Rio Grande, but broken with intervening ranges and spurs, the most important of which are Socorro Peak and the Lemitar Mountains. The highest point in the Magdalena range is "Old Baldy," with an elevation of 10,800 feet. To the west of the town and these mountains are broad elevated plains, with widely separated mountain ranges.

The elevation of Socorro is 4,571 feet; the elevated plains around Magdalena, about 5,500 to 6,000 feet; the mining operations around Kelly about 7,500 to 8,000 feet.

The Magdalena mining district has been described in Professional Paper No. 68, of the United States Geological Survey, from which some of the following data are taken.

The first claim staked out in 1866 was the Juanita, whose outcropping vein shown in Fig. 2 stands prominently in view about one-quarter mile southeast of Kelly.

In the upper part of the vein oxidized lead ore carrying silver, and in places a little copper, occurs.

The early workings of the Graphic mine, which was located less than a month later, yielded sandy carbonates which were smelted on the ground in an adobe furnace and the bullion hauled to Kansas City in ox carts.

Gustav Billings who obtained control of the Kelly mine in 1881, built a smelter about 2½ miles west of Socorro. The furnace was favorably located, at the time, for treating ores from southwest New Mexico and Old Mexico, and later fuel was obtained from the coal fields of northern New Mexico. The smelter treated lead-silver ores from Magdalena and some silver ores from mines near Socorro until about 1890 when the Windom bill went into effect increasing the duties on certain grades of lead-silver ores coming into the United States from Mexico. Then followed the establishment of larger smelting plants in Mexico and at El Paso, which were nearer the main supply of ores than the Rio Grande Valley smelter at

The Magdalena Mining District, N. Mex.

A Zinc-Lead-Silver District the Development of Which Shows Interesting Geological Features

By Edgar G. Tuttle, E. M.

Socorro. Due to this cause and the high freight rates, the Billings smelter closed down about 1893.

The plant employed 500 to 1,000 men and when the smelter closed down Socorro became nearly deserted.



FIG. 1. MAGDALENA RANGE, FROM MAGDALENA, N. MEX.

In 1896 the Graphic smelter was built, near Magdalena, and treated the red-lead surface ores. This supply diminished and the furnace closed down in 1902.

From 1894 to 1902 the Kelly and Graphic mines were only slightly worked. Then the Sherman-Williams Paint Co. bought the Graphic mine.

In 1904 Mrs. Billings sold the Kelly mine to the Tri-Bullion Mining and Smelting Co.

The surface ores were mostly lead carbonates with copper carbonates in small quantity. A little deeper, zinc carbonates came in. As greater depth was attained, zinc and

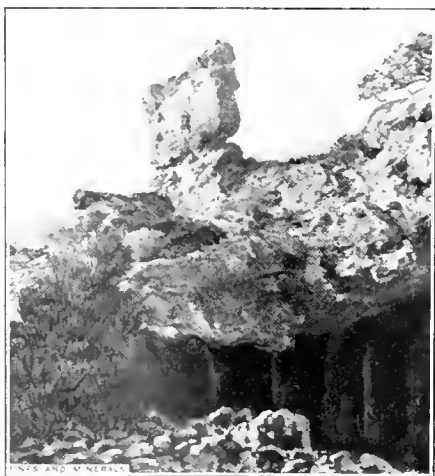

FIG. 2. JUANITA VEIN

lead sulphides with iron sulphides and occasionally some chalcopyrite were encountered.

This has been the chief zinc producing camp of New Mexico. A large part of the ore has been used for the manufacture of zinc-lead paint.

Up to 1907 the ore was shipped crude. Then attention was given to concentration with more or less satisfactory results.

About 1908 the Mistletoe and Magdalena Tunnel Co. had completed a pneumatic concentrator which operated for a while.

In 1909 the Tribullion Smelting and Development Co. began operating a wet concentration plant with roasters and magnetic separators for the treatment of the zinc-lead-iron sulphide ores which they were mining from the deeper workings of a continuation of the same ore horizon as worked near the surface at the original Kelly workings. The Tribullion owns this property but leases it, allowing the lessee to mine the oxidized ores.

About this time the Ozark Smelting and Mining Co., operating the Graphic mine, after various tests, erected a concentrating plant to treat the Graphic ores. The plant contains ore sizers, dry concentrating tables, a roasting furnace, and magnetic separators. The mine and mill are closed down for the present and some experiments are being made with the flotation process.

The basal rocks are pre-Cambrian, consisting of greenstone schists and granite. On these rest formations of the Carboniferous system, designated in ascending order: First, the Kelly limestone group (Mississippian series) lying immediately above the basal rocks. Second, the Sandia formation resting on the Kelly limestone. Third, the Madera formation on top of the Sandia. The Sandia and Madera formations belong to the Magdalena group of the Pennsylvanian series of the Carboniferous.

Ryolite, andesite, and porphyry rocks are also exposed over parts of the field.

The stratified formations of the Carboniferous are approximately conformable and have a general strike of about N 30° W and dip westerly at an inclination of 30 to 40 degrees. On the east side of the Magdalena range the formations are reversed and dip easterly. The principal developments on the east side of the mountain are at Water Cañon. Although the indications here are very promising nothing of importance has as yet been developed.

The Kelly limestone formation varies from about 70 to 150 feet in thickness and is the principal ore-bearing horizon of the region. Except at its contact with the basal rocks and the overlying Sandia formation, it consists of 60 to 150 feet of fine-grain subcrystalline limestone, near the middle of which is a hard compact layer of limestone, 4 to 8 feet thick, known as "silverpipe" limestone, or the "east," or "lower silverpipe."

The silverpipe varies in color in different parts of the field, from white to light blue, buff, and red, and it is of a fine close texture by which it is readily recognized. In development work, when the silverpipe is encountered it can generally be accurately determined how far it is necessary to drive,

and in what direction, to reach the ore. It thus serves as an indicator.

Near the top of the Kelly limestone there occurs at some localities another layer of silverpipe, known as the west or upper silver-

lower part of this section rests immediately on the Kelly limestone.

The Madera formation is the uppermost of the series and consists of 400 feet, more or less, of mainly blue compact limestone

upper workings on the carbonate ores and the outcrop workings in the region of faults or dikes, where it is somewhat of an irregular ore body. In the deeper workings on the dip to the west, the ore varies from 6 to 16 feet in thickness, although in some places it pinches out.

In the deeper workings the ore is a zinc-lead sulphide in combination with iron pyrites and a little gangue.

In the upper workings the ores are zinc and lead carbonates sometimes associated with copper in small quantity, also occasionally with a little gold and silver. Beautiful specimens of white and green smithsonite, sphalerite, and azurite have been found.

The ore may be regarded as a limestone replacement, the deposits making in the bedding planes of the limestone.

There are five or six ore horizons, but the two in the Kelly limestone are the only important ones so far as known.

The first ore horizon is at the contact of the Kelly limestone with the underlying basement greenstone. Some ore is occasionally found here.

The second ore horizon is in the Kelly limestone below the 4 to 8 feet of lower or east silverpipe limestone. This is the bed worked by the Kelly mine and at depth by the Tribullion.

The third horizon is in the Kelly limestone above this silverpipe. This is the bed worked by the Graphic mine.

These beds or horizons are the most important.

A fourth ore horizon is in the 2 to 10 feet of silicious fine grain crystalline limestone

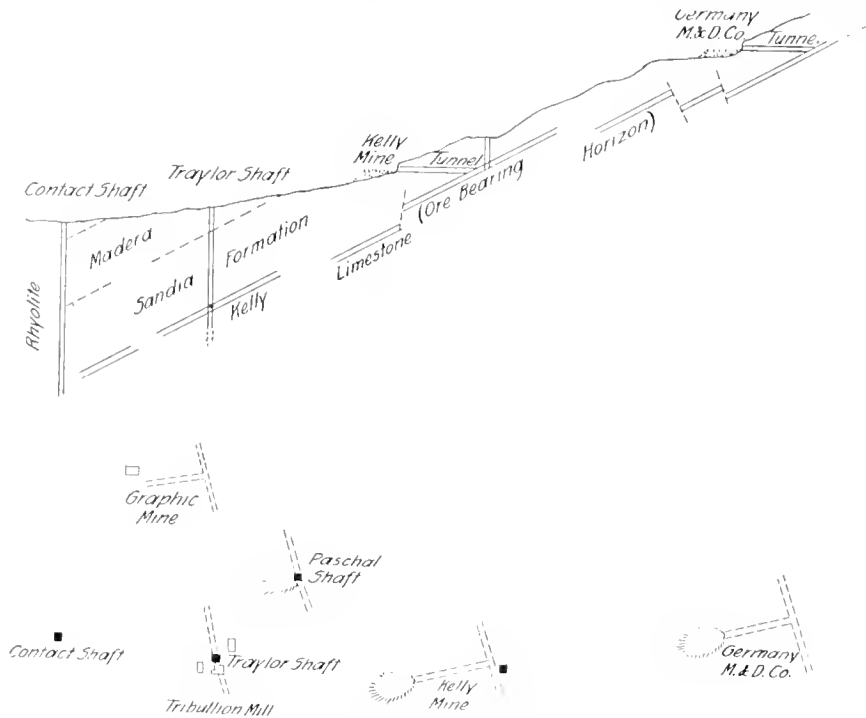

FIG. 3. SECTION AND PLAN OF WORKINGS ON KELLY LIMESTONE, MAGDALENA DISTRICT, N. MEX.

pipe. This in some places attains a thickness of 3 feet, but is frequently entirely absent.

The Sandia formation is probably more than 400 feet thick and less than 700 feet. It consists of shale, quartzite, limestone, and conglomerate. One body of shale in the

with some shale. The ore deposits are fairly regular and conformable with the stratification of the sedimentary rocks. The ore is fairly continuous, except where interrupted by faults or other disturbances. It varies considerably in thickness, being 20 feet and more in the

TABLE 1. ASSAYS OF ORES FROM MAGDALENA MINING DISTRICT

Name of Mine	Assay							Description
	Lead Per Cent.	Zinc Per Cent.	Copper Per Cent.	Iron Per Cent.	Silica Per Cent.	Gold Ounces Per Ton	Silver Ounces Per Ton	
Graphic Mine of	±	±	±	±	±	±	±	
1. Ozark Smelting and Mining Co.	5	20		30.00	some			Sulphide
2. Tribullion Smelting and Develop. Co. (Kelly)	6	30		15.00	10		2	Sulphide
3. Key Development Co. (Kelly)	2	25	5	15.00			2	Heavy sulphide
Terry & Martin (Kelly)	8 to 16	30	little	10-15	some			Sulphide
Sunrise (near Magdalena)	20			19.00	35		3	Cerussite shipped to El Paso smelter
Rivera (Mill Cañon)	9	15		some	35		7	Sulphide
Wm. Tell (Water Cañon)	55	10		12.00	18	?	5	Auriferous iron sulphide in quartz porphyry. Pans well Oxidized gold ore (10 miles south of Kelly)
							1.00	Lead sulphide (on east side of range)

TABLE 2. METALLIC PRODUCTION OF MAGDALENA DISTRICT, SOCORRO COUNTY, N. MEX., 1901-1908

	Gold Value	Silver Value	Copper Value	Lead Value	Zinc Value	Total Value
1901	\$151	\$2,906	\$ 116	\$29,593	\$ 674,692	\$ 707,761
1905		2,899	19,920	18,339	863,173	934,322
1906			12,160	13,571	1,039,604	1,065,725
1907				37,123	39,905	77,428
1908	72	241	314	675	156,296	157,631
						\$2,912,767

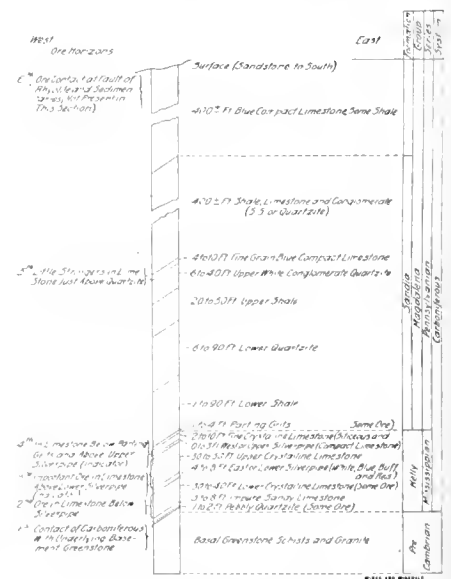

FIG. 4. GEOLOGICAL SECTION, MAGDALENA MINING DISTRICT

above the upper or west silverpipe. A little ore is occasionally found here.

A fifth horizon consists of little stringers of ore in the 4 to 10 feet of limestone above the upper white conglomerate quartzite in the Sandia formation.

A sixth occurrence of ore is as a contact of the sedimentaries with the rhyolite. This is shown in the eastern part of the field.

Favorable conditions for the making of ore have been created through the disturbances caused by rock intrusions, also a system of fracture and fault zones and accompanying mineralizing agencies.

The fault lines extend N W and S E generally. The most important of these disturbances is the Kelly-Graphic fault, extending on through the Juanita property, northwesterly, near the Kelly and Tribullion mines to the Graphic mine. Near this fault the ore body was very large at the Juanita mine, and the ore beds are very thick at the Kelly mine.

The sedimentaries and their ore-bearing horizons are probably cut off where they come in contact with the intrusive rocks about one-fourth mile west of Kelly.

The assays in Table 1 are interesting in that they show the wide variation that occurs in ores in the same district:

Up to 1901 the production of the Kelly and Graphic mines was \$5,800,000, and for the whole district \$6,600,000 to \$8,800,000. From 1904 to 1908 the production, as far as reported, was about \$3,000,000 of various grades of ore. The metal values are given in Table 2.

Since 1908 the production of the district has been about \$800,000 to \$1,500,000 annually. Exact figures are not at hand, but the average is about \$1,000,000 yearly. The total output of the camp from the beginning to date is approximately \$15,000,000.

來 來

Men vs. Machines

[Under the above title, Josiah Bond, mining engineer, Patagonia, Arizona, publishes an article in the Mexican *Mining Journal*. The following is an abstract.—EDITOR.]

It frequently has been put forward as an argument that as soon as a mine is somewhat developed, machines can advantageously replace hand labor. Miners generally believe, for instance, that machine drilling will undercut hand drilling so much as to leave no choice in the matter. It seems certain, however, that no general assertion to this effect can be sustained, if consideration is confined to the single item of costs.

It is also assumed by many that more rapid progress can be made with proper machinery and proper men to run it, than by hand labor. Often it may be legitimate to incur the expense of such a plant to insure greater speed; as, for example, in the case of a property that, for reasons of administrative policy, must be developed and brought to a productive stage as quickly as possible. Such rapid progress will perhaps make an attractive showing to the ordinary class of stock-

holders, but the value of such a procedure from this purely sentimental point of view is discouraged; since the overhead charges will necessarily be increased. An acquaintance of the writer, wishing to sink a 200-foot shaft, submitted the proposition to a contractor, who offered to do the work for \$2,000, providing he were permitted to do the work by hand, and to use a whim for hoisting. He also agreed to finish the contract in 3 months, if a large amount of water did not develop during the progress of sinking. The nearest railroad was 2 miles distant, was at a lower elevation, and there was no wagon road built. However, this owner deemed the proposal too slow, so he built 2 miles of wagon road, and bought and installed a plant consisting of a boiler, steam hoist, air compressor, machine drills, and all accessories. The plant worked well, no water was found and at the end of six months, the shaft was down 170 feet, the owner had spent \$22,000, and the project was bankrupted.

A most ridiculous sight is to see a fine hoisting plant standing idle over a shallow shaft, say a shaft less than 200 feet deep. It is a conspicuous monument to the ignorance or the vanity of its owners. Once in a while it happens that the shaft is sunk to greater depth later; but it more often is the case that the plant is sold to others who may perhaps do just as foolishly with it. The writer knows of one such plant that has been placed over six different shafts, every one of which was less than 175 feet deep.

It is astonishing how some stockholders, who are generally successful business men in their own lines, will require the management of their mines to uselessly spend money in an effort to get quick action, when the patient carrying out of a slower program would more likely insure the success of their enterprises. Sometimes the result of such a policy has been that the management, being unable to stem the tide, has deliberately "let things slide" and has gone in for any graft that could be devised while the available capital lasted.

If a shaft is to be sunk through known, very wet, ground, that will require power-driven pumps, it is economy to erect the power plant so that all of the work may be done by machinery. In such a case, the investment in plant will be but slightly augmented, and the cost of operating it will be chiefly in the increased consumption of fuel. If it should happen that drainage can be effected by occasionally pumping a few hours, the operations of sinking may be so arranged as to secure the greatest benefits from the power plant, that can be kept running close to its highest efficiency. If the flow of water is so small that its removal will not require power pumping for an interval

corresponding to the space between other operations of shaft sinking, then it will be cheaper to sink the shaft by hand.

The writer sunk two shafts on the same lode, about 1,500 feet apart. One of these he sunk by hand to a depth of 275 feet. The other he sunk by drilling with compressed air, also using the same form of power for pumping. The cost of the shallower shaft averaged \$6 per foot, including everything; while the cost of the deeper shaft was \$17 per foot including everything except the interest on the plant and its depreciation. The conditions in these shafts were practically identical. The water, in each case, could have been easily handled by a bucket.

In tunnel work, hand labor shows up to decided advantage. A certain company drove a 5'x7' adit 2,000 feet, using compressed air for drilling. The progress was a trifle less than 3 feet per shift, and the cost per foot was \$14.87, exclusive of salary for management. A portion of this work was done by contract at an excessively high figure, but making due allowance for this, the actual cost per foot was more than \$12. Just afterward, in the same rock, a 4'x6½' tunnel was driven 1,200 feet by hand labor. The progress was a trifle over 2 feet per shift, and the cost \$4.60 per foot.

One of the main reasons for the difference in favor of hand work lies in the fact that there is practically no loss through "overhead charges" when, for any one of many reasons, the regular progress is not being made. There may be a significant loss if a shift, using machines, gets behind with its duties.

The arguments in favor of hand work apply principally to mines operating upon small scales. The larger the scale of operation and the greater the cost of administration and management, the more economical will mechanical work be found. If a company has 100,000 tons of blocked ore, and can add to the reserve at the rate of 5,000 tons per month by hand labor, the cost per ton of ore thus produced, chargeable against management at \$1,000 per month, would be 20 cents. Were the work done by machinery, more than four times as much ore might be produced, so that the item of management cost would be reduced to 5 cents per ton. All other fixed charges that are independent of tonnage would be correspondingly reduced by about 75 per cent. This saving would soon pay for the mechanical installation.

In a general way, machinery will pay best when it can be used steadily during its natural life to its capacity. If the work is intermittent and limited, it will be cheaper to do it by hand.

There are many cases in which hand work is entirely impracticable as in deep mining. The hoisting of ore and the

lifting of water from deep workings call for machinery. The outlook is that most of the mining of the future will call for machinery. Deep mining will be the

Greenwood, B. C., and New York, has been developing its large holdings on Copper Mountain, which is about 12 miles south of Princeton. Late last year it took a bond

shaft, which is down so deep it has headings that require a tripod head-frame, horsepower hoister, and blower ventilating fan, in fact has passed the "strong-arm" hoister stage. Fig. 2 is the Silver Dollar prospecting shaft which has passed the horsepower hoister stage and uses the steam winch, shown on the ground to the left of the three men. This prospect uses buckets, and in addition an ore car on the surface. The underground working is ventilated by what seems to be a "steam siphon," the air pipe being held in position by poles to the rear of the shaft. In prospecting work of this kind where fuel is scarce the horsepower hoister can lift 100 tons of rock in a day, from a depth of 150 feet, and were it not for the other uses to which steam is applied there would be no portable boilers hauled around for sinking prospect shafts.—EDITOR.]

Whipsaw Camp has received considerable attention this summer and the owners of the different properties are well pleased with the general outlook, and expect to have several shipping mines next year. The ore is a high-grade silver-lead carrying both gold and silver besides a little copper; work was carried on all last winter by Messrs. Knight & Day, in driving a long tunnel on the vein. Whipsaw Creek is situated at the foot of Kennedy Mountain, and empties into the Similkameen River opposite Copper Mountain; the camp is situated on Whipsaw Creek, about 10 miles south of Princeton.

The new silver-lead camp situated at the summit of the Hope Mountains, near the head waters of the Tulameen River, has changed its name from Summit Camp to that of "Leadville" where three different Spokane companies have lately bonded several groups of silver-lead prop-

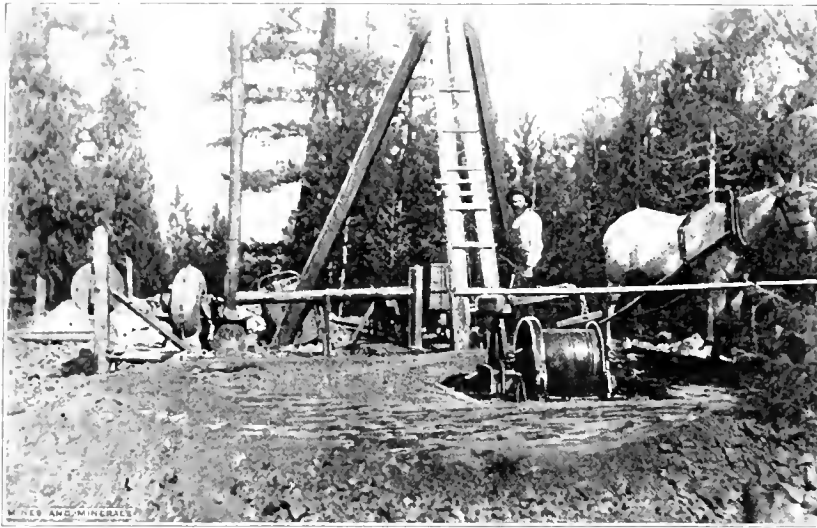

FIG. 1. ADA B SHAFT, PRINCETON, B. C.

order of business; and labor is becoming so scarce that machinery must be resorted to, to perform most of the work.

采采

Princeton, B. C., Mining Notes

By Frank Bailey, M. E.*

Considerable development work throughout the Similkameen and Southern British Columbia has been carried on steadily for the last 9 months and is still improving and showing valuable commercial tonnage at depth.

The Hedley Gold Mining Co., of New York, that owns and operates a large group of mines in Camp Hedley (in the Similkameen Valley, 35 miles below Princeton) continues to distribute its usual quarterly 25 per cent dividend to the stockholders. The property today has more ore blocked out in the Nickel Plate mine than ever before, and its diamond drills have proved also the existence of payable ores on the surrounding properties. Production of the Hedley Gold Mining Co.'s mines up to June 30, 1912, is approximately \$4,157,310.

Besides the development of the above company, the Kingston mine and adjoining properties have been worked, but are not as yet in the producing stage; they also are controlled by American capital.

C. H. Brooks is employing about 20 men developing the Golden Zone group of claims which was opened some years ago. A. Creelman, the superintendent, is sinking a 300-foot shaft, and running drifts both ways on the 150-foot and 250-foot levels, blocking out considerable commercial ore. Development work is also being carried on on the Apex group by M. K. Rogers, L. W. Shatford, M. P. P., and associates.

The British Columbia Copper Co., of
* Princeton, British Columbia.

on the Voight group of 62 mineral claims, on which it has several diamond drills at work on different parts of Copper Mountain, with Mr. Mitchell in charge. This summer it took another bond on the Silver Dollar and Ada B mineral claims, which have shown large deposits of high-grade cupriferous ores in their working shafts. It has been reported that the British Columbia Copper Co. will install a large smelter near Princeton in the near future, to treat its ores on Copper Mountain. It has declared a second dividend of 15 cents a share, payable October 15, aggregating \$88,726.35. A similar amount having been disbursed in August, this

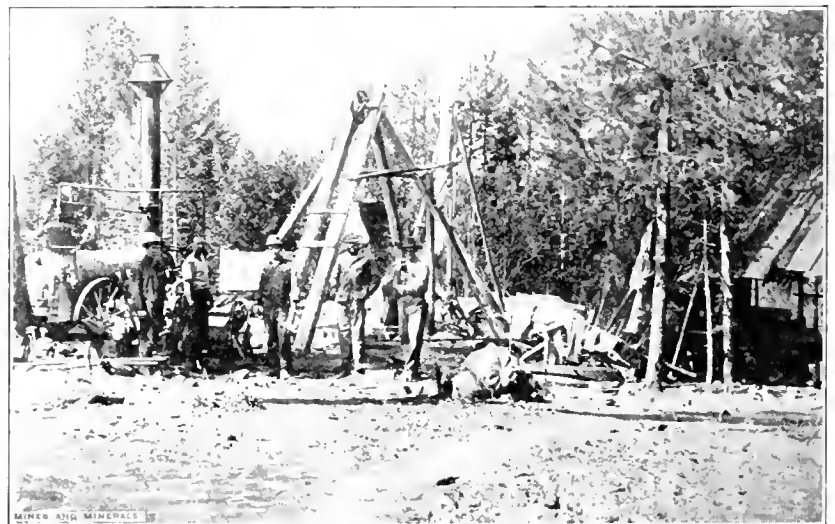

FIG. 2. SILVER DOLLAR SHAFT, PRINCETON, B. C.

makes the total dividends to date \$526,643.35.

[Mr. Bailey sends two photographs on shaft sinking, on which he makes no comment. Fig. 1 is the "Ada B" prospect

erties, and will continue development work all winter. The Provincial Government has lately surveyed a wagon road from Tulameen City up the river to Leadville and this will be built before spring.

Standard Silver Mine

A Description of the Development, the Ore, and the Method by Which It Is Treated in the Mill

By William Fleet Robertson*

THE Standard mine in 1911 was one of the most successful developments with depth of any property in the Slocan, B. C., mining district, and now has more ore developed—practically ore in sight—than at any time in its history.

The Standard vein cuts through three properties, the Alpha, Standard, and Emily Edith, each of which has already made a record as a large shipper of silver-lead ore. These properties are located on the slope of the mountain on the east side of Slocum Lake, and on the north side of Four-mile Creek, which flows into the lake at the town of Silverton.

The vein fissure cuts through the Slocan slates in a general east-and-west direction, and has been developed by various adit tunnels from the upper workings of the Alpha, the highest of the three properties, at an elevation of 2,834 feet above Slocan Lake, down to the lowest workings of the Emily Edith, which are at an elevation of about 720 feet above the lake.

The general slope of the hillside along the line of the fissure is from 20 to 30 degrees, and, as the ore shoots dip into the hill, the adit tunnels become quite long before they reach the ore shoots, when any depth is attempted.

The vein in the upper workings of the Alpha is somewhat irregular and broken, but as it goes down the hill it becomes more uniform. In this fissure there are shoots of ore between which the fissure is almost barren.

On the Alpha the ore shoot was discovered practically on the surface, dipping into the hill; and before the property was shut down in 1894, owing to litigation, some 1,200 tons of high-grade silver-lead ore were shipped, chiefly from a large body of galena and from lead carbonates found near the surface. This property has lain idle since 1894; it was held for some years by the late N. F. McNaught, and is now owned by his estate.

The development consists of five adit tunnels driven in on the vein; the upper tunnels contained good ore, but Nos. 4 and 5, the two lowest tunnels, did not reach the ore shoots, although the vein there is clearly defined.

It would seem that these two tunnels had not been driven far enough in to expect to strike the ore shoot seen in the upper levels, and that allowance had not been made for the dip of the ore shoot into the hill and the low slope of the hillside.

A scheme was in progress last fall not only to extend these lower levels, but also

to prospect the ground at a greater depth by using one of the Standard tunnels, permission to do so having been granted by that company.

The Standard mine, owned by George H. Aylard, of New Denver, and John A. Finch, of Spokane, consists of three Crown-granted claims, the Shunieaw,

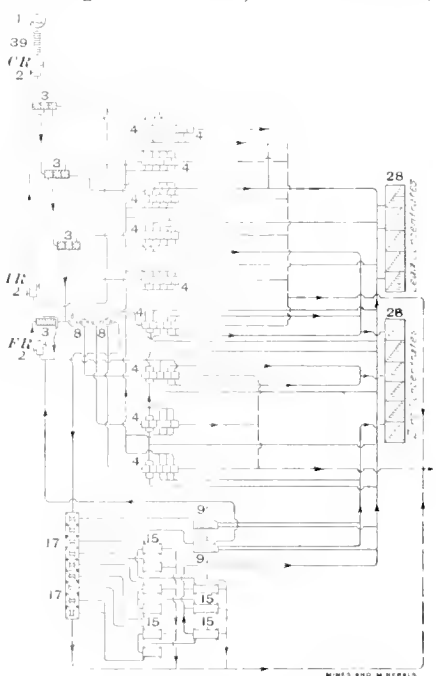

FIG. 1. FLOW SHEET, STANDARD MILL
1, Crusher; CR2, Crushing Mills; IR2, Intermediate Rolls; FR2, Fine Rolls; 3, Trommel; 4, Jigs; 8, Classifiers; 9, Concentrating Tables; 15, Frue Vanners; 17, Spitzkasten; 28, Ore Bins

Standard, and Surprise, and the same partners have also acquired the adjoining property of the Emily Edith company.

The Standard mine has been opened up by a series of adit tunnels, the highest at an elevation of 1,987 feet above the lake, or 300 feet lower than the lowest tunnel of the Alpha, while No. 6 tunnel is at an elevation of 1,414 feet above the lake, thus developing between these levels a vertical depth of 573 feet, while it is considerably more on the slope of the vein.

No. 1 tunnel appears to have been above the ore shoot, and was driven in some 85 feet without striking anything very encouraging.

No. 2 tunnel, some 77 feet vertically lower down, was driven in about 250 feet, and passed through a shoot of ore about 150 feet long, which extended upwards to the No. 1 tunnel.

No. 3 tunnel is 81 feet lower than No. 2, and has been driven in 415 feet, passing

through the same ore body as seen in No. 2.

No. 4 tunnel, 100 feet lower, has been driven 900 feet, and has also passed through the same ore body, which here extended for 300 feet along the level.

No. 5 tunnel is 125 feet lower than No. 4, and after having been driven 1,300 feet struck the ore body, which continued for about 300 feet, having a maximum width of over 40 feet, of which 20 feet was clean galena and 20 feet ore, which would concentrate approximately three into one.

No. 6 tunnel had, in September last, been driven in about 1,800 feet, the face showing strong mineralization, with blende and a little galena, but not enough to constitute ore.

About 200 feet back from the face, a small fissure, carrying a little galena, had been followed off to the left by a drift; this drift in following the ore had assumed the shape of a letter S, and contained a very nice stringer of ore, galena, and blende—quite sufficient, in September, to be workable.

Later advices from the mine indicate that this drift, as it was extended, opened up a very considerable body of galena ore, and that the drift had become parallel to the main tunnel, but some feet to the left.

Whether this particular ore body is the downward continuation of the ore body developed on No. 5 is not yet determined; it appears to be rather too far out, and then, again, it may be the top of an ore shoot from below which did not extend up to the No. 5 level; work being done will, however, soon solve the question.

The showing of ore on No. 5 level is one of the largest exposures of high-grade galena ever seen in British Columbia, and is practically intact up to No. 4 level, constituting a block of "ore in sight" above No. 5 level, which on a rough calculation figures out to a net value in the neighborhood of \$1,000,000.

The ore shoot is at its strongest on the No. 5, and so, undoubtedly, continues for some distance below; whether the ore found in the No. 6, some 200 feet lower, is the same ore body has not been proved, but it probably is, in which case over \$2,000,000 more of ore will be available.

The ore shipped in former years gave smelter returns which averaged about 60 per cent. of lead and 80 ounces of silver to the ton, and there is no doubt this continuation of the ore body will run about the same.

Concentrator.—The owners of the property were, last fall, completing the erection of a concentrating mill, which has since been finished and is now running. This mill is situated on the town-

* Provincial Mineralogist. In the 1911 Report of the Bureau of Mines, British Columbia.

site of Silverton, adjacent to the lake shore, and is connected with the No. 6 tunnel of the mine by a self-acting aerial tramway, 7,900 feet long. The flow sheet of the mill is shown in Fig. 1.

At both the upper and lower terminals this tramway is provided with separate bins for clean and concentrating ores, so that each can be sent down separately, permitting of the clean ore being shipped from the mill without further treatment, while the concentrating ore will go through the mill process.

The advisability of this procedure is evident, as the higher values in silver are usually contained in gray copper, "freibergite," or some high sulphide which, from its nature, crushes to a fine powder, causing great losses in slime, so that a large proportion of the values would be lost in water concentration. By shipping the cleaner ores direct, this loss is obviated, although at the expense of a somewhat increased freight and treatment charge.

The water for power and washing purposes is taken out of Four-mile Creek (sometimes called Silverton Creek), about 2 miles up from the lake; the intake is formed by a short tunnel driven through a projecting shoulder of rock in a cañon forming a natural dam, which cannot be swept away by the freshets to which the creek is liable every spring.

From the tunnel intake the water is conveyed by ditch and flume for about half a mile, passing on the way, by tunnels, through two gravel and clay sliding banks, in which the water is confined in tight flumes.

At a point just below the wagon road to the Emily Edith mine, the water from the ditch enters a 20-inch iron pipe, and is conveyed down to the creek level, where, beside the wagon road, an air-compressor plant has been installed. This plant consists of a 10-drill air compressor of the Canadian Rand type, driven by a 5-foot Pelton waterwheel, working under a head of 160 feet, the whole being housed in a well-constructed, permanent building.

The waste water from the Pelton wheel is caught up by a second ditch line, this time on the north bank of the creek, and is conveyed by flume along the hillside to a point directly above the concentrating mill, down to which the water is conveyed by a 16- to 12-inch iron penstock, about 1,200 feet in length.

At the compressor plant a by-pass is arranged so that, if for any reason the Pelton wheel is not in operation, the water can be passed, by opening a valve, from the compressor penstock directly into the concentrating mill flume.

The Emily Edith mine is an extension, down the hill, of the Standard, and, although formerly owned and operated by another company, has of recent years been acquired by the Standard company.

The Emily Edith has not been worked since about 1904, and, as the shale country rock weathers easily, the old workings today reveal nothing and cannot be examined.

The mine was originally opened up by some seven or eight adit tunnels, mostly driven in on the vein from the outcrop, although some were primarily cross-cuts to the vein. The highest of these tunnels is at an elevation of 1,128 feet above the lake, approximately 286 feet vertically lower than the present lowest (No. 6) tunnel on the Standard. The lowest tunnel on the Emily Edith is at an elevation of 720 feet above the lake; therefore the vein has been explored in this property for a vertical height of 408 feet.

As far as can be gathered from the old mine plans, the tunnels have been driven, respectively, starting with the highest, 140 feet, 250 feet, 300 feet, 370 feet, 410 feet (partly cross-cut), 350 feet, and 220 feet. It would, therefore, seem as if such development as had been done was exceedingly superficial when it is considered that the two lower tunnels in the adjoining Standard had to be driven 1,200 feet and 1,800 feet before reaching the ore shoot which has made its success, and that there remains a considerable section of the vein absolutely virgin and unprospected.

The mine formerly produced a considerable tonnage of galena ore running well into silver, but associated with a high percentage of blende.

It is expected that the Standard company will commence the development of the Emily Edith as soon as the Standard No. 6 tunnel is producing.

The property is thoroughly equipped with good office, laboratory, bunk, and cook houses, from which a wagon road

leads down to the main wagon road up Four-mile Creek.

The accompanying flow sheet of the Standard concentrating mill has been made from a sketch kindly furnished by the management after the mill was completed.

The mill, which was started in the spring, treats about 100 tons of milling ore daily with results that are satisfactory to the management. Later advices from Angus McLInnes, mining recorder, state that the galena in No. 6 tunnel gave place to 8 feet of zinc ore.

來 來

Cost of Milling in South Africa

The following data, taken from the *South African Mining Journal*, are published with a view to allowing the hydro-metallurgists in Canada, Mexico, and the United States to compare their cost sheets with the South Africans. There are some matters which increase the cost over that in the western hemisphere; on the other hand there are matters which decrease the cost. Among the first may be mentioned supplies; and among the latter, large tonnage treated, which materially decreases in fixed charges. No particular choice of mines has been made, and the results have been obtained from the yearly reports of the companies. The assay value is reported in pennyweights, one of which is equivalent to \$1.0335. The report was in shillings and pence, which has been converted by considering one shilling 25 cents, and 1 penny 2 cents United States money. So far as costs of reduction are concerned the Wolhuter, with its 120 stamps, is run at less cost per ton milled than the Crown Mines, with its 620 stamps.

GOLD EXTRACTION RESULTS ON THE RAND

Name of Mine	Milling			Cyanide Treatment						Total Extraction
	Value of Ore Dwt's	Daily Duty Per Stamp Tons	Extraction Amalgamation	Sand Treatment			Slime Treatment			
				Per Cent. Sand	Value of Charge	Actual Extraction	Per Cent. Slime	Value of Charge	Actual Extraction	
Wolhuter.....	6.71	8.47	63.76	65.77	2.89	84.13	34.23	1.58	87.78	94.61
New Kleinfontein.....	7.34	5.99	63.04	66.66	2.71		33.33		85.50	94.06
New Modderfontein.....	7.22	9.10	74.70		1.83				88.10	97.00
Knight Central.....	5.81	9.14	68.18	60.80	1.84		39.20		86.52	95.60
Nourse.....	7.30	7.60	69.60		2.24				83.20	95.10
Crown.....	8.68	8.80	68.50		2.73				87.50	96.00

GOLD REDUCTION COSTS ON THE RAND

Name of Mine	Sorting and Crushing	Milling	Cyaniding		General Expenses	Total
			Sand	Slime		
Wolhuter.....	\$ 2274	\$ 5542	\$ 2708	\$ 0832	\$ 2266	\$1 362
New Kleinfontein.....	2110	4156	2576	0682	1622	1 115
New Modderfontein.....	1000	4100	4300	4300	3940	1 334
Knight Central.....	1340	4820	2500	0888	3042	1 249
Nourse.....	1000	5300	2500	2000	3900	1 470
Crown.....	1600	4700	2500	1400	4100	1 430

Low Costs at Wasp No. 2 Mine

Successful Methods Employed in Stripping, Mining, and Milling Ore of Very Low Grade

By Leroy A. Palmer*

THE Wasp No. 2 mine has made a record for low cost of mining and treating gold ores that has probably not been approached by any other company operating on the same tonnage, the annual report for 1911 showing a total cost for mining, milling, and treating bullion, including all general expenses, of \$1.25 per ton.

The property is located in South Dakota, about 7 miles from Deadwood, on the Chicago, Burlington & Quincy Railroad, connection with which is had by an inclined tramway. The company's property ex-

the quartzite, systematic tests of this formation were made and showed that it carried an average of \$2.40 in gold per ton. This is slightly above the average ore being treated at present, which is \$2.20 in gold and .2 ounce in silver recovered per ton. The schist under the quartzite shows an occasional shoot of high-grade ore, one 40-ton shipment of wolframite ore from one of

a shot will break 3,000 tons of rock, a six-day, smill run, and, as shown in the illustration, the ore is broken in large blocks and dumped directly in front of the face.

The broken ore is loaded by hand, the pieces too large for handling being drilled with a 2½-inch Ingersoll-Rand plugger. On the north side of the pit, the ore is shoveled direct to the mill skip, but on the south side, it is transferred by 20-cubic-foot cars which are trammed over a platform and side-dumped into the skip. Two 500-ton bins are in process of construction to pro-

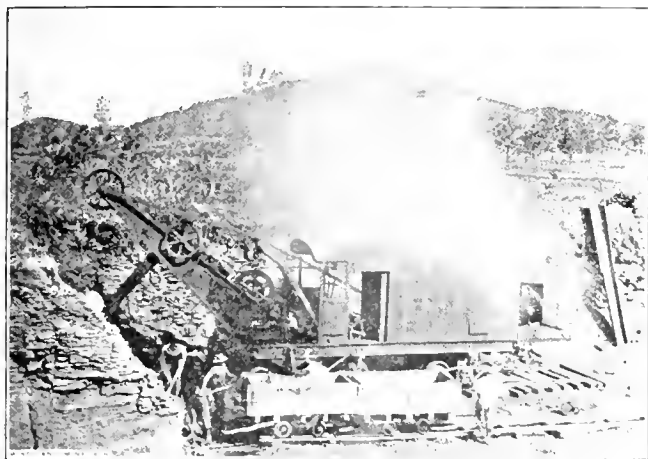

FIG. 1. STEAM SHOVEL STRIPPING, WASP NO. 2



FIG. 2. LOADING BY HAND, WASP NO. 2

tends about 2,500 feet north and south and 1,000 feet east and west, in the so-called "flat formation" that contains several of the well-known mines of the region, including the Golden Reward which, next to the Homestake, is the largest producer in the Black Hills.

The ore-bearing formation at the Wasp No. 2 is a massive Cambrian quartzite with noticeable iron stain. This quartzite has an average thickness of 19 feet and overlies the Algonkian schists of the region. Above the quartzite is a layer of friable sandstone, also Cambrian, and soil to a total thickness of 10 feet on the average. All of the strata are conformable and flat. The quartzite is traversed by a large irregular dike of porphyry which strikes across it in a direction slightly east and south and is evidently the source of mineralization. This dike faulted the Cambrian beds with a throw about 20 feet and, toward the south end, split into two dikes, one of which curved over so that the intervening ground was almost enclosed by the porphyry. Between these two dikes, in the earlier days of the mine, an ore body 60 ft. x 40 ft., yielded \$65,000.

For some time, mining was carried on, where the overburden is thickest, by underground methods to recover the gold found in some shoots in the sandstone, but as this work demonstrated the presence of gold in

these shoots recently yielding \$10,000 in gold.

Stripping is carried on by two methods. The overburden on the north side of the pit is removed by a 35-ton steam shovel, while that on the south side is stripped by hand after the soil has been removed by a slip scraper. The sandstone is drilled with 3¼-inch Ingersoll-Rand piston machines, each hole being given a burden of 12 to 14 feet. The object of this excessive burden is to prevent the rock being thrown from the free face into the pit where it would mingle with the ore or would have to be hauled out, and to cause the shot to "kick back" and thus loosen the rock on all sides of the hole. The hole is chambered with about 15 sticks of 20-per-cent. Aetna dynamite and is then loaded with three or four kegs of black powder which is fired by a fuse. One such shot will loosen about 50 yards (solid) of capping. Two-yard cars, hauled by mules, are used for handling the capping which is dumped into the worked-out portion of the pit. On the south side, the quartzite is drilled by machines, the average depth of the holes being 19 feet. Ten feet of this depth is drilled with a cross bit and the remainder with an ordinary chisel bit. The holes are given a burden of 8 feet more than their depth, are chambered with 200 sticks of 40-per-cent. dynamite, and are fired with 30 kegs of black powder. Such

vide some storage and to do away with the inconvenience of handling the ore under the present system.

The mine force consists of 70 men, all told, and the daily output is 500 tons, a little more than 7 tons per man.

The ore is loaded into two 5-ton mine skips running on a double, 4-foot gauge track laid with 40-pound steel rails. A double hoist geared to a 52-horsepower General Electric induction motor hauls a skip at a speed of 500 feet per minute up the plane to a 200-ton slope-bottom bin at the mill, where the usual wide-tread arrangement causes it to dump automatically. The haulageway is 1,500 feet long on the slope, with a grade of 10 per cent. up to the last 200 feet where it is 18 per cent. On its way, it passes through a 40-foot cut which is snow-shedded to obviate drifting full in winter. Adjacent to the hoist room at the mill, is the compressor room containing an Ingersoll-Rand, straight-line, three-drill compressor working to 80 pounds pressure.

From the bin, the ore is fed by eccentric feeders to two No. 6 Gates gyratory crushers which crush to pass a 3 inch ring. Each crusher discharges to an 18-inch elevator, with pans 18 in. x 8 in. x 8 in., running at a speed of 210 feet per minute. These elevators dump over 1½-inch grizzlies, each to a No. 4 Gates gyratory crusher, crushing to 1½ inches and discharging to a 300-ton bin.

*Denver, Co'o.

Each crusher is driven by a 50-horsepower motor and each elevator by a 1-horsepower motor.

Below this bin, are four sets of 16"×36" rolls, two sets used for roughing and two for finishing. All have a speed of 100 revolutions per minute and are driven by 48-inch, wooden pulleys, the usual type of "bull wheel" used on a gravity stamp battery. The roughing rolls are set to $\frac{1}{4}$ inch and are fed from the bin by swinging feeders actuated by cams. The product from each pair of rolls is delivered to an elevator, similar to the one described, but running at a speed of 340 feet per minute. This dumps onto a stationary screen having $\frac{1}{4}$ -inch mesh and set at an angle of 45 degrees. The undersize of this screen goes to the finished-ore bin while the oversize returns by gravity to the finishing rolls. Each pair of rolls is driven by a 50-horsepower motor. A 30-horsepower motor drives the feeders and elevators.

At each end of the finished ore bin, is a solution storage tank of 25,000 gallons capacity. The main tank room is 72 feet by 108 feet and contains six sand tanks, each with a capacity of 420 tons, fitted with the usual duck and cocoa matting bottoms and four 18-inch, bottom-discharge valves. The ore is fed through rack-and-pinion gates to an 18-inch rubber belt conveyor. The conveyor frame is mounted on wheels so that it is movable back and forth on a track, and its motion is reversible so that it may dump to any one of the six cross-conveyers delivering to the different tanks, thus doing away with the usual arrangement of trippers. A 1-horsepower motor drives the main conveyor and a 40-horsepower motor drives the feeders and cross-conveyers.

Quicklime, sufficient to give a protective alkalinity of 2½ to 3 per cent., is spread over the surface of the ore. The strong solution, consisting of 5 pounds KCN per ton of water, is then turned in. Instead of the usual arrangement of pipes running into the bottom of the tank, the pipes are led up the side to the top where they discharge into a wooden compartment that conducts the solution beneath the filter bottom. This has the advantage of making all of the stopcocks readily accessible from the tank floor and, with the coarse crushing practiced, gives sufficient pressure to cause the solutions to permeate the sands.

After 12 hours treatment, the strong solution is run to a 10,000-gallon tank and thence to the strong zinc box. A weak solution—3.2 pounds to the ton—is next run on for 12 hours, after which it is run to a 10,000-gallon tank and thence to one of the two weak zinc boxes. Next the sands are washed, the wash water running to the weak solution sump. The tank is emptied by shoveling through the valves to 1½-ton cars which are trammed to the dump. Six men empty one of the 420-ton tanks in an 8-hour shift.

Precipitation is on zinc shavings con-

tained in three metal zinc boxes, each 16 ft. × 4½ ft. × 2 ft., with two rows of six compartments. The first compartment of each box is filled with excelsior to act as a filter and the remaining compartments with zinc shavings.

Strong and weak barren solutions each flow to a 25,000-gallon sump tank, from which they are pumped by a 5½" × 6" triplex pump, having a capacity of 60 gallons per minute, to the storage tanks where they are brought up to standard strengths. The pump is driven by a 45-horsepower motor that can be belted through a counter-shaft to either one of two pumps, only one of which is used at a time.

The precipitate is transferred to a 900-gallon tank and given the usual acid treatment for 3 hours, after which it is transferred to a vacuum tank and is dried by a Gould vacuum pump. At the refinery, it is slagged with borax glass and soda and is run down, in clay crucibles, in an oil-fired Donaldson tilting furnace.

Power, Labor, Etc.—Electric power is purchased from the Redwater plant of the Consolidated Light and Power Co. It is received at 1,500 volts and stepped down to 440 volts at which voltage it is distributed. The following motors, all General Electric, three phase induction, are in use:

Use	Number	Horse-power	Total Horse-power
Two coarse crushers.....	2	50	100
Two elevators from coarse crushers.....	2	1	2
Two fine crushers.....	2	50	100
Four rolls.....	2	50	100
Two elevators to fine bin and four roll feeders.....	1	30	30
One conveyor.....	1	1	1
Three conveyor feeders and cross-conveyer.....	1	40	40
One solution pump.....	1	10	10
Total.....			383

Power per ton of ore treated, .766 horsepower.

In one corner of the mill is a machine shop in which is equipment sufficient to handle all ordinary repairs for the mine or the mill.

The regular day shift at the mill consists of 2 crushermen, 1 rollman, 1 solution man, 7 tankmen, 3 helpers, 1 millwright, 2 roustabouts.

The night shift employs only four men, one each to crushers, rolls, solutions, and tanks. A general foreman has charge on the day shift and the solution man has charge on the night shift. All shifts are of 8 hours, and the minimum wage at both mine and mill is \$3 a day.

Supplies are delivered by the Burlington railroad to a spur at the foot of the hill. From this point they are hauled by a 52-horsepower electric hoist up an incline 1,300 feet on the slope with an average grade of 20 per cent. Coal is hauled in side-dump cars that pass over the storage bin, while

all other supplies are delivered to one of three convenient landing places.

Costs.—During the year 1911, 160,860 tons of ore were treated at an average cost per ton of \$1.25, as follows: Mining, .5348; milling, .6682; general expense of all kinds, .0435; total, \$1.2465.

The average of the heads in gold was \$2.196, and the average of the tailing was \$.53, thus giving an indicated extraction of 75.8 per cent. The actual extraction as shown by the bullion returns was 76.31 per cent. In addition, 31,654.27 ounces of silver were produced, equivalent to a recovery of .1967 ounce per ton.

The mining expense given above was divided as follows: Stripping, \$12,692.00, 30 per cent., \$.1604 per ton. Mining, \$31,078.18, 70 per cent., \$.3744 per ton.

Consumption of chemicals for June, 1912, was as follows: Cyanide, .36 pound per ton of ore treated, cost \$.0778; zinc, .39 pound per ton of ore treated, cost \$.0377; lime, 2.30 pounds per ton of ore treated, cost \$.0109; total cost for chemicals, \$.1264.

The Wasp No. 2 has been paying dividends, made possible by the very low cost attendant on the operations, at the rate of about \$60,000 per year. These low costs are largely due to the natural favorable conditions for mining and milling; the advantage of open-cut work as against underground methods; and the coarse crushing and straight leaching, as against fine crushing and agitation. At first thought, it might appear that the extraction could be bettered, as no doubt it could be. However, when it is considered that the higher extraction would call for the fine crushing of a hard quartzite and that there would be required additional equipment and labor for the slime treatment that would secure a further recovery of 30 to 40 cents per ton in value, it appears that the present method shows the greater economy.

So far, the Wasp No. 2 has been largely an experiment. Consequently, the management did not make heavy investments in the matter of equipment until the feasibility of treating so low a grade of ore was conclusively proved. The steam shovel was installed this spring, but it has been successful, and the stripping costs for the current year should be lower than the figures given. By next year, it is the intention to have another shovel for loading the ore, and saddle-tank locomotives for handling the cars. These should materially reduce the force at the mine with a consequent lowering of mining costs.

The writer wishes to acknowledge the courtesy of the officials of the Wasp No. 2 Mining Co., and especially that of Mr. S. L. Williams, mine superintendent.

來 來

It has been estimated that five-eighths of the world's supply of sapphires comes from the alluvial workings of southeastern Siam.

SPECTROSCOPIC traces of lithium are found in nearly all igneous rocks and in many springs. When lithium minerals occur to any great extent they

are associated with granites and adjacent rocks which have been altered by hot gaseous emanations—a process known as pneumatolytic action. The places of occurrence of lithium are practically those of tin, but the large deposits of tin seldom contain workable deposits of lithium minerals. The lithium minerals are found ordinarily associated with beryl, columbite, wolframite, tourmaline, uranium-radium minerals, and the various minerals carrying phosphorus.

The lithium minerals of economic importance are amblygonite, a fluophosphate of aluminum and lithium, $Li(AlF)PO_4$, containing theoretically between 7.6 per cent. and 9.5 per cent. Li ; spodumene, a silicate of lithium and aluminum, $LiAl(SiO_3)_2$, containing theoretically between 4.5 per cent. and 7 per cent. Li ; lepidolite, a lithia mica, $R_3Al(SiO_3)_3$, R_3 being generally Fe , Mg , and Li in varying proportions; and lithophilite, a phosphate of Fe , Mg , and Li containing between 8 per cent. and 9 per cent. Li .

Most of these minerals occur in workable quantities in California, Maine, Massachusetts, New Hampshire, North Carolina, and Black Hills, South Dakota.

Since 1909 the Black Hills have afforded the entire production of lithium minerals used in the United States, and before 1909 they produced most of it. The minerals mined in the Black Hills are spodumene, amblygonite, and of less importance, lithophilite and lepidolite, all of which are found in connection with tin ores and mica minerals in pegmatite dikes. Probably the most noted lithium mine is the Etta mine, about $1\frac{1}{2}$ miles south of Keystone in the southern part of the Black Hills, in Pennington County, South Dakota. At this mine the crystals of spodumene lie at all angles in extremely coarse pegmatites carrying tin, which led to the original opening of the mine. The crystals found are the largest of their kind in the world; one crystal was 42 feet in length with a cross-section of 3 ft. \times 6 ft. Thirty-seven tons of the mineral were obtained from this one crystal. These crystals of spodumene, termed "logs" by the miners, weather readily when exposed to the action of the atmosphere and water. A feature of interest is that amblygonite is almost wholly absent from this deposit, while in the Peerless mine, one-half mile away, it occurs in large masses associated with spodumene. The spodumene, however, is of no importance.

Lithium

The Forms in Which It Occurs, Its Uses, Methods of Determination, and Processes of Extraction

By Amil A. Anderson*

At the Peerless mine, near Keystone, Mr. Herman Reinhold, of Omaha, Nebraska, mined a large deposit of amblygonite in 1907 and 1908. The mass, about 20 feet wide, was pearly white, and had one good cleavage plane. It has been worked to a slight depth but has produced several hundred tons of the ore.

There are several other mines in the vicinity of Keystone and a few in the vicinity of Hill City and Custer that have been worked for their lithium minerals. Among these are the Bond mine, about 5 miles south of Custer, and the Ingersoll mine, $1\frac{1}{2}$ miles west of Keystone. The mineral mined at these places is amblygonite with a small amount of lepidolite and spodumene.

The compounds of lithium used in the arts are lithium carbonate (Li_2CO_3), lithium hydroxide ($LiOH$), lithium bromide ($LiBr$), and lithium chloride ($LiCl$). The metal itself has no practical use. It oxidizes quite readily, is soft and of low specific gravity. It has, however, been proposed for the generation of hydrogen in aeronautics. One pound of lithium will generate over 25.5 cubic feet of hydrogen at normal temperature and pressure, when treated with sufficient acid.

The carbonate is used in the manufacture of artificial lithia waters and for medicine. Eminent physicians have claimed that it has a neutralizing effect upon uric acid, which in the blood gives rise to certain diseases. Equally eminent physicians, however, have recently claimed that it does not possess such power. Small amounts of the carbonate are used in the manufacture of fireworks. The hydroxide is used mainly in storage batteries of the Edison type, in connection with alkaline electrodes, in which the depolarizing electrode makes use of an oxygen compound of nickel, whereby the capacity of the battery will be increased and the time during which the capacity is a maximum will be prolonged. The chloride and bromide of lithium are used in photography and in medicines. Spodumene when occurring fresh and glassy with an emerald green color sells for high prices as a gem.

Before amblygonite was mined at the Peerless mine the price of lithium carbonate was \$2.50 per pound, but upon opening up this vast amount the supply became greater than the demand and a drop in prices ensued. Lithium carbonate now brings 40 cents per pound.

Lithium belongs in the alkali group with sodium, potassium, rubidium, and

cæsium. It is a soft, silver colored metal, has a specific gravity equal to .5936, atomic weight equal to 7. Its valence is one. It melts at 180° C. and vaporizes at about

$1,000^\circ$ C. It very closely resembles sodium, potassium, rubidium, and cæsium in its reactions. In the wet way it may be distinguished from potassium and ammonium salts in that it forms no precipitate with chloroplatinic acid (H_2PtCl_6), while on the other hand it forms an insoluble (Li_2CO_3) upon the addition of a carbonate, while potassium and ammonium salts do not.

Lithium salts give to the non-luminous flame a carmine red color, which is visible as violet through a blue glass, but is obscured by a green glass, giving a distinction from potassium. $LiCl$ is soluble in absolute or amyl alcohol while sodium and potassium chlorides are almost insoluble.

The best and quickest method for the qualitative determination of lithium is the spectroscopic determination, or if a spectroscope is not available the ordinary flame test as described above may be used. The lithium spectrum is characteristic.

The standard quantitative determination is the J. Lawrence Smith method and is as follows: One-half gram of the rock powder is ground fine in a large agate mortar, mixed with its own weight of sublimed ammonium chloride, and the two thoroughly ground together, then four grams of calcium carbonate are added and the grinding continued until a thorough mixing has resulted. The contents of the mortar are transferred to a 20-30 centimeter crucible, which is capped and placed through a hole in a piece of strong asbestos board and heated for 10 minutes by a low flame placed at considerable distance beneath. As soon as the odor of ammonia is no longer perceptible the nearly full flame of two Bunsen burners is substituted for 40 to 50 minutes. The sintered cake detaches readily from the crucible as a rule; if not, it is softened in a few minutes by hot water and digested in a dish until thoroughly disintegrated. It is first washed by decantation, and any lumps are broken up by a pestle, then thrown on a filter and well washed with hot water. The residue should dissolve completely in hydrochloric acid without showing the least trace of unattacked mineral, not even of quartz, though sometimes a few black particles of iron ores will dissolve slowly.

The next step in the determination is the separation of calcium and sulphuric acid, which will be present in practically every lithium ore. All but a trifling amount of the calcium is separated at a boiling heat in a large porcelain or

* In the *Pahasa Quarterly*.

platinum dish by double precipitation by ammonia and ammonium carbonate. The combined filtrates are evaporated to dryness and the ammonium salts are carefully driven off. From the aqueous solution of the residue—but a few cubic centimeters in bulk—the rest of the calcium is thrown out by ammonia and ammonium oxalate, the last thing being more effective than the carbonate. The filtrate is evaporated to dryness and gently ignited; the residue is moistened with hydrochloric acid to decompose any alkali carbonate that may have been formed, again evaporated, ignited and weighed. On solution in water a few tenths of a milligram of fixed residue is invariably left, which should be collected, ignited, and weighed in the same crucible or dish in order to arrive at the weight of the chlorides.

If the rock contains sulphur this will be in part found with the chlorides as sulphate. Therefore, if the sulphur is at all considerable in amount it must be removed by a drop of $BaCl_2$ before the final precipitation of the calcium. The excess of barium is removed by ammonium carbonate and the last of the calcium by ammonium oxalate as before.

From this solution the lithium is determined by Gooch's method, as follows: To the concentrated solution of the chlorides, amyl alcohol is added and heat is applied, gently at first, to avoid danger of bumping, until the water disappearing from the solution and the point of ebullition rising and becoming constant for some time at a temperature which is approximately that at which the alcohol boils itself, the chlorides of sodium and potassium are deposited and lithium chloride is dehydrated and taken into solution. The liquid is now cooled and a few drops of strong hydrochloric acid added to recover traces of lithium hydrate in the deposit, and the boiling continued until the alcohol is again free from water. If the lithium chloride is small, it will now be found in solution and the chlorides of sodium and potassium will be in the residue. If, however, 10 or 20 milligrams of the lithium chloride is present, it is advisable at this point, though not absolutely essential to the attainment of fairly correct results, to decant the solution from the residue, wash the latter a little with anhydrous amyl alcohol, dissolve the residue in a few drops of water, and repeat the separation by boiling again in amyl alcohol.

To the solution add H_2SO_4 , evaporate to dryness, take up in water, filter to remove carbon that has been deposited from the alcohol, place in porcelain or platinum dish, evaporate to dryness, ignite at a low red heat, and weigh as Li_2SO_4 . From this weight the Li may readily be calculated.

This method is accurate under proper manipulation and is used in the determinations of lithium in waters and minerals.

But little information in regard to the extraction of lithium from its ores is available. Numerous electrolytic methods are known. A process has also been proposed by Hugo Muller and is outlined in Roscoe and Schorlennner's "Treatise of Chemistry." It consists of dissolving the mineral acid with a ferric salt. The solution is evaporated and the chloride of lithium removed by dissolving in water. Manganese can be removed from the solution by treatment with barium sulphide and the excess of barium removed with sulphuric acid. The lithium is finally evaporated with oxalic acid and ignited to convert to the carbonate.

Another method employed in a Paris, France, refinery is by using H_2SO_4 contained in acid sodium sulphate, pulverizing the acid sulphate and the ore, then mixing them in exactly determined proportions, gradually heating this mixture to redness, lixiviating the roasted mass to obtain a solution of lithium sulphate, and after purification, precipitating the lithium as the carbonate Li_2CO_3 by the addition of sodium carbonate.

采 采

Calumet & Hecla

The annual report of the Calumet & Hecla Mining Co. for the year ending December 31, 1911, shows that 74,130,977 pounds of copper were made by the company during the year at an average cost of 8.52 cents per pound, which is exclusive of the \$90,355 paid for interest on the notes in excess of dividends received from subsidiary companies.

At the end of the year the company had a surplus of \$11,720,106.

The cost per pound in 1910 amounted to 8.96 cents and in 1909 it was 8.28 cents.

Calumet & Hecla stamped 2,909,972 tons of rock in 1911, and the mining cost per ton of rock, not including construction work, amounted to \$1.84, as compared with \$1.92 in 1910; \$1.93 in 1909, and \$2.15 in 1908. The copper per ton of rock averaged 35.47, while in 1910 it was 25.77. The average price received for the product for the year was 12.85 cents.

Total dividends paid to the close of 1911 totaled \$115,850,000, and dividends received from subsidiary concerns amounted to \$1,048,882. The statement of the assets and liabilities does not include the present timber holdings of the company, which are conservatively estimated at 492,000,000 feet.

President Shaw says: "Development work in ground adjacent to the Red Jacket shaft is very nearly completed. Openings in the five forties continue to show ground of about average quality. At the Hecla and South Hecla branches ground opened is quite up to the average of last year. Openings on the Osceola lode have shown ground of average quality and even greater amounts of good

ground have been opened and mined on the foot-wall side of the lode."

The holdings of Calumet & Hecla in its subsidiary companies are as follows:

Companies	Shares Issued	Shares Owned December 31 1911
Ahmeek.....	50,000	24,800
Allouez.....	100,000	43,000
Centennial.....	90,000	43,500
Cliff.....	60,000	19,400
Dana.....	40,000	36,500
Frontenac.....	20,000	20,000
Gratiot.....	100,000	50,000
Isle Royale.....	150,000	27,500
La Salle.....	302,977	152,977
Laurium.....	40,000	33,500
Manitou.....	20,000	18,000
Osceola.....	96,150	32,750
Seneca.....	20,000	11,207
Superior.....	100,000	50,100
St. Louis.....	40,000	35,450
Tamarack.....	60,000	19,400
White Pine, preferred..	3,792	3,792
White Pine, common...	85,320	43,202

采 采

Mill Feed Sampler

By L. M. Banks*

The apparatus shown in the accompanying sketch is used in sampling the mill feed in the No. 6 concentrator of the Arizona Copper Co., at Morenci, Ariz.

It comprises a moving sample bucket supported between two chains about 18

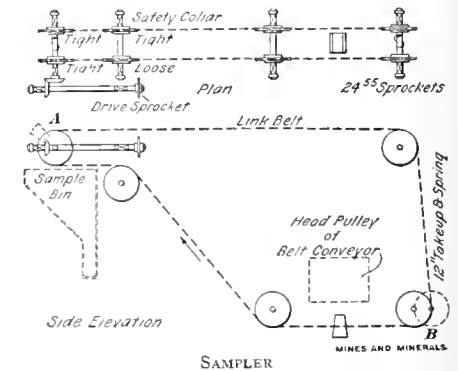

inches apart, so arranged as to run through the discharge from a belt conveyor.

The bucket is made of sheet steel, is bolted to special links on the chain, and is easily renewable. The chains are of the commercial type known as link belt and run on 24-inch sprockets. Each of the five shafts contains two sprockets—one tight, the other loose. Shaft B is provided with a take-up and spring. The device is driven from a line shaft by means of bevel gearing on shaft A.

The sample is taken, as above stated, when the bucket passes through the ore stream from the belt conveyor. The bucket then moves up at an angle of nearly 45 degrees and dumps while passing around sprocket A, the sample discharging into one of three wooden bins. One bin is reserved for the sample from each shift. The samples caught in the bins are subsequently cut down to laboratory size by coning and quartering.

*Mining Engineer, Morenci, Ariz.

IN report No. 4 of the Topographic and Geologic Survey of Pennsylvania, will be found the economic geology of ochers, metallic paint ores, black, yellow, and red shales, iron ores, and minor products. The "Mineral Pigments of Pennsylvania" is by Benjamin L. Miller, and, while a report, is virtually a textbook on the geology, mining, and manufacture of mineral paints. The following abstract it is believed will prove interesting reading.

Materials containing over 30 per cent. iron are classed with iron ores, below this per cent. of iron, as ochers, provided their chemical composition agrees in other respects. Thus ocher is a variety of clay. When pure, clay is white; but more usually it is colored red or yellow by iron oxides, forming red and yellow ocher. Unless otherwise specified, ocher means clay permeated with anhydrous ferric oxide. It has a decidedly golden yellow color, a specific gravity of 3.5, and contains 20 per cent. or over of hydrated ferric oxide. Ocher is found in nature and cannot be produced artificially, and if burned so that the hydrate is converted into anhydrous iron oxide it will form red ocher. Red ocher is also found in nature.

Metallic paint is a commercial term applied to material containing more than 30 per cent. ferric oxide. The term does not represent any definite composition, and the iron oxide varies from 33 to 64 per cent.

Sienna is a deep-yellow, high-grade ocher, which if burned produces a dark red substance. Umber, or brown ocher, is a variety of yellow ocher consisting of iron and aluminum silicates, containing varying proportions of manganic oxide, its degree of color varying according to the percentage of the latter. The raw variety is drab in color, which on burning changes to reddish brown, and is called burnt umber.

In eastern Pennsylvania, ocher is mined by "open cut" and by shafts. The pocket nature of the deposits does not justify elaborate equipment, and the mines soon cave after operations cease. Little timber is used in some mines except in the shafts and main drifts, but if much water is present the squeezing action of the clay requires much timber, even in the small stopes. In most of the mines the ocher is a band, and drifts run from the shaft in either direction. When a pocket of ore is found that extends upwards, overhead stoping is practiced. In drifting it is usual to follow on the ore in whatever direction it extends; and where it pinches out the drifting is carried on in almost any direction, but mainly parallel to the principal band where there seems to be

Mineral Pigments in Pennsylvania

The Different Minerals Used, and Their Analyses—Methods of Mining and Preparing

such an arrangement of the ore. After mining, the ore is wheeled in barrows to the shaft, loaded into buckets and hoisted to the surface, where it is washed and prepared for shipment.

As the ore comes to the surface, it is mixed with clay, limonite nodules and fragments, and pieces of chert. The clay is not removed by washing, but the hard particles are. Log washers are used effectively; the ocher and clay flow out the lower end, while the hard particles are worked by the blades to the upper end and discharged. The good iron ore is picked from the hard material at the upper end and when sufficient has accumulated it is sold to some nearby furnace. The ocher and clay are carried by the wash water to nearby settling troughs that are slightly inclined so that the water flows slowly through them. The current is also retarded by baffle boards behind which the coarser particles settle. At one mine the water carrying the suspended particles passes through 28 troughs, 14 to 16 feet long and 13 inches wide. The coarsest sand settles in the first two or three, and sediment diminishes in size in each trough until the last one is reached, where the little sand present is extremely fine. From the troughs, the water and suspended material flows through a launder to a series of settling ponds, roughly rectangular in shape. An average settling pond is made by digging a few feet in the surface and throwing the excavated material so as to form an embankment. It will be possibly 40 ft. \times 25 ft. and from 3 to 4 feet deep. Settling ponds are frequently in series, so that the coarsest material will settle in the first pond and the finest in the last. The overflow from the last pond flows away through a pipe.

It is possible to grade the material by diverting the wash water from the best grade of ocher brought to the surface into a certain pond, while that in which there is much clay goes into another pond. When a pond is filled the surplus water is allowed to evaporate until the material is in a condition where it can be dug and carted to the drying sheds. It may be several weeks or months before a condition is reached where the material can be removed to the drying sheds. At some places steam is used for drying in the winter, but usually the material is air dried. From the drying shed it is ground in French buhr mills and then shipped in bags or barrels.

An analysis of material coming from near eastern Pennsylvania before and

after burning is given herewith. Neither analysis is complete and it is probable that the undetermined material was the cause of the loss of the silica in slugging.

	ANALYSIS	
	Before	After
Silica.....	39.70	39.00
Ferric oxide.....	37.40	12.35
Alumina.....	12.36	13.33
Magnesia.....	1.37	Traces
Moisture.....	7.83	2.50

There are but three known deposits of "umber" in Pennsylvania, one about 2½ miles north of Bethlehem; one about 5 miles east of Doylestown, and one about 1 mile west of Bethel. The first two have been operated at intervals, while the last is a prospect.

The term sienna is properly applied only to those pulverulent substances whose composition is that of a high-grade limonite ore. With an increase in silica and alumina, sienna passes into ocher. The sienna from Neversink Mountain near Reading, Pennsylvania, has the following analysis according to C. K. Williams & Co., of Easton:

FeO_3 , 69 per cent.; SiO_2 , 24 per cent.; Al_2O_3 , 3 per cent.; combined water and undetermined properties, 14 per cent.

The ore is taken from the mine in wheelbarrows, partly dried, and shipped. This deposit is worked to the amount of between 125 and 200 tons yearly and the material is worth about \$20 f. o. b. at Reading.

Carbonate of iron has been mined in Carbon County for pigment since 1856. The ore resembles an impure limestone, and were it not for its specific gravity, 3.25 to 4, might be taken as such. The dark blue color oxidizes to red on exposure, and, where weathered, is termed "sunburned ore." Mr. A. S. McCreath stated that the elements in the raw ore existed for the most part as carbonates, and furnished the following percentage in an analysis of roasted ore:

Fe , 34.6; Mn , 9.29; Al_2O_3 , 2.492; CaO , 3.510; MgO , 1.081; S , .674; P , .018; SiO_2 , 16.21; loss in roasting, moisture, and CO_2 , 24.35. Sometimes the fossils constitute as much of the ore as the cementing material that binds it; and this is to be expected, as the ore belongs to the Devonian period and is located between the Oriskany sandstone and the Marcellus shale. As the ore bed dips from 60 degrees to 70 degrees, it is worked along the strike by drifts and stopes. The drifts are 7 feet high and 5½ feet wide, the ore being 2 feet thick, and are timbered by stulls hitched to the cement rock hanging wall every 3 feet, and resting on a timber leg 9 inches in diameter, at the other end. This two-stick timbering is closely lagged above and on one side. In case of shaft

mining, a pillar of ore is left each side for protection, and beyond this stoping commences. The drift is advanced 30 to 40 feet at a time, after which a section of this length is stoped to the surface.

This work of underhand stoping requires that at the top of the stope a drift be kept in advance and the remainder on an inclination, so that gravity will assist in moving material to the level. The stopes are 4 to 6 feet wide, 2 feet being ore, the remainder clay and cement rock.

The ore is carefully assorted and rolled down the stope, the clay and cement rock being used as filling on the stulls. At intervals risers are driven from the top of the stope to the surface for fresh air, which is conducted to the face through timbered airways. The ore is drilled by hand and blasted with dynamite. After being taken from the mine the ore is stored in sheds until needed at the mill, where it is first calcined and then ground. As the ore comes from the sheds it is in lumps which are broken by sledge hammers so that they are not larger than 6 inches in diameter.

The kilns are situated so that the charging doors can be reached from a trestle without hoisting the ore. Kilns are constructed of brick, 25 feet high and 10 feet in diameter. Fireboxes are built on either side of the kiln, and these increase the width at the base to 18 feet. The fuel used is wood, and the ore is heated to a cherry red, and remains in the kiln about 24 hours, 10 tons being withdrawn every 12 hours and an equal quantity of raw ore charged at the top. The object of calcination is the elimination of the sulphur of the pyrite, the carbon dioxide, and the moisture, thus obtaining a dark reddish-brown colored oxide. After withdrawal from the kiln the material is crushed to about the size of buckwheat, then conveyed to bins on the top floor, from which it is fed to 36-inch buhr mills and vertical mills, and ground to impalpable powder.

Metallic paint is this powdered material mixed with oil. The finished product of the Prince Metallic Paint Co.'s mill gave the following percentage analysis: Fe_2O_3 , 43.70; SiO_2 , 38.65; Al_2O_3 , 5.79; MnO_2 , 1.85; CaO , 1.80; MgO , 2.04; moisture, .30; undetermined, 3.33.

Black shales, ground and sold under the name of mineral black, are extensively used in paint, but there is a tendency for the shale to settle out of the oil.

Yellow shales are utilized in the manufacture of paint and when ground fine and mixed with oil are said to be serviceable. Their principal use is for making oil cloth and linoleum. They are lighter than ocher in color and seldom contain more than 5 per cent. hydrous iron oxide.

Red shales, Clinton iron ore, graphite, soapstone, talc, barite, chromite, pyrite, and clay are also used as pigments.

The Use of the Pantagraph

By H. G. Henderson

The pantagraph, although a well-known and useful instrument for the enlargement and reduction of plans, is hardly regarded with favor by mine surveyors in cases where extreme accuracy in the work to be done is necessary. The main reasons for this are two in number. In the first place the graduations on the arms of the pantagraph cannot give sufficient detail to suit all cases. For example, the reduction of an ordinance town map which is $\frac{1}{500}$ scale, to be drawn to 50 feet to the inch or $\frac{1}{600}$ scale can only be managed with difficulty, as the setting of the instrument to effect such work can

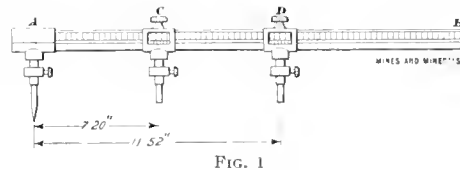

FIG. 1

only be accomplished by the tedious system of "trial and error." The second consideration is that of temperature variation. The instrument may possibly have been graduated in the height of summer, whereas it may be required for use in the depth of winter, or vice versa, and under such conditions the expansion and contraction of the metal arms makes reliability not to be expected.

The writer some years ago discovered the fact that the radii of the pantagraph after being set are always in proportion to the numerators of the representative fractions of the two scales of the plan under construction. He accordingly had a pantagraph "setter" made as shown in Fig. 1. The portion AB represents a piece of hard wood, say 50 inches long, accurately divided into inches and decimals. At A there is attached a fixed socket, while at C and D there are two traveling sockets with verniers reading to $\frac{1}{600}$ inch. These sockets hold, as shown, two blunt-ended metal styles or spills and one longer pointed spill, all three being interchangeable. In order to show the application of this setter it may be supposed that it is desired to enlarge the plan from 50 feet to the inch to a scale of 30 feet to the inch. The representative fractions of these scales are respectively $\frac{1}{600}$ and $\frac{1}{360}$, the denominators of course being 600 and 360. Now the ratio of 600 and 360 is equal to that of 6 and 3.6 but since these distances are rather small for the purpose they may be each multiplied by 2, giving ratio numbers of 12 and 7.20. The setter is then taken and the spill C is clamped to read 7.20" while the spill at D is clamped to read 12". The pointer spill is then inserted in the socket at A and is dropped into the fulcrum funnel of the pantagraph. The other two

traveling funnels are then worked with the hand simultaneously until the blunt-ended spills C and D drop easily into them. The traveling funnels are then clamped, the setter rod is carefully withdrawn and the instrument will then be found to be accurately set. It will generally be found that the pantagraph can be worked more easily if the fulcrum spill be placed between the other two. This can very easily be arranged by making the distance A to C 7.20" as before while instead of making the distance A to D 12" this distance A to D should be made 19.2" or the sum of the two numbers. In other words the distance CD becomes 12". It is obvious that with a setting rod no graduations on the arms of the pantagraph are necessary and there need be no fear whatever as to error through unequal contractions and expansions of the arms. Moreover, at the present time pantagraphs are made of flat brass rods, but in the new method above described tubular rods might supersede these with great advantage both with regard to lightness and rigidity.

來 來

Colorado Mineral Production, 1911

The value of the output of gold, silver, copper, lead, and zinc recovered from placers, gold-silver bullion, and from ore sold or treated in 1911, from Colorado mines, according to Charles W. Henderson, of the United States Geological Survey, was \$32,418,218, as compared with \$33,673,879 in 1910, a decrease in value for 1911 of \$1,255,661. These figures are compiled and tabulated strictly as a mine report and with reference to the locality of each individual mine, and not with reference to the locality of the shipping point of the product.

Cripple Creek supplied 56 per cent. of the total gold yield of the state, with an output of \$10,562,653, as compared with \$11,002,253 in 1910. Conditions in the Cripple Creek district were much the same in 1911 as in 1910, for the subsidence of water through the Roosevelt tunnel was so slow that it was not possible to increase operations. At the close of the year, after the tunnel had been driven farther, the water drained more rapidly. The gold yield from the San Juan region fell off considerably, San Juan and Ouray counties contributing chiefly to the decrease. Counties showing an increased output of gold were Boulder, Costilla, Gilpin, and Mineral. The placer output of gold was \$319,759, a decrease of \$75,706 from the output for 1910.

The number of deep mines producing metals in 1911 was 861, against 856 in 1910. The average total recoverable value per ton of ore produced decreased from \$13.67 in 1910 to \$13.50 in 1911.

Russian Platinum Industry

Written for Mines and Minerals

The long-threatened monopolization of the platinum industry by the Russian government may be said to have entered on its first legal phase by the acceptance of the proposition in legal form by the Duma. The opinion is held in Russia that Imperial sanction will be duly acquired; and that the Russian platinum industry will be a Russian industry in all its stages from the collection of the platiniferous sand to the production of refined platinum sheets, wire, etc.

The Russian platinum industry does not correspond to that importance which the platinum sands in the Urals warrant. In the course of the long series of years these sands have constituted practically the only source for supplying the world's market with platinum. The Urals provide about 95 per cent. of the world's production, and of all the remaining deposits of platinum known in the world the only ones worthy of mention are the sands of Colombia; which, however, because of their small production—about 360.7 pounds per annum—represent rather an historic interest as a place where platinum was first discovered, and where it has been produced for something like 2 centuries.

Since Russia has a practical monopoly of the production of platinum it might be expected that this would result in a large profit; as a matter of fact it is quite otherwise. Of the total platinum produced, only 2 per cent. is refined in the country, and 98 per cent. is exported unrefined. The metal is bought by a large foreign firm which controls the business and fixes the price according to its discretion. That is why platinum producers are entirely dependent on it, whilst on the other hand it would be much more natural that the price of platinum should be regulated by its producers, according to the demand and the cost of its production.

Turning to the question of refined platinum, it should be observed that refining, in Russia, is in an unfortunate condition, since under the prevailing industrial conditions the manufacturers might be able to sell abroad the refined metal at a higher price than in the crude form.

Besides this, the various associates of platinum such as iridium, rhodium, ruthenium, osmium, and palladium, which constitute by weight from 2 to 10 and even to 15 per cent., if held in Russia, might be sold at high prices. At present these metals, with the exception of iridium, are included in the number of insoluble metals, and are not paid for by the foreign refiners. The platinum refining laboratories, both existing in Russia and abroad, not only separate platinum from its associated metals, but they manufacture from platinum, sheets, wire, chemical vessels, and they also save the associated metals of the platinum

group and manufacture preparations therefrom. The concentration of these laboratories in Russia would constitute a direct link between the national platinum industry and the foreign consumers of refined platinum, both in ingots and simple manufactures, since these constitute materials used in the jewelry industry, in the preparation of artificial teeth, and in other spheres.

In close connection with the monopoly of refined platinum in Russia will be prohibition of the export of crude platinum. While platinum refining laboratories exist in Russia, their operations are very insignificant, since in them no more than 360.7 pounds of platinum per annum are treated; but this is explained by the monopolistic position which is occupied by the foreign refiners. There is no doubt but they will be able to retain such a position if, without hindrance, they receive crude metal from Russia, since according to the conditions of the sale of refined metal the foreign refineries are in a better position than the Russian, and with a free export of the crude platinum it would be difficult to struggle with any stolen or secretly conveyed metals; whilst the appearance of such metal on the market would depress the price.

In view of this it will be necessary to prevent ingots carrying less than 99 per cent. pure metal from being exported. Following the example for the encouragement of the development of the gold production in Russia, loans should be granted to platinum producers, especially as running expenses necessary for working the mines. These questions according to the statutes of the Imperial Bank are being now brought under the consideration of a council of the bank.

Respecting the circulation of the crude platinum and trading with it in the empire, the existing freedom of circulation of this metal has, in the opinion of the Council at the Mining Department, led to the condition that the platinum produced by poachers and secret workmen and by servants, has been sold without hindrance; in consequence of which, not only has poaching and concealing of metal developed largely, but along with this the constant supply of platinum has increased as offered through merchants to foreign refiners at prices which do not accord with the actual expenditure in producing the metal at the mines. This encourages the foreign refiners' position, and brings sharp declines in the market value of the metal.

In order to successfully compete with the foreign refineries it is desirable to take measures which shall prevent the circulation or poaching of secret metal. According to the judgment of the Interdepartmental Council such measures are: (1) The exact registration of the platinum produced at the mines; (2) the issue by the mines of special certificates guaranteeing or in-heating the place where the

metal was produced; (3) an obligation on the part of every holder of metal to possess these certificates; (4) the registration by holders of platinum of the business done in it; (5) the institution of sufficient penalties for the non-observance of the rules issued with the object of giving force to the said measures.

來 來

Platinum Near Princeton, B. C.

*By Frank Bailey**

For the last year there has been a revival in the placer-mining industry on the Tulameen River, which is the richest alluvial platinum deposit on the North American continent. The British Columbia platinum Co., Ltd., is one of the oldest companies operating in the Tulameen platinum belt. This company was organized as a development syndicate some years ago with a capitalization of \$200,000.

In December last Mr. Bair, the president sent to the Department of Mines at Ottawa for examination a sample of 4 ounces of black sand, concentrated from 1½ to 2 cubic yards of river sand and gravel. On assay, this material was found to contain platinum at the rate of 521.57 ounces per ton of 2,000 pounds of concentrates; osmiridium, at the rate of 58.82 ounces; gold, at the rate of 75.82 ounces; silver, very small quantity, undetermined. The platinum Gold Fields, Ltd., of Vancouver, B. C., was organized to explore the large gravel benches and bars of the Similkameen and Tulameen rivers, where they have lately taken 10 miles of dredging leases.

Last winter the company successfully prospected its ground with two Keystone drilling machines on the ice, proving the average value to be \$19,362 per acre.

The Tulameen Gold and Platinum Co., Ltd., is the third company operating in the Tulameen platinum belt; its holdings are on the Tulameen River, between Eagle and Bear creeks, and on the Similkameen River below the holdings of the Platinum Gold Fields, Ltd.

A sample of black sand taken from one of the old placer tailings dumps, from which the gold had been taken out in early days, was assayed by N. W. Pirrie, Provincial Assayer of Vancouver, which gave the following results: Platinum, 3.83 ounces; gold .62 ounce; osmiridium, .04 ounce; silver, .24 ounce.

The old-time placer miners who came into the country during the Granite Creek excitement, discarded the platinum as it was at that time considered useless, and they called it "white gold" and dumped it out of their sluice boxes; later on a lot of it was bought for 50 cents per ounce and shipped to New York and London. Today it is worth about \$45 per ounce.

Late this summer Messrs. Johnson, Matthey & Co., of Hatton Garden, London, (the big platinum buyers), sent out their

* Princeton, B. C.

expert, A. B. Coussmaker, M. E., from Siberia, to investigate the platinum possibilities of the Tulameen. Accompanied by Mr. Colby, of Baker & Co., New Jersey, they examined the field, with the result that Mr. Coussmaker has established a working camp and is at the present surveying the extensive bars and benches of the Tulameen River and its tributaries

采 采

Raising Shaft at Rolling Mill Mine

By Edwin N. Cory*

The new shaft of the Rolling Mill mine of the Jones & Laughlin Steel Co., was raised from the 621-foot level to the surface by the following method:

The work was started from the level and carried through to surface with one continuous raise. A force of nine miners divided into three shifts of three men to each shift, working 8 hours per day, was employed. These men also trammed the material from the raise to No. 1 shaft, a distance of 750 feet, and put in the timber. The difficulties of raising so great a distance were successfully overcome and no accidents or delays occurred.

The raise was 8 ft. X 8 ft. in size and was divided into three compartments as shown in Fig. 1. One compartment, 4 ft. X 4 ft. including the timber, was used for hoisting tools and timber and a station was cut at the bottom of the compartment on the main level, in which was placed a small hoist. Another compartment, 4 ft. X 4 ft. was used for ladders and an 8-inch air pipe from the fan, also one 1½-inch pipe for speaking tube and one 1½-inch air pipe for the power drills. The other half of the raise 4 ft. X 8 ft. was used for the rock broken in the raise, and was not timbered but kept filled with rock up to the height of the timber in the other compartments. A chute was constructed in the bottom of this compartment through which the rock was loaded into tram cars, as shown in Fig. 2. A fan was placed at No. 1 shaft which forced the air through the 8-inch pipe up to the top of the raise, the current going down through one of the compartments, thus securing perfect ventilation.

An Ingersoll-Rand, 2-inch cylinder butterfly-valve hammer drill was used, three machines being operated at one time to drill 18 holes in three rows, six holes in each row. The cut holes were drilled so as to break, when blasted, a space the entire length of the raise directly over the rock compartment as shown in Fig. 2, so that the other holes would throw the rock toward this opening and it would fall into the rock compartment. Before blasting, the ladder and bucket compartments were covered with 10-inch round timber, flattened on two sides to prevent rolling, and placed at an angle to deflect the falling rock into the rock compartment, necessitating only a

minimum amount of shoveling. The space directly over the ladder compartment, was covered with 3-inch plank to permit the men to get away quickly when blasting, also to give them perfect protection in going up and down the raise. The blast-

hoisting drills and machines. The drilling machines were thoroughly overhauled after each round of holes while the miners were blasting and timbering, and no delay was occasioned during the work.

When the raise had been carried to a height of about 200 feet, hitches were cut in the rock and a set of bearing pieces put in about 4 feet above the last set of timber, and planked up with 3-inch plank. This was done to take the weight of the timber for the next 200 feet instead of letting it rest upon the timbers below. Stations about 15 feet long were cut in the side of the raise every 200 feet, to shelter the men when blasting and save the exertion of going down the ladders the whole distance to the level below.

In this manner the raise was carried to the height of 570 feet, which was 51 feet from the surface, when a smaller raise was carried up, as shown in Fig. 4, a test hole being drilled in advance of the top of the raise to ascertain the depth of the sand. When within 18 feet from the surface, sand was reached by the test hole, and the raise continued, by carefully working through the sand, to within 10 feet of the surface. A hole was then drilled from the surface, blasting the sand through the opening below.

The work of enlarging the shaft was then begun. The surface at the opening made by the blast was leveled and two stringers, 2 feet 6 inches in diameter and 25 feet long, were placed in position for timbering through the sand. The dimensions of the shaft are 10 feet 2 inches by 12 feet 2 inches inside; 12" X 12" fir timber was used and the plan of timbering is shown in Fig. 5. The principal feature of this work was the method used in enlarging the opening made by the raise to the dimensions required by the permanent shaft. The drills used in raising were also used for this work. The rock was drawn off through the chute at the 621-foot level the same as when raising, until it was lowered about 15 feet. The timber from the raise was then pulled out for a distance of 15 feet and the two smaller compartments covered over as before. The holes were drilled upwards at an angle of 45 degrees, and were started 10 feet below the permanent shaft timber and so located as to strip 5 feet of the shaft at one blast, thus making room for one set of the shaft timber.

Ordinarily this work is done by drilling holes downward, but, as the above method proved very successful, it was continued for the entire shaft. The use of the hammer drill seems to be a great improvement over the reciprocating drill with the shaft bars on tripods.

The progress of the work was as follows: Raising 621 feet; Number of days, 125; average progress per day, 5 feet; Cutting down 621 feet; Number of days, 114; average per day, 5.44 feet.

The work which was started September 5, 1911; was completed by July 15, 1912.

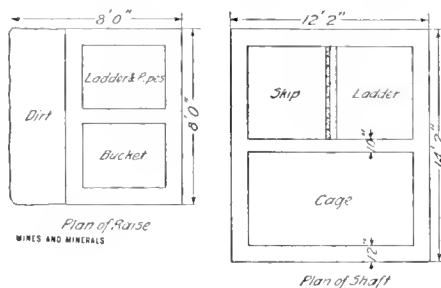

FIG. 1

ing was all done with fuse cut in various lengths to give the desired results. After blasting, and while the smoke was clearing out of the raise, the miners would tram enough rock out of the chute so that timbering could be commenced at the top of the

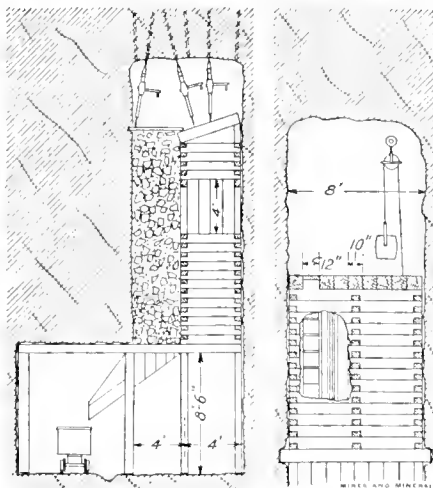

FIG. 2

FIG. 3

raise. A gin pole was erected about 8 feet from the last set of timber on which was hung a 10 inch sheave wheel as shown in Fig. 3, for the rope used in hoisting the timber from the level below. After the timber had been put in it was also used for

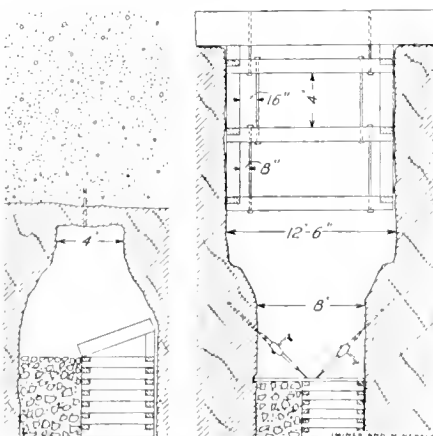

FIG. 4

FIG. 5

* Paper read before Lake Superior Mining Institute, August, 1912

NEW MINING MACHINERY

Manganese Steel for Economy

As evidence of the remarkable endurance of "Stag" Brand manganese steel, The Edgar Allen American Manganese Steel Co., of Chicago, Ill., and New Castle, Del., have a photograph of a pinion, together with others of the same make, that was used for driving conveying machinery, and was in continual operation for over 25½ months, while the average service given by cut-steel pinions under exactly the same conditions, was only 3 weeks. That the metal is wonderfully tough is unmistakable, for even though worn down very thin the teeth did not break. While it is not good practice to wear out a pinion to such extent, this is an example of the economy which results from using good manganese steel. The makers of "Stag" Brand manganese steel are turning out and selling many hundred tons of castings per month in the form of gears, pinions, and other heavy service equipment, which fact demonstrates the extensive adoption of this metal.

來 來

Motor for Stamp-Mill Drive

It has been the practice in the past to belt a large motor to a long line shaft and from this line shaft to connect each battery of 10 stamps with a belt. This method caused a loss of power in the transmission owing to the continual jar of the stamps throwing the line-shaft bearings out of alinement, and involving considerable loss in the belt friction when different groups of stamps are out of service. Following machine-shop practice a motor is now designed to belt directly to a battery of 10 stamps. It is of 25-horsepower capacity at 580 revolutions per minute and is constructed as shown in Fig. 1 with a back-gear cradle that carries a countershaft, and on which is mounted a gear and pulley for especially slow belt speed. The gear ratio is 27 to 99, giving a countershaft speed of approximately 650 feet per minute. The gear case is oil-proof. The cradle and gear-case are standard, but a smaller motor can be used where the drops are fewer per minute, or the stamps lighter. This combination of motor drive for each battery of stamps has the advantage of dispensing with the long line of countershafting and its consequent losses, and drive, the belt and cam-shaft of the battery when out of service. With line shaft drive the belt and cam-shaft of the battery continues to run when the battery is idle. The motor, gear, and pinion can be replaced or taken away for repairs with-

out disturbing the line-up of the pulleys and the handling of the extremely heavy belt. An especially long sliding base is furnished to take up the stretch of belts. The cradle to which the motor is belted is securely held to the sliding base by means of four machine bolts which can be loosened when it is necessary to change the tension of the belt.

This individual motor equipment for stamp-mill drive, compared with the older

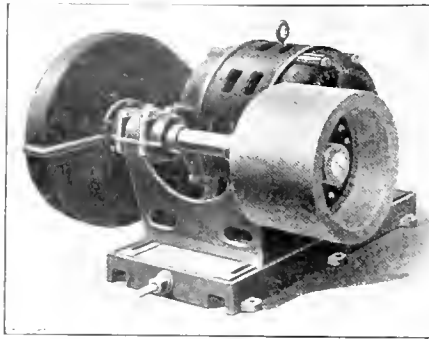

FIG. 1. MOTOR FOR STAMP MILLS

methods, and more particularly in preference to the long line-shaft drive with a single motor belted to the line shaft, seems to have a number of advantages and should serve to popularize the use of electric motors in stamp mills. The motor here described is made by the Westinghouse Electric & Mfg. Co. of Pittsburgh, Pa.

來 來

Ready-Made Houses

Modern steel building construction methods have been adapted in a unique way to the construction of dwellings, bungalows, and other types of frame structures. The application has been in the manner of construction rather than the materials used. Results obtained are striking and in some ways almost revolutionary.

As is well known all the material for the steel framework of modern office buildings is manufactured, sized, cut to exact lengths, shaped and numbered at the steel mills, ready for assembling, erecting, and bolting in place on the job. No further cutting or fitting is necessary after leaving the mills. Naturally this greatly facilitates the rapid and accurate progress for which this type of construction is noted.

Exactly this same system is now applied to the construction of a ten-room frame dwelling. Every piece of lumber in the house is first figured out in shape, size, length, breadth, and thickness by expert designers and draftsmen. These figures

are turned over to skilled carpenters, operating fast machinery in the factory. The time-honored ways of the hand saw are eliminated and every cut, miter, and bevel is accomplished by machinery. Every piece of lumber is numbered and marked by a surprisingly simple system and the house, for it is a house now, is loaded into the car and shipped to destination. Everything for the complete house is included in the shipment at a stated price, except the masonry; all sills, joists, studding, rafters, siding, sheathing, flooring, porch work, stairways, windows, doors, frames, moldings, locks, hinges, nails, paint, oil and varnish, putty, shingles, lath, and plaster, in fact everything is included at a plainly stated price.

The ready-cut system of construction was first brought to public attention 7 years ago, since which time it has made wonderful progress. It practically eliminates the necessity for skilled laborers in erecting dwellings and cuts the usual time of erection in half—and at a proportionate saving in cost.

There are several firms selling material for houses by mail, but only one manufactures houses complete by the ready-cut system—The North American Construction Co., of Bay City, Mich., who are exclusive manufacturers of Aladdin houses.

來 來

Trade Notices

Change of Name.—The S. Jarvis Adams Co. announces the change of its name to the Pittsburg Iron and Steel Foundries Co.; the general offices are at the works at Midland, Beaver County, Pa.

Nokomis Mine Plant.—J. E. Rutledge of the Rutledge & Taylor Coal Co., St. Louis, Mo., also president of the Nokomis Coal Co., has awarded a contract to the Roberts & Schaefer Co., Engineers and Contractors, McCormick Building, Chicago, for the designing and building of a complete fireproof coal-mining plant of large capacity, to be built at Nokomis, Ill., contract price approximately \$125,000. This plant will, in many respects, be similar to the large plant which the above company erected for the United Coal Mining Co., at their Mine No. 2, Christopher, Ill.

Loud-Speaking Telephone.—The Western Electric Co., installed ten of their loud-speaking telephones in the Boston Electric show. This telephone combines the articulating qualities of the telephone receiver, and has the intensifying qualities of the megaphone. The installation was made to demonstrate their use as announcers of

interesting events about to take place at the exposition. They were also used to transmit music and were so loud in their doing it, that the leader of the band protested that "it interfered with the music he was playing."

Order for Boiler Compound.—The United States Government order for \$5,000 pounds of boiler compound has again been awarded to the Geo. W. Lord Co. The boiler compound business is undoubtedly on a much better basis than formerly. Today the goods must have merit back of them to be able to stay in the field; for the engineer has learned more about the chemicals to be used for certain water troubles, and this has been brought about by the educational advertising campaigns carried on by the successful boiler compound houses in the field today. Of course, none of them tell what ingredients are used in their special formulas, but practically all the mystery as to what they are trying to accomplish has been removed, as the successful houses furnish a complete analysis of the water to show the engineer what he is up against. The credit for this is claimed by the Geo. W. Lord Co., who started furnishing certificates of analysis many years ago, when the boiler-compound business was in its infancy.

New Instrument Co.—Under date of October 8, 1912, the formation of the Davis Instrument Mfg., Co., Inc., 110 W. Fayette Street, Baltimore, Md., is announced. The company will manufacture and handle mining and scientific instruments, etc., of the highest grade; and accurate anemometers and their repair, test, and adjustment will be a specialty. Scientific instrument repairs are solicited. The officers are, Herbert Davis, president; A. U. Davis, vice-president; F. H. Holthaus, secretary treasurer.

The Joseph Dixon Crucible Co.—At the regular monthly meeting of the Board of Directors of the Joseph Dixon Crucible Co., on October 21, the following changes in the officers and Board of Directors were made on account of the death of Vice-President William H. Corbin. George E. Long, former treasurer, was elected vice-president to succeed Mr. Corbin; J. E. Schermerhorn, was elected to membership in the Board of Directors and treasurer of the company. Mr. Albert Norris was elected to the office of assistant secretary and assistant treasurer.

Catalogs Wanted.—O. M. Jones, 30 Church Street, New York City, who is a jobber and manufacturers' agent, selling materials used for steam, water, air, gas, and oil supplies, and specialties covering complete power plants, is desirous of obtaining from manufacturers of such equipment and materials complete catalogs, and price lists and best jobbers' discounts.

Lunkenheimer "Puddled" Semisteel Valves.—The increasing use of high pressures and superheated steam has created a demand for something better than the

ordinary cast-iron, brass-mounted valves. To meet this demand, the Lunkenheimer company offer their line of "Puddled" Semisteel valves. "Puddled" Semisteel is an extremely high-grade iron and steel alloy, of close grain and great strength, not to be confounded with the mixtures made in cupolas where the admixture of steel with the iron is beyond control, and the resulting metals lacking in uniformity. The Lunkenheimer method is to melt the iron and steel together in a specially modified puddling furnace, thoroughly mixing them during the process, and by pouring off at the proper time and temperature, they secure an invariably uniform alloy. The best grade of Lake Superior charcoal iron is used and the percentage of deleterious chemical elements is kept very low, a result impossible to obtain in any cupola.

By this process, the tensile strength is controlled to any point between 30,000 and 40,000 pounds per square inch. Ordinarily, the strength maintained is 35,000 pounds, which is over 100 per cent. stronger than the cast iron used in the majority of valves, and about 50 per cent. stronger than that used in Lunkenheimer valves. The "Puddled" Semisteel valves have been extensively used in high-pressure plants carrying superheated steam, and have given satisfaction. These valves are made in two combinations as regards the material used for the trimmings; Combination C is guaranteed for 600° temperature and Combination D for 550°. Both combinations are suitable for 250 pounds pressure per square inch. For extreme conditions of pressure, superheat, and strain, the company manufactures the above line made of cast steel, the tensile strength of which is about 80,000 pounds per square inch. For lower pressures and temperatures, the line is made of a high-grade cast iron. A full description of these valves, together with that of the complete line of high grade engineering specialties made by the Lunkenheimer company, can be obtained by referring to their 654-page catalog, 1912 edition, a copy of which will be sent upon request.



Catalogs Received

GOYNE STEAM PUMP CO., Ashland, Pa., Goyne Mine Pumps and Plunger Pattern Heavy Pressure Boiler Feed Pumps, 58 pages.

E. I. DUPONT DE NEMOURS POWDER CO., Wilmington, Del. Explosives for Quarries, 16 pages; Blasting Supplies, 126 pages; High Explosives, 142 pages; Storage for Explosives, 27 pages.

E. KEELER CO., Williamsport, Pa. Water Tube Boilers, 46 pages.

THE AMERICAN WELL WORKS, Aurora, Ill. Standard Types of Centrifugals, 32 pages, "American Deep-Well Pumps," 63 pages; Centrifugal Pumps, 127 pages.

INGERSOLL-RAND CO., 11 Broadway, N.Y. Temple-Ingersoll Electric-Air Rock Drills, 34 pages; "5-F" Temple-Ingersoll Electric-Air Drill, 22 pages; Temple-Ingersoll Electric-Air Rock Drill Type "4-E", 4 pages.

THE GARDNER GOVERNOR CO., Quincy, Ill. Compressed Air and Its Commercial Uses, 39 pages.

GENERAL ELECTRIC CO., Schenectady, N. Y. Index to Bulletins, 10 pages; Price List No. 5267; Cloth Pinions; The G-E Steam Flow Meter, Bulletin No. A4004, 25 pages.

SYMONS BROTHERS CO., Milwaukee, Wis. Symons Disc Crusher, 17 pages.

THE DENVER ENGINEERING WORKS CO., Mine Timber Framing Machinery, 15 pages; Blake Ore Crusher, 7 pages.

SUTTON, STEELE & STEELE, Dallas, Tex. Bulletin D3, S. S. & S. Dielectric Separator, 5 pages; Bulletin T5, S. S. & S. Dry Concentrating Table, 5 pages.

BARCO BRASS AND JOINT CO., 230 North Jefferson Street, Chicago, Ill. Barco Flexible Joints, 20 pages.

WM. JOHNSON & SONS (Leeds), Ltd., Armley, Leeds, England. Briquetting Machinery, 16 pages.

CHICAGO PNEUMATIC TOOL CO., Chicago, Ill. Bulletin No. 121, Pneumatic Rammers and Foundry Equipment, 8 pages.

THE EARLE GEAR AND MACHINE CO., Philadelphia, Pa. Herringbone Gears, 11 pages.

McKIERNAN-TERRY DRILL CO., 115 Broadway, N. Y. "Bust Bee" Hammer Drills, 15 pages.

B. F. STURTEVANT CO., Boston, Mass. Gasoline Electric Generating Sets, 23 pages.

THE DEANE STEAM PUMP CO., 115 Broadway, N. Y. D 202, Duplex Steam Pumps Piston Pattern, 40 pages; D 224, Horizontal Double-Acting Single-Cylinder Power Pumps, 16 pages; D 219, Modern Water Works for Town and City Supply, 24 pages; D 222, Automatic Pumps and Receivers, 12 pages; D 167, Sand Riddlers, 8 pages; D 169, Hydraulic Air-Charging Device, 4 pages; D 171, Horizontal Duplex Piston Pumps Operated by Direct-Connected Vertical Gasoline Engines, 4 pages; Deep Well Pumping Machinery, 22 pages; D 220, Portable Mine Pumps, 8 pages; D 217, Duplex Horizontal Double Acting Power Pumps, 44 pages.

EDGAR ALLEN AMERICAN MANGANESE STEEL CO., McCormick Building, Chicago. The "Konata" Liner (Patented) For Tube Mills, 19 pages; The "Missabe" Dipper, For Steam Shovels and Dipper Dredges, 15 pages.

SULLIVAN MACHINERY CO., Sullivan Portable Drilling Rigs, 16 pages; Sullivan Rock Drill Mountings and Accessories, 31 pages; Sullivan Small Air Compressors, 15 pages.

THE J. M. DODGE CO., Philadelphia, Pa. Coal Handling and Storing Machinery, 96 pages.

Mines and Minerals

Vol. XXXIII.—No. 6.

JANUARY, 1913—SCRANTON, PA.

Price, 25 Cents

PUBLISHED MONTHLY AT SCRANTON, PA.

ESTABLISHED 1861

INTERNATIONAL TEXTBOOK CO., PUBLISHERS

T. J. FOSTER, President S. P. ALLEN, Secretary E. H. LAWALL, Treasurer
RUFUS J. FOSTER, Vice-President and Manager
EUGENE B. WILSON, Editor HUGH ARCHBALD, E. M., Asst. Editor
CHICAGO OFFICE: 1006 Michigan Ave.

Entered at the Post Office at Scranton, Pa., as second-class matter
Address all business communications to MINES AND MINERALS, Scranton, Pa.
CABLE ADDRESS, "RETSOF, SCRANTON"

LONDON OFFICE: INTERNATIONAL BUILDINGS, KINGSWAY, LONDON, W. C.
SOUTH AFRICAN OFFICE: MANSION HOUSE CHAMBERS, ALDERLEY STREET,
CAPE TOWN.

NEW ZEALAND OFFICE: 63 DIXON STREET, WELLINGTON.

AUSTRALIAN OFFICE: 83 PITT STREET, SYDNEY.

SUBSCRIPTION RATES

Single Copies 25 cents
Yearly Subscription, including postage:
To United States, Mexico, Cuba, Porto Rico, Hawaii, and Philippines. . . \$2.00
To Canada 2.50
To all other countries 3.00
The date after your name on the wrapper is that of the month to which your
subscription has been paid. If you do not want to continue your subscription
after that time, kindly notify us.

Notice to discontinue or change of address should be sent to the Scranton
office.
When notifying us of a change of address always give your FORMER as well
as your present address.

TABLE OF CONTENTS

Editorial—	
Editorial Notes—Rocky Mountain Coal Mining Institute—Electricity in Mines—Mischievous Statements—Substantial Sympathy—The Fire Boss and Mine Accidents.	291
Book Review	294
Personals	294
COAL MINING AND PREPARATION	
Washery at Soddy Mine, Tenn., by Frank E. Mueller.	295
Coal Mining Institutes.	298
Hogan on B. T. U.	299
Mine Surveying Wrinkles, by W. J. Crocker.	300
Obituary—	
William G. Simpson.	301
Mining Steep Dipping Coal, by A. A. Steel.	301
Rational Mine Sociology.	303
Concrete Coal Pockets	304
Carbon Dioxide Blower in a German Colliery, by Bergrath Laske.	305
Why Leave Shaft Pillars?	305
Prize Contest.	306
Robbing Coal Dust of Its Dangers, by Sim Reynolds.	307
Electric Cables for Mines, by William White.	309
Moving Minerals in Thin Flat Beds.	310
Portable Apparatus for Firedamp Analysis.	312
Old Rails as Stringers.	312
Telling Hogan, by John Verner.	313
The Letter Box—	
Fossils in Coal—Mine Drainage—Source of Blackdamp—Booster Fans —Gases from Acetylene Lamps—Acetylene Dangers—Shaft Sinking —Stone Dust in Mines—Scientific Management	316
Coal Mining Notes, by Special Correspondents.	318
Iowa Mine Report	318
Examination Questions—	
Mine Firemen, Second Grade, Pennsylvania Bituminous, 1912—Colo- rado Mine Inspectors, 1911.	319
Airways with Circular Tops.	322
ORE MINING AND METALLURGY	
Mammoth System of Fume Control, by Al. H. Martin.	323
Foreign Mining Costumes, by C. L. Bryden.	324
Rockhouse of Quincy Mine, by T. C. Disoller.	325
Controlling the Direction of Bore Holes, by John I. Hoffman.	327
Pipe Ore, Secondary Limonite.	329
Manufacture of Acid Phosphate, by Strauss L. Lloyd.	329
North Mt. Lyell Mine Fire.	330
Driving a Tunnel in Japan, by Wm. L. Saunders.	331
Shaft Sinking Device.	332
Phosphate Ore Dressing, by Strauss L. Lloyd.	333
Practical Cyaniding—Part 6, by John Randall.	335
The Formation of Diamonds, by Leonard Keene Hirschberg.	339
Lake Superior and Cuban Iron Ores, by Day Allen Willey.	340
Berry Safety Catch.	342
New Mining Machinery—	
Storage Battery Electric Locomotives.	343
Trade Notices.	343
Catalogs Received.	344
Squibs—	
Drains, 301—Life of Treated Timbers, 310—Moisture in Coal, 318 —Freezing Process Shaft Sinking, 322—Deep Michigan Shafts, 325 —Minerals in Uruguay, 329—Fire Assay Reducer, 332—Disposition of Heat in Blast Furnace, 334—Combatting Ankylostomiasis in Italian Sulphur Mines, 339—Russian Gold, 342—Increase in Plati- num Production, 344—Chloral Hydrate as a Solvent.	344

OUR cover picture for this month shows a scene familiar to most of our readers. The cage, showing evidence of hard wear, is just about to be lowered down the shaft carrying with it the fire boss and miners to their day's work.

來 來

IN our Letter-Box department, a reader asks for information regarding the service rendered by "booster" fans. This is a matter of considerable importance to mine officials and we hope those of our readers who have had experience with them, or who have studied and investigated the subject will freely use the Letter-Box department to discuss it.

來 來

THE economic importance of a good light in mines has not long been recognized, and from ancient times the sputtering candle and smoky torch have held their place as illuminators without dispute. Recently, however, improved oil safety lamps and acetylene and electric hand lamps have been shown to result in increased output as well as greater comfort, safety, and economy, and it seems that the older lights must soon be superseded.

來 來

THE United States, while producing considerable silver in connection with copper and lead, has had very few strictly silver mines. According to the United States Geological Survey the silver production in 1911 amounted to 57,796,117 ounces, valued at \$31,787,866. During the year ending October, 1911, Cobalt, Can., produced 32,000,000 ounces, valued at \$16,500,000.

As the cheapness of gold is increasing, it naturally follows that the price of silver will rise, and this will set the prospectors to looking for more "Mollie Gibsons."

來 來

Rocky Mountain Coal Mining Institute

THE organization of the Rocky Mountain Coal Mining Institute by men who are in real earnest in their endeavors to make their own work and that of their subordinates more efficient, both in the matter of economical mining and in the safety of the mine workers, cannot be too highly indorsed. The Institute begins life vigorously and will undoubtedly prove beneficial in the influence it will exert on mining methods. The only criticism, MINES AND MINERALS can make, and it is made in all kindness, is that the annual dues of \$2 per year are too low.

The membership of the Rocky Mountain Coal Mining Institute is scattered over a very large territory with, in many cases, rather inconvenient and expensive transportation facilities. As a result it will be impossible for many members to regularly attend the meetings, and unless the papers presented at the meetings and the often important discussions are printed and promptly distributed among the members, the absentees will miss one of the principal benefits of the organization. The editing of the papers, the stenographic reports of the discussions, and the illustrating, printing and distributing of the transactions, require considerable money, more probably than the gross amount received as dues. This, of course, is a matter that can be easily remedied by the Institute, and we merely call attention to it, so that if action on the matter is required, those of our readers who are members, may realize that a reasonable increase in dues may be necessary, and if such is the case, they ought to favor the movement.



Electricity in Mines

WHILE the Special Rules for the Installation of Electricity embodied in the Pennsylvania Bituminous Mine Law of 1911 practically saddle factory rules on the coal-mine operator and add to the cost of production, there has been little if any complaint against them. The object of these rules is of course to decrease the number of accidents in mines due to the use of electricity, and their incorporation in the new law was timely, for 39 persons, or .26 per 1,000 employed in the bituminous coal mines of Pennsylvania in 1911, were killed by electricity. In England at no time have the fatal accidents from electricity in 1 year exceeded 1.54 per cent. of the total, while in the bituminous mines of Pennsylvania in 1911, practically 8 per cent. (39 out of 490) of the fatal accidents were due to this power. The use of electricity in mines is a problem by itself, for conditions are quite different from those prevailing in electrical generating stations, where most of the employes have considerable technical knowledge, and where maintenance and supervision are observed necessarily. Underground, the numerous opportunities for the disarrangement of cables, conductors, and machines offer dangers of shock and mechanical injury that do not appear in surface work. While electrical accidents on the surface are confined to one or two individuals, in the mine the danger of setting fire to gas or causing a mine fire which may endanger the lives of hundreds calls for rigid laws governing the use of this power.

Under these conditions it must be admitted that if electricity is carelessly installed or supervised so as to produce sparking, serious accidents may occur, and this more than justifies the enactment of special rules for the use of electricity in mines, rather than in other places. Quite a number of the rules seems almost too simple for insertion in a state code because in the course of the construction of an electric plant they must be observed; however, the installation must be carefully maintained to avoid accident.

The standard of underground electrical installations must be high and kept high by suitable supervision, but when it comes to deciding what rules should be made to prevent accidents, the entire list will become inoperative unless the miner is instructed in regard to the dangers liable to happen to him, and possibly others, provided he neglects to do his part.

The special rules relative to the use of electricity were proposed by the American Mining Congress for use in coal mines generally, and were adopted by the Commission whose duty it was to draft the new bituminous mine code prior to its enactment.

While the majority of coal operators take a proper view of their responsibilities, and the number of places where the installation of electricity is inherently dangerous is relatively few in this state, owing to the nearness of the coal to the surface, it is believed that the Inspectors should have the right to object to the use of electricity in certain places.

The experience and qualification of these men is such that it is unlikely any of them would recommend a matter which would entail expense merely to show authority, particularly when, if in the wrong, they would lose their case on appeal to the Director of the Bureau of Mines of Pennsylvania.



Mischievous Statements

THE following item clipped from the Philadelphia *Public Ledger*, of November 26, would be amusing if it was not untruthful and mischievous:

"The Rev. C. P. Futeher, who is conducting the Anthracite Social Service Mission of the Philadelphia Conference, with headquarters at Tamaqua, addressed the Methodist Preachers' Meeting in Wesley Hall yesterday upon his work among the immigrants.

"He said that agents of big companies induced them to leave their poor but neat homes in Europe by glowing promises of the prosperity that awaited them in America. In their ignorance some land in New York expecting to pick up gold in the streets. In the coal fields they find life the severest kind of drudgery, while they are compelled to live in miserable shanties.

"Speaking of the hard drinking of some of the foreign miners, Mr. Futeher quoted a mine superintendent, who declared that it was necessary, owing to the miners' diet. This consists of only one hot meal (a bowl of soup) daily. The rest of the day's menu consists of bread, without butter, a turnip and an onion."

Anthracite miners as a rule do not live under wretched conditions. Such a statement is an insult to thousands of anthracite mine workers. Those who live in hovels and squalor do so because it is the way they have lived for generations, and it is the cheapest way to live, from their standpoint, as it enables them either to save more money or have more to expend for "polinkey."

The implied statement that agents of big mining companies induced them to leave their "poor but neat homes

in Europe by glowing promises of the prosperity that awaited them in America," is an absolute falsehood. The only agents who induce immigration to the United States are steamship agents. The mining companies are not in that business even in the most indirect way. There isn't a mine official in the country who would employ these non-English speaking men if he could get English speaking mine workers. The time and money the large mining companies are expending in teaching these men English through mining institutes, night schools, etc., is in itself a refutation of the statements of the Rev. Mr. Fitcher.

The daily diet of the miners as given by that gentleman is also a misstatement. The anthracite mine workers are among the most prosperous wage earners in the country, and as a rule they purchase more and probably better food stuff than does the reverend gentleman who, for the sake of notoriety, or possibly an appropriation from the Methodist Conference, makes false statements regarding them.

It is such deliberate misstatements made by some few ministers that cause many men to wrongly judge those who tell the truth and paint conditions in true colors.

來 來

Substantial Sympathy

FOR many years it has been a custom at coal mines to suspend operations on the day of the funeral of a man killed by accident in the mine. Naturally, in the case of large mines especially, but comparatively few of the employes who were personal friends of the deceased attended the funeral. The result was considerable loss to the operating company and the mine workers, and no benefit, except an intangible sentimental benefit, accrued to the family of the deceased.

A commendable innovation was recently made by the employes of the Philadelphia & Reading Coal and Iron Co., at the Locust Gap colliery, at Locust Gap, Pa.

Instead of suspending work on the day of the funeral, entailing a loss of about \$5,400 in wages for the employes, numbering about 1,800, they decided to remain at work, and to contribute 25 cents each to a fund for the benefit of the widow, thus giving her the substantial sum of \$450 and saving themselves an aggregate of over \$5,000. In this movement every employe including the officials joined, and the sympathy expressed in this substantial way was infinitely more practical than the old kind.

It is true that this plan has been in force at a few industrial establishments, and possibly at some mines, but it has been far from general. It is a plan that should be adopted at every colliery, and the amount each individual contributes should be such a sum as will be of material advantage to the widows and orphans. Regardless of any other remuneration which the widows and orphans of mine workers may receive, either through benefits, insurance, or other sources, when their wage earner is killed, a few hundred dollars contributed by the victim's fellow workmen is always acceptable and of real help.

The Fire Boss and Mine Accidents

ACCIDENTS will occur in coal mines as long as the human element, is involved in the industry. There are some accidents which cannot be prevented by any precautionary measure, but they are few. The greater number of the accidents are due to the carelessness of some one or a violation of mine rules.

The mine foreman is the official generally supposed to see that mine rules are enforced. His duties, however, are such that in an extensive mine he can only give general and occasional or cursory attention to matters other than the production of coal. He must, in a large measure, depend on the fire boss in the regulation of the actions of the individual employes. The very nature of the fire boss' duties stamps his office as the one that has most to do with the safety of the employes.

In most cases the fire bosses are capable men, but as the most capable fire bosses are from time to time promoted to foremanships there is frequently trouble to get men to take their places. In almost every field the fire boss must pass an examination to prove his qualification for the position. In some instances he must pass the same examination as do the assistant foremen. Miners capable of passing the required examination, and possessing the executive ability to enforce discipline, are usually men who can earn more as miners than as fire bosses, and besides they do not have to work the unseasonable and often long shifts required of fire bosses. Therefore they do not look on a position as fire boss with much favor. Its only advantage is that it is a stepping stone to possible promotion to an assistant foremanship or a foremanship.

In a recent conversation a State Mine Inspector said: "Many accidents in mines can be prevented by the fire bosses. They naturally visit each working place daily and are supposed to notice all other elements of danger to the men as well as the presence of gas. Under the mine foreman, the fire boss should have authority to require miners to promptly set necessary props, to use more caution in regard to the stability of the top coal, and to strictly enforce the mine rules under penalty of discharge for the violator. Naturally, a fire boss to do this must not only be a careful man himself, but he must possess technical knowledge and the executive ability and force necessary to secure prompt and full compliance to his orders. Such men, as fire bosses, are scarce. They are growing scarcer every year. There is but one remedy as I see it. The position of fire boss must be made more remunerative. The incumbent of the position must be paid a salary larger than the amount he can earn as a miner in shorter hours and with no responsibility other than his own safety. The position must be made more attractive to first-class men. Such men can do a great deal to lessen the number of accidents, and in my opinion no greater movement toward decreasing the number of mine accidents can be made than the employment of the best possible men as fire bosses at salaries that will warrant their accepting the positions."

Book Review

COAL. By E. E. Somermeier, Professor of Metallurgy, Ohio State University. McGraw-Hill Book Co. Price, \$2 net.

In this book Professor Somermeier has given a concise yet comprehensive statement of the various aspects of coal. He has not only concerned himself with the chemical composition of coal and its determination by analysis; but has included chapters upon the improvement of coal by washing, and the purchase of coal under specifications. The material in this book is all new, having been gathered by the author. The contents are divided into 12 chapters as follows: Composition and Heating Value; Chemical Analysis of Coal; Sampling; Methods of Analysis; Determining the Calorific Value; Summary of Chemical Determinations; Improvements of Coal by Washing; Purchase of Coal Under Specifications; Flue Gas Analysis; Analytical Tables. There are 175, 6×9 pages in the book, including index, and no padding. In the preparation and arrangement of the book, Mr. Somermeier has kept in mind the mechanical and power-plant engineer; the chemical engineer, and chemist; and the non-technically trained business man and operator, who has to do with the buying and selling of coal. He advises the reader to pass over any discussion that is too technical or elementary for his needs and select whatever may be of interest and use. Unfortunately the business man who purchases and the man who sells coal are bound to be mystified, if they are unable to understand the text, which on this subject depends largely on theory and technical formulas.

THE METALLURGY OF IRON AND STEEL, by Bradley Stoughton, Ph.B., B. S. McGraw-Hill Book Co., publishers. Price, \$3 net. This is a second edition of Professor Stoughton's authoritative book upon the metallurgy of iron. The subject matter of the first edition has been so thoroughly revised and added to, that this edition is practically a new book. Professor Stoughton is an authority upon iron metallurgy and has brought his book up to date, the first edition being published 3 years ago. The advances have been so great in this time that a new volume was needed.

SMOLEY'S PARALLEL TABLES OF LOGARITHMS AND SQUARES, seventh edition, has just been published by the McGraw-Hill Book Co. Besides the tables of the previous editions which made the book so well known, this edition has two new features that

will further enhance its value. The first is a diagram that enables the designer to obtain at a glance any side of a right triangle when the other two sides are given. Results may be obtained directly to eighths, and estimated with close accuracy to sixteenths. In cases where greater exactness is required, the second added feature of the book may be used. This is an additional table, giving in parallel columns logarithms and squares of linear dimensions up to 16 inches, by intervals of a sixty-fourth of an inch. These two additions will increase still more the reputation of the book as a time saver. In these days of rush and hurry, tables like these are a real asset to an engineer in calculating dimensions in feet and inches and for many similar purposes.

AN EXTENSION OF THE DEWEY DECIMAL SYSTEM OF CLASSIFICATION APPLIED TO THE ENGINEERING INDUSTRIES, by L. P. Breckenridge and G. A. Goodenough, was originally issued as Bulletin No. 9 of the Engineering Experiment Station of the University of Illinois, in 1906. The filing and classification of engineering data has become a matter of much importance, and this bulletin was prepared for use as a guide in carrying out such work. The original edition of Bulletin No. 9 was subject to the usual gratuitous distribution, and the subsequent demands were such that a second edition was printed and ultimately distributed. Altogether 20,000 copies were sent out. The demand having continued, it was finally decided again to revise and to print a limited edition. This has now been accomplished and the revised bulletin, much extended as compared with the original edition, is ready for distribution. It presents subdivisions of subjects in such detail as to constitute a complete classification for most engineering industries, even though they are highly specialized. The revision has been made in accordance with the 1911 edition of "Decimal Classification" by Melvil Dewey.

The revised edition of Bulletin No. 9 will not be subject to gratuitous distribution. A copy will be sent postpaid upon the receipt of 50 cents. Address: W. F. M. Goss, University of Illinois, Urbana, Ill.

ELECTRICAL TRADES DIRECTORY AND HANDBOOK, published by "The Electrician," Salisbury Court, Fleet Street, London, E. C., England. The new annual edition will be ready in January, 1913. This is a very complete directory of engineers, supply firms, manufacturers, etc., connected

with electrical business throughout the world. Price, prepaid, in the United States, 18s. 6d.

Personal

George Porter, of Uniontown, Pa., has been appointed bridge constructing engineer for Fayette County, Pa., and Messrs. Chaney and Armstrong have been appointed bridge constructing engineers for Washington County, Pa.

George Watkin Evans, Mining Engineer and Geologist, of Seattle, Wash., was appointed by the Governor to represent the Commonwealth of Washington at the meeting of the American Mining Congress. He also represented MINES AND MINERALS.

George S. Barton, civil and mining engineer of Pittsburg, Pa., is engineer for the George M. Jones Co., of Toledo, Ohio, who are to develop large tracts of coal land near Bellaire, Belmont County, Ohio.

George M. Colvocoresses has opened an office at 43 Exchange Place, New York City, for the practice of consulting mining and metallurgical engineering. He is also prepared to advise on the development, management, and operation of mines and to value and report on mining properties.

William D. Waltman, civil engineer, for 5 years on the Panama Canal construction as general superintendent, and for the past 2 years with the Costilla Estates Development Co., at San Acacio, Colo., as chief engineer, has resigned the latter position and is now general manager of the Franco-Wyoming Oil Co., at Casper, Wyo.

W. E. Hamilton, 17 Deshler Building, Columbus, Ohio, is now an Ohio Correspondent for MINES AND MINERALS. He will write on important new developments, descriptions of new methods of production and handling output at mines. He would be pleased to receive any news concerning coal mines. Bell phone 7735 Main.

Robert L. Streeter, of the Department of Mechanical Engineering, Rensselaer Polytechnic Institute, Troy, N. Y., is writing a series of articles for the *Engineering Magazine*.

W. B. Powell has been appointed in charge of the Canadian government mine rescue station at Lethbridge, Canada.

William Brown Dickson was elected President of the International Steam Pump Co., on November 19, 1912. He succeeded the late Benjamin Guggenheim, who went down on the "Titanic."

COAL MINING & PREPARATION

Washery at Soddy Mine, Tennessee

THE Durham Coal and Iron Co., of Chattanooga, Tenn., was organized to purchase several coal companies in Tennessee and Georgia, the largest acreage of which is along Walden's Ridge, from 20 to 35 miles from Chattanooga, north,

A Plant for Cleaning Coal from Different Mines Each Containing Impurities Peculiar to Itself

*By Frank E. Mueller**

being produced from the slack and some nut. The lump and egg are marketed as domestic coal.

The coal from the Soddy mine

and it was due to market conditions and the need for a lower ash coke that the new company decided to build a modern tippie for preparing more sizes of steam and domestic coal and to install a more efficient washer to better the quality of the coke.

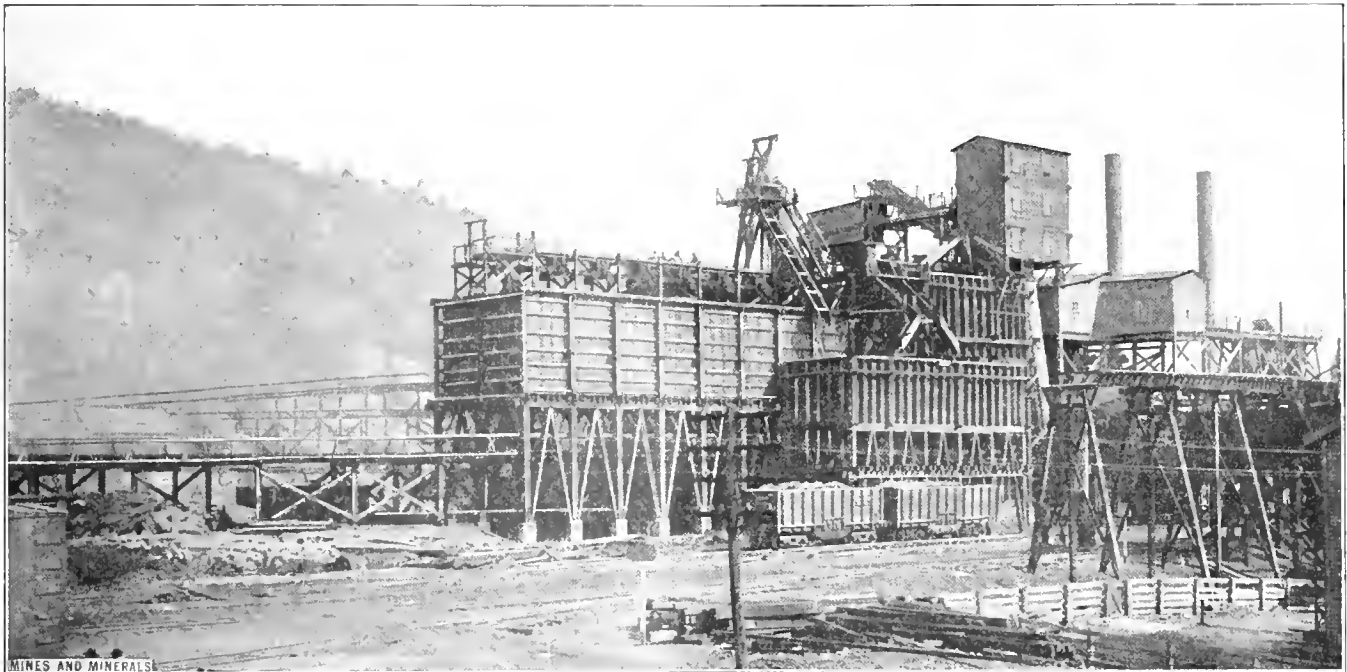

FIG. 1. COAL WASHING PLANT, SODDY MINE, RATHBURN, TENN.

along the line of the Cincinnati, New Orleans & Texas Pacific Railway.

The Soddy mine, at the town of Rathburn, is one of the oldest coal mines in the state, and is well known from the "Soddy coal" which bears its name. Here the No. 7, or Soddy seam, is opened about 1½ miles from the railroad and at an elevation of 1,270 feet above sea level. This coal averages 27 inches in thickness and runs fairly uniform. It is hard and is shot from the solid, and the impurities which give trouble in making coke come from the top and bottom and are composed of fireclay, slate, and a bony rash. Such impurities, however, are found chiefly in the nut and slack coal produced and are easily separated in washing, coke

prior to the time of the building of the new plant, was prepared over an old and inefficient tippie and washer;

The Soddy tippie receives Soddy coal only, but the washing plant treats not only the nut and slack from Soddy mine, but the nut and slack from other mines of the company.

At Chamberlain Siding, near Rathburn, the No. 7 seam is also worked at Big Soddy mine, the opening being 1 mile from the railroad and at an elevation of 1,240 feet above sea level. It averages 32 inches in thickness and is irregular, this coal being hand mined and shot from the solid. The impurities are chiefly a draw slate 8 inches thick that comes down with the coal and gives difficulty in separation.

The No. 2, or Nelson seam, is mined at Sale Creek, Tenn., about 1½ miles from the main line, the

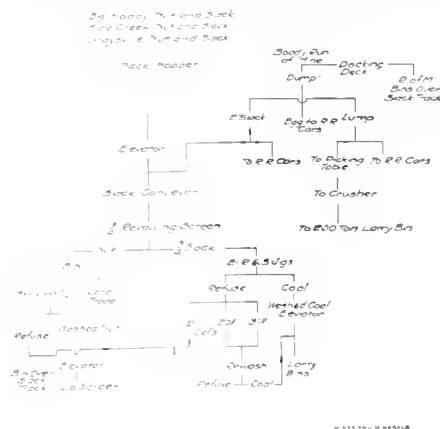

FIG. 2. FLOW SHEET, SODDY WASHER

*Contract Manager, Roberts & Schaefer Co.

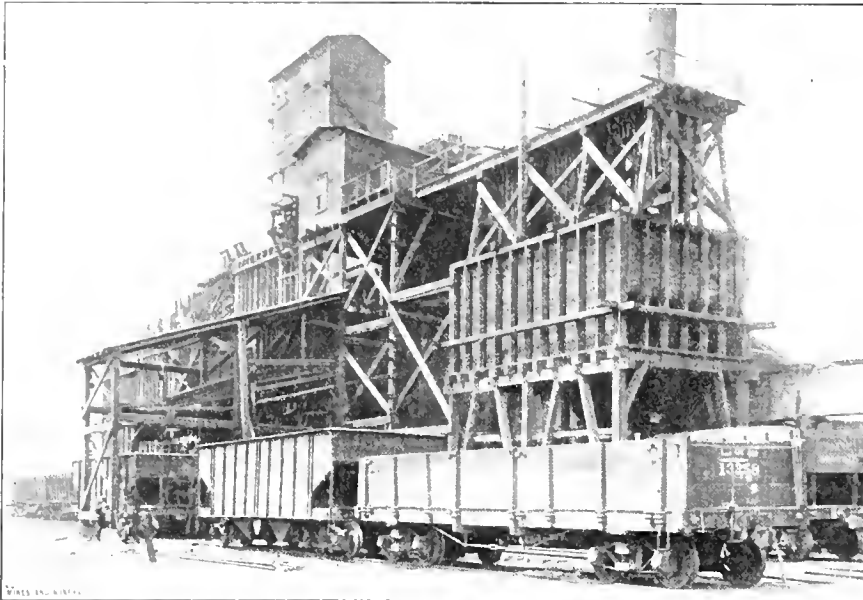

FIG. 3. SCREENS AND LOADING CHUTES, SODDY MINE

elevation above sea level being 790 feet. This coal averages 42 inches in thickness and runs fairly uniform. The seam carries two bands of bone, each being about $1\frac{3}{4}$ inches thick, and difficult to separate from the coal, as the specific gravities are about the same. These bands occur in regular formation at about 12 inches and 30 inches from the top. The coal is undercut and also shot from the solid. The bone is the principal impurity in the seam, but slate and fireclay appear in smaller proportions.

At Graysville, Tenn., the No. 5, or Richland, seam is mined. The opening is about 3 miles from the main line of the railroad and at an elevation of 1,250 feet. The coal averages 30 inches in thickness and is irregular. It is friable and is hand mined. The principal impurity is a black rash that has never shown any regularity in formation, and a shot in a clean face of coal may bring out a pocket of this rash. It is sometimes found on the bottom and again at the top of the coal; yet, again, it will show running diagonally through the face of the coal. Its specific gravity is close to that of the coal, and hence gives difficulty in separation. Top slate is also to be found, but not in sufficient quantities to give any trouble in washing.

As all of the nut and slack coal from the mines mentioned was to be transported to the Soddy washer for coke making, great care was exercised in designing a washing plant to meet the varying conditions imposed, as Soddy nut and slack coal might be coming into the plant from the tippie at all times during the working day, and at the same time nut and slack coal from either Big

Soddy, Sale Creek, or Graysville would be unloading and sent through the washer. As this condition could not be met in the old tippie and washer, the company decided to build an entirely new plant to meet the varying conditions of washing, and to improve the Soddy tippie as well. This task was intrusted to the Roberts & Schaefer Co., of Chicago.

A careful investigation of the old methods of washing in use by the Durham Coal and Iron Co. was made, together with analyses of the nut and slack coals from the Soddy and Sale Creek mines, which would constitute the bulk of coal going through the plant. It was found that the No. 7, or Soddy, seam would give no trouble, but in order to make a good separation of the Nelson and Richland coals

from the impurities, the jigs should be so designed as to retain the coal in suspension a sufficient time to permit, with the proper pulsation, the separation of the coal and rash. To this end a new jig was designed. It was also found advisable to wash the nut and slack coals separately, not only on account of market conditions and the simplifying of the plant, but for effectiveness in washing.

Description of Plant.—The coal from Soddy mine is let down to the tippie in trips of 20 cars on to the loaded track, where they are uncoupled and run by gravity to the foot of a car haul which delivers them to the dump room. If a car looks as if it had been loaded with dirty coal, it is switched off to a track at the left, which leads to run-of-mine storage bins and over the bins. This car is then carefully examined, the amount of rock ascertained, and the miner docked accordingly, after which the coal drops below into the bin, from which it can be shipped as run of mine or it can be delivered into the boiler house through proper chutes. From the head of the car haul the cars pass over a cross-over dump, the empties returning by gravity to be made into trips preparatory to returning to the mine.

The coal is discharged from mine cars into a weigh basket, which in turn discharges the coal on to a pair of roller shaker screens, the plates of which are perforated and rolled corrugated to facilitate the screening of the coal. The chutes shown in Fig. 1 are arranged to screen and load lump, egg, and coal screenings on three tracks. Or, the screenings—that is coal passing through 2-inch

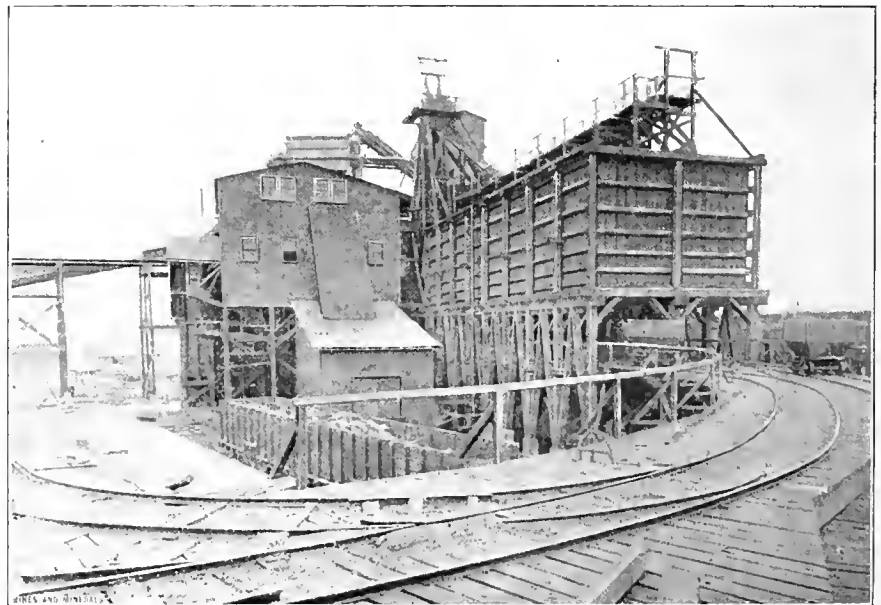

FIG. 4. END VIEW OF SODDY PLANT, SHOWING SLACK BINS, ENGINE ROOM AND WASHER BUILDING

diameter holes—can be delivered direct to the elevator of the washer. The screens are also arranged so that a portion of the lump and egg coal can be diverted to a picking table from which the small amount of impurities can be removed by hand and the clean coal delivered to a Williams crusher. In the latter case, the coal is raised by a separate elevator to a 200-ton larry bin for making a special grade of low-ash coke. This coal without washing will analyze as low as 5 per cent. ash.

The nut and slack coal from the other mines is delivered to the washery in hopper-bottom railroad cars, and a receiving hopper has been provided under the slack track of the tippie. From this hopper the coal is fed into the same elevator that raises the nut and slack from the tippie screens to a flight conveyer, which delivers it to a revolving screen fitted with $\frac{3}{4}$ -inch perforations. This screen separates the slack from the nut in order that each may be washed separately.

The nut coal is delivered from the discharge of the revolving screen by means of the chutes and telegraphs into a bin of about 25 tons capacity, which also serves as a local-trade bin. From this bin the nut coal to be cleaned is fed automatically into a Stewart jig, having a capacity of 25 tons per hour. The washed coal from the jig is sluiced to the nut-coal elevator tank, and raised from the water to lip screens located over the nut-coal bins shown in Figs. 1 and 4, and which serve the purpose of removing breakage caused by washing and handling. From the lip screens the nut coal is lowered into a storage bin of 100 tons capacity by telegraphs.

The refuse from the Stewart jig is sluiced to the final refuse tank from which it is elevated in a perforated bucket elevator to a 10-ton bin.

The coal which passes through the $\frac{3}{4}$ -inch perforations of the revolving screen is discharged into storage bins, from which it is fed regularly to two Roberts & Schaefer Co. jigs, consisting of three compartments each with a total jiggling surface of 126 square feet and having a capacity of 25 tons per hour. The coal fed into the first compartment is given a preliminary wash, after which it is sluiced to a second compartment wherein it is again washed, after which it is sluiced to the third compartment of the jig, where the final separation of rock and coal is completed.

Each jig compartment is independent of the other in order to

facilitate repairs, and should any one of the three be out of commission, the other two can temporarily handle the product. All three plungers are arranged to impart different lengthed strokes at different speeds from one another, and all shafting is overhead,

hand. An examination of the following analyses will show the results accomplished by this successful washing.

Average analysis of the Sale Creek, Graysville, and Soddy coals mixed, for month of October, 1912, was:

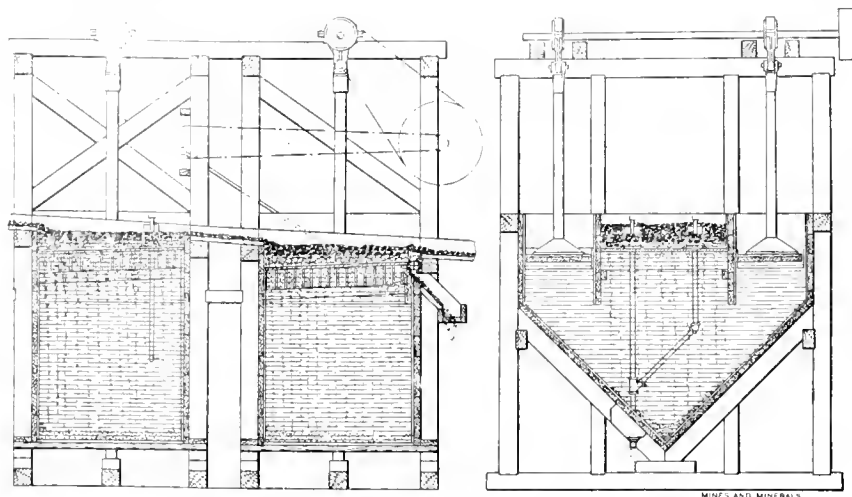

FIG. 5. SECTIONS SHOWING TWO COMPARTMENTS OF ROBERTS & SCHAEFER CO.'S JIGS

so that the operator has an unobstructed passageway to view the jig parts. Each jig compartment is provided with adjustable refuse valves, so graduated that the first cell takes out the bulk of the refuse, which, with the hutch product from jig screens, is sluiced to the final refuse elevator. The refuse from the second and third compartments, together with hutch products, can be delivered to an independent set of rewashing jigs or can be rehandled on the same jigs, this depending upon the percentage of ash desired in the coke.

The washed product from the Roberts & Schaefer jigs is sluiced to the washed-coal tank from which it is elevated to a distributing conveyer located over the 800-ton slack bins, Fig. 4, or to a 100-ton bin located over the slack track, for shipment.

Provision is made to mix the washed nut coal with the washed slack whenever desired. Settling tanks for the recovery of the fine sludge and refuse have been provided, this sludge and refuse being returned to the jigs and the washed product mixed with washed slack coal; or with the minor additions to plant it can be used with the product from the rewashing jigs as boiler fuel.

It is worthy of note that the change from the old tippie and washer to the new plant was made without a single day's delay to the Soddy mine. The washer usually starts at 5 or 6 o'clock A. M. and continues throughout the day until 6 or 7 P. M., all depending on the amount of foreign coal on

Unwashed mixed $\frac{3}{4}$ -inch slack coals, 20.25 per cent. ash; washed coal (final), 10.62 per cent. ash; refuse final, including nut refuse, 55.10 per cent. ash; unwashed nut coal, 19.35 per cent. ash; washed nut coal, 9.45 per cent. ash; refuse nut coal, 63.08 per cent. ash; coke, 15.12 per cent. ash.

Percentage of rejections approximately 23 per cent. Refuse has averaged during month 3.96 per cent. float on a 1.45 specific-gravity solution, having given an ash analysis of 10.48.

As a comparison it may be of interest to give some analyses made, upon which selection of the types of jigs were based:

SODDY NUT ABOVE $\frac{1}{2}$ INCH		
	Per Cent.	Ash
Float 1.45 specific gravity.....	77	6.80
Sink 1.45 specific gravity.....	23	67.20
	100	
SODDY SLACK BELOW $\frac{1}{2}$ INCH		
Float 1.45 specific gravity.....	82	7.68
Sink 1.45 specific gravity.....	12	62.85
	100	
SALE CREEK NUT ABOVE $\frac{1}{2}$ INCH		
Float 1.45 specific gravity.....	61	9.11
Sink 1.45 specific gravity.....	39	57.00
	100	
SLACK BELOW $\frac{1}{2}$ INCH		
Float 1.45 specific gravity.....	75	9.80
Sink 1.45 specific gravity.....	25	57.50
	100	

Allowing for errors in sampling, variation in size of coal, and changes in mining conditions, the above results are exceptionally good and are indicative of the thorough manner in which the management of the Durham Coal and Iron Co. investigate and care for all their plants.

THE Rocky Mountain Coal Mining

Institute, with a charter membership of 250 representative men engaged in coal mining in Colorado, Wyoming, Utah, and New Mexico, was organized in the hall of the House of Representatives in the Colorado State Capitol, Denver, November 13.

The membership comprises men engaged in coal mining in all capacities from miners to mine owners and managers. The meeting occupied the whole day, and at its adjournment the Institute was on a firm basis with a definite policy established and with particularly able, and greatly interested men as officers. E. H. Weitzel, manager of the Fuel Department of the Colorado Fuel and Iron Co., was unanimously chosen as the Institute's first president. Under the rules adopted, four vice-presidents, one from each of the four states, were elected. They are: for Colorado, W. J. Murray, Vice-President and General Manager of the Victor American Fuel Co., Denver; for Utah, W. B. Williams, General Manager of the Utah Fuel Co., Salt Lake City; for New Mexico, T. H. O'Brien, General Manager of the Stag Cañon Fuel Co., Dawson; for Wyoming, Frank A. Manley, General Manager of the Union Pacific Coal Co., Omaha.

An executive committee of thirteen members consisting of the president, four vice-presidents, and two members from each state, was provided for in the rules. The members named, other than the officers were: For Colorado, John P. Thomas, of Glenwood, and C. W. Babcock, of Denver; for Utah, F. N. Cameron, of Salt Lake City, and J. E. Pettit, of Coalville; for New Mexico, D. H. Summerville, of Gibson, and Alan French, of Raton; for Wyoming, P. J. Quealy, of Kemmerer, and H. C. Campbell, of Rock Springs. F. W. Whiteside, of Denver, was chosen as Secretary-Treasurer. The annual dues for members were fixed at \$2 per year.

Meetings will be held in June and November of each year, the places of meeting being points in each of the four states in rotation. The next meeting, in June, 1913, will be held in Salt Lake City; the November, 1913, meeting will be in Albuquerque, N. Mex., and the June, 1914, meeting will be in Cheyenne, and the next meeting in Denver.

Coal Mining Institutes

Rocky Mountain Coal Mining Institute—Meetings of the West Virginia and Kentucky Institutes

By Special Correspondents

The purpose of the institute is for the exchange of ideas and discussion of methods that will tend to safety and economy in coal mining operations.

That the institute will in time be productive of excellent results is assured by the class of men directing its work and the general character of its membership. It begins life under most encouraging circumstances, has the active support of the leading men in the coal industry in the territory it covers, and has a fertile field in which to carry on its work. In its membership are many men of more than ordinary mining ability, and their cooperation in the work of gathering and disseminating details of best methods of meeting the mining conditions of the Rocky Mountain coal fields will be productive, not only of greater economy in operation, but of increased safety of the mine workers. That the necessity for such an institute is a real one, is evidenced by the fact that each of the four states represented in the organization has had higher death rates from accidents in mines than almost any other coal producing state. In fact, but two other states show as high death rates as any one of the four Rocky Mountain states.

WEST VIRGINIA MINING INSTITUTE

From the point of numbers and enthusiasm the 12th annual meeting of the West Virginia Mining Institute was the most successful so far held. The meeting was held at Parkersburg, W. Va., December 10 and 11, 1912. Frank S. Smith, President of the Parkersburg Board of Commerce, delivered a felicitous address in which he welcomed the visiting delegates to the city. Neil Robinson, E. M., of Charleston, and J. C. McKinley, of Wheeling, accepted the hospitality of Parkersburg on behalf of the visiting members. President Frank Haas then delivered his address, and the election of officers for the ensuing year followed. They were as follows:

Mr. Neil Robinson, of Charleston, president; Prof. E. W. Zern, of Morgantown, secretary-treasurer. Vice-Presidents were moved up one notch: George T. Watson, first vice-president; John Laing, Charles-

ton, second vice-president; R. S. Ord, Elkhorn, third vice-president; J. F. Healy, Elkins, fourth vice-president; J. C. McKinley, Wheeling,

fifth vice-president. Executive Committee, Lee Ott, of Thomas; Prof. C. R. Jones, Morgantown; J. J. Lincoln, Elkhorn; Daniel Howard, Clarksburg.

Frank Haas, consulting engineer, of the Consolidation Coal Co., Fairmont, W. Va., next delivered an address on "Conservation in West Virginia," in which he made some remarks not complimentary to the United States Bureau of Mines.

In the evening session Mr. J. C. Gaskill presented a paper on "Common Sense Mine Ventilation for Saving Horse Power in Operation of Mine Fans." A number of practical points were brought out and discussed.

J. E. Beebe, M. D., delivered an address on the "Value of Organization," and as a psychological demonstration said: "I have something in my pocket I have never seen, you have never seen, and none of us will ever see again." He then produced a peanut, broke the shell and ate the nut. Having got the audience's attention he gave a short talk with verbal illustrations on what organization had accomplished in the coal business and what organizations such as the West Virginia Institute were accomplishing for the technical end of coal mining. He was followed by W. W. Slocum who explained the Westinghouse plant in East Pittsburg by lantern slides. Interior views of the shops gave an insight to the immense electrical factories, and a general idea of the sociological end of the business was shown by interior views of the Casino and first-aid hospital.

The next paper taken up on the following morning was that of Prof. C. R. Jones on "The Progress Made by the Department of Mining Engineering at University of West Virginia." The paper developed a side issue which was debated pro and con to such an extent that the outcome was referred to a committee who should draft a resolution to be presented to the present legislature requesting an appropriation in behalf of the State Mining School.

Illinois has a large appropriation, West Virginia has almost nothing, while the latter state produces more coal, and in fact the entire state depends upon the mining industry. The suggestion that the operators pay

a tonnage tax to support the University mining department, as they would be the ones benefited, is so small and narrow-minded that the writer could hardly realize the point was raised in good faith.

Mr. Josiah Kealey, of Fairmont, presented a paper on "The New Loader." G. A. Burrell, Bureau of Mines, presented a paper, "Notes on Some Mine Gas Problems." Mr. H. A. Williamson of the engineering department of the Consolidation Coal Co., Fairmont, W. Va., read a paper on the "Relation of Forestry to Coal Mining." The last paper was by Sim Reynolds, inspector for the Hartford Insurance Co., defending the Bureau of Mines from Hogan's attacks.

On Tuesday evening after the meeting a large number of the members were entertained at the Elks Club by Lew Fields' Minstrel Troupe.

On Wednesday evening the Parkersburg Board of Commerce entertained the members at a banquet and smoker. This meeting will long be remembered although a number of familiar faces were absent.

KENTUCKY MINING INSTITUTE

The Kentucky Mining Institute held its winter meeting at Lexington, Ky., December 9, 1912, at which the following papers were read:

"The Relative Hazard of All Vocations in Relation to Mining," by Hywel Davies, Louisville, Ky. Mr. Davies' paper will attract attention, and possibly precipitate some discussion. It will appear in the February MINES AND MINERALS, and the columns of the journal will be open for its discussion.

A paper on "First-Aid Work," was read by W. L. Moss, general manager Continental Coal Co., Pineville, Ky.

At this meeting a plan was inaugurated to hold a State First-Aid Contest in May. A number of teams were pledged to enter the contest, and the Goodman Mfg. Co., of Chicago, has offered a handsome silver cup as first prize.

J. D. Rodgers, Superintendent of Mines, Miller's Creek Division of the Consolidation Coal Co., read a paper on "Preparation of Domestic Coal." Dr. J. D. Pryor, Professor of Anatomy and Physiology, read a paper on "Hookworm Disease," which is a classic and will appear in February MINES AND MINERALS. H. La Viers, Manager North East Coal Co., Paintsville, Ky., read a snappy paper on "The Successful Mine Foreman From Four View Points."

The following is a list of those who registered at the College of Mines and Metallurgy, State University: Hon. Henry S. Barker, President State University, Lexington, Ky.; T. J. Barr, Assistant Inspector of Mines, Lexington, Ky.; S. L. Bastin, Manager Star Coal Co., East Bernstadt, Ky.; Wm. S. Canning, Resident Engineer, Lect-Maupin Engineering Co., Jackson, Ky.; P. V. Cole, Assistant Inspector of Mines, Barbourville, Ky.; C. R. Conner, Engineer, Cunningham & Conner, Consulting Engineers, Huntington, W. Va.-Ashland, Ky.; H. G. Boumer, Westinghouse Electric and Mfg. Co., Louisville, Ky.; W. H. Cunningham, Cunningham & Conner, Consulting Engineers, Ashland, Ky.; Hywel Davies, President Mine Owners' Association of Kentucky, Louisville, Ky.; C. F. Frasset, Manager of Mines, Taylor & Williams Coal Co., Beaver Dam, Ky.; Thomas Gower, 152 Ohio Ave., Latonia Station, Covington, Ky.; J. Henry Hall, Manager Bastin Coal Co., Idamay, Ky.; Walter F. Hanley, 232 W. 3d St., Maysville, Ky.; B. M. Horndon, Georgetown, Ky.; W. E. Hobson, Frankfort, Ky.; George M. Humble, Engineer, Stearns Coal and Lumber Co., Stearns, Ky.; B. R. Hutchcraft, Mining Engineer, Hernando Bldg., Lexington, Ky.; H. La Viers, Manager North East Coal Co., Paintsville, Ky.; A. R. Long, Manager Ohio Valley Coal and Mining Co., De Koven, Ky.; Wilbert A. Miller, District Manager, Goodman Mfg. Co., Chicago; W. L. Moss, Vice-President and General Manager, Continental Coal Corporation, Pineville, Ky.; M. O. McKenny, General Electric Co., Madisonville, Ky.; Henry L. Noel, 252 Foote Ave., Bellview, Newport, Ky.; C. J. Norwood, Chief Inspector of Mines, Lexington, Ky.; Dr. A. M. Peter, Kentucky Experiment Station, Lexington, Ky.; J. W. Pryor, M. D., Professor Anatomy and Physiology, State University, Lexington, Ky.; R. D. Quickel, Fuel Agent, Q. & C. Route, Lexington, Ky.; Frank D. Rash, Vice-President and General Manager, St. Bernard Mining Co., Earlington, Ky.; J. D. Rodgers, Superintendent of Mines, Millers Creek Division, Continental Coal Corporation, Van Lear, Ky.; A. D. Schoenseigel, 420 Fairfield Ave., Bellview, Ky.; Oliver S. Smith, 26 W. Robbins St., Covington, Ky.; C. W. Taylor, Vice-President and General Manager, W. G. Duncan Coal Co., Greenville, Ky.; H. E. Taylor, Mining Engineer, Williamsburg, Ky.; W. C. Tucker, General Superintendent, Wisconsin

Steel Co., Benham, Ky.; David Victor, Chief Mine Inspector, Consolidation Coal Co., West Virginia and Kentucky, Van Lear, Ky.; H. M. Wilson, United States Bureau of Mines, Pittsburg, Pa.; R. M. Woodson, Kuttawa, Ky.

來 來

Hogan on B. T. U.

Say, Hogan, I've been radin' about British thermal units in coal. Wid all my work in the mines I've niver seen wan of thim to know it. D'ye know phwat they are?

Well, Reilly, I'm not surprised that ye're not acquainted wid thim. 'Tis wan thing to mine coal an' another thing to know phat's in id. 'Tis only racintly that I



HOGAN

knew there were such things as British thermal units in coal, 'an whin I heard iv thim I thried to find out phat they were from a book. Begorra, whin I read phat they were, described be some high brow, I didn't know anny more than befor. I have the book here in the house an' I'd lave ye rade it, if it wud do anny good, but I know you won't understhand it anny better than I did mesel. But you know, Reilly, there are many things in books we can't understhand, an' that's not sayin' the books are wrong an' iv no use. Some min can tell ye about phwat's in coal in a way ye can't understhand an' another will tell ye the same in a way ye can understhand. Whin I found that phwat the book said about thermal units wuz too dape for the little larnin' I had, I wint to see Father McGovern an' axed him could he tell me phwat they were. Says he, Hogan, 'tis a reasonable question ye're askin' me, an' wid a bit iv a twinkle in his eyes he said, though offhand I can tell ye more about the hate that some will feel if they don't mind their ways, mebbe iv I saw the book, tellin' phwat British thermal units are, I can exsplain thim to ye. I had the book wid me, an' I showed him the place. Whin he read it, he said 'twas no wonder I didn't understhand it. He thought a little while an' thin tould me that coal, like iverything else, wuz med up iv iliments, which be the same token, Reilly, are the only things that are not thimselves med up iv other things. To find out phwat ilimints

are in coal an' how much of aich ilimint is in id is the wurrk iv a chimist. "All coal is not the same, as you well know, Hogan," sez he. "There's hard coal, an' soft coal, an' coal bechune the two, an' coal that is naither wan nor the other, like the lignite they have in some parts of the country. Aich kind iv coal has some ilimints in it that projuce hate, an' some ilimints in it that are no good at all, at all, for making hate. They make the ash. All hard coal is not alike, naither is all soft coal or all lignite. Some has more hate projucin' ilimints an' less ash makin' ilimints than others, an' some has ilimints in it that makes clinkers and some has not. Now, sez he, the ilimints that projuce hate determine the number of British thermal units in the coal. The more hate projucin' ilimints in the coal the more thermal units."

Now, Reilly, it's plain to ye, isn't it? The hatin' quality iv coal is missed by the thermal units in it, and the name British Thermal Units wuz give thim becase 'twas Englishmin that diskivered thim, an' that's a pity. I'd be betther satisfied if they were called Irish Thermal Units, or aven American Thermal Units, an' I don't see fwhy they're called out iv their name when they're in American coal.

But Reilly, aven whin we admit that hate units in coal are nicissary, I don't take anny sthock in this new fangled idea iv buyin' an' sellin' coal be the thermal units only, aven if the government does it and thereby sets a bad example fer others. Av coorse whin you buy a ton iv coal, or whin I buy it, we don't buy it be the thermal units. We buy coal an' lave it go at that, if there's not too much shlate or bone in it. If there is, we raise a hullabaloo, an' that's all the good it does us.

But it's the min that buy many tons iv coal ivery year for sthame purposes that are buyin' it be thermal units, an' I don't think much iv the plan. If they'd buy it be the thermal units they cud get out iv it, there'd be more sinse in it. It's wan thing to find hate units in the chimist's laboratory an' it's another thing to make the same hate units do their work. The lads in the laboratory, that wear eyeglasses, smoke cigarettes, an' use the sink for a quare purpose, can find hate units in coal aisier than the lads in overalls fer-nist the bilers can get them out. Begorra, I think the brain units in a fireman are as nicissary as hate units in coal to make sthame an' kape the prissure showin' right in the gauge.

There's some coal that has a lot iv hate units in it, but it's the Devil's own sthuff to fire wid. Besides the hate units, it has other things in it that make clinkers the size iv the firebox. Av coorse all coals high in hate units are not that way, but some av thim are. Thin there's some coal that don't clinker that hasn't as many hate units as wan that does, and bechune the two if I was payin' for id, I'd take the coal that doesn't clinker.

I'm tould that 'tis no hard matther for the chimists to larn has the coal the clinker-makin' sthuff in it, as well as the hate units. If that's so, fwhy don't the government high-brows advise the buyin' iv the coal be the hate units in id, wid a dhraw-back fer the clinker units? Phwat is it that makes the clinkers? Well, Reilly, id's a common enough thing, fer it's iron mixed wid another ilimint that helps it melt an' glue the ashes together, an' be that means choke the dhraft and cause a lot iv throuble.

I'm thinkin' that if the ould way iv buyin' coal isn't satisfactory, an' they want a scientific way, the best plan would be to considher three things, an' they are: the price, the hate units, an' the character iv the ash.

Yer right, Reilly, scientific ways are great ways if common sinse is mixed wid 'em.

采 采

Mine Surveying Wrinkles

By W. J. Crocker*

In mine surveying accuracy must always be the first consideration, next in order comes the question of speed; the following "wrinkles" have been found beneficial in preventing mistakes in surveying, thus saving time, and incidentally lowering the cost while raising the standard of the work done.

Double Reading of Angles.—After the transit has been set up, leveled and centered, set the verniers at zero zero; that is, have the zero line of the upper plate coincide with the zero line of the lower plate; clamp both plates together, focus the telescope on the backsight, tighten the lower plate, the reading of the vernier still being zero zero; loosen the upper plate and focus on the foresight; when properly focused, tighten the upper plate and read the vernier. Suppose the reading to be $213^{\circ} 46'$, now loosen the lower plate and focus on the backsight again, this will not change the reading of

$213^{\circ} 46'$; when focused, clamp the lower plate, loosen the upper plate and again focus on the foresight; if the previous reading of $213^{\circ} 46'$ was correct the vernier now should read $67^{\circ} 32'$. In doubling angles the transit is always turned to the right, making a complete turn around the circle, thus dropping 360 degrees; remembering this, the second reading of $67^{\circ} 32'$ plus the 360° dropped = $427^{\circ} 32'$; or, worked the other way, $213^{\circ} 46' \times 2 = 427^{\circ} 32'$; then $427^{\circ} 32' - 360^{\circ} = 67^{\circ} 32'$. This method of doubling angles discovers errors in vernier reading, mistakes oftener being made in reading degrees than minutes, because the surveyor's attention is taken up in counting the lines representing minutes until he comes to the coinciding line, while a glance is all that is usually given to the reading of the degrees. By doubling the angle reading, it is possible to get a more nearly correct reading in drafty tunnels and drifts where it is hard to keep the plumb-bob from swinging. The greatest benefit is that any mistake made in reading the vernier is caught at the time of reading, and is not entered in the field-book notes, carried on in a line of survey, reduced in the office notes, and only discovered when a plat cannot be properly made, or the survey properly closed, thus necessitating a resurvey until the mistake has been located. It takes a little more time to double angles, but if only one mistake a year is saved by doubling, the precaution pays for its use.

Doubling the Tape Reading.—In most mine surveys a standard steel tape, graduated to feet, tenths, and hundredths of a foot, is used. In measuring between stations, usually from 60 to 100 feet apart, the rodman holds the end of the tape reading from zero up; he places the zero mark on the station at his end, the surveyor holding at the station where he measures from, reads, say, 87.14 feet, jots it down on a slip of paper, but does not tell the rodman what the reading is; then the surveyor holds the tape at the 100-foot mark, the rodman reading the tape at his end; if the rodman calls 12.86 feet, the surveyor puts it on his slip of paper, and adding 87.14 feet to 12.86 feet he gets 100 feet even, the length of the tape, and knows that the first reading of 87.14 feet is the correct distance between the stations, enters it in his field book and proceeds with his survey. This method will catch a mistake in tape reading at the time it is made and before it is carried into the field notes.

*Negaunee, Mich.

Mining Steep Dipping Coal

A Method Suggested to Meet Certain Conditions in Thin Seams in Arkansas

By A. A. Steel, B. S. in C. E., and E. M.*

An aid in measuring between stations where the plumb-bob is suspended from the roof, is a small slip knot on the plumb-bob string; the transit telescope being leveled and sighted through, the rodman slides the little knot up or down the plumb-bob string until it is intersected by the cross-hairs of the telescope; it is then level with the axis of the telescope, and by measuring from the axis of the telescope to the knot, measurement is made on a level plane, and of course the shortest distance taken between the two points.

Aid to Focusing Underground.—If a sheet of white paper is held between the rodman's light and the plumb-bob string, the string will show up plainer, thus giving a quicker focus, and will also make the plumb-bob string stand out more distinctly against the cross-wires of the telescope when sighting.

Locating Old Stations.—In returning to carry a survey farther, it is wise to set up under the second station back, backsight on third station back, foresight on first station, and to read the vernier, thus checking the angle, and also to measure the distance between the set up and foresight. This precaution should be taken because it sometimes happens that the miners blast out the station last put in, it being nearest the working face, and they may replace it as near as possible to where it was; or if the timbers have been blown down the miners sometimes change the caps end for end; the distance between the last two stations would be the same, or so near it as to identify the station, but the angle would never check if the station had been disturbed in any way, consequently, by getting both angle and distance any change cannot fail to be detected.

Obituary

WILLIAM G. SIMPSON

William G. Simpson, the builder of the first anthracite coal breaker in Northeastern Pennsylvania, died at his residence in West Pittston, Pa., on December 7, aged 88 years. From 1861 till 1895 he had charge of construction work for the old Pennsylvania Coal Co., with his headquarters at Pittston, Pa.

Obituary

Drains should be so made and graded that the water will be kept below the bottom of the ties, preventing decay to them and corroded rails and metal fastenings.

IN Arkansas there is a good deal of coal of such steep dip that it is expensive and dangerous to run the cars down the rooms, even when wooden sanded rails are used. In some mines, the rooms are driven diagonally across the dip. This is not very effective and greatly increases yardage costs because the entries must be closer together for the same room length. In such cases, some saving can be made by also giving the entries an up-grade so they are more nearly at right angles to the rooms, which of course increases the cost of haulage.

such a grade that the cars must be pushed both ways and can be easily handled by one man. In order to keep the small hoist busy, it is best to complete the place before any rooms are started. The breakthroughs can be spaced to serve as necks for the rooms and the pillar workings on the air-course side. All rooms may be started full width because the room pillars must be adequate to prevent squeezes, and no real room necks will be needed.

Both the main entry and its air-course will carry a current of fresh air, and a separate split can be sent

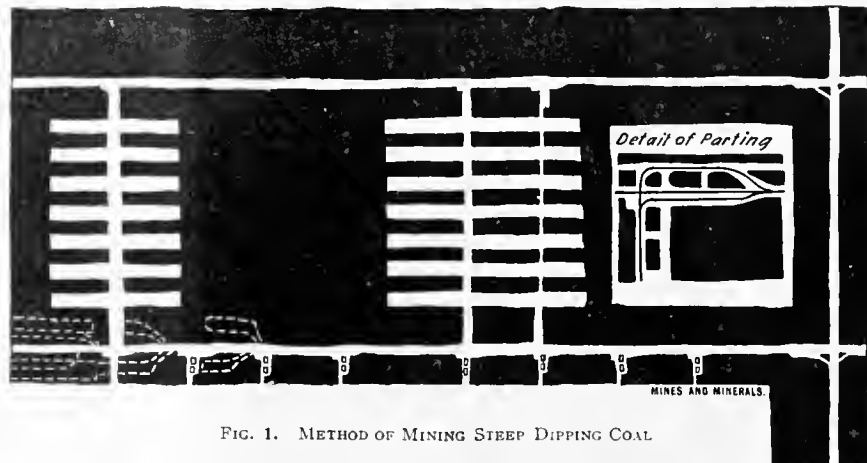

FIG. 1. METHOD OF MINING STEEP DIPPING COAL

Instead of using these methods, it is far better to run the rooms nearly level and gather the cars by small engine planes off of a few main-level entries along which the cars are taken to the slope by electric motors. This plan is shown in Fig. 1. The method is very convenient and has been much used in the West, but failed in Oklahoma because the pillars in the soft coal were left so narrow that they rolled over. Under the existing breakthrough law, at least every second pillar must be kept narrow, but the width of the rooms can be held down to 24 feet or less and every second pillar should be 40 feet wide.

The track will be near the lower side of the room with space below it for all the waste. This material can be used to level up the track in high coal. In low coal, bottom brushing can be done to level the track. In all cases, the room men should be required to lay the track at

up through each small plane. The amount can be adjusted by a regulator at the top, and this air can be sent through the rooms by maintaining a curtain opposite each little pillar.

As soon as the rooms are finished, the pillars can be mined by taking a good-sized skip off the bottom and pulling back all the rest except a narrow strip to hold up for a time the gob above. The main entries may be protected above and below by omitting one or more rooms, and if necessary the pillars can be reinforced by shooting the roof and floor of the nearest room. The greatest strain will come on the entry above the robbed pillars, but this entry need be maintained only a short time after the rooms below are finished. At considerable depth the workings may in general retreat, and the pillars of the entry above can be promptly mined. In this case, the room above the pillar of the lower entry can be reinforced

*"Coal Mining in Arkansas."

readily by rock shot from the roof. These entry pillars can be mined by horizontal rooms connected with the main entry by inclined roads. The room farthest from the entry may be finished first, and the pillar beyond pulled before the next room is started.

In most cases, at the less depth, it will be possible to pull the pillars immediately. It is then advisable to drive the original planes a long distance apart and rob back the first



FIG. 2. STATION FOR DOUBLE-DECK SLOPE CARRIAGE

room pillars only on the side away from the main slope. The hoist can then be moved over to the line of breakthroughs in the large pillars, and the other room pillars robbed toward this new plane at the same time the rooms are being advanced on the other side, until the plane is moved again. In this way, the capacity of the small plane will be nearly maintained. The saving in yardage will be great, but twice as many partings on the entry will be necessary and a little more money must be invested in preliminary work.

To keep the motor busy, all the engine planes of the entry should be developed before the room mining is started. If the continuous-cutting electric machines are used in the rooms, as can be done readily in all the dips known in the state, the development work can be rushed by the use of the electric-air post puncher. There will be sufficient places rather near together to keep one machine busy on each entry. In a machine mine, the rooms will advance at an equal rate and the punchers will be concentrated occasionally on a single line of breakthroughs. This can be driven part way down from the room above for ventilation and to save moving the machines.

At most of the mines in high coal, it will be possible for a mule to drag the empty car up the engine plane, but the loaded cars had best be let down by fastening an old wire rope to a strong prop at the top of the plane and fastening the car to this rope by a screw clamp. The screw can be loosened just enough to let the clamp slide over the rope to lower the car. In low coal, the cars are best brought up by a light hoisting rope passing over pulleys and

pulled by a mule walking in the entry.

In most places, the dip is not sufficient to interfere greatly with switches along the plane. Under these conditions, the cars can be handled in trains. The hoisting rope must, however, be so light that it can be readily pulled down the plane by the rope rider and it will rarely be possible to handle more than three cars in a trip. Even this introduces delays in shifting cars, and in general it would seem better to handle but one car at a time. The miners, according to their agreement with the operators, will handle the cars in level rooms both ways for 150 feet, but must not have to wait for a car. Under these conditions, there should be attached to the hoisting rope, two chains, one about 10 feet long and the other 25 feet. The empty car can be attached to the long chain and stopped when the other hook is opposite the loaded car waiting at the switch. The load is then attached to the short chain and pulled out on to the entry while the rope rider holds the long chain down in the cut in the curved rail while the wheels pass over it. The empty is then let down on the empty track and detached. The rope rider can signal the miners to run out their cars as needed. In longer rooms, the miners will push the cars one way, but it seems more economical under these conditions to handle the cars both ways for the miners and let them wait for the empty car until it can be brought up from the entry, and to handle the cars on the plane in trains.

The partings at the foot of the plane are most conveniently arranged as shown in detail on Fig. 1. The empty cars may be dropped off the end of a motor trip and run over the sidetrack. Any empty car standing here may be pushed to the end of the entry until a trip is gathered for the last plane. The old dip switch may be used for the loaded track and no yardage is needed. The rope will be pulled down the plane and attached to the empty trip; the operator of the little hoist will be able to see and avoid collisions with the entry motor, and the loaded cars will be placed so as to be attached to the end of the outgoing trip.

If the dip is steep, it is better to handle the cars on a slope carriage. For this purpose, it is recommended that a long carriage be used with two platforms. The empty car will be put on the upper deck and pulled up past the room so that the load

can be put on the lower deck. The carriage is then lowered until the empty car can be taken off. The miner or loader is always ready to help the rope rider and there will be the least amount of delay in changing cars or waiting for cars. A gravity plane on which an iron counterpoise is run on an inside track depressed at the passing place might prove serviceable and economical, provided the slope weight is heavy enough to pull the slope carriage and the empty car and light enough to be raised by the slope carriage and loaded car. No electric power plant would then be needed. A single-deck slope carriage will work just as well, provided the cars come equally from rooms on both sides of the plane and the miners lay off in pairs, and will wait for their cars. The last feature would be unlikely and there will be a large expense for car pushers. All the slope carriages should have a device for holding them opposite the level track on the slope.

A sketch of the station at the bottom of the plane is given in Fig. 2. A similar arrangement with tracks on the same level can be used with switches, provided the cars are turned end for end at the slope. This can be done by dropping them from the motor on the parting on the far side of the slope, but there are no apparent advantages in this kind of parting, over the one shown in Fig. 1.

Each jig slope should be so arranged that the engine plane will be kept nearly busy. It is advisable to give the latter surplus capacity in order to provide good trips and to keep the pushers busy. If the arrangement of rooms, the speed of the travel, and the delays in switching, are known, this length is easily computed. The delay will be determined by the arrangement and the number of men. Two minutes per car may be assumed. It may also be assumed that the speed will be 600 feet per minute, that there are on each side of the plane four rooms in each 110 feet, and that each room yields four cars per day. Then in addition to the 60- or 75-foot pillar next the entry, 1,000 feet of slope will be required if three cars are handled at a trip. If only one car is handled at a time, as will generally be advisable, and if there is no reduction in the delay, the distance is 700 feet. A smaller hoist handling one car at 400 feet per minute will need 600 feet of plane. The daily output from each plane will

then be about 320 tons, 224 tons, and 192 tons, respectively. If coal cutting machines are used with a pair of miners in each pair of rooms, the output will be increased slightly and it will be possible to make the planes shorter.

These figures show at once that only a few planes will be needed and the output can all be handled by one or two motors on a single pair of entries. Unless the planes be put in breakthroughs, it will be necessary to have at least two sets of planes in process of development while the first set is producing room coal.

As compared with driving rooms up the dip, the method here outlined has the disadvantage of requiring a little more capital for the initial development. It requires more machinery and, therefore, a different type of mine foreman is necessary. It is a slight departure from present methods.

The advantages of the method are a good extraction at a low interest charge, because the pillars can soon be mined; the entry yardage is greatly reduced; there are no wrecks and overworked mules; the haulage cost is less; and finally, it is the only satisfactory way of using mining machines in the moderately steep coal. It is in a way the system of twin haulage entries applied to steep coal.

The steep coal soon reaches a depth at which even 40-foot pillars will fail, and for thick coal it is then advisable to use a system of longwall retreating from the property line to the main slope. Entries driven double for ventilation, will divide the face into panels some 250 to 300 feet along the dip. Between these entries, conveyers discharging at the lower end may be placed along the retreating face. Some special piece of machinery can be attached to the lower part of these conveyers, for carrying the coal to the cars passing on a parting in the wide entry at right angles to the face conveyers. This is necessary to insure a heavy output without incurring the expense of maintaining a double-track entry beyond the end of the face conveyer.

It will be some time before such coal is opened and before the problem of labor for conveyers is adjusted. Until then no more discussion of this problem seems necessary. The thin seams of steeply dipping coal are best mined by the aid of conveyers and by the adoption of the longwall advancing method of mining.

Rational Mine Sociology

Written for Mines and Minerals

IN *MINES AND MINERALS* for December, 1911, were illustrated and described the swimming pool and bath houses constructed at the Leisenring No. 1 plant, of the H. C. Frick Coke Co., near Connellsville, Pa. To this convenience and pleasure feature has since been added a recreation hall and a children's playground.

For a number of years past there was a large well-constructed frame Lodge building near the Leisenring No. 1 plant, which was erected by an organization on ground under free lease, with the stipulation that if the building

his plan, and the building, which had a remarkably good frame, was taken down and reerected near the swimming pool as shown in the illustration.

The main portion of the building, two stories in height, is 30 ft. x 60 ft. The first floor is arranged as a gymnasium equipped with bowling alley, pool tables, and the usual gymnasium appliances. The second floor is a large hall equipped with a small stage. It has a smooth, polished floor and can be used for dancing or other entertainments, for serving dinners, or for basket ball.

On the stage there is an upright piano and a music cabinet. The two-story extension shown in the



FIG 1 AMUSEMENT HALL AND SWIMMING POOL AT LEISENRING NO. 1

ceased to be used for the purposes for which it was built it should revert to the land owners. For several years the building has not been used for the purpose for which it was constructed and it reverted to the H. C. Frick Coke Co. as owners of the land.

Charles Franks, superintendent of the Leisenring No. 1 plant, who takes great interest in the welfare of the miners and coke workers under his charge and who was largely responsible for the construction of the swimming pool, conceived the idea that if the building was moved to a more convenient location and put in first-class condition it would be a source of pleasure and benefit to the employees. He secured the consent of his superior officers to

foreground contains a well-equipped kitchen and a boiler room on the first floor, the former being entered through the door on the left. On each side of the extension the steps shown lead to doors opening into a hall connecting with the main room on the second floor and also with lavatories and toilet rooms. The entrance on the right is for the women, and on the left for the men. This extension also has on the second floor a room fitted up for a barber shop. This is occupied by a competent barber who receives free rent in return for caring for the building and keeping it clean. As before this arrangement was carried out there was no barber nearer than Connellsville, the barber shop is a much appreciated institution. The

entire building is heated by steam and lighted by electricity. The work of taking down the building and rebuilding it on its present site, of finishing the interior, painting both exterior and interior, the installation of water, light, and heat was all done by the mechanics regularly employed at Leisenring No. 1.

The piano, kitchen furnishings, and the entire equipment of the gymnasium were furnished by the employes at the plant, who have organized an athletic association with very moderate monthly dues. This recreation hall is naturally very popular with the employes and their families, who make free use of it, to their great enjoyment and benefit. The small building on the edge of the pool is the women's and girls'

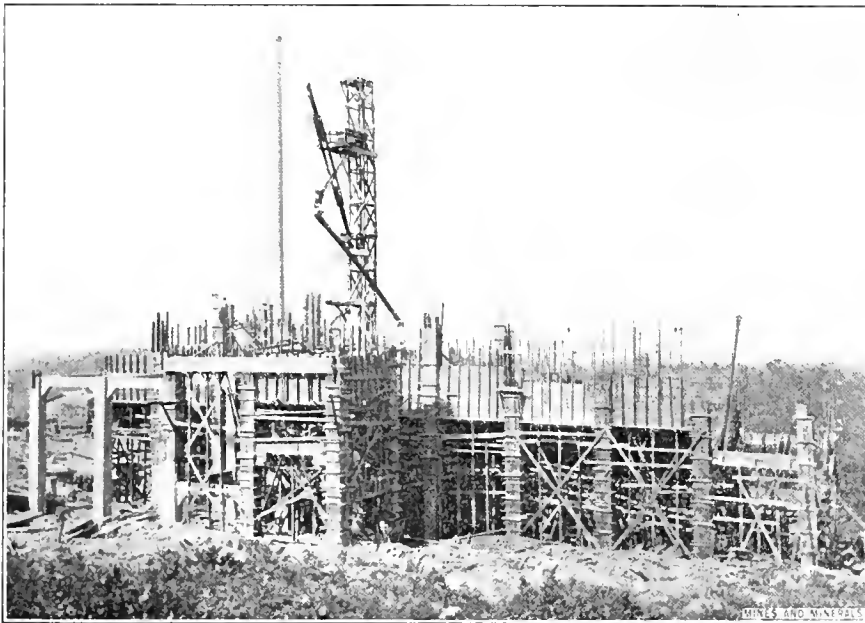

FIG. 1. UNDERWOOD BREAKER, SHOWING CHUTES FOR POURING CONCRETE

dressing room and shower baths; an exactly similar building to the right, not shown in the picture, contains a dressing room and shower baths for the men and boys. Back of these dressing rooms and to the right of the recreation hall is a children's playground, equipped with a swing, horizontal bar, trapeze, a teter or see-saw, a merry-go-round, a slide, and a large revolving cylinder. This feature of the recreation plant is naturally greatly appreciated by both the children and their parents.

It is a fact that should be significant to sociologists, that while the H. C. Frick Coke Co. has encouraged and aided this movement, not only in this case but others, a large part of the work is in the hands of the employes themselves, thus insuring their personal interest.

Concrete Coal Pockets

Written for Mines and Minerals

The Pennsylvania Coal Co., has commenced the erection of a new breaker at Throop, Pa., which is to be known as the Underwood breaker. In the construction of this breaker both reinforced concrete and steel are to be used; reinforced concrete for the coal and rock pockets, and part of the washery, and steel for the main part of the building, which will contain the washery.

The capacity of the coal pockets is to be 3,500 tons. The coal cars are to be loaded directly beneath the pockets, while box cars are to pass on the outside of the building and are to be loaded from a chute leading from the center of the bottom slab of the

beams and walls are thoroughly reinforced and tied to one another.

In the construction of the concrete part of the breaker, the contractors have used the chute system of pouring the concrete and have thereby reduced the usual cost of pouring when using hand work and wheelbarrows, by two-thirds, being able to pour at a cost of 35 to 40 cents a cubic yard. With eight men working, from 10 to 12 cubic yards can be poured in one hour.

These chutes are made of sheet iron curved a little more than a semicircle and stiffened along the edge with a small size angle iron, which is cross-braced at regular intervals with a flat bar. At one end of the chute is a hopper and some of the chutes are trussed so as to stiffen them. In the construction of these pockets three chutes have been used; the first 50 feet long, the second 40 feet and the third 20 feet, making a total of 110 feet. The middle chute, 40 feet in length, is the only one which is trussed. The reason for this is that it is only supported at each end. By making the chute in three parts, the parts can be so manipulated, as they are hung from a boom, that the pouring can be done at any point of the work.

In the use of these chutes, the usual tower for hoisting is built out of 4"×6" timber, cross-braced, and having guy ropes to steady it. Instead of a carriage on which to hoist the mixed concrete, a bucket is used which automatically dumps into a hopper feeding the first chute. This chute is hung from a boom which is pivoted at the tower. The rope controlling the elevation of the boom is attached to the drum on the hoisting engine. The rope passes from the engine to the top of the tower, through a double pulley block to a single pulley block at the end of the boom, then back to the double pulley block on the tower and then through another single pulley block on the boom, and is then fastened to the tower. The boom is 50 feet long and is made of two pieces of 8"×10" timber, and two pieces of 4"×8" timber. The 8"×10" timbers are about 15 feet long and are placed at the ends, the 4"×8" timbers lap on the sides of these timbers so that a space the width of the timber is left between them, through which the first chute extends. The boom is trussed by two iron rods so as to stiffen it.

The first chute is hung from the hopper on the tower, at one end, and from a block and tackle at the end of the boom and is also supported near

pocket. The slope on the bottom of the coal pockets is 9 in 12 and on the rock pockets 6 in 12. The width of these pockets varies from 10 feet 8 inches to 16 feet. Where the pocket is not over 12 feet wide, the floor slab is designed so as to carry the load without any beam for support. But for the pockets 16 feet wide a beam is placed beneath the floor slab. The walls of the pockets are designed as usual to carry that part of the load which comes from arching of the coal in the pocket and also to withstand the pressure against them when one pocket is full and the next empty. The posts beneath the points of the pockets are placed so as to be beneath the dividing walls, but beneath the outside walls the posts are spaced equidistant in a hit or miss manner in respect to the dividing walls. All

the middle by ropes attached to the boom. The second chute hangs from the first chute and is supported at its other end by means of block and tackle hung from the guy ropes of the tower. The third chute is short and hangs from the second at one end, while the other end is moved according to the part of the form it is desired to fill.

We are indebted to Mr. Richardson, of Williams & Richardson, contractors, Scranton, Pa., for the information concerning these pockets.

采 采

Carbon Dioxide Blower in a German Colliery

By Bergrath Laske*

In the eastern district of Waldenburg are several collieries in which outbursts of carbon dioxide are not infrequent. One of these, which took place on September 17, 1911, in the Cons. Rubengrube, at Neurode, resulted in the death of a miner. The colliery is situated on the south-eastern extension of the lower Silesian coal basin, from which it is separated by a 13-mile belt of barren coal measures. Here seven seams are distinguished, six of which are worked. The outburst took place in the uppermost or Josef seam (20 to 36 inches thick), which is immediately overlain by a thin band of plastic very tough clay, this again by thin beds of sandy shales, and these by some 330 feet of sandstones and conglomerates. Doubtless the tough plastic clay effectually seals up the carbon dioxide evolved by processes of oxidation.

The evolution of carbon dioxide in the workings has been noted for many years past. In the Josef seam it was first observed at the third, or lowest, level. At higher levels, considerable quantities of firedamp exuded from this seam; the other seams at the lowest level showed but little exudation, either of methane or carbon dioxide. It is reckoned that the daily evolution of carbon dioxide from the entire colliery amounts to 701,481 cubic feet. Outbursts were unknown at the colliery before 1911, and so far they have all taken place in the Josef seam at this level; it seems plain that forewinning operations have reached a zone subject to these outbursts. Between April 28, 1911, and the following September, twelve of these occurrences were recorded.

Special regulations were drawn up in May and perfected in July for

guarding against sudden outbursts of gas, and for assuring the escape or rescue of the work people.

In the course of the night shift of September 16-17, 1911, at 12:45 A. M., a "double shot" was fired in the Josef seam, by means of an electric fuse. Exactly an hour later, the outburst of carbon dioxide took place, although the working face, apart from the fallen coal, which had been loaded and carried off, had remained untouched since the shot firing. Strenuous but unavailing efforts were made to save a miner who had been busied in setting the timbering in order; he had been knocked backwards by the blower

reasonably straight and incline toward the solid coal, reaching the surface in advance of the working face. On starting longwall mining these breaks reach back toward the shaft and may affect it, all depending upon the physical condition of the strata.

Four methods of mining out the shaft pillar are suggested, using the common case where two shafts 150 feet apart are sunk. The first method suggested is that the mining be started at a point between the shafts; the second method, that headings be driven a certain distance and then the coal be mined back toward the shafts; third, that the

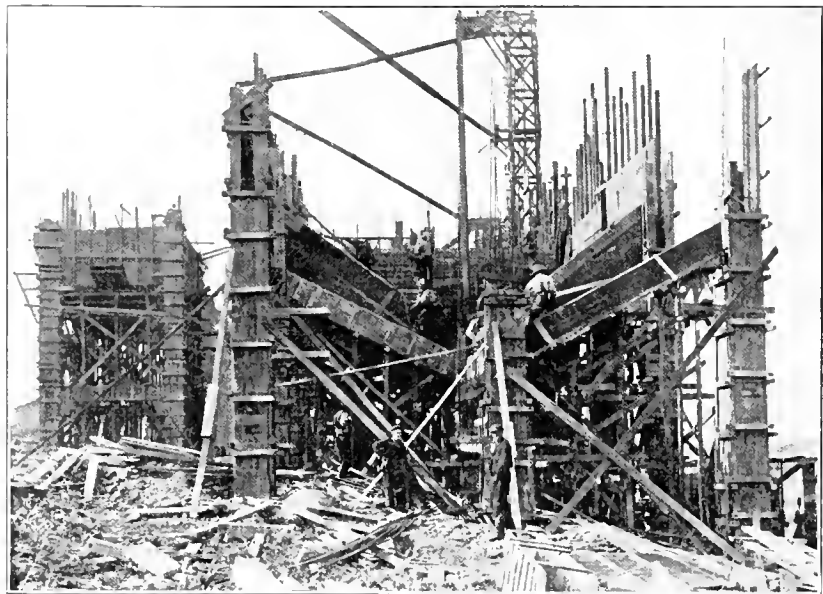

FIG. 2. COAL POCKETS, UNDERWOOD BREAKER

against the packing, and was practically buried in small coal and rock debris. His lifeless body was recovered an hour later.

采 采

Why Leave Shaft Pillars?

Why leave shaft pillars is a question which W. H. Pickering and Basil H. Pickering raise in a paper read before a meeting of the Institution of Mining Engineers and published in the transactions.

The authors call attention to the fact that even when large shaft pillars have been left, crush has not been avoided and consequent damage to the shaft, necessitating in some cases that the shaft pillar be withdrawn to avoid repetition of the troubles. Different engineers have recommended various sizes of shaft pillars, but no rule can be laid down. In longwall works the breaks due to the settlement of the strata are parallel to the face, when it is

mining be started at each shaft and continued in a widening circle. All of these methods Messrs. Pickering consider to be liable to damage the shafts. The fourth method, which they recommend, is to drive a heading between the shafts and beyond the shafts and with this as an axis to mine on both sides of the heading, removing all the coal and taking great care with the packing.

The advantages claimed in favor of not leaving a shaft pillar, are that the output is quickly reached after reaching the coal, that there is no waste of coal, and the danger of gob fires along the edge of the pillars is avoided. The material which had been broken in sinking the shafts and in making the roadways, would be used to make the tight packing around the shafts.

This proposal would not be advisable in case there were a fault, or the seams were inclined, for then the break would be uneven and the shaft would be damaged.

*Zeitschr. f. Berg-Hutt. u. Salinenwes. n.

Prize Contest

With the idea of stimulating interest in practical mining questions, and at the same time drawing out ideas from our readers who constitute a large portion of America's most progressive mining men of all classes, we offer the following prizes:

For the best answer to each of the following questions, we will give any books on mining or the sciences related thereto, now in print, to the value of \$3.

For the second best answer, similar books to the value of \$2 will be given.

Both prizes for answers to the same questions will not be awarded to any one person.

CONDITIONS

1. Competitors must be subscribers to MINES AND MINERALS.

2. The name and address in full of the contestant must be signed to each answer, and each answer must be on a separate paper.

3. Answers must be written in ink on one side of the paper only.

4. "Competition Contest" must be written on the envelope in which the answers are sent to us.

5. One person may compete in all the questions.

6. Our decision as to the merits of the answers shall be final.

7. Answers must be mailed to us not later than one month after publication of the question.

8. The publication of the answers and names of persons to whom the prizes are awarded shall be considered sufficient notification. Successful competitors are requested to notify us as soon as possible as to what disposal they wish to make of their prizes, and to mention the numbers of the questions when so doing.

9. In awarding prizes, other things being equal, a carefully written and arranged answer will be given the preference.

10. Employees of the International Textbook Company, or of MINES AND MINERALS, are not eligible to enter this contest.

Questions for Prizes

5. *Booster Fan*.—An exhaust fan at a mine is capable of supplying 150,000 cubic feet of air per minute, and 40,000 cubic feet per minute more are required. The amount of unmined coal is insufficient to warrant sinking additional air-shafts, and leakage along the airways has been reduced to a minimum. Will a "booster fan" located in the mine meet the requirement? Give reasons for the answer, and state at what point such booster fan should be located, if in your opinion it will do the work.

6. *To Stop a Squeeze*.—A flat coal seam 8 feet thick lies from 350 to 450 feet below the surface, and has a strong bed of micaceous sandstone 40 feet thick next above the top slate which is 13 inches thick; a squeeze has started in an area of 20 acres which was originally worked on the pillar-and-stall system, and the pillars left are well distributed and constitute about one-third of the original coal. How would you proceed to stop the squeeze so as to eventually recover a maximum amount of coal in the pillars?

7. *Raising Water*.—In a certain region it is desired to concentrate into one sump the drainage of several mines, amounting as a maximum to

800,000 gallons per day of 24 hours, and raise it out through a shaft 550 feet deep. Which system will be most economical and efficient—piston pumps, centrifugal pumps, or hoisting in tanks, the water being slightly acidulated? Give reasons in detail.

8. *System of Mining*.—In the case of two seams of coal separated by 36 feet of comparatively soft strata and lying at a dip of 10 degrees, the upper seam is 6 feet thick and the lower seam is 8 feet thick, and it is desired to mine them simultaneously through one shaft 560 feet deep to the lower seam, and to have the daily production approximate 1,000 tons. The top over the upper seam is strong, that over the lower seam comparatively weak, and both seams give off considerable gas. What system of mining would be best as regards safety and economy?

來 來

Educational Notices

On Pennsylvania Day, November 22, 1912, at Pennsylvania State College, the first unit of the Mechanic Arts Engineering Buildings was dedicated. This building is intended to be the first of a series of interconnected units of similar size and design. It is the result of a special study made by the school of engineering to work out a structure

which in form, size, and lighting would readily lend itself to laboratory, class-room and drafting-room purposes by simply shifting the internal arrangement. The materials are largely steel and red brick with brown sandstone trimmings. The new building is 110 feet long by 60 feet wide and harmonizes architecturally with the main engineering building.

The Oregon Agricultural College issued a Book on Camp Cookery, notice of which was printed in MINES AND MINERALS at the time. The demand for this book was so great that the supply was soon exhausted. Excerpts, however, will be published from time to time and will appear in MINES AND MINERALS.

Prof. E. N. Zern, of the Mining Department of the West Virginia University, is sending out posters announcing special courses in the School of Mines. This work is being promulgated in direct response to a demand from the mining interests of the state. Much benefit to the coal industry is bound to result from the higher efficiency and reliability of the men who, in addition to their practical knowledge of mining, will be well fortified in the theory of all pertaining to the art after having made good use of the facilities offered by the courses.

Robbing Coal Dust of Its Dangers

Experience in Applying Steam to the Air Current and Its Effect Upon the Dust in the Mine

By *Sim Reynolds**

EVER since we, in common with other mining men, became thoroughly convinced that coal dust was an element not to be safely ignored, it has been a vital question with us as to the best method of handling it. By "best" is meant that condition emanating from local circumstances: the most economical and at the same time the most effectual. Like other mining men, we have been more or less confused by the large number of methods suggested by the Federal Bureau and others interested in guiding us to a safe haven in this premise. We failed to take into account the fact that the general suggestions sent broadcast by the government men are intended to cover any case and any mine, between the arid operations of the Rocky Mountains and the more moisture-laden pits of the East; from the three-car-a-day drift, with an antiquated furnace, to the modern shaft or series of shafts ventilated by a fan with blades as wide in diameter as the walls of an ordinary house room, and 35 feet deep.

In the end we reached the conclusion that we must adapt the system to the local conditions regardless of any desire of our own, rather than try to fit the conditions to any given method. The natural conditions affecting mines cannot be changed. But men who are interested have experimented sufficiently to show a way out of the difficulty, no matter what kind of installation is run, and no matter what conditions have been imposed on the operation by Nature. For that reason, what we have to offer in this article will be of use only where steam is used or can be procured at an expense commensurate with the mine's output. Fortunately, perhaps, by far the greater number of mines have at hand steam in some form, or can procure it at a price within the limits set for upkeep.

In the first place let us explain that in the mine where these ideas are being carried out successfully, we have to contend with natural and artificial conditions about as adverse as are generally met in the United States. We have an overlying stratum which is "quickened" by moisture at any degree of temperature above freezing point—the un-

certain stratum lying immediately above the Pittsburg No. 8 seam. So fearful were our predecessors in management concerning the possibilities of constant and costly roof falls that, despite the fact of their being wholly conversant with the air moistening method, even to the extent of giving it a slight but insufficient trial, a far different system was in vogue when we determined to change from the costly and inefficient water wagon and spray to the saturation of the air-current. Some sprinkling had been done at irregular intervals; and through the winter months persistently. At points where water lines were available a hose was used, at other places the water wagon and the bucket. That expense did not stand in the way of safety in this matter was evidenced by the fact that several men were detailed to do the wetting, for the mine is a large one. Poorly performed and unsatisfactory as the method then employed was, it kept several names on the pay roll, where now there is but one. These men were still drawing their salary for this work when on certain days we went through the various sections on a "coal-dust tour," only to find hundreds of places where no drop of moisture had apparently ever found its way. Almost anywhere, if one blew a breath on top of a timber or on a stone in a gob, a tiny cloud of dust would rise and partly float away on the current. In such an extensive mine the water wagon and spray method cannot produce any other result, at least not with a normal effort. To have wetted sufficiently for safety every square yard of even the live workings, let alone the innumerable places which were not as easily reached, would have taken a force of men and an amount of money impossible for any firm to stand.

These facts, and the knowledge that all the efforts then being made to make that particular mine safe were nullified, urged the immediate consideration of some other system. In face of the locked safety lamps, in face of the permissible explosives and shot firers to use them, even despite an occasional jail term for some law-breaking employe, in our opinion the mine was dangerous,

because dry and explosive dust lay over acres upon acres of the floor, upon innumerable ledges and timbers of that vast mine, and in scores of

air-courses and places where no tracks were available for the wagon nor any lines for the spray, only a place here and there being wetted as it ought to be. Our opinion being the one to warrant a change, we set about it in the following way.

The fan was steam driven. It was working on the exhaust principle. The first move was to reverse it and change it to a blower, making the main return air-courses the intakes, so as not to befog the atmosphere along the haulways. The pump-room is situated a short distance from the bottom of the downcast air-shaft, and the steam is conveyed from the power plant on the surface through a bore hole. We had two certain supplies of "dead" steam at hand, one from the fan and one from the pumps, neither serving any useful purpose. As would be the case in nearly any mine changing from water wagon and spray to the saturation system, we found a number of things to do, connections to make, etc. Most of this we were able to do with old pipe, and all of it at a nominal cost compared to the results which we anticipated, and which we did eventually get, although not quite so soon as we expected. On the surface a still greater volume of steam was wasted, and we made formal requisition for all of this steam after its use. We did not get it right away, although we had the promise of it. We did not let that stop us. Like many other mining men in direct control of a large operation we found that one can sometimes get things in an indirect way which one cannot get direct. Personally we believed in the idea and were willing to go to a little trouble to carry it into execution. We turned in all the available "dead" steam, and more or less anxiously awaited results. Not much materialized.

The mine, as we have said, was a large one, and the air-courses seemed to absorb all the moisture being sent into the mine, leaving none to float on the air-current into the live workings. Investigation after a week's trial showed that the active rooms and entries were still dry and dusty, no appreciable difference being noticed. Doubtless some changes had been wrought, but they

* This article will be followed at an early date by another by Mr. Reynolds entitled "Robbing Mine Air of Its Danger."

were so microscopic that they were far from satisfying. So down the shaft we laid a pipe line, and connected it with the fan exhaust, using in our first effort the only available steam nearby which was the pumps exhaust and was at our call without a great deal of trouble. It was a bit difficult, but we went after it, reluctant to see the steam going out into the air above where it was doing no good, while we needed it so very badly down below. This made some difference, but still not quite enough to suit us, so, not being able to get the use of the steam from the shops on the surface, we grinned slyly. We had casually remarked that the power plant on top emptied itself more or less frequently by blowing off, so perhaps it wouldn't notice a little extra to the pumps. This gave us quite a tidy volume of live and dead steam, and augmented our fears in another direction.

In common with many others we had read—but never seen tried in practice—of the theory that moistening the mine atmosphere—unlike moistening the mine walls and floor—would certainly prove detrimental to the health and working abilities of the employes. In this, as in the fears of others concerning the roof, our surmisings proved groundless in fact. In any event the trial has now become a permanent institution at the mine mentioned, and we have yet to hear the first complaint. Rather have heard many, who did not know "what had happened," express their agreeable surprise at the change which had come over the workings, wondering what had taken the irritating, dust-laden, dryness out of the air, and substituted a coolness and freedom from dust atoms unusual in that mine.

The hygrometer registering the amount of moisture contained in the air, was set up near the outlet of the mine and it gave us an exact knowledge of the amount of work our by-product aids were doing to lower the percentage of danger from coal dust. We watched it closely, also the inner parts of the mine. In a day or two after the application of the full power available we remarked the canvas checks becoming damp, and on close examination we could discern tiny drops of moisture on the smooth faces of the coal. The dust about the floor spaces, on ledges, timbers, and other innumerable places, which before had been easily dislodged by a man's breath and sent floating off in the air-current, was absorbing moisture to such an extent that we could pack it like moistened

flour between the fingers, each atom so freighted with water that, through its power of adhesion consequent on its being wet, and its additional weight, it refused to be removed from its resting place by any force blown against it.

Our little battle with nature was won. The scientific questions relative to the principles involved did not interest us. For us and the several hundred men in that big underground plant, it was immaterial, in view of the facts previously stated, whether that little pinch of stolen live steam, and the larger volume of dead vapor from pumps and fan, wetted the mine air or merely (as the scientists tell us) served simply to prevent the quick absorption by the dry air of the natural moisture inherent to the mine itself. We were interested in results, not theoretical deductions, and got them as any man will who has half a chance and goes after them hard and persistently. With Mr. Frank Haas, we can assert from practical experience that many of the arguments adduced against the method herein detailed "emanate rather from opinions than from facts." And so far as the roof is concerned, we can faithfully assert that practical tests have proven most of the horrors prophesied to be largely imaginary. In the case mentioned here, where the roof strata are reckoned to be of a nature decidedly susceptible to atmospheric humidity, it has not required the constant service of even one man to clean up all the falls resulting in this very large mine from this cause alone during the winter months just ended. Such falls as did occur were mostly near the intake and along the air-courses, the effect of the change in the live workings not being sufficiently in evidence to be noticed. But even were this the case, it is, in the opinion of the present writer, far better for men and masters to have the security a little trouble will give sometimes, than run any risks from a dust explosion. It would not take the least of several disasters, caused almost if not entirely by dust, which we have with others helped to disburden of their cruelly broken and burnt dead, to pay morally and financially for more falls than are likely to occur from this source in any normal mine even unto the day the last car is mined. Such as do really happen, can be augmented or diminished in extent, by care or lack of it in timbering.

The worst faults thus far adduced against mine-air saturation are off set by the following things in its favor:

1. Ease of installation; it being possible in many mines to throw the entire plan into operation in a few hours' time.

2. Economy. The original expense is nominal, varying with the conditions at each mine and the amount of vapor needed. Unlike most other plans for this purpose, the system is mainly self-perpetuating, even in large mines the services of one man being generally ample to keep such falls as may occur cleaned up, watch the lines and the hygrometer, and increase or decrease the amount sent into the current accordingly, as he is instructed and the needs indicate.

3. Efficiency. Wherever air goes this method of "laying" the dust does effectual work. Places which could not possibly be reached by any other means will on investigation be found to be thoroughly dampened, quite as much so indeed as those more readily accessible. It is automatic, working as readily through the hours of the night as through the day, and causes no trouble with the union. The only thing which can put it completely out of commission is for the boilers on top to blow up, which is a far less possibility than many others underground.

Other results which are interesting as coming to our notice through actual test, and which have been proven conclusively to our satisfaction at least, are:

1. The workmen at the face suffer no inconvenience from the improved humidity of the mine atmosphere when the hygrometer registers 95 degrees or less. With sufficient steam this degree of moisture can be attained even in cold, frosty weather, when for instance the Pennsylvania thermometers are registering anywhere from freezing point to 20° below zero, and the atmosphere outside contains about 55° of moisture. If no spare steam is available during the regular working hours of the day, an extra supply can be arranged for during the rest of the 24 hours. This gives the maximum effect throughout two-thirds of each working day, idle days, all of Saturday night, Sunday and Sunday night, without lessening the steam power for the regular work and without any appreciable addition to expense. We have had this done as occasion required and brought the humidity up to 100, which is too high for comfort when the mine is full of men.

2. We have proved that when the mine atmosphere was kept at this point for 10 or 15 hours it has

kept the entire mine in a very moist condition for several days thereafter, during which time the normal (90° to 95°) can be sustained, and the whole mine kept relatively safe from the dangers of coal dust.

In closing this article we feel impelled to add a few words regarding the subject as a whole, particularly as concerns the attitude still held by too many mining men, that coal dust is in itself not an explosive. We regret that there should even yet be those identified with bituminous operations who refuse to accept as serious the admonition sent forth concerning the possibility of an explosion of coal dust unaccompanied by methane to act as a detonator. To such it is perhaps useless to suggest that they read Miners' Circular No. 3, issued by the Bureau of Mines, with special reference to page 9, second and third paragraphs. Evidently they and their employes must participate in an underground holocaust, such as has caught so many in late years, before they can be converted, and then, as a rule, the victims of this ruthless conversion are not in a physical nor mental condition to profit by the experience. Such criminal indifference to positively proven facts should not longer be tolerated anywhere among any class of men identified with the bituminous mining industry. Years ago there was cause for doubt, and up to a certain point, we are decidedly partial to one's right to disbelieve. We would not have the proper freedom of thought of any man abridged. But there are cases when it would seem to be necessary, namely, when the persistent clinging to an antiquated idea long proven wrong, imperils human life and valuable property.

As a concrete illustration of this tendency to doubt, even when conclusive proof has been shown, we may be pardoned for mentioning here an actual fact which recently came to our notice. It was at the big demonstration at Pittsburg, on the day that the President was there, with other dignitaries, to witness a "real" coal-dust explosion. The particular doubter in this case was not one of the outsiders, but one of our very own, an old mine foreman who had probably never put in a day's labor outside of the sight of coal dust.

Some time before the time set for the "blow-up" we came across him and his Davy making very careful tests for methane, which he did not find. Having satisfied himself on this score, he pulled from a pocket

an envelope, and, scraping a bit of dust from this ledge and from that, he put it all in the container and sealed it. We became interested and learned that he had been sent by his employers to witness the demonstration, and, either on their or his own account, was gathering the dust. As though it were any profit for the government men to pull off any tricks on the very men the demonstration was inaugurated to benefit!! But evidently this logic did not occur to the old pit boss. Having deliberately sealed the envelope and placed it carefully away, he remarked to a group of more or less amused bystanders: "There may be somethin' in it besides dust."

Then, while waiting for the explosion, and during one of those intervals between the different attempts to set the blast off, he added with a contemptuous smile spreading across his poor, mine-scarred old features:

"If there *is* nothin' in it but just dust I wouldn't be afraid to light the shot with a squib and sit around a rib corner till it went off."

We are rather inclined to the belief that after seeing what the shot did, the old mine foreman changed his mind. Our imagination doesn't have to stretch far to see the surprise that was awaiting him when that dust he had so carefully chosen proved, on analysis, to be the exact duplicate of many tons lying scattered throughout his mine.

來 來

Electric Cables for Mines

By William White

Electric-cable installations in collieries are extremely important, and this is not an attempt to deal with the subject in anything like its entirety. While both the insulated-return and the earth-return systems have merit, it would not be fair to let the subject go without mentioning that earth-return systems in mines have sometimes brought about accidents. Most of these affairs could have been avoided, but unfortunately, the troubles reached their culminating points before anything effective was done to prevent them. In one instance, the driver of a coal cutter received a serious shock, which was traced to where the trailing cable was clamped on to the machine. At this point it was necessary to put a sharp bend in the earth wire in order to get it into its terminal and at each time this was done a strand was broken, until finally the few remaining strands were insufficient to carry the current,

and they fused. This caused the whole machine to become alive, and the man on the front was shocked from the haulage rope. The trouble was cured by altering the terminal arrangement, and splicing in another earth wire, so that in case one wire broke the other would prevent the machine from becoming alive.

There is danger in using single-core armored cable utilizing the armor for the return on an earth circuit in mines, especially for feeding coal cutters. In such situations the blowing of the fuse in the circuit occurs repeatedly, and apparently cannot be stopped. When such a fuse blows it occasionally starts an arc onto the sides of the gate-end switch box, and this arc may persist until all the internal parts have melted. This by no means uncommon accident has occurred in boxes lined with asbestos ¼-inch thick and where mica plates have been tried. An expensive box has been put to work for a night shift, and taken out again in the morning useless, with a hole fused through the lid. This is difficult to remedy unless one does away with the system (these remarks apply to direct-current practice).

In many mines the road signals are an ever-present source of dissatisfaction. This is probably because they are often left in the care of the rope splicer or some other handy man. Among the many causes of failures may be mentioned bad jointing along the road, zinc eaten away, porous spots which are of no use, terminals and wires so badly covered by crystallized salomoniac that they are no use, hopeless muddle of wires at battery, bells all out of adjustment, and so on. When the importance to the working of the mine of an effective system of road signals is considered, it is astonishing that in so many cases such matters have been left to unskilled men. In one case where this sort of thing had been occurring, the whole outfit of road signals was put under the charge of the electrical staff, and after they had been put into thorough working order and adjusted, they were examined daily, with the result that very little trouble occurred afterwards in that part of the colliery due to such causes.

It is not too strong an assertion to say that many miss shots in mines are caused by the shot-firing cable, which is usually very cheap twin braided material. In most cases it gets wet and in addition to this it is quite usual to find on examination that the joints made by the mine

deputies are not very satisfactory. The number of misfires in such cases may easily reach 50 to 60 per cent. of the total shots and it is, of course, a rule in an efficient mine that these have to be reported and reasons given for the occurrence. In one case where misfires were distressingly frequent, as a last resource the case was placed in the hands of the electrical staff, and after all the bad joints in the shot-firing cable had been made good, and the cable itself

Moving Minerals in Thin Flat Beds

Swinging Chutes, Scraper Conveyers, and Shaking Conveyers for Transporting Minerals Underground

Written for Mines and Minerals

WHILE not sure, the writer is under the impression that "swinging chutes" were first introduced in the gold mines of the Witwatersrand, South Africa, where

Into this chute ore is shoveled at the upper end and moved downwards by swinging the chute without snubbing. Ore or coal will not readily start and slide by gravity unless the pitch of the chute is 32 degrees, or it is given momentum; if, however, it is given momentum it will slide downwards on a comparatively flat plane. In the case in question the swinging chute is moved back and forth, and the momentum the ore attains on the forward swing prevents its moving with the chute on the backward swing, thus the ore is kept in motion so that it slowly goes to the lower end of the chute.

In the case of thin beds of coal having an inclination of less than 25 degrees it is difficult to move the coal to the haulway, for which reason the small coal beds in the United States have not been exploited to any great extent. In Iowa, Pennsylvania, and possibly in Illinois, where longwall is practiced in comparatively thin flat beds, conveyers have been installed, and in one or two places in the anthracite fields of Pennsylvania, where the beds are small and the coal valuable, scraper lines have been adopted to move the coal to the haulways. In the Vinton Colliery Co.'s mines, at Vintondale, Pa., the "B" or lower Kittanning seam, is worked longwall. It is 42 inches thick and has a pitch of about 8 degrees. The coal is cut by an air machine. Between the machine and the conveyer shown

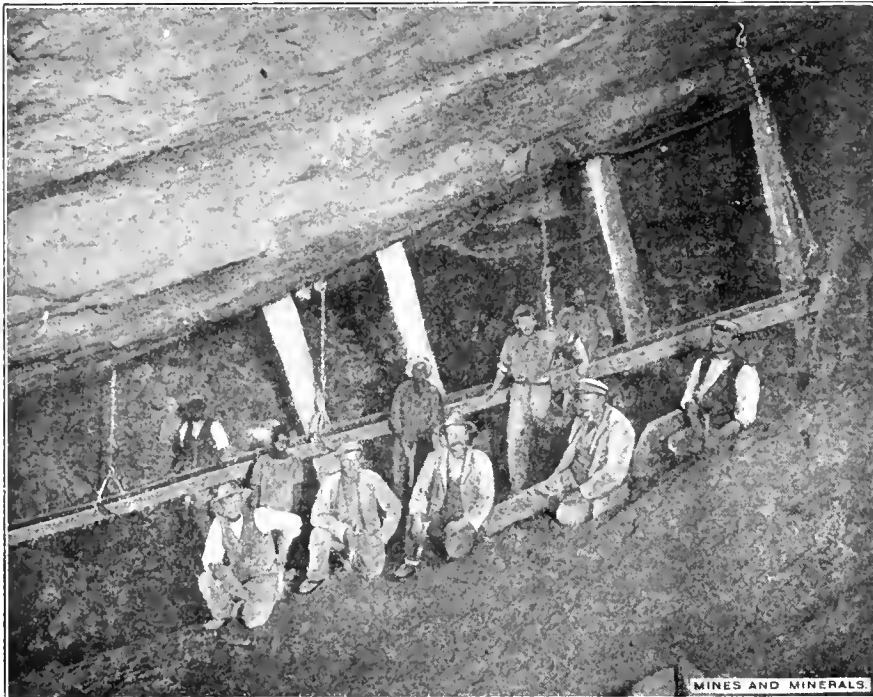

FIG. 1. SWINGING CHUTE IN STOPE, SOUTH AFRICA

had been dried, the electrician fired shots repeatedly with such satisfactory and certain results that the matter was placed permanently in his charge, and a new set of cables was given out so that one set could be dried and repaired while the other set was in use. By this simple method it was found that in subsequent practice misfires were rare.

the ore bed was so flat that broken material would not slide down ordinary chutes to the ore pockets. The device adopted at one mine at least consisted of a sheet-iron trough suspended from the roof by chains as shown in Fig. 1.

來 來

Life of Treated Timbers

The following was compiled by the Forestry Division United, States Agricultural Department, relative to the life of timber treated with creosote:

Species	Average Years Untreated Life	Average Years Treated Life
Cedar	12 to 15	25
Chestnut	8 to 10	20
Lodgepole pine	5	20
Western yellow pine	6	25
Cypress	12	25
Juniper	10 to 13	25
Redwood	12 to 15	30
White oak	8	20
Douglas fir	8	20

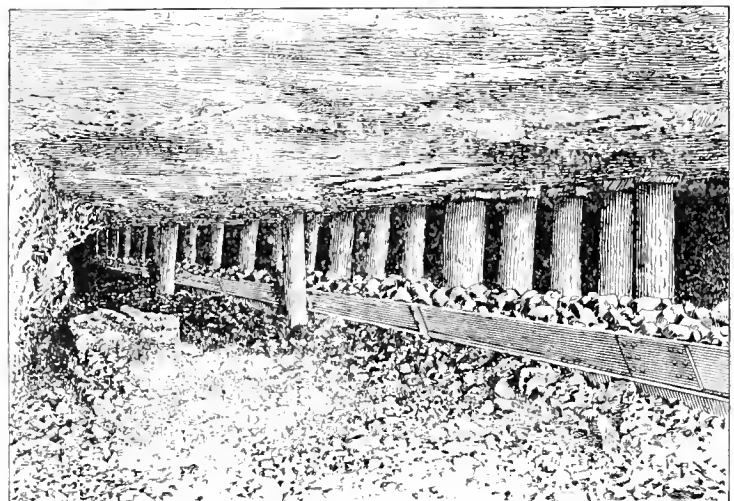

FIG. 2. UNDERGROUND CONVEYER

in Fig. 2 is a row of props, and on the gob side of the conveyer two rows of props. The conveyer trough or pan is made of $\frac{1}{8}$ -inch steel plate 12 inches wide at the bottom and 18 inches wide at the top. It is 6 inches high and set on strap-iron standards. The conveyer is made in sections of 6, 12, 15, and 18-foot lengths. These are connected by $\frac{1}{2}$ -inch flat-headed bolts, thus making the apparatus portable; and when connected it has the arrangement shown in Fig. 3.

The car-loading end of the conveyer is inclined for a distance of 45 feet to allow clearance for the mine cars. This arrangement has been modified so that the head, or car-loading end, is now like that shown in Fig. 4.

Mr. J. I. Thomas read an interesting paper on "Mechanical Conveyers Applied to Longwall Mining" at the Coal Mining Institute of America, June, 1907, which will be found in Vol. 28 of MINES AND MINERALS. According to Mr. Thomas the complement of men required to mine a block of coal with 250-foot face is 13, composed of "block boss," machine runner and helper, driller, and shot firer, engine boy, head man, and six loaders.

The "block boss," or leader of the crew, has direct charge of the block. He must be a man who has some knowledge of mining and the care of machinery and possesses good executive ability. The balance of the crew, with the possible exception of machine men, are generally non-English-speaking men.

In preparation for the day's work, the machine has cut one rail (30 feet) on the previous afternoon. In

the morning this coal is shot down and the loaders begin work immediately. It requires from $4\frac{1}{2}$ to 5 hours for the machine men to finish the cut. The machine is then overhauled and moved up in position to start the return cut. After finishing

along the block 40 feet apart and placed in position.

The shot firer keeps closely after the machine, and is through shooting shortly after the undercut is finished. He then starts from the far end of the block to drill holes

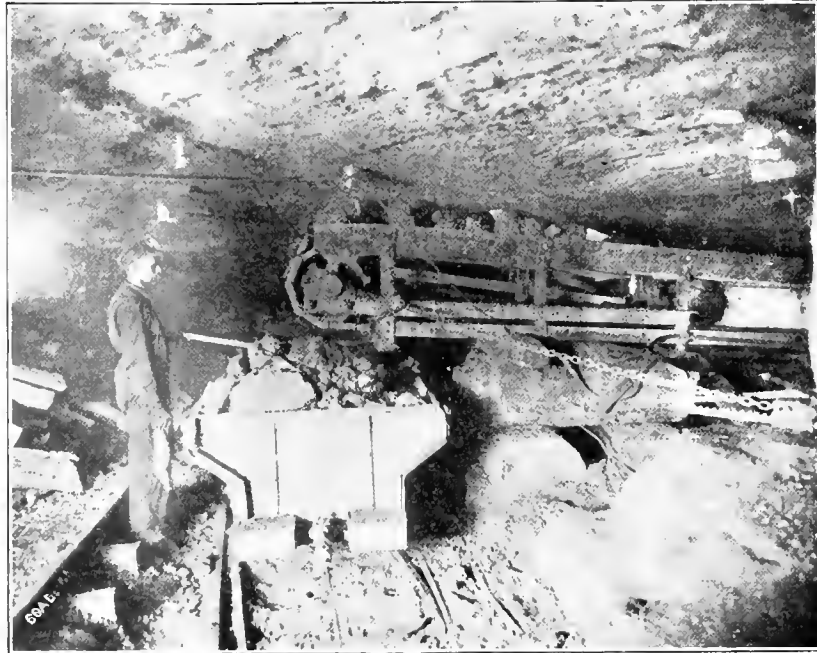

FIG. 4. HEAD END OF MAIN CONVEYER

their own work, the runner and his helper go back on the block and make preparations for the moving of the conveyer. This consists of setting a line of props, called the line row, about 8 feet apart, and a distance from the conveyer equal to the depth of the undercut. As these are placed, the old line row, which is now against the conveyer, is withdrawn. The pulling jacks for moving the conveyer are distributed

in the new face. It usually takes him about 2 hours to drill the entire width of the block.

Each loader is supplied with a pick and shovel and a piece of sheet iron 9 inches wide and 6 feet long, which he attaches to the conveyer to act as a sideboard. As each loader cleans up his place he moves forward to the head of the line. This continues until the coal is loaded out, which usually requires about $6\frac{1}{2}$ hours.

When cleaned up, the drive is reversed and the timber which has arrived on the last trip, is run through on the conveyer to the points on the block where it is required. When this is accomplished the power is shut off by means of a valve located at the top of the block heading. The hose is disconnected from the main feedpipe and the conveyer is moved up to the line row. This lateral move of the conveyer requires very little time, very seldom exceeding 5 minutes. A break row, consisting of two rows of props set 2 feet apart, is now placed along the lower side of the conveyer. These props are set on a cap piece, placed on a small pile of slack, and wedged at the top. Two break rows are all that is necessary to protect the block. In the meantime, a portion

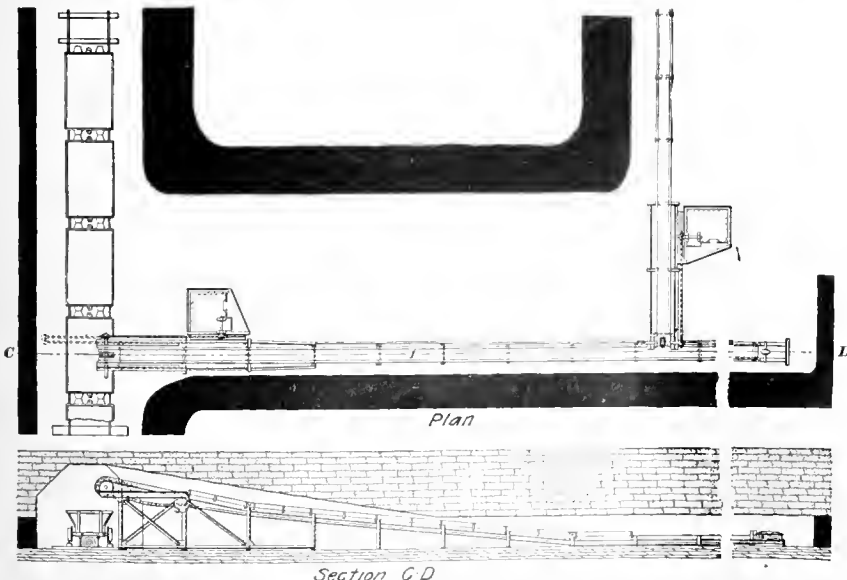

FIG. 3. ARRANGEMENT OF CONVEYER

of the crew are engaged in pulling out the extra break row. This is the most hazardous work on the block, and is given personal attention by the block boss. Axes are used in this operation, and about 75 per cent. of the props recovered are practically uninjured.

While the block crew are employed timbering, the conveyer man

ment of the piston. This jerk aids materially in moving forward the coal in the chute. The motor shown is in line with the chute and is connected with it. By means of the lever *d* fastened at one end to the front crosshead and by the other end to the upright *e*, reciprocating motion of the motor is transmitted to the chute. It can be seen that

passing through a water-jacket to absorb the water formed and to cool the air. The change in volume is then noted on the burette. One minute is sufficient to burn the fire-damp.

By the use of this instrument the percentage of fire-damp can be determined within one-tenth of 1 per cent., but it cannot be used in places where there is more than 6 per cent. of fire-damp, as the burette will be too short.

來 來

Old Rails as Stringers

When wooden rails are used as stringers to which the trolley wires are attached where the roof is high, it is found that they are frequently broken. Moreover, the wood will rot sooner or later, according to the conditions at the place where it is used. In collieries where a change has been made from mule haulage to motor haulage, a quantity of old light rails often are on hand and not in use. These, as well as any old rails which have served their purpose for track work, can be used as stringers to support the trolley hangers and the trolley wire. It is not necessary to bore holes in the rail. Any blacksmith can make a clamp which will fasten on to the bottom of the rail, out of 2"× $\frac{1}{4}$ " flat bar iron. It is made in two pieces, a chair which will hook over one side of the bottom of a rail, Fig. 1, and extend beyond the bottom at the other side, so that the second piece, which presses on top of the bottom part of the rail on the opposite side, can be bolted to it by the same bolt which holds the yoke of the trolley hanger, thus both the clamp and the hanger will be firmly held.

The rail is set in the hitches on each side of the roadway and may be

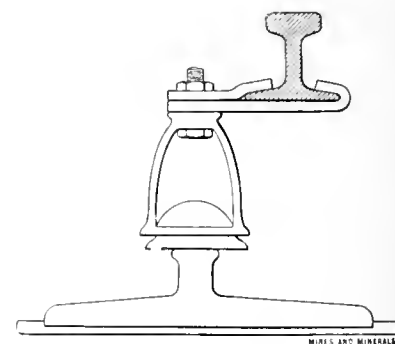

FIG. 1

firmly held in place with a little cement mortar.

This device especially where second hand rails can be used is cheap to make and install and will be exceedingly long lived.

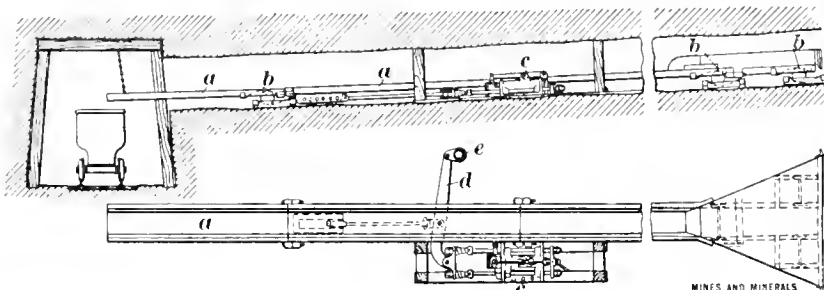

FIG. 5. EICHHOFF CONVEYER SYSTEM

and hoist boy make the necessary connections, and go along the conveyer with a pump jack and level it up. They also build a crib at the head end, which is so placed as to prevent the roof from breaking over into the block heading.

When the timber drawers have advanced such a distance from the machine that the noise of the exhaust will not annoy them, the machine begins cutting, and is usually able to cut 30 feet before the shift is over. With a 5-foot undercut the block furnishes 125 tons of coal. Four cuts a week are obtained from each block, which makes a daily average of 100 tons. This system was worked for several years, when it was improved by the use of a triple-conveyer system.

The most recent advancement made is termed the Eichhoff system. It moves the coal forward by a swinging and rocking motion given to the chute, which is worked by a compressed-air motor. As it is possible that this or some similar machine may be found useful in some fields in this country it is described. Fig. 5 shows the device in plan and elevation. The sheet-iron chute *a* is suspended from the roof by chains, in such a way that it will have a uniform inclination to the car. At *b* there are rockers arranged as shown. These are given a reciprocating motion by the motor, and also an up-and-down motion by the wheels traveling on the artificial planes. In addition to this motion the motor *c*, Fig. 5, is supplied with springs on the crosshead arms which are compressed on the backward motion of the piston and give a quick release on the forward move-

ment when the roller end of the chute is raised the springs are compressed, and that when the wheels start down the plane the springs give a quick acceleration to the chute. This quick movement gives momentum to the chute and the coal, but the coal continues its movement after the chute has been brought to a stop by the piston of the motor. The motor is sometimes placed to one side in a breakthrough and the motion imparted to the chute by a wire rope. The arrangement suggests flexibility and ready movement from place to place, as the motor is on skids and the chute can be hung from the collar of a temporary three-piece timber set.

來 來

Portable Apparatus for Fire-damp Analysis

A portable apparatus for the analytical determination of fire-damp in an airway in which a lamp will burn, has been devised by Dr. J. S. Haldane. The apparatus, which is simple, is enclosed in a strong case 13 in.×11 in.×3 in. It consists of an air burette, a combustion pipette, and a bichromate cell which furnishes a current to heat a platinum spiral. The apparatus is intended for use by those who are not chemists. In principle it depends upon the burning of the fire-damp by means of a hot platinum wire and the consequent change in volume of a measured quantity of air. The air is drawn into the burette, which is graduated, and then forced into the combustion pipette where the fire-damp is burnt. Then the air is again forced back into the burette after

HOGAN'S joking remarks about the Bureau of Mines, appearing in the November number of MINES AND MINERALS, in at least one respect, are worthy of serious consideration for in his droll harangue can be seen the sober truth that the greatest possible success in promoting the safety of our mines cannot be secured, unless Hogan can be induced to accept the advice of those qualified for the job, and, being convinced of its soundness, give his willing and intelligent help in the work for the prevention of accidents. It must be realized by all who understand the situation that he will prove a very helpful factor in this respect, probably as valuable as the well-informed and well-intentioned superintendent, and in some instances perhaps more so; because my knowledge of human nature permits me to say that the former's suggestions and advice to his fellow miners regarding their individual and collective protection against danger and disaster will be more readily accepted and followed by them than the instructions and requests of the latter. I admit that the teaching of Hogan appears to be a big and difficult undertaking. He has his own peculiar views about things, and he is generally inclined to overestimate the value of mere practical experience and to underestimate the value of technical training; but he also knows many useful facts, and I believe he can be taught successfully, if these facts are rightly used and correlated and their full meaning is made plain to him in simple terms.

Hogan declares that he knows that hard coal dust does not explode and that soft-coal dust does explode and is willing to "lave it go at that." I do not believe that Hogan by this remark intended to show indifference on his part to the acquirement of helpful information or to convey the impression that he has no desire to increase his knowledge regarding the causes of explosions, and I think he only intended to express his inability to understand the technical presentation of the matter. If that is true, then Hogan's failure to grasp the meaning of technical terms should make him all the more eager to get possession of the facts for his own interpretation. As he cannot develop all the facts himself, he must depend on others to furnish them and they should come from a reliable source.

"Telling Hogan"

Can We Impress Upon the Miner the Importance of Well-Known Facts Regarding Explosions?

By John Verner*

The Bureau of Mines is a reliable source in this respect. It has conducted its experiments and tests for several years and has established a large number of facts relating to explosions, many of them more or less well known before, some of them new, but all of them useful. As Hogan knows a few facts himself, it seems to me that his better understanding of the reasons why coal dust explodes is not depending on the discovery of new facts, but rather on his own efforts to get the facts already known and all the information concerning them he can obtain. To start him along this line I will give him a few facts regarding explosions for his consideration.

Hogan knows that every shot fired in a mine produces more or less wind and that this wind is driven away from the shot ahead of the flame. He knows that the force of this wind varies greatly; with one shot it may be very small, with another it may be strong enough to move heavy objects and become a menace to life. He may or may not know that this wind wave, after its extremely short duration, is succeeded instantly by a reactionary air wave of proportionate force, but if he has had the opportunity to observe the behavior of "windy" shots at close range, as I have had, he knows. I have observed the actions of a number of these dangerous shots, not because I was inquisitive in this respect, but because in each case the opportunity was forced on me. With all these shots I noted the wind wave coming from them, its stoppage and its immediate reversal, but in one case the rapidity of change in the air movement was particularly plain and distinct. I was standing near a door when the windy shot occurred. The door was violently forced open about half way and instantly and violently closed again. This was followed by continued vibrations of the door, decreasing rapidly in force. All this transpired within very few seconds. I will add that there was no ignition of the dust by the shot and that the mine was entirely free from gas.

The above facts have been known almost from the beginning of mining coal by blasting, they are old and common, and on that account perhaps may be considered of little value, and

yet they appear to have an important part in preventing or promoting an explosion. Hogan may disregard my views in the matter, but I want him

to take the evidence and form his own conclusions.

Several years ago I witnessed a number of tests at the Pittsburgh Experiment Station. In one test a mixture of gas and air, the amount of gas being 8 per cent., was confined in the gallery. The test was made to demonstrate whether or not this highly explosive mixture could be ignited by an electric spark. The firedamp was quickly exploded in this manner. In a subsequent experiment another explosive mixture was prepared and confined as in the previous test and was then fired into by a shot charged with a permissible explosive. In this case the firedamp was not exploded, notwithstanding the fact that the shot produced a much larger flame than the electric spark. In explanation Mr. Clarence Hall says: "The flame temperature of all explosives exceeds the ignition temperature of inflammable gas and dust mixtures, but fortunately the flame of a permissible explosive properly detonated is of such short duration that under the conditions of blasting coal it does not ignite the inflammable mixtures." This is undoubtedly true; but it is also more than probable that, if the flame produced by the permissible explosive could have been applied to the inflammable gaseous mixture in the gallery without the commotion caused by the firing of the shot, there would have been an explosion. Evidently the wind or pressure wave preceding the flame repelled the firedamp and kept it momentarily beyond the flame's reach, and when the immediate reaction occurred and the gaseous matter was drawn back into the space from which it had been expelled, the flame had either died out or, if still in existence, its temperature had been reduced below the ignition point. It may therefore be concluded that the danger of igniting the firedamp by the flame, having a temperature, according to Mr. Hall, in excess of the ignition temperature of the inflammable gas mixture, was at least materially reduced, if not entirely averted by the repelling action of the wind or pressure wave preceding the flame.

During the meeting of the International Mining Experiments Stations Conference last September a number of tests were made in the Bruceton

*Inspector of Mines, Chariton, Iowa.

mine to demonstrate the behavior of dust explosions. In one, the test main entry for a distance of 500 feet from its mouth was spread with fine fresh coal dust, 1 pound of dust being used per linear foot of entry. The cannon, charged with $2\frac{3}{4}$ pounds of black powder, was placed at the end of the dust zone, or 500 feet from the mine mouth, the muzzle of the cannon facing the entrance. No dust was placed behind the cannon. When the shot was fired the dust exploded, the flame extending back of the cannon into the dustless space over a distance of 50 feet. In another test the dust was spread in the same manner as before, but the dust zone was extended 150 feet and the cannon was placed 550 feet from the mine entrance with the dust charge extending 100 feet behind the cannon. When the shot was fired the dust in front of the cannon exploded as before and, as in the other test, the flame, preceded of course by a wind or pressure wave, was again projected 50 feet to the rear of the cannon into the now dust-charged zone but failed to explode the dust. It should be remembered that the dust used in these tests was readily inflammable, was specially prepared and carefully spread under conditions highly favoring its ignition and therefore the failure to fire the dust behind the cannon, although the flame in that direction measured 50 feet in length, may also be accepted as good proof that the mere projection of a long flame, if preceded by a wind or pressure wave, is not sufficient of itself to ignite the dust present with explosive results.

These examples are good, but I want Hogan to take a larger view of the matter. During the last 10 years eight explosions of dust, causing the loss of eleven lives, occurred in Iowa. All these explosions were of rather limited extent, and only in two cases, where the workings were yet within a few hundred feet of the shafts, did they extend to the surface. The mines of Iowa are non-gaseous and generally dry. About four-fifths of the total coal output is blasted from the solid by the use of black powder. Sprinkling or otherwise wetting the dry dust in rooms and other working places is not practiced, but the shots are examined before they are charged and fired by shot firers after the miners have left the mine. The average yearly coal production in this state for the last 10 years, mined by the use of powder, was in excess of 5,000,000 tons. I will assume that each shot fired yielded 5 tons of coal; on an average

there were then 1,250,000 shots fired for each explosion. I will assume further that only 1 per cent. of these shots or 12,500, a very low estimate, were tamping blowers or otherwise ineffective. From every one of these shots, good and bad, flame of greater or less length was projected, preceded by a wind or pressure wave driving what dust there may have been present away from the flame. The evidence of the results of the million and a quarter shots shows conclusively that the mere projection of flame under the condition named is comparatively harmless, and, inferentially, that the repelling action of the wind or pressure wave tends to prevent the rapid ignition of the dust in large enough quantities to produce explosive effects. If this interpretation of the evidence is correct, it is then apparent that the voluminous ignition of the dust by the flame of the one shot that caused an explosion occurred during the period of reaction and that the flame was of unusually long duration.

Let Hogan take the facts and judge for himself. The Lost Creek mine, in Iowa, was opened in 1901 and in January, 1902, the workings had become so extensive that about 100 men could be employed. The mine was non-gaseous, dry, well ventilated and in good condition. Although there was some dust, it was not permitted to accumulate, and in this respect the mine was kept exceptionally clean. The coal was blasted from the solid and shots were fired twice a day, at noon and at quitting time in the evening. The miners prepared and fired their own shots, and, as the use of fuse was not permitted, they were well tamped. On January 23, 1902, the miner in room 10, second north on the east side, fired at quitting time a shot which blew the tamping, but did no damage whatever. The room, about 500 feet distant from the hoisting shaft, had been driven about 50 feet, was slightly dipping and had no cross-cuts connecting it with adjacent rooms. On January 24 the miner recharged the hole and fired it at noon. The result was a terrific explosion causing the death of 20 miners and injuring many more. In looking for the primary cause of the explosion it was apparent that it could not have been due to a difference in dust conditions. The quantity of dust in the room and its immediate vicinity was not increased over night nor was its condition changed otherwise in any way. The effects of the firing of other shots in the nearby working places could not have been contributing factors in

starting the explosion, because the shot in room 10 was the first shot fired at noon. There was this difference, however. The shot at noon had not only blown the tamping again, but also had found vent through a horizontal fissure in the coal that had been made by a shot fired several days before. The flame issuing from the fissure evidently had been of unusual intensity and duration, for when I examined the room in the morning of January 25, I found that the roof along the face in front of the fissure had been cracked and blistered by the great heat, while further out from the face toward the room mouth the roof was far less affected in this respect. Notwithstanding the absence of a cross-cut, I found the air in the room pure and fresh, due to the effects of natural ventilation. The presence of several persons and lights at the face increased the air movement in the room perceptibly, and when I placed my lamp on the floor between the rails the air-current was sufficiently strong to deflect the flame horizontally toward the face. Now, as this air movement was produced by the difference of only a few degrees between the temperature of the air at the face of the room and the temperature of the air in the entry, what would be the probable result if, through the effects of the shot, the difference in temperature between the two points was 1,000 or 1,500 degrees? Evidently, the force of the return air wave would be increased tremendously and a fierce draft would result, rushing along the bottom from the entry toward the face of the room, raising and sweeping along with it the dust in its path, a great volume of a highly inflammable mixture of dust and air would thus be injected into the flame still burning at the face, and instantaneous ignition of the mixture would follow with explosive results.

A comparison of the results of the shot fired in the Lost Creek mine on January 23 with the recharged shot fired on January 24, permits the conclusion that the starting of a dust explosion, other conditions being the same, depends on the intensity of heat and flame developed by a shot or other inciting agent capable of producing heat and flame. That this conclusion is justified, is further shown by the results of a series of trials to start an explosion at the main entry face in the Brucecon mine. At the time of the trials the entry face was 1,250 feet distant from the mine entrance. Flush with the entry face a cross-cut connected the main entry

with the air-course. The whole length of the main entry from the face out was charged with dust, 1 pound per linear foot, and the cross-cut and a small part of the air-course were similarly charged, so, apparently, a better opportunity for dust ignition by the flame of the shot was provided than existed in previous tests, resulting in explosions, where the dust for primary ignition was available in one direction only. The hole at the entry face contained the usual charge of $2\frac{3}{4}$ pounds of black powder and was tamped with 4 inches of clay. The shot failed to cause an explosion. In the next trial, made precisely under the same conditions, failure again resulted. I stated before, that, in my judgment, the primary projection of flame, preceded by the wind or pressure wave caused by the expansion force of a shot, does not ignite the dust explosively. Flame projection of the first blown-out shot in room 10 in the Lost Creek mine did not cause a dangerous ignition of the dust, and immediately subsequent events proved that there was sufficient dust present to start an explosion. In the two Bruce-ton tests, flame projection into carefully prepared and amply charged dust zones also failed to produce explosions.

The men in charge of the Bruce-ton experiments were determined, to have an explosion and so they prepared for a third trial. In this test the hole in the face of the entry was charged as before with $2\frac{3}{4}$ pounds of powder. Another charge of $2\frac{3}{4}$ pounds of powder was put in the cannon that had been placed in the cross-cut near the entry in such position that the flame from the cannon's mouth was projected along the entry toward the mine entrance. As the shots were fired electrically, their explosion was simultaneous. This time there was no failure and the result was a violent explosion.

In looking for the causes responsible for the failure to explode the dust in the first two trials, careful consideration should be given to any known difference in conditions as they existed in the tests productive of explosions and in the tests that failed. Two differences are readily apparent. First, in all the previous tests, resulting in explosions, the greatest distance between the location of the shot and the mine entrance was about 850 feet, while the distance between the mine entrance and the face of the main entry where the shots were located in the unsuccessful trials was 1,250 feet. Increase in distance between the mine openings and the shot fired appears

to have a preventive influence (the matter is explained further on). In this case the difference in distance was only 400 feet and consequently its preventive influence, if it existed, was correspondingly small, but its possible effects should be considered, for the margin between safety and danger is often very narrow and little causes may have great effects. Second, in previous tests made to note the effects of shots fired in the face of the main entry, then 750 feet distant from the mine entrance, the cross-cut from the main entry to the air-course was 100 feet from the face. With the cross-cut so located the shots fired in the face of the entry produced explosions of the most violent types. In the trials that failed, the cross-cut was located right at the face and it should be determined if this fact has any bearing on the results. Hogan knows about the wind preceding the flame of a shot and he is sufficiently informed regarding conditions affecting mine ventilation to know that, if a given force produces an air movement of a certain velocity through a single channel, and a second similar channel, starting from the point of force, is provided, the velocity of the air movement in either channel will be materially less than the former velocity in the single channel, and he also knows that an increase of the lengths of the channels will result in a still further reduction in the speed of the air flow. Then, assuming the shots to have been of equal force, it appears that, on account of the presence of the two channels starting from the main entry face, the velocity of the air wave preceding the flame in the trials that failed was less than in the previous successful tests. The reduction in velocity brought two results. One was that less dust was blown from the shelves, the other that the recoil or the return air movement had less force and velocity. Hogan will readily understand the first result and I shall try to explain the meaning of the second. The return air movement toward the point where a shot was fired is due to two causes, first, the contraction through rapid cooling of the gaseous matter in the immediate vicinity of the shot; second, the well-known draft-producing effects of heat and flame. Both forces work combinedly. For the purpose of illustration, I will only consider the effects of heat at the main entry face; and to make matters as plain as I can, let it be assumed that a shaft is sunk at the main entry face in front of the cross-cut and that the natural heat of the mine near the face is sufficient to produce an air-

current, the shaft being the upcast. The air is now traveling on the main entry and on the air-course and from the latter through the cross-cut to the shaft. A greater air velocity on the main entry is desired. This may be accomplished in two ways: first, by closing the cross-cut at the face and causing all the air to travel on the main entry; or, second, by leaving the cross-cut open, and artificially increasing the heat at the bottom of the shaft until the desired air velocity on the main entry is produced. Evidently, as the return air movement in the trials that failed was too weak to be effective, it could have been increased by firing one shot with the cross-cut closed; or, with the two channels open, by increasing the heat by firing two shots simultaneously. The latter process was used in the third trial that resulted in exploding the dust. By firing the two shots together in this trial the force of the wind or pressure wave preceding the flame was increased, and consequently it stirred up and dislodged from the shelves a greater quantity of dust than in the former trials, the reaction was greater and materially accelerated through the effects of the much increased heat at the face, and these combined influences produced a dust-charged draft, highly inflammable, that rushed along the bottom toward the heat center and flame area at the face and fired there with explosive results.

I have given Hogan only facts as they appeared at the starting points of explosions because it is the knowledge of such facts he needs most. He knows the terrible consequences of big explosions and there can be no doubt about his willingness to do all he reasonably can to help in the work of preventing these disasters, but he cannot be sufficiently effective in this respect because he has not the necessary thorough rudimentary knowledge to enable him to understand the combination of factors and the influence of each that tend to bring them about.

He must know the nature of the danger in all its essential details before he can fairly judge the value and effects of proposed means of prevention and apply them intelligently according to the needs in each case. This rudimentary information should be made available to Hogan not only to enable him to recognize dangerous conditions in his own working place and to use the right means for their removal, but also to make him fit to become a competent instructor and adviser of his less experienced neighbors.

The Letter Box

Readers are invited to ask or answer any question pertaining to mining, or to express their views on mining subjects in this department. All communications must be accompanied by the name and address of the writer—not necessarily for publication.

The editors are not responsible for views expressed by correspondents.

Fossils in Coal

Editor Mines and Minerals:

SIR:—Some time ago I was told by a miner in one of the anthracite mines near Scranton that he had a fossil fish which he found in the mines. I did not see it and I have been taught that no fishes existed at the time the anthracite coal measures were laid down. I would like to know if any one else has found any fossils supposed to be fishes in such coal measures.

G. A. C.

Pittston, Pa.

Mine Drainage

Editor Mines and Minerals:

SIR:—In dip workings, I desire to drain a sump that holds 10,000 gallons and that fills every 12 hours. Will a pump located 30 feet vertically above the sump, with a 3-inch suction pipe 1,000 feet long, and a discharge pipe 4 inches in diameter, and 3,000 feet long, with a 20-foot vertical lift, work satisfactorily? If so, what size pump is necessary to handle the water without constantly emptying the sump?

T. E. R.

Millsboro, Pa.

Source of Blackdamp

Editor Mines and Minerals:

SIR:—Some workings near the surface have been making blackdamp quite steadily and it is something of a mystery what is the source. There are numerous breaks to the surface in the territory affected and the part where the most blackdamp is found is nearly under a large slack pile. It has been suggested that fire is starting in the pile and the gas from it gets into the mine through cracks to the surface. If this is so, would there not likely be carbon monoxide in dangerous quantities as well as blackdamp? No indications of the former have been discovered.

MINER

Booster Fans

Editor Mines and Minerals:

SIR:—As a matter of interest to mine officials, and to settle constant controversy, I would ask my colleagues in the coal-mining industry to aid in the settlement of the fol-

lowing question: Are "booster" fans of any real service, and is the service they render of sufficient amount to justify their installation?

By the term "booster" fan, I mean an auxiliary fan set up some place along the air-course and operated with the idea of increasing the volume of air supplied by the main fan.

I would request statements from mine officials who have had practical experience with "booster" fans as to actual results obtained; and also from those who have studied the matter from the standpoint of flow of air in mines, as to the conclusions they have formed.

MINE MANAGER

Denver, Colo.

Gases From Acetylene Lamps

Editor Mines and Minerals:

SIR:—In your November issue Mr. T. S. Almond requested information on carbide gases in mines. In this isolated place, not having a "Chemistry" at hand I will not attempt to answer the second question.

From actual experience I can answer the first question.

The mines of this company, Cia. Minera Jesus Maria y Anexas, are gold mines. The vein is narrow, dips 26°, and is broken and faulted. Drifts on the vein become impassable if neglected for several months. There are several openings to the surface. There is no system of artificial ventilation. Drifts are driven as far as possible, about 300 feet, then a connection is made with the level above. As can be imagined, before a connection is made these drifts have very poor air and become very hot from the continual slow movement of the mountain along the broken vein. A temperature of 100° F. is common in the drifts.

Candles were formerly used. In the hot places only the best American candles, at a cost of 15 cents per man per day, could be used; in other parts of the mine a cheaper candle, costing 12½ cents per man per day was used. In an endeavor to cut down this expense many other methods of lighting were tried, among them being

coal oil, a mixture of one-fourth coal oil and three-fourths lard oil, ordinary miners' oil, and carbide in acetylene lamps. The costs per day per man were: coal oil and lard oil, 6 cents; miner's oil, 15¼ cents; and acetylene or carbide lamps, 5 cents. The carbide was not only the cheapest but was the most satisfactory in all ways. It is not smoky, and for a given amount of light does not require nearly as much oxygen. By using it, the men can drive a drift much further before connecting with the next level than before. The air is clearer than when any of the other lights, not excepting candles, were used, and the surveyor can take longer sights. I have heard of coal miners objecting to the odor of acetylene, claiming that the gases given off when it was burned were poisonous. In our mine, where there is practically no ventilation, after being underground a few minutes we do not notice any odor, and it has no ill effect whatever on the men, and this statement could not be made of the smoke and gases resulting from the use of the various oil lamps tried.

The lamps we use are "Baldwin, No. 34." When several men are working in a stope, two of these lamps yield as much light as six candles. The costs given are in United States currency and are based on each man having one light. They were given me officially by Mr. V. York.

G. W. PFEIFFER

San Jose de Garcia, Sin., Mexico

Acetylene Dangers

Editor Mines and Minerals:

SIR:—The three letters concerning the possible harm that may come from the use of acetylene lamps published in your issue for December fail to emphasize what seems to me to be a very important point, namely, that ordinary commercial calcium carbide contains several impurities, notably calcium sulphides and phosphides. On adding water these give rise to the more or less poisonous gases hydrogen sulphide (H_2S) and phosphine (PH_3) which contaminate the acetylene and give it the familiar strong odor. These gases can be removed by passing through a solution of chromic acid (CrO_3) and the resulting pure acetylene is odorless and harmless, as your correspondents state. But if acetylene gas without such purification, which is of course impracticable in the ordinary miner's lamp, is inhaled in any quantity, the poisonous nature of the two gases mentioned will be revealed by the appearance of headache and

other symptoms. Again, if such impure acetylene is burned and the products of combustion breathed in, the injurious effects on the kidneys and other organs from the sulphur dioxide (SO_2) formed from the H_2S , and the irritating action on the lungs and throat produced by the phosphoric acid ($P_2O_5 + H_2O$) formed from the PH_3 , cannot fail to be noticed sooner or later. It is therefore incorrect to state, as your correspondents seem inclined to do, that the use of acetylene lamps is without deleterious effects on the health of the miner.

EDGAR T. WHERRY,
Assistant Professor of Mineralogy
Lehigh University

Shaft Sinking

Editor Mines and Minerals:

SIR:—I read with interest your article on "Shaft Sinking in South Africa," in November MINES AND MINERALS, and while reading it, it brought to mind my experience in shaft sinking in the Vogelstruis Deep property, Florida, South Africa. Our record for 1 month in a three-compartment shaft, 10 ft. \times 23 ft. over all, excavating in quartzite, was 145 feet; although instead of sinking by hand we had five machines, one man and a boy to each machine. The men would go down, rig up their machines, drill the bottom over, pull down, and blast the sinking holes before coming off shift. The other conditions were similar to those of the article referred to. In my belief, no men should be down the shaft when the timbermen are lowering the wall plates and end plates. In one instance an end plate fell to the bottom and severely hurt a Kaffir, and although it was purely accidental, yet, the best are liable to make mistakes, and that is why no workmen should be in the shaft during the time of lowering timber. I also think it would be a great saving of time if two or three men were employed to put in the timber in shafts, for it would give the men who were sinking more time, and enable them to sink to a greater depth every month. I think considerable time would be saved in the Lake Superior district if self-dumping skips were used instead of buckets. The skip holds more, and empties into a pocket on the surface holding probably twenty or thirty skips, so that while the men are drilling, the pocket on the surface can be emptied. Again, time would be saved, which is now employed in knocking up the catches on the bucket, dumping, pulling it back,

putting on the catches, and pulling up the protection door. The bonus system seems to meet with the hearty approval of the men wherever it has been tried, as it not only gives the men a better pay, but it makes them eager to make a record, and gives better satisfaction between master and men. I think one of the greatest assets a company can have is the good will and hearty cooperation of its men.

SAMUEL HARRIS

Negaunee, Mich.

Stone Dust in Mines

Editor Mines and Minerals:

SIR:—I am surprised to know that our mines at Delagua, Colo., are the only ones in the United States using stone dust.

If the steam men who have several haulage roads will treat one with stone dust, and then make comparisons with conditions in the "wet" roads, I believe they will be converted. All our pit bosses who had experience with water before the adobe dust was applied are now enthusiastic stone dust men.

The credit for introducing a machine for distributing stone dust in mines rests with Mr. W. J. Murray, vice-president and general manager of the Victor-American Fuel Co., and I believe the appliance serves a very useful purpose at a trifling cost. The machine consists of a small Roots blower, belt driven from a 3-horsepower direct-current motor, the whole arrangement with dust hopper carried on a small truck 9 ft. \times 3 ft. The motor takes current through a trolley pole, and the whole outfit consists of a locomotive, mine car carrying dust, and the machine. There is a 3-inch rubber hose attached to the blower, and two men can cover from 1 to 2 miles of entry in a night, spraying the dust on the roof and sides. The finer dust is carried long distances in the air-current when distributing is going on, but I see very little or no dust in the air during the day time. So far, the use of stone dust here has caused no inconvenience to the workmen, nor has it delayed the traffic underground, something which cannot be said about the use of water.

After a roadway has been treated by hand, all ledges cleaned free from coal dust and filled with stone dust, all necessary shelves erected and loaded, and the floor having been reasonably cleaned, then the blower can travel on the roadway and give another coating of stone dust, and also from time to time when coal

dust begins to collect on the stone dust on the projections. These subsequent treatments can be done rapidly and at small cost. To secure safety the roofs and sides must be loaded with stone dust, or adobe dust, as heavily as possible. The machine will not give that heavy first supply which is requisite, and the work will have to be supplemented by hand.

Where the bulk of distributed dust settles on a floor, and the floor is cleaned from time to time, the adobe dust is removed with the small coal and dirt, consequently, after that, there is no benefit from the dust which reached the floor. Stone dust placed on roof and side projections, either natural or artificial in the form of shelves, remains there during the life of the mine to act as a diluent should ever the occasion arise, and money spent placing dust in those places gives a permanent return.

A comparison between the stone dust and steam or water methods is too big a proposition to be dealt with in this letter; but after a varied experience with water I favor the stone or adobe dust method unreservedly. I believe it gives more safety when properly applied, is less costly, and is more sanitary.

A mine may be treated with water for 5 years or for 25 years, and if the water supply fails, the condition is as dangerous as ever in 2 or 3 days. Time does not reduce the cost of steam or water method, but it does reduce the cost of the stone-dust method. Stone dust does not evaporate.

You are probably aware that a large number of the mines which have "blown up" in the last 18 months were water-treated. Cokedale, near here, which was considered a "safe" mine, and was so well watered that the miners complained about having to travel through the water on the roads, blew up and the flame swept through the workings from the face to the outside. This mine is not fiery, open lights are used throughout. A commission visited this mine a few weeks before the explosion, and I take this extract from their report: "It is a pleasure to say that in the Cokedale mine there was very little dust, in fact we were unable to find a suitable sample for analysis." A blown-out shot was the cause, and I venture to say that if the entries had been stone-dusted the explosion would have been confined to the room in which the shot was fired.

In conclusion, will say that the work of stone dusting all the Delagua mines is not yet complete. The work is proceeding.

SAMUEL DEAN

Scientific Management

Editor Mines and Minerals:

SIR:—As a student of efficiency engineering applied to mining, I am much interested in query of "Superintendent, Pittsburg, Pa.," in December Letter Box. I am sorry that space will be lacking if I write fully, therefore, if Superintendent will correspond with me I will be only too glad and very much obliged to him if he will submit his conditions to me.

Each individual case needs its individual handling, although the same general rules can be applied. By a close unbiased, unprejudiced study of the conditions in the mine and mill, of the men and their state of mind, by a comparison of what his mine and mill are doing to what they should do, and to what others of equal size are doing, by a comparison of his machines, what they do to what they should do, by analyzing his organization, his mill layout, and by cultivating his sense of proportion, he can apply the principles of the efficiency engineer. However, as I have mentioned before, specific cases need specific handling.

M. L. BECKER

703 E. Illinois St., Urbana, Ill.

Editor Mines and Minerals:

SIR:—In reply to "Superintendent" in your December issue, I would state that there are several engineers engaged in efficiency work among collieries of Pennsylvania and West Virginia. This work not only covers the general problems of scientific management, but also goes exhaustively into the preparation of the output, haulage, ventilation, drainage, methods of accounting, organization and kindred problems with a direct view to reducing the cost per ton; and it is a matter of gratification that our Captains of Industry are sitting up and taking notice.

STEPHEN T. WILLIAMS

New York, N. Y.

來 來

Moisture in Coal

Experiments by E. H. Archibald and J. N. Lawrence on the drying of bituminous and anthracite coal under different conditions are described which show that the U. S. A. official method (heating for 1 hour at 104°–107° C.) gives figures for moisture, which are much below the true value, the error in the case of some bitu-

minous coals amounting to 40 per cent. of the true content of moisture. The errors, probably mainly due to the oxidation of iron, or sulphur, or both, and to the incomplete expulsion of moisture, are much greater for bituminous coal than for anthracite. For determining moisture in bituminous coal, it is recommended that the coal be heated in a current of dry air at a temperature not below 110°C. and the moisture expelled be absorbed by anhydrous calcium chloride. (J. Ind. Eng. Chem., iv, 258.)

來 來

Coal Mining Notes

By Special Correspondents

CAPE BRETON, N. S.

The collieries of the Glace Bay district have had the most successful year in the history of the industry. The output of the Dominion Coal Co. for 1912 will exceed 4,500,000 tons showing an increase on the output for 1911 of over 500,000 tons. This company has now in operation 15 collieries, and two in course of development. Several others are projected in the near future.

For a number of years past the Dominion Coal Co. has been perfecting a scheme for the general electrification of its collieries, and the four newest mines are operated exclusively by electric power. The use of electricity underground has so far been restricted to the driving of pumps, the current being introduced into the mine through boreholes. The motors are all placed in fireproof pump houses. The mining machines are driven by compressed air, obtained from electrically driven compressors on the surface.

A new power station was recently completed, which is interesting, in that the boilers are of a novel type, so far as is known the first of their kind in America, although a number are being successfully operated in England. These boilers are the invention of the late Lieutenant Bettington, who was recently killed by a fall from an aeroplane in the British Army maneuvers. The boilers are fed by dust fuel injected into a vertical combustion chamber under pressure, the dust being consumed in a vertical jet some 20 feet in height. The combustion chamber is lined with firebrick set in without cement. Vertical water tubes are arranged in a circle around the firebrick lining, the superheater tubes being coiled spirally around the vertical tubes. The flame temperature in the combustion chamber reaches 2,500° F., and all the combustible matter of the fuel is

consumed, the irreducible residue falling into the pit as molten slag. The walls of the combustion chamber are said to need no relining as they are automatically kept at one thickness by the deposition of molten slag, the thickness being regulated by the cooling effect of the surrounding water tubes.

The present installation consists of three boilers, two of which are now under steam. It is as yet too early to say what results may be expected from this innovation, but so far they justify sanguine hopes.

The electrical part of the plant consists of two 2,000-kilowatt turbo-generator units, the turbines taking live superheated steam.

ALABAMA

Mr. Carr McCormack has resigned as superintendent of the Flat Creek mines of the Pratt Consolidated Coal Co. and accepted the position of general manager of the property of the Milner Coal and Railroad Co., at New Castle, recently acquired by Erskine Ramsay and G. B. McCormack, of Birmingham.

A fire at the Banner Mines of the Pratt Consolidated Coal Co., December 7, destroyed the tippie, coal bins, and coal washers entailing a loss of \$40,000. The company expects to be loading coal in 2 weeks over a temporary structure. The old structure is to be replaced by a steel and reinforced concrete structure.

The coke ovens of the New Castle mine are being fired. The 250 ovens at this plant have been closed down for the past 3 years.

The car situation is still short. The coal production will go above past years; it is expected to go above 18,000,000 tons.

來 來

Iowa Mine Report

The report of the State Mine Inspectors of Iowa, for the 2 years ending June 30, 1912, shows that there has been one fatality in Iowa for every 220,462 tons of coal mined, and for every 251 persons employed inside the mines, or at a rate of almost four per thousand employed. The following are the figures:

District	Inside Fatal	Non-Fatal	Production	Inside Employes
1	21	90	5,355,697	6,727
2	23	78	4,893,097	5,047
3	22	126	4,301,708	4,788
Totals...	66	294	14,550,502	16,562

Of fatal accidents, 60 per cent. were caused by falls of roof or coal, as were 53 per cent. of the non-fatal. Two fatalities were due to explosions of dust ignited by blasts.

Answers to Examination Questions

Second Grade Mine Foremen, Pennsylvania, Bituminous, 1912, (Concluded)—Colorado Mine Inspectors, 1911

QUES. 17.—What regulations should a mine foreman enforce to prevent accidents to drivers, motor men, and all other employes on haulage roads?

ANS.—No person must be allowed to travel to and from his work on any locomotive road unless no other road is provided for the purpose, and no person other than the driver or trip rider shall be allowed to ride on the loaded cars.

Drivers must not leave a car or a trip where another car or trip is liable to run into it, nor where it will interfere with the ventilation; in running down grade, cars must be kept under control by brakes or sprags; drivers must see that no one is allowed to ride upon loaded cars or drive a mule or horse in their place; and when opening a door must see that it is properly closed after the trip has passed.

Trip riders must see that all hitchings and couplings are in good condition and that the cars are properly coupled before the trip starts. Any defects must immediately be repaired or made good, and, if this is not possible, the trip rider must hold the trip and at once notify the foreman or assistant foreman. The trip rider must not allow any person to ride on the loaded trip at any time, nor upon the empty trip without the authority of the mine foreman. The speed of the trip shall not exceed 6 miles an hour.

The motor man must keep a sharp lookout and sound his bell or whistle frequently when coming near the parting or landing, and must not exceed the speed allowed by the mine foreman. He must see that the motors, cables, and controlling parts are kept clean and that the headlight is burning brightly when the locomotive is in motion. He must allow no person but the attendant to ride on the loaded trip.

QUES. 18.—(a) From what source would you obtain useful data to govern you in driving toward old abandoned workings likely to contain water or gas, and how would you proceed to tap same to comply with the law, and (b) if there was a head of water of 125 feet, what thickness of barrier pillar would you leave?

ANS.—(a) Absolutely reliable information as to the near approach of active workings to abandoned ones can only be obtained from an examination of accurate maps. This is particularly so if present workings must be kept the legal distance of 50

feet from the old ones. When the distance to the old workings is less, it sometimes happens that there is a seepage of water or even gas from the old, through the coal, to the new workings. Bore holes drilled ahead may tap the old workings. Water in old workings may legally be removed by driving a passageway to drain it off. If gas cannot be removed by the ordinary methods of bratticing, etc., one or more bore holes not less than 6 inches in diameter must be sunk from the surface to some high point in the old workings that the gas may have an opportunity to escape to the surface.

If the workings are approaching abandoned workings supposed to contain either water or gas, two bore holes must be maintained not less than 12 feet in advance of the face, and must be driven the same distance into each rib and at intervals of not more than 8 feet apart; and all headings, under these conditions must not be more than 8 feet wide. Old workings must not be tapped until all employes except those actually engaged in the work have left the mine. Those actually employed in the work must be under the immediate supervision of the mine foreman and must use nothing but locked safety lamps.

(b) The law states that the barrier pillars must be 1 foot thick for each $1\frac{1}{4}$ feet of head of water. In the case in question, the head is 125 feet, so that the pillar required is $125 \div 1.25 = 100$ feet.

QUES. 19.—What method would you use in extracting pillars in the mine by mining machines under ordinary conditions of roof and floor?

ANS.—It is not generally possible to use mining machines, even of the pick type, to undercut all the coal in pillars which are being drawn, because the weight of the roof causes the coal to settle on the chain and so stop its motion. As a general rule a cut-through is made across the pillar some 10 to 12 feet back from the breakthrough at the face. This cut-through may be from 8 to 12 feet in width, and the stump left will be of about the same dimensions. In some cases all this stump may be undercut by machines, but it will generally be necessary to get this with a pick. Another cut-through may then be made by machine, leaving a second stump to be removed (probably) by

hand; and similarly until the pillar is removed. The details as to the width of the cut-through, size of stump, arrangement of pillars, etc., will probably be different in each mine.

QUES. 20.—What would be the height of the motive column for upcast and downcast shaft in a case where the depth of each shaft is 300 feet, and the temperature of the down cast 32° F., and the temperature of the upcast 48° F.?

ANS.—The motive column is a head of air of such a height that it will equal the difference between the weight of the downcast and upcast columns of air.

The formula for the motive column is $M = D \times \frac{T-t}{460+t}$ in which D is the depth of the shaft in feet and T and t are the temperatures of the upcast and downcast shafts, respectively. The motive column for the upcast air would be $D = 300 \times \frac{48-32}{460+32} = \frac{300 \times 16}{492} = 9.75$ feet. That for downcast air would be $D = 300 \times \frac{48-32}{460+48} = \frac{300 \times 16}{508} = 9.44$ feet.

It must be understood that these two heights are equivalent to each other, the difference being accounted for by the difference in weight of 1 cubic foot of air according to the temperature.

QUESTIONS ASKED AT THE EXAMINATION FOR STATE MINE INSPECTOR, COLORADO, 1911

QUES. 1.—If you were driving rooms 30 degrees off the entry, how far apart would you turn the rooms in order to have each room 35 feet wide and leave a 25-foot pillar?

ANS.—As shown in the Fig. 1, the distance between the center lines of

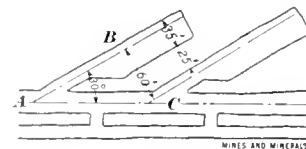

FIG. 1

any two rooms measured at right angles to the direction of the rooms is $25 + 35 = 60$ feet. In the right-angled triangle ABC we have given the angle 30 degrees at which the rooms are turned off the heading, and the side opposite it, which is the distance between room centers, or 60 feet. We have to find the hypotenuse AC , which is the distance along

the entry between the stations at which the sight plugs are set for driving the rooms. $\text{Hy.} = \frac{\text{side opposite}}{\text{sine}}$

$= \frac{60}{\sin 30^\circ} = \frac{60}{.500} = 120$ feet as the distance apart of the rooms measured along the entry.

QUES. 2.—If you had a double acting pump running at a piston speed of 90 feet per minute, the diameter of the plunger being 10 inches, how much water per hour would it discharge?

ANS.—A double-acting pump delivers water through the full length of its stroke, hence the discharge per minute is equal to the volume of a cylinder whose length is the distance traveled by the plunger, or 90 feet, or $90 \times 12 = 1,080$ inches, and whose area is equal to that of a circle of 10 inches diameter $= .7854 \times 10^2 = 78.54$ square inches. This volume when multiplied by 60 and divided by 231 (the cubic inches in a gallon) will give the discharge in gallons per hour. We then have, $\text{Vol.} = \frac{78.54 \times 1,080 \times 60}{231} = 34 \times 1,080 \times 60 = 22,032$ gallons per hour.

QUES. 3.—Name and describe the different gases common to the mines of Colorado. What are their dangers to life, and their injurious effects on the workmen employed therein? Give also their symbols, specific gravities, and properties. Where are they found? How produced? State other effects on combustion.

ANS.—As the coal mine gases of Colorado differ in no way from those of other states, reference should be made to the answers to this and similar questions which have appeared in MINES AND MINERALS during the past 6 months.

QUES. 4.—How many cartridges 15 inches long and $1\frac{1}{2}$ inches in diameter can be made from a full keg of powder 11 inches long and 9 inches in diameter.

ANS.—This problem is solved by finding the volume of the two cylinders, respectively, $15 \times 1\frac{1}{2}$ and 11×9 inches, and dividing the greater by the less. The volume of any cylinder is equal to the area of the base multiplied by the height or altitude, and the area of the base is equal to the square of the diameter multiplied by .7854. The problem may be placed in the following form:

$$\frac{.7854 \times 9^2 \times 11}{.7854 \times 1.5^2 \times 15} = \frac{81 \times 11}{2.25 \times 15} = \frac{891}{33.75} = 26.4. \text{ Ans.}$$

QUES. 5.—Of what is the atmosphere or the air composed?

ANS.—The atmosphere is composed,

by volume, of 79.3 per cent. of nitrogen (symbol *N*) and 20.7 per cent. of oxygen (symbol *O*), with about 1 per cent. of argon, xenon, krypton, etc., rare gases allied to nitrogen. The percentages by weight are nitrogen 77 and oxygen 23. In all normal air there is more or less watery vapor, and minute amounts of carbon dioxide, ammonia, vegetable matter, etc., which vary from one place to another. In cities traces of sulphuric and hydrochloric acids may be detected by analysis, and near smelting plants are to be found acids of which the base is sulphur, arsenic, or the like, depending upon the nature of the ores being treated thereat.

QUES. 6.—Is spontaneous combustion possible in a coal mine? If so, what are the probable causes producing it, and what means would you employ to prevent it?

ANS.—Yes, spontaneous combustion is possible in mines and is particularly apt to occur in those where the coal contains much water, as in the lignite and subbituminous mines of Colorado and Wyoming. The oxidation of iron pyrites if it occurs in considerable amount may cause spontaneous combustion, but the oxidation of the coal itself seems to be the chief cause of the trouble. In Colorado, the water-bearing lignites of the northern field often ignite spontaneously, while such action is very rare in the bituminous fields of the southern part of the state. The only way fires originating through spontaneous combustion may be prevented is to leave no coal in the gob; that is, by loading everything out, and taking the pillars clean, a matter of great difficulty. With our present systems of mining the prevention of gob fires from spontaneous combustion is practically impossible. About all that can be done is to clean up as well as is economically possible, and then keep a close watch upon all places, both abandoned and working, that a fire may be detected in its early stages, before it has had time to acquire dangerous headway.

QUES. 7.—If you were assigned a colliery of 400 acres with five veins, the third and fourth being mined, the fifth or bottom vein just being opened and you were about to mine pillars; state briefly what restrictions you would impose for the safeguarding of life, limb, and property, there being no unusual conditions.

ANS.—Regardless of how the pillars are drawn, the two upper and unmined veins will be badly disturbed and in a very unfavorable condition for safe and economic working, the roof being broken and the floor very

irregular. Of course the effect of pillar drawing in No. 3, upon Nos. 1 and 2 will depend upon the thickness of No. 3, and the distance between it and No. 2. Had the upper veins been of a quality such that the market would absorb their product, the better practice would have been to have worked No. 1 first, and while drawing its pillars to have carried on the advance work in No. 2, and similarly until all the seams were worked out in regular order beginning with the uppermost. Under existing circumstances the best course would be to begin drawing the pillars in No. 3 first, and after a break of the rocks (surface break) has been secured, to begin on those of No. 4 seam; keeping the drawing in No. 3 always a little ahead or further advanced than that in No. 4.

QUES. 8.—What is a safety lamp? Why is it safe?

ANS.—This has been answered several times in these columns recently.

QUES. 9.—What is afterdamp, and what would be the composition of the afterdamp from the explosion of fire-damp containing a large volume of air and what would it likely be if the fire-damp contained but a small quantity of air?

ANS.—Afterdamp is a term applied to the gaseous products resulting from what is known as a mine explosion. It was first supposed that afterdamp was the result of the explosion of methane and air, or firedamp, but since it is now recognized that coal dust enters into practically all explosions in bituminous mines, the term afterdamp is now used in the sense given in the definition; that is, to include the gases resulting from any mine explosion.

Under the circumstances stated, where there was an ample supply of air, the reaction in the explosion would be $\text{CH}_4 + 2\text{O}_2 = \text{CO}_2 + 2\text{H}_2\text{O}$; that is, 1 volume of methane would combine with 2 volumes of oxygen to form 1 volume of carbon dioxide and 2 volumes of watery vapor.

Authorities differ as to the composition of afterdamp resulting from the explosion of firedamp containing too little air to completely burn the methane. Doctor Brookman has shown that under such circumstances the firedamp does not form carbon monoxide, but does form ethylene, otherwise known as olefiant gas. On the other hand, Doctor Otto Brunck states that carbon monoxide is formed probably upon the reaction $2\text{CH}_4 + 3\text{O}_2 = 2\text{CO} + 4\text{H}_2\text{O}$.

QUES. 10.—The depth of a shaft is 400 feet and the power required in the ventilation of the mine is 37.8 horse-

power, find the required area of the furnace grate necessary to produce this power.

ANS.—If we let A equal the required grate area in square feet, D equal the depth of the shaft in feet and HP equal the horsepower required to produce the ventilation, the formula usually employed is $A = \frac{34}{\sqrt{D}} \times HP = \frac{34}{\sqrt{400}} \times 37.8 = \frac{34}{20} \times 37.8 = 1.7 \times 37.8 = 64.26$.

QUES. 11.—In the event of a mine fire, how would you approach the burning section of the mine; and where workmen are employed in extinguishing the fire, what precaution should be taken to prevent the dangers always to be expected in such cases?

ANS.—In event of discovering a mine fire all men except those actually employed in fighting it should be sent from the mine, the helmet crew should be notified to prepare for possible duty, and some one should volunteer to approach the fire as close as possible to obtain information as to its location, extent, etc. The fan should be kept at such a speed that the coal will burn as far as possible to CO_2 , which is non-explosive. If the fan is slowed down too much and the fire has considerable headway, there is danger of the coal burning to CO , which is highly poisonous and likewise explosive. However, the fan should not be speeded up, as the fire will then be intensified. In fighting the fire, it should be approached from the intake side so that the workers will not be compelled to breathe the gases given by it. In a mine which does not generate firedamp the chief source of danger will be from CO , which may be formed as stated, and helmets may have to be worn, or the helmet crew may be called upon to revive those who may have been overcome. If methane is given off by the seam the work of extinguishing the fire is extremely dangerous and a destructive explosion is almost certain to occur. In such a case the fan should be stopped, all openings sealed tight, and an attempt thus made to smother the fire. If this is not possible, the mine must be flooded. The actual work of fighting the flames at and near the fire depends so entirely upon local conditions, which will differ in each case, that it is not possible to give them here.

QUES. 12.—What, in your opinion, constitutes an efficient and safe hoisting plant for a coal mine? Describe in detail, from the foundation of the engine to the delivery of the carriage at the tippie.

ANS.—The hoisting engine should be of the duplex type and of such size that each cylinder singly will be capable of picking up and handling the entire load on the engine at any point in the shaft. The engine and drum should be firmly anchored to a heavy foundation of masonry or concrete by a sufficient number of bolts. If the engine is of the second-motion type, the gear-wheel and pinion should be so protected as to avoid the possibility of anything dropping between them and breaking the teeth. The appliances for the safe hoisting of the men should be of the best design and material. The brake should be such that it can be quickly applied by the engineer while standing at the throttle; it should be capable of stopping and holding the cage and its load at any point in its journey. An indicator should be so fixed as to show plainly the position of the cage in the shaft at any time and the hoisting rope should be marked with white paint to indicate the near approach of the cage to a landing. The throttle for shutting off the supply of steam to the cylinders should be positive and certain in its action, and its mechanism should be such that it cannot fail to act at the proper moment. The rope drum of the engine should be of sufficient diameter to avoid producing an undue bending strain on the hoisting rope. The hoisting rope should be capable of hoisting a load at least five or six times that ordinarily coming upon the engine. The head-sheaves should be well secured at the top of the head-frame, and should have such a diameter as not to produce an undue bending strain in the hoisting rope. The rope should be thoroughly secured in the socket by which it is connected with the cage, and bridle chains should be used connecting with the safety catches. The cages should be supplied with proper hoods or covers, and safety catches, and each landing should be provided with substantial safety gates and a proper arrangement of wings or keeps on which the cage may rest while being loaded and unloaded. A speaking tube convenient to the engineer should extend from the engine room to each landing. Proper signaling apparatus should be kept in good working order, so that the engineer cannot fail to understand all the signals as given.

QUES. 13.—A shaft is in the form of an equilateral triangle whose perimeter is 30 feet. What quantity of air is passing down the shaft when the velocity is 280 feet per minute?

ANS.—It is first necessary to find

the area of this peculiarly shaped shaft. As the triangle is equilateral each side is one-third of 30, or 10 feet long. The perpendicular height of an equilateral triangle is equal to the length of one side (10) multiplied by .866025, or 8.66025 feet. The area is equal to one-half the base multiplied by the perpendicular height, or $\frac{1}{2} \times 8.66025 \times 10 = 43.30125$ square feet. The volume passing per minute is $43.30125 \times 280 = 12,124.35$ cubic feet per minute. Calculations such as this need not, for actual use, be carried to so many decimal places. It will answer every purpose if the area of the shaft is called 43.25 square feet, or even 43 square feet. The area may also be found from the formula $A = \sqrt{s(s-a)(s-b)(s-c)} = \sqrt{15 \times 5 \times 5 \times 5} = \sqrt{1,875} = 43.30+$. In this formula, s is equal to one-half the sum of the sides, or one-half of $30 = 15$, and the values of the terms $(s-a)$, $(s-b)$, and $(s-c)$ are obtained by subtracting the length of each side, which is 10 feet, from s or 15. As the sides are all of the same length, 10 feet, $(s-a) = (s-b) = (s-c) = 15 - 10 = 5$ feet.

QUES. 14.—If, after the miners have started to work, you discovered a fire on the intake airway, what course would you pursue?

ANS.—This question has been answered several times in these columns during the past year. The question is so general in its nature, so many places may be imagined where the fire may be supposed to have started, and there may be so many and such varied local conditions to be taken into consideration, that a plain, concise, definite answer cannot be given.

QUES. 15.—How would you proceed to clear a shaft that is filled nearly to the top with carbon dioxide?

ANS.—In case an air compartment has been carried down one side of the shaft while sinking as, of course, should always be done, a fan erected over it should be able to clear the air. If a fan is not available, steam or compressed air forced through pipes opening near the bottom of the shaft may be used to dilute the air sufficiently so that a fire basket will burn, and a circulation thus be started. In event of there being no air compartment, the problem is difficult. As CO_2 is heavier than air it may be slowly and laboriously bailed out in the sinking buckets, or the cages may be boxed in and used in place of buckets. Or steam or compressed air may be introduced near the bottom of the shaft, and when the air is sufficiently diluted so that lights will burn, an air compartment

may be built. In this last case, it would be better to first introduce the air near the top of the shaft and after clearing that portion and building a brattice to form an air compartment over which a small fan should be erected, clear another length of the shaft, build the air compartment, and similarly until the bottom is reached.

QUES. 16.—An entry is parallel to a land line and 150 feet from it. If the rooms turned off the entry run at an angle of 45 degrees with the entry, what distance can they be driven?

Ans.—It is assumed that it is the center line of the entry which is 150 feet from the land line and that the rooms are to be driven exactly to the

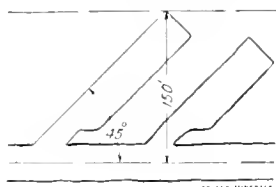

FIG. 2

line without leaving a barrier pillar, which is, ordinarily, not good practice. By referring to Fig. 2 it is seen that the answer is obtained when we have found the hypotenuse of a right-angled triangle, whose sides are each 150 feet and whose acute angles are each 45 degrees. If one acute angle of a right-angled triangle is 45 degrees the other is 45 degrees, and if one side is 150 feet, the other is the same; the hypotenuse may be found from the relation, $Hy. = \sqrt{150^2 + 150^2} = \sqrt{45,000} = 212.132$. That is to say, measuring from the center line of the entry, which is the customary engineering practice, the rib of the room may be driven 212.132 feet, when it will just touch the land line. If a 10- or 20-foot barrier pillar is left, the distance is not as just obtained, being less. If a table of natural sines is available, the better way to find the hypotenuse is by substituting in the formula

$$\text{Hypot.} = \frac{\text{side opposite}}{\text{sine}} = \frac{150}{\sin 45^\circ} = 212.13 \text{ feet}$$

It should be noted that the .13 of a foot is negligible, as rooms are not driven this close. To allow for carelessness on the part of the miners and to prevent running over the line, the rib would ordinarily be driven 210 feet from the center line of the entry, or 204 feet (about) from the rib. If the entry was wide or narrow at this particular point the distance from the entry rib to the face might be more or less than this 204 feet (about) and it would be better to

measure from the center line of the heading which is fixed by the mine surveyor, and the position of which may always be determined by the mine foreman by sighting along the line plugs.

QUES. 17.—With a fan 8 feet in diameter making 240 revolutions and passing 62,000 cubic feet of air per minute, when the water gauge stands at 1 inch, what is the equivalent orifice.

Ans.—The size and number of revolutions of the fan do not affect the equivalent orifice of the mine which is found from the formula.

$$A = \frac{.0004 q}{\sqrt{i}}$$

in which A = the area in square feet of the equivalent orifice of the mine, q = the quantity of air circulating per minute = 62,000 cubic feet, and i = the water gauge = 1 inch.

By substituting, $A = \frac{.0004 \times 62,000}{\sqrt{1}}$

$= .0004 \times 62,000 = 24.80$ square feet. The factor .0004 is sometimes given as .00038, in which case $A = 23.56$ square feet, but it is obvious that the simpler term, .0004 is close enough.

來 來

Airways With Circular-Shaped Tops

Since the departure of the old type of pick miner to that land where all good miners eventually go, a sheared entry, and particularly one with the roof shaped in the arc of a circle, is difficult to find. They are, however, occasionally met in old mines, and the calculation of the area of their cross-section has proved a source of trouble to many; to overcome this the accompanying solution is offered.

What is the area of a heading the lower part of which is a rectangle 6 feet high and 8 feet wide, the roof being in the arc of a circle with a rise of 2 feet?

The dimensions of the heading are shown in Fig. 1. In the formulas, the length, AB , is known as Ch , the chord. The rise of the arc, forming the roof above the "spring line" or point where the curved portion begins, is EF in the figure and is known by the letter H , in the formula.

The radius R , of the circle of which the arc AEB is a portion, is first found by the formula, $R = \frac{Ch^2 + 4H^2}{8H}$.

In this, Ch is the length AB , or 8 feet, and H is the length EF , or 2 feet. Substituting these values, $R = \frac{(8)^2 + 4 \times (2)^2}{8 \times 2} = 5$ feet. That is, the line $AO = BO = R = 5$ feet.

The angle, AOB , or C , at the

center of the circle and subtended by the chord (Ch) AB , or what is the same thing, by the arc, AEB , is found from the formula, $\sin \frac{1}{2}C = \frac{Ch}{2R} = \frac{8}{10} = .80000$. The angle corresponding to this natural sine is $53^\circ 7.0863'$. This is the half of the angle C , and the whole angle is, of course, $106^\circ 15.6126'$. The minutes must be reduced to the decimal parts of a degree by dividing by 60. The angle is, thence, 106.2604° . The area may now be found from the formula,

$A = .008727 R^2 C - \frac{Ch}{2}(R - H)$, in which the first term is the area of the sector, $EAOB$, and the second term is the area of the triangle, AOB . By

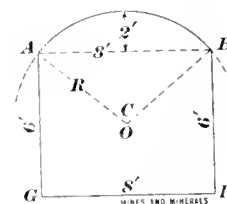

FIG. 1

substituting the various values, $A =$

$$.008727 \times (5)^2 \times 106.2604 - \frac{8}{2}(5 - 2)$$

$= 23.18 - 12 = 11.18$ square feet. For all practical purposes the angle C may be taken to the nearest whole degree. Thus, if we use 106° instead of the more exact 106.2604° , the area of the sector (the first term of the formula) is 23.13 instead of 23.18, which difference is much less than that probably due to errors of measurement in the lengths of the lines AB and EF , respectively equal to Ch and H .

The area of the lower, or rectangular, portion of the airway is, of course, $6 \times 8 = 48$ square feet, so that the area of the entire heading is $11.18 + 48 = 59.18$ square feet.

來 來

In a coal mine at Doncaster, near Sheffield, England, while a shaft was being sunk, immense quantities of water were encountered rendering the pumps useless. Those in charge adopted the freezing process. All around the shaft, down to the depth of 130 meters, auxiliary holes were drilled, through which a freezing mixture was introduced. In this way the ground in the vicinity of the shaft was frozen, as also was the water, thus forming around the original shaft a safeguard which made a continuance of the work possible. After the shaft had been walled up water-tight, hot water was run through the auxiliary pipes, which were then removed.

ORE MINING & METALLURGY

Mammoth System of Fume Control

Bag House and Apparatus at Mammoth Copper Co. Smelter that Operates Successfully in a Farming Region

By Al. H. Martin

THE control of smelter fumes has developed into an imperative problem in California. Valuable properties are idle in various sections of the state because of agitation against smelter smoke, and the output has fallen from the 53,568,708-pound mark of 1909 to about 35,000,000 pounds for 1912. The Shasta copper

The Mammoth mines are situated near Kennet, on the Sacramento River. The ores are sulphides in the form of massive pyrites containing large percentages of chalcopyrite. The ore carries about 3 per cent. of

400-horsepower motors. Under the tremendous draft of the fans the gas is driven into a chamber commanded by the cooling pipes. There are nine sections of these pipes, with five pipes to a section. The pipes are

leads into the fan chamber where the gas is violently agitated and cooled by two Sirocco fans operated by



FIG. 1. BAG HOUSE AND COOLING PLANT, MAMMOTH SMELTER

belt, the foremost copper region of California and one of the leading copper districts of the world, has been particularly affected, as the mines are situated in an agricultural country and the farmers have waged incessant warfare against the operators. As a result the magnificent plants of the Balaklala, Bully Hill, and Mountain copper companies are idle, and hundreds of thousands of dollars in the form of costly buildings and equipment are going to waste. The vast developed reserves of commercial ore lie idle, because the sulphur fumes generated by their reduction prevent their operation. The Mammoth Copper Co. alone has succeeded in keeping its smelter in commission, and by compensating the grangers for alleged losses from fumes, and the erection of a combination cooling-pipe and baghouse annex, the plant continues to maintain a heavy output.

copper and 4 per cent. of zinc with gold and silver values averaging \$1.50 to \$2 per ton. The noxious gases are neutralized to a certain extent by the zinc forming oxides in the furnace. The plant contains five furnaces, but only three are operated. The furnaces have tuyère dimensions of 50 in. x 180 in., with capacities of 425 tons per day. About three-fourths of this is copper ore, the balance consisting of silicious ore, lime, and coke.

The fumes from the hoods are received by steel gooseneck take-downs and delivered into two hopper-bottom brick flues. Each flue has a length of 260 feet, and the dust settles through the hopper bottoms into a collecting chamber of brick and steel. Four 8-foot steel pipes lead the gas from the chamber into a second collecting compartment terminating in a steel flue 15 feet in diameter. This

arranged in three divisions, whereby the smoke is first driven slantingly upward, thence horizontally and finally permitted to emerge from the final sloping section. By this means a considerable percentage of the solid material is deposited in the pipes and the bag house has less to handle. Each pipe is 200 feet long by 4 feet in diameter. Sprays are located at intervals and the pipes constantly cooled with jets of cold water. It was early found that the temperature of smoke must be reduced to a low point to prevent injury to the costly woolen bags in the baghouse, and this the cooling pipes and sprayers have accomplished.

The bag house contains 3,000 woolen bags, each 34 feet long by 18 inches wide. The bags are attached to mechanical shaking devices and discharge into hoppers placed directly beneath. Short pipes connect the

bag house with the collecting chamber receiving the fumes from the cooling tubes, and practically all the solid matter carried by the fumes is arrested either in the pipes or by the bags.

With three furnaces in commission, the bags collect approximately 25 tons



FIG. 1. CHAPEL AT HIMMELSFÜRST MINE

of solid material per day, consisting largely of zinc sulphates and oxides, with some gold, lead, and silver and traces of copper.

A portion of the material that is deposited in the bag-house hoppers is collected, mixed with the fume secured from the pipes, and briquetted. The remainder of the bag-house product is stored pending the adoption of a satisfactory and economic method for extraction of the zinc and other minerals.

After passing through the bags the smoke is permitted to escape from the four bag-house vents. During its passage through the flues, pipes, and bags the gas is largely diluted by atmospheric air, and the sulphuric gas is sufficiently reduced to permit its escape into the outer air in compliance with the regulations prevailing in California. The system, of course, is unable to prevent the escape of sulphur dioxide, but the treatment has sufficiently neutralized the noxious vapors to allow the operation for 2 years, and the fact that the Mammoth Copper Co. is operating in an intensely hostile region conclusively demonstrates the value of the method here used.

One of the greatest problems to be mastered after the plant went into commission was the reduction of gas temperatures sufficiently to prevent damage to the bags, and the cooling pipes and sprayers presented a satisfactory solution.

Foreign Mining Costumes

By C. L. Bryden

The American mining man abroad is impressed with the costumes worn by the miners of the different countries, and even in different sections of the same country.

The peculiarity of the Cornish miner's outfit is his hat and the way he carries his candle. The hat is broad-rimmed, stiff, and heavy. In the Cornwall district a plastic clay is obtained to act as a candlestick. A mass of clay about the size of a baseball is kneaded into shape by the hands, and, after passing the candle through its center, is slapped onto the crown of the hat where it holds firmly. As the candle burns shorter the miner pushes it through the clay. The candles are made specially hard as the heat in the lower levels of the tin mines would soon melt the ordinary candle.

The costume of the German miner is quite elaborate. During parades by the Bergleute it is an interesting sight to see the different costumes worn by the miners. The Freiberg district of Saxony is of special interest as the old traditions and costumes are followed. In the Mining School at Freiberg some of the professors and students wear coats similar to the miners, except that they are made out of better material, and may have buttons of silver or gold, a velvet collar and black or gold braid decorations on the sleeves half way between the elbow and the shoulder. Metallic cross hammers are placed on each sleeve just above the braid and smaller ones on each side of a stand-up velvet collar.

Fig. 2 shows two American professors in the costume of the Saxon

miner at the mine Himmelsfürst, which is one of the few mines of the Freiberg district which is profitable to operate. The mines belonging to the government have not been on a paying basis for some time and it is expected that they will be closed in 1913.

The peculiar hat is of stiff felt, quite heavy, but good to protect the head from falling rocks and bumps. A piece of muslin cut to fit and cover the head and having long streamers to tie in a bow in the back is worn under the hat.

The coat is made of strong material comparatively light in weight. It fits loosely around the body, but the sleeves are tight from the elbow to the wrist. A large collar serves as an extra protection to the shoulders. The buttons on the coat are very conspicuous and are both useful and ornamental. The useful buttons are in the center front of the coat and on the sleeves; the ornamental ones are the two rows on each side of the chest. Cross hammers are on each button.

Another noticeable thing is the revolving leather apron worn by the miners. This is of practical value as in these ore mines a great deal of the cobbing is done and when the miners sit down to cobb, the leather serves as a protection against the cold, damp rock. This portable seat is worn by the engineers and super-



FIG. 2. COSTUMES OF SAXON MINERS

intendents as well as by the miners themselves.

The lamp box is made of wood and lined with brass. Centered in the bottom of the box is a small cup to hold a candle. A little to one side is a wooden peg upon which the miner can put a specially made oil lamp,

if he wishes to use a glass slide front, which, when not in use, is slid into a compartment at the back of the box. The glass front is only used in rapidly moving air-currents. On the back of the box is a long copper hook, which serves as a handle or as a hook by which to hang the lamp on a leather strap passing around the miner's neck. Trousers are of the same material as the coat. Leather boots with hob-nail soles, and a stout cane with a sharp metal point complete the outfit. In the case of parades and celebrations a great deal of other paraphernalia is appropriated for decorating the persons of those taking part.

Fig. 1 is a view of the chapel at Himmelsfürst, where the miners worship every morning before entering the mine. They enter one door and pass out of another after services to a small room in which is a ladderway to a landing where the miners descend to their work by means of a man engine. Himmelsfürst has one of the few man engines now running in Europe.

The pipe organ shows how music is installed into the German and how it accompanies him even to the mine. The chapel benches are made of very heavy timber and show the wear of many years. On the pillar in the center of the room, is the notice of the sanitary engineer: "Nur in den Spuckhpf spucken," which translated literally into English would read "Only in the spittoon spit." Similar notices are posted throughout all parts of the plant.

采 采

Deep Michigan Shafts

Shaft No. 4 of the Calumet & Hecla Mining Co. is considerably more than 8,000 feet long. This distance of more than 1½ miles is measured along the shaft, which is really an incline having pitch of 37° 30'. In this same region there are the four deepest mine workings in the world. Shaft No. 5 of the Tamarack mine, near Houghton, Mich., has opened up the earth to a distance of more than a mile from the surface.

Within 1 mile from this shaft are the three next deepest shafts in the world. They are Shaft No. 3 of the Tamarack mine which, together with a 300-foot winze, penetrates to an actual depth of 5,553 feet; the Red Jacket vertical shaft, of the Calumet & Hecla Co., 4,920 feet deep; and another Tamarack shaft that is 4,450 feet deep. Very deep precious metal mines have been opened at Grass Valley, Cal., and in Bendigo, Australia.

Rock House of Quincy Mining Co.

Methods Used in Hoisting, Dumping, Handling and Cleaning Rock and Ore at No. 2 Mine

By T. C. Desoller*

THE Lake Superior methods of handling copper ore or copper rock, as it is locally termed, have undergone many improvements during the past few years, both with respect to underground and surface operations. It is the purpose of this paper to describe briefly one of the combination shaft rock houses, commonly known as "rock house." As the various rock-handling systems in the district work toward the same

bins are cylindrical, with flat bottoms, and instead of having inclined floors built to the discharge gates, they have rock dumped into them until the angle of the floor assumes a natural slope down which ore will slide to the openings. The building is 150 feet long by 30 feet wide except where the "large stamp" rock bin, 44 feet in diameter, is situated.

The crusher floor, as shown on the flow sheet, Fig. 1, is above the

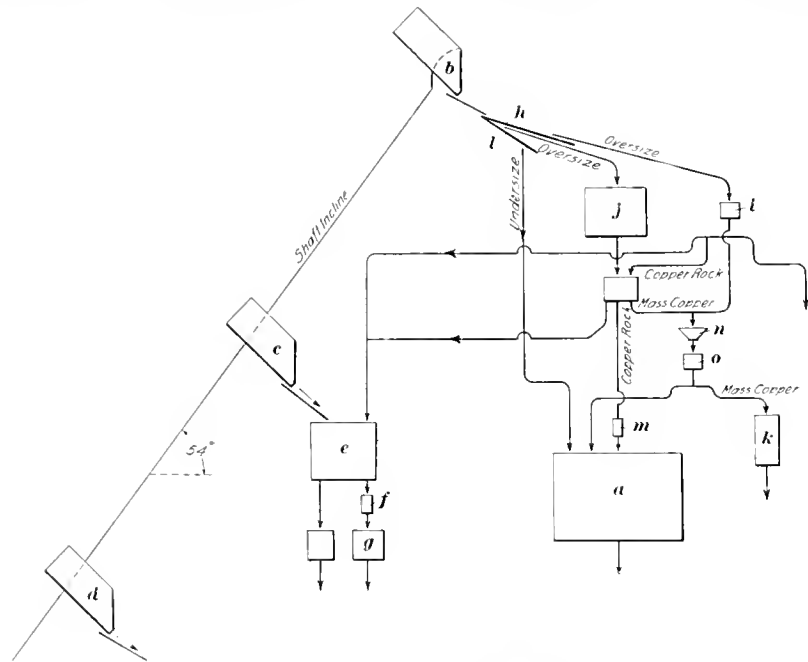

FIG. 1. FLOW SHEET, ROCK HOUSE NO. 2

end—that of crushing copper rock—it is only the intermediate steps that differ in the rock houses of the various companies. It is thought that the following remarks relating to Quincy No. 2 rock house might be of interest as illustrating the best practice devised by the Quincy Mining Co. Past experience has shown that it is advisable to break the rock at the mine to a size that can be fed to the steam stamps at the mill. The material, as it is hoisted to the surface, varies from fine material to large masses of native copper, copper rock, and poor rock, weighing at the maximum several hundred pounds.

The Quincy No. 2 rock house has reinforced-concrete foundations; steel frame construction; and is sided and roofed with corrugated iron. The

*Hancock, Mich. Paper Prepared for the Houghton Meeting of the Lake Superior Mining Institute, August, 1912.

stamp rock bin *a* and 45 feet above the discharge aprons to this bin. In order to accommodate the variations in the rate of hoisting and delivery of railroad cars for shipping, the stamp rock bin has a capacity of 2,000 tons.

Above the collar of the shaft, the stringers for skip tracks are inclined at an angle of 54 degrees, until the hump *b*, Fig. 1, is reached, where the front wheels of the 8-ton skips, which are run in balance, follow the regular track gauge, while the wide flanged back wheels ride on the hump, thus lifting the back of the skip higher than the front end and causing it to discharge. The skip has three points of discharge *b*, *c*, and *d*. The upper dump *b* is for ore; the middle dump *c* is for rock broken while sinking the shaft or driving bottom-level cross-cuts. The lower dump *d* is for mass copper and dull drills.

Dumps *c* and *d* are provided with sliding rails which are thrown by levers operated by the lander on his receiving the proper signal. Fig. 2 shows in detail the sliding rail. The slide *a* moves up and down parallel with the rail, the sliding rail *b* moves laterally. By moving *a* upwards, by means of a lever and reach rod, the rails *b* are moved to the left, opening a space of 5 inches through which the narrow front wheels of the skip pass while the wider hind wheels keep on the rails, thus dumping the skip as shown. After dumping, the movement of slide *a* to the right places the rails *b* in position so that the skip can pass without dumping if so desired. The lander is stationed in a building at one side of the shaft collar, where he transmits the signals to the hoist engineer as communicated to him from the underground chute

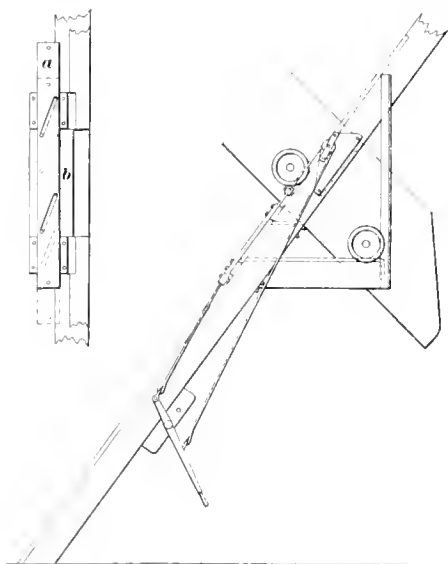

FIG. 2. SLIDING RAIL SKIP DUMP

man. The lander without leaving this room manipulates the sliding plates as described. An 8"×8" steam hoist in one corner of the building, is for handling timber, cranes and other supplies; also for the track forms used to remove damaged slope cars from the slope track. The man cars, water skip, and rock skips are suspended from cranes and can be quickly swung into place and put in operation.

The head-sheave wheels, 12 feet in diameter, and wood filled, are 119 feet vertically above the collar of the shaft. These are securely stayed by means of a batter brace. The first skip dump *d*, Fig 1, has a slope of 30 degrees which gradually flattens out to a platform of the right height to load mass copper into railroad cars or drills into wagons. The floor of the slope and the platform is of con-

crete faced with old rails having the flanges up. Mass copper weighing as much as 8 tons is loaded on the railroad cars by means of an 8-ton chain block suspended from a crawl supported by 18-inch, 55-pound, I beams over the railroad track. When rock is hoisted the second dump *c* is opened by the lander and the skip discharges into a reinforced-concrete chute, which empties into a cylindrical steel bin *e*, 13 feet in diameter. The rock is drawn off by two chutes, one of which feeds the 24"×18" jaw rock crusher *f*, which breaks the rock to a size suitable for concrete and road work. Under the crusher is a cylindrical steel bin *g*, 9 feet in diameter from which the crushed rock is loaded into wagons or railroad cars. The second chute from poor rock bin *e* delivers the coarse rock into a vertical 5-foot-diameter tube in which is a slightly inclined reinforced-concrete block to break the fall. A discharge chute is connected on the tube for loading rock into cars or wagons.

When copper ore is hoisted, the top dump *b* is used. The ore is discharged on a steel dumping plate, arranged so that the lip of the skip might remain in a position close to the steel dumping plate and not cause the rock to be violently thrown from the skip. The copper rock dump was designed in order that the skip would discharge into a pocket, which would fill until the rock took its natural slope, the rock then discharging onto the grizzlies *h*. It was found during the erection of the building that there was a mistake of about 3 feet between the blueprints and the steel construction, and a steel dumping plate was substituted.

The dumping plate spreads the rock upon 6-inch steel grizzly bars approximately 16 feet long, set at 16 degrees, and having 20-inch openings. Immediately above the grizzly bars is a battery of heavy bars, which serves the double purpose of breaking the fall of the rock and spreading it upon the grizzlies. The oversize from the grizzlies passes down on a reinforced concrete chute, striking a second battery of bars, then drops vertically into a bin having its side open toward a 3,000-pound drop hammer at *i*. Between bin *j* and the hammer is a 15-inch, 42-pound I beam carrying a traveling 8-inch 2-ton air lift. This I beam is bent in the shape of a horseshoe and permits the air lift to be used at either crusher, or poor rock chute. Here the oversize, if mass copper, is cleaned of the poor rock under the hammer; if copper rock, it is broken to a size that can be handled by the crushers;

or, if poor rock, it is thrown into a chute leading to the poor rock bin.

In case the broken oversize is small mass copper, it is thrown into a mass-copper chute leading into a cylindrical steel bin *k*, 6 feet 8 inches in diameter, which discharges into railroad cars. If it is mass copper too large for this chute, it is loaded onto a pan, swung from a crane, and lowered outside the building to a reinforced-concrete platform at the right elevation for loading on a railroad flat car.

The undersize from the 20-inch grizzlies falls upon a second grizzly *l*, composed of 3½-inch steel bars, 6 feet long, set at 30 degrees, and having 2¾-inch openings. The undersize from this grizzly passes directly into the stamp rock bin *a*, below the crusher floor. The oversize is discharged into a cylindrical steel bin *j*, 14 feet in diameter, holding approximately 10 skip loads of rock. The outlet from this bin is by two chutes 19 feet apart. Vertically sliding steel doors, 4 ft.×4½ ft., with replaceable steel linings, operated by 6"×36" air cylinders, control the feed into steel chutes set at 30 degrees. This feed is directed into the two 36"×24" jaw rock crushers *m*, and is regulated by a hinged apron, which is operated by a 6"×18" air cylinder. One man at each chute feeds the crusher, and picks out the poor rock and mass. The poor rock goes into a chute leading to the poor rock bin *e*. The mass is stored upon an inclined semicircular chute *n* called the "copper pan," on which it slides to a small steam hammer *o*, where it is cleaned from the poor rock, and thrown into a chute leading to the mass copper bin. This steam hammer is run by a third man, who handles the trolley, cleans the mass copper, oils and has charge of the machinery.

The crusher jaws are made of manganese steel, and are set to crush to 3 inches. The crushers running at 140 revolutions per minute are operated by a 12"×24" steam engine running at 110 revolutions per minute. A 75-horsepower electric motor occupying less space is installed, and is ready to run in case of a breakdown to the engine.

The rock from the stamp-rock bin is loaded into railroad cars for the mill by means of discharge aprons operated by 5"×13" air cylinders.

Three men handle upwards of 1,000 tons of rock every 12-hour shift, change man cars and skips, and load all timber and supplies that are lowered underground. Between shifts when the large mine air compressors are not in operation, power for the operation of the air lifts and air

controls is furnished by a small 11" × 11" × 12" Westinghouse air pump, so arranged that when the air pressure from the mine compressor drops, the air pump starts automatically. A combination of check-valves prevents loss of this air into the under-

ground system and, likewise, when the air pressure from the compressor is raised, the air pump is automatically stopped. This system of handling material has shown an average rock house cost of less than 2 cents per ton.

Controlling the Direction of Bore Holes

Apparatus Employed in Surveying the Holes and for Deflecting Them as Desired

IN Bulletin No. 91, of the Institution of Mining and Metallurgy, there is a description, by John L. Hoffman, of a means for controlling the direction of diamond drill bore holes, as practiced in South Africa, and of which an abstract is given here. By means of this contrivance, when it is found by a survey of a bore hole, that it is deflecting from the intended course, it is possible to change the direction so as to bring the hole back toward the direction originally intended. And it has also been possible to purposely deflect an auxiliary hole from a deep bore hole, so that the vein might be cut in two places, as shown in Fig. 2, and the drilling of another long hole be avoided.

The surveying instrument, Fig. 1 (a), which is now exclusively used on the Rand for determining the direction of bore holes, was invented by Mr. Oehman and improved upon by Mr. A. Payne-Gallwey. The instrument is an electric light photographic apparatus and consists essentially of a gun-metal tube in two halves, *a*, connected by a coupling, *o*. In the lower half of the gun-metal tube are placed a magnetic needle, *b*, and a plumb-bob, *c*, each independent of the other and each swung over a gimbal, *d*. Above the needle and plumb-bob, respectively, is fixed a small electric lamp, *e*, and all are held in position and pressed by a spiral spring, *g*, attached to the bottom screwed plug, *h*. In the side of the tube, a series of small screws, *i*, are placed in a straight line parallel to the side, their ends projecting inside the tube about one-sixteenth inch. The cylindrical cases carrying the lamps and those carrying the needle and plumb-bob have a slot down the side, the projecting screws acting as guides for the slotted cases to slide into and keep them in position.

The top half of the tube contains a dry battery, *k*, and a clock, *j*, which has a spiral spring, *l*, attached to it. The spring presses against the top end piece *m* of the tube so that when the two halves of the tube are screwed

together everything inside is held rigidly together and contact assured by means of the spiral springs at the top and bottom.

To the top end piece a ball-bearing swivel, *n*, is attached in order to lower the instrument on a wire, if necessary.

The cases, *p*, which carry the magnetic needle and the plumb-bob are made of vulcanite, for insulating purposes, the compass attachment being made of brass, the outer ring of which is held in position by two brass screws on which the ring swings. On the face of each gimbal is a fixed pin point and round the edge is a recessed ring which holds the disk of sensitized photographic paper in place, the pin points holding them in position. The plumb-bob is made of gold attached to a fine silk thread swung from the center of a thin disk of plate glass, *q*, which fits into a recess in the top of the vulcanite case.

Both the magnetic needle and the plumb-bob swing immediately above (almost touching) the sensitized papers.

The clock has an extra wheel, *r*, to which is attached a copper projection *s* which at a certain set time makes connection with a copper spring, *t*, attached to the frame of the clock and completes an electric circuit, lighting up the lamps above the plumb-bob and the needle, and photographing a sharp shadow of each on the sensitized paper.

When the two photographs are developed, the dip and direction can be read off by making the pin pricks coincide.

The deflecting contrivance consists of a pilot wedge, a guide wedge, and a main deflecting wedge, and the method of procedure is as follows: •

In the case of a Sullivan "B" hole (2½ inches diameter) a pilot wedge, Fig. 1 (c), is made of round iron, 2 inches in diameter, the length being 18 inches over all and the wedge face being about 6 inches long. The end opposite the wedge face is screwed to fit a piece of 1½ inches (inside diam-

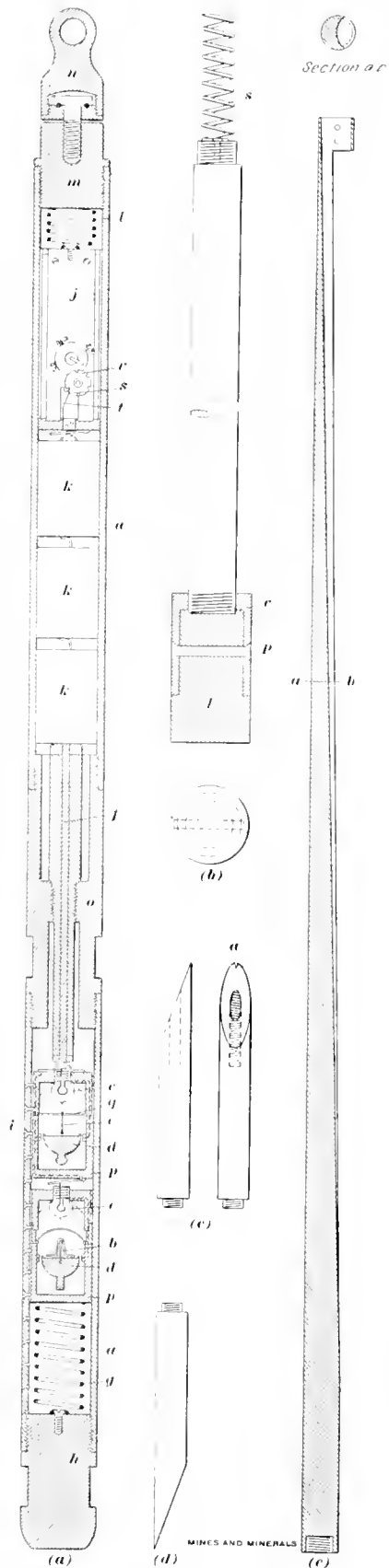

FIG. 1

eter) black piping. A ¾-inch hole is drilled in the face of the wedge and tapped, and a nick *a* is made with a chisel on the top of the wedge, along

its longitudinal axis. This nick is for surveying purposes, as will be explained later on. This wedge is screwed into a piece of $1\frac{1}{2}$ -inch piping about 3 feet long, the piping being jagged at the end opposite to where the wedge is screwed into it. The bore hole is then filled with water and the pilot wedge and piping are dropped down the hole, wedge face upwards. The main rods are then lowered to find out whether the pilot wedge and pipe are resting on the bottom of the hole. If not, the wedge has to be lifted, by means of the tapped hole referred to above, and again dropped, until it is found that the wedge and pipe are resting on a solid bottom, or at any rate are fast and rigid somewhere near the bottom of the hole.

The position of the wedge is surveyed with Mr. A. Payne-Gallwey's invention, Fig. 1 (b), which consists, for a "B" hole, of a brass rod, about $1\frac{1}{8}$ inches in diameter and 3 feet long, screwed at both ends. To one end is fixed a spiral spring, *s*, similar to that fixed to the bottom plug of the surveying instrument. To the other end a brass cup, *c*, 2 inches in diameter is screwed, having a $\frac{1}{4}$ -inch diameter brass pin, *p*, riveted through across the diameter of the cup. This cup is filled with lead, *l*, which projects about 1 inch beyond the edge of the cup and is turned to the same diameter (2 inches). The end of the rod with the spiral spring is screwed into the bottom of the instrument, in place of the bottom plug.

The survey is made as follows:

The relative position of the pin points on the gimbals to the guide inside the case of the surveying instrument being known, the position is marked on the outside of the case and the line continued along the brass rod, cup, and projecting lead. The top end of the instrument is screwed into a brass tube 10 feet long and that again screwed on to the end of the drill rods.

The whole arrangement is lowered down the hole until the lead is resting on the top of the wedge, which, with its chisel cut, makes an impression on the lead, a photo of the magnetic needle being taken at the same time. On raising the rods, a disk with the impression is sawn off, and the direction of the wedge calculated.

The guide wedge, Fig. 1 (d), is an exact counterpart of the pilot wedge, and the butt end of this is screwed into the butt end or bottom of the main deflecting wedge.

The main deflecting wedge, Fig. 1 (e), is made out of a solid piece of 2-inch diameter round steel about 7 feet

long. The bottom end is drilled and tapped to receive the butt end of the guide wedge. The top end is drilled with a $1\frac{3}{4}$ -inch bit for 2 inches deep, thus leaving a ring of metal $\frac{1}{4}$ inch thick. The solid portion of the 7-foot length is then planed, commencing from the underside of the aforementioned metal ring down to about 1 foot from the bottom, in such a manner that a wedge is formed with a concave face with a radius of 1 inch and having a thickness of $\frac{1}{8}$ inch at the top and 2 inches at the bottom end. (See section *a-b*, Fig. 1.)

For surveying purposes a chisel cut is made in the top of the ring, along its diameter, coincident with the longitudinal center line of the wedge, as shown in section *a-b*, Fig. 1.

The direction of the face of the



FIG. 2. PLAN SHOWING DEFLECTED BORE HOLE

pilot wedge now being known from the survey, the guide wedge is screwed into the main deflecting wedge in such a way that when the faces of the pilot, and guide wedges are together, the main deflecting wedge is facing in any predetermined direction.

The end of a "C" rod ($1\frac{1}{2}$ inches in diameter) is now placed into the metal ring at the top of the main deflecting wedge and riveted thereto with two $\frac{1}{4}$ -inch copper rivets. To the other end of the "C" rod is attached a 10-foot length of "B" rod ($1\frac{1}{8}$ inches in diameter), on the top end of which is screwed a ball-bearing swivel, and the main drill rods are connected to the top of the swivel. The whole contrivance is then lowered down the hole, and, as soon as the point of the guide wedge touches the face of the pilot wedge, the swivel allows the guide wedge, and with it the deflecting wedge, to revolve until the faces of the guide and pilot are coincident, the top one sliding on the

bottom one until they jam. If the weight of the rods is not sufficient to shear the rivets, hydraulic pressure is put on the piston of the drilling machine and the copper rivets sheared off, leaving the main deflecting wedge in position at the bottom of the hole.

At first it was necessary to drill the deflected hole with a smaller bit, but a means was devised whereby the deflected hole can be kept the same size as the original hole.

When the deflecting wedge has been set, the "C" hole is only drilled to a depth of about 12 feet below the top of the deflecting wedge, after which the rods are withdrawn and the taper tap is then lowered and screwed into the guide ring at the top of the main deflecting wedge, which is pulled out of the hole by this means; after which, the pilot wedge, together with the bottom pipe connected to it, is also raised.

A piece of round iron about 1 inch in diameter, and in this case about 13 feet long, the bottom end of which has been bent about $\frac{1}{4}$ inch out of the straight, is fastened to the end of the main rods with two copper rivets, and lowered down the hole until the bottom end of the round iron is level with the top of the new hole which has been drilled by the "C" bit. The rods are then lowered very gently and twisted around at the same time so as to humor the bent end of the round end to the new hole. Once the operator thinks this has been done the rods are further lowered until the bottom end of the round iron rests on the bottom of the new hole. When this has been effected, the copper rivets are sheared off in the same way as explained above, and the main rods withdrawn, leaving the iron rod at the bottom of the new hole.

A fairly liquid mixture of Portland cement is now made and put into a piece of piping of a length sufficient to carry the required amount of cement to fill up both the old and the new holes to about 1 foot above the top of the iron rod. The bottom end of the pipe is burred on the inside so as to hold a blank flange, made of thin insertion, the same diameter as the inside of the pipe. The pipe is then filled with a liquid cement and a similar insertion flange fixed on the top, but having a flap valve cut into it. The pipe is then fastened on to the end of the main rods and lowered down the hole until the bottom of it is about 1 foot from the top of the iron rod. Water is then pumped down the center of the drill rods, the pressure opening the insertion flap valve downwards and

forcing the cement together with the bottom insertion flange, out of the pipe, and thus filling both old and new holes with cement up to the requisite height.

This cement is allowed to harden for two or three days, after which, drilling with a "B" bit, the same size with which the original hole is drilled, is commenced, and the cement is drilled away until the top of the iron rod enters the hole in the bit and acts as a guide, pulling the bit and rods over from the old hole into the new. Drilling is continued to some depth below the bottom of the iron rod; when once the core breaks, the iron rod, together with the core, which has broken off underneath it, is drawn out of the hole in the core barrel in the usual manner.

采 采

Pipe Ore, Secondary Limonite

In Volume 10, second series of the Missouri Bureau of Geology and Mines, H. A. Buehler, Director, it is stated that there are three forms of secondary limonite. These are hard boulder and tabular ores; stalactitic or pipe ore; and soft granular or ochreous ore. By secondary limonite is meant a deposit of iron obtained through the oxidation and hydration of marcasite and pyrite. Deposits of secondary limonite are of frequent occurrence and are widely distributed throughout the Ozark Plateau.

The stalactitic iron ore comprises so large a part of the secondary limonite that the term "pipe ore" is used freely in referring to it. In many instances the deposits are composed largely of pipe ore which, as a rule, is associated with both boulder and tabular ores, and in some instances with ochre. Pipe ore occurs chiefly in the upper portion of the deposits, giving place to ochre and tabular ores below. Except where exposed by erosion, it is usually imbedded in red clay.

The pipes vary in size, from one-twentieth of an inch to 6 inches in diameter, and from a few inches to several feet in length. They are usually one-quarter of an inch in diameter and 6 or 8 inches long, their length being governed by the size of the opening in which they were formed. The pipes are usually nearly circular in cross-section and for the most part nearly uniform; some, however, show tapered or enlarged ends. Sometimes they branch, forming two or more pipes which may unite again and form a single pipe, or they may occur as single individual pipes more often in parallel arrangement,

forming bundles. Occasionally pipes have confused, mis-cross or twisted structure, the pipes being frequently twinned. The parallel arrangement is the more common, notably in the small pipes, or the wire pipes which have a diameter of one-tenth of an inch, or less. The wire pipes, when in massive bundles, have coalesced so firmly in instances as to form one solid mass, while in other instances they are so loosely cemented, that when exposed to the air the whole mass crumbles to a heap of individual pipes.

In cross-section the pipes exhibit a simple concentric banding or both radial and banded structure. Concentric banding is due to alternating light and dark rings of limonite encircling a closed center, the outer surface being relatively smooth and without crystal, botryoidal, or other pseudomorphous forms.

The following is the average analysis of shipments of pipe ore from ten mines: Iron, 55.27; silica, 7.56; phosphorus, .082; manganese, .138; moisture, 4.77.

采 采

Manufacture of Acid Phosphate

*By Captain L. Lloyd**

At Port Ingle, Levy County, Fla., the Dunnellon Phosphate Co. has installed a plant for the manufacture of acid phosphate from the crude phosphate ore derived from their several mining plants. It is well known that phosphates, even when finely ground, are but slowly assimilated by plants; they are used, therefore, almost exclusively for making superphosphate, the process consisting in treating the dressed ore with sulphuric acid. Calcium carbonate, a common impurity in phosphate ore, consumes sulphuric acid in this treatment to form calcium sulphate. Two other impurities in phosphate ore, ferric oxide and alumina are objectionable, because they form insoluble phosphates, so that the proportion of soluble phosphates in the prepared superphosphate is diminished by their presence. The crude phosphate should be as free as possible from iron and alumina, and contain more than 3 per cent., also from calcium carbonate. The material to be treated is ground to a fine powder, having 80 meshes per linear inch, and then is charged intermittently in 400-pound and 500-pound bins, into a lead-lined wooden tank, equipped with an agitator, and is treated with sulphuric acid.

run in as required from an adjacent tank. The quantity of acid varies with the composition of the phosphate, from 1,300 to 1,800 pounds per ton of phosphate being the usual quantities. The mixer is built above a brick chamber known as the "pit" or "den," and into this the semifluid mass, after it has been agitated for several minutes, is discharged through a chute. The temperature of the mass in the pit rapidly rises to 110° C., and CO₂, HCl, and HF gases are evolved before solidification sets in. The gases drawn off through flues are passed through a scrubber, a necessary process on account of the objectionable hydrochloric acid gas and the still more objectionable hydrogen fluoride gas. When the pit is nearly full, one of the sides, which is of wood and removable, is taken down and the product dug out and passed through a disintegrator, which reduces it to a powder. The proportion of sulphuric acid used in making a superphosphate is generally as large as it is possible to use and not impair the dryness of the finished product.

The value of the superphosphate depends on its content of phosphoric acid soluble in water. An ordinary superphosphate will contain from 20 to 30 per cent. of soluble phosphate, 40 to 49 per cent. of calcium sulphate, and 2 to 3 per cent. of insoluble. This the Dunnellon company contemplates will be a great saving of freight, as the product from their acid phosphate plant is used entirely for foreign export. No attempt has ever been made, by this company, to produce the "double superphosphate" to further save carriage and transportation charges.

采 采

The minerals known to exist in paying quantities in Uruguay are as follows: Agates, amethysts, antimony, asbestos, asphalt, boracite, coal, chalcedony, copper, chrome iron, dolomite, graphite, iron, lead, magnesium, manganese, manganese hornblende, mica, ochre, onyx, peat, platinum, radioactive galena and blende, rock crystal, silver, talc, tin, red and green porphyry, sandstone of all colors, granite, limestone, marly lime schist suitable for cement manufacture, more than 300 varieties of marble, including pure white, red, and pink; red and yellow quartz in great quantities, very hard roofing slate infiltrated with silica, grindstone, lithographic stone, white clay, plaster, kaolin, oilstones, flint, water stones, tourmaline, jasper in many colors, topaz, and sulphur.

ON October 12, 1912, a fire in the N. Mt. Lyell Mine, Tasmania, caused the death of 42 of 102 men in the mine.

The fire originated in the pump house on the 700-foot level, close to and on the east side of the main shaft, where it is believed there was a break in the electric motor that drives the pump, and which caused the insulation to fire and ignite the timbers. The fire was discovered at 10:45 A. M., but no special heed seems to have been given to it until 12:10 P. M., when the men rushed to the shaft which was the only exit. The one other exit provided was an engine winze that several days previous had become blocked by a cave and which at the time of the fire had not been opened. The usual number of miners were breaking ore on the 400-, 500-, 700-, 850-, 1,000-, and 1,100-foot levels when the smoke accompanying the conflagration gradually filled the shaft and levels, but was considered to be due to some unimportant cause, hence but a few of the men left the mine, and when the increasing smoke caused a large number to rush to the shaft it was too late.

The fire was not expected to spread, as with few exceptions the mine was wet, but in the incomplete combustion of the timber, carbon monoxide was generated, and the men not realizing this danger, lost their lives. This gas in the small proportion of 1 per cent. does not effect the burning of a candle, but poisons men quickly. The first symptom is the sudden failure of leg power, and the man who falls can never rise by himself, but drifts rapidly and painlessly to unconsciousness and death. If he is only unconscious when found he can be restored by fresh air or oxygen as a rule, and those gassed seem to suffer no ill effects after a day or two of rest.

As soon as the fire got under headway it carried the deadly carbon monoxide throughout the mine. In a metal mine such as the North Mt. Lyell, no special system of ventilation is provided, natural ventilation being depended upon; hence with changing weather and temperature the fresh air may be going into the mine through some of the various passages and the bad air out of the shaft, or the reverse. What direction the smoke took is not clear, but it rapidly filled all the workings both above and below the 700-foot level,

North Mt. Lyell Mine Fire

A Disastrous Fire in a Tasmanian Metal Mine—Methods Employed in Rescue Work

while at the same time smoke poured forth from the mouth of the shaft. The heat from the fire soon made the main shaft an upcast through which a steady volume of smoke poured to the surface, but there were eddies which kept constantly changing. At one place the smoke is said to have changed its direction of movement about every 2 hours.

The rescuers directed their endeavors to keeping the main shaft open; to breaking through the engine winze that had closed between the 500- and 600-foot level; and to reaching the 1,000-foot level where it was known 50 men were alive but shut off. The Marine Board, of Devonport, supplied a diving outfit which arrived by special train, and as there were several expert divers among the company employes it was of great service for penetrating the gases in the inspection of the landings at the 500- and 700-foot levels.

Little evidence of fire was observed by the diver at the 500-foot landing, while the climax came by the shaft becoming damaged by heat, steam, or some other cause, at about 500 feet down so the cage could no longer pass this point.

Meantime the work on the engine winze had progressed until a rough passage had been forced to the 700-foot level. There were 60 feet of chain ladders passing through a mass of timber debris to the 600-foot level and then 100 feet of vertical ladders to the 700-foot level. There was a flow of water down the winze and this was caught by a penthouse or shaft sinker's roof and poured down over the ladders, to insure a draft, but it made ladder climbing difficult for the men weakened by gas. Explorers proceeded to the 700-foot level and along toward the main shaft, but the fumes compelled them to retreat and the task of getting the weakened men up the ladders was very great. Communication was established with the 50 men at the 1,000-foot level by P. Peasnell, an employe, who talked with and got supplies to them. In the meanwhile strenuous efforts were made to repair the shaft so as to send the cage down to the 1,000-foot level and bring the men up through the smoke. This was given up, as the movement of the cage

affected the ventilation of the mine elsewhere. Men again descended the engine winze and found the air quite good and

clear on the 100-foot level to the main shaft. Chickens were lowered to the 850-foot level on the cage by the air winze and after 5 minutes were hauled up none the worse. Two men then went down to this level and reported the air good in the shaft, but bad in the level. The chickens were then lowered to the 1,000-foot level for 5 minutes, and on hauling them up they were found on their sides. Two men were quickly sent down with Draeger helmets to explore the 850-foot level and break through to the 1,000-foot level if possible. At the 850-foot level the explorers could not proceed far, but conversed with those on the 1,000-foot level. The exploring party then returned to the surface and other men went down to fix a canvas brattice at the 700-foot and 850-foot levels in order to turn all the fresh air down to the 1,000-foot level, and on Wednesday the imprisoned men reached the bottom of the engine winze and were drawn to the surface. As soon as the 1,000-foot level was clear of men, two men with Draeger helmets were sent down with others to the 850-foot level. Chickens were also taken, and by their use the drive was tested by men without helmets to the main shaft. Beyond the main shaft the chicken lost the use of its legs and the explorers halted. At this point the helmet men arrived back at the engine winze and reported 10 men dead in the stope, where conditions were most favorable, and the possibility of any man surviving there seemed too remote to warrant the evident risk to life, that the attempt to reach beyond this point would involve, so the explorers were withdrawn and arrangements started to attack the fire.

The engine winze was covered at the 700-foot level and the sides bratticed between it and the main shaft, while the main brattice was opened, but retained for emergency. The firemen were now able to reach the original source of the fire, and found it almost burned out at the pump house, but further examination showed the flames had extended to a rise farther in, and it was supposed the fire was quenched on about the 18th of October. This was a mistake; and after battling with it 9 days and the gases con-

tinuing to increase owing to the fire having gotten a foothold in a caved abandoned stope it was decided to fill the mine with water. Conditions of the mine at last report were not encouraging, and much regret is manifested because the bodies were not removed prior to flooding the mine, which will consume a long time and it will take a longer time to pump it out.

Hartwell Couder, M. A., A. R. S. M., in his account of the accident says: "**** A few points stand out clearly.

"In the first place, however wet a mine may be, it is not safe from fire. Some organization should exist in all mines of any size to cope with an outbreak. If helmets can be procured the men should be trained to their use. The work of the helmets was much discounted because the miners were not accustomed to helmets and the firemen did not know the mine. It is unsafe to rely on ventilation as a safeguard in rescue work, even if there are several sources of supply. Too many eddying air-currents are set up; for instance, at one place the smoke came up a rise and proceeded a short distance along the level and then went down a winze.

"These eddy currents were a great source of danger in the rescue work. Miners should be taught the danger of carbon monoxide. In this fire the carbon monoxide fumes were very deadly, and if the proportion of the gas had remained the same to the end, probably many of the rescuers would have perished. Their courage was not to be restrained, but it might have proved fatal not only to themselves but to the progress of the main work.

"The small animal test was only slightly used. Where used, it proved valuable, and it is the only known indicator for carbon monoxide."

Those men on the 1,000-foot level owe their lives to one man who had a knowledge of the flow of liquids. The men directed the compressed air directly at the approaching smoke which advanced steadily. Men commenced to fall when one of their leaders requested them to come close to the wall of the stope and face it while he directed the air against the wall. This gave a current of good air that followed the wall and resulted in saving the lives of 50 men. This man deserves many medals.

There is one lesson to be drawn from this disaster by the management of every mining company, viz.,

in mining it is always the unexpected that happens, consequently no risk should be permitted that involves the lives of men. In metal mines, fires when once fairly under way are more difficult and expensive to extinguish than fires in coal mines. There are two or three exceptions to this rule where coal mine fires have been allowed to burn for years until they have got beyond control, such as the Midlothian colliery, in Virginia; and Summit Hill and Carbondale fires in Pennsylvania.

Metal miners should be instructed in the laws of ventilation and mine gases, and the large mines should have trained helmet crews and fire-

Driving a Tunnel in Japan

By William L. Saunders*

The Japanese people have given many evidences of their progressiveness, but nothing emphasizes their spirit of progress more than the work which they are now doing in building a double-track, wide-gauge electric railway between Osaka and Nara. Osaka has been called the Pittsburgh of Japan. It is the commercial metropolis with 1,000,000, inhabitants, covering an area of more than 8 square miles, intersected from east to west by the river Yodo and with numerous canals running through it. Osaka is admirably situated for a manufacturing city. Its principal

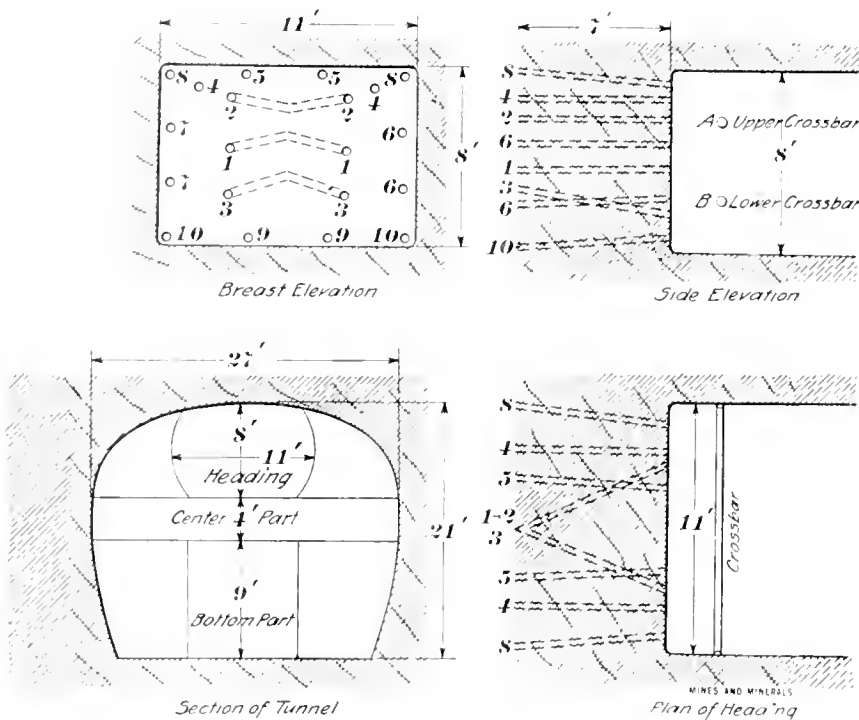

FIG. 1. METHOD OF DRIVING TUNNEL

fighting apparatus always ready for instant use.

At an underground fire in the Bunker Hill mine, Idaho, in October, one man was killed, and to suppress the outbreak the No. 4 car of the United States Bureau of Mines was called on. The object lesson produced by the sight of these men entering the smoke stirred the miners to such a degree that a request was made for instructions in the use of the helmet. The last information received was to the effect that No. 5 car of the Bureau of Mines would be sent to Wallace for this purpose.

For the details of this disaster we are indebted to the very comprehensive articles in the *Australian Mining Standard* of October 17, 24, 31, 1912.

trade is with China. On arriving a Osaka one is impressed by its industrial activities as illustrated by the large number of chimneys. Old Osaka has left its monument in the great Castle, built by Taiko Hideyoshi in 1583. Little remains of the old Castle but the ruins and principally the walls of the moat. These walls contain huge blocks of hard granite, some of them measuring 40 feet in length and 16 feet in height.

From Osaka to Nara is from new to old Japan, for Nara is in every respect representative of what Japan used to be. It was the ancient capital during seven reigns and until the seat of government was removed to Kyoto. At Nara is the largest statue of Buddha, built in the year 746.

*President of Ingersoll-Rand Co.

The railway now under construction is a short cut designed to reduce the time of travel and the mileage. The line runs through Mount Ikoma, which is about half-way between Osaka and Nara.

The contract for the construction of this tunnel was awarded to Obayashi Gumi, the engineering work being in charge of Dr. Eng. T. Oka. The tunnel work begins in the eastern end at Ikoma village, extending westwardly to Hineichi village, a distance of about 2 miles.

The finished dimensions of the complete tunnel are 22.2 feet in width by 19.35 feet in height. A cross-section of the tunnel is shown in Fig. 1. The heading, or upper bench, is driven ahead of the bottom or lower bench. Between the heading and bottom bench there is a central bench. To the right and left of the heading and lower bench are sections that are mined by the use of stoping drills, and the center bench is removed in the same way.

The heading, shown in elevation, is 8 feet high and 11 feet wide; the center bench is 4 feet high and 27 feet wide; and the bottom bench is 9 feet high and 8 feet wide.

In the heading a cross-bar 5 inches in diameter and 10 feet in length is fixed horizontally across the tunnel as shown in the plan. Jack-screws, in each end of this bar, serve to adjust and to fix it rigidly against the walls. Three water Leyner drills are mounted on this bar at A, Fig. 1, and the upper holes are drilled. Then the bar is lowered to B and the lower holes are drilled.

Because of the use of these lightweight drills, which do not kick hard against their mounting, it is possible to employ the cross-bar in place of the columns. Columns with arms are mainly used in America because drills of the percussion type require an absolutely rigid mounting. It is obvious that the use of the horizontal bar facilitates handling the drills and makes it possible to set up after a blast quicker than by the use of columns. The cross-bar with the drills mounted is handled by a gang of men, who climb up over the muck, place the bar in position and drill the holes while the muckers are at work below them.

The center, or cut holes, are drilled to a depth of 8 feet, all the other holes being 7 feet in depth. Blasting is done by time fuse, which is admitted nowadays to be the best practice. Gelatine dynamite is placed in the bottom of the hole next the primer, over it is placed more gelatine dynamite and then 60 per cent.

dynamite. Clay is used for tamping. Where the rock is hard, from 22 to 26 holes are drilled in the heading, but in softer rock this number is reduced to 16 holes in some cases and in others as low as 12 holes. The rock in Mount Ikoma is granite, usually hard, especially in the east end. Progress in this tunnel has averaged over 10 feet of heading per day. Records have been made of 20 feet in 24 hours, single heading. This was on the west side where the rock is of moderate hardness. It usually requires 5 hours to drill 20 holes, 6 feet, to 7 feet deep. The work of loading, firing, and taking out the rock consumes about 3 hours, or a total shift of 8 hours. The work is done by the miners in 6-hour shifts, working day and night. One superintendent is in charge of each heading, with three drillers and three helpers.

Wooden mine cars having a capacity 30 cubic feet, are hauled by an

tunnel is to be lined with brick about 1,000 feet being already completed.

來 來

Shaft Sinking Device

Where shafts follow the dip of the ore and hoisting is done by buckets, an ingenious contrivance for tipping the bucket was planned by Mr. Harris, of the Harris Pyrite Co., in Ontario, as seen by Figs. 1 and 2. Stout lugs *a* are attached to each side of the bucket *b*. These lugs travel on skids until they come to rest in a notch *a*, Fig. 2, above the grizzly on which the ore is to be dumped. As the lugs are set below the center of the bucket, lowering causes the bucket to dump. The bucket is then raised a few feet and when lowered, the lugs catch a pair of curved arms *b*, which, when inverted by lowering the bucket, completely cover up the notches and

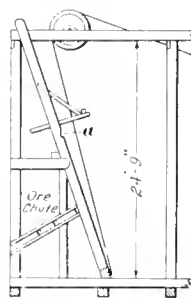

FIG. 1

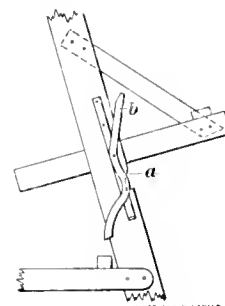
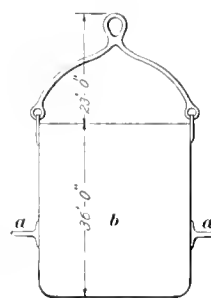

FIG. 2

electric locomotive in trains of 10 over a 25-pound rail track, having a 30-inch gauge.

For ventilation, 50-horsepower Roots blowers exhaust through a 20-inch stack. Ingersoll-Rand air compressors of 115 horsepower each furnish the compressed air at 100 pounds pressure, the air being conducted to the heading through a 5-inch pipe.

The holes drilled are usually about 2 inches in diameter and the progress of the drills is from 7 to 12 inches of hole per minute. Although water is fed into the bottom of the hole the discharge of the cuttings is really effected by compressed air which is forced in with the water, the minimum amount of water being used and only for the purpose of laying the dust.

Power at the portals of the tunnel is transmitted electrically a distance of 16 miles at 3,500 volts. The tunnel is lighted by 16-candlepower electric lamps.

Up to May 31, 1912, an advance was made in the east end of 2,127 feet, and in the west end 1,917 feet, or a total progress of 4,044 feet. The

allow the bucket to proceed down the shaft. It will be noted that the head-frame must be within sight of the man at the hoist. Skids at the Harris mine are on an angle of 72 degrees and should not be steeper for successful operation. Mr. Harris states that the reason for the safety bar which prevents the buckets from turning back and discharging down the shaft, is in case a bucket is sent up when nearly empty and loaded on one side; but if the buckets are loaded one-quarter full or more, no care need be taken to have the load even.

來 來

Fire Assay Reducer

It is stated by C. A. Rose that according to the formula

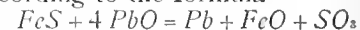

1 gram of iron sulphide should reduce 9.4 grams of lead. In practice 9 grams is obtained. Following charge is used: Ore, 5 AT; PbO , 80 g.; $HNaCO_3$, 20 g.; K_2CO_3 , 10 g.; FeS , 3 g. The use of FeS prevents boiling and saves from 15 to 20 minutes in time of fusion.

Phosphate Ore Dressing

Loss of Soft Ores--Separating the Ores from Clays, Etc., and Process of Roasting or Drying

By Strauss L. Lloyd*

THAT there is considerable loss of phosphate in mining is well known. Practically all the deposits contain, with other material, more or less phosphate in a soft or pulverulent condition. Under present methods of mining and treatment this "soft" phosphate is necessarily lost in the process of washing, being carried to the dump along with the

26.80 to 27.92. It was estimated in this particular case that approximately 4 tons of material was excavated and washed in order to obtain 1 ton of the high-grade rock phosphate (77 per cent.). From this it is

mostly from the older countries of Europe, and the phosphate now produced is largely exported. The time is not far distant, however, when an equally strong demand will come from the exhausted soils of our own country. The hydraulic method of stripping the overburden and then mining the phosphate rock was described in Mr. Barr's article on

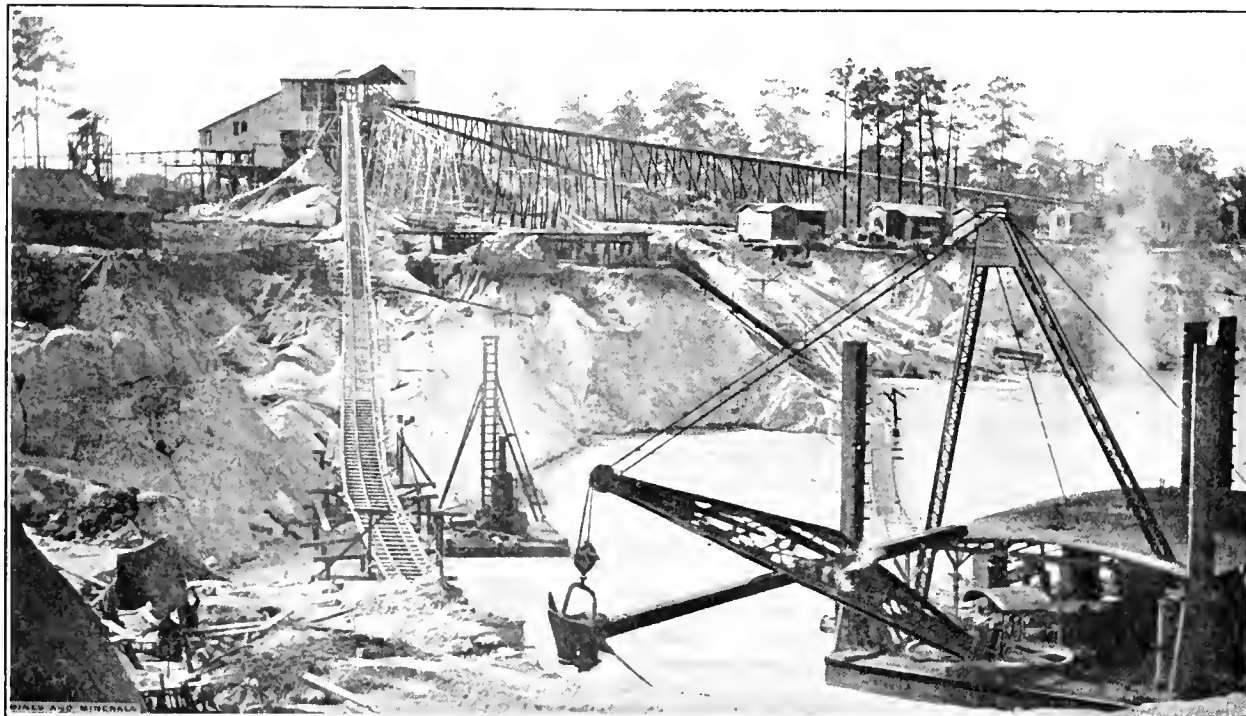

FIG. 1 DREDGING PHOSPHATE ROCK IN FLORIDA

sand, clay, and other constituents of the matrix. The amount of phosphate thus discarded may be expected to vary with different deposits and under different conditions. After reaching the dump there is also more or less mechanical separation so that samples taken from one part may be found much richer in phosphate than from some other part of the same dump. Samples taken at random from phosphate dumps in the hard-rock region gave the following analyses: Total phosphoric acid, 9.99 to 12.14; which is equivalent to tricalcium phosphate, 21.81 to 26.50. In another case, a sample of floats from the dumps in the land-pebble section gave as follows: Total phosphoric acid, 11.47; equivalent to tricalcium phosphate, 25.04. In still another analysis made of the plate-phosphate ore, it was as follows: Silica, 58.95 to 60.10; iron and alumina, 11.70 to 11.20; calcium phosphate,

evident that of the material taken from the pit three-fourths, carrying about 27 per cent. calcium phosphate, goes into the dump, while one-fourth, carrying 77 per cent. calcium phosphate, is saved; thus of the total phosphate ore taken from the pit, in this instance at least, one-half goes into the dump.

From these data it is apparent that a large amount of phosphate ore is being lost annually in this section and that any economical methods of reclaiming this waste or of utilizing the floats, if such can be devised, are clearly of the greatest importance to the phosphate industry, and ultimately to the agricultural interest of the whole country.

With the extension of agriculture necessary to support increased population, together with the progressive exhaustion of the new and naturally rich soils, there arise increased demands upon the phosphate supply. At present this demand is coming

phosphate mining in Florida.† In many places dredging for phosphate rock is practiced and in Fig. 1 is shown a steam dipper dredge which loads skips that are hauled up an incline and delivered to the top of the washer. The phosphate ore carried from the pits is dumped upon grizzlies where it is sized. That which passes through the bars of the grizzlies is ready for sizing, the "separator," or trommel, but that which is too large to pass through the bars is broken by hand with pick or axe and made to pass through the bars of the grizzly. The ore passing into the "separator" is sized for the first set of double log washers where it receives its first treatment for the removal of the clay which adheres to phosphate material. That part of the ore which is too large to pass through the perforations of the revolving screen, passes out the lower end and falls into a roll-jaw

*Chemist and Mining Engineer, Inverness, Fla.

†Florida Phosphate Practice, MINES AND MINERALS, December, 1912.

crusher and after being crushed it falls through a chute into the first set of log washers where it is washed with the ore which has been sized by the revolving screen. In the log washer shown in Fig. 3, one end of the washer log revolves in a gudgeon placed below the water in the box containing the ore to be washed; the other end works in journals. The

passing the "rinsers," falls through a chute on to a slowly revolving table where boys and old men pick out the "sand rock" and other foreign matter not removed by the log washers and screens. The ore after hand-sorting is automatically pushed through the center of the table by a large brush or scraper into a chute leading to a car under the table, in which it is carried

The excess of moisture in the hard rock in this section of Florida during the early years of mining was removed entirely by kiln burning, a process still in use by many operators. For this purpose the phosphate ore is placed on ricks of wood. The wood is then fired, and the phosphate partly smothering the flames permits slow burning, and by the gradual spread



FIG. 2. PHOSPHATE MILL OF FLORIDA MINING CO.

log, which is driven by gear-wheels, works the ore toward the head of the box and discharges it into the second washer which may have either a single or a double log. In the majority of cases it is a single log. Water is introduced at the upper end of the box, while the ore is fed at the lower end; the clean water thus meets the ore and when it becomes dirty it flows out at the lower end, carrying with it the clay in suspension. There is no general standard for these log washers. The box is about 4 feet deep at one end and 2 feet at the other, according to the length of the logs, which vary from 16 feet to 30 feet and are pitched at an angle sufficient to give a rise of $1\frac{1}{4}$ inches to the foot. The dirty water from the washers generally flows away in sluices, but where the fall is not sufficient a centrifugal pump of some type is used to assist in its removal.

After the log washers have removed most of the clayey matter, the ore passes through a chute into a trommel with an internal spray, which eliminates the remaining clay and the smaller portions of the sand from the ore. These screens have jackets ranging from one-eighth inch to one-sixteenth inch, and are commonly known as "rinsers." The ore after

to the drying shed, where it is kiln dried before being loaded into the railway box cars for transportation.

To reduce the moisture to the required 3 per cent. the producers of land-pebble phosphates use mechanical dryers entirely. While there are several kinds of these dryers, all are of the rotary cylinder type; that is, heated air and gases of combustion

of heat, the phosphate becomes more or less uniformly dried. More recently, with the growing scarcity of wood in the hard-rock section, several large producers have installed mechanical dryers similar to those used by the land pebble miners. In a number of instances the mechanical dryers are in a different part of the country, and away from the actual mining operations. 來 來

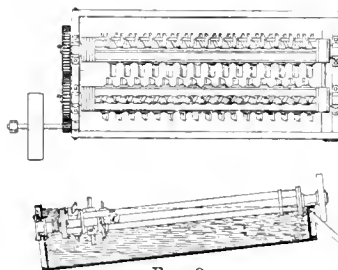

are made to pass through the cylinder from a furnace. The wet phosphate ore is fed automatically into the cylinder and by means of shelving riveted to the sides of the cylinder is gradually worked from the cold to the hot end, being repeatedly showered through the hot gases in its passage until discharged. After leaving the cylinder, the ore is carried by an elevator to the storage bin. The fuel is coal, wood, or crude petroleum.

The disposition of the heat delivered to a blast furnace is a matter of interest always. Not very much work has been done on this problem of late years. Gruner, Schintz, Lowthian Bell, and others, did considerable investigation on the heat consumption of iron blast furnaces in the '60s and '70s. Their work is classic, but very much out of date. For western conditions in water-jacket furnaces recent work indicates that the heat furnished a pyritic furnace by coke and pyrites is absorbed in doing the following work: Expulsion of CO_2 in limestone, 16 per cent.; expulsion of water, 3.2 per cent.; heat absorbed by jacket water, 23.9 per cent.; by slag, 30 per cent.; by matte, 1.9 per cent.; by flue dust, 3 per cent.; by escaping gases, 10 per cent.; by water in blast, 7.2 per cent.; radiation, 6.7 per cent.

Practical Cyaniding—Part 6

Cleaning Zinc Boxes—Acid Treatment.—Drying and Roasting Gold Slime—Melting Precipitate—Tube Mills

By John Randall*

THE cleaning out of the zinc boxes when begun is required to be carried forwards without delay and the value of the material handled makes it necessary that good equipment should be used for the purpose.

The acid tank required is a circular wooden tank 5 to 7 feet in diameter by 4 feet deep and does not need a lead lining. Its top is placed below the zinc box or precipitation floor, and is covered by a stationary hood connecting with a flue. In this flue should be placed a nozzle for a jet of steam in order to create a strong draft to remove the fumes arising from the tank. In the side of the hood is an upward sliding door large enough to admit a man. In the bottom of the tank and near one side is an outlet formed of a piece of lead pipe to which on the outside is attached a piece of rubber hose. When the outlet is not in use the free end of the hose is kept above the level of the top of the tank. The tank bottom is three-fourths inch lower on the outlet side than the opposite side. Inside the tank the outlet is preferably closed by means of a wooden plug, the upper end of the plug reaching above the top of the tank for convenience in handling. This tank should also be provided near the top with an overflow pipe or launder leading to the vacuum filter or filter press, as the case may be.

The vacuum filter shown in Fig. 2 is not so convenient as a filter press for this work, but is inexpensive and is adequate for a small plant. It is constructed of steel, from 3 to 4 feet in diameter, with the part *a* above the filter bed *c* 1½ to 2 feet in height. If it is operated by a wet vacuum pump the gauge glass at the side may be omitted and the chamber *b* below the filter bed made lower. The filter cloth that covers the filter bed is calked around the sides by a rope as shown in the plan, care being observed to fit the calking rope into the recess around the tank so as to form a perfectly tight joint and not allow connection with the vacuum chamber *b*. The calking rope cannot be depended upon to make a tight joint against the side of the tank and it will be seen that if there is any leak a portion of the clean-up may be lost. The perforated filter planks cover the radial iron supports *e* and they are covered by cocoa matting *m*.

Over this matting is placed a filter cloth *w* of 8-ounce duck, and above this may be placed a thickness of muslin, the duck and muslin being secured by the calking rope. The muslin is intended to be taken up and

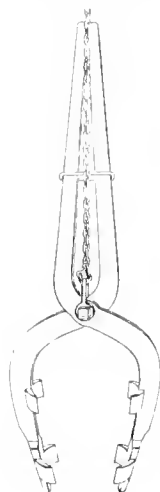

FIG. 1

washed or burned when necessary to recover the gold without disturbing the canvas. This vacuum filter is placed with its top a little below the level of the bottom outlet of the acid

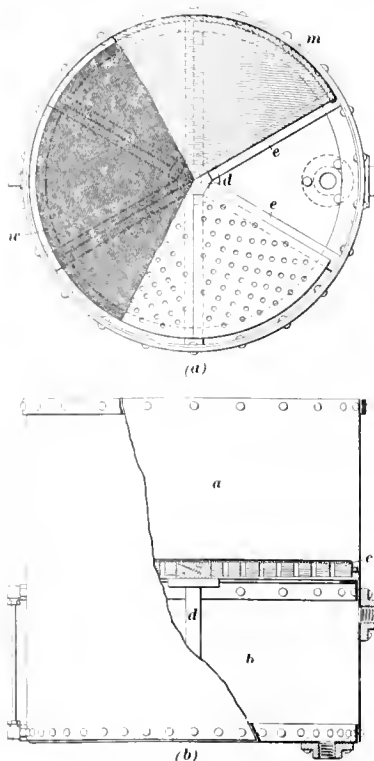

FIG. 2. VACUUM FILTER

tank and within reach of the outlet hose.

Simply constructed filter presses with round plates 18 inches to 2 feet in diameter are preferable to the vacuum filter for mills having a daily capacity of 100 tons or over. The type known as the recess frame press, having no distance frames, is good on account of its simplicity. It should be supplied with a "dummy plate" or solid plate to slip in at any point between the other plates when it is desirable to use only a part of the press. The cast-iron plates of the press may be kept painted as a protection against the acid liquor. In place of the vacuum filter is a tub in which is placed the suction of the filter pump.

Drying pans, 2 ft. × 2 ft., or 2 ft. × 2½ ft., and 6 inches deep are made of heavy sheet steel or cast iron, with suitable hooks provided for handling the pans when hot. Cast-iron muffles can be had of the right size to accommodate two such pans. The muffle furnace is made of brick, and the iron work for the furnace is purchased from the manufacturers, who usually furnish drawings for the brickwork.

If the melting is to be done by coke, a wind furnace combined with the muffle furnace is used. The latest practice favors liquid fuel for melting, it being more convenient, besides the heat is always under perfect control. Liquid fuel compares favorably with coke in cost, as a large amount of the heat from coke is used on the furnace instead of the bullion.

The melting room should be provided with one or more conical pouring molds large enough at least to hold the contents of a No. 125 crucible, and also rectangular molds for bullion. A bullion mold having the inside dimensions 6½ in. × 3¼ in. × 3¼ in. will hold 500 ounces of gold or a little more than half that amount of silver. Another convenient sized mold is 9 in. × 3¾ in. × 3¾ in. and holds 1,000 ounces of gold. Either mold will turn out a very attractive gold bar if filled only one-third to one-half full.

The form of crucible tongs shown in Fig. 1 is used for raising the crucibles from the furnace. Before using the tongs they should be carefully fitted to the crucible on which they are to be used. When the tongs are in use an attendant raises or lowers them by means of a pair of blocks, but they should be moderately

Boulder, Colo. Part 1 appeared in August MINES AND MINERALS.

heated before attempting to pick up a hot crucible.

A few days previous to the clean-up the zinc is allowed to run down in the boxes, little or no fresh zinc being added. The solution is shut off from one box, the excess of solution siphoned to the sump by means of a piece of hose, and its gold slime launder connected with the acid tank, and beginning at the upper end of the box, as soon as the first two compartments are ready, the slime plug is pulled from the first compartment to allow the slimy liquid to run into the acid tank. The operator then puts on a pair of rubber gloves reaching to the elbows and raises a quantity of zinc, gently rubbing and squeezing it between his hands while an attendant sprays the zinc with a stream of water from a $\frac{3}{4}$ -inch hose. The "gem" nozzle, used for sprinkling lawns, is good for washing zinc as the stream can be conveniently regulated. The water running from the zinc will at first appear inky, but will clear in a few seconds. The zinc as soon as washed is piled upon the second compartment. Short zinc may be rubbed through the screen at the bottom of the compartment, or, to save time, transferred to the acid tank in a tub. The screen at the bottom of the compartment is pulled up and washed and the compartment is washed perfectly clean with the hose, after which the screen and plug are replaced, and operations are begun on the second compartment, the washed zinc being removed to and packed in the first. These operations are repeated upon the other compartments until the box is finished. As soon as a compartment can be made ready it should be filled with cyanide solution, as the zinc oxidizes rapidly in contact with the air, sometimes generating a considerable amount of heat. If the zinc begins to heat before a compartment is ready for solution it may be cooled by dashing a bucketful of solution over it. Plenty of fresh zinc should be on hand for repacking the boxes, and the first box is generally put in operation before beginning work on the next. Quite an amount of short zinc may be returned to the boxes, but zinc that is quite fragile and easily rubbed to small particles is of little value for precipitation and is best sent to the acid tank. This matter is of necessity left to the judgment of the operator. When the acid tank is filled it will overflow into the vacuum filter and the pump must be started.

The water in the acid tank is siphoned to the vacuum filter or filter press until but from 8 to

16 inches in depth, according to the size of the clean-up, is left. If a filter press is in use, only three plates are needed for this operation, the remainder being kept clean until after the acid treatment is finished. After the steam draft is started in the acid-tank flue, about 25 pounds of commercial sulphuric acid is poured into the acid tank and the hood door closed. The seething mass is occasionally stirred with a wooden paddle about 4 inches wide and long enough to reach across the tank. While the acid treatment is going on the filter tank or press is cleaned and the small amount of product returned to the acid tank. Fresh acid is added from time to time according to the amount of short zinc in the clean-up. When the addition of a quart of acid does not cause further effervescence, and exploration with the paddle fails to disclose but very little zinc, the operation may be presumed to be complete. From 1 to 2 hours, with occasional stirring, may now be allowed for the dissolution of the remainder of the zinc. The tank should be explored with the paddle to see that no crusts of zinc have formed on the bottom, and then filled with hot water, or cold water may be run in and heated by steam, the contents being occasionally stirred while the tank is filling. Some prefer to allow about 12 hours for the gold slime to subside and then siphon off the acid liquor, filling the tank again with water for a wash. Others allow 2 hours for the greater part of the slime to settle, then siphon the acid liquor to the vacuum tank or filter press. The acid tank is then half filled with water, and the mixture thoroughly stirred, after which the plug on the inside of the acid tank is carefully raised, and the material sent to the filter, an attendant controlling the flow by means of the plug and stirring the slime to keep it in suspension. An 8-mesh screen has previously been placed on the outlet of the acid tank (over the filter tank) to intercept nails, gravel, or other undesirable material that often finds its way into the zinc boxes but should be kept out of the pump. After the liquid is out of the acid tank, a stream of water from the hose is turned in, the sides washed down, and finally a man goes inside the tank with the hose and cleans up the bottom. He then transfers the hose to the tub at the suction of the filter press pump until all the slime is in the press. Water is now pumped through the press to wash the cakes until the effluent from the press contains little or no acid, when com-

pressed air, if available, is sent through the press for 10 minutes to dry the cakes. If the vacuum filter is used the cake can be washed by spraying water upon it. Some mills have a settling tank of a capacity of about 10 tons to which all the waste liquors from the clean-up are sent, a little gold subsiding in the bottom. As some iron salts are a solvent for gold, the acid liquor usually contains about \$1.50 per ton of gold in solution.

To dry and roast the gold slime, the roasting pans are made ready by spreading paper over their bottoms and sides and then the slime cake is dumped into them. The paper in burning forms a film of carbon next the iron and prevents the cake sticking and also protects the iron. The muffle should be at a low red heat, the pans shoved in and the muffle door partly closed. When the greater part of the cake is at a low red heat it may be withdrawn from the muffle, cooled and weighed, the weight of the pans being previously known.

The fluxes used in melting the precipitate into bullion will vary considerably, different ores and different methods of extraction yielding precipitates that vary widely. The question can best be decided by running a few trial melts in 10-gram crucibles, assaying the slag. The quantity of flux required varies greatly, the office of the flux being to slag off the impurities in the precipitate, the metal itself not requiring a flux; therefore a precipitate yielding 60 per cent. bullion will require only half as much flux as a precipitate yielding only 20 per cent. bullion. A fluid slag must be secured or it will contain shot or prills of metal. A flux composed of equal parts of bicarbonate of soda and borax glass, with a little silica added if necessary to protect the crucible, generally answers every purpose, and the amount of flux used need never exceed the weight of the roasted precipitate, and may often be very much less. The flux is spread evenly over the top of the precipitate, the pan is set on the cement floor of the melting room, and the cake cut into half-inch pieces by means of a square-pointed shovel. This shovel is used in charging the crucibles and consists of an ordinary square-pointed shovel with the sides turned up. The cake may be cut in this manner with but very little dusting if care is used.

The crucible is filled level full, as the charge will settle. If the liquid fuel is used it is convenient to refill the crucible as the charge settles, but the refilling must be done before the

top becomes fluid. By this means the crucible can be made to hold about 50 per cent. more than if not refilled. After the fusion is fluid it may be stirred with a plumbago stirrer or a green pole, and then left in the furnace for 10 to 15 minutes provided the heat is under control, when it is ready to pour.

The pouring mold is coated on the inside with lime whitewash or a clay wash to prevent the slag sticking, then made perfectly dry, and placed with its top on a level with the charging door of the furnace. The melt is poured in a steady stream in the center of the mold, which is the best way to avoid metal prills in the slag. After the slag has chilled, the button is detached and if there is any matte adhering to the button it must be cut off with a chisel.

The buttons are placed in a crucible with a little borax glass, and melted niter is added in small portions at a time in order to oxidize base metals as well as any remaining matte. On account of the convenience in cleaning the bar, it is best to have the slag of such a composition that it will dissolve in hot water. The potash from the niter is generally sufficient to form such a slag. Just previous to pouring, the melt is stirred with a graphite rod, heated before plunging it into the molten metal. The bullion mold should be warmed, rubbed on the inside with wax and then heated. It is then brought to the edge of the furnace, carefully leveled and the metal poured. As soon as the gold is set and while yet very hot, it is dumped into a small tub of water. If the bullion is tolerably fine and the slag right, the water will clean the bar perfectly and no scrubbing or treatment with acid is necessary. The bar is next sampled and weighed. A convenient method of sampling, and one that generally answers every requirement at the mill, is by means of a drill, making a hole about one-fourth inch deep in the top of the bar half way from the middle to the end and also in the bottom the same distance from the other end. No drillings from the bar should be put in the sample until after the entire cutting edge of the drill has penetrated the metal, as the drillings from the surface might contain a little slag.

In Clark's gold-refining method adopted in Rhodesia the gold slime is first treated with dilute acid to dissolve the zinc and such materials as can be converted into sulphates. If sodium hydroxide or sodium carbonate is present, as it usually is, hydrochloric acid is used to form calcium

chloride, without dissolving much zinc. This solution is filtered or decanted. If the calcium compounds are treated with sulphuric acid, the bulk of the precipitates will be increased and in a measure interfere with subsequent operations. The slime is dried until it is almost free from moisture and is then wetted slightly with a solution obtained by dissolving niter cake in sulphuric acid. Afterwards a solution of sulphuric acid and water, made up of equal parts, is added. The proportions should be one part of liquid to five parts of slime, and to the mixture a small quantity of niter cake should be added. The fusion of such a mixture must be gradual to evaporate the moisture and then to prevent frothing. The temperature should be gradually raised to a visible red, at which heat the material is fused; it is afterwards allowed to cool. If a moist, but not sloppy, mixture of slime, sulphuric acid, and niter cake is fused, the time will be shortened and less frothing will occur. When cold, the mass should have a reddish-brown color and should be free from black patches. In the first fusion, cyanides, ferrocyanides, sulphides, and volatile compounds are eliminated, and sulphates formed; in the second fusion, more niter cake is added and the gold is collected in a form which may be dealt with mechanically. The second fusion is performed at a visible red heat, the object being to maintain the sulphates of silver and base metals without decomposing them; the niter cake accomplishes this at a higher temperature than would be possible without it.

To ascertain whether the fusion is complete, that is, if the gold has run together, an iron rod is thrust into the hot mass. If the cake on the rod appears white to greenish white between the patches of gold, the action is complete; if on cooling it appears as a brown mass, the gold has not properly run together. When fusion is complete, the melted material is ladled out and poured on a clean, cold iron plate and when cold it is broken into lumps.

To lixiviate it, the soluble portion of the fused mass is placed in wooden tubs and steam blown in until all solubles have been dissolved. The solubility of silver sulphate varies with the amount of sulphuric acid and other salts present, therefore the vat must have sufficient capacity to hold all the liquid required for the solution of silver sulphate; for instance, for each one-half ounce of silver one-fourth gallon of solution

will be required. When the silver has been taken in solution there will remain gold, lead sulphate, calcium sulphate, and probably some other oxides and sulphates.

As the gold is now freed from sulphate of silver, it can be amalgamated and the insolubles eliminated, thus doing away with the necessity of fluxing and slagging them from the gold. If it is desired to remove the lead sulphate it is done previous to amalgamation, and after the silver has been removed, by adding a solution of sodium carbonate until the washings come away alkaline. The reaction is expressed by the equation

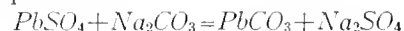

If dilute acid is added until the solution coming away is slightly acid, the lead nitrate can be washed out with water. The gold amalgam can now be retorted. If small quantities of impurities are in the retorted gold, they may be eliminated by placing the gold in a clay crucible, and heating, adding a small quantity of chlorate of potash and a little common salt. When the latter has melted and run through the porous cake of retorted gold, small pieces of dry niter cake should be added and, when frothing has ceased, a little borax poured in. This treatment will remove every trace of base metals and even small quantities of silver.

The following method of treating the gold precipitate was introduced into South Africa by Mr. Tavener:

The gold slime from the zinc boxes is sent to the clean-up tank, where it is washed and sent to the filter press. The fine zinc in the tank is collected and kept separate from the filter-press cakes, although both are dried for 15 minutes in pans placed in an oven. The slime cake is rubbed through a 4-mesh sieve, then weighed and mixed with the proper flux in about the following proportions:

Materials	Parts by Weight
Gold slime, partly dried	100
Litharge, <i>PbO</i>	50
Assay slag	12½
Sawdust	1
Slag previously used	12½

The proportions of litharge must be varied to agree with the amount of the gold present, so that the base bullion produced will carry 8 to 10 per cent. of gold. After the gold slime has been mixed with flux it is shoveled into a small reverberatory furnace. The fine zinc which was partly dried is then mixed with flux in about the following proportions:

Material	Parts by Weight
Fine zinc	100
Litharge, <i>PNO</i>	125
Mixed slag	25

This mixture is charged in the furnace above the slime, and on top of this, litharge and some easily

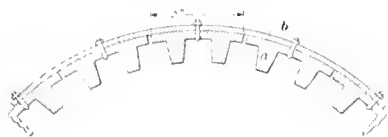

FIG. 3

fusible slag. The fire is then lighted, and after 2 hours the heat is raised and maintained at a high temperature. The charge is stirred and sawdust added for a reducer until the slag gives a clean sample, when it is run off into pots. Lime is thrown over the remaining slag with the object of making a pasty slag, which is then removed and kept for the next smelting.

The lead bullion is tapped into molds in the usual way. To dispose of the lead, the bullion is reduced in a large bone-ash cupel over which a stream of air plays, thus oxidizing the lead to litharge for future use. Part of the lead is absorbed by the bone ash as in cupeling. When the gold has partly cooled, it is drawn from the furnace and broken in pieces suitable for refining in a small crucible. This method has the advantage over the acid treatment that it permits mill sweepings and other materials carrying gold to be treated in the furnace.

Zinc can be removed from gold slime quite as completely by distillation as by the acid process. Enough carbon must be mixed with the dried precipitate to reduce the zinc oxide to metallic zinc, in which form it may be recovered for future use. The best results are obtained by quickly raising the heat above 2,100° F., although it requires 2,372° F. to remove the last of the zinc. All gold and silver volatilized in retorting is recovered when the zinc, as fume, is used over for precipitation. Clevenger, who advocates this process for treating gold precipitates, states that the material in the retort has the same appearance after as before distillation and that it can be poured like sand without any sticking.

The electric refining process is practiced at a plant where the copper and gold are deposited from a cyanide solution on a lead cathode. To refine the deposited metal, the cathode

is removed from the precipitating tank, and placed in a wooden frame with cotton cloth sides but closed bottom. It is then suspended as an anode in a tank containing dilute sulphuric acid. The cathode in this refining tank is also lead, and when the current flows the copper is dissolved from the anode and precipitates on the cathode, where it slimes and falls to the bottom of the tank. The gold which is released as the copper is dissolved falls to the bottom of the frame that contains the anode and is lifted out when the anode has been cleaned by electrolysis. The gold slime is removed and dried, then melted and poured into molds.

The advantages of this system are that it obviates the necessity of scraping the cathode and separates the copper and gold without trouble.

The copper is recovered in cement form and in this case in sufficient quantity to pay the expense of refining the gold. The compartments in the precipitating tank hold five anodes and six cathodes, which are spaced 4 inches apart and are connected in series. The current strength is 5 amperes per square foot of anode surface, with an average resistance in the box of 8 volts, including the copper sliming on the cathode.

CYANIDE MILL MACHINERY

The preliminary crushing of ore for the cyanide process does not differ from the methods used in other processes, but the increasing prevalence of fine grinding requires a somewhat extended discussion of the tube mill which is best used when all sliming is desired.

The tube mill is an iron cylinder varying from 16 to 22 feet in length and from 3 feet 6 inches to 5 feet in diameter. The larger diameter is better because of the greater ease with which repairs are made. At first it was assumed that Danish pebbles were the only ones suitable for tube mills, until it was found that pieces of hard ore worked fully as well and were cheaper. A mill 22 ft. × 5 ft. with 4½-inch feed aperture, kept over one-half full of pebbles, utilizes about 3 tons daily. Tubes are lined with blocks of quartz bedded in cement; also with manganese steel, and a cast-iron and quartz combination lining.

The El Oro tube mill lining is composed of grooved iron plates *a*, Fig. 3, bolted, as shown, to the shell *b*, of the tube mill. Quartz stones placed in the mill automatically fill the grooves. In case one stone wears from the groove another replaces it, thus preserving the metal

from wear. The internal appearance of the El Oro mill is shown in Fig. 4.

The life of tube-mill linings varies with the material to be ground, but where comparisons have been made, it has been found that 3,000 pounds of white cast iron, 1¼ inches thick, lasted 3 months; silix lining, 2½ inches thick, lasted 4 months; while El Oro lining, weighing 13,700 pounds, lasted 10 months. Silix or chert lining lasts much better than cast iron, and further prevents the charge of pebbles from slipping and wearing the pebbles flat. Silix lining is laid in hydraulic cement, and after it is in place the interior of the tube is subjected to steam for 24 hours. It requires about 50 hours to reline, dry, and steam a tube mill before it can be placed in commission, although it is probable that with the aid of quick-setting cement this time could be decreased.

Before the tube mill was generally accepted as a reerusher, a large number of experiments were made to compare it with other machines. Table 1, made by Banks, in Waihi,

TABLE 1

Size of Screen	Material Passing Before Milling Per Cent.	Material Passing After Milling Per Cent.
30	5.32	.03
- 30 + 40	9.77	.12
- 40 + 60	15.94	1.13
- 60 + 100	13.96	7.43
- 100 + 150	12.72	18.42
- 150	42.72	72.87

furnishes a fair index of tube-mill capacity. A large proportion of the 72.87 per cent. of the tube mill product is less than 200 mesh. Chilean mills have been suggested in the place of tube mills. The Huntington mill is probably better than the Chilean

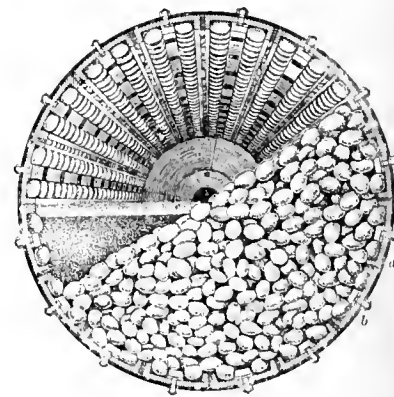

FIG. 4. INTERIOR OF TUBE MILL

mill, although both have been proved inferior to the tube mill. The capacities of these mills are given in Table 2. In this table the starting power for

the mill is given. Its actual running requires about 45 horsepower.

TABLE 2. COMPARISON OF MILLS

Type of Mill	Size Feet	Power Required Horse-power	Ore Crushed Tons Per Hour
Huntington mill	6	8	1.75
Chilean mill	6	6	.75
Tube mill	4 x 22	60	5.50

來 來

The Formation of Diamonds

By Leonard Keene Hirschberg*

Dr. Orville A. Derby, of the Brazilian Bureau of Minerals and Mines, in Rio de Janeiro, has just finished an investigation into Nature's method of generating diamonds. From his studies he has evolved this law, namely: "Diamond crystals have been formed suspended in a medium sufficiently mobile or susceptible to solution, to permit an all around, free development."

Two Germans, Fersmann and Goldsmidt, have also studied the formation of diamonds in nature, and from their work Doctor Derby concludes that the extreme delicacy of the saturation point for carbon of the solution from which the material of the diamond crystals was derived, resulted so that the growth and reabsorption alternated in the development period of the great majority of brilliants in a way quite different from those of any other minerals.

Complete crystals of primary origin in certain rocks, are naturally formed in a mother liquid susceptible of dissolving the mineral. In rocks already consolidated, space for such crystals could only be gained through displacement of granules by the force of crystalline growth, or through the removal of solutions of the rock which occupied the space to be taken up by the crystal in the process of its formation. Such mineralizing agents as sulphur, carbon (in gas form), fluorine, and boron all have such solvent power.

No exact character of the molds left by dislodgment of diamond crystals from their parent rock (called kimberlite) has been accurately given, but judging from the idea that these are formed in place or floated up from some preexisting rock, they should be as sharply outlined as the mineral itself.

A number of nodules examined in the Newlands mine showed only a single diamond-bearing one. The others were garnets and diopsides. The one nodule had a flake about 3

inches long, and showed five diamonds, on the fractured faces. Six others were obtained by crushing detached fragments. Thus the whole layer (or flake) contained several dozen diamond crystals and the original nodule from which it was



FIG. 1

broken—about the size of a 3-year-old child's head—must have contained hundreds.

The diamonds were embedded in the diopside, a yellowish green crystal made up of calcium, magnesium, and iron, or between this mineral and garnet. The granules of the garnet were covered with a thin, dark crust similar in appearance to the well-known kelyphite rim found on the mineral in many other rocks, but apparently of a somewhat different character.

The accompanying Fig. 1 will give an idea not only of kelyphite, but of the relation of a diamond crystal to its nearby granule of garnet.

Professor Friedlander, the Prussian scientist, in 1898, proved experimentally that the diamond could be produced artificially by introducing solid carbon into the fused volcanic minerals called chrysolite without any artificial pressure and at a temperature far below what had been hitherto considered indispensable. The fact that diamonds were also produced by Mosso and others in the electric furnace is beside the point.

Doctor Derby in speculating on the genesis of the diamond is thus able to "put aside the formidable ancient bugbear of extraordinary pressure and heat." From this he evolves the thoughtful theory that the diamond is a secondary daughter mineral crystallized out of a solution of carbon, which is also able to dissolve parts of the rock which also opens its spaces to the diamond crystals. He maintains from experimental and geological discoveries that the diamond occurs in the form of isolated and whole crystals closely embedded in rocks which occur in dykes, and which are composed of meteor-like, volcanic chrysolite.

This rock, wherever diamonds have been discovered in it, contains evidence of having been fractured after it was consolidated. The fracture was so complete that a free circulation of subterranean solutions could

take place and produce a very advanced stage of alteration in all the volcanic mineral parts. The only portions that were perfectly fresh were the unfractured garnet sections, free from chrysolite.

The solutions and carbon gases that filtered into the fractures and fissures, says Doctor Derby, became locked up in the secondary minerals. These, the solutions of rock and carbon, also if they were fractured, attacked the enclosed garnet sections, which made a changed crust of secondary minerals. After the alteration of the garnet, the dissolved carbon formed crystals in the shape of diamonds attached to the secondary crusts, or a variety of carbon known as graphite.

來 來

Combating Ankylostomiasis in Italian Sulphur Mines

It appeared from observations made during the first half of 1910, at the Busca mine, where lime is strewn on the floor of the workings, and in that of Formignano, where sea salt mixed with 1½ per cent. of iron sulphate is similarly used, that the infection if not retrograding, was at any rate making very little advance. It was, however, decided to make certain, by microscopic examination of the dejecta of all the workmen at both mines. The 29 men found to be infected were sent for further examination at the Cesena hospital, where the dictum was confirmed for 21 cases, 14 from the Formignano and 7 from the Busca mine. This proportion of 5.2 per cent. compares favorably with the 38 per cent. recorded before prophylactic measures were taken.

These results tend to show inferiority of the sea salt distribution as compared with that of lime, since the proportion of cases is 6.9 per cent. for Formignano against 3.5 for Busca. Moreover, the use of lime, which costs appreciably less, is not accompanied by the slimy mud due to the melting of salt, as to which the pushers have so frequently complained, on account of the roadway being rendered slippery. For all these reasons, the Trezza Albani Co., which owns both the mines, had decided in future to use only lime for strewing on the floor of the workings and also for disinfecting portable conveniences. It has moreover decided to have an examination of all the workmen made at least once a year, as well as one, at the Cesena hospital, of each new hand taken on.

*A. B., A. M., M. D. (Johns Hop'ins.)
33-6-6

THE largest iron-ore deposits in the United States so far as discovered, are in the states of Michigan, Minnesota, and Wisconsin. These deposits differ somewhat in analysis even in the same range and in the same mine; however, as a rule they may be classed as Bessemer ores. The Menominee Range in Michigan includes the Crystal Falls, Metropolitan, Iron River, and Florence areas. The Marquette Range in Michigan, includes the Republic and Swanzy areas; the Vermilion and Mesabi

Lake Superior and Cuban Iron Ores

Companies Controlling the Deposits—Description of Mining and Handling Methods in Cuba

By Day Allen Willey

Year	Annual Output	Rate Per Ton	Total Cost
1907	750,000	\$1.65	\$1,237,500
1910	3,060,000	1.75	5,250,000
1915	6,750,000	1.92	12,960,000
1917	8,250,000	1.99	16,417,500

This price is based on the understanding that all ore mined shall contain at least 59 per cent. of iron.

called merchantable will not be sufficient for the demand, at the present rate of mining.

This report has led to inquiry as to other sources of iron ore, and attention has been directed to the beds of Eastern Cuba which have been opened long enough to prove that the ore is of a high quality for steel making.

Two investigations of these deposits have been made by engineers of the Pennsylvania Steel Co. and its auxiliary company the Maryland

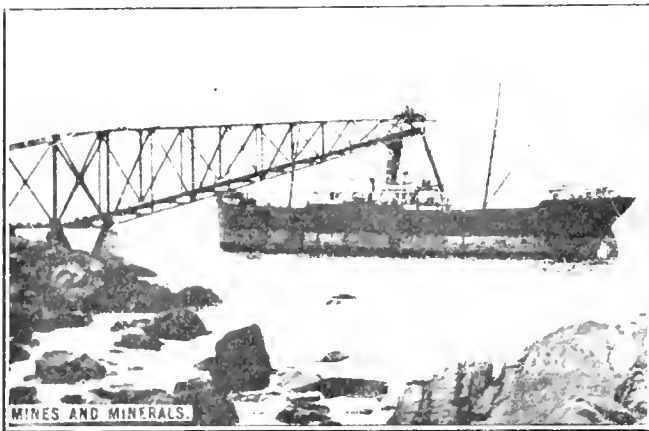

FIG. 1. ARRANGEMENT FOR LOADING ORE INTO STEAMERS

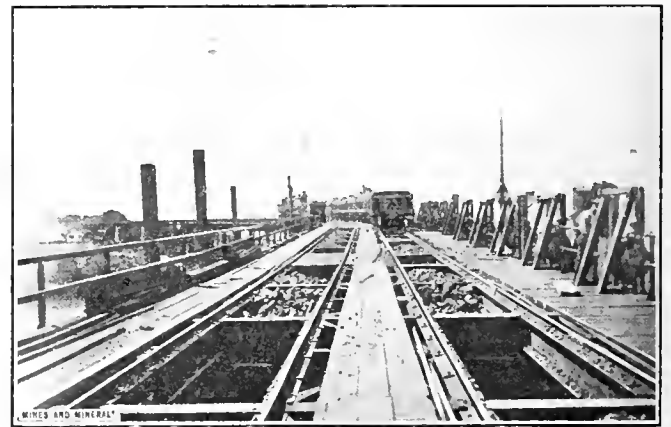

FIG. 2. ORE STORAGE BINS AT DAQUIRI, CUBA

ranges are in Minnesota, and the Penokee-Gogebic Range is in Michigan and Wisconsin.

These districts produce about 75 per cent. of the iron ore in the United States. There has been a natural yearly increase in production in these ranges to comport with the annual increase in the consumption of pig iron. The United States Steel Corporation leased a large section of the ore beds on a royalty basis, which called for mining 750,000 tons the first year, to be increased until the annual output showed 8,250,000 tons. The corporation was to pay a running scale of prices, which increased from year to year. Thus, while the ore taken in 1907 cost \$1.65 per ton, delivered at the Lake Superior ports, it must pay an increase amounting to 3.4 cents, per ton during the next year, a further increase of the same amount on the tonnage of 1909, and so on until 1917, when it is expected to mine at least 8,250,000 tons, which, according to its agreement, will cost it \$1.99 per ton delivered at the shipping docks. To give a further idea of the terms of the lease, the following table shows the output price per ton, and total cost to the company yearly for a series of years:

In addition to the mining of the beds leased by the United States Steel Corporation, several independent companies have depended on the Superior ranges, for raw material. There are no less than six independent owners who control iron ore beds estimated to contain from 25,000,000 tons to 75,000,000 tons each. They include the Jones & Laughlin Co., 50,000,000 tons; Lackawanna Steel Co., 75,000,000; Republic Iron & Steel Co., 30,000,000 tons; Rogers, Brown & Co., 50,000,000 tons; and Cleveland-Cliffs Iron Co., the same quantity. Including the smaller mines, the interests outside of the Steel Corporation control fully 500,000,000 tons of the ore known to exist in the northwest ranges out of 2,500,000,000 tons, the corporation about 80 per cent. with its latest acquisition.

These figures give an idea of the great tonnage of ore extracted from the ranges, and have caused engineers to make investigations as to the available remaining supply containing a sufficient percentage of iron to make it available as a basis for steel. The opinions have differed, one estimate being made that in 20 years the supply of ore which might be

Steel Co. The latter obtains from the present mines, the bulk of its iron ore for the manufacture of 400,000 tons of steel rails annually, in addition to the other forms of steel products. The second investigation made by the engineers was far more exhaustive and the borings and tests covered a much greater area of territory.

One ore body is on the summit of a gently rolling plateau, roughly speaking 10 miles long and 4 miles wide, with its principal axis lying northeast and southwest. Its elevation is about 1,600 feet at the northwestern extremity, which is nearest to Nipe Bay, and rises toward the southwest, to an elevation of 2,200 to 2,300 feet, with one peak reaching to 2,600 feet, and another to 3,200 feet. The surface of the plateau is almost entirely covered by a growth of pine lumber of medium size and averaging some 40 trees to the acre. There is little or no undergrowth other than ferns, and, except for a few islands, or "keys," of dense tropical forest, occurring in places where the ground is very moist, and where a certain amount of rich soil has collected, the entire plateau for 25,000 acres or more is open pine country.

The deposit of iron ore covers

practically the entire plateau. On the immediate surface, where it has been exposed to the weather, the ore is in the form of particles like bird shot, this being slightly superior in iron contents to the earthy ore beneath, although the difference will generally not exceed 1 to 2 per cent. The blanket of ore covers the plateau, and follows out on the points to the extremity of the gentle slope, stopping where the declivity becomes very abrupt, usually at an elevation of 1,600 feet. The slopes of the two peaks mentioned are also bare of ore.

At an early stage in the exploration it was apparent that a large body of ore existed. At certain plains, borings were made only 50 feet apart, to

fair average depth of 15 feet over 15,525 acres, which, at 20 cubic feet to the ton, gives 605,000,000 tons. The engineers of the company consider it not improbable that when every acre of the ore ground has been explored, this figure may be exceeded, and regard it as certain that not less than 500,000,000 tons of ore, accessible for economical mining, exists on the plateau.

The ore is generally a limonite, varying from dark red to yellow in color. The latter color is found at greater depth, but there is no difference in chemical analysis. Some analyses indicate the existence of hematite with limonite. About 5 per cent. of the borings are in material below 27 per cent. in iron and high

amounting almost to stickiness, has made it necessary to design a new form of car for its transportation, as it will not tip from any old form of dump car. The high percentage of water in the ore makes some sort of drying process indispensable preliminary to shipment, to avoid paying freight and duty on water.

The finely divided, almost dust-like, condition of the dried ore requires that this drying process shall go a step further and produce an agglomerated product in the form of clinker and bricks, to make it suitable for use in the furnace. The alumina content produces an unusual blast furnace slag and one which demands careful and intelligent operation. The chromium present, going into the pig iron, must be largely eliminated from the steel, and the characteristic behavior of the small remaining quantity of chromium in combination with varying percentages of carbon require to be studied in detail.

The experiments with the drying and clinking plant and with the elimination of chromium in the steel-making process have been carried on at the Steelton plants of the Pennsylvania Steel Co., and are not available for publication.

The ore is mined by steam shovels and loaded into 50-ton cars. These are lowered over double-track inclines as shown in Fig. 3 to a yard $2\frac{1}{2}$ miles distant. Two separate inclines are connected by 4,000 feet of level track. The inclines are laid with 90-pound steel rails and operated by "barney" cars, running on a narrow-gauge track of 60-pound rails, inside the main track. The two barneys to which the main cable is attached are connected by a tail-rope running around a sheave at the base of the incline. Two cars can be lowered at one time, over a maximum grade of 25 per cent., and simultaneously two empty cars may be raised on the other track. The weight of the loaded cars is sufficient to raise the empties, but winding engines are installed at the head of each incline to provide for rapid starting and better control. The main hoisting ropes, $2\frac{1}{2}$ inches in diameter, are attached to the barneys, and pass around the drums of the winding engines in the usual manner. The smaller tail-rope, connecting the rear ends of the two barneys, is for convenience in manipulating them and acts also as a sort of balance.

At the foot of the incline the barney drops into a pit, and the loaded cars, run out over it to the yard track, while the empties, to be hoisted on



FIG. 3. CUBAN IRON ORE MINE

determine the topography of the underlying rock, with a view to the most economical working of the ore body; but the greater part of the later borings were spaced 1,000 feet apart. In this manner 18,500 acres were prospected and over 53,000,000 tons were calculated as available. The earlier pits and borings reached a depth of 5 to 17 feet, the bottom generally in ore.

No attempt was made to cover every acre of the ground, as a very large tonnage was already sufficiently assured.

The bed rock is serpentine, partly decomposed, and in some places so soft that the auger will enter. This rock outcrops in a few places, and in others the ore reaches a depth of 40 feet or more, but, in general, the depth is reasonably uniform. An open cut made in the claim shows a

in silica or alumina, or both. This can be avoided in mining.

Physically the ore presents some noteworthy peculiarities. One grade of the ore is the agglomeration of the shot-like particles, caused by the action of water and sun. These occurrences while local, will aggregate several million tons. Another grade is the shot ore, which while forming a large total tonnage could not be mined separately, as it varies from an inch to as much as a foot in thickness on the surface. The third grade which forms the great bulk of the deposit, is an earthy ore, dark red, through light red to yellow in color.

It is evident in dressing this Mayari deposit it presents new features, both mechanical and metallurgical. Its soft nature and blanket form permit the use of steam shovels for excavation, but its tenacity,

the next trip, are fed by gravity past the Barney pit, to be picked up by the Barney as it comes from the pit on its up trip.

From the foot of the upper incline to the head of the lower, a locomotive shifts the cars over the 4,000 feet of intervening level track; but at the foot of the lower incline no locomotive is required, as by an ingenious arrangement of yard tracks, the loaded cars, from either incline track, run off to the same yard track, where they are coupled into a train, while the empties in the yard feed in by gravity to either incline track. The inclines have a capacity of 6,000 to 8,000 tons in 10 hours, and are so arranged that the size of the rope may, when necessary, be increased to carry three cars, thereby increasing the capacity 50 per cent.

From the foot of the lower incline there is a railroad 13 miles long, with a maximum gradient of one-half of 1 per cent., all grades favorable to the traffic and a maximum curvature of 6 degrees, the ore is carried in 30-car trains over this railroad to the terminal town of Felton, on Cagimaya Bay. The railroad, is laid with hardwood ties and 90-pound rails, and heavily ballasted. All bridges, except a trestle across the narrow estuary which separates Cagimaya Key from the mainland, are of steel; culverts are of concrete and drains of cast-iron pipe.

At Felton, the tidewater island terminus, the ore is dried and stockpiled for shipment. The ore cars open on one side, and cranes lift the entire car body off the trucks by the other side, so that the bottom of the car may, if necessary, be raised to a vertical position, and the ore will slide out into a long trough. From this trough it is lifted by a 15-ton grab bucket, operated from a bridge or gantry crane, and served directly to the drying plant.

The product of this plant is carried by an electric transfer car to the storage for clinkered ore. This is located with its main axis parallel to the shore line, and as close thereto, as conditions permit. The transfer car deposits the dried ore in another trough from which a second bridge with a 15-ton grab bucket lifts it for storage in a stock pile, or, by means of an extension boom reaching out over the water, loads it from the pile into steamers lying along the water front close to the island.

A dredged channel 3,000 feet long, 200 feet wide, and 28 feet deep allows vessels to reach the shore line of the island, where a dredged basin gives shore frontage and admits of turning the vessels.

As the process of drying the ore requires a large amount of coal, all of which must be brought from the American coast, provision for coal discharge and storage is made along the 1,000 feet of deep-water front. The coal is discharged by unloading machines on a bridge similar to the ore bridge and stored in a pile near the shore and in continuation of the ore pile. The cranes, bridges, and unloading devices are electrically operated, and an electric power and lighting plant, together with machine, blacksmith, boiler, and carpenter shops, foundry and terminal railroad yards, form part of the installation at the Felton terminal.

What, if any, portion of the Mayari ores will become available for other eastern steel makers is a matter for the future. Whatever tonnage comes to the United States will strengthen by so much the position of the iron industry on the eastern seaboard. That section has seen the disadvantage of even its partial dependence upon lake ores increased in recent years by the declining iron content of these ores and the increasing proportion of Mesabi ores with their higher moisture. The costs are accentuated by the long rail haul. The Mayari deposit and the knowledge that it is of very large extent, have brought out the suggestion in some quarters, that Cuban ores and Virginia and West Virginia fuel will soon be assembled on the lower Chesapeake Bay. Newport News, as the terminal of the Chesapeake & Ohio Railroad, and Lambert Point, across the bay, the terminal of the Norfolk & Western, or some point at which both roads could be utilized, would afford an advantageous rate on coal, in case by-product coke ovens were erected at the seaboard, or on coke, if it should be regarded more economical to produce the coke at the mines.

采 采

Russian Gold

The production of gold in Russia in 1911 is estimated at 2,326 poods or 83,975 pounds. The largest yields come from the Ural and from Siberia. Heretofore, the gold production has been limited almost exclusively to the washing process, but it is now the intention to attempt the smelting process for the gold ores from veins, since the former method has shown a large decrease of gold production on account of the exhaustion of the beds. The gold production in 1911 in East Siberia was 3,610 pounds less than in the preceding year, which may, however, mostly be due to the want of

workmen. In the Lena district, in the river basins of the Olekma and the Witin, 95 per cent. of last year's find was obtained through sand washeries. No doubt it will be in the Ural Mountains where the smelting process will be used first, because the placers there have been exhausted through many years exploitation.

采 采

Berry Safety Catch

The use of crossheads in shafts has been condemned by a large number of mining men, but in several countries where inquiries have been made into their use, the consensus of opinion has been that the danger was lessened by the use of a crosshead, provided it was equipped with a safety appliance to prevent hanging up in the shaft. In the Transvaal, the Berry safety catch, shown herewith, according to E. T. Cook, Inspector of Mines, Ontario,

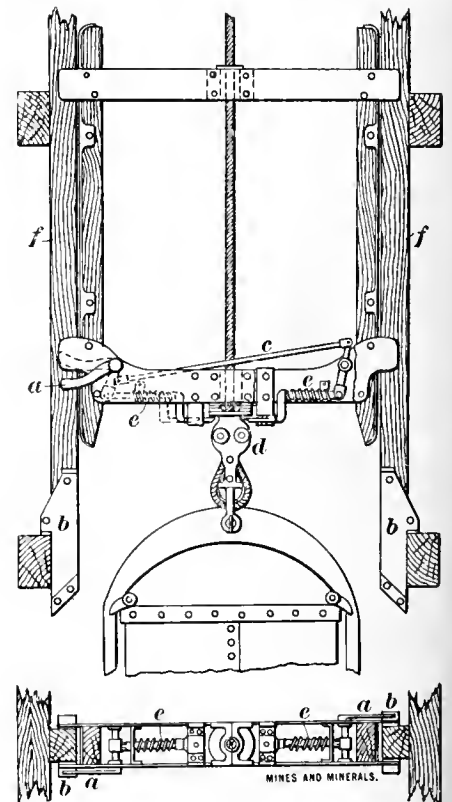

BERRY SAFETY CATCH

Can., has given satisfaction, in preventing the crossheads of sinking buckets hanging in the shaft. The levers *a*, in descending, strike the stops *b*, and by means of the connecting-rod *c* operate both levers. When the cross-head is raised from the stops by rope clamp *d* the tension on the springs *e* is released and the cross-head rides freely between the guides *f* which also center the bucket in the shaft.

NEW MINING MACHINERY

Storage Battery Electric Locomotive

Ten storage-battery electric haulage locomotives are being used by Holbrook, Cabot & Rolins Corporation, New York, who are executing a contract on one of the sections of the New York Aqueduct now being built to convey the Catskill water supply into the city. These locomotives are used for transporting excavated material on cars to the shafts which have been sunk approximately a mile apart for expeditious tunnel driving. The material is then hoisted to the surface. The locomotives are of somewhat different design to the twelve locomotives Smith, Hauser, Locher & Co. are employing for putting through another section of the tunnel.

These are the pioneer storage-battery locomotives built for underground haulage. The new locomotives have a 4-ton rating and are coupled up to four cars to form the usual train. Tunnel locomotives impelled by storage batteries are designed for short distance hauls at moderate speeds, where it is not feasible to install an overhead trolley system. The latter system is employed to better advantage in most cases; but where local conditions demand the storage-battery type, it has proved an excellent substitute.

In the case of the New York Aqueduct tunnel, trolley locomotives were impossible because the tunnel headings would not permit their entrance, and the storage-battery haulage locomotives, manufactured by the General Electric Co., have proved efficient and economical for this work and permitted laying the tracks without the filling necessary when hauling by mules.

The locomotives are built to conform to the following specifications: Diameter of wheels, 20 inches; wheel base, 34 inches; total weight, 8,000 pounds; length over all, 7 feet 10½ inches; height over batteries, 49¾ inches; track gauge, 34 inches; speed at maximum tractive effort, 3½ minutes per hour.

The batteries have 44 cells, have a 5-hour discharge capacity, and to facilitate removal, the battery trays are provided with rollers. The locomotives are equipped with an

ampere-hour meter, headlight, and gong.

The frame consists of two steel channel sides and steel-plate ends. A seat for the operator is provided in front and couplers suitable to the cars in use are attached at both ends. Cast-steel pedestals, which carry the journal boxes, are bolted to the lower web of the channel side frames.

The cast-steel journal boxes are fitted with roller bearings, which assure efficient mechanical transmission of power and consequent economy in battery current consumption. The weight of the car is supported from the journal boxes by two coiled springs.

The wheels are pressed on and keyed to the axles, which are case-hardened at the journals, so that

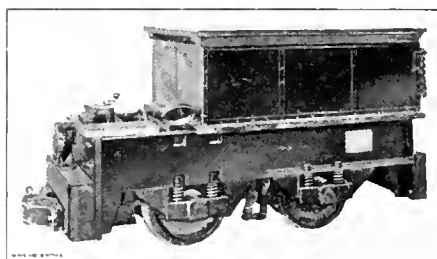

STORAGE BATTERY LOCOMOTIVE

there is practically no wear either on the roller bearings or the axles.

The motors are of the automobile type, designed to operate from batteries, and to effect the maximum possible economy in the use of battery current. They have large overload capacity and operate with practically sparkless commutation. High efficiency is obtained by designing the motors with a small air gap; and by running the iron at low densities, the speed and torque are steeper than in the ordinary series motor, thereby tending to limit the overload which can be thrown on the batteries. The armature shaft rotates in ball bearings, which reduces the friction losses, and makes the bearing wear practically negligible. The motors are compact, readily accessible for inspection and repair, dust and moisture proof, and are mounted in cast-steel suspension cradles, one side being supported on the axle bearings and the other side spring-suspended from the locomotive frame, in accordance

with standard locomotive compensator practice.

The motors drive the axles through double reduction gearing, an intermediate shaft, carrying the intermediate gearing. As slow speed service is ordinarily required of a storage-battery locomotive, the use of double reduction gearing permits such speeds without rheostatic losses; and, due to the large gear reduction from armature shaft to wheel tread, very high tractive efforts are obtained at comparatively small current inputs to the motors.

The storage batteries have plates with high ampere-hour efficiency; the cells being grouped in four or more trays mounted on top of the locomotive frame in a sheet-iron case with wooden base and cover.

Trade Notices

Coal Briquetting.—The Roberts & Schaefer Co., of Chicago, has recently reorganized its coal briquetting department, which will henceforth be in charge of Mr. Charles L. Wright, formerly of the Fuel Testing Division of the Bureau of Mines, where he had large opportunities for investigations into the briquetting of coals and lignites. The company has acquired an operating plant and is prepared to make briquetting tests for prospective clients. It has also secured the exclusive United States rights for the manufacture and sale of a briquetting press of unusual merit.

Pump Catalog.—A finely illustrated catalog of 58 pages has been issued by the Goyne Steam Pump Co., of Ashland, Pa. In this is described the extensive line of heavy mine pumps for which this firm is well known. These pumps are the outgrowth of experience since 1881 in some of the most difficult work in the anthracite regions of Pennsylvania, and the firm is prepared to build mine pumps both small and large for any conditions.

New Electric Installations.—The Colorado Fuel and Iron Co., Denver, Colo., is installing additional apparatus for equipping its mine at Pictou, Colo., with electric drive. This includes a 500-kilowatt rotary converter, motors, and switchboard apparatus. For operating its coal mine, at Carron City, Colo., electrical

hoist apparatus consisting of a 125-horsepower motor-generator set, 250-horsepower motor, air compressor and switchboard, is being added to the power-house equipment. The Calumet & Hecla Mining Co., Calumet, Mich., is installing sixty-five motors, of 40-horsepower capacity each, for equipping its mines and smelters with electric drive. The St. Joseph Lead Co., Bonne Terre, Mo., is adding to its power plant at the Leadwood mines a 1,000-kilowatt alternating-current generator, and in the power plant of the Bonne Terre mines a new 1,250 kv-a. Curtis turbogenerator is being installed. All the above equipment is made by the General Electric Co.

Manager of Atlanta Office.—The H. W. Johns-Manville Co. announces the appointment of Mr. C. S. Berry as manager of its Atlanta, Ga., office, located at 31½ South Broad Street. A stock of roofings, packings, pipe coverings, and other J-M asbestos, magnesia, and electrical products is carried at this address.

A Bird Man's Eye View.—The bird's-eye view of a manufacturing plant, drawn from the imagination or an architect's set of plans, is common in advertising literature. The bird man's eye view, showing things as they are and not as the manufacturer would like to have them, is the latest move toward truthfulness in advertising.

Previous composite pictures of the Hawthorne Works, of the Western Electric Co., had not been satisfactory because so many obstacles to obtaining a true perspective were presented by the immensity of the complex of buildings, and the idea of obtaining an aeroplane picture was suggested by the proximity of the grounds of the Chicago Aero Club, at Cicero, where some of the world's greatest flights have been made. Five flights were necessary to secure an acceptable picture. The aviator and the photographer rose to a height of 2,500 feet and the aeroplane was permitted to glide down to 1,000 feet at a speed of 45 miles an hour. Between heights of 1,500 and 1,000 feet the picture was taken. Experts who have seen the result declare it to be the most remarkable photograph ever taken. A reproduction of the photo was published as a supplement to the *Western Electric News* for December.

Chain Stokers.—The Illinois Stoker Co. has issued a handsome and useful pamphlet on "Chain Stokers." In this are incorporated the proximate analyses of coals from every state in

the United States. Also an efficiency based on evaporation from and at 212° F. Naturally this table is entirely theoretical but it shows what might be done, if, etc.; however, it will be interesting to those who would like to see how close their boilers are coming to theory.

來 來

Catalogs Received

ALBANY LUBRICATING CO., 708-710 Washington St., New York City. The Soothsayer, 5 pages; "Some Don'ts" for buyers of Lubricants.

DE LAVAL STEAM TURBINE CO., Trenton, N. J. De Laval Steam Turbines Velocity Stage Type, 47 pages.

GREEN FUEL ECONOMIZER CO., Mattewan, N. Y. Best Proportions of Boiler and Economizer Surface, 24 pages.

STRONG, CARLISLE & HAMMOND CO., Cleveland, Ohio. Strong Steam Traps, 16 pages.

ILLINOIS STOKER CO., Alton, Ill. Chain Grate Stokers, 51 pages.

THE C. F. PEASE CO., 166 West Adams Street, Chicago, Ill. Everything for Blueprinting, 32 pages.

GENERAL ELECTRIC CO., Schenectady, N. Y. Bulletin No. A4039, Direct-Current Motor-Starting and Speed-Regulating Rheostats and Panels, 35 pages; Bulletin No. A4040, Contractors for Industrial Service, 10 pages; Bulletin No. 4993, Type K Single-Phase Motors, 15 pages.

NATIONAL TUBE CO., Pittsburg, Pa. "National" Pipe, 3 pages.

來 來

Increase in Platinum Production

California and Oregon produced all the platinum which was mined in the United States in 1911, and this, as shown by Waldemar Lindgren, of the United States Geological Survey, in an advance chapter from "Mineral Resources" for 1911 was \$8,631 greater in value than the output for 1910. The following is a statement of production in troy ounces and the values for the two years. In 1910, California produced 337 ounces valued at \$8,386 and Oregon 53 ounces valued at \$1,121; in 1911, California produced 511 ounces, valued at \$14,873, and Oregon 117 ounces valued at \$3,265.

The average price paid for platinum in 1911 was \$28.87 an ounce, compared with \$24.38 in 1910, the higher price undoubtedly resulting in an increased production.

Importations in 1911 of crude platinum sands resulted in an esti-

mated refined product of 27,500 ounces, nearly four times the domestic production. An additional amount was derived from imported ores and mattes, so that the total quantity of refined platinum produced in domestic refineries is estimated by Mr. Lindgren at approximately 29,140 fine ounces, of which about 940 ounces, valued at \$40,890, was derived from domestic sources of various kinds—platinum sands, copper and gold bullion, etc. The corresponding estimate for 1910 was 773 ounces, valued at \$25,277.

The platinum imported and entered for consumption in the United States in 1911, including ores and manufactured products, was valued at \$4,866,207, an increase over the 1910 figures of \$1,212,543. The exports amounted to only \$8,139.

The world's production of platinum in 1911 was 314,323 troy ounces, compared with 286,952 ounces in 1910.

Mr. Lindgren's report of platinum contains an interesting discussion of the platinum-bearing minerals, the uses of the metal, its sources in the United States, and the possibility of new discoveries. It also contains notes on the other platinum metals such as iridium and palladium.

來 來

Chloral Hydrate as a Solvent

Attention may be drawn to the extraordinary solvent powers of chloral hydrate. It has long been used for microscopic purposes to render objects transparent, but its solvent power may also be utilized in many other ways. For example, in toxicological investigations for the detection of alkaloids a 60-per-cent. solution of chloral hydrate dissolves all alkaloids and their salts, even the usually insoluble tannates. Resins, gum-resins, and balsams are almost all soluble, and in case of gum-resins a quantitative separation of the constituents may easily be effected, because by adding alcohol to the chloral solution the gum is precipitated while the resin is thrown out by adding water. Fats, oils, and waxes show variations of solubility which may serve for their partial differentiation. Vegetable coloring matters are dissolved by chloral-hydrate solutions, with the exception of indigo; and the presence of indigo in litmus, which is stated to be very common, may be thereby detected. In the investigation of blood-coloring matter, starch, gelatin, and proteids, the solvent action of chloral hydrate may also find useful application.

Mines *and* Minerals

Vol. XXXIII.—No. 7.

FEBRUARY, 1913—SCRANTON, PA.

Price, 25 Cents

PUBLISHED MONTHLY AT SCRANTON, PA.

ESTABLISHED 1861

INTERNATIONAL TEXTBOOK CO., PUBLISHERS

T. J. FOSTER, President S. P. ALLEN, Secretary E. H. LAWALL, Treasurer

RUFUS J. FOSTER, Vice-President and Manager

EUGENE B. WILSON, Editor HUGH ARCHBALD, E. M. Asst. Editor

CHICAGO OFFICE: 1006 Michigau Ave.

Entered at the Post Office at Scranton, Pa., as second-class matter

Address all business communications to MINES AND MINERALS, Scranton, Pa

CABLE ADDRESS, "RETSOF, SCRANTON"

LONDON OFFICE: INTERNATIONAL BUILDINGS, KINGSWAY, LONDON, W. C

SOUTH AFRICAN OFFICE: MANSION HOUSE CHAMBERS, ALDERLEY STREET, CAPE TOWN.

NEW ZEALAND OFFICE: 63 DIXON STREET, WELLINGTON.

AUSTRALIAN OFFICE: 83 PITT STREET, SYDNEY.

SUBSCRIPTION RATES

Single Copies 25 cents

Yearly Subscription, including postage:

To United States, Mexico, Cuba, Porto Rico, Hawaii, and Philippines. . . \$2.00

To Canada 2.50

To all other countries 3.00

The date after your name on the wrapper is that of the month to which your

subscription has been paid. If you do not want to continue your subscription

after that time, kindly notify us.

Notice to discontinue or change of address should be sent to the Scranton

office.

When notifying us of a change of address always give your FORMER as well

as your present address.

TABLE OF CONTENTS

Editorial—	
Editorial Notes—A Suggestion to State Mine Inspectors—Stray Electric	
Currents in Coal Mines—The Selection of State Mine Inspectors	
Electrical Knowledge for Mine Foremen—The Coal Miner	345
COAL MINING AND PREPARATION	
Cleaning Coke-Oven Gas, by Sydney F. Walker	349
The Manufacture of Coke, by F. E. Lucas	351
The Proposed Anthracite Mine Law, by Rufus J. Foster	353
Stray Electric Currents, by C. J. Norwood	356
Obituary—	
Prof. R. Sampson—Dr. Frank L. McKee—Martin McLaughlin—Major	
Emil C. Wagner	357
Personals	358
Difficulties in Mine Surveying, by H. G. Henderson	359
Book Review	360
Some Features of Mine Disasters, by Geo. S. Rice	361
Prize Contest	363
Pumping Through Coal	365
Notes on Mines and Mining	366
Track Extension With Rails on Side	368
Examination Questions—	
Colorado Mine Inspectors, 1911 (Continued)	369
The Letter Box—	
Coal Dust and Steam—To Remove Marsh Gas Dangers of Acetylene	
Lamps—Combustion of Gas and Dust - Waste in Mining	372
Chemical Interpolation of Anthracite, by M. S. Hachita	373
The Mine Foreman, by Thomas Turner	375
Mining Societies and Institutes	377
The U. S. Bureau of Mines	380
Keeping Snow Off the Tracks	381
Blasting Coal On to Pans	382
ORE MINING AND METALLURGY	
Sudbury Nickel-Copper Industry, by Reginald E. Hor	383
Automatic Sand Sluicer	385
Kansas and Oklahoma Gas Fields, by L. L. Wittich	386
Platinum and Allied Metals	389
Practical Cyaniding, by John Randall	391
Efficiency in Mining, by W. J. Crocker	395
A Drift Candlestick, by Wm. J. Crocker	396
Safety Crossheads	396
Woodbury Slime Classifiers, by Edward T. Wright	397
Equalizing Load Moment on Hoisting Engines, by Mark Ehle	399
New Mining Machinery—	
Safety Lamp Igniter—A New Acetylene Mine Lamp—Locking Device	
for Electric Switch	400
Trade Notices	401
Catalogs and Calendars Received	402
Squibs—	
Steam Plants at Mines, 348—Coal Mine Employes in the United States,	
352—Haldane's Apparatus for Analysis of Mine Air, 352—A Union	
Cut in Wages, 355—Cerium Igniters, 362—World's Gold Production,	
1912, 365—Use of Coke-Oven Gas, 368—Depth of Oil Wells, 371—	
Coal Trade of Natal, 382—Blow-Pipe Bead Without Platinum Wire,	
385—Determining Platinum, 390—Manganese Discoveries in the	
Philippines, 396—Asbestos Mines in China	398

MINING engineers, who, without collegiate education, have obtained prominence in the profession by reason of natural ability, broad experience, and hard study, are unanimous in stating that their successes would have been easier and more quickly attained if they had had the benefit of a first-class course in a technical school or college.



THE demand for rational laws regulating the working of coal mines is always caused by the necessity of measures to conserve the health and safety of the mine workers. The mine worker who opposes any measure calculated to ensure careful and constant inspection of mines, and the impartial enforcement of the law, is not only his own enemy, but is opposing the best interests of his fellow workman.



MEN who have received degrees as mining engineers from good technical schools, and who have not been successful, should not be considered examples of the value of the education given them. No engineering course makes an engineer of a man. It simply gives him a good foundation on which to build a successful and practical experience. If the possessor of such a foundation does not build a first-class superstructure on it, the fault lies either in his lack of industry or the fact that his mental attributes do not fit him for the profession.



A Suggestion to State Mine Inspectors

SOME years ago this journal advocated a national convention of State Mine Inspectors as a preliminary step toward uniformity of State Mine Laws and State Mine Inspectors' Reports. This resulted later in the formation of the Mine Inspectors Institute of the United States of America. It has been in existence for several years and has been productive of much good.

It can greatly increase its usefulness if, as an organization, it will use its influence to bring about a uniformity of mine laws and of annual reports. To make possible the latter it will also be necessary to establish a uniform fiscal year. With such uniformity, it will be easy to make comparisons of results in the various states and to compile national statistics, and make deductions of greater accuracy than is now possible.

As a model for tabulated reports, those of the mine inspectors of Pennsylvania can be commended in the highest degree. If, for some states, these reports are too comprehensive, a part might be eliminated. But the more important ones can be adopted to advantage. If best results are to be secured, every state should insist on reports as complete as those of Pennsylvania.

With a uniformity of mine laws and rules, coal miners from one state migrating to another will find that the conditions in the mines to which they go are practically the same as in the mines from which they came. This will mean that, in a large measure, they will be free from the troubles and dangers incident to more or less different conditions existing in the mines or in the laws and mine rules.

Another feature in which uniformity will be of great advantage is in the matter of danger signals. In the Bituminous Mine Code of Pennsylvania there is a provision that danger signals in all mines must be uniform and of a design approved by the Chief of the Department of Mines. Chief Roderick, of Pennsylvania, has approved of a danger signal which was illustrated and described in our issue of December last. This signal is simple but conspicuous. Its meaning is readily understood by non-English speaking workmen after it is once explained to them. A description of it is as follows:

"Its size is 30 in. x 10 in. with an oval in the center 14 inches long and 10 inches wide. The color inside the oval is red and outside the oval black. In the red oval the word 'Danger' appears in white letters, as large as possible consistent with the preservation of the contrast of colors."

Every mine worker in the bituminous mines of Pennsylvania will be familiar with this danger signal in the near future. If the same design is used in other states, the miner from Pennsylvania locating in such states will know what it means, and, conversely, this will be the case with miners coming to Pennsylvania from other fields.

Modern methods of travel have minimized distances; State boundaries, except in a legal sense, are obsolete. An earnest effort should, therefore, be made to have the conditions attached to our coal-mining industry as nearly uniform as possible. The Mine Inspectors Institute is composed of men who realize this fact, and it is hoped that it will, as a representative body, use its influence to bring about this uniformity.

來 來

Stray Electric Currents in Coal Mines

ACCORDING to information furnished by Professor Norwood there is a new element of danger in coal mines where electricity is used, not heretofore suspected. We have been advocating the use of copper needles and copper tipped tamping bars to prevent sparking and premature explosions, now we find that if

stray electric currents are running through the coal, copper needles are dangerous and will cause explosion.

As we understand conditions, permissible explosives can only be fired by detonators, but there seems to be danger of stray electric currents coming in contact with the caps and causing detonation before things are ready. Danger from this source can be minimized by placing the cap in the center of the cartridge using only wooden sticks for tamping and not using two kinds of explosives in the same shot hole. The attention of our readers is called to the article of Professor Norwood, who is Chief Inspector of Mines for Kentucky.

來 來

The Selection of State Mine Inspectors

THE most important function of a rational coal mine law is to provide for the maximum protection to the health and safety of the mine workers. A secondary function is to provide for the safety of the mine property.

Violations of the mine law by operators or mine officials must be prosecuted by the Mine Inspector, or he fails in his duty. Violations of the mine law by mine workers, whereby they endanger the lives and health of either themselves or their fellow workers, must also be prosecuted with equal vigor.

A competent Mine Inspector must be a man thoroughly conversant with all conditions existing in mines. He must possess a thorough knowledge of the technicalities of mining and he must have had extensive practical experience. In addition he must be a man possessing both physical and moral courage and a mental temperament that will always ensure the use of good judgment and the avoidance of hasty and ill-advised action.

Such men are procurable, but they cannot do their full duty unless their entire time is devoted to the actual work of an Inspector. If they do their duty impartially they are bound to offend those whom they prosecute for breaches of the mine law. Every man, whether operator, official, or mine worker, whom he offends, no matter how just his case may be, becomes his enemy. That is human nature. Every enemy he makes in doing his duty exerts more or less influence over others.

It is evident that if inspection is to be properly performed, competent Inspectors must be obtained. They must be free from any influence that will tend to detract from the full exercise of the powers vested in them.

There is only one way in which competent Inspectors free from bias or outside influences can be secured. That way is provided in the proposed new or codified Anthracite Mine Law of Pennsylvania.

This proposed article in the mine law provides for the appointment by the Governor of an examining

board to consist of five miners in actual practice and four mining engineers. This board is to examine candidates in a thorough manner both in writing and orally. All candidates passing both the written and oral examinations with a percentage of 90, or more, are to be certified to the Governor who shall appoint to the office or offices the one or more candidates having passed with the best records. The records of the written examinations and stenographic reports of the oral examinations are to be filed in the Department of Mines at Harrisburg. While this plan of selecting inspectors is a great improvement on the present plan of electing them, it can be further improved by a slight change in the make-up of the Examining Board. In our opinion, an examining board composed of two mining engineers, two qualified mine foremen, and five miners, will be better. This puts on the board, in the persons of the mine foremen, representatives more familiar with *all* the details of mining than the others. At the same time it gives the miners a majority of the board.

Men selected in this manner are under obligations to no one. They know that enemies made by enforcing the law cannot affect their reappointment. They can feel secure in their positions and can reasonably expect reappointment if they do their full duty and keep so well abreast of progress in mining matters as to pass the examination necessary for reappointment. If some one else shows greater proficiency and superior qualifications, naturally that man will succeed to the office.

The man who opposes the above rational plan and advocates the election of State Mine Inspectors from among those who hold certificates of competency as mine foremen, is, either through lack of consideration of the duties of an Inspector, or designedly, doing an injury to the mine workers.

In the first place every man who can pass the technical examination necessary to secure a mine foreman's certificate is not competent to be a State Mine Inspector. In fact some men holding certificates of competency as mine foremen are not capable of being mine foremen. There is something more than practical experience and technical ability necessary.

In the second place, out of about 172,000 mine workers in the anthracite regions only about 35,000 are certified miners.

All of these are not voters, and no one of common sense will admit that all who are voters have ability to select a competent mine inspector. But assuming they are, they are but 35,000 voters in a voting population of 135,000 in the counties forming the anthracite regions. This leaves 100,000 voters incompetent to judge as to whether the candidates for mine inspectors are competent or not. This is no reflection on the general intelligence of the 100,000 voters. It means simply that as most of them are of avocations varying from farm laborers to business and professional men; they are not familiar with mining conditions.

Under the present law, the State Mine Inspectors in the anthracite regions are elected. This provision of the law, bad as it is, is not as bad as the one now proposed which makes every man holding a mine foreman's certificate eligible as a candidate for election.

Even as the law now stands, Inspectors in office, who have been diligent in enforcing the mine laws, cannot be reelected. The men whom they have prosecuted can bring enough influence to bear to defeat them either at the primaries or the general election.

We have in the past condemned the election of State Mine Inspectors as a vicious plan, and have shown that if an Inspector wants to succeed himself in office he must neglect his official duties to electioneer before the primaries, and continue to do so till after the general election. In fact he must be electioneering more or less all the time. He must be a "trimmer" at all times. He must not offend the mine officials or they will defeat him at election time. He must not prosecute mine workers for violations of the law or they and their friends will defeat him at the polls. In fact, if he wants reelection the less he does as an Inspector the better for himself.

A good Inspector should be kept in office as long as he is physically able to perform the duties. Each year of service adds to his ability as an Inspector. Constant changes in the Inspectorship mean a handicap to the main object of the mine laws, viz., the protection of the health and safety of the mine workers.

The mine worker who advocates the election of State Mine Inspectors by popular vote is either misled by designing men, or has formed his opinion on the matter without considering the subject from all sides. It is the duty of every intelligent mine worker and mine official to use his influence to correct this wrong. Every man in the state of Pennsylvania who possesses enough humanity to earnestly desire that the coal mines of the state shall be made as safe as possible should use his influence to help the enactment of the measure providing for the selection of candidates for State Mine Inspectors by special, rigid, examinations, and the appointment of the most competent men by the Governor.

來 來

Electrical Knowledge for Mine Foremen

AN OLD mine foreman said to a young mine electrician who happened to have graduated from school and was starting to work: "George, you do be a bright fellow, now tell us, how many volts do there be in an ampere?" This question was told to another foreman who was acquainted with the first, the second laughed heartily and said, "That's a good one on him, that's good. Of course, why the amperes are in the volts."

It is knowledge such as this which has caused the frequent arrangement for mine management that the mine electrician should be responsible to an electrical engineer

or electrical district foreman, and not to the mine foreman, except indirectly. This has often been a cause of friction. For the mine electrician realizes that he cannot be discharged by the mine foreman, when responsible to some other official. The electrician knows that his knowledge of electricity is superior to that of the mine foreman. What he does not realize is that it is superior knowledge on a minor point. A little knowledge here becomes a dangerous thing, for inattention to the desires of the foreman is likely to develop on the part of the electrician, with the consequent hampering of the man who is responsible for the output of the mine and who knows what should be accomplished.

The Bituminous Mine Law of Pennsylvania prevents this difficulty, for it is distinctly stated in the law that the "mine electrician * * * shall be subject to the authority of the mine foreman." In the Anthracite Law under the general rules it is stated that "the owner * * * of a mine * * * shall place the underground workings thereof and all that is related to the same, under the charge and daily supervision of a competent person who shall be called Mine Foreman." Therefore, in Pennsylvania at least, this divided authority is prohibited by law. In other states where conditions have seemed to render necessary this division of authority and it is not forbidden by law, there is a remedy without having recourse to the law. It is to demand of a mine foreman, as the demand is made in other directions, that he have a certain knowledge of electricity, if he is to obtain his results by its use. A foreman is not required to be a skilled machinist, but it is demanded that he make intelligent use of steam and machinery. So too it might be required that he have sufficient knowledge of electrical machinery that an electrician can be entrusted to his care.

Under any conditions, however, a mine foreman must have full charge over a mine, if he is to be held responsible for the result. Good management cannot be obtained when there is a dual authority and one-half of that authority is absent a greater or less portion of the time, as will happen when a mine electrician is responsible to an electrical engineer.

來 來

The Coal Miner

THE competent coal miner is a mechanic, just as is the competent carpenter and machinist. There are "wood butchers" who call themselves carpenters and there are similar incompetent men who call themselves coal miners. To be a competent coal miner a man must learn the trade. He must learn how to break down the coal in the safest and most economical manner, and this means the learning of numerous important details. He must know how and when to set props, how to recognize and guard against danger to himself and his laborer, and numerous other important mechanical and cautionary operations.

Such being the case, and coal mining, especially in the anthracite seams, being a dangerous occupation,

there is much to be said in favor of a rational miners' examination law.

Such a law, if enacted, should provide for the employment as miners of only such men as have learned the trade, and who have shown by an examination that they are competent mechanics. Three years is generally considered the length of apprenticeship in other mechanical trades. There is no reason why the same apprenticeship term should not apply to miners. As there is no discrimination in other trades on account of the country or locality in which a mechanic learned his trade, there should be no such discrimination in any coal field.

The present miners' examination law for the anthracite regions is a failure. It has put in the mines, as miners, thousands of men who never learned the trade. These men are inefficient and add to the natural dangers of the mine. Legally they are miners, actually they are not.

If the miners' examination section of the proposed codified and revised anthracite mine law is to be of salutary effect in conserving the "health and safety of the mine employes, and the protection and preservation of the mine property," it should provide that each applicant for a miner's certificate shall be over 21 years of age, and shall have had at least 3 years' experience as a miner's laborer, or at such other work inside of coal mines as would enable him to learn his trade as a coal miner. There should be no restriction as to where he learned his trade, as long as he proves to the examining board that he has learned it. Naturally, he should also prove his familiarity with safety lamps and the use of explosives, and that he has sufficient knowledge of the English language to understand the instructions given by the mine officials.

Such a law will be in entire harmony with the object of the general mine law. It will prevent incompetent men, who are not only inefficient, but who are in a measure a menace to the safety of their fellow workers, posing as miners, and will compel them to learn the trade if they desire to become miners. It will also encourage actual miners from other regions, and other countries, to seek work in the anthracite mines, instead of excluding them as is now the case.

Under present conditions no competent English, Welsh, Scotch, or German miner will seek work in a region where he is compelled to serve 2 years in a laboring capacity under a man who is not as competent as he is, and who in many instances is more illiterate and of less natural intelligence.

來 來

Thirty years ago the steam plant at the average American coal mine consisted of primitive cylindrical boilers and none of the efficient and economical appliances usually found at large steam plants used in other industries. Today the reverse is the case. Coal mine managers recognize the value of boilers and appliances that increase efficiency and economy in fuel and labor.

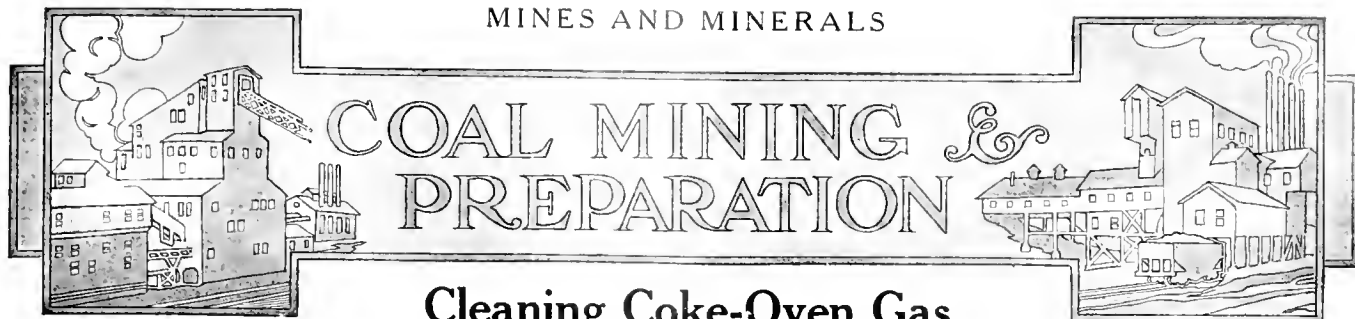

Method of Condensing and Separating By-Products Method of Manufacture of Sulphate of Ammonia

By Sydney F. Walker

THE successful operation of a by-product coke-oven plant depends upon the thoroughness with which the gas is cleaned. The by-product coke oven, practically a large retort containing coal, is subjected to external heat in order to drive off the volatile matter in the coal. The pro-

cess in Fig. 1, which has been so successful in cleaning the gas that a large quantity of it is used in generating electric power by the aid of gas engines.

blower type rather than a fan, particularly when the gas is impure.

Lowering the temperature of the gas causes a considerable portion of the water vapor to precipitate; also, a considerable portion of the tarry matter, and a certain quantity of the dust. The tar, water, and dust are led into

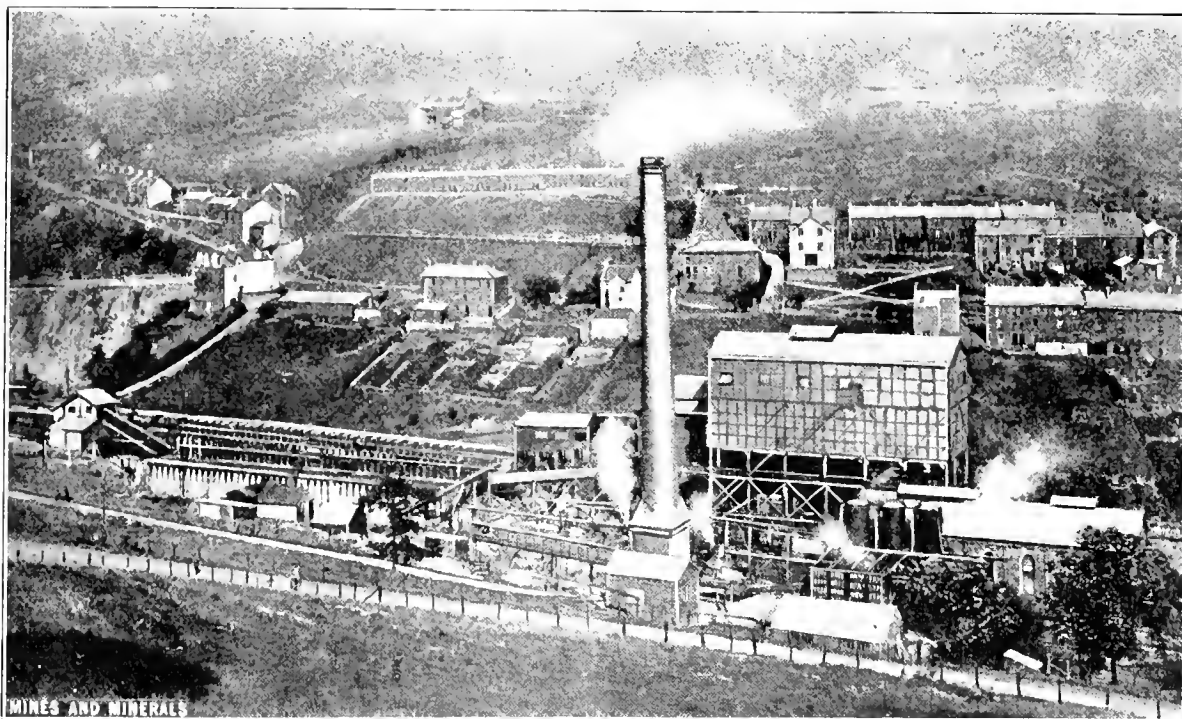

FIG. 1. CWINTILLERY BY-PRODUCT COKE PLANT, SHOWING WASHERY AND STORAGE BUNKER

cess is merely one of distillation in which the gaseous part of the coal is separated from the fixed carbon which remains in the retort with the ash and is termed coke. The gas as it leaves the retort is hot and contains a number of substances which may be removed either by condensation or by absorption, the principal ones being tar, ammonia, and hydrogen sulphide. Ammonia is converted into sulphate of ammonia which finds an increasing market in the United Kingdom; and as the quantity increases the demand and price seems to increase. At the Bargoed colliery there is a by-product coke-oven plant similar to the Cwintillery plant shown

The first process in the treatment of gas from the coke ovens is to pass it through a condenser which may be horizontal or vertical. One of the common horizontal forms shown in Fig. 2 consists of cast-iron pipes coupled end to end, with return bends placed in a zigzag manner so that the gas may pass in at *a* and out at *b*. Fig. 3 shows one kind of vertical pipe condenser, the cooling pipes being arranged vertically, the lower ends of the pipes being fitted into partitioned boxes, or headers, of larger area than the pipes through which water circulates. The gas is kept in motion by an exhaustor, which is usually of the Connorsville

receptacles provided for them. After the condensers come the scrubbers, which are used to remove the ammonia vapor from the gas. Water has a great absorptive power for ammonia, and the different types of scrubbers, seal, tower, or rotary, are based on this fact. Fig. 4 shows the more common form of tower scrubber. It consists of a cylinder *a* containing perforated partitions on which coke or shavings are placed loosely. The water or weak ammonia liquor enters through pipe *b* and works downwards while the gas enters through pipe *c* and travels upwards and out the pipe *d*. The water in trickling downwards absorbs ammonia and flows out at *e*.

The quantity of ammonia that any volume of water will dissolve, depends entirely upon its temperature, and directly upon the pressure to which it is exposed. The lower the temperature of the water, the larger

ture; and consequently when it is required to drive off the ammonia from the water all that is required is to raise its temperature. At about 60° F., a gallon of water can dissolve nearly 6 pounds of gaseous

that need not be entered into here. The ammonia gas passes from the still into the saturator shown to the right of the lime still, where it is made to double through a solution of sulphuric acid. Sulphate of ammonia is formed, and falls into the receptacle provided for it below the saturator, from which it is driven out by the steam ejector shown, and delivered on to the draining table still further to the right, from whence it passes to the centrifugal drier, and thence to the bucket conveyer which delivers it to the sulphate store-room. The carbonic acid and steam, and any sulphuretted hydrogen that has come over from the ammonia still, are carried off by the waste gas pipe, shown above the sulphuric acid, to condensers similar to those employed for cooling the gas as it comes from the coke ovens. The sulphuretted hydrogen is carried from the condensers to the sulphur ovens where it is burned with that coming from the gas purification plant.

Perhaps one of the most interesting and economic portions of the

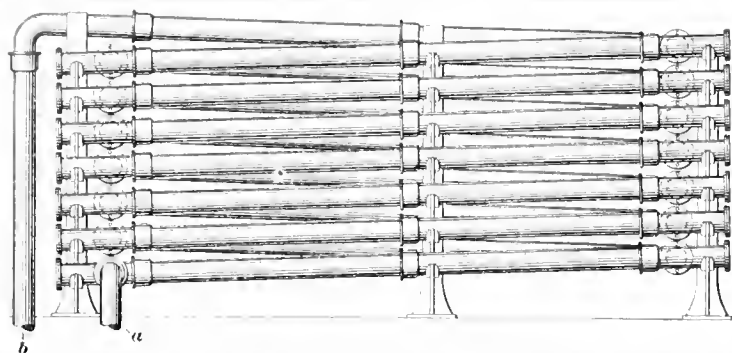

FIG. 2. HORIZONTAL PIPE CONDENSER

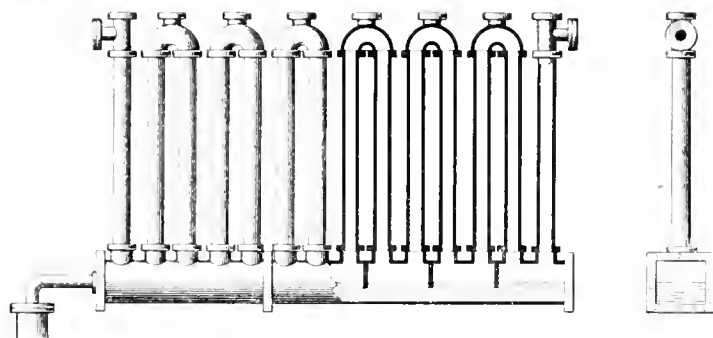

FIG. 3. VERTICAL PIPE CONDENSER

the quantity of ammonia it will dissolve. Two operations take place in the scrubber, viz., the absorption of ammonia from the gas by the water, and the deposit of more of the tarry matter upon the substances contained in the scrubber. In some scrubbers, what are practically gratings of wood, are employed, and the tar is deposited upon them. In other scrubbers, coke and sawdust are employed; the tar is deposited upon the surface and in the pores of the coke, and on the sawdust. In all cases the wood grids or boards, and the coke or sawdust require renewing when saturated with tar.

To remove the ammonia from the ammoniacal liquor obtained in the scrubber it is treated with sulphuric acid and converted into sulphate of ammonia. There are various ways for bringing about the reaction, the common method, however, is to pass ammonia gas upwards through a chamber or tower, where it is exposed to a fine spray of sulphuric acid. The resulting products are sulphate of ammonia, which falls to the bottom, water vapor, and sometimes other gases. The quantity of ammonia that water can hold in solution, varies inversely with its tempera-

ammonia; at 80° F. the possible quantity is reduced to about $4\frac{1}{3}$ pounds; at 100° F. it is only $3\frac{1}{3}$ pounds, and so on.

At Bargoed the ammoniacal liquor is drained from the scrubbers, and from the gas coolers, into a tank provided for them. It is pumped from the drainage tank into another tank above the ammonia still, into which it then passes. The ammoniacal-liquor still shown in Fig. 5 consists of a number of trays, over which the ammonia liquor passes from above downwards, the liquor forming a water seal in each tray. Steam enters at the bottom of the still, and passes up through the ammonia liquor on the trays, thus heating it, and causing the ammonia gas, and any sulphuretted hydrogen gas that remains, to evaporate. Some of the ammonia liquor which contains ammonium salts in solution, is passed through the lime still to the ammonia still. The ammonium salts break up in the presence of lime, when aided by heat, and the liquor is kept passing through the lime still, to ensure the thorough change of all ammonium salts. The ammonia passes into the still, and the remainder of the salts combine with the lime, to form other products,

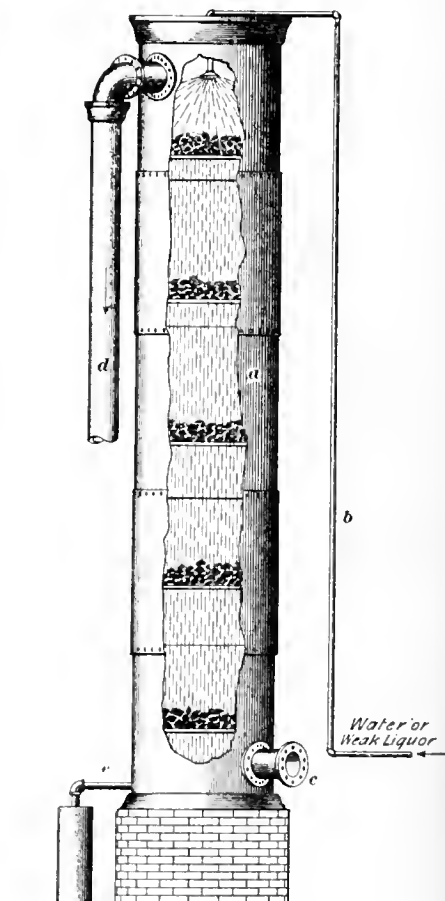

FIG. 4. GAS SCRUBBER

Bargoed recovery plant, is that by which the sulphuretted hydrogen is removed from the gas, and made to furnish the sulphuric acid required to form the sulphate of ammonia. In

The Manufacture of Coke

Comparison of the Costs of Beehive and By-Product Ovens Economies by Saving By-Products

By F. E. Lucas*

this particular case, it happens that the amount of sulphur recovered from the sulphuretted hydrogen is just sufficient to make the required quantity of sulphuric acid. The reaction of sulphuretted hydrogen upon the hydrated oxide of iron is the basis for the ammonium sulphate process, but it appears to be uncertain whether the chemical reaction which takes place results in the formation of a sulphide of iron and free sulphur or merely a higher sul-

THE following is abstracted from a paper presented by F. E. Lucas, superintendent of the Coke Oven Department of the Dominion Iron and Steel Co., at

serve them or find a substitute. Railroad companies and mine owners will find it to their advantage to creosote all railroad ties and pit timbers as well as bridge and pier

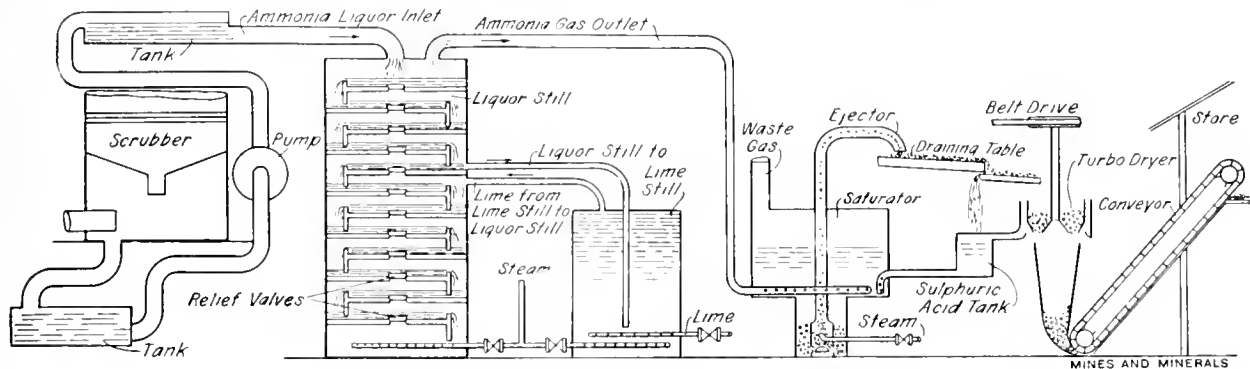

FIG. 5. DIAGRAM SHOWING SEQUENCE OF OPERATIONS IN SULPHATE OF AMMONIA PLANT

phide of iron. In any case, however, the sulphur is removed from the sulphuretted hydrogen, and is absorbed by the hydrated oxide of iron. The apparatus in which the action takes place consists of a number of boxes, in which are wooden grids, having the hydrated oxide of iron spread over them. The boxes are closed by iron lids with water seals; and the gas to be purified is forced through them. At Bargoed, two sets of iron oxide purifying boxes are employed, one set being used at a time. The purification can only be carried on until a certain proportion of sulphur has been taken up by the hydrated oxide; then the oxide has to be exposed to atmospheric air, with the result that the iron sulphide is converted into iron oxide, and the sulphur is deposited free amongst the oxide. The oxide is used over and over again, until a certain percentage, at Bargoed it is stated to be 60 per cent., of sulphur is deposited. The oxide and sulphur are then burnt together in a furnace specially arranged for the purpose, the sulphur being converted during the process into sulphurous acid, then sulphuric acid, after which it is deposited in the usual lead chambers. The purified iron oxide is used over again for further purification of the gas. From the oxide purifier, the gas passes on to a gas holder arranged to store 300,000 cubic feet, any tar or dust remaining in it being taken out by rotary washers, on the way.

the Cleveland, Ohio, 1912, meeting of the American Institute of Mining Engineers.

In selecting a by-product oven, the considerations should be simplicity in design; accessibility for inspection and repairs; such arrangement for combustion chambers and flues as will furnish a uniform temperature to all parts of the oven; and a by-product plant that will turn the gas out free from tar and with only traces of the ammonia.

The advantages of the by-product oven are its higher yield of coke over other ovens, and the economic factors which save the by-products and gas. The ammonium sulphate recovered finds a ready market, and the demand for this product as a fertilizer must always increase as the population of the country increases, and the farm and garden lands require more fertilization.

The tar finds a ready market, and this also is bound to increase. The value of tar by-products is rising as the demand increases. It would make a book in itself to describe the many products made from tar, all the way from pitch to drugs and perfumes. But we will consider the main products alone, viz., pitch, creosote oils, and light oils. For road making, roofing, and briquetting there will always be a market for the pitch. With the exhaustion of our timber lands in sight, we must either do something to con-

timbers. The lighter oils will be used in internal-combustion engines.

Probably the greatest waste the country has ever seen, or ever will see, has been going on for all the years we have been making coke in beehive ovens and burning the gas out in the air. Making coke in by-product ovens, and utilizing the gas by the most economical means, will revolutionize the production of power. It has already been done, most notably in Germany; and we must come to it sooner or later. The sooner we arrive at that point the better for the industries of the country, and the more we shall have done toward conserving our coal resources.

A modern by-product oven, run at a reasonable capacity, will give 50 per cent. or more of surplus gas from a coal of about 28 per cent. volatile content. The surplus gas is the gas over and above the quantity needed to keep the oven up to the required temperature. This surplus gas should run from 450 to 500 British thermal units per cubic foot. The quantity of surplus gas is approximately 5,000 cubic feet; hence, $5,000 \times 450 = 2,250,000$ British thermal units per ton of coal carbonized is available for the production of power = 93,750 British thermal units per hour. The builders of gas engines tell us we can get 1 horsepower on a heat consumption of 11,000 British thermal units. On that basis, we find 8.5 horsepower

*Sydney, N. S.

per hour from the surplus gas from 1 ton of coal.

The surplus gas can also be used for illuminating purposes. This is done at some plants in this country and at a great many in Germany. By installing two collecting mains on top of the ovens, the rich gas, given off during the earlier hours of the coking time, can be collected in one main, and the leaner gas in the second. By this means gas of 650 to 750 British thermal units, or from 16 to 19 candlepower, can be derived direct from the ovens without enriching. The lean gas is still of sufficiently high calorific value for heating the ovens. Gas from the by-product ovens can be piped for hundreds of miles if necessary. Again, the gas may be used for steam raising or for heating all manner of furnaces; or in conjunction with steel works, can be used in a steel furnace instead of producer gas. The recent investigations by Professor Bone have shown how by flameless combustion we can get 95 per cent. of efficiency out of the gas we burn.

In any of the above ways the gas can be used with great economy; but I believe the production of power from gas engines opens up the largest field.

In the year 1911 there was produced in America approximately 29,338,000 tons of coke, of which approximately 21,448,000 tons was produced in beehive ovens. I do not know the figures for the average volatile content of the coal that went to make this coke; but, assuming a fairly low volatile coal of say about 24 per cent., to produce 21,000,000 tons of coke in by-product ovens would take about 26,000,000 tons of such coal. Allowing the small amount of 4,000 cubic feet of surplus gas per ton of coal, and 15 pounds of ammonium sulphate, and 7 gallons of tar, and allowing the surplus gas to furnish only 400 British thermal units per cubic foot we find that we would have 26,000,000 \times 4,000 = 104,000,000,000 cubic feet of gas per year; this at 400 British thermal units per cubic foot = 41,600,000,000,000 British thermal units; reduced to hours = 4,748,858,447 British thermal units, at 11,000 British thermal units per horsepower = 431,714 horsepower. Or allowing the value of 10 cents per 1,000 cubic feet, for the gas, we have the sum of \$10,-400,000. Of ammonium sulphate we have 174,107 gross tons at a value of approximately \$60 per ton = \$10,-

446,420. Of tar we have 182,000,000 gallons, worth at 2 cents per gallon, \$3,640,000. Total value of gas, ammonia, and tar, \$24,486,420.

I do not doubt that the coal from which the coke was made would have given better results than I have shown here, but even at these conservative figures we can see what a loss there has been.

The above amount is 7 per cent. on about \$350,000,000, a sum which would build by-product ovens enough to carbonize 125,000,000 tons of coal yearly. Besides this loss, there has been the loss of the coal burned in the beehive oven. Allowing 64 per cent. as a fair yield for the beehive and 78 per cent. for the by-product ovens, there would be a loss exceeding 6,000,000 tons of coal. This at \$1 per ton added to the other loss gives us a grand total of over \$30,000,000 lost in one year. It seems to me that this is well worth "getting after." Much can be done if we approach this subject in the same manner, and give it the same study and attention as has been given in past years to questions pertaining to mining and metallurgy.

COMPARISONS BETWEEN BEEHIVE AND BY-PRODUCT OVENS

Beehive.—

Ordinary type, 12.5 feet in diameter.

Cost from \$700 to \$1,200 per oven.

Produces 4 net tons of coke in 48 hours, equal to 2 net tons in 24 hours.

Yield of coke from coal, 60 per cent.

By-products and surplus gas, none.

By-Product Ovens.—

Oven charge, 9 tons.

Coking time, 24 hours.

(Ovens may be larger or smaller than this, but 9 tons would probably be about the average charge for the modern type of oven.)

Coke produced on 70 per cent. yield, equals 6.3 tons of coke per oven in 24 hours.

By-Products.—

Ammonium sulphate, 22 pounds per net ton of coal = 31 pounds per net ton of coke. Value, 2.25 cents per pound above cost of manufacture = 70 cents per ton of coke made.

Tar, 8.5 gallons per ton of coal = 10.7 gallons per ton of coke, at 2 cents per gallon = 21 cents per ton of coke.

Surplus gas, 5,000 cubic feet per ton of coal = 7,143 cubic feet per ton of coke, at 10 cents per 1,000 cubic feet = 71 cents per ton of coke.

The total value of by-products as above is, ammonium sulphate, \$.70; tar, \$.21; gas, \$.71. Total, \$1.62 per ton of coke. Add to the above the difference between 60 per cent. yield in beehive ovens and 70 per cent. in by-product ovens on the same coal. Taking coal at \$1.50 per ton: Coal per ton of coke produced in beehive oven, = \$2.50; coal per ton of coke produced in by-product oven = \$2.14. Balance in favor of by-product oven, \$.36. So that the total saving in coal and by-products equals \$1.62 plus \$.36 = \$1.98 per ton of coke made, = \$12.47 per oven in 24 hours = \$4,551.55 per oven per year. Or for by-products alone, without saving in coal, \$3,723 per oven per year.

For a plant of 100 ovens, the saving equals \$455,155 per year. Cost of 100-oven plant complete is approximately \$1,000,000. A 100-oven plant of above capacity will produce 630 tons of coke per day = 229,950 tons per year, working on 24 hours coking time.

If benzol is recovered it will further add to the income from by-products.

采 采

Coal Mine Employes in the United States

According to statistics compiled by the United States Geological Survey, the total number of employes at coal mines in the United States in 1911, was 722,335, of whom 172,585 were employed in the anthracite regions of Pennsylvania, and 549,750 in the bituminous and lignite mines of the country.

The anthracite miners averaged 246 working days during the year, as against 211 days for the bituminous and lignite miners. The average annual production for each employe was 524 tons in the anthracite mines and 738 tons in the bituminous and lignite mines. The average daily production for each employe was 2.13 short tons in the anthracite mines and 3.5 short tons in the bituminous and lignite mines.

采 采

Dr. J. H. Haldane has designed a portable apparatus for the analysis of mine air and the determination of the percentage of firedamp in any return air. The apparatus is arranged so as to burn the firedamp in a closed tube by means of a platinum wire, heated by means of a bichromate cell, and then measure the decrease in the volume of the air. The determinations are quickly and simply made.

The Proposed Anthracite Mine Law

A Review and Criticism of the Act Proposed by the Subcommittee of the Commission to Revise and Codify the Law

By Rufus J. Foster, Mining Engineer

A CAREFUL study of the Act proposed by the subcommittee, and which at this writing is being considered by the full Commission, shows a proposed law containing many excellent features, as well as some omissions, and some provisions that are in part at least impracticable. These faults are, I am confident, not due to lack of ability or of conscientious work on the part of the members of the subcommittee. When the scope of the proposed law, and its length are considered, it is not surprising to find some points meriting adverse criticism.

In commending the general features of the proposed act, and in criticizing some of the details, the writer's opinions are based on the fact that the law should be, what its title calls for, "An Act to Provide for the Health and Safety of Persons Employed in and about the Anthracite Mines of the Commonwealth of Pennsylvania, and for the Protection and Preservation of the Property Connected Therewith." The man who advocates provisions in such a law which are for political purposes, or for purposes other than those stated specifically in the title of the act, no matter whether he is mine worker, mine official, or mine owner, is untrue to the best interests of both employes and employer.

Inasmuch as this review to be of greatest value must be as brief as is consistent with clearness, each point adversely criticized is treated in as few words, and with as little argument as possible.

In this connection, it is but fair to state, that, before writing this, the author had an opportunity to read the criticisms of the operators' committee. These criticisms and suggested improvements he found in practically every instance to be betterments tending to make the various sections either more specific in their requirements, or to modify the sections so as to make their enforcement practical wherever possible. Naturally, in many of the opinions here expressed, there will be a similarity with those expressed by that committee. However, as the gentlemen composing the operators' committee do not possess, or claim to possess, a monopoly of mining knowledge, or good mining sense, the writer claims the right to express his opinions, based on

nearly 40 years of experience in and study of coal mining, regardless of whether such opinions agree or disagree with those of others.

In Section 1, Article 2, the definition of the term "mine" can be improved. As it stands in the report, the workings in each seam at a colliery working more than one seam would constitute a separate mine, as far as the provisions of the law are concerned, even if all the coal produced is hoisted from one shaft or slope.

In the same section the use of the unbonneted Davy lamp by fire bosses is prohibited. The section will be all right if the word unbonneted is omitted and the requirement be limited to safety lamps approved by the Chief of the Department of Mines.

The definition of the term "mining engineer" needs considerable modification. As proposed, it describes a mine surveyor, and the experience requirement is unnecessarily long. A better definition, though incomplete, broad enough for the purpose of the act would be—the term mining engineer means any person who is competent to accurately survey and plot the inside workings of a mine and the surface topography, and to construct geological cross-sections, and who has had at least 3 years practical experience at such work. To require the young man who is not a graduate of a school of mines or similar institution to have had 10 years experience, and the graduate 5 years experience, will work a hardship on many bright, careful, and thoroughly competent young men. The fact that a man is a graduate of a school of mines is not by any means infallible proof that he is the more competent or careful man. His course in such school merely means that he can learn the practical work quicker and more easily, if he wants to, and experience has shown in many cases that he doesn't want to. This is by no means the fault of the school.

In Article 3, defining the duties of superintendents, there are a number of points in which improvements can be made.

In Section 6 the word "signals"

is used when "signs" is meant. In Section 7, the locality at which copies of the General and Special Rules shall be posted is not specifically stated. The addition of the words "near the main entrance of the mine" will remedy this. In Section 8, the superintendent is limited to the use of the telephone or telegraph in notifying the State Mine Inspector of accidents. As occasions may arise where a special messenger will be quicker, he should have the right to use such means. In Section 13 a self-recording thermometer is required at every mine. This we think is unnecessary. The self-recording barometer provision is all right; but the thermometer will serve no practical purpose and will entail on the mine foreman an additional duty without any compensating benefit, but which will lessen the time at his disposal for more important duties to both his employer and subordinate employes.

As all working mine maps in the anthracite region are made on a scale of 100 feet per inch, there is no necessity of the provision of the old law being changed, particularly when mine maps on a scale of 100 feet per inch are more intelligible and easier read than those made on a smaller scale.

The provision requiring a duplicate print of the mine map in the mine foreman's office should be changed to read a "true copy" of the mine map, so that either a blue-print, a brown print or a tracing will meet the requirement.

The requirement that the superintendent shall under certain conditions extend the workings on the Inspector's map should be changed to require him to have this work done. It is not the duty of the superintendent to do the actual surveying and mapping.

In Article 6, which defines the duties of a mine foreman, Section I, which provides for the employment of certificated foremen, should be so modified, that the one mine foreman may have charge of several detached openings at the same colliery, if each of those openings employing 20 or more men is under the supervision of a properly qualified assistant mine foreman.

That section requiring daily inspection of every working place during working hours by the foreman or an assistant foreman should

be modified by the insertion of the words "whenever it is practicable to do so." The reason for this suggested modification is that something unusual, and possibly dangerous, may occur in one section of a mine requiring the attention of the foreman and all his assistants, and thereby prevent strict compliance with the law. Inasmuch as the fire boss *must* make a daily examination, and his report of his inspection must be examined and countersigned by the mine foreman, this should be considered a sufficient compliance with the law, when such unusual occurrences happen. The provision that the mine foreman shall instruct the miner as to when, where, and how to set timber, and in blasting the coal, should be eliminated. The law requires that the miner shall hold a certificate of competency secured by passing an examination to show "that he is competent to do the work of the miner without endangering his own life or the lives of others." If a man passes such an examination it must be assumed that he knows his business, and he should assume the full responsibility for his own acts. Naturally, if a mine foreman sees a miner doing any work improperly, it is his duty to correct him, but he cannot, in addition to his numerous other duties act as an instructor to the miners, and in many cases his doing so would be resented.

The section providing for biweekly measurements of the ventilating currents will be more easily understood if the words "inside breast" and "outside breast" are more specifically denoted as "inside working breast" and "outside working breast."

In Section 6, of Article 6, which directs that the mine foreman shall see that all stoppings between gangways and airways are properly built, reference is made to Article 15. This is a typographical error and should read Article 14. The section providing that the mine foreman or a competent other person shall each day examine the shafts, slopes, traveling ways, signal apparatus, etc., should be modified to read each *working* day. As it now stands, it will require such examinations every day of the year regardless of whether the mine is in operation or not.

Sections 12 and 13, of Article 6, require the mine foreman and assistant foremen to make a daily report, in ink, stating the general condition of the working places visited by them. As in all mines where fire

bosses are employed, this duty is performed by them as directed by law, there is no necessity for the work being duplicated and additional duties placed on the foremen, that will take time that should be devoted to more important details. These sections should be modified so as to apply only to mines where fire bosses are not employed. Sections 15 and 16 use the word signal for sign. It should be modified to read "signal, or sign," thus making its meaning clearer.

Section 17 of the same article should be modified to permit the use of lime or cement mortar in building stoppings, as in many instances lime mortar is equally as good as cement mortar, and while the kind of stoppings required by this section are suitable in the Wyoming and Lackawanna regions, they are not always practicable in the thick and heavy pitching seams of the Hazleton and Schuylkill regions. Therefore the section should be modified so as to require such stoppings where the use of the designated material is practicable.

Section 18, of Article 6, requires that any accumulation of explosive or noxious gas in the worked-out or abandoned section of a mine shall be removed as soon as possible after its discovery, if practicable. It then orders that no person shall be allowed in that portion of the mine until such gases are removed or rendered harmless. This should be modified to read "No person excepting those employed in the removal of the gas shall be allowed, etc., etc."

Section 26, which provides for the withdrawal of all the men in case of an accident to the fan whereby ventilation is seriously interrupted, should apply to the mine or portion of the mine, instead of to the whole mine. In some cases the ventilation of the entire mine is not furnished by one fan, and many cases arise in which the interference with the air-current in one section of the mine does not affect the other section in any way whatever. Under such circumstances it is unjust to both men and officials to require the men in the unaffected sections to quit work.

Section 27 of the same article requires that the mine foreman and assistant mine foreman shall measure the bits of the miners' drills to see that they cut a hole at least $\frac{1}{8}$ of an inch larger than the diameter of the cartridge. Article 24, Section 3, under the title "Duties of the

Miner," provides that no miner shall force a tight cartridge into any hole. To comply with this rule it is incumbent on the miner to see that his drill is of the right size, and therefore the section in Article 6 is unnecessary and unjustly places responsibility on the mine foreman and his assistants that should be borne by the miner.

In Section 30, the words "or any other" occur in such a way that they seem confusing and unnecessary. This is probably a clerical or typographical error. In Article 7 defining the duties of the fire boss there are several instances in which the intent of the law can be made clearer by the use of additional words.

As a criticism, I claim that the fire boss, while required to use a safety lamp for testing purposes, should not be prohibited from having an approved storage-battery electric light to use in lighting him through sections of the mine where examinations are not necessary, and also to enable him to more closely observe the character of the roof and sides as regards danger from falls.

Section 4, of this article, should not only require the fire boss to report to the mine foreman or his assistant the dangerous condition of any place in which men are working, but he should be required to instruct the men to make the place safe, or if necessary send them out until the place is made safe.

In general, Article 9 regulating the selection of State Mine Inspectors, is one that I heartily approve, though some minor changes will improve it. Its adoption will effectually remove the selection of Inspectors from politics and will ensure the selection of capable men of a high technical and moral standard. I have consistently advocated this system for years, so will not repeat arguments in its favor. I am of the opinion, however, that that portion of Section 3, requiring the candidates to have had at least 6 months experience as a fire boss, should be eliminated. Many miners, who never served a day as a fire boss, are as conversant with, and have had as much experience in gas, as most fire bosses, and they should not be discriminated against.

In Article 14, Section 4, the provision for walls separating the inlet and return airways, where such walls are required, should be modified the same as suggested for Section 17 of Article 6, and for the same reasons.

In Section 7 of the same article, an improvement can be made by a more definite statement as to what constitutes a "main door," and it should also be modified to permit of a self-acting door without an attendant, when such automatic or self-acting door is approved by the Inspector of the district. There are a number of such doors in successful use in mines in the anthracite regions as well as in many bituminous fields.

Section 1, of Article 15, should be modified so that, in addition to signaling apparatus, the tops and bottoms of slopes should be connected with telephones or speaking tubes.

The section providing for safety gates controlled by the cages, at the heads of shafts should be modified so as to permit gates raised or lowered by other means, at shafts where the coal is not landed at the shaft head, as is the case at many mines. Safety gates should be required, but their control should be made practicable.

In the case of the coupling chain attached to the wire rope at hoisting shafts, either iron or steel chain should be allowed, as it is a well-known fact that a good iron chain is, for the purpose intended, better than a steel chain.

The section providing for the examination of ropes used for hoisting should be so modified as to place the responsibility for the examination of ropes on inside slopes, planes, and shafts, on the mine foreman, and not on the outside foreman. The latter should, of course, be responsible for the ropes under his charge.

Section 3, of Article 17, is all right as far as shafts are concerned, but in many cases it is impracticable to construct a passageway such as described from one side of the bottom of a slope to the other. Therefore the word slope should be eliminated from the section.

The requirement of fireproofing the sides, roof, and bottom of mine openings for a distance of 50 feet or more from the surface, should be modified so as to apply to permanent openings and not to every outlet to the surface, as the latter are often only temporary openings, and should be exempted in the same way as are cave-ins.

Section 8, of Article 17, which provides that the top of each shaft and also of each slope or any intermediate lift thereof shall be securely fenced off, is impracticable as far as

slopes are concerned, and the requirement as to slopes should be eliminated.

In that portion of the proposed law regulating the use of electricity in mines, there are a number of instances in which an opinion as to what is safe and practical and what is unsafe or impractical, should be obtained from an able and experienced electrical engineer, or better still a committee consisting of an able electrical engineer, a certified and thoroughly competent mine foreman, and one of the State Mine Inspectors.

Article 22, of the proposed law, is not only unnecessary, but opens a way for frequent and annoying interferences with the mine foreman in his duty to his employer, and to the state as set forth in the mine law. In the first place, the state requires a mine foreman to show through a rigid examination that he knows very much more regarding the safe conduct of mine workings than is required of the miner. Therefore, under no circumstances should he be placed in a position subordinate to the miner. In the second place, the law provides for more thorough inspections by fire bosses, mine foremen, and State Inspectors, than a committee of two miners can make. If such inspections are not made, or if dangerous or unhealthy conditions are not remedied, any individual miner or any group of miners can lodge a complaint with the State Inspector, and if the complaint is well grounded, redress or punishment for the violation of the law will follow.

In Article 24, defining the duties of the miner, Rule 24, of Article 12, of the present mine law is omitted, and this omission is a serious mistake. This is the rule requiring the miner to report to the foreman any dangerous condition he may notice in the mine. This omission was probably an oversight on the part of the subcommittee. Another rule should be added prohibiting the miner leaving his working place in an unsafe condition without reporting it to the foreman or assistant foreman. Neither should he be permitted to leave his laborer in the working place when he leaves for the day. Neither should laborers be allowed to work in said place unless the miner is present, and neither miners or laborers should be allowed to unnecessarily be on haulage roads or be allowed to enter idle or abandoned workings without receiving permission from the fore-

man, the assistant foreman, or the fire boss.

Article 26, of the proposed law, which provides for Rescue and First-Aid Corps, contains some details which are inconsistent with the practice originated by the anthracite companies, and which has been developed to such a high degree of efficiency that it has won world-wide commendation. There are also some requirements, particularly in the number of helmets, which in the case of the establishment of a central station are in excess of the number that will ever be required.

Article 27, providing for ambulances and stretchers, is not exactly what it should be. The provision that when 90 per cent. of the employes live within a radius of one-half mile from the principal entrance of the mine, an ambulance is not to be required, should be stricken out. There should be an ambulance ready for service at each mine.

Sections 3 and 6, of Article 30, are so worded that they prohibit the use of acetylene mine lamps. This is a mistake that should be remedied. Section 1, of Article 33, providing for fireproof building in the mine, should be modified to permit the use of any incombustible material approved by the district mine inspector.

In the interest of safety the General Rules proposed can be improved or made more practical as follows:

By an addition to Rule 6 prohibiting the use of any explosive, detonator, cap, squib, or fuse, in the mine, except on the written approval of the superintendent.

By the insertion of a rule prohibiting the use of mixed explosives.

乘 乘

A Union Cut in Wages

The American Fuel Co. and the Rocky Mountain Fuel Co., operating in the northern Colorado coal field, are cutting prices, the former being a union and the latter a non-union mine. The American company's employes agree to cut their wages in half if the national organization will pay them strike benefits to make up the loss. It is stated that the national organization will do this to prevent monopoly of the coal business by the Rocky Mountain Fuel Co. It looks as if the union was trying to create a monopoly of the labor business and coal business as well.

Stray Electric Currents

Three Instances Where Shots in Mines Were Prematurely Exploded by Electric Currents

By C. J. Norwood*

I HAVE NO formal paper to present, nor even a formal statement to make. But some interesting information has come to me that may be of interest to you gentlemen.

I have been interested, as a mine inspector for the state, in the effort to get an explosive to replace black powder in our coal mines. If we are to get a safer powder, it must do as good work as black powder, it must be as readily handled, and it must cost practically no more. Some months ago a new powder, a loose, granular powder, came to my attention. It may be handled like black powder; that is, made into cartridges and fired by a fuse, a squib, or by electricity. After having made some investigations, I witnessed some tests intended to determine the question of safety in handling it, including a friction test much more severe than may be expected in the charging of a shot hole. I then witnessed a number of tests made with it in shooting coal in one of the mines of the St. Bernard Mining Co., at Earlington. Standing but a short distance away from the face, I watched the shots as they broke the coal, a thing that would have been impossible in the case of black powder, and noted the very short and fleeting flame made by each shot, the excellent coal produced, and the practically clear atmosphere left after shooting. The ultimate cost per pound figured out to be about the same as black powder. I was favorably impressed with all I had learned and had seen, and felt that a thorough, practical test, such as would be given by the exclusive use of the powder in a mine for 30 days or more, would be justified. The St. Bernard Mining Co. undertook such a test, setting aside two of its mines, representing two different seams (No. 9 and No. 11), for the purpose. In each mine the coal is undercut by "air puncher" machines, and the holes are drilled by rotary drills making 1,600 revolutions per minute, the usual depth of a hole being $4\frac{1}{2}$ feet. Firing is done with squibs. The main haulage is by electric motor.

Frank D. Rash, vice-president of the company, advised that the work proceeded satisfactorily until on August 9 two premature shots occurred in one of the mines in the No. 11 seam, in different rooms, and about

30 minutes apart. In the first room several holes had been drilled. The shooter had loaded the lower left rib hole, using a copper needle, had tamped it, and withdrawn the needle. Another hole was then loaded with the same needle. After an interval of a few minutes the needle was inserted into the first hole, to clear it for firing with a squib, when the shot went off while the shooter was holding the needle, heaving the coal down in good fashion. The shooter was at the side of the hole, within about 18 inches of the face, but was not hurt; he simply felt the jar. Six other men were in the room, near the face, but no one was hurt. In the second room the top hole on the left rib had been loaded, a copper needle being used. The squib failed to fire the powder and the needle was inserted to clear the hole. When the needle reached the powder, the latter went off, heaving out the coal. The shooter, who was inserting the needle, had his arm jarred, but was not injured. The men thought they could account for the premature shots in ordinary ways, and went on with their work, but on August 28 a third premature shot occurred, this time in a room neck. In this case the shooter held the cartridge (about 12 inches long) in his left hand, inserted his copper needle into it about 4 to 6 inches, then placed it in the lower right rib hole and pushed it until near the bottom of the hole, when it exploded, throwing the coal out about 3 feet. The shooter's hand was badly lacerated, and he was severely but not dangerously burned. The driller, about 10 feet away, was not hurt. Upon the occurrence of this third premature shot, Mr. Rash at once stopped all use of the powder and put the case up to the manufacturers.

You gentlemen will observe that conditions were uniquely favorable for an intelligent investigation of the causes of the premature explosions, as the men still lived, all but one uninjured, to tell precisely what had happened. Had black powder been used not a man would have lived to tell the tale, and the usual explanation would have been accepted. I wish to bring to your attention certain important facts developed in the investigation undertaken by the manufacturers to account for the premature

explosions of their powder. The facts developed are of interest without regard to the particular powder. Therefore, I will not undertake to tell of all the tests to which the powder was submitted while the manufacturers were seeking an explanation of the explosions. It is sufficient to say that they satisfied themselves that the explosions were not due to any chemical reaction in the powder, or to a spark caused by "sulphur," or to any fire in the hole, or to friction, and so on. Finally, it was thought that in some way electricity might have exploded the powder, and Prof. H. B. Dates, of the Case School of Applied Science, Cleveland, Ohio, was called upon to assist in the investigation. Professor Dates visited the mine and, with the proper instruments, made tests to ascertain whether there were any stray currents or other electrical conditions in the places where the premature explosions occurred that might have been concerned in the latter. I have a copy of his report. He found stray electric currents, in the coal, and in at least one instance of sufficient intensity, under the proper combination of conditions, to have ignited the powder, or even black powder.

In order that you may be able to understand the readings reported to him, I will say that the coal, which is 6 to 7 feet thick, has two thin dirt bands, one about 18 or 20 inches below the roof and one about 2 feet above the floor. It also carries some thin, irregularly placed, horizontal "sulphur" bands, usually only a few inches in length. You will recall that the haulage is electric. Also that a copper needle was always in evidence; that the first and second explosions occurred while such a needle was being inserted into the holes, and that in the third case the cartridge was on a copper needle, part of the needle of course coming in contact with the coal. The rails are used as the return for the current. The compressed-air pipe, to which is attached the wire-wrapped hose for the punchers and drills, was reported by Professor Dates to be bonded to the rails. Tests were made in several rooms, including those in which the premature shots occurred, also at the face of one of the entries, and were conducted on two days. Readings of potential were obtained many times on both days between points on the coal and the floor, and between

*Remarks made before the Kentucky Mining Institute, December 9, 1912, by C. J. Norwood, Chief Inspector of Mines.

the air pipe and the coal. Also, in several instances readings were obtained between points in shot holes and the floor. In all cases cited here a high resistance instrument was used. Points on the floor and air pipe were positive to those on the coal.

Maximum potential readings obtained in rooms 6 and 7 (faces about 200 feet in from the entry) on entry East 18 were as follows:

	Volts
Between floor and upper dirt band.....	.75
Between floor and lower dirt band.....	.50
Between floor and sulphur band.....	1.20
Between floor and point in shot hole.....	.50

When the tests were made these rooms were "beyond the point to which the locomotive runs and outside the direct path to the power house, except in so far as the rails in entry E 18 influence the path of the return currents."

In room 13 on entry W 18 (face about 10 feet in from entry), "potential readings could be obtained at practically all points on the face of the coal and on the side walls of the room." The following are "typical of those obtained on both days, and repeated many times on both days," between the air pipe and points on the coal seam:

	Volts
Approximately 2 inches below roof.....	.5
Approximately 2 inches above upper dirt band.....	2.0
On upper dirt band.....	2.0
Approximately 2 inches below upper dirt band.....	1.0
Midway between upper and lower dirt bands.....	1.8
Approximately 2 inches above lower dirt band.....	2.0
On lower dirt band.....	2.0
Approximately 2 inches below lower dirt band.....	.8
Approximately 2 inches above floor.....	1.3
On floor at foot of coal face.....	1.0

Potential readings of similar value were also obtained in room 14 of entry W 18, and at the face of the entry; also between points near the rear of shot holes and the floor at those places.

Professor Dates observes: "Rooms 13 and 14 are in a more or less direct line from the end of the locomotive run to the power house, and the rails in W 18 are so situated as to aid the currents to take a return path through this part of the mine."

He also says: "At times very high readings were observed. The conditions producing these high readings were temporary and evidently of short duration, as evidenced by the fact that such values were obtained only over very limited periods of time, often not exceeding a few seconds." For room 13, W 18, he reports that "a reading of 25 volts was observed between air pipe and lower dirt seam; several of 12 volts and one of 10 volts between floor and lower dirt seam." The variation in the values of potential differences from time to time between the floor and coal are "according to the posi-

tion of the locomotive and the operation of other apparatus."

Here we have demonstration of the fact that a difference as high as 25 volts may occur. Was that sufficient to fire the powder? And if such voltage is sufficient to fire this powder, will it fire black powder also?

This question was at once taken up by Mr. W. C. Waddell, electrical engineer, with the cooperation of Professor Dates, in the latter's laboratory, and some interesting results were obtained. It was demonstrated that it was impossible to fire either the powder under investigation or black powder by an electric spark with so low as 10 volts unless the current exceeded .25 ampere; but that "with a low amperage and a fairly high voltage, 15 to 30 volts, the 'spark' becomes an 'arc,' by means of which either the powder in question or black powder may easily be fired." It was concluded, after considering all the results obtained in the experiments, with different combinations of voltage and amperage, that "a fair average" of the current required to fire the powder under investigation would be 25 volts and .30 ampere; and to fire black powder it would be 25 volts and .35 ampere. Mr. Waddell "found that with a high resistance in the current there must have been at least .30 ampere present to get a reading of 25 volts," a reading that was obtained in the No. 11 mine.

As the results of this investigation were new to me, I have brought the matter to your attention thinking that it may be new to you. I understand that the Pittsburg Testing Station is interested in the matter also. It seems to me well worth your consideration, especially those of you who have electricity in your mines. We know that men have been killed while loading or needling out shot holes; we know about "premature" shots with black powder, but as a rule we have not known just what caused them—the man has not been here to give information. We have made the same guesses for "electrified" mines as have served for those not using electricity. But it appears that in mines that are "electrified" stray currents may occur in the coal seam, and that it is possible for such a current to fire black powder. With the rapid growth in the use of electricity in mines there appears to be an increase of danger that some of us have not thought of; we should consider this, and be on the lookout for stray currents in the coal that may be sufficient to explode black powder.

Obituary

PROF. R. SAMPSON

Prof. R. Sampson, of the School of Mines at Washington State College, was run down by a passenger train in December, while crossing the Northern Pacific tracks near the College campus, at Pullman, Wash. Professor Sampson was a graduate of Massachusetts Institute of Technology and specialized in ore dressing. He was highly respected and liked by all who knew him, and by his death the Institution loses a valuable instructor.

DR. FRANK L. MCKEE

Dr. Frank L. McKee died in Wilkes-Barre, January 13, after being operated on for appendicitis. Doctor McKee, once Colonel of the 9th Regiment, N. G. P., was a resident of Plymouth. He received a gold medal for his work at the Johnstown flood; he saw service in the Spanish-American war; and in late years has been active in promoting first-aid work among the miners of the Parrish, Lehigh and Wilkes-Barre, and the Susquehanna coal companies. He had many friends among company officials and coal miners.

MARTIN MCLAUGHLIN

Martin McLaughlin, State Mine Inspector for the Sixteenth Anthracite District of Pennsylvania, died at his home in Shamokin, Pa., on December 22, 1912, aged 55 years. Mr. McLaughlin was born and raised in the anthracite region and received his early education in the public schools of Ashland. He worked in various capacities around the mines, from slate picker to miner, and by study, integrity, and natural intelligence advanced successively to the positions of fire boss, assistant foreman, foreman, and State Mine Inspector. In the latter position he served the state most efficiently for almost 7 years.

MAJOR EMIL C. WAGNER

Major Emil C. Wagner, Assistant Superintendent of the Girard Estate, in charge of the lands in Schuylkill and Columbia counties of Pa., died at his residence in Girardville, Pa., on December 16, 1912, in the 67th year of his age. Major Wagner was born in Geissen, Germany, on May 29, 1846, and came to America with his parents who located in Philadelphia in 1849. In 1869 he became Assistant Superintendent of the Girard Estate. In this position Major Wagner was identified in a prominent manner with the coal-mining

interests of the Mahanoy region. He was, respectively, a captain and a major of the Eighth Regiment, National Guard of Pa., and was a director of the State Hospital at Fountain Springs near Ashland. Major Wagner was twice married. His first wife was Miss Margaret H. Kerr, of Philadelphia, to whom two children were born, Charles W. Wagner, of Pottsville, Division Engineer for the Hudson Coal Co., and Christina, wife of John S. Barnhart, of Girardville. His second wife and widow was Miss Laura E. Ulmer, of Pottsville. Major Wagner was a man of lovable character and most genial disposition.

來 來

Personals

W. C. Rogers has been appointed manager of the Reliance Coal and Coke Co., with headquarters at Third and Walnut Streets, Cincinnati, Ohio.

William J. Jones, ex-mine inspector of New York state, has been appointed Inspector of Explosives in the Department of State Fire Marshal, with headquarters at Akron, N. Y.

Charles T. Main, engineer, 201 Devonshire Street, Boston, has been awarded the contract for the engineering work in connection with the development of the Big Falls of the Missouri River, near Great Falls, Mont., and Thompson Falls, on Clark's Fork, of the Columbia River.

H. C. Hoover has been elected a member of the board of trustees of Leland Stanford University.

Arthur J. Hoskin, mining engineer, of Denver, Colo., is at present in Dahlonga, Ga., where he is going to start an operation to treat Georgia gold ores, after which he will return to Denver.

Mr. Davidson, Secretary Alabama Operators Association, has prepared and had printed "Safety Pamphlet" No. 2 for the use of the association.

Dr. Henry M. Payne, formerly mining and metallurgical expert for Stephen T. Williams and staff, incorporated, 50 Church Street, New York City, is now chief of staff. Stephen T. Williams, the pioneer efficiency engineer, established this business in 1879.

J. P. Hutchins was recently engaged in examination work on mines for the Cabinet of the Czar of Russia, in consultation with the engineers of the cabinet.

E. J. Haddock has resigned his position with the Montgomery Coal Washing and Mfg. Co., Inc., Birmingham, Ala., to accept the position of chief engineer of the I. L. Smith Co.

and Smith & Post Co., Milwaukee, Wis.

R. B. Brinsmade recently returned to his office in Puebla City, Mex., after a protracted visit in the northern part of Puebla State on mine-examination work.

P. J. Friel, of Buck Mountain, near Mahanoy City, Pa., has been appointed State Mine Inspector for the Sixteenth Anthracite District of Pennsylvania, vice Martin McLaughlin, deceased. Mr. Friel previous to his appointment was in charge of the Lehigh Valley Coal Co.'s operations at Buck Mountain. He will serve the unexpired 3 years of the late Inspector McLaughlin's term.

The Governor of Illinois has appointed as members of the Illinois Mine Rescue Station Commission, Thomas Moses, general superintendent of the Bunsen Coal Co., as one of the operators, in place of the late W. W. Taylor, and J. M. Zimmerman, representing the United Mine Workers of America, in place of Charles Krallman, recently resigned.

The Governor of Illinois has appointed the Mining Investigation Commission consisting of the following members: H. H. Stoek, J. A. Holmes, J. E. Williams, Richard Newsam, G. W. Traer, Thos. Jeremiah, Benj. Williams, Geo. McArtor, Wm. Hall. This Commission was authorized by the last session of the Illinois legislature and was given power and authority to investigate methods and conditions of mining coal in the state of Illinois with special reference to the safety of human lives and property, and the conservation of the coal deposits.

Robert Morris, of Greensburg, Pa., for many years chief engineer of the Keystone Coal and Coke Co., in charge of mines in central and western Pennsylvania, is a candidate for appointment as a mining engineer member of the Bituminous Mine Inspectors Examining Board. He is especially fitted for the appointment because of his ability and wide experience as to the needs and requirements for safety in the mines of the entire district.

I. A. Boucher, general manager of the Logan Coal Co., that operates a number of mines in the central Pennsylvania district, is spending considerable time in West Virginia in the organization of the Decota Coal Co., to operate mines on the Coal and Coke Railroad. He is associated in this new enterprise with William J. Faux, of Philadelphia, and others identified with the Logan Coal Co.

J. W. Preston, of Johnstown,

operating mines at Hollsopple, Somerset County, has organized the Lydalia Coal Co., to operate the Anspach mine on the Listonburg Branch of the B. & O. Railroad. This mine was formerly operated by the Anspach Coal Co. It consists of a lease of about 500 acres of the C' coal. The mine is equipped with electricity for haulage and for the purpose of mining coal, and is capable of an output of 500 tons per day.

Jacob Swives, one of the pioneer coal operators of Philipsburg, Pa., and Charles E. Sharpless, of Cresson, have organized the Benscreek Coal Mining Co., and have taken a lease of 300 acres from the Cambria Mining and Mfg. Co., on the Benscreek Branch of the Pennsylvania Railroad. The coal bed leased is what is known as the "B" Rider, found at an interval of about 15 feet above the "B" or Miller seam, and runs from 3 to 5 feet in thickness. As far as known, this is the only locality in the county where this seam is found of commercial thickness and quality.

Hon. Timothy L. Woodruff, of New York, president of the Pneumoelectric Machine Co., with John L. Wagner, vice-president of the same concern, visited the mines of the Berwind-White Coal Mining Co., at Windber, in December, for the purpose of inspecting the mines and seeing in operation some of the 180 or more Pneumoelectric mining machines in use by the Berwind-White Co. in the Windber district.

The following men have received the degree of Mining Engineer from the Massachusetts Institute of Technology: Reuben Bermudez, Jr., Honduras, C. A.; John Leighton Bray, Boston, Mass.; Robert Sayre Cox, Terre Haute, Ind.; Frank Henry Curtis, East Weymouth, Mass.; Harold Beukman Davis, Lancaster, N. Y.; Leslie Burton Duke, Wellesley Hills, Mass.; Christopher Fallon, Wayne, Pa.; Harold Robert Leslie Fox, Jamaica, W. I.; Leslie Hall Goodwin, Allston, Mass.; Edmund Lewis Homan, Marblehead, Mass.; James Henry Morley, C. E., Swarthmore, Pa.; Stalker Elijah Reed, Hudson, N. H.; Wellesley Joseph Seligman, Brookline, Mass.; Harold Harris Sharp, A. B., Melrose, Mass.; Frank Elijah Starr, Fitchburg, Mass.; Walter Howell Triplett, B. S., Bangor, Me.; Paul McIntosh Tyler, Hyde Park, Mass.; Ralph Edward Vining, South Weymouth, Mass.; Robert Everett Whipple, Beverly, Mass.; Oscar Karl Wiessner, Lawrence, Mass.; Clarence Richardson Woodward, Wellesley Hills, Mass.

Difficulties in Mine Surveying

Examples Showing How Difficult Emergencies Have Been Met by a Resourceful Surveyor

By H. G. Henderson

THE work of the mine surveyor is not at all times plain sailing, and the practical value of a skilled man is demonstrated by the way in which he can overcome unexpected and awkward difficulties. For this reason it may be stated that technical training is worth about 80 per cent. of a man's value as a surveyor, the other 20 per cent. being

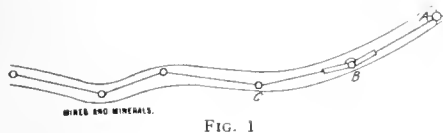

FIG. 1

made up by his originality and resource in overcoming such difficulties. To illustrate what is meant by the above remark, it will be interesting to describe some special difficulties which have been met with in survey work, and the way they were overcome.

There are occasions when a surveyor is called upon to make surveys at a moment's notice; and it is quite likely that when such emergencies arise no suitable instruments can be obtained without considerable delay; in such cases a method of approximate survey, which has been tested in practice with satisfactory results, may be of interest.

The surveyor on a large group of mines in the Western States had ridden over to one of the smaller mines from his office for the purpose of inspection only, and found himself at this mine, 2 or 3 days' ride from his office where he had left his instruments, and faced with a difficulty of an urgent nature. He found that owing to the bad air in the adit drive, it would be necessary to at once sink an air-shaft from the surface to the back of the end. As he had no time to send for his instruments he made a rough survey with a 2-foot rule and tape in the following manner.

The level had been driven with five bends or turns, as shown in Fig. 1, and at each turn the surveyor drove a 6-inch nail into the center of the tram sleepers, and also placed a peg at the mouth of the adit. He then took his 2-foot rule which was jointed at the middle, and marked at the bend in degrees, and placed in it three pins as sights, one at each end and one in the center. He then proceeded to point B at the angle of the first bend from the mouth of the adit, and from the head of the nail

at that point he sighted to A in one direction, and then on to a light held behind a nail at C. In this way he was able to read the angle $CB A$ with a considerable degree of accuracy, and to proceed in the same way at successive stations to the end. When this was done he came out of the pit to the peg at A and started in a like manner to survey on the ground up the hill, or rather he repeated his angles in the same direction as the adit, taking care to allow for the slope of the ground. In this way he reproduced on the surface the position of the end underneath, and the shaft was sunk at this point, and "holed" to a few feet from the end.

It often happens in preparing a surface survey of a mining property, that while it is possible to take offsets of one side of a stream or road, it is impossible to get anything like an accurate measurement at the other side. Such cases of difficulty occur when a bank is overgrown or steep, preventing the assistant from getting accurately into place. For this reason it may be of interest to give a typical instance where on a mining property there occurred a stream which it was important to take in on the plan. The survey was conducted from the road bordering one boundary of the property under survey, and the surveyor, who was pressed for time, found himself on one side of the stream and unable to approach it except in one or two places on account of the marshy ground. Fig. 3 shows diagrammatically the disposition of the ground at this point. It was impossible, owing to the marsh, to approach within 15 or 20 feet from the road. It was, however, noticed

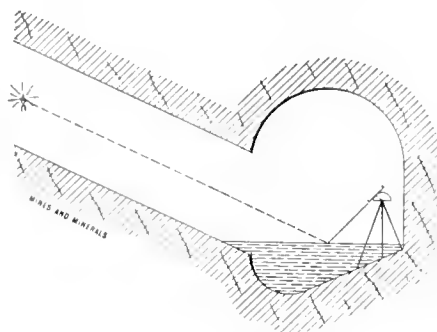

FIG. 2

that by making a detour it was possible to get into a field on the other side of the stream without difficulty, and the following method was

adopted both as a means of saving time, and fixing accurately the course of the stream. From the stations A and B at the ends of the line 21 of the survey conducted along the road, observations were

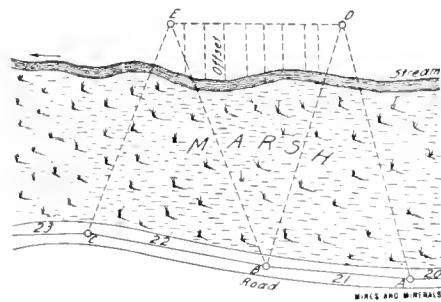

FIG. 3

taken to a pole fixed at D. In a similar manner observations were taken at the ends of line 22 on the road survey to a second pole fixed at E, and in this way the positions of points D and E were determined on the plan. Crossing over the stream to the line DE thus found, the surveyor was able to take his offsets of the stream in the usual way, as shown by the dotted lines on the sketch. This method, besides overcoming the frequently occurring difficulty of inaccessibility, is interesting as demonstrating one of the means of saving time which are so important to the practical surveyor.

In underground survey work the difficulties of narrow and tortuous passages are sometimes further increased by the presence of water in the workings. On one occasion the surveyor, in the course of his underground work, found himself very nearly up to his waist in water in the bottom level of the mine, and owing to the increasing depth of the water near the shaft he found it impossible to approach a position which he wished to obtain. The state of affairs can be understood by reference to Fig 2. It was important to take the angle of the inclination of the shaft, but owing to the presence of water, the surveyor was unable to bring his instrument into a position suitable for taking this inclination. As, however, "necessity is the mother of invention," the surveyor utilized the surface of the water as a reflecting mirror. He sent a miner some distance up the

shaft with a candle as indicated in the sketch, and the light from this candle was, of course, reflected from the surface of the water enabling the surveyor by shifting the position of his instrument, to read with the utmost accuracy the angle by the reflection of the ray of light from the surface of the water when this was still. This angle of reflection was, of course, equal to the angle of inclination or "dip" of the shaft, and in this way the surveyor obtained his reading without further trouble.

The surveyor in metalliferous mines often has great difficulty in getting from a higher to a lower level, owing to the narrow and twisted rises and winzes between the two levels. He is very fortunate if he succeeds in getting a straight sight fore and back with his theodolite. In numerous cases where, for such reasons, it is not possible to see one or both ways, the following method has been adopted.

In Fig. 4, it will be observed that while it is possible to take observations from the theodolite at the point *A* to the stand at the point *B*, it is impossible, owing to the hanging wall, to take a back sight from *B* to *A*, inasmuch as the head of the stand at *B* although set as low as possible is not visible from the lower level. In the method adopted in such an instance, a plumb-line was hung from the stand *B* and a light held behind it. A piece of greased paper was interposed between the light and the plumb-line, because the diffusion of the light obtained caused the plumb-line to show up more plainly against the illuminated surface of the greased paper. The foresight was observed from the point *A* and the distance measured to the plumb-line. The height of the stand above the point on the plumb-line to which the sight was taken was also measured. As the surveyor knew that he could not take a backsight of *A* from the point above, he, before unclamping his theodolite, had a candle fixed by means of a lump of clay to the foot-wall near the ladders, and in the line of sight at the point *D*. He then proceeded to the stand *B*, and took a backsight to the candle at *D*. This was, of course, equivalent to sighting to the last station *A* owing to the fact that the candle had been placed in line with the telescope when this was at *A*. This method is of advantage in tortuous passages as it gives great flexibility of operation. Instead of using greased paper to show up the plumb line it is better to use ordi-

nary tracing paper, as it is not so liable to catch fire from the candle as is the former.

The above examples may be taken as sufficiently indicative of the

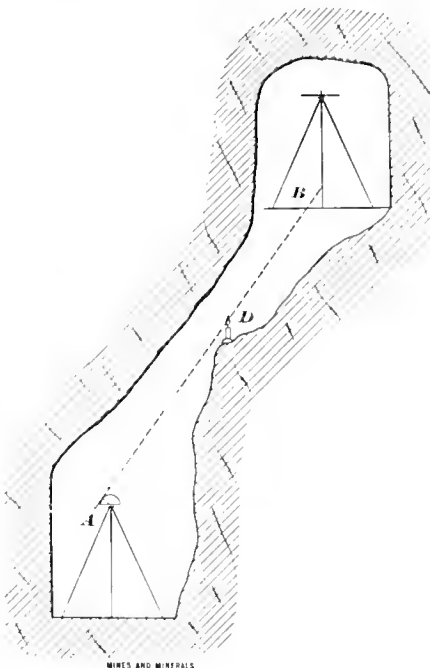

FIG. 4

troubles to be met with to demonstrate that originality is occasionally necessary, and therefore the surveyor should seek to cultivate it.

采 采

Book Review

EXPLOSIVES, a synoptic and critical treatment of the literature of the subject as gathered from various sources by Dr. H. Brunswig. Translated and annotated by Charles E. Monroe and Alton L. Kibler. This book, printed by John Wiley & Sons, New York, contains 350 pages with illustrations wherever necessary. In it will be found facts, recorded in the literature of the explosives, that have been applied and arranged by Doctor Brunswig according to the physical-chemical methods of the subject. It is to the diligent use of these physical-chemical methods that we owe the lasting worth of the classical experiments of Berthelot and Abel. Of more recent writings, Doctor Brunswig says Van-T Hoff, le Chatelier and Nernst hold prominent places. The difficulty in reviewing a book of this kind lies in the fact that nearly every paragraph contains matter which dovetails in the next paragraph and so on through succeeding paragraphs to the end.

If one takes any particular point in reviewing he can do the entire work, but if he attempts to follow

out lines of reasoning his review becomes too prosaic. The only attempt, therefore, is to give a general impression of the book through the table of contents and from reading paragraphs here and there.

The book is divided into 10 chapters: Chapter 1 being General Behavior of Explosive Systems; the next on the Velocity of Explosive Reactions; Chapter 3, treats of Explosive Pressure, in which we are informed that the brisance of an explosive reaction is one which causes the surrounding inert substances to lose their form entirely and become fragmentary. Further the brisance is judged from the size and extent of compression and shattered region caused by the explosion; Chapter 4 deals with Temperature of Explosions; Chapter 5, Gases from Explosive Reactions; Chapter 6 treats of Explosions by Influence; Chapter 7, Flame of an Explosion; Chapter 8 treats of the Peculiarities of Particular Explosives, such as Physical Changes in Explosives, Igniters, Fuses, and Detonators; also of the Mercury Fulminate; Chapter 9 treats of Propellants, such as black powder, and smokeless powder; Chapter 10, on Blasting Explosives, a number of which are analyzed; and finally on Hints on Handling, Application, and Destruction of Explosives.

Some of these chapters have as many as ten subdivisions, others have but one. In this book, theoretical and mathematical discussions have been omitted, giving development of our knowledge of explosive processes and forcing them more and more into the narrow field of exact chemistry of explosives; or, in other words, the physical-chemical science which deals with the velocities of chemical reactions and chemical equilibria at very high temperatures and pressures.

BUSINESS PROSPECTS YEAR BOOK FOR 1913, edited by Joseph Davies and C. P. Hailey. Published by The Business Statistics Co., Ltd., Cardiff, Wales, \$2.50, or 10 shillings net. This is the seventh year for this forecast of the business situation to be published. In this book the statistics of fourteen subjects are compiled in a concise form and from them conclusions are drawn as to what will happen to coal, iron, copper, tin, cotton, etc., the best recommendation of the book is the heading on the title page; whether we agree or differ with the conclusions, the facts and estimates given cannot fail to be of interest to every business man.

Some Features of Mine Disasters

Gas and Coal Dust Explosions—Explosives—Electricity—Lighting Apparatus—Mine Fires, Etc.

By George S. Rice*

AS A RESULT of the investigation of mine explosions and mine fires by the engineers of the Bureau of Mines, the following features have been noticed:

Gas Explosions.—At a number of mines where disasters have occurred the operators had considered the mines non-gaseous, and accordingly had not taken sufficient precautions to insure ventilation at the face. Usually the mines had ample fan capacity, but investigation showed that at the face there was insufficient current, largely because of leaky stoppings. In some mines too much reliance was placed on line brattices to conduct the air-current to the face. In some mines rooms had been turned ahead of the last breakthrough, so that when a fall of roof had knocked down the brattice, or curtains, or the doors on the roadways had been carelessly left open for greater convenience in haulage, there was no circulation of air, with the result that gas had collected and been ignited by an open light or the flame from a shot of black powder or dynamite.

Several disasters were caused by the mine foremen allowing miners with naked lamps to enter districts containing gas, or by the fire boss endeavoring to "brush" or fan out a pocket of gas by using a coat or canvas sheet and thus throwing the inflammable gas upon an open light. In the majority of American mines there is very little inflammable gas (methane chiefly) under ordinary conditions, but at a time of low barometer, or when there has been a large fall of roof, or through encountering a fault or crevice containing gas, dangerous conditions arise suddenly between the time when the mine is inspected in the early morning and when the miner enters the working place. Many such disasters have occurred in so-called "non-gaseous mines" in which open lights were used. When a mine is considered gaseous, safety lamps are generally used, and many other precautions are taken. The absence of gas for days or weeks lulls suspicion and causes relaxation of effort on the part of the foreman. The remedy would appear to be a greater extension of the use of safety lamps.

Coal-Dust Explosions.—In practically all the bituminous coal mines in which disastrous coal-dust explosions have occurred, the engineers of the bureau have observed that no attention was paid to the accumulations of dry coal dust in the inner workings. In some mines near the shaft or on the main roads artificial watering had been done, which satisfied the casual visitor that the conditions were safe; but the inner workings contained vast amounts of inflammable coal dust, which, when ignited by a small explosion of gas or a blown-out shot, or other cause, had initiated an explosion that traversed not only these inner workings but also more or less of the outer roadways which had been more or less dampened by sprinkling.

Even where an explosion has been stopped before it reached the mouth of the mine, the afterdamp gases have smothered the miners throughout a much larger area than that traversed by the explosion. None of the mines in which large dust explosions have occurred had prior to the disaster employed systematic humidifying with steam.

Improper Handling of Explosives. In many mines examined by the mining engineers explosives were carelessly handled. In certain instances the operators supposed that they had admirable shot-firing and inspection systems, but examination at the face disclosed that there had been many blown-out shots. In some cases it was found that detonators and explosives had been kept in the same box, and that shot firers had carried detonators in the same sack with the explosives. Where firing had been done with a battery it was found that many batteries were of the ordinary dry-cell type without any safeguards. In one accident during the year the state mine inspector reported that a shot firer was killed by putting a dry-cell battery in the same sack with detonators and explosives.

The use of permissible explosives that passed the tests of the bureau has much decreased the dangers of igniting gas and dust, but it has been found that they have not been used in some mines according to the

methods prescribed by the bureau; that is, they have not been properly tamped, or the charge limit has been exceeded.

In many cases the miner has been permitted to have too large a quantity of explosives in his possession. In some states he is permitted to have 25 pounds or more of black powder.

The method of bringing explosives into the mine and the method of storing them is bad at many mines. Stringent regulations on this subject should be made by state authorities. In some districts kegs of powder or other explosives belonging to the miners are left exposed in their respective working places instead of being placed in tight boxes with locks.

Accidents From Electricity.—Several disasters have been attributed to electric arcs from grounds or short circuits igniting coal dust or gas. Trolley haulage should not be permitted in entries in which there is one-half per cent. or more of inflammable gas.

In a large number of mines using electrical machinery it has been found that the installation was very imperfect, particularly as regards insulation. The use of electricity in coal mines is constantly extending, and an increasing number of accidents have been attributed to its use; hence greater care should be exercised in insulation. It would be desirable if every coal-mining state had an electrical engineer on its inspection staff.

Lighting and Accidents.—In all but two of the mines in which large disastrous explosions have occurred during the past few years, open lights have been used. In many of these mines there was more or less inflammable gas, generally not in noticeable quantities, but sufficient to produce dangerous conditions under certain circumstances. On the other hand, the mines that have been considered and acknowledged by the operators to be gaseous have generally been free from explosions, although one small disaster was attributed to the imperfect condition of a safety lamp. Safety lamps give a poorer light and are especially unsatisfactory for examination of the roof and floor, but their use tends to produce discipline and care in other directions. Where used, however, they must be inspected daily by some competent

*Chief Mining Engineer, U. S. Bureau of Mines. Abstracted from advance sheets of the Second Annual Report of the Director.

person. Portable electric lamps give much better light and are being adopted to some extent in the Pennsylvania anthracite field. Different types of electric lights for use by miners are now under investigation by the bureau at Pittsburg. If the safety conditions are to be improved, it seems probable that the use of these electric lamps will be widely extended, and will much lessen the danger of explosions and mine fires that attends the use of open lights.

Ventilation.—As already mentioned, there is great need for improvement in mine ventilation, especially at the face where the miner works. Mine foremen are sometimes too easily satisfied with sending down large volumes of air into the mine and disregard the fact that it does not reach the face in sufficient quantity to sweep away gases that may accumulate there, either the firedamp from the coal or poisonous gases from the powder used in bringing down the coal. Generally the fan equipment at coal mines is sufficient, but in many of these mines the underground system of ventilation in the more remote parts of the mines is not as efficient as it should be. It is usually easy enough to have good air along the main entries and haulage roads and manways, where the men travel, but it is more difficult, though just as important, to have good air at the places where the men work.

Mine Fires.—Some disastrous mine fires have occurred during the past few years through gross carelessness in handling open lights, or from short circuits of electric currents due to improper insulation, or from underground power plants. These have been the causes of fires in certain metal mines investigated, as well as in coal mines. One bad fire, which occasioned loss of life, was caused by setting fire to oil used for lubrication. Such instances are due both to the use of open lights and to the arrangements for storing the oil or other inflammable material. There has been a great disregard of danger in the employment of wood for underground engine houses, pump rooms, and stables, which are especially liable to fires. But in some districts, following disastrous mine fires, as in Illinois and in the anthracite fields of Pennsylvania, many drastic improvements have been made. Similar precautions against mine fires should be taken and facilities for fighting such fires should be introduced in mines throughout the

country, without awaiting the occurrence of additional mine disasters. A preliminary report on mine fires, by G. S. Rice, has been prepared for publication as a technical paper (No. 24); and another, by J. W. Paul, has been prepared for publication as a miners' circular (No. 10).

Escape Arrangements.—Many of the mines in this country have inadequate facilities for escape in case of fire or explosion. These should always be in duplicate, and either escape way should provide adequate means of exit from the mine. Few mines have sufficient provision in the way of fire-fighting equipment in and about the exit ways. The state of Illinois has passed some excellent laws and regulations for fire fighting, but unfortunately very few of the mining states have even fundamental regulations requiring such improvements.

Refuge Chambers.—Most victims of explosion disasters have been overcome by afterdamp and not by violence or burning, but some miners have escaped from disasters by bratticing themselves off in inner workings. These facts show that had refuge chambers been provided many of the miners that were lost might have been saved. Chambers of simple type are easy to make, and the several engineers of the bureau advise that all mines provide them. Even if nothing more than several mine rooms or chambers of ordinary size in different parts of the mine were utilized, these could have tight-fitting doors in duplicate, a supply of drinking water in sealed bottles, a limited quantity of food in cans, a supply of first-aid equipment, a few fire extinguishers, and, if practicable, a protected telephone. Such rooms would prove useful under many conditions arising in the daily routine of mining operations, and would prove a good investment even though no large disasters occurred. Rescue parties would naturally aim to reach these rescue chambers promptly before making a random search throughout the mine; and in time of trouble, when ordinary escape ways were blocked by poisonous gases or rock falls, men in the mines would endeavor to reach these safety chambers. Where the mines are not deep, special holes might be bored from the surface down into such chambers, through which holes fresh air might be forced when needed below and through which telephone lines could be run to the surface.

While thus calling attention to the advantages of such rescue chambers, the bureau has not urged their installation as equal in importance to precautionary measures looking to the prevention of mine disasters. But interest in them increases as it is realized that mine disasters may still occur notwithstanding all precautions, though, let it be hoped, at increasingly less frequent intervals.

Falls of Roof Coal.—By far the largest annual loss of lives in mines is caused by falls of roof and coal; this is true of metal mines as well as coal mines. The underlying cause of this large loss, which in the calendar year 1910 was 1,310 lives, and in 1911, 1,321 lives, is being sought by the mining engineers of this bureau. Though the immediate cause is lack of sufficient timber, the mining system seems also at fault, in view of the much smaller loss of life per thousand employed in the mines of Europe. Closely connected with this question is the reckless use of explosives, which shatters the roof, and the lack of sufficient direct supervision of the working faces by the mine foremen. The use of less timber and fewer mine foremen but more powder in American coal mines, as compared with those in European countries, meets the American demand for cheaper coal, but at heavy cost in the loss of human life and waste of fuel resources.

These facts need not be considered as a basis of criticism of either the miner or the mine owner, but they indicate an urgent need for recasting the economic conditions under which the coal-mining industry is now being operated.

Meanwhile the Bureau of Mines is beginning a careful examination into the nature and means of preventing accidents from these and other miscellaneous causes.

來 來

Cerium Igniters

Cerium alloys possess the property of emitting sparks when struck, and this property has been made use of in an igniter. The alloy used is composed of cerium and iron and the spark produced by a rubbing contact with a steel wheel ignites a wick saturated with gasoline. This application of a metal which heretofore has had no commercial use is quite an advance. The same idea has also been used in a device for lighting gas. The apparatus has a holder with a cerium-iron alloy which rubs on a steel file and emits a spark sufficient to ignite gas.

Prize Contest

With the idea of stimulating interest in practical mining questions, and at the same time drawing out ideas from our readers who constitute a large portion of America's most progressive mining men of all classes, we offer the following prizes:

For the best answer to each of the following questions, we will give any books on mining or the sciences related thereto, now in print, to the value of \$3.

For the second best answer, similar books to the value of \$2 will be given.

Both prizes for answers to the same questions will not be awarded to any one person.

CONDITIONS

1. Competitors must be subscribers to MINES AND MINERALS.
2. The name and address in full of the contestant must be signed to each answer, and each answer must be on a separate paper.
3. Answers must be written in ink on one side of the paper only.

Questions for Prizes

9. There is a tract of land containing 840 acres in a nearly square plot, in which at a depth of 630 feet there is 4 feet of clean coking coal lying practically horizontal. The floor of the seam is so soft it creeps; the slate roof rock next to the coal is from 2 to 4 feet thick and liable to fall unless pulled down. It is desired to know what system should be followed when mining the coal and the advantages of the system advocated, using a sketch.

10. What quantity of air in cubic feet per minute will be obtained with a 2-inch water gauge, when a fan 24 feet in diameter makes 90 revolutions per minute under the following conditions: Diameter of the central orifice of intake 12 feet, area of the discharge, 60 square feet; length of the blades, 9 feet; length of the airway, 3,600 feet; area of the airway, 60 square feet.

11. From a coal shaft 650 feet deep, it is desired to hoist 1,200 tons of coal in 8 hours. The engine is 20 in. X 36 in. first motion and is run so as to give an average speed of 1,600 feet per minute. What steam pressure will be required and what weight of coal should a car contain?

12. The following data of an underground survey being given, find

4. "Competition Contest" must be written on the envelope in which the answers are sent to us.

5. One person may compete in all the questions.

6. Our decision as to the merits of the answers shall be final.

7. Answers must be mailed to us not later than one month after publication of the question.

8. The publication of the answers and names of persons to whom the prizes are awarded shall be considered sufficient notification. Successful competitors are requested to notify us as soon as possible as to what disposal they wish to make of their prizes, and to mention the numbers of the questions when so doing.

9. In awarding prizes, other things being equal, a carefully written and arranged answer will be given the preference.

10. Employees of the International Textbook Company, or of MINES AND MINERALS, are not eligible to enter this contest.

the course and distance from A to E and give the area of the figure enclosed:

From A to B 35° 18', 448 feet; from B to C 106° 20', 565 feet; from C to D 190° 36', 368 feet; from D to E 160° 31', 433 feet.

NOTICE TO PRIZE CONTESTANTS

It is especially important that Condition 2 of this contest be observed. A number of contestants have failed to do this. Be as original as possible, writing so that others not knowing the subject can learn from your answers. Be careful in copying the answers you send us; leaving out decimal points might count against you when there is a large number of contestants and the work otherwise correct.

Answers for Which Prizes Have Been Awarded

QUES. 1. *Calculation of Size of Fan Required for a Given Circulation.*

What size and type of fan would you employ for the circulation of a volume of 160,000 cubic feet of air per minute against a water gauge of 2 inches? Show method of arriving at size.

Ans.—To produce 160,000 cubic feet of air per minute with a 2-inch water gauge, a double intake centrifugal fan should be used. The inner diameter of this fan is obtained by the following formula,

$$d = .023 \sqrt{Q}$$

$$d = .023 \times 400 = 9.2 \text{ feet}$$

The breadth of a double intake fan equals five-eighths times the inner diameter, or by formula,

$$b = \frac{5}{8} d = \frac{5}{8} \times 9.2 \text{ feet} = 5 \text{ feet } 9 \text{ inches}$$

The relation of the inner diameter to the outer diameter is expressed by formula

$$m = \sqrt[3]{\frac{\sqrt{a} Q}{m^2} \left[c + \left(\frac{3,000}{x} \right)^3 \right] + 1}$$

in which $m = \frac{d_1}{d}$ = outer diameter / inner diameter

a = sectional area of fan drift, in square feet where power is measured;

Q = quantity of air in circulation in feet per minute;

m = number of revolutions per minute, assumed 100;

c = fan constant, 4;

$$x = \sqrt[3]{\frac{Q^2}{p}} \text{ Velocity assumed } 1,200 \text{ feet per minute.}$$

Since the velocity assumed is 1,200 feet per minute the area equals

$$\frac{160,000}{1,200} = 133\frac{1}{3} \text{ square feet} = a.$$

$$m = \sqrt[3]{\frac{\sqrt{a} Q}{m^2} \left[c + \left(\frac{3,000}{x} \right)^3 \right] + 1}$$

$$x = \sqrt[3]{\frac{Q^2}{p}} = \sqrt[3]{\frac{160,000^2}{10.4}} = 1,350.23$$

Substituting,

$$m = \sqrt{\frac{\sqrt{133\frac{1}{3}} \times 160,000}{(100)^2} \times \left[1 + \left(\frac{3,000}{1,350.23} \right)^3 \right] + 1}$$

Solving, $m = 2$

Therefore the outer diameter equals twice the inner diameter which is 9.2 feet, or the outer diameter equal 18.4 feet.

JAMES R. WALTHOUR,
Fairmont, W. Va.

Second Prize, R. F. McKay,
Brier Hill, Pa.

QUES. 2. *Diffusion of Mine Gases.*

(a) Why does marsh gas CH_4 diffuse more rapidly into the air-current than carbonic acid gas CO_2 . (b) In a close place, where the ventilation is poor, is there any limit to the diffusion of marsh gas into the atmosphere.

ANS. (a) *Diffusion.*—All fluids which do not act chemically on each other, especially air and gases of different densities, where in proximity, tend to diffuse into each other; that is to say, their molecules pass freely among each other, and tend to form a complete intermixing of the two gases. This property is called diffusion, and is caused by lack of equilibrium between the molecular vibrations of the two masses; so that the molecules of the two masses tend to thoroughly intermingle.

Rate of Diffusion.—The relative rates of velocities of the diffusion of the gases into each other are as the inverse ratio of the square roots of their densities or specific gravities.

In determining the rates of diffusion, air is taken as the standard unit (1), the relative rates of diffusion of the different gases can be found by dividing 1 by the square root of the density of the different gases. Thus,

$$1$$

$\sqrt{\text{density or specific gravity of gas}}$

The density, or specific gravity, of marsh gas is .5590.

Then, $\frac{1}{\sqrt{.5590}} = \frac{1}{\sqrt{.7477}} = 1.3375$,
say 1.340 velocity of diffusion, taking air as 1.

The density or specific gravity of carbonic acid gas is 1.5291.

Then, $\frac{1}{\sqrt{1.5291}} = \frac{1}{\sqrt{1.2366}} = .8087$,
say .810, velocity of diffusion, taking air as 1.

From this we see that 1,340 volumes of marsh gas will diffuse in the same time as 810 volumes of carbonic acid gas.

(b) *Limit of Diffusion.*—The diffusion of gases takes place more

rapidly in a moving current than in still air. The diffusion of gases continues to take place until the moisture of gases is uniform, or complete saturation takes place. The action of the gases rising from the floor to the roof, if a feeder is on the floor, helps a diffusion of the lighter gases very much. On the other hand, with a feeder located in the roof, giving off the same gases, the gases would tend to accumulate along the roof, and if the air-current is at all sluggish at this point, the diffusion of the gases will be comparatively slow.

It often happens that a feeder in the roof or other high point of the workings gives off gas more rapidly than diffusion can take place, where the air-current is sluggish. This results in the accumulation of a body of pure marsh gas at this point.

In like manner we often have an accumulation of a large body of carbonic acid gas, or blackdamp, near the floor or other low place in the mine workings, when the air-current is sluggish and where the carbonic acid gas is formed quicker than diffusion takes place.

GEORGE WILKINSON,
South Wellington, B. C.

Second Prize, Thomas English,
La Salle, Ill.

QUES. 3. *Distance Between Centers.*—(a) Given a gangway driven due north and chambers turned on a course N 75° W so that there will be 50 feet between centers, what is the distance on the gangway between center lines?

(b) If the course of the gangway is changed to N 20° W 20 feet inside of the center line of a chamber, what will be the distance on the course of the gangway between the center lines of the chambers?

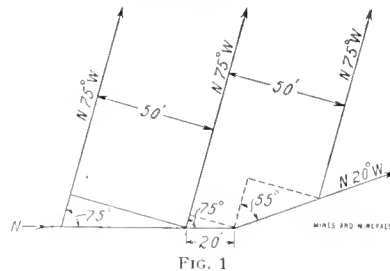

FIG. 1

ANS.—(a) Since the course of the gangway is due north, and the course of the chamber is N 75° W, the included angle between the course of the gangway and that of the chamber is 75 degrees. The distance between centers is always measured at right angles to the course of the chambers; hence we have a right triangle formed, with the length 50 feet as

the side opposite, and the angle 75 degrees as the included angle, while the distance on the gangway between centers corresponds to the hypotenuse whose length is required.

From the solution of right triangles:

$$\text{Hypotenuse} = \frac{\text{side opposite}}{\text{sine included angle}}$$

Hence, by the same rule: Distance on gangway

$$= \frac{\text{distance between centers}}{\text{sine of included angle}}$$

$$\text{Or, distance along gangway between center lines} = \frac{50}{\text{sine } 75^\circ} = \frac{50}{.96593} = 51.76 \text{ feet. Ans.}$$

General rule:

$$\frac{\text{distance between centers}}{\text{sine of included angle}} = \text{distance along gangway}$$

(b) Since the gangway has advanced 20 feet on the old course, it has advanced $20 \times \text{sine } 75^\circ$, or 19.32 feet of the required 50 feet between centers. (See Fig. 1.) There still remains $50 - 19.32 = 30.68$ feet between centers which is to be attained by the new course of the gangway. As the new course of the gangway is N 20° W, the included angle between the course of the chamber and the course of the gangway is now 55°. Then, by the general rule given in answer to Ques. 3 (a), the distance between centers along the gangway, from where the gangway changes its course to the center line of the next chamber is $\frac{30.68}{\text{sine } 55^\circ} = \frac{30.68}{.81915} = 37.45$ feet.

For all succeeding chambers the distance between centers measured along the gangway will be $\frac{50}{\text{sine } 55^\circ} = \frac{50}{.81915} = 61.04$ feet.

MILTON R. EVANS,
443 Chestnut Ave., Kingston, Pa.
Second Prize, W. F. Evans,
Franklin Furnace, N. J.

QUES. 4. *Size of Pumps.*—If a mine is making 4,000 gallons of water an hour and the shaft is 260 feet deep, what is the size of a plunger pump which will be necessary to take care of this water? What is the size of a centrifugal pump?

ANS.—Assuming that there is a sump large enough to hold 24 hours water at the bottom of this shaft, namely 96,000 gallons, and the water is to be pumped in 8 hours of each day, then $\frac{96,000}{8 \times 60} = 200$ gallons per minute.

To this must be added one-fourth for slip of water past the piston of the pump, making $200 \times \frac{5}{4} = 250$ gallons per minute.

If a duplex double-acting pump that makes 15 double strokes per minute is used at a speed of pumping of 60 feet per minute; then, $\frac{250 \times 231}{2 \times 60 \times 12} = 40.1$ square inches will be the area of each water cylinder and $d = \sqrt{\frac{40}{.7854}} = 5$ inches, as the diameter of each water cylinder.

Allow 40 per cent. of the power for frictional losses, and a mean effective steam pressure of 60 pounds per

the rough usage of the mine that the plunger pump is.

M. J. RAFFERTY,
Ehrenfeld, Pa.

Second Prize, Morgan Owen,
Crockett, Cal.

采 采

Pumping Through Coal

Written for Mines and Minerals

At Storrs No. 1 mine belonging to the D. L. & W. R. R. Co., near Scranton, Pa., trouble was experienced in the maintenance of a column pipe for the pumps at the foot of No. 1 slope. A 10-inch cast-iron pipe was used, and the water here being exceptionally acidulous, the pipes were quickly corroded as shown in Fig. 2, and also from time to time became blocked with sediment and iron precipitate. H. E. Harris, assistant superintendent for the district in which Storrs mine is located, conceived the idea of doing away with the pipe on the slope where it was in the way, and in its place driving a small hole through the pillar at one side of the slope and using this as a pipe as shown in plan, Fig. 1.

The slope is 520 feet long with a dip of 12 degrees. The head on the pumps is 93 feet and the thickness of the coal bed at this point between 7 and 8 feet.

To make this hole, cross-cuts were driven from the slope into the pillar a distance of 33 feet, and about 70 feet apart. To drive these cross-cuts, which are about 2 feet square, a special set of tools was made. In the coal face a number of holes were drilled with the small auger and then the coal was picked out with the small picks. The hole for the water was driven at right angles to the cross-cuts and in the same manner. The lower end of the waterway *c* was curved to the slope so that it can be completely drained. The pipe from pumps *b* is led into the first cross-cut *c*. Where the cross-cuts meet the waterway they are closed with brick and concrete; and outside of this they are completely filled and con-

creted tight, with the result that there has been no leakage. In the bottom cross-cut and in one cross-cut near the top, valves have been placed so that it will be possible to enter the waterway to clean it, if it should become blocked with "yellow boy" or sediment.

This waterway has been in operation for several months and has worked very satisfactorily. It took 8 months for the miner to drive this hole, but it is expected that the maintenance cost of the old pipe, which

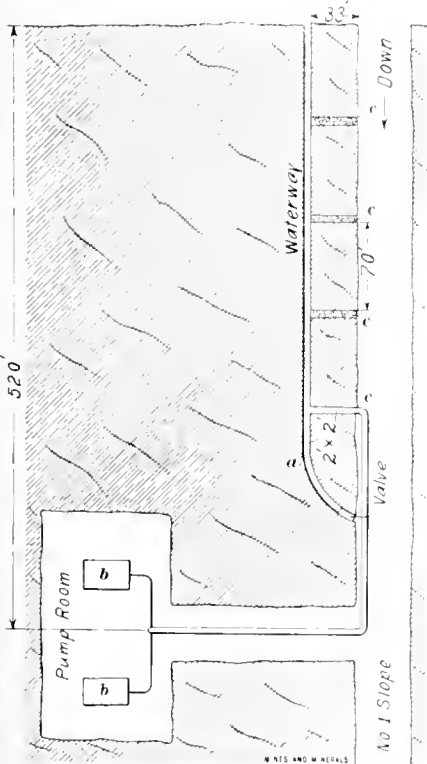

FIG. 1. PLAN OF PUMPING ARRANGEMENT

square inch, the pump being located at the bottom of the shaft; the diameter of each steam cylinder is

$$d = 3.76 \sqrt{\frac{Gh}{2(pS)}} = 3.76 \times \frac{250 \times 270}{2 \times 60 \times 60}$$

= 9, or in practice, 10 inches as diameter of steam piston. In the above formula,

d = diameter of cylinder;

G = gallons per minute;

h = head, in feet;

p = steam pressure, per square inch;

S = piston speed of pump, feet.

Then the size of duplex, double-acting pump is as follows: Steam cylinder 10 in. x 24 in.; water cylinder 5 in. x 24 in.

Centrifugal pumps are not adapted to pump against this head, they are sometimes rated for 35 to 40 and 100 feet, but it is seldom they are able to give results, even at this; in fact they are not equal, nor near so, to

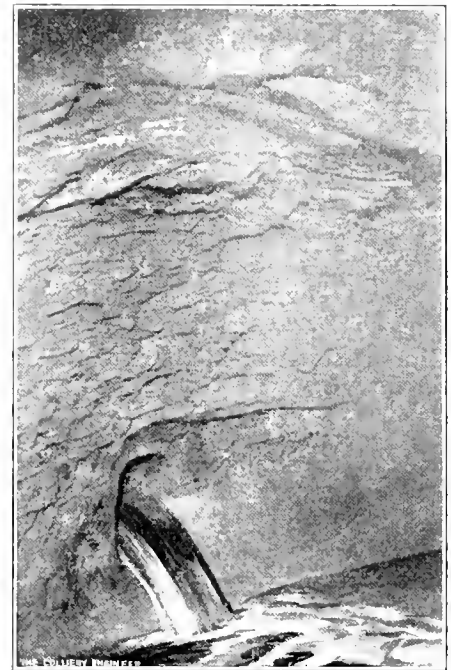

FIG. 3. DISCHARGE FROM PUMP

amounted to about \$1,500 a year, will be eliminated. The speed of the pumps has been reduced from 37 to 19 strokes and the water is now pumped out in 14 hours. Fig. 3 shows the water discharging at the upper cross-cut into the water tunnel leading from the mine.

采 采

World's Gold Production 1912

The world's production of gold during 1912 was \$5,500,000 greater than in 1911, the total having been \$465,000,000, according to a preliminary estimate prepared by George E. Roberts, director of the mint. Gold production in the United States amounted to \$91,685,168, compared with \$96,890,000 in 1911. California led with \$19,988,486; Colorado was second with \$18,791,710; Alaska third with \$17,398,946; Nevada fourth with \$13,331,680, and South Dakota fifth with \$7,795,680.



FIG. 2. SHOWING CORROSION OF PIPE

Notes on Mines and Mining

Reports on Conditions and Other Matters of Interest in Various Coal Fields

By Special Correspondents

COLORADO. Mr. Edwin Thomas, formerly chief inspector for the Stag Cañon Fuel Co., at Dawson, N. Mex., accepted the superintendency of the Weaver mine of the Victor-American Fuel Coal Co., at Gibson, N. Mex., assuming his duties there December 1, 1912.

Joseph Smith, who has been general superintendent for the past 3 years over the properties of the Stag Cañon Fuel Co., at Dawson, N. Mex., leaves there January 1 to take charge of his own coal-mining interests near Trinidad, Colo. Wm. McDermott, formerly with the Victor-American Fuel Co. as division superintendent of their Trinidad division, has accepted the position left vacant by Mr. Smith's resignation. Mr. McDermott's successor has not yet been appointed.

POTTSVILLE, PA.

The Board of City Trusts of the Girard Estate has awarded to Baird Snyder, Jr., of Pottsville, Pa., the lease of a tract of 300 acres of coal land, north of Shenandoah. The tract contains approximately 8,000,000 tons of coal and the operation will be one of the largest ever opened in the region. There were ten bidders for the lease, among them being some of the largest coal companies.

Mr. Snyder will organize a company under the laws of the state of Pennsylvania, with a capital stock of \$500,000. All the stock has been sold. Mr. Snyder will be the president and general manager of the company. The product will be handled by Weston, Dodson & Co.

JOHNSTOWN, PA.

After a great deal of opposition on the part of Mayor Joseph Cauffiel, of Johnstown, Pa., the Johnstown & Stonycreek Railroad Co. have completed their line to the mines of the Valley Smokeless Coal Co., affording this concern an outlet for their product over the Pennsylvania Railroad, in addition to their present connection over the B. & O. R. R. With this new outlet and in anticipation of good car supply, the development of the B seam of coal on this property, in addition to the C' which is now being worked, is being pushed as rapidly as possible.

There has been considerable activity in the purchase of coal lands in the Blacklick district of Cambria and Indiana counties during the past year. During the months of August and September the Manor Real Estate

and Trust Co., of Philadelphia, a subsidiary concern of the Pennsylvania Railroad Co., purchased upwards of 10,000 acres of coal land, at a cost of \$1,250,000. This land adjoins the property of the Ebensburg Coal Co., who have recently built the new town of Colver, whose output is shipped over the New York Central lines by way of the Blacklick & Yellow Creek Railway. As this entire acreage adjoins, or was tributary to, the Blacklick & Yellow Creek Railroad, it is said this purchase was made on the part of the Pennsylvania Railroad Co. interests to assure them the freight. The property is said to contain two seams of coal, the "B" and the "D" or Moshannon seam, of excellent thickness and quality, although, on account of the great depth of the coal measures below the surface, requiring expensive shaft operations, the property may not be developed at an early date. Its acquisition by the Pennsylvania interests will mean over \$100,000,000 in coal freight alone to that system. During the past month title to 2,311 acres in the Ebensburg district of Cambria County, at a cost of \$291,714, has been taken in the name of Benjamin W. Carskaddon, manager of the above-named real estate company, which will add considerably more to the amount of freight assured the Pennsylvania Railroad system. It is said the Ebensburg Coal Co., in the interest of the New York Central Railroad, are negotiating at the present time for the purchase of 3,000 acres more in the same district, which is the last acreage of any size or importance in the district not in holding concerns.

A case of unusual interest to the mining fraternity of the state was that of the Calvin heirs against the Henrietta Coal Mining Co., tried in the courts of Cambria County during November and December. It was the longest case of record in Cambria County, occupying the time of the Court for 3 weeks, and was a case without precedent in the state. It involved the question of skillful and economical mining and the percentage of coal that should have been recovered in the "B" or Miller seam. The plaintiffs in the case were the Calvin heirs, who leased to the Henri-

etta Coal Mining Co. the "B" seam of coal in a tract of land containing 433 acres. The lease was made in the year 1895 for a period of 10 years, at 8 cents per ton, with the provision that at the end of that period the lease could be renewed on terms satisfactory to both parties. At the end of the 10-year period negotiations were entered into for a renewal of the lease, and at the end of 2 years and 8 months, upon their failure to agree on satisfactory terms, the coal company ceased their operations on the property of the plaintiffs. It was claimed by the plaintiffs that a certain acreage of coal had been worked out or lost to them by unskilful mining and that in the mining the company should have accounted to them for a great deal more coal than was paid for. The engineers for the plaintiffs made careful surveys of the area worked over, taking hundreds of measurements of the thickness of the workable coal in the seam. From samples of coal taken from the different parts of the mine the specific gravity was determined in order to ascertain the weight of the coal per cubic foot, and from this information a calculation was made of the total quantity of coal which should have been in this area originally. Fifteen per cent. for loss in mining was deducted and a claim made for the difference between this result and the tonnage upon which royalty had been paid the plaintiffs. The engineer for the defendants also took hundreds of measurements and made calculations as to the recovery of coal, claiming that an 80-per-cent. recovery, or 20-per-cent. loss, would be a fair recovery in the mining of that coal at the time in which the mining was done, during the period from 1895 to 1907. The questions at issue were, first, the percentage of coal which should have been recovered in this seam, the thickness of merchantable coal, and the weight per cubic foot of the coal. There was considerable difference of opinion as to what constituted bony coal, and the testimony of a great many witnesses was heard on that point, witnesses for the defendants claiming that coal exceeding 9 per cent., in ash and 1½ per cent. in sulphur would be considered bony and not merchantable "B" seam coal. Most of the mining engineers, mine superintendents, and mine inspectors of the district were concerned in the case on one side or the other, and much

technical evidence was offered to substantiate the claims of both sides. The recovery of coal in the "B" seam, as testified to by various witnesses, ranged from 77 to 91 per cent. The total claim of the plaintiffs was a little over \$23,000, while a verdict was secured for \$16,100. The plaintiffs were represented by Evans & Evans, attorneys at law, Ebensburg, who were assisted in the preparation of the case by Andrew B. Crichton, mining engineer, Johnstown, Pa., while the defendants were represented by O. H. Hewitt, Kittle and Shettig, assisted by Joseph S. Sillyman & Co., engineers, Altoona, Pa. Both sides have asked for a new trial, and the progress of this case through the higher courts will be watched with interest by those interested in mining in this community, if it is appealed.

OKLAHOMA

Recently in the Oklahoma field, the old stockholders of the Folsom-Morris Coal Mining Co., at Midway, transferred their holdings to the new Folsom-Morris Coal Mining Co. The company owns 1,920 acres of coal land at Midway, and is capitalized at \$500,000. On December 1 the new company took over the holdings of the Western Coal and Mining Co., at Lehigh, which comprise 7,200 acres of coal land adjoining the other tract. The general office will be maintained at Lehigh.

The area now controlled by the company has four working mines, all worked by shafts of about 200 feet depth. The daily capacity of the different mines ranges from 200 tons to 500 tons. About 700 men are employed all told. The coal is the Lehigh or McAlester bed and varies in thickness from 3 feet 10 inches to 4 feet 6 inches. It is of good quality.

Mining machines in the Oklahoma coal field are used only in a very limited number. In 1909 there were 34 machines of various types used; in 1910 the number dropped to 13; in 1911 it increased to 26, and during the past year a number of machines have been added. In 1911 the amount of coal mined by machines in the state amounted to less than 3 per cent. of the total production. This year will show an increased tonnage as well as some increase in the percentage.

The use of the machines is showing good results especially in the thinner coal beds. As an example of the work which is being done, Mine No. 6 of the Oklahoma Coal Co., at Dewar, may be taken. In this mine

are three machines of the continuous-cutter type. During the months of June and July these three machines maintained an average tonnage per day per machine of nearly 100 tons of mine-run coal. The coal averages about 3 feet, and the cutting is done in the coal. Each machine is operated by a runner and helper, and the rate for cutting is 18 cents per ton, and the average daily earnings for the two were \$9. The price paid for loading coal after the machine is 62.5 cents, and the average daily wages made by each man were \$5.54. The total cost of cutting and loading was 80.5 cents per ton, being a difference of only 3 cents between this method and the solid shooting rate of 83.5 cents. The profit to the operator is in the greater percentage of lump coal. This coal when mined by the ordinary mining methods of the state produced lump, 35 per cent.; nut, 30 per cent.; slack, 35 per cent. The machine-mined coal averages 60 per cent. lump, over a 2-inch screen; nut, 20 per cent.; slack, 20 per cent.

SEATTLE

A party of coal miners under the direction of R. Y. Williams, mining engineer of the United States Bureau of Mines, returned on the last trip of the steamer "Yukon," from the Controller Bay coal field, of Alaska. Mr. Williams and his party have been in the coal field for several months, and were engaged in getting out a large sample of coal to be tested by the United States Navy on one of the battleships.

The party had great difficulty in landing at Katalla, and lost their first barge containing instruments and supplies. The Alaskan coast at this place is comparatively open and is storm-swept for the greater part of the autumn and winter months.

The party spent the greater part of the time in mining coal from the Cunningham coal claims. Most of the work was done on Trout Creek, in one of the drifts opened by Clarence Cunningham prior to 1906. The coal beds at this particular point are considerably broken and the Bureau of Mines party had considerable trouble in getting the coal out, due to the broken condition of the strata.

About 855 tons of coal have been mined and are now on the side of the trail near the mouth of the drift awaiting transportation to tidewater. It is the intention to get this coal down to Stillwater during the coming winter. Horses will be used to drag sleds down Stillwater Creek.

The grade of coal on this property is very good, but badly crushed. Coal of a similar quality taken from the MacDonald mine in the western part of the field proved equal to the best semibituminous coal of West Virginia.

Mr. Williams and his party experienced considerable trouble in getting out of the alleged harbor at Controller Bay. They were taken to Wigham Island, with the intention of having one of the passing steamers call for them, but the storms were so severe and so continuous that it was impossible to get to them for 2 weeks.

Mr. Williams speaks very highly of the miners, most of whom were engaged in Seattle. They are accustomed to western conditions and knew what to expect in the northern country. They had a very stormy season and many discomforts but he states that they did splendidly.

The Issaquah and Superior Coal Mining Co., Ltd., a Canadian and German company, are engaged in opening the old Issaquah coal mine, in King County, Wash. Mr. J. Raymond Watkins, a recent arrival from the coal fields of South Wales, is superintendent in charge. The intention is to open the mine on bed No. 5 and drive a rock tunnel to the underlying and overlying beds. Issaquah mine was at one time a big producer, but about 10 years ago, a pre-glacial erosion was struck as the lower gangway was being driven east, and in this manner the mine became flooded. The No. 4 bed was always popular on the coal market and it is the intention of the present company to get to this bed and ship principally from it.

The coal markets in the Northwest are very good at present, due perhaps to several causes. One of the principal factors is that several of the mines are having labor troubles which have cut down their capacities considerably, and some of the mines on Vancouver Island are closed entirely. California fuel oil is still a big factor in the fuel supply of the Pacific Coast and will continue to be for many years. But the West is developing so rapidly and new industries are coming in so fast that the prospects for a good coal market are bright.

UTAH

The following statement in regard to the mining industry of Utah has been issued by J. E. Pettit, state mine inspector:

We close the fiscal year, November 30, 1912, with the largest increase of coal and coke for any one year in the history of the state.

The output of coal increased 586,885 tons or 23.16 per cent.

The coke production increased 134,988 tons or 63.56 per cent.

The hydrocarbons decreased 3,393.69 tons or 9.1 per cent.

The most important reason given for the large increase in coal has been the demand for coke.

In the manufacture of coke 603,446 tons of coal were used during the past year against 365,822 tons for 1911.

The increase in the use of coal in the state for the past year is also noticeable. The amount used in 1911 was 2,124,500 tons and in 1912, 2,466,745 tons, while exports to neighboring states increased from 418,671 tons to 463,349 tons in the same period of time.

The distribution of coke provides some interesting figures. The Nevada smelters received 31,563 tons, against 335 tons in 1911. The Montana smelters increased their order from 86,714 tons to 135,865 tons. Idaho used 894 tons, while Utah increased her tonnage from 123,752 tons in 1911 to 176,426 tons in 1912.

The decrease in the hydrocarbon product is due to peculiar eastern conditions by which the market for this product is governed. The marketing of this product seems to be intermittent, one month the mines are working to full capacity, the next month the forces are reduced.

There have been no labor troubles during the past year. The wages of those employed in and around the mines and coke plants remained practically the same as last year, and from close observation, we are convinced that a good feeling exists between employer and employed.

The selling price of coal remained the same as in 1911; however, the market price for the hydrocarbon product is somewhat lower.

Three new coal properties, viz., the Willow Creek mine, operated by the Utah Fuel Co., the Panther Cañon or Cameron mine, operated by the Castle Gate Coal Co., and the Neslen mine, operated by the American Fuel Co. have been added to the list of coal shippers during the past year.

The Storrs mine, being developed and equipped by the Spring Cañon Coal Co., will be shipping coal by February 1. A railroad $4\frac{1}{2}$ miles in length has been built to the mine, connecting with the main line of the Denver & Rio Grande Railroad Co., one-half mile west of Helper.

A new contrivance (for the Western States) in handling coal from the mine to the tippie is being installed

at this mine. The coal outcrops on a bluff several hundred feet above the bed of the cañon. On account of the cañon grade being too steep to build the railroad to within 3,600 feet of the opening, it was decided to transport the coal this distance by an aerial tramway, which is in course of erection, and the company expects it to be in operation by February 1, 1913.

No serious shortage of cars has been reported during the year, except in the latter part of September and October. It has been impossible for the State Mine Inspector to visit all of the coal and hydrocarbon mines of the state as required by law, owing to the increase of new mines and the development of the old producing mines and their scattered condition. All of the large operating mines have been visited. Those which were not visited are mines in Iron and Uintah counties and which are in operation a few months in the winter season, only.

During the past 60 days, Mr. G. B. Smith has been employed as deputy state mine inspector.

The coal production for 1912 was 3,088,356 tons, or an increase of 586,885 tons.

Coke production for the year was 347,356 tons, an increase of 134,988 tons.

Hydrocarbon production was 33,656.31 tons, which is a decrease of 3,393.69 tons.

The amount of explosives used: 351,505 pounds of black powder and 395,218 pounds of giant and permissible powders, a total of 746,723 pounds, or 1 pound of powder used for every 4.13 tons of coal mined.

The number of men employed in and around the coal and hydrocarbon mines and coke plants during the year was 4,063, or an increase of 265 men over 1911. The average days worked by the regular producing mines was 280 days.

Average amount of coal produced per man (including miners, day men, and outside men, but not including coke workers) was 770 tons.

There were 6 mine foremen's certificates issued, and 3 fire boss's certificates.

There were 160 accidents in and around the coal and hydrocarbon mines during the past year. Eighteen resulted fatally, 31 serious, and 111 non-serious. Two of the fatal accidents occurred outside of the mines, one in an open rock cut, and one in an engine house.

As a result of the fatal accidents, there are seven widows and eighteen fatherless children.

Track Extension With Rails on Side

Instead of using short pieces of rails to extend the track as a chamber or gangway advances, the arrangement shown in the accompanying sketch can be used. This is to lay a rail on its side so that the head of the rail lies against the web of the rail which is permanently in place, and drive a spike on the outside against the bottom of the rail so that it will not slide out. Then as the car travels on the track it passes from one rail to the other, the wheel will run first on the tread and then on the flange as it drops into the groove formed by the web and head of the rail. The drop from

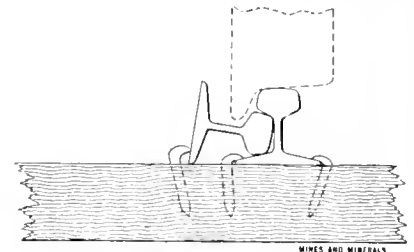

ARRANGEMENT OF RAILS

one rail to the other is not enough to make any difference in the running of a car. As the track advances, the rail, which lies on its side, is merely shoved forward, ties of course being laid beneath it. The plan cannot be used where an electric locomotive must pull a car away from a face and where it would be expected to travel on the loose rail, for the motor would then lose the return connections.

來 來

Use of Coke-Oven Gas

The entire gas supply of Mulheim-on-the-Ruhr, Germany, and of Barmen, about 40 miles distant, is obtained from two coke-oven plants. The installation consists of 50 Koppers, horizontal, regenerator ovens, each capable of taking from 8 to 10 tons for a charge; the time of carbonization is 24 hours and only the richer portion of the gas, that evolved from the second to the twelfth hour, which is about 50 per cent. of the yield, is used for distribution. During this period one oven will produce 70,600 cubic feet of gas of a calorific value well over 600 British thermal units per cubic foot with the average composition— CO_2 , 1.2; CO , 6.8; H , 49.5; CH_4 , 38.3, and N , 4.2 per cent. A yield of 65 to 69 per cent. of large coke, 5 to 6 per cent. of tar, and 1.3 to 1.5 per cent. of ammonium sulphate is obtained. The gas costs 17 cents per 1,000 cubic feet, and is sold for 70 cents per 1,000 cubic feet.

Answers to Examination Questions

Questions Asked at the Examination for State Mine Inspector, Colorado, 1911

(Continued from January issue)

QUES. 18.—Name six essential features of a good safety lamp.

ANS.—The qualities that make a lamp the best for testing for gas are not altogether those that render it desirable for general use in gaseous mines. For the latter purpose six of the essential features, are: (1) giving of ample light in all directions, which is attained by the use of a glass globe surrounding the flame; (2) failure to pass the flame through the gauze and thus ignite the gas outside the lamp when held in a strong current of air; which is brought about by the use of a bonnet; (3) a lock that cannot be opened by unauthorized persons or in an unsafe place, usually of the magnetic type requiring the application of a strong magnet to open the fastenings; (4) freedom from smoking, which is accomplished through providing a good draft; (5) ability to relight the lamp, usually done by the use of a percussion igniter as in the Wolfe lamp; (6) freedom from explosions inside the lamp, obtained by the use of a bonnet, by multiple gauzes, etc. To these might be added light weight and consequent portability; simplicity of construction with attendant easy cleaning; materials of good quality and strength, with resultant long life and low cost of upkeep, etc.

QUES. 19.—What thickness of steel plate is required in the shell of a cylindrical boiler 60 inches in diameter, for a safe working pressure of 100 pounds per square inch, the tensile strain on the boiler plate not to exceed 8,000 pounds per square inch, and no allowance to be made for joints?

ANS.—The formula generally used for this purpose is: Thickness in inches = $\frac{\text{working pressure}}{\text{safe load}} \times \text{radius}$

of boiler = $\frac{100}{8,000} \times \frac{60}{2} = \frac{3}{8}$ inch. In this formula, the working pressure and safe load (tensile strain) are expressed in pounds per square inch, and the radius of the boiler is given in inches.

QUES. 20.—Explain briefly the difference between natural and artificial ventilation.

ANS.—Natural ventilation is produced by what are known as natural agencies, or causes that exist in nature without the application of

artificial means. Some of these natural agencies producing a circulation of air are water falling down a shaft dragging the air with it; air blowing down a windsail or funnel placed at the top of the air-shaft; and, chiefly, the difference between underground and surface temperatures by means of which one column of air is heated and consequently expanded and made lighter than another connected column, so that, in the effort to secure an equilibrium or balance in weight, an upward motion of the lighter air column is produced. Artificial ventilation is brought about through the agency of some mechanical means, such as a furnace, air compressor, fan, etc. Artificial ventilation, particularly

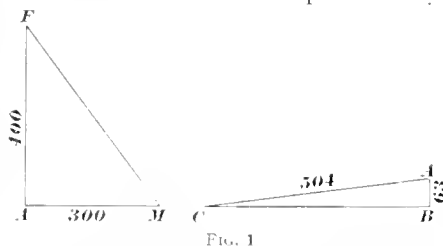

FIG. 1

when produced by a good fan, is to be preferred to natural ventilation, as it can be made independent of changes in the weather, etc., which always affect natural ventilation.

QUES. 21.—An entry runs west 100 feet, thence north 135 feet, thence west 140 feet, thence north 165 feet, thence west 160 feet. What is the length of a straight line from start to face?

ANS.—The sum of the northings is $135 + 165 = 300$ feet. The sum of the westings is $100 + 140 + 160 = 400$ feet. Hence the face of the entry is 400 feet west and 300 feet north of the starting point. This is shown in the triangle, Fig. 1, in which the unknown line MF is the required distance from mouth to face. As this is a right-angled triangle we have $MF = \sqrt{MA^2 + FA^2} = \sqrt{300^2 + 400^2} = \sqrt{90,000 + 160,000} = \sqrt{250,000} = 500$ feet

QUES. 22.—What, in your opinion is the reason that there are more explosions in the winter months than at any other time of the year?

ANS.—It is questionable if there are more explosions at one season of the year than the other, as methane,

blown-out shots, mine fires, poor electrical connections, etc., are as abundant or as apt to occur in July as in January, and any one or all of

these may produce an explosion.

On the other hand, explosions occurring in the winter months are commonly, almost universally, much wider spread and more disastrous than those happening in the warm months. This is due to the fact that in the winter the coal dust on the floor, roof, and ribs of a mine is much dryer than in summer; and this dry coal dust is the chief, if not the only, means by which an otherwise local explosion, affecting but a small part of the mine and endangering but a few men, is carried throughout the entire workings, frequently killing all the workers. During the winter months the temperature of the outside air is lower than that of the mine. As the temperature of the air rises, either by natural or artificial means, its ability to absorb moisture increases very rapidly. Hence, during the winter months, the cold outside air enters the mine, is heated to the prevailing mine temperature, and thus has its capacity for moisture increased. This moisture it gathers from the dust, leaving it dry and in the best possible shape to extend and thus render very disastrous what, in the summer, would otherwise be a minor and local explosion. In the summer, the reverse is the case, and the air enters the mine at a higher temperature, is cooled, and frequently deposits moisture, often making the roads muddy, and wet dust cannot be gathered up and thus propagate an explosive wave.

QUES. 23.—What is the rubbing surface per square foot of section for an airway 7 feet high, 11 feet wide, and 4,672 feet long?

ANS.—The perimeter, or distance around the outside of this airway is $7 + 7 + 11 + 11 = 36$ feet, and the rubbing surface is $36 \times 4,672 = 168,192$ square feet. The cross-section, or area, of the airway is $7 \times 11 = 77$ square feet. The rubbing surface per square foot of section (or area) is $168,192 \div 77 = 2,184.31$ square feet.

QUES. 24.—What are the duties of a mine inspector in the state of Colorado?

ANS.—These are plainly stated in the state laws relating to coal mines, a copy of which may be obtained by application to the Chief Coal

Mine Inspector, State Capitol Building, Denver.

QUES. 25.—If there are 60,000 cubic feet of air passing in a single airway, and this current is divided into 9 splits, each split having the same size area as the original current, how much additional air will be obtained?

ANS.—When the power remains constant the quantity of air circulated is proportional to the number of splits; hence the total quantity in circulation will be $60,000 \times 9 = 540,000$ cubic feet. The increase in the amount will be $540,000 - 60,000 = 480,000$ cubic feet. This assumes that the nine splits radiate out from the foot of the shaft like the spokes of a wheel, which is manifestly improbable.

QUES. 26.—A Guibal fan is 20 feet in diameter with 8-foot blades making 50 revolutions per minute. What quantity of air would you expect to be put in circulation, the modulus of the fan being .75, the deduction for center being 100?

ANS.—The total area of the fan is $20^2 \times .7854 = 314.16$ square feet. The available area, the central opening having an area of 100 square feet, is $314.16 - 100 = 214.16$. As the blades are 8 feet wide the volume of air displaced at each revolution is theoretically $214.16 \times 8 = 1,713.28$ cubic feet. As the efficiency of the fan is 75 per cent. the actual volume discharged or put in circulation, is $1,713.28 \times .75 = 1,284.96$ cubic feet per revolution. As the fan makes 50 revolutions per minute, the total volume of air circulated is $1,284.96 \times 50 = 64,248$ cubic feet per minute.

QUES. 27.—How would you lay out your works so as to insure the least damage in case of an explosion?

ANS.—If the mine is not dusty although gaseous, the effects of a gas explosion may be limited in extent if the mine is divided into a series of districts or panels, the workings of which are not connected and each of which is ventilated by a separate split of air. If the mine is dusty, the panel or district system is also to be recommended, with stone dust or water barriers at the mouth of each panel of sufficient width that the burning dust of a "dust explosion" may be extinguished before the explosive wave reaches the main haulageway and adjacent panels.

QUES. 28.—Under what conditions may afterdamp become explosive?

ANS.—In the case of what is

known as a dust explosion, if not sufficient air is present to burn the coal dust to CO_2 a considerable volume of CO may be formed; or, in event of a simple gas explosion, more or less methane, CH_4 , may remain unburned. In either case it is possible, when the proper amount of air is mixed with the gases named, that an explosive mixture may be produced.

QUES. 29.—What are the duties of the State Inspector of Coal Mines of Colorado in regard to loss of life or serious personal injury at any coal mine in the state?

ANS.—See answer to Ques. 24.

QUES. 30.—If the quantity of air in the downcast shaft weighs 1,800 pounds, the depth of the shaft being 300 feet, and the difference of the weight of air in the two shafts is 250 pounds, what will be the length of the motive column, assuming that the shafts are of the same size and depth?

ANS.—As the depth of the shaft is 300 feet and the total weight of air in it is 1,800 pounds, each layer of air 1 foot thick weighs $1,800 \div 300 = 6$ pounds. As the difference in the weight of the air in the two shafts is 250 pounds and each foot in depth weighs 6 pounds, the length of the motive column producing this weight or pressure is $250 \div 6 = 41.66 + \text{ft.} = 41 \text{ feet } 8 \text{ inches.}$

QUES. 31.—In a mine giving off 2,500 cubic feet of marsh gas per minute, the volume of air entering the intake opening is 4,500,000 cubic feet per hour; what is the percentage of gas in the return current? Would you consider this percentage of gas dangerous?

ANS.—If 2,500 cubic feet of gas are given off each minute, $2,500 \times 60 = 150,000$ are given off each hour. The volume of the return current, neglecting any increase in volume due to increase in temperature, will be that of the intake air and that of the gas combined, or $4,500,000 + 150,000 = 4,650,000$ cubic feet. The percentage of gas in this firedamp mixture will be $150,000 \times 100 \div 4,650,000 = 3.23$ per cent. and this is the percentage in the return air-current. This amount of gas will not in itself explode, but indicates a very dangerous condition in a dry and dusty mine, as a much lower percentage of marsh gas will communicate the flame of a blown-out or windy shot to the dust with the probability of producing an extensive and disastrous explosion.

QUES. 32.—Explain how you would determine the safe working

load for a seasoned hemlock mine prop 10 inches square and 10 feet long, assuming the crushing load per square inch is 5,300 pounds.

ANS.—The area of the cross-section of this post is $10 \times 10 = 100$ square inches. The total weight that will crush the post is equal to the crushing load per square inch multiplied by the number of square inches in the cross-section or $5,300 \times 100 = 530,000$ pounds or $530,000 \div 2,000 = 265$ tons. As the load supported by a mine post is not a moving one, a factor of safety of 3 is probably ample; that is, the safe working load may be considered to be one-third of the crushing load or $265 \div 3 = 88\frac{1}{3}$, say, 90 tons.

QUES. 33.—Two drill holes 1 mile apart are put down to a seam of coal. The depth of the first is 634 feet and that of the second 850 feet; the surface of the former is 25 feet above the top of the latter. What is the inclination of the coal seam between the two points, measured in inches per yard?

ANS.—The depths of the two holes must be reduced to a common level or datum as the top of one is 25 feet above that of the other. The depth to the coal is in the one hole 850 feet and in the other $634 - 25 = 609$ feet when both holes are measured from a common level. The difference in level is $850 - 609 = 241$ feet = $241 \times 12 = 2,882$ inches. One mile contains $5,280 \div 3 = 1,760$ yards. As the distance between the bore holes is 1,760 yards and the total difference in elevation of the coal at the bottoms of the holes is 2,882 inches, the inclination of the seam is $2,882 \div 1,760 = 1.64$ inches per yard. It should be noted that this is only the average inclination, and while actual mining operations in undisturbed regions may show but little variation from this, in regions that are at all mountainous or disturbed, the seam is very apt to show a grade much more or less than this at points between the two drill holes.

QUES. 34.—What constitutes firedamp; and what gaseous mixtures does it include?

ANS.—Damp is a term brought to America from England where it was used to mean a state or condition of the mine air wherein it differed from outside air. Various "damps" were recognized, as blackdamp, white-damp, stinkdamp, chokedamp, fire-damp, etc., each indicating a different condition of the atmosphere. Firedamp originally meant a condition of the mine air in which the flame of a candle might cause an

explosion, apparently of the air itself. It is recognized more clearly now that these dampers are ordinary air containing variable amounts of different gases given off from the workings. Unfortunately, careless usage has brought it about that both the pure gas and its mixture with air are now known as dampers. Thus, strictly, firedamp is a mixture of methane, marsh gas, or CH_4 , with air, but the term is as often applied to the pure gas as given off, say, by a feeder. Likewise, firedamp, includes in its meaning any mixture of air with an explosive gas, such as CO (carbon monoxide), H_2S (sulphuretted hydrogen), and the like, although these mixtures from their poisonous nature were early recognized as being different from firedamp, and were called whitedamp and stinkdamp, respectively.

QUES. 35.—In what time can an engine of 40 effective horsepower pump 4,000 cubic feet of water from a depth of 360 feet?

ANS.—A horsepower is equal to 33,000 pounds raised 1 foot high in 1 minute. As the engine is of 40 horsepower, it is capable of raising $40 \times 33,000 = 1,320,000$ pounds 1 foot high in 1 minute. At 62.5 pounds per cubic foot, 4,000 cubic feet of water weighs $4,000 \times 62.5 = 250,000$ pounds. But this is raised 360 feet, so the work involved in pumping is equal to raising $250,000 \times 360 = 90,000,000$ pounds 1 foot high. As the pump is capable of raising 1,320,000 pounds in 1 minute, it will require $90,000,000 \div 1,320,000 = 68.18$ minutes to raise 4,000 cubic feet of water 360 feet.

QUES. 36.—What will be the difference in the strength of two pitch-pine timbers each 9 feet long and supported at both ends, the one being 10 in. \times 10 in. and the other 8 in. \times 12 in., placed on edge?

ANS.—For the same span the strength of beams is proportional to bh^2 , in which b is the breadth and h the depth or height. For the first beam, where both b and h are equal to 10, this expression becomes $10 \times 10^2 = 1,000$. For the second beam, $b = 8$ and $h = 12$, and $bh^2 = 8 \times 12^2 = 1,152$. That is, the strengths of the two beams are to each other as 1,000 : 1,152, or for every 1,000 pounds carried by the first beam, the second will carry 1,152.

QUES. 37.—How would you open a 30-foot coal seam pitching at an angle of 45 degrees with a lift of 300 feet, to get a sufficient supply of air to the face of the entry and rooms, the seam being very gaseous? State

where and how you would place the fan, the property being opened by a tunnel, all the workings being above water level.

ANS.—A pair of tunnels would be necessary to open the seam. The lower one, *l*, Fig. 2, connecting with the main entry, *E*, being used for haulage and the upper one, *R*, connecting with the air-course, *A*, being the return and at the mouth of which the fan is placed. These rock tunnels should be driven with sufficient grade to insure proper drainage. When the coal is reached, entries, *E*, and air-courses, *A*, are driven each way with a slight rising gradient; and they are connected the one with the other as often as the amount of gas given off makes it necessary. In very gaseous seams it might be advisable to carry a line

points the manways, which are also airways, are carried up along each rib as shown. The miner works out the full thickness of the seam, standing upon the loose coal behind and beneath him and which is retained in place by the battery, *k*, and the timbered sides of the manways, *m m*. In very gaseous mines each room may have a separate split of air by connecting the manway, *m*, near the lower part of the room, with the main return, *A*, by a separate cross-cut, *d*. In this case the breakthroughs, *c*, between the rooms are not necessary, as the air enters from the main entry, *E*, passes up through the entire length of the manway, *m m*, around the face and into the main return by way of the cross-cut, *d*. If the rooms are ventilated in pairs, or groups of

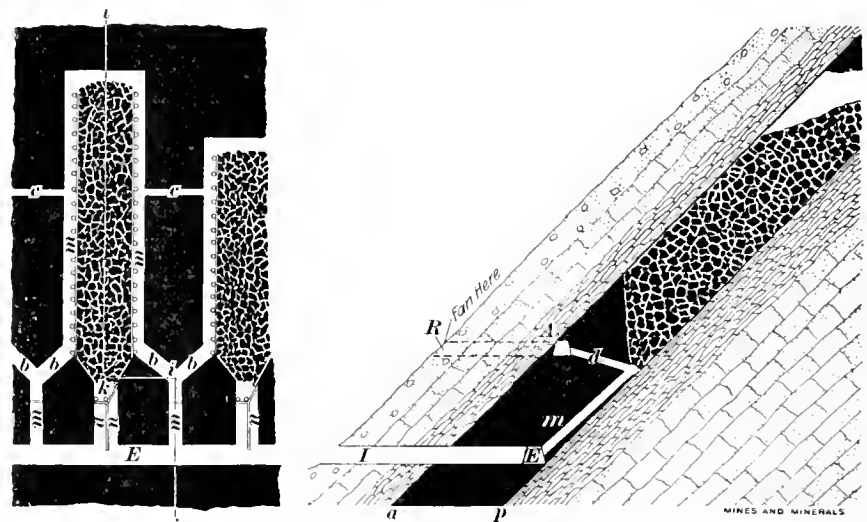

FIG. 2

of brattice along one side of the entry to insure a supply of fresh air at the face.

The room necks are about 6 ft. \times 9 ft. and are driven up on the floor of the seam for a distance of 20 feet to 25 feet when they are widened out to full room width; at the point of widening out a battery, *k*, of heavy timbers is built through an opening in which the coal is run by way of the chute, *a*, into the cars on the entry. The room neck is usually divided into two parts by a brattice, one of which constitutes the loading chute, *a*, and the other and much smaller one, *n*, is a manway to give access to the battery. In the middle of the pillar between the room necks a narrow manway, *m*, is driven in for from 15 to 20 feet, or a little more, and branches *b b*, are turned off in both directions and continued until they intersect the rooms on either side. From these

three, four, or more, these breakthroughs between the rooms are, of course, necessary.

The fan should be placed on the hillside at the mouth of the tunnel, *R*. How it should be placed will depend entirely upon local conditions of surface configuration, building material available, etc. The section is taken on the lines *lk-ij*.

(To be continued)

來 來

Depth of Oil Wells

The depth of Colonel Drake's oil well, at Titusville, Pa., the first in the state, was $69\frac{1}{2}$ feet, and from it 25 barrels of oil were pumped in 1 day. His derrick was 34 feet high and his drill rope manila. In California, in the Coalinga oil field, the wells are over 4,000 feet deep, the derricks 82 feet high, and the ropes coming into general use are steel of six strands of 19 wires each.

The Letter Box

Readers are invited to ask or answer any question pertaining to mining, or to express their views on mining subjects in this department. All communications must be accompanied by the name and address of the writer—not necessarily for publication.

The editors are not responsible for views expressed by correspondents.

Coal Dust and Steam

Editor Mines and Minerals:

SIR:—I have just read Mr. Reynolds' article on "Coal Dust and Steam." If he had explained the principle of this it would have made the matter simpler for those to whom the idea is new.

Many years ago when I first worked in a coal mine as a mining engineer, a young man who was about as new to the mines as I was, asked me the question:

"Mr. Hooper, what makes the mine sweat in the summer and get dry in the winter?"

The answer explains the whole question.

In summer the air condenses and gives off moisture to the mine so that everything is thoroughly dampened.

In winter the cold air going in expands and drinks up the moisture like a sponge, taking up, in a large mine, many thousands of gallons per day, particularly from the dust, the gob and everywhere.

My object in writing this is that the principle being well understood, the remedy would also be easier.

The air should in winter or at any other time, be at a higher temperature, than that of the mine. This could be brought about by use of steam pipe.

The steam fed to this hot air, is taken up and the condensation deposits the moisture where needed.

This matter is simple and we have much to thank Mr. Reynolds and men like him for, for leading the way to a better understanding of this matter. J. DE B. HOOPER
Dixie Springs, Ma.

To Remove Marsh Gas

Editor Mines and Minerals:

SIR:—For the benefit of the readers of MINES AND MINERALS I am sending details of my proposed method of removing marsh gas from entry and room headings and would like to have their opinions.

As marsh gas accumulates near the roof because of slow diffusion, the plan is to place a perforated pipe near the face at the roof and attach

it to another pipe that continues to a miniature exhaust fan placed on the return beyond all the working places. This fan is to exhaust through a 4-inch pipe, but as the quantity of gas to be exhausted is not large the friction will not prevent the proper working of this fan, if calculations are made relative to the size of the pipes.

It is not practicable to brattice all working places and even if it were the gas would be on the return in some cases in so large quantities as to cause an explosion, where with this system it would be possible to eliminate the gas so as to use open lights.

T. J. GANNON
Oklahoma City, Okla.

Dangers of Acetylene Lamps

Editor Mines and Minerals:

SIR:—I have read with interest the articles on page 254 of your December issue regarding the use of acetylene gas lamps, and for the benefit of your readers I desire to give you my experience.

The acetylene lamp is admittedly a very convenient thing for a miner on account of the brilliant light it gives. But something more is needed by the miner in addition to a bright light. You cannot tell anything about the condition of a roof by simply looking at it. You must sound the roof to know its condition. The carbide light on account of its brightness has been taken up by many miners who do not realize the danger that there is in its use. It deceives the miner because it consumes so very little oxygen. The officials of this company realize the danger attached to the use of this lamp and have discouraged as much as possible the use of same.

To verify our belief in the dangers attendant upon the use of this lamp, we made a short time ago an experiment with the assistance of our helmet crew. The crew was sent into an abandoned piece of workings where there was a large accumulation of blackdamp. They entered this place with three lights, an electric hand light, an acetylene lamp, and an ordinary pit lamp filled with lard oil. The pit lamp became extin-

guished before going but 5 feet into this place and more than one effort was made to keep it lighted. The carbide light was not affected at all.

The men went into this place a distance of 500 feet, and for practice worked on stoppings, cleaned away some rock, and did a little timbering. This work lasted 2 hours and at the end of this time, the acetylene lamp was still burning. This convinced us that this lamp was a very dangerous thing, as the condition of the light and the manner in which it is affected is about the only caution that the miner has of the presence of blackdamp or CO_2 .

In going through the mine, I have often seen instances where men have emptied partly exhausted carbide on the roadway and I have ignited same and watched it burn for some time. It is such things as this which cause mine fires that cannot be accounted for. I have seen men with as much as 5 pounds of carbide at one time in a box at the face and in a large mine where there are about 300 men daily, and especially if the mine is damp, I consider it a very dangerous practice.

I wish that some of the many crews of helmet teams in the country at the present time would try the carbide lamp in CO_2 and verify the experiment which I made.

D. H. SOMERVILLE
Gibson, N. Mex.

Combustion of Gas and Dust

Editor Mines and Minerals:

SIR:—The first part of Dr. J. C. Haldane's work entitled "The Investigation of Mine Air," is written by Dr. Otto Brunck, Professor in the Royal Saxon Mining College, Freiberg. On page 21 Doctor Brunck says: "It (carbonic oxide, or CO) also forms a constituent of the after-damp produced by an explosion of firedamp, when the percentage of methane exceeds 9.5, because then the proportion of air no longer suffices for the complete combustion of the methane."

Doctor Brunck does not give the reactions involved in the two cases but they may be assumed to be, $CH_4 + 2O_2 = CO_2 + 2H_2O$ (for complete combustion), and $2CH_4 + 3O_2 = 2CO + 4H_2O$ (for incomplete combustion).

On page 35 of "Ventilation in Mines." by Robert Wabner, E. M., of Tarnowitz, Silesia, it is stated: "Now, Doctor Brookman of Bochum, has shown that the product of the imperfect combustion of methane is ethylene (olefiant gas, or C_2H_4), and not carbon monoxide (CO). Con-

sequently the coal dust is the sole cause of the formation of CO and of the poisonous and dangerous character of the afterdamp."

From this view point, the reactions may be assumed to be, $CH_4 + 2O_2 = CO_2 + 2H_2O$ (for complete combustion), and $2CH_4 + O_2 = C_2H_4 + 2H_2O$ (for incomplete combustion).

This would appear rather an important and interesting difference and I would very much like to know which statement is to be relied upon. Wabner's work was published in 1903, and Haldane's in 1905.

FRANCIS G. WELLES

Waste in Mining

A number of prominent mining men were asked to answer two questions relative to the statement of Dr. J. A. Holmes, in Bulletin 47, Bureau of Mines, that "During the the past year (1911) in producing 500,000,000 tons of coal, there were wasted, or left underground in such condition that it probably will not be recovered in the future, 250,000,000 tons of coal." The questions were as follows:

1. Does the waste occur in your field?
2. Do you know from observation where such waste occurs, and if so, where?

The replies received are well worth reading and digesting.

Mr. John Laing writes: "The only district in West Virginia where we have coal left underground and where there is a possibility that it will not be recovered without great expense, is in the mines of Marshall and Ohio counties. They have a system of mining there where they claim it is impossible to draw pillars successfully because the overlying stratum is so strong that it will not break, but simply brings on a squeeze each time they attempt to draw the pillars, regardless of the method used. With this exception I know of no other district in West Virginia where coal is being promiscuously left in the ground because of any crude methods.

JOHN LAING, Chief Dept. Mines

NOTE.—Marshall and Ohio counties produced but 1.39 per cent. of the total quantity of coal mined in West Virginia. If any of the readers of MINES AND MINERALS can formulate a plan to decrease the waste in Marshall and Ohio counties of West Virginia it surely will be appreciated.

Next month there will be a letter from a noted coal man telling of the waste in Indiana and Illinois and suggesting a remedy.—EDITOR.

Chemical Interpolation of Anthracite

A Method of Rapidly Determining the Composition of Commercial Anthracite

By M. S. Hachita *

ANTHRACITE as shipped to market may properly be called "commercial coal." This fuel consists of normal coal which is free from impurities, and a small amount of refuse or inferior grade of fuel. The latter may be divided into two classes: slate and bone.

If, however, the amount of refuse in the prepared product exceeds the allowable limits, due to improper working conditions of the machinery, etc., it is detected by the coal inspector, whose sole duty is to inspect every railroad car of coal loaded for the market. In testing a car of coal, the

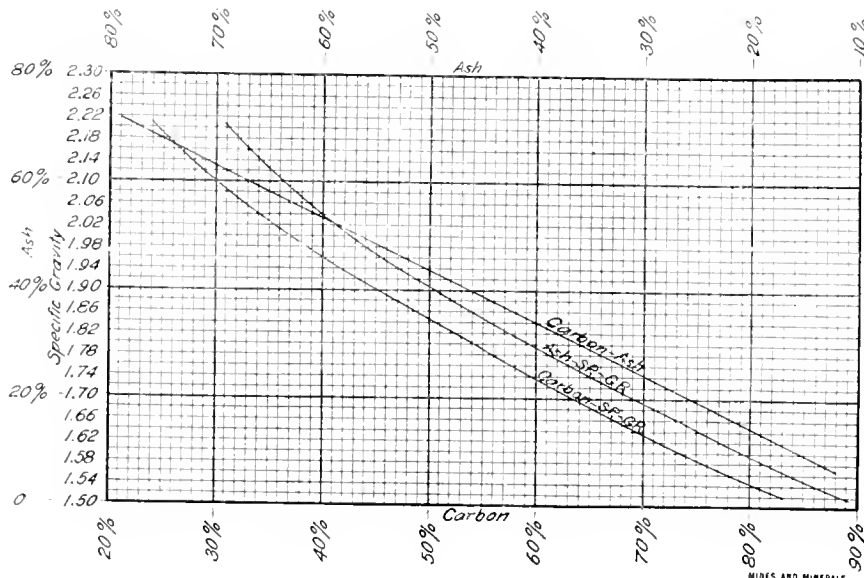

FIG. 1

The commercial anthracite coal therefore consists of normal coal, slate, and bone. The presence of such impurities in the commodity is unintentional on the operator's part, in fact, the companies spare no expense in the attempt to keep their output free from the undesirable materials. Slate and bone occur in the seams of coal in bands the thickness of which varies from that of paper up to many inches. In mining, the refuse comes down with the coal. The preparation of the coal for market begins at the face of the workings; in that the laborer, when loading a car, picks out as much of the slate and bone as time permits. Mine picking is by no means perfect on account of the poor light and surrounding darkness. When a car is thus loaded it is brought to the surface and dumped into the breaker where the raw coal undergoes many processes of mechanical preparation.

inspector takes three samples of 50 pounds each, one at the middle and one at each of the extreme ends of the car. The result of the three tests is averaged, and if the figures show greater than that allowed, the car is condemned and has to go through the process of preparation again. This method of sampling applies only to the prepared sizes; that is, chestnut coal and larger. For pea coal a 6 1/4-pound sample is taken from all over the car; and for buckwheat coal, the size of a sample is 2 pounds taken the same way as in the case of pea coal. The quantity of a sample of buckwheat No. 2 and No. 3, is proportionately smaller. Every car of coal shipped is carefully inspected and reported to the main office with the car number, the size of coal, the tonnage and the percentage of impurities it contains.

To make a chemical test of every car of coal shipped, entails extra work, which under the present market condition is prohibitive, although the majority of the large producers

* Paper read at the December, 1912, meeting of the Lackawanna Chemical Society, by M. S. Hachita, chemist for Lehigh Valley Coal Co., Wilkes-Barre, Pa.

maintain laboratories where the coal is analyzed along certain lines.

In connection with the present method of coal inspection, it has occurred to me that there is some chemical relation between normal

A₁ = percentage of ash in the average slate;
B = percentage of bone in the commercial coal;
S = percentage of slate in the commercial coal.

Any other combination of slate and bone with normal coal can be calculated in the same way. Table 1 is constructed by the equations 1, 2, and 3. The figures in the top row give the percentages of slate and those in

TABLE 1. SHOWING PERCENTAGES OF FIXED CARBON AND ASH OF COMMERCIAL COAL HAVING VARIOUS COMBINATIONS OF IMPURITIES

Table with 17 columns representing percentages of impurities (0 Per Cent. to 100 Per Cent.) and 2 rows for Carbon and Ash. The table contains a grid of numerical data for each combination of impurity percentage and component.

coal and the commercial product, for varying amounts of refuse in the latter. Experience has shown that the composition of normal coal for a given colliery is practically constant for at least 6 months or longer, depending upon the proportion of coal mined in each seam; and the same may be said in regard to the composition of slate and bone. When results of such analyses are available it is an easy matter to interpolate the composition of a given commercial coal. The interpolated figures are sufficiently accurate for commercial purposes. To obtain a normal coal it is advisable to use either pea or buckwheat coal, as the particles in the small sizes are more uniform and representative. Daily samples of buckwheat or pea must be taken for at least a month, and the accumulated sample reduced to about 25 pounds by quartering, then the sample is picked by a coal inspector according to the established standard, and divided into three parts; namely, normal coal, average slate, and average bone. Analyses made of these materials would form the basis for the interpolation of commercial products. A method I herewith propose is as follows: Let

C_c = percentage of carbon in the normal coal;
C_a = percentage of carbon in the average bone;
C_s = percentage of carbon in the average slate;
A₁ = percentage of ash in the normal coal;
A_b = percentage of ash in the average bone;

Then 100 - (B + S) = percentage of normal coal in commercial coal (1).
Total carbon in commercial coal = [100 - (B + S)]C_c + BC_b + SC_s (2).
Total ash in commercial coal = [100 - (B + S)]A₁ + BA_b + SA_s (3).
Taking C_c = 85.2; C_b = 53.6; C_s = 19.1; A₁ = 9.3; A_b = 40.7; A_s = 73.5; when B and S each equals zero, the (1) becomes 100 per cent.; (2) becomes 85.2 per cent. of carbon and (3) becomes 9.3 per cent. of ash. If B = 3 and S = 2, (1) becomes 100 - (3 + 2) = 95 per cent. of normal coal; (2) becomes 95 × .852 + 3 × .536 + 2 × .191 = 80.94 + 1.608 + .382 = 82.93 per cent. of carbon; (3) becomes, 95 × .093 + 3 × .407 + 2 × .735 = 8.835 + 1.221 + 1.470 = 11.526 per cent. of ash.

column 1 give the bone. The table is calculated up to 15 per cent. of slate and bone. The use of such a table as this is familiar to you, and I therefore omit an explanation of it.

A car of coal was condemned some time ago on account of the slate it contained. A representative sample was taken from the car and tested for slate and bone and the table was applied according to the percentage of these materials. Then the slate and bone were mixed with the coal. This sample was analyzed and the result of the analysis compared with that of the table figures. The comparison was as follows:

By the table: Carbon 72.81; ash; 21.86.

TABLE 2. NORMAL COAL

Table with 5 columns: Moisture, Volatile, Carbon, Ash, Specific Gravity. It lists data for various coal fields (Northern, Eastern, Western, Southern anthracite) and provides averages for Bone and Slate.

By analysis: Carbon 73.09; ash 21.54.

From this comparison it will readily be seen that the table figures are only .28 per cent. too small for carbon and .32 per cent. too large for the ash. These errors are not too large, and are within the error allowed in the commercial analyses of fuel. Having the percentage of slate and bone, with the aid of the Table 1 we can properly interpolate the chemical composition of any given car of coal shipped. It frequently happens that a coal dealer complains about a shipment of a car or two on account of the appearance of the coal. In such cases it is not practicable to send a representative to a distant point to examine and take a sample of coal. Such a step, if taken, shows the weakness of the shipper's position. On the other hand the use of the table as I have suggested will enable the operator to convince the dealer without sending anybody and the business can be transacted more quickly.

The composition of normal coal differs in different collieries and in different fields. Table 2 gives the average composition of normal coal, bone, and slate in the different fields.

Dividing each element in the slate and bone by the corresponding element in the normal coal in Table 2, gives the figures shown in Table 3 in which it will be noted that all bone, except one, contains less moisture and a larger amount of volatile matter than the normal coal, and the same is true with the slate, while the carbon in the bone varies from 61 to 67 per cent. of the carbon in the coal and that in slate from 27 to 31 per cent. of the coal. Ash in the bone varies from 2.85 to 4.28, or an average of 3.60 times that in the coal, while in the slate it varies from 4.95 to 7.25 or an average of 6.20 times that in the coal. The similar variations in the specific gravity will also be noted. The quality of heat produced by the carbon in the slate and bone is undoubtedly the same as that produced

by the carbon in the coal, but whether or not the volatile matter in the refuse, especially in the slate has any heating value has not been investigated.

From the average values of the analysis of the normal coal and refuse a chart, Fig. 1, is constructed. The lines connecting the carbon-ash loci show that they are practically in the same straight line. In other words the percentage of carbon in a given fuel varies inversely as ash. Generally speaking, the higher the specific gravity of the material the greater the ash percentage; but the lines connecting the loci show that this is not in a straight line but forms a curve. The chart also shows that the specific gravity increases more rapidly as the percentage of the ash becomes higher. Carbonization of anthracite can also be determined by the specific gravity of a given material. The lines of loci show that this also is not in straight line; but that it is similar to the ash specific-gravity loci. In this curve it will be noted that the increase of specific gravity is more rapid as the percentage of carbon becomes less and less. To obtain percentage of the refuse in the steam sizes, especially the rice and barley coal, it is almost impossible to get an accurate figure. The reason is that the particles composing the material are so small that it is hard to draw lines between the normal coal and bone, and the bone and slate. In such cases a determination of specific gravity is made of the fuel. When such data are available, the chemical composition of coal can be obtained diagrammatically. For instance, if a given fuel has a specific gravity of 1.58, from the carbon-specific gravity curve on the diagram the carbon content of the coal is 75.5 per cent. and from the ash-specific gravity curve the ash is 18.5 per cent. The use of this diagram is not limited to the steam sizes, and can be used for the larger coal if so desired.

The Mine Foreman

By Thomas Turner*

The company operating a mine has certain interests that must be taken care of by the foreman and fire boss, and this can only be done successfully, with each one working for the same great interest. We must not, however, forget that the workingmen have certain rights and privileges, that can only be taken care of when the bosses consult each other on matters pertaining to their labor, and consider the man worthy of his rights.

Having never been a mine foreman, perhaps I am not able to judge what is called a model boss, but as we all have our own opinion, perhaps you will allow me to express in a few words some traits of character that a foreman should have.

The foreman I consider as a general over his staff, his orders should be given when he knows they are right, in firmness and kindness, expecting nothing else but obedience, and treating his men with such kindness that they will stand ready to do his bidding. Social enjoyment has become the fad of the day, and Mr. Boss, if you have to be out late at night, and have perhaps indulged in such dissipation that causes you to feel a little out of humor in the morning, please remember the fire boss and give him that good morning that he likes to hear. Think of his entering the mine at 2.30 o'clock, coming in contact with gas, bad roofs, squeezes, and many other things that fill the thoughtful man's mind, and you will agree with me that this, above any other time, is the wrong time to show that you are in an ill temper and perhaps want to take it out of him. One of the best ways to bring your assistants in close touch with you is to let them know that you appreciate their work when it is well done.

I think it is wrong for a foreman to think that his plans and ideas are the only ones that are right without consulting his assistants. A few years ago I worked as a fire boss for a mine foreman, and as usual I made suggestions that I thought were for the saving of labor for the men, and also for the benefit of the company, and he told me, if not directly, then indirectly, that he was paid for thinking and I for working. What do you think was my attitude toward him in respect to giving my opinion? Of course I did not give it, after that, and, just because we did not consult, it was detrimental to the interest of

* Fire Boss, Alden Coal Co., Alden, Pa. Abstract from a paper read before the Nanticoke, Pa., Mining Institute under title of "The Mine Foreman and His Relation to His Assistants."

TABLE 3. BONE

	Moisture	Volatile	Carbon	Ash	Specific Gravity
Northern anthracite field.....	.54	1.34	61	4.38	1.22
Eastern middle anthracite field.....	.68	1.50	65	3.75	1.14
Western middle anthracite field.....	.74	1.39	63	3.84	1.19
Southern anthracite field.....	1.20	1.06	67	2.85	1.20
Average.....	.76	1.28	.65	3.60	1.19
Slate					
Northern anthracite field.....	.65	1.65	27	7.25	1.50
Eastern middle anthracite field.....	.63	1.85	28	6.63	1.40
Western middle anthracite field.....	.60	1.70	28	6.55	1.46
Southern anthracite field.....	.78	1.12	31	4.95	1.48
Average.....	.66	1.51	.30	6.20	1.46

both the men and the company. This foreman never had the good-will and cooperation of his assistants. His work as a foreman was not a success, and after a very short time another foreman came to the mines where I was fire boss. A very hard problem was up to us in the nature of a mine trouble. The very first day that man came into the mine he called me and another assistant back from some men we had working, and said: "Now men, I have come here not only to boss but to work hand in hand with you, and what I know I want you to know. Every opinion or suggestion you may have, do not be afraid to tell it to me. I am sure it will be considered. Let us work in harmony and we will get through this trouble all right." What was the outcome of that conference? We were successful in that, what I called the most difficult mine trouble that I met in all my mine experience. Was it all that was accomplished through that little conference? Oh, no, our relations continued of the most pleasant kind, and we worked together in harmony. His interest in the mines became my interest and I always felt that there was nothing too much for me to do for him.

Do not understand me to mean that a mine foreman, in order to have the good-will of his assistants, must be lenient with their mistakes. Oh, no, he should be firm and determined in his correction of mistakes made by his men and always ready to enforce discipline.

A mine foreman should have a certain amount of executive ability and have a good knowledge of how to handle men, and also when he has a good man, try and keep him, for every good man strengthens your organization. There are a great many good men that would never make good foremen. It seems as though a good mine foreman has to be made to order. Consequently there are some holding positions today who are not filling them as they should be filled. They are of a nervous disposition and their judgment is led astray by their ill temper. They do not think they are bosses unless they are swearing at, bulldozing, or discharging someone all the time. Such foremen may have able corps of assistants who could help them, if they were of a different disposition, but as they are ignored by the foremen, the latter always has more trouble than is necessary.

I well know that the foreman who is willing to take the grievances of his men as they come to him, in a spirit of respect for their rights, is the

man who will have their good will, and harmony will exist. He will be able to handle his men better and give better service to his employer. When men approach their foreman on a question of price, it is not always the disappointment of not getting the dollars and cents, but sometimes in not receiving a kind word and manly treatment of which they are deserving. I am glad that we have so many superintendents and foremen who have charge of our mines, who are willing at all times to consider the workmen's needs and treat them as men, but I have known some mine foremen, and I am sorry to say there are some holding positions today, that act as if they were very far above their fellow men, and will not give them the consideration that every man should have when he comes to talk business.

With an experience of about 25 years as fire boss, I ought to be able to judge what kind of a man should fill this position. I do not hesitate for a moment to say that a fire boss ought to be a temperance man, for a man that drinks and keeps late hours is not a fit man to examine miners' places, and protect their lives and the company's property or interests.

The fire boss, to a certain extent is the keeper of his brother's life. Therefore we must be faithful in the making of our examinations, knowing that our neglect can bring accident or death to our fellow workmen and great loss to the company that employs us. A fire boss ought to be a man who stands ready to receive orders from his foreman and carry them into execution. The foreman's interest should be his interest. He should be a man who would go into extreme danger if need be to protect life and property. A fire boss should be such a man as will study the needs of his brother. I think that if we practice the maxim "Do unto others as you would have them do unto you," even in our mine work we would meet with more success. Every man whether he be the most experienced miner or the common laborer, is worthy of your respect and courtesy. If he is ignorant, then let us help educate him; if experienced, let us appreciate his knowledge. We should so treat men that they will respect us, and so understand our fair dealings with them that they will be willing to do anything for us, knowing that we are fair between man and master. A fire boss should be a man who has had broad mining experience, one who has done nearly all kinds of work in the mines or had charge of such work, so that he has gained a

practical experience, which will give him the proper judgment to enable him to direct his men and give orders and insist that they be carried out. Misjudgment on the part of the fire boss in giving orders has in the past been the cause of a number of accidents, and especially has this been so in cases where gas has been found and air splits have been changed and interfered with. The man that is not practical in his position, is thoughtless in regard to the danger of making any change in the air split of his section.

No change should ever be made in an air split in the mines while the men are at work, unless it is a case of extreme necessity; maybe a mine fire, cave or such causes, and only then after informing the men in that section of the change. An assistant foreman should be free at all times to consult with his foreman, to bring about the best results in his section and to assure the very best protection to his men.

He should not think that he has gained so much knowledge about the mine that he need not consult the foreman or bring matters of importance to his attention. A good foreman is always ready to consult with his assistants to bring about the best results for the men and company. My brother fire boss, experience has taught me that our position is one of very sacred trust and no man that goes into the mine has an equal responsibility with you, not even the mine foreman, for he is obliged to take your word and report.

Don't be a conceited fire boss, because your foreman has taken you from a breast, or from a position as driver boss, and given you charge of a section of men. Don't feel that you are the superintendent or an officer of the company, but feel that you have still much to learn. Then your fellow men, seeing your attitude, will be open and friendly with you and you will be able to learn many valuable things from them. On the other hand, if your promotion fills you with pride and raises you far above the men you have just left, your success will not be assured, for these men will be against your interests, and your foreman will not be able to advance you very fast in your mine education, for you will not have the same spirit toward him.

In the great business of mining, the organization of each mine should be in harmony and working together, that the most careful protection may come to each man and boy's life and the property and rights of the company.

Mining Societies and Institutes

American Mining Congress—Coal Mining Institute of America, Canadian Mining Institute, and Others

THE fifteenth annual session of the American Mining Congress opened, at Spokane, Wash., on November 25, President Samuel A. Taylor presiding.

Mr. Graham B. Dennis, of Spokane, called the meeting to order, and Mr. R. Isinger, president of the Spokane Chamber of Commerce, made the address of welcome, after which President Taylor was introduced. Then followed the responses to the address of welcome. Delegates were there from Peru to Alaska, and each in turn manifested a desire to partake of the good things that Spokane had prepared for them.

The reception to the President was given Monday evening in the quarters

each pioneer recited his experiences of the North and the hardships placed upon him by the bureaucratic enthusiasts of the East, there was much evidence of indignation among the members present. The much discussed, but little understood, question of Alaska coal had the floor for a considerable space of time. There was strong feeling among the members of the congress that something should be done whereby justice could be meted out to those that had acted in good faith, and the following resolution was passed: "We urgently rec-

ommend that Congress pass an act immediately authorizing all claimants to Alaska coal lands, whose claims were filed prior to November 12, 1906, to maintain action in the United States courts, with right of appeal to circuit and supreme courts of the country, so that any judgment finally rendered shall be conclusive of the rights of the parties, thereby canceling such claims as may be adjudged invalid and requiring the immediate issuance of patents to such claims as may be adjudged valid."

Alaskan railroads received some attention and it was voted that Congress be asked to aid in the building of one or two trunk lines in the territory, so that the enormous freight rates now being demanded could be materially reduced.

While Alaska received a great deal of attention there were other important matters that created more or less discussion. W. R. Allen, Lieutenant-Governor of Montana, made a lengthy speech in favor of a "Blue-Sky" law. He was in favor of each state having

away in the past ages. He advocated the opening of the Alaska coal mines so that the people of that territory could now get the benefit of their resources.

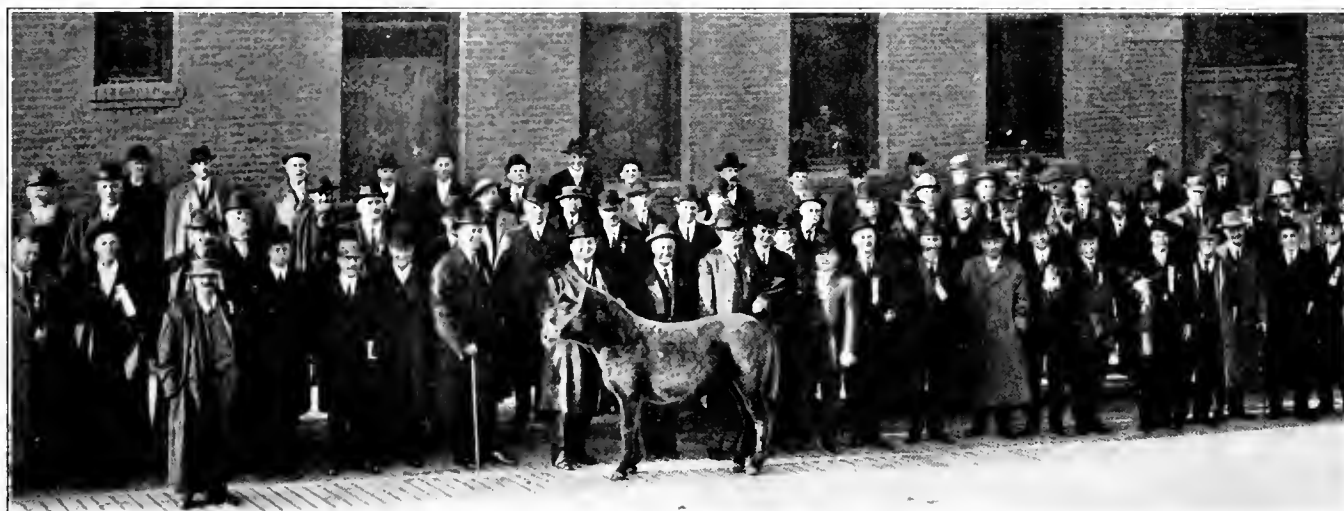

AMERICAN MINING CONGRESS AT SPOKANE

of the Spokane Club. President Taylor at this time gave the annual address.

The work of the congress began in earnest on Tuesday morning, at which time several papers were read and a number of speeches were made. The paper prepared by Henry S. Graves, Chief Forester, and read by Mr. Silcox, a member of the forestry department, was the spark that kindled a brief but intense fire. Mr. Graves in his paper asked that specific examples be given wherein the forestry department as now operated had been a detriment to the progress of mining in the West. There were examples a plenty. Men from Alaska and Idaho related specific instances where they had been handicapped greatly by the operation of the department.

Alaska had many representatives at this congress and also many friends who never saw the northland, but as

ommend that Congress pass an act immediately authorizing all claimants to Alaska coal lands, whose claims were filed prior to November 12, 1906, to maintain action in the United States courts, with right of appeal to circuit and supreme courts of the country, so that any judgment finally rendered shall be conclusive of the rights of the parties, thereby canceling such claims as may be adjudged invalid and requiring the immediate issuance of patents to such claims as may be adjudged valid."

In speaking of conservation, David Ross, Commissioner of Labor of Illinois, said in a speech that was to the point, that his own state of Illinois had enough coal to supply the entire United States for the next thousand years, and that there was no need for this great cry of conservation, and that the present generation should in some manner get the benefit of the great storehouse that had been laid

a department whereby any investor could secure reliable data relative to any mining venture, in which shares were advertised for sale. Others made speeches along the same line and for a time it appeared that the congress was in favor of such legislation, until J. D. Decker, Congressman-elect from Joplin, Mo., arose, stated the fact that he was from that state, the mention of which provoked many smiles, then said that he could not see any virtue in such a law and called attention to a great many defects and shortcomings that such a law would necessarily have. It was decided to appoint a committee and let this committee draft such a law as they thought would cover the question to the best interests of all concerned. The report of this committee will be submitted to the congress at a later date.

Compensation was another subject that was given considerable attention.

John Wallace, State Industrial Insurance Commissioner of the state of Washington, gave in some detail the working of the compensation law of that state. The congress was made up mainly of operators rather than employes, but the sentiment of the congress was greatly in favor of such a law as the state of Washington now has, and went on record to that effect. Mr. Wallace stated that the law as now operating in Washington has a few defects, but these he hopes will be remedied at the next meeting of the legislature.

The congress went on record against the reduction of tariff on lead and zinc.

The following officers were elected to hold for the ensuing year: D. W. Brunton, of Denver, for president; Hennon Jennings, of Washington, D. C., for first vice-president; E. A. Montgomery, of Los Angeles, second vice-president; Carl Scholz, of Chicago, as third vice-president, and J. F. Callbreath, secretary.

Spokane offered to build a temple at a cost of not less than \$500,000 for a permanent home for the American Mining Congress; the offer was accepted with thanks, but it was decided to hear from other cities before final action was taken. There were many present who thought the headquarters should be at Washington, D. C.

The committee at Spokane had provided for the entertainment of the visitors, among other things, a mining camp scene which was intended to portray the conditions of pioneer days. Thursday night was ladies' night and at this performance there were to be seen the original camp scenes, and life where there was much drinking and gambling games of all kinds were to be seen. The scenic effects were realistic and "Taylor Gulch" was a very popular place. Friday night was "for men only" and it was here the lid of Spokane, which by the way is a closed town, was pried up a little, and in the opinion of some the lid was entirely removed. There was a great variety of stunts that night, and among them was one dance that many of the good people of Spokane objected to. It is certain, however, that this matter got out of the hands of the local committee and the performers overstepped the limit. It is regrettable that they should have done so, for it marred what would otherwise have been a very instructive and enjoyable entertainment.

On Sunday a party of about 250 members of the congress visited the mining camps of the Cœur d'Alene and examined the underground work-

ings of some of the more important mines. The visitors were treated with the novel feature of listening to a band playing down in one of the mines. After the visits to the various mines an athletic program was given in which the employes of several of the mines took part. At the conclusion of the athletic program the members of the congress returned to Spokane and from there scattered to their several homes.

COAL MINING INSTITUTE OF AMERICA

The Coal Mining Institute of America held its annual session in Pittsburg, December 18 and 19, in the School of Mines building of the Pittsburg University. This meeting was largely attended, but as it came in a busy season of the year, and the soft coal business was particularly a busy one in December, many who would have gladly attended were unable to do so.

Retiring President A. W. Calloway, manager of the Rochester & Pittsburg Coal and Iron Co., could only afford sufficient time to read his address and then hasten to take a train.

W. R. Calverley, superintendent Berwind-White Co., spent one evening at the Fort Pitt Hotel and left early the next day to visit one of the numerous mines in his charge.

George K. Krebs, Somerset, Pa., general superintendent of the Reading Iron Co.'s bituminous mines, spent part of one day at the meeting and then vanished.

William Seddon, Brownsville, who was the Institute's first secretary when it started, 27 years ago, contributed a history of the Coal Mining Institute of America. Messrs. F. Z. Schellenberg, Rufus J. Foster, and Thomas K. Adams, and some of the earlier members of the Institute, also added to the history of the Institute with appropriate remarks.

The following papers were read at the meeting: "Clinkering of Coal Ash," E. B. Wilson, Scranton, Pa.; "Roof Action," R. D. Hall, New York; "Welfare, at the H. C. Frick Coke Co.," by Thomas W. Dawson, assistant chief engineer. Mr. Dawson illustrated his address by the use of the stereopticon, making it unusually interesting. Prof. H. D. Palister, of the Pennsylvania State College, read a paper by Dr. W. R. Crane, who is studying the Alaska coal measures of the Bering River coal field, Alaska.

In the evening the annual Institute dinner and social session was held at the Fort Pitt Hotel. At the dinner Thomas K. Adams spoke on the

"State Inspection of Mines"; John W. Boileau, on "The Future of the Coal Industry in Western Pennsylvania"; W. H. Glasgow spoke on "The Welfare of the Miner is the Welfare of Industry"; J. C. Johnston, editor of *Coal and Coke Operator*, spoke on "Evolutionary Revolution in the Coal Trade"; R. J. Foster, manager of MINES AND MINERALS, spoke on "The Necessity of the Operators in the Bituminous Fields cooperating with the Operators in the Anthracite Fields to prevent politics entering into the construction of state mine laws." He showed the necessity of having the Governor appoint the mine inspectors in the anthracite field as is done in the bituminous fields, drawing a comparison of the workings of the two systems prevailing in the two coal fields of Pennsylvania. J. H. Callbreath, secretary of the American Mining Institute, spoke forcefully against the present system of conservation of public lands; W. D. Affelder, general manager Bulger Block Coal Co., delivered an address on "Rib Drawing by Machinery." This precipitated a debate which lasted for some time, the various members participating in the discussion and endeavoring to disapprove the ideas advanced by Mr. Affelder. Al C. Fieldner, chemist in the Coal Laboratory of the Pittsburg Testing Station, United States Bureau of Mines, read a paper on "Accuracy and Limitation of Coal Analyses." This was an excellent paper and will appear in MINES AND MINERALS.

At the business session the following were elected officers for the ensuing year: President, W. E. Fohl, Consulting Mine Engineer, Pittsburg; First Vice-President, Jesse K. Johnston, Charleroi, Pa.; Second Vice-President, Thomas D. Furnis, Punxsutawney, Pa.; Third Vice-President, George K. Krebs, Somerset, Pa.; Secretary and Treasurer, Charles L. Fay, Wilkes-Barre, Pa.; Executive Board, H. Hinterleiter, Clearfield; Samuel C. Taylor, Pittsburg; A. P. Cameron, Irwin, Pa.; F. W. Cunningham, Charleroi, Pa.; Auditors, C. L. Clark, New Alexandria, and R. M. Husler, Indiana, Pa. R. Dawson Hall, New York, was reelected Editor of the *Proceedings*.

At noon the Institute members were guests of the University of Pittsburg at a luncheon in Hotel Shenley. After luncheon, E. B. Guenther, East Pittsburg, Pa., read a paper on "Gas Producers from the Standpoint of Mining Men." E. B. Wilson, who in his paper on the "Clinkering of Coal Ash," made the

statement that "pyrite was not the cause of coal clinkering," took exceptions to Mr. Guenther's statement that "pyrite causes clinkering in gas producers."

R. D. Hall thought that this would be a good time to settle the question. He stated that some metallurgists agreed with Mr. Wilson, and others did not, naming a Mr. Liddell who he said he had consulted in the matter, not knowing anything of it himself.

G. R. Delamater, Philadelphia, read a paper on "Improved Coal Washing Conditions," after which the meeting adjourned, to meet probably in Wilkes-Barre next summer. Taken as a whole the meeting was a most successful one, the membership having increased to 800, some twenty-five or thirty members having joined at this meeting.

CANADIAN MINING INSTITUTE

The Annual Meeting of the Canadian Mining Institute will be held in Ottawa on March 5, 6, and 7, 1913. The Institute's headquarters will be the Chateau Laurier. Since the hotel accommodation is limited it is important that members should make early application for reservations either to the Secretary, H. Mortimer Lamb, Room 3, Windsor Hotel, Montreal, or direct to the manager of the Chateau Laurier, at Ottawa.

Among the papers already promised for the meeting are the following: "Mining Methods as at Present Employed in the Yukon," by Dr. H. M. Payne, of New York; "The Evolution of Gold Metallurgy," by R. B. Lamb, Toronto; "Grinding Analyses and Their Application to Cyanidation, Classification, Etc.," by John W. Bell, McGill University, Montreal; "Some Notes on the Geology of the Pearl Lake Section of the Porcupine District," by H. G. Skavlem, Aura Lake, Ont.; "Monel Metal," by Dr. W. Campbell, Columbia University, New York; "Recent Metallurgical Developments," by Dr. Alfred Stansfield, McGill University, Montreal; "The Steel Industry of Nova Scotia," by Thos. Cantley, New Glasgow, N. S.; "The Iron Resources of Quebec," by Prof. E. Dulioux, Ecole Polytechnique, Montreal; "The Agglomeration of Iron Ores," by N. V. Hansell, New York; "Prospecting the Iron Sands of Natashkwan, Que., with the Empire Drill," by G. C. Mackenzie, Department of Mines, Ottawa; "Mica Mining in Canada," by Hugh de Schmid, Department of Mines, Ottawa; "Mica Manufacturing and Marketing," by S. O. Fillion, Ottawa; "The Origin of

Graphite," by John Stansfield, McGill University, Montreal; "The Clay Resources of Western Canada," by Dr. Heinrich Ries, Cornell University Ithaca, N. Y.; "The Utilization of Exhaust Steam," by J. M. Gordon, Montreal; "State Aid to Mining in Australasia," by H. Mortimer-Lamb, Montreal; "The Evolution of Mining and Milling," by J. J. Penhale, Sherbrooke; "The Use of Rescue Apparatus in Metal Mines," by H. E. Bertling, Toronto; "Gold and Placer Mining," by W. J. Dick, Ottawa; "The Best Methods of Mining Coal under Various Conditions," by Alex. Sharp, Vancouver; "Core Drilling," by H. P. Moore, Toronto.

ROCKY MOUNTAIN COAL MINING INSTITUTE

A local chapter of the Rocky Mountain Coal Mining Institute was organized in Trinidad, Colo., December 28, by those members of the organization whose homes are in southern Colorado. James S. Thompson, division superintendent of the Colorado Fuel and Iron Co., was chosen as president; F. P. Bayles, vice-president; and Ben Snodgrass, superintendent of the Del Agua mine of the Victor-American Fuel Co., secretary-treasurer. The following executive committee was elected: J. S. Thompson, F. P. Bayles, B. W. Snodgrass, J. E. McLaughlin, M. O. Danford. The first regular meeting was called for January 25, 1913. Meetings are to be held every three months. The founding of this chapter is in accordance with plans made by the Rocky Mountain Coal Mining Institute, which was organized at Denver last November, provision being made to have local chapters of the institute organized in the various mining districts of the state in order that the members in these districts should be able to meet as often and as conveniently as possible to discuss mining problems.

OLD FREIBERGERS

On Friday evening, December 20, at the Hofbrau-Haus, Broadway and Thirtieth Street, New York City, a number of old students of the Freiberg Bergakademie sat down to dinner. This meeting was called for the purpose of forming an association in America to be known as the "Old Freibergers in America." After the dinner a business meeting was held and the following officers were elected: President, R. W. Raymond, Freiberg, 1861; Vice-President, Gardner F. Williams, Freiberg, 1868; and Secretary-Treasurer, C. L. Bryden, Freiberg, 1907.

It was decided to hold two meetings a year, one on March 25, the anniversary of the founding of the Akademie, March 25, 1765, and the other on the 20th of December, this to be the annual meeting. The following members were present: Dr. R. W. Raymond, 1861; Gardner F. Williams, 1868; P. J. Oettinger, 1867; Stuart M. Buck, 1868; T. Walm Morgan Draper, 1876; Baron Alfred von der Ropp, 1882; Franklin Guiterman, 1877; F. G. Corning, 1879; R. Boice, 1908; Albert Meyer, 1908; R. M. Payne, 1909; Dr. E. E. Lungwitz, 1886; F. H. Siermans, 1885; Geo. M. M. Godly, 1900; Walter V. Rohlfis, 1903; H. H. Knox, 1886; H. A. Wilkens, 1889; and C. L. Bryden, 1907. All old Freibergers who have not already done so, are requested to send in their names to the Secretary, C. L. Bryden, 1015 Myrtle Street, Scranton, Pa.

The second annual Northwest Mining Convention will be held in Spokane, February 19 to 21, inclusive. Invitations will be sent to the American Institute of Mining Engineers, the electrical and chemical engineers' organizations, the societies of civil and mechanical engineers and others. Negotiations looking toward reduced railroad rates will at once be taken up. The Pacific northwestern states and the western Canadian provinces constitute the territory to be represented.

From information received from T. J. Barr, secretary of the Kentucky Mining Institute, a state First-Aid Contest will be held in Lexington next May. A number of teams are pledged to enter the contest which insures its being a success. The Goodman Mfg. Co., Chicago, Ill., has offered a silver cup as first prize.

On December 19, 1912, the Pittsburg Coal Co.'s Relief Department of River Coal, held their annual banquet and smoker at the Monongahela House, Pittsburg. During the banquet a negro quartette kept things lively, and at the end of the session Mr. Wilson and Mr. Wachung delivered speeches. After the banquet the company visited the theater. Mr. G. W. Schluederberg, of the Pittsburg Coal Co., presided.

Walter R. Calverley, general superintendent of the Berwind-White Coal Co., will deliver an address on "Some of the Phases of Bituminous Coal Mining," before the Yale Mining Society in New Haven, Conn. Mr. Calverley's experience is such that he is able to talk interestingly and instructively on any phase of soft-coal mining.

The U. S. Bureau of Mines

Some Good Things It Has Accomplished, as Shown in Its Second Annual Report

IN HIS Second Annual Report as Director, Doctor Holmes truly states that the work of the Bureau of Mines has not been continued long enough to make possible any accurate measure of the benefits to come from it. He does, however, mention some of the apparent benefits, and in calling attention to them he does not claim for the Bureau all the credit, but says: "In this connection large credit is to be given to many private individuals—engineers, operators, and miners—and to many State Mine Inspectors who have aided in bringing about these results." While several of the larger coal-mining companies had inaugurated the use of explosives with a shorter and cooler flame than black powder before the organization of the Bureau, there is no doubt that its work hastened a more general adoption of what are styled "permissible explosives," until in the year 1911 the consumption was more than 13,000,000 pounds, and this amount was largely increased in 1912. The work of the Bureau in investigating explosives has been recognized by all intelligent mining men as of great value. The Bureau has also accomplished considerable good in its investigations of mine explosions, both as regards to the prevention of gas explosions, and also to limiting the extent of those due to sudden outbursts of gas or sudden appearances of gas due to causes not controlled by reasonable precautions. It has also been instrumental, through the cooperation of mine officials, in having adopted certain precautions that lessen the dangers incident to the use of electricity in gaseous and dusty mines. This has not only been of distinct benefit to the mine workers, but has also been of value in making the use of a most convenient method of transmitting power in mines practically as safe as any other. The investigations of the Bureau in connection with accidents from falls of roof and of coal and from failure of mine equipment, have been too few and too incomplete to warrant Doctor Holmes claiming any extended beneficial results; but safety recommendations of the Bureau, based on preliminary examinations, are being more widely adopted than was the case in the past. In regard to the matter of mine fires and mine rescue work we

quote from Doctor Holmes' report: "The investigations of mine fires have resulted in making clear many of the contributory causes of such fires and have shown the proper equipment and methods for preventing and fighting fires. Especial attention has been given to the analysis of the atmosphere of fire areas as an aid in determining whether an area has been so sealed that outside air can not reach the fire, which, in such event, will be smothered. The findings of the bureau in this respect are proving of service to operators and to State Mine Inspectors.

"The mine-rescue work, including both investigations and general demonstration and educational work, has been carried on in connection with the operations of the mine-rescue cars and mine-rescue stations and has already yielded worthy results. Some new methods have been adopted, and in the first-aid and the rescue methods several thousand miners have been given training that will prove useful to them and to their fellow miners in time of minor accidents or of great mine disasters.

"In connection with such rescue work, some 20 lives have been saved by employes of the Bureau of Mines, and several additional lives have been saved by miners trained by the bureau through the operation of the mine-rescue cars and stations. Meanwhile, the general demonstrations and illustrated lectures given by the employes of the bureau in

connection with the work of the cars have been attended by more than 200,000 miners in different parts of the country, and some 2,000 miners have been granted certificates as fully trained in mine-rescue and first-aid work.

"Another important part of the movement for greater safety in mines to which the bureau has contributed largely is the organization of private mine-rescue stations, equipped and maintained at the coal mines by the larger operators. More than 1,500 sets of artificial breathing apparatus have been purchased and are now in use at such stations, and in addition a half dozen of the larger coal companies have equipped and are operating special mine-rescue cars for use at the groups of mines under their management. One of the states has equipped and is now operating three mine-rescue stations and three mine-rescue cars."

The investigation of certain diseases to which mine workers are more or less subject, especially "miners' asthma," or as the report calls it "miners' consumption," has been undertaken in cooperation with the Public Health Service, and it is hoped that these investigations will lead to immediate improvement in the conditions responsible for the diseases.

Doctor Holmes also shows in a comparative table a marked improvement in the fatalities in American coal mines in the five calendar years ending December 31, 1911. This table shows the figures to be as follows:

PRODUCTION, NUMBER OF MEN EMPLOYED, AND NUMBER OF MEN KILLED IN AND ABOUT THE COAL MINES OF THE UNITED STATES IN THE CALENDAR YEARS 1907 TO 1911, INCLUSIVE*

Year	Production (Short Tons)†	Number Employed‡	Production (Short Tons)†	Number Employed‡	Number Killed			Production Per Death (Short Tons)
					Total	Per 1,000 Employed	Per 1,000,000 Short Tons Mined	
1907	480,363,424	680,492	461,406,000	655,418	3,197	4.88	6.93	144,000
1908	415,842,698	600,438	404,933,000	672,794	2,449	3.64	6.05	165,000
1909	460,814,616	666,555	460,761,000	666,523	2,668	4.00	5.79	173,000
1910	501,596,378	725,030	501,596,000	725,030	2,840	3.92	5.66	177,000
1911	496,221,168	728,348	496,221,000	728,348	2,719	3.73	5.48	183,000
Total	2,354,838,281	3,490,863	2,324,917,000	3,448,113	13,873			
Average	470,967,657	698,173	464,983,000	689,623	2,775	4.02	5.97	168,000

* The figures for production and number of men employed are from "Mineral Resources of the United States," E. W. Parker, U. S. Geological Survey, except for the number of men employed in 1911, which were compiled by the Bureau of Mines.

† These figures represent the total production and the total number of employes in the entire coal-mining industry of the United States.

‡ These figures represent the production and the number of men employed in those states in which records of fatal accidents are in existence. The figures are directly comparable with the number of men killed as given in the fifth column and are those on which the mortality rates given herewith are based. It will be noted that the portion of the industry not represented in the rates for 1907-1909 is extremely small and that in 1910-11 the entire industry is covered.

In another line, the Bureau has been of service to the Government in the preparation of specifications under which the coal used for governmental purposes is purchased. This work has not been of value to the Government only. It has been made available to large purchasers of fuel generally. In regard to the utilization of inferior fuels, the report says:

"The utilization of fuels that have heretofore been considered waste products because of their being low grade and containing an excessively high proportion of ash has been much aided through the Government's investigations in connection with the use of the gas producer for low-grade fuels.

"In its preliminary investigation into the subject of waste of resources in the mining of coal and other mineral products, the bureau has already contributed to an awakening of public interest and an awakening of many of the mine operators of the country to the importance of a thorough examination into this subject. It is hoped that this examination can be made, for it will, if made, point the way toward more efficient and less wasteful methods of mining, handling, and utilizing the more important mineral resources of the country."

Among the features of the work of the Bureau during the fiscal year ended June 30, 1912, Doctor Holmes says: "The investigations conducted by the bureau during the fiscal year, 1912, like those of the preceding year, were devoted chiefly toward the prevention of large coal-mine disasters." Every mine in the United States at which an explosion or fire of any note occurred, was visited by one or more engineers connected with the Bureau, who, in cooperation with or with the approval of the state or mine officials, investigated the cause of the disaster and rendered such aid as was possible.

To facilitate its investigations of mine disasters and to demonstrate the use of mine-rescue apparatus and approved methods of rendering first aid to the injured, the bureau maintains six mine-rescue stations and seven mine-rescue cars in those of the larger coal fields in which mine disasters are most likely to occur. The stations are at Pittsburgh, Pa.; Urbana, Ill.; Knoxville, Tenn.; Seattle, Wash.; McAlester, Okla.; and Birmingham, Ala. The cars were distributed as follows:

Car 1, in the anthracite fields, with headquarters at Wilkes-Barre, Pa.

Car 2, in the coal fields of New Mexico, Colorado, and Utah, with headquarters at Trinidad, Colo., and Salt Lake City, Utah. Car 3, in the coal fields of western Kentucky, Indiana, and Illinois, with headquarters at Evansville, Ind. Car 4, in the coal fields of Wyoming, northern Colorado, and Utah, with headquarters at Rock Springs, Wyo. Car 5, in the coal fields of Montana and Washington, with headquarters at Billings, Mont., and Seattle, Wash. Car 6, in the coal fields of western Pennsylvania and northern West Virginia, with headquarters at Pittsburgh. Car 7, in the coal fields of southern West Virginia, western Virginia, eastern Kentucky, and eastern Tennessee, with headquarters at Huntington, W. Va.

The foregoing brief summary of the report is necessarily abridged to the relation of matters of most general interest to our readers. The complete report, which will shortly be published, contains very much of interest and value.

來 來

Keeping Snow Off the Tracks

Last winter when the thermometer was 12 degrees below zero and 14 inches of snow lay on the ground, it became necessary to make use of a "bullgine" at the mine No. 1 of the Johnston City Coal Co., at Johnston City, Ill. The "bullgine" consisted of two yoke of oxen. The country at the time was so covered with snow that the railroad was hampered and unable to move the cars

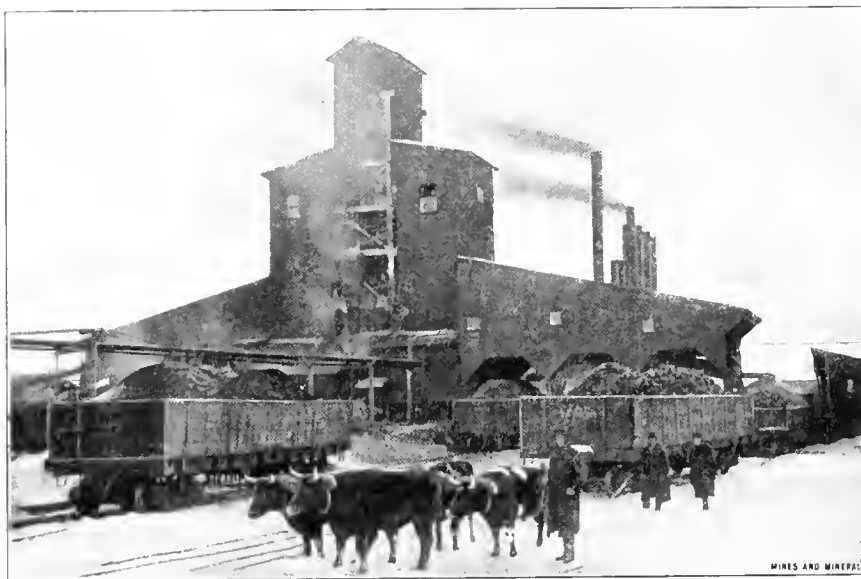

AN ILLINOIS SUBSTITUTE FOR A LOCOMOTIVE

So many miners have desired to receive training in mine-rescue and first-aid methods that the present training facilities are inadequate. By reason of insufficient supplies and equipment, these facilities were not operated during the year at more than 50 per cent. of their maximum possible effectiveness.

Nearly 65,000 persons (mainly miners) visited the safety cars and stations; more than 36,000 miners attended the mine-safety lectures; more than 10,000 miners took partial training in rescue or first-aid work; and about 1,000 certificates were issued to miners showing proficiency in such work. Miners and operators in all coal fields have taken active interest in the demonstration work of the bureau, and many operators have organized and equipped mine-rescue corps at their own mines at their own expense.

about the tippel. So resort was at first had to horses, but they could not do the work. With the oxen it was possible to move the cars and keep up the output of the mine, which amounted to about 3,000 tons a day.

In this connection, the description of a mining wrinkle which is used to keep the tracks at a colliery free from ice, is not out of place. In winter the tracks leading from the loading chutes often get so covered with ice that instead of the cars moving by gravity, power must be used to move them. But if a steam pipe is laid alongside the rail and kept warm with a little steam the track can be kept free from ice and the cars will run as usual. An inch or an inch and a half pipe serves for this purpose. It is fastened to the ties close to the rail, but care is taken that it is in such a position

that the car wheel flanges will not break the pipe, and the pipe should not be fastened so tightly that it cannot expand when the steam is turned into it. Exhaust steam may be used to supply the heat, but live steam is preferable for the reason that the pipe then can be kept warm during the time that the engines are not running, such as at night when the temperature is the lowest. The pipe is laid alongside the rail as far as the empty and loaded cars usually stand on the delivery tracks.

來 來

Blasting Coal on to Pans

Written for Mines and Minerals

A new method of mining coal is being attempted by the D. L. & W. R. R. Co. under the direction of Col. R. A. Phillips, general manager of the Coal Mining Department. This method is to first undercut the coal by machines and then to blow the coal down on to pans or scows which have been placed in the undercut. These pans are then pulled out over the bottom and the coal dumped into the cars.

The method is still more or less in the experimental stage, but enough work has been done so that more machinery has been ordered and the value of the plan is proven.

The mine where this work is being done, is the Storrs No. 1, situated on the city line of Scranton. Fourteen places are now being worked by machines in the Clark seam, which varies from 30 to 50 inches in thickness. The seam is all clean coal so that all of it is sent to the breaker, no cleaning at the face being necessary. It is worked by the room-and-pillar method, as there are overlying seams. The car in use at this mine stands 4 feet 2 inches above the rail, so that it has been necessary, in order to get the car into the chambers, to cut 2 feet or more of bottom rock, the bottom being softer than the roof rock which is hard and strong, though the bottom is often so hard that jumpers must be used for drilling. It is to avoid this lifting of bottom that this method is being tried, for blasting and loading the rock is not only expensive but it causes a loss of production.

The rooms are being driven 27 feet wide, and after the machine undercut is finished, the fine coal is cleaned thoroughly from it with scrapers, and then pans, 6 feet wide by 8 feet long, are inserted into the cut. There are four pans to each cut, which leaves a distance of 1 foot between the pans when they are in

position. The coal breaks easily and is blown down on to these pans, in large pieces.

The first pans were made of sheet iron with a 1-inch round iron frame. At the sides were placed 2-inch angle irons so that one edge pointed upwards. It was found that when the coal was blown down it split along the edge of the pans. The

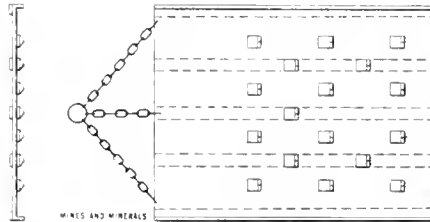

FIG. 1

pans are now made out of quarter-inch boiler plate as shown in Fig. 1. The sides are turned up for 2 inches and the bottom of the pan is strengthened by flat bar iron. Three chains centering in a ring are fastened to the front of the pan and the pan is drawn along by a rope attached to the ring. There are spikes on the inside of the pan bottom to grip the coal in order that when the tractive force is applied, the pans will not be drawn from under the broken coal. A crab locomotive is used to pull the pans. It has been found that it takes a pull of 400 pounds to draw the pan full of coal over the bottom.

The hardest part of getting the cut out is to draw out the first pan. In doing this, attachment is made to the coal as well as to the pan, the

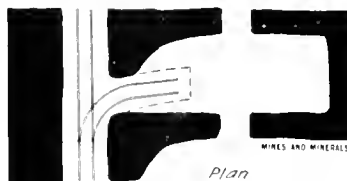
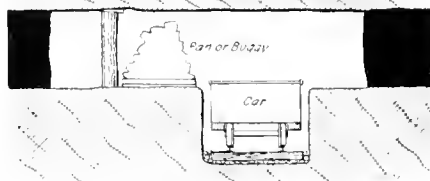

FIG. 2

block of coal being drawn along also. The attachment is made by means of round iron bars 1 or 2 feet long with a link at the end, an inch hole being bored at an angle into the coal and into it the bar is inserted. As soon as one pan is drawn the rest are easily moved.

The bottom rock at the mouth of the rooms is cut so deep that the

edge of the bottom is level with the top of the car as shown in Fig. 2. This is done to facilitate the loading. Attempt is to be made to dump the coal directly from the pans to the car by means of a tipping platform, but this is not a proven success.

By the use of the pans, and under the most favorable circumstances, the cut in a room has been drawn in an hour and a half. It yields twelve cars. Three men, a miner and two laborers, are expected to clean two rooms in a day. In reckoning the number of men employed in getting out the cut, account must be taken of the motormen and rock men as well as the machine men and miners. But 20 men are expected to load about 85 cars per day, the cars having 2½ tons capacity.

When the seam increases in thickness after the room has been started, it will not be possible to get a solid chunk of coal on a pan out of the chamber. In this case buggies are to be used. These buggies stand 2 feet from the rail and are 18 inches deep. The sides fall down so that the coal is easily loaded into the car. The usual style of buggy has one end open and the coal is dumped from it on to the bottom rock or into the bottom cut made for the car and then loaded by hand into the cars. This method has been improved upon by bringing the buggy alongside the car. As the bottom of the buggy is then on a level with the top of the car, it is a simple matter to drop one side of the buggy and tip the buggy, letting the coal fall into the mine car.

Ropes and pulleys are provided to pull the buggies back and forth, that they may not have to be pushed out by hand.

The pans can be used only under the special condition which exists here. The roof is strong, requiring few props; the bottom is so regular that the pan will slide upon it; and the coal is so clean that no sorting is done at the face.

來 來

Coal Trade of Natal

The Natal collieries during 1911 maintained the progress of 1910. The output was 2,394,238 tons of 2,240 pounds each, compared with 2,296,687 tons in 1910. The output of the coal mines was restricted in 1911, as in previous years, by the scarcity of railway rolling stock and native labor. Track improvements are in progress and rolling stock has been added, but it is hard to keep up with the increasing traffic.—*U. S. Consular Report.*

ORE MINING & METALLURGY

Sudbury Nickel-Copper Industry



FOR the past 10 years, the world's chief supply of nickel has come from the Sudbury mining district of Ontario, Can. Previous to this, New Caledonia produced most of the nickel and at present is the only important competitor of Sudbury. New Caledonia produces about one-third of the world's supply of nickel.

Extent of the Deposits—Methods of Mining the Ore, Heap Roasting, and Smelting to Matte

By Reginald E. Hore*

Fortunately recognition about this time, 1890, of the valuable properties of nickel-steel placed the industry on a substantial basis, and the profit from nickel in the Sudbury ores soon became greater than that from the

refined metal a total valuation of \$10,229,623.

The matte value is the one considered in the Canadian reports because the refining is not done there. Of the 36,014,782 pounds of matte produced in 1911, there was exported to the United States 30,679,451 pounds and to Great Britain 5,335,331 pounds. The Cana-



FIG. 1. OPEN PITS, CREIGHTON MINE



FIG. 2. SHAFT HOUSES, CREIGHTON MINE

while Sudbury produces two-thirds. The Sudbury ore deposits were originally worked for copper by the Canadian Copper Co. in 1887. Cars of picked ore were shipped to eastern refiners and the difficulty experienced in treating it for copper, led to the discovery of the nickel. There was no available method of separating this metal from the copper, and a period of experimentation followed. It was finally discovered that repeated melting of the copper-nickel-iron matte, obtained on smelting the ore with an alkaline sulphide, gives a satisfactory separation. It was then necessary to find a market for the large quantity of nickel available.

* Instructor in Michigan College of Mines, Houghton, Mich.

copper. The known ore reserves are very large and there are numerous promising properties which are yet undeveloped. Increased yield in future years is therefore to be expected. Table 1 from the 1911 report of Thomas W. Gibson, Deputy Minister of Mines of Ontario, shows the growth of the industry in recent years.

The values given in this table are not for refined metal, but spot value of matte shipped. The metallic contents of the 32,607 tons of matte shipped in 1911, according to J. McLeish, of the Department of Mines, Canada, were, copper, 17,932,263 pounds and nickel, 34,098,744 pounds. Estimating nickel at 30 cents per pound, Mr. McLeish finds for the

dian Copper Co. and the Mond Nickel Co. produce practically all the matte shipped at present.

The nickel mineral is pentlandite ($FeNi$)S which occurs intimately associated with the sulphides, pyrrhotite and chalcopyrite, at or near the basic margin of a thick laccolithic rock which Dr. A. P. Coleman has described as "a great boat-shaped mass, 36.2 miles long, 16.6 miles wide and 1.25 miles thick." The basic lower and outer portion of this rock mass is a quartz-hypersthene-gabbro, or norite. There are several large deposits of sulphides occurring with the norite in such a way that some geologists believe the sulphides and norite to have been formed from the same magma.* The deposits, which yield about 3 per cent. nickel and 1.5 per cent. copper, occur in thick masses dipping toward the norite, and most of them have been developed from inclined shafts sunk in the foot-wall. From the shaft, levels are driven through the ore to the hanging wall; raises are then put through to the

TABLE I. NICKEL-COPPER PRODUCTION OF ONTARIO, CAN. (IN TONS)

	1906	1907	1908	1909	1910	1911
Ore raised.....	343,814	351,916	409,551	451,892	652,392	612,511
Ore smelted.....	340,059	359,076	360,180	462,336	628,947	610,834
Bessemer matte produced.....	20,364	22,041	21,197	25,845	35,033	32,607
Nickel contents of matte.....	10,776	10,602	9,563	13,141	18,636	17,049
Copper contents of matte.....	5,260	7,003	7,501	7,873	9,630	8,966
Spot value of nickel.....	\$3,839,419	\$2,270,442	\$1,866,059	\$2,790,798	\$4,005,961	
Spot value of copper.....	\$806,413	\$1,020,913	\$1,062,680	\$1,122,219	\$1,374,103	

NOTE.—For discussion of origin see *Mining World*, June 29, 1912.

surface and the ore mined by enlarging the opening from surface downwards, the system being, in mining parlance, "milling." Large open pits are thus formed as shown in the view of the Creighton mine, Fig. 1. When

face the ore is crushed, screened, and sorted on traveling belts, and sent to be heap roasted, an operation preliminary to smelting. Fig. 2 shows the head-frames and rock houses at the Creighton mine and Fig. 3 the

per cent. copper-nickel. There are five blast furnaces 4 feet by 17 feet at the tuyeres and 19 feet high from hearth plate to charging floor.

Recently, for the purpose of treating fine ore and flue dust, two mod-

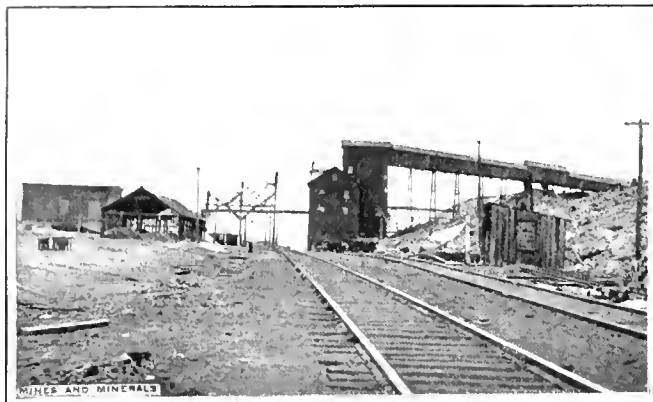

FIG. 3. ROCK HOUSE AND HOIST, COPPER CLIFF MINE



FIG. 4. WOOD PILED FOR HEAP ROASTING

a depth is reached where it is necessary to provide protection for the men, the open-pit work is abandoned; a floor pillar is left and the mining continued by underground methods. In some mines the levels are protected by dry walls and mining carried on by a filling method similar to that of the Baltic copper mine. Conditions are not remarkably favorable for the dry-wall method, however, and ordinary drift sets are now being used in preference. The necessary quantity of waste rock suitable for walling is not broken in mining the ore.

At the Creighton mine, the largest nickel mine in the world, most of the ore has been taken from what is now an enormous open pit. In the pit the ore is being broken in benches by

rock house and hoist at Copper Cliff mine.

The ore is brought to the roasting yard on railroad cars and spread over the cord-wood piles, shown in Fig. 4. Each heap consists of from 1,000 to 2,000 tons of ore. A layer of fine ore is spread on top of the heap to prevent free burning, and then the wood below is fired. The sulphides once ignited furnish the fuel for the partial oxidation of the iron, copper, and nickel, while a part of the sulphur is dissipated as sulphur dioxide SO_2 . It requires about 4 months to roast a pile of 2,000 tons of ore to a product that contains about 12 per cent. sulphur. When this stage is reached the fire is quenched with water and the roasted ore is loaded by steam

ern reverberatory furnaces, shown in Fig. 6, 19 feet wide by 112 feet long, were built and put in operation.

From the stock bins, the roasted ore, quartz, scrap, raw ore, and coke are loaded into charging cars, and hauled to the blast furnaces by electric motors. The charging cars of the side roll-dump type, hold about 3,000 pounds of ore and are drawn in trains of 7 or 8. A common furnace charge is 3 cars of roasted ore, 1 car of raw ore, a few hundred pounds of quartz and enough coke to make from 11 to 12 per cent. by weight. Each furnace produces about 300 tons per day of matte averaging 22 to 23 per cent. copper-nickel. Experience has shown that it is most economical at this plant to produce a low-grade



FIG. 5. HEAP OF ORE ROASTING AT COPPER CLIFF

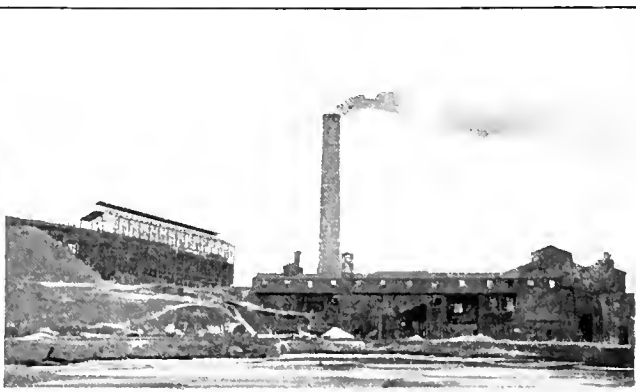

FIG. 6. REVERBERATORY PLANT, COPPER CLIFF

drilling deep vertical holes and blasting with 40-per-cent. dynamite. Much of the ore breaks in large pieces and this is broken again by sand-blasting or by sledges. From the pit floor the broken ore is loaded into cars and trammed through the levels to the shafts in the foot-wall. On the sur-

shovels into railroad cars and hauled to the smelter bins. Fig. 5 shows a heap of ore roasting.

The smelting plant of the Canadian Copper Co. at Copper Cliff, Ontario, produces annually about 7,000 tons copper and 15,000 tons of nickel in the form of a matte containing about 80

matte with consequent cleaner slag. From the forehearths the slag flows into 25-ton pots mounted on standard-gauge trucks and is hauled in trains to the dump. The matte which accumulates in the settlers or forehearths is tapped into 7-ton steel-plate ladles which are placed on

trucks by a crane and hauled to the converter building.

Until recently there were ten stands of acid-lined converters in use, but during the past 2 years these have been replaced by five stands of basic-lined converters.

In the mattes treated, there is about 2 pounds of iron, to each pound of copper-nickel; and to oxidize this iron, 3,000 cubic feet of air per minute is blown through the molten material. To supply silica with which the iron oxide unites to form slag, quartz or other silicious material is dumped on top of the matte in the converter as required. It is stated that while the acid-lined converters required relining after bessemerizing 6 or 7 tons of matte, the basic-lined converters make from 3,000 to 4,000 tons before relining is necessary.

Starting with a charge of about 60 tons of furnace matte and 10 tons of quartz the blast is turned on for about 40 minutes. The converter is then turned down to skin the slag and more furnace matte and quartz are added. This process is repeated until about 70 tons of Bessemer matte containing about 80 per cent. nickel-copper is obtained. It is then poured into molds. The bessemerized matte is not refined in Canada, as the necessary raw materials are not cheaply assembled at Copper Cliff. The process of refining is to melt the matte with an alkaline sulphide and repeatedly remelt the nickel "bottom" thus obtained, with more alkaline sulphide. A comparatively clean separation is thus obtained. The refining is done at Constable Hook, N. J., where salt cake, oil, coal, and chemicals are readily obtained.

While the product of the Sudbury mines comes into the market chiefly in the form of metallic nickel and copper, another product seems likely to prove of great importance. This is the alloy of copper and nickel known as Monel metal, which contains the metals in nearly the same proportion as does the bessemerized matte, viz., copper from 28 to 30 per cent.; nickel from 70 to 60 per cent., and iron 2 per cent. and more. Monel metal besides being less costly than nickel has high tensile strength and non-corrosive properties, and can take its place in many cases. It has been used for numerous purposes such as propellers for war vessels, roofs for large buildings, steam turbine parts, motor-boat shafts, and as ropes for mine hoists and cableways. Constantan, an alloy composed of 60 per cent. copper and 40 per cent. nickel is said to be unaffected by changes in temperature.

Automatic Sand Sluicer

The principle involved in the reaction wheel has long been in use as a means of evenly distributing sand in cyanide tanks, but it remained for Edwin L. Oliver, of San Francisco, to make use of practically the same device for sluicing sand out of the tank after leaching was completed. In Fig. 1 is shown the reaction wheel

the balance being treated by the cyanide process. The tailing from the cyanide treatment contained 24 cents in gold.

The apparatus will sluice out a 25-foot diameter tank, 8 feet deep, holding 120 tons of sand in from 1 to 1½ hours without any attention, using for the purpose from 1 to 1½ tons of water per ton of sand. The

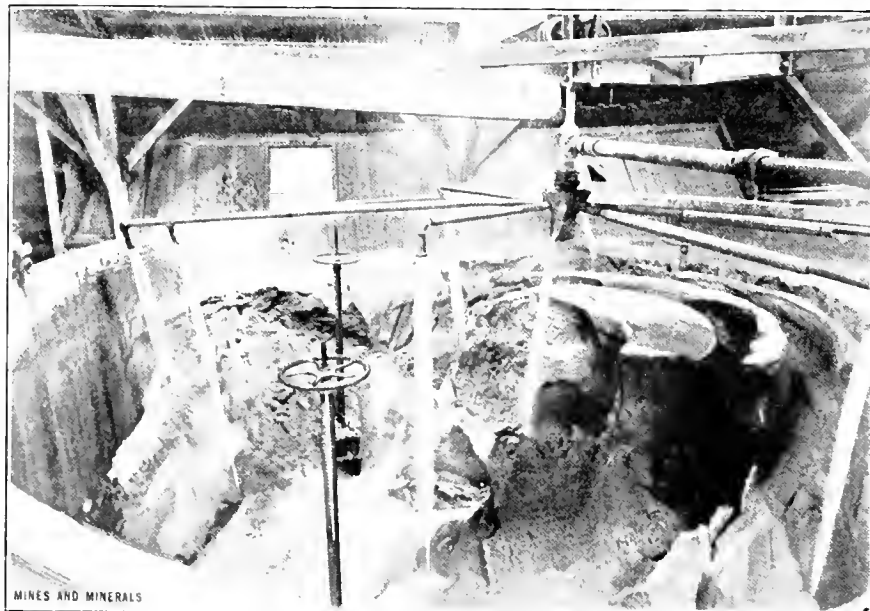

FIG. 1. AUTOMATIC SLUICER FOR SAND TANKS

suspended from a crawl. After cleaning sand out of one tank the sluicer may be readily removed to another. The large horizontal pipe which carries water to the wheel is pivoted so it can be revolved and the sluicer placed over another tank opposite; or it can be readily uncoupled and the sluicer moved to the next tank in the row. The excellent illustration shows the valve stems and hand wheels for raising the discharge valves in the bottom of the tank through which the sand flows out into launders. It also shows the straight walls cut in the sand by streams of water issuing from the wheel, a feature which indicates that the sand is free from slime, as it should be, and which is one of the reasons why such excellent recovery is accomplished at the North Star mill in Grass Valley, Cal.

At this mill the average recovery has for several years been between 92 and 94 per cent. of the assay value of slime and sand, while the total recovery from the ore has averaged slightly better than 98 per cent. The value of the ore, going to the mill, in 1911 was \$10.75 per ton. By means of stamp-mill amalgamation 70 per cent. of this gold was recovered.

apparatus has been used successfully at the North Star mill; at the Trinity cyanide mill at Carrville, Cal., and also at the Empire mill in Grass Valley. This new wrinkle in sand sluicing will be appreciated by those who have been using hose and nozzle, revolving scrapers, and shovels for cleaning sand out of the tanks.

采 采

A Blow-Pipe Bead Without Platinum Wire

Since the price of platinum wire has doubled during the past year, the following method of forming beads in blow-pipe analysis will prove interesting.

To obtain a borax bead without the aid of a platinum wire, heat one end of a glass rod in an alcohol flame and then dip into a mixture consisting of two parts by weight of powdered borax and one part of litharge. The end of the rod is then heated again, whereby an easily fusible bead of lead borate is formed. This is cooled off slightly, dipped into the substance to be examined, heated again, and after thorough fusion cooled off. The bead will then show the characteristic color.

Kansas and Oklahoma Gas Fields

Conditions Affecting the Gas Supply—Description of Compressor Plants for Transporting Gas in Pipes

By Lucius L. Wittich

IN an effort to supply cities and towns in Missouri, Kansas, and Oklahoma with a sufficient quantity of natural gas to meet their requirements, the Kansas Natural Gas Co. and the Quapaw Gas Co. are extending their lines into new districts in Oklahoma and many new wells are being opened; yet even with these additions the production is on the wane and it is only a question of a few years, according to geologists and experts on natural gas, before the stores of natural gas will have been so seriously depleted that only the communities in the immediate gas zone can continue to draw their supply from this fuel. At present, pipe lines extend as far north as

business men took advantage of this opportunity to inspect the fields and a tour of investigation was made late in the fall. The party was made up of representatives of the Joplin Commercial Club, the East Joplin Business Men's Club, the South Joplin Booster Club, the Villa Heights Commercial Club, several bankers and other business men and the writer, representing MINES AND MINERALS. From Joplin they went by rail to Cherryvale, Kans., one of the first cities in the gas belt. This place is on the extreme eastern

Gas Co., a distributing concern which procures its supply from the Kansas Natural, and B. J. Crahan, general manager of the Joplin Gas Co., also were members of the party and explained many interesting and instructive details of the development.

At the central offices of the Kansas Natural Gas Co., at Independence, visitors were shown a large roller map, giving the location of all wells and pipe lines and other points of interest in connection with the procuring of natural gas, and Mr. MacBeth pointed out the proposed automobile route to be followed. He showed the location of the 673 active wells of his company, 235 of which are located in the Independence field. It was also explained that an open-air pressure of say 400 pounds meant a pressure of about 40 to 80 pounds when turned into a pipe line. The greatest number of new wells, it was pointed out, are of about 5,000,000 to 10,000,000 cubic feet flow daily and are located in the Osage Nation, Wilson County, Kans., which formerly produced 130,000,000 cubic feet daily, is now turning out barely 8,000,000 cubic feet. A great many wells are still flowing in this field, but their volume is greatly reduced. This field lies to the north of the Independence field and formerly was an important factor in the gas production. The gas from this field passes through the compressor station at Petrolia, Kans. Formerly a large compressor station was located at Scipio, Kans., but this was only a substation, handling gas that came from the Grabham station in the Independence field and aiding in pumping it on to Kansas City. This plant has been removed to the Hogshooter district at a heavy expense. Therefore, all of the gas with the exception of the 8,000,000 cubic feet that passes through the Petrolia station, goes through the Grabham station, which, in turn will likewise handle all of the new supply from the Oklahoma fields which will be pumped through from the Hogshooter station.

The first stop was at the Grabham station, 6 miles south of Independence, where \$10,000 is yet to be spent in improvements in order that the plant may be better fitted to handle the greater volume of gas. The fact that the Kansas Natural Gas Co. went into the hands of receivers recently necessitated the procuring of a court order before the necessary



FIG. 1. GRABHAM GAS COMPRESSING STATION

Kansas City and St. Joseph, Mo., and Topeka, Kans.; the Quapaw is a new company and produces a comparatively small volume of gas. The Kansas Natural Gas Co., the pioneer company in the field, is now producing less than 70,000,000 cubic feet of gas daily, compared with 150,000,000 cubic feet a few years ago. The company believes the extension of pipe lines and the construction of a large compressor station, in what is known as the Hogshooter district in Oklahoma, will add 30,000,000 cubic feet daily, thus bringing the total to about 100,000,000 cubic feet. The greatest estimate placed on the future production is 108,000,000 cubic feet, or 42,000,000 cubic feet less than the maximum of a few years ago.

In order that consumers might know the true conditions, the Kansas Natural Gas Co. has requested commercial organizations in the various communities using natural gas to visit the sources of supply. Joplin

boundary of the gas fields and procures its supply from the Iola-Portland Pipe Line Co., a small company furnishing gas to several cities and towns in the immediate vicinity. The chief source of supply comes from fields 40 miles distant although some gas is found not far from Cherryvale, Kans.

From Cherryvale to Independence, Kans., the trip was made by trolley, and from Independence to Tulsa, Okla., a distance of 175 miles, the trip was made by automobile, the visitors stopping at Bartlesville, Okla., the first night out. In this trip the main compressor station in the Independence field, the newly constructed compressor station in the Hogshooter field, compressor stations of other gas companies, and innumerable wells were visited. A. B. MacBeth, of Independence, general manager of Kansas Natural Gas Co., being present to explain all details. J. T. Lynn, of Detroit, president of the Joplin

funds could be appropriated for the construction of the needed improvements. The court granted the company the right to proceed with its work. The cost will be divided as follows:

	Total Cost	Already Expended
Hogshooter station	\$115,000	\$88,000
Hogshooter intake	56,000	33,000
Collinsville extension	68,000	4,500
Tulsa extension	63,000	160

Fig. 1, a view of the Grabham station, shows what the officials of the company claim to be the largest natural gas compressor station in the world. For this and other photographs in this article the writer is indebted to W. Moeller, Jr., engineer of the company and in charge of construction.

The plant is equipped with nine twin compressors, six of which have

purpose, and in order that the water may not become heated from constant contact with the hot pipes, a spray system has been installed, the water being kept in constant circulation, while it passes continuously through spraying devices and is sent high into the air and thus cooled. Only the gas that goes to Kansas City, Topeka, and points in northern Kansas and Missouri passes through the Petrolia station. Joplin and many other cities and towns in eastern Kansas and western Missouri get their supply directly from the Grabham station.

One mile southeast of the Grabham station the visitors stopped at a well which Mr. MacBeth stated had a flow of 26,000 000 cubic feet daily 3 years ago when it was brought in. It also had a rock pressure of 350 pounds. He opened the cap and tested the volume and the pressure,

was deliberately withholding much of its gas supply in order to make it appear that the volume is decreasing, but the company maintains that the capped wells have been almost exhausted, and are being held in reserve in the hope that the pressure and the volume may increase. In connection with this, Erasmus Haworth, geologist of the state of Kansas, says it is possible for wells to recuperate. "The real explanation of the gradual decrease of the pressure," he observes in his Report on Kansas Oil and Gas, "may be the movement of water within the sandrock. Suppose we have a well drilled into a gas bubble in the sandrock, which bubble is entirely surrounded by water on all its borders; should the well be used lavishly gas would travel from different places in the pool to the foot of the well and escape more rapidly than the water



FIG. 2. HOGSHOOTER GAS COMPRESSING STATION

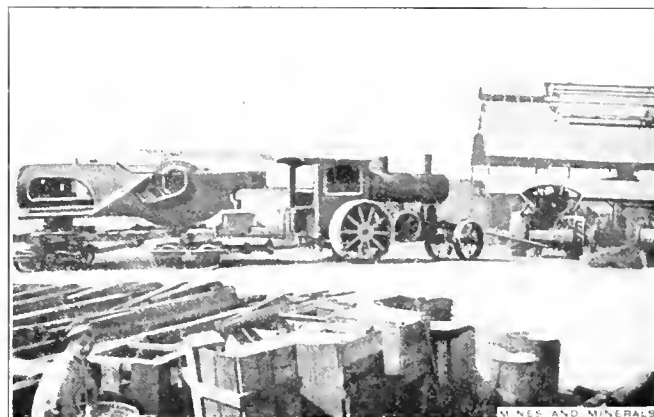

FIG. 3. HAULING GAS ENGINE FRAMES

a horsepower of 1,100 each, while the remaining three have 1,350 horsepower each, making a total of 10,650 horsepower daily. The gas comes into the compressor station through two 16-inch mains, the average pressure for one being 35 pounds, for the other 25 pounds. The capacity of the compressor is greatly increased when the intake pressure is greater, but the rock pressure of the Kansas and Oklahoma fields is much less than that of the Eastern States where the rock in which the gas occurs is much harder and where the pressure is higher, retaining its strength for years after the average Kansas or Oklahoma well is exhausted. The outgoing pressure from the Grabham station ranges between 190 and 200 pounds. The compression of the gas causes great heat and it is necessary to run the gas in pipes through water in order to cool it before permitting it to pass into the distributing mains. Two large reservoirs have been constructed for this

showing that the former has dropped to 55 pounds. He said this was true of virtually all of the remaining 234 wells in the immediate Independence field. As the country is open prairie slightly rolling, the visitors were enabled to see to great distances in all directions. Many wells were visible. Another well, 6 miles southeast of Grabham, was visited. At this point both oil and gas are encountered in different wells, the former being sold to the Prairie Oil and Gas Co. The cap was removed from this well, which had a flow of 8,500,000 cubic feet and a pressure of 400 pounds. It was recently brought in and is considered one of the best in the field. When the cap was removed the noise of the escaping gas was deafening. It was stated that a few years would see this well's capacity materially reduced.

Many wells that had been capped were noted along the route. Residents of the immediate districts were inclined to believe that the company

could close in on the ever-decreasing bubble of gas, and in this way the gas pressure would be gradually decreased as the well became exhausted. If, however, the well should be closed for a period of weeks or months we would expect it to regain its pressure and ultimately reach the normal pressure when the well was first drilled."

The wells southeast of Grabham station feed into 10-inch mains which in turn feed into the 16-inch mains that lead to the compressor station. From this field an 18-inch line leads southward into Oklahoma.

A new field known as the California field is being opened in the northern part of Oklahoma. This district lies 12 miles south of the city of Coffeyville, Kans., which is within a mile of the state line. In this immediate district 36 wells are pouring their output into the 18-inch main that leads northward. The field, when at its maximum capacity a year ago, was producing about

4,000,000 cubic feet to the well daily. This volume has been decreased to an average of less than 1,000,000 cubic feet to the well. A small 600-horsepower compressor was recently removed from the Chanute, Kans., field and is now in operation at a point 5 miles north of the California field.

One mile west of the first well visited in the California field the visitors stopped at a well which had been drilled for gas, but which had encountered oil. Pipe lines had been connected with the mains of the Prairie Oil and Gas Co., and the output, which is small, is sold for 70 cents a barrel.

The Kansas Natural Gas Co. owns a comparatively small acreage, save where it has compressor stations. Prospecting for gas is common among the landowners of the district, and when they bring in a gasser they find no trouble in marketing their production at the rate of 3 cents per 1,000 cubic feet. The same company, likewise, procures leases from landowners and does its own drilling, the customary rate being \$50 a year for a producing well brought in through this method, regardless of the volume or pressure. Conditions of course vary, the price paid for gas in some fields being only 2½ cents while in other regions as high as 3½ cents is paid. It is seldom necessary to shoot the wells, save where the pressure at the start is very weak. A nitroglycerine "go devil" is then utilized. It is necessary to shoot the oil wells more often than the gas in bringing in a producer.

Toward dusk of the first day of the tour the visitors passed through a region where countless scores of flambeau lights were blazing on every side, and as night came on the glare of the torches became more and more in evidence. Many of these burn day and night. Many residents of the outlying districts depend on the torches for the lighting of their houses, one or two big jets of flame, stationed near the dwelling, making the premises almost as light as day and making it unnecessary to have gas burners on the inside. Where prospecting rigs are at work two or three flambeaux are stationed, and it is seldom, indeed, that any effort is made to shut them off through the day. The waste of gas in this manner is undoubtedly heavy. The glare of these torches was to be seen in every direction until the tourists finally pulled into Bartlesville, Okla., for the night.

The Hogshooter district, 14 miles southeast of Bartlesville, was the

first region visited on the following day. Work on construction of the big compressor station was advancing rapidly. Fig. 2 shows the progress that had been made at that time. Six twin compressors will be operated in this station. Formerly the plant was operated at Scipio, Kans., north of Petrolia. With the aid of the Scipio plant the Grabham station could have pumped 92,000,000 cubic feet daily; as the gas supply decreased the Grabham plant found it possible to handle, unaided, at least 70,000,000 cubic feet; hence the northern compressor station was removed to the Hogshooter area to

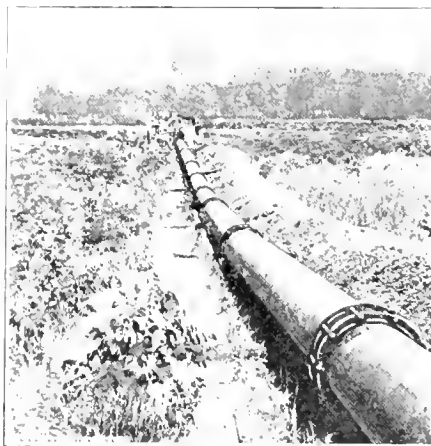

FIG. 4. MAIN GAS PIPE LINE, HOGSHOOTER FIELD

the south. The rebuilt station will handle gas from the Collinsville, Owasso, and Tulsa fields. In the Hogshooter field there are now about 100 wells; formerly there were 125 and the pressure and volume were much greater than at present. The gas is encountered in sandrock at a depth of 1,200 feet. The average rock pressure is 125 pounds. Toward the south the pressure increases, being 150 pounds at Collinsville, 480 pounds at Owasso, and 600 pounds at Tulsa. The natural flow took the gas to the Grabham station before the Hogshooter plant was built. About 20,000,000 cubic feet daily went from this field before the building of the new compressor station. The flow will be more than doubled by the new station.

The cost of moving the compressor station from Scipio will aggregate more than \$50,000. Powerful traction engines were employed to haul heavy pieces of machinery from the nearest railroad point, the Dewey, Okla., spur, 11 miles distant to the Hogshooter field. In order to get stone necessary in the construction of this plant the company operated its own stone quarry, a suitable formation being found near the site of the

station. To move each of the main frames of the big gas engines, three traction engines were employed. The weight of each frame is 40 tons, Fig. 3 showing one of these enormous pieces of machinery being brought to the station. In all, 150 freight cars were filled with machinery. In moving the equipment from the Dewey spur, 50 teams, wagons, and drivers were employed in addition to the traction engines.

In order to make the capacity of the transporting system greater, parallel pipe lines are laid for some distance south of the Hogshooter station for a distance of about 12 miles, from which point only one main extends into the new fields (Fig. 4). The intake at the Hogshooter station is 16 inches in diameter. An 18-inch line extends some distance south, connecting with the two 16-inch mains.

The houses of the workmen at the Hogshooter station are substantially constructed of corrugated metal and cement. A small army of laborers is employed, and every reasonable care is taken to see that sanitary conditions are good.

The visitors went from the Hogshooter station to the new compressor plant of the Quapaw Gas Co., 1 mile to the north. Steam instead of gas engines are used to generate power at this plant, gas, of course, being used for fuel. The company is experiencing difficulty in procuring enough gas from the immediate vicinity to keep the plant running at full capacity. There are two steam compressors of 750 horsepower each, the capacity of the plant being 20,000,000 cubic feet daily when the intake pressure is 100 pounds or better.

Returning via the Hogshooter station the trip was continued southward. The plant of the Henry Oil and Gas Co. was passed some distance to the south. This is a small concern that supplies gas to the Bartlesville smelters. Scattered throughout the gas belt are a number of other similar plants supplying gas to the smelters at low rates. Gradually, however, the supply is being exhausted and the smelters are returning to the use of coal for fuel.

Further to the south the new Owasso field was reached and here the cap was removed from a well that had just been brought in and which was considered an exceptionally heavy producer. A test showed the pressure to be close to 500 pounds and the volume 10,500,000 cubic feet daily. Gas was encountered at a depth of 1,171 feet and the boring was continued to a depth of 1,185 feet. This well was

16 miles north of Tulsa, and throughout the remainder of the trip wells in the newly developed region were plentiful. To the south of the Arkansas River new fields are being opened, but these are so remotely located from the pipe lines of the Kansas Natural Gas Co., that for the present at least no effort will be made to extend lines into those districts.

Natural gas was first used commercially in Kansas in 1873. Prior to that time prospect drilling had been carried on for a number of years, the first systematic efforts dating back to 1870. Iola, Kans., was the first town to get natural gas for lighting, and it was found within 737 feet of the surface. Iola continues to have natural gas from wells near the city although the supply is limited. Paola, Kans., got gas as early as 1882 and it was found as near the surface as 300 feet.

The real development of the Kansas gas fields did not begin until about 1890, Neodesha being the first city to get its supply from the big fields of southern Kansas. Coffeyville was among the first cities to make use of natural gas from the southern Kansas fields.

In the vicinity of Muskogee, Okla., a few wells have been sunk into the Mississippian limestones and some gas and oil procured, but with these exceptions virtually all the oil and gas is confined to the coal measures, or Pennsylvanian series, overlying the Mississippian, judging from development in the Midcontinental field. Of all the horizons of the coal measures the most productive is that formed of the Cherokee shales, occurring at an average depth of 1,000 to 1,200 feet beneath the surface. Within the shales occur the sandstones, of much less lateral extent than the shales themselves. The sandstones grade into the shales in all directions, and it is from the sandstone that the bulk of the gas is procured, although gas is obtained in some instances from holes drilled into shales that showed no hint of sandrock, while, in some cases, near Bartlesville and other points in Oklahoma more noticeably than in Kansas, gas is in some places found in limestone.

As a rule the gas from both Kansas and Oklahoma is high in fuel value, although an occasional well produces a gas that is low in combustible constituents.

A wide difference is noted in the gas from different portions of the two states, but it is indicated that the variation in composition follows some regular order, related presumably to the geological structure.

Platinum and Allied Metals*

The production of platinum in the United States is increasing owing to the high prices paid for the metal. The production reported in 1911 was 628 troy ounces, an increase of 238 ounces compared with the output of 1910.

The entire output of crude platinum in the United States is recovered from placer mines in Oregon and California, which also produce gold. Of the California product, 488 ounces were recovered as a by-product in dredging operations in Butte, Yuba, Sacramento, and Calaveras counties, 205 ounces being derived from Butte County and saved in the dredging of gold-bearing gravels at Oroville. Smaller quantities were recovered from placer operations of various kinds in Calaveras, Del Norte, Humboldt, Placer, Siskiyou, and Trinity counties.

In Oregon the quantity recovered in 1911 was 117 ounces, having a reported value of \$3,265. The ocean beaches in Coos and Curry counties yielded 50 ounces. The remainder came mainly from placer mines in Josephine County, near Kerby.

The production of refined platinum from crude metal derived from placers is calculated on the basis of a content of fine metal of 70 per cent. and, thus computed, 440 fine ounces is found to have been the output from domestic placers in 1911.

In 1911 crude platinum sand was imported into the United States to the amount of 34,412 ounces. Assuming a content of fine platinum of 80 per cent. we arrive at the approximate figure of 27,500 ounces of refined platinum produced in the United States in domestic refineries from foreign sands.

In calculating the production from bullion there is some difficulty because of some refineries like that of the United States Mint, the output of which is in large part derived from secondary sources—that is, from scrap platinum and from sweepings, etc., bought from jewelers and dentists. During 1910 private refineries also began the separation of platinum metals from gold bullion.

According to the best estimate that can be made, domestic refineries produced in 1911 about 1,200 fine ounces of platinum from bullion. It is not possible to differentiate between that derived from domestic

and that from foreign ores. Probably not more than 500 ounces were obtained from bullion derived from domestic mines.

In conclusion, the total quantity of refined platinum produced in domestic refineries would be approximately 29,140 fine ounces, of which only about 940 ounces, valued at \$40,890, were derived from domestic sources of various kinds. The corresponding estimate in 1910 was 773 ounces, valued at \$25,277.

Most of the platinum recovered from mines is contained in the gold and copper bullion only in small quantities, and consequently it is in still smaller quantities in the original ores, which can therefore not be considered as platinum ores. During 1911 a shipment of material which may properly be classed as a copper-platinum-palladium ore was made from the New Rambler mine, in Wyoming. The quantity recovered was not large compared to the total production of refined platinum given above, but nevertheless the shipment constitutes a notable event.

The New Rambler mine is in the Medicine Bow Range about 32 miles west of Laramie. The deposit, which mainly contains oxidized copper ores and secondary covellite, is in dioritic rock of pre-Cambrian age. H. L. Wells and S. L. Penfield found sperrylite (arsenide of platinum) crystals in this ore in association with covellite and pyrite. The occurrence of platinum in the ore was first announced by Prof. Wilbur C. Knight. It is reported that the rich ores and concentrates shipped contained about .5 ounce of platinum and 1 ounce of palladium per ton. A secondary concentration of the platinum metals has doubtless been effected during the oxidation of the deposits. A specimen of covellite from the Rambler mine assayed 1.8 ounces per ton of platinum and 1.1 ounces of gold. A small quantity of palladium was also noticed in this sample. The gold is principally in the free state, but these metallic particles contain no platinum. Low-grade ore from the mine was found to contain .25 ounce of platinum and .03 ounce of gold, besides a trace of palladium.

The owners of the New Rambler mine have built an experimental mill with the capacity of 150 tons per day, and are experimenting on the problem of the utilization of the lower grade ores.

A platinum deposit discovered some years ago in southern Nevada east of Moapa consists of a dike of peridotite which contains copper

*Abstracted from advance chapters from "Mineral Resources of the United States."

minerals and carries a little platinum, as described in "Mineral Resources" for 1908.

The strong demand for platinum and the remarkable rise in quotations which began in 1910 continued throughout 1911. The year began with refined platinum quoted at about \$29 per ounce. There was an almost uninterrupted increase in price until November and December, during which months the price had risen to \$46 per ounce. At the end of December \$48.50 was paid. The demand abated somewhat in the first months of 1912.

The apparent consumption is measured by the approximate production of refined metal in the United States, which was about 29,140 fine ounces, added to the imports of bars, manufactured metal, and manufactured products, amounting to approximately 91,600 fine ounces. The total apparent consumption was, therefore, 120,740 fine ounces, which is about one-half of the world's production of refined platinum. This estimate takes no account of the secondary platinum recovered from scrap.

THE PLATINUM METALS*

Six closely related metals are usually referred to as the "platinum group." They are platinum, iridium, osmium, ruthenium, rhodium, and palladium. According to their atomic weights, they fall into two groups, the first including ruthenium (101.7), rhodium (103), and palladium (107); the second group including osmium (191), iridium (193.1), and platinum (194.9). The atomic weight of gold (197.2) is close to that of platinum. In specific gravity the purified metals range as follows: Osmium, 22.48; iridium, 22.42; platinum, 21.48; ruthenium, 12.26; rhodium, 12.1; palladium, 11.4.

In fusibility the order is as follows: Osmium is the most refractory of the metals, melting considerably above 2,000° C.; ruthenium, iridium, and rhodium follow in order; the fusion point of iridium is from 2,150° to 2,250° C. At 1,100° C., iridium begins to oxidize to a purple oxide. The melting-point of platinum is 1,779° C. Palladium is the most fusible and melts at about 1,549° C., or at about the same temperature as wrought iron.

Platinum.—The mineral called platinum is really an alloy of platinum, iridium, rhodium, palladium, and

often osmium, with varying amounts of iron, copper, and gold. It is usually found as small nuggets, scales, and rounded or irregular grains; its color is steel gray. The specific gravity of the crude platinum varies from 14 to 19. The percentage of platinum varies also within wide limits, but is generally from 70 to 85 per cent. The native platinum may be strongly magnetic or comparatively inert. The metal platinum is of grayish white color and is hard, malleable, and ductile.

Iridium.—Iridium is generally present in crude platinum sand in alloy with osmium, as iridosmine, or more rarely in alloy with platinum as native metal. In its manufacture from crude platinum it is obtained as a sponge, which is then melted with the addition of a little phosphorus. Melted iridium is a brilliant white, brittle metal. Owing to its hardness, which is 6.7 Mohs scale, it is used for pointing gold pens. The price varies and at this writing is quoted at \$68 per ounce in New York City.

Osmium.—Osmium occurs generally as an alloy with iridium, in which the other metals of the group are very subordinate. The mineral called iridosmine forms hexagonal crystals or flattened grains and has a white color considerably lighter than that of platinum. It contains from 40 to 77 per cent. iridium and from 20 to 50 per cent. osmium.

The metal in refined state is bluish gray, hard, and brittle and oxidizes rather easily.

Palladium.—Palladium is a white metal, intermediate in color between platinum and silver. Its hardness is about equal to that of platinum. It is malleable, ductile, and sectile, and dissolves easily in nitric acid. Palladium is present in almost all varieties of crude platinum, but the analyses rarely show more than 2 per cent. In larger quantities it is present in some copper ores, but its state of combination is in doubt. Probably it is combined with arsenic, like sperrylite.

Rhodium.—Rhodium is a white metal of the color of aluminum. It is ductile and malleable at red heat. The metal occurs in crude platinum in quantities up to 4 per cent. Like palladium, it probably occurs in combination with arsenic in certain copper ores.

Ruthenium.—Ruthenium is a white, hard, and brittle metal, which is scarcely attacked by aqua regia. Like osmium, it oxidizes rather easily in the air. It is found to small extent in crude platinum, but

mainly occurs to the extent of a small percentage in the mineral iridosmine.

Other Platinum Minerals.—Very few platinum minerals are known beyond those already mentioned. Sperrylite or arsenide of platinum ($PtAs_2$), with a little antimony and rhodium, occurs as small crystals of an isometric form and tin-white color in certain copper and nickel ores—for instance, at Sudbury, Ontario, and at the New Rambler mine, Wyoming. The minute crystals are embedded in pyrrhotite or covellite.

Laurite is an extremely rare sulphide of ruthenium with a minor amount of osmium. It is known only from the platinum washings of Borneo.

Palladium in quantities up to 10 per cent. also occurs in combination with gold. This mineral, called porpezite, has been described from Brazil, where it occurs in gold-bearing veins.

Platinum has been found in some varieties of tetrahedrite and bournonite. In minute quantities it occurs in some quartz veins, mainly of the so-called "high-temperature class," for instance, in northern Finland and in the gold-bearing veins of Beresowsk, Russia. Occasionally platinum is found in clay shales and in coal ashes, but so far not in recoverable quantities. Platinum is present in some meteorites and in the sun.

來 來

Determining Platinum

Small quantities of platinum pass into the nitric acid solution obtained in the regular course of assaying on parting gold from silver. To this solution a limited quantity of a very diluted solution of hydrogen sulphide (1 part of the strong solution diluted with from 10 to 20 parts of water), sufficient to precipitate the platinum and three to five times as much silver, is added, and after standing for 3 or 4 hours, or preferably over night, the precipitate is collected and dried, the paper burnt off, and the residue wrapped in a piece of thin lead foil and cupelled. The resulting bead is parted in strong sulphuric acid, leaving the platinum usually in the form of sponge, which is washed, annealed, and weighed. The same method of concentrating in a precipitate of silver sulphide may be used for the determination of minute quantities of gold in high-grade silver. (F. P. Dewey, *J. Ind. Eng. Chem.*, 1912, 4, 257-S, *Journal of the Society of Chemical Industry*, Vol. 31, 437.)

* The following paragraphs are in part taken from Kemp, J. F., "Geological Relations and Distribution of Platinum and Associated Metals"; Bull. U.S. Geol. Survey, No. 193, 1902.

THE Goldfield Consolidated mill treats daily 850 tons of complex sulphoteluride ore having the average value of \$40 per ton, principally gold. After being delivered to the mill bins the ore is stamped in water to a four-mesh battery screen (.18 inch opening), the 100 stamps weighing 1,050 pounds each, the

Practical Cyaniding—(Concluded)

Descriptions of Practice at Some Large Cyanide Mills in the United States and Mexico

By John Randall*

steel consumed per ton of ore milled is .32 pound. The product of the Chilean mills joins the product of the tube mills and passes to cones and spitzkasten where a large amount of the

water to one part of ore by weight and is sent to 76 Deister No. 3 slime tables. The concentrate recovered on these tables amounts to 5½ per cent. of the ore by weight and contains 72 per cent. of the gold. The concentrate is then sent over amalgamating plates where 20 per cent. of the gold is recovered by amalga-

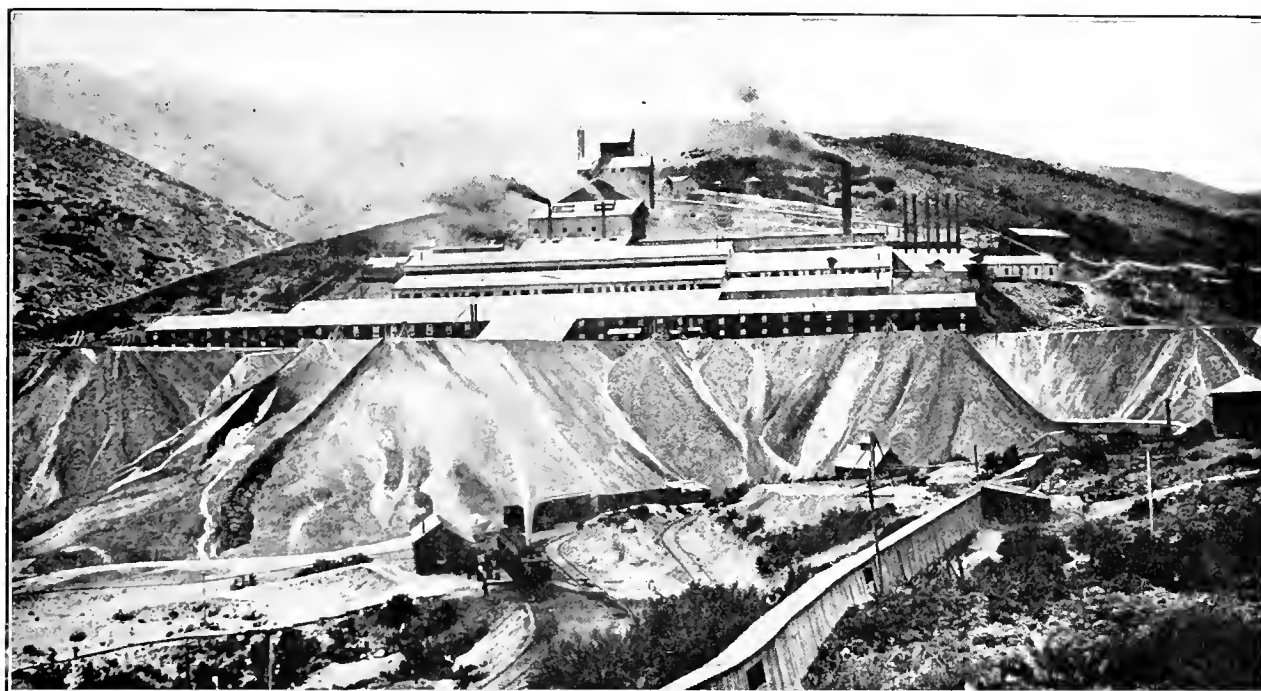

GOLDEN GATE MILL, MERCUR

stamp duty being 8½ tons. The battery product sizes as shown in Table 1.

TABLE 1

Mesh	Per Cent.
+ 10	15
- 10+ 30	34
- 30+ 50	10
- 50+ 80	10
- 80+100	3
-100+150	3
-150+200	4
-200	20
Loss in sizing	1
	100

The material is next classified in two 7-foot spitzkasten, each taking the product of 50 stamps. The overflow from the spitzkasten goes to the concentrating department. The underflow goes to six 6-foot Chilean mills crushing to a 16-mesh screen. The product of these mills sizes as shown in Table 2.

The Chilean mills are of the L. C. Trent make and use Midvale forged steel for roller shells and dies. The

water and a portion of the slime are separated in the overflow which goes

TABLE 2

Mesh	Per Cent.
+ 10	trace
- 10+ 30	4
- 30+ 50	10
- 50+ 80	16
- 80+100	9
-100+150	6
-150+200	6
-200	48
Loss	1
	100

to the concentrating department. The coarse underflow goes to six Dorr classifiers, the sand product from which is fed to six tube mills, the tube mill product being returned to the classifiers in the usual manner. The slime product from the Dorr classifiers goes to the concentrating department. The final product of the grinding and crushing machinery as it reaches the concentration floor sizes as in Table 3. At the concentrator floor the pulp is dewatered in cones until it contains three to three and one-half parts of

solution with mercury. The plate tailing is afterwards treated with cyanide

TABLE 3

Mesh	Per Cent.
+ 80	.4
- 80+100	2.2
-100+150	8.1
-150+300	9.2
-200	79.1
Loss	1.0
	100.0

solution in a separate department of the mill and receives different treatment from the concentrator tailing which is also treated by cyanide.

The tailing from the concentrators is dewatered in 29½-foot settlers to 40 per cent. moisture, milk of lime being added in the settlers. The pulp is next sent to a battery of ten Pachuca tanks operating in series, where it receives treatment with cyanide solution for the first time. These tanks are 15 feet in diameter by 45 feet in height. The solution has a strength of 1.2 pounds KCN per ton and protective alkalinity equivalent

* Boulder, Colo. Part 1 appeared in August, 1912, MINES AND MINERALS.

to .5 pound CaO . A small amount of lead acetate is fed into the Pachuca tanks. The pulp then passes to storage tanks equipped with mechanical stirrers to keep the coarser particles in suspension and thence goes to a Butters filter plant of 336 leaves. In the operation of the filter the pulp flows to the filter tanks by gravity through 16-inch pipe lines and the excess pulp flows to a sump in the same manner, thus considerably shortening the time required for a

cake, 60 to 80 minutes; discharging excess pulp, 14 minutes; filling with wash solution, 10 minutes; washing, 85 to 100 minutes; decanting and discharging, 20 minutes. Total time, 3 hours 15 minutes to 3 hours 50 minutes.

The concentrate after passing the amalgamating plates is worth about \$400 per ton gold. It is then dewatered, agitated for 8 hours with a weak sulphuric-acid solution, receives three water washes, and lime is added. It

introduction of the blast furnace. No acid is used in the treatment of precipitate. About equal weights of gold and silver are recovered, and the average percentage of extraction is 94½. It is interesting to note that the extraction from the unroasted concentrate is a little better than 95 per cent.

The cost of cyaniding the concentrate is \$5.85 per ton, 93 cents being for labor, \$4.44 for supplies, mostly chemicals, and 48 cents for power. This cost when distributed over the entire ore tonnage is calculated as 38.1 cents per ton. The following analysis, by Mr. Hutchinson, the mill superintendent, gives the principal items of cost and the total cost per ton at this notable mill for the year 1911:

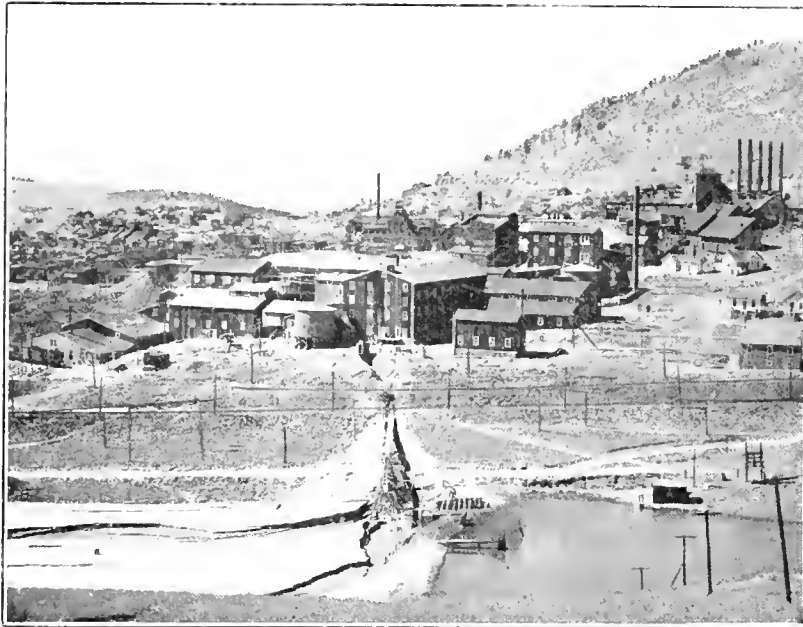

STRATTON'S INDEPENDENCE MILL

cycle of operations. The excess pulp in the sump is returned to the storage tanks by a centrifugal pump of moderate capacity but running continuously. Diffusion losses are obviated by using a fresh portion of barren solution for the wash at each cycle, the excess solution not being returned for use on the following cake but sent to the Pachuca tanks. A value of 30 cents gold is said to be dissolved from the cakes during washing, which cannot be gained by further agitation in the Pachuca tanks, but it is probable that the most of this could be dissolved in the Pachuca tanks if they could be operated on the series-decantation principle with barren solution added to the last one and passing up the series. The extraction during the washing of the cake is found to be better by lengthening the time under a reduced vacuum. No wash water is used, the cake being dropped in solution, the excess solution decanted to the mill and the tailing sent to waste with a low content of moisture.

The cycle of operations for the Butters filter is as follows: Filling vats with pulp, 10 minutes; forming

is then agitated in Pachuca tanks with a 4½-pound cyanide solution, some sodium peroxide and Na_2O_2 lead acetate being added. The agitation is carried on in 8-hour intervals, the solution being decanted and fresh solution added between each interval. The concentrate then goes to a Kelly filter press.

The gold-bearing solutions leaving the filters are apparently clear but contain a small amount of very light flocculi, and in order to remove this they are passed through three clarifying filter presses having 60 frames 3 feet square. This improves precipitation and insures that the barren solution shall not contain more than 6 cents gold per ton. Zinc dust is used for the precipitant, by means of the regular Merrill equipment, four 30-frame, 4-foot, triangular, presses being used. The precipitate from the Merrill presses is briquetted with litharge, dried, run down in a small blast furnace, and the resulting lead bullion cupeled. The product from the zinc filter presses was once dried in a furnace and melted in Faber Du Four tilting furnaces, previous to the

Crushing-conveying ..	\$.040
Stamping134
Chilean milling097
Tube milling177
Concentrating057
Agitating604
Water service098
Steam heating056
Filtering-discharging068
Precipitating074
Refining098
Other items510
Mill total	\$2.013
Cyaniding concentrate351
Total	\$2.394

Some of the elements of mill cost at Goldfield are high, notably water. In comparing the cost at this mill with that of other plants it must be borne in mind that the allowable milling cost depends upon the grade of the ore and the consequent gain to be derived from refinements in treatments giving a higher percentage of extraction.

The Goldfield Consolidated mill was described in MINES AND MINERALS, Vol. 32, p. 610. It treats \$40 ore and is the most modern cyanide mill.

Mercer, Utah, is the oldest cyaniding district in the West. At first all the ore was oxidized and was treated without roasting but now the Golden Gate mill, the principal one in the district, roasts about one-third of its ore. This mill receives two kinds of ore, the more oxidized being termed "mixed ore" and the other "base." All the ore is crushed dry, the base ore being crushed to a ¼-mesh screen and afterwards roasted. It is necessary that the roasting be very carefully done, to avoid fritting which occurs at a low heat. The "mixed ore" is sent to a different part of the mill, put through a Gates crusher, thence through two sets of rolls, being screened between the two, and is separated finally into coarse and fine by means of a trommel covered with three-mesh screen wire. The oversize from this trommel is not re-crushed but sent to the leaching vats. Some

of these pieces are nearly 1 inch in diameter but the ore is soft and so porous that the solution penetrates it. After the vat is filled, a layer of lime is put on the top and the cyanide solution turned on from the bottom. Generally no attempt is made to drain the vat between successive applications of solution, as it tends to pack the ore and cause slime to settle on the filter. Sometimes a part of the vat charge is made up of roasted ore. The size passing through the meshes of the trommel contains a considerable amount of clayey material and this is loosened from the harder particles by being mixed with solution and passed through two modified log washers operated in tandem. These "mixer-separators" as they are termed, are set at an inclination of 1 inch to 1 foot, the action of the revolving blades being to work the coarse ore toward the upper end where it is discharged, while the fine ore and slime are washed to the lower end discharge, this going to the second washer where the operation is repeated. The following is a sizing from the coarse ore discharge of the No. 1 mixer-separator:

Mesh	Per Cent.
+ 4	37 8
- 4+ 8	33 5
- 8+16	10 7
-16	7 8
Slime	10 1
Loss	.1
	100 0

As this coarse sand contains 10.1 per cent. slime, it is afterwards classified. All the product from the mixer-separators is sent to Dorr classifiers, the granular material from the sand discharge end of the classifiers being distributed in solution to leaching vats. The slime is sent to thickeners and thence to a Moore filter plant without agitation, as extraction seems to occur as soon as the slimed ore can be separated in the classifiers. Lately the practice has been to send a portion of the roasted ore to the log washers and classifiers, as the dust from the roasted ore tends to make the slime cake more permeable. The strength of solution used is 1.8 pounds per ton and the cyanide consumption is stated at .7 pound per ton of ore. The value of the ore is below \$3.50 per ton gold and the extraction 70 per cent. Some of the gold is insoluble and this has received a large amount of careful attention. The practice has been changed from time to time to meet new conditions. In 1911, 33 per cent. of the ore was roasted at a cost of 92 cents per ton, making the roasting cost 30.36 cents

when distributed over the whole tonnage. The following is the mill cost per ton as compiled from the company's report for the year 1911:

Crushing	\$ 1082
Roasting	3036
Extraction	5331
Precipitation	0532
Refining	0419
	\$1,0400

During that year the mining cost was \$1.29 per ton, milling \$1.04, total \$2.33. An average of \$2.32 per ton

in order to secure a fair extraction. The ores are roasted to oxidize the tellurium, with the result that shot gold is formed, and this requires additional appliances for recovery, besides fine grinding. The present practice is to crush as coarse as possible in ball mills, that is, to a product which will roast satisfactorily. After roasting, fine crushing is carried on in Chilean mills, and, instead of amalgamation, blankets are employed to save the free

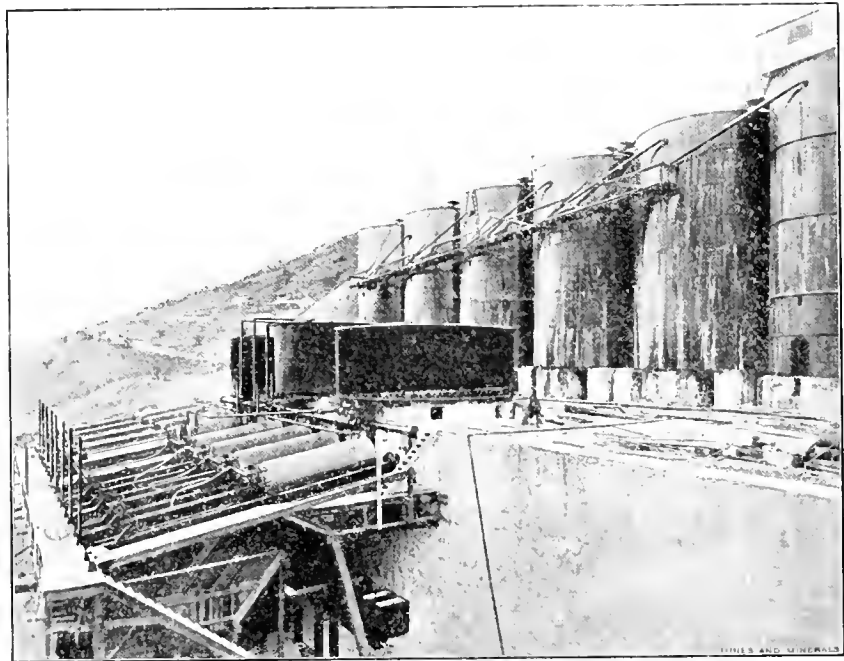

PARRAL AND PACHUCA TANKS

was recovered from the ore, being for the year \$55,696 in bullion. The operating loss of 1 cent per ton was turned into a small net profit by miscellaneous sources of income.

The ores of the Cripple Creek district, consisting of porphyry, andesitic breccia, phonolite, decomposed granite, and quartz, usually carry on the surface iron oxide, manganese oxide, and oxide of tellurium; below the water level the gold occurs in the minerals calaverite and sylvanite and is associated with more or less iron pyrite. The mineral fluor spar frequently occurs in the veins. While the surface ores contain free gold, they do not yield their gold in amalgamation, it usually being coated with oxide, or tellurium, or some substance that interferes with its extraction by this method. The extraction of gold from the surface ores by potassium cyanide presents no difficulties; but the treatment of telluride ores without subjecting them to a preliminary roast has been attended with the drawbacks of extremely fine grinding and prolonged percolation in the tanks (sometimes from 12 to 14 days)

gold. The sands are next separated from the slime and percolated with cyanide solution, while the slime is treated by vacuum or pressure filters.

The first mill to treat Tonopah, Nev., ore was erected at Millers, 11 miles away from Tonopah, where an abundance of water for milling purposes was struck at a depth of 35 feet below the surface. The mill, while named the Desert, belongs to the Tonopah Mining Co., and treats an ore containing silver and gold in the proportion of 100 to 1, with a recovery of about 90 per cent. of both the silver and the gold. The ore is treated by stamping, amalgamating, concentrating, and cyaniding; Huntington mills are used for grinding the ore crushed by the stamps and the middling product from the concentrating tables.

The mill is capable of crushing 450 tons of ore per day through a 10-mesh screen, and regrinding the pulp in Huntington mills to a 30-mesh screen. From the crushers the ore is raised to classifiers, the sands going to the tables and the slime to the collecting tanks. The middlings from the

tables are sent back to the Huntington mills and thence to the classifiers. The pulp from the classifiers is carried in a launder to collecting tanks 33 feet in diameter and 8 feet deep to the filter bottom, into which it is distributed by means of a revolving wet-pulp distributor.

The water and slime are discharged through curtained overflow gates and pass to the slime-treatment tanks. The sand remains in the collecting tanks and, after being drained by gravity and finally by vacuum, it is discharged by the tank excavator upon belt conveyers 20 inches wide and 90 feet long, located under the collecting tanks.

The belt conveyers under the collecting tanks discharge upon two inclined belt conveyers, which carry the

sand distributor from one row of tanks to the other, a transfer table is provided. This table consists of a heavy framed platform car, which operates on rails placed at right angles to the excavator tracks. The transfer table is driven by a small electric motor belted and geared to one axle. The nominal capacity of the sand-handling system is 100 tons per hour.

The belt conveyers are driven by one 25-horsepower, three-phase, alternating-current, Westinghouse motor. The excavator is operated by one 10-horsepower motor; the sand distributor by one 5-horsepower and one 3-horsepower motor, and the transfer table by one 3-horsepower motor. One man is required on each shift to operate the sand-conveying machinery. To prevent the repre-

by means of Butters distributors. The vats are filled with water before the distribution of sand begins, and during the filling an overflow is maintained around the entire circumference of the vat into a peripheral overflow launder. The No. 1 plant has 14 leaching vats, each 44 feet in diameter and holding a charge 9 feet in depth. Two of these vats are filled every 24-hour day, making a daily sand tonnage of 1,200 tons. The 14 vats thus provide for a 7-day cycle of operations. After the water is drained off, the standard solution, 2.8 pounds KCN per ton, is run on, and this treatment, with frequent drainings to admit air, is kept up for about 3 days. Owing to the large amount of water in the charge before the solution is run on, the effluent solution contains only about 2 pounds of cyanide per ton and is sent to the weak gold tank and after precipitation in Merrill presses is used as the weak solution for another ore charge. After treatment with standard solution the vats are leached with weak barren solution followed by water washes for the remainder of the allotted time. The effluent weak solution goes to a sump without precipitation, as it contains only about 40 cents gold per ton. It is then standardized to be used as the strong or standard solution on a succeeding charge of sand. The solution is thus enriched by passing through a second sand charge before it goes to the precipitating presses. The solution before precipitation contains about \$2 gold per ton. The residue is sluiced out with water from two lines of hose, the operation requiring 4 hours of time. At Deadwood, 4 miles below the mills, is the Homestake slime plant that treats the slime from 4,000 tons of ore per day. The entire treatment, dewatering, extraction, and washing, is done in Merrill presses. The Merrill zinc-dust precipitation method is also used. The slime coming into the plant has a head value of 90 cents per ton but a good profit is made in treating this low-grade material.

The Treadwell cyanide plant, at Douglas Island, Alaska, was built to treat the sulphide concentrate from the tailing of the free milling plants. The concentrate amounts to 1.8 per cent. of the ore, and the mills produce from 80 to 100 tons of this concentrate per day which contains a little over 3 ounces of gold per ton. The material is ground in Abbe tube mills until 98 per cent. will pass a 200-mesh screen, the sizing of the finished product being done in a Dorr classifier. It then has a preliminary treatment

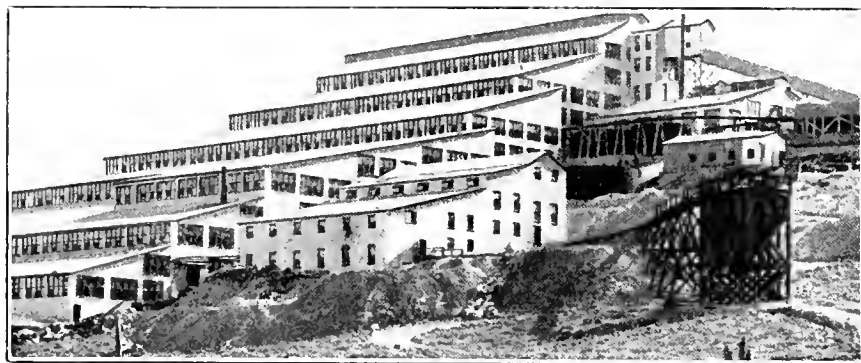

GOLDFIELD CONSOLIDATED MILL

sand to a long conveyer located above and between the two rows of sand-leaching tanks. This conveyer is 20 inches wide, 290 feet long, and is driven by an electric motor, at its discharge end. It is arranged with shafts and pulley wheels so as to drive the conveying belts under the tanks. There are 18 sand-leaching tanks 33 feet in diameter and 8½ feet deep, each one being equipped with filter bottom and plug. The long belt conveyer discharges the sand by means of a tripper, upon a belt conveyer that is connected with the sand distributor, both being supported on a movable bridge. After the first treatment, the sand is discharged from the leaching tanks by the sand excavator upon 20-inch belt conveyers 307 feet long, which deliver the sand to cross-conveyers and back to the long conveyer, which feeds it as before to a sand distributor placed over one of the second set of treatment tanks. After the second leaching treatment the sand is discharged from the tanks by the excavator upon the belt conveyers 307 feet long, which are reversed in direction of motion, and discharge upon an inclined stacker conveyer. In order to move the excavator and

precipitation of silver as sulphide, 1 pound of lead acetate is added for 3 tons of sand in the tanks. The concentrate from the tables carries on an average 650 ounces of silver and 8 ounces of gold. To produce 1 ton of concentrate requires the milling of 100 tons of ore. Concentrate is shipped to the smelter.

The wet crushing mills in the Black Hills of South Dakota use cyanide solutions in the stamp-mill mortar in place of water. The ore is crushed from 8-mesh to 20-mesh screen, and requires from 3 to 8 tons of solution per ton of ore crushed; however, although the ore is crushed coarse, about 35 per cent. is slime. The crushed ore passes to classifiers, the sand going to leaching vats and the slime to agitating tanks and Moore filters.

At the Homestake the ore is largely free milling and is crushed in water to 30 mesh, amalgamated, and the tailing sent to the cyanide plants. The sand and slime are separated by a system of cones of special construction run in series, the sand being washed by water as it passes down the series of cones until it is very clean, when it is sent to the sand vats and distributed

in Pachuca tanks with lime water, next it is agitated in Pachuca tanks with a 2-pound cyanide solution, after which it is washed in Kelly pressure filters. The solution goes to clarifying presses, thence to a Merrill zinc-dust precipitating plant. An extraction of 97 per cent. is obtained at a cost of a little under \$2 per ton.

Cyanide practice in the Republic of Mexico is thoroughly modern, exceptionally good work being done in the treatment of silver ores. The milling plant of the *Compania Beneficiadora de Pachuca* consists of two mills. Both are here described, the old one being interesting on account of the manner in which it has been adapted to modern conditions, and the new one, known as the *Santa Gertrudis*, being a fair example of the best modern practice.

The Guadalupe mill consists of a converted patio plant, the old Chilean mills having been retained, tube mills added, and a cyanide plant substituted for the patio process. The ore for this plant is brought down from the mine by the Pachuca Railroad Co., on 1-ton flat-bottom cars drawn by Shay locomotives, a distance of $2\frac{1}{2}$ miles. The fine ore is hauled separately from the coarse ore, the screening being done by the mine sorting grizzlies. The coarse ore is put through a Blake crusher, mixed with the fine ore, and trammed by hand to mill bins and fed to 14 slow-speed Chilean mills modernized by putting on steel-tired mullers and driving them by electric motors. The mills retain the stone sills or crushing dies, and are equipped with $\frac{1}{2}$ -inch mesh screens. The effluent pulp passes through four Dorr classifiers, the slime therefrom going to eight $15' \times 45'$ Pachuca tanks and the sand to three $5' \times 22'$ tube mills, each belt driven by a 100-horsepower motor. Each tube mill discharge is returned to the Dorr classifier by means of a $10'' \times 54''$ Fremier pump. The slime from the classifiers is elevated to the Pachuca tanks by means of centrifugal pumps. The eight Pachuca tanks are operated continuously in series, the discharge from the last tank of the series being elevated by a short air lift to the two $15' \times 30'$ storage tanks supplying a 300-ton Moore filter plant. Precipitation is effected by zinc shavings, the precipitate being unusually clean, running 78 per cent. bullion. The bullion produced runs about 920 fine, of which 920 parts are silver.

The new mill near the *Santa Gertrudis* mine treats 850 metric tons (dry weight) of silver ore per day by all-slipping and cyanidation. The

equipment consists of four gyratory crushers, sixty 1,550-pound stamps, 18 Dorr classifiers, 12 tube mills, 13 Dorr thickeners, and 28 Pachuca tanks, with 4 Merrill slime presses with Merrill zinc-dust precipitation. The silver extraction amounts to over 90 per cent. and the consumption of zinc dust is nine-tenths of 1 ounce for each ounce of bullion precipitated.

來 來

Efficiency in Mining

W. J. Crocker*

The two main avenues of cost in all mining are labor and supplies; there are many subdivisions of these two, but in considering mining efficiency as a cost reducer, these two heads should be considered separately.

In the matter of labor, because the work is not constant or always under the eye of a foreman, as in a manufacturing plant, it is more necessary to obtain the good-will of the workman than in other industries. It is not always true that the cheapest labor is the most profitable. To illustrate: the writer knew a superintendent who was called upon to increase the average production of his men; he first ascertained that his superiors were willing to pay more than the scheduled rate of wages provided ore could be mined cheaper. He then went underground, selected a crowd of Austrian miners, stayed with that one crowd from morning till quitting time, when they went to the chute with a car of ore he followed them out, he was with them in their timbering operations, planned their holes for them, and saw that they performed a good day's work; they almost doubled their ordinary output for one day. Next day he took a crowd of Italians doing the same kind of work; he told them what the first crowd had accomplished, jollied them up, telling them Italians were as good workmen as Austrians, etc., followed the same method as in the preceding day, and obtained an even better day's work from them; next day it was a crowd of Finnish miners that had his attention; the fourth day he was back with the Austrians. He had a plain talk with them. They reasoned they would only be allowed to earn from \$2.50 to \$2.85 per 10-hour day as formerly; he promised them all they could make, set them a contract to be abided by for a year, basing the contract to allow them about \$2.50 for the day's work as performed while he was with them, guaranteed them

* Negaunee, Mich.

a minimum of \$2.50 per day, and showed them they could earn over \$4 per day if they worked; they made over \$4 per day for a year, and in 3 months, when the miners gained confidence in him, they came to him asking for contracts which he gave. The result was the average tons per man per day were raised from 4.5 or 5 to over 7 and kept there for a year. The overhead charges, such as engineers, landers, trammers, motormen, surface labor, office force, etc., were all included in the 7 tons per man per day; all these got the same pay as formerly but had to speed up and meet the pace set by the miners underground. In this case the good-will of the miners meant increased production for all the mine, but only increased pay for the miners.

In another mine where 12 to 14 tons of coal per 24-hour day was being consumed, a new fireman was hired, who had fired lake and ocean going boats, and locomotives, as well as stationary boilers, and was an expert fireman. Where other men who had held that job quit because the work was too hard he had time for a smoke; an account of coal consumption showed that he used from 1,500 pounds to a ton less coal per shift than other men did; he asked for a raise, was told there was a set rate for firemen, he quit, the company hired another man and coal consumption again increased. In this case the company lost the difference between the cost of a ton of coal and a raise for the fireman because of a standard wage rate.

In the matter of supplies there are three big items, fuel, timber, and powder. In the previous instance fuel could have been saved; it also can often be saved by installing a telephone underground; many trips are made by men and boys coming up on the cage when a phone message would answer as well, thus saving the steam necessary to hoist a cage, and steam means money. Water draining to lower levels may be used to run a fan for ventilation purposes, saving compressed air, which also means money; and in getting well-ventilated working places miners can accomplish more work with less fatigue. Foremen and bosses should know just what is the cost of supplies handled by the men, and its direct bearing on the cost per ton produced. In some districts poles cost almost twice as much as split lagging, yet miners use poles where lagging would serve; if the boss knew the difference in cost he could prevent this waste. In the matter of powder, 40-per-cent. powder is often used where 30-per-

cent. would do the same work, sometimes even 20-per-cent. will serve; there is approximately a difference of seven-tenths of a cent per pound in price between 30-per-cent. and 40-per-cent., which could be saved in many places. Candles, too, can be saved; in many mines the men are given three or four candles for a shift's work; it makes a big difference whether they are given sixes or eights, if they are given four candles per shift, eight to the pound, then they use $\frac{1}{2}$ pound per shift; if four candles, six to the pound, then they use $\frac{2}{3}$ pound per shift, which makes a big difference in cost in a year.

There are various ways in which a practical miner with a knowledge of mining costs can apply his experience so as to create efficiency and lower the cost per ton for ore produced.

來 來

A Drift Candlestick

By William J. Crocker*

It is a very common thing in mines where candles are used to see two 5-inch or 6-inch nails driven in the timbers to hold a candle. Many mine fires can be traced to this dangerous practice, candle grease and snoffs (short candle ends) dropping on the level close to the timbers as the candles burn through the nails. Occasionally a candle wick drops while burning and sets fire to the accumulation of grease and wicks at the bottom of the level, the fire thus spreading to the mine timbers; or because of the imperfect grip of the round smooth nails on the round smooth candle, the candle tilts over on its side while burning and sets

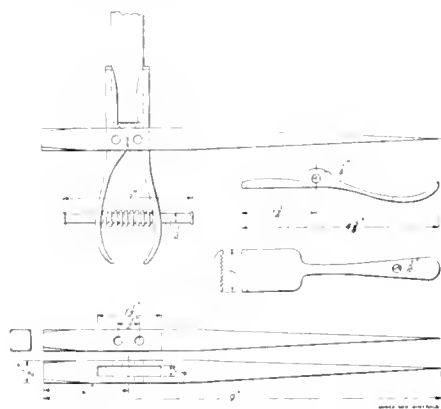

DRIFT CANDLESTICK

the timbers afire higher up. After reading about a fire in a mine where 17 men lost their lives, from such cause, Captain Thomas Nicholas, of the Mohawk mine, Aurora, Minn.,

*Nipissing, Mich.

now superintendent of the Cascade Mining Co., Palmer, Mich., designed, and had made the drift candlestick as shown, which automatically puts

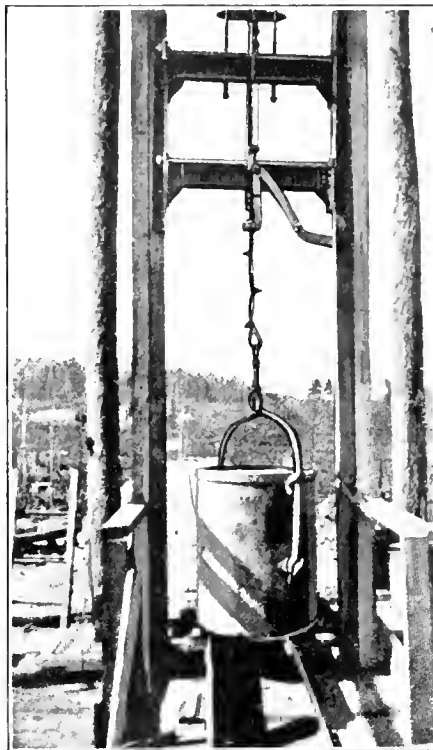

FIG. 1. MORIN CROSSHEAD

out the candle. When the candle burns down to about one-half inch from the bottom, the wax then gets soft, and the spring operating against the candle closes the jaws of the holder, putting the candle out, and holding the snoff until some one opens the clutch again, thus preventing the accumulation of grease on the level bottom. The jaw grip holds the candle erect and the stick being 9 inches long or 7 inches from the timbers to the candle flame, even a 8-inch candle cannot tilt against the timbers. Several of these candlesticks were tried out in the Mohawk mine, Aurora, Minn., for over a year, and in every case the candle was put out, and the snoff held in the stick until released. These sticks can be made by any mine blacksmith in a few minutes, the cost being small.

來 來

Manganese Discoveries in Philippines

According to the Bureau of Science at Manila, manganese ore has been discovered in the Philippines in considerable quantities, and it seemed possible to develop the industry, but when the matter was looked into it appeared that an export wharfage

charge exists on all kinds of ore. If the ore was taken in ballast to Japan, this charge would not be serious, but if it was shipped to the west coast of America, the freight rate would reduce profits to the vanishing point. The same is true in regard to iron ore. A geologist from Japan in the employ of the Mitsui Bussan Kaisha, examined the iron deposits on a small island in Mambulao Bay in Ambos Camarines where iron ore occurs, but the royalty to be paid to the persons owning the land, and the export dues, would leave little for the expenses of mining and the profit. It is recommended that a law remitting these export dues be passed as soon as possible.

來 來

Safety Crossheads

In the report of Mr. E. K. Corkill, Chief Inspector of Mines, Ontario, Can., on the number of shaft accidents, he says "that quite a number of accidents have occurred through the falling of crossheads in shafts." To overcome this difficulty, a crosshead has been devised by Messrs. Morin and Sargeson, master mechanics at the Nipissing mines, Cobalt. In the Sargeson crosshead, shown in Fig. 2 (a), (b), and (c), the attachment is fastened to the crosshead at C. If the crosshead sticks, this arm automatically engages the clip B attached to the rope, and so stops the bucket. In sinking operations, the arm A is automatically tripped by a stop-block E, allowing the bucket to descend to the bottom of the shaft.

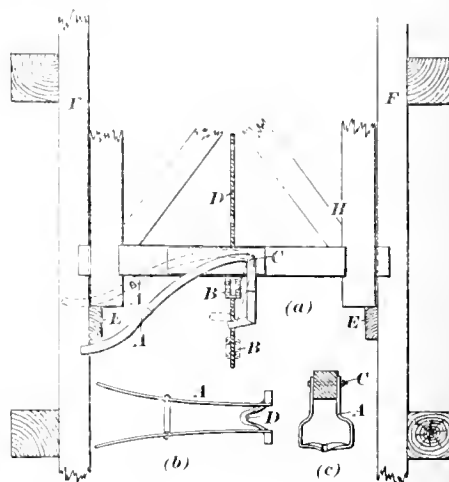

FIG. 2. SARGESON CROSSHEAD

The same equipment is adopted in the Morin crosshead shown in Fig. 1. It is further equipped with an automatic safety device which, by the aid of springs, enables the dogs to grip the guides, thus making it impossible for the crosshead to fall.

The Woodbury Slime Classifier

A Proposed Method of Milling by Using Plunger Jigs on Mixed Feed Not Coarser than 3/8-Inch Round

By Edward T. Wright*

UNDER the sizing system of concentration, classification is the bugbear of the mill designer and operator. No part of the mill presents so much of detail, all preliminary to the actual work of separating mineral from gangue. The "preliminary separation" has been elaborated until many mills are very complicated. The proper graded sizes of ore must be determined, and a selection made of the kind of screens to be used; the merits of trommels, impact, vibratory screens, etc., must be considered to suit the service and ore in hand. Sizes such as 1 1/2 inch, 7/8 inch, 3/4 inch, 5/16 inch, 3/32 inch, and 2 1/2 millimeters may be made with screens, then for the finer sizes hydraulic classifiers are selected, with their four to eight classifications and large consumption of water.

All this detail is to prepare the ore for the concentrating machines—jigs and tables—that to do perfect work must treat nicely sized ore. The hydraulic classifier in making a separation of slime from sand causes a dilution of slime of from 50 per cent. to 100 per cent., making it necessary to provide elaborate settling systems with resulting overflow losses in fine mineral in order to obtain material of proper density for treatment on tables or vanners.

The purpose of this article is to point out a means of simplifying and modernizing the mill, with largely increased recovery.

Jigs of the Hartz type do indifferent work on mixed or unsized feeds, and the sizing system has been built to conform with them. Consider, therefore, a means whereby the complications of the sizing or "preliminary treatment," can be almost entirely eliminated, while at the same time the slime is separated with little or no dilution.

An ideal concentrator would be one that would effect a perfect separation of all free mineral and middling from an unsized feed. As a matter of fact, an unsized feed when passing over a suitable jigging apparatus separates naturally into two fundamental classes; viz., slime, i. e., suspended material which will not settle and which floats along over the jig; and sand, i. e., material which will settle. Therefore, to bring the ideal concentrator down to a practical basis, a device must be provided for separating the slime as an unfinished

product for subsequent treatment; at the same time, the apparatus must be capable of stratifying and separating from a mixed feed the free mineral and middling from the gangue.

The Woodbury slime classifying jig, shown in Fig. 1, in use at the

slime from this compartment as a product for further treatment on suitable tables. This separation is positive and complete, the sand on the sieve acting as a filter and being itself discharged thoroughly freed of slime. At the same time this classifying jig performs all the regular functions of a jig, and separates a large tonnage of clean cup and hutch mineral, usually from 50 per cent.

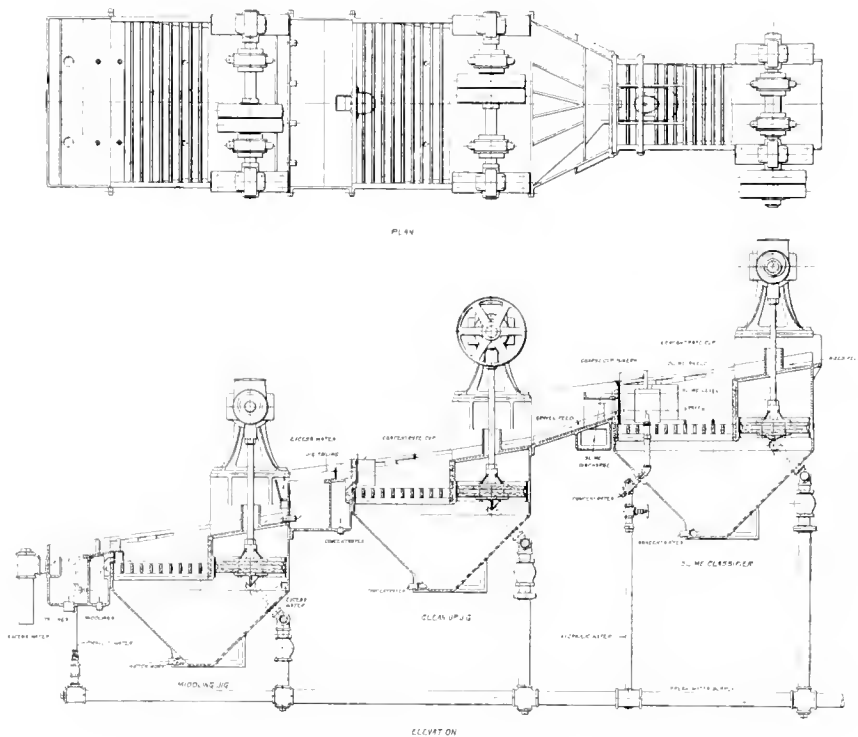

FIG. 1. CONCENTRATING PLANT

Calumet and Hecla mill, Lake Linden, Mich., is a form of plunger jig so arranged that the feed flowing on to the jigs parallels the currents of water, caused by the plunger impulse, enabling the jig to rapidly stratify the sand in an absolute mixed feed. An unsized ore (not coarser than 3/8-inch round) is delivered at the head of the first compartment of the slime classifying jig.

This compartment is a jig of the plunger type 24 inches wide. The feed flowing over the sieve quickly separates into its two fundamental classes; viz., slime, and sand which settles and is stratified. The latter is thoroughly scrubbed free of slime which is held in suspension by the hutch water, introduced under the plunger.

A device for skimming off the slime in suspension delivers a dense original

to 60 per cent. of all free mineral being separated on this slime classifying jig.

The second compartment, which follows the jig described above, is a "clean-up" jig for completing the separation of free mineral. This jig is 48 inches wide and usually discharges two finished products, viz., "cup" and "hutch" concentrates. The tailing from jig No. 2 passes to jig No. 3 termed "middling" jig, and provided with suitable middling discharge.

These middling jigs are equipped with a very efficient device for discharging middling from an unsized feed; viz., the "hydraulic middling discharge." An angle-iron shield is fastened across the tail of the jig, extending down into the middling stratum which seals it against the entrance of tailing. From under

*Ore Milling Engineer, Chicago, Ill.

this shield a number of openings placed at intervals of 6 inches lead into a hydraulic chamber. A fresh water supply therein, under valve control, regulates the quantity and quality of middling discharged from under the shield through these openings into the hydraulic compartment and out through plugs in the bottom. The advantages of this device are a uniform discharge over entire width of jig; and the separating and discharging of a true middling as stratified on the jig, the hydraulic water controlling and holding back any light tailing material.

An important feature of these jigs is the "water-saving" device for diverting the excess water in the feed into the hutch of the next succeeding jig. The tailing from one jig passes over the angle-iron shield and the hydraulic compartment to the "water lessener" box of next succeeding jig, from which it is discharged through plugs over the plunger compartment and becomes the feed for the next compartment. The surplus water which cannot discharge through the plugs flows over the top of the lessener into a trough communicating with the hutch under the plunger, thus effecting a material saving in hutch water as well as reducing the quantity of top water which otherwise accumulates and tends to carry off the light values.

The material discharged from the hutches of the jig compartments No. 1 and No. 2 is usually clean mineral, and is included in the general concentrate. From the hutches of the middling jigs is obtained an enriched sand containing any light fine mineral which may have been carried over from the second compartment, this sand usually being redressed on a table of the Willsley type. From the end of the last compartment is discharged tailing to waste.

To summarize, this is a means of handling large quantities of a mixed feed without preliminary sizing, and to classify it into the desired products; viz., slime (approximately 60 mesh and finer) for subsequent treatment on tables; concentrate; middling for regrinding; hutch sand for further table treatment; tailing to waste.

This mixed-feed system has been applied to various kinds of jiggling ores, including native and sulphide copper, lead, zinc, tin, iron, and sapphires, and has thoroughly demonstrated its practicability and superiority in coarse, medium, and fine jiggling. Any ore amenable to wet concentration can be handled to advantage with this system. In ores

other than native copper, the mineral is usually softer and more friable than the gangue; and in the process of crushing is more easily slimed. It is therefore advisable to begin concentration as early in the process as possible, in order to recover the mineral as soon as liberated and before it is slimed by further crushing. The proper limiting size at which concentration should begin varies materially on different ores; in some the mineral is liberated during coarse crushing, while in others the mineral is so finely disseminated that the rock requires pulverizing.

Inasmuch as the Woodbury machines will treat unsized ores, preliminary sizing is unnecessary, except where material coarser than $\frac{3}{8}$ inch is to be concentrated, when a screen separation is necessary at $\frac{3}{8}$ inch, the oversize is treated on coarse jigs and the undersize on the classifier jigs. The material coarser than $\frac{3}{8}$ inch is treated without further sizing on special jigs, having adjustments and discharges suited to coarse material. When the maximum size of the ore is not over $\frac{3}{4}$ inch, the 4S-inch oversize jig is used; on a larger maximum size the 60-inch "bull jig." The undersize of $\frac{3}{8}$ -inch screens is treated without further sizing on the Woodbury classifier and jigs.

Where it is desired to rough out the free mineral before grinding, nothing approaches the simplicity of this arrangement, as the ore from the crushers has simply to be screened at $\frac{3}{8}$ inch, the coarse mineral in the oversize material being separated on an oversize or bull jig, and the free mineral and slime in the undersize material being separated on the two-compartment classifier jigs. The rich original slime is gotten out of the system without undue dilution and is passed on to the slime department. The tailing from the roughing jigs is recrushed, the coarse jig tailing being crushed to $\frac{3}{8}$ inch while the classifier jig tailing is finely pulverized and retreated. In case the mineral is not freed by coarse crushing in sufficient quantity for jiggling, the coarse jigs are omitted and the classifier jigs only used as roughing machines.

Brown and red hematite, coal, pyrite, chalcocite, and chalcopyrite, can be roughed in immense tonnages and with great economy in floor space, water, attendance, etc. The unfinished products, slime and middling, are in far better condition than under the sizing system, the slime being dense, not coarser than 60 mesh, and separated high up in the mill. The middling is a thoroughly classified

"included" product, being cleaned of free mineral which otherwise would be slimed in the regrinding.

In the Woodbury slime classifier and clean-up jig, two compartments only are required to clean the free material and slime from an unsized feed. When it is desired, however, to finish the operation by separating the middling material for regrinding, two middling jigs are usually added to the unit, making the standard finishing unit four compartments in all.

A finishing unit of jigs will handle approximately 250 tons per 24 hours, and separate the following products: Slime, concentrate, middling, table sand, and tailing. The feed is unsized and may be the undersize of any size screen not to exceed $\frac{3}{8}$ -inch round.

The advantages of the system on finishing work are marked, a dense slime, clean concentrate and classified middling being separated with lowered tailing losses. Considerable economy is effected in water, floor space and attendance, and the mill greatly simplified. It should be noted that hydraulic classification and fine screening are entirely eliminated in this system.

Where it is necessary to separate two minerals of different specific gravity, a jig of five or even six compartments is required. The slime is separated as above on the first compartment, the heavier mineral on compartment Nos. 1 and 2, the lighter mineral on Nos. 3 and 4, and middlings on Nos. 5 and 6, tailing being discharged from the end of the jigs.

采 采

Asbestos Mines in China

Consul Baker, of Antung, China, states that valuable deposits of asbestos have been found in the vicinity of Kuantien, a small town lying about 45 miles northeast of Antung. The product appears to be of good quality. The price at Antung is about 60 cents United States currency per pound, but as the mining is done in a desultory and primitive manner, the cost could be greatly reduced by using modern machinery and up-to-date methods. There are three mines now in operation, each employing about 30 workers. These workers, however, are mostly farmers who devote only their spare time to mining and use simply hammers and chisels and gather only the asbestos which lies near the surface. For this reason the output is limited, but further working should disclose the extent and value of the deposits.

Equalizing Load Moment on Hoisting Engines

By Mark Ehle*

In hoisting ore from considerable depths by the ordinary method of two drums operating balanced cages, the problem of equalizing the load moment on the engine, due to the great variation in rope loads, must be met, if anything like maximum efficiency is to obtain.

In the larger installations the problem is usually met at the outset by the use of conical drums, flat rope and reel, or some form of tail-rope. It often happens, however, that a hoisting engine, originally installed to care for considerable output from relatively shallow depth, is called upon to do the hoisting from depths far exceeding the original estimate. In such case the long lengths of

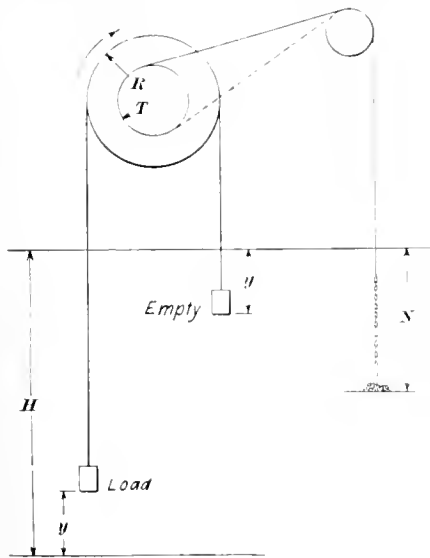

FIG. 1

unbalanced rope may easily become a determining factor in the possibilities of the engine, and some simple method of annulling this variable rope load must be provided. It is the object of this paper to set forth a few of the many successful devices employed to this end.

The drawings, in each case, are simply diagrammatic sketches of the load moments acting on the winding drums and are not intended to show any true relation of parts.

The system outlined in Fig. 1, simple of construction and very effectual in operation, is known as the "Despriz."

The two winding drums, of radii R , are shown with the loaded and empty cages at some general position during a hoisting period. A third drum of radius T has been keyed to the main

drum shaft and carries a small rope to which is attached a chain, as shown. The small rope is so wound on to its drum that at the commencement of the hoist the chain, of length N , is suspended at full length in a small compartment specially provided. Immediately as the hoisting commences the small rope starts to unreel, piling up the chain at the bottom of its compartment until the cages reach their point of passing midway of the shaft, at which instant the hoisting-rope loads balance, the piling up of the entire chain length is complete, and its load moment on the main shaft is zero. At this instant, also, the small rope, carrying the chain, has all unreeled from its drum and its point of fastening is about to pass around underneath and take the rope into the position shown by the dotted line.

Hence, as soon as the cages have passed each other the chain rope begins to reel up again, extending the chain upward until, at the termination of the hoist, it again hangs at full length, giving a load moment of opposite sign to that which it had at starting of the hoist. That is, during the first half of the hoisting period the load moment of the chain on the drum shaft is plus, while during the second half of the period it is minus.

The problem then is to deduce the proper weight of chain in order that the system, in so far as the rope loads go, represents at all times a balanced one.

Let Π = weight of the hoisting ropes per unit length;
 w = weight of the chain rope per unit length.

H = total depth of hoisting;

N = total length of chain;

y = distance the loaded cage has ascended, which will also equal the distance the empty cage has descended.

In the position shown the equation of moments would be:

$$(H - 2y)\Pi R = \left(N - \frac{Ty}{R}\right)wT;$$

$$\text{but } N = \frac{HT}{2R}$$

Substituting,

$$(H - 2y)\Pi R = \left(\frac{HT}{2R} - \frac{Ty}{R}\right)wT,$$

which reduces to

$$w = \frac{2R^2\Pi}{T^2}$$

which gives the relative weight of the hoisting rope and chain in terms of the radii of the drums, for

$$R = T; w = 2\Pi \text{ and } N = \frac{H}{2}$$

It may be noted that the weight of the small chain rope has not been taken into account. While this weight might have some influence, its effects may very properly be neglected.

The system outlined in Fig. 2 is known as the Monopol. An auxiliary drum of diameter equal to the winding drums, is keyed to the main shaft and is of sufficient width to carry two relatively small ropes, one of which is underwound and the other overwound.

These ropes support a length of heavier balancing rope in the position shown; this balancing rope is usually a length of old hoisting rope of the size used in the hoisting operations and which has been discarded on account of wear. A glance at the

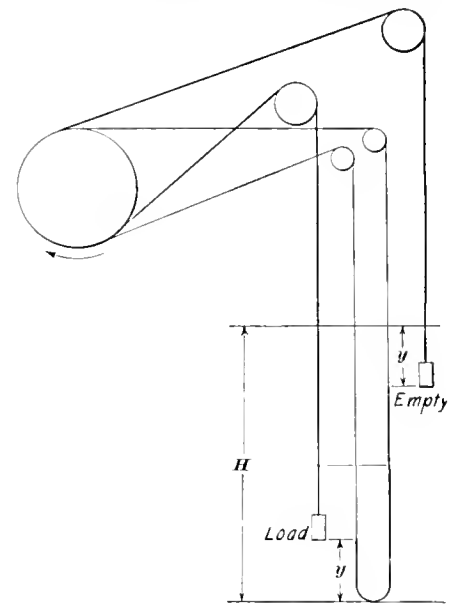

FIG. 2

diagram makes it evident that if this balancing rope is adjusted at the outset, so that each of its ends is in position opposite one of the cages, as shown, they will so remain whatever the position the cages take during a hoisting period, and the load moment on the drum shaft, so far as the hoisting ropes are concerned, will be equalized throughout. As in the former case, the weight of the small rope can be neglected.

In practice either of the above systems requires that a small compartment be provided for the accommodation of the balancing device. This is usually partitioned off from one end of the pump compartment of the main shaft at a nominal expense. As for the rest of the arrangements almost any mechanic at the mines would find little trouble in providing whatever would be required for the installation.

*In the *Pahasa Quarterly*, December, 1912

NEW MINING MACHINERY

Safety Lamp Igniter

An igniter for safety lamps has been invented by Mr. L. D. Vaughn, Mine Inspector in the Third District of West Virginia, for use with the common Wolfe lamp to take the place of the explosive igniters generally used. No change need be made in the lamp as the igniter fits easily into the space occupied by the ordinary igniter. In the illustration the

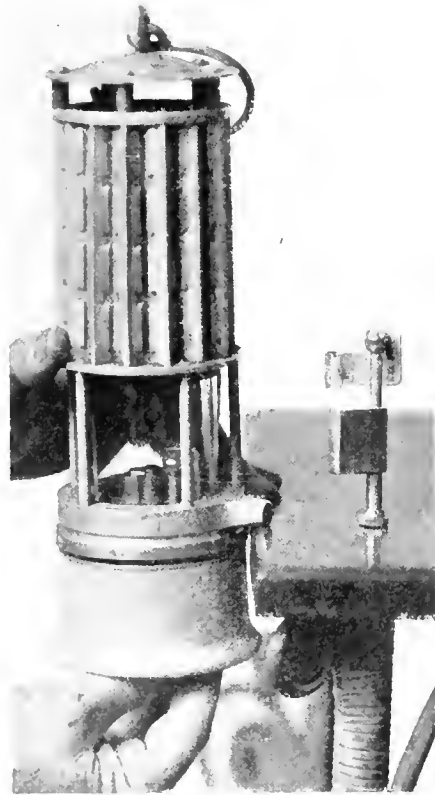

SAFETY LAMP IGNITER

device is shown standing by itself on the table as well as in position in the lamp.

The principle of this igniter is the common one of scratching a steel disk with a pencil of carborundum and so getting a spark hot enough to ignite naphtha fumes arising from the wick. The steel disk is mounted on a spindle which passes through the bottom of the lamp and which can be turned between thumb and finger. It is on a level with the wick of the lamp when the igniter is in position. A pencil of carborundum is so placed that the steel disk when rotated, rubs against it, the carborundum being pressed forward by a small spring. The pencil is mounted on a piece which hooks around the wick of the

lamp so that the spark always is emitted in the correct direction. A blank is placed on the middle of the spindle to fill up the space occupied by the match box in the ordinary igniter; 5,000 lights can be obtained from one pencil of carborundum.

Tests have been made on lamps using this igniter by the Bureau of Mines at Pittsburg, and it has proved safe in a gaseous atmosphere and in atmospheres of high velocity. With it, no particles will be cast against the gauze to lodge there and flame afterwards when the lamp fills with gas, so lighting gas outside the lamp. The igniter is for sale by the Vaughn-Miller Co.

來 來

A New Acetylene Mine Lamp

Acetylene is now recognized as a most economical illuminant for use underground, and the Arnold carbide candle, developed by Ralph R. Arnold, a mining engineer of Cripple Creek, Colo., is an improved device for the generation and burning of acetylene gas.

Fig. 1 shows the form of the lamp, which consists of a tubular body of 22-gauge brass $1\frac{1}{4}$ inches in diameter by 12 inches in length and weighs but one-half pound. A diaphragm in the center divides it into a water (upper) chamber closed by a revolving shutter at the top, and a carbide (lower) chamber closed by a gasket-lined cap at the bottom; there is a water-control valve in the diaphragm and a gas tube extends from the chamber through the diaphragm to the top where there is an improved burner.

A cartridge containing the charge of calcium carbide is placed in the carbide chamber, the water chamber filled, and upon opening the water valve the water is fed by gravity on to the carbide cartridge, which being made of absorbent material, the generation of gas is immediately begun, it being ignited at the burner. The flow of water, the consequent generation of gas and thereby the size of the flame, is controlled by the water valve, permitting a variation in the candlepower of the light of from $\frac{1}{2}$ to 10 candlepower, the charge of carbide being sufficient to furnish a 4-candlepower light for 4 hours or more.

The lamp is non-explosive, and as soon as the pressure of the gas exceeds the maximum water pressure (5

inches) the pressure will stop the flow of water, and any gas in excess of that burned will pass through the water chamber and flash at the burner instead of escaping into the atmosphere. When the carbide is consumed, the cartridge may be instantly removed, and a new one, carried in a pocket tube, substituted, the water chamber refilled, and the lamp relighted, within a few seconds.

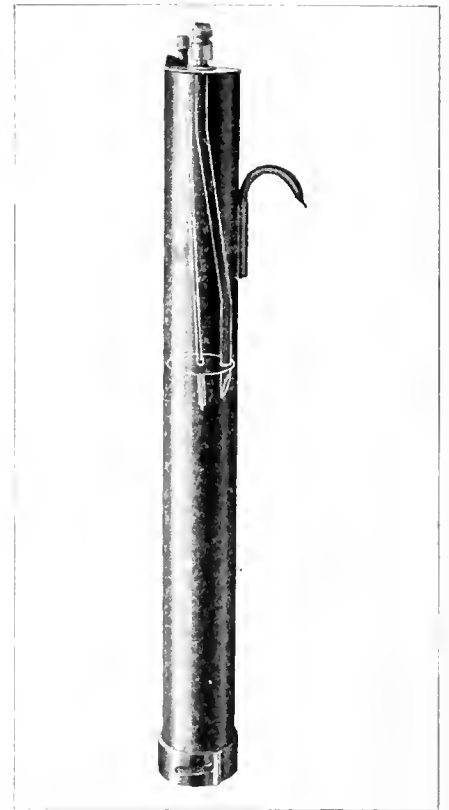

FIG. 1. CARBIDE CANDLE

The cartridge case is made of an especially woven absorbent fabric that acts as a conductor for the water to insure the constant generation of gas, admits of the expansion of the carbide, filters the gas generated therein, and retains the residue, thereby preventing the obstruction of the water valve, gas tube, or burner, and eliminating the necessity of cleaning the filtering chamber after using and the use of filtering devices; a maximum water pressure of 5 inches insures the maintenance of a steady flame from start to finish, and the total consumption of the carbide without any attention whatever.

A removable sliding reflector answers the purpose of a wind shield and water deflector as well, and when

slid down below the flame, when general illumination is required, serves as a guard for the burner tips. The burner produces a fan-shaped flame, giving maximum illumination with a minimum of gas.

This lamp has demonstrated its value by continuous use at Cripple Creek for the past 2 years, and the fact that it is made by Wm. Ainsworth & Sons, the well-known instrument makers of Denver, Colo., insures that the workmanship and material are of the best.

來 來

Locking Device for Electric Switch

Fig. 1 shows a locking device that prevents the blade of a disconnecting switch from opening except under the direction of the operator. Instances are on record where the blade of a disconnecting switch not protected by this device has been thrown open, or partly open, by magnetic repulsion and destroyed when a short circuit has occurred on the line, resulting in the loss of the switch and putting the circuit out of commission till a new switch could be installed.

The safety catch, or locking device, is a unit in itself and can be applied merely by clamping it to a support placed between the clip block and the insulator cap. It is of rugged design and is operated with a switch hook.

The locking device consists essentially of two brass bell-cranks hinged together at the ends of the two shorter arms and held closed by compression springs. The projections or jaws in the outer ends of the two longer arms close in front of the blade thus preventing the latter from coming out of the clips. Each bell-crank is provided with a dog which moves in a slot in the bell-crank's elbow, the dog being hinged at this point. Two compression springs, one pressing outwardly from the switch base against the elbow of each crank and also against the dog, keep the bell-crank closed and the dogs pressed against the back of the switch blade.

To open the switch, the outer ends of the bell-cranks are pressed back away from the blade allowing the dogs to come forward so as to rest upon the sides of the blade, in which position they hold the jaws in front of the blade apart, allowing the switch to be opened. Withdrawing the blade of the switch from between the dogs causes the jaws to automatically close against the sides of the blade and to snap shut as soon as the blade is completely withdrawn.

As the outer edges of the jaws are beveled the switch blade can be readily pressed back in the clips into the closed position, when the jaws close automatically in front of the blade, locking the latter in the closed position. The operator can't forget to lock the switch closed as it automatically locks itself.

This device is made in sizes to fit 300, 600, 800, and 1,200 ampere switches as standard and can be fur-

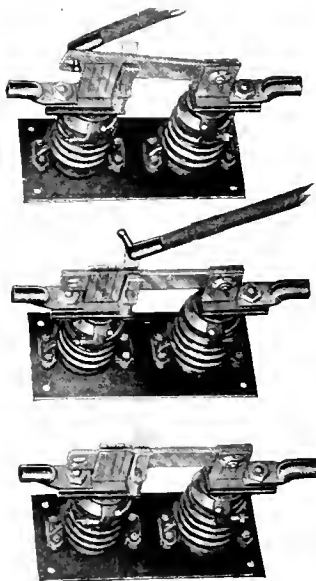

LOCKING DEVICE FOR SWITCHES

nished for a switch of any capacity. It has been on the market for a comparatively short time, yet it is being used by practically all the important electrical operating companies in the United States. The device is made by the General Electric Co., Schenectady, N. Y.

來 來

Trade Notices

New Supply Concern.—Fred M. Blethen, for many years with the Hazleton Machinery and Supply Co., announces that he has engaged in business for himself with office at 704 Markle Bldg., Hazleton, Pa., and will handle everything in the line of machinery, tools, power transmission, and equipment, either new or second-hand.

Stromberg-Carlson Telephone Mfg. Co. announce that they have transferred their Kansas City sales office to 708-710 West Jackson Boulevard, Chicago, Ill., where they have a more complete line of telephones and apparatus and also more complete and efficient sales organization. They will still continue to carry at Kansas City a selected stock of standard telephones, boxed and ready for immediate shipment to Kansas City

territory, but all orders should be sent to the Chicago office.

Test of Wire Rope.—At the mines of the Pennsylvania Steel Co. at Mayari, Cuba, cars with a capacity of 100,000 pounds of ore are lowered by means of cable down an incline plane 5,800 feet long. Recently it was decided to ascertain the strength of the cable after a year and a half of service, as compared with the strength of portions not worn; and three pieces from the main cable, each about 20 feet in length, were shipped to the works of the manufacturers, the John A. Roebling's Sons Co., at Trenton, N. J. There special yokes were placed on the ends to make possible the tests, which were conducted by the Civil Engineering Department of Lehigh University at the Fritz Engineering Laboratory. Three tests were made, all highly satisfactory. A portion of the cable that had been in use for a year and a half withstood a pull of nearly 300 tons.

The construction of this cable was without a precedent in rope making. It consists of six strands, each of 19 wires, twisted around an independent wire rope center, this center having six strands of 19 wires each, twisted around a hemp core. The finished cable was 7,810 feet long and weighed 125,360 pounds.

The D'Olier Centrifugal Pump and Machine Co. is a new organization having taken over the plant and business of the Lathbury-D'Olier Engineering Co. General offices will be maintained in the Morris Bldg., Philadelphia, Pa.

Sullivan Machinery Co. Changes. Roy D. Hunter has resigned as general sales manager of the Sullivan Machinery Co. Howard T. Walsh, who has been the European agent of the company, with headquarters in London, is appointed general sales manager, with headquarters in Chicago. Austin Y. Hoy, representative of the company in Spokane, Wash., succeeds Mr. Walsh in London. Louis R. Chadwick of the St. Louis office, succeeds Mr. Hoy as local manager in Spokane.

Reduction in Price.—The Joseph Dixon Crucible Co., of Jersey City, N. J., announce that the selling price of their Silica-Graphite "One Quality Only" paint is reduced. They say they make this reduction because the decrease in the price of linseed oil enables them to do it, and it is their aim at all times to give their customers any benefit possible in reduction of price of materials. This paint, which has been the standard for nearly 50 years with leading

railroads and manufacturing plants as a maintenance paint, is a long service protector of exposed steel and metal surfaces.

Sirocco Fans.—The Pond Creek Coal Co., and the United States Coal and Oil Co., who are under practically the same management and have a common purchasing agent, are opening new mines at Williamson and Holden, W. Va., for the ventilation of which nine Sirocco fans, with a combined capacity of 1,800,000 cubic feet of air per minute, against 2-inch water gauge have been purchased. Each of these fans will make a carload shipment.

Western Agents.—The Goulds Mfg. Co., of Seneca Falls, N. Y., announce that the Mine and Smelter Supply Co., Denver, Colo., have been appointed as agents for the Goulds line of triplex power pumps. Their territory will include the entire state of Colorado and adjacent counties in the states of Wyoming, New Mexico, South Dakota, and Montana.

New Pump Co.—A new company, known as the Lea-Courtenay Co., Inc., with office at 90 West Street, New York City, has taken over the engineering and manufacturing business of Albert G. Lea. The company will manufacture high-duty turbine pumping machinery for all classes of service, and also cold metal sawing machinery. The officers are Albert G. Lea, president; Courtenay R. Rothwell, vice-president and general manager, and Edgar W. Heller, treasurer.

Coal Stations.—The Roberts & Schaefer Co., contractors and engineers, of Chicago, have been awarded a contract by the Queen & Crescent Route for two 500-ton capacity reinforced concrete Holmen coaling stations, electrically driven, for installation at Danville, Ky., and Oakdale, Tenn. Price \$37,000. These plants are to be exact duplicates of two former plants that this firm erected for the Queen & Crescent at Montlake, Tenn., and Ludlow, Ky. They have also received an order from the Pratt Consolidated Coal Co., of Birmingham, Ala., for a 1,000-ton Stewart coal washing plant, steel tipple, and storage bins, to replace the structure recently burned at the mines at Banner, Ala.

New Asbestos Plant.—The completion of the new plant of the H. W. Johns-Manville Co., at Manville, N. J., marks another important chapter in the history of this concern. The company has manufacturing plants in different parts of the country. The new plant at Manville, consists of nine buildings, as follows:

Textile and packing, rubber plant, electrical specialties and printing department, pipe coverings, paper mill, magnesia, roofing, mastic and waterproofing, roofing coatings, power plant and pump house.

These buildings represent the most advanced ideas in fire-proof construction, being of brick, steel and concrete, with roofs of J-M asbestos roofing. They are planned not only for safety but to afford the best operating conditions for the employes. Each building has an average length of 1,000 feet, and is a separate factory in itself. The combined floor area of all the buildings is about 1,000,000 square feet.

Chou Nickel Bronze is a product of the Exeter Machine Works of Pittston, Pa., developed after extensive experiments in an endeavor to secure a material for screen plates that will resist the action of acidulated water and provide uniformity in the sizes. Screen plates of this material are made with perforations of any size or shape required.

Wooden Pipe.—The early waterworks systems in this country made use of logs with holes bored through them for pipe, and nothing more durable has ever been found, as is shown by the existence of such pipe in good condition that were laid nearly a century ago. They were not, however, capable of withstanding high pressures. After much experimenting, the Michigan Pipe Co., of Bay City, Mich., has developed a method of reinforcing wood pipe by which it is able to stand pressures as high as 700-foot head. Such pipe has the advantage of being unaffected by acids and chemicals and the company states that it costs less than iron pipe, is cheaper to lay, and has other advantages, all of which are fully described in a new catalog which they will send on application.

來 來

Catalogs Received

BABCOCK & WILCOX Co., New York. The Stirling Water-Tube Boiler, 64 pages.

ROBERTS & SCHAEFER Co., Chicago, Ill. Combination Screens and Picking Tables, "Marcus" Patents, 12 pages.

MINNESOTA MANUFACTURERS ASSOCIATION, North St. Paul, Minn. Gravity Carriers, Automatic Elevators, Power Conveyors, and Spirals, 28 pages.

DEANE STEAM PUMP Co., 115 Broadway, New York. Triple-Plunger Well Pumps, 16 pages

EDGAR ALLEN AMERICAN MANGANESE STEEL Co., McCormick Bldg., Chicago, Ill. Renewable Point Teeth for Steam Shovel and Dredge Dippers, 11 pages.

EDWARD DARBY & SONS Co., 233 and 235 Arch Street, Philadelphia, Pa. Pen-Dar Steel Lockers, 34 pages.

LEA-COURTENAY Co., Inc., 90 West Street, New York. Lea-Courtenay Turbine Pumping Machinery, 30 pages.

POWER AND MINING MACHINERY Co., Milwaukee, Wis. Bulletin No. 106, Loomis-Pettibone Gas Generating System, 15 pages.

CHICAGO PNEUMATIC TOOL Co., Fisher Bldg., Chicago, Ill. Air Receivers, Aftercoolers, Air Line Drain Traps, Reheaters and Economizers, 15 pages; Heavy Duty Electric Drills, 7 pages; Heavy Duty Electric Drills for Alternating Current, 7 pages; Universal Electric Drills Operating on Direct or Alternating Current, 7 pages.

ACKLEY BRAKE AND SUPPLY Co., 50 Church Street, New York. The Monarch Refillable Fuse, 4 pages.

GOODMAN MFG. Co., Halsted Street and 48th Place, Chicago, Ill. The Goodman Electric Shortwall Mining Machine, 32 pages.

McKIERNAN-TERRY DRILL Co., 115 Broadway, New York. Pile Hammers, 27 pages.

INTERNATIONAL PRAEPOSIT Co., 45 W. 34th Street, New York. Praeposit, a new, safe and powerful explosive, 8 pages.

MICHIGAN PIPE Co., Bay City, Mich., 44 pages.

來 來

Calendars Received

WHITE & WYCKOFF MFG. Co., Holyoke, Mass. Manufacturers of "Autocrat" linen stationery.

BALDWIN LOCOMOTIVE WORKS, Philadelphia, Pa.

THE BITTENBENDER Co., Inc., Scranton, Pa. Mine, Mill, and Contractors' Supplies.

THE ROESSLER & HASSLACHER CHEMICAL Co., 100 William Street, New York City. Chemicals.

MORRIS MACHINE WORKS, Baldwinsville, N. Y. Centrifugal Pumps.

JOHN A. ROEBLING'S SONS Co., Trenton, N. J. Manufacturers of Wire Rope.

J. H. WILLIAMS & Co., Brooklyn, N. Y. Manufacturers of Williams wrenches, Calendar 1913-1916.

THE LUNKENHEIMER Co., Cincinnati, Ohio. Steam Specialties.

WESTON DODSON & Co. Inc., Bethlehem, Pa., Anthracite and Bituminous Coal.

The Colliery Engineer

Formerly
Mines and Minerals

Vol. XXXIII—No. 8

MARCH, 1913

Scranton, Pa.

PUBLISHED MONTHLY AT SCRANTON, PA.

ESTABLISHED 1881

INTERNATIONAL TEXTBOOK CO., PUBLISHERS

T. J. FOSTER, President S. P. ALLEN, Secretary E. H. LAWALL, Treasurer
RUFUS J. FOSTER, Vice-President and Managing Editor
EUGENE B. WILSON, Editor HUGH ARCHBALD, E. M., Asst. Editor
CHICAGO OFFICE: 1006 S. Michigan Ave.

Entered at the Post Office at Scranton, Pa., as second-class matter
Address all business communications to THE COLLIERY ENGINEER, Scranton, Pa.

Subscription Rates: \$2.00 per year to United States and all possessions,
and Mexico; \$2.50 to Canada; \$3.00 to all other countries. Single copies 25 cents each.

Notice to discontinue or change of address should be sent to the Scranton office.
When notifying us of a change of address always give your FORMER as well as your present address.

TABLE OF CONTENTS

Editorial—

Editorial Notes—Breaking an Agreement—John Fritz—Coal Mine Laws—Taxing Coal Lands..... 403

Personals 406

Obituary—

Prof. George A. Koenig..... 406

Coal Stripping in Kansas, by Barry Scobee..... 407

Use and Care of Safety Lamps..... 408

Common Sense Mine Ventilation, by J. C. Gaskill..... 409

The Control of Ventilation..... 413

Book Review 414

Amortizing and Interest Charges for Coal Mines, by Louis Cleveland

Jones 415

Too Much Ventilation, by W. H. Booth..... 419

Coal Mining Institutes 420

Hogan on the Election of Mine Inspectors..... 421

British Tests for Miners' Safety Lamps..... 422

Coal Mine Ventilation in the Connellsville Coke Region, by Austin

King 423

Preparation of a Domestic Coal, by J. D. Rogers..... 426

Car Couplings 428

Facts and Theories Relating to Fans, by David M. Mowat..... 429

Testing for Firedamp With Wire Loop, by Henry Briggs..... 439

Waste in Coal Mining, by A. J. Moorshead..... 441

Practical Talks on Coal Mining—

Formulas and Their Use—Gases Met With in Coal Mines—Mechan-

ics of Mining—Electricity in the Mines..... 443

Prize Contest 451

Letter Box—

Are "Heat Waves" Visible?—Changing Hoisting Ropes—Law

Regarding Mine Inspectors—Booster Fans..... 454

Fast Hoisting at English Collieries..... 455

Examination Questions—

Colorado Mine Inspectors, 1911 (Concluded)..... 456

The Use of Explosives in Coal Mines, by F. H. Gunsolus..... 459

Humidifying the Air—Current, by Jesse K. Johnston..... 460

New Mining Machinery—

New Safety Catch for Hoists—Pipe Cutter—Temporary Electric

Bond—Brownell Engine—Gasoline Rock Drill—The Spiro Steam

Turbine—Two Speed A. C. Motor for Mine Fan Drive—Electric

Hoist 465

Trade Notices 466

Catalogs Received 466

Squibs—

Coal Discoveries in Holland, 414—Coal in Transvaal, S. A., 418—

Employes' Association of River Coal, 418—The Unit of Quantity,

the Coulomb, 442—Briquets in Wales..... 458

With this issue, Mines and Minerals appears under its former name - The Colliery Engineer. It will be devoted entirely to the publication of the best literature on modern methods of coal mining and the preparation of coal for market. With several new departments it will be the most useful and interesting journal for all classes from miners to mine managers and owners.

*Rufus J. Foster
Managing Editor.*

WHEN a mine official really thinks he knows it all and that there is nothing more for him to learn about coal mining, it's time for him to resign, and thus avoid being discharged later for incompetency.

來 來

THE mine official who learns from every available source is the man who gets to the top and eventually fires the subordinate who knows it all and has nothing more to learn.

來 來

MANY years ago THE COLLIERY ENGINEER called attention to the well-founded supposition that the barometric pressure was a good index to the variation of outflow of methane in coal mines. From time to time this subject was called to the attention of its readers, and in connection with numerous gas explosions the barometric pressure of the atmosphere was noted. In all of these cases it was remarked that large outbursts of gas, other than those due to squeezes or heavy falls, were coincident with a falling barometer.

In our issue of last September we published an interesting article showing the result of the investigations of Messrs. J. W. Hutchinson and Edgar C. Evans, which strongly corroborated the fact that barometric pressure influenced the outflow of gas.

The attention of officers of the United States Weather Bureau was drawn to this article, and at the suggestion of Dr. J. A. Holmes, Director of the Bureau of Mines, the Weather Bureau has arranged to send to the American coal mines warnings of impending barometric changes.

來 來

Breaking an Agreement

THE constantly recurring strikes in the anthracite coal regions because non-union men are employed at the mines, or because certain mine employes refuse to join the union, are gross violations of that portion of the agreement made last spring which reads "No person shall be refused employment, or be in any way discriminated against on account of membership or non-membership in any labor organization, and there shall be no discrimination against or interference with any employe who is not a member of any labor organization, by members of such organization."

This agreement was entered into in good faith by the operators' committee and the United Mine Workers of America through its National President, John White, and a committee consisting of district presidents. Mr. White and his associates labored long and strenuously in the interest of the men they represented. They secured certain advantageous terms for the miners, and, relying on the loyalty of their followers, pledged them to a strict adherence to the agreement by affixing to it their official signatures. The breaking of the agreement by such strikes as mentioned above is contrary to Mr. White's ideas of fairness, and he has time and again emphatically expressed his disapproval of them. He has told his followers in plain language that if they expect others to keep an agreement, they must themselves strictly adhere to their part of it. In this policy Mr. White has the support of the most intelligent members of the organization. But there are members who permit themselves to be misled in some instances by men who do not realize the true principle of an agreement, or by men who are mischief makers and enemies of the United Mine Workers as an organization. In John P. White, the United Mine Workers have as a leader a man of strong character. His honesty and loyalty to his organization cannot be questioned. He is a man who commands the respect of his opponents by his honesty and fairness. He is worthy the loyal support of his organization and has time and again proved it. The members of the organization who listen to and follow emissaries of other organizations, and particularly those of the organization known as the Industrial Workers of the World, and by their advice break the agreement, should be disciplined by the United Mine Workers, and if they persist in such actions, they should be regarded by the loyal members as worse enemies

of the organization than any other class of men, and the fellows who lead them into acts disloyal to the organization and its pledged policy should be so ostracized as to cause them to leave the region.

來 來

John Fritz

JOHN FRITZ, the grand old man of the iron and steel industry died at his home in South Bethlehem, Pa., on February 13 in his ninety-first year. The engineering profession knew *John Fritz*, or "*Uncle*" *John Fritz*. Mr. Fritz was only heard when comparative strangers or very young engineers spoke of or to him. By birth he was of German and Scotch-Irish blood, a mixture which has given to America many men who have been an honor to the nation.

His educational advantages in youth were limited, but no man could class John Fritz as an uneducated man. He gained the greater part of his education, and all of his professional skill, in the school of experience, in which he was a faithful student and a keen observer.

His character and his engineering skill and achievements won for him not only respect and honor in America, but leading scientific societies of Europe honored themselves by honoring John Fritz.

Space is too limited to even attempt to outline his engineering experience and accomplishments, or to portray his energy and kindly character. The latter, however, are well stated in the two following quotations, the first from Mr. D. A. Tomkins, a former subordinate, and the second poetical one, from Dr. Rossiter W. Raymond, one of Mr. Fritz's oldest friends:

"The best work done by him was the training of the young men who worked under him."

"Whose heart is warmer than his blast?
Whose faith more steadfast to the last
Than any steel he ever cast?
That figure hits
John Fritz.

"Whose fame commands our homage, such
As bears of envy not a touch,
Because we love the man so much?
Why, there he sits—
John Fritz."

來 來

Coal Mine Laws

MINE workers, mine officials, and mine owners have a common interest in the enactment of laws regulating the working of coal mines in a manner that will provide a maximum degree of safety to the mine workers and mine property. The framing of such laws requires extreme care and a broad knowledge of both practical mining and the technical principles involved. In framing such laws, politics or the differences existing, or likely to arise between capital and labor should have no consideration whatever.

If laws to regulate the relations between employer and employe are necessary, they should be separate enactments. They have no place in a law, the sole purpose of which is the safeguarding of life and property.

The man who tries to inject into a mine law, either directly or indirectly, a measure that is for any purpose other than the securing of safety, no matter whether he be mine official, mine worker, or politician cannot be too severely condemned by all interested in the industry.

If he attempts to inject provisions in the law that are foreign to the purpose of such a law, and which also weaken it in its true function, his action is that of an enemy to both mine worker and mine owner, and he is also a traitor to the class he professes to represent.

A mine law to be effective must be enforced. Mine Inspectors must inspect and enforce the law. They must be men of broad experience and of superior mining education. They must be absolutely independent and honest in their official acts. They must not be under obligations to any one. They must be paid fair salaries and in return must devote *all* their time to their official duties. No opportunities should be afforded politicians and "trimmers" to secure positions as State Mine Inspectors.

來 來

Taxing Coal Lands

THE question of the proper method of levying taxes on coal lands is one that is attracting attention in several states. In Pennsylvania, and particularly in some counties in the anthracite region, assessments have been based on the "foot-acre." Or in other words on the thickness in feet of workable coal under each acre of surface. This method of assessment is inaccurate, unfair, and a source of trouble.

It is inaccurate, because no man can tell what local conditions affecting the value of the coal will be met with in mining it. Two tracts of coal land lying side by side, may be, and often are, of widely differing values. Surface indications may show practically the same features. Actual mining may show radically different conditions. One tract may offer natural conditions under which practically all the coal may be mined. The conditions existing in the other tract may be such that only one-half or two-thirds of the coal can be mined. These conditions are often unknown until actual mining is being done. Under such circumstances, the first tract has from 50 to 100 per cent. greater value than the second. To assess two such tracts alike is manifestly inaccurate and unfair.

To make an accurate assessment on the coal in the ground requires an accurate knowledge of the geological conditions affecting each acre. Such knowledge can only be acquired with a fair degree of accuracy by careful and complete surveys and frequent geological cross-sections made by capable mining engineers. The cost of such work by men capable of doing it best, would be prohibitory. When done, no honest, capable mining engineer, would attempt to give more than a fairly approximate estimate of the coal in each tract, and further, he would

not assume that such an estimate was a fair measure of the amount of coal that could be profitably mined.

Besides, there is as great a variation in the value of the coal in different tracts as there is in the value of city lots or farm property.

In many bituminous coal regions there are vast tracts of coal land which cannot be worked under present conditions, the conditions in general being lack of market or lack of facilities to get the coal to market. The same is true in the anthracite regions, but for a slightly different reason. In some cases, particularly in the heavy pitching measures of parts of the anthracite field, the conditions are such that even with present market prices the coal cannot be mined and prepared for market at such cost as will yield a profit. To tax such coal lands by the foot-acre, is not only inaccurate and unfair, but it also results in time to a partial if not a complete forfeiture of the owners' property.

As an anticonservation measure the taxing of coal lands by the foot-acre will be a success. It will compel many coal land owners to mine the coal held in reserve for future use. This will flood the market, prices will necessarily drop to a ruinous figure, lower wages will follow and partial time only will be worked. It will result in the speedy mining of the cheapest mined coal and the wasting of millions of tons unminable under such conditions. It will by this means hasten the exhaustion of, and cause enormous waste in, the greatest source of prosperity the nation possesses.

No rational man believes that the coal-mining industry should not bear its share of taxation. But it should bear only its share. The only just way to levy a tax is on the tonnage produced each year. The surface improvements and such surface area as is used for income-producing purposes should be fairly assessed as is the case with other industrial plants, but allowance should be made for the rapid deterioration due to excessively hard wear on machinery and buildings and to the fact that the exhaustion of the coal detracts from the plant's value every year.

Advocates of the foot-per-acre tax on coal lands contend that such a policy results in a tax that the general public, or coal consumers, will not feel. Such a contention is a mistake. Most coal-mining companies own the coal they are mining, in fee simple, and they naturally include taxes paid, or levied, in operating expenses, and as the cost of production, under normal conditions, regulates selling price, it makes no difference whether the tax is levied one way or the other.

The comparatively few operators mining from leased lands would of course, not pay the tax, if levied by foot-acre, and they would be given an unfair advantage, which would last until their leases expired. When they made new leases or renewed their old ones, they would naturally be compelled to pay a proportionate increase in royalty, and that of course will add to cost of production.

To tax coal properties on the tonnage produced is the only fair method, and it is one that is simple in operation, and it will avoid constant and expensive controversies.

PERSONALS

Geo. Watkin Evans, coal mining engineer, of Seattle, has recently moved into larger quarters, and will be found at 423-24-25 New York Block, Seattle, Wash. He will continue to specialize in coal mine examination and coal mining engineering.

Sir Richard McBride, Minister of Mines, for British Columbia, sent out in January a "Preliminary Review and Estimate of the Mineral Production of 1912 for British Columbia." The people of British Columbia are justly proud of their hustling Minister of Mines.

Wemyss Jackson has been appointed General Sales Agent of the Consolidated Indiana Coal Co., with headquarters at 139 West Van Buren Street, Chicago, Ill.

Frank Ragan has been appointed District Sales Agent of the Consolidated Indiana Coal Co., with headquarters at 403 Terminal Traction Building, Indianapolis, Ind.

Alfred Knight Chittenden, Forester in the United States Indian Service, Department of the Interior, has been appointed assistant to the Director of the Engineering Experiment Station and Lecturer on Timber and Timber Resources in the College of Engineering of the University of Illinois.

In our Letter Box of January the writer of the interesting letter on shaft sinking was Samuel Haines, of Negaunee, Mich., not Samuel Harris as signed.

W. R. Ingalls, Editor of the *Engineering and Mining Journal*, delivered a lecture to the members of the Lackawanna Chemical Society on the occasion of their annual dinner, February 27 last.

F. A. Hill, of Pottsville, Pa. is general manager of coal mines for Madeira, Hill & Co., of Philadelphia. This company operates in the anthracite and bituminous coal fields of Pennsylvania.

Dr. James Gayley the inventor of the dry-blast process who began as a steel chemist and afterwards became

first vice-president of United States Steel Corporation, has received the Sir William Perkin medal for achievements of high value in applied chemistry.

James S. Thompson, Division Superintendent of the C. F. & I. Co., in Las Animas County, resigned to accept a position with the Albuquerque-Cerillos Coal Mining Co., with headquarters at Albuquerque, and mines in New Mexico.

W. B. Lloyd, of Trinidad, well known to the readers of *Mines and Minerals*, is Secretary of the Prospect Coal Co., with headquarters at Trinidad, Colo. Mr. Lloyd will probably continue to represent THE COLLIERY ENGINEER in southern Colorado.

Thomas Harvey, formerly of Forest City, Pa., is now superintendent of the Sugarite coal mine of the St. Louis, Rocky Mountain and Pacific Co. He made his advent in the West with the Bureau of Mines instruction car, and as he is a good student and practical miner he will be heard of again.

C. P. Collins, of Johnstown, an expert sanitary engineer who had much to do with the installation of the very efficient plant in Providence, R. I., is now engaged for the Berwind-White Coal Mining Co. in designing a sewage disposal plant for the town at their new No. 42 operation. He is also designing a plant for the treatment for bacteria of the domestic water supply of various mining towns of the Berwind-White Coal Mining Co. in that locality.

Telford Lewis, formerly a mining engineer of Johnstown, Pa., who has for many years been general manager of the Knickerbocker Smokeless Coal Co., at Hooversville, is interested in the formation of a selling agency known as the Knickerbocker Fuel Co. with its principal office at No. 1, Broadway, New York, who will sell the output of the Hooversville and other mines of the district.

James Crosby Brown and Davis L. Lewis, of the firm of Brown Brothers & Co., bankers, of Philadelphia, and Vance G. McCormick, of Harrisburg, who are interested in coal properties in the vicinity of Portage, Pa.,

recently spent some time in the district in a hasty examination of their various interests. They were accompanied by Andrew B. Crichton, mining engineer of Johnstown, and John E. Evans, attorney at law, Ebensburg, Pa.

J. C. McSpadden, the Rockwood contractor, who has had much to do with the development of southern Somerset County, Pa., especially with the building of its various highways and railroads, has entered into the coal business and is developing a mine on property he owns just west of Rockwood, the product from which will be shipped over the new Connellsville Division of the Western Maryland Railroad. The operation is on the C' seam on a tract of 500 acres of land.

John E. Ashley, who for the past 6 years has been mine foreman of the Cambria Steel Co.'s Rolling Mill mine, has resigned to accept a position with the Ebensburg Coal Co., at their new Cambria County operation at Colver, Pa.

T. D. Morgan, formerly foreman of the mines of the Bolivar Face Brick Co., Bolivar, Pa., has accepted the position of superintendent of the Sunnyside Coal Co., at Johnstown.

OBITUARY

PROF. GEORGE A. KOENIG

Prof. George A. Koenig, of the Michigan School of Mines died in Philadelphia in January. Professor Koenig received the degree of M. E. at Karlsruhe; degree of A. M. and Ph.D. at Heidelberg; attended the Mining Academy, Freiberg, Saxony, in 1867-68. He was connected with the University of Pennsylvania, teaching in chemistry, mineralogy, and geology from 1872 to 1892, after which he taught in the Michigan School of Mines. He discovered a number of new minerals, and did considerable research work along chemical and mineralogical lines. He joined the American Institute of Mining Engineers in 1894 and has contributed papers to various scientific societies and journals.

COAL MINING & PREPARATION

Coal Stripping in Kansas

STRIPPING and open-cut mining in Cherokee and Crawford counties

of southeastern Kansas, the Pittsburg coal district, has become a large industry. Already 15 steam shovels, with which the shallow lying veins

The Use of Steam Shovels to Remove the Prairie Soil Overlying Coal Seams Near the Surface

By Barry Scobee*

strip to a depth of 30 feet. The dirt they pile up looks like small mountain ranges from a distance; and the machines are actually making a

than undercutting and more effective, for in many places the coal is hard. The shooting pro-

gresses with the work of the shovelers, who are on hand with mine cars the minute the coal is broken by the blast. All of the strip-pit hands

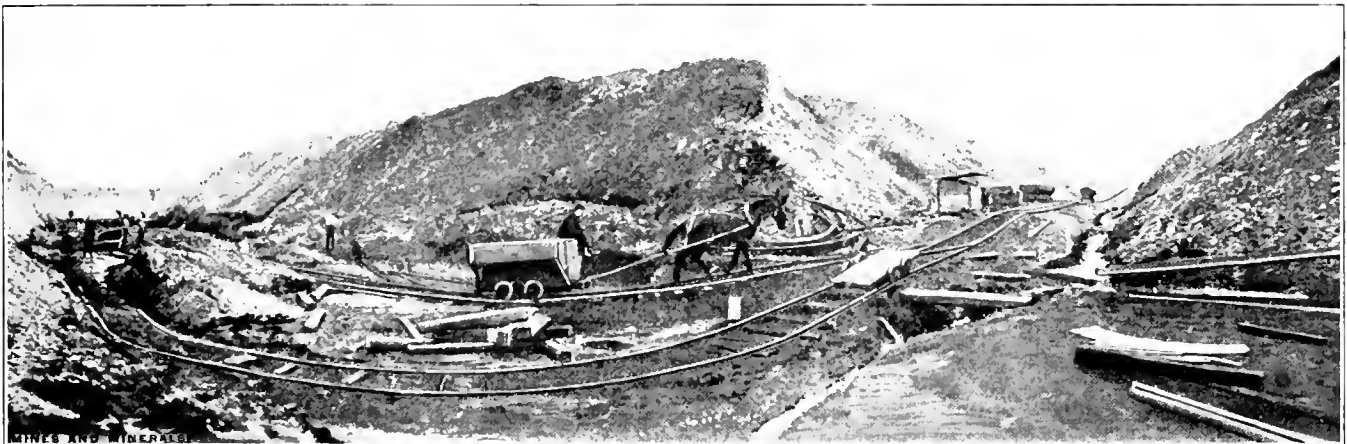

A STRIP PIT COAL MINE IN SOUTHEASTERN KANSAS

of soft coal are uncovered, have been put to work and others are being installed. The coal, from 14 to 28 inches thick, is from 9 to 35 feet below the surface of a considerable portion of the two counties, which adjoin the Joplin mineral fields. The fuel beds are too thin to mine in the ordinary way, besides have no rock roof, and as the operators have exhausted partly the thicker veins far below, they are making use of steam shovels where the coal does not lie at a depth to exceed 30 feet.

Two of the shovels at work are remarkable for their size, being, it is claimed, the largest in the world, not excepting any even that are used on the Panama canal. They have 90-foot booms with 50-foot thrust arms to the dipper shovels and will

prairie country into broken land, for they leave ridge after ridge where they pass.

About 500 men are employed in the pits, and they have a division of the United Mine Workers' union all their own. Many men who will not work in underground mines are glad to get employment here, for the dangers from bad air, explosions, and rock falls of course do not exist in mining with the "lid off."

Where the "crop" lacks 20 feet or so of reaching the surface, the average steam shovel used in this district will strip, if employed pretty constantly, 10 or 12 acres a year, and some of the holdings offer work for them for 10, 15, and 20 years.

The coal is "shot" from the top by holes placed a few feet back from the face, this method being quicker

here are being employed by the day.

The coal is hauled up the inclines from the pits by steam winches and cables and conveyed in the pit cars to the tipples at the railways, usually but a short distance away. Mules are used in the pits.

The country being decidedly prairie, there is but little slope for natural drainage and as a consequence the pit fills up with water in the rainy season and days are required to pump it out. In the spring of 1912, which was very rainy, shovels in some pits were under water for 2 or 3 weeks.

The cream of the shallow coal is being worked now, though not all of it is being touched by any means, the operators claim. They were inclined to reticence regarding costs, saying they have not been at work long enough yet to be familiar with

*Pittsburg, Kans.
33-8-3

them, but those given herewith are considered authentic, in fact, are the figures for one of the largest companies. Of the 15 shovels in the field very few, if any, are working in coal less than 36 inches thick, though the bed, taken all over the two counties where it crops close enough to the surface to be worked, averages not more than 20 inches in thickness.

The average thickness of covering being stripped now is between 17

duce 4,500 tons and the selling price will be, approximately, \$9,337.

The surface 6 feet of the covering material is dirt, soil partly; the next 6 feet below is soft shale or soapstone; and the portion below to the coal bed is blue shale. There is very little slate and the shovels work easily.

The average wage scale of the union for 8 hours' work is very close to \$2.50, varying from \$1.95 for a waterboy to \$3.05 for a blacksmith.

gasket being doubled upon itself, so that a part of the glass was not in contact with the gasket, and an open space was left between the top of the glass and the gauze. When this lighted lamp was inserted into an explosive mixture of gas and air, the gas flamed within the lamp and ignited the gaseous mixture outside.

The second explosion also resulted from a lamp being improperly assembled. In this case the pull bar which operates the scratcher



STRIPPING COAL WITH STEAM SHOVEL IN KANSAS

and 18 feet, a little running as shallow as 6 feet and some as thick as 24 feet. The Elsworth-Klaner people have what is claimed to be the largest steam shovels in the world and they say they will strip to a depth of 30 feet before all their coal is removed.

The amount of coal yield to the acre, on the average holding, is 4,500 tons, according to figures given out by various mine superintendents; and this is secured by the removal of less than 20 feet of soil.

The average cost per cubic yard for stripping and removing the covering material of the coal is between 5 and 6 cents. The dirt is removed no farther than the shovels will place it.

The average amount received per ton for the coal at the tippie is approximately \$2.07, running higher if anything. This is for lump or mine-run coal, the strip pits products not being screened. Figuring the average thickness of the coal bed as 36 inches, an acre will pro-

Most of the men receive from \$2.42 to \$2.62.

It is believed that this industry will develop to large proportions, because there are thousands of acres of coal yet untouched by the shovels, and it has developed from small landholders stripping very shallow crops with teams and scrapers for the last 15 or 20 years.

來 來

Use and Care of Safety Lamps*

Two disasters have occurred within recent months due to certain defects in miners' safety lamps. The lamps were of the modern naphtha or gasoline burning type with double gauze, shield, and glass globe. Each lamp caused an ignition of gas within a mine; in one case a dozen men were killed, and in the other case several men were burned.

The first explosion resulted from the parts of the lamp being improperly assembled, the top asbestos

for igniting the match that lights the wick was left out of the lamp. The lamp when lighted and placed in an explosive mixture of air and gas in every case ignited the gaseous mixture outside of the lamp.

A number of miners' safety lamps have been found in use in gaseous mines with the pull bar removed. To remove the pull bar is a most dangerous practice, and should not be allowed, since it renders the lamp as dangerous as an open-flame lamp.

At one mine where safety lamps with magnetic locks are used, fine holes were detected in the bases of several lamps. These holes had been drilled so that the lamps could be opened in the mine by the use of a pin or needle, thus nullifying the safety value of the magnetic locks.

Lamps should be carefully examined when they are turned in at the end of a shift, as well as when they are given out, in order that the miner or other employe may be held accountable for any alteration or damage to his lamp.

*Abstract from Miners' Circular, Bureau of Mines

Common Sense Mine Ventilation

What Constitutes Good Mine Ventilation From the Economic Standpoint and How to Obtain It

By J. C. Gaskill*

THE following paper, read at the West Virginia Mining Institute, gives some facts on the conditions met in mine ventilation and the distribution of air. Many are familiar with mine ventilation, but it is probable that all of them have not gone so deep into the subject as to determine what constitutes good mine ventilation from the economic end of the subject.

It is not necessary for a mine to have an overabundance of air, but it is necessary that it should have enough air to properly ventilate it and comply with the law. This will require that the air-current be split so as to avoid using doors on main haulage roads; and this air should be furnished with a reasonably low water gauge.

The question of what constitutes a low water gauge will depend on the quantity of fresh air wanted in the mine, the length of the airways, and the quantity of coal the mines are expected to produce per day. For example, take a mine producing from 400 to 500 tons of coal per day. This mine can be ventilated with a 3'×12' common fan, delivering from 50,000 to 55,000 cubic feet of air per minute. It is possible to do this with one main airway, provided the distance to the first room heading where the air is first split is not too great. It must be remembered that when the room headings are worked out the first air split will be abandoned, the second likewise, and so on, until after a while this 50,000 cubic feet of air, which started with a 1-inch water gauge, registers a 3-inch water gauge. Then the main airway is found to be too small and it is believed that a high-pressure fan will solve the problem of more air. After the high-pressure fan has been installed at a great expense, and is found to be running smoothly, it will be noticed that the water gauge remains at 3 inches for the same quantity, viz., from 50,000 to 55,000 cubic feet of air.

The next thing in order is to lay the blame on the fan and say it is not a good fan. If the mine is investigated carefully it will be found that the fan is not at fault; but that instead of one airway, through which to deliver 50,000 to 55,000 cubic feet of air at a 3-inch water gauge, there should be two airways, which would pass this same volume of air with one-fourth the water gauge, and at one-fourth the horsepower, for it takes four times the water gauge, and it requires four times the horsepower to deliver 55,000 cubic feet of air through one airway as it does to deliver the same amount of air through two airways of the same size and length.

The Consolidation Coal Co. is operating two fans of the same make, duplicates of each other. One was installed in October, 1910, at No. 43 mine, which had been in operation for about 18 years at that time. It had four main return airways 7 ft. × 10 ft., area about 4,000 feet in length. It was ventilated with a fan 8 feet wide and 11 feet in diameter, running at 224 revolutions per minute. The fan which replaced it is 6 ft. × 20 ft., and with a 3.5-inch water gauge, at 90 revolutions per minute, delivers 202,320 cubic feet of air per minute. This fan delivered 100,000 cubic feet of air with a .855-inch water gauge, and gave 119 per cent. volumetric capacity. The water gauge and quantity of air were the same on the old fan as on the new one; but the peripheral speed on the old fan was 7,740 feet, while on the new one it is 5,654 feet, a difference of 2,086 feet in favor of the 6'×20' fan.

The second fan referred to was installed in 1912 at No. 119 mine, which has been opened for 6 years and has three return airways, 3 feet 8 inches high by about 16 feet wide. It is 4,200 feet to the first air split,

and 3,800 feet from the first split back to the mouth of the mine. The fan gives 1.9-inch water gauge at 71 revolutions per minute

and delivers 71,000 cubic feet of air. With this fan, to deliver 100,000 cubic feet would require a 3.77-inch water gauge, and to deliver 200,000 cubic feet of air would require a 15-inch water gauge, besides the fan gives but 53 per cent. volumetric capacity.

Here are two practical tests at two mines of two fans, equal in dimensions, and of guaranteed capacity, built by the same company. Both fans have 10'×12' shaft openings, about 60 feet deep. One fan has proven to be all that was expected, giving 119 per cent. volumetric capacity, while the other is disappointing, in that it gave but 53 per cent. volumetric capacity. These practical tests of fans in service at the mines prove conclusively that mine conditions make good and bad mine fans to a large extent. Notwithstanding these facts, the company which made these fans issued a guarantee that both fans would deliver 250,000 cubic feet of air with a 6-inch water gauge.

The fan at No. 43 mine would deliver 250,000 cubic feet of air with a 5.34-inch water gauge, while the one at No. 119 mine would require a 23.56-inch water gauge. At No. 119 mine two airways are being added which will reduce the water gauge. Calculations show that the water gauge will be .99 inch for 71,000 cubic feet of air; subtracting 10 per cent. loss in air and 19 per cent. on water gauge, .8-inch water gauge remains for the 71,000 cubic feet of air through five airways 4,200 feet long, and four airways 3,800 feet in length. With similar conditions, 100,000 cubic feet of air will require a 1.6-inch water gauge, nearly. If 200,000 cubic feet of air is desired it will require 6.4-inch water gauge. This mine will require about 150,000 cubic feet of air per minute. The coal being low, it will not need so much air to obtain the same velocity

* Consulting Assistant Engineer, The Consolidation Coal Co., Fairmont, W. Va.

and for 150,000 cubic feet of air will require 3.4-inch water gauge.

It was known before this fan was put in commission that a high water gauge would be reached, so other airways had been provided for. Before the 6'×20' fan was installed this mine was ventilated with a 5'×14' fan, situated at the mouth of the mine. The new fan, 6 ft.×20 ft., is located over an air-shaft 8,000 feet from the old fan.

It is common to prepare specifications for a fan for some particular mine, and invite bids for its erection. One of the conditions required of the fan will be "250,000 cubic feet of air with a 6-inch water gauge."

Almost any manufacturer will advise you that he can do "lots" better than this with a much smaller fan. Possibly he will not ask about the airways, but take chances on securing the contract for furnishing and installing the fan. Nine times out of ten this fan is to go to a new mine where the airways are short. It will do good work for a few years; but after a while the mine foreman complains that there is not enough air in the mine. The manager looks up the specifications and also the guarantee by the makers of the fan, and the foreman is directed to run the fan faster, as it is guaranteed to deliver the air. The air is not increased to an amount worth noticing, but a much higher water gauge is noticed. The manager and the mine foreman begin to think, look, figure, and finally discover the cause of the air shortage. It is more than likely that only one airway has been provided for in this mine where from 65,000 to 75,000 cubic feet of air are needed. One airway 7 ft.×10 ft., 6,000 feet long, will only pass 50,000 cubic feet of air; two airways of the same size will pass 100,000 cubic feet, with a reasonable water gauge of 2.85 inches, as 50,000 cubic feet of air in this size of airway gives a water gauge of .475 inch for every 1,000 cubic feet in length. If the airway becomes 3,000 feet in length one way, two ways would be 6,000 feet in length; 6,000 feet×.475-inch water gauge=2.85-inch water gauge, and it

is not long until the airways will reach this distance, and continue to be extended. Two airways will deliver 100,000 cubic feet of air per minute, three will deliver 150,000 cubic feet, and four 200,000 cubic feet, with a water gauge of 2.85 inches, where the airways are 6,000 feet long. Just as the length of the airway is increased, just so will the water gauge be increased.

Consider next the difference in horsepower and water gauge between 50,000 cubic feet of air and 100,000 cubic feet of air passing in the same airway 7 ft.×10 ft., 1,000 feet long. Using Fairley's value for the coefficient of friction or $k=.00000001$, then in equation $\frac{k s v^2}{a} = p$, $p \div 5.2 = 1.9$ inches water gauge for 100,000 cubic feet of air in one airway, while .476-inch water gauge will pass 50,000 cubic feet through this same airway. As this is one-fourth the water gauge, it will require one-eighth the horsepower, and if the airway is 3,000 feet long one way, it will be 6,000 feet long in and out. 6,000 ft.×1.9 in. = 11.4 inches water gauge for 100,000 cubic feet through one airway 6,000 feet long and would require 180 horsepower in air. All mining engineers and foremen understand from these figures that it would be impracticable to deliver 100,000 cubic feet of air through one airway of this size a distance of 6,000 feet against 11.4 inches of water gauge; but 100,000 cubic feet can be delivered through two airways 7 ft.×10 ft. area, 6,000 feet long, with a 2.85-inch water gauge and 45 horsepower in air. It will be necessary to add 40 per cent. to the horsepower in the air for friction of engines and fan wheels.

Assume that it is desired to know what total horsepower will be required to deliver 200,000 cubic feet of air through three airways 7 ft.×10 ft., 6,000 feet long.

It is found that 226 is the total horsepower that will be necessary, and the water gauge will read 5.08 inches. Thus it is possible for 200,000 cubic feet of air to be delivered through three airways of this size with 5.08 inches of water gauge

and 226 horsepower, but 200,000 feet of air can be delivered through four airways 7 ft.×10 ft. area, 6,000 feet long with 126 horsepower and 2.85 inches of a water gauge, thus saving 100 horsepower by adding one more airway. Five pounds of coal will be saved for each horsepower saved. $100 \times 5 = 500$ pounds of coal per hour, or a saving of 12,000 pounds of coal per day. If the coal is worth \$1 per ton it means a saving of \$6 per day, \$180 per month, or \$2,160 per year.

At all mines the water gauge should be kept down to at least 1 inch per 100,000 cubic feet of air, for everyday duty, and if it could be kept lower it would be better, as a 1-inch water gauge for 100,000 cubic feet of air means a 4-inch water gauge for 200,000 cubic feet of air.

It requires 40 pounds of water per horsepower per hour, and 1 pound of coal will evaporate 8 pounds of water per horsepower hour. Some engineers say that it will not take 40 pounds of water per horsepower hour, but in practice an instance is known where 52 pounds of water was used per horsepower hour, the case referred to being a steam engine, which was working below capacity with the boiler house not over 30 feet from the fan engine. My opinion is, that where from 80,000 to 100,000 cubic feet of air is required per minute, two intakes and two outlets should be provided; and where from 120,000 to 150,000 cubic feet of air will be needed per minute, three intakes and three outlets should be provided; and where 200,000 cubic feet is anticipated, four intakes and four outlets should be provided. If this practice is followed a great saving in the coal bill will result.

In providing these airways, it is important that all overcasts on main airways be large, that the slopes on each side of the top reach well back, and that they be filled in behind the sides to a slope of about 45 degrees, so as to offer the least resistance to air passing. All overcasts and brattices on main airways should be of concrete so as to prevent leakage.

For the last 10 years it has been the practice of the Consolidation

Coal Co. when opening a new mine to project on the map enough intakes, returns, and overcasts to ventilate that mine with a low water gauge. Where old mines were contending with a high water gauge, air-shafts were sunk to shorten the airways and lower the water gauge. At No. 26 mine an air-shaft was sunk 11,700 feet from the mouth of the mine and a 6'×20' fan and the necessary boiler plant installed. By moving the fan to this location it shortened the airway one-half; besides, the two return airways could be either the former outlets or intakes; four inlets were thus provided in place of two as under the former arrangement. Previous to the transfer of the fan this mine had but two inlets and two returns, but by moving this fan the water gauge was reduced from 3 inches for 100,000 cubic feet to 1.36 inches, thus notably demonstrating the practical value of shortening airways. It will be noticed that a 1.36-inch water gauge is too high for 100,000 cubic feet of air, as for where 200,000 cubic feet is required the water gauge would be 5.44 inches, which is too high to maintain in every-day practice. It may be, however, that this is the best that can be done with an old mine.

The saving of coal by moving this fan was calculated on the difference in actual total horsepower required on each engine, which was found to be 123 horsepower saved on 150,000 cubic feet of air. Five pounds of coal per horsepower per hour means 615 pounds of coal per horsepower hour, or 14,760 pounds, or 7.4 net tons per day of 24 hours. If coal is \$1 per ton, the cost is \$7.40 per day, or \$222 per month, \$2,664 per year. The water gauge on the new fan will be 3.06 inches for 150,000 cubic feet of air, and on the old fan it would require a 6.75-inch water gauge for the same amount of air. The new mines opened in the West Virginia coal field are Nos. 63, 32, and 84.

No. 63 mine was opened about 8 years ago and an 8'×20' fan installed. The mine inspector's report states that on October 17, 1912, this fan was delivering 151,510 feet of air

at 70 revolutions per minute and a 1.8-inch water gauge. This would equal a .78-inch water gauge for 100,000 cubic feet of air, and would require a 3.13-inch water gauge for 200,000 cubic feet of air.

No. 32 mine has been opened for 3 years. It has a 6'×20' fan, which was recently started. The mine inspector's report of September 26, 1912, states that this fan delivered 108,000 cubic feet with 48 revolutions per minute and .6-inch water gauge. This equals a .514-inch gauge for 100,000 cubic feet of air, and would require a 2.056-inch gauge for 200,000 cubic feet. It must be remembered that this mine is new and the airways are short.

No. 84 mine has no large fan, but has four return and four inlet airways 7 ft.×10 ft.

No. 43 mine, which has been referred to before, shows a rising in the water gauge. The mine inspector's report of October 16, 1912, states that this 6'×20' fan is furnishing 171,424 cubic feet of air at 84 revolutions per minute and a 3.2-inch water gauge. This equals 1.09 inches for 100,000 cubic feet of air, and will require 4.37 inches water gauge for 200,000 cubic feet of air. An air-shaft is being sunk at 8,500 cubic feet from the mouth of the mine to relieve this high water gauge.

At No. 3 mine, Frostburg, Md., the Consolidation Coal Co. had a 6'×20' fan installed some 3 years ago. This is an old mine, with large airways. The mine inspector's report of October 13, 1912, states that the fan at this mine is delivering 120,000 cubic feet with 68 revolutions per minute and a 1.1-inch water gauge. This would equal .76-inch water gauge for 100,000 cubic feet of air, and would require 3.04-inch water gauge for 200,000 cubic feet. There are some things concerning this fan to which attention is directed. The blades were put on backward, an error of the builders. The mistake was not discovered until after the fan had been completed and running some time. When the maker of the fan came to test it he found that his workers had made this error

and the fan was running the wrong way. It was for the writer to decide whether the maker should take down the fan and rebuild it correctly. He had not seen the fan since its erection and in making an examination found that a part of the wind box, surrounding the fan wheel, would have to come down. This wall consisted of brick and concrete, no steel being used. It was decided to let "well enough" alone, as the fan was doing its work. That was 3 years ago, and it is believed that this is one of the best fans the company owns.

From the foregoing arguments it will be seen that all fans will deliver air when given a low water gauge. Some fans have a larger volumetric capacity than others, which is a good thing, as such fans can be run at slower speed and make the same water gauge.

The Consolidation Coal Co. has adopted the same method for the ventilation of their new coal field in Elkhorn division, Kentucky. The mines are all projected on the map of the coal field, showing how the mines will be developed and the amount of coal each mine is expected to produce and the amount of air to be put into each mine. Then the proper number of airways are projected on the map, together with all overcasts, so as to handle this amount of air with a given water gauge. The large mines from which it is intended to produce not less than 2,000 tons of coal per day, are expected to require about 200,000 cubic feet of air per minute when fully developed.

In these large mines there will be four return airways and four intakes, each of which will average 6½ feet high by 10 feet wide, making an area of 65 square feet. From the fan to the first split is generally about 1,200 feet and at that point two pairs of cross-entries turn off—two to the right at about 1,200 feet and two to the left about 1,320 feet—so that they will not come in the way of each other's switches, as the cross-entries are turned with a 112-foot radius curve. Each of these two pairs of entries will have four room entries, making eight room entries for each

25,000 feet of air, and these four room entries will be ventilated with one split of air of about 12,500 cubic feet to each four room entries, which will be about 1,000 feet long. Cross-entries will be turned every 2,100 feet, and room entries turned both ways from the cross-entries. I will give you the water gauge that calculations show will be made in passing 200,000 cubic feet of air to the first, second, third, and fourth splits. The water gauge to the first split which, say is 1,260 feet, an average between the two pairs of cross-entries where is taken 50,000 cubic feet of air for these four entries is as follows: Using Fairley's coefficient of friction, which is .00000001, the water gauge for 200,000 cubic feet of air will be
$$a = p \div 5.2 = .72 \text{ inch}$$
 for the first 1,260 feet. The next 2,100 feet it will be 150,000 feet of air, and the water gauge will be
$$\frac{k s v^2}{a} = p \div 5.2 = .68 \text{ inch.}$$
 The next 2,100 feet will have 100,000 cubic feet and the water gauge will be
$$\frac{k s v^2}{a} = p \div 5.2 = .3 \text{ inch water gauge.}$$
 This leaves 50,000 cubic feet of air to ventilate the next four cross-entries, which will be the fourth and last split until the No. 1 split has been done away with. The distance is 2,100 feet and the water gauge will be .071 inch for one way. These water-gauge values are multiplied by 2 to get the water gauge for the mine. There are for the 1,260 feet and 200,000 feet of air, four airways $6\frac{1}{2}$ ft. \times 10 ft., and a water gauge of .72 inch; call this No. 1 split. No. 2 split is 2,100 feet long, has 150,000 cubic feet of air, has four airways $6\frac{1}{2}$ ft. \times 10 ft., with a drag equal to a .68-inch water gauge. No. 3 split is 2,100 feet long, has 100,000 cubic feet of air, for four airways $6\frac{1}{2}$ ft. \times 10 ft., and a drag equivalent to a water gauge of .3 inch. No. 4 split is 2,100 feet long, has four airways $6\frac{1}{2}$ ft. \times 10 ft., passing 50,000 cubic feet that gives a water gauge of .071 inch. These water gauges doubled, will make a water gauge of 3.54 inches. Figuring that there will be a loss of at least 10 per cent. in air,

which means a loss in water gauge of 19 per cent., then 19 per cent. from 3.54 inches leaves 2.87 inches water gauge for 200,000 cubic feet of air on the whole mine to this point. The splits to the cross-entries show a water gauge of only .071 inch for 2,100 feet with 12,500 cubic feet of air, so that the water gauge on main airways is always higher than the cross-entry water gauges.

All regulators on cross-entries should be placed near the main airway and must not be placed beyond the first room entry under any consideration.

Relative to the 19-per-cent. reduction in the water gauge, the writer has found this loss to reach as high as 25 per cent. in practice. It is safe, therefore, to call it 19 per cent., as 10 per cent. loss in air means 19 per cent. reduction in water gauge, and 20 per cent. loss in air means 34 per cent. reduction in water gauge. This reduction is not all from loss of air, but from air passing breakthroughs and wide places which reduce its velocity.

At some of the Consolidation company's mines there are three inlets and four returns, and it is about 1,000 feet to the first split. To pass 200,000 feet of air through three airways $6\frac{1}{2}$ ft. \times 10 ft. for 1,000 feet will require 1.027 inches water gauge. There are four return airways and the water gauge on them will only be .57 inch for 1,000 feet of length, making a 1.59-inch gauge total in and out, the 1,000-foot long one being one way, while four airways each way for 1,260 feet make 1.44 inches total water gauge for the 200,000 cubic feet of air in and out. With 200,000 cubic feet of air passing with 2.87-inch water gauge it will require 90.4 horsepower in the air, or a total of 127.5 horsepower in air, motor, and fan wheel.

The mine fans in the Elkhorn field will be operated by 150-horsepower alternating-current motors, which should not produce so much frictional resistance as a steam engine working below capacity, for the reason that the motor will run at regular speed at all times, and by

having different-sized pulleys for the motor shaft any speed needed for the mine fan can be obtained. Even should the motors have the same friction in fan wheel, the 150-horsepower motor will work until the water gauge becomes higher and then a larger motor can be installed. The fan, 5 ft. \times 14 ft., should furnish 200,000 cubic feet of air at from 145 to 160 revolutions per minute at this water gauge and the volumetric capacity should be at least 180 per cent.

A boiler plant will be erected at each of the mines near the fan house, for the purpose of adding steam to the air-current whenever there is need of putting water vapor in the mine air, a plan that makes it unnecessary to do any watering to dampen the coal dust.

At one mine there was a fan 7 feet wide and $13\frac{1}{2}$ inches in diameter, which was delivering 116,000 cubic feet of air at 112 revolutions per minute with a water gauge of 1.3 inches. The fan was being driven by a 125-horsepower motor, and was guaranteed to deliver 300,000 cubic feet of air per minute against a 6-inch water gauge, at 300 revolutions per minute. At that time this mine was new and the airways were not long. But suppose 300,000 cubic feet of air had been desired while the airways were short. The water gauge would increase as the square of velocity and the horsepower as the cube of the quantity of the air. The water gauge and horsepower for each 25,000 cubic feet of air would increase from 100,000 cubic feet up to 300,000 cubic feet, as follows: Take 100,000 cubic feet as a base of beginning the illustration. The fan delivers 116,000 cubic feet of air on a 1.3-inch water gauge, which is equal to .966-inch water gauge for 100,000 cubic feet of air. Use Fairley's formula for the coefficient of friction (.00000001), and the water gauge for 100,000 cubic feet as a base of calculation. The volume of 116,000 cubic feet with 1.3-inch gauge could be used, but it is better to take 100,000 cubic feet, for the reason that the water gauge and total horsepower is in pounds for each 25,000 cubic feet increase of air.

From the assumed data, 100,000 cubic feet of air with .966-inch water gauge, the following results are obtained:

Cubic Feet of Air	Total Horsepower	Water Gauge Inches
100,000	21.5	.966
125,000	42.0	1.500
150,000	72.0	2.170
175,000	114.0	2.950
200,000	171.0	3.860
225,000	224.0	4.890
250,000	336.0	6.040
275,000	446.0	7.300
300,000	575.0	8.690

Allowance has been made in this calculation for 71 per cent. mechanical efficiency on horsepower for friction of motor and mine fan.

來 來

The Control of Ventilation

By Special Correspondent

No colliery manager in these days requires to be informed that the regulation of ventilation is one of the most important factors in the safety of his employes; or that efficient ventilation has a most important bearing on the output of the colliery. It will therefore be understood that the days for the old rule-of-thumb methods with regard to the supply of air to collieries have passed, and that it is one of the objects of every up-to-date colliery engineer to note precisely what air is being delivered into the workings and in what way it is being distrib-

uted. From both these points of view it is highly necessary that some form of measurement should be instituted as to the volume of air which is being passed into the mine.

consists of a cylindrical body *A* in which are filling tubes *B*, a pressure pipe *C*, and a suction pipe *D* connected to a double cock *E* by means of which the difference in pressure

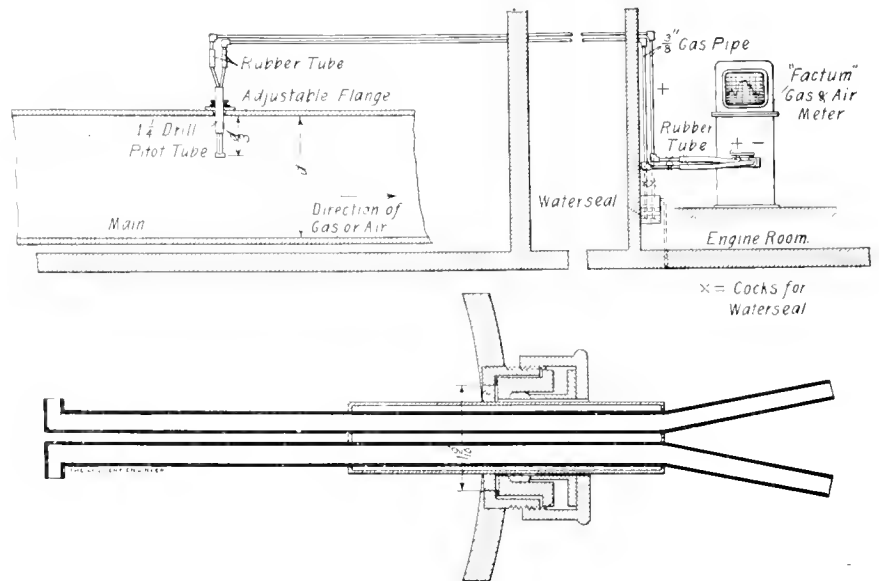

FIG. 2. METHOD OF INSTALLING AIR METER

An interesting instrument for this purpose is now being made in England, and is known as the "Factum" air meter or volume recorder. Its construction and method of operation will be observed by reference to Figs. 1 and 2, the former showing a partial vertical section while the latter shows diagrammatically the way in which this meter is installed. It will be seen that the instrument

created by the Pitot tubes installed in the airway is conveyed to the instrument by the tubes *C* and *D*. The float *F* is self-balanced and is supported in special non-evaporative oil, *G* being float guides and *H* lifting eyes for the float. It will be seen that the motion of the float is directly transmitted to *L*, a writing pen gear which operates on a chart placed on the drum *U*. This drum is revolved by means of the clock *L* and the gear is covered by a metal hood *O* to keep dust and dirt from interfering with the mechanism. The rubber disk *P* insures that the joint is perfectly sealed. Combined with the instrument is a depression recorder, the meter of which is shown at *R*, *S* being its float, and *T* being the pen gear of the depression meter. At *U* will be noticed the necessary small connection with the external air to obtain the atmospheric pressure. The method of installation requires no further description than is contained on the drawing Fig. 2.

As the speed of the air in the airway increases in the proportion of the square of the difference in pressure, the speed itself can be

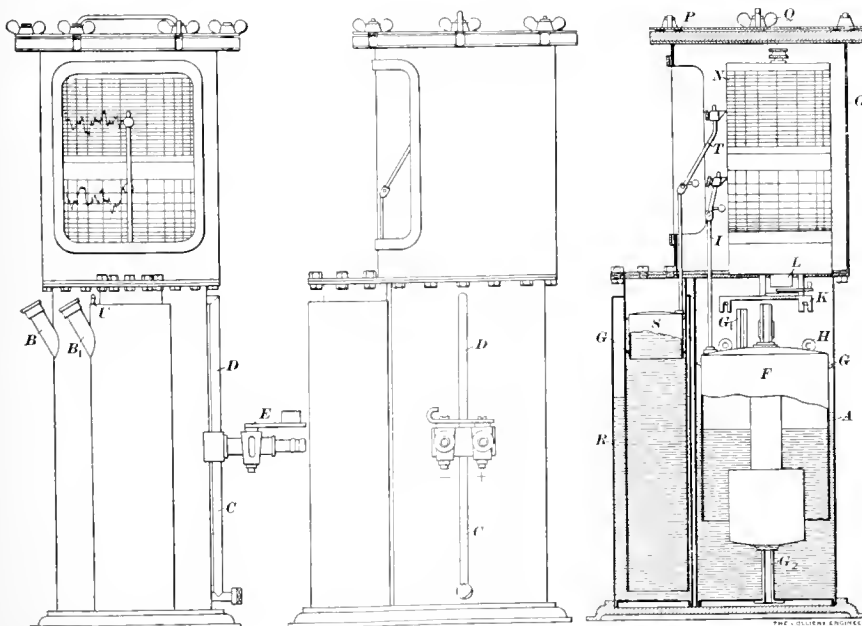
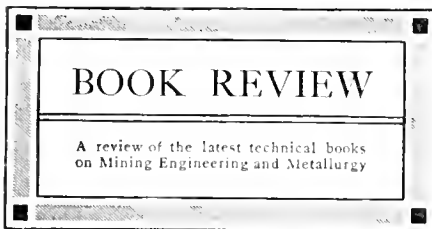

FIG. 1. FACTUM AIR METER AND VOLUME RECORDER

recorded on the chart. By making use of the formula

Volume = Speed · Area of Airway
the actual volume of gas is recorded on the chart to a suitable scale, and these indications can be made in cubic feet per second or per minute as desired. It should be noted that the distance between the instrument and the place of measurement has no influence on the readings, so that this simple apparatus is of very considerable importance to the mine manager who desires to accurately determine the distribution of the air in his colliery workings. Another important feature in the accuracy of the method is that the Pitot tubes effect no such interference with the draft as would disturb the accuracy of the reading.



CYANIDE PRACTICE IN MEXICO, by Ferdinand McCann. 194 pages and index, with 39 illustrations. Price \$2. Mining and Scientific Press, San Francisco, publishers. Mr. McCann treats his subject entirely differently from the textbooks on cyaniding, evidently assuming the reader knows that end of the subject. This makes the book descriptive of the cyanide practice at the following mills: El Oro Mining and Railway Co.; El Oro, Ltd.; Dos Estrellas Co.; Esperanza Mining Co.; Guanajuato Consolidated Mining and Milling Co.; Real del Monte y Pachuca C^o., Blaisdell Coscotillan Syndicate, Compania Beneficiadora de Metales Hacienda de San Francisco, San Rafael y Anexas Co., Lucky Tiger Combination Gold Mining Co.; Veta Colorado, of Parral, Chih. The method of treating the subjects, without going into the detail of machinery construction or chemical reactions is as follows: Grinding, Regrinding and Classification, Slime Treatment; Precipitation and Melting; Extraction;

Chemical Consumption, and Cost of Treatment. Each statement is apparently official and concise; for instance, in Chemical Consumption at El Oro Limited, the author states: "Each ton of ore treated consumes 1.5 pounds KCN; from 1 to 1.2 pounds metallic zinc; from $\frac{1}{4}$ to $\frac{1}{2}$ pound lead acetate, and from 15 to 20 pounds of lime. The same concise statements are rendered in describing other plants, the subheadings necessarily varying to suit conditions involved. Probably no other book on cyaniding so far written is so well suited to the practitioner as this one.

MODERN MINE VALUATION, by M. Howard Burnham, 160 pages, 19 illustrations, cloth. Griffin & Co., London, and J. B. Lippincott Co., Philadelphia. This work has been prepared for the practicing mining engineer. It deals with the matter of estimating the values of mining properties from the sampling of the ore bodies. Nothing is said of the wholly undeveloped property—the prospect—and it is assumed that all ore reserves are of the vein type, or are, at least, in tabular forms. With this restriction, apparently unconscious on the author's part, the book is a very carefully prepared analysis of the methods to be practiced in taking samples of veins of varying "strike, thickness, color, texture, parting, and pay, such as might be observed when stoping, as practiced or practicable." The ordinary custom of cutting grooves is followed by this writer and he has presented numerous sketches to show how such grooves should be cut in various shapes of drifts and backs of stopes.

Mr. Burnham is a firm believer in the modern idea that a mining engineer should also be a good business man and should be held responsible for the successful financing of every mine he examines. Accordingly, this book contains many tables on sinking funds, life of mines in terms of dividends, varying risk rates, delayed dividends, and similar economic features, and these are well worth study, although largely prepared from the British view point. The analytical portions of the book show that the

author writes from experience; it is quite likely that the average reader will pass over the higher mathematical solutions and be content to accept the author's conclusions.

MODERN COPPER SMELTING, by Donald M. Levy, Griffin & Co., London, and J. B. Lippincott Co., Philadelphia, 259 pages, 76 illustrations, cloth. The author may be pardoned for adopting a title that was used years ago by our American authority on this subject, on two counts, viz., he admits that Doctor Peters' work is a classic and also that there "exists a scope, particularly on this side of the Atlantic (the eastern side) for a compact volume dealing broadly with the principles underlying modern copper smelting." The first three chapters deal with generalities that have little bearing on smelting, as development of the copper industry, prices, costs of production, uses for copper, alloys, impurities, mechanical and chemical properties, compounds and ores, and sampling. In the succeeding chapters, preliminary treatments, briquetting, sintering, roasting, reverberatory smelting, blast-furnace practices, pyritic smelting, disposal of products, bessemerizing of mattes, converter linings, refining, and casting, form the special topics. A commendable feature of the book is the extensive list of references, at the end of each chapter, to recent published articles in the technical press. The book deals almost exclusively with American practice as exemplified at Anaconda and Ducktown, at which places the writer evidently spent considerable time in study.

來 來

Coal Discoveries in Holland

Good progress is reported in connection with the mining explorations which are being carried out in the province of Gelderland, near Winterswijk. The coal formation, consisting of five seams covered with an important bed of salt, has been reached. The borings of the state engineers have been completed to a depth of 485 meters. Coal has also been discovered in Overijssel.

IN Transactions of American Institute of Mining Engineers, Vol. 41, 1911, pages 912-913, in a discussion of a paper by J. B. Dilworth, is given Professor Merriman's formula for calculating sinking fund, thus:

When S = principal to be extinguished;
 Q = periodical payment of charge for sinking fund;
 B = Balance unpaid to date of n th payment, but before the payment is made;
 r = rate of interest per period per cent.;
 n = number of payments or periods.
 Then $Q = \frac{S(1+r)^n}{1+(1+r)^n - (1+r)}$

By this formula the accompanying Table 1 has been calculated to give the equal annual payments required to extinguish the cost of coal in ground. Though column G gives figures at 6 per cent., 8 per cent. is considered a more liberal figure to cover inter-

Amortizing and Interest Charges

For Coal Mines (Leasehold and Fee)—Costs of Carrying Unmined Coal in the Ground—Economical Period for Exhausting Mines

By Louis Cleveland Jones*

est, insurance, administration, and taxes, and most of the figures of the table are on this basis.

Certainly 8 per cent. is not too much to cover the always present risk of faults and other irregularities which may at any time greatly depreciate the estimated value of a coal property.

From the figures in the table have been plotted on accompanying charts, curves graphically representing the relations between the various cost factors due to interest, royalty, and other fixed charges against the coal as mined.

From this table and these charts (applicable to any kind of mine or quarry), it is possible to compare any leasehold mining proposition with the corresponding purchase of the mining land in fee. Further, there is indicated for any given cost of plant and coal in the ground, the most economical rate of exhaustion.

When Operator Owns Coal.—For example, when owner and operator are identical, with 1,000 acres of land containing 5,000,000

tons of coal, with plant cost equal to the annual output, and when coal cost in the ground is 2 cents or less, the most economical rate of exhaustion is about 150,000 tons per year. In fact the rate of mining (see curve C) that will exhaust any property, with plant costing \$1 per ton annual output, and coal costing 2 cents or less per ton in ground, in about 25 or 30 years, will be the most economical. Coal costing 5 cents should be exhausted in 18 years and coal costing 10 cents in 12 years.

It therefore further follows that operators of fee lands should construct plants for mining low-cost coals (1 cent per ton or less) of such capacity that the land will not be exhausted within \approx 30 years, while high-priced coal (costing 5 cents per ton or more) should be exhausted in 12 to 20 years. All land purchased or held above such requirements must

TABLE 1. SHOWING ANNUAL CHARGE REQUIRED TO CARRY AT 8 PER CENT. (TAXES, INSURANCE, AND INTEREST) AND AMORTIZE COAL AT ORIGINAL COST OF ONE CENT PER TON IN GROUND FOR DIFFERENT SPEEDS OF MINING

For Coal in Ground							For Plant Costing \$1 Per Ton Annual Output			Total Amortizing Cost Against Coal For Land and Plant—Cost of Coal in Ground				
Basis: 1,000 Acres, 5,000 Tons Per Acre = 5,000,000 Tons, at Cost of 1 Cent Per Ton, \$50 Per Acre							H	I	J	K	L	M	N	O
A	B	C	D	E	F	G	Cost of Plant	Cost of Plant Per Ton Coal in Ground	Amortizing Royalty For Plant 8 Per Cent.	In Ground 1 Cent Per Ton	In Ground 2 Cents Per Ton	In Ground 5 Cents Per Ton	In Ground 10 Cents Per Ton	In Ground 1/2 Cent Per Ton
Tons Mined Per Year	Years Required to Exhaust	Annual Payment	Cents Per Ton Amortizing Charge 8 Per Cent. Cents	To Equal 10 Cents Royalty, Coal May Cost in Ground Cents	To Equal 10 Cents Royalty, Coal May Cost Per Acre	Amortizing Royalty at 6 Per Cent. Per Ton Cents			$(I \times D)$ Cents	Total Amortizing Royalty Per Ton Coal $(I \times D + D)$ Cents	Total Amortizing Royalty Per Ton Coal $(I \times D + 2D)$ Cents	Total Amortizing Royalty Per Ton Coal $(I \times D + 5D)$ Cents	$(I \times D + 10D)$ Cents	$(I \times D + 1/2 D)$ Cents
1,000,000	5	\$12,545.00	1.25	8.00	\$400.00	1.18	\$1,000,000	20.00	25.00	26.25	27.50	31.25	37.50	25.63
500,000	10	7,441.00	1.49	6.72	336.00		500,000	10.00	14.90	16.39	17.88	22.35	29.80	15.65
333,333	15	5,845.00	1.75	5.71	286.00		333,333	6.67	11.67	13.42	15.17	20.42	29.17	12.55
250,000	20	5,095.00	2.04	4.90	245.00		250,000	5.00	10.20	12.24	14.28	20.40	30.60	11.22
200,000	25	4,685.00	2.34	4.28	214.00		200,000	4.00	9.36	11.70	14.04	21.06	32.76	10.53
166,667	30	4,442.00	2.67	3.75	187.00	2.18	166,667	3.33	8.89	11.56	14.23	22.24	35.59	10.23
142,857	35	4,291.00	3.00	3.33	167.00		142,857	2.86	8.58	11.58	14.58	23.58	38.58	10.08
125,000	40	4,194.00	3.36	2.98	149.00	2.66	125,000	2.50	8.40	11.76	15.12	25.20		10.08
100,000	50	4,088.00	4.09	2.45	123.00	3.17	100,000	2.00	8.18	12.27	16.36	28.63		10.23
83,333	60	4,040.00	4.85	2.08	104.00	3.71	83,333	1.67	8.10	12.95	17.80	32.35		10.53
71,429	70	4,018.00	5.63	1.78	89.00	4.27	71,429	1.43	8.05	13.68	19.31			
62,500	80	4,009.00	6.41	1.56	78.00	4.85	62,500	1.25	8.01	14.42	20.83			
55,556	90	4,004.00	7.21	1.39	70.00	5.43	55,556	1.11	8.00	15.21	22.42	44.05	80.10	11.60
50,000	100	4,002.00	8.00	1.25	62.50	6.02	50,000	1.00	8.00	16.00	24.00			12.00
41,667	120	4,000.40	9.60	1.04	52.00		41,667	.83	7.97	17.57	27.17			

*V.-P. Solvay Colliers Co., Syracuse, N. Y.

be regarded as an investment entirely separate from the operating proposition.

Leascholds.—In the case of leaseholds the lessor's interest is to induce the operator to exhaust as quickly as possible, the lessor's profit (curve *F*) being the difference between the flat royalty charged and carrying and amortizing cost given in column *D* (curve *A*), such profit decreasing rapidly with the increase of the period of exhaustion.

For coals costing more than 1 cent, the lessor's profit (curve *F*) falls still more rapidly with the increase in exhaustion period.

It is to the interest of the lessee to build a plant and operate at a rate that will exhaust the leasehold in not less than about 30 to 35 years (curves *B* and *E*). Below that point, the cost of carrying and amortizing the plant is excessive; while after the 30-year period, though the cost of carrying and amortizing the plant decreases slowly, an entirely new plant above ground must be constructed.

The cost of a second plant is not considered in the table and charts given.

In column *A* of the table it is rather surprising that 40 cents above the interest charge starts the forces which wipe out the debt of \$50,000 in a 120-year exhaustion period.

Comparison of Leaschold With Purchase of Fee Land.—For example, if an operator desires to produce 166,600 tons a year from 1,000 acres, containing 5,000,000 tons (or $3 \times 166,600 = 499,800$ from 3,000 acres) by purchase at 1 cent per ton, and exhausting in the most economical period, i. e., 30 years, the amortizing royalty required per ton of coal mined would be (column *D*—curve *A*) 2.67 cents. While to equal the payment of 10 cents royalty the cost of land could be increased to 3.75 cents (curve *D*) per ton in the ground, or \$187 per acre.

In other words, under these conditions, leasing at 10 cents or buying at \$187 per acre, would result the same to both the land owner and operator. 8.89 cents (column *J*—curve *B*) per ton additional, or 18.89

cents (curve *E*) total royalty, would have to be charged against coal as mined. The fact that the lessor might require a smaller minimum royalty would not be an inducement, since the cost per ton of coal for

for amortizing plant would likewise result in columns *J*, *K*, *L*, *M*, *N*, *O* (curves *C*).

DISCUSSION OF CURVES ON CHART A

Cheap Coal Even With Slow Exhaustion Rate Gives Lessor Good Profit.—Curves *A* show that coal costing 1 cent per ton in the ground can be exhausted slowly without producing excessive amortizing charge against the coal.

The period of exhaustion may be extended to 100 years, producing at 8 per cent, a charge against the coal of only 8 cents per ton as mined, or at 6 per cent, the resulting charge would be only 6 cents. A period of exhaustion extending to 125 years at 8 per cent, would be required to equal 10 cents royalty charge. In other words, for coal having a value of 1 cent per ton in the ground, a plant of a capacity of 400,000 tons per year at 10 cents royalty exhausting in 125 years, operating on 10,000 acres of 4-foot coal, 50,000,000 tons, would still pay the owner of the land 8 per cent, and amortize his investment.

In like manner, if the period of exhaustion is 60 years, the owner at 10 cents royalty gets his money back with 8 per cent, interest and ≈ 5 cents per ton of coal besides as clear profit.

Value of Coal in Ground Corresponding to 10 Cents Royalty and Different Rates of Exhaustion.—Curve *D* indicates the value of coal in the ground equivalent to 10 cents royalty for varying rates of exhaustion. Thus, if the leasehold contract is such that the period of exhaustion is brief, the leasehold contract puts a higher value on the coal in the ground. That is, a 10-cent royalty and a period of exhaustion of about 28 years indicates an equivalent value of coal in the ground of 4 cents per ton, or \$200 per acre of 4-foot coal. The period of exhaustion may be delayed to about 60 years for a value of coal equal to 2 cents per ton in the ground. Conversely, high-priced coal lands at 10 cents royalty require rapid exhaustion, coal costing 5 cents per ton in the ground at 10 cents royalty must be exhausted in 20 years, 3-cent coal

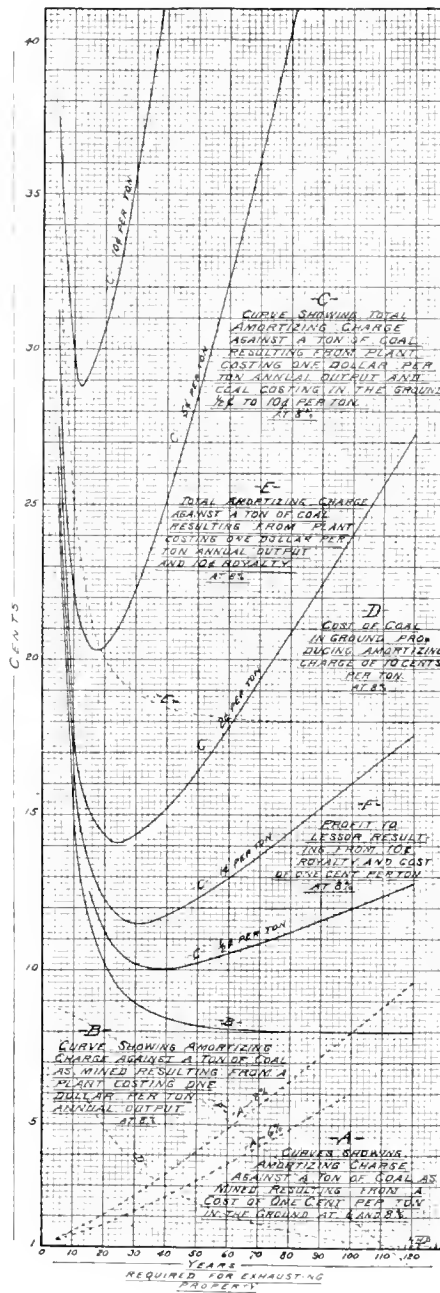

CHART A

amortizing plant would increase considerably, due to the fact that practically a renewal of the external plant would be necessary after 25 to 30 years. Taking this into consideration, the amortizing cost for plant (in column *J*) would increase considerably with the period of exhaustion and a still greater increase in cost

in 40 years, in order to amortize the lessor's investment and pay him 8 per cent. interest.

For Given Coal Value, Plant of Definite Size Requires Corresponding Tonnage Coal in Ground.—Curve D, indicating the period of exhaustion required for coals of different values, consequently indicates the tonnage of coal that should be provided for a plant of any given output.

Three-cent coal exhausted in 40 years equals a 10-cent royalty, therefore a 400,000-ton yearly output requires 16,000,000 tons of coal in the ground, or at 5,000 tons per acre, 3,200 acres.

A small operation of 100,000 tons annual output in 3-cent coal requires but 4,000,000 tons, or 800 acres of 4-foot coal; 2-cent coal land permits a period of exhaustion of 60 years; that is, a 400,000-ton plant should have 24,000,000 tons coal or 4,800 acres of 4-foot coal.

Profit to Lessor Falls With Slow Exhaustion.—Curve F (10—curve A) shows how profit to lessor falls off with increase of exhaustion period. For coal of higher value, say 2 cents per ton in ground, curve F would become (10—2A), in which case the lessor's profit would be reduced to zero for a period of exhaustion exceeding 62 years.

Total Amortizing Charges Resulting From Plant and Cost of Coal in the Ground.—Curve B showing charge against coal as mined resulting from cost of plant, and curve E showing total charge against leasehold coal at 10 cents royalty, suggest that operator of a leasehold gets little lowering of charge against coal by extending the exhaustion period beyond \approx 40 years, especially when considering plant renewal. He would gain, however, by thus tying up a larger amount of coal or the same amount of coal for a longer period.

Total Charge for Leasehold and Purchase Compared.—Curve E also shows that coal could be purchased at 5 cents per ton and exhausted in 18 years for the same charge against coal (20.3 cents) as if operating under leasehold at 10 cents royalty exhaust-

ing in the same period. Leasehold at 10 cents royalty exhausting in 62 years gives the same charge against the coal as purchased coal at 2 cents exhausted in the same period.

Economical Period of Exhausting Coal Mines.—Curves C, as already pointed out, show the economical period of exhaustion for coal of dif-

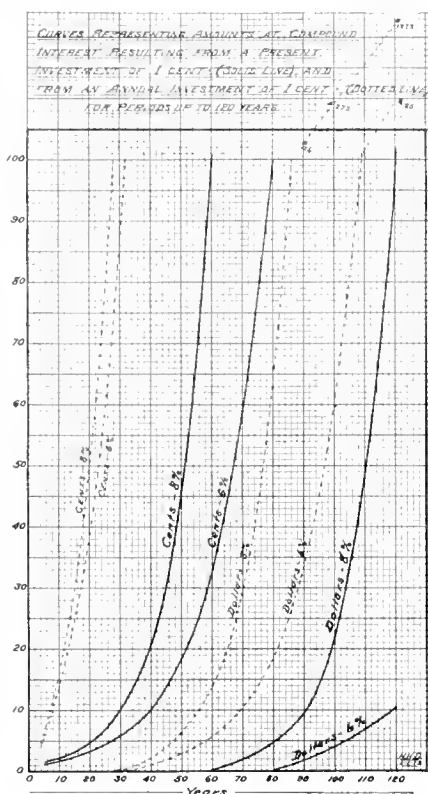

CHART B

ferent values in the ground, and also indicate the particular necessity of rapid exhaustion for high cost coals. These curves also indicate the amount by which the net selling price of the coal must exceed the cost to cover interest and depreciation.

Mining Cost.—Of first importance in considering a mining proposition are the factors influencing actual cost of putting the coal in mine cars.

In making comparisons of specific operations favored by thickness of seam, labor conditions, dip of seam, or freight differential, we have only to subtract the saving in costs thus brought about from the charges against coal indicated by the curves on the chart. For example, curve C, with coal in the ground costing 5 cents per ton; we may have physical mining conditions producing a lower mining

cost by 10 as compared with a cheap coal costing 1 cent per ton represented by curve C; 10 cents should therefore be taken from all points of curve C 5 cents per ton, resulting in a minimum cost for a 20-year exhaustion period of 10.3 cents compared with 11.5 cents at 30-year period for cheaper coal.

Unusual Expense Due to Inaccessibility.—The influences upon amortizing charges against coal as mined, due to sinking shafts, constructing conveyers of unusual length, bridges, and railroad spurs, may be obtained by multiplying values in curves A by total cost of plant and accessories, in terms of cents per ton of coal to be mined. Thus, if a shaft cost 2 cents per ton of coal available with exhaustion period of 30 years, there is added, besides cost of operating shaft and pumping, a charge against coal of (2×2.67 or) 5.34 cents per ton of coal mined.

Cost of Carrying Unmined Coal as an Investment.—On chart B (solid lines) is given the amount at compound interest of 1 cent for periods up to 120 years. It is rather startling to learn that if coal land investments are to earn 8 per cent. less taxes and administration charges, coal now costing 1 cent per ton in the ground will at the end of 120 years have a value of \$102 per ton. In other words, coal lands now worth \$50 per acre for 4-foot coal should then be worth \$510,000 per acre. Coal costing 4 cents per ton in the ground would then be worth \$408 per ton. Even at 6 per cent., in about 170 years the same figures would be reached. In the case of anthracite the values would be proportionately greater. These figures are absurd, and of course coal could not be used at any such figures. The exhaustion of the world's coal supply is generally placed at a far more distant period than 170 years. These curves then show that coal, even at 1 cent per ton in the ground, can be held with profit only if mined in the not distant future.

In like manner, from these curves, values at 8 per cent. should increase 100 fold each 60 years, and at 6 per

cent. each 80 years. Coal, now worth \$50 per acre, 60 to 80 years ago should have been worth only 50 cents per acre. This is surprisingly near the actual values of coal land 60 or 80 years ago, and instead of making wonderfully profitable investments, the holders of coal lands have made only about 6 to 8 per cent. interest on their money.

Values Increase 10 Fold in 30 to 40 Years.—Values at 8 per cent. in 30 years increase tenfold, and to the same extent at 6 per cent. in 40 years.

Cheap coal (1 cent per ton) can be easily carried for this period, while coal costing 5 cents or 10 cents should be mined at once, since these greater values generally represent cheap mining conditions, accessibility, or some other advantage which does not appreciate in value commensurate with compound interest.

Amortizing Charge Against Coal for Various Plants.—With the data now at hand it is possible to find the overhead charge that must be made against coal mined under almost any actual conditions, also to say whether the addition of capital, and how much, with corresponding increased production would bring about a saving in costs per ton of coal.

CONCLUSIONS

1. The factors determining amortizing and interest charges against coal as mined, as shown by the table and charts herewith presented, are *A*, cost of coal in the ground; *B*, period of exhaustion; *C*, amount of coal available; *D*, annual output of plant; *E*, cost of normal plant.

2. For conditions of maximum economy a definite relation is fixed between all these factors.

3. Of these factors, *A* is fundamental; i. e., the cost of coal in the ground determines the economical period of exhaustion. *A* determines *B*.

4. Period of exhaustion equals the amount of coal available divided by the annual output or by the cost of normal plant.

$$B = \frac{C}{D} = \frac{C}{E}$$

5. Amount of coal that should be available equals the period of exhaustion multiplied by the annual output desired or by the cost of normal plant.

$$C = B \times D = B \times E$$

6. Annual output, likewise cost of plant, should equal the amount of coal available divided by the period of exhaustion.

$$D = E = \frac{C}{B}$$

7. For each period of exhaustion there should be a definite ratio between the cost of plant and the tons of coal available. For a 30-year period the cost of plant is about 3.3 cents per ton of available coal. For a 20-year period the plant cost should be about 5 cents per ton of available coal.

For 30-year period

$$\frac{E}{C} = \frac{D}{C} = 3.3 \text{ cents}$$

For 20-year period

$$\frac{E}{C} = \frac{D}{C} = 5 \text{ cents}$$

8. The value of coal in the ground equivalent to leasehold at 10 cents royalty (curve *D*—column *E*) falls rapidly with the increase of the period of exhaustion, and conversely, the shorter the exhausting period at any given fixed royalty, the greater the equivalent value of the coal in the ground.

For an exhaustion period of 30 years and 10-cent royalty a coal value is indicated of 3.75 cents per ton in the ground, \$187 per acre of 4-foot coal.

9. The lessor's profits fall rapidly with the increase in the period of exhaustion allowed, while the operator's profits are not increased by slow exhaustion after \approx 30 to 40 years.

10. Under conditions of maximum economy, with coals valued at 2 to 5 cents in the ground, the average bituminous coal operation requires that the net selling price of coal exceed the actual cost of administration and mining by 14 to 20 cents per ton (curves *C*).

11. It is remarkable that experience seems to have worked out in

practice the economic relations between the cost factors due to investment which so nearly correspond to these reached from mathematical considerations.

來 來

Coal in Transvaal, S. A.

In addition to the gold and diamond mines, the Transvaal province, South Africa, has coal which is marketed as cheaply as anywhere else with the possible exception of some places in America and Japan. The only difficulty with the industry at present is that the coal supply far exceeds the local demand. There has been no great encouragement for export of the product. It is thought that if the Transvaal collieries could obtain an export trade for their coal the greater part of the gold mining and other industries could be run with "small coal" at a cheaper rate than that now paid for the kind used. The output of the coal mines of the Transvaal for 1911 amounted to 4,343,680 tons, valued at \$5,102,000 against 3,970,069 tons, valued at \$4,931,000, for 1910. The coal industry at present employs 500 white men and about 9,000 natives.—*U. S. Consular Report.*

來 來

Employes' Association of "River Coal"

The Employes' Association of the Monongahela River Consolidated Coal and Coke Co. of Pittsburg, Pa., was organized March 1, 1907, for the purpose of mutual benefit and accident association. Since its organization the total collected amounts to \$323,752.41, of which employes contributed \$262,394.19 and the company \$67,432.35. To November 30, 1912, there have been paid out in benefits \$274,867.46 for fatalities and \$33,439.13 for non-fatal accidents. At the end of the fiscal year there was \$15,445.82 in the treasury. The benefits paid to dependents in fatal accidents during the fiscal year amounted to \$53,050.81.

Too Much Ventilation

Importance of the Amount of Moisture in the Ventilating Current, and the Methods That Have Been Employed for Its Control

*W. H. Booth, F. G. S.**

AIR at a given temperature will be saturated, if loaded with a certain fixed amount of moisture. The higher the temperature the greater is the weight of moisture requisite to saturate a unit volume. When air is taken from the surface and forced down a mine, work is done upon it by way of compression, and this work all appears as heat; other things being equal, the air will be hotter when it has descended a shaft, and its capacity for moisture will therefore be greater, and as that air flows through the mine it will tend to arrive at saturation point by absorbing moisture from the things with which it comes into contact. Over a great part of the year the interior of a mine is warmer than the external air, and air which leaves the surface fully saturated with moisture may become relatively dry when heated in the mine. In such a condition it will dry the mine, perhaps below the desirable extent of moisture, and may cause the very danger it is intended to avert.

Yet it is not desirable to reduce ventilation in gassy mines below what will preserve the percentage of gas well below the agreed minimum. As regards atmospheric purity, factories are considered to be well ventilated with 2,000 cubic feet of air per person per hour. The old English Cotton Cloth Factory Act provided for 600 cubic feet each per hour, but this has been raised to 2,000 cubic feet in a later amended act. The generally accepted datum of sufficient ventilation is such a supply of air as will prevent the accumulation of CO_2 beyond 9 parts per 10,000 of air, that is to say 5 parts per 10,000 in excess of the ordinary external atmosphere. When the CO_2 reaches or goes beyond this amount, the atmosphere commences to become more or less fetid. So far as concerns the CO_2

itself, this amount is very much less than what can be endured without discomfort if the CO_2 is pure, as it would be in case of its evolution from chalk by the action of sulphuric acid.

But where the gas is the product of the lungs of man or other animals, the presence of CO_2 is appropriately regarded as signifying a proportionate amount of organic impurity, and thus the CO_2 , being easily tested for analytically, is simply an indication that organic impurity also stands at such a point as to be detrimental or otherwise, according as the gas is above or below 9 parts per 10,000 of air. Thus the air for ventilation, regarded from a sanitary standpoint, may ordinarily be neglected, for it is never more than a fraction of the 1,000 cubic feet per minute required by the dictum of a prominent engineer.

Factory ventilation may very well be quoted in terms of cubic feet per worker, but the care of the mine is different, for it must be regarded from the point of view of the amount of explosive gas given out. And probably there are few mines where ventilation as required by the workers is not exceeded by that required to sweep away the gas in a state of sufficient dilution.

Since over dryness of the air is to be avoided, it appears that mine air should be accorded the same treatment as factory air by way of moistening or conditioning. In factory ventilation, where the temperature and moisture are both desired to be within a narrow range, this is best secured by first warming the air to a certain degree, then saturating it with moisture at that temperature and finally warming it to the temperature at which it should enter the factory. The tem-

perature at which the air is saturated is fixed so that when the air is finally discharged into the factory its percentage of

saturation or relative humidity shall be correct. This system of warming is based on the fact that it is easy to saturate with moisture by means of steam or of water sprays, and it is not difficult to warm air to a given desired temperature. But it is more difficult to moisten air to a percentage of humidity 10, 20, or 30 per cent., as the case may be, below the saturation point. Hence the heating at two stages, each of which can be controlled by thermostat, and the saturation at the intermediate temperature.

Ordinary air has a relative humidity of 50 to 75 per cent. of saturation, and upon this depends its absorptive ability. Its absorptive capacity depends upon its temperature, for a cubic foot of air will absorb more at 70° than at 60°.

As an example of the working out of the double stage warming with intermediate saturation, let it be supposed that the air traverses the workings at about 70° and that it is desired to limit it to about 80 per cent. of humidity.

At 70° air is 80 per cent. saturated when it contains about 6.4 grains of moisture per cubic foot. Looking further into a table of relative humidity, it appears that air which is saturated at 63° contains nearly 6.4 grains of moisture; obviously, therefore, the air to be supplied must be heated to 63° and then saturated with moisture and then when it becomes warmed to 70° it will only be 80 per cent. saturated.

A very useful table of this kind is published by the Carrier Air Conditioning Co. of America. As an illustration of the moisture capacity of air, Table 1 shows the weight of moisture per cubic foot of air at different temperatures.

Now, air that is 80 per cent. saturated will carry, per cubic foot,

*Caxton House, Westminster, S. W., England

moisture as follows: 70°, 6.38 grains; 75°, 7.49 grains; 80°, 8.74 grains; 85°, 10.19 grains; 90°, 11.83 grains; or approximately saturated air holds the same amount of moisture per cubic foot as is contained by air 7° hotter and saturated only 80 per cent.

TABLE 1. MOISTURE CAPACITY OF AIR

Degrees	Grains
63.0	6.35
68.0	7.48
73.0	8.78
78.5	10.11
82.5	11.80

11.83 grains; or approximately saturated air holds the same amount of moisture per cubic foot as is contained by air 7° hotter and saturated only 80 per cent.

And, similarly, 70 per cent. saturation represents $11\frac{1}{4}^{\circ}$ lower temperature air fully saturated. This means that the mere acquisition of $11\frac{1}{4}^{\circ}$ of temperature renders air capable of absorbing a considerable further weight of moisture, and if the air starts with only 50 or 60 per cent. of saturation its heating by 10° may render it absolutely parching in its effects.

To avoid this, it must be initially moistened to the necessary degree. This moistening will be determined by surrounding conditions. If the air must travel long distances along wet airways in which no dust can be produced, these may be allowed their effect; but ordinarily the moisture will be artificially added by water sprays in the manner described.

The degree of relative humidity in air is ascertained by the wet- and dry-bulb thermometer. With saturated air, a thermometer with a dry bulb reads the same as a thermometer the bulb of which is enveloped in wetted muslin; but as the degree of saturation decreases so does the difference between the two thermometers increase.

TABLE 2

Dry Bulb Degrees	Wet Bulb Degrees	Dew Point Degrees	Moisture Per Cubic Foot	Percentage of Saturation
87	65	50	4.08	30
82	65	55	4.65	40
78	65	57	5.13	50
75	65	59	5.61	60
72	65	61	5.96	70
69	65	63	6.18	80
67	65	64	6.52	90
65	65	65	6.78	100

Table 2, given by the Carrier company, will show this effect.

Here the final temperature is taken as 65° and the air is saturated. As the temperature rises the air is relatively dried. The dew point is the temperature below which any further fall of temperature causes deposition of moisture. Moisture is being absorbed by the air, and as the air cools and approaches saturation, both by absorption and cooling, the two thermometers read more and more closely until they coincide at 100° saturation.

The depression of the wet bulb thermometer is a matter of relative humidity at the then temperature. Thus the wet bulb will read lower than the dry bulb by so many degrees, according to the relative humidity at the then temperature and the difference is as follows: 80 per cent., 7° ; 75 per cent., 9° ; 70 per cent., $11\frac{1}{4}^{\circ}$; 65 per cent., $13\frac{1}{4}^{\circ}$; 60 per cent., $16\frac{1}{4}^{\circ}$; 55 per cent., 19° .

These thermometers thus form a useful means of determining relative humidity at all ordinary temperatures, and it is this relative humidity that is needed to be known if a control is to be held over the drying quality of mine air.

It would hardly be correct from a physiological standpoint to humidify the air to the saturation limit, for it would be most disagreeable for miners to work in such air. Workers must always be supplied with air that will carry off the perspiration for the body. When men are working in a copious stream of air they can of course submit to a higher degree of humidity than when the air moves less slowly. In winter a mine is more apt to be dried out than it is in summer, simply because the air is taken by the fan at a lower temperature and it contains very little moisture; and if it also requires to be warmed it will become extremely dry, so that when artificial warming is needed in winter, the application of exhaust steam would serve the double purpose of warming and humidifying.

It is usual to speak of air absorbing moisture, but this is not scientifically correct. Water vapor to a certain fixed quantity, will occupy the space above any vessel of water of a certain temperature; it will do so whether air be present or whether it be absent from that space. The air has no effect except to retard the occupation of the space by the water vapor. But of course space by itself cannot have temperature. The amount of moisture in the space depends on the temperature of the parent water. And when no water in liquid form is present the space temperature is of course that of the air, so that the air so far does determine the amount of water in suspension in a given space, and in practice it is quite allowable to regard the air as a carrier of moisture, for without moisture purposely added air will deprive other substances of humidity.

來 來

Coal Mining Institutes

American Institute of Mining Engineers is a society devoted to the advancement of mining and metallurgy. With this society a number of college societies, composed of undergraduates, are affiliated as associates, but not as members of the Institute. Owing to the wide area covered, the parent society has a number of chapters whose members meet monthly in various cities. State Coal Mining Institutes meet twice a year, when the members read, listen to, and discuss, papers pertaining to coal mining. The members of such societies are engaged actively in coal mining or in some branch closely connected with coal-mining operations. The papers read at these institutes are excellent, practical, and usually provocative of wide discussion.

District Mining Institutes are local affairs confined to the coal fields and include the mine officials and their assistants locally. These meet monthly to listen to papers and discuss the various mining subjects on their minds. These meetings are practical and helpful. In connec-

tion with these institutes are mining schools for the instruction of miners, in many instances under the auspices of the Young Men's Christian Association.

來 來

Hogan on the Election of Mine Inspectors



Hogan. f'what d'ye think of the eliction iv mine inspiethors?

Well, Reilly, I don't think much of the plan. It's not a reasonable way iv gettin' good min for the job. If the prisidint iv a coal minin' company wants a shuperintinder, does he ax the farmers, and bar tinders and praichers and sthore kapers and politicians and lawyers and doethers all over the county to help him pick a good wan? Not on yer loife, he don't. Iv he doesn't know the right man, he axes min that know coal minin' to ricommind a man. An' whin they tell him iv a good man, that doesn't settle id. He'll sind for the man an' question him. He'll find out phwat ixperience the lad has had, and does he know his business. He'll find out, too, is his charac'ther for soberness and dacincy good, and has he the good sinse that they call execu'tive ability.

Now Reilly, iv that's the right way for business min to get a man capable of doin' things, isn't it common sinse to pick State Mine Inspiethors in the same way, or be the most careful and intilligent way?

You know Reilly, a State Mine Inspiethor is in many ways a shuperintinder, not only of wan or two mines, but iv all the mines in his dishthriect. The regular shuperintinder works for the mine owner. 'Tis his business to get out the coal as chapely as possible. The mine inspiethor is the shuperintinder that works for the State. 'Tis his business to see that the coal is mined in such a way as will consarve the health and safety of the min and

the property of the mine owners. To be anny good at the job he musht know more about minin' and be more larned in manny subjects than most iv the mine bosses. Some min, an' I'm sorry to say min that have a lot iv influ'ence wid the mine workers, are thryin' to have a law med that will make anny man wid a mine foreman's certificate elligible for election as State Mine Inspiethor. This manes that manny min wid certificates that have had no ixperience as bosses, as well as min that have had and ben found wantin', can run for inspiethor. The besht min, the min that have the minin' education, the charac'ther an' the ixperience and common sinse necessary for the job, are the min that sthay home nights, an' are not known be the bar tinders and politicians, and they'd have no show as candidates. The lads that would have the besht show in the eliction would be the fellows that cud get the mosht votes, and the vote iv a bar tinder or a hostler wud count as much as yours or mine. Av coorse the lad that spint the most money wid the saloon kapers and gev the farmers the most taffy, promisn' thim chaper coal, an' usin' the same kind of talk wid other classes of min, wud be the fellows to win, and they'd be the Devil's own inspiethors.

I see be the paapers that the proposed new mine law for the anthracite ragions, prepared by a subcommittay' of the Commission, provides for the seliction of min for mine inspiethors be a plan that is more likely to get good min than be anny other manes, and I can't undherstand how anny man wid sinse, who raaly wants to see the mines mel as safe as possible, and who has though the matther over can be agin id.

In the frsht place, no man but wan over thirty-five years ould of good charac'ther and good health and sthrength can be a candidate for examination. Besides this, he musht have had at laste tin years practical ixperience in the mines,

five years of which just afore the examination musht have been in the mines of the ragion.

In the second place, the proposed law says plainly phwat they musht be examined in, and begorra Reilly 'twill take a shmart lad to have brains enough to hould all he musht know.

Thin, in the third place Reilly, the law proposes an examin' boord in which the miners will have a majority. This boord is to be appointed be the Governor, and musht be med up iv min of good charac'ther over thirty-five years ould. The boord is to consist of nine min, five of thim to be reputable miners of at laste five years ixperience in gassy mines in the ragion, and four iv thim to be minin' engineers of not less than five years practical ixperience in anthracite mines.

Whin this boord houlds an examination it musht not only be open to the public, but ivery question, an' the answers med be the candidates, both in written examination, and whin questions an' answers are be word iv mouth, musht be put on file in the Minin' Department in Harrisburg, where anny wan wantin' to, can see thim an' detarmine was the examination fair.

Whin the examination is over, the boord iv examiners musht sind to the Governor the names iv all the candidates that have pasht wid a credit of ninety per cint. or better, and the Governor musht appint the man or min havin' the besht record.

Isn't that the besht way to find is a man fit for the job? Av coorse it is. And, besides, the man that gets the job be this plan, is beholden to no wan but his own charac'ther and brains for the job, and he'll do his juty widout fear or favor. Wid such min as inspiethors, the mines will be inspiethed and the law enforced. It won't make anny difference who breaks the law, whither 'tis the mine owner, the boss, or the miner, the law will be put on him, bekase the inspiethor will not have to be kapin' frinds wid everybody so

as to get their votes at election time.

What the Devil use is a mine law, if id isn't enforced, and how the Devil can a man who has to kape frinds wid everybody enforce it?

The hishtory I was radin' the other day tould iv George Washington sayin "Eternal vigilance is the price iv liberty." Be the same token eternal vigilance is the price iv safety in the mines, and the mine inspiethor can't be eternally vigilant if he has to spind wakes and months iv his time runnin' around to the grog shops electioneerin', instead iv bein' in the mines seem' that conditions are healthy an' safe.

采 采

British Tests for Miners' Safety Lamps

The following information in regard to tests of safety lamps is given by Deputy Consul General Carl R. Loop, of London:

Pursuant to the provisions of the coal mines act of 1911, tests have recently been carried out by a departmental committee appointed by the British Home Office which, in the opinion of the committee, miners' safety lamps should pass in order to be admitted to the list of "approved" lamps. It is not proposed that each individual lamp used in coal mines should be tested, but it is considered that no lamp should be adopted if it does not conform, in all particulars, to an official specification which is the direct outcome of an official test.

The tests which the committee considers flame safety lamps should pass, fall under three heads: (1) Mechanical test, (2) photometric tests, and (3) tests in an explosive mixture.

Mechanical Tests.—In order to discover whether the lamp is capable of withstanding the conditions of rough usage to which it is likely to be submitted in a mine, it is proposed that it shall be submitted to three tests. First, it is to be dropped, complete with its glass, from a height of 6 feet upon a

woolen floor five times in succession. A different glass is to be employed each time, and not more than one broken glass is to be permitted in the five tests. If two glasses break, the lamp is to undergo five more tests, and if the glass breaks in two of these it will be held to fail. The second test consists in dropping a weight of 5 pounds from a height of 6 feet vertically upon the lamp. If the glass is cracked, the test is to be repeated twice, when one failure will condemn it. The third test is intended to try the security of the attachment of the different parts, and consists of dropping a 10-pound weight, attached to a cord, from a height of 6 feet, the other end of the cord being secured to the bottom of the lamp, which is suspended at a height of 7 feet from the ground.

Two tests are also proposed for the lamp glasses separately. In the first a weight of 1 pound is to be dropped from a height of 4 feet upon them as they stand in a vertical position, and in the second they are to be heated in an air bath to a temperature of 212° F. and plunged into water at 60° to 65°. In both these tests 20 glasses of each kind are to be tried, and in each case 10 per cent. of failures will cause rejection.

Photometric Tests.—The committee considers that the minimum candlepower to be required of flame lamps should be .30 (pentane standard*), and that they should give this minimum for 10 hours. The lamps tested varied between .325 and .65 candlepower, the higher figure being given with naphtha as fuel and the lower with a mixture of half colza and half paraffin.

Tests in Explosive Mixtures.—In respect of explosion, two tests are proposed. The lamp, after passing the mechanical tests, is to have its behavior tried first in a still inflammable atmosphere and then in horizontal and inclined currents in an

explosive mixture at a maximum velocity of about 1,200 feet in a minute. Each test is to last 2 minutes, and an ignition is to constitute a failure to pass. The mixture is to be, within limits, the most explosive obtainable with the particular combustible gas or vapor employed.

In addition the committee holds that all approved lamps should ultimately have double gauzes of steel or best charcoal annealed iron wire (or copper wire in the case of those used for surveying purposes) of 28 B. W. G. (.014 inch diameter) with 28 meshes to the linear inch (784 to the square inch); but they suggest that this requirement shall not be enforced until January 1, 1914. When lamp pillars are employed, the pillars ought to be so arranged that a straight line touching the exterior part of consecutive pillars will not touch the glass.

Electric Safety Lamps.—It is recommended that only the first of the mechanical tests be required for electric safety lamps, the test being carried out with the battery removed and a dummy of the same weight substituted. The lamp should be required to give not less than 1½ candlepower after 10 hours' use; and as regards the danger of causing explosion, it should be tested by having the light switched on and off while it is in an explosive mixture. Another requirement is, that no liquid escape from the battery when the lamp is turned upside down; and the committee think it desirable that the light should be well distributed outside the lamp and that a movable reflector should be provided to concentrate or shield the light at will.

[The United States Bureau of Mines is also studying the problem of improved lamps for miners, having already issued one pamphlet on the subject, and is preparing another. The above bureau (address, Washington, D. C.) may be communicated with in regard to any feature in connection with lamps or other devices for safety in mining.]

*The British standard candlepower is obtained from a sperm candle weighing 6 to the pound and burning at the rate of 2 grains per minute. The pentane bunsen standard has the equivalent of 1 British candlepower, hence the above is .3 of a candlepower.

Coal Mine Ventilation

In the Connellsville Coke Region—The Conditions Existing and Manner of Dealing With Them by the Large Companies

*By Austin King**

IN treating this subject we regret that, with one exception, to which we will refer later, we cannot point to some newly invented system of ventilating mines, but the fact is that invention has done little to assist in simplifying ventilation methods underground during the last half century. The roads and airways now made are perhaps larger, straighter, and rougher than in the days of yore, otherwise there is practically no difference between them. The trouble from obstructions in them, caused by falls and water pools, is still the same.

The many disasters in the bituminous coal mines, which occurred during the past few years and which involved such enormous loss of life, have stimulated research into the chemical composition of mine gases and the physical properties of coal, to such extent and with such success that bituminous coal-mine ventilation as a factor in the prevention, or cause, of mine explosions is now better understood than ever before, and we sincerely hope that with such knowledge and its timely application the days of such disasters are past.

The purpose of this paper is to show what is to be reckoned with in coal-mine ventilation in the coke region and how the difficulties are met and overcome. It will show the practice of supplying large volumes of air per person in the mine for circulation around the working faces and through the roadways, as a means of preventing mine accidents and providing safe, comfortable, and healthy conditions for men to work in.

The territory intended to be covered by this paper includes, roughly, that portion of Westmoreland County, Pa., lying south of Latrobe, and between Chestnut Ridge on the east and the Indiana, or Blairsville, anticlinal on the west, and that portion of Fayette County, Pa., lying between Chestnut Ridge and the Monongahela River, being practically the western half of that county.

The way in which explosive gas appears in these mines is somewhat different in different portions of the region. In the mines located in the basin between Chestnut Ridge and the Indiana anticlinal, explosive gas is rarely encountered in the advance entries or rooms. In 1889 the writer had charge of what was then the deepest mine in western Pennsylvania, yet no explosive gas was met with in it until pillar drawing had so far progressed as to cause large falls of roof. Another large shaft operation near by was worked with open lights for about 8 years. Other operations might be cited to show the freedom of these mines from explosive gas from the coal seam prior to the fracture of the rocks above by the extraction of pillars.

The analyses in Table 1 give the composition of the air at the working faces of four entries in mines in this portion of the field, and at a very unusual distance from the passing air-current.

The purpose of taking samples from those places was to obtain positive information as to the composition of the atmosphere at the face of the most advanced and, therefore, the poorest ventilated entries in a large number of mines. It will be observed that a good percentage of oxygen and a very small percentage of deleterious gases were found to be present.

When the cover exceeds 200 feet, or thereabout, in thickness and the coal is mined out of a sufficiently large area to permit the overlying rocks to break or fall, explosive gas is usually liberated and, if the cover exceeds 300 feet, large quantities often escape into the workings of the mine from the fissures so produced.

During the extraction of the coal pillars the excess pressure of the strata on their ends disturbs the rocks beneath the seam for a depth of several feet and sets free explosive gas sometimes pent up in them. The escape of gas from the bottom happens occasionally, but the general opinion of mining men in the region is, that the floor of the mine gives off very little gas.

In that part of the region in Fayette County lying west of the Indiana anticlinal, explosive gas issues very freely from the chinks and crevices of the coal seam at and near to the freshly worked faces of the advanced entries. The composition of this gas is shown by the analyses in Table 2.

In the last place 16,560 cubic feet of air was passing. The place was idle.

When mining has so far progressed that pillars are extracted or mined out, additional quantities of explosive gas are liberated from the rocks above and the problem of ventilating such sections becomes very similar to that of the other mines located east of the anticlinal.

TABLE 1

Mine	CO ₂	O ₂	CH ₄	N ₂	Distance From Passing Air-Current Feet	Time Taken	No. Men at Work
A	.30	19.30	.40	80.00	345	11:30 A. M.	1
B		20.30		79.70	240	10:20 A. M.	1
C		19.90	.10	80.00	300	11:15 A. M.	1
C	.10	19.15	.30	80.45	189	11:55 A. M.	2

TABLE 2

Mines	CO ₂	C ₂ H ₄	O ₂	CO	H ₂	CH ₄	N ₂	Sample Taken From
D	.60	1.50	1.60	1.30	7.35	79.40	8.25	Drill hole in coal face
E	1.70	1.30	1.80	.90	2.04	63.27	28.99	Crevice in roof at face of entry
F			18.40			6.50	75.10	Station 6+17 main par. entry (return)

*Chief Inspector of Mines for the H. C. Frick Coke Co.
33-5-4

What are known as "hot gobs" are not infrequent in the mines of the region, and temperatures as high as 118° F. have been noted without any discovery of fire. The analyses of a sample of the air from the place having this temperature gave the following percentages: CO_2 , 2.20; O_2 , 15.20; CH_4 , 1.20; N_2 , 81.40.

In the central part of the region several mines were troubled with fires which originated spontaneously in the gob. A peculiarity of one of these fires was that it was not discovered until some years after the abandonment of the section in which it was found. These fires were due, no doubt, to some special chemical constituent in, and the finely pulverized condition of, the coal, which, together with the passage of air over the combination, favored rapid oxidation in them.

In addition to the intrusion of explosive gas and some danger from spontaneous combustion, there is the vitiation of the air, caused by the smoke from lamps and explosives, the breath and exudations from men and animals, the decomposition of timber, and the absorption of the oxygen by the gases evolved from coal and rocks in solid or pillar workings in contact with it.

Having briefly described the difficulties which relate to mine ventilation in the region, it will now be stated how they are dealt with and controlled.

The proper ventilation of a mine must accomplish two things: first, supply sufficient pure air to the men and animals employed; and second, remove, dilute, and render harmless the noxious and dangerous gases generated therein.

In several of the small non-gaseous mines of the region "furnaces" (or coal fires) are still used to produce ventilation. The workings are mostly of small extent and, not having much cover, "falls to daylight" frequently occur. The volume of air required by law for this class of mines is much less than is required in gaseous ones.

The appearance of inflammable gas in a mine calls for a large increase in

the volume of air over that formerly required for its thorough ventilation. The increased volume of air meets with much increased resistance in passing through the mine, therefore, when the quantity of air required is large, ventilating appliances of ample capacity and driving strength must be installed. Experience has proved that mechanical ventilators are the best and that the fan is the most efficient, as well as the least troublesome, form of mechanical ventilator.

Many of the fans used are of steel and fireproof construction and are, generally, driven by powerful direct-connected engines. Table 3 shows the results of tests of three fans installed within the past 5 years.

showed 824 cubic feet per person entering the mine; and 495 cubic feet per person passing in the last cross-cut. The total number of persons employed underground in these mines was 7,800.

These large volumes of air having been introduced, the greater difficulty remains, i. e., that of conducting it into the various districts, working places, gob sections, and other ramifications of the mine.

The air, on reaching the coal seam, or shaft bottom, is usually divided. The number of the divisions, or splits, may be two or ten, according to the layout and size of the mine, the number of persons employed, and the quantity of explosive or noxious gases

TABLE 3

Mine	Size of Fan	Size of Engine	Revolutions Per Minute	Indicated Horsepower	Cubic Feet of Air Delivered	Actual Water Gauge	Remarks
A	25'×6'	30"×30"	84.0	216.33	251,929	4.00	Ventilating an old mine
			111.5	422.76	302,249	6.35	
			133.0	673.90	370,817	8.75	
B	26'×7'	Two 20"×30"	80.0	195.94	207,656	3.45	Ventilating a new mine
			102.0	417.46	281,818	6.05	
			117.5	631.90	334,745	7.85	
C	26'×7'	Two 22"×24"	75.0	157.74	218,796	2.85	Ventilating an old mine
			107.5	454.97	326,356	5.70	
			125.0	693.82	379,988	7.65	

The first of these fans was substituted for a 25'×9' fan and the last for a 25'×8' fan of an old type. Both delivered nearly double the volume of air, per revolution, that was delivered by the old fan.

As far as the writer has been able to discover, auxiliary fans are not used underground in the region.

In the matter of volume of air, the Bituminous Mine Law of Pennsylvania requires, in a gaseous mine, a minimum of 200 cubic feet per minute per person employed, to be directed to and around the working places, etc. The rules of the larger companies call for a much larger minimum. One of them requires that not less than 500 cubic feet per minute per person employed must enter the mine, and that not less than 300 cubic feet per minute must be conducted to the working places for each person employed in each split, or subdivision of the volume of air entering the mine. An average of 50 mines of that company, consisting of 20 slope and 30 shaft operations

to be dealt with; besides, a sufficient number of entries must be driven in which to pass the air without excessive resistance.

To effect the division above mentioned, it is often necessary to cross entries in which air must travel in a different direction. For this purpose overcasts (or air bridges) are built. These are made of brick or concrete walls, with steel-reinforced concrete floors and, to be efficient, they must be of large sectional area.

After the air is brought across to the entry or entries desired, it is frequently necessary to conduct it in one or more entries for long distances to the working faces, and to return it by like, or parallel, entries for the same distance, to the outlet of the mine. To do this, walls, called stoppings, are built in the cross-cuts between them. These walls must be of ample strength, air-tight, and made of incombustible material (usually brick or concrete). Every large mine contains many hundreds of such walls and, as the develop-

ment progresses, additional ones must be constructed. If, however, the life of a pair of entries is short, stoppings made of wood are frequently made.

The larger mines contain from 20 to 50 or more miles of airways, which must be kept dry and clear of obstructions. The nature of the roof for a few feet over the seam makes it very difficult to maintain airways of such length free from obstructions.

When an air-current is conducted through a haulage or a traveling road, it is sometimes desirable to deflect it into a different road, or to prevent short circuiting. For this purpose doors are erected. If it is desired to have the air sweep the face of the working places or gob edges, canvas curtains, suspended in the path of the air-current at necessary points, are used.

In order to maintain proper ventilation in mines where the workings are greatly extended, auxiliary air shafts, usually of large section, are provided. These are located close to the working places. The economy of these shafts is effected by reduction of the resistance to the passage of the same quantity of air, or by an increase of quantity, with the former resistance.

When explosive gas is liberated in large quantities in gob falls, it is necessary to remove and dilute it as fast as possible, and for this purpose large volumes of fresh air are conducted to and, wherever possible, over the gob. When conditions, such as the proximity of a boundary line or barrier pillar, prevent the passage of air over or around a newly formed section of gob, if explosive gas appears and threatens the safety of the mine, holes from the surface are drilled into the cavities above the gob area to allow the gas to escape. Sometimes the gob penetrated by the drill is so tightly closed by the pressure of the superincumbent strata that no cavities remain and the results anticipated are not realized. Fortunately, in most gobs, blackdamp is generated in such quantities as to render the firedamp in explosive, and when it descends to the workings it is immediately diluted and removed.

The composition of the gases that pass through some of these bore holes is shown in Table 4:

As these bore holes do not exceed 10 inches in diameter, and the velocity in them does not exceed 600 feet per minute, it can easily be seen that their effect is purely local and the great bulk of the air in most mines must be returned to the main outlet, which is usually but a few hundred feet from the main inlet.

For the purpose of providing against a sudden influx of explosive gas, the temporary failure of ventilation, or of those in charge of it to do their duty, the use of open lights is absolutely prohibited and safety lamps are substituted. These are owned, trimmed, and kept clean and in good condition by the operators, and, after close examination, are delivered, locked, to the workmen when entering the mine.

All these shafts, fans, airways, etc., are of no avail if careful supervision is not exercised over them and the same kept in good working order.

week, all the airways of the mine and enter their condition in a record.

As a further provision for safety, one company has a committee of workmen appointed in each mine, whose duty, among other things, it is to examine and report, once every 4 months, any dangers or defects in the ventilation that may come under its notice. As a further provision for safety, that company also employs mine inspectors who thoroughly inquire into and inspect each mine at least once every 60 days.

A danger not heretofore mentioned, and which deserves more than a passing notice, is that of coal dust. During the winter season a large volume of comparatively dry air passes through the mine, which absorbs the moisture, and, while providing good ventilation in the mine, creates a new and dangerous condition—that of a dry and dusty mine. For the purpose of avoiding this danger a system of water lines is laid through the mine and a sufficient number of spray nozzles and hose

TABLE 4

Mine	CO ₂	C ₂ H ₄	O ₂	CO	H ₂	C ₂ H ₆	CH ₄	N ₂	Remarks
F	2.50		10.40		1.35		11.90	73.85	525 feet deep
G	5.20		3.20				12.64	78.96	406 feet deep
H	1.80		14.90				2.20	71.68	One year later
I	4.60		4.20	.20	14.16		8.89	67.52	475 feet deep
I	6.90	.10	9.20	.40		1.60	38.30	48.50	

For underground supervision a specially qualified set of men, called "fire bosses," are employed. These men hold certificates of competency from the State Department of Mines. Their duty is to enter the mine, see if the air is traveling in its proper course, and carefully examine for danger, all the roads, working places, and places adjacent, and to record the condition of them within 3 hours before the next shift begins work. They must also make a second examination while the men are, or should be, at work, and enter a record of their findings. In addition to this policing of the mine twice each shift by the fire bosses, the mine foreman or an assistant must visit every working place at least once each shift during working hours and make a record of the condition of the mine. He must also examine, at least once each

connections are placed at necessary points, so as to thoroughly moisten the air and airways and wash the dust from the top, floor, and sides, when necessary. In deep mines where forcing fans are used, exhaust steam is used to mix with the intake air-current, to assist in raising its temperature and moisture-carrying capacity. In very cold weather live steam is added for this purpose.

This will, no doubt, suggest to your minds the idea which has been discussed a great deal lately—that of the over or excessive ventilation of mines. Excessive ventilation, however, is to be viewed with concern only where the means to provide moisture are not installed and a careful and systematic use of such means is not rigidly enforced.

That the idea of excessive ventilation is held to be of serious import

is evidenced by a recently expressed view, which some may call extreme, and which is diametrically opposed to over-supplying air to mines. This was made by a British scientist who, a few months ago, startled mining engineers with a proposition as to what constitutes good and safe mine ventilation. His scheme to prevent coal-dust explosions is to put into the mine, air of the following composition: CO_2 , $1\frac{1}{2}$ per cent.; O_2 , 19 per cent.; N_2 , $79\frac{1}{2}$ per cent.

To prevent ignition of firedamp and

Preparation of a Domestic Coal

Methods of Avoiding Breakage and Securing Accurate Sizing by Which a Better Market May Be Obtained

By J. D. Rogers*

THE following extract is from a paper read at the December, 1912, meeting of the Kentucky Mining Institute.

In eastern Kentucky, over an area covering several counties, there are a number of persistent coal

cal in formation with those found on Elkhorn Creek and on the headwaters of the North Fork of Kentucky River, there known as the Elkhorn coals. The structure and analyses of the two coals, however, are very different.

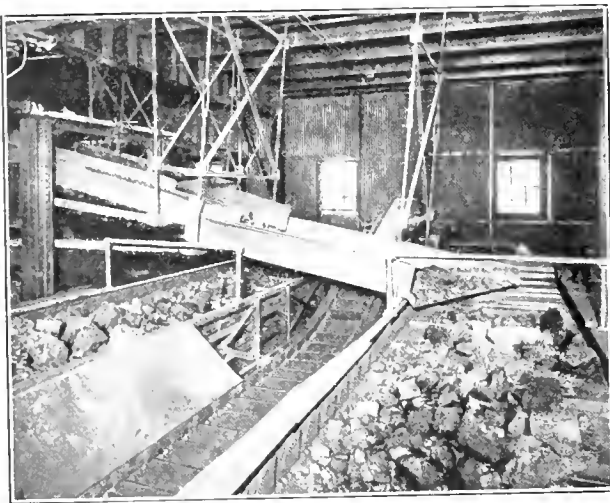

SHAKING SCREENS DISCHARGING ONTO PICKING BAND

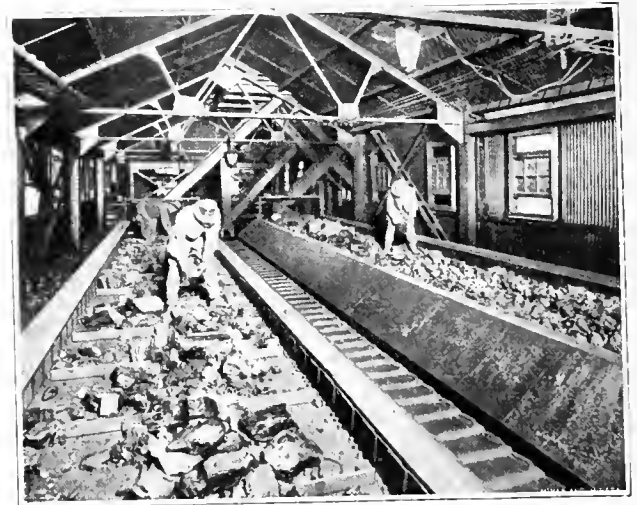

PICKING BAND AND WASTE CONVEYER

fires of all sorts in mines, the composition would be: CO_2 , $1\frac{1}{2}$ per cent.; O_2 , $17\frac{1}{2}$ per cent.; N_2 , 81 per cent.

This he claims (and he has his idea patented) would prevent future fires and explosions in mines. In such an atmosphere lamps using oil or naphtha as an illuminant could not be used. Acetylene or electric lamps only would be of service. We believe his theory is based on correct chemical principles, but its practicability and pathological effects remain to be tested. Should it prove practical, it will be beyond doubt the greatest step made since the discovery of the safety lamp, in the prevention of mine accidents.

In conclusion, we believe that the best means of keeping a mine in a safe and healthy condition is to supply large volumes of air and so conduct the same as to sweep every road, working place, and corner of it free of dangerous and deleterious gases.

seams of commercial value. Present information tends to show that the field is broken into fat and lean portions, with a preponderance of the lean ones, and local areas only promise a successful development.

At Van Lear, Ky., on the Levisa Fork of the Big Sandy River, 68 miles below Ashland, and 3 miles below Paintsville, the Consolidation Coal Co. commenced development 3 years ago, on what had been previously known as Millers Creek field. The most valuable bed of coal in this field, designated as the No. 1 or Millers Creek seam, is the lowest known coal bed of workable thickness in this vicinity. It is only with difficulty that it can be followed and recognized many miles distant. It is, however, not a generally accepted fact that the coals of the Millers Creek field are identi-

David White says it is probable that the Elkhorn coal beds belong to the lower portion of the Kanawha formation and the upper Elkhorn seam is probably at or near the Peerless or Cedar Grove coal on the Kanawha River, W. Va. Geographically, at Elkhorn, this is considered to be about 1,000 feet above the Lee conglomerate.

"Millers Creek Block," as it is known to the trade, is a splint coal of remarkable hardness and blocky and brittle, but it is an extremely good coal to ship. It can be stocked for almost an indefinite time without any appreciable weathering. Besides this, it is a high-volatile, quick burning coal, and is a most desirable product for domestic use. The thickness of the seam varies from 36 to 54 inches with no partings. It has pronounced butt and face cleavage, which must be

*Superintendent of Mines, Millers Creek Division Consolidation Coal Co.

followed in mining. All rooms are worked on the face of the coal, the course being approximately N 45 E, or the reverse.

A vertical section of the seam shows two different and distinct kinds of coal, the upper bench, varying from 18 inches to 36 inches, being a hard blocky splint almost a semicannel coal, while the lower 18 inches is softer, and resembling a strictly high-class bituminous coal. In mining, this lower coal breaks into comparatively small pieces, that make a good smithing coal and to a certain extent will coke. It might be noted here that as the thickness of the seam varies, this lower bench remains practically at 18 inches, the increase or decrease being almost entirely on the upper bench of splint coal.

All coal is cut by electric chain machines, the Sullivan six-foot low-bed machines predominating. The coal is gathered from rooms by motors and conveyed from the partings by haulage motors to the tipples.

The preparation of a domestic coal begins at the working face, and, with this end in view, the attempt is made to train the inside organization to load as clean coal as possible into the mine car. The man who shovels bug dust, slate, and coal, without any other object than to load as many mine cars as possible, seldom gets through the first day smoothly. By the time two or three cars of his coal have passed over the scales, the mine foreman is notified that check loader No. — is loading dirty coal. Sometimes a personal warning does not have the desired effect, and upon his coming out that night, he finds that two or three cars of his coal are standing awaiting his inspection or have been run over the slate dump. A few lessons of this kind usually have the desired effect and the company is seldom compelled to resort to extreme measures.

In grading domestic coal at the tipple, probably the three most important points to be watched are

as follows: (1) Absence of slack in the prepared grades; (2) absence of impurities in all grades; (3) uniformity in size of smaller grades.

Probably all operators are familiar with letters from the sales managers stating that a customer has forked over a certain car of coal and found 5 or 10 tons of slack in what was shipped as a car of lump coal.



LOADING BOOM

Of course he asks for a deduction of that amount, counting the slack as a total loss. It is surprising how many customers have absolutely no way of disposing of lump coal screenings.

From limited inspection in different coal fields it is evident to me that in many instances preparation of the output receives secondary consideration, if it is considered at all. Many mines are using the same equipment with which they started 5, 10, or 15 years ago. The coal is handled in the same way, and without doubt the screened sizes contain practically the same amount of slack and impurities as in the beginning.

The bituminous domestic coal trade has changed radically during the past 5 years. Previous to that time picking tables, loading booms, washers, etc., were associated with only anthracite breakers, bituminous coal being considered too cheap to warrant any such expenditures. The margin of profit per ton was too small, but in this day of compe-

tion a step in advance ought to be expected. Producers say there has been an overproduction of soft coal during the past few years, and for that reason, if for no other, the rivalry to secure contracts has brought out the best efforts of all concerned. If one operator had quality but not preparation, he was at a disadvantage with the fellow who had the reverse—preparation without quality.

When a sales department approaches an operator with a proposition that if he will eliminate all slack from his lump coal it will sell for 25 cents advance in price, the operator begins at once to figure how to secure that increase. If he does not he is no operator, or at least will not be one long. A proposition similar to this was placed before our company a little more than a year ago. Our tipples and equipment were then practically 2 years old, but the fact was obvious that first-class preparation could never be secured unless radical changes were made. Four grades, lump, egg, nut, and slack, together with combinations of any or all grades were being made at this time. The lump coal contained too much slack, as did also the egg and nut grades. A small amount of slate found its way into the egg and nut cars which could be removed by picking, but the slack could not be removed in that way.

Originally the tipples were equipped with 16-foot screen bars spaced according to the size of coal desired: 1¼-inch, 2-inch, 3-inch, 4-inch, or 6-inch lump. Upon dumping a mine car of coal the lumps passed over these bars, into a basket at the lower end of the chute from which they were dumped into the car. No other preparation was given and the car was billed and sold as lump coal. Owing to the fact that all kinds of equipments are furnished by the railroads, it was extremely difficult to regulate the height of the basket so that the lumps would not fall from 6 to 10 feet into the bottom of the railroad

car. The resulting breakage caused a considerable percentage of loss to the customer, which in the end the operator usually had to stand. In addition to this there was also a certain amount of fine coal carried over the screen bars with the lump, which also found its way into the railroad car. You well know that if a customer orders a car of 4-inch lump, he expects every piece to be at least 4 inches in diameter. With a brittle coal it is little wonder that there were many complaints about the large lumps being broken and the excess of slack.

The egg, nut, and slack sizes were prepared from the coal that passed through the 4-inch screen bars. This was received on a double-decked shaker screen 16 feet in length, the upper deck being covered with plates having 2-inch circular perforations and the lower deck with $\frac{3}{4}$ " \times "2" slots. The preparation in its simplest form was as follows: Over 4-inch bars, lump coal; through 4-inch bars and over 2-inch screen plate, egg coal; through 2-inch screen and over $\frac{3}{4}$ -inch screen, nut coal; through $\frac{3}{4}$ -inch screen, slack coal.

This method of preparing our small coal also got us into trouble. Providing the coal as it came from the mines was perfectly dry, everything worked fairly well and a good grade of egg and nut was secured; but as fully 50 per cent. of our output was wet, the resulting grades were unsatisfactory. Too much slack stuck to the egg and nut and found its way into the railroad car. On the whole, our preparations were far from satisfactory to the customer and salesman. Of a necessity the operator is not long ignorant of this fact. To obviate this and to take advantage of that promised increase in price, practically the entire screening and loading arrangements were remodeled. The lump coal is now received on the screen bars as before, goes thence to a shaker screen with 3-inch perforations in the bottom, which in turn delivers to a loading boom and

picking table combined. This process practically frees the lump from all slack. The loading boom is controlled by mechanical devices so that the man operating it can raise or lower the end at will, depending upon the height of the railroad car. The lumps now never fall vertically into the car. As the loading proceeds and the car is dropped down, the end of the boom is raised or lowered to suit and the lumps roll off, never falling more than 2 or 3 feet, and usually less. The capacity of this arrangement has never been reached though the 4-inch lumps from 200 tons run-of-mine coal have been loaded per hour, and without delay. It is believed that this is as good preparation as it is possible to secure for this kind of bituminous coal. The fact that we have no more complaints from consumers is conclusive evidence that the new arrangement has greatly aided in satisfying our trade.

We have not done so much to increase the quality of the egg and nut sizes, partly because the tonnage is small, but principally because the original design of the tipples will not allow much change. However, we did make two shakers out of the original one and also added another to deliver the egg coal to the car. Every opportunity is taken to run this coal over extra screens, and all chutes have perforated bottoms, so that by the time the coal is delivered to the car it is practically free from slack.

In general this is an outline of some of the difficulties encountered in the preparation of a bituminous domestic coal and the manner in which they have been met. It is quite probable that every individual operation may have distinct troubles, but for continued success they must be met and overcome. You censure the miner because he shoots his coal so hard that he breaks up all the lumps; you censure the motorman for being too rough in the handling of his trip; you censure the dumper because he elevates his car too quickly and sends the

coal over the screen so rapidly that the lumps are broken, by his carelessness you say, but might it not be that the force of gravity does more than all the others combined? I firmly believe that more coal is broken up in the loading and so-called preparation than is destroyed by the carelessness of the miner and tipple hand.

來 來

Car Couplings

Car couplings are the most aggravating if not expensive part of the car equipment. In Fig. 1 is shown a car coupling which is in use at the Fidelity mine, at Greenwood, Ark.

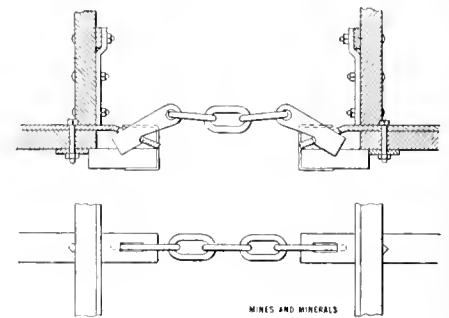

FIG. 1

The coupling was designed by a blacksmith at the United Iron Works, Springfield, Mo., and is giving satisfaction. It does not jar loose or come unfastened and is easily coupled. The drawbars and the couplings are made alike at both ends. The coupling has the advantage that the net section can be so designed that the cross-section is equal to the cross-section of the drawbar or center straps of the car.

The pin, which is rectangular, has a small notch on one side which catches on one end of a shaped slot in the drawbar end. Two of these flat-shaped pins are joined by three links. When there is a pull on the coupling the pins turn on the notch as a center and tighten in the slot, the side opposite the notch pressing against the back of the slot. When there is no pull, the weight of the links holds the pins in place. The center stay is bent down at the end so that all the bending strain does not come upon the pin.

Facts and Theories Relating to Fans

Methods of Testing Exhaust Fans and of Calculating Efficiencies from the Results Obtained

By David M. Mowat*

THE writer does not claim to propound new theories or to state new facts, but rather to express in form which he hopes will be readily understood, certain useful facts concerning fans.

In this paper he has confined himself to the consideration of exhaust fans.

If a weight attached to one end of a piece of twine is swung in a vertical plane round a fixed point until it acquires a certain velocity, and the twine is released when the weight is making an upward movement in a vertical direction, the weight will rise to a certain height, which can be easily calculated. It is the same as a height from which a body requires to fall, in order to obtain a velocity equal to the upward velocity of the revolving weight at the moment of its release. If v be the velocity of the body in feet per second, and g the force of gravity (which may be taken as 32 feet per second), then s is the distance in feet to which it will rise, the relationship between these factors being expressed by the formula:

$$s = \frac{v^2}{2g}, \text{ or } v = \sqrt{2gs}$$

The tips of the radial blades of a fan throw off at a tangent particles of air with a velocity equal to the velocity of the tips of the blades.

In an open running fan without a peripheral casing, the theoretical difference in pressure created between the inlet of the fan and the outlet at the periphery, expressed in feet of air column, will be:

$$s = \frac{v^2}{2g} \quad (1)$$

In such a fan the air is discharged into the atmosphere at a high velocity after the fan has done its useful work. This is a waste of energy, which is partly recovered in a closed fan.

In a fan having an *évasé* casing, and chimney, the theoretical difference of pressure created is double that produced in the case of the open

fan, owing to the restitution of energy stored up as velocity in the air leaving the tips of the blades, by means of the reduction in velocity of the air in the *évasé* casing; that is,

$$s = \frac{v^2}{g} \quad (2)$$

s is expressed in feet of air column, and, in order to obtain practical results, it is necessary to find the value of this depression in inches of water gauge from the data usually available, namely, the diameter of the fan and its speed.

If v = the velocity of tips of blades of fan in feet per second;

d = the diameter of fan in feet;

r = the number of revolutions per minute,

$$\text{then } v = \frac{d \times 3.1416 \times r}{60} \quad (3)$$

$$s = \frac{v^2}{g} = \frac{v^2}{32}$$

Substituting the value of v in terms of d and r we get

$$s = \frac{\left(\frac{d r \times 3.1416}{60} \right)^2}{32} = .0000856 d^2 r^2 \quad (4)$$

The relative weight of air and water at ordinary temperature and pressure is about 820 to 1. Therefore, the height of air column which will be equal to 1 inch of water gauge is 820 inches, or 68.4 feet, or,

$$\text{Water gauge in inches} = \frac{s}{68.4},$$

$$s = 68.4 \text{ W. G.} \quad (5)$$

Substituting this value in formula 4,

$$\begin{aligned} \text{Theoretical water gauge} &= \frac{.0000856 d^2 r^2}{68.4} \\ &= .0000125 d^2 r^2 \quad (6) \end{aligned}$$

This theoretical water gauge is never obtained, owing to defects in design and construction. The percentage actually obtained depends on the manometrical efficiency of the

fan, which may vary from .4 to .75, the actual water gauge produced being, therefore, from 40 to 75 per cent. of the

theoretical water gauge.

If the fan drift be closed to exclude the entry of air, the water gauge then produced at a given speed is the highest which the fan can produce at that speed. This water gauge thus measured, divided by the theoretical water gauge (equation 6), gives the manometric efficiency m .

Thus, $m = \frac{\text{Actual water gauge}}{\text{Theoretical water gauge}}$
or actual W. G. = theoretical W. G. $\times m$, the actual water gauge being measured with closed drift.

$$\text{Actual W. G.} = \text{theoretical W. G.} \times m = .0000125 d^2 r^2 m \quad (7)$$

In actual practice how is this water gauge to be measured, and when will it be obtained? In a given fan running at a certain speed it will always be produced, but it will very seldom be possible to measure it under working conditions. It is only when the fan drift is completely closed, so as to prevent the entry of air to the fan, that this water gauge will be obtained. If air is allowed to enter the fan in increasing quantity, by opening up the fan drift, the water gauge will be found to be apparently decreasing, until it falls to a very low value, when the air is allowed to enter at the mouth of the drift freely.

To understand what has taken place, it is necessary to consider the relationship between the fan and the drift, or mine, as the case may be. By his conception of the equivalent orifice and the orifice of passage, Murgue has enabled a perfect analysis of these relations to be made. He has compared the resistances of the mine and the fan with the resistances offered to the passage of the air by two orifices in sheets of iron arranged in series, as shown in Fig. 1. O_e represents the orifice having a resistance equal to that of the mine, and O_p represents the orifice having a resistance equal to that of the fan. The area of O_e will

*From the Transactions of the Mining Institute of Scotland.

vary with every varying condition of the mine, while the area of O_p for a given fan will remain constant.

The "equivalent orifice" is the expression used to denote the measure of the resistance which the air encounters in a mine. In measuring electrical resistance in a conductor, the result may be expressed in two ways: (1) it may be said that, in

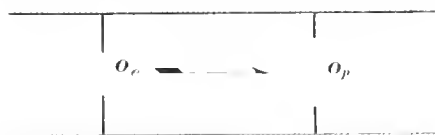

FIG. 1. RESISTANCE OF FAN AND OF MINE COMPARED

order to pass a quantity of 6 amperes along a conductor, a pressure of 216 volts is required; or (2) it may be said that the resistance of the conductor is 36 ohms.

In a mine it may be found, by means of the water gauge and the anemometer, that when the water gauge is 1 inch the quantity of air passing is 20,000 cubic feet per minute; but in this form the comparative impression conveyed to one's mind is very indefinite. Murgue found a definite value similar to the ohmic resistance for the resistance of a mine when he compared the mine with its "equivalent orifice."

The "equivalent orifice" of a mine is the area of an aperture in a sheet of iron which would, if subject to the same water gauge or difference of pressure between the two sides of the sheet, pass the same amount of air as would pass in the mine. To ascertain what this area is, it is necessary to go back to the relationship between the height and the velocity of falling bodies. The velocity of flow of water from an orifice in the bottom or in the side of a tank depends on the form of the orifice and on the height of the water above it. The theoretical velocity of flow in feet per second is $v = \sqrt{2} g s$, and the theoretical quantity of water flowing will therefore be $v a$, a being the area of the orifice. The actual quantity is considerably less on account of the "crowding" of the water through the orifice. If the tank be of sheet iron,

the reduction of area, or *vena contracta*, may be taken as .65, so that the actual flow of water will be .65 $v a$. The same laws apply to the flow of air, s being the height of air column equivalent to the ventilating pressure.

The problem is, therefore, to find the area of an orifice in a sheet-iron plate which will have the same resistance as a mine which passes a quantity q in cubic feet per minute with a water gauge in inches of W. G., the area thus formed being the equivalent orifice O_e of the mine. Let v and V be the velocity of the air passing through the orifice O_e in feet per second and in feet per minute, respectively,

$$\begin{aligned} \text{then} \quad v &= \sqrt{2} g s, \\ \text{and} \quad V &= 60 v = 60 \sqrt{2} g s. \end{aligned}$$

Substituting for s its W. G. value by equation (5)

$$\begin{aligned} V &= 60 \sqrt{2} g \times 68.4 \text{ W. G.} \\ q &= V \times \text{area} \times \text{vena contracta} \quad (8) \\ \therefore q &= .65 V a, \text{ or } .65 V O_e \end{aligned}$$

Substituting the value of v as in equation 8

$$\begin{aligned} q &= .65 \times 60 \sqrt{2} g \times 68.4 \text{ W. G.} \times O_e \\ \therefore O_e &= \frac{q}{.65 \times 60 \sqrt{2} g \times 68.4 \text{ W. G.}} \\ \therefore O_e &= \frac{.00039 q}{\sqrt{\text{W. G.}}} \quad (9) \end{aligned}$$

The area O_e thus obtained is therefore the area having a resistance equivalent to that of the mine. Similarly, the area of the orifice of passage of the fan,

$$O_p = \frac{.00039 q}{\sqrt{\text{W. G. } p}} \quad (10)$$

W. G. p being the water gauge required to pass the quantity q through the fan itself, W. G. p being that part of the total water gauge produced which is always invisible.

In practice, therefore, the actual water gauge produced is expended in two portions, one portion overcoming the resistance due to the passage of the air through the equivalent orifice O_e —that is, the mine—and the other portion overcoming the resistance due to the passage of air through the orifice of passage O_p —that is, the fan. The relationship between the values of O_e and O_p is a most impor-

tant one. The work done in overcoming the resistance in O_e is useful work, while that done in overcoming the resistance in O_p is so much waste.

If we assume that O_e is equal to O_p , then of the pressure expended in producing ventilation one-half goes to overcome the resistance in the fan, and the other half to ventilate the mine. Ignoring altogether the losses due to friction, defective construction, or design, it is evident that the maximum efficiency cannot exceed 50 per cent., and will be, because of these defects, a great deal less, only half of the effort being usefully employed.

If $O_p = 2 O_e$, the velocity in O_p will be to the velocity in O_e as 1 : 2. The pressure required to overcome the resistance in these areas will therefore be as 1 : 4. That is, a fifth of the water gauge will now be expended in overcoming the resistance in the fan, and four-fifths in overcoming the resistance of the mine. The maximum efficiency of such a fan on such a mine, ignoring losses due to friction and defects in construction and design, would therefore be 80 per cent.

If $O_p = 3 O_e$, the velocity in O_p will be to the velocity in O_e as 1 : 3. The pressure required to overcome the resistance in these areas will therefore be as 1 : 9. That is, a tenth of the water gauge will now be expended in overcoming the resistance in the fan, and nine-tenths in overcoming the resistance of the mine. The maximum efficiency of such a fan on such a mine, ignoring losses due to friction and defects in construction and design, would therefore be 90 per cent. These efficiencies of 50, 80, and 90 per cent. are purely theoretical efficiencies, and are subject to reduction on account of (a) manometrical inefficiency, (b) defects in design and construction, and (c) frictional losses (mechanical).

The power lost under (a) is not directly in proportion to the manometrical efficiency. If the revolving wheel, on account of the form or angularity of the blades, is not producing water gauge, it is not using power to drive it as a fan, but is running only as a flywheel. The actual efficiency obtained will probably not

exceed 80 per cent. of the theoretical efficiency, so that in the foregoing cases the actual efficiencies may be about 40, 64, and 72 per cent., respectively.

If O_p is more than 3 O_e , it will probably be found that the saving in power thus effected will be more than counterbalanced by the increased friction of the machine, owing to its greater size and weight.

The most economical relationship between O_e and O_p appears to be when O_p is from two to three times as great as O_e .

It appears to the writer to be very desirable that data should be obtained as to the most economical relationship between O_e and O_p in the various types of fans. It may be in a mine having a very large equivalent orifice, an open-running fan would give more economical results, on account of its comparatively low internal resistance. To ventilate a hall, which is just a mine of large equivalent orifice, no one would think of using an encased fan.

The principal difficulty in obtaining such data with the necessary degree of accuracy is that of measuring the power required to drive the fan. If the fan is engine driven, the horsepower obtained by means of indicator diagrams is a very uncertain measure of the actual power expended. In order to obtain such data accurately, the fans would require to be motor driven, and the motor carefully tested by means of a dynamometer or other suitable method, in order to ascertain its efficiency.

The writer had occasion several years ago to make careful tests of the performance of two fans on a mine. The tests were made at Bardykes colliery with one fan 7 feet in diameter by 7 feet in width and the other 10 feet in diameter by 7 feet in width. The smaller fan was first erected, but was found to be too small for the work to be done, and was therefore replaced by the larger fan.

Fig. 2 shows the fans and fan drifts connecting with the shaft.

where it joins the shaft. When the tests were made, the pit mouth was not closed, the fans drawing air from the surface at the end of the drift. Resistances were inserted in the drift at *A* and *B*, consisting of spars and spaces, each 3 inches wide alternately, the spars in *A* being vertical and in *B* horizontal, so as to baffle eddy currents as far as possible. The area of the resistance *A* was altered during the tests by closing some of the spaces. The water gauge was

The fans were driven by a squirrel-cage motor of 150 horsepower by means of a leather belt 20 inches wide. The motor was connected with a 500-kilowatt turboalternator, the speed of which was varied, so as to obtain the required number of revolutions in the fan. The speed of the fan was measured by means of a speed counter. The velocity of the air was naturally much higher at the outside of the curve than at the inside, the current at the inside during

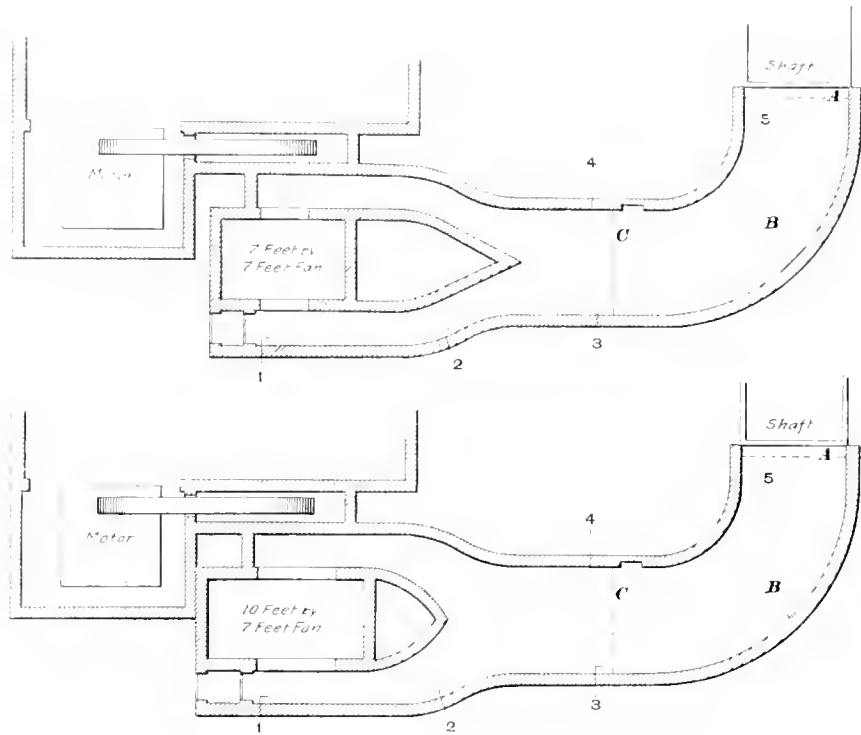

FIG. 2. CONNECTIONS OF FANS AND FAN DRIFTS WITH THE SHAFT

measured at five gauges numbered 1 to 5. Nos. 1, 2, and 3 were fitted with Pitot tubes, while Nos. 4 and 5 were fitted on open-end tubes. No. 4 was fitted telescopically, so that the water gauge could be measured at any point of the drift from one side to the other.

The quantity of air passing was measured at *C* with an anemometer attached to a small traveling crane, by means of which the anemometer could be moved into any position in the drift, without the observer having to leave the manhole in which he was situated. The drift at that point was 10 feet square, and was divided by wires into 25 squares of equal area.

the passage of the smaller quantities being reversed.

It was found that the measurement of the water gauge by a plain tube at No. 4 was absolutely unreliable, the readings varying as the tube was moved from one side of the drift to the other. With a Pitot tube at No. 4 the readings were the same from side to side of the drift. It was also found that No. 1 gauge (which was out of the current) gave the same reading when hooded or when turned down. The form of Pitot tube used is shown in Fig. 3. Experiments were also made with various forms of hood on the ends of the tubes, but these were not found to be satisfactory.

The writer is satisfied that the

sults obtained with the Pitot tubes are quite reliable. The water gauges were carefully measured by means of a scale graduated to tenths of an inch. The anemometer used was a new one, which had just been adjusted; it was compared with another, and found to agree closely with it.

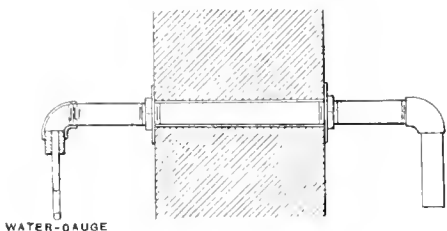

FIG. 3. FORM OF PITOT TUBE

The result obtained by measuring and reading the velocity in each square separately was the same as was obtained by shifting the anemometer each half-minute or minute into another square and reading the total at the end of 12½ or 25 minutes. The latter method, which was simpler, was therefore followed. One comparison was made simultaneously between the quantity of air passing in the drift and that leaving the chimney of the fan, and the results were practically identical.

The electrical horsepower at the motor was measured by means of a Kelvin wattmeter, which had just been adjusted. The efficiency curve

of the motor obtained by actual tests is shown in Fig. 4. The results of the tests are stated in Tables 1 and 2.

Columns 1, 2, 3, 4, 5, 6, 7, and 8 are the result of observations; column 9 is estimated from the motor efficiency and the efficiency of the belt drive, which has been taken at 95 per cent.; whilst columns 10 and 11 are calculated from the quantity, water gauge, and horsepower, as follows:

$$\begin{aligned} \text{Efficiency} &= \frac{q \times W. G. \times 5.2 \times 100}{E. H. P. \text{ or } H. P. \times 33,000} \\ &= \frac{.01576 q \times W. G.}{E. H. P. \text{ or } H. P.} \end{aligned} \quad (11)$$

Columns 12, 13, 14, 15, 16, and 17 are calculated from the foregoing data; column 18 shows the water-gauge readings with closed drift corrected for slight variations in the speed of the fan, the corrections being made on the principle that the water gauge varies as the square of the number of revolutions; whilst column 19 shows the total water gauge obtained in column 18 minus the actual water gauge registered at No. 1 gauge in column 2, the difference thus obtained being the invisible part of the water gauge created which is required to pass the air through the fan itself. The orifice of passage shown in column 20 is calculated by equation (10) from the data con-

tained in columns 7 and 19. Column 21 shows the ratio between O_e and O_p .

An examination of columns 12, 13, 14, 15, 16, and 17 affords proof of the accuracy of the observations. With one or two exceptions, the relation-

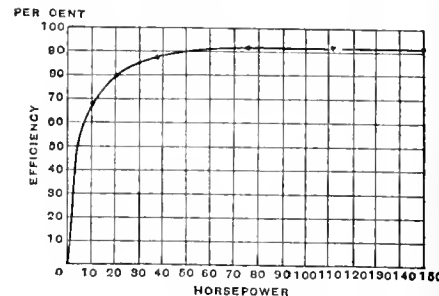

FIG. 4. EFFICIENCY CURVE OF ELECTRIC MOTOR

ship between the speed of the fan, the quantity of air, the square root of the pressure (W. G.), and the cube root of the power is remarkably close.

Fig. 5 shows graphically the relationship between the speed of the fan, quantity of air, water gauge, power, equivalent orifice, and efficiency. It will be seen that the highest efficiency is obtained in the 7-foot fan with an equivalent orifice of about 15 square feet, and in the 10-foot fan with an equivalent orifice of about 28 square feet. The orifice of passage of the 7-foot fan may be taken as 30 square feet, thus giving the highest efficiency when $O_e : O_p :: 1 : 2$.

TABLE 1. TESTS ON A BARCLAY FAN, 7 FEET IN DIAMETER AND 7 FEET WIDE, AT BARDYKES COLLIERY

Revolutions of Fan Per Minute	Water Gauges					Quantity of Air, in Cubic Feet Per Minute	Electrical Horsepower in Fan Shaft	Efficiency		Equivalent Orifice, No. 1 Gauge O_e	Ratios No. 1 Gauge					W. G. Corrected for Speed When $O_r = 0$	Invisible W. G. A-B		Ratio $O_e : O_p$			
	No. 1	No. 2	No. 3	No. 4	No. 5			Overall	Fan		No. 1 Gauge			Inches	Square Feet							
											Quantity	W. G.	E. H.P.				H. P.					
	B Inches							Per Cent.		Square Feet			A Inches			Inches	Square Feet					
217	1.850	1.850	1.850	1.850			18	13	Mano-metric {	61.20		1.000	1.000	1.000	1.000	1.85		1	∞			
294	3.250	3.250	3.250	3.250			40	33		61.50		1.353	1.325	1.305	1.36	3.25		1	∞			
360	5.000	5.000	5.000	5.000	5.000		72	63		63.50		1.659	1.648	1.585	1.69	5.00		1	∞			
360	4.550	4.500	4.500	4.550		33,300	76	66		31.20	36.20	6.07				5.00	.45	61.20	1	10.00		
359	4.060	4.060	3.940	4.000		74,560	91	80		52.50	58.75	14.42				4.95	.89	30.80	1	2.10		
215	1.250	1.187	1.187	1.250	1.250		24	19		46.40	58.75	19.76	1.000	1.00	1.000	1.000	1.82	.57	29.20	1	1.43	
292	2.187	2.125	2.030	2.250	2.250		56	48		48.60	56.70	20.82	1.360	1.39	1.320	1.320	3.21	1.02	30.55	1	1.41	
359	3.250	3.125	3.030	3.375	3.125		102	89		48.60	55.80	21.00	1.670	1.71	1.610	1.620	1.67	4.95	1.70	29.10	1	1.34
217	.750	.750	.720	.810	.750	81,442	30	24		32.00	40.20	36.70	1.000	1.00	1.000	1.000	1.00	1.85	1.10	30.30	1	.81
292	1.250	1.187	1.150	1.375	1.250	107,840	68	59		31.20	36.00	37.50	1.340	1.32	1.290	1.320	1.35	3.21	1.06	30.00	1	.75
360	2.000	1.940	1.750	2.090	1.875	133,584	127	111		33.10	37.92	36.80	1.660	1.64	1.640	1.620	1.67	5.00	3.00	30.10	1	.75
216	.625	.560	.560	.625	.560	84,846	31	25		27.00	33.45	41.70	1.000	1.00	1.000	1.000	1.83	1.20	30.20	1	.68	
290	1.060	1.000	.940	1.125	.940	113,824	71	62		26.80	30.70	43.20	1.340	1.34	1.300	1.320	3.17	2.11	30.50	1	.67	
357	1.500	1.440	1.310	1.625	1.440	139,575	133	116		24.80	28.42	44.30	1.650	1.65	1.550	1.620	1.67	4.92	3.42	29.50	1	.62
214	.500	.500	.440	.530	.375	89,486	32	26		22.00	27.10	49.30	1.000	1.00	1.000	1.000	1.80	1.30	30.70	1	.58	
291	.940	.780	.720	.940	.750	119,676	73	64		24.30	27.70	48.20	1.350	1.34	1.370	1.320	3.18	2.24	31.20	1	.57	
364	1.250	1.187	1.125	1.375		153,800	140	122		21.60	24.81	53.50	1.700	1.72	1.580	1.630	1.68	5.10	3.85	30.50	1	.54

The orifice of passage of the 10-foot fan may be taken as 62 square feet, thus giving the highest efficiency when $O_e : O_p :: 1 : 2.21$.

Both these are Barclay fans of the double-inlet drum type, and the orifice of passage in this type appears to be:

$$O_p = .62 d^2, \text{ or } d = \sqrt{\frac{O_p}{.62}} \quad (12)$$

If similar reliable data were available for other types of fans, there would be no difficulty in determining the most economical size of fan for any required duty. For example, if a Barclay double-inlet fan was wanted to give 200,000 cubic feet per minute with a water gauge of 3 inches, by equation (9)

$$O = \frac{.00039 q}{\sqrt{W. G.}}$$

$$\therefore O_e = \frac{.00039 \times 200,000}{\sqrt{3}}$$

= 45 square feet

Taking the most economical ratio between O_e and O_p as 1 : 2.3, then $O_p = 45 \times 2.3 = 103.5$ square feet.

By equation (12),

$$d = \sqrt{\frac{O_p}{.62}}$$

$$\therefore d = \sqrt{\frac{103.5}{.62}} = 13 \text{ feet diameter}$$

At the risk of repetition, and the restatement of many well-known for-

mulas, the writer has endeavored to place before the members of the Institute a simple statement of some facts relating to fan ventilation, in the hope that others who may have the opportunity may repeat the experiments he has just described on other fans, so that reliable data on the subject may be obtained. Results are often published by fan makers in the form of advertisements, which, in the writer's opinion, are absolutely unattainable, and are therefore misleading.

DISCUSSION OF MR. MOWAT'S PAPER
BY OTHER MEMBERS OF
THE INSTITUTE

At a subsequent meeting of the Institute, Mr. John B. Thomson stated that Mr. Mowat's paper was of great interest and value, and that he had properly described how a fan should be tested. He particularly commended Mr. Mowat's emphasizing the fact that the use of the Pitot tube in ascertaining the true water gauge due to depression was the proper way, and that results obtained by a straight tube were inaccurate. In support of this he described a small experiment which he made a number of years ago.

He had connected up to the ear of a small fan a short pipe 10 inches in diameter, and to the other end of the

pipe he had connected an old grease barrel, into the further end of which he had put another short length of 10-inch pipe. He had then inserted water-gauge tubes at three points in this air-course, one in each 10-inch tube, and one in the barrel. When the fan was started up, the water gauge farthest from the fan indicated a larger gauge than the one in the barrel. By reversing the process and blowing air through this same air-course, the water gauges should all have shown a positive gauge, but the one farthest from the fan showed a negative gauge, demonstrating clearly that the water gauge taken with a straight tube indicated the gauge due to velocity as well as that due to depression or compression, as the case might be.

The formulas that Mr. Mowat had given in his paper were old friends with new faces; they were very concise and easily understood. He could not, however, follow Mr. Mowat's reasoning when he said that the theoretical water gauge of an open-running fan should be calculated from the formula $s = \frac{v^2}{2g}$, and for a closed fan $s = \frac{v^2}{g}$, the difference being due to the fact the the closed fan had an évasé chimney.

TABLE 2. TESTS ON A BARCLAY FAN, 10 FEET IN DIAMETER AND 7 FEET WIDE, AT BARDYKES COLLIERY

Revolutions of Fan Per Minute	Water Gauges					Quantity of Air, in Cubic Feet Per Minute	Electrical Horsepower in Fan Shaft		Efficiency		Equivalent Orifice, No. 1 Gauge O_e	Ratios No. 1 Gauge					W. G. Corrected for Speed When $O_e = 0$	Invisible W. G. A-B	Orifice of Passage O_p	Ratio $O_e : O_p$	
	No. 1	No. 2	No. 3	No. 4	No. 5		Overall	Fan	Revolutions	Quantity		$\sqrt{W. G.}$	$\sqrt{E.H.P.}$	$\sqrt{H. P.}$	A	Inches					Square Feet
	1	2	3	4	5																
130	1.30	1.30	1.30	1.30	1.30	19	14	61.70	1.00	1.00	1.00	1.00	1.00	1.30	.16	43.00	1	2.70			
176	2.25	2.25	2.25	2.25	2.25	42	35	58.20	1.35	1.32	1.30	1.35	2.25	.21	49.00	1	3.13				
216	3.30	3.30	3.30	3.30	3.30	72	63	56.50	1.66	1.59	1.56	1.64	3.30	.40	75.00	1	3.80				
131	1.16	1.15	1.20	1.27	1.20	44,040	18	13	44.70	62.00	15.95	1.00	1.00	1.00	1.00	1.32	.16	43.00	1	2.70	
177	2.06	2.05	2.08	2.15	2.10	57,615	43	36	43.50	52.00	15.65	1.35	1.31	1.33	1.33	1.40	2.27	.21	49.00	1	3.13
216	3.12	3.05	3.12	3.20	3.15	69,348	80	70	42.80	48.70	15.30	1.65	1.57	1.64	1.64	1.75	3.30	.18	63.80	1	4.17
131	1.10	1.10	1.10	1.25	1.10	74,585	22	17	58.80	76.20	27.80	1.00	1.00	1.00	1.00	1.00	1.32	.22	62.00	1	2.23
176	1.90	1.90	1.90	2.12	1.80	99,412	51	43	58.30	69.10	28.10	1.34	1.33	1.31	1.32	1.36	2.25	.35	65.60	1	2.33
216	2.90	2.82	2.80	3.10	2.60	122,326	96	84	58.25	66.60	28.00	1.65	1.64	1.62	1.63	1.70	3.30	.40	75.00	1	2.63
131	1.00	.97	1.00	1.16	.70	87,655	25	20	55.30	69.05	34.20	1.00	1.00	1.00	1.00	1.00	1.32	.32	60.30	1	1.76
177	1.75	1.65	1.70	1.95	1.25	118,169	60	51	54.30	64.00	34.90	1.35	1.35	1.32	1.34	1.37	2.27	.52	64.00	1	1.81
218	2.60	2.45	2.50	2.85	2.00	146,502	112	98	53.70	61.30	35.40	1.66	1.62	1.62	1.64	1.70	3.37	.77	65.00	1	1.80
131	.85	.80	.80	1.00	.40	103,060	29	23	47.70	60.00	43.70	1.00	1.00	1.00	1.00	1.00	1.32	.47	58.70	1	1.30
177	1.50	1.36	1.35	1.72	.80	137,608	70	61	46.50	53.40	43.80	1.35	1.33	1.33	1.36	1.38	2.27	.77	61.00	1	1.32
216	2.15	2.00	1.95	2.55		165,974	128	112	43.80	50.20	44.20	1.65	1.62	1.59	1.64	1.70	3.30	1.15	60.50	1	1.31
130	.75	.70	.65	.95		111,333	30	24	43.80	54.75	50.20	1.00	1.00	1.00	1.00	1.00	1.30	.55	58.60	1	1.08
176	1.30	1.25	1.15	1.60		150,713	73	64	42.50	48.20	51.50	1.35	1.35	1.32	1.31	1.38	2.25	.95	60.20	1	1.10

Many old open-running fans had so-called "manometric" efficiencies almost as high as closed fans, and some newer fans had manometric efficiencies of over 100 per cent. He had a fan running which showed a manometric efficiency of 180 per cent. When Mr. Mowat had ascertained

that the term "manometric efficiency" was a dead letter. The initial water gauge of a fan depended not only on the velocity of the tips of the blades, but also on the shape of the blades. If a fan was required to give a low water gauge, the blades had to be bent backwards,

the tests made by Mr. Mowat. He would have expected a greater variation, due to the fact that the efficiency of the belt drive (namely, 95 per cent.) had been taken as constant at the various speeds. He believed that the efficiency of belt drives and rope drives had been overestimated,

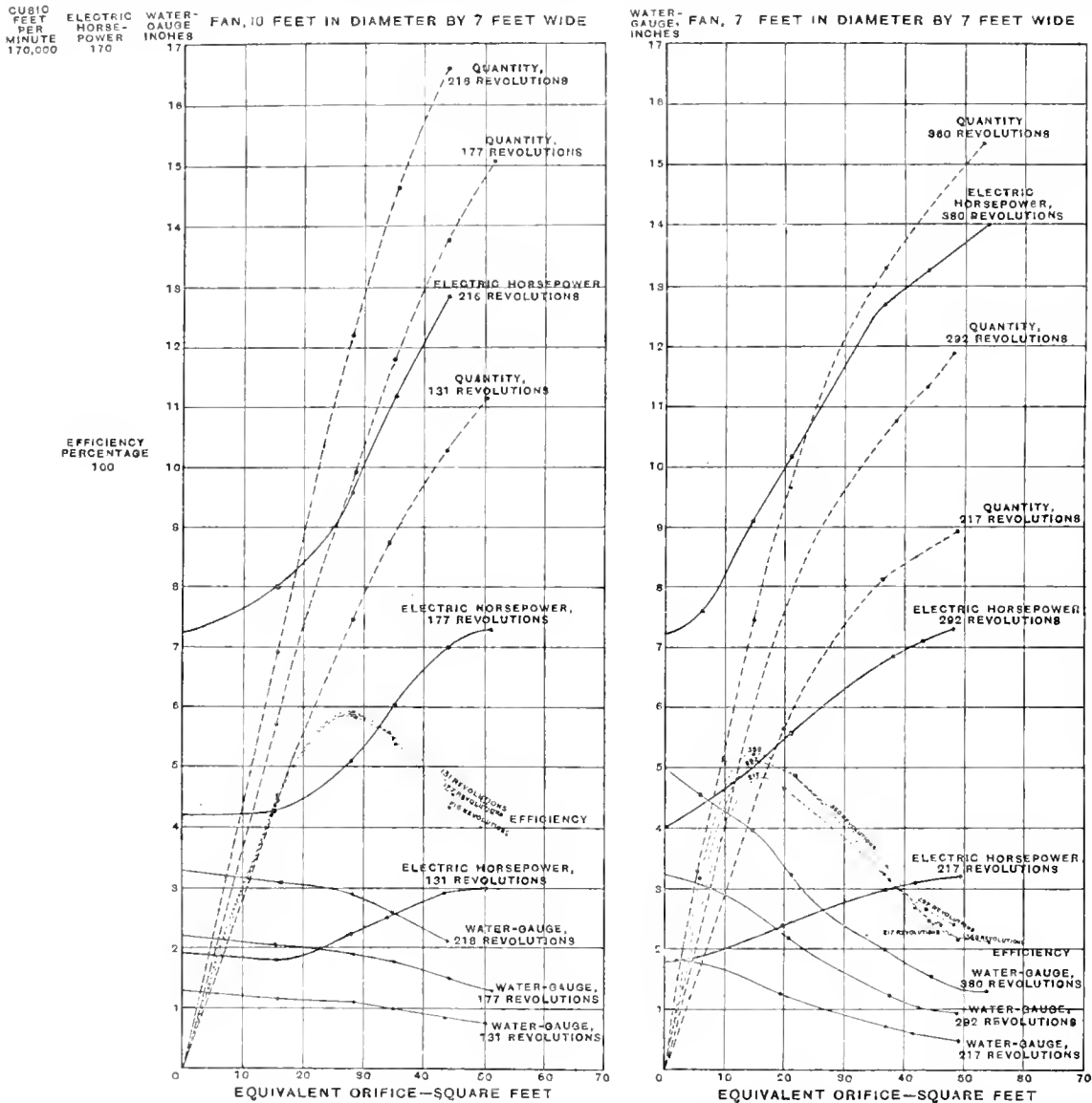

FIG. 5. RELATIONSHIP BETWEEN SPEED OF THE FAN, CUBIC FEET OF AIR, WATER GAUGE, EQUIVALENT ORIFICE AND EFFICIENCY

the initial water gauge, the fan draft was closed up, and there was no air passing, so that the évasé chimney could have nothing whatever to do with the manometric efficiency. This term puzzled him when he was a student, and he thought that Mr. Mowat's explanation was the first that had been given; but he thought it entirely erroneous, and considered

and if a fan was required to give a high water gauge, the blades must have a forward bend. The efficiency of these fans might be equally good although there would be a big difference in their manometric efficiencies. Mr. Thompson expressed surprise at the nearness of the ratios in columns 13 and 17 of Tables 1 and 2, which went to prove the accuracy of

even when running at the most efficient speeds. He thought that 90 per cent. would be nearer the mark for the average belt or rope drive.

Before referring to the formula which Mr. Mowat had deduced from his experiments, by which he proposed to calculate the size of fan required to produce a given quantity

of air at a given water gauge, Mr. Thomson stated the results of tests that he made some time ago with a Sirocco fan, 8 feet 2 inches in diameter, driven by a cross-compound steam engine through a rope drive. He had calculated the invisible water gauge, orifice of passage, and the ratio between the equivalent orifice and the orifice of passage. He had also plotted the results, which are contained in the diagram Fig. 6. By referring to the diagram it will be seen that the quantity curve is almost an absolutely straight line; the water-gauge curve is also nearly straight after it leaves the initial water-gauge point, the slight bend being probably due to an inaccurate observation, as the difference at the various points is so very small. The overall-efficiency curve is fairly regular, but the fan-efficiency curve is not satisfactory, because the loss for engine and ropes is taken at a constant.

Referring now to Table 3, the invisible water gauge and orifice of passage gradually increased with the increased duty, and the ratio gradually diminished, if the second last experiment was left out, the water gauge of which was in doubt and affected the calculated portions of the table. These results did not fit in with the results obtained by Mr. Mowat, and he did not think that a similar formula to that given by Mr. Mowat for finding the size of a fan for a given quantity and water gauge could be deduced for a Sirocco fan. He was of opinion that it would not apply to any other than a Barclay, and even with a Barclay fan it did not apply very accurately. If one

worked out the size required for 200,000 cubic feet of air with a 3-inch water gauge, from the results obtained from the 7-foot fan, the answer would be about 12 feet 4 inches instead of 13 feet. Very probably if a 13-foot fan were put to work on such a duty, and a test made, it would be found that it was either too big or too small, and this was about the state of perfection that fan makers and mining engineers had reached: that was, the correct size of a fan was obtained by the old-fashioned rule of trial and error.

He had yet to see a fan-maker's list of fans with truly reliable information of what the fans could do, so that the size for any given duty could be picked out, the fan erected and started to work, and a definite result given in the same way that could be done with a pump or a haulage gear.

Mr. William McCreath said that by giving in the first part of the paper the formulas for the calculations of efficiency, etc., in connection with centrifugal fans, and working them out from the velocity due to a falling body, Mr. Mowat had added greatly to the ease with which one could grasp the points brought out therein.

In comparing the equivalent orifice of the fan with that of the mine, Mr. Mowat had pointed out in a very clear way the mistake of using a small fan to produce a large quantity of air. In choosing a fan for the ventilation of a colliery, one was much tempted to put in a small one, on account of the small first cost and its adaptability to an electric drive. The use of small quick-running fans for the ventilation of a colliery of considerable size was, in his opinion, a mistake. A

very high water gauge in many cases was not required, as with such much leakage was caused, owing to the air being drawn through doors and underground wastes, while a moderately high water gauge, with judicious splitting of the air and good airways, would be much more efficient. The

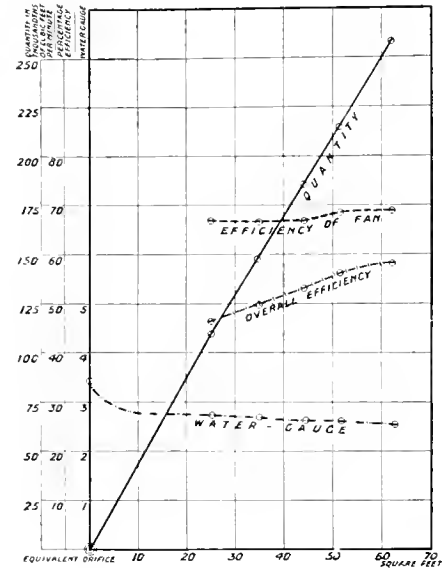

FIG. 6

size of the fan, however, depended to some extent on the design.

With regard to the pressure efficiency, as brought out by the formula given in the paper, it should be borne in mind that it was worked on the basis of a theoretically perfect fan receiving the air at the center and discharging it at the velocity of the tips of the blades, while the water gauge given by a fan depended to a considerable extent on the design of the blades. This was brought out very clearly by the experiments of Mr. Donkin, who showed that in most cases fans, the blades of which were curved forward or concave to the outlet, give a higher water gauge than those with concave blades, but give a lower mechanical efficiency. It was possible, therefore, to design a fan to give a high pressure or manometric efficiency with a low mechanical efficiency.

The readings of No. 4 water gauge were much higher than he would have expected, as compared with those of the other water gauges. Taking the author's Table No. 2,

TABLE 3. RESULTS OF TESTS WITH A SIROCCO FAN, 8 FEET 2 INCHES IN DIAMETER, DRIVEN BY A CROSS-COMPOUND STEAM ENGINE WITH ROPE DRIVE

Revolutions Per Minute	Water Gauge	Quantity of Air, in Cubic Feet Per Minute	Indicated Horse-power	Estimated Horse-power in Fan Shaft	Horse-power in Air	Efficiency		Equivalent Orifice	Water Gauge Corrected for Speed When $O_c = 0$	In-visible Water Gauge A-B	Orifice of Passage	Ratio $O_c : O_p$
						Overall Per Cent.	Fan Per Cent.					
	B						Manometric Efficiency	A				
182½	3.45		79.3				125.0		3.45			
183	2.78	109,096	102.5	72.5	47.8	46.6	66.0	25.5	3.50	.72	50.0	1 : 1.96
182½	2.72	147,888	126.3	96.3	63.4	50.0	65.8	35.0	3.45	.73	67.5	1 : 1.93
182	2.66	185,952	146.0	116.0	78.0	53.5	67.2	44.5	3.44	.78	82.0	1 : 1.84
181	2.66	216,528	161.1	131.1	90.8	56.4	69.2	51.8	3.40	.74	98.5	1 : 1.90
181	2.59	258,960	181.4	151.4	105.6	58.1	69.7	62.6	3.40	.81	112.0	1 : 1.79

and the highest velocity (1,659 feet per minute), the difference between the readings of Nos. 1 and 4 water gauges was .40 inch, representing a velocity of 2,520 feet per minute. The water gauge due to the mean velocity of the air (1,659 feet per minute) represented .17 inch, so that the reading was .23 inch greater than that due to the velocity in the air drift.

Mr. Mark Brand said that Mr. Mowat had provided a fund of information tabulated in a readily accessible and understandable manner, which would save much research, and stand as a model example in the testing and comparison of fan duties and efficiencies. In particular, Mr. Mowat had to be congratulated on the clear and convincing manner in which he had brought out the precise meaning and relationship between the theoretical water gauge and the maximum manometric efficiency; also the method of arriving at the information required to give the orifice of passage of the fan and equivalent orifice, and the relationship between the orifices under different conditions. Another point of great value, clearly brought out by the paper, was the area of equivalent orifice at which the fan gave its maximum efficiency.

Mr. Mowat had mentioned that the theoretical difference of pressure created in an enclosed type of fan was double that created in an open-running type, but it was doubtful

whether this point had been sufficiently proved.

Generally, in papers on fans, little or nothing was said about the breadth of the fan, this apparently being a dimension which was left to look after itself; and, as the writer had occasion lately to make tests with a steam-driven Capell fan, which was a type of fan somewhat similar to that described by Mr. Mowat, the results of the tests might be of interest, as the question of breadth and volume came up rather prominently in connection with the tests.

The plant consisted of one rope-driven, double-inlet Capell fan, 10 feet in diameter by 7 feet in width, designed to run at about 285 revolutions per minute, the power being provided by a two-cylinder horizontally coupled engine, each cylinder being 21 inches in diameter with a 3-foot stroke, and designed to indicate about 300 horsepower when running at from 75 to 80 revolutions per minute, with steam supplied at a pressure of 50 pounds per square inch at the stop-valve. The fan was rope driven, the drive consisting of nine cotton ropes 1 3/4 inches in diameter. The inlet to the fan was 7 feet 2 1/2 inches in diameter. The fan drift at a point 30 feet from the ear of the fan, was 12 feet wide by 10 feet 10 inches high, which was equivalent to an area of 130 square feet. The water gauge was taken in the usual way at the same point in the vault as that at which the velocity was

measured. The fan drift was divided by wires into 12 squares, and the velocity taken by means of an anemometer moved over each square for 1 minute. The total result of the 12 minutes' reading was divided by 12, so as to give the average velocity per minute of the air in the vault. The results of repeated tests showed less than 1 1/2 per cent. of error. Table 4 embodies the results of various tests made with the fan at full power, and one test at half power.

All the tests tabulated were made with the fan exhausting from the mine, with sufficient communication doors open underground, and with a slight adjustment of the doors on the pit head (where necessary) to give the various volumes and water gauges required for the tests. The first test tabulated showed that the fan was not yielding either the quantities or the efficiencies expected, and it was then suggested that the fan was rather large for the quantity of air passing, as this type of fan was stated to yield its maximum efficiency when passing about 160 per cent. of its volume per revolution.

Air was supposed to be reentering the fan from the évasé chimney, and to prevent this, four removable shutters, each 15 inches deep, extending the full breadth of the fan at the throat of the évasé chimney, were fitted. These shutters reduced the area of delivery at the throat as follows:

Number of shutters...	0	1	2	3	4
Square feet...	46.87	40.62	33.75	28.74	25.62

TABLE 4. RESULTS OF TESTING A CAPELL MINE VENTILATING FAN, 10 FEET IN DIAMETER BY 7 FEET IN WIDTH, AT DUMBRECK COLLIERY

Details of Test.	No. 1 Test	No. 2 Test	No. 3 Test	No. 4 Test	No. 5 Test
Steam pressure, in pounds per square inch...	51	55	57.25	57.5	54
Engine, revolutions per minute.....	78	78	78	78	63
Mean steam pressure.....	33.3	30.7	31.47	31	43.5
Indicated horsepower of engine.....	327	297	304	299	170
Fan, revolutions per minute.....	290	292	292	292	229
Water gauge, in inches.....	5.95	5.925	6.06	6.05	3.95
Quantity of air, in cubic feet per minute.....	184,970	183,690	187,600	211,510	180,440
Horsepower in air.....	167.6	171	117.5	198	112.3
Efficiency overall, per cent.....	51.25	57.6	58.38	66.2	66.8
Shutters fitted.....	None	4	3	2	2
Area of discharge at fan neck, in square feet.....	46.87	25.62	28.74	33.75	33.75
Circumferential area of discharge, in square feet.....	220	220	220	220	220
Peripheral speed of fan, in feet per minute.....	9,110	9,174	9,174	9,174	7,200
Radial flow of air in fan, in feet per minute.....	840	831	852	961	820
Velocity of air through fan neck, in feet per minute.....	3,944	7,170	6,529	6,267	5,347
Fan volume, in cubic feet.....	550	550	550	550	550
Cubic feet of air per revolution.....	637	629	642	724	788
Volumetric capacity, per cent.....	116	111	117	131	143

REMARKS.—No. 1 Test: No orifice in vault. Doors underground open to pass quantity. Doors at pit mouth all closed. No. 2 Test: Conditions same as in No. 1 test, except doors at pit mouth opened wider. No. 3 Test: Conditions same as in No. 1 test, except doors at pit mouth partly open. No. 4 Test: Conditions same as in No. 3 test, except doors at pit mouth opened further. No. 5 Test: Conditions same as in No. 3 test, except right-hand engine off. Four driving ropes off.

Results Nos. 2, 3, and 4 in Table 4 gave figures with four, three, and two shutters fitted. In No. 2 result, with four shutters fitted, the quantity of air was about the same as in No. 1 test, but the efficiency was improved by about 6 per cent. In No. 3 result, with three shutters fitted, the quantity of air was increased by about 2,000 cubic feet per minute and the efficiency by about 7 per cent. over No. 1 test. In No. 4 result, with two shutters fitted, the quantity had increased by about 26,000 cubic feet per minute over No. 1 test, and the efficiency

by about 15 per cent. No. 5 test at half load, with two shutters fitted, gave the results expected. Designers of types of fans similar to that tested by Mr. Mowat in some cases made a claim for large volumetric results, the highest efficiency being said to ensue when the fans were passing from 150 to 160 per cent. of their volume per revolution. This did not appear to be the case with the fan tested by Mr. Mowat, as the first group of tests gave about 330 cubic feet of air per revolution of the fan, which had a capacity of 550 cubic feet. The next series of tests gave 565 cubic feet per revolution, and at that point the maximum efficiency of the fan was obtained. The next series of figures gave 670 cubic feet per revolution, the next 770 cubic feet per revolution, and the last 850 cubic feet per revolution, clearly showing that the fan could not pass more than about 100 per cent. of its volume per revolution at maximum efficiency under the test conditions.

In some cases designers had evidently difficulty in obtaining the guaranteed quantities and efficiencies in the fans, and this, in the speaker's opinion, might be due in part to the following causes:

1. There was a considerable leakage of air from the delivery to the ears of the fan along the clearance between the fan cheeks and the sides of the building, and this in many cases might be reduced by more attention being paid to the proper training of the fan on its shaft.
2. Fans with a smaller number of blades allowed a certain reentry of air at the back of the blades, which needlessly absorbed power.
3. Where fans were too large for the work for which they were designed, there was a certain volume of air carried round by the fan blades from the discharge at the throat of the évasé chimney, which also absorbed power besides increasing friction losses.
4. In some cases the design and finish of fans were such as to offer more resistance than was necessary to the passage of air through the fans.

Probably some of the difficulties experienced in this matter might be overcome if the ratio between the radial flow and the periphery speed of fans was considered.

Taking similar fans, each 1 foot wide, with different diameters, as in Table 5, all running at, say, one

TABLE 5

	2 feet	4 feet	8 feet	16 feet
Diameter of fan.....	2 feet	4 feet	8 feet	16 feet
Circumferential area, in square feet.....	6.28	12.56	25.13	50.36
Cubical capacity.....	3.1416	12.56	50.26	201.06
Radial flow of air, in feet per second.....	3.1416	12.56	50.26	201.06
Equal to.....	6.2800	12.56	25.13	50.26
Tangential speed, in feet per second.....	.50	1.00	2.00	4.00
Ratio.....	.08	.08	.08	.08
If the fans had been passing 150 per cent. of their capacity per revolution, the ratio would have increased to.....	.12	.12	.12	.12

revolution per second, the ratios there given resulted and were constant, when passing 100 per cent. of the fan's volumetric capacity per revolution.

This ratio would vary in different types of fans and in the same types of fans with different volumes passing, but if the ratio could be determined at which maximum efficiency was produced, that was to say, the quantity of air that the fan could put through efficiently per revolution, an exceedingly easy method of calculating fan dimensions and power duties would be available.

It would be interesting to know whether if shutters were fitted on the fan described by Mr. Mowat, this would in any way alter the results already obtained, as the volumetric capacity of this fan seemed very small.

The important points in fan construction might be summarized as follows: (1) The area of the fan inlet in relation to the resistance of the mine; and (2) the area of the fan outlet to the resistance of the mine. This to include the area of the passage through the fan itself. The efficiency of a well-designed ventilating plant depended on these two points.

With an electrically driven fan, tests could probably be more readily made than with one that was steam driven, but Mr. Mowat's contention that indicator diagrams were uncertain measures of the actual power

expended would not (the speaker thought) be readily accepted by engineers, as this method of measuring the power exerted by engines of all kinds had been generally recognized and accepted in the past, and had yielded results sufficiently accurate for all practical purposes.

With properly calibrated instruments, the engine could be indicated correctly. The difficulty with indicator diagrams was that they were mostly taken by people who had not had the opportunity of understanding the best conditions suitable for the particular installation to be tested. A fairly correct method, and one which could be depended on, was to determine roughly what power was likely to be required in the engine, then to adjust the point of cut-off to suit that power, so as to give a low terminal pressure, and to put in a spring which would give the largest possible figures with the given initial steam pressure. The chances of error with a figure 2½ inches deep must necessarily be much less than with a figure only 1 inch deep, both having the same initial steam pressure.

Mr. Henry Briggs said that it was not correct to make use of the expression $\frac{v^2}{g}$ in calculating the mechanical efficiency of fans of all characters, since it was true only for those the blades of which were radial at their tips. He believed that the use of the expression was due chiefly to Murgue's work; yet he thought that if Murgue's book on "Centrifugal Ventilating Machines," was referred to, it would be found that the author had expressly stated the formula in question to be true only for radial vanes. The result of making use of this formula for fans the blades of

which were turned forward at a large angle, was that the manometrical efficiency worked out sometimes at more than 100 per cent. One such instance had been mentioned by a previous speaker. Now, the efficiency of no machine could be over 100 per cent.; it was an evident impossibility. For any other sort of machine, indeed, such a statement would never be accepted for a moment; but fans had always been considered rather mysterious contrivances. The fact was that such a result did nothing else than prove the theory false, and pointed to the need of revising that theory. The proper expression for fans with non-radial blades, although a little more complicated than the orthodox one, was quite workable, and gave reasonable results.

The manometrical efficiency could be put to good practical use, and a better criterion of the design of a fan did not exist, since it compared the work output and the work input without considering outside losses in the drive. In the fans which he had tested he had always found that, when rightly expressed, the manometrical exceeded the mechanical efficiency, and by means of the two efficiencies it was not difficult to find out the loss occurring in the fan drive—a useful achievement.

Mr. James Hamilton, the president, asked whether Mr. Mowat could explain why it was that in one test, namely, that of the 7' x 7' fan, the orifice of passage was constant, while on the other fan it varied very much, and varied apparently very irregularly. The orifice of passage was calculated from the unregistered or unseen water gauge of which Mr. Mowat spoke, and this Mr. Mowat assumed was nothing while the car of the fan was closed. There would be a certain amount of resistance in the fan running with the car closed and no air entering, due to air friction on the casing and reentry of the air at the chimney. This resistance could be expressed by "orifice of passage," although it might appear a contradiction in terms to use that expression.

Mr. Mowat said that he was greatly indebted to the various gentlemen who had taken part in this discussion for dealing with the different points that he had raised in his paper. The subject was one regarding which they were a good deal in the dark, and he must confess that he was a good deal in the dark himself. In his paper he had given them the results of experiments which had been made as accurately as possible. He had recorded the deductions which he had drawn from these experiments, and he had to say that his opinions and deductions were to a large extent derived from his reading on the subject.

He did not propose to answer Mr. John B. Thomson fully, because he would require time to digest the figures which had been put before him. He would say, however—and this applied also to the criticism by Mr. Briggs—that in his paper he had been most careful to avoid any question relating to the design of fans, in so far as the angle of the blades was concerned. As a matter of fact, he believed that he had particularly indicated that in the paper. The formulas given were only applicable to fans having radial blades. With regard to the efficiency of the belt drive, he (Mr. Mowat) did not profess to have any experience thereof. He had heard of 2½ per cent. and 5 per cent., and he thought that he was quite safe in taking it at 5 per cent. He quite appreciated what Mr. Thomson had said with respect to the efficiency with different loads, but he did not think that the difference would be very great when one considered that this belt was put in to develop 150 horsepower. The loads were all relatively small compared with the ability of the belt drive, and accordingly he did not think that the efficiency of the belt drive had much to do with the experiments. He did not understand one figure in Mr. Thomson's results, namely, the value of the equivalent orifice. From Mr. Thomson's figures the orifice of passage calculated from the first experiment would be 50 and from the last 112 square feet. It was rising all the

time. Then Mr. Hamilton had mentioned the variation in equivalent orifice between the 10-foot and 7-foot fans in his (Mr. Mowat's) experiments. In the 7-foot case it was very constant, whereas in the other case, even ignoring the lower reading, it varied from 58.7 to 75. He believed that 75 was exceptional. He had gone over the observations and personally checked them to see whether there was any error in the calculations, and he was unable to give any explanation whatever of the variation. If they excluded the first two (43 and 49, and, of course, 75) they would find that the variation was not very great in the others—it was just about 58 to 62. There was one factor that might have a certain effect in the calculations, namely, that the method of making the closed test was not absolutely perfect. They had covered the wood resistance with brattice cloth, and it was quite possible that there would be a small amount of air passing through there. That might account for some little difference in the higher velocities, but he did not think that it would make any appreciable difference. So far as the point raised by Mr. McCreath was concerned, in regard to blades radial at the tips and blades turned backwards or forwards, he had no suggestion to make as to which form was correct, and he did not pretend to offer an opinion as to which was the better design for the mine. Much, he thought, would depend on circumstances as to whether it was a high or a low water gauge that was required in the mine. With reference to what Mr. McCreath had said regarding No. 4 gauge, he believed it possible that the reading might have been taken on the outside of the curve where the velocity was very much higher than in the inside. He did not pay much attention to that matter after he found the readings of No. 4 gauge erratic, and the explanation that he had given might account for the difference. He did not know at any particular moment where No. 4 gauge was. Mr. Hamilton had mentioned the point as to the power necessary when the

drift was shut in churning the air. If they referred to the first three experiments, they would find what the power necessary was. The fan was throwing off the air which was entering behind the blades and preventing it from getting to the inside of the fan. He would put it in another way—that the power used was in overcoming the friction of the machinery and creating a vacuum. There was a vacuum being created, although there was no air passing, and there was a different pressure being maintained between the inside of the drift and the outside atmosphere. What he wished to emphasize was that, although they were not passing any air, they were maintaining a vacuum in the drift lower than the atmospheric pressure.

Mr. Hamilton said that a fan running in a perfect vacuum would not have the resistance of the air running along the blades. Would it not require more power to overcome that?

Mr. Mowat replied that the fan was throwing off the air particles. These air particles were entering behind the blades and being thrown off again, thus maintaining a difference in pressure between the outside and inside.

Mr. Mark Brand had been good enough to send him a copy of what he had just said at the meeting, and there were one or two observations that he would like to make in regard to his contribution. With reference to the shutters, Mr. Brand had stated (he took it) that these shutters were added as they used to be in Guibal fans.

Mr. Brand said that was so.

Mr. Mowat, continuing, said that Mr. Brand had touched on the question of breadth, and the position seemed to be something like this: Where the equivalent orifice of the mine was small, the breadth would be the minimum; and where the equivalent orifice of the mine was large, then the breadth would be as much as would be effective. The breadth would be a factor in determining the volume which would be passing through the fan and the resistance internally in the fan. The

width of the fan would depend on the largeness or smallness of the equivalent orifice of the mine. He did not agree with what Mr. Brand had said in reference to indicator diagrams. He certainly did not think

that many people would claim that an indicator diagram would give them an approximation nearer than 10 per cent. Most engineers would admit that the results obtained were very varied.

Testing for Firedamp with Wire Loop

A Device by Which a Safety Lamp Flame Is Rendered Non-Luminous
Enabling the Gas Cap to Be Clearly Seen

By Henry Briggs, M. Sc., A. R. S. M.

THE purpose of this paper is to describe methods of detecting firedamp and blackdamp, and to give an account of some experiments made in putting the methods to the test. The British Mines Act of 1911 requires that workmen shall be withdrawn from a part of a mine in which naked lights are used should $1\frac{1}{4}$ per cent. or more of firedamp appear in the general body of the air in that part. Section 60 of the act makes it necessary to cut off the current from cables and electrical apparatus, if the same amount of inflammable gas should be found in the air in which that apparatus is at work. It is evident that no method of analysis would serve here; sudden danger, besides calling for prompt measures, must be met by still greater promptitude of detection. Thus, in endeavoring to find out a practical method of determining firedamp, sufficiently refined to allow not only of detecting these low percentages, but of discriminating between them, the experimenter is at once driven back on the "blue-cap" method as being, notwithstanding several drawbacks, the simplest, most rapid, and best known of all.

The report of Prof. John Cadman and Mr. E. B. Whalley on "The Methods of Examining for Firedamp" has established the fact that the usual safety lamp cannot be counted upon to show less than about 2 per cent. of gas on the average, under actual working condi-

tions; and it seems impossible to distinguish with certainty proportions of gas so low as $1\frac{1}{4}$ per cent.

The aim of the Cunynghame-Cadman device is to improve the testing powers of the ordinary lamp by means of a simple attachment and, so far as firedamp testing is concerned, the attachment described is a modification of the Cunynghame-

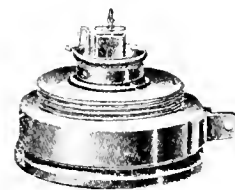

FIG. 1

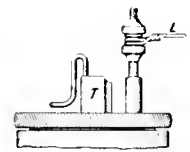

FIG. 2

Cadman device, although, as an indicator of blackdamp, its principle of action is new.

The device consists of a $\frac{1}{2}$ -inch loop of No. 22 gauge copper wire, pivoted on a spindle to swing horizontally in or out of the flame of a safety lamp. The position of the loop when in the flame and a side view of the loop *L* when in the "off" position are shown in Figs. 1 and 2. Immediately the loop is placed in the flame the luminosity disappears, although the dimensions of the flame are scarcely affected. The explanation is that the luminosity of the flame is due to the incandescence of minute carbon particles, which, cooled below a certain temperature, cease to be incandescent, and the flame ceases to give white light.

The writer's aim was to discover some medium which, when inserted

* Abstracted from the Transactions of the Mining Institute of Scotland, Volume 34, page 3.

in the flame, would abstract sufficient heat to render the flame non-luminous, without shortening or cooling it so far as to affect seriously its capabilities as a cap maker. Gauzes of different mesh were first tried, then a straight horizontal piece of strong copper wire, and after trying many different shapes and sizes, a loop $\frac{1}{2}$ inch in diameter was finally selected as most suitable.

To convert the working flame of a safety lamp into a testing flame is practically an instantaneous operation with this loop. There is no need to draw down the wick when looking for gas; indeed it is usually better to lift it a little to minimize the risk of the flame being extinguished during the operation. If firedamp is present, a clear cap is seen on the flame on swinging the loop into place. To ascertain if gas is present takes almost exactly 2 seconds, that period being long enough to swing the loop across the flame, to notice if a cap forms, and to bring the loop out again. At no time, indeed, is a cap for one of the low percentages more clearly seen than during the very short interval between the moment the cold loop is brought into position and the flame's recovery of its original height. During that interval the cap is seen to form first; then the upper part of the flame drops down from above on to the loop. Of course, it takes longer than 2 seconds to make a conscientious estimate of the amount of firedamp present, for then the cap has to be studied for a long time and its length judged.

The question of standardization of the test flame (a very serious question for the ordinary method of testing) has not given any trouble during the experiments on the loop; for in estimating firedamp, the standard flame is merely that which is of the greatest bulk with a uniform, but very slight, luminosity. Of course, the amount of yellow light present is not allowed to be sufficient to mask the cap. The curves of Fig. 3 were constructed

from data obtained by means of a flame so standardized. While the practical applicability of such a simple standardization must be admitted, it might be thought to be of only a rough nature. That this is not the case can only be proved by taking a considerable number of measurements of caps, preferably spread over more than one day, and necessitating a readjustment of the flame for each observation, when the concordance of the readings will be found somewhat striking to anyone familiar with the rather irregular indications given by a flame

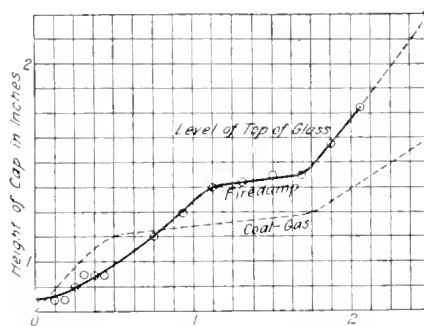

FIG. 3 PERCENTAGE OF INFLAMMABLE GAS

lowered in the ordinary way. The following set of readings will serve to show this; they were obtained on three different days, using the same lamp, and taking due precautions to prevent any one determination from biasing the next:

Percentage of coal gas, $1\frac{1}{2}$.

Measured height of cap, in inches, $1\frac{13}{16}$, $1\frac{1}{4}$, $1\frac{1}{8}$, $1\frac{3}{16}$, $1\frac{7}{32}$, $1\frac{3}{32}$.

Mean height of cap, $1\frac{13}{16}$ inches.

Average error of a single observation, $\pm 1\frac{1}{32}$ inch.

This mode of standardizing the flame by making it always of the largest possible size, with a uniform tinge of yellow, has one great advantage when dealing with the effect of blackdamp and firedamp in combination.

The dotted line graph, Fig. 3, was constructed to show the relation between the height of cap and percentage of coal gas present with a loop of $\frac{1}{2}$ inch. The lamp employed was one of Messrs. John Davis & Son's "A1" fireman's lamps, with brass oil vessel, copper wick

tube, aluminum bonnet, and two copper gauzes. The lamp burned a half-inch wick, and the fuel used consisted of three parts by volume of colza oil to one part of paraffin.

The caps were measured from their tips to the base of the test flame. The reasons for abandoning the orthodox mode of measurement, namely, from the top of the flame to the top of the cap, were, firstly, because a cap is an envelope and not merely an extension of the flame; it actually covers the flame down to its foot; secondly, because with the flame standardization used, the flame was not always of the same height; and thirdly, a measurement between one definite and one indefinite point is more accurately made than between two indefinite points. The common method of measuring caps could perhaps claim the advantage that curves drawn from such measurements pass through the origin; yet the writer's experiments on large flames have led him to think that with no test flame, except probably that of hydrogen, ought it to be assumed that the origin must necessarily be a point on such a curve; for even when the fuel cap is not seen, its influence on the lower end of the curves like those of Fig. 3 is too marked to be neglected.

Fig. 3 shows a measurement that was obtained for $\frac{1}{4}$ per cent. of gas, the cap, largely due to the influence of a fuel cap, being quite clear. In this case the fuel cap was partly visible in pure air; the base was easily seen, but the upper part was too indistinct to permit of an accurate measurement; its length, however, so far as could be judged, was about $\frac{3}{4}$ inch from the bottom of the flame. The difference between the appearance of the flame in fresh air, and in air holding $\frac{1}{4}$ per cent. of gas was marked.

To be able to measure the cap for $\frac{1}{4}$ per cent. of gas, nevertheless, is not usual; in the majority of the trials made with different lamps and fuels, this proportion of gas was always discernible, but the length of cap could not be read. A person of

ordinary eyesight, however, can always see the whole of the gas cap when the loop is employed and anything more than $\frac{3}{8}$ per cent. of gas is present.

The points on the dotted curve of Fig. 3 represent the mean values of 68 measurements taken on several days. It will be seen that, for the most part, readings were taken at every eighth of one per cent. of gas. The measurements were, therefore, sufficiently numerous to fix the shape of the curves with considerable nicety, and there can be no question of the flattening evident in the middle of both curves being the result of experimental error. This curious flattening is not the less interesting because of the writer's complete inability to explain it at the present time.

To determine to what extent the results obtained by using coal gas were applicable to marsh gas, tests were conducted, with the same lamp and fuel and a half-inch loop, upon methane prepared from aluminum carbide and dilute hydrochloric acid. Before being led to gas cylinders, the gas was passed through a mixture of chromic and sulphuric acids—one of the strongest oxidizing agents known—in order to remove unsaturated hydrocarbons. As it was not easy to insure that the gas so made was free from air, which in a lengthy preparation sometimes finds a means of entry, and as such gas always contains a little hydrogen, it was necessary to ascertain its methane value. This was done by means of a Le Chatelier explosion tube, and the percentages of gas fed to the lamp were then modified accordingly. The heavy line in Fig. 3 contrasts the results obtained from coal gas and marsh gas. The points on the curve are observations. The remarkable flattening of the middle portion of the curve is again evident; it cannot then be due to a peculiarity of coal gas. The graphs indicate that although there is no wide difference, over the greater part of the range of the curves, between the two kinds of inflammable

gas so far as their cap-forming abilities are concerned, yet firedamp is so much the stronger in that respect for the higher percentages as to lift the tip of the cap for $2\frac{1}{2}$ per cent. about $\frac{5}{8}$ inch above the level of the top of the glass of an ordinary lamp, while with the same proportion of coal gas the tip is just on that level. It is not difficult to remember that with $1\frac{1}{4}$ per cent. of firedamp present, another important proportion, the cap is about $1\frac{1}{4}$ inches high from the base of the flame, a statement which Fig. 3 shows to be a little on the safe side. At $2\frac{1}{2}$ per cent. of firedamp the lowered flame gave a cap $\frac{1}{16}$ inch high; thus, at that percentage, the cap obtained by using a loop was four times the length of that given by the ordinary method of testing.

In testing for small percentages of firedamp underground, at a height of roughly $2\frac{1}{2}$ feet from the floor, an indication of firedamp was seen on each of three lamps fitted with loops. The ordinary lowered flame gave no indication, and a Chesneau alcohol lamp gave a very indistinct reading of about $\frac{1}{2}$ per cent. Two air samples were then taken, at intervals of about 20 minutes apart, and these were analyzed the same afternoon. The results of the analyses were, respectively, .36 and .28 per cent. of methane.

By dipping the loop or its twisted support in zinc-chloride solution (soldering flux), a chemical replacement of the zinc by copper takes place under the heat of the flame, and a green coloration is given to the flame, the fuel cap (if present), and, although to a lesser extent, the gas cap. This improves the indication considerably; but the chloride soon burns off. The wire, however, sometimes gives a fairly strong green flame reaction without treatment—especially if it has not been used for some days—and it generally gives a very faint one.

The Loop as an Indicator for Use With Electric Motors.—The usual safety lamp is not the most satisfactory contrivance to use with an

electric motor working under conditions requiring the provision of such a lamp by the Rules for the Use of Electricity in Mines, since the lamp, if left to itself, could not continue to burn long with the wick drawn down to give a test flame. Hence it is not a continuous indicator. When fitted with the loop, however, the lamp will burn without requiring more than ordinary attention, with the loop standing in position from the beginning to the end of a shift. In this way a test flame is continually available, and a quick glance is sufficient to show whether gas is present.

Unless special means are provided for removing it, the crust which forms over a wick burning pure colza or a colza mixture gives a great deal of trouble when one is looking for gas by the ordinary method, and greatly increases the risk of losing the light. The loop, however, has been found almost equally efficacious with a crust present or with a clean wick.

采 采

Waste in Coal Mining

In reference to Doctor Holmes' statement that "in producing 500,000,000 tons of coal during 1911, 250,000,000 tons were wasted or left in the ground in such condition that it would not probably be recovered in the future," the following questions were asked of a number of prominent mining men: Does the waste occur in your field? Do you know from observation when such waste occurs, and if so, where? The following is one of the answers:

Editor The Colliery Engineer:

SIR:—I am in receipt of your favor of the 11th, with reference to a statement made by the Hon. J. A. Holmes, Director of the Federal Bureau of Mines, which, as you say, has been published broadcast, to the effect that 250,000,000 tons of coal are wasted or left underground annually which cannot be removed in the future.

The writer will say that in a general way Doctor Holmes is correct,

and the systems of mining employed are very largely responsible for it, in this: that the blocks or pillars left for supporting the roof in working on the room-and-pillar plan, in all probability could not, for many reasons, be recovered in the future, and I think it is fair to say that, covering the entire coal fields now being operated on the room-and-pillar plan, 35 per cent. of the coal seam is left in the form of pillars when the mines are abandoned. In fact, I know of large fields where fully 50 per cent. of the coal was left in the pillars when the mines were abandoned, because any attempt to remove any portion of them would have caused a surface subsidence and such damage to the farm property (worth fully \$250 per acre) that they could not afford, in those days of cheap coal, to pay for damaging the surface; and the question, of course, is: What is the remedy? And that brings us face to face with two all-important subjects in mining:

(1) Economy in operation, and particularly with reference to the timber supply, which is becoming so scarce and expensive.

(2) Conservation of the coal.

To accomplish the best results in economy and conservation in the operation of coal mines, an entire change of plans and methods is necessary:

First. No mine should be permitted to be located, in my opinion, directly on the line of a railroad, and the reasons are (a) because with their workings and shafts directly alongside of and underneath permanently-located railroads, there is constant danger from subsidences that must occur in the future; and (b) because they are unsightly. All mines should be located sufficiently far back from a railroad so that the boundary limit of its workings will not come within 200 feet or 300 feet of any railroad track.

Second. The coal company should be compelled to own its property in fee.

Third. It should be compelled to mine on the "retreating" system, which, like the longwall method, will

permit of taking out all of the coal, and the subsidence which would naturally follow would not affect the railroad, and it would be practically uniform all over the territory mined, leaving the land in good condition for cultivation afterwards.

Fourth. In the driving of the entries to the boundaries before commencing to break off rooms, the work should be permanently done, in this: that where conditions would permit it, all roof stuff should be taken down to cap rock, making clean, safe, haulageways and air-courses, and where not possible to take down everything to cap rock, it should be secured with steel I beams and if necessary lagged with creosoted oak. Entries developed in that way would be permanently safe and secure. This method and system of operating would require the use of but little timber. At any rate, the use of it would be reduced to the minimum, and ventilation would be more perfectly maintained.

Fifth. All mining plants should have (especially where freezing winter weather prevails) an independent escapement shaft; in other words, there should be a hoisting shaft, air-shaft, and an independent escapement way.

Sixth. No woodwork whatever should be permitted around pump rooms, stables, or anywhere in the underground workings, and particularly should there be no woodwork whatever around about any of the shafts, whether at the stables or other places of a similar character, or for roof protection, etc.

Seventh. All buildings on the surface should be fireproof.

If laws in the several states were enacted requiring mining to be done in this manner, then you would get the maximum of safety and the maximum of conservation, as well as the greatest economy of operations in general. It is the only way, in my opinion, that the severe competition which has had such a distressing effect upon the industry for years can be permanently done away with, because it would eliminate a class who construct and mine cheaply, taking

out only such coal as can be secured at little expense and leaving large acreages untouched. Too often such workings are carried on in a manner that makes them a constant source of danger for all who must work in them. By the elimination of that class in the industry, it would become healthy in every respect and as reasonably profitable as it ought to be, and I believe this is the only way that permanent good for the business of coal mining can be accomplished, and that any other that may be attempted can only bring temporary relief, as is always the case with anything artificially supported.

It is not to be expected that such views as here expressed will meet with general approval by many of those now engaged in the operation of coal mines, but when we complain of wastage, and since our records show that coal mining in our country is far more hazardous and the loss of life and injuries far greater per ton of coal mined than is the case in the dangerous gassy mines of Europe, and further, since we complain that the business is unprofitable, we should be willing to face the situation squarely and tell the truth about it as we see it, and that is what I have tried to do in this case.

A. J. MOORSHEAD,

President and General Manager Madison Coal Co.

來 來

The Unit of Quantity, the Coulomb

Since the quantity of electrical current passing a point in a circuit is rate of flow \times time, i. e., current \times time, the unit of quantity will be that which passes a point in 1 second when unit current is flowing.

Since the ampere is one-tenth of the absolute unit of current, it follows that the practical unit of quantity, or, as it is called, the *coulomb*, is one-tenth of the absolute unit of quantity.

The commercial unit of quantity is an ampere-hour, and is the quantity corresponding to 1 ampere flowing for 1 hour. Thus 1 ampere-hour equals 3,600 coulombs.

PRACTICAL TALKS ON COAL MINING

For men who desire information on Coal Mining and related subjects
presented in a simple manner

TO understand the principles upon which the ventilation of mines is based, and, in fact, to make many calculations which are necessary in laying out and working mines, it is needful to know what a formula is and how it may be used.

A formula is a short and simple way of stating a rule. It shows at a glance all the steps that have to be taken to get the result, uses much less space, and is much more easily remembered, than a rule. Often three or four letters when put together to make a formula explain a process more simply than 40 or 50 words written out in full. Men who have not had much schooling in their younger days and are not used to formulas, are apt to think of them as something far beyond their powers of learning. If such men are shown what formulas really are, what they are for, and how to use them, they quickly see their value. For this reason, the first article is, naturally, a short one on formulas.

To understand formulas the reader must learn the meaning and use of a few signs which are first met in the study of arithmetic.

The sign of addition, + (called plus), when placed between two numbers means that the two numbers are to be added together or that their sum is to be taken, as, $7+4=11$, which is read 7 plus 4 equals 11.

The sign of subtraction, - (called minus), when placed between two numbers means that the second or the smaller of the two numbers is to

Formulas and Their Use

A Simple Explanation of the Signs and Symbols Employed in Mining Calculations

be subtracted from the first or larger of the two, or that their difference is to be taken, as, $9-3=6$, which is read 9 minus 3 equals 6.

The sign of multiplication, \times (called multiplied by, or times), when placed between two numbers means that one is to be multiplied by the other, as $3\times 6=18$, which is read 3 multiplied by 6 equals 18. Multiplication is really a short way of doing addition because the calculation called for by the figures and signs, 3×6 , means that six threes are to be added together.

The sign of division, \div (read divided by, or into), when placed between two numbers means that the first number is to be divided by the second, as $12\div 3=4$, which is read, 12 divided by 3 equals 4, or 3 into 12 makes 4, etc.

The sign of equality, = (read equals, is equal to, or makes), when it appears between two signs or numbers, or between a group of numbers on one side and a single number or group of numbers on the other, means that all the numbers or signs on one side are equal to all the numbers and signs on the other side, as $2\times 3=18\div 3$. This we see is right, because both 2×3 and $18\div 3$ are equal to 6. In a like way we can write $2\times 3=12-6$, or $2\times 3=5+1$, because in each case the figures on one side of the equality sign when multiplied, subtracted, or added, as called for by the

signs placed between them (\times , $-$, or $+$) are equal to six.

The sign of grouping, or the parentheses, may be written

in either of two ways, as $()$, or $[\]$, etc. The latter of these signs are often called brackets. When a number of figures and signs are found between parentheses or brackets, it means that all the work called for by the signs (as $+$, $-$, \times , or \div) must be done and the result taken by itself before the next step in the calculation is made. Thus, $(5\times 6)\div (2+3)$, is read 5 multiplied by 6 is to be divided by 2 added to 3. Now $5\times 6=30$, and $2+3=5$, and $30\div 5=6$. Thus $(5\times 6)\div (2+3)=30\div 5=6$. Now, if the parentheses were not there, instead of $(5\times 6)\div (2+3)$, we would have $5\times 6\div 2+3$. In this case we would first multiply 5 by 6 and have 30 for the result. This 30 would then be divided by 2 giving us 15, and to this 15 we would add 3, making 18 for the final result. When the parentheses are used the result is 6 and when they are not used the result is 18, so the need of paying attention to the parentheses is plain. These are sometimes indicated by a straight line above the figures. Thus $(4\times 3\div 6)$ may be written $\overline{4\times 3\div 6}$.

The sign of involution, or of squaring, cubing, etc., or of the power of a number, is a small figure placed above and to the right of the number and is called an exponent. This exponent shows how many times the number to which it belongs is to be

multiplied by itself to get what is called a power of the number, which power is named or called from the exponent. Thus 2^5 means that five twos are to be multiplied together, and the result, which is 32, is known as the fifth power of two. So 2^5 is read two to the fifth power, or as the fifth power of two, and is exactly the same thing as $2 \times 2 \times 2 \times 2 \times 2$, and is equal to 32. In the same way 3^4 is read three to the fourth power, or the fourth power of three, and is equal to the product of four threes multiplied together, or $3^4 = 3 \times 3 \times 3 \times 3 = 81$. Again, 4^3 is read four cubed, or the third power of four, and is the same as three fours multiplied together, or $4^3 = 4 \times 4 \times 4 = 64$. In the same way 5^2 is read five squared, five to the second power, the square of five, etc., and is the same as two fives multiplied together, as $5^2 = 5 \times 5 = 25$.

A root of a number is another number which multiplied by itself a given number of times will make the first number. Thus the fourth root of 16 is 2, because four twos multiplied together make 16. In the same way the fifth root of 32 is 2 because five twos multiplied together make 32. The third root, or as is commonly said the cube root, of 27 is 3, because three threes multiplied together make 27. In the same way the second root, or as is more commonly said the square root, of 16 is 4, because two fours multiplied together make 16. The sign which shows that a root is to be taken, or extracted, is $\sqrt{\quad}$. A little figure usually written above and to the left of the root sign, is known as the index of the root, or more simply the index, and shows which root is to be taken. Thus $\sqrt[5]{32}$ means that the fifth root of 32 is to be found, and as explained, is equal to 2 because two multiplied by itself 5 times (as called for by the index of the root, 5), or $2 \times 2 \times 2 \times 2 \times 2$, is 32. In the same way $\sqrt[4]{16}$, $\sqrt[3]{27}$, $\sqrt{25}$, are read the fourth root of 16, the cube root of 27, and the square root of 25. The square root is in very common use, so it has become customary in order to save space to omit the figure for the index. Really the square

root of 25 should be written $\sqrt[2]{25}$, but it is always written $\sqrt{25}$, the 2 being omitted.

In formulas, letters are used instead of numbers because numbers represent or give the size, or value, (for example) of one thing only, while letters give the same thing in a general way. This may be made clearer by a simple example: A mine foreman's shanty is 8 feet wide and 10 feet long. Suppose the size of the floor of this shanty is wanted. The rule for finding the size of a room is to multiply the length in feet by the width in feet and the result is the area (size) in square feet. Now, if we say that in such rules the length of the shanty is to be called L and the width of the shanty, W , and the area (or size) of the shanty, A , we can write this rule as a formula, thus, $A = L \times W$, which means just the same thing as the rule and takes but three letters and two signs and takes less space and is much more easily remembered. This is what is called a general formula because it may be used to find the area of any shanty, room, building, and the like, no matter how long or wide it may be. In the example just given the shanty is 10 feet long and 8 feet wide; that is, the length of the shanty, or L , is 10, and the width of the shanty, or W , is 8. If for L and W in the formula we use these figures, we have $A = 10 \times 8$, which is equal to 80, and the area (size) of this particular mine foreman's shanty is 80 square feet. But all shanties are not of the same size and the expression $A = 10 \times 8$ for the size is good only for this particular one, but if we write a formula as $A = L \times W$, this can be used in any case simply by taking the values of L and W as we measure them.

When letters are used in formulas the \times , or sign of multiplication, is often left out in order to save space. The formula for the size of a room may be written either $A = L \times W$ or $A = LW$. In either case the meaning is that the area, A , is equal to the length of the room, L , multiplied by its width, W .

In some formulas a letter or group of letters is written above another

letter or group of letters with a line between. Thus we may have $\frac{a}{b}$, or $\frac{a \times b}{c + d}$ or any other set of numbers above or below the line. In any case the meaning is that the single figure above the line, or the result gotten by combining the figures above the line, is to be divided by the single figure below the line or by the result obtained by combining the figures below the line. In the first case a is divided by b , and the formula may be written either $\frac{a}{b}$, or $a \div b$. In the second case a must first be multiplied by b ; then c must be added to d , and the first result is then to be divided by the second. As with the first case, the second may also be written in two ways, either $\frac{a \times b}{c + d}$ or $(a \times b) \div (c + d)$.

To show the reader how formulas are used in connection with underground work two practical examples are given:

(1) What is the ventilating pressure per square foot in an airway with a rubbing surface of 36,000 square feet, when the velocity of the air-current is 500 feet per minute, and the sectional area of the airway is 20 square feet?

(2) What is the ventilating pressure per square foot in an airway with a rubbing surface of 48,000 square feet, when the velocity of the air-current is 300 feet a minute, and the sectional area of the airway is 25 square feet?

The rule to work out either of the above questions is: To find the pressure per square foot, multiply the coefficient of friction by the rubbing surface, then multiply this product by the square of the velocity, and divide this last product by the sectional area.

This rule may be changed to a simple and easily remembered formula by placing letters for the various things that are to be grouped together.

Thus, if we let
 p = pressure in pounds per square foot;

k = Atkinson's coefficient of friction, or .000000217;

s = the rubbing surface in square feet;
 v = the velocity of the current in feet per minute;

a = the sectional area of the airway in square feet,

the rule, in the shape of a formula, becomes,

$$p = \frac{k s v^2}{a}$$

In place of these letters the numbers taken from example 1 may be written and the formula, in shape for making the calculation becomes,

$$p = \frac{.0000000217 \times 36,000 \times 500^2}{20}$$

or 9.765 pounds

The actual work is carried out as follows:

.0000000217	
36000	
1302000	
651	
.0007812000	
250000	
39.0600000000	
156 24000	
20)195.3000000000(9.765 lb.	
180	
153	
140	
130	
120	
100	
100	

While in the second question the same formula is used, the letters, except k , stand for different numbers than they did in the first example. As in the first example

$$p = \frac{k s v^2}{a}$$

but when we use the new values for these letters the formula, in the right shape for calculation becomes,

$$p = \frac{.0000000217 \times 48,000 \times 300^2}{25}$$

or 3.74976 lb.

The actual work is carried out as follows:

.0000000217	
48000	
1736000	
868	
.0010416000	
90000	
25)93.7440000000(3.74976	
75	
187	
175	
124	
100	
244	
225	
190	
175	
150	
150	

would find that every five parts of air is made up of four parts by volume of nitrogen and one part by volume of oxygen. That is, 5 cubic feet of air consists of 4 cubic feet of nitrogen and 1 cubic foot of oxygen. These are not exactly the true figures but they are near enough for every-day use and are easy to remember. Both oxygen and nitrogen are without odor, color, or taste. Oxygen is about one-tenth heavier than nitrogen. Each of these gases has its use in the air, but in a different way. Oxygen supports both life and combustion; nitrogen does neither and serves to dilute or make the oxygen weaker, as by itself it is too strong. No one could live without oxygen, as it is drawn into the lungs with every breath and there combines with the blood and is taken by it through the arteries and veins to every part of the body. Likewise, without oxygen we could have no fires, as it combines and unites with the carbon of coal, wood, or oil, to make what we call burning, and this burning gives out heat.

FIRE-DAMP

Quite a number of people call fire-damp by such names as marsh gas, methane, or light carburetted hydrogen. This is not correct because the gas which is known by the name of methane, marsh gas, or light carburetted hydrogen is one thing and fire-damp is another. The best name and the one most often used for this gas is methane. Now fire-damp is a mixture of methane with the ordinary mine air. Methane is the name of the pure, simple, unmixed gas; fire-damp is the name given to the product when it is mixed with air.

Methane will not support life or combustion. In other words a person will die from suffocation if compelled to breathe pure methane, and likewise a lamp or a fire will go out if placed in it. Suffocation and death from breathing methane are just the same as suffocation and death from drowning. Neither methane nor water is poisonous, but in the one case the lungs become

Gases Met With in Coal Mines

Air—Firedamp and Its Properties—Principle of the Safety Lamp—Detection of Gas With Safety Lamp—Blackdamp

TO MAKE this subject clear to the average miner, it is necessary to treat it in a different way than is commonly done in books. It is the custom in most books to first speak of the simple, single gases that when mixed with one another are found in mines, and after that to take up these mixtures or combinations. The miner, who knows these mixtures as "firedamp," "blackdamp," and "whitedamp," often finds it very hard to understand what is written about the

properties of gases because words and names are used which he has not seen before and the meaning of which is not given. In this article we will begin with the mixtures of gases the miner knows, and he will be told what other things he should know about these gases in a plain and simple way.

Air, or as it is sometimes called the atmosphere, is a mixture of two gases which when alone are known as nitrogen and oxygen. If we could separate the two gases we

full of methane and in the other case full of water so that in neither case is there room for oxygen which alone keeps one alive. In just the same way pure methane will put out a lamp, or fire, or any form of burning, because it keeps oxygen away from the flame, and oxygen

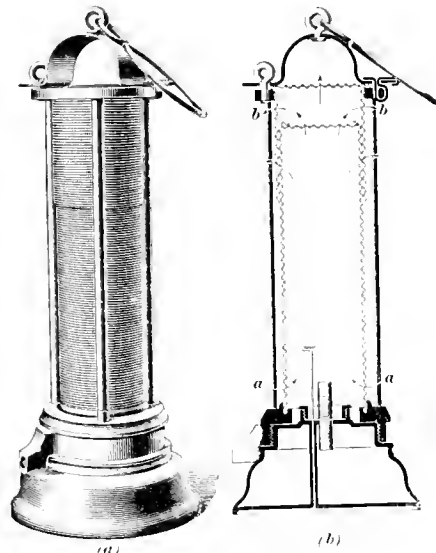

FIG. 1. DAVY LAMP

is the only simple gas that will support combustion.

While methane will not support combustion, it will burn with a blue flame when the right amount of air is present, and in some cases will explode. When firedamp is composed of 1 part methane and 5 parts air it will explode when a light is placed in it, but the explosion will be a mild one. When firedamp is 1 part methane and $9\frac{2}{3}$ parts air, a most violent explosion will take place. When the mixture is 1 part methane and 13 parts air, there may also be an explosion, but as in the case where the firedamp is 1 part methane and 5 parts air, the explosion will be light.

Very violent explosions take place when the mixture ranges from 1 part methane and 6 parts air to 1 part methane and 12 parts air. When the mixture is diluted or weakened by air so that it is composed of one-fifth gas and four-fifths air, the chances are that, if set fire to, the men in the neighborhood of the explosion will sim-

ply be burned more or less severely. Just the same will be the case if the mixture contains one-fourteenth gas and thirteen-fourteenths air. Between these two mixtures, however, say 1 part gas and $9\frac{1}{2}$ parts air, there is a very explosive point. If such a mixture is set fire to, the men near the explosion will not only be burned but will be thrown around in a violent manner and will likely be struck violently by timber, coal, rock, or any other hard object in the path of the explosion.

As the gas, methane, is but little more than half as heavy as air it would always be found in a layer next to the roof if it were not for the properties of expansion and diffusion common to all gases. Owing to diffusion it is not always true that firedamp will collect against the roof or at the highest point in a pitching place, but as a general thing it will do so.

As methane is colorless, tasteless, and odorless, just the same as air, firedamp cannot be found by sight, taste, or smell. Therefore, the safety lamp gives the only practical means of finding it in mines.

To make clear the principle of the safety lamp, to understand how and

the Davy lamp. This lamp is made on the principle that a piece of wire gauze with 784 square openings to a square inch will not allow a flame to pass through it; 784 openings to the square inch means that there are 28 openings in each inch of length and breadth of the gauze. Wire makers call this "28 mesh gauze," or "28 mesh wire cloth." If a piece of wire gauze of this "mesh" is placed above a flame, the top of the flame will flatten out against the gauze without passing through, just as it would against a solid plate of iron or tin.

The Davy lamp is still in use among fire bosses for testing for gas, but it is so unsafe for general use in the working places that it is prohibited by law as a working lamp in many states. Fig. 1 shows a Davy lamp. The Davy lamp when used by fire bosses is often provided with a movable metal shield encircling the gauze for two-thirds of the way around, and arranged to slide upwards when desired. This shield protects the flame of the lamp against strong air-currents, and is of great use when testing for gas in airways or other places where the air is moving with considerable

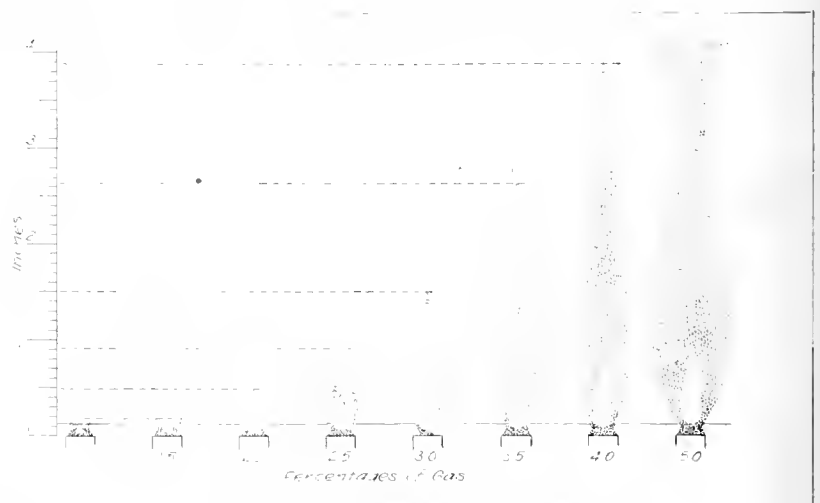

FIG. 2

why it is safe, the reader must be told how flame acts when it comes against fine wire gauze. In 1815, Sir Humphrey Davy made a safety lamp, now known the world over as

velocity. Owing to the free admission of air through the gauze, this lamp shows a good flame cap in gas. The presence of 3 per cent. of methane in the air can always be

detected with this lamp, and a careful and experienced fire boss will see a cap when as little as $2\frac{1}{2}$ per cent. of gas is present. Some fire bosses claim to be able to detect as low as 2 per cent. of methane, but there seems to be some doubt as to this. In using the Davy lamp for testing for gas, the flame is lowered as much as possible without entirely putting it out. The lamp (it must be held straight up so that the flame does not play on the gauze) is slowly and carefully raised and stuck into any place it is desired to examine, a sharp watch being kept on the small oil flame. Fig. 2 shows the cap of gas on the flame which will appear in a Davy lamp when it is held in firedamp containing different amounts of methane. Very few can see with the naked eye the cap formed by less than $2\frac{1}{2}$ per cent. of methane. A Davy lamp fitted with a Beard-Mackie sight indicator and in the hands of a competent man, will show as little as one-half of 1 per cent. of methane. This indicator, shown in Fig. 3, is a piece of No. 14 Birmingham wire gauge brass wire bent in the form of the letter U turned upside down, and is firmly fixed to a thin brass disk fitting into the neck of the lamp, and held firmly upright by the nipple which holds the wick tube in place. Sometimes this inverted U is attached to the nipple itself, as shown at *b*. On the standard formed by this inverted U, fine platinum cross-wires are arranged at such heights above the flame as to indicate by their glow the amount of methane in the air. The indicator shows the presence of gas varying in amount from one-half of 1 per cent. to 3 per cent., each successive strand of platinum wire showing by its glow an increase of one-half of 1 per cent. In the use of this indicator the flame of the lamp is first lowered in pure air so that the lowest wire, called the standard wire, is aglow. The other wires, called percentage wires, are looped in the center to make them show better through the gauze.

This indicator is based on the principle that platinum wire is very sensitive to methane.

Methane is composed of the elements carbon and hydrogen in the proportions of 1 part carbon to 4 parts hydrogen. Its chemical symbol is CH_4 . This symbol shows at a glance the constituents of methane. The letter, C, without any small figure attached, means that the proportion of carbon is one, and the small figure, 4, written at the lower right side of H means that the proportion of hydrogen is 4. In other words, 1 atom of carbon combined with 4 atoms of hydrogen forms methane. Carbon has an atomic weight of 12 and hydrogen has an atomic weight of 1. In other words, carbon is 12 times as heavy as hydrogen. Then the atomic weight of methane is:

1 part carbon with atomic weight of 12 =	12
4 parts hydrogen with atomic weight of 1 =	4
	16

This is known as the molecular weight. Chemists in practice use the atom as the smallest division of any gas. A combination of atoms to form the smallest division of the combination is called a molecule. A molecule of methane is composed of 1 atom of carbon and 4 atoms of hydrogen. In this case the molecule is composed of 5 atoms. The molecules in different combinations varying, it is evident that a molecule of any gas will differ in the number of atoms it contains with the molecule of another gas composed of varying numbers of atoms. For instance, a molecule of carbon dioxide, the gas which when mixed with air forms "blackdamp," is composed of 1 atom of carbon and 2 atoms of oxygen (CO_2) and is, therefore, a molecule composed of 3 atoms, while a molecule of methane is composed of 5 atoms. As mentioned previously, a cubic foot of methane weighs but little more than one-half as much as a cubic foot of air. In other words, if a certain specified volume of air weighs

1 pound, the same volume of methane will weigh .559, or about $\frac{14}{25}$ of a pound.

BLACKDAMP

There is another "damp," or mixture of air and a gas known to miners as blackdamp, although sometimes called chokedamp, which

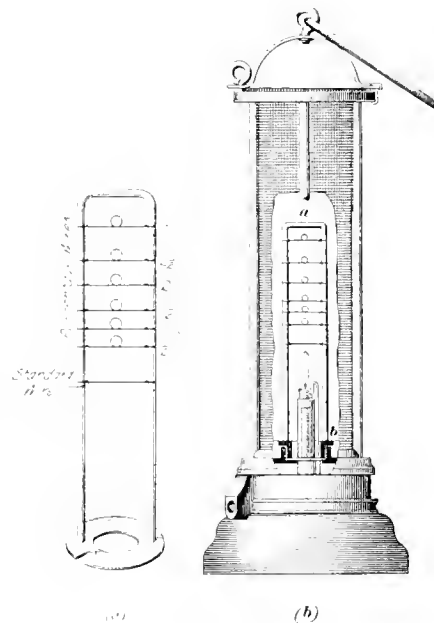

FIG. 3

is composed of air and carbon dioxide. Just as the term firedamp is often given to the methane which when mixed with air forms the real firedamp, so the term blackdamp is often wrongly given to carbon dioxide, which is only a part of the real blackdamp. Carbon dioxide gets its name from its composition, which is shown by the symbol, CO_2 , which means that a molecule of the gas is composed of 1 atom of carbon and 2 atoms of oxygen; the symbol *di* meaning two. So carbon dioxide is carbon two-oxide, there being another oxide of carbon with the symbol, CO , and known as carbon monoxide (or one-oxide), which will be described under the head of whitedamp. Carbon dioxide was at one time known as carbonic acid, but this term is now rarely used.

Carbon dioxide is a very common gas as it is always present in the air to a slight amount. It is given off by the breathing of all men and

animals, and by all burning, such as the flame of lamps, of coal or gas fires and the like. In the mines, it is also given off in other ways than these, and like methane is given off by the pores of the coal. It is formed by the decomposition or rotting of wood and the weathering of coal, so decaying props and slack piles in the gob give off this gas. It is also given off by gob or mine fires and very large amounts are formed when there has been an explosion of firedamp or of coal dust.

Carbon dioxide is the heaviest gas commonly found in coal mines, its specific gravity being 1.529. That is, if a cubic yard of air weighs

2.186 pounds, a cubic yard of carbon dioxide will weigh 3.343 pounds or a little more than one and one-half times as much. For this reason this gas is commonly found near the floor and particularly at the bottom of dip workings, in old shafts and wells and the like.

Carbon dioxide is colorless and has a prickling, faintly acid taste and smell. It does not support combustion because it is a product of complete combustion, and a light placed in it will go out. The gas is not poisonous but causes death by suffocation because it is a compound gas that will not give up its oxygen to the lungs.

(To be continued)

Mechanics of Mining

An Explanation of the Principles Underlying Calculations Relating to Engines, Pumps, and Other Machinery

By R. T. Strohm, M. E.

TO UNDERSTAND how to make calculations relating to engines, pumps, haulage systems, and various classes of machinery used in and about mines, it is very necessary to know something about forces, because the action of all kinds of machines depends on forces.

To begin with, it may be said that a force is something that causes motion. If a stone is lying on the ground, it rests there without moving, so long as nothing touches it; but when a man stoops and takes hold of it, it is lifted, or moved upwards. The difference between its lying still and its movement upwards is caused by a force, and the force is the effort put forth by the strength of the man in lifting it.

Again, suppose that an empty mine car is standing on a level track and that it is to be moved a short distance. A man simply pushes against it in the direction in which he wishes it to go, and it moves along the track. The motion of the car is due to the force of the push exerted by the man. When the car

has moved to the proper spot, the man stops it by pulling in the opposite direction to that in which he had been pushing. The stopping of the car is due to the force of the pull; therefore, it may be said that a force is something that stops or destroys motion, as well as causes motion.

Forces may act in any direction. In lifting a stone, for example, the force acts upwards. In pushing a car along a level track, the force that moves the car acts parallel to the track, that is, in the same general direction in which the track runs. In the case of a hoisting rope that runs down on a slant from the head-sheave to the drum, the force of the pull in that part of the rope acts at an angle to the ground level.

The values of forces are usually stated in pounds, and it is then an easy matter to compare them with one another. For example, suppose that the stone mentioned in a preceding paragraph weighs 20 pounds. Then, to lift it from the ground the man must exert a force of 20 pounds. If the stone had weighed 40 pounds, he would have had to lift

with a force of 40 pounds, or twice as much as in the first case. In lifting weights by pulling straight upwards, therefore, the force required is equal to the weight lifted.

In moving a car along a level track, the force required may be measured in pounds by using a spring balance, as shown in Fig. 1. The balance *a* is hooked fast to the coupling link of the car *b* and a steady pull is exerted on the ring *c* at the end of the balance, until the car moves along the track *d*. The amount of this pull, as shown by the hand on the dial of the spring balance, is then the force in pounds, required to move the car. Under ordinary conditions, a well-lubricated mine car weighing about 6,000 pounds can be moved along a level track by a force of 60 pounds.

In the last case, the force required to cause the car to move is a great deal smaller than the weight of the car; whereas, in the case of the lifted stone, the force was equal to the weight of the stone. The difference is due to the direction in which the force acts. It always takes a greater force to move a body straight upwards than to move it along the level; and if the body is moved up a slope, the force required becomes greater as the slope grows steeper. These facts are proved by every-day experience.

Forces may act without producing motion, however. Take the case of a mine prop that is carrying a load of 4 tons. The overlying rock and earth are pressing down on the prop with a force of 4 tons, or 8,000 pounds; but at the same time the prop is pushing upwards with an equal force of 8,000 pounds. The result is that the two forces just balance each other and there is no motion of either the prop or the rock. In general, then, if a body is at rest, or has no motion, the forces that act on it are balanced; or, stating the same fact in the reverse way, if the forces that act on a body are balanced, the body will not move.

Whenever a body is in motion, there are two kinds of forces acting

on it. One force is acting to keep it moving, and the other force is acting to prevent it from moving, and these forces act in opposite directions, or against each other. The force that acts to keep it in motion may be called the driving force, or the motive force; and the

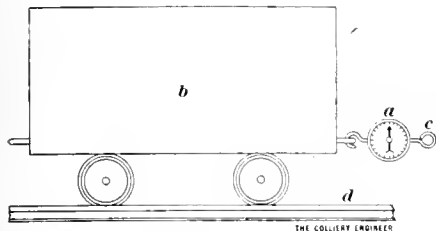

FIG. 1

force that tends to prevent it from moving may be called the resistance. As long as the motive force is greater than the resistance, the body will keep on moving; but when the resistance becomes greater than the motive force, then the motion will stop.

To illustrate these points, take the case of a mine car on a level track. While the car is moving along the rails, the force that keeps it in motion is greater than the force that tends to stop it. The resisting force, or resistance, is caused by dirt on the rails, flat spots on the wheels, friction of the bearings in which the wheels or axles turn, and so on. If the motive force is removed, or made less than the resistance, the car will slow down and come to a stop.

Another term that is very often used is *work*, which means simply the overcoming of resistance of any kind. In order that work may be done, there must be a motive force, a resistance, and motion of the body acted on. For example, if an engine hoists a car of coal in a shaft, it does work. The engine gives the motive force through the hoisting rope; the weight of the coal, car, and cage, and the rubbing of the cage against the guides, give the resistance; and as the pull of the engine on the rope is greater than the downward pull of the resistance, the load moves.

In the same way, a mine locomotive does work when it hauls a trip

of cars. The locomotive furnishes the driving force, or motive force; the weight and friction of the cars produce the resistance; and the motion is due to the fact that the pull of the locomotive is greater than the resistance. The only difference between this case and the one just mentioned is that the locomotive does work by moving the load along a fairly level track and the hoisting engine does work by lifting the load straight up the shaft. But in either case work is done, because the resistance of a moving body is overcome.

It was stated in a preceding paragraph that forces can be measured; and so, likewise, it is possible to measure work. But work is not measured in pounds, as forces are. Instead, work is measured by the *foot-pound*, which is the amount of work done when a resistance of 1 pound is overcome through a distance of 1 foot.

The idea of the foot-pound of work may be made clear by a few simple examples. If a piece of iron weighing exactly 1 pound is lifted straight upwards a distance of 1 foot, the amount of work done is 1 foot-pound, because the resisting force, or 1 pound, has been overcome through a distance of 1 foot. If the piece of iron weighs 10 pounds and is lifted vertically 1 foot, the amount of work done is 10 times as great, or 10 foot-pounds. If the weight of the iron is 1 pound and it is lifted 10 feet, the amount of work done is 10 foot-pounds, as before.

The general rule to be followed in

finding the amount of work done is to multiply the resistance, in pounds, by the distance it is moved, in feet. This rule may be used to find the work of hoisting a load up a shaft, hauling it up a slope, or drawing it along a level track. If a load of 6,000 pounds is hoisted up a vertical shaft 200 feet deep, the work done is $6,000 \times 200 = 1,200,000$ foot-pounds.

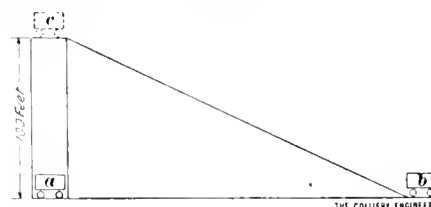

FIG. 2

If it takes a pull of 300 pounds to haul this same load up a slope 200 feet long, the work done is $300 \times 200 = 60,000$ foot-pounds. And if this load requires a steady pull of 60 pounds to draw it along a level track 200 feet long, the work done is $60 \times 200 = 12,000$ foot-pounds.

If a weight is moved from a lower level to a higher level, the work done is the product of the weight and the distance it is raised, and it makes no difference whether the load is moved straight upwards or on a slope. In Fig. 2, the two loaded mine cars *a* and *b* are supposed to weigh 6,000 pounds each and to be at the same level. If the car *a* is hoisted vertically to the position shown at *c*, or 100 feet above, the work done is $6,000 \times 100 = 600,000$ foot-pounds. If the car *b* is pushed up the slope to the position *c*, it is raised 100 feet, and the work done is $6,000 \times 100 = 600,000$ foot-pounds, as before.

(To be continued)

Electricity in the Mines

What Electricity Is—Its Manifestations—Positive and Negative Electricity
Explanation of Potential

By H. S. Webb, M. S.

WHILE many persons have endeavored to determine what electricity is, no one has been able to give a more satisfactory definition than that electric-

ity is the cause of all electrical phenomena. While this definition does not give us much information and although the exact nature of electricity is not fully understood,

nevertheless, much is known about electricity and it is made to serve many useful purposes.

We do not know what gravitation is, and yet we know its laws and how to make use of them. Similarly, we have many laws relating to electricity that always hold true, and many of the effects of electricity are known and methods for controlling and utilizing it are well understood. For instance, a copper or iron wire can be suspended in a mine shaft, connected at one end to what we call a battery and at the other end to an electric bell, then by connecting both the other terminals, or binding posts, of the battery and the bell to the ground, or to another iron or copper wire, the bell can be made to ring. We cannot see and, except under certain conditions, we cannot feel the electricity, yet the bell by ringing demonstrates its presence and it rings only when the electrical circuit is completed. Electrical instruments have been devised with which the strength of electricity present in the wire when the bell rings can be measured.

The presence of electricity may be detected in many ways. Under certain conditions it will (1) attract and repel light particles of matter, such as small pieces of paper. (2) It will decompose certain forms of matter; thus if it flows through water it will break the water up into oxygen and hydrogen. (3) It causes a freely suspended magnetic needle to be deflected to one side or another, and magnetizes a piece of iron if it passes through one or more turns of cotton-covered wire wound around the iron. (4) It violently agitates the nervous systems of animals and men, causing shock and even death. (5) It heats substances through which it passes.

Electricity may reside on the surface of a body, in which case it is called a charge of electricity, or it may flow through the body, in which case it is called a current of electricity. The branch of the science that treats of surface charges is commonly called electrostatics,

because it considers electrical charges in the state of rest and such charges are commonly called static charges of electricity. As static charges are of small importance in mine work, but little consideration will be paid to this subject in these articles. Electrodynamics is the branch that treats of the action of electrical currents or of electricity in motion. Electricity in motion is frequently called dynamic electricity. As a matter of fact there is really no difference between static and dynamic electricity. If a charge of electricity is moved along a copper or iron wire with sufficient rapidity, it becomes a current of electricity, because it then follows the laws which apply to dynamic electricity.

Static electricity is dangerous in some cases and quite troublesome in many others, and it is sometimes important to know how to eliminate or avoid it; furthermore, some electrical measuring instruments depend upon it for their operation. For these reasons practical workers should understand the production and behavior of static charges.

When a glass rod or a piece of sealing wax is rubbed with silk or fur, the parts rubbed will have the property of attracting light pieces of paper, feathers, wool, gold leaf, etc., which, after momentary contact, are usually repelled. These attractions and repulsions are caused by static charges residing on the surface of the body, which in this condition is said to be electrified.

If two light, dry pieces of pith are hung from the ends of two dry pieces of silk thread several inches long and each piece of pith is charged by bringing it in contact with a stick of sealing wax that has just previously been rubbed with a silk handkerchief, it will be found that the two pieces of pith, when brought near together, will repel each other. If one is charged from the sealing wax and the other from the silk handkerchief, or better from a glass rod after it has been rubbed

with fur or flannel, they will attract each other when brought near together.

From carefully performed experiments of this character, it has been proved that charges of an opposite character are developed on the sealing wax and on the silk. If that developed on the sealing wax is called positive (+) electricity that on the silk may be called negative (-) electricity. The charge developed on a glass rod by rubbing it with silk is opposite in character to that developed on sealing wax when rubbed with silk. Hence, if the charge on the sealing wax is called positive (+) electricity, that on the glass may be called negative (-) electricity. These experiments further prove that two bodies charged with the same kind of electricity tend to repel each other and that two bodies charged with the opposite kinds of electricity tend to attract each other.

When an electrified body, such as a glass rod after being rubbed with fur, is brought into contact with the ground, as may be done by wiping it with the hand, the electricity on the rod disappears. It has been proved that the electricity has passed through the body touching it to the earth, which acts as a large reservoir of electricity. In the case of glass rubbed with fur, it has been commonly agreed that the glass has a positive charge, and further, that the electricity on the glass has a higher pressure than the electricity on the fur or in the earth, and hence the electricity on the glass always tends to pass to a body, such as the earth, which has a lower pressure. This may be likened to two tanks of water, one above the other. When connected with a pipe the water in the higher tank tends to flow into the lower tank because the pressure toward the earth of the higher body of water is the greater. In electrical work the term potential is used in place of pressure. Thus the electric charge on the glass is said to be at a higher, or greater, potential than the charge on the fur.

(To be continued)

PRIZE CONTEST

For the best answer to each of the following questions we will give any books on mining or the sciences related thereto, now in print, to the value of \$3.

For the second best answer, similar books to the value of \$2 will be given.

Both prizes for answers to the same questions will not be awarded to any one person.

1. The name and address in full of the contestant must be signed to each answer, and each answer must be on a separate paper.

2. Answers must be written in ink on one side of the paper only.

3. "Competition Contest" must be written on the envelope in which the answers are sent to us.

4. One person may compete in all the questions.

5. Our decision as to the merits of the answers shall be final.

6. Answers must be mailed to us not later than one month after publication of the question.

7. The publication of the answers and names of persons to whom the prizes are awarded shall be considered sufficient notification. Successful competitors are requested to notify us as soon as possible as to what books they want, and to mention the numbers of the questions when so doing.

8. In awarding prizes, other things being equal, a carefully written and arranged answer will be given the preference.

9. Employees of the publishers are not eligible to enter this contest.

Questions for Prizes

13. *Horsepower of Engine.*—Calculate the horsepower of an engine that is capable of hauling a trip of 15 cars, each weighing 1,200 pounds, and having a capacity of 3,000 pounds. The haulage road has a uniform grade of 1 per cent. against the load, and is 4,000 feet long. It is desired to get out 600 cars a day. Assume the coefficient of friction as $\frac{1}{40}$.

14. *Tracks in Rooms.*—What is the maximum pitch on which tracks can be laid in rooms and cars handled with safety? What methods are adopted for handling the coal in the rooms on steep pitches? Answer briefly.

15. *Size of Airway.*—Are two airways 8 feet square equal to one airway 8 by 16 feet; and which will pass the most air and why, the pressure per unit of area being the same in both cases?

16. *Standing Props.*—How would you stand a prop in a seam of coal 6 feet thick, which has from one foot to two feet of slate above it, (1) when the seam is flat; (2) when the seam pitches 30 degrees; (3) when the seam pitches 70 degrees? Give details and reasons for your answer.

Answers for Which Prizes Have Been Awarded

QUES. 5. *Booster Fan.*—An exhaust fan at a mine is capable of supplying 150,000 cubic feet of air per minute, and 40,000 cubic feet per minute more are required. The amount of unmined coal is insufficient to warrant sinking additional airshafts, and leakage along the airways has been reduced to a minimum. Will a "booster fan" located in the mine meet the requirement? Give reasons for the answer, and state at what point such booster fan should be located, if in your opinion it will do the work.

Ans.—The question is whether or not it would be practical to use a "booster" or an auxiliary fan where the ventilation is to be increased above 150,000 cubic feet per minute? Two fans each being capable of providing 150,000 cubic feet of air per minute working on the same airways in a mine would fall short of providing the increased quantity of air.

It is well known that the power producing ventilation varies directly as the cube of the quantity. The increased power therefore would require to be $\left(\frac{190,000}{150,000}\right)^3$ or $\left(\frac{19}{15}\right)^3$

$= \frac{6,859}{3,375}$ or 2.033, nearly, that the power would have to be increased; for which reason it would not be practical to install a booster or an auxiliary fan. It is well known that the

quantity of air in circulation varies directly as the cube root of the horsepower; therefore, if a small fan (booster) of about 10 horsepower were placed in the workings to increase the ventilation in a certain part of the mine, and the horsepower of the principal ventilating fan at the surface was 100, the influence of the so-called "booster" on the total quantity of air would be practically nothing, because the ventilation varies directly as the cube root of the horsepower and $\sqrt[3]{100} : \sqrt[3]{110}$ or $\left(\frac{110}{100}\right)^3 = 1.032$. So if 200,000 cubic feet of air per minute was produced with 100 horsepower, there would be produced with the increased power $\sqrt[3]{110} = 1.032 \times 200,000 = 206,400$ cubic feet.

The effect then of an auxiliary or "booster" fan for the purpose of ventilation in some part of a mine is merely local, having comparatively no effect on the entire bulk of the ventilation. But where the auxiliary or small fan is applied, its results no doubt will be beneficial locally.

GEORGE W. SMITH,
Superintendent Cornell Coal Co.
Hite, Pa.

Second prize, S. J. Jennings, Pittston, Pa.

QUES. 6.—*To Stop a Squeeze.*—A flat coal seam 8 feet thick lies from 350 to 450 feet below the surface, and

has a strong bed of micaceous sandstone 40 feet thick next above the top slate which is 13 inches thick; a squeeze has started in an area of 20 acres which was originally worked on the pillar-and-stall system, and the pillars left are well distributed and constitute about one-third of the original coal. How would you proceed to stop the squeeze so as to eventually recover a maximum amount of coal in the pillars?

Ans.—Assuming that 1 inch of this coal to the acre weighs 100 tons, there will be 192,000 net tons, two-thirds of the coal being extracted. Therefore, for the area of 20 acres, not enough pillars are left to withstand the weight thrown on them. The best method of stopping a squeeze is to prevent the causes that lead up to it. Those in charge of this work could hardly have overlooked the conditions given in this question and it is self-evident that the pillar-and-stall method is not practical and should have been changed to the room-and-pillar system, extracting one-third of the coal and leaving two-thirds in the pillars. Assuming that there is a bed of soft fireclay on the bottom, the 13 inches of top slate may be also soft and cause the pillars to slab off, thereby weakening them more. Then to stop the squeeze or retard its progress as much as possible, work not too many men, restrict the gob line, and concentrate the work as much as possible. It is difficult to give a definite answer to this question, as the conditions vary in every case. There are times when the timbers will be crushed and broken as quickly as they are put in, and at times the floor of the roadway will heave so rapidly as to afford little opportunity to save the tracks, and yet the conditions of the roof and coal are such that there is no immediate danger to the lives of the workmen employed in the necessary work of securing the roadway or saving material. It is always wise to abandon work on the coal at the face of breasts where a severe squeeze exists. This is made imperative under many conditions in order to avoid the possibility of accidents from falls of roof or coal; it is

not, however, necessary at all times to withdraw the men working in other parts of the mine during the progress of the squeeze. The writer has knowledge of squeezes where approximately all of the coal was recovered. Every reasonable effort should be made to withdraw standing timber in the gob and work out such pillar coal as can be done safely in order to cause a fall and thereby relieve the entry pillars of weight. If this is done and no fall is made, it will be necessary to blast down the roof in the worked-out area to get the first fall or break.

Timbers should be set and cribs should be built in all places along the roadway where it is possible to reinforce the pillars. This work should not be abandoned as long as there is reasonable hope of controlling the squeeze. In the removal of these pillars it would be a matter of wisdom to use nothing but the best types of safety lamps and employ shot firers to blast under this thickness of cover.

M. J. RAFFERTY,

Ehrenfeld, Pa.

Second prize, Alex. Wilson, New Lexington, Perry County, Ohio.

QUES. 7.—*Raising Water*.—In a certain region it is desired to concentrate into one sump the drainage of several mines, amounting as a maximum to 800,000 gallons per day of 24 hours, and raise it out through a shaft 550 feet deep. Which system will be most economical and efficient—piston pumps, centrifugal pumps, or hoisting in tanks, the water being slightly acidulated? Give reasons in detail.

Ans.—A triple expansion, duplex, outside-packed, plunger steam pump would be the most economical and efficient for the following reasons: The efficiency of a centrifugal pump is less than that of a reciprocating machine. The water flows through the rotary machine at a high velocity, and in case of acidulated water the rings, bushings, impellers, etc., wear considerably, making the cost of repairs high. The initial cost of a steam pump is probably a little higher than that of a centrifugal stage

pump, but it is more easily cared for. The labor costs for looking after either pump are about equal, but a rotary pump needs more attention, because of its high motor speed and its liability to lose its water unobserved, unless a check-valve is placed at the end of the suction pipe.

Centrifugal pumps for 24 hours continual service in mines are not as reliable as plunger pumps. They are more compact and take less room, but the other disadvantages are more persistent. Without going into detailed calculations, would say that the amount of steam required to run an ordinary generator to furnish power to do this work would be far more than sufficient to run the steam pump in question.

To hoist the water, would mean to keep in repair a shaft having a depth of 550 feet, equipping it with guides, buntons, tower, sheave wheels, ropes, water tanks, hoisting engines, etc., all of which would require attention and repairs. The services of an engineer would also be necessary.

The maximum amount of water to be raised would be 550 gallons per minute, and taking all things into consideration, I would prefer the old reliable steam pump.

S. J. JENNINGS,

No. 9 Prospect Place, Pittston, Pa.

Second Prize, Alex Wilson, New Lexington, Perry County, Ohio.

QUES. 8.—*System of Mining*.—In the case of two seams of coal separated by 36 feet of comparatively soft strata and lying at a dip of 10 degrees, the upper seam is 6 feet thick and the lower seam is 8 feet thick, and it is desired to mine them simultaneously through one shaft 560 feet deep to the lower seam, and to have the daily production approximate 1,000 tons. The top over the upper seam is strong, that over the lower seam comparatively weak, and both seams give off considerable gas. What system of mining would be best as regards safety and economy?

[NOTE.—This question has been answered from the standpoint of both the anthracite and the bituminous practice. As the answers are

different and especially good, a first prize has been awarded to each of the following.—EDITOR.]

Ans.—*Anthracite*.—The question does not give the location of the shaft on the property. In case it is to be put down on the higher elevation, a slope would be driven on the dip of the seam at a convenient place on the shaft level. Lifts would be turned at right angles to the slope. If the shaft is put down on the lower or dip end of the property, an engine plane would be driven up the pitch and lifts turned at right angles, so arranged that trips could be dropped in on to the turnouts.

In either case the engine room should be on the surface, which would eliminate the steam and heat inconveniences and lessen the danger of fire in the mine. Gangways and airways should be driven nearly level, and the chambers driven up the pitch at right angles to the gangways. This is done to give the pillars greater strength and to avoid chipping of pillars, which would probably be the case if they were driven across the pitch at an angle of 45 degrees. It would also add to the strength of the pillars very materially when the work of taking them out was commenced.

A seam 560 feet deep, 8 feet in thickness with another seam 6 feet thick 36 feet above, with comparatively weak strata intervening is in need of all the strength that it is possible to provide. The intervening strata, on account of the upper seam being gaseous, and especially if the gas is pent up with much pressure, would tend to weigh heavily on the bottom-vein pillars, causing them to chip freely and increase the danger of a squeeze.

The work suggested so far has been in the bottom seam, because it is from this seam that the coal from both seams will be hoisted to the surface. The coal from the upper seam should be mined and taken to the lower seam by means of tunnels, at convenient intervals, driven on a level with the gangway in the bottom seam, back against the pitch. The

seams pitching 10 degrees and the intervening rock being 36 feet thick, the tunnels would be about 200 feet long. They could be driven from each lift and the coal brought out through them to the turnouts at the foot of each lift. The same transportation facilities would then do for both seams without installing any

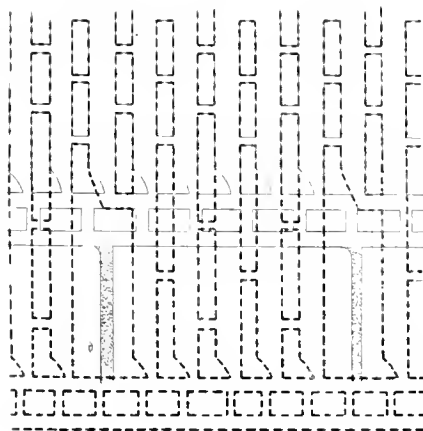

FIG. 1

machinery in the upper seam. The reduced help with such a system would pay for driving a great many tunnels during the life of the property.

Good safe second openings should be driven from the bottom to the top seam for each tunnel. These openings could be additional tunnels, or shafts equipped with steps, and would be used for ventilation as well as a second way of exit.

The chief feature or successful mining in this case would be the size of the pillars to be left for support. Pillars 8 yards wide between headings and airways and 7 yards wide between chambers in each vein would make a strong mine. Places in the top seam should be driven on line immediately over the places in the bottom seam. The cross-cuts should be driven at intervals equal to the maximum distance allowed by law and alternated or staggered, so as to give all the strength possible, and that the faces of the places will not be more than one-half the distance of a pillar length away from a cross-cut when the pillars are left the maximum length.

Each seam should be ventilated separately.

The accompanying Fig. 1 shows

arrangement of workings in both seams, the dotted lines representing the upper seam and the full lines the lower.

When the pillars are to be removed, it would probably be better to keep the pillar in the bottom seam about one-half a pillar length in advance of the one in the upper seam. In both seams the pillars should be drawn simultaneously. Experience in handling the breakage of the overlying strata would probably show best the proper manner of successfully removing the pillars.

S. J. JENNINGS.

No. 9 Prospect Place, Pittston, Pa.

Ans.—*Bituminous*.—The system of work which I would adopt under the given conditions would be bord-and-pillar panel system. My reasons for adopting such a system are because the question calls for safety and economy. As this is a gaseous mine the ventilation must be considered as the prime factor toward safety and perhaps economy. The conditions stated in this question give every inducement toward creep and thrust, so they must also be guarded against. To guard against creep and thrust and bring about a maximum of economy, strict discipline should always be enforced. Before explaining the bord-and-pillar panel system of work, it will be necessary to state that when the pillars are being formed it is known as "working in the whole," and when they are being extracted it is known as "working the broken." Bord-and-pillar working is divided into two distinct operations: First, driving narrow places 9 to 12 feet wide in the solid coal, and at every 60 to 90 feet driving places the same width at right angles, thus forming a pillar or rectangular block. The whole field is to be blocked out in this way. The panel system calls for a block of coal being left until the first panel of pillars is nearly all extracted. It is then cut into rectangular blocks and made ready for extraction when needed. This panel serves a double purpose. It is a means of confining creep to one locality, and it permits

each territory to be separately ventilated, which is very important in a gaseous mine. Following up the "whole with the broken" should be commenced as soon as the first panel of pillars reaches the line. The great advantage of this method of working, as compared with the older system of forming pillars over large areas, is that the pillars stand only a short time after being formed, therefore better coal may be got and a larger number of men can be employed, hence a larger output or capacity.

In simultaneous working of bord-and-pillar system, great precaution should be taken to see that both veins be kept in such a position as to allow the angle of break to be uniform; the angle of break may be approximated at 45 degrees; this is another great feature in favor of economy. In conclusion, the width of a panel should be at least the width of two pillars and the full length of the territory.

ALEX WILSON,
New Lexington, Perry County, Ohio

shall be eligible to reappointment by the Governor."

The operators firmly opposed this. The miners were willing for it to go in, but indifferent.

The Governor favored it, so they compromised and left to the Governor the power to discharge any mine Inspector at any time with or without cause.

This is the law in Alabama today. I would like to have the views of those interested on this subject.

My idea is that mining laws are passed for the protection of those working in the mines.

That the law should be such that the Governor will only keep in charge of that department a suitable man. That the Governor should be relieved from having to discharge an official, but the law should be so that he can keep the same man in office if he thinks best.

J. DE B. HOOPER
Dixie Springs, Ala.

THE LETTER BOX

Readers are invited to ask or answer any question pertaining to mining, or to express their views on mining subjects in this department. All communications must be accompanied by the name and address of the writer—not necessarily for publication.

The editors are not responsible for views expressed by correspondents.

Are "Heat Waves" Visible

Editor *The Colliery Engineer*:

SIR:—Can any of your readers tell me why it is that we see "heat waves" when a current of warm air strikes a body of cold air or when a current of cold air strikes a body of warm air? The hot gases ascending from the top of a chimney are apparently visible, but are they really visible and what is the reason that they appear to be so?

M. O. F.

New York

Changing Hoisting Ropes

Editor *The Colliery Engineer*:

SIR:—Can any of your correspondents tell me how to change ends on our hoisting rope, the lay-out being shown in Fig. 1. It is about 3,000

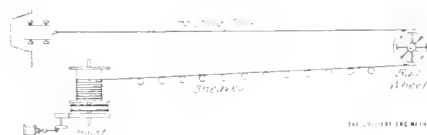

FIG. 1

feet from the engine to the bull wheel, and the sheaves, which are placed every 100 feet on the engine side of the bull wheel, are closed and

not easy to open. What we want to do is to use the end now on the drum for attaching to the trip and vice versa, without going to the trouble and expense of opening the sheaves.

SUPERINTENDENT

Law Regarding Mine Inspectors

Editor *The Colliery Engineer*:

SIR:—While all of us acknowledge the desirability and necessity for examination of mine foremen, superintendents, mine inspectors, etc., about the mines, still the most of us realize that in point of practical experience and technical knowledge a man may stand the very best examination in every respect and still be entirely unfit for one of these places.

Two years ago I submitted the following clause to be added to the mining law then before the legislature:

"Provided—That in the event of an accident costing the lives of twenty-five or more men, or if the death record for a year exceed that of one life lost for two hundred thousand tons of coal mined, then the tenure of office of the Chief Mine Inspector shall terminate automatically, but he

Booster Fans

Editor *The Colliery Engineer*:

SIR:—Herewith find an answer to Mine Manager's query in your January issue regarding booster fans. While not a superintendent or other mine official at present, I have been employed in and around mines from trapper up, therefore, I speak whereof I know.

Being employed in this instance as electrician, it fell in my line of duty to instal a "booster fan." The main fan was a steam-driven affair, running at about the limit of its speed with the load it had; viz., 60,000 cubic feet per minute. It was desired to raise this amount to 85,000 or 90,000 cubic feet, hence, the booster.

It was installed at the point marked 3 x. shown in Fig. 2, three-fourths of the total air being wanted down this airway. The booster was of the same capacity as the main fan. When started up, all air entering main airway went to booster, none went down the airway on the north side of first dip. This not being satisfactory, the fan was moved to point 2 x in the main airway to boost the entire input; the amount going

to the north side of the first dip being proportioned by a regulator. The booster did boost about 10,000 cubic feet per minute, running at full capacity, using a 25-horsepower motor which cost about \$9 per day of 24 hours to operate. An expensive 10,000 cubic feet that!

An experiment follows: New gearing was made, that slightly increased the speed of the booster, and it was put on one Sunday morning. Conditions were ideal for an experiment. Air measures with both fans going before the gearing was changed on the booster, showed 70,000 cubic feet.

The outside fan was stopped, new gears were put on the booster and when started the air measured 85,000 cubic feet. With the old gear, the fan motor had a current consumption of 19 kilowatts, with the new gear 26 kilowatts. The motor, rated at 25 horsepower with a current consumption of 19 kilowatts, developed slightly better than 35 horsepower during the test with the new gearing.

Evidently these tests were not satisfactory to the management, for very soon the various parts of a new fan began to arrive which upon installation furnished all the air needed (with approximately 35 horsepower), running a little above half speed.

From the foregoing, I concluded that boosters were all right, say to boost the air in an out-of-the-way entry with an airway full of obstructions, that it would cost too much to clean up, but to boost the entire intake, never!

I might add that this opinion was shared by a former Mine Inspector of the State of Colorado.

I would call the reader's attention to the statement of fan capacities, each one 60,000 cubic feet, both together 70,000 cubic feet.

If 25 horsepower would deliver 60,000 cubic feet, which it did, why did it take 25 horsepower to boost just one-sixth of that amount?

I believe that if the above booster had been put on the extreme return there would have been more benefit realized than there was. How much more, I am not prepared to say.

I learn from this and other instances of a like nature, that if you want a greater amount of air in a mine, the only thing to do is to get a larger fan, and thereby save trouble and expense.

The foregoing figures are approximately correct, as applied to motor current, etc., but have been slightly altered as to air—the relative values, however, are correct, or nearly so.

MINER.

Editor The Colliery Engineer:

SIR:—In answer to the question asked by Manager in the January

Fast Hoisting at English Collieries

The following leading British collieries, which show fast hoisting under normal conditions, supply good examples of modern practice: Dowlais mine, Cardiff, 2,220 feet in 52 seconds, an average winding speed of 2,562 feet per minute; Ashton Moss colliery, 2,850 feet in 1 minute 25 seconds, or 2,010 feet per minute; Lady Windsor colliery, 1,500 feet in 35 seconds, or 2,571 feet per minute; Bolsover colliery, 1,116 feet in 28 seconds, or 2,388

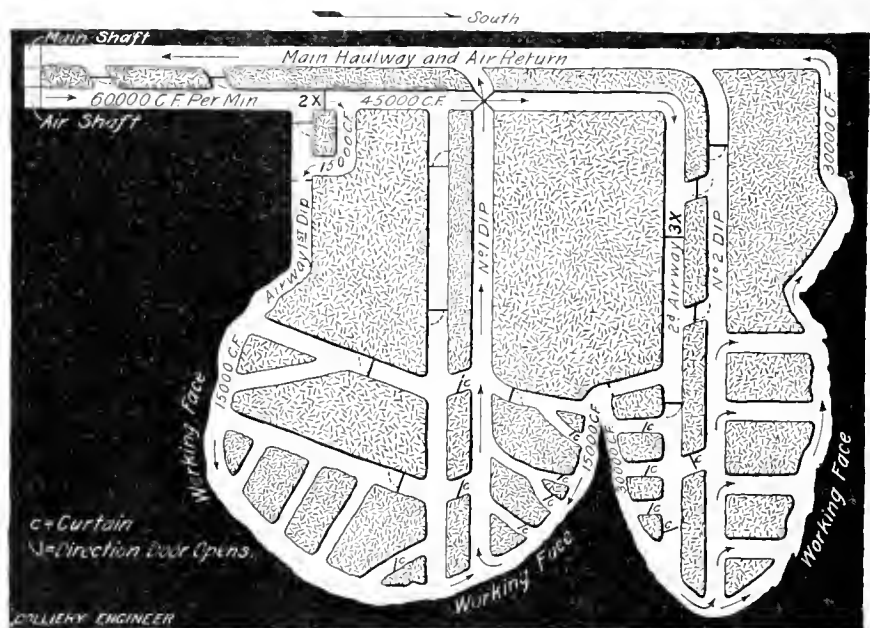

FIG. 2. INSTALLATION OF A BOOSTER FAN

issue of MINES AND MINERALS regarding booster fans, I would say that such fans will help under certain conditions. I have installed one under the following conditions: I put a "booster" fan in the return airway and used one of 25 per cent. greater efficiency than the fan which was outside. But there are so many various local conditions to be considered that there is no rule in general by which you may go. If Manager would give me the details of the trouble I should be glad to give him a plan that I have used successfully in a number of such cases. Local conditions however must be considered first.

H. GEDOSH.

Poteau, Okla.

feet per minute; Denaby and Cadeby collieries, 2,289 feet in 55 seconds, or 2,497 feet per minute; Rhodes Rotherham colliery, 1,650 feet in 45 minutes, or 2,358 feet per minute; while at the Rosebridge colliery, a maximum hoisting speed of 5,100 feet per minute has been recorded; but this is excessive, as, for considerations of safety, it should not exceed 4,000 feet per minute. From the foregoing data, and taking into consideration the needs of a regular output, an average hoisting speed of 3,000 feet per minute may be assumed to represent the best modern practice in England. A comparison of these figures with American and Continental practice would be of interest.

ANSWERS TO EXAMINATION QUESTIONS

Questions Asked at the Examination for the State Mine Inspector of Colorado, in 1911

(Concluded from February Issue)

QUES. 38.—What kind of safety lamps have you used in places where firedamp was known to exist? What lamp do you prefer and why?

Ans.—The answer to this question will vary according to the experience of the candidate. Some guide to the choice of the lamp is afforded by the answer to Ques. 18. A good lamp should possess the qualities named therein.

QUES. 39.—What is the highest percentage of explosive gas in which you deem it safe to carry on blasting operations in the mine?

Ans.—So much depends upon local conditions which are not named in the question that a precise answer is difficult to give. If the coal is properly undercut, the holes properly placed and properly charged with a permissible, short-flamed powder, and if dust is not allowed to accumulate, and the face, floor, ribs, roof, and timbers are *thoroughly* washed down and saturated with water for from 60 to 100 feet back from the face, electric shot firing is probably safe with as much as 4 per cent. of methane present, provided this amount of gas is confined to that portion of the working place which is in by the last cross-cut, and is not everywhere present in the mine air.

Under adverse conditions, where the coal is very dry and dusty and where watering is not employed, and particularly in those mines where black powder is used and the shooting done off the solid, blasting is absolutely unsafe, whether a mere trace of gas only is present or none at all, as a blown-out shot can easily ignite the inflammable dust.

QUES. 40.—Explain the law of the diffusion of gases, and its effect on their behavior in mines. Give rule and example showing how to find the comparative velocity of the diffusion of different gases.

Ans.—When a space is occupied by a certain gas and another gas is gently liberated into the same space, the velocity with which the gases will diffuse or mix uniformly with one another is proportional to the square root of the densities, or specific gravities, of the two gases. The operation of this law is to cause methane, carbon dioxide, or any other gas given off by a seam, to make a uniform, homogeneous mixture with the mine air, if sufficient time is allowed for the process of diffusion. Specific gravities are usually referred, in the case of gases, to air as unity. Thus, air being the unit, the specific gravity of methane is .559. The relative rate of diffusion of air and methane is, by the law given, as $\sqrt{1} : \sqrt{.558}$, or as $1 : .748$; that is, 1,000 volumes of methane will diffuse into air in the same length of time that 748 volumes of air will diffuse into methane. Similarly, the specific gravity of carbon dioxide, CO_2 , being 1.529, the velocity of diffusion is in the ratio $\sqrt{1} : \sqrt{1.529}$ or as $1 : 1.237$; that is, 1,000 volumes of CO_2 will diffuse into air in the same length of time that 1,237 volumes of air will diffuse into CO_2 .

QUES. 41.—Give a brief description of the Draeger helmet and what is it used for?

Ans.—This is one of the several types of helmet, or "rescue" apparatus, used in recovering mines after

an explosion when the workings are full of poisonous gases. It consists essentially of a leather helmet, strengthened by ribs of wire, worn on the head, the part covering the face being provided with a plate of transparent mica so that the user can see. The helmet is air-tight and fits the head by means of an inflated rubber tube so closely that no outside air can enter through or around it. On the back of the wearer are two steel cylinders containing pure oxygen gas under a pressure of 125 to 150 atmospheres, a supply sufficient to last for 2 hours. On the back are also two tin flattened cylinders containing caustic soda or potash, the duty of which is to absorb the CO_2 given off by the breath. On the chest is worn a rubber-lined leather air bag divided by an interior partition into two parts.

When in use, the impure air from the lungs passes through a flexible tube to one compartment of the air bag and thence through other tubes to the potash cylinders, or cartridges, where the CO_2 is absorbed. This air is then charged with oxygen from the storage tanks, goes to the second compartment of the air bag, and thence by another flexible tube to the helmet for the use of the wearer. This cycle of operations is kept up as long as oxygen remains in the cylinders.

QUES. 42.—What is an explosive?

Ans.—An explosive is either a single chemical compound or a mixture of such compounds which, upon the application of heat, is instantly (for all practical purposes) converted into a large volume of gas through the decomposition or combination of the

elements entering into its composition.

QUES. 43.—What are the three-fold principles of all safety lamps?

ANS.—The question is not quite clear. The essential features of safety lamps have been given in the answer to Ques. 18. The single principle upon which a safety lamp differs from an ordinary lamp is the isolation of the flame from the outer air by a wire gauze; and the application of this principle is common to all safety lamps. The action of the gauze is: the burning gas in passing out through its meshes is divided into a series of very thin streams or jets, the temperature of which is reduced below the point of ignition by contact with the cool metal, and the flame thus is extinguished before it has had an opportunity to ignite the methane in the external air.

QUES. 44.—A slope dips 1 foot in 8 feet for a distance of 504 feet measured on the slope. What is the difference in elevation between the mouth and face and what is the horizontal distance between them?

ANS.—The total rise of the slope is $504 \div 8 = 63$ feet. In the triangle

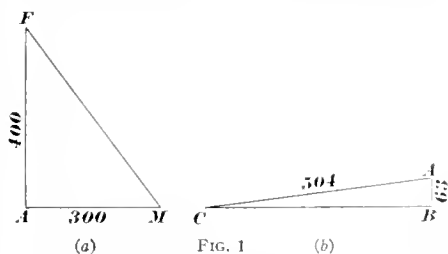

ABC , Fig. 1 (b), the side $AB = 63$ represents the difference in elevation of the mouth and face, and the hypotenuse, AC , is the slope distance, 504 feet. The horizontal distance,

$$BC = \sqrt{AC^2 - AB^2} = \sqrt{504^2 - 63^2} = \sqrt{250,047} = 500.46 \text{ feet.}$$

QUES. 45.—What do you understand by a water blast in a coal mine?

ANS.—A water blast is a sudden inrush of air from old workings which have been tapped at a point above the level of the water contained in them. The workings are, naturally, those which have been driven to the rise, and their upper portion contains air under pressure of water, the surface of the main portion of which

is at a higher elevation than that in the room in question. The greater the head of water, the more will the air be compressed, and the more violent will be the "water blast" when the workings are tapped.

QUES. 46.—100,000 cubic feet of air pass through an airway 6 ft. \times 5 ft. in sectional area, and 10,000 feet long, which is divided into three splits as follows: Split A is 6 ft. \times 6 ft. in section, 2,000 feet long; split B is 6 ft. \times 5 ft. in section, 4,000 feet long; and split C is 6 ft. \times 4 ft. in section, 6,000 feet long. What quantity of air will pass in each split while the pressure remains the same?

ANS.—The main airway need not be considered in the calculation if we assume that the three splits start from the same point at its end and that the pressure is the same at the mouth of each.

The quantity passing each split will be proportional to the expression

$a \sqrt{\frac{a}{s}}$, in which a = the area of the airway and s = the rubbing surface. For split A, $a = 6 \times 6 = 36$ square feet, and $s = (6 + 6 + 6 + 6) \times 2,000 = 24,000$ square feet; for split B, $a = 6 \times 5 = 30$ square feet, and $s = (6 + 6 + 5 + 5) \times 4,000 = 88,000$ square feet; for split C, $a = 6 \times 4 = 24$ square feet, and $s = (6 + 6 + 4 + 4) \times 6,000 = 120,000$ square feet. By substituting these values in the above expression the relative quantity of air passing in each split is

$$\text{Split A} = a \sqrt{\frac{a}{s}} = 36 \sqrt{\frac{36}{24,000}} = .9859$$

$$\text{Split B} = a \sqrt{\frac{a}{s}} = 30 \sqrt{\frac{30}{88,000}} = .5539$$

$$\text{Split C} = a \sqrt{\frac{a}{s}} = 24 \sqrt{\frac{24}{120,000}} = .3394$$

The quantity of air passing in each split is equal to the total amount of air in circulation multiplied by the ratio of each of these individual ratios to the sum of the three individual ratios, and

$$\begin{aligned} \text{Split A} &= \frac{.9859}{1.8792} \times 100,000 \\ &= 52,464 \text{ cubic feet.} \end{aligned}$$

$$\begin{aligned} \text{Split B} &= \frac{.5539}{1.8792} \times 100,000 \\ &= 29,475 \text{ cubic feet.} \end{aligned}$$

$$\begin{aligned} \text{Split C} &= \frac{.3394}{1.8792} \times 100,000 \\ &= 18,061 \text{ cubic feet.} \end{aligned}$$

QUES. 47.—Does a high water gauge always indicate a large quantity of air passing? What does a low water gauge with a large quantity of air passing indicate?

ANS.—No; a high water gauge only indicates great resistance to the passage of the air through the mine. This resistance may indicate long airways or those of too small area and but a small amount of air in circulation, as well as meaning a large volume of air moving at high velocity.

A low water gauge with a large quantity of air passing indicates large and unobstructed, or short, airways of good area.

QUES. 48.—What is a dumb drift, and why is it used in gaseous mines?

ANS.—While the use of furnaces should be, and is in many states, prohibited by law, yet they are still to be found at small mines. When the return air-current is heavily charged with methane it cannot be carried through the fire of the furnace without serious danger of an explosion. Under such circumstances the furnace drift is isolated from the rest of the workings and the fire fed by a separate split of air from the main intake. At any convenient distance inby the furnace, a tunnel is driven through the rock on such a grade as to strike the furnace shaft at a point above the fire where the furnace gases are cooled below the temperature of ignition of methane. This rock tunnel, which conveys the return air-current of the mine over the furnace, is known as a dumb drift.

QUES. 49.—Find the rubbing surfaces of three airways each 6,000 feet long and all having the same sectional area, 75 square feet. The forms of the three sections are as follows: The first, A, is rectangular, 5 feet high and 15 feet wide; the second, B, is square; and the third, C, is circular.

Ans.—It is first necessary to find the perimeter of each airway. The perimeter of $A = 5 + 5 + 15 + 15 = 40$ feet; the side of the square forming the airway, B , is $\sqrt{75} = 8.66$ feet, and the perimeter is $4 \times 8.66 = 34.64$ feet; and for C the diameter of the circular airway is $\sqrt{\frac{75}{.7854}} = 9.77$ feet, and the

perimeter is $9.77 \times 3.1416 = 30.69$ feet.

The rubbing surfaces are, thence: $A = 40 \times 6,000 = 240,000$ square feet; $B = 34.64 \times 6,000 = 207,840$ square feet; $C = 30.69 \times 6,000 = 184,140$ square feet.

QUES. 50.—In an airway that has three sides, 6, 8, and 10 feet, respectively, and is 900 yards long, what is the area, perimeter, and rubbing surface? What quantity of air will be passing in this airway with a velocity of 425 feet per minute?

Ans.—This airway is in the shape of a right-angled triangle, the base of which is 8 feet and the altitude 6 feet.

Its area is, thence, equal to $\frac{6 \times 8}{2} = 24$ square feet. Perimeter: This is found by adding together the lengths of the sides and is $6 + 8 + 10 = 24$ feet. Rubbing surface: This is equal to the perimeter multiplied by the length $= 24 \times (3 \times 900) = 64,800$ square feet. The quantity of air passing is $24 \times 425 = 10,200$ cubic feet a minute.

QUES. 51.—How many horsepower will it take to pull 20 loaded cars up an incline 400 feet long in 1 minute, the weight of the coal in each car being 3,000 pounds, and the weight of the empty car 900 pounds; the resistance of the rope and pulleys is 13 per cent. and the grade is 7 per cent.?

Ans.—The weight of each loaded car equals $3,000 + 900 = 3,900$ pounds. As there are 20 such cars the total weight hoisted is $20 \times 3,900 = 78,000$ pounds. But the resistance of the rope and cars, that is, the friction of the wheels on the axles and rails and that of the rope and rollers, is equivalent to that of a certain weight, which is estimated to be 13 per cent. of the real load lifted. This added "resistance" weight is equal to $78,000 \times .13 = 10,140$ pounds. The

weight the engine has to overcome is thus $78,000 + 10,140 = 88,140$ pounds. The distance through which this weight is raised in 1 minute, which is the unit of time in estimating work, is $400 \times .07 = 28$ feet (the grade being 7 per cent., or 7 feet in each 100 feet, or .07 foot per foot).

$$\text{Hp.} = \frac{\text{Wt.} \times \text{Vert. Dist.} \times \text{Time}}{33,000}$$

$$= \frac{88,140 \times 28 \times 1}{33,000} = 74.78 + \text{Hp.}$$

QUES. 52.—Presuming you had a 30-foot room in an 11-foot seam of coal pitching from 45 to 50 degrees with a 300-foot lift and a 50-foot pillar on each side, and that the room had been carried to a smooth 7 feet from the foot-wall and the coal taken out; how would you take the remaining 4 feet of top coal, starting the work from the bottom with a view of getting the highest possible amount of the 4 feet of top coal, and provide for the safety of the miners? Give answer briefly.

Ans.—If the top coal is still in place, as the question indicates, the method of mining would be the same as that employed in originally working out the lower 7-foot bench. The method used would be the room-and-pillar, with a battery at the room neck similar to that described in the answer to Ques. 37. It will be necessary to leave inside the battery sufficient loose coal for the miners to stand upon in order to reach the roof coal which they are working out. If the seam is gaseous, the original manway, which is also an airway, as shown in the cut under Ques. 37, will have to be replaced with one of the posts which are 11 feet long. The chutes, cross-cuts between rooms, and those connecting the room manway with the main return, used in the original working, may all be used in working out the top coal.

QUES. 53.—A pipe line in the slope of a mine has an area of 144 square inches, and is 3,000 feet long; the slope is on a grade of 1 in 10; what is the pressure per square inch at the bottom of the pipe when it is full of water?

Ans.—As the grade of the slope is 1 in 10, the vertical depth of the

slope, which is the same as the head of water causing pressure on the bottom of the pipe, is $3,000 \div 10 = 300$ feet. As a column of water 1 square inch in cross-section and 1 foot high weighs .434 pound, the pressure upon the bottom of the pipe will be $300 \times .434 = 130.20$ pounds per square inch. The total area (144 square inches) of the pipe does not affect the pressure per individual square inch. The total pressure on the bottom of the pipe would be $144 \times 130.20 = 187,488$ pounds.

QUES. 54.—Give the comparative advantages and disadvantages of the longwall and room-and-pillar methods of working coal mines.

Ans.—The main advantages of the longwall system of mining are: (a) the removal of all the coal in one operation with the minimum amount of roadways, working places, etc., to be maintained; (b) concentration of work in a continuous face making systematic working and proper supervision of men and operations much easier; (c) the gaining of a larger percentage of lump coal with a much less amount of powder, with consequent higher wages for the men, a better selling price for his product for the operator, and with lessened liability to all classes of accidents due to the use of explosives; (d) the maintenance of a minimum length of roadways until all the coal is removed, whereas in the room-and-pillar system (as ordinarily employed) many thousand feet of entries and rooms must be kept open until the pillars are drawn; (e) better and more efficient ventilation with decreased liability of gob fires, roof falls, etc.; (f) the risk of creep or squeeze is reduced to a minimum and the surface settles uniformly and evenly, whereas in room-and-pillar working, squeezes are common and the surface caves in a series of irregular breaks; (g) there is no expense for narrow work, and usually the expense for haulage and timbering is less than under the room-and-pillar system.

The chief disadvantages of the longwall system of working are: (a) in gaseous workings, the impossibility of isolating any particularly

dangerous part of the mine, or the impossibility of dividing the mine into a series of disconnected panels or districts and thus confining the effects of an explosion to a small extent of the workings; (b) where the mine is not operated continuously, that is, where the car supply is poor and there are numerous idle days, the expense of keeping open the average longwall face is much greater than that required to keep in proper condition the rooms and entries in a mine operated under the room-and-pillar system; (c) the system is expensive where the coal is pitching steeply, where the roof is strong, and when the seam is clean and does not furnish sufficient rock for stowing.

QUES. 55.—If the anemometer records a velocity of 500 feet per minute in an intake airway having a sectional area of 60 square feet, and the thermometer shows a temperature of 32° F., what will be the volume of air passing in the same airway per minute, when the temperature has risen to 60° F.?

ANS.—The volume of air passing through the intake is $60 \times 500 = 30,000$ cubic feet per minute.

The change in the volume of any gas through an increase in its temperature is proportional to the absolute temperature, which is measured from the absolute zero, which is 459 degrees below the zero of the ordinary Fahrenheit scale. The absolute temperature of the intake air is $459 + 32 = 491$, and that at the higher temperature is $459 + 60 = 519$. The volume at the higher temperature is $\frac{519}{491} \times 30,000 = 31,711$ cubic feet.

來 來

Considerable coal is briquetted in South Wales. The briquets are of large size, and weigh from 14 to 28 pounds, the latter being generally in demand on account of the convenience in handling. These briquets are shipped abroad for steam raising, chiefly for railroad use, particularly in tropical countries where their gas retaining properties make them more valuable than coal.

The Use of Explosives in Coal Mines

By F. H. Gunsolus*

When the problem is to get an explosive to be used in coal mines where gas and dust are present in dangerous quantities, the temperature factor of strength must be eliminated as far as possible in order to reduce the possibility of igniting the gas or dust by the blasts. In short, the strength of the best permissible explosives must necessarily be not equal to those of the higher grade dynamites. The strongest explosives on the United States Permissible List are the Monobels. By the use of ammonia nitrate as a base it is possible to manufacture a permissible explosive having a weight for weight strength equal to a 60-per-cent. dynamite, but on account of the low specific gravity of nitrate of ammonia, the bulk for bulk, or cartridge for cartridge, strength is only equal to that of a 35-per-cent. dynamite. Fortunately it is only on rare occasions that rock is encountered in coal mines, where extra strong explosives are required to give the most economical results. If this kind of rock is encountered where there is danger of gas or dust explosions, the only method of blasting to follow is to give the holes lighter burdens and use the permissible explosives.

The blasting of the coal itself is a problem of getting out the largest percentage possible in the shape desired, rather than to reduce the actual cost of extraction to the lowest possible figure. For instance, it is cheaper and the output per man is greater, to smash the coal up fine in the blasting, because it can be shovelled up in less time, than to break it in large lumps. But on the other hand the prices obtained for the large sizes of coal are enough higher to make it an object, except where the coal is to be coked, to maintain the output of lump coal at a maximum.

When blasting powder was the principal explosive used in coal mines, where the seams were under-

cut, the holes were placed in different positions than is done at the present time when permissible explosives have largely replaced blasting powder. With blasting powder, the holes were bored fairly flat about two-thirds of the distance from the floor to the roof. When permissible explosives were introduced, it was found that with undercut coal better results were obtained if the holes were started from 12 to 18 inches below the roof and given an upward slant that would bring the point against the roof about directly over the back of the cut. Also, where the tight shot is on one side of the room instead of the middle of the face, the blast would make more lump coal if the hole was about 18 inches from the rib.

In the coke regions the desire is to break the coal as fine as possible in the blasting. The rooms are narrower and in some fields often the blasting is done from the solid.

The first permissible explosives placed on the market caused some complaint by the producers of lump coal to the effect that they smashed the coal too much, thereby increasing the production of fine coal and diminishing their profits. This led to an extended study of their requirements by the principal manufacturers of explosives, and the consequent production of permissible explosives better adapted for the production of lump coal.

Among the best producers of lump coal are Monobel No. 3 and Monobel No. 5. These two powders, No. 5 being a low-freezing explosive, have the nearest approach to the action of blasting powder that it is possible to obtain with a high explosive, and when they are properly used will produce as much lump coal as the best grades of blasting powder. For coking coals and anthracite, Monobel No. 1, No. 2, No. 4, and No. 6 will give good results.

Where the work is wet the Carbonites will probably be more reliable. The Carbonites are really low-flame dynamites that have passed the United States Government tests

*Wilmington, Del., Manager Technical Div. E. I. duPont de Nemours Powder Co.

for permissible explosives and have the same water-resisting qualities as the ordinary dynamite. The Carbonites can be made with practically the same variations in quickness as the Monobels but where the latter can be used satisfactorily, they are to be preferred.

With the permissible explosives it is of the utmost importance to use strong detonators. The United States Government, with the excep-

several cases on record where mine gas has been ignited by the spit from freshly lighted fuse.

It is also of the utmost importance to tamp charges well. This not only greatly increases the work done by the explosive (given as 30 per cent. increase in the United States Government tests) but it prevents flame from projecting out into the working places and reduces the amount of the bad fumes liberated.

arranged so that warm water is used in winter time and cold water in summer. On account of the cold outside air in winter time having very little moisture, it rapidly dries out the mine dust inside of the mine and, therefore, warm water must be used in connection with the apparatus in order to equalize the inside temperature of the mine and have a large percentage of moisture in the mine air.

The apparatus is placed about 25 feet inside of the mine in the intake airway and receives the exhaust steam from the 20-foot Vulcan exhaust Guibal fan, on the return airway; the exhaust steam from the fan enters the center of the top cross-connecting pipe and is distributed along the top pipes. The ends of these pipes being plugged, the steam passes through the $\frac{3}{8}$ -inch openings into the $\frac{3}{4}$ -inch pipes which condense the steam into water. The water then passes through the lower $\frac{3}{8}$ -inch holes into the bottom pipes, and then passes to the far end, where it enters the lower cross-connecting pipe and from the pipe it enters to the hot well.

The water line for the sprays enters the top cross-connecting pipe at the center, passes through the inside of the top pipes to the far end, then returns back in the center pipe to the front end. Demoler and Simplex spray nozzles are placed on each side of the water line every 5 feet or closer if desired, and, as stated, warm water can be used in the winter and cold water in the summer.

The air cocks on the inside of the exhaust steam pipes are to allow the desired amount of steam to be admitted to the air, and they can be placed at any distance apart that seems desirable.

The 20-foot Vulcan exhaust Guibal fan ventilates a coal field of about 1,200 acres. Hygrometer readings are taken at regular intervals at different points inside of the mine and have proven this apparatus to be very efficient in moistening the mine air.

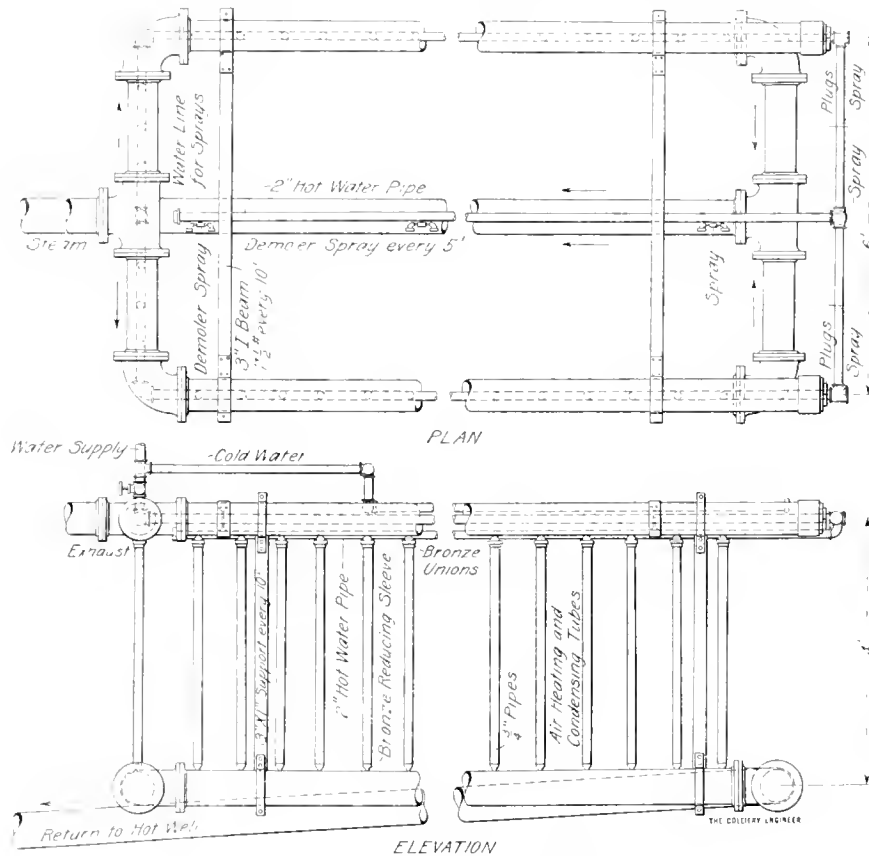

FIG. 1. HUMIDIFYING APPARATUS

tion of one or two that require stronger, states that the coal-mine explosives are only permissible when used with No. 6 or stronger blasting caps or electric fuses. In addition to this, photographs show that the flame of detonation of the permissible explosives is reduced when they are shot by means of No. 7 and No. 8 blasting caps or electric fuses. Also, the use of strong detonators increases the work done by the explosive and reduces the production of obnoxious fumes.

The best method for firing charges of permissible explosives is to blast by electricity. There are

Humidifying the Air-Current

By Jesse K. Johnston*

The air moistening apparatus shown in Fig. 1 was designed by Joseph M. Hoskins, electrician for the Charleroi Coal Works mine, Charleroi, Pa.

It was first put into operation in 1905, being one of the first systems used for humidifying air ventilating currents in southwestern Pennsylvania. The apparatus is used to heat the air going into the mine so that it will absorb a high percentage of moisture, and it is

*General Mine Superintendent, Charleroi Coal Works, Charleroi, Pa.

NEW MINING MACHINERY

New Safety Catch for Hoists

The new safety catch invented by Peter Hinkle is being installed by A. F. Plock, Park Building, Pittsburg.

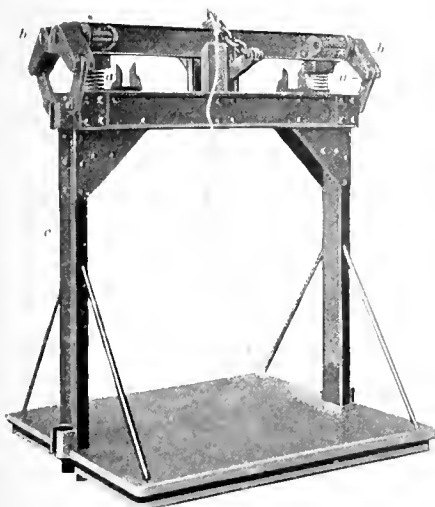

FIG. 1. SAFETY CATCH ON CAGE

The catch may be applied to both cages and skips, and is arranged so as to form a double safety guard in case the hoisting rope breaks. As shown in Fig. 1 there are two powerful springs *a*, which bring the eccentric grippers *b*, in contact with the cage guides, not shown, but over which the cage shoes *c*, slide.

The mechanism employed to actuate the safety catch is entirely independent of the load carried by the cages, or the power used. But when once applied, the weight of the car and its load holds the cage locked to the guides and it is no longer dependent on the springs.

The device can be installed without any changes to the cage or the guides. In Fig. 2 is shown a skip with the safety cams *a* gripping iron or steel cage guides *b* and *c*. The guide *b* is worn until it is only one-quarter of the original thickness and the other guide *c* is only about three-fourths of the original thickness. It matters not how badly worn the

guides may become on one or both sides, so long as there is a guide left the safety device will hold tight; besides, each side works independently of the other.

The presence of the guide shoes and guides make it impossible for the skip to jump the track, as is often the case with some kinds of skips, a feature which although not new prevents serious damages and delay.

Fig. 1 shows the cage of a vertical hoist. A number of tests have been made on a recent installation of this kind where varying loads up to 6 tons were "cut loose" and at no time did the device fail to stop the load instantly.

It is interesting to know that the smoother the faces of the cams the tighter they grip steel guides, and a cam designed for steel guides will not work satisfactorily on wooden guides. The powerful grip of the smooth cam

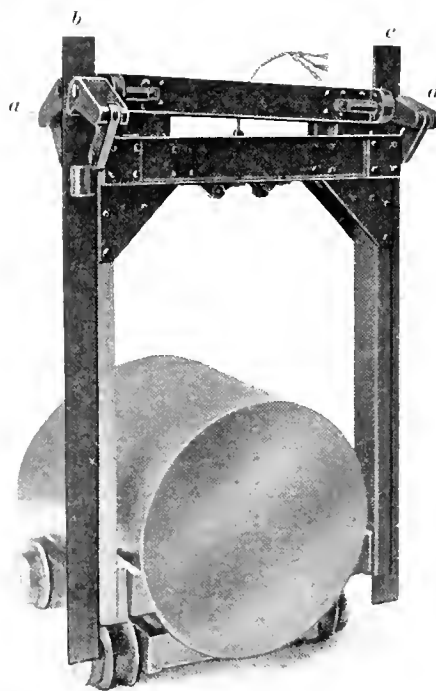

FIG. 2 SAFETY CATCH ON SKIP

causes the wood to spring outward, partly due to the oil which penetrates

the guide and partly due to the elasticity of the wood. Thus it was found necessary to employ a cam or eccentric with a corrugated face, after the manner of ordinary corrugated iron, and arranged in such

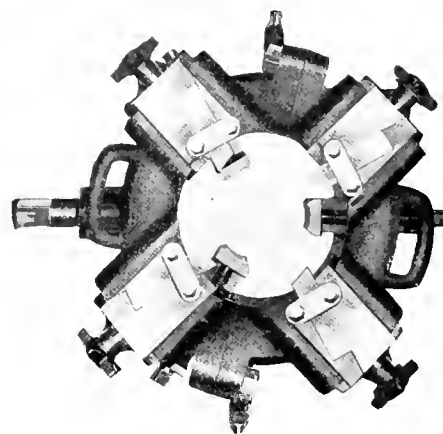

FIG. 3. HAND-OPERATED PIPE-CUTTING MACHINE

manner that no sharp edges exist to injure the wooden guides. Even wooden guides are not injured by the action of the cams or eccentric in locking the cage; and the cams are immediately released and returned to their normal working position, so soon as sufficient tension exists in the hoisting rope, and the cage is again ready for service.

The safety catch will hold the cage in the shaft while necessary repairs are being made either to the hoisting rope or hoisting machinery. This dispenses with the necessity of holding the cage or car in place by means of chain blocks or other rigging as is often the case.

來 來

Pipe Cutter

The Toledo Pipe Threading Machine Co. is manufacturing a hand-operated pipe-cutting machine Fig. 3 for pipes ranging in size from 2½ inches to 6 inches, inclusive. The cutting is done by four knives which are automatically fed by star feed. Two of these knives are beveled across

the edge and cut out a V-shaped section of the pipe; the other two knives are square and follow in the V-shaped cut, cutting out the edges, thus eliminating any tendency the knives might have to bind in the cut. The tool is fastened to the pipe by a three-jawed chuck, each jaw being actuated independently and containing a set of size marks so the tool can be centered on the pipe. The knives are set down to the pipe by turning the stars by hand until each knife in succession comes in contact with the pipe.

The tool is driven by a pinion working on a bevel gear, the pinion being turned by means of a ratchet and handle. In order that the pipe which is already in place may be cut in two, the cutter is made in two parts and can be taken apart by removing four cap screws. When fastened together additional stiffness is given by dowel pins.

來 來

Temporary Electric Bond

The Ohio Brass Co. is manufacturing a rail bond for tracks in mines where electric locomotives operate, which can be used many times and is suitable for temporary tracks. It is well known that tracks are often laid down for temporary purposes only, but which need to be bonded while they are used.

Briefly, the Type N bond consists of two tapered steel terminals joined together by a flexible copper cable as shown in Fig. 4. The cable is headed and soldered into the terminals and

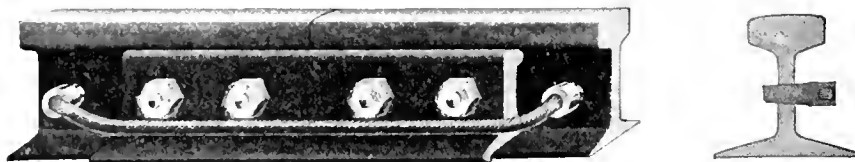

FIG. 4. REMOVABLE BOND, INSTALLED AND SECTIONAL VIEW

the terminals are tinned all over. The taper has been carefully worked out so that when the bonds are first installed they need only be driven in a slight distance, and then the next time they are installed they are driven a little further, etc.

The compressed terminal bond is recommended for permanent work as

the connection is better, but the use of this bond once, destroys the terminal, so that it cannot be used again. The steel terminal bond however can be used again and can be rapidly

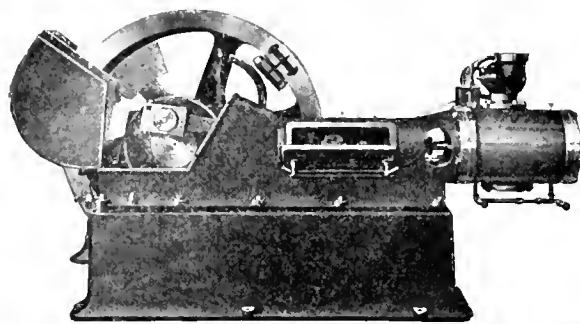

FIG. 5. THE BROWNELL ENGINE

placed, requiring only that a $\frac{5}{8}$ -inch hole be drilled in the rail and then the terminal driven in tight with a hammer. It is made up in 00 capacity only.

來 來

Brownell Engine

The application of several new ideas, and of other features not heretofore applied in steam engine design has resulted in the production of an engine, by The Brownell Company, of Dayton, Ohio, that has been highly commended by mechanical engineers. A general view of this new engine is shown in Fig. 5.

In this engine great flexibility in speeds and powers is secured by interchangeability of parts so that any size cylinder and stroke desired may be obtained. The frame is also constructed in such a way that fly wheels and cylinders of varying size may be used. In the construction of the

frame, from which it can be drawn and filtered for reuse. The splash system of oiling, common in gas-engine practice, but new when applied to large steam engines has been so

designed as to thoroughly confine the oil. The bottom of the cover plate which closes the opening to the crosshead, fits into a cast-iron groove draining to the guide chamber, from which the oil is carried by gravity to the main oil reservoir. There is also a covering or casing over the eccentric which carries the oil to the main reservoir.

The four-part main bearing has an extra large bearing area to insure cool running. To prevent end motion the bottom piece fits into a bored seat with tongue and groove. Both side pieces are adjusted by wedges at each end, bearing the distance pieces, and the adjustment is made by means of bolts through the cap. The top piece is adjusted by liners and is held down by jamb screws through the cap. All pieces are babbitted and provided with oil grooves starting from the upper edge, but which do not carry quite to the lower edge, so that the grooves must fill before the oil will be wiped across the bridge into the reservoir formed by beveling back the quarter-box edges, from which the next grooves below take their supply.

Enclosing the crank disk, which is forced on the shaft by hydraulic pressure, there is a casing of planished steel and polished angles. This casing is vented by a hole, in the upper handle, having an L outlet, so that the oil is not forced out.

The solid end connecting-rod has split boxes with wedge adjustment in the same direction, and turns on a

frame extra metal is used, and where necessary, additional internal ribs are provided to stiffen and increase its strength. Between the guides and the cylinder a space is provided which forms a chamber into which the oil and water from the stuffingboxes drain. From here the oil and water flow to a pan, in the base of the

crosshead pin held into the head by a flange and four clamp bolts. Two distance screws through the flange and bearing on the crosshead, serve to remove the pin. The pin may be turned 90 degrees to insure even wear. The crosshead shoes have large bearing area with oil grooves cast in the surface; they are bronze castings of wedge shape, adjusted by nuts against an end lug, and having at the forward end stud bolts to clamp them to the head. The piston rod is held in the crosshead by a screw and jamb nut, and in the piston by a straight forced fit and nut on the outside end.

The flywheel, eccentric, and Rites governor are split and removable. The governor is specially designed to permit the use of a light spring, which, with long inertia arms, insures great sensitiveness to instantaneous change of load.

A forged steel valve rod guide bar, carried in brackets runs in a flood of oil supplied from a pocket which is kept full by the splash system.

The valve is of the Sweet double-ported type designed without center web, to obtain lightness and freedom from casting strains. It is covered by a flat plate held from endwise motion by adjusting screws so that the lead can be varied between the ends of the cylinder. The plate is held against the valve by flat springs, bearing on the steam chest cover, providing relief in case of excess pressure.

The steam and exhaust ports are designed for low steam velocity, the live steam not exceeding 4,500 feet per minute velocity, and the exhaust steam ranging as low as 2,000 feet.

For use where variable speeds are required, a form of Stephenson link is used, but with both eccentrics set ahead of the crank, one of them being 129 degrees ahead and the other 191 degrees ahead, so that the travel of the valve is changed by setting the link to bring the valve under the control of either eccentric. Engines so equipped are peculiarly adapted for fan engines as they permit of easily increasing or decreasing the speed of the fan. The illustration

given shows the arrangement of the link and eccentric, and the form of cylinder head used in all Brownell engines.

The same type of engines are built either tandem or cross-compound, condensing or non-condensing.

used throughout, and they are not exposed to crank-case pressure, so that leaks from the crank case are impossible; no deflecting plate is used on the piston, and the inlet and exhaust ports are not opposite, so there are no leaks between ports, as com-

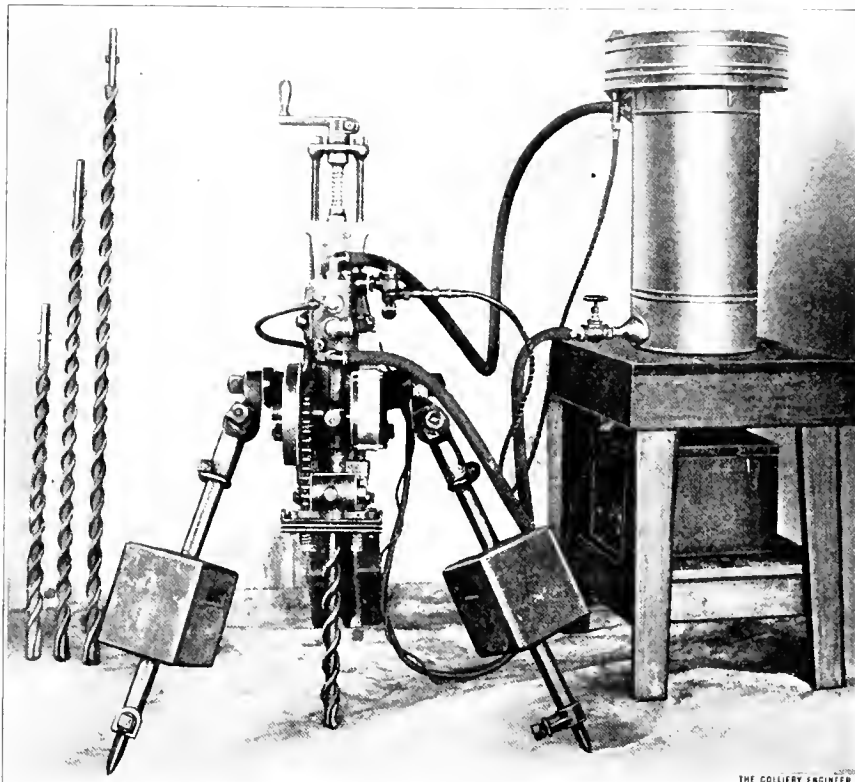

FIG. 6. GASOLINE ROCK DRILL

Gasoline Rock Drill

A gasoline rock drill has been developed by L. L. Scott, of St. Louis. Mr. Scott has been engaged in the manufacture of mining machinery and has been working upon the development of a gasoline rock drill for 7 years, having finally perfected four sizes of machines weighing respectively 35, 85, 140, and 265 pounds. The smallest size is a hand machine while the others will drill holes to a depth of 5 feet, 10 feet, and 20 feet, according to the weight of the machine, and are mounted upon a tripod or column.

All of these drilling engines work on the two-cycle single acting principle; they are free from all gears, cams, push rods, etc., and have none of the common faults of two-cycle engines. Back firing is impossible; speeds up to 3,000 revolutions per minute can be had if desired; roller bearings are

mon to ordinary constructions. These machines drill rock on the "hammer" principle; the hammer piston is made of vanadium steel and is acted upon by a 300-pound explosive pressure, and when it strikes the blow on the shank of the drill steel, it is free from all connected parts of the machine, in fact it strikes the same blow as the air drill which has no crank shaft, i. e., direct, uncushioned, and free piston. The piston is moved rearwardly by energy stored in the flywheel, and is picked up for this return stroke on a cushion of air.

The drill steel used in this machine can be either the hollow steel, arranged so that a part of the explosive pressure will pass through the drill, or the solid steel with a thread, which is extensively used in Germany. The drills are set loose in the chuck, having lugs on each side which catch in slots in the chuck,

while the chuck is rotated by means of a worm on the rotating parts which drives a sprocket and chain that in turn drives a worm connected to the chuck.

In narrow work where the ventilation is poor the exhaust from the drill must be piped out of the way,

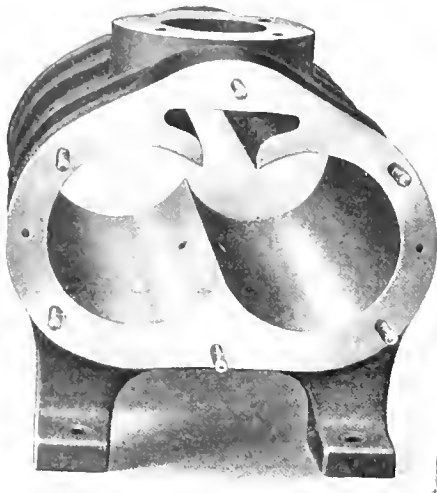

FIG. 7

but in places where the ventilation is good, there is no necessity to pipe the fumes away any more than with the gasoline engines commonly used in the mines.

The drill was tried out at a quarry belonging to the Fruin-Bambrick Construction Co. The great advantage claimed for this drill is the elimination of the powerhouse requirements of the usual drill, for this drill is self-contained, in that the source of power goes with the drill, as shown in the Fig. 6 which is taken from a photograph.

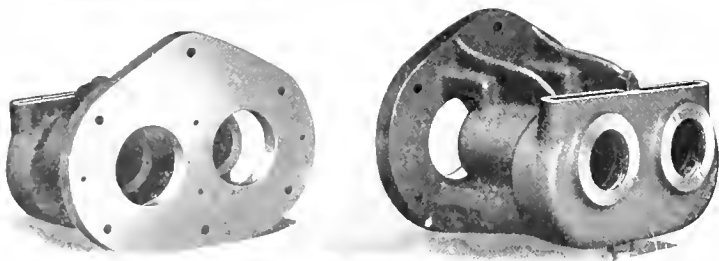

FIG. 10

The Spiro Steam Turbine

The Spiro steam turbine, a remarkably efficient and revolutionary prime mover has recently been put on the market by the Buffalo Forge Co., of Buffalo, N. Y. The rotors,

shown in Fig. 9, run in mesh, enclosed in the casing shown in Fig. 7. The ends of the casing, which contain the bearings for the rotors are shown in Fig. 10, and a diagrammatic end view is shown in Fig. 8. The steam enters the turbine at mid-length through the port holes shown in Figs. 7 and 8, on each side of the central rib, which divides the casing into two partly-closed cylinders, in which the rotors

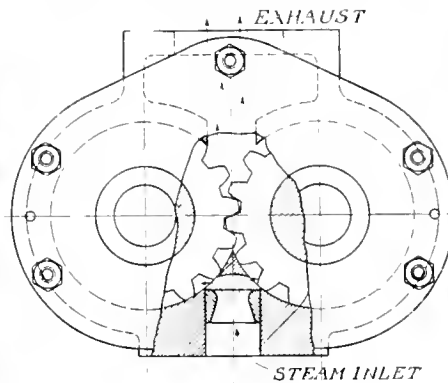

FIG. 8

revolve, and the steam exhausts through the ports shown at the top in Figs. 7 and 8.

The steam when it enters occupies the space between two adjacent teeth, and this space is closed at the points by the closely fitting casing. As each rotor turns, the space occupied by the steam increases in length and the steam expands, finally escaping when the outer ends of the teeth pass the line of contact between the two rotors. The increase in the length of the tooth space from the time steam is admitted until exhaust oc-

cluding screws, nuts, bolts, and every minor part. This is in striking contrast to the hundreds of parts usually found in engines and turbines.

There is an entire absence of the delicate parts, which usually require careful attention and repairs.

The ratio of expansion is dependent on the design and length of the rotors, and can also be made variable by the use of an adjustable port open-

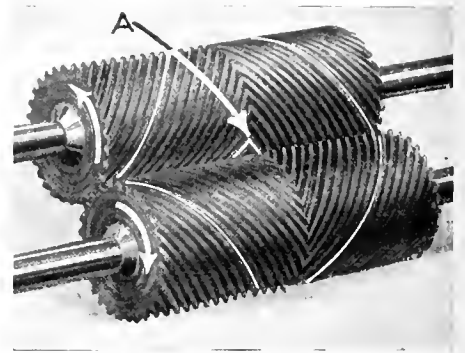

FIG. 9. THE ROTORS

ing that is operated by a governor. The ratio of expansion ranges from 1 to $3\frac{1}{2}$ up to 1 to 6. As the steam velocity does not exceed 300 feet per second, there is no necessity for a diverging nozzle. As shown in Fig. 8, the steam jet is diverted into the general direction of rotation. The jets impinge against the angular pockets formed by the junction of the left- and right-hand helical teeth, and this results in a pressure drop and a corresponding turning moment, depending in amount on the rotative speed and initial pressure. The remaining available energy of the steam is used expansively in the tooth spaces. This expansion takes place at a high velocity. With, say 2,000 revolutions per minute and 20 teeth in each of the two rotors, there are 80,000 impacts and expansions per minute.

It is to this rapidity of the steam action that the Spiro owes its small size. There are also several minor reactions, which, while small, in the aggregate increase the general efficiency of the motor. The manufacturers claim that a Spiro with 8-inch rotors will develop the same power as a reciprocating engine with a $13\frac{3}{4}$ -inch piston running at a speed

is shown by the length of the outer white lines on Fig. 9 as compared with the very short inner white lines.

The construction is very simple, consisting of only 60 or 70 parts, in-

of 600 feet per minute. The overall dimensions of such a turbine are 49 in. \times 18½ in. \times 19 in. It therefore provides a large amount of power with very small weight and space, and with no necessity for packing.

Tests made with Spiros, when condensing at atmospheric pressure showed a water rate as low as 31.8 pounds per brake horsepower per hour on a 150-horsepower turbine.

來 來

Two-Speed A. C. Motor for Mine Fan Drive

An excellent example of the efficient adaptation of electricity to mine service is illustrated in Fig. 11, which shows a two-speed, alternating current, three-phase, 60 cycle, 440-volt motor belted to a 12-foot Guibal fan installed in the Greensburg No. 1 mine of the Keystone Coal Co., near Greensburg, Westmoreland County, Pa.

The force of miners is considerably less at night than during the daytime, and consequently it is desired to run this fan at only about one-half the speed at night that is required during the day. For this service there was selected a Westinghouse squirrel-cage type induction motor with a rating of 7½-horsepower at 600 revolutions per minute, and 15 horsepower at 1,200 revolutions per minute to perform the work.

The change in speed is accomplished by changing the number of poles. The stator of the motor is provided with two windings; one of which gives 6 poles, resulting in a speed of 1,200 revolutions per minute, and the other gives 12 poles, with a speed of 600 revolutions per minute. The connections are changed for one set of windings to the other by the controller. This is a most efficient form of control as the motor can be operated at low speeds at its highest efficiency; there being no losses in the control resistance.

Current for the operation of this motor is furnished by the West Penn Electric Co. In order to determine the results obtained from the installation, tests were made by Mr. C. V. Elliott, electrical engineer of the

lighting company, which gave the following data:

The fan is 5 feet 6 inches wide, and the depth of blades 3 feet 6 inches. When running at 120 revolutions per minute, with 1.5 inches water gauge, or an equivalent pressure of .87 ounce per square inch,

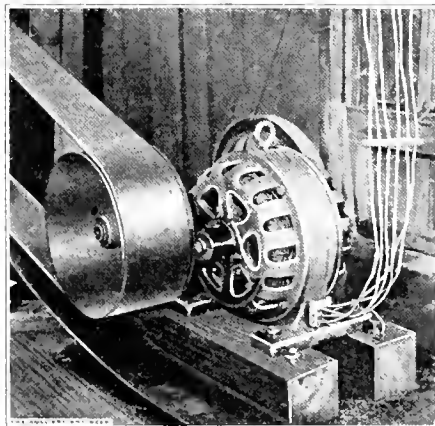

FIG. 11. TWO-SPEED A. C. MOTOR FOR MINE FAN

46,200 cubic feet of air per minute were delivered. The motor in performing this work took 9.6 kilowatts, giving an efficiency of 63.03 per cent. for the outfit. When running at half speed, or 60 revolutions per minute, with .6 inch water gauge, or .29 ounce pressure per square inch, 14,850 cubic feet per minute were delivered, and an efficiency of 58.33 per cent. was obtained.

These results are particularly important as they show economy in the use of purchased power, which is becoming standard practice where alternating current is available.

來 來

Electric Hoist

The Vulcan Iron Works, of Wilkes-Barre, Pa., has recently built two electric mine hoists for the Woodward Iron Co., of Alabama. Both hoists are similar in design. One is to be operated on a slope inside the mines while the larger one is to hoist the ore to the surface and is located on the outside.

This large hoist is of 700 horsepower, geared for a rope speed of about 1,800 feet per minute on a 30-degree slope and having a load of 33,600 pounds of ore in a car weigh-

ing 30,000 pounds. The load is to be counterbalanced by a weight of 15,000 pounds arranged on a two-part rope, so that its travel will only be about 900 feet, the length of the slope being 1,800 feet; a 1½-inch rope will be used. There are two 10-foot drums, grooved so that the rope will coil in two layers.

The motor for the hoist was built by the General Electric Co., and is a 700-horsepower, 10-pole, 3,300-volt, three-phase, 25-cycle, induction motor of the variable-speed type with polar-wound rotors. The speed is controlled by cutting resistance into and out of the rotor circuits, the rheostat being of the liquid type, with magnetically operated oil-immersed contactors. The resistance of the rheostat is varied by varying the level of the water, which is controlled by a hand-operated weir, though the level of the water can be made independent of the weir, so that automatic acceleration is obtained.

The motors are directly geared to the drums, there being only a single reduction. The gears are made of steel and are of the herringbone machine-cut type, each gear being protected by hinged covers. The brake is operated by a cylinder and is balanced by weights, the arrangement being so controlled that it cannot operate with a shock.

The hoist is equipped with over-wind gear. A gear at the end of the driving shaft operates a worm and gear, a disk with adjustable cams being mounted on the shaft with the gear. The cams engage levers, which shut off the power and apply the brake.

The 500-horsepower hoist pulls the cars in trips of 20 up the slope to the point where the cars are dumped and the ore hoisted the rest of the way by the 700-horsepower hoist. The first hoist has a 500-horsepower, 8-pole, 375-revolutions-per-minute, 3,300-volt, three-phase, 25-cycle, form "M" General Electric motor. The arrangement is similar to the 700-horsepower hoist, except that all parts are sectionalized so as to facilitate transportation and erection inside the mines.

TRADE NOTICES

Pump Installations.—The Deane Steam Pump Co., of Holyoke, Mass., has installed seven electrically operated plunger pumps for one Pennsylvania mining concern. These pumps are especially adapted for use where the water is excessively acid. The Deane company is a large manufacturer of pumps and has issued a new catalog, No. D-218, which describes electrically operated pumps, and the vertical and horizontal in the duplex, triplex, and quintuplex types.

Orenstein-Arthur Koppel Co.—Mr. A. Reich, general manager of the Orenstein-Arthur Koppel Co. is now in Berlin, Germany, where the head office of this company is located, for consultation with the executive officials regarding the extensive improvements to be made during the coming year at their American plant, at Koppel, Pa. There a new office building is being erected, two stories high, of brick and steel fitted with all modern conveniences, and the entire executive department of the American organization, which is now located in the Machesney Building, Pittsburg, Pa., is to be moved to the plant at Koppel, Pa.

Davis-Biram Anemometer.—Letters Patent for the Davis-Biram anemometer have recently been granted to John Davis & Son, (Derby) Ltd., All Saints Works, Derby, England, whose American representatives are J. F. McCoy Co., 157 Chambers St., New York. Messrs. Davis & Son state that, on account of the advantages contained in the new instruments many colliery companies are substituting them for the old form of Biram anemometer, even when the latter are in good condition. Full information and description of the instruments will be furnished on application to either the American or the home office.

The Roberts & Schaefer Co., engineers and contractors, of Chicago, have engaged Mr. Trevor B. Simon,

formerly associated with the Jeffrey Mfg. Co., as one of their engineers. They have also secured the services of Mr. Arthur L. Ware as their representative in the Kentucky and Tennessee coal fields.

The Link-Belt Co., of Philadelphia and Chicago, designers and manufacturers of coal tippie equipments and other conveying machinery, announce that hereafter the contract work in the West Virginia and Virginia coal fields will be in charge of their engineer, Mr. F. F. Waechter, replacing Mr. A. Kauffmann, who has been transferred to the Chicago plant. Mr. Waechter has been in the Link-Belt Co.'s employ for the last 15 years, a great part of this time in the Engineering Department, as chief draftsman, and the last 2 years in the Sales Department.

Protection Against 40° Below Zero. A temperature of "40 below" is quite usual in the vicinity of South Porcupine, Canada, a gold mining settlement 500 miles north of Toronto. When the Northern Electric Heat and Power Co. built their new plant in that town they required a material that would prove an effectual insulation against this excessive cold and would not crack and go to pieces under low temperatures. It was necessary also to have a roofing that would withstand the melting snows of spring, without rusting or rotting, and that would not dry out and run during the short but often hot Canadian summer. They made a thorough test of J-M Asbestos roofing and a siding known as J-M Asbestoside, which proved so successful that they adopted these materials. The H. W. Johns-Manville Co., of New York, the manufacturers of this roofing, will send a booklet describing it upon request.

New Catalog.—A most complete catalog has been issued by the Joseph Dixon Crucible Co., Jersey City, N. J., describing the graphite, crucibles, paint, lubricants, pencils, and other productions of the Dixon company. Though this catalog contains over 100 pages, it does not attempt to carry a full description of the entire line, and only a few of the

many hundreds of Dixon's American Graphite pencils are listed, the intention being to acquaint those who are already users of one form of graphite with its many other forms and uses. It will be sent on request.

CATALOGS RECEIVED

A. S. CAMERON STEAM PUMP WORKS, 11 Broadway, New York. Illustrated pamphlet of Steam Pumps; 48 pages.

THE BRISTOL CO., Waterbury, Conn. Wm. H. Bristol Electric Pyrometer; 16 pages.

JOHN A. ROEBLING'S SONS, Trenton, N. J. Roebling Wire Rope and Where to Get It; 8 pages.

A. LESCHEN & SONS ROPE CO., St. Louis, Mo. Leschen's Hercules, How to Splice Wire Rope; 11 pages.

KEYSTONE LUBRICATING CO., Philadelphia, Pa. Lubrication of Mining Machinery; 19 pages.

THE C. S. CARD IRON WORKS CO., Denver, Colo. Coal Handling Machinery and Equipment; 71 pages.

THE DEANE STEAM PUMP CO., 115 Broadway, New York. Electrically Operated Mine Pumps; 100 pages. Triple-Plunger Artesian Well Pumps, 16 pages.

SULLIVAN MACHINERY CO., 129 South Michigan Ave., Chicago, Ill. Sullivan Portable Drilling Rigs, 16 pages.

CHICAGO PNEUMATIC TOOL CO., Fisher Building, Chicago, Ill. Design and Construction Class G "Chicago Pneumatic" Compressors; 28 pages.

AMERICAN BLOWER CO., Detroit, Mich. "A B C" Disc Ventilating Fans; 24 pages. Unit Heaters; 4 pages. Dry Kilns for Timber Products; 78 pages.

CALENDARS RECEIVED

GENERAL ELECTRIC CO., Schenectady, N. Y.

AJAX METAL CO., Philadelphia, Pa.

DUPONT POWDER CO., Wilmington, Del.

HAZARD MFG. CO., Wilkes-Barre, Pa.

WATT MINING CAR WHEEL CO., Barnesville, Ohio.

The Colliery Engineer

Formerly
Mines and Minerals

Vol. XXXIII—No. 9

APRIL, 1913

Scranton, Pa.

PUBLISHED MONTHLY AT SCRANTON, PA.

ESTABLISHED 1881

INTERNATIONAL TEXTBOOK CO., PUBLISHERS

T. J. FOSTER, President S. P. ALLEN, Secretary E. H. LAWALL, Treasurer
RUFUS J. FOSTER, Vice-President and Managing Editor
EUGENE B. WILSON, Editor HUGH ARCHBALD, E. M., Asst. Editor
CHICAGO OFFICE: 1006 S. Michigan Ave.

Entered at the Post Office at Scranton, Pa., as second-class matter

Address all business communications to THE COLLIERY ENGINEER, Scranton, Pa.

Subscription Rates: \$2.00 per year to United States and all possessions, and Mexico; \$2.50 to Canada; \$3.00 to all other countries. Single copies 25 cents each.

Notice to discontinue or change of address should be sent to the Scranton office.

When notifying us of a change of address always give your FORMER as well as your present address.

TABLE OF CONTENTS

Editorial—	
Editorial Notes—The Mine Gas Chart Supplement—The Report of the Anthracite Mine Cave Commission—The Mining Building at Pennsylvania State College—Welfare Work at Coal Mines.....	467
Personals	470
Obituary—	
William A. Cather	470
Machine Mining in Anthracite Mines, by Hugh Archbald.....	471
American Mine Safety Association.....	476
Barometric Pressure and Mine Gases.....	477
Forecasting Barometric Changes	479
Trinidad Chapter, Rocky Mt. Coal Mining Institute.....	480
Welfare Work at Coal Mines—	
A Bath House Proposition—Saved by the Mine Telephone—Lunch House at a Colliery—Emergency Car, C. F. & I. Co.—First Aid in Kentucky—American Museum of Safety.....	481
Relative Vocational Hazards, by Hywel Davis.....	485
Practical Talks on Coal Mining—	
Mechanics of Mining—Electricity in Mines—Gases Met With in Coal Mines	487
Book Review	495
The Railroads Invisible	496
Unwatering Two Notable Excavations.....	497
The American Institute of Mining Engineers.....	499
Examination Questions—	
Fire Bosses and Mine Foremen, West Virginia, 1912.....	500
Steam Line Suspension	503
Mine Cave Commission Report.....	504
The Letter Box—	
Method of Mining—Acetylene Lamps—Centrifugal Pumps—Hay—Humidity of Mine Air—Waste in Mining.....	507
Eldorado Mine Explosion.....	509
The Successful Mine Foreman From Four View Points, by H. La Viers	510
Forestry as Related to Mining, by Frank D. Rash.....	511
Coal Statistics	512
Stopping Ventilation at Firing Time.....	514
Prize Contest	517
A Coal Miner in the Cabinet.....	520
Notes on Mines and Mining, by Special Correspondents.....	521
Pit-Car Cleaning Device for Self-Dumping Cage.....	525
New Mining Machinery—	
New Type Mine Locomotive—Plummet Lamp—Stine Fan Fitted With Hyatt Roller Bearings—Fusible Signal Plugs for Air Compressing Machinery—Storing and Rehandling Anthracite Under Cover	526
Trade Notices	531
Catalogs Received	532
Temperature Control for Air Compressors.....	532
Squibs—	
To Lay Out a Baseball Diamond, 476—Institution of Mining and Metallurgy, 480—Electrical Unit of Current, "Ampere," 495—American Institute of Electrical Engineers, 503—Iron and Steel Institute of Great Britain, 503—International Geological Congress, 503—Cunard Steamship Co.'s Coal Mine, 513—Practical Miners' Course, 516—Coal in Nigeria.....	530

The resumption of our old name and the devotion of all our pages to coal mining literature has been fully justified. While we felt that the change would be welcomed, we were not prepared for the enthusiasm with which it was received in the various coal fields. It is impossible to answer each congratulatory and commendatory letter personally, therefore I take this means of thanking those who so heartily expressed their approval of THE COLLIERY ENGINEER.

Sincerely,

RUFUS J. FOSTER,
Managing Editor

采 采

IT'S simply outrageous! Anthracite mine owners made profits last year! The shameless heads of the companies declined to consider that anthracite mining was for recreation only. Is there any punishment severe enough for such miscreants?

采 采

THE newspaper report that 72 men were killed in an explosion at Yale, B. C., is some exaggeration. Our special correspondent interviewed Mr. Thomas Graham, Chief Inspector of Mines, who stated that "there was but a slight explosion and only one or two men slightly burned."

采 采

THE "prominent mining engineer" who finds valuable coal deposits in the Devonian rocks is usually the fellow who has a card in a country weekly describing himself as a "civil, mining, mechanical, and electrical engineer—farm lands surveyed and platted for \$1.50 per day."

采 采

The Mine Gas Chart Supplement

THE Gloman Mine Gas Chart, issued as a supplement to this number of THE COLLIERY ENGINEER, contains in most convenient form all necessary information regarding gases met with in coal mines, and is well worth preservation by mine officials and mining students. It is not intended as a textbook for beginners, but as a reference chart. At the same time, its arrangement is such, and the information given so plain, that it is intelligible to almost any man familiar with coal mining practice who can read English. The chart was prepared

and copyrighted by Mr. Chas. K. Gloman, Chief Clerk of the Susquehanna Coal Co., Wilkes-Barre, Pa., for use in mining institutes. For such use he has had the chart printed in smaller type, and of about half the size of our supplement, so that it can be folded and conveniently carried in the pocket. It was primarily prepared for local mining institutes in the anthracite regions, in which Mr. Gloman is greatly interested, but we have no doubt that he will be glad to furnish copies of the smaller chart to other mining institutes, or to mine officials, at a very low price.

來 來

The Report of the Anthracite Mine Cave Commission

THE Anthracite Mine Cave Commission has completed its work. Its report and the proposed solution of a difficult and trying problem is in the hands of Governor Tener. It is a voluminous document of nearly 600 type-written pages, and represents many days of careful thought, study, and investigation. A summary of the report is published on other pages.

The Commission was composed of able men, all but two of whom were experienced mining men. These two, were Mr. E. J. Lynett, Editor and Proprietor of the *Scranton Times*, and Hon. J. Benj. Dimmick, an attorney, President of the Lackawanna Trust Co., and a former Mayor of Scranton, and both owners of valuable real estate in Scranton—the city most interested in a satisfactory solution of a perplexing problem. They accepted positions on the Commission believing that a different solution was possible—a solution that would satisfy all real-estate owners in Scranton, even if it did mean the practical confiscation of the coal belonging to the coal owners.

They were honest in their belief and argued strenuously in its support, but they finally saw that the terms of the deeds held by most real-estate owners, and a restriction of the city's basic industry, made their plan impracticable.

They were not familiar with the technicalities and details of coal mining, and did not, at first, realize the great importance the industry is to the city, or the great loss the city would sustain through a curtailment of mining operations. When they realized these points they were broad enough to see the truth of the statements of able men who understood coal mining in all its details, and who are familiar with the annual production, and its value to the city, and who also are familiar with the extent to which exhaustion has advanced, and the actual amount of coal left. Then they joined with the practical and successful mining men in the solution proposed.

It is but natural that there should be much adverse criticism of the report. Such criticism, however, will not honestly come from men really capable of expressing an opinion on a subject so complex and technical as the one considered by the Commission. Some, who know better, may criticise it adversely with the object of getting in the lime light or for the purpose of aiding personal

political advancement, but men who know, men who have given the matter careful consideration, will agree in pronouncing the report an exceedingly careful statement of facts as they are, and the most rational solution of the question.

Messrs. Dinuniek and Lynett attended the sessions of the Commission. They took part in the examination of witnesses, they aided in all the efforts to get at bottom facts, they discussed every feature with their fellow commissioners, and made themselves familiar with every phase of the problem. They wanted another solution. They were convinced that no other solution was possible, and joined with their colleagues in making the report.

If men like Messrs. Dimmick and Lynett, after deep study and investigation, commend the report, it is very strong evidence of its sound value, no matter how much adverse criticism may be given it by men ignorant of facts or by demagogues.

The members of the Commission have done a great work. They have obtained from the coal owners liberal concessions—more liberal than we thought probable—they are entitled to the gratitude of the citizens of the region, and their report should be commended and concurred in by every real-estate owner.

來 來

The Mining Building at Pennsylvania State College

THE School of Mines building at Pennsylvania State College is a disgrace to the state.

The State College was provided to furnish free tuition to young men of the state, who have ambition enough to take advantage of an opportunity to acquire a higher education, but who have not the means to attend more expensive institutions of learning. In a state like Pennsylvania with its great industrial establishments, technical education is of prime importance. As coal mining is the most important single industry in the state, and Pennsylvania's metallurgical establishments are of great magnitude, special attention is given at the State College to the teaching of mining and metallurgical engineering.

The mineral production of Pennsylvania, including metals, is valued at over \$500,000,000 per annum—a greater sum than the combined value of the mineral production of any three other states. Many states, with mineral productions less than one-fourth as large, have fine and well-equipped mining buildings connected with their state institutions of learning. New Mexico, whose mineral production is valued at less than one-sixth that of Pennsylvania, has a School of Mines building worth many times that of Pennsylvania.

The School of Mines building at Pennsylvania State College is a cheap wooden structure with a tar-paper roof, inadequate and unfit for the purposes of a first-class school of mines.

As the mineral industry of Pennsylvania is not only the greatest industry, but the one on which the prosperity

of other industries, including agriculture directly depends, the Legislature of the state should at once make an appropriation for a building that will be suitable for use, and a credit to the state.

Every Pennsylvanian engaged in any branch of the mineral industry should urge his representative in the House and Senate, to not only vote for the modest appropriation of \$120,000 asked by the trustees for a mining building, but for as much larger a sum, within reason, as will provide a building and equipment as good or better than that of any other state.

來 來

Welfare Work at Coal Mines

THE social uplift of the mine worker is a subject that merits the serious consideration of all mine managers, and it is receiving such consideration by some. Others, who have recognized the necessity for such work, have either endeavored to secure results too speedily, or have, by relegating the work to impractical faddists, spent considerable money to but little purpose. Others are watching the results of those who have initiated sociological work, so as to profit by the experiences of their more liberal colleagues. Some mine owners and mine managers in a very commendable desire to uplift their employes, and to inspire them to higher things and better citizenship have been too eager to bring about the desired end. As a result, their efforts and large expenditures are not appreciated by the employes.

A majority of the mine workers in many regions are men from southern and central Europe. They are not only unfamiliar with the English language, but their national modes of living and customs differ from their predecessors, who as a rule came from northern and western Europe. The latter in nearly every case understood and spoke the English language, and in their mode of living and customs were closely allied to American workmen generally. Besides, the percentage of illiteracy among them was much smaller.

The mine workers from southern and central Europe are men whose ancestors for centuries lived in the most primitive manner. Their diet was of the coarsest nature and often consisted of things that their predecessors in America would not eat. They brought, and are still bringing, to this country the ideas of life which they inherited and to which they are accustomed. If they thoroughly understood the English language, it would take considerable time to wean them over to our ideas of living. Not understanding English, they cannot be easily made to understand American ideas of cleanliness and sanitation. They prefer to live as they lived in Austria, Italy, and other countries from which they came. The average frame miner's house in America is palatial as compared with the thatched huts and dirt floors they are accustomed to. They must be educated gradually to better conditions. The experiment of putting them in houses equipped with bath tubs and toilets has invariably

resulted in non-appreciation and a misuse of those conveniences.

We are not of the class, that says "anything is good enough for the Slav or Italian." We believe in every rational effort to help them to a higher plane of living and in the Americanizing of them.

If success in sociological work is to be secured, the work must be begun right and it must be accomplished gradually. It must originate with the mine management, and some responsible man must direct the work. It must not be tinged with any religious sectarianism. The more intelligent of the mine workers, particularly those who appreciate better things, must be enlisted as aids in the work. Their methods of life, their cleanliness, their regard for sanitation should be used as examples for the others.

As a first step in the work the houses in the mining village should be put in repair, tumble-down fences should be straightened, make-shift outhouses built of old discarded lumber and tin cans should be replaced with suitable buildings and sheds. Drainage should be supplied, the village cleaned up generally, and sanitary rules should be adopted. Then some one responsible man should be appointed inspector, who will see that the houses are kept clean, that the sanitary rules are complied with, and that each family is required to attain a standard of neatness and cleanliness as high as the best in the village. Objections to such rules should be met with kindly explanations showing the men and their families the advantages of such living. If any persist in living in squalor and amid unsanitary surroundings they should be discharged and required to move out of the village, as they are a menace to their neighbors.

When a community of mine workers has become accustomed to the foregoing, such conveniences as bath tubs, toilets, electric light, etc., can be gradually given them, beginning with the most progressive first.

Suitable play-grounds for the children and a recreation hall for the elders, not too elaborate, but plain, comfortable, and equipped with simple furniture and appliances, will aid in the preliminary work.

The sociological movement is one that will grow. It will grow because economic as well as social and sanitary conditions demand it. It will grow because American patriotism demands that the hundreds of thousands of non-English speaking workmen coming to us must be Americanized and made good citizens as speedily, as possible.

To be successful, a sociological movement in a mining village must not only be started. It must be pushed by an energetic, competent man. It is not work that can be successfully carried out by some fellow that has failed in every thing else and then poses as a sociologist, or who uses a religious or philanthropic organization as a means to get an easy job with more salary than he could earn in any other position. If the local mine superintendent hasn't the time to attend to the work, and in most instances he hasn't, he should put it in charge of an able, energetic man who will be constantly on the job.

PERSONALS

George Watkin Evans, of Seattle, delivered an address, in February, before the British Columbia Section of the Canadian Mining Institute on the "Ground Hog Anthracite Field."

The Consolidation Coal Co. has made the following appointments in its operating department: F. R. Lyon is general manager of all the properties with headquarters at Fairmont, W. Va.; John G. Smyth is chief engineer; Everet Drenneen is manager of the Elkhorn division with headquarters at Jenkins, Ky.; Samuel Steinback is manager of the Pennsylvania division; R. L. Kingsland is superintendent of the power and mechanical department.

Thomas F. Grogan has been appointed deputy mine inspector for Belmont County, Ohio, with headquarters at Bluefield, W. Va.

Robert D. Hennen, civil engineer, and G. B. Hartley, civil and mining engineer, announce that they have combined their offices under the firm name of Monongahela Valley Engineering Co., with offices in the Brock, Reed & Wade Building, formerly occupied by Mr. Hartley. The firm will engage in the practice of general engineering.

Harry S. Matthews, former president of the Alabama Consolidated Coal and Iron Co., has been appointed vice-president and general manager of the International Steel Corporation, with headquarters in Seattle, Wash.

Patrick J. Freil has been appointed Mine Inspector of the Sixteenth Anthracite District, Northumberland, Pa., to fill an unexpired term. Mr. Freil lives in Mahanoy City, Schuylkill County, out of the district, but the judges of the county made the appointment because none of the citizens who were after the job were eligible on account of not having the necessary certificate issued by Mine Inspectors' Examining Board.

John P. Thomas, of Cañon City, has been advanced to division superintendent of the Colorado Fuel and Iron Co. to succeed J. S. Thompson.

George Osler, of the Monongahela River Coal and Coke Co., will be general manager in charge of the Charleroi and Panhandle mines of the Carnegie Coal Co.

William H. Grady, formerly with the Tennessee Coal, Iron and Railroad Co., at Birmingham, Ala., is now chief mine inspector of the Pocahontas Coal and Coke Co.

Charles Dorrance, Jr., former fuel engineer of the Lehigh Coal and Navigation Co., has been appointed chief engineer of the Mining Department of the company, with headquarters at Lansford, Pa.

Thomas Small, has resigned as superintendent of the United Fourth Vein Coal Co. The position is now held by Clayton Moss, of Jasonville, Ind. Mr. Small's resignation was due to ill health.

Frank Baldwin, until recently assistant to Superintendent Gibson of the mines of the United Coal Co. in the Boswell, Pa., field, has been placed in charge of the operations of the same company at Jerome.

Neil McHugh has been made general superintendent of the Hodleigh colliery of the Pittston Coal Co., at Sugar Notch, Pa. He is one of the youngest mine superintendents in the state. When given a Fireman's Certificate he was only 21 years of age.

Edgar I. McGee has been appointed assistant superintendent of the Mechanical Engineering Department of the H. C. Frick Coke Co.

James Beatty, superintendent of the Shawmut Mining Co., near Meadville, Pa., has resigned.

B. J. Lynch has assumed the general managership of the Superba Coal Co., at Evans Station, near Connellsville, Pa.

Whitney & Kemmerer are planning to make improvements at their Wise Coal and Coke and Sutherland Coal and Coke companies, in Wise County, Va.

Karl F. Schoew is a candidate for chief of the Department of Mines in West Virginia in case John Laing retires, which it is given out he wishes to do.

Dr. James H. Gardner, recently assistant geologist on the State Geological Survey of Pennsylvania, has formed a partnership with Mr. F. J. Fohs, of Lexington, Ky., the firm being known as Fohs & Gardner. They will engage in the practice of commercial geology and mining engineering with offices in the Security Trust Building, Lexington, Ky.

F. J. Fohs, geologist and mining engineer, of Lexington, Ky., is engaged in preparing a report on a large coal property in western Kentucky and upon its completion will take up work along similar lines in Oklahoma.

E. M. Chance, who for the past four years has been chemist for the Phila. & Reading Coal Co., with headquarters at Pottsville, Pa., has resigned, and will open an office and laboratory at Wilkes-Barre as consulting chemist for several coal companies.

OBITUARY

WILLIAM A. CATHER

William A. Cather, owner and manager of the Franklin Iron Works, at Point Carbon, Pa., died at his residence in Pottsville, on March 5, aged 50 years. In 1887, Mr. Cather, with a brother, succeeded his father in the ownership of the Shenandoah Iron Works, at Shenandoah, Pa., and in the same year moved the plant to Bluefield, W. Va. In 1901, Mr. Cather purchased the Franklin Iron Works from his uncle, Robert Allison, who many years ago established the business as a partnership under the firm name of Allison & Bannan, later becoming sole owner of the plant. It was at these works that the one-time celebrated Allison Cataract Mine Pumps were built.

COAL MINING & PREPARATION

Machine Mining in Anthracite Mines

ALTHOUGH mining machines of the undercutting type have been extensively used for years in bituminous coal mines, they are just being introduced in anthracite mines.

Methods of Cutting and Handling the Coal that Render it Possible to Work Thin Seams Profitably

By Hugh Archbald

difficult. The impression has prevailed that anthracite was too hard to mine with undercutting machines,

miner can only break from three to four cars with a keg of black powder. It is probable that if it were not for the difficulty of mining, and the small output per miner, the undercutting

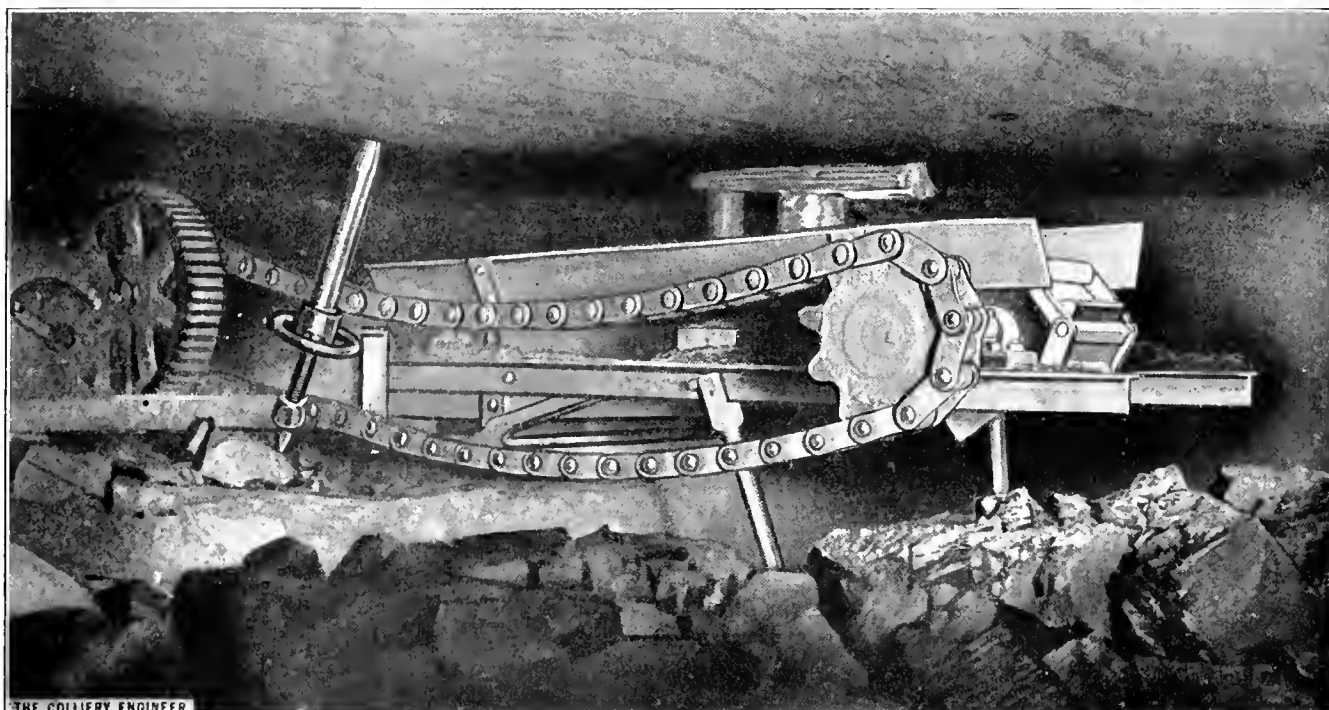

THE COLLIERY ENGINEER.

FIG. 1. CONVEYER DELIVERING INTO CAR

Until recently the seams of coal worked in the Lackawanna Valley ranged in thickness from 4 to 6 and 8 feet, but only small areas of these seams remain for first mining.

The rapid exhaustion of the thicker seams, particularly in the northern coal field, has made necessary the mining of seams which until recently could not be profitably mined under conditions existing in the anthracite trade. Now much of the anthracite is being obtained from thin seams in which the coal is tight and tough, making mining

however, it is a fact that their use is growing in those places where the mining by hand is most difficult, especially in those places where a

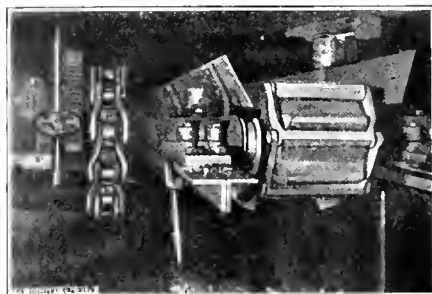

FIG. 2. SHOWING SHAPE OF CONVEYER

machines would not have been introduced in anthracite mines.

The cost of mining had become so high in the thin, tight coal beds, and the output so irregular, that a new way of doing things had to be devised; and while machine mining is not universal or even general it is obtaining a strong foothold.

At present there are 52 machines of various makes in use in the vicinity of Scranton, being divided between the manufacturers as follows: 3 Morgan-Gardner, 10 Jeffrey, 18 Sullivan, and 21 Goodman.

The Hillside Coal and Iron Co. were the first to experiment with undercutting machines, at their Butler colliery near Pittston. They used a Sullivan machine.

The coal in the Lackawanna Valley region is not so brittle as in the Lehigh and Schuylkill regions, and further it is not so tilted and folded; consequently, while conditions may be somewhat favorable in one locality for machines, it is possible that

ing of a greater percentage of the larger sizes of coal. At one colliery where an attempt was made to mine a thin coal seam without undercutting, it was found that 59 per cent. of the coal was broken by blasting into sizes smaller than those used for domestic purposes. Also the amount of coal blown into the gob when mining without undercutting has been estimated as varying from 9 per cent. to 22 per cent. No coal

When the thick seams of past times were being mined, this arrangement allowed the miner to reach home between noon and 2 P. M., however, under the present conditions he cannot do this, in the northern field at least, consequently, he feels somewhat disgruntled over the changes that have occurred, and which force him to work a full day shift in order to obtain his proper number of cars of coal.

The cost of production owing to the changed conditions in the thickness of coal beds has steadily increased, because the miners demand higher prices per car owing to their being unable to obtain as many cars of coal in a shift as when the coal was thicker and the facilities for working were more convenient.

Another reason why the cost of production has increased, is the lessened and irregular output, which naturally reflects on the fixed charges of a colliery. At one place where undercutting machines have been introduced and where one machine cuts two places daily, the cost per car of coal has been reduced from 35 to 40 per cent., and the cost in other places is about 50 per cent. less than hand mining. In addition, the quality of the coal reaching the breaker is better.

The manner of using the machines and the system of which they form a part, varies somewhat, according to the conditions at each colliery. In the majority of cases the room-and-pillar method of mining is followed, as there are overlying seams which have not been completely mined. The exceptions to this rule are found at the Dodge and Continental mines belonging to the D. L. & W. R. R. Co., where the surface seam is being worked on a panel longwall system.

At the No. 5 colliery of the Pennsylvania Coal Co. a Sullivan machine, shown in Fig. 3, is being used in the No. 1 Dunmore seam, which at this mine varies in thickness from 30 inches to 4 feet. The coal is tough, sticking to top and



FIG. 3. SHORT-WALL MACHINE IN A 4 FT. ANTHRACITE SEAM

they may not be at all favorable in another. In this connection therefore a good way to test the matter is to experiment, because undercutters are susceptible to improvements, and might be made to meet and overcome unfavorable conditions as they are presented. In one place at present they are being used on a 15-degree pitch and they can be used on pitches of 20 and 25 degrees. The manner of doing this is to place an iron rail behind the machine, after making the sumping cut, parallel with the face of the chamber, holding the rail in place by means of a jack at each end and moving the rail when the machine has cut to the end. The undercutting machine has power enough to pull itself up to the coal and make the sumping cut at the same time.

The principal advantage of using undercutting machines, besides that of lessening the cost, is the obtain-

ing of a greater percentage of the larger sizes of coal. At one colliery where an attempt was made to mine a thin coal seam without undercutting, it was found that 59 per cent. of the coal was broken by blasting into sizes smaller than those used for domestic purposes. Also the amount of coal blown into the gob when mining without undercutting has been estimated as varying from 9 per cent. to 22 per cent. No coal

is blown into the gob where undercutting is done, and it is easier to clean the coal, as the bony coal is not broken into small pieces. As less powder is required where undercutting machines are used, there is less jarring of the roof and it is not so liable to fall; also props are not knocked out by flying coal, as only sufficient explosive is required to break down the coal. These two features tend to lessen the dangers from accidents and so increase the safety of mine workers.

By the use of machines, two features are particularly advantageous to economic coal production, namely, the concentration of work, and the increased regularity of coal output as compared with hand work.

Anthracite miners have become accustomed to shooting down the coal in their working places and then going home, leaving the remainder of the work to their laborers.

bottom, and when each chamber was driven by a miner and laborer only three or four cars could be obtained to each keg of powder. After undercutting with a machine, from 30 to 60 cars are obtained to a keg of powder. At this colliery only eight places are being mined by machine. The rooms are driven 30 feet wide and have been undercut in 15 minutes when especially favorable conditions prevailed, but as it is worked, the machine is not taxed to its full capacity.

After undercutting, the coal is drilled, shot down by a miner, and loaded by laborers, each miner taking care of two chambers and having four laborers, two loading the coal in each chamber. The cars are taken in to the face and the coal loaded directly. About 2 ft. x 10 ft. of the bottom rock on the left rib is taken up at night by a miner and laborer to give height for the car. The track is not carried close up to the face of the coal, a bench of rock being left on which to manipulate the machine and also blow down the coal. From this bench the coal can be loaded readily into the cars.

At the Taylor colliery (D. L. & W. R. R. Co.) the same system is being used under slightly different conditions, in the Clark seam. This coal bed is thicker, averaging about 5 feet. A section of the seam at one point gave coal, 6 inches; bone, 2 inches; coal, 12 inches; bone, 7 inches; coal 28 inches. When the chambers are driven by a miner and laborer, without undercutting, a miner will only send out from 28 to 30 cars in two weeks, because the coal is so tight and the bottom rock so hard. Also it takes the miner several days each week to break and take up the bottom in his chamber, as it is necessary to use a jumper in many of the places, a ratchet drill not being able to penetrate the rock.

The Goodman undercutting machine used here will cut about three places in a day, five places in a day being good work. The greatest cause of delay at this mine comes from the necessity for changing the

cutters, 183 cutters being used in cutting one place where the bottom was particularly irregular and the coal mixed with pyrite, termed "sulphur" by miners. In trying a machine at the National colliery in the same seam, "the Clark," the undercutting was done in 5 inches of coal between the irregular bottom and a streak of bony sulphur, with the result that 245 cutters, or bits, were required. This is the high



FIG. 4. CONVEYER CARRYING COAL, NEAR THE FACE

record for the number of cutters used in one place, nevertheless the machine made the cut across the place, 27 feet wide.

The rooms, at Taylor mine, are driven 24 feet wide, about 18 inches of rock being taken up on the left rib side to give head room for the cars. The machine cuts from right to left. The road, which is on the left of the chamber, is kept 5 feet from the face, in order to allow a bench for the machine to travel on. As the gob is kept on the right of the room, where the sumping cut is made it must be at least back 10 feet from the face in order not to interfere with handling the machine. If the gob is piled on the left, and the road is on the right of the room, with the machine cutting toward the left, the road would be kept 10 feet back from the face to give room to handle the machine while making the sumping cut.

To break down the coal after an undercut, three holes are drilled in the face. The center hole is charged with 30 inches of FFF black powder, the side holes with 28 inches, and these when fired bring down the coal in humps, generally suitable for loading in the car, but sometimes in sizes which must be broken.

After the coal is broken it is loaded by laborers, five cars per man being considered a shift.

To advance the track, the rock is taken up at night, a miner and laborer being able to take up from 22 to 24 linear yards, 10 feet wide and 18 inches thick, in 2 weeks.

At the No. 1 colliery of the Pennsylvania Coal Co., undercutting machines are being used in a seam about 10 to 12 feet high. The undercut is made in a bench from 18 inches to 2 feet thick, which is blown down first. Above this bench there is about 3 feet of rock which is blown down and gobbled, so as not to mix the coal and the rock. After this the top benches are blown down. The chambers are driven 22 feet wide. The saving in the use of machines at this colliery is in the concentration of work and the saving of that coal which ordinarily is blown into the gob.

At the Bellevue colliery of the D. L. & W. R. R. Co., two machines are taking care of 34 rooms 24 feet

wide in the No. 1 Dummore coal seam. The undercut is made in a bottom bench of coal about 7 inches thick, above which there is about 10 inches of rock which is blown down separately. No bottom rock is taken up in the chambers, iron ties being used and the first mining taking about 5 feet of the seam. Above this there are 2 feet of rock and 20 inches of coal, which are taken down retreating, after the

rooms have been cleaned of coal and rock, and are in readiness for the machines.

The undercut is made in bony and coal at the bottom of the seam, above which there is 3 feet of clean coal. Dynamite is used to break down the coal as it acts better in this case than powder.

Formerly top rock was taken down in each chamber to give height for the cars. With undercutting, no

A description was given in the February, 1913, issue of MINES AND MINERALS, of the buggy system as used at the Storrs and Diamond

TABLE 1. BUGGY PARTS

No. of Pieces	Number	
4	1	C. I. Axle box
4	2	C. I. Axle box cover
4	3	Brass Seat for axle
4	4	W. I. $\frac{3}{4}$ " special tap bolt
4	5	C. I. Wheel 6" diameter
2	6	Steel Axle
1	7	Steel 6" channel U shaped R. H.
1	8	Steel 6" channel U shaped L. H.
1	9	Steel 6" channel
1	10	Steel 4" channel
4	11	Steel Connecting knee
4	12	Steel Connecting knee
2	13	C. I. Shaft bearing
1	14	Steel Shaft
1	15	W. I. Bracket
2	16	W. I. Strap
2	17	W. I. $\frac{3}{4}$ "x $1\frac{1}{4}$ " special bolt
2	18	W. I. Connecting chain
1	19	Steel 48"x71 $\frac{3}{4}$ " plates for bottom
1	20	Steel 16 $\frac{1}{2}$ "x73"x $\frac{3}{4}$ " plates for back
2	21	Steel 15 $\frac{1}{2}$ "x48"x $\frac{3}{4}$ " plates for sides
4	22	Steel 3"x2"x $\frac{1}{4}$ " U shape angles
2	23	Steel Handle
3	24	Steel 3"x2"x $\frac{1}{4}$ " angle 11 $\frac{1}{2}$ " long
2	25	Steel 3"x2"x $\frac{1}{4}$ " angle 4' 0" long
2	26	W. I. 1 $\frac{1}{2}$ "x $\frac{3}{4}$ " flat iron 4' 0" long
1	27	W. I. 1 $\frac{1}{2}$ "x $\frac{3}{4}$ " flat iron 6' 1" long
2	28	W. I. Hook
1	29	Steel 2 $\frac{1}{2}$ "x2 $\frac{1}{2}$ "x $\frac{1}{4}$ " angle, 10 $\frac{1}{2}$ " long
1	30	Steel 2 $\frac{1}{2}$ "x2 $\frac{1}{2}$ "x $\frac{1}{4}$ " angle, 6 $\frac{1}{2}$ " long
14	31	W. I. $\frac{3}{4}$ "x2 $\frac{1}{2}$ " bolts and nuts
2	32	W. I. $\frac{3}{4}$ "x2 $\frac{1}{2}$ " bolts and nuts
8	33	W. I. $\frac{3}{4}$ "x $1\frac{1}{2}$ " bolts and nuts
14	34	Steel $\frac{3}{4}$ "x2 $\frac{1}{2}$ " round head rivets for frame
156	35	Steel $\frac{3}{4}$ "x $1\frac{1}{2}$ " round head rivets for body
7	36	Steel $\frac{3}{4}$ "x $1\frac{1}{2}$ " round head rivets for body
1	37	Steel 2"x2"x $\frac{1}{4}$ " stop angle 6" long
2	38	W. I. Draw bars
8	39	$\frac{3}{4}$ "x2 $\frac{1}{2}$ " rivets for draw bars

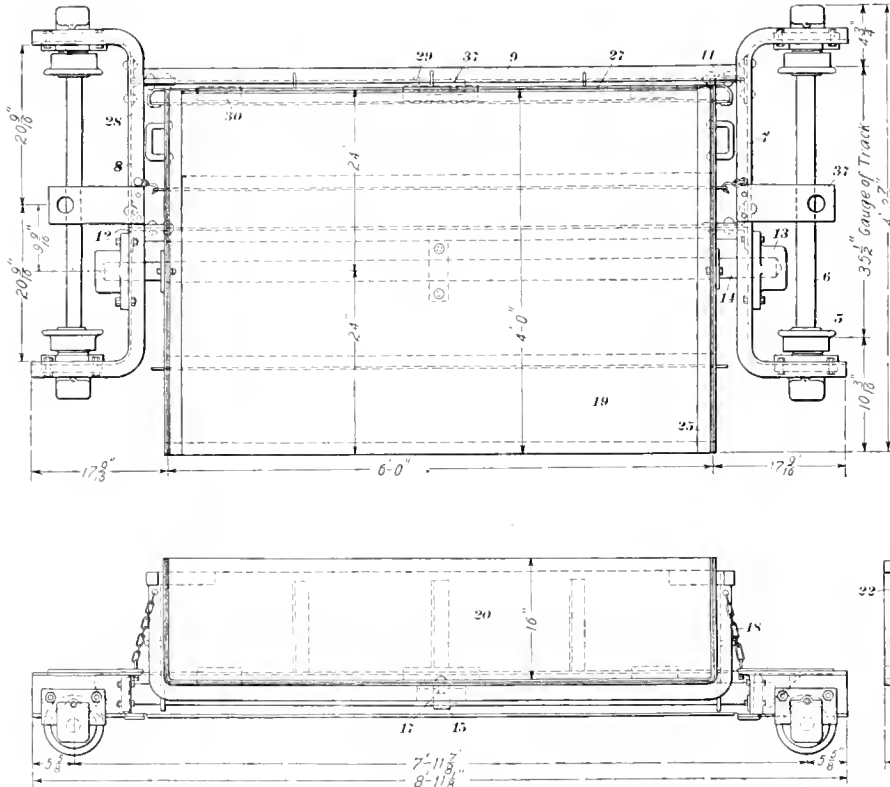

FIG. 5. BUGGY FOR LOW PLACES. FOR EXPLANATION OF NUMBERS SEE TABLE 1

chamber has been driven to its length. Seven cars of coal only are obtained to a cut on account of the mixed material in the seam. The advantage to be derived from undercutting at this mine is the obtaining of clean coal in large sizes. As the seam is so mixed with impurities, mining in the customary way was not especially profitable.

At the Brisbin colliery of the D. L. & W. R. R. Co., two Jeffrey machines care for 20 rooms 24 feet wide in the 4-foot seam. The system of rotation in vogue at this mine is for each machine to cut three rooms a day, so that by the time the last rooms have been cut the first

rock is moved, the buggy system being adopted; that is, the coal is loaded into a buggy or small car at the face and then reloaded into the mine car at the mouth of the chamber. Two loaders are employed at the face for this work and one at the mouth of the chamber. To obviate the necessity of the men pushing the buggies back and forth, a half-inch steel rope is used, by which a mule pulls the loaded buggy out of the place, one mule and driver taking care of seven places. The buggies hold about half a car of coal. Eleven cars are obtained from one undercut and about four cars are loaded per day from each chamber.

mines of the D. L. & W. R. R. Co. The buggy which has been designed by H. M. Warren, electrical engineer of the Coal Mining Department of that company, for use in these places, is shown in Fig. 5. Its frame is made of angle bars and channels, and its body of sheet iron.

The wheels are placed at each end of the frame outside the body so that the latter, which is pivoted to the frame, can be unloaded by tipping the coal directly into mine cars.

To bring the top of the mine car on a level with the floor of the coal seam on which the buggy stands, rock is taken up at the mouth of the room, and with this arrangement the

coal in the buggy is tipped into the mine car without further handling. Because of the unusual construction of the buggy and because its use can be adopted to advantage in many other coal mines, the bill of material which has been kindly furnished us is given in Table I.

At the Dodge colliery belonging to the D. L. & W. R. R. Co., a seam of anthracite 30 inches high is being successfully mined by a panel longwall system, in which undercutting machines are used and the coal is loaded into the cars by means of a conveyer. The cost of mining this coal by the usual room-and-pillar method was prohibitive, and the coal obtained was excessively broken as the shooting was done from the solid. By undercutting the coal, the maximum percentage of large sizes is obtained and the cost is reduced to the normal cost for mining in a 6-foot seam.

The coal being mined is known as the 4-foot seam, and varies at this colliery from 24 to 40 inches in height, probably averaging about 30 inches. As it is clean coal, except for 2 inches of bony coal at the bottom, it can be loaded out as it falls, very little hand picking at the face being necessary. Over this seam there is about a hundred feet of cover, the roof being sandstone. There is this disadvantage, however, that the seams underneath this one, which is the surface seam, were mined some years ago and the rocks have settled so that both the top and the bottom are very much broken. Some of the cracks in the roof are sufficiently large for a man to put his arm into them. The breaks are not parallel to the face but run across it at an angle. This broken roof requires that extra precautions be taken in timbering and in taking down loose pieces of rock. Its condition also prevents the control of the roof, which probably would be simple as it is a sandstone which would bend behind the mining.

The manner of working the seam is to turn a gangway and airway off a main road, as shown in Fig. 6.

The bottom rock of the gangway is taken up to give height for the cars, whose tops are 3 feet 9 inches above the rail. As soon as the two entries are far enough advanced so that a pillar can be left along the main road, two headings or rooms 220 feet long are driven in from the gangway. No rock is taken up in these places, a small car being used

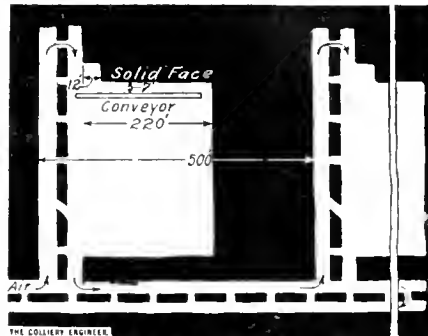

FIG. 6. METHOD OF WORKING

to remove the coal to the mine cars on the gangway.

As soon as the places are driven to the desired length, a conveyer and undercutting machine are installed. After the coal is undercut and broken down, it is loaded into the conveyer; carried to the gangway, and discharged into the mine cars placed beneath the end of the conveyer, as shown in Fig. 1.

The coal face is now driven parallel to the face of the gangway and all the coal is removed as the place advances. Starting at the inside of the room or heading which has been driven 220 feet, the undercut is made along the rib for the full length of the chamber. With a 6-foot undercut, and coal of 30 inches high, from 130 to 140 tons of coal is gotten out each day. The length of face is proportioned so that undercutting and loading can each be done in one shift, the loading being done during the day, while the undercutting is done at night.

Goodman and Sullivan shortwall machines have been used in this work, as well as a Jeffrey longwall machine. The longwall machine is used in the especially low places, as it stands only 17½ inches high, it being humorously stated that the

place got so low that the name plate was scraped off the top of a 24-inch high machine when making an undercut. However, the fact remains that the Jeffrey machine is operating in coal which is only from 27 to 28 inches high. One great advantage which the longwall machine possesses, on account of its shape, is that props can be placed within 3 feet of the face without interfering with its operation. The cutter bar of this machine when in cutting position is at right angles to the body, whereas with a shortwall machine 7 feet must be left back from the face.

It takes usually from 8 to 9 hours to move the machine into position and make the undercut. During the day the machine is left at the end of the cut. In making the cut, from two to two and a half sets of bits may be used, though at times, when hard coal is encountered, three or four sets of bits may be needed for a cut. In comparison with some of the anthracite mines where undercutters are being adopted, this is not hard undercutting. The conveyer in use extends along the face of the room and is driven as shown in Figs. 1 and 2 by a motor and chain, placed near the gangway. About 5 feet of bottom rock is taken up in the gangway so as to give sufficient height to place the mine cars beneath the conveyer, and allow a topping to be put on the car. The top of the conveyer stands 12 inches from the floor. The coal moves in a flaring trough, 6 inches deep, along the bottom of which passes a chain with flat broad links, as wide as the bottom of the trough.

This chain passes over a sprocket wheel at the discharge end of conveyer and then travels back on angle iron guides underneath the trough. The driving motor and conveyer are built together, so that they can all be moved forward each day at one time. The height of the conveyer allows the coal to be shoveled in on top, and the conveyer is made in sections so that it can be lengthened or shortened as desired; however, it

is not separated when being moved toward the face, but is drawn bodily forward by chain and pulley blocks.

The gangways and airways are driven both day and night shift, an advance of about 9 yards a week being maintained. No undercutting is done in driving them, the coal being shot from the solid as is the usual practice in anthracite mining. The face of the gangway is kept far enough in advance so that there is an open cross-cut ahead of the long-wall face, in order to furnish ventilation and an avenue of escape in case the road behind should cave. The coal on the side of the gangway on which the face is driven, is mined as the haulway advances for a width of 10 or 12 feet, thus making the total width of the coal mined along the road from 20 to 24 feet, while the width of the bottom rock which is taken up for the track is about 10 feet. The purpose of this is to have a place for the undercutting machine to end the cut and to stand during the day, without interfering with the loading of the coal. The width of 10 feet in the bottom rock is taken so as to give room to pass on each side of the car.

Twenty-four or twenty-five men are employed each day in loading out a cut and doing all that is necessary to be ready to start on the next cut. They are employed on two shifts. The night shift is composed of a machine runner and his helper, a miner and laborer, who blast the coal down after the machine, and four (sometimes five) men cutting out props and moving the conveyer forward. The day shift is made up of eleven loaders along the conveyer, two timber men, a miner to put in pop holes, a man to run the conveyer, and a boss.

The conveyer itself can be moved forward readily, possibly two men could do this in a couple of hours, but local conditions interfere, the roof being so bad that it settles down on the props, which are set on each side of the conveyer, and to remove the props and stand them again after the conveyer is moved

forward, requires time. Only props are placed on the inside, but along the gangways cogs are built, using old car lumber for the purpose. This allows the roof to come down and not hang so hard on the coal face.

Dynamite is used in blowing down the coal after undercutting, where the coal is cracked, otherwise black powder is used. Sometimes the coal is so broken that it falls as soon as it is undercut, no powder being needed. Over 200 cars of coal are obtained to a keg of powder.

The gangways for these panels are driven 500 feet apart. In this way half of the road is taken while advancing, and half while retreating. This method also provides that the shortest length of roadways shall be driven for the coal obtained. At the same time the working face is made the correct length so that a certain quantity of coal can be obtained from it each day. The length of undercut is such that it can be done in one shift, and even when the runners have been late in finishing the cut, the coal has been loaded out by hustling, so that the place was working regularly the next day. To obtain the same amount of coal by room-and-pillar mining as is obtained by this method, some 25 or more rooms would have to be maintained. Over 1,500 cars were mined by the panel system in February last. One great advantage that this method has, is that the work of taking up bottom rock and its great cost is reduced to a minimum. Moreover, a greater proportion of laborers are employed to the number of miners and skilled workmen, and the coal that is obtained makes a larger percentage of prepared sizes.

來 來

American Mine Safety Association

As the result of a conference held under the auspices of the United States Bureau of Mines last September, between men who are interested in the saving of the lives of miners,

there has been formed a society known as the American Mine Safety Association, with headquarters at 40th and Butler Streets, Pittsburg, Pa. This association, which is now enrolling among its members the leading coal and metal mine operators, mining engineers, and mine safety engineers of the country, has for its purpose the conservation of the lives and health of the miner, and a reduction in property loss due to explosions or fires in mines. It will attempt to place before the miners standard methods to be used in rescue work and in first-aid to the injured. Membership in the American Mine Safety Association is open to any individual, firm, corporation, or society interested in reducing the loss of life and property in mines.

來 來

To Lay Out a Baseball Diamond

Boys or young men employed about a coal mine can easily lay out a baseball diamond of regulation size and shape with no other instrument than a tape line, by using the following directions: First, determine where the home plate is to be, and drive a stake there. Then decide in which direction, from the home plate, second base is to be. Measure in that direction a straight line 127 feet $3\frac{3}{8}$ inches long and drive a stake there. That is the location of second base. Then with a twine exactly 90 feet long or 90 feet of the tape, hold one end on the second base stake, and with a stick held at the other end scratch arcs or parts of a circle on the ground at the approximate locations of first base and third base. Then with one end of the twine or tape held on the home plate stake, scratch arcs, as before, at the approximate locations of first and third bases. Where the arcs intersect drive stakes for the proper locations of first and third bases. Now all bases are located. To locate the pitcher's box, measure 60 feet, 6 inches, from home plate in line with second base, which gives the center of the pitcher's box.

IN THE November, 1912, issue of MINES AND MINERALS was printed an abstract from a paper by J. W. Hutchinson and Edgar C. Evans on "Analysis of Mine Air," in which were given the results of their experiments, together with curves that conclusively proved that changes in barometric pressure did have an influence on the flow of gas into a mine.

The following article is a discussion of that paper and is taken from Volume XXVIII, of the Proceedings of The South Wales Institute of Engineers:

Mr. Edgar C. Evans called attention to further work that had been undertaken by himself and Mr. Hutchinson since the publication of their last paper. In their second paper Mr. Hutchinson mentioned that under certain conditions a variation in the methane content of a mine preceded a barometric variation. It was thought that any further work on this point would be of interest; and for the purpose of their experiments they chose a time for taking samples that had been preceded by a period of 6 weeks of continued high barometric pressure. The same place was chosen for sampling as was described in their supplementary paper, and samples

Barometric Pressure and Mine Gases

A Discussion of the Paper by Hutchinson and Evans, an Abstract of Which Appeared in November, 1912, MINES AND MINERALS

were taken hourly from 3 P. M. on October 11, to 2 P. M. on October 15. The results obtained are illustrated on the accompanying chart. Two facts were clearly evident: First, considering the chart as a whole, barometric changes, however small, were in general accompanied by

those obtained in their previous experiments, and that was the great changes that were brought about in the methane percentage by only slight barometric depressions after an extended period of high pressures. Thus, in the example already given, a change of .06 inch of mercury

orological changes than the barometer.

One other important point was brought out by a comparison of these figures with

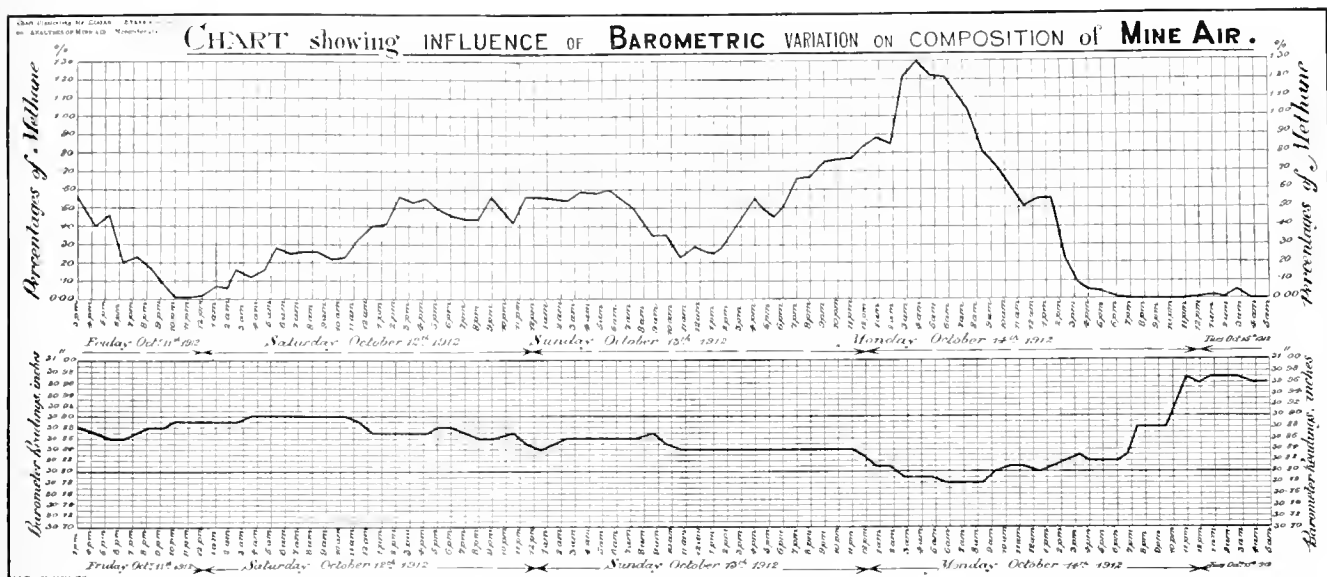

corresponding changes in the methane content. Second, variations in the methane percentage preceded barometric variations. This second fact was noticeable in several places, but was especially marked in the period from 12 A. M. on Sunday, October 13, to 12 A. M. on Monday, October 14. From 12 noon on Sunday until midnight, the barometer remained steady at 30.84 inches, yet during that period the methane percentage rose steadily from .26 to .77 per cent., preceding a barometric depression of .06 inch during the next 7 hours. During that period the methane percentage further rose to 1.3 per cent., and then commenced to fall rapidly, the fall again preceding by several hours a rapid barometric rise. It was clearly evident that the methane in old workings was more sensitive to mete-

in 7 hours caused an increase in the methane of 1.30 per cent. In absolute quantities (from a consideration of the volume of air passing) this meant that a rate of fall of only .01 inch of mercury per hour caused an ultimate evolution of 325 cubic feet of methane per minute from the old workings. The importance of these facts could scarcely be overestimated, and helped to account for the many mining disasters that had occurred after extended periods of high barometric pressure. The conclusions arrived at from a consideration of these results had been affirmed by some observers, but denied by others. The discrepancies were probably due to the different conditions under which the experiments were made. In the present case the conditions were peculiarly favorable; the authors were tapping

a very large area of old workings, and the results were not affected by any other factors, such as those due to working the coal, etc.

Mr. T. E. Richards said the writers of the two papers on gas analysis were to be congratulated upon their contributions to the memoirs of the Institute.

By their efforts the rough-and-ready observations of the past had been proved and placed upon a more secure and scientific basis, showing, in the first place, that barometric movements were indicative of greater or less exudations of gas; and, in the second place, that by careful observation it was now clearly proved that variations of the gas pressure were more sensitive than barometric movements. It might be interesting to place on record how many of our old firemen were possessed of the knowledge of the above facts without being able to give scientific reasons therefor. The speaker remembered some 25 years ago seeing in a gob wall across a main level in a Rhondda colliery (which level had been stowed from the face back for some 150 yards) a hole about 15 inches square and about 3 feet deep, where the fireman was accustomed to keep his walking stick and deposit his lunch. It was his daily habit before the morning examination to make a preliminary test of the conditions of his district by pushing his Davy lamp into this hole each morning, and he invariably found that if the hole was perfectly clear of gas to the furthest extremity he would have no difficulties with gas feeders that morning. If he found a gas cap at the back of the hole he would expect to find the strongest feeders in his district manifesting themselves to a greater degree; whereas if he discovered that gas could be found within 12 to 15 inches of the mouth of the hole he could calculate upon having considerable trouble with the arrangements of his brattice sheets that day. The ingenious indicator very much impressed the speaker at the time; and for many years after, endeavors were made to correlate the movements of gas blowers with those of the barometer,

and the observations made from time to time by a large number of officials were to the effect that with a fairly steady gas feeder the pressure variations of the atmosphere could be detected by it a considerable time before the barometer had commenced to move.

As to the effect of the ventilating fan upon the issue of gas, a number of experiments carried out by the speaker, under the superintendence of the late Mr. Wm. Thomas, Brynawel, Aberdare, conclusively proved that by watching closely the action of a number of constant feeders, that almost invariably the level of the igniting line was lowered as the fan speed was reduced; but there were one or two blowers which acted otherwise, a feature which could not be explained, but no doubt with further experiments it would have been shown, as indicated in the author's paper, that it was the result of opposing factors.

Further experiments were made at the same time as to the result of placing regulators of different dimensions between the downcast and return airways, and they bore, invariably, conclusive evidence as to the correctness of the remarks made by Mr. Wight during the last discussion.

One of the most important points emphasized by these papers was that the greatest percentage of methane was found in the return air at the end of the coal shift, and the effect of this on the question of shot firing has, he believed, not been brought forward yet. It has been a practice at some collieries to take advantage of the afternoon shift, when the fewest number of men are in, to perform any shot firing that might be needed. It was now clearly shown that it was very probable a new arrangement must be made, and that a considerable time must be allowed to elapse after the coal shift had terminated before any blasting could be permitted. The colliery manager was now between Scylla and Charybdis: he must, if necessity compelled, take the risk of carrying out the shot firing during the night shift, with its large

body of men, or take advantage of the latest hour possible of the afternoon shift, with its risk of a dangerous cap; or if both are too far in the danger zone he will have to postpone all shot firing until Sunday, and thus keep his "rippins" in order (if possible) by taking advantage of this one day in the week for this work, with its consequent heavier cost, and disturbance of the Monday's output.

Mr. J. W. Hutchinson's remarks had reference to observations that were made at the previous meeting. He stated at the last meeting held in Cardiff that Mr. Evans and himself intended to submit a supplementary paper showing the effect which the variation in the speed of the fan had on the amount of methane on the return airways. The slowing and stopping of the fan certainly increased the barometric pressure through the mine. The effect this had on the amount of methane exuding from cavities and fissures was clearly shown in the charts and tables attached to the paper. The quantity of methane was, for a time at any rate, checked by the increased pressure, and when the fan was again started the methane at once exuded in large quantities.

He agreed with Mr. Hugh Bramwell that the natural changes in atmospheric pressure had no applicable effect upon the issue of gas from the coal itself, but he thought the experiments clearly proved that slight changes in the barometric pressure did affect the amount of methane issuing from cavities and old workings. With regard to the question of methane issuing from the strata before any changes could be observed on the barometer, mining engineers generally had for many years accepted this as an established fact. At a colliery in Durham a blower of gas was piped to the pit bottom and allowed to burn. The burner end of the pipe was fitted into a large glass case, and sometimes before any change could be observed on the barometer a change could be seen on the flame, a fall in the barometer being indicated by an increase in the length of the flame, and a rise by a decrease—some-

times 2 hours before any change took place on the barometer. He was inclined to agree with Doctor Atkinson that what was called the personal equation was not sufficiently appreciated. He had certainly proved by

actual experiments that practical firemen of many years experience would differ as to the exact height of a gas cap, although their eyesight was shown by doctor's examination to be equally good.

Forecasting Barometric Changes

An Explanation of the Methods of Working. Use of the Information Given on the Daily Maps of the United States Weather Bureau

Written for Mines and Minerals

A WEATHER map of the United States is issued daily by the Weather Bureau in the Department of Agriculture. It has been proposed by

is accustomed to reading the maps and understands the lines and figures which are printed on them, a special warning is not necessary, as that

is marked the word "high." This indicates a center where a high barometric pressure exists. The curved line which passes through Florida is called an isobar, and indicates a line along which the barometric pressures are equal. At each end of this line are placed the figures 30.1, which indicate that the barometric pressure is 30.1 inches of mercury along this line. These lines of equal barometric pressure, or isobars, are drawn solid; whereas lines of equal temperature, or isotherms, are drawn dotted. There are only two lines of equal temperature on this map, both of them indicating zero temperature. Isotherms are only drawn for three temperatures, 0, 90, and 100 degrees.

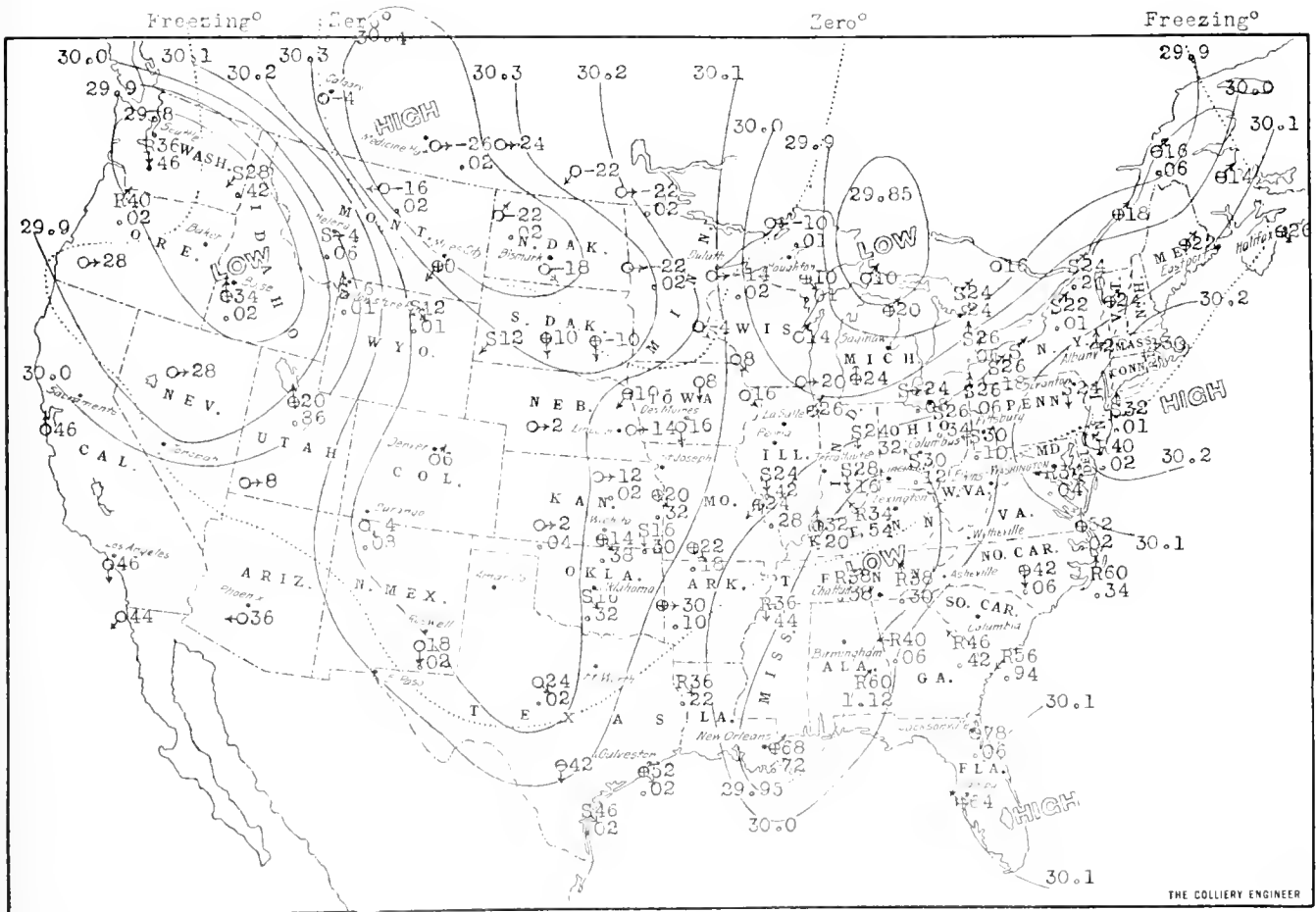

FIG. 1. UNITED STATES WEATHER MAP

the Bureau of Mines that a warning be issued in the mining regions, similar to that which is now issued to shippers and which accompanies the weather forecast. For any one who

person can tell what atmospheric conditions are approaching his mine.

In the reproduction of one of the maps, Fig. 1, it will be seen that on the east coast of the state of Florida

Marked on the state of Tennessee is the word "Low," indicating a center of low barometric pressure, which is less than 29.95 inches of mercury. For the low is marked

inside of an equal barometric line—an isobar—indicating a barometric pressure of 29.95 as marked on the map in the break on the line off the coast of Louisiana. Another low is marked on the map just above the Great Lakes, where the pressure is less than 29.85 as shown by the figures just above the word Low, placed in a break in an isobar.

All the barometric pressures are reduced to sea level. The barometric pressure of places such as Denver and Pittsburg have air pressures as recorded, which are less than at a point at sea level, as barometric pressure decreases with altitude above sea level. But when an addition is made to the recorded barometric pressure, which is equal to the decrease due to altitude, it may so happen that Pittsburg and Denver have equal air pressures.

The map has also certain symbols and numerals, which indicate various things; a circle indicates clear weather at that point; a circle with a horizontal bar through the center means partly cloudy weather; a circle with a cross in it shows cloudy weather; the letter R means rain; S snow; M report missing. Arrows attached to the circles or letters, show which way the wind blows, pointing with the wind, not in the direction from which it blows.

The figures which are printed associated with the circles indicate first the temperature; below that the rain precipitated during the past 24 hours; and then sometimes below that the maximum wind velocity.

For instance at Tampa, Fla., is found a circle with a cross in it, an arrow pointing northwest, and 64; it means that the weather was cloudy at Tampa with a southeast wind and a temperature of 64 degrees. At Jacksonville, Fla., the wind blew from the south and it was partly cloudy with .06 inches of rain during the day, at a temperature of 78 degrees. The maximum wind velocity is not given at either place on the map but in the printed record which accompanies the map can be found a record of the velocity of the wind at S. A. M.

In one corner of the map is the following legend: "When the wind sets in from points between south and southeast and the barometer falls steadily, a storm is approaching from the west or northwest and its center will pass near or north of the observer within 12 to 24 hours, with wind shifting to northwest by way of southwest and west. When the wind sets in from points between east and northeast and the barometer falls steadily, a storm is approaching from the south or southwest and its center will pass near or to the south or east of the observer within 12 to 24 hours, with wind shifting to northwest by way of north. The rapidity of the storm's approach and its intensity will be indicated by the rate and amount of the fall in the barometer."

Centers of low barometric pressure are storm centers. It has been found that storms move across the United States in certain general directions, and therefore forecasts can be made.

The things which the miner must watch are not the storms with high winds, which are so much feared at sea, but the atmospheric conditions of cold dry air or of a low barometer. When there is in a mine a large area of old workings, which might contain a body of gas, then the variations in the barometer must be watched. For gas explosions often occur at times of low barometric pressure. Dust explosions, however, may occur when the barometric pressure is high, but when the air does not carry much moisture, or has not for some time. This will happen when the temperature is low and the weather clear.

As an advantage to the miner, the Weather Bureau might publish the hygrometric condition of the air, that is the amount of moisture which it contains, so that dangers from dry dust might be more thoroughly avoided. For when the daylight temperature falls below the temperature of the mine, it is probable that, unless the outside air is very moist, water will be absorbed from the mine. And this absorption will vary slightly according to the barometric pressure, being greater with a high barometer, especially with a blowing fan.

Trinidad Chapter, Rocky Mountain Coal Mining Institute

The first quarterly meeting of the Trinidad Chapter of the Rocky Mountain Coal Mining Institute, was held at the Columbian Hotel, in Trinidad, Colo., in February. About one hundred members of the chapter were present. Mr. M. O. Danford was the chairman of the evening and in opening the meeting explained the purposes for which the institute had been organized and the formation of local chapters.

The first paper of the evening was read by Robert McAllister, mine inspector for the Colorado Fuel and Iron Co., the subject being "The Duties of a Fire Boss." Mr. McAllister showed how much dependence is placed upon the faithfulness of the fire boss in the operation of a mine. Mr. Dave Griffiths added some remarks to those of Mr. McAllister.

Mr. E. H. Weitzel, general manager of the C. F. and I. Co., who is president of the Rocky Mountain Institute, spoke upon the relation between employe and employer, especially in the avoidance of accidents, and of the need of the steadiest men as those to be employed in the mines, reviewing at the same time the statistics of accidents in Colorado mines, showing that in Las Animas County 220,339 tons of coal had been mined for each fatal accident. Dr. T. J. Forhan delivered an address upon first-aid and welfare work around the mines.

來 來

Institution of Mining and Metallurgical Engineers

The Institution of Mining and Metallurgical Engineers has been established in London, England. Its object is to advance mining and metallurgical science, more particularly for promoting the acquisition of that species of knowledge which constitutes the profession of a Mining Engineer. At present the headquarters will be at offices of *The Mining Journal*, 99 Shoe Lane, Fleet Street, London, E. C., England.

WELFARE WORK AT COAL MINES

A Bath House Proposition

By J. E. Butler*

The bath house for the use of coal miners is not an innovation. In the older mining communities it is as much a part of the equipment of the modern mine as the tippie, the machine shop, and the power plant, but in Kentucky, and especially in the mountain district, it is uncommon.

The Stearns Coal and Lumber Co., when it attempted to improve the condition of its miners, by erecting for them a wash house, did so with misgivings. It is rather a delicate subject to approach, to suggest that any man would feel better if he had a bath once a day, and some men are sensitive, especially when it is the "company" which does the suggesting.

The first experiment, for it was so considered, was at mine No. 4, which employs about 200 men. A simple wooden building, with 60 lockers, four showers, and about a dozen basins, over which were hot and cold water faucets, was constructed. It was heated by a stove and electric lighted. The water was piped from a reservoir and heated by an old portable boiler.

The problem of supporting the bath house was a serious one, for an attendant, night and day, was required. It was solved by charging all who used a locker 50 cents per month, and all other employes at the mine 25 cents per month "whether they needed a bath or not." There was considerable opposition to this at first, but the miners soon realized the advantages and were willing to pay for them. As it stands the company furnishes the building, equipment, water and light free, and the miners pay the other running expenses. This means of maintenance seems based on sound business principles. Luxuries that

cost nothing are not usually appreciated.

In a short time the miners at No. 10, a larger mine of the company, sent a petition signed by no less than 90 per cent. of their number, asking for a bath house on similar terms.

Saved by the Mine Telephone

The public at large has for some time past appreciated what great reason they have to be grateful for the invention of the telephone; but

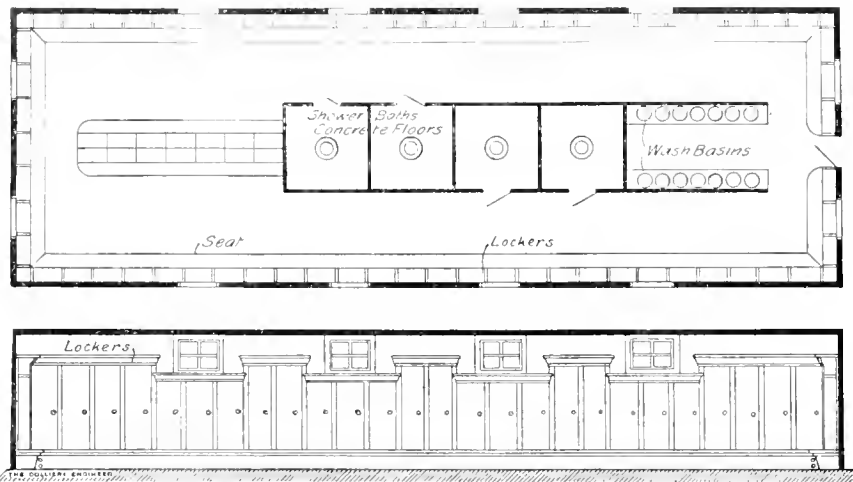

FIG. 1. PLAN AND ELEVATION OF BATH HOUSE

The plan shown in Fig. 1 will give an idea of the one which was constructed in answer to their request. It is larger than that at mine No. 4, and contains 100 lockers, four showers with concrete floors, and a good supply of basins. No lockers are placed over others and they are of such height as will receive a full suit of clothing without folding. Holes are bored in the doors for ventilation. The building is electric lighted and steam heated. A motor-driven pump and a 10,000-gallon tank take care of the water during dry weather, at other times water will be piped from hillside springs.

Possibly the principal beneficiary of the miner's bath house is the housewife, but the miner derives much comfort from it, since it permits him to leave his working clothes at the mine, where they belong, and to appear on the trains, in the office, commissaries, and at home in apparel befitting the well-to-do workman.

there are today two miners in Kansas who are more than grateful. They owe their lives to it.

These two miners are shot firers, employed by the Girard Coal Co., in a mine at Radley, Kans. The mines of this company have recently been equipped with mine telephones. According to the rules of the coal company, the shot firers must report to the night engineer, by means of the telephone, the progress of their work as they go through the mine lighting the shots. This enables the engineer to know where the men are, so that if he does not hear from them at certain intervals, a rescue party may be sent down.

One evening after the miners had left, the shot firers went down as usual to fire the shots. The two men had entered a refuge hole and one was in the act of ringing the engineer to tell him that they had lighted the shots in that particular entry, when an explosion occurred. The force of the

*General Manager of Mines, Stearns Coal and Lumber Co., Stearns, Ky.

explosion was so strong that it blew in the back end of the refuge hole and the shot firer did not have a chance to talk, but was stunned and overcome by the afterdamp. His partner was likewise overcome. The night engineer, knowing that this was the

planned as shown in Fig. 3. It stands several hundred feet from the breaker on the south side of the knoll, so that it is somewhat protected from the winds, has the warmth of the sun, and is away from the thick dust of the breaker.

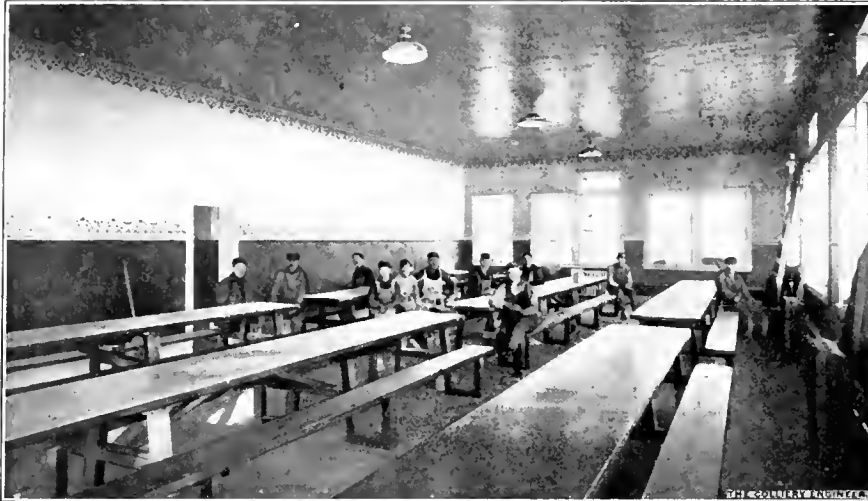

FIG. 2. LUNCH ROOM, PROSPECT COLLIERY

station from which they should next report, immediately tried to call them, and being unable to get any response, blew the distress whistle. Fifteen minutes after the explosion had occurred, a rescue party was in this refuge hole. The two shot firers were carried out and resuscitated. Had a little more time elapsed before they were reached it would undoubtedly have been impossible to revive them.

來 來

Lunch House at a Colliery

The Lehigh Valley Coal Co. have remodeled the old machine shop at their Prospect colliery, near Wilkes-Barre, Pa., into a building where the outside employes can eat their lunch and change their clothes. The Prospect colliery buildings are built on a knoll that rises above the level of the Wyoming Valley, so that they are exposed to winter winds. It was realized that it was due to the employes, especially the boys and the old men, that a place should be provided where they could eat their lunch in warmth and comfort and have a smoke at noon.

The building which was taken for the purpose, is 54 feet square and

The building inside is divided into three rooms and a hall. The lunch room, shown in Fig. 2, occupies one-half of the building, the other half being divided into the hall, a locker room, and a wash room. To form the partitions between the rooms, expanded metal has been fastened to all the joists and upon this has been placed concrete plaster. The ceiling has been plastered in the same way, so that all the rooms are completely plastered. The plaster has been painted black up to a height of the usual wainscoting and white above that, the white surface being relieved by stenciled borders. The woodwork around all the windows is also finished in white. The result is that the rooms are very cheerful. The floors are concrete, the ground being leveled and then 6 inches of concrete placed on top, and painted gray.

Of the 225 outside employes, not all care for the use of a locker, so 100 lockers of the common metal form, have been provided, that those who may desire to change their clothes before and after work, may do so. In the wash room there are six toilets, two shower baths, and 12 enameled wash basins. Hot and cold running water is provided and the building is

heated throughout by steam. Drainage is by means of a 6-inch bore hole at a little distance from the building, which goes down about 100 feet to the old workings in one of the seams.

In the lunch room there are six tables 30 inches wide, made with a bench on each side, the bench being made as a part of the table. They are made out of 2-inch oak, being finished in the natural color, oiled and varnished, so that they can be easily taken care of. City water is supplied for drinking purposes.

It is not the intention of the company to supply food, but to provide a place where the men can eat what they bring in their buckets. About 50 of the men have formed a small club to provide warm coffee, each man paying his share of the expense. To facilitate this, the company has agreed to put coffee percolators in the lunch room which the men are to use.

It is the intention of the company to grade about the building, cover the ground with loam, and over this lay sod and possibly have flower beds. A fairly good idea of the way the Lehigh Valley Coal Co. is improving the grounds about its collieries can be obtained from the August, 1911, cover of MINES AND MINERALS.

When the Buck Mountain breaker was built by the same company a year ago, a room beneath the coal pockets was provided for the men. This breaker was built with a combina-

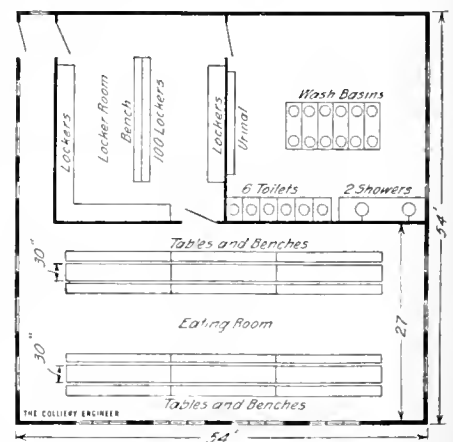

FIG. 3. PLAN OF LUNCH HOUSE, PROSPECT COLLIERY

tion of concrete and steel, the pockets being made out of concrete and the rest out of steel with corrugated iron siding. The room for the men was

built under the breaker floor. An emergency hospital was provided here also. The arrangement at Buck Mountain is not so elaborate as at the Prospect colliery, as it is not a separate building; but owing to its situation on top of the mountain, and its distance from the men's homes, it is fully as much appreciated by the men as the Prospect colliery lunch room.

來 來
Emergency Car—C. F. & I. Co.

The Colorado Fuel and Iron Co., in addition to their helmet car, have a standard box car fitted with material that is likely to be wanted in the case of a coal-mine fire or coal-mine explosion. Fig. 4 is a plan and elevation of the car showing the positions in which the supplies are kept. The equipment on this car is as follows: One 5-foot diameter Stine disk fan complete, with a sectional case bolted together and all mounted on a truck. The fan shaft extends beyond one of the bearings and has on its end one-half a flexible coupling to which a motor supplied with a similar half is attached. As it is the intention to use the fan at mines which are supplied with either alternating or direct current, three kinds of motors are carried in the car, each of which will fit the conditions of current at some one of the mines.

No. 1 is a direct-current motor, semienclosed, 20 horsepower at 550

of 20 horsepower at 480 revolutions per minute and 440 volts. No. 3 is an alternating, 60-cycle, three-phase-wound rotor, induction motor of 20 horsepower at 57.5 revolutions per

current motors; one controller for direct-current motors; one resistance for the alternating-current motors; one controller for the alternating-current motors.

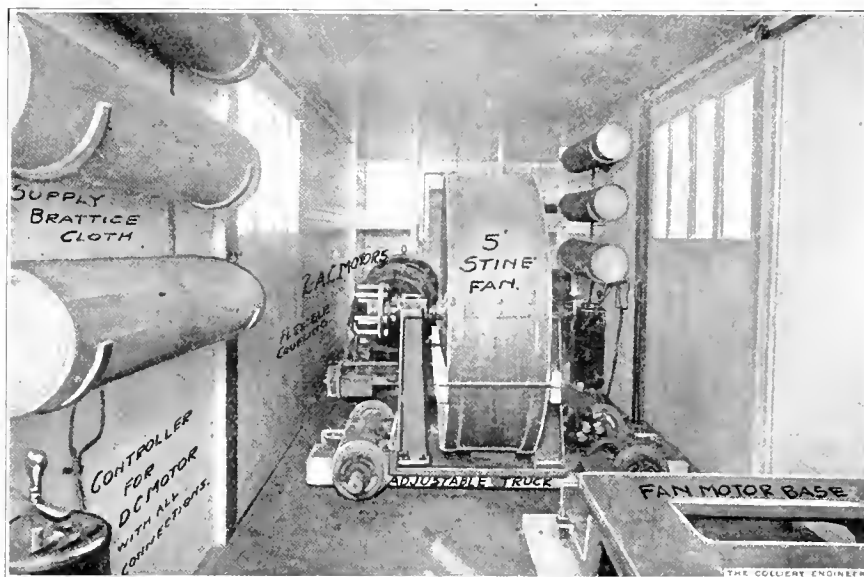

FIG. 5. PART OF INTERIOR OF EMERGENCY CAR

minute and 440 volts. As the motors are of different heights, a special bed-plate with bolt holes to match those of the motors is provided. The motors which have the half couplings are brought to center with the fan shaft by building up the bed-plate with ready-made liners. In this manner no time will be lost in getting the fan in position and to work. Each machine is mounted on a truck constructed especially for it and having a movable wheel base, as shown in

The trucks containing the machinery are pushed through the side doors of the car and over two gang planks connecting the car with the platform or unloading station. These gang planks are 3 inches thick, 18 inches wide, and 14 feet long, properly shod and ironed. In the car there are 2,000 feet of No. 4 wire duplex rubber-covered cable on a reel; two 4-ton jacks; three iron blocks for 1-inch rope; 250 feet of 1-inch rope; two 10-foot 3/8-inch cable chains with loops and hoops; four iron dollies; six rolls of 72-inch brattice cloth which are shown in Fig. 5 supported on the sides of the car; and the two gang planks already mentioned which are used for handling the heavy material.

The supplies carried on this car are supplemented by those carried on the helmet car, it being the intention to move the two cars together; they consist of a full supply of shovels, picks, axes, saws, hammers, bars, sledges, disinfectants, rubber gloves, cooking utensils, 2,000 feet of 1/2-inch fire hose, stretchers, tents, pipe wrenches, dies, pipe fittings, nails, besides the eight Draeger helmets, two Pulmotors, a good supply of potash cartridges, oxygen, safety lamps, gasoline, fire extinguishers,

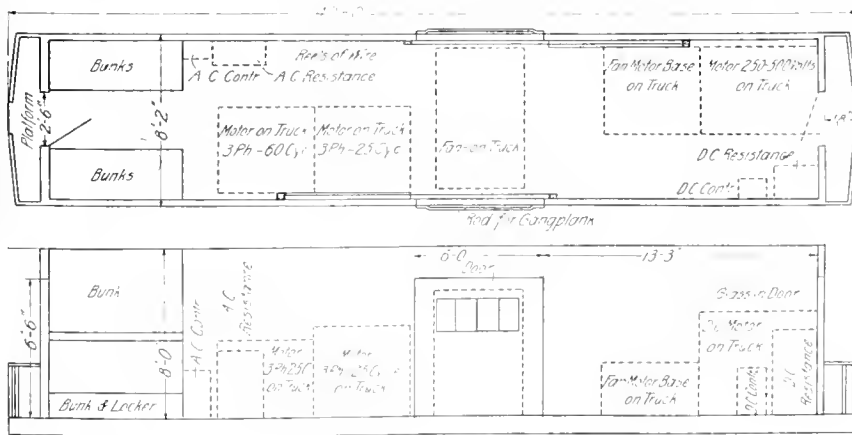

FIG. 4. PLAN AND ELEVATION OF C. F. & I. CO., EMERGENCY CAR

revolutions per minute under 250 to 500 volts. It has a controller. No. 2 is an alternating, 25-cycle, three-phase-wound rotor, induction motor

Fig. 6, so that it can be run on a 36-inch, 38-inch, or 40-inch track gauge.

The additional electric equipment consists of one resistance for direct-

complete first-aid equipment, flash lights, lanterns, a full set of blue-prints of all mines, and eight portable telephones equipped with 1 mile of twin conductor cable made up in accordance with the United States Army General Specifications No. 548,

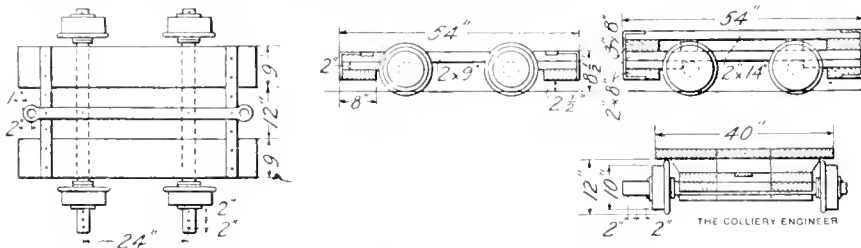

FIG. 6. TRUCK WITH MOVABLE WHEEL BASE

as follows: Each conductor made up of seven wires .010 inch, the center wire being copper, surrounded by six steel wires, each conductor insulated with $\frac{1}{64}$ -inch 30 per cent. rubber compound and braided conductor, laid parallel, and covered with weather-proof braid.

The telephones are for use in rescue work, which, with the light wire to be carried by helmet crews will facilitate advancing, in case of necessity.

來 來

First Aid in Kentucky

The following letter has been sent by the Chief Inspector of Mines to all coal operators in the state of Kentucky:

Naturally, I am solicitous that our mining companies shall adopt every means possible for reducing the death rate from mine accidents, and for affording quick and proper relief for the injured generally.

I am thoroughly satisfied that many a man has died from loss of blood, from shock ("heart failure"), from delayed attention to fractures, from asphyxiation due to electric shock, etc., who might have been saved had his associates known what to do for him while waiting for a doctor. I think it unquestionable that many an injured man has died really from the way he was handled while being taken from the mine. I have good reason to believe that men who have died from blood poisoning following injuries not otherwise fatal, suffered blood poisoning simply be-

cause of improper treatment, or lack of proper treatment, at the time of the injury and before the physician could see them. A man had a leg broken; some weeks thereafter he died from blood poisoning. It appears quite probable that the infec-

tion occurred through improper treatment before the doctor could reach the patient. Other examples will occur to you.

Men are hurt in the mines almost daily. Simply through lack of proper care, or because of ill-advised treatment before the physician arrives, a comparatively simple injury may result in permanent disability.

I deem it of utmost importance, therefore, that the men employed at mines shall know what to do and what not to do in the case of accidents; they should know the methods of "first aid." With the miners themselves trained in such methods, a long step will be taken toward the reduction of fatalities; and through intelligent application of "first aid," suffering will be relieved, fewer cripples will be made, and recovery will be hastened in the case of non-fatal accidents generally.

If you have not already done so, I respectfully but earnestly urge that you take this matter up at your mines, and arrange for instruction in "first aid" to be given your men.

The cost of the necessary outfit is very little; your mine physician can readily take care of the training. Moreover, the United States Bureau of Mines now has mine safety cars in the state especially for instructional purposes, and I am advised by Mr. Wilson that the cars will remain in the state so long as there is work for them to do. I do not doubt that the Bureau will gladly send a car to your mine or vicinity if you will ask for it. You should address H. M.

Wilson, Engineer in Charge, Bureau of Mines, Pittsburg, Pa.

The Red Cross, Washington, D. C., also offers to assist in giving "first aid" instruction at our mines.

As you doubtless know, the Kentucky Mining Institute is arranging for a state-wide "First-Aid Contest," to be held at Lexington next May. This affords an opportunity for you to arouse an interest in "first aid" on the part of your men, by organizing a team or teams at your mines to take part in said contest. I hope you will do so, for I believe if the mining companies generally will heartily cooperate in making the contest notably successful, it will exert an influence for great good throughout our mining fields. "Do it now."

I will be glad to hear from you in regard to this matter. Anything that I can do to serve you will be done with pleasure.

C. J. NORWOOD,
Chief Inspector of Mines.

來 來

American Museum of Safety

The Jury of Awards of the American Museum of Safety met in the United Engineering Societies building in January last and awarded four medals. The Scientific American Gold Medal is presented for some safety or life-saving device, invented within the past 3 years, and exhibited in the Museum's collections. The device selected for 1912 for this medal was the Pulmotor, belonging to the Draeger Oxygen Apparatus Co., of Pittsburg, Pa., a machine for setting up artificial respiration in a person asphyxiated, or whose nerve centers having been partly paralyzed by electric shock, causing respiration to stop, although there may still be some slight heart action.

The Pulmotor has been very successful in saving life and is worthy of all the praises, never mind the medals, it has been receiving; for example, in one place in one year 24 lives were saved; two people had taken overdoses of morphine; two others were revived after serious

operations; one recovery was a case of electric shock and the remainder were cases of gas poisoning.

The phenomena of respiration are combinations of mechanical action and chemical reactions. The presence of poisons in the blood current stimulates the brain cells, which automatically start up the muscles of diaphragm and thorax whereby the chest cavity is expanded and air flows in to react upon the blood exposed to such oxygenating action. If the poison is excessive, if the lung

cavity is filled with water, or if the chemical compound in the blood is stable and unbreakable, oxygenation does not take place, the nerve centers are paralyzed and death results. Artificial respiration has been accomplished by hand many times, but it is hard, tedious work that only the most determined will stand, and the Pulmotor comes therefore as a relief, and great help, for it operates automatically and will continue for 40 minutes, or until its oxygen tank is exhausted.

Relative Vocational Hazards

A Comparison of the Number of Accidents Occurring to Those Engaged in Various Trades in Different Countries

By Hywel Davis*

THE most perfectly regulated industrial organization is liable to disaster unless a perfect knowledge exists of the dependence of each unit and the absolute necessity for a harmonious whole.

The present age of good intentions is paving the way to a greater number of injured mankind than existed in prehistoric times, because with our limited knowledge and ignorance some sacrifice is prerequisite to success. The six bloodiest battles of the Civil War sink into insignificance compared with the annual industrial toll of casualties extracted by the present so-called civilized age.

In 1908 Great Britain had 3,447 killed and 323,224 injured, the German Empire 9,687 killed and 662,321 injured, while the United States had 40,000 killed and over 500,000 injured, the railroads contributing 10,396 killed and 150,159 injured.

Our statistical records of accidents, outside the railroads and mining, are far from being as complete as the German and British, and it is interesting to note the analysis of the German records showing the actual proportion of all accidents

divided between the different vocations and their respective hazards:

GERMAN PERCENTAGE OF ACCIDENT HAZARDS

Classification	Deaths	Injured	Partial Disablement	Complete Disablement
Agriculture and horticulture.....	30.5	43.50	45.00	32.50
Iron and steel industry.....	7.5	10.50	13.00	13.00
Mining.....	19.0	8.25	6.00	5.00
Building construction.....	8.5	7.50	6.00	5.50
State employ and railroads.....	8.5	4.00	4.00	18.00
Wood industry.....	2.0	3.50	3.25	1.00
Warehouses.....	2.5	2.00	2.25	2.25
Quarries.....	2.5	2.00	1.50	3.00
Textile.....	1.0	2.00	2.50	1.00
Excavations.....	2.0	1.75	1.50	4.25
Teaming.....	2.5	1.50		
All other industries.....	13.5	13.50	15.00	14.50
Total per cent.....	100.0	100.00	100.00	100.00

ANALYZED

	Industrial Per Cent.	Agricultural Per Cent.
The hazard of industry or occupation.....	43	33
Employer's fault.....	17½	18½
Worker's fault.....	29½	25
Employer's and worker's fault.....	10	23½

Note specially the surprising ratio of agricultural casualties.

German deaths caused by occupational accident have practically doubled since 1890, when they numbered only 45 per 10,000 deaths in the Empire, but in 1908 the latest record shows the number had grown to 80 per 10,000 deaths, or 8/10 of 1 per cent. of the total annual deaths.

The British relative hazard of occupation other than agricultural

is shown for the year 1908 as follows:

	Deaths Per 1,000 Employed
Home shipping trade.....	14
Decks.....	14
Mines.....	14
Quarries.....	1
Railways.....	1
Building trade.....	.9
Factories.....	3

British home and foreign shipping trade:

	Per 1,000 Employed
Deaths on sailing vessel trade.....	12.69
Deaths on steam vessel trade.....	4.45

The last attempt at a complete record by the United States Census Bureau is that of 1909, which gives the following surprising totals of deaths from accidents due to familiar causes:

Railroads.....	6,659
Autos.....	632
Gunshot and wounds.....	944
Horses and vehicles.....	2,152
Drowning.....	4,558
Street cars.....	1,723
Burns and scalds.....	3,992
Injuries at birth.....	3,598
Coal mining.....	1,779
Sunstroke and heat.....	816

Other causes not given in detail raise the total accidental deaths to

nearly 43,500, which justified a recent writer to say that "the tragedy of death through industrial accidents is enacted 100 times daily in this country, or 35,000 times a year. The danger to the laborer increases with the progress of the age. With each new invention the number of the killed and injured rises." This being largely true, let the country at large know also that in what they consider a very dangerous avocation employing 750,000 in the coal mines, the toll of accidents places them sixth in the list of relative hazards, with a death toll of 1,779 in 1909 or only 60 more than the 1,719 total killed on 10 successive 4ths of July, ending with 1911, or only 56 more than killed by street cars in the same

* An abstract from a paper read by Hywel Davis, of Louisville, Ky., at the December meeting of the Kentucky Mining Institute.

year, and 1,000 less than the number killed by horses and vehicles and automobiles in the country at large.

The purpose of this paper is not to minimize the gravity of mining accidents, nor deplore their fatal recurrence the less, but rather a plea that the Government Bureau of Statistics shall give the subject of all industrial accidents the proper consideration, so that bulletins on accidents will furnish an intelligent review or analysis of causes, that will be fair and just to all industries, instead of the present policy of exploiting the accidents of one industry or vocation without regard to the greater contribution to the toll of deaths by industries, vocations or preventable diseases not supervised by commissions or tabulated by bureaus.

Analyses of the casualties or industrial accidents with such meager statistics as we have for the United States show the following relative hazards of vocations for the ten years ending in 1906:

First.—Navigation in 1910: 1,443 wrecks; 365 vessels totally lost with loss of vessels and cargo amounting to 13½ million dollars and 403 lives lost. The ratio of lives lost among the Gloucester fishermen was 11.7 per thousand employed.

Second.—Railroad trainmen, 7.46 per 1,000 employed. Railroad switch and flagmen, 4.50 per 1,000 employed.

Third.—Iron mines of Michigan, 4.25 per 1,000 employed.

Fourth.—Anthracite mines of Pennsylvania, 3.18 per 1,000 employed.

Fifth.—Lead and zinc mines of Missouri, 3.01 per 1,000 employed.

Sixth.—Gold and silver mines of Colorado, 2.85 per 1,000 employed.

Seventh.—Copper mining and quarries, 2.80 per 1,000 employed.

Eighth.—Bituminous coal mining, 2.77 per 1,000 employed.

A further analysis of the casualties in coal mining brings out some marked differences in the record of the different mining states, and no wonder the Western metal miners

look upon coal mining as very dangerous compared with their own relative state experiences.

Although the average for the bituminous mines of the United States was only 3.08 per 1,000 employed for the last 42 years, the average for Utah for 15 years is 11.67 per 1,000 employed, while that of Washington for 17 years is 6.40; that of New Mexico for 14 years, 7.25; and of Colorado for 20 years, 5.51 per 1,000 employed.

Coming to the Southern States, the average for Tennessee for 18 years has been 4.38 per 1,000 employed; West Virginia for 25 years, 4.62; and Kentucky for 22 years, 1.71 per 1,000 employed.

But Kentucky has two distinct coal fields, which further show a very material difference in the element of safety. The Eastern field covers 10,000 square miles and forms part of the Appalachian coal field. This section of the state employs about 50 per cent. of the miners and produces 40 per cent. of the coal. It has never had a serious explosion that killed over five men at the same time, but two-thirds of the mining accidents in the state occur in this field—they are principally from falls of roof.

Western Kentucky has 6,000 square miles of the southeastern corner of the great Central States coal field, produces 60 per cent. of the coal or about 8,000,000 tons per annum, and employs nearly 12,000 men.

This district deserves the special consideration of the statistician of the Bureau of Mines, because here is a field almost as large as that of Great Britain, Germany, Belgium, and France put together, with untold possibilities of development, with its location adjacent to the Ohio and Mississippi rivers, yet with a mining record of freedom from accidents and industrial peace that shatters the much exploited records of low European mining fatalities.

The average for 13 years ending in 1905, according to Bulletin No. 90 of United States Labor Bureau,

gives Western Kentucky the enviable record of only 1.05 killed in the mines per 1,000 employed, while the average for the following was:

	<i>Per 1,000 Employed</i>
Belgium, 20 years ending 1906.....	1.21
Great Britain, 16 years ending 1906.....	1.35
Prussia, 14 years ending 1904.....	2.30
France, 10 years ending 1910.....	1.25

The latter is one-third higher than the average on account of the Courrieries explosion, which killed more than 1,000 men and is the Titanic disaster of mining.

Western Kentucky not only holds the record for fewer fatal accidents per thousand employed than any coal field in the world, but in addition produces a much larger tonnage per death. Thus in 1906 the United States produced about 180,000 tons for each life lost; Great Britain 230,000 tons; Belgium, nearly 200,000 tons; and France nearly 240,000 tons. These were the best records for the European countries in several years.

Now take Kentucky with a record of an average of 300,000 tons for over 10 years, and then separate the Western Kentucky field, and you have a record of over 800,000 tons produced per life lost, with the largest company producing the average of 1,100,000 tons per annum for the last 10 years and only 10 men killed in the 10 years.

Here is a field that is rapidly expanding, and yet for safety of operation compares most favorably with the best part of the mining world.

Just one more comparison: Falls of roof cause approximately 50 per cent. of the fatalities in the United States. Bulletin No. 333 of the Bureau of Mines gives the following comparison of deaths from this cause:

	<i>Per 1,000 Employed</i>
1906, Belgium.....	.40
1906, France.....	.47
1906, Great Britain.....	.64
1906, Germany.....	.70
1906, United States.....	1.72
Western Kentucky for 1911 (3 for 12,000 men employed).....	.25

These comparisons are given only to emphasize the danger and unconscious injury which indiscriminate collective statistics and the mania for general averages lead to.

PRACTICAL TALKS ON COAL MINING

For men who desire information on Coal Mining and related subjects presented in a simple manner

Mechanics of Mining

An Explanation of the Principles Underlying Calculations Relating to Engines, Pumps, and Other Machinery

By R. T. Strohm, M. E.
(Continued from March)

THE power of an engine or of a motor is the rate at which it does work. To find the power, it is necessary to take into account not

only the amount of work done, but also the time required to do it. If one engine can hoist a loaded cage in 40 seconds, and another engine can hoist the same loaded cage in 20 seconds, then the second engine has twice the power of the first, because it can do the same work in just half the time; or, stating it in another way, it can do twice as much work as the first engine in the same time.

The power of engines and motors is usually measured by the horsepower, which is the doing of 33,000 foot-pounds of work in 1 minute, or 550 foot-pounds in 1 second. To find the power required to move a certain weight in a certain time, therefore, multiply the resistance, in pounds, by the distance moved, in feet, and divide the product by 33,000 times the time required, in minutes.

Suppose, for example, that it is desired to know how much power is required to lift the car *a*, Fig. 2, to the position *c* in 30 seconds, or ½ minute. According to the rule just given the horsepower required is

$$\frac{6,000 \times 100}{33,000 \times \frac{1}{2}} = \frac{600,000}{16,500} = 36.4 \text{ horse-}$$

power. If the car *b* is hauled up the slope in 2 minutes, the power is

$$\frac{6,000 \times 100}{33,000 \times 2} = 9.1 \text{ horsepower. Thus,}$$

it will be seen that if the time taken to do a certain amount of work is made greater, the power required is made correspondingly less. By hoisting slowly, therefore, an engine of small power may be used for lift-

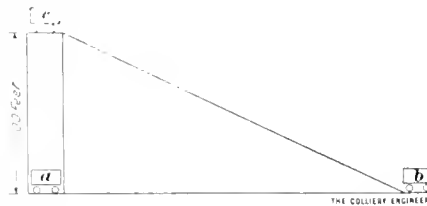

ing heavy loads; but if these same loads are to be hoisted at high speed, the engine used must be of much greater power.

The power required to pull a load along a track may be found by the same rule. For example, suppose that a trip of cars requires a pull of 660 pounds to move it, and that it is hauled along at a speed of 300 feet a minute. The resistance is 660 pounds, the distance moved is 300 feet, and the time is 1 minute; therefore, by the rule given the power is

$$\frac{660 \times 300}{33,000 \times 1} = 6 \text{ horsepower. If the}$$

speed is increased to 600 feet a minute, the power required is therefore

$$\frac{660 \times 600}{33,000 \times 1} = 12 \text{ horsepower, or twice}$$

as much as in the former case.

This shows that the power required for hauling a given load increases as the speed of hauling is increased.

The work done in and about mines

depends very largely on machines of different kinds. Now, a machine is simply a device or contrivance by means of which a force acting at one place is made to produce another force acting at some other point. A hoisting engine is an example of a machine, because the force of the steam pressure in the cylinder is transmitted through the connecting-rod and the crank to cause a drum to turn, and a rope wound on the drum lifts the loaded cage in the shaft; thus the force of the steam acting in the cylinder produces a force that finally acts on the cage, and the engine and the drum form the machine by which this is made possible.

A hoisting engine is a machine that is composed of many parts; but a machine may have only one part, in which case it is called a simple machine. To this class belongs the lever, shown in Fig. 3. A lever is a stiff bar, usually of wood or metal, that rests on a supporting block, pin, or pivot, on which it may be turned or tilted. This support is called the fulcrum. In Fig. 3 the bar *a* is the lever and the block *b* is the fulcrum. The lever is shown as being used to move the weight *c*, a force being applied by hand at *d*, near the other end of the lever. It will be noticed that this arrangement

is simply an ordinary crowbar such as is commonly used for moving or lifting heavy weights. But it is also a machine, because the force applied

as the other. And if the lever is placed as in Fig. 6, so that 5 feet extend on one side and 1 foot on the other, a force of 20 pounds at the end of the long part will balance a weight of 100 pounds at the other end, because the long part is 5 times as long as the short part.

The parts of the lever that extend on each side of the fulcrum are called the arms of the lever. The length from the fulcrum to the point where the force acts is called the force arm, and the length from the fulcrum to the point where the weight or load acts is called the weight arm or load arm. In Fig. 4, these arms are equal, each being 3 feet long; in Fig. 5 the arms are 4 feet and 2 feet; and in Fig. 6 they are 5 feet and 1 foot. Now, when the force acting on a lever balances the weight or load, it is always found that the force multiplied by the length of the force arm is equal to the weight multiplied by the length of the weight arm.

Take the case of Fig. 4, for example. The force is 20 pounds and the force arm is 3 feet, while the weight is 20 pounds and the weight arm is 3 feet; then, $20 \times 3 = 20 \times 3$, which agrees with the statement made at the end of the preceding paragraph.

In Fig. 5, the force is 20 pounds, the force arm 4 feet, the weight 40 pounds, and the weight arm 2 feet; then, $20 \times 4 = 40 \times 2$, which again proves the statement. Similarly, in Fig. 6, the force is 20 pounds, the force arm 5 feet, the weight 100 pounds, and the weight arm 1 foot; then, $20 \times 5 = 100 \times 1$.

If the lengths of the force arm and weight arm are known, and also the weight to be lifted, the force required may be found by multiplying the weight by the length of the weight arm and dividing the product by the length of the force arm. For instance, suppose that a weight of 240 pounds rests on the end of a weight arm $1\frac{1}{2}$ feet long, and suppose that it is desired to find what force must be used at the end of an 8-foot force arm to balance this

weight. According to the rule just given, the force required is equal to

$$\frac{240 \times 1\frac{1}{2}}{8} = \frac{360}{8} = 45 \text{ pounds}$$

If the force and the lengths of the force arm and weight arm are known, the weight that can be balanced by the force is equal to the force multiplied by the length of the force arm and divided by the length of the weight arm. Thus, suppose that a lever has a weight arm of $1\frac{1}{2}$ feet and a force arm of 8 feet and that a force of 45 pounds is applied at the end of the force arm. Then, the greatest weight that can be lifted at the end of the weight arm, according to the rule just given, is

$$45 \times 8 \div 1\frac{1}{2} = \frac{360}{\frac{3}{2}} = 360 \times \frac{2}{3} = 240 \text{ pounds}$$

In the levers thus far described, the fulcrum is at some point between the force and the weight, or load; but there are other kinds of levers. For example, in Fig. 7 is shown a lever *a* that has its pivot, or fulcrum, at the lower end *b*, and the force applied at the upper end *c*, the load being at *d*, between the force and the fulcrum. In this case, as before, the force arm is the distance *bc* from the fulcrum to the point where the force acts, and the weight arm is the distance *bd* from the fulcrum to the

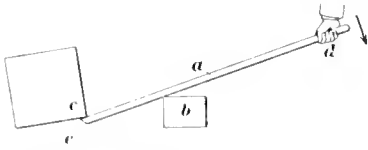

FIG. 3



FIG. 4

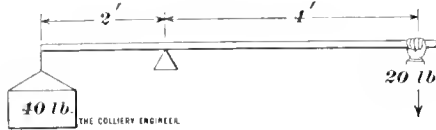

FIG. 5

at *d* causes another force to act at the point *e* and lift the weight *c*.

Now, every one knows that by moving the block *b*, or the fulcrum, closer to the lower end of the crowbar, or lever, the greater is the lifting power when the end *d* is pushed down; but if the fulcrum is moved toward the middle of the bar, it will take a much greater pressure at *d* to lift the weight *c*. It is possible to figure out just how great a weight can be lifted or how much force is required to lift a given weight with a lever of this kind. To do so, it is necessary to know the length of the lever on each side of the fulcrum.

In Fig. 4, for example, suppose that the straight lever *a* is 6 feet long and that it is placed on the fulcrum *b* so that half of the lever extends on each side. Then, if a weight of 20 pounds is placed on one end, a pull of 20 pounds on the other end will be required to hold up the weight. That is, if the fulcrum is at the middle, the force required is equal to the weight, and the two ends will balance. If the lever shown in Fig. 5 is placed on the fulcrum so that 4 feet extend on one side and 2 feet on the other, then a force of 20 pounds at the end of the long part will balance a weight of 40 pounds on the short part, because one part is twice as long

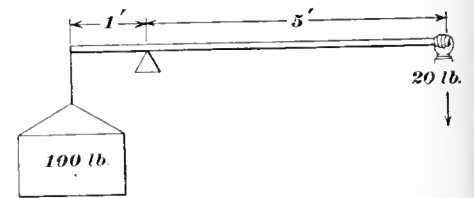

FIG. 6

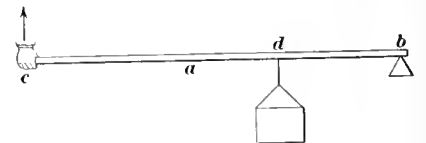

FIG. 7



FIG. 8

point where the load rests on the lever. The upward pull that can be exerted at *d* may be found by the same rule that was used for the

other levers. Thus, if bc is 6 feet long and bd is $1\frac{1}{2}$ feet, and a force of 20 pounds is applied at c , the upward pull at d is

$$\frac{6 \times 20}{1\frac{1}{2}} = \frac{120}{\frac{3}{2}} = 120 \times \frac{2}{3} = 80 \text{ pounds}$$

Another kind of lever is shown in Fig. 8, in which the force a is between the weight b and the fulcrum c . The force arm of this lever is ac and the weight arm is bc , and the weight that can be lifted at b is found by the rule already given. If ac is 2 feet and bc is 6 feet, and the force at a is 60 pounds, the greatest weight that can be lifted at b is

$$\frac{60 \times 2}{6} = \frac{120}{6} = 20 \text{ pounds}$$

Several important things should be observed in the examples that have been given. If a lever like that in Fig. 3 is used, having the force arm longer than the weight arm, the force required will be smaller than the weight moved; but the force will have to move considerably farther than the weight. If the force arm and the weight arm are equal, as in Fig. 4, the force required is equal to the weight, and each moves the same distance in the same time. If the lever is like that shown in Fig. 8, the force is shorter than the weight arm and the force required is greater than the weight; but the force will move only a very short distance in order to make the weight move through a much greater distance.

From these statements the following facts may be obtained: If it is desired to use a small force to move a heavy load, without regard to the amount of time required, the force arm should be made much longer than the weight arm. But if the load is to be moved rapidly, so as to save time, then a large force should be used, and the force arm should be made much shorter than the weight arm.

If a very great weight is to be balanced by a very small force, without using a lever with an extremely long force arm, a compound lever may be used. This is a series of simple levers in which

the force arm of one is connected with the weight arm of the next. An example of a compound lever is shown in Fig. 9, which is similar to that used in a platform scales. The weight or load a on the platform b rests on the short end c of a lever d having a fulcrum at e . The other end f is connected by a rod g to the short end h of a second lever fulcrumed at i , and the end j of the long arm of the second lever is joined by a rod k to the short arm l of a third lever fulcrumed at m . The scale bob n hung on the long arm of the third lever is the force acting to balance the weight a .

With this arrangement, the arm ec is a weight arm and ef is a force arm. But the upward force at f pushes against the end of the arm hi , which is thus a weight arm, while ij is the second force arm. Similarly, the pull at j acts through the rod k on the end of the third weight arm lm , and mn is the third force arm. Now, in a compound lever, the force times all the force arms is equal to the weight times all

the weight arms. Suppose that the lever arms have the lengths as marked on them. Then a force of 4 pounds at n , or a bob weighing 4 pounds, will balance a load of 1,200 pounds at a , because $4 \times 40 \times 36 \times 50 = 1,200 \times 10 \times 6 \times 4$.

In any compound lever, the load that can be balanced by a given

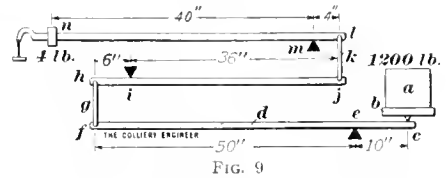

force is as many times as great as that force, as the number obtained by dividing the product of all the force arms by the product of all the weight arms. In the case illustrated, the product of all the force arms is $40 \times 36 \times 50 = 72,000$ and the product of all the weight arms is $10 \times 6 \times 4 = 240$. As $72,000 \div 240 = 300$, it follows that a force at n will balance 300 times as much at a ; that is, a 4-pound bob at n will balance $300 \times 4 = 1,200$ pounds at a .

(To be Continued)

Electricity in the Mines

Conductors and Non-Conductors—Static Electricity—Electric Currents, Direct and Alternating

By H. S. Webb, M. S.

(Continued from March)

IF a piece of sealing wax is rubbed with fur or silk, the charge on the sealing wax is negative and it is said to be at a lower, or smaller, potential than the charge on the fur; because if the two are left in contact the electricity on the fur is supposed to pass to the sealing wax and there neutralize the negative electricity that previously resided on its surface. All we really know is that both charges disappear and it is supposed that they neutralize one another. When an electrified body positively charged is connected to the earth by a conductor of electricity, electricity is said to flow from the body to the earth; and, conversely, when an electrified body negatively charged is connected to

the earth, electricity is said to flow from the earth to that body. That which determines the direction of the current is the relative electrical potential, or pressure, of the two charges in regard to the earth.

It is impossible to state with certainty in which direction electricity actually flows, or whether there is any flow of electricity at all, nor can we declare which of two points has the higher and which the lower electrical potential. All that can be said with certainty is that, when there is a difference of electrical potential, there is a manifestation of electricity, which is called an electric current and that it tends to flow from one point, which is said to be at the higher, to another point,

which is said to be at the lower potential.

For convenience, it has been agreed that the electrical condition called positive is at a higher potential than that called negative, and that electricity tends to flow from a positively to a negatively electrified body. The earth may be regarded as a reservoir of electricity of infinite quantity, and its potential is considered as zero.

The electrical condition called positive is assumed to be at a higher potential than that of the earth, while that called negative is assumed to be at a lower potential than that of the earth. Electricity will, therefore, flow from a positive body to the earth, but will flow from the earth to a negative body.

Electricity does not flow in a metal wire in the same manner that water flows in a pipe, because water is matter and its particles move, while we do not know that electricity is matter; anyway it cannot be scientifically treated as such. However, a great many things that are true about electric action are simplified by the assumption that electricity does flow in a manner like water, and the comparison of electricity to water, as far as it can be conveniently carried, is helpful in studying electric currents.

CONDUCTORS AND NON-CONDUCTORS

When a glass rod is rubbed with fur, only the rubbed part of the glass will be electrified; the other parts will produce neither repulsion nor attraction when brought near a small piece of paper. The same is true of sealing wax or resin. The charges seem to remain exactly where produced and such bodies do not readily conduct electricity; that is, they oppose or resist the passage of electricity through them. When a metal receives a charge at any point, the electricity immediately flows through its substance to all parts of the metal body. Metals, therefore, are said to be good conductors of electricity. Substances are accordingly divided into two classes: non-conductors, or insula-

tors, which are those substances that offer a very high resistance to the passage of electricity, and conductors, which are those substances that offer a comparatively low resistance to its passage. All bodies conduct electricity to some extent, while there is no known substance that does not offer some resistance to its flow. Furthermore, there is no sharp dividing line between conductors and non-conductors. Some substances are poor conductors and also poor insulators.

In the following list are given conductors in the order in which they conduct electricity, and the insulators in the order in which they resist it.

Conductors.—Silver, copper, gold, aluminum, zinc, iron, platinum, steel, lead, charcoal, ordinary (not pure) water, the human body.

Non-conductors or Insulators.—Hard rubber, paraffin, shellac, dry wood, glass, mica, asbestos, dry paper.

Silver is not used, except in some electrical instruments, because it is not a better enough conductor than copper to make up for its much greater cost. Aluminum is used as a conductor somewhat, but the difficulty of soldering or otherwise making good electrical joints between aluminum wires, and also its somewhat greater cost per pound, has seriously interfered with its use. Zinc, platinum, and lead are not good enough conductors compared with their relative cost to warrant their use commercially for wire. Platinum, on account of its freedom from corrosion, has been extensively used for small contacts on bells, telephone and telegraph instruments, but its constantly increasing cost has led to the use of hardened silver in its place. Practically the only materials used for conductors of electricity, in the form of wires and cables, are copper, iron, steel, and aluminum. While iron and steel are poorer conductors than copper, nevertheless they are extensively used for bare overhead telephone and telegraph lines, because they are

stronger and cheaper than copper, and sufficiently good conductors for the purpose. Iron and steel wires are not only poorer conductors than copper wire of the same size, but they corrode much more rapidly when subject to moisture, and then, of course, become weaker and weaker until they break or are replaced. To protect them from corrosion they are generally coated with a thin layer of zinc and are then called galvanized iron or steel. Galvanized iron and steel will last much longer than ungalvanized iron or steel, but not near so long even then as copper or aluminum. The least scratch or break through the thin zinc coating that leaves the iron bare, allows it to rust and rapidly deteriorate at that point. Hence care should be taken in handling galvanized wire not to nick, scratch, or otherwise produce a break through it so as to expose the iron.

For use in mines, where there is generally moisture, copper should be used for conductors for all purposes, except perhaps for a bell or signal circuit that is not to be used more than a few years, when galvanized iron or steel may be good enough. Compared with most metals, water and the human body are very poor conductors. The fact that horses and mules are so much oftener shocked and killed by electricity than human beings under similar circumstances is generally attributed to the steel nails which are driven into the animals hoofs to hold on the steel shoes, thereby affording a much better contact through the nails and the steel shoes with the ground than in the case of a person, whose feet are further protected by the leather soles of his shoes.

When working upon circuits through which a current of electricity is passing and from which disagreeable or dangerous shocks might be received, protection may be secured by fastening four good porcelain, or glass insulators to the under side of a stout board or box. By standing upon such an insulated platform, one is comparatively safe

when working upon any electrical circuits ordinarily used in any mine. Another good point to remember, when working upon circuits from which disagreeable shocks may be received, is to use one hand only at a time, keeping the other away from the circuit and especially from all objects that may be in contact with the ground. While the hand in use may be shocked or even burned, the electricity has less opportunity to flow through the body and less opportunity to do harm to the heart or other vital parts of the body.

To insulate conductors, such as line wires, from the ground and from other conductors, use is made of porcelain, or glass, knobs, called insulators. Sometimes hard dry wood is used where the potential is not high. Hard rubber is used as an insulator for parts of electrical instruments, and paraffin or shellac is used to make wood, paper, and other such substances better lasting conductors by painting or soaking them in it so that moisture cannot enter. Mica and asbestos are used in electrical devices that are apt to get warm or hot, because heat has little effect upon their insulating qualities and they will not burn. Paper is used where it can be sealed up so that it is protected from moisture which it would otherwise quickly absorb and become a very poor insulator. It is used to insulate wires and conducting cables that are enclosed in a moisture-proof casing of sheet lead. Sometimes the paper is saturated with moisture-proof insulating compound.

Before leaving the subject of static electricity it may be useful for the reader to know that belts used between any two rotating pulleys sometimes become so charged with electricity that they will give a disagreeable shock if touched or even closely approached. The electricity seems to be developed partly by the internal friction between the fibers of the belt when the latter bends around the pulley, and partly by the friction between the air and the belt. Most of the electricity so developed

is conducted harmlessly to ground through the pulleys and shafting. More electricity is apparent in a dry atmosphere than in a damp one, because moist air is a better conductor than dry air, and consequently in a moist atmosphere the electricity passes more readily over the damp surface of belts, pulleys, and shafts to the ground.

If a belt is charged to a high enough potential a spark or a pale bluish-colored discharge will pass from the belt to one's hand or to any piece of metal held near it. Also one's hair may stand out and a peculiar sensation as if brushing against cobwebs may be observed when standing near a charged belt. Sometimes a peculiar odor is produced due to the chemical action of the discharge upon the air, forming what is called ozone. Such ozonized air is healthful, but it also supports combustion better than ordinary air, hence more care than usual should be taken not to leave oily waste or cloths around where ozone may be produced, as spontaneous combustion may result.

If sufficiently troublesome, static electricity can be removed from belts by arranging a row of wires, nails, or tacks across but not quite touching the moving belt. Their ends should be within an inch of the belt and preferably at a point just after the belt leaves the pulley. The wires, nails, or tacks must all be connected together with an iron or copper wire and well grounded to water pipes, to the metal frames of machines not insulated from the ground, or to a metal plate buried in the earth. Such a device can be made by driving tacks through a piece of sheet metal, such as so-called tin, and grounding the piece of tin, which may be fastened to a board or plank to hold it in the desired position.

Lightning is considered to be due to the accumulation of static charges of opposite polarity on the surface of the earth and in the clouds. When the difference of potential becomes great enough, the

air can no longer stand the electric strain and breaks down, the result being a lightning discharge.

When properly put up, lightning rods are undoubtedly a source of much protection. The conductor may be copper or galvanized iron; one is just as good as the other as far as protection from lightning is concerned. Flat strip is a little preferable to wires, the object being to secure as much surface as practicable from a given amount of material. The conductors should be carried to all high points of the building, up all the corners, along all ridges and eaves and over all chimneys. All should be connected together and thoroughly grounded by burying several feet of the ends in damp earth. Broken coke or charcoal holds moisture and therefore a load of it in the hole where the ends are buried will assist in making a good ground. If the earth connection is broken, the network of wires over the building is a source of danger rather than a protection. All metal work on or in the building, such as water, steam, or gas pipes, metal cornices, etc., should be connected together and also grounded, but should not be connected to the lightning conductors.

In cities the network of telephone, telegraph, electric light, and other wires seems to be a great protection to buildings. Lightning does more damage in the country and towns not so protected.

For a fluid, as water, to do work it must have motion; the same is true of electricity. To give electricity motion, electrical pressure is required. The electrical pressure necessary to make electricity do work may be secured from chemical action, such as occurs in primary batteries, or from electromagnetic action, as in dynamos.

To produce what is called an electric current, it is necessary to cause a difference of potential between two bodies, or between two parts of the same body. For instance, if a rod of zinc and a rod of carbon are

dipped into a solution of sal ammoniac, which is a white granular material composed of the elementary substances hydrogen, nitrogen, and chlorine, the two projecting ends will be at different potentials. The rods should not touch each other, either inside or outside of the solution, which is made by dissolving about 4 ounces of the sal ammoniac in about a quart of water. This constitutes the essential features of an ordinary Voltaic cell or primary battery, such as is used for ringing electric bells.

Furthermore, it has been determined that the exposed terminal of the carbon rod is charged with the same kind of electricity that is on a glass rod after it has been rubbed with a silk handkerchief, and the exposed end of the zinc rod is charged with the same kind of electricity as that on the silk handkerchief. Hence, if the glass rod is positively charged and at a higher potential than the silk handkerchief, then the exposed end of the carbon rod will be positively charged and at a higher potential than the exposed end of the zinc rod. Conversely, the exposed end of the zinc rod is negatively charged and at a lower potential than the exposed end of the carbon rod. The potential of the charge on the glass is, however, much greater than that on the carbon rod, which is a matter of little importance for the purpose of these articles.

If the exposed ends of the carbon and zinc rods are joined by a conductor, a piece of copper wire for instance, a current of electricity is said to flow from the carbon rod through the conductor to the zinc rod, into the solution and through the solution back to the carbon rod. The path just traced is called an electric circuit. If this experiment is actually performed by the reader he may be unable to observe any current of electricity because there may be no apparent manifestation of it. However, it can be readily proved that what is called a current of electricity does actually pass

through the circuit that has been traced. For instance, if the piece of wire joining the carbon and zinc is fine enough and short enough it will get hot enough to be felt or perhaps even to make the wire glow. Thus an electric current is produced and is expended in heating the conductor. In fact all electric currents tend to heat the conductors through which they pass. If the connection between the copper wire and the carbon is suddenly broken, as by pulling the wire from contact with the carbon, a minute spark of electricity may be observed, which, also shows that electricity has been produced by the battery.

The difference of potential between the protruding ends of the rods depends upon the materials used for the rods and for the solution. The rods should be of different materials. Pieces of zinc and copper properly immersed in solutions of copper sulphate and zinc sulphate, give a smaller potential difference but a much more uniform current than is obtained from carbon and zinc immersed in a solution

of sal ammoniac. The passage of the electricity through the conductor joining the exposed ends, which are called terminals, is primarily due to the terminals, but its maintenance is due to the chemical actions that take place in the solution. If the chemical action becomes weak, the current will diminish in strength. In many cells, the chemical action will cease as soon as the circuit is broken by separating the conducting wire from either terminal. The terminals of batteries are usually provided with binding posts or screws by means of which a good firm contact may be made between the terminals and the wire. While it has been stated that electricity will flow through a wire when it is connected between the terminals of a battery, the reader should not try this experiment unless he is willing to stand the consequences of damaging the battery or rendering it useless either temporarily or permanently. Very few batteries are made that will stand uninjured such use. This will be better understood a little later.

(To be continued)

Gases Met With in Coal Mines

A Description of the Nature of Whitedamp, Chokedamp, and Afterdamp—The Properties and Laws of Gases

(Continued from March)

WHITEDAMP.—Still another "damp" is "whitedamp," a mixture of air and carbon monoxide, the other oxide of carbon mentioned under the head of blackdamp. Carbon monoxide, which in the early days was known as carbonic oxide, derives its name through its chemical symbol, CO , which shows that one molecule of the gas is composed of 1 atom each of carbon and oxygen. As *mon* means one, carbon monoxide is the same thing as carbon one-oxide, or the first oxide of carbon, the second oxide being carbon dioxide with the symbol CO_2 , as explained under blackdamp.

Carbon monoxide weighs just a

little less than air, its specific gravity being .967, so that if a cubic yard of air weighs 2.186 pounds a cubic yard of this gas will weigh 2.114 pounds. Since it has so nearly the same weight as air it mixes with it very easily, and so is found in all parts of a working place (if present at all), on the roof as well as at the floor.

Carbon monoxide is colorless, tasteless, and without any smell. It does not support combustion keeping the oxygen away from the flame just as carbon dioxide. Unlike the other oxide of carbon, it will burn and forms carbon dioxide in the process. It is not known to be given off by the coal itself as are

both the gases just described. It is a product of incomplete combustion and is formed in the mines by the explosion of powder, particularly the old-fashioned black powder, by smoldering gob fires, and above all and in large amounts as the result of what is called a dust explosion, as will be explained under the head of afterdamp.

Carbon monoxide is the most treacherous and deadly gas with which the miner has to deal and has probably caused the death of far more men than have all the others put together. While an explosion of firedamp will kill a few men near the room where it has exploded, the carbon monoxide resulting from a gas or dust explosion will often sweep through the workings killing all in its path. The 1,100 men at Courrières, France, and those at Monongah, Darr, Harwick, etc., were nearly all killed by inhaling carbon monoxide. This gas is not only suffocating, but is also poisonous, as it coagulates the blood, something the other gases do not do.

Even as little as one-fifth of 1 per cent. results in death if breathed for any great length of time, so it is clear that there is no way of determining its presence in a mine by its action on the flame of a safety lamp, as the fire boss who gets into air containing enough of this gas to show in the flame, will be killed almost instantly. The only test thus far found for this gas is its action upon small animals such as mice and particularly canaries or other small birds, which are affected by much smaller amounts of this gas than are men. For this reason the United States Bureau of Mines Rescue Corps use canaries. Other small birds will serve as well, but canaries are easily purchasable, and compensate the men for their care by singing when kept in the cars. When the birds begin to show signs of weakening or fall off the perch it is evidence of the presence of carbon monoxide, and the men then seek safety in a better atmosphere.

Carbon monoxide will explode as

does firedamp but a much larger amount must be present, a little over 15 per cent., to cause a violent explosion.

CHOKEDAMP

Chokedamp, while a name sometimes given to blackdamp, is more properly a name for that mixture of gas and air given off from a smoldering gob, or mine, fire. It consists of air with which is mixed more or less of both oxides of carbon, carbon dioxide and carbon monoxide, resulting from the burning coal. As it sometimes contains as much as 3 per cent. of carbon monoxide it is particularly deadly in its effects upon those breathing it. Chokedamp generally has a peculiar, burning smell.

AFTERDAMP

Afterdamp is the name given to that mixture of air and gas found in a mine after a mine explosion. What is in the afterdamp will depend upon the substances or gases which have caused the explosion. If, as is the case in the anthracite regions of Pennsylvania, it is a simple explosion of methane, the afterdamp will be a mixture of air and carbon dioxide and a very small quantity of carbon monoxide. But gas explosions in the anthracite regions are trivial in comparison with the gas and dust or dust explosions in bituminous coal fields and in which as many as 1,100 men have lost their lives at one time, as at Courrières, in France. In these explosions the powdered coal dust found on the roof, floor, and ribs, is gathered up by the force of a small gas explosion, of a blown-out shot, or of any large amount of blasting material, and the heat is sufficient to distill or drive out the volatile gases from the dust, which also explode, and the incomplete combustion of dust causes the formation of carbon monoxide in such proportion that its deadly effect is more potent than the effect of the carbon dioxide due to the complete combustion of some of the dust and all of the gas. This afterdamp is carried by the force of the explosion

and aided by the ventilating currents to all parts of the mine. It is the carbon monoxide given off by the imperfect burning of the dust that renders the mixture so deadly that all those reached by it, who have not been killed by the direct force of the explosion, are poisoned by the carbon monoxide.

PROPERTIES OF GASES

All gases have certain properties which must be understood by any one who wishes to study the subject of ventilation. A few definitions must be given at the outset.

Matter is the substance of which anything consists or is anything that has weight or occupies space or can be recognized by our senses. Thus, iron, gold, coal, water, and the like are forms of matter with different names and different properties, and are called matter because they have weight, occupy space, and may be recognized by the senses of touch, sight, or taste. There are three divisions of matter. A mass is a body of matter than can be recognized by the senses regardless of its size or weight; thus, a single drop of water is as much a mass as a barrelful. A molecule is the smallest subdivision of a mass of matter that can exist. A molecule is composed of the same material or materials as the mass from which it came, because many molecules combined or added together form a mass. Thus, the molecules that go to form the mass known as a barrelful of water are each one composed of water and nothing else. An atom is a subdivision of a molecule and is a distinct chemical substance which cannot be further subdivided. Atoms have distinct names, as an atom of carbon, an atom of hydrogen, an atom of oxygen, or the like, and combine to form molecules, which in turn combine to form masses. A familiar example is water. A mass of this substance may be of any size from a single drop to an ocean. This mass may be divided into a great many molecules, each of which is still water of the same identical kind as that in

the drop or the ocean. But when we come to subdivide any one of these molecules of water into atoms a change takes place and we find that the simple molecule of water is composed of two atoms of a gas known as hydrogen combined with one atom of a gas called oxygen. But here we must stop. These atoms cannot be further subdivided; no matter how we attempt it, they always remain hydrogen and oxygen just as when they were first separated out of the molecule of water, which, itself, was separated out of a mass of similar molecules of water, called, perhaps, a glassful, or an ocean.

The properties or peculiarities of matter in general are called the physical properties of matter and among them are weight, volume, density, mass, the action of forces as heat, light, electricity, etc. The study of these properties constitutes the science of physics.

The properties of matter, considering it as composed of atoms of distinct kind, are chemical properties, and the science which treats of atoms and how they combine and act toward one another is known as chemistry. In a general way, physics has to do with molecules and masses, while chemistry deals with atoms.

PHYSICAL PROPERTIES

The force that binds atoms together to form molecules is a chemical one, because, as said before, it causes a combination of atoms. As an illustration, it is the force which causes two atoms of hydrogen to unite with one atom of oxygen to form one molecule of water. This combining force between atoms of the same or different kinds to form molecules is known as chemical affinity, or more simply as affinity. The force or attraction that holds two or more molecules together to form a mass is a physical force known as molecular force or cohesion. By the application of other forces to matter, such as heat, the force of cohesion between the molecules is gradually lessened and

the molecules show less and less attraction for one another until they finally fly apart. This tendency on the part of the molecules of a mass to separate or fly apart under the action of some outside force is known as repulsion.

The mass of a body is the matter it contains, and this is proportional to its weight; thus, a body weighing 2 pounds contains twice the matter and twice the mass of another body weighing 1 pound. A pound of cork has the same mass or amount of matter as a pound of lead, although it occupies a very different space or volume.

Density has reference to the amount of matter in a given volume of any substance, or is the compactness of mass. There is more density and therefore more weight in a cubic foot of iron than in a cubic foot of water; hence we may say that iron is more dense than water.

Weight is the result of the attraction that exists between the mass of the earth upon which we live and the mass of any substance. The weight of a body is always proportional to its mass.

Specific gravity is the ratio between the weight of a given volume of any substance and the weight of an equal volume of another substance which is taken as the standard. There are two such standards in common use. Water, which weighs approximately 62.5 pounds per cubic foot, is the standard for liquids and solids, and air, which weighs .07638 pound per cubic foot is the standard for gases. When we say that iron has a specific gravity of 7.21, anthracite a specific gravity of 1.50, or slate a specific gravity of 2.80, we mean that any volume of these substances, whether it be a cubic inch, foot, or yard, weighs 7.21, 1.50, or 2.80, times more than a cubic inch, foot, or yard of water. In the same way when we say that the specific gravity of nitrogen is .971, of carbon monoxide 1.529, of methane .559 we mean that a cubic inch, foot, or yard of these

gases weighs .971, 1.529, or .559 times a cubic inch, foot, or yard of air. Whether we are dealing with solids or liquids where water is the standard, or with gases where air is the standard, these measurements must all be made at the same temperature, as measured by the thermometer, and under the same pressure of the atmosphere as measured by the barometer. Knowing the specific gravity of a substance, it is easy to calculate the weight of any volume of it through the relation
Weight of a given volume of any substance = specific gravity of substance \times weight of an equal volume of the standard

EXAMPLE.—What is the weight of a cubic foot of iron the specific gravity of which is 7.21?

By substituting in the formula, water being the standard, we have
Weight of cubic foot of iron = 7.21 \times 62.5 = 450.625 pounds.

EXAMPLE.—What is the weight of a cubic yard of carbon dioxide gas the specific gravity of which is 1.5291?

We use the same method as before, remembering that in the case of gases the standard is air which weighs .07638 pound per cubic foot. Also since there are 27 cubic feet in a cubic yard, the weight obtained must be multiplied by 27.

Weight of cubic yard of carbon dioxide = 27 \times 1.5291 \times .07638 = 3.1534 pounds.

EXAMPLE.—What is the weight of a cubic yard of anthracite in the solid, if the specific gravity of the coal is 1.50?

As the first example, the standard is water weighing 62.5 pounds per cubic foot, and as in the second example, the weight per cubic foot must be multiplied by 27 as there are that number of cubic feet in a cubic yard. From this we have
Weight of cubic yard of anthracite = 27 \times 1.50 \times 62.5 = 2531.25 pounds.

EXAMPLE.—A certain room in a mine is 300 feet long, 20 feet wide, and the coal is 5 feet thick. What is the weight of nitrogen in this

room if the specific gravity of this gas is .971, and four-fifths of the air consists of it?

The solution of this problem is made in three steps. We first find the volume, that is, the number of cubic feet of air in the room, which is done by multiplying the three dimensions together thus, $300 \times 20 \times 5 = 30,000$ cubic feet. The second step is to find the amount of nitrogen in this number of cubic feet of air. This is done by multiplying 30,000 by four-fifths, or $30,000 \times \frac{4}{5} = 24,000$. The final step is to find the weight of 24,000 cubic feet of nitrogen, the specific gravity of which is .971 and the weight per cubic foot of the standard, air, is .07638. We then have

Weight of nitrogen = $24,000 \times .971 \times .07638 = 1779.96$ pounds.

As stated before, all matter is believed to be made up of a very great number of molecules of the same kind as the mass, and further these molecules are supposed to be in constant motion, moving about in the mass of the substance, striking and clashing against one another. The motion of the molecules is called vibration and it is this motion which causes the sensation or feeling known as heat. The faster the vibration of the molecules, the greater the heat and the slower the vibrations the less the heat, or, as it is commonly said, the greater the cold. The more rapid the vibration the more the molecules fly apart and this causes the body to expand. A familiar illustration of this is the expansion of a rod of iron when heated in a blacksmith's fire.

(To be continued)

來 來

Electrical Unit of Current "Ampere"

The absolute unit of current is defined as that current which, when passing through a conductor 1 centimeter long, bent in the arc of a circle of 1 centimeter radius, produces a unit force of 1 dyne on a unit magnetic pole at the center, or in other words, produces at the cen-

ter a magnetic field of unit strength. This absolute unit of current was found to be inconveniently large and the practical unit was fixed at one-tenth its value and called the ampere.

The ampere is that unvarying electric current which, when passing through a solution of silver nitrate of particular strength, deposits silver at the rate of .001118 gram per second. The ampere therefore denotes the rate of flow or the strength of the current.

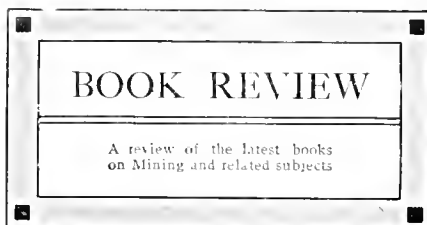

BOOK OF STANDARDS. This book, which is an excellent pocketbook for reference, contains material which makes it strictly a pipe handbook. Unless a man is in the pipe business he will be astonished at the numerous purposes for which pipe is required about mines, and it is probably news to mining men that the index of this pipe book has 4,000 subjects all bearing on practical matters which are apt to arise in the use of pipe. The National Tube Co., of Pittsburg, Pa., have assembled these data and placed them in a pocketbook 4 in. \times 6½ in. with 559 pages.

The formulas and data for flow of air, gas, steam, and water through pipes make it extremely useful to the mining man. Several pages are devoted to descriptive articles on the manufacture of butt-welded, lap-welded, and seamless drain pipes. There is a glossary of terms used in the pipe trade, which will undoubtedly be found useful as will be the factors for calculating the weight, strength, areas, and properties of tubes. The price of this book, which is to replace the 1902 edition, is \$2.

BUILDING STONES AND CLAY PRODUCTS, by Heinrich Ries, Ph. D. Published by John Wiley & Sons;

415 pages, illustrated. \$3 net. This book is intended as a handbook for architects, and follows in its general arrangement the course of lectures delivered each year to the students in the College of Architecture of Cornell University, where Professor Ries is Professor of Economic Geology. It is interesting to the mining man as it supplies information concerning the stones used for building.

JOHNSON'S FIRST AID MANUAL, by Fred B. Kümer. Published by Johnson & Johnson, New Brunswick, N. J. 144 pages, illustrated. This book is invaluable to any one who is likely to be responsible for the treatment of an injured person after an accident. It is written in a simple manner telling how to do simply those things which ought to be done before a doctor arrives, whether it be a serious or a small accident. The directions are concise and not technical and in their application call for only the usual material which is handy. The manual is well illustrated throughout so that the descriptions are easily comprehended, the illustrations being taken from photographs which were especially posed.

REPORT OF THE DEPARTMENT OF PUBLIC WORKS OF THE PROVINCE OF ALBERTA, 1911, A. L. Sifton, Minister of Public Works. Published at Edmonton. This book contains the reports of the mine inspectors for the Province of Alberta, pages 58 to 153, inclusive, being devoted to the Coal Mines Branch of the Department of Public Works.

DETERMINATIVE MINERALOGY, by J. Volney Lewis. Published by John Wiley & Sons, 151 pages. \$1.50 net. This book covers 380 minerals. In order to simplify the procedure and facilitate the use of the tables, the more difficult and elaborate chemical tests have been avoided, and blowpipe or "dry" tests have been preferred, in general, to those made in the "wet" way. The plan of the Brush-Penfield tables has been followed in the main, but

with considerable modification. The book is intended for students, which is rather hard on the student, since no method of verifying his results with the blowpipe are at hand unless he purchases Brush and Penfield's book. Several minerals will furnish the same colored bead, and frequently the minerals are mixed with impurities which destroy the color so that blowpipe tests are about as decisive as looking at the mineral and testing its physical properties. The person testing minerals is sure to make mistakes if he depends alone on the blowpipe and physical tests, particularly when a mineral is new to him.

THE RESOURCES OF TENNESSEE, which for 18 months has been issued as a monthly bulletin of the Tennessee Geological Survey, begins Vol. 3, January, 1913, as a quarterly. A. H. Purdue, State Geologist, is editor, and Wilbur A. Wilson, Assistant Geologist, assistant editor. With two short exceptions the issue is devoted to the Tennessee coal fields. Home office of the Survey, Nashville, Tenn.

HEATON'S ANNUAL, 1913. The commercial handbook of Canada and Boards of Trade Register, is published at 32 Church Street, Toronto, Canada. The price is \$1, and 13 cents postage. British edition, 5 shillings. This ninth edition of Heaton's Annual is not only a commercial handbook but an encyclopedia of Canada, her government and industries, clubs, engineering societies, etc. Every Canadian needs this book for reference, and every American and Englishman interested in the development of Canada's natural resources.

MINERAL RESOURCES OF MISSOURI. H. A. Beuhler, State Geologist, Rolla, Mo., has issued a neatly illustrated vest-pocket pamphlet which gives the mineral resources of Missouri. It shows that Missouri leads all other states in the production of zinc, lead, barytes, and tripoli. It has beds of coal, limestone, granite, fireclay, and glass sand, and it also has deposits of cobalt,

nickel, copper, pyrite, and iron ore. The output of the mineral deposits of Missouri is valued at more than \$45,000,000 annually.

AMERICAN MINE ACCOUNTING, by W. H. Charlton, P. A.; McGraw-Hill Book Co., publishers, New York, 367 pages. \$5 net. Many people find things that are needed. Few people take it upon themselves to satisfy that need. In a book on mine accounting Mr. W. H. Charlton has supplied a need. He has gathered together the details of different systems of accounting, as in use with various companies engaged in different kinds of mining, from coal and coke to gold and copper smelting, and, although the book is one of ordinary size, the things stated are put briefly and concisely, the meat of a subject in a few words. The text is accompanied by 250 figures illustrating that number of forms which are in use in these systems.

ESSENTIALS OF ELECTRICITY, by W. H. Timble, of Wentworth Institute, Boston; edited by J. M. Jameson, Pratt Institute, Brooklyn, 262 pages, 223 illustrations. John Wiley & Sons, New York, publishers. This book is one of the Wiley Technical Series intended for vocational and industrial schools, and was developed from notes which Mr. Timble has been using in short trade courses for students who wish to advance in some one branch of the electrical trade. While designed as a book of self-instruction it lacks at least one material essential, viz., the answers to problems given. This omission is not so noticeable when the student is able to attend a vocational school. The price of the book is \$1.25 net.

METAL STATISTICS, 1913, sixth annual edition, issued by American Metal Market and Daily Iron and Steel Report, 81 Fulton Street, New York. This, as its name indicates, is a statistical report of the production and price of metals for the year 1912. A very useful book for those who purchase, manufacture, and sell metals, for as P. Henry is quoted "I

know no way of judging the future but by the past."

來 來

The Railroads Invisible

In the February issue of the *Railroad Man's Magazine*, Frank J. Arkins, under the above title describes mine haulage. He has unconsciously chosen an appropriate title, for such mine railroads as he describes were never seen. The following quotation from his article will be read with amusement by mining men.

"Every mine has such a railroad. Some have several tiers of them. One has forty-eight, each one hundred feet below the other. Some have systems that are six, eight, and even ten tracks wide in places, and have terminals far in the bowels of the earth, the roofs of which, sometimes weighing millions of tons, are held up by joists.

"A train starts up the incline from the bottom of one of these mines. It enters a passage barely wide enough to admit it. It roars by a number of great, abandoned openings that resemble a series of forgotten catacombs. It hugs the side of a cliff, below which the miners have excavated a world of raw material. It passes a heated zone, on whose other side a furnace, acres in extent, awaits only a breath of air to give it headway. Now it crosses a series of timbers that shake and tremble.

"Now the train rumbles through deserted workings, from the roof of which water drips. It strikes the face of the one human being on this weird ride, the single man the train carries. The next instant the cars plunge into a corridor that roars with the sound of other trains, and a moment later it dashes into the night air made damp by a steady drizzle.

"A short distance from the mouth of the mine a locomotive waits, burning an electric headlight. A lantern swings. The cars that have traveled miles underground are coupled onto the engine. They have now become a part of the country's mighty railroad freight."

Unwatering Two Notable Excavations

Methods Employed in Sinking a Shaft on the Catskill Aqueduct and in Driving Tunnels Under the East River, New York

PERHAPS the most remarkable feature, aside from the Hudson River siphon, of the Catskill Aqueduct is the Rondout siphon, for the same aqueduct. The distance across Rondout Creek Valley is about 4½ miles and the method of carrying the water across this valley is to sink two shafts, one on each side of the valley, and connect them by a horizontal rock tunnel, the combination making what is termed an

of the strata passed through here is as follows:

	Feet
Glacial drift.....	6
Helderberg limestone.....	226
Binnewater sandstone.....	39
High Falls shale.....	92
Shawangunk grit.....	134
Total.....	497

When the shaft had reached about the 80-foot level and was in the midst of very dry limestone, a sud-

nipple was driven into the hole casing, and carried up to a point above. Down through the casing, a 1-inch pipe was let down to the Shawangunk grit below. The water was permitted to return, thus providing against currents of water. Through the 1-inch pipe, cement mortar was put down, the pipe being raised as the grout filled in. By persevering with this procedure, the bore hole was filled with cement,

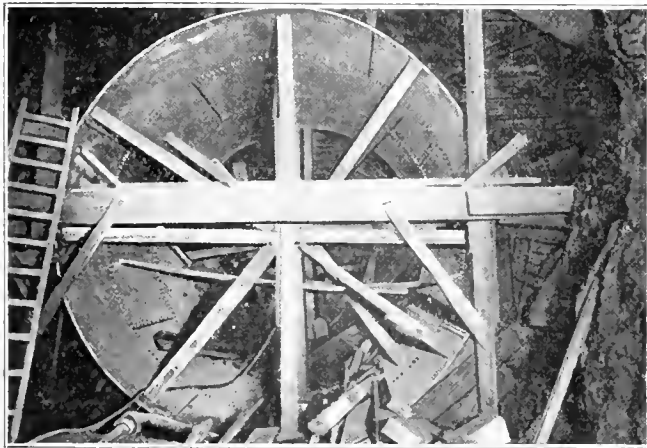

FIG. 1. INTERLINING MUD SEAM, RONDOUT TUNNEL



FIG. 2. RONDOUT TUNNEL, SHOWING CONCRETE AND STEEL LINING

“inverted siphon,” the intake shaft mouth being higher than the outlet shaft mouth. In order to facilitate tunnel driving, six intermediate shafts were excavated, five of them being for temporary use. One temporary shaft, No. 4, having an area of 18 ft. x 22 ft., required the excavation to be carried to a depth of 500 feet before the tunnel level was reached.

To reach the level of the tunnel 500 feet below the surface required 18 months. During this time the shaft was partly filled with water six times. Looking back over the experience, one may now say that some of those floodings could probably have been prevented. Indeed, it is possible that not all the precautions were taken to prevent flooding that prudence would have dictated from the start. A section

den inrush of water took place through a 4-inch bore hole which had been put down for exploratory purposes and which the shaft followed. The quantity of water entering was not greater probably than 600 gallons per minute, and could probably have been taken care of without difficulty by a very moderate pumping equipment. But the inrush caught the contractor unprepared, and continued until the shaft was half full. It is perhaps not to be wondered at that the contractor was taken off his guard, as the limestone had not yet been penetrated half way. A considerable pumping plant for emergencies had been ordered; but had not yet been installed. However, the shaft was pumped out to within a short distance of the bottom and measures taken to seal up the bore hole. A

including its immediate ramifications. This cement filling was so successful that the contractor reached, eventually, the 260-foot level without a flooding. The shaft was now in the Binnewater sandstone, and was making perhaps 225 gallons of water per minute, which inflow was being taken care of by two Cameron sinking pumps. While drilling the sump, however, an additional inflow of about 600 gallons per minute came in through one of the drill holes, with the result that the shaft was again flooded. The water did not, however, reach the same level as before but fell 30 feet short. The shaft was unwatered after a time, only to be flooded three additional times in as many weeks, with little or perhaps no advance in the excavation. Altogether, the shaft had now been

flooded five times and had only been excavated a little over half-way to the tunnel level. It was known that, just a little below the foot of the shaft, large crevices were to be expected in the rocks. In fact, one 8-inch opening was distant only $1\frac{1}{2}$ feet. Four floodings had

to be trusted. Six holes were put down about 100 feet to the Shawangunk grit. Half of these had 1-inch cores and half 2-inch cores. Using a pressure of 275 pounds per square inch, the machines were able to force into the crevices only about 175 bags of cement. It was doubt-

the mouth of the shaft. The steam connections were made with 4-inch piping wrapped first with asbestos, then with felt, and finally with tin.

No great trouble was experienced thereafter and the success of the final operations is to be attributed largely to the grouting of the strata as well as the fixed pumping plant of considerable capacity.

The foregoing gives an account of the methods employed recently in connection with an open shaft. It will be of interest to place alongside a short narrative dealing with the withdrawal of water from headings under air pressure.

It is only now and then that compressed air is employed in tunnel work to hold back the ground and water from the excavation. This is due in part to the fact that excavation under air pressure has a distinct limitation. The air pressure has to be increased continually with depth below the water line. As the increase amounts to .433 pound per square inch per vertical foot, the short distance of 100 feet below the water level requires a pressure of 43 or 44 pounds per square inch. This is about the greatest air pressure the excavation men can endure and so marks the point near which the compressed-air method must be abandoned.

The most important horizontal excavation through wet material that has ever been carried out was no doubt that of the four tunnels for the Pennsylvania Railroad beneath the East River at New York. The amount of water to contend with was unlimited; and so the method of excavating and boring had to conform with this condition. A modern form of the shield originally patterned by Brunel, in England, nearly one hundred years ago, was adopted as the principal aid in excavation. The heading in which a shield would be working would be put under compressed air. The actual excavation took place just ahead of the shield. Back of the head which partitioned off the air

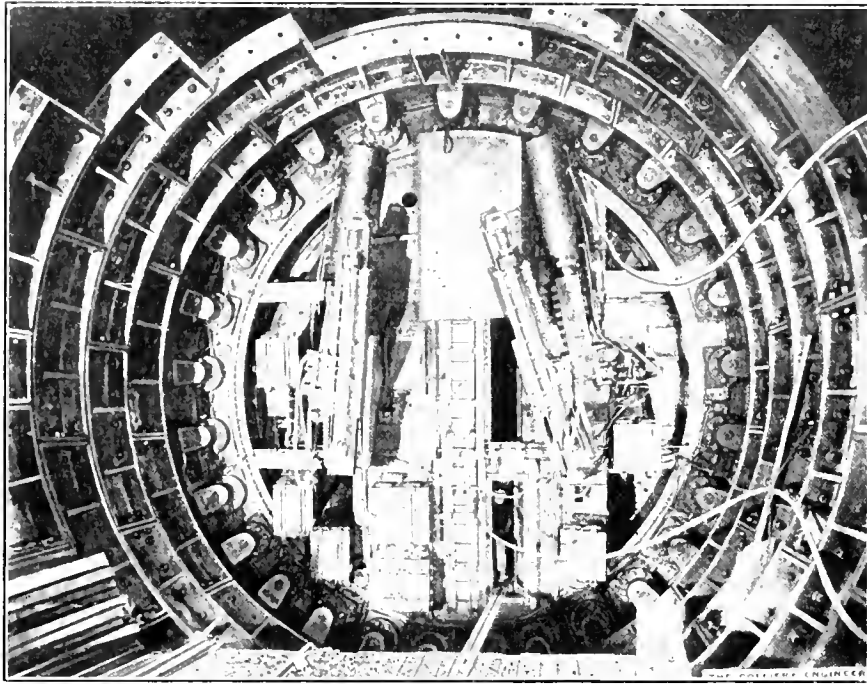

FIG. 3. SHIELD IN PENNSYLVANIA TUNNELS SHOWING CIRCULAR ROW OF JACKS AND TUNNEL LINING

occurred because of the crevices being tapped by drill holes, and fears were entertained relative to what was yet to come when the large openings began to be laid bare. The excavation could scarcely have been continued had it not been for the grouting operations undertaken and carried through. Four grouting machines on the surface were connected with suitable piping run to the shaft bottom. The main piping had a diameter of $2\frac{1}{2}$ inches, the terminal hose, 2 inches. Difficulty was at first experienced because of back leakage. This trouble was overcome by the use of finely ground horse manure intermingled with the grout. The holes were cemented up in three days with the consumption of 2,900 bags of Portland cement. A few additional holes were now drilled, and 60 additional bags of cement forced in. Conditions were, however, not yet

ful what this small amount of cement indicated. The excavation was resumed and carried to a depth of 320 feet, when the shaft was flooded for the sixth time.

At the 309-foot level, an excavation was made on one side of the shaft with the view of providing accommodations for a stationary pumping plant. A pump chamber 10 feet high and having a floor area of 17 ft. \times 24 ft., was made together with a sump $5\frac{1}{2}$ feet deep beneath the floor level. This sump had a horizontal section of 16 ft. \times 22 ft., and a capacity of 14,500 gallons. In the chamber were installed three horizontal condensing pumps, each of the 24 \times 10 \times 20-inch size, built by the A. S. Cameron Steam Pump Works, of New York City. The combined capacity of this plant was 1,050 gallons per minute. Steam was furnished by three 100-horsepower boilers on the surface near

chamber, would be the permanent east-iron lining. This lining is composed of metal rings 2 or 3 feet long, securely bolted to one another. Each ring consists of a number of segments bolted to each other, end to end. The extreme forward end of the iron lining would lie within the shell of the rear of the shield. When the face of the heading would be excavated the length of a ring, the shield would be forced ahead by means of hydraulic jacks operating between the end face of the final ring and an inward projection of the shield. There would thus be left a space within the shell which would then be filled by means of a new ring. Just back of the shield, grouting operations would be carried on to seal the spaces just outside the newly constructed rings.

The water was excluded by the resistance supplied by the air. Of necessity, the air pressure had to be equal, or nearly equal, to the hydrostatic head, a condition which entails a difficulty that pertains to horizontal compressed air work but not to vertical. In such large tunnels as those of the Pennsylvania Railroad the hydrostatic head corresponding to the top would be less than that at the bottom. Ordinarily, a pressure suited to an intermediate head is employed. Consequently, the water above the roof of the new excavation will be subjected to an upward pressure. This is offset at times, however, by the excess specific gravity of the soil over that of water.

In consequence of the interplay of nearly balanced upward and downward forces, danger of "blow-outs" would arise wherever the material overhead is loose and open or where its thickness is much diminished. At the bottom, on the contrary, the insufficient air pressure would often result in the inward leakage of water. In fact, the removal of the bottom water was an ever present problem where the ground permitted the passage of water.

The withdrawal of this water was accomplished in an interesting man-

ner during the progress of a portion of the work beneath the East River. All four tunnels were driven simultaneously from both shores of the river. Shafts were put down on each shore to permit the inception of this work at the proper levels. Some of the shaft work was done under compressed air; some was done in the open. After the commencement of tunneling it was ordinarily unnecessary to have a shaft under air, even where air had been used in vertical excavation. Consequently, with the heading under air pressure and the shaft open, there would be a very considerable difference between the air pressures in the two. Advantage was taken of this condition to drive water from the heading into the sump of the shaft. That is to say, a pipe would be laid horizontally from the shaft through the bulkhead and along the tunnel to a point in the vicinity of the shield. A stuffingbox was bolted to this pipe, in which was a telescopic pipe fixed rigidly to the traveling stage. From this a 6-inch flexible pipe dropped to the invert with a strainer on the end of it. Water would be forced by air pressure through the strainer and the pipe to the sump. At the bulkheads branches would be arranged to care for water at these points. However, a difficulty manifested itself. When passing through sand, a great deal of this material would be forced in and driven along, with water, which resulted in cutting the pipe. The pipes were easily replaceable except at the bulkheads, and it was necessary that they should be replaceable there. In some of the bulkheads 8-inch pipes had been placed and by using 6-inch pipes for the passage of the water through a bulkhead, the 8-inch pipe could be used simply as a sleeve. In this way, the interior pipe when cut could be replaced without disturbance of the 8-inch pipe imbedded in the bulkhead. The extra heavy 6-inch pipes would be run through and flanged, and the annular space between the two pipes calked with lead. The sumps in the

shafts were unwatered ordinarily by means of Cameron pumps.

采采

The American Institute of Mining Engineers

The one hundred and fourth meeting of the American Institute of Mining Engineers was held in New York City at the headquarters of the society, February 17, 18, and 19. There were twenty-seven papers on mining geology and allied subjects, and seventeen papers on iron and steel subjects.

The American Institute of Mining Engineers is the second in age of the four great national engineering societies. The American Society of Civil Engineers preceded it by 19 years. The Institute was called into being by a circular issued from Wilkes-Barre by Eckley B. Coxe, Richard B. Rothwell, and Martin Coryell, all three at the time engaged in anthracite mining. This circular brought together in Wilkes-Barre, May 16, 1871, twenty-two persons, who founded the American Institute of Mining Engineers. Three of the twenty-two are still on the rolls. They are, President Henry S. Drinker, of Lehigh University; Dr. Rosco W. Reynolds, who was secretary of the Institute; Mr. Williard P. Ward, mining engineer, in the Mills Building, 15 Broad Street, New York.

Before the first meeting adjourned 46 others were elected, of whom 10 are members today, and among whom are Mr. Anton Eilers and Prof. George W. Maynard, representatives of the metallurgical profession in New York, and Mr. Stewart M. Buck, dean of the coal mining profession in West Virginia. Martin Coryell was the first secretary, Prof. Thomas M. Drown, of Lafayette College, was the second secretary. Doctor Raymond was elected secretary in 1883.

At the recent meeting Charles F. Rand, president of the Spanish-American Iron Co., was elected president, and Bradley Stoughton was chosen secretary by the Board of Directors.

ANSWERS TO EXAMINATION QUESTIONS

Questions Asked at the Examination for Fire Bosses and Mine Foremen, Held in West Virginia, 1912

QUES. 1.—What are the legal qualifications and duties of a fire boss in the state of West Virginia? Should he have any other qualifications than those demanded by law? If so, state them.

ANS.—The legal qualifications of a fire boss are: "He shall be a citizen of this state, and shall have such knowledge of firedamp and other dangerous gases as to be able to detect the same with the use of a safety lamp, and shall have a practical knowledge of the subject of the ventilation of mines and the machinery and appliances used for that purpose, and be a person with at least 3 years' experience in mines generating gases."

The duties of a fire boss, condensed from those set forth in the code of mining laws, are (a) he must prepare and place at the entrance of every gaseous mine a colored danger signal beyond which no one but the operator, mine owner, or his agent may pass (and then only in case of an emergency) until the mine or dangerous parts of it have been examined by the fire boss and reported safe; (b) he must visit all the working places in a mine where gas exists, or may exist, and examine them with a safety lamp and, if gas is present, shall remove it himself or have it removed by others; (c) he must make his rounds and the examination and removal of the gas (if there is any) within 3 hours of the time the shift goes to work; (d) he shall leave some evidence or mark of his visit at the face of each working place examined; (e) he shall remove or change the color of the

danger signal if no gas is found in order that the men may know the mine is safe to enter; (f) he shall have no superior officer while performing his duty, all employes inside the mine being subordinate to him; (g) he shall, upon leaving the mine, make a written record of the condition of the workings in a book provided for the purpose.

Yes. A fire boss should possess the same qualities to succeed that are demanded of other men. Among these qualities may be named faithfulness and attention to duty, a willingness to work hard, a sense of fair dealing, the power of observation, with the ability to reason well and rapidly so that he may be able to act promptly and properly in an emergency, bravery in the face of danger, etc., etc.

QUES. 2.—What are the gases found in coal mines? How are they produced? Where are they found? What effects are they likely to have upon the workmen? How are they detected? What are their specific gravities and compositions? What would you do to render them harmless?

ANS.—Aside from the oxygen and nitrogen composing the air, the gases generally met in coal mines are methane, carbon dioxide, and carbon monoxide.

Methane is generally slowly given off from the pores of the coal, or rapidly from blowers or from crevices, should these latter be encountered in mining. Being lighter than air, it is found near the roof of level workings or at the face of pitching places. Methane is not poisonous,

but if much is present in the air it fills the lungs in place of the necessary oxygen and the person exposed to it dies of suffocation. Methane has a specific gravity of .559 and its symbol, CH_4 , shows that it is composed of four parts of hydrogen and one part of carbon. It is detected by its effect upon the flame of a safety lamp upon which it produces a slightly luminous cap which increases in height as the percentage of gas in the air increases. Mixed with air, methane forms what is commonly known as firedamp, which is often explosive and the cause of many serious mine accidents. Methane is also known as marsh gas, light carburetted hydrogen, or merely as gas.

Carbon dioxide is produced by the breathing of men and animals, by the burning of lamps or any other burning where there is an ample supply of air, by the slow decomposition of coal and wood (timbers), by the explosion of powder, and sometimes is given off from the rocks enclosing the seam itself. Carbon dioxide is frequently found in the gob or abandoned workings where the ventilation is poor. In any particular working place this gas is generally found near the floor or at the bottom of dip workings, as it is very much heavier than air. The gas is not poisonous, but when breathed for any length of time produces headache, nausea, and pains in the back, etc., followed by death from suffocation. The only means for its detection is afforded by the behavior of the lamp flame which in the presence of this gas burns with

less and less brightness and finally goes out. The specific gravity of carbon dioxide is 1.529, and its symbol, CO_2 , shows that it is composed of two parts of oxygen and one part of carbon. This is also known as carbonic acid gas and, when mixed with air, forms blackdamp.

Carbon monoxide is not given off by the coal or the rocks enclosing the seam, but is formed by the explosion of many kinds of powder, by mine fires where there is not enough air to burn the coal to carbon dioxide, and is one of the chief products of gob fires or of any other burning where the air supply is limited. The chief source of this gas is the afterdamp resulting from coal-dust explosions, and it is the cause of the vast majority of the deaths in these accidents. As this gas is very nearly as heavy as air it readily diffuses through it, so it is not generally found either at the roof or floor, as with methane or carbon dioxide, respectively, but in any part of the working place. This is by far the most dangerous gas met in mines, as it is highly poisonous even in very small amounts. It acts as a narcotic poison producing a speedy death. It coagulates the blood, which has 250 times the affinity for this gas that it has for oxygen. It is difficult of detection by mechanical means, as the percentage of it in the air which will show a cap on the safety lamp flame, will result in almost instant death. In rescue work after dust explosions it is customary to carry along one or more canaries or other small birds which are very much more sensitive to small amounts of this gas than is man. As soon as the bird begins to show signs of distress the party, unless provided with helmets, should leave the place. The specific gravity of the gas is .967 and its symbol, CO , shows that it is composed of one part of oxygen and one of carbon. It is sometimes known as carbonic oxide, and, mixed with air, forms what is known as whitedamp.

These gases are all removed in

the same way, namely; by having an ample amount of air carried to all parts of the workings, particular attention being given to those places where these gases are being given off in unusual amounts.

QUES. 3.—Describe the structure of the safety lamp and show on what principle its safety depends. Under what conditions does it become unsafe? What effect, if any, do high velocities of air-currents have on it?

ANS.—The safety lamp consists essentially of a metal receptacle for oil, provided with the necessary wick, etc., for burning the same and producing a light. The wick is surrounded by a cylindrical shield of glass, the upper part of which is replaced by a fine wire gauze having 784 openings or meshes to the square inch. There is sometimes an interior conical metal chimney to increase the draft and the gauze may or may not be surrounded by an outer metal shield known as a bonnet. The safety of the lamp depends upon, or is brought about by, the fact that the flame of a mixture of methane and air burning within the lamp is so cooled by passing through the meshes of the gauze that its temperature is reduced below the point at which the same mixture outside the lamp will ignite.

The safety lamp is dangerous when there is a hole in the gauze that will pass the flame to the outside, or when the gauze is dirty so that any particular spot may be overheated, or when gas is allowed to burn within the lamp until the gauze is red hot, or when the velocity of the air is so great that the flame is blown through the gauze.

Safety lamps should not be used in air-currents of very high velocity, owing to the possibility of the flame being passed through the gauze, but much will depend upon the composition of the mine air. It is generally considered that the best modern safety lamps may be exposed to currents of velocity as great as 2,000 feet a minute, except where much dust or gas is present, in which case

they are not safe in currents moving more than 1,200 to 1,500 feet a minute.

QUES. 4.—What are the instruments that are most useful in aiding the fire boss to determine the conditions existing in the mines? Describe the character of the information obtained by each of them and the manner of their use.

ANS.—Aside from the safety lamp described above, the instruments in common use are the water gauge and the anemometer, although at some mines a barometer, thermometer, and hygrometer are provided, but these latter are usually handled by the superintendent or mining engineer.

The water gauge consists of a glass tube about one-half inch in diameter bent in the form of the letter U, and partly filled with water. It is placed in a brattice so that one end is open to the return and the other to the intake air-current. The difference in the pressure of the air in the two entries causes the water to sink in the tube open to the intake and to rise in the tube connected with the return. The difference in the level of the water in the two arms is read off, in inches and decimal fractions thereof, upon an adjustable scale. Each inch of water gauge reading corresponds to a ventilating pressure of 5.2 pounds per square foot. The water gauge thus measures the pressure necessary to overcome the frictional resistance of the passage of the air through the mine workings.

The anemometer consists of a small vane or number of blades fixed to an axle revolving in a circular frame. The number of revolutions made by the vane is recorded by means of a number of pointers on the face of the anemometer. This instrument is used to measure the velocity of the air-current by being held in a selected part of the airway for a definite length of time, say, 1, 2, or 3 minutes. The velocity of the air or distance traveled in 1 minute multiplied by the area of the cross-section of the airway

will give the number of cubic feet of air passing in cubic feet per minute.

QUES. 5.—How would you proceed to look for and detect explosive gases in mines; also state the manner by which you would detect other dangers while making your examination and the precautions you would use to prevent accidents from these dangers.

ANS.—The flame should be lowered the better to show the "cap" formed by the burning gas (if any is present), and carefully watched for the first appearance of the flame cap as the lamp is slowly raised to the roof and into cavities where gas is apt to be found. The roof should be examined to see if it is sound and not apt to fall. If gas or unsafe roof is found, the place should be fenced off, or notice posted in some way, so that men will not enter until the dangers are removed. The fire boss should be on the watch for any evidences of squeeze, excessive amounts of water in the workings, broken or poorly working doors, bad track, accumulations of dust, blown-out shots or poorly mined coal, in fact he should look into, as far as his time permits, the same sources of danger and trouble as the mine foreman to whom he should report anything amiss in the mine.

QUES. 6.—Is coal dust explosive? If so, where are explosions from coal dust most apt to occur? What weight of dust in air makes an explosive mixture? What weight of dust and what percentage of marsh gas will make an explosive mixture? What means have been proposed to remove coal dust from air? What method has been found most successful for purging the air of coal dust? Is it best to prevent the suspension of coal dust in the air or to remove the dust after it has been suspended?

ANS.—Coal dust by itself is explosive and may be ignited by burning firedamp, by a mine fire if large amounts of finely powdered dust are thrown into the air passing over or through, by the flame produced by

the short-circuiting of an electric current and when the trolley wires become crossed, by a blown-out or windy shot from a misplaced or over-charged hole and by the explosion of a large amount of dynamite or other high explosive even if not confined in a hole. The flame of an explosion, which in itself would do but little harm, is by coal dust carried throughout the workings.

Explosions of coal dust are apt to occur in bituminous mines where the percentage of volatile matter in the coal varies from 14 per cent. to 38 or 40 per cent., particularly if the coal possesses good coking qualities; where the coal is soft and makes large amounts of fine dust; where improper methods of mining, such as shooting off the solid, the use of too much powder in improperly placed holes, etc., are employed; where the climate is "dry," as in the Rocky Mountain regions, so that (usually) more water is being carried out by the air-current than is brought in by other means; where the outside air during the winter months is much colder than the mine, as in the eastern part of the United States, this having the same effect upon the power of the air-currents to absorb moisture as prevails in the dry climate of the West; and where, in general, anything may happen by means of which a flame is made and fine clouds of dust are, at the same time, thrown into it.

The United States Bureau of Mines has shown that when bituminous coal dust is fine enough to pass through a 200-mesh sieve (one with 200 openings in the length of an inch, or 40,000 openings in 1 square inch of area), and thus floated easily on a strong air-current, 1 pound of dust in 500 cubic feet of air readily spreads an explosion. Much, however, depends upon the kind of dust, and particularly upon the violence or intensity of the explosion of flame which first ignites the dust.

It is not possible to give an exact weight of dust and exact percentage of methane (marsh gas) that will form an explosive mixture, as this

varies with the nature and fineness of the dust, etc. In general, however, a mixture of marsh gas and air containing less than 1 per cent. of gas is explosive if it also contains a highly inflammable coal dust.

The entrance of coal dust to the mine air can probably never be entirely prevented, but the amount in suspension in the air, and which is, of course, carried along and deposited on the floor, roof, and ribs, may be materially lessened if certain precautions are observed. In order to reduce the amount of dust made at the working face the seam should be undercut to a depth about equal to its thickness and if this is done by chain machine the outer edge of the cut should be snubbed so that the coal will fall easily. The shot holes should be so placed as to require the smallest possible amount of powder to bring the coal, and no hole should be charged with more than 1½ pounds of explosive, which should be of the permissible type recommended by the United States Bureau of Mines. To prevent the distribution of coal, either as dust or lumps, along the haulage road, the cars should be made with tight joints and the topping should be low, so that the lumps will not roll off when the cars are bumped together. Fine coal, as was as larger lumps, is soon ground to powder by the feet of men and mules, and tight cars and little or no topping will prevent it falling on the track. Many recommend that the fan be stopped or slowed down at shot-firing time to lessen the velocity of the air-current so that the very fine dust made by the blast may settle where made and not be carried throughout the mine on the air. Also all bug dust should be loaded out and all working places should be well watered before shot firing, so that the fine dust may not be thrown upon the air by blasting. It is further recommended that the tops of all cars and their entire contents, if possible, be wetted before, or very shortly after, they are delivered to the gathering driver, in

order, also, that the fine dust may not be blown, swept, or knocked from them as they are being hauled to the parting.

Two general methods of preventing dust explosions prevail, which may be called the wet method and the dry method, although neither of them purges the air of dust. In the wet method the mine roads, roof, and ribs are either washed down with hose and water, so that the dust is reduced to mud, or else moisture for this purpose is admitted by means of jets or sprays of water placed at intervals along the entries, or the intake air may be heated by exhaust steam and saturated with moisture at a high temperature, which moisture is deposited when the preheated and premoistened air comes in contact with the cooler mine. Sometimes one of these methods of wetting the mine is used by itself, in some mines two are used in combination, and in a few all three are used. In the dry method no attempt is made to settle the dust. Instead, the floor, roof, and ribs are heavily sprinkled with very finely powdered shale dust, which is also placed on racks and shelves throughout the mine. Shale dust is inert, that is, it will not explode and if enough is present it will prevent the explosion of an otherwise dangerous dust. The wet methods are preferred in the United States, being used in all but one mine and, although the wet method is in general use in Europe, there are many places where the dry method is used. It is absolutely certain that neither a perfectly wet mine nor a mine in which the coal dust has been replaced by powdered shale can explode, but just what amount of water or what amount of shale dust is necessary to prevent or stop a dust explosion is not yet determined. It depends in a very large measure upon the composition and fineness of the dust, the volume and velocity of the air-currents and the force or intensity of the initial explosion or burning which ignites the dust.

It is better, by all means, to prevent the dust getting into the air than to remove it afterward, but this is not possible. The best practice reduces as far as possible the amount of dust made at the face, and then washes down or deadens with inert dust that which is unavoidably carried away and deposited by the air-currents.

(To be Continued)

來 來

Steam Line Suspension

When a steam line crosses a railroad track or any similar obstruction, a simple suspension can be constructed by the use of old rails and old wire rope. In making it, a pair of rails (marked *A* in Fig. 1)

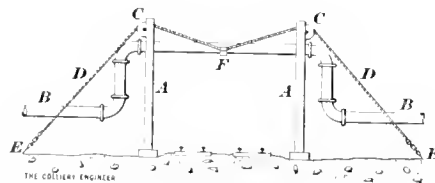

FIG. 1. STEAM LINE HANGER

is placed on each side of the track to support the steam line *B*. The rails are stood in the usual manner slanting toward one another. The bottom should be placed on a foundation so that the rails cannot work into the ground, and the top ends are held together by a strong rod to which the supports for the steam line are fastened. On the rod at each side of the steam line hanger is placed a pulley *C* over which the wire rope *D* is strung and which will allow the wire rope to move without a tendency to break. Two lengths of wire rope are used. They must be long enough to pass from an anchor *E*, located at a distance behind the rail supports, up over the pulleys on the uprights and under a stirrup *F* beneath the steam line at the center of the span and down to an anchor on the other side. The ropes should be coned and a turnbuckle used so that the rope can be pulled taut, for the support of the pipe depends upon the drawing taut of the rope. The pulleys over which the rope passes are higher than the stirrup, and conse-

quently as the wire rope is tightened there is a lifting effect beneath the stirrup. The uprights are prevented from falling in toward one another when the ropes are tightened, by means of the hangers which are placed behind the flanges on the bends.

來 來

American Institute of Electrical Engineers

The meeting of the American Institute of Electrical Engineers will be held in Pittsburg, Friday and Saturday, April 18 and 19. Mr. George R. Wood, consulting engineer of the Berwind-White Coal Mine Co., is chairman. A number of papers on the use of electricity in mines have been promised and it is expected that interesting discussions will take place.

Owing to this meeting being in the largest bituminous coal mining district, it is expected that a number of coal mine papers will be presented, and mine managers and operators generally are invited to attend. E. C. Turpin is secretary of the Pittsburg section of the institute, and communications may be addressed to him, care of Westinghouse Co., East Pittsburg, Pa.

來 來

The annual meeting of The Iron and Steel Institute of Great Britain will be held at Storey's Gate, Westminster, London, May 1 and 2, in the rooms of the Institution of Mechanical Engineers.

來 來

The International Geological Congress will hold its twelfth session in Toronto, Canada, August 7 to 14, 1913, with headquarters at the University of Toronto. No professional qualification is necessary to become a member in this society, but a fee of \$5 must accompany each application for membership. Address Secretary, Twelfth International Geological Congress, Victoria Memorial Museum, Ottawa, Canada.

Mine Cave Commission Report

IN the populous anthracite coal regions of Pennsylvania, the effect of the mine workings on the surface and the build-

ings thereon, particularly in the northern field, developed a serious state of affairs, and presented a difficult problem. In the majority of cases, when building lots were sold the coal rights were reserved to the original owners, their heirs and assigns. In the Lackawanna region, in most cases, the purchasers of lots, not only purchased them subject to the coal reservation, but also, in the deeds, agreed that the owners of the coal should have the right to mine it without liability for damages done the surface or buildings thereon.

Due to the extension of mine workings under the city of Scranton and adjacent boroughs, particularly in localities where all or nearly all the coal in the seams was extracted, there were numerous surface disturbances, and considerable damage was done to buildings. This damage, however, taken collectively, was comparatively small, when the entire valuation of the real estate in the city is considered. Naturally losses to individual owners of real estate were comparatively large, though in some instances the company mining the coal voluntarily repaired the damage.

The assessed valuation of real estate in the city of Scranton is nearly \$80,000,000. The real valuation probably exceeds \$125,000,000. The damage done by mine caves in the past 20 years has not totaled over \$200,000 or \$250,000—really less than the loss occasioned by a single large city fire, and very much less than the damage done by spring floods in many cities located on large rivers. However, the rapid exhaustion of the anthracite requires now, and will require in the future, the working of seams that were formerly regarded as practically unworkable, and the extraction of a maximum percentage of all the seams. This necessity, naturally, means that large sections of thickly populated territory will

The Recommendations of the Anthracite Mine Cave Commission—The Remedy Suggested to Meet Conditions

be seriously affected by the mining. For the purpose of thoroughly studying the situation and investigating methods of surface supports, and of offering a rational solution of the problem, Governor Tener, early in 1911, in accordance with an act of the legislature, appointed a remarkably well-selected and able Commission.

This commission consisted of W. J. Richards, of Pottsville, Vice-President and General Manager of the Philadelphia & Reading Coal and Iron Co., an able mining engineer and an executive with ability of the highest order; G. M. Davies, of Lansford, an experienced and intelligent coal miner; Wm. H. Lewis, of Pottsville, a retired mine superintendent of long and successful experience; W. A. Lathrop, of Wilkes-Barre, an able mining engineer and manager of many years' experience, and President of the Lehigh Coal and Navigation Co.; Charles Enzian, of Wilkes-Barre, a mining engineer of excellent repute, connected with the United States Bureau of Mines; Hon. W. L. Connell, former Mayor of Scranton, and a successful operator and mine manager; Hon. J. Benjamin Dimmick, of Scranton, former Mayor, and an attorney and banker; E. J. Lynett, editor of the *Scranton Times*, and one of the most progressive citizens of Scranton; and Col. R. A. Phillips, of Scranton, General Manager of the Delaware, Lackawanna and Western Coal Co., a man who knows coal mining through practical experience in every position from miner to general manager.

Owing to ill health, and his subsequent death, Mr. Lathrop did not serve, and the Governor appointed in his place, Samuel D. Warriner, an able engineer, at that time Vice-President and General Manager of the Lehigh Valley Coal Co., and later Mr. Lathrop's successor as President

of the Lehigh Coal and Navigation Co.

From the time of organization until March 1, the Commission held up-

wards of 50 meetings, and in addition subcommittees devoted a great deal of time investigating details. Every obtainable source of information was drawn on and prominent mine officials and mining engineers were called before the Commission, their testimony taken and opinions asked.

Naturally, in a body of such men, there arose at times, differences of opinion, and these differences had to be fought out and reconciled. Finally, on the night of February 28 the work was completed, and the report of nearly 600 typewritten pages was delivered to Governor Tener on March 1.

During its deliberations, the Commission entered into negotiations with the presidents of the principal coal mining companies, and secured voluntary concessions from the companies as set forth in a general way in the following concise statement:

"On condition that and so long and so far as the exercise of their rights to mine coal are not restrained, restricted or penalized by the passage or enforcement of state laws or municipal ordinances, the mining companies agree to

"1. Protect all public highways and city streets; this protection, however, to be based generally upon the principle of the conservation of the coal thereunder for market purposes, and to involve a reasonable attitude upon the part of the communities having jurisdiction over said public highways and city streets, and also a reasonable use of the right of said companies to mine thereunder, so far as affecting the surface is concerned.

On the one hand, the communities to refrain from unreasonably enjoining mining where no serious public injury will result, and, on the other hand the companies to refrain from so conducting their mining operations as to seriously interfere with the centers of traffic in municipalities

where the conditions are such that serious public injury will result, and to provide for the security and convenience of the public by giving proper notice of proposed mining which may affect the surface, by providing temporary ways of passage, and finally, by repairing at their own expense any and all damage caused to the municipalities by said mining.

"2. Pay at least one-half of the cost of repairing all structures (except those of mining and railroad companies) damaged by mining having a value of \$5,000 or less.

"3. Whenever danger of subsidence is imminent, sell, so far as they have the legal right so to do, for a fair consideration to owners (except mining and railroad companies) of structures exceeding \$5,000 in value, such pillar coal as they may reasonably desire to purchase for the support of said structures, such consideration to be 25 per cent. above the prevailing value upon leases made at or near the time of purchase, the basis of computation being 1,800 tons to the foot acre. In the event of such purchase, however, the coal thus purchased to be forever appropriated to the support of the surface. If, however, support may be reasonably provided by filling or otherwise, then to flush, fill or build artificial supports in such portions of the mines as may be desired by the surface owner at a price not to exceed the cost thereof to the mining companies, but at the expense of such surface owner, provided that when such support is at the election of the mining company, the expense to the surface owner shall not exceed the cost of pillar coal as hereinbefore provided.

"4. In recognition of the peculiar conditions and the general fear of immediate surface damage in the city of Scranton and borough of Dunmore and with a purpose of relieving the public solicitude, but without admission or interpretation of the present value of the coal, the principal operators in this territory agree that during the period of 18 months after March 1, 1913, they will sell so far as they have the legal right so to do to owners (excepting mining and rail-

road companies) of structures exceeding \$5,000 in value such pillar coal as they may reasonably desire to purchase for the support of said structures at the rate of 35 cents per ton on the basis of 1,800 tons to the foot-acre.

"5. Provision to be made for the adjustment of any disputes arising in connection with such sale or putting in artificial supports."

The coal mining companies agreeing to these points were: The Lehigh Valley Coal Co.; Philadelphia & Reading Coal and Iron Co.; Pennsylvania Coal Co.; Hillside Coal and Iron Co.; D., L. and W. Coal Co.; Scranton Coal Co.; Delaware & Hudson Co.; Green Ridge Coal Co.; Lehigh and Wilkes-Barre Coal Co.; Edgerton Coal Co.; Northwest Coal Co.; Sterrick Creek Coal Co.; Lackawanna Coal Co., Ltd.; Mount Lookout Coal Co.; Forty Fort Coal Co.; Elk Hill Coal and Iron Co.; Northern Coal and Iron Co.; Hudson Coal Co.; and the Susquehanna Coal Co. In expressing its unanimous opinion of the results that will follow the carrying out of the plan suggested the Commission says:

"The undertaking as set forth upon the part of the companies is revocable; on the other hand, the communities remain perfectly free as regards the exercise of police power, a power that they could not divest themselves of even should they consent thereto.

"The commission, however, are unanimously of opinion that when the practical benefits of the plan are appreciated, the benefits being substantial to the communities, to the surface owners and to the mining companies, that all parties will be led, not only through selfish interest, but also through a regard for the public welfare, to exercise that self-restraint that will be necessary to render the plan substantially and permanently effective.

"That the plan may occasionally work a hardship is undoubtedly conceivable, but no solution of so complex a problem could presumably be without that defect.

"That the benefits are mutual and substantial is the well considered be-

lief of the commission, and that they may be the more easily and clearly comprehended, they are herewith set forth.

"Speaking broadly, all the parties—the communities, the individual and the mining companies—are benefited, obviously, by any prolongation of their basic industry, and therefore, as far as compatible with community and individual rights and necessities, this principle was acknowledged and kept in view. It was recognized in the classification of property, under which pillars are not to be left, by the dividing line of value of \$5,000 and under; such line not only increasing the total amount of coal to be mined, but also decreasing the burden of making good the surface property of a very large percentage of the total structures of the anthracite regions, inasmuch as the cost of repairing the damage caused by letting down the surface under the structures of \$5,000 or under, will average much less than either of the two other methods, namely, the 'leaving of pillars,' or 'flushing.'

"The prolongation of the basic industry is also helped by the suggested permission to mine under highways and streets, except under traffic centers, said highways and streets, however, being restored, in all cases, to their original status and condition, by and at the expense of said mining companies.

"The mining companies, therefore, benefit by such broadened activities, and in consideration of same, they participate in the burden of making good all surface property, such participation taking two forms. First, by paying one-half, at least, of the cost of repairing all structures having a value of \$5,000, or under, and, secondly, in selling the necessary pillar supports for all structures exceeding \$5,000 in value, at a price that is a distinct concession from the actual value of such pillar coal to them as coal miners. The former burden is estimated in the city of Scranton alone, at say, \$3,500,000, while the concessions upon the coal pillars, also in Scranton alone, would probably reach the same figure.

"The benefit to the surface owners, is, therefore, substantial, the companies, roughly speaking, paying one-half of the cost of the ultimate solution of the problem, as regards probably 90 per cent. of the property owners of the anthracite regions and making a distinct contribution wherever pillar support is demanded by reason of the character and value of the remaining 10 per cent.

"The communities are benefited by the prolongation of the industry and by the securing of terms for individual property holders that while burdensome are not considered as being prohibitive. Possibly one of the greatest benefits of the community is the sentimental reassurance that should come from the placing in immediate operation of a practical remedy for conditions that not only menace, but are actually retarding community development. As to the placing of a portion of the cost of supporting private property upon the communities as such, which is, in effect, but changing the form, but not the weight, of the burden, it was felt that such action would be impracticable, owing to the voluntary character of the plan, to say nothing of the inequalities that would be worked through the varying conditions in any given community or of the complications that would arise from increased municipal indebtedness.

"The query very naturally arises as to what will be the attitude of the smaller companies who are not included in the arrangement. The commission can only suggest that it will be difficult for any mining operator, however small may be his field, to decline to acknowledge this reasonable measure of his responsibility so overwhelmingly established by his competitors in trade, unless it be that such operator is indifferent not only to equitable, but also to ethical obligations."

So as to make effective the agreement and plan suggested, the Commission recommended the enactment by the legislature of the two following bills:

AN ACT

To afford additional protection to the public against dangers resulting

from the caving in or subsidence of the surface overlying anthracite coal mines.

SEC. 1. Be it enacted by the senate and house of representatives of the commonwealth of Pennsylvania in general assembly met, and it is hereby enacted by authority of the same, that where the owner or operator of any anthracite mine in this commonwealth possesses the right to mine out all the coal without obligation to support the surface, and proposes to exercise that right by removing or materially weakening the support theretofore afforded to the overlying surface by pillars of coal, it shall be unlawful for him to do so until sixty days after he shall have caused to be served, in the manner provided by law for service of the writ of ejectment, a written or printed notice of his intention so to do upon the owner or owners and the occupant or occupants of the surface lands liable to be affected by such action.

Such notice shall specify the time when such pillar mining will, in the operator's opinion, render further occupation of the surface dangerous and shall be served at least sixty days before the date stated therein.

Within the period during which the said occupant or occupants are thus given an opportunity to remove from such place of danger, it shall be his or their duty to do so and remain absent therefrom until the danger from subsidence of the surface has passed.

SEC. 2. The said owner or operator shall cause to be served in the manner aforesaid, a notice of fifteen days upon gas companies and electric light or power companies maintaining pipes and wires in territory under which mining operations are being conducted, which notice shall state when, in the operator's opinion, said mining operations will be liable to disturb said gas pipes and electric wires; whereupon it shall be the duty of said companies to shut off the gas and electric currents and discontinue the supply thereof in the threatened territory until subsidence of surface shall have occurred or the danger to

be apprehended therefrom has passed away.

SEC. 3. Any owner, operator, superintendent, or other person having charge of a mining operation who shall wilfully refuse or neglect to give any notice required by this Act, and any official, superintendent or other person in control of the operation of any gas or electric company which has received notice as aforesaid, and shall thereafter wilfully refuse or neglect to perform the duty enjoined upon such company by this act, shall be guilty of a misdemeanor and upon conviction thereof shall pay a fine not exceeding one thousand dollars and undergo an imprisonment for a term not exceeding six months, or both, or either, at the discretion of the court.

AN ACT

Providing for the appointment of arbitrators to settle disputes as to certain facts concerning the damage to public or private property by mine caves and fixing their compensation and providing for the payment of the cost thereof.

Whereas, a joint resolution for the appointment of a commission by the governor of this commonwealth for the purpose of investigating and reporting upon both physical conditions and legal rights in the matter of surface support where anthracite has been removed or the right to remove said coal is vested in others than the owner of the surface; and for the further purpose of suggesting new legislation relative to the same; and making an appropriation to meet the expenses of said commission, approved by the governor, March 24, 1911, and,

Whereas, in pursuance of said resolution said commission has organized and fully considered the matters submitted to it under said resolution and has made its report to the governor as therein required, and,

Whereas, the said commission has reported that there has been a voluntary offer made on the part of mining companies to the effect that upon certain conditions they agree to bear certain proportion of the cost of repairing property and also will repair streets under certain conditions,

and further, that under certain other conditions coal for the support of the surface will be sold at rates therein fully set forth or supports will be furnished for the support of the surface, and,

Whereas, it is necessary to enact a law whereby any disputes arising as to the cost of repairing property, ascertaining the quantity of coal left to support the surface and improvements thereon, or the cost of furnishing artificial support, and further as to the repairing of public highways under conditions named in said report.

Now, therefore, it is hereby enacted by the senate and house of representatives of the commonwealth of Pennsylvania in general assembly met, and it is hereby enacted by the authority of the same.

SEC. 1. That whenever any dispute shall arise concerning the matters as herein stated, that such matter of dispute shall be submitted to a board of three arbitrators, one to be appointed by each of the parties to such dispute, and the said two arbitrators to appoint a third and in case of their failure to agree upon a third arbitrator, within a period of thirty days after their appointment, then the said third arbitrator to be appointed by the president judge of the county in which the land is located about which the dispute arises. The decision of a majority of said arbitrators shall be as effective to all intents and purposes as if signed by all of the arbitrators.

SEC. 2. Said arbitrators shall be entitled to receive the sum of five (5) dollars each day actually and necessarily employed in the performance of their duties.

SEC. 3. Either party aggrieved by the award of said arbitrators shall have the right to appeal to the court of equity of the proper county.

SEC. 4. All the cost of said arbitration and appeal shall be borne equally by the parties.

采 采

One horsepower is 550 foot-pounds of work in one second, or 33,000 foot-pounds in one minute, or 1,980,000 foot-pounds in one hour.

THE LETTER BOX

Readers are invited to ask or answer any question pertaining to mining, or to express their views on mining subjects in this department. All communications must be accompanied by the name and address of the writer—not necessarily for publication.

The editors are not responsible for views expressed by correspondents.

Method of Mining

Editor The Colliery Engineer:

SIR:—Will you insert the following questions in your Letter Box:

Under normal conditions of roof, floor, and seam, what will be the safe minimum widths of chamber pillar in a flat seam of coal 5 feet thick, 900 feet below the surface when the width of the room is 24 feet? What should be the width of opening chambers on the gangways. This question refers to the Dumnore No. 4 seam.

I would like to have a good explanation of how to rob anthracite pillars for the benefit of the operator and the safety of the men when robbing.

CHAS. H. ROBINSON

Blakely-Olyphant, Pa.

Acetylene Lamps

Editor The Colliery Engineer:

SIR:—I have read the different opinions concerning the acetylene mine lamp, and if some one has not written of the same experience I would like to tell mine.

During the last six weeks I have been employed with a gang of men tearing track, wire, etc., out of workings that have been abandoned for a long time. There has been very little fresh air in circulation at any time since the workings were abandoned, and we found them full of blackdamp. Some of the men used oil lamps and others, including myself, used carbide lamps. Often the oil lamps would go out and we would continue working by the light of the carbide lamps for a long time. We worked up the heading till at last the carbide lamps threatened to go out and then we quit. Afterwards I went up the

heading till the carbide lamp became extinguished.

None of us suffered any ill effects, and I am satisfied that a man is safe to work any place that a carbide lamp will burn, so far as blackdamp is concerned.

FOREMAN

Centrifugal Pumps

Editor The Colliery Engineer:

SIR:—In considering Mr. M. J. Rafferty's answer in February issue to Ques. 4, in Prize Contest, it would appear that he has overlooked the fact that during the past few years centrifugal pumps have been designed which are made very effective against high heads, by reducing the clearance and building in multiple stages. The most interesting installation of this sort that I have seen was at the Centennial Eureka mine in the Tintic district of Utah. This was a Swiss pump of 13 stages, built in two sections, one of five stages and one of eight stages with a 400-horsepower motor between the two, one shaft serving for both sections of the pump and the motor. This pump gave good satisfaction, delivering 500 gallons per minute against a head of 1,700 feet.

In the January 11 issue of *Mining and Engineering World*, is an abstract of a paper on pumping on the Comstock lode, read before the California Miners' Association by Mr. Whitman Symmes, in which he states that at the Ward shaft they had a five-stage Byron Jackson centrifugal pump driven by a 200-horsepower motor which handled as high as 600 gallons per minute against an 818-foot head.

I have seen other installations of a similar nature, but on a smaller scale,

which tend to show that in the future the centrifugal pump will find a distinct use as a station pump.

LERROY A. PALMER

Denver, Colo.

Hay!

Editor The Colliery Engineer:

Hay! "Hay should be dipped in water." You see it was this way. A mine once got on fire and some men were suffocated, all because of a bale of hay. A workman set fire to the hay with his lamp. Some people say that the man was careless with his lamp. Others say that the hay should not have been where it was. Comments are also made on the condition and arrangement of the mine. But the association of ideas is there. Dry hay will burn, wet hay won't. Therefore wet the hay. The mules may not like it. But wet the hay before you take it into the mines and—safety first—avoid mine fires.

A child whose mother never wore earrings and always used plain soap, was picked up into her arms by an aunt. The child examined first one earring, snuggling his nose down into her neck, and then squirming around, examined very carefully the other earring. "Do you like them?" asked the aunt. "Yes, they smell good," was the answer.

It was a perfectly good answer. The child made a logical association of ideas. Earrings were a new sight for him as well as the gentle aroma of powder and good soap. Therefore it was the earrings, which were visible, that produced the smell.

So too an estimable gentleman whose duty it is to write authoritatively, has made an association of ideas. A mine fire—a bale of hay—wet the hay and avoid mine fires.

But how wet shall we wet it? And what tests shall we have to determine how wet it is? Why not a government bureau to determine standards of wetness? For shall we pour one bucket of water over each bale and do we need to wet the bale on the underside? Or shall we turn the hose upon the hay and what size of hose shall we use? Suppose we arrange that the whistle should blow

a signal of two longs and three shorts whenever a bale of hay was to be sent down into the mine? Then the fire crew could turn out for practice and instead of attempting to squirt water over everything and a few friends, accidentally of course, would perform their function of fire prevention. An ounce of prevention is worth a pound of water cure.

To be sure the barn boss might object to wet hay. He generally does make remarks whenever any one allows the bales to stand in the rain for a minute. Says that the mules don't like it; talks about using different lights around a bale of hay and keeping the hay dry. But why pay attention to a barn boss or cater to mules?

It is a shame to pick a man up on one sentence in one report. But hay—wet it! BARN BOSS

Olyphant, Pa.

Humidity of Mine Air

Editor The Colliery Engineer:

SIR:—In the July, 1912, Alabama examination for first-class mine foremen's certificate, one question had reference to the quantity of aqueous vapor air will carry or support: My answer which may be of some value to others is given herewith.

The amount of water vapor that the air will carry or support varies with its temperature.

To explain I will give figures but not attempt to give them accurately as I have not the books to refer to.

Say that 3,300 cubic feet of air will support 1 pound of water at freezing, or 32°, that at 62° it will support 3 pounds, then a current of air of 33,000 cubic feet per minute entering a mine at 32° will absorb moisture up to its capacity at 62°, or whatever the temperature is. Thus the current of air takes up and carries away 20 pounds per minute, or about 2½ gallons per minute, which would make 150 gallons per hour or something like 3,500 gallons per day. This goes on for months, the mine getting dryer and dryer.

No ordinary sprinkling system will entirely correct this, for the air will only absorb moisture as it becomes heated, expands, and dries.

On the other hand, air at 92° will carry or support about 14 pounds of water vapor for 3,300 cubic feet, thus it will be seen when the air enters the mine at 92°, by the time the temperature is reduced to 62° it has given off 11 pounds of water. Assume now, as before, an air-current of 33,000 cubic feet, then instead of drying out the mine, it is depositing moisture in every part of it where the air enters, on the walls, roof, in the gob, and everywhere, creating the condition that exists in the summer time, when the walls and roof sweat from the condensation of the water vapor that the air refuses longer to support, owing to its lower temperature.

I have always doubted the efficiency of sprinkling, not that I have discouraged it, but when the air is increasing in temperature, it will take up moisture, if it has the opportunity, and carry it outside.

Notice in the winter time the frost formed on the trees, timbers, etc., when the warm air from the air-shaft precipitates the water vapor it is carrying as it encounters the cold air on the outside.

The same conditions must be created artificially in the winter that exist naturally in the summer.

This can be done.

The intake at some suitable point in the shaft or elsewhere should be heated up to 90° or 100°, then wet steam supplied or artificial rain, or a pond of water prepared for the heated air to pass through or over, so that it enters the mine workings at about 90° fully charged with water vapor. Then condensation takes place as in the summer time.

This is no original thought of mine, though I do not know of its being applied to coal mines.

I examined the same plan for the ventilation of the Capitol at Washington, D. C., over 30 years ago. The only question is, who will first do it. It is perfectly feasible and practical.

The disastrous losses of life have not been caused by the primary explosion, but by the secondary dust explosions.

So long as we work mines we will have explosions and accidents, but this, coupled with the mine being properly arranged otherwise, will minimize the loss of life.

J. DE B. HOOPER

Dixie Springs, Ala.

Waste in Mining

A number of prominent mining men were asked to answer two questions relative to the statement of Dr. J. A. Holmes, that "During the past year (1911) in producing 500,000,000 tons of coal there were wasted or left underground, in such condition that it probably will not be recovered in the future, 250,000,000 tons of coal. The questions were as follows:

1. Does the waste occur in your field?
2. Do you know from observation where such waste occurs, and if so where?

The replies received are well worth reading and digesting. Mr. Frank Haas writes:

"I think that Doctor Holmes statement is rather broad, at least from the observation and experience I have had. In the first place it would be necessary for us to determine what the definition of coal is, whether it is a chemical, physical, or commercial definition. To illustrate the point, I can state that in the Fairmont region, of West Virginia, the loss of coal in mining the Pittsburg seam does not exceed 10 per cent. and is probably less than this amount; there is, however, over a considerable area of the Pittsburg seam in the Fairmont region, a seam which is known as the Sewickley seam. It is about 130 feet above the big seam and will materially suffer in the extraction of this latter seam. Unfortunately, however, the character and quality of this Sewickley seam are such that it cannot be marketed at the present time and consequently no operator in this field has attempted to mine it. Now if this Sewickley seam is called a commercial coal, at the present time it is certainly a waste, but on the other hand it is not fit for consumption and I do not see how it can be called wasteful to mine the other seam first.

"The broad statement of Doctor Holmes would indicate wasteful methods of mining, and assuming all coals which are being mined or are commercial propositions at the present time, I do not believe there is any waste going on in coal mining in the mines with which I am familiar. But I do recall many instances like the one cited above, not only in the Fairmont field, but also in the Georges Creek field of Maryland and the Somerset field of Pennsylvania, and possibly in the new field that is being opened up in eastern Kentucky.

"I am indeed glad that you have undertaken to correct this rather misleading and incomplete statement on the part of Doctor Holmes."

采 采

Eldorado Mine Explosion

By Special Correspondent

On the morning of February 19, at 7:25 a gas explosion occurred at the Eldorado Coal Mining Co.'s mine about 1 mile north of Eldorado, Ill., in which four men were killed and three others badly injured. The mine is quite a large one, is worked by shaft, and hitherto has been comparatively free from accidents, no fatal accident having been reported since 1909 when a miner was killed by a blown-out shot which he fired himself on an idle day when the mine had not been examined and the management did not know he was in the mine. This shows good intelligent work because about half the coal is mined by shooting off the solid and half with undercutting machine and then shooting. Like all the coal operations in Saline County it is a shaft mine, and is worked by the pillar-and-room method.

The explosion on February 19 took place just after the last cage of men descended into the mine, and that there were no more killed is due to the accumulation of gas being small and confined to the first, or second north entry, off the second west north entry.

The State Inspectors of this district are constantly in fear of just such accidents as these, for gas ex-

plosions occurred at Rend City, November 5, 1908, in which four shot firers lost their lives, and on November 19, 1908, an explosion occurred in which three out of six shot firers lost their lives. On December 12, 1908, three shot firers were killed from the same cause as the accident of November 5. On February 16, 1909, an explosion occurred at the Dering Coal Co.'s No. 18 mine while four shot firers were in the mine. The explosion at Zeigler, January 10, 1909, is not in the same class as the others, which caused the State Inspectors of Mines and the Mining Board to recommend to Governor Deneen that where coal was undercut by machines the cuttings should be collected and carried away before any shots were fired.

Mine Manager Ginney of the Eldorado company, asked aid from District Superintendent Bagwell of the O'Gara Coal Co., who responded quickly and requested his company to send the regular helmet crew with their equipment to the mine. This request was received at Harrisburg at 8 A. M. and by the aid of a special Big Four train the crew was at the Eldorado mine at 8:45 A. M., just 45 minutes after the notification.

After organization of rescuing parties, William Taylor and Joseph Robison, who were familiar with the mine and regularly certified rescue men, were equipped with Draeger helmets and sent ahead of the others of the party, who followed with pulmotors, stretchers, etc. At 10:30 the first body was recovered and just after this Thomas Harris of O'Gara No. 11 mine, who was one of the party following the helmet men, rushed into a part of the mine hot with noxious gases and brought two men out on the parting who were severely burned and unconscious. After over one-half hour's work with the aid of the pulmotors they were resuscitated, and had it not been for Mr. Harris there would have been six instead of four deaths. Soon after these two men had been brought to, it was found that three of the rescue party who had rashly rushed into the mine were down from the effects of

the noxious gases and it was only by the efficient work of the men in charge of the pulmotors that their lives were saved.

來 來

The Successful Mine Foreman From Four View Points

By H. La Viers*

At the close of a successful or unsuccessful year's business, too often we turn to, and begin the analyzation of an inventory composed of numerous items and figures representing so many dollars, together with a statement of business transacted; and ask the question, what commodities have we exchanged for dollars and cents, and in what amount, have they brought to us either profit or loss (as the case may be); and from such figures and statements, begin to formulate plans that shall guide us in our next year's undertakings, omitting or overlooking perhaps the most important factor—to what extent has the personal equation entered into the results of the past year's work?

A successful year's business in dollars and cents, is purely a mathematical calculation, but it is not conclusive as to mining; for there enter into the operation of a coal mine, considerations other than dollars and cents, which may affect its future profit-paying existence. Such considerations are organization, equipment, and mine condition. In these, we find pronounced the individual equation of the successful or unsuccessful mine foreman, which may be viewed from four points, namely: miner, foreman, engineer, and mine manager; from which view points, the writer has had the privilege of observing, and in a brief way wishes to discuss.

First, View Point of Miner.—The successful mine foreman is he who, through truth and honest dealings, has won the respect and confidence

of his men—they knowing that their welfare, financial interests, and personal safety are his daily concern—giving a just remuneration for labor expended, discerning what is right between fellow workmen and so adjudging, and in so governing, bringing about a complete working organization properly disciplined in rules of safety, personal rights and just remuneration that create conditions and an atmosphere that one appreciates and will desire to abide in.

Second, View Point of Mine Foreman.—To be successful, one conceives the idea that he must excel his predecessor in certain things, and jumps at an increased tonnage, with the expectation in so doing to create a lower cost sheet, which he hopes will be the proper road to the desired end.

The two features, or shall I say facts, just mentioned, if obtained, are only the apparent results of success, and to find success, we must look for the forces which create or bring it about. Primarily, we can say it is due to the man on the job, with mind and body from start to finish of the day's work, hearing the needs of this and that party, seeing that they are satisfied, adjusting another's complaint, filling here and there a vacancy, seeing that each party performs his allotted duty, and thereby making it possible to procure maximum results from the entire operating body; eliminating through eternal care and vigilance the unnecessary expense due to waste of material, unnecessary yardage cost, the moving of material that in a few days will require moving again; and when making an improvement, having it made in keeping with the time and extent to which it will be used; bearing in mind that the rank and file are practically what their leader is. He should be a man with a clear conception of justice, few words, kind but positive, always open for counsel, and these with an unlimited power to do, should bring the reward of success.

The successful mine foreman, from an engineer's view point, is one who keeps in mind a plan whereby his mine will be most completely exhausted, and who can forbear the temptation of procuring a few tons today, that a condition of safety may be maintained and a cheaper tonnage procured in the future; one who realizes that straight and well kept entries mean a good road and easy transportation of coal over same; who keeps all the rooms well timbered with no waste of caps and posts due to overtimbering or leaving timber in the gob. Giving greater attention to that part of the work about exhausted and possibly hardest to visit, such as long rooms, pillar drawing, low and wet places, in which places valuable unused material may be left to rust and decay or be covered up in place of being recovered and put into use again, thereby temporarily stopping the inflow of unnecessary new material when old and used will do as well. Above all, avoiding the unnecessary expenditure of money in blasting roof and making haulways, thus averting loss to his company and embarrassment to himself later by finding that had more thought and broader judgment been exercised, a more desirable and much cheaper way could have been opened. In short, letting the day's work be such that it will be the best for the complete exhaustion of the entire property and not for a one day's tonnage; availing himself of every opportunity to use a mechanical device of small cost to eliminate a fixed charge that would in a short time overpay for the piece of machinery. Always maintaining good roads and airways, and when possible taking advantage of gravity in movement of loads.

That of Manager.—From this point of view, there enters more than from any other, the question of safety, harmony, and finances, and very often (or shall I say always) the pronounced personality of the mine foreman which should hold in

* Manager Northeast Coal Co., Paintsville, Ky. A paper read before the Kentucky Mining Institute, December 9, 1912.

a staple condition these three great essentials necessary for the life and success of any business. Here, in the ideal, we look for the foreman to be a leader, broad minded, just, sober, honest and industrious, with a clear conception of right and wrong between employer and employes. A leader, that he may lead and have the respect of his men, broad minded enough to overlook the personal peculiarities of the employe, so long as they do not affect the above mentioned essentials. Just, that he may deal justly between men and employer; sober, honest, and industrious, that he may ask from his men only that which

he passes and practices himself, as "like begets like." Having at heart these attributes and principles, we may look for them to go down the line with beneficial results.

Conversely: The many failures of mine foremen, and with them mining companies, can be traced to scrap heaps, waste material, tailings, culm dumps, rust and decay of machinery and material, personal neglect, avoidable accidents and breakdowns, non-punctuality, and wilful absence, then the increased expenditure of money overcoming Nature's difficulties encountered in the ordinary mining proposition of today.

ditions in 54 counties of Kentucky, together with an estimate of the number of years the supply would last. The figures on the conditions in several counties of the western Kentucky mining district are given in Table I.

These figures but reflect the condition of the timber supply in many of our coal fields; therefore, reforestation should appeal to the mining companies by reason of their ownership of denuded hills and broom-sedge fields, particularly as they are peculiarly situated to take the lead in the work so necessary to the country as a whole, and so vital to the mining industry in particular.

Among these Kentuckians who early perceived the necessity for making provisions to replace the increasing annual slaughter of timber, the name of the late John B. Atkinson stands preeminent, and, unlike many who after forming a correct theory fail to put it into practice, this forceful pioneer in the field of tree planting proceeded to prove his faith by his works. In taking up this work, he was actuated by unselfishness and patriotism of a higher order, since he sowed without the expectation of reaping, and conscious of the fact that even while coming generations are enjoying the results of his wise forethought, they may be unmindful of the benefactor. In this article many of the facts in connection with the methods and results in tree growing are gleaned from his observations and experiences.

As managing director and president of the St. Bernard Mining Co., Mr. Atkinson, about 24 years ago began planting walnuts upon the hills and waste lands of that company, and this early planting was

Forestry as Related to Mining

Experience of St. Bernard Mining Co. in Planting Different Kinds of Trees in Kentucky

By Frank D. Rash*

THE following paper was presented at the December 9, 1912, meeting of the Kentucky Mining Institute:

That the rapid depletion of our timber resources and the consequent necessity for the perpetuation of at least a portion of our forests is now one of the most pressing questions of our national life, is most generally recognized. Taken in their entirety, the effect and influence of forests on the climate, stream flow, and water conditions of a country, is of inestimable value, while the products of the forest go to make up the raw material for, or are in some way necessary to, the greater portion of our useful arts.

Among the many industries closely dependent upon the forest, that of mining stands in the forefront and, although the artisans of steel have taken steps toward a partial replacement of wood in various phases of mining operations, yet timber is, and will remain, vitally necessary in the winning of coal and other minerals. In considering the seeming prodigal use of timber the country over, it is well to draw near to the

"Old Kentucky Home" and note the consumption in the mining operations in this field. Based on an experience of a number of years, it has been found that one company in the western Kentucky district has used 3 board feet of timber in raising 1 ton of coal, and, since this figure obtains in a locality where no particular difficulties of top present themselves, it is but fair to assume that this may be considered somewhere near the average for the district. And while the mining operations are requiring a toll of the forest to this extent, yet even this amount is but a small proportion of the total annual cut.

About 2 years ago the United States Geological Survey, in connection with the Kentucky Survey prepared a table showing forest con-

TABLE I

	Acres in Forest	Total Stand	Annual Cut	Years Will Last (Not Counting Annual Growth)
Christian County	117,000	178,000,000	14,600,000	12
Muhlenberg County	110,000	204,000,000	36,000,000	6
Hopkins County	147,000	186,000,000	23,600,000	8
McLean County	74,000	197,000,000	62,000,000	3
Webster County	35,000	38,000,000	15,000,000	2
Union County	12,000	15,000,000	4,000,000	3
Henderson County	37,000	56,000,000	11,000,000	5
Daviess County	114,000	220,000,000	13,000,000	17

*Vice-President and General Manager, St. Bernard Mining Co., Earlington, Ky.

quickly followed and broadened to include *Catalpa speciosa*, tulip (yellow poplar), and black locusts. The plantings of this company to date are represented by the following species and figures:

Black walnut (*Juglans nigra*), 1,500,000 (430,000 on 162 acres); *Catalpa speciosa*, 211,000 on 300 acres; black locust (*Robinia pseudacacia*), 314,000 on 440 acres; tulip (yellow poplar) (*Liriodendron tulipifera*), 30,000 on 60 acres. A total of 2,055,000 trees, of which 985,000 are planted on 962 acres. One million seventy thousand black walnuts were planted in many vacant spots in different parts of the property.

The matured black walnut was planted in the autumn, in prepared ground, spaced approximately 4 ft. \times 4 ft. This apparently close spacing of the trees was designed to bring about an upward rather than a spreading growth and it has had its effect. As time has passed it has become necessary to occasionally thin out the grove by removing some of the trees, but usually nature may be depended upon to do this by applying the rule of "the survival of the fittest." The largest of these trees now measures about 10 inches in diameter, the smallest 4 inches in diameter.

The *Catalpa speciosa* has been planted extensively and in the majority of instances has proven a hardy and rapid growing tree. Its best growth has been made in good soil, but it has made satisfactory progress on poor land. It is planted 7 ft. \times 7 ft. or thereabouts, and in order to give it a good start in life, should be cultivated for a few years. According to authorities, the catalpa possesses most of the virtues of the best of our trees, with practically none of their bad qualities.

That the black locust has proven the most satisfactory of any of the plantings of this company may be safely stated. Belonging as it does to the pulse family and drawing its nitrogen from the air and enriching the soil, this hardy tree is flourishing on poor ground as well as on the rich, although it should not be planted in

lowlands or damp places. These trees are spaced about the same as the catalpa. The locust usually makes a straight trunk and trims itself, the lower limbs dying and falling off as the tree continues its growth. An interesting comparison of the walnut, catalpa, and locust has been made on one of the farms of the St. Bernard Co. by planting each of the species in the same locality, in the same soil, and under the same general conditions as nearly as possible. The trees have been out for 7 years, and at this time the black locust is apparently the leader in the novel race. The locust, like the catalpa, becomes a perpetual forest, throwing out new shoots from the stump after cutting. It is valuable for mine timbers, fence posts, and many other purposes.

The tulip (yellow poplar) has been planted in good ground 10 ft. \times 10 ft. apart and shows a satisfactory growth. This is a beautiful tree and the timber is useful in many ways.

Blue grass has been sown in the walnut and locust plantings at several points and a good "stand" made, which affords grazing and throws a safeguard around the young forest by preventing burning over in the dry fall seasons. The locust groves also kill out the heavy broom grass, so frequently seen in our old fields, and this fact, taken in connection with the small size of leaves from these trees, reduces the danger of forest fires to a minimum.

Having thus considered the method and means for reforestation, a process that will require years before fruition, it would seem fitting to sound a note of warning to those companies and individuals who are so fortunate as to find themselves still in possession of timbered lands. In the observations of the late Mr. Atkinson it was ascertained that in producing a tree 12 inches in diameter the various species require the following number of years:

Black locust, 45 years; tulip, 50 years; black oak, 50 years; black walnut, 56 years; sweet gum, 62 years; ash, 72 years; hickory, 90 years; white oak, 100 years.

And so mighty oaks and poplars were not grown in a decade nor yet in a century, and it should be a fixed policy to protect and harvest these wisely and conservatively. Much timber is still wasted in the stump and tops, and younger trees many times are destroyed in the felling of a larger neighbor, all of which evils may be corrected by proper attention. The forest fires, recurring as they do with each fall season, are destructive to young trees as well as to old, and the prevention and proper handling of this menace constitutes one of the serious problems of forestry. Where practicable, forest reserves should be fenced so that the young trees may begin their growth protected from cattle and other destructive agencies.

In concluding, it is to be hoped that mining men may be keenly alert to the dependence of our industry on forestry, and lend their aid in the solution of this national problem, by planting and caring for young trees and by conserving the present supply of timber through wise harvesting and protection from the many ever-present dangers. The situation increases in seriousness and we should do our part in relieving it.

采 采

Coal Statistics, 1912

PENNSYLVANIA

Pennsylvania more than retains its distinction as the greatest coal producing territory in the United States, the production for 1912 aggregating the tremendous total of 245,231,555 net tons, one-half of the output of the entire country.

The bituminous coal production was 160,973,428 net tons, an increase of 18,784,099 net tons over 1911 and 11,414,381 net tons over 1907, the year showing the highest previous record.

Along with this great output it is gratifying to note that the number of fatal accidents has been decreased, a matter of sincere congratulation and the direct result in the bituminous region of the enforcement of the new Bituminous Code passed at the Legislative Session of 1911. This

Code during its progress through the Legislature was made the object of bitter attack by the mine workers of Western Pennsylvania and also by some of the operators, and a stubborn fight was made against its passage. It did not meet the views of the mine workers in its provisions relating to safety conditions, which they thought were not drastic enough, and was objectionable to the operators whose point of view was diametrically opposed to that of the mine workers, because its provisions were deemed too drastic and their enforcement would be likely to entail great expense.

The operation of the Code during 1912 has demonstrated that as far as its requirements regarding safety are concerned it is an improvement on previous laws, as the number of accidents was reduced more than 15 per cent., and as far as the increased cost of operation is concerned, it may be said that the operators have met the requirements of the law with a promptness and completeness most commendable.

The number of employes in the bituminous coal region was 182,680; the number of fatal accidents was 437, a decrease of 78 from the previous year.

The tonnage that was produced per fatal accident was 368,360, an increase of 92,264 tons. This production per life lost has not been equaled since 1888. Under the new Code the number of inspectors in the bituminous coal region has been increased and the operators have almost doubled the number of assistant mine foremen, which affords more protection and more thorough inspection of the mines, and will, no doubt, add greatly to the safety of mining operations.

The production in the anthracite region in 1912 was 84,258,127 net tons, a decrease of 6,659,049 net tons from the preceding year, due to the suspension of operations in April and May pending a settlement of the wage agreement. The number of employes was 175,964; the number of fatal accidents was 593, a decrease of 106 from 1911. The number of fatal

accidents in 1911, however, was unusual, as 79 lives were lost that year in mine fires. The tonnage produced per fatal accident was 142,088, an increase of 12,021 tons over 1911.

If the proposed Code for the

	1911	1912
Number of mines reporting.....	45	48
Machine men employed.....	220	181
Loaders.....	435	563
Miners.....	1,715	1,538
Inside day men.....	764	746
Outside day men.....	642	570
Total employed.....	3,776	3,598
Average per day per man.....	3.3 tons	4.3 tons
Total tonnage produced.....	2,913,406 tons	3,143,799 tons
Total value, selling price.....	\$4,904,620.83	\$5,600,097
Tonnage per life lost.....	224,108	314,380 tons
Tons per serious accident.....	58,268	66,889 tons
One life lost for every.....	290 employed	360 employed
One serious accident every.....	76 employed	76 employed
Per 1,000 employed, killed.....	3.44	2.78
Per 1,000 employed, injured.....	13	13
Black blasting powder used.....	1,808,745 pounds	1,818,500 pounds
Dynamite.....	35,220 pounds	25,331 pounds
Hand mined and shot off solid.....	1,847,318 tons	2,069,540 tons
Machine mined.....	1,066,088 tons	1,074,258.6 tons

anthracite region to be presented to the present Legislature should become a law, it is believed that it will further add to the safety of mining in that region.

In both regions during the past few years there has been a marvelous advance and improvement in the equipment of the mines. Every approved safety device has been adopted and every intelligent means is being taken to safeguard human life. The equipment of Pennsylvania mines, the facilities for the extraction of coal, and methods of operation, together with the progressive spirit displayed by leading mine officials along the lines of greatest safety to their employes, and the excellent progress made recently in welfare work, place the state ahead of any other coal mining territory in the world.

FATAL ACCIDENTS IN 1912 IN ALABAMA COAL MINES

Cause	Avoidable	Unavoidable	Per Cent.
Fall of rock.....	40	14	45.0
Fall of coal.....	6		5.0
Fall of rock and coal.....	1		.8
Gas.....	12		10.0
Powder.....	1	1	1.6
Electrocuted.....	7		5.7
Machinery.....	1		.8
Tram cars.....	11	1	10.0
Motors.....	2		1.6
Railroad cars.....	3		2.4
Suffocation from gas.....	13		10.7
Haulage rope.....	2		1.6
Shaft.....	3		2.4
Going back on shot.....	3		2.4
Totals.....	105	16	
Percentages.....	87	13	100.0
Total of accidents.....	121		

MONTANA

The following are the statistics concerning coal mining in Montana for the years 1911 and 1912 as compiled by James B. McDermott, State Coal Mine Inspector:

	1911	1912
Number of mines reporting.....	45	48
Machine men employed.....	220	181
Loaders.....	435	563
Miners.....	1,715	1,538
Inside day men.....	764	746
Outside day men.....	642	570
Total employed.....	3,776	3,598
Average per day per man.....	3.3 tons	4.3 tons
Total tonnage produced.....	2,913,406 tons	3,143,799 tons
Total value, selling price.....	\$4,904,620.83	\$5,600,097
Tonnage per life lost.....	224,108	314,380 tons
Tons per serious accident.....	58,268	66,889 tons
One life lost for every.....	290 employed	360 employed
One serious accident every.....	76 employed	76 employed
Per 1,000 employed, killed.....	3.44	2.78
Per 1,000 employed, injured.....	13	13
Black blasting powder used.....	1,808,745 pounds	1,818,500 pounds
Dynamite.....	35,220 pounds	25,331 pounds
Hand mined and shot off solid.....	1,847,318 tons	2,069,540 tons
Machine mined.....	1,066,088 tons	1,074,258.6 tons

IOWA

The following coal mine statistics for 2 years ending June 30, 1912, are taken from the Sixteenth Biennial Report of State Mine Inspectors, of Iowa:

Dist.	Inside Fatal	Non-Fatal	Production	Inside Employes
1	21	90	5,355,697	6,727
2	23	78	4,893,097	5,047
3	22	126	4,301,708	4,788
Total	66	294	14,550,502	16,562

One fatality for every 220,462 tons mined; one fatality for every 251 men employed in mines; 40, or 60 per cent. of the fatalities due to falls of top or coal; 156, or 53 per cent. of non-fatal accidents due to falls of top or coal; two fatalities due to dust explosions originated by shots. No accidents, fatal or non-fatal, due to gas explosions.

乘 乘

The Cunard Steamship Co. is said to be developing at Morrisdale, Clearfield County, 1,600 acres of a 5-foot thick bed of bituminous coal, which with the adjoining acreage of the same bed leased by the company, will require 50 years to mine.

Modern machinery and electric power and haulage will be installed. Two thousand tons a day will be shipped until the heart of the deposit is reached, when the output will be vastly increased.

Stopping Ventilation at Firing Time

Can It Be Safely Done?—A Discussion of the Dangers Likely to Result From Such a Proceeding

By W. H. Reynolds and Sim Reynolds

TO one conversant with Pennsylvania's larger and more dangerous bituminous mines, and the conditions governing them, in so far as concerns the control of gas and dust, the suggestions frequently repeated of later weeks in the contemporary mining press relative to the closing of the mine to all air at firing time seem almost ludicrous, if it were not that beyond those suggestions lie possible death and destruction of property. Personally speaking we have followed bituminous mining for upwards of 30 years but never have we heard or read of a reform idea meriting, in our opinion, more caution in acceptance.

But at the outset we would not be misunderstood. The field from which this still-air idea emanates is not our field. We never worked in that particular country, and base our surprise and criticism on the promulgation of the idea only on this fact: like our own, the Iowa and Oklahoma coal territory is bituminous, and like ours generates gas and dust in explosive quantities; and it is (*sic?*) to forestall these elements from exploding, that Messrs. Verner and McAllister—as the leaders of The Ventilation Reduction Party—ardently, and no doubt earnestly, advocate the stoppage of the fan, and, where possible, the shutting off of even any slight natural ventilation previous to and at all times while the firing continues.

While we do not for a moment doubt the truth and accuracy of the investigations made by the gentlemen mentioned, yet we cannot convince ourselves that the coals where the tests were wrought to a successful conclusion are in circumstance and condition similarly adjusted with our own. We are reactionaries and "stand patters" in this premise, that's sure, although we are honored with a reputation for advocating and putting into practice—wherever possible—any well-founded reform pertaining to mining. However, we cannot convince ourselves that disaster would

not follow on the heels of a forward movement of this character, if essayed in some of Pennsylvania's bituminous mines, or in those rather where one-half to 1 per cent. of inflammable gas is thrown into the mine air every minute of the 24 hours. Stopping the fan, for say only an hour in many entries driving into virgin coal, would certainly be a risky proposition even with permissible explosives used to break down the coal.

The contention of Messrs. Verner and McAllister is that placing steel doors over the upcast, stopping the fan over the downcast, and closing up every opening that could admit air, would so deprive the mine atmosphere of oxygen that it would be practically impossible for an explosion to happen, since there would then be not enough of oxygen for the flame of an explosion to feed on, or else that the stopped air would prevent any outlet to the initial pressure. The natural elasticity of air compressed under pressure from any source, the principle of which is well-known to most schoolboys, is in itself sufficient refutation of that idea. And the other phase of the matter seems equally unfounded on actual facts and natural laws, unless the latter vary in accordance with longitude and latitude. Mine atmosphere so devoid of oxygen as to be incapable of giving body to an explosion would certainly not give the combustion necessary to sustain human life.

Hence the utter incongruity of this statement regarding the non-combustible properties of ordinary mine air just merely stilled. Such cannot be the case, we would think, unless some chemical action took place, or its equivalent in the transpiration of immunizing gases. And there is no record in any of these articles which have come to our notice of anything like that. Therefore we must assume that the contention is based

solely on the immaturity caused by making the air absolutely still at the face for a certain length of time. And if we understand the mat-

ter rightly as above stated, we wouldn't give much for the conservatism—however much we respected bravery bordering closely on foolhardiness—of any shot firer, fire boss, or mine foreman, who would willingly enter any one of a hundred entries now being driven into virgin territory in the Washington-Greene section of the Pittsburg seam, and in a number of other parts of the bituminous region of Pennsylvania, 1 hour only after all natural and artificial ventilation had been cut off, and fire a series of heavy shots. Of course it might be possible, but hardly practicable, to so dilute the mine atmosphere with carbon dioxide or other non-combustible gases that firing could go on safely in so far as concerned the engendering of an explosion. But in that event a corps of shot firers would not live long enough to fire one round of shots, let alone 400 or 500. And how long would it take to reduce an extensive mine to that condition? Certainly longer than all the time that could be allowed between the stoppage of work and the time of firing.

Regarding one phase of this subject, we are fully in accord with our western contemporaries. No man well versed in contemporaneous coal mining will deny that the powerful air-currents met with in many of our modern mines would aid greatly in an explosion, once the start was made; but, would not the velocity and pressure of explosions such as wrecked Darr, Monongah, Harwick, or Marianna, have been quite sufficient in either case for the completion of its tragic purpose: the wrecking of the mine and killing of all living men and animals in it, even if the fan had been closed in and stopped a few minutes previous to the gas, or arc, or powder-engendered flame's inception? Would not the oxygen content of any one of these mines, when of sufficient volume

to sustain human life at all, have served for all the combustion needed to complete the job? Let us take a few actual measurements and see.

For the purpose of this article we will assume a newly opened heading in the thicker portion of the Pittsburgh bed. The coal, we'll say, is 7 feet thick; the entry is 10 feet wide. Assuming the place is driven in 100 feet, we have an area of 8,000 cubic feet of air space. Gas is transpiring into that heading at the rate of one-half of 1 per cent., a by no means uncommon quantity we have personally experienced. Four other headings, in all essentials the same, take their air from the same split, along which we have a volume of 20,000 feet per minute. Therefore, at the end of 1 hour of still air, there is lying at the face of the heading first referred to 1,200 feet of gas. Assuming the seam to be normally flat, this body is all in near proximity to the point where the shots are to be fired. We have assumed 1 hour as being about the average interval of time between the stoppage of work and the time of firing. Under these conditions, at the moment the shot firer enters this heading on his round of the section, in this short entry alone we have a volume of 5,800 feet of ordinarily pure mine air, 1,200 feet of the 7,000 being crowded out by the amount of gas transpired. Since its oxygen content has not been reduced by any chemical action, this 5,800 feet of air is quite capable of serving as a starter for the 1,200 feet of gas, and whatever dust might be lying near. Thus we have a condition in this one heading alone that on the firing of a shot would have within itself the possibility of engendering approximately 11,000 feet of flame, a body of fire calculated to do quite efficiently the work the same chain of circumstances have done—at Harwick, for instance—where the fan had been stopped "over Sunday." And in this case, while it had been started up shortly previous to the firing of the fatal shot, through the downcast being practically closed with ice, the "blind butt" in which the explosion of that mine started

had at that moment no doubt its full length of "still air." For it was proven afterward that the fan shaft at Harwick was practically, if not altogether, closed at least all of Sunday night, thus unintentionally doing the very thing this theory of air stopping would have us do intentionally. In the fatal "blind butt," where the shot was fired about 8 A. M., it has been proved almost conclusively, since the disaster, that a body of gas was lying, owing to the air not being in normal circulation at the time to clear it out. And we mention this instance because of its pertinence to the subject in question, as being unintentionally as near an approximation of what could be expected to happen if the same condition were to be brought about deliberately, in the Pennsylvania field at least. And the pressure of that, seeking, as it would inevitably do, whether the air were still or otherwise, the place of least resistance to get an outlet for itself, would move any doors which might be placed against it.

Let us assume, however, that steel or other heavy doors had been placed over the upcast of that mine mouth out of which there escaped force sufficient to lift the body of a mule clear from the shaft bottom to the surface, high above the tippie, and heave it some 300 feet beyond the shaft. Does it stand to sense that any temporary barrier would have barred the outlet of such increase of pressure as would inevitably follow the explosion of the gas and dust throughout an ordinary mine, even if it did withstand the initial shock incidental to the burning of the gas and dust in the short heading furnishing only 11,000 feet of flame? We believe not, and while we respect the courage of our contemporaries in the middle coal field in giving themselves up to test this theory in their own premises, and have not the slightest doubt as to their truth and earnestness, yet we would be loath to essay the same effort in many mines in Pennsylvania, nor would we like to suggest the trial to any one else. A better plan would be to give the shots no chance

of exploding anything except their own constituents.

We would suggest to the reader in search of experiments that he try that which has been proved good, not in one or two unusual environments, but in hundreds of gaseous and dusty mines. Let him dilute whatever marsh gas is generated by a conservative quantity of air. And right here, before we go any further, let us say that in this phase of the subject we are practically agreed with Messrs. Verner and McAllister. The mining man, being only human, is, like all humanity, prone to go to extremes in anything he undertakes. And this matter of ventilation is in many places being radically overdone. We all know that to fire shots against too much pressure is not the safest thing in the world. And despite the production of a large amount of firedamp in some mines there is too much water gauge. Of course this is preventable but the means thereof cannot be discussed here. Many of our "model" mines are victims of this habit. Like the dear ladies, God bless 'em! with their inverted dishpan and peach-basket hats, their tight corsets, high heels and hobble skirts, we mining men run greatly to "fashions" in reform, avoiding, in many instances, the good and practical because it is old. And while, far be it from us to decry the seeking after new things, or a better way of doing mine work, for only the explorer finds new lands and fairer, yet the wise general looks well to the lines behind him before pushing too far to the front. There is such a thing as the radical mine manager going so far into untried fields as, like Napoleon, to find another Moscow and be compelled to retrace his steps in sorrow and regret. The better plan is, as we have said, to feel one's way cautiously into the newer things and stick meanwhile to those which have been proven practical in his own field, remembering at all times that as circumstances and conditions differ so will vary any method in mining.

And in his effort to strike the proper proportion of air, any up-to-date

mine foreman should be able to solve the problem by careful analysis. If he have any doubt the nearest Federal Mine Bureau men will gladly tell him just what to use and how to use it, and will aid him in reaching the proper amount for complete safety. They will aid particularly by making accurate tests of samples of the mine air. This done several times, and taken in its proper correlation with other conditions, will soon enable the mine foreman to gauge the requisite amount of air that will serve his need best. And we firmly believe the lower this can be reduced, in safety, the better. But this is a matter demanding great caution.

The second essential is to keep the mine as well moistened as possible with water or steam, and particularly the vicinity of every shot within at least 25 yards.

Third, let him have his coal properly mined, and particularly the rib sides well squared up, and demand of the miners and shot firers that no holes be fired which enter the solid at all; and if the bed be more than normal thickness, for instance like Harwick, where two seams come together with a parting of heavy slate or "bone" coal, it were far better that the lower section be blown down separately, rather than the terrifically heavy shooting be allowed which is necessary to blast two seams bound in or near the center with a stratum of from 6 inches to 18 inches of foreign substance.

Moreover, a good idea is the method of having the shots fired from the return end of the current, assuming of course that all the men be out of the mine except the shot firers, which should be the case of course in mines where any necessity exists for shot firers. Chances of a more explosive atmosphere being created through the rapid firing would obviously be lessened in this way, and likewise the firer would have a clearer air in which to inspect and do his work.

These few simple precautions, with the use of an explosive as near flameless as can be found, will, without

stopping the fan or any other extreme measure, give to the most naturally dangerous mine as much safety as we at present know how to gain. And in a matter like this, which involves in many mines the lives of hundreds of men and the possible destruction of tens of thousands of dollars' worth of property, the well-proved way to safety is the only way the wise manager will take, even if the more enticing and quicker method of shutting off all air may be easier to put into practice, and show a larger monetary return. And by "well proved" we mean methods of mining which have been tried out under varied conditions in his own field and under circumstances similar to his own. For the good mine manager will only be guided by another man's suggestion in so far as he fully believes it coincides with needs created by the artificial and natural conditions affecting his own particular mine.

There is no trade in which "cut-and-dry" theory or "established practice" is liable to lead a man into more pitfalls, nor any trade where a sound judgment, common sense, and inflexible discipline (which means a perfect willingness to bring suffering, mental and physical, on himself and family if need be) will be more certain to bring ultimate success. Not necessarily at one mine, but sooner or later it is sure to.

And particularly tragic would it be if some misguided man were to lose his own life or the lives of others through misdirected zeal regarding the application of a method which, while conserving life and property in some other field, may be the cause of destroying both in his own. Hence the great need, in these days of radical changes, for caution. "Be sure you're right then go ahead," applies more pertinently to the man in control of a dangerously dusty and gas-producing mine than to any industrial officer we know of. For there exists in all truth every possibility for such misadventure, since many a sensitive man, knowing his mine to be dangerous (and believe us, reader, all the men in control of

the Underground are not calloused yet to the possible loss of human life, and will go to any lengths to avoid it), such a man will, with the best of intentions sometimes try out even so extreme a plan as this one of shutting off all the air from his "faces," if he have but a faint idea "it might work."

For many a mine manager, with a mine always in a state bordering the danger line, the "proofs" of this method and the "proofs" of that come like the patent "cure all" to the chronic dyspeptic: as a beacon light warranted to lure him gently but permanently (*sic?*), if he but take enough of bottles, from the possible tragedy which haunts his days with mental torture—fearing always the devilishness of some careless subordinate—and his nights with troublesome dreams. Wise is he who finds one that will work and sticks to it until he be sure of a better.

來 來

Practical Miners' Course

Prof. C. J. Norwood, Dean of the College of Mines and Metallurgy, State University, Lexington, Ky., announces through his assistant, H. D. Easton, E. M., that the practical course for miners, mine foremen, and managers will begin its session, May 19, 1913, and end July 12.

Persons pursuing correspondence courses will find the 8 weeks of personal instruction beneficial. This course has the authority of the Board of Trustees of the State University back of it, and each man who completes this course will be given a certificate showing the fact.

The equipment used for demonstrating mining at this institution is excellent, and cannot but be helpful to any one studying the course of coal mining. The ground covered is, coal mining, mine gases and testing, explosions and fires, surveying and mapping, mine-rescue apparatus. The fee charged is \$10, and room and table board can be had from \$2.50 to \$3.50 per week. For further information address H. D. Easton, E. M., Lexington, Ky.

PRIZE CONTEST

For the best answer to each of the following questions we will give any books on mining or the sciences related thereto, now in print, to the value of \$3.

For the second best answer, similar books to the value of \$2 will be given.

Both prizes for answers to the same questions will not be awarded to any one person.

1. The name and address in full of the contestant must be signed to each answer, and each answer must be on a separate paper.

2. Answers must be written in ink on one side of the paper only.

3. "Competition Contest" must be written on the envelope in which the answers are sent to us.

4. One person may compete in all the questions.

5. Our decision as to the merits of the answers shall be final.

6. Answers must be mailed to us not later than one month after publication of the question.

7. The publication of the answers and names of persons to whom the prizes are awarded shall be considered sufficient notification. Successful competitors are requested to notify us as soon as possible as to what books they want, and to mention the numbers of the questions when so doing.

8. In awarding prizes, other things being equal, a carefully written and arranged answer will be given the preference.

9. Employes of the publishers are not eligible to enter this contest.

Questions for Prizes

17. *Diameter of Collar.*—The diameter of a collar, 8 feet between supports, is 10 inches; what should be the diameter of a collar, 16 feet between supports, the weight increasing in proportion to the length.

18. *Weight of Rope.*—What weight of rope will be required to hoist 7 gross tons from a shaft 400 feet deep.

19. *Blasting Coal.*—Explain the principle involved in the use of powder in blasting coal, stating why common black powder is better for this purpose than high explosives, such as dynamite or other nitro-glycerine compounds.

20. *Laying a Cross-Over Switch.* Explain each step in the laying of a cross-over switch between the loaded and empty tracks, on a mine haulage road. Show the method of locating the frog in each track, and give the proper frog angle that should be used, the frog distance, the degree of curvature of switch rails, etc.

Answers for Which Prizes Have Been Awarded

QUES. 9.—*Method of Mining.* There is a tract of land containing 840 acres in a nearly square plot, in which at a depth of 630 feet there is 4 feet of clean coking coal lying practically horizontal. The floor of the seam is

so soft it creeps; the slate roof rock next to the coal is from 2 to 4 feet thick and liable to fall unless pulled down. It is desired to know what system should be followed when mining the coal and the advantages of the system advocated, using a sketch.

Ans.—Before deciding upon a method of working any coal seam we must have a clear understanding of the conditions under which the seam has to be worked. The chief conditions stated in this question put us up against one of the greatest difficulties in modern mining.

To be brief, the necessary precautions should be taken to guard against thrust and creep; and to overcome this difficulty the longwall retreating method should be adopted. In this method of work, narrow roadways are driven to the boundary line in each district and the coal is worked back by a longwall face, leaving the goaf

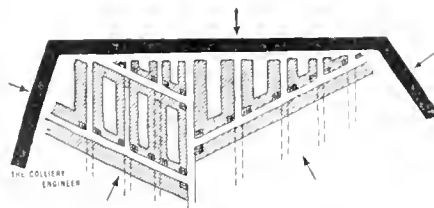

FIG. 1. LONGWALL ADVANCING

behind. There is only one objection to this system of work; it requires a large amount of capital to be laid out before there is any return, but when some of the districts reach the line, it is the beginning of a rich har-

vest, as practically all dead work is left behind.

If the necessary capital was not available I would then adopt the longwall advancing system, as shown in Fig. 1. Under this system the whole of the mineral is usually extracted in one operation with a probable loss of from 5 to 10 per cent. My reasons for selecting this method over pillar and stall or stoop and room are: (1) Because we have the necessary conditions here to build pack walls, therefore all debris is kept in the mine; (2) more adequate and simpler ventilation; as the ventilation travels along the line of face it finds a new course, so to speak, every day, therefore, it will be much cheaper; (3) because a greater percentage of coal can be got from that obtainable. As regards consumption of timber and safety, there is but little difference, but any difference there is, may be in favor of longwall, therefore, longwall would be much more economical, especially the retreating method. I might say that machine-cut coal is another great factor where a top is weak, because the line of face advances quicker and allows a more uniform sinking of the strata, and if this system of work is judiciously carried out the workmen will be working under newly exposed roof every 24 hours.

The machine I would prefer to use would be one of the most up-to-date bar type, as there is no danger of its

being held up with the coal setting down on it, as there is only the diameter of the bar plus the length of picks (which may not exceed 8 inches) under the cut.

As the coal is likely to fall, due to the natural conditions, I would put sprags under it to keep it up until the loaders come to work. As the floor is soft and creepy I would prefer to cut in it; this would further increase the percentage of good marketable coal, and would also give more height for tramroads, which in this system will be brought along the face from the road head, as shown in Fig. 2.

As the top is likely to fall, it calls for a good system of timbering; the system I would adopt would be to cross-timber at right angles to the cleats and line of face. The best way to do this is to use cross-timbers sufficiently long to permit one end to rest in a hole cut out in the top of the coal as seen in Fig. 2, and a post under the other end next to the pack wall. This system serves a double purpose; it supports the roadway along the line of face, and it allows the machine to cut without moving any posts. There should be a man there, when machine is cutting, to put a second post up to the cross-timbers just as soon as the machine gets past. I would suggest the length of walls to be 50 or 55 feet, roadways 10 feet wide, pack walls 6 feet along the roadside by 10 or 12 along the face. There will be a space left from the back end of the pack wall on the one road to the back end of pack wall on the next road equal to about 20 feet, and I would support this by putting in two wood pillars or chocks, always keeping two rows of them near to the line of face; and as the face advances I would withdraw the back row and reset them when needed. As the strata overlying the pack walls, etc., are gradually sinking, this causes a locking effect on the strata due to the angular position from the horizontal, and as the packs, or, as we might call them, cushions, become compressed they tend to maintain the height on the roadway by carrying the weight over in to where the

greater space has been left unsupported.

The debris required to build the pack walls is got by ripping down the slate roof, which is likely to fall, equal to the width of roadway, which I suggest to be 10 feet; my reasons for making roads that width are because all the ripping can be used in

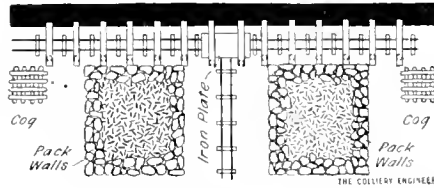

FIG. 2. PLAN SHOWING PACKS, TIMBER AND TRAMROAD

the pack walls or buildings and because the roadways will get narrower, due to compression and strata movement.

ALEXANDER WILSON,

Box 257, New Lexington, Perry County, Ohio.

Second Prize, R. J. Pickett, Shelburn, Ind.

QUES. 10.—Capacity of Fan.—What quantity of air in cubic feet per minute will be obtained with a 2-inch water gauge, when a fan 24 feet in diameter makes 90 revolutions per minute under the following conditions: Diameter of the central orifice of intake 12 feet, area of the discharge, 60 square feet; length of the blades, 9 feet; length of the airway, 3,600 feet; area of the airway, 60 square feet.

Ans.—The quantity of air that a fan will yield equals the efficiency multiplied by the centrifugal force and divided by the unit of ventilating pressure multiplied by one-half the acceleration multiplied by 60, or by formula,

$$q = 60 \left(\frac{K F}{p} \times \frac{f}{2} \right)$$

when K = efficiency of fan;

F = centrifugal force in pounds;

f = acceleration in feet per second;

p = unit of ventilating pressure.

The centrifugal force is found from the formula

$$F = \frac{W V g^2}{g R g}$$

when W = weight of air revolved in pounds;

$V g$ = velocity of revolved weight (W) in feet per second;

g = force of gravity in feet per second, usually 32.16 at sea level;

$R g$ = distance of center of gravity from center of revolution in feet.

Breadth $b = \frac{5}{8} d = \frac{5}{8} \times 12 = 7.5$ feet. Then for the volume, $V = .7854 (D^2 - d^2) b = .7854 (24^2 - 12^2) 7.5 = 2,544.696$ cubic feet.

Assuming that 1 cubic foot of air weighs .0788 pound, then $W = 2,544.696 \times .0788 = 200.522$ pounds.

Solving for the value of $R g$, $R g = \frac{2}{3} \left(\frac{R^3 - r^3}{R^2 - r^2} \right)$, in which R = outside radius, r = inside radius; then $R g = \frac{2}{3} \left(\frac{12^3 - 6^3}{12^2 - 6^2} \right) = \frac{2}{3} \left(\frac{1,512}{108} \right) = 9.3$ feet

from center of fan shaft. For each revolution of the fan the center of gravity passes over $3.1416 (9.3 \times 2) = 58.43376$ feet, the fan making 90 revolutions per minute, $58.43376 \times 90 = 5,259.0384$ feet per minute. $\frac{5,259.0384}{60} = 87.65064$ feet per second.

$$F = \frac{W V g^2}{g R g} = \frac{200.522 \times 87.65064^2}{32.16 \times 9.3} = \frac{1,540,537.234}{299.088} = 5,151 \text{ pounds nearly.}$$

The acceleration is expressed by the formula $f = \frac{K F}{p a} g$. Then assuming

$$f = \frac{.60 \times 5,151 \times 32.16}{5.2 \times 2 \times 60} = \frac{98,793.696}{624}$$

= 158.323 feet per second; then

$$q = 60 \left(\frac{K F}{p} \times \frac{f}{2} \right) = 60 \left(\frac{.60 \times 5,151}{10.4} \times \frac{158.323}{2} \right) = 60 \times 29.813 \times 79.1615$$

= 141,602.50797, or say, 141,600 cubic feet per minute. Ans.

The foregoing shows the correct way of calculating the quantity of air that a fan will yield under the given conditions, although a calculation may be gathered from the following

which is near enough for all practical purposes:

The total area = $24^2 \times .7854 = 452.3904$ square feet.

Area of central orifice = $12^2 \times .7854 = 113.0976$ square feet. Then breadth = $\frac{5}{8}d = \frac{5}{8} \times 12 = 7.5$. The volume of air displaced at each revolution of the fan is $(452.3904 - 113.0976) 7.5 = 2,544.696$ cubic feet. The efficiency of the fan was assumed to be 60 per cent., therefore, the volume discharged is $.60 \times 2,544.696 = 1,526.8176$ cubic feet for each revolution. The fan making 90 revolutions per minute, $1,526.8176 \times 90 = 137,413.584$ cubic feet per minute, or, say 137,400 cubic feet per minute.

WM. HOLLOWAY,

Box 526, Henryetta, Okla.

Second prize. None.

QUES. 11.—Hoisting.—From a coal shaft 650 feet deep, it is desired to hoist 1,200 tons of coal in 8 hours. The engine is 20 in. \times 36 in. first motion and is run so as to give an average speed of 1,600 feet per minute. What steam pressure will be required and what weight of coal should a car contain?

Ans.—Hoisting speed equals 1,600 feet per minute, or $\frac{1,600}{60} = 26.6$ feet per second.

To make one trip would then require $\frac{650}{26.6} = 24.4$ seconds; to this must be added 10 seconds for changing cars each trip; this would then be $24.4 + 10 = 34.4$ seconds each trip. Allowing 30 minutes for delays, this will leave $7\frac{1}{2}$ hours actual hoisting, $7\frac{1}{2} \times 60 \times 60 = 27,000$ seconds for 1 day's hoisting.

The trips per day that can then be made equals $\frac{27,000}{34.4} = 785$.

Then the capacity of car will equal tonnage hoisted divided by number of trips, $\frac{1,200}{785} = 1.529$ tons.

The actual load on the engines equals the net load plus 10 per cent. of the gross load.

The weight of coal in a car equals $1.529 \times 2,000 = 3,058$ pounds. Assuming weight of empty car 1,200

pounds, and weight of rope 1.8 pounds per foot, and weight of cage 4,000 pounds.

Then, two cages 4,000 pounds each = 8,000 pounds; two cars 1,200 pounds each = 2,400 pounds; two ropes $(1,300 \times 1.8) = 2,340$ pounds; one lot of material = 3,058 pounds. A total of 15,798 pounds.

Ten per cent. of 15,798 pounds = 1,579.8 pounds. The actual load will then equal $1,579.8 + 3,058 = 4,637.8$ pounds. This load has to be hoisted 650 feet in 24.4 seconds, which equals $\frac{4,637.8 \times 60 \times 650}{24.4}$

= 7,412,877 units of work per minute, or foot-pounds.

Then, $H. P. \times 33,000 = u$

$$u = P L A N$$

Then, $7,412,877 = P L A N$

$$\text{or } P = \frac{7,412,877}{L A N}$$

The number of strokes per minute is twice the number of revolutions. To get the number of strokes per minute we will have to find the size of the drum required.

Assuming that a $1\frac{1}{4}$ -inch rope is used, the drum should then be 100 times the diameter of the rope,

$$100 \times 1.25 = 12.5 \text{ feet.}$$

The circumference will then be $3.1416 \times 12.5 = 39.27$ feet. The num-

Sta.	Bear.	Dist.	North	South	East	West
A-B	N 36° 18' E	448	365.63		258.88	
B-C	S 73° 40' E	565		158.89	542.20	
C-D	S 10° 36' W	368		361.72		67.69
D-E	S 19° 29' E	433		408.21	144.42	
Total...			365.63	928.82 365.63	945.50 67.69	67.69
Difference.....				563.19	877.81	

ber of revolutions per trip will be $\frac{650}{39.27} = 16.55$. The number of strokes per trip $16.55 \times 2 = 33.10$. Assuming 3-foot cylinders, the piston distance traveled per trip will equal $3 \times 33.10 = 99.30$ feet. Then, $\frac{99.30 \times 60}{24.4} = 244$ piston speed per minute.

Then,

$$P = \frac{7,412,877}{(20^2 \times .7854) \times 244} = \frac{7,412,877}{76,655}$$

= 96.7 pounds.

Assuming the engine has an efficiency

of 90 per cent. Then the steam pressure required will be $\frac{96.7 \times 100}{90} = 107.44$ pounds, practically 110 pounds.

Ans.—110 pounds steam pressure; 3,058 pounds capacity of car.

GEORGE WILKINSON,

Chase River, Nanaimo, B. C.

Second prize, Thomas F. Kissler, Mammoth, Pa.

QUES. 12.—Surveying.—The following data of an underground survey being given, find the course and distance from A to E and give the area of the figure enclosed:

From A to B 35° 18', 448 feet; from B to C 106° 20', 565 feet; from C to D 190° 36', 368 feet; from D to E 160° 31', 433 feet.

Ans.—In order to get the course and distance from A to E the survey must first be traversed, and to do that it is necessary to transpose the several bearings from azimuth to quadrant courses, and the notes of the survey become as follows:

		Feet
A-B	N 35° 18' E	448
B-C	S 73° 40' E	565
C-D	S 10° 36' W	368
D-E	S 19° 29' E	433

Traversing these bearings give the following result:

Sta.	Bear.	Dist.	North	South	East	West
A-B	N 36° 18' E	448	365.63		258.88	
B-C	S 73° 40' E	565		158.89	542.20	
C-D	S 10° 36' W	368		361.72		67.69
D-E	S 19° 29' E	433		408.21	144.42	
Total...			365.63	928.82 365.63	945.50 67.69	67.69
Difference.....				563.19	877.81	

The connecting bearing can now be calculated by the following rule: Divide the difference between the eastings and westings by the difference between the northings and southings. The quotient will be the tangent of the required bearing, the distance is obtained by dividing the difference between the eastings and westings by the sine of the bearing obtained by the above rule.

Applying these rules to the above example we have the following:

877.81 divided by 563.19 = 1.55863 = tangent of $57^{\circ} 19'$.

As we need a northing of 563.19 and a westing of 877.81 to close our traverse, the bearing is evidently $N 57^{\circ} 19' W$ from $E-A$ or $S 57^{\circ} 19' E$ from $A-E$.

The sine of $57^{\circ} 19' = .84167$. The difference in eastings and westings 877.81 divided by .84167 = 1,042.94, the required distance.

The area of the enclosed survey, including of course the calculated bearing, can be obtained in two ways: First, by platting the survey to a fairly large scale, say 100 feet per

distance of the last course is always equal to the departure of that course.

Having obtained the double meridian distances, multiply the double meridian distance of each course by its latitude, setting the products of the north latitudes in one column and the products of the south latitudes in another. The area of the field is equal to one-half the difference obtained by subtracting the sum of the north products from the sum of the south products or vice versa.

Tabulated in this manner our example shows as follows:

Sta.	Bear.	Dist.	North	South	East	West	Double Mer. Dist.	North Products	South Products
A-B	N $35^{\circ} 18' E$	448.00	365.63		258.88		258.88	94,654.29	
B-C	S $73^{\circ} 40' E$	565.00		158.89	542.20		1,059.96		168,417.04
C-D	S $10^{\circ} 36' W$	368.00		361.72		67.69	1,534.47		555,048.48
D-E	S $19^{\circ} 29' E$	433.00		408.21	144.42		1,611.20		657,709.95
E-A	N $57^{\circ} 19' W$	1,042.94	563.19			877.81	877.81	494,373.81	
Totals			928.82	928.82	945.50	945.50		589,028.10	1,380,175.47

inch, which also gives a check on the calculated bearing and distance.

By dividing the plot into triangles and scaling them off, the area can be ascertained with a degree of accuracy that will generally be sufficient for ordinary purposes, but where the ground is very valuable a more accurate method is by latitudes and departures.

The survey is traversed, in the example under consideration, by getting the latitude and departure of the calculated bearing, and from this traverse the double meridian distances of each course are found, the rule for which is as follows: Starting from the station farthest west, the double meridian distance of the first course is equal to the departure of that course, and for any succeeding course is equal to the double meridian distance of the preceding course plus the departure of that course plus the departure of the course being calculated. These additions are algebraic, for as long as the line is moving toward the east the departures are added, but when they start toward the west they are subtracted from the previous courses. As a check on the calculation, the double meridian

1,380,175.47 - 589,028.10 = 791,147.37 = the difference between the sums of the north and south products, and that divided by 2 equals 395,573.68 square feet, and that divided by 43,560 = 9.081 acres, the required area.

The area figured from the plot in this instance comes to 9.102 acres, or a difference of only .021 acre, but where the field is very irregular, containing a large number of triangles or trapezoids, the difference amounts to as much as an acre in some instances, and when coal is selling around \$1,000 an acre it pays to make the more exact calculation. In fact in a case of that kind I generally do it both ways as a check.

W. N. COLE,

Engr. Spring Valley Coal Co.,
Spring Valley, Ill.

Second prize, J. H. Sinclair, Calgary, Alberta, Canada.

來 來

A Coal Miner in the Cabinet

For the first time in the history of the United States a coal miner holds a cabinet position, and is a member of the advisory board to the President.

William B. Wilson, Secretary of Labor, came to America from Scotland when a small boy. His educational opportunities in youth were limited, as, at an early age he had to seek employment in the bituminous mines of Pennsylvania. Later he became a miner, and took an active part in labor organizations. He became a local leader, and was a member of the committee of United Mine Workers at Harrisburg, when a general bituminous mine law, as well as a number of other measures pertaining to both anthracite and bituminous mining, were before the Pennsylvania legislature. His evident honesty of purpose and his general character won for him the respect of mine owners and mine officials who were his opponents as far as some of the measures were concerned. He had his own views, and while sticking tenaciously to them, he respected the opinions of his opponents, and when convinced that they were wise, he readily admitted it.

Mr. Wilson has a great deal of natural ability. He cultivated it by reading and study, and broadened intellectually. Always loyal to his coworkers in the mines, and always fighting for what he considered was for their best interests, he, at the same time considered the rights of the mine owners, as he saw them.

In course of time he was nominated by the Democratic party for Congress and was elected. He made good as a Congressman and continued to broaden. While still a staunch advocate of union labor he believes in fighting labor's battles within the law, and deprecates violence and incendiary utterances. He has a Scotch conscience and a Scotch respect for law and order. His public life and intercourse with able men, aided by careful reading, have made him a well-educated man. His reputation has been such that when President Wilson chose his cabinet, he selected him for Secretary of the new Department of Labor.

Notes on Mines and Mining

Reports on Conditions and Other Matters of Interest in Various
Coal Fields

By Special Correspondents

ALABAMA—
Harry Coffin,
president of
the Alabama Con-
solidated Coal and
Iron Co., was given
permission by the
Federal Court to reopen Searles
mines, which have been idle for
several months.

The Tennessee Coal and Iron Co.
has contracted for the entire output
of the coal, amounting to 1,000 tons
per day, the intention being to use it
in the by-product coke plant at Corey.
The Searles mines are between Jeffer-
son and Tuscaloosa counties.

The Pierce Coal and Lumber Co.,
Bridgeport, Ala., is developing 24,000
acres of land near Princeton. The
first car of coal was shipped in
December. It is claimed to be high-
grade domestic coal carrying 3 to
4 per cent. ash, low in sulphur but
having about 40 per cent. volatile
combustible matter. It is therefore
a better gas coal than domestic coal.

COLORADO

About 12 miles from Steamboat
Springs, Colo., are several coal de-
posits. The road bed is nearly all
coal for a stretch estimated to be
at least one-half mile in length. The
bed is 4 feet in thickness and the coal
is being thrown away to make the
grade. A similar thing happened in
the Oak Creek as the graders were
building the road bed through the
coal fields, but not on so large a scale.

ILLINOIS

The first entirely electrical equipped
mine in Illinois is that of the
Christopher Coal Mining Co., at
Christopher, Ill. The coal seam at
this mine is 12 feet in thickness and
about 593 feet below the surface.
The record day's output for this
mine is a fraction over 3,075 tons, the
average number of men employed
being 500.

The Superior Coal Co., of Gil-
lespie, Ill., operates three mines and
places on an average of three air
stoppings per day. It's officers have
been experimenting with concrete
block stoppings and have demon-
strated that these blocks can be easily

and substantially made of cinders and
cement if the proper equipment is at
hand.

It is claimed that these stoppings
have special value as they can be
quickly built for emergency stoppings
to wall up a mine fire and after the fire
is quenched can be easily removed.
It is believed that shot explosions
which usually destroy other kinds of
stoppings will probably separate the
blocks but leave them in shape to be
reused.

Two were killed and 30 others
injured by an explosion in the Latham
coal mine near Lincoln, Ill., on
February 1. Three hundred men
were working in the mine at the time
and only two were killed. It is
stated that the lamp of Thomas
Loomis, the electrician, set off a
pocket of gas that caused the explo-
sion. He and Henry Weitkamper, his
assistant, were buried under a fall of
roof.

The Bunsen Coal Co., one of the
subsidiary companies of the United
States Steel Corporation, has over
25,000 acres of coal lands in the
vicinity of Danville, Ill. The new
mines, to be started in February,
will be located one-half mile west of
that city. Mr. Clay Lynch is general
manager.

KANSAS

Strip mining, the process of remov-
ing 10, 20, and 30 feet of covering
from a coal bed with a steam shovel,
is finding investors every week or so
in the Pittsburg, Kans., district,
where the method is in vogue to the
extent of twenty or more shovels.
Land dealers are renewing and buy-
ing options, as well as coal companies.
This is true not only of the shallow
beds, but of the deep coal also. The
Southwestern Development Co.,
known as a subsidiary of the "Katy"
railroad, recently optioned thousands
of acres of deep coal land on the west-
ern border of the present field.

Miller Brothers, on
the north side, con-
trol 3,700 acres, and
many other com-
panies and men
have large holdings.
The Moka Coal Co.,

was the last formed in the district for
steam-shovel mining. Six men, headed
by Oliver T. Jones, a practical coal
miner, capitalized at \$30,000 and
applied for a charter the first of
March. Also they leased 165 acres
on the Missouri-Kansas line on the
north side of the field and will install
a shovel in the immediate future. It
is said \$35,000 will be required to
start work. The stripping with
shovels started but little over a year
ago, and operators say it is in its
experimental stage, but they are
watching quietly and investing. Sev-
eral companies are preparing to put
in shovels.

KENTUCKY

From 20 to 30 cars of coal a day
are now being shipped by the Con-
solidation Coal Co.'s plant at
McRoberts, on Wright Fork, Ky.
The shipment goes over the Lexing-
ton and Eastern Branch of the
Louisville and Nashville. It is ex-
pected that, shortly, from 75 to 100
cars will be shipped a day from four
of the seven mines.

The Semet-Solvay Co., Syracuse,
N. Y., which will put in operation
the Ashland, Ky., by-product plant
this spring, is negotiating with
Rogers-Brown Co., of Chicago, who
are operating two pig-iron furnaces
at Ironton, Ohio, for the installation
of a similar plant for supplying coke
to these furnaces. The Semet-Solvay
people own their coal property under
the name of Solvay Collieries Co.

Messrs. Cunningham & Connor,
consulting engineers, Huntington, W.
Va., announce that they will com-
mence the construction of 10 miles
of standard gauge railroad running
from Stafford Station, 1 mile below
Paintsville on the Big Sandy division
of the C. & O., to the mouth of Green-
back branch on Jerry Creek in John-
son County. This line will later
be extended 20 miles to Quicksand,
Ky. All coal tonnage will come to

Paintsville going through the Big Sandy division.

When completed it is expected to be one of the heaviest feeders that the C. & O. will have, because of the fact that it will penetrate a coal tract of 150,000 acres. The road will be known as Big Sandy and Kentucky. Its entire length is through virgin coal and timber land, besides vast coal fields lay all along Paint Creek, Jerry Creek, and Middle Creek, as well as in the upper Licking River. It has been estimated that there are 650,000,000 tons of coal along this line. The entire line when completed will pass through Johnson, Magoffin, and Breathitt counties, and parts of Floyd, Knott, and Morgan counties.

The road will be laid so as to permit the handling of the heaviest class of equipment at any point.

Another large company, termed the Elkhorn Fuel Co., incorporated under the laws of West Virginia, has for its purpose the acquisition and operation of approximately 300,000 acres of coal property in the Elkhorn field of Kentucky. The company has a capitalization of \$30,000,000, of which \$4,000,000 is represented by five-year five per cent. notes; \$6,000,000 of five per cent. accumulative preferred stock, and \$20,000,000 of common stock. The management of the company will be vested in a board of fifteen directors. The officers of the company are J. A. Clark, Fairmont, W. Va., president; J. C. Fenhagen, treasurer; and C. T. Williams, vice-president and secretary.

It is reported that a Welsh syndicate represented by D. A. Thomas, of Newport, Wales, contemplates developing a large area of coal land in eastern Kentucky. After opening the mines the intention is to ship the coal by a line of steamers to South America. The Cambrian syndicate, as it is called, expects to ship 4,000,000 tons of coal a year as soon as it gets started.

SECOND OHIO MINE RUN LAW

Operators in Ohio pay their miners on the screened coal basis, that is, for coal passing over screen bars with spaces $1\frac{1}{4}$ inches between them. The

miners want to be paid on the run-of-mine basis; that is, for coal as it comes from the mines, and failing to come to an agreement with the operators, had William Greene introduce in the present Ohio legislature, a bill calling for the weighing and payment of all coal before it is screened.

At the annual meeting of the Ohio miners in January they passed resolutions indorsing this law and also demanded the following concessions from the operators:

A uniform working day of 6 hours at the working place for all classes of inside and outside day labor, based on the present price with a holiday on Saturday.

Uniform inside day-labor wage scale with proportionate advances with mine rates.

General substantial advance on machine and pick mining at the basing point; substantial advance on all dead work, deficient work, yardage, day labor, and that all breakthroughs be paid for at entry price.

That the next joint agreement be based on machine mined coal.

The present rate of pick mining was determined on the screened coal basis, that is, \$1 per ton for pick-mined coal passed over a screen with bars not to exceed $1\frac{1}{4}$ inches in spaces between.

REPORT ON OKLAHOMA COALS

For more than a year the Oklahoma Geological Survey has been carrying on field work in the coal area of the state. Much of the geology of the area has been worked out in considerable detail in former years, both by the United States Geological Survey and the State Survey. The chief work of the past year has been along economic lines. The main considerations were concerning quality and quantity, questions affecting the cheaper production and supply, and the uses which may be made of Oklahoma coals.

The results along these lines, which have been investigated both in the field and laboratory, together with the geological conditions of the field, will be published as a bulletin.

The report will contain much general information concerning coal, coal mining and coal consumption. Several maps, charts, diagrams, and half-tones will be used. About 150 new chemical analyses and heat tests will be given, and 100 or more other analyses will be included. The analyses are being made from samples collected from the mines and from earloads at the tipples. All samples were taken according to standard specifications adopted by the United States Geological Survey and Bureau of Mines. With each analysis will be stated the condition under which the sample was taken.

The report is intended to show to the consumer the quality and heat value of coals from the various beds and districts, to give some knowledge of the rate situation, transportation facilities and general mining conditions.

Edward Boyle, chief mine inspector of Oklahoma, closed the No. 2 mine of the Great Western Coal and Mining Co., on the grounds that the manways had not been completed. While 150 men were thrown out of employment, there was no other alternative if Mr. Boyle was to live up to his oath of office.

PENNSYLVANIA

The Lehigh and Wilkes-Barre Coal Co. has purchased the holdings, machinery, and good will of the Parrish Coal Co., of Wilkes-Barre. The Parrish company is an old concern with large collieries at Plymouth and Buttonwood, both near Wilkes-Barre. The Buttonwood mine caught fire a few weeks ago and to extinguish the blaze the mine was sealed.

A. D. Lamb, mine inspector of the Thirteenth Pennsylvania District, advocated that the Mine Code Commission embody in its report to the legislature a provision imposing a tax of one and one-half cents on every ton of coal mined. The money to be used for the benefit of the families of the men who are killed or maimed in the mine. Mr. Lamb declared that a greater part of the hard coal is shipped outside the state and that a small tax would not be felt.

Dolan Bros., of Pottsville, have started work on driving a 6,000-foot tunnel at Brownsville, for the Locust Mountain Coal Co., of which Baird S. Snyder, Jr., of Pottsville, is President. The ground will be removed until solid bottom is reached, then the work of driving the tunnel will commence. The main tunnel will be 4,000 feet long and the tunnel to the east basin about 2,000 feet. This is located on ground north of Shenandoah, recently leased from the Girard estate. The contract for the erection of the breaker and foundations has been awarded to H. K. Christ, of Mahanoy City.

The Lehigh Coal and Navigation Co., which has been having trouble with the men, has settled its grievances, and according to reports, loaders in the mine have received an increase of 30 cents a day, and battery men an increase of 40 cents.

Since the suspension in the anthracite field there has been continual friction between the men and the companies, petty strikes occurring in numerous places. The Oakdale, No. 4 colliery, of G. B. Markle & Co., was closed because the breaker boys' pay was in error. 1,000 men at the Henry colliery of the Lehigh Valley Coal Co. went on strike because all men did not wear Union buttons. 700 men struck at No. 7 Susquehanna Coal Co. because the company refused to allow Union officials to examine miners' buttons. 6,000 miners working for the D., L. & W. Coal Co. went on strike because the hoisting engineers were not members of the Union. 1,000 miners of the D. & H. Co. went on strike because of the discrimination in car supply.

The Brookside colliery, belonging to the Philadelphia & Reading Coal and Iron Co., suspended work indefinitely because miners refused to work with a dozen non-union men. The colliery at Williamstown, belonging to the same company was closed down for the same reason. To stop the annoyances resulting from petty strikes, because one or two men at the mine are not affiliated with the United

Mine Workers, the Philadelphia & Reading company has adopted a policy that in the future when such strikes are called the operation shall remain idle until the operators get ready to resume.

The development of the hitherto untouched coal fields of Washington and Greene counties, is forecasted in the information that the Pennsylvania Railroad is preparing to extend its line from Washington County south through the central part of the county and probably on into Green County. This branch has been discussed for years. It will give the coal a market route over the Pennsylvania line from northern Washington County. Josiah V. Thompson and his assistants are said to own over 130,000 acres of this coal land.

The Charleroi Coal Works property consisting of 1,200 acres and owned by the Pittsburg Plate Glass Co., has been sold to the Carnegie Coal Co. In 1910 the Charleroi company shipped 400,000 tons of Youghiogheny coal, and it is intended to market all this coal through the Carnegie Dock Co., at Duluth and Superior.

J. D. Boyd is suing the Wharton Coal and Coke Co., at Uniontown, Pa., asking triple damages aggregating \$72,000 for coal mined beneath his property. It is alleged by Boyd that 8,000,000 bushels were either mined or made inaccessible between the years 1907 and 1911.

Three men were imprisoned in the Draper colliery by Mahanoy Creek breaking through from the surface. This colliery is near Gilberton, Schuylkill County, Pa. Immediate steps were taken to change the channel, and the men were rescued after spending three days in the mine. The P. & R. C. and I. Co. were able to pump at the rate of one-half million gallons of water per day and so unwater the mine very fast, but the sludge and small coal that washed in made the cleaning in the gangways slow work. So soon as the first shift went to work there was a gas explosion in which several were burned.

Several men were hurt and several others had a narrow escape when a trip of three mine cars ran away down

a slope in one of the Susquehanna Coal Co.'s mines at Nanticoke, Pa. The rope that was hoisting the trip broke. There were 17 men in the cars. After going 200 feet the cars were derailed, some of the men saving themselves by jumping.

Recently there has been going the rounds of the press the information that a large coal bed, unknown to the Philadelphia & Reading Coal and Iron Co., had been discovered in Bear Valley. Experts are said to have declared it a new discovery that will yield millions of tons, and will be inexhaustible for hundreds of years. Since 1880 every acre of land owned by the Philadelphia & Reading Coal and Iron Co. in the Schuylkill regions has been cross-sectioned, but the Reading company was not in readiness to work all the coal beds owned, and this bed now stated to be recently found is one of them. There undoubtedly will be a large yield from this coal bed, but it was not newly discovered and has been included in the estimates of the coal in the Schuylkill regions, which already have been given out.

A NOTABLE RECORD

Jenkin T. Reese, mine inspector for the Fourth Anthracite District, called attention to the remarkable record of the National mine in his report to Chief Roderick, of the Bureau of Mines. This mine belongs to the D., L. & W. R. R. Co., and since 1910 there has not been a fatal accident, although 1,000,000 tons of coal have been mined. Superintendent C. E. Tobey in commenting on this record stated that the Manville mine, another of this company's collieries also had a perfect record for 2 years but it did not produce so much coal as the National. John Owens is inside foreman of the National and Frederick Peters is outside foreman.

VALLEY CAMP MINE EXPLOSION

An explosion occurred at the Valley Camp mine, February 26, near New Kensington, Pa., in which two men were said to have been fatally injured and two others badly burned. A searching party had a narrow escape as there was a second explosion which burned four of their number.

The 300 men that work day shift had left the mine before the explosion occurred.

SOMERSET COUNTY DEVELOPMENT

The development of Shade Township, Somerset County, coal lands by an extension of the Windber branch of the Pennsylvania Railroad from Eureka, No. 39 mine, at Foustwell, is now assured. In January last a contract was let to the firm of McMenamain & Sims for the building of 8 miles of railroad on Shade Creek from Foustwell to Reitz. It will mean millions of tons of coal freight more to the Pennsylvania Railroad, who are now hauling an immense daily tonnage from this field. Work was begun immediately, and it is expected by early Summer the road will be in operation. The Loyal Hanna Coal and Coke Co., who bought from 3,000 to 3,500 acres of coal in the field several years ago, in anticipation of the completion of the road, at once let a contract to M. M. Sheesley & Sons, of Johnstown, for the driving of two tunnels to tap the coal at a point affording gravity drainage for a large part of their acreage. Their present development plans include an opening on Shade Creek about 1 mile above the town of Reitz and an opening on Miller Run a mile or so west of Reitz. The mines are to be equipped with every modern device adaptable to this field for the preparation and handling of this coal. A large electric power plant is to be built for furnishing power for cutting coal and the electric haulage system which is to be installed. A tippie is being designed with a capacity of 2,000 tons per day, and all other arrangements now being made for the first opening are for a mine of that capacity.

The new town necessary to house the employes for this development, Cairnbrook, named for John Pitcairn, president of the Loyal Hanna Coal and Coke Co., is now in course of construction.

Arrangements are being made to secure a gravity supply of pure mountain water for mine and domestic use from the headwaters of Beaver

Dam Run at a point above the outcrop of the coal measures and above any possible source of pollution or contamination.

The coal to be mined is the Miller or "B" seam, comparing in quality with the Henrietta and other coals of the South Fork district. Because of its low sulphur and ash contents, averaging less than 1 per cent. and 6 per cent, respectively, the coal from that district should find ready sale in the eastern market.

The location of development is at a point in Shade Township where the Berlin basin and Negro Mountain anticlinal run together, with result that the measures are nearly flat with light cover but a firm roof, affording ideal conditions for economical mining.

The Loyal Hanna development is in charge of General Superintendent Joseph Patterson, of Onnalinda, who has long been identified with coal mining in the "B" seam in this district.

The Berwind-White Coal Mining Co. are also arranging for the development of a tract of 1,000 acres lying between the waters of Clear Shade Creek and Beaver Dam Run, which it is understood will be a model and compare favorably with any of their many modern plants in the Windber district.

John Lochrie, the Scalp Level coal operator, has closed a lease for an acreage in the district and will commence the development of it at an early date. With the announcement of the building of this Shade Township extension of the Pennsylvania Railroad there has been a rush of coal speculators to this district, and many other important developments may be expected in the near future.

The Puritan shaft, one of the oldest operations in Cambria County, opened on Martins Branch above Portage, over 25 years ago, and considered by many to be practically worked out, is now under lease to the Forge Coal Mining Co. and has taken on a new lease of life. By a recent addition to the lease they now have from 300 to 400 acres of solid coal just north of the shaft, lying

partly to the dip. Failure to provide for proper handling of the water heretofore has delayed the development of that section of the property. By collecting the water from various parts of the mine by gravity to a main sump at the lowest point in the property, where a main pumping station is established, the water is now pumped through a bore hole to the surface. This arrangement had been made with the idea in mind of later collecting all of the water of Puritan shaft, as well as the water of four or five other mines lying above, to this sump, from which point it is to be conducted through a pipe line on the coal seam down the pitch of the seam to a point where the surface is lower than the Puritan sump, thus affecting a gravity drainage plan for many of the mines on the Branch. With this plan in effect, one of the most serious problems to contend with in the operation of slope or shaft properties, the pumping of water, will have been eliminated. They are operating on the "B" or Miller seam of coal, which is unexcelled in quality by any mine of the district. Heretofore, in this or any other mine outside of the Windber district, it has been thought not feasible or profitable to mine the "B" or Miller seam of coal with mining machines. However, this plan has been successfully started at the Puritan shaft. They are now getting from 80 to 85 per cent. machine coal. Because of the differential between the pick and machine mining rate in the district, with this arrangement this mine will soon be one of the cheapest producers in the region. The property is now in excellent shape and is producing 500 tons per day, which will be gradually increased to 1,000 tons per day.

WASHINGTON

Plans are on foot for the development of the new Reserve mine which is owned by the Western Fuel Co., an American company operating on Vancouver Island, in British Columbia. It is expected that by 1914 they will be mining and shipping 1,000,000 tons annually. The company has expended \$500,000 in the development of the new colliery, and

it is estimated that there is sufficient tonnage proved to last for a period of 50 years with a daily output of 1,500 tons. Thomas Stockett, general manager of the company, stated recently that he expected the main shaft to be down to a depth of 1,000 feet by the end of March, at which point they expect to encounter the coal seams which they plan to mine. Nanaimo is one of the early coal mining districts of British Columbia, and has proven to be a very profitable district. The mines are very extensive, some of them extending out under the sea. A great portion of the coal is shipped to San Francisco, Portland, Ore., and Seattle. It is considered one of the best domestic coals on the Pacific Coast, and finds a very ready market.

COAL TRADE OF NOVA SCOTIA

The coal production of Nova Scotia in 1912 reached the highest figure in the history of the industry. A comparison of the outputs of the larger coal companies with 1911 is as follows:

	1911 (Long Tons)	1912 (Long Tons)
Dominion Coal Co.:		
{ Glace Bay mines.....	3,985,000	4,513,000
{ Springhill mines.....	266,000	420,000
Nova Scotia Steel and Coal Co.....	780,000	842,000
Acadia Coal Co.....	370,000	433,000
Other companies.....	849,000	692,000
	6,250,000	6,900,000

Cape Breton Island produced 82 per cent. of the total tonnage, and will produce an even larger proportion in the future.

A number of new openings and collieries are projected for 1913, but they will not add greatly to production in the current year. In 1914, however, a decided advance in tonnage may be anticipated, under normal trade conditions.

There were no accidents during the year involving serious loss of life. The fatality rate will be less than that of 1912, and will be about 2.5 per 1,000 employed.

The ownership of the coal seams in Nova Scotia is vested in the government, and as a result of this

wise reservation, the provincial revenue in 1912 from coal royalties was a little over \$800,000. Some of the operators, including the Dominion Coal Co., pay a royalty of 12½ cents per ton, and the other operators pay 10 cents per ton. It is understood that the government will shortly raise all royalties to the higher figure.

The most striking advance in mining practice during the year has been the extended use of electrical power and the utilization of inferior fuels for raising steam. Groups of collieries are being supplied with motive power from centrally placed generating stations, where unsalable fuels are consumed, in some cases by the latest types of chain-grate stokers, and in one instance by a dust-fired boiler. Several large size electrical winding engines have been installed, and at many collieries the entire plant is electrically operated, including air compressors, ventilating fans, hoisting and screening machinery, and underground pumps. So far, electricity underground has been confined to the operation of pumps and auxiliary haulage motors. It has not been used at the coal face or in trolley haulages, and local opinion does not favor the use of electricity for these purposes.



Pit-Car Cleaning Device for Self-Dumping Cage

The accumulation of slack coal in pit cars in many cases is an item of considerable loss at mines where the coal is paid for by weight and the weighing is done in the cars. Where cars are passed over a dump to an outside track for empties, they can occasionally be cleaned, or an especially bad one can be cleaned when necessary, but it is a more difficult matter to clean cars which are dumped on self-dumping cages.

To meet the latter condition, a cleaning tool like that shown in Fig. 1 is being used successfully at a mine where the loss between mine weights and railroad scale weights

ran as high as over 400 tons per month. The device promptly converted a heavy loss in weights to a slight gain.

As seen in the sketch, the tool simply consists of a plate of sheet

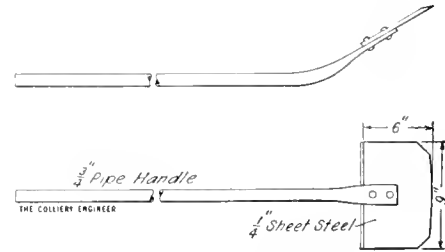

FIG. 1. CAR CLEANER

steel 9 in. x 6 in. x ¼ in., riveted to a handle of ¾-inch pipe of suitable length, the handle being slightly concave near where it joins the plate, so that the plate can be pushed under the slack which has become packed on the car bottom, especially toward the rear end of the car. It is not uncommon for this slack to extend 3 feet from the rear end of the car, in a bed the full width of the car and tapering down from as much as 2 inches at the rear end to nothing at the front, amounting to as much as three-quarters of a cubic foot in some instances, the weight of which depends upon its compactness and dampness.

It is customary to clean the cars on the self-dumping cages as often as their condition warrants, generally once a month on a "Blue Monday" following a Saturday pay day, as on such a day the little delay occasioned by the stoppage of the cages is not noticeable. The tool is always kept within reach of the dumper so that he can clean any cars that become especially dirty between regular cleaning days. By systematically cleaning the cars, a saving in weight of from 50 to 60 pounds per car has been effected. The magnitude of this saving is partially due to previous undue laxity in keeping cars clean, but it would hardly be an exaggeration to state that at most mines an average of 30 pounds could be effected, which would amount to a ton for every 67 cars of output.—W. F. A.

NEW MINING MACHINERY

New Type Mine Locomotive

The accompanying illustrations show a new type of mine locomotive which has recently been placed on the market by the Baldwin Locomotive Works and the Westinghouse Electric and Mfg. Co. The notable

An attractive feature introduced on locomotives with outside frames is the Vaucrain removable gib. To remove a journal box with this gib, it is only necessary to drop the binder and take the weight off the journal box. The journal box may then be slipped out from the side, as shown in

The axle bearings and suspension are on the lower half of the frame, so that the upper half, the armature, and bearing housings can be removed without disturbing the suspension or axle brackets. The armature and axle bearings are of bronze and are oil-and-waste lubricated. The arma-

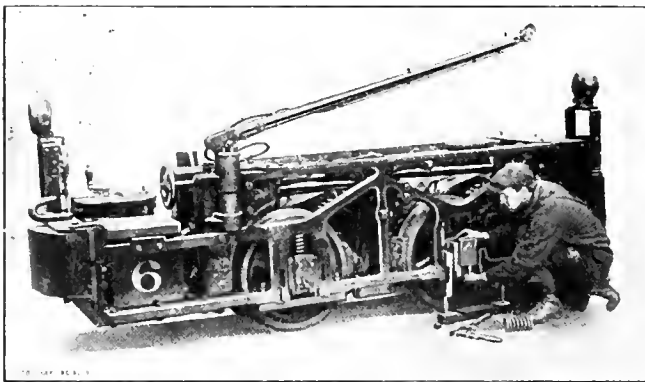

FIG. 1. LOCOMOTIVE SHOWING REMOVABLE GIB

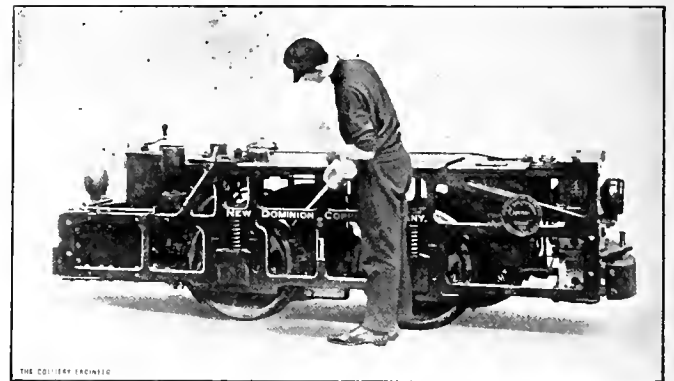

FIG. 2. ANOTHER VIEW OF LOCOMOTIVE

features are the open, cast-steel bar frame and the specially designed commutating pole mine motors.

The frame of this locomotive is designed to give maximum strength and to allow ready access to all parts, so that the locomotive can be inspected or overhauled, when necessary, in the least possible time. The construction is the same as that used on heavy Baldwin steam freight engines.

The open frame gives much better ventilation to the motors and resistance than that obtained by armor-plate frame construction. The motors, brake rigging, brake shoes, and sand boxes are easily accessible. The upper parts of the motors and armature-bearing housings can be removed without disturbing the suspension, so that each part of the motor is exposed for inspection. To remove the grid resistors the only work necessary is to take off the locomotive covers and loosen the bolts and terminals that hold the resistor frames in place.

Fig. 1. On locomotives with inside frames, the journal box collars are arranged to be easily dropped out for repacking. If it is desired to take out a set of wheels and axle, this may be done without disturbing the motor suspension or connections by simply blocking the motors in place and removing the binders. The wheels may then be dropped.

The motors used in this locomotive have decided advantages over other types, of which their excellent commutation, due to the use of commutating poles, is of first importance because it increases reliability of operation and cuts down the cost of maintenance. With good commutation, the commutator and brushes require very little attention and brush renewals are seldom necessary. The insulation of armature and field coils remains in good condition for a much longer time than on other types because of the absence of copper and carbon dust.

The frames of the motors are made of cast steel and are split diagonally.

ture coils are form wound and are made moisture-proof by means of an impregnating compound. The field coils are impregnated and protected from vibration by heavy cushion springs placed between them and the motor frame. The armature core is mounted on a spider to which it is keyed, making it possible to remove the shaft without disturbing the windings, and also reinforcing the shaft against bonding. Large openings are provided in the spider and through the core to give sufficient ventilation.

來 來

Plummet Lamp

Every surveyor in the mines knows the trouble of maintaining a light behind a plumb-bob cord, especially when it is necessary to use a safety lamp with its small light. Probably each surveyor has devised some method in taking sights underground which he thinks is the easiest, quickest, and most accurate; but one of the common methods is to hold a

piece of tracing cloth or white translucent paper between the plumb-bob cord and the lamp, so that the cord or, if he likes, the silhouetted point of the plumb bob, is against a white background. Another method is to hold a piece of white paper, often

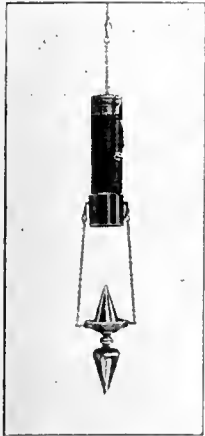

FIG. 3. THE LAMP



FIG. 4. AS SEEN

using an open notebook for this purpose, behind the plumb bob, and at the same time holding the lamp in front in order to light up the cord or plumb bob and also the paper, being careful that the light itself is shaded so that it does not shine toward the instrument.

The latest invention, designed to assist the mine surveyor, is a plummet lamp, which has been patented by Dr. C. V. Martin, mining engineer. It consists of a double plummet, coupled and swung in gimbals by detachable chains from an electric battery lamp. The lamp has a sliding sleeve to cover or expose the lens as desired, and has a hook at the top so that it can be hung from the eye of a spad Fig. 3. The lamp, as shown in Fig. 4, throws a steady light upon the upper point of the plummet.

One great advantage that this lamp possesses is that it can be placed in position and will not require the presence of some person behind it to hold a light, when a sight is being taken. This allows whoever would be called upon to hold a light to assist in other work, such as measuring or taking offsets. Moreover, the lamp is safe in gaseous mines. It is not large and can be carried in the pocket or in a case attached to a belt.

Stine Fan Fitted With Hyatt Roller Bearings

In the design of disk fans there is just one position where the blades must set to enable them to work with the least air slippage, without a loss of power. Moreover there are a fixed number of vanes needed; too many or too few will decrease the output of the fan to a great degree, requiring much more power. It is only with a thorough understanding of the principles that any disk fan can be built to properly perform its functions.

It is a common statement that disk fans will only work economically and satisfactorily at low speeds, that after reaching a certain peripheral velocity they churn the air, which leaks back through the center.

This is true of many disk and so-called propeller fans, but it is not true in a properly designed fan. Many manufacturers of this class of machinery finding this trouble in their fans, have added more vanes, presenting a multiplicity of frictional surfaces that set up eddy currents which absorb the greater proportion of the mechanical effort of the driver. Others attach large shrouds to overcome the leakage in the center which is entirely absent in a properly constructed fan. There is a fixed number of blades for each diameter of fan which will give the best results, and one angle of blades combined with the right number which will give the greatest volume. A certain overlap at center and periphery prevents recentries and develops a corresponding water gauge proportionate to the speed of the fan and mine resistance. Two well-defined actions are set up when the fan is in operation; that of a screw in which every blade forces through the casing a definite amount of air at every revolution, and that of centrifugal force, in which a vacuum is set up at the center where the blades are narrower, the air being discharged at the wider tips of the periphery.

A thorough test of a 7-foot J. C. Stine patented disk fan, manufactured by the J. C. Stine Co., Tyrone, Pa., was made by the Meadow Lands Coal Co. at their mines near Pitts-

burg, Pa., by their general superintendent, Mr. Wilson. This was a standard 7-foot machine, electric driven, the motor and fan both being mounted on one cast-iron subbase, and the armature shaft being connected directly to the fan shaft with suitable insulated coupling. While this test does not show as good results

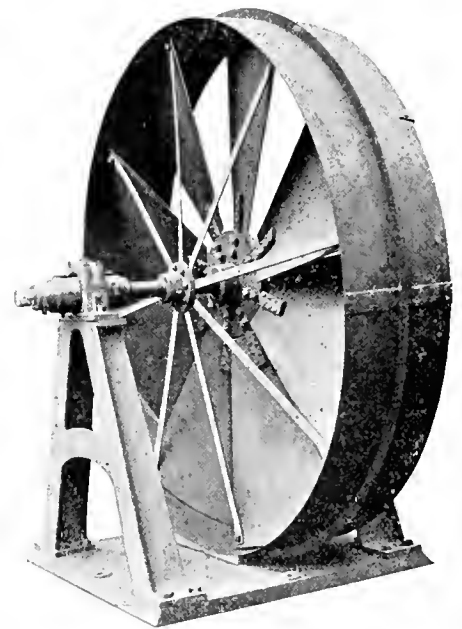

FIG. 5. STINE FAN

as have frequently been obtained at other operations, yet it shows conclusively that there is a volumetric increase of air per revolution, which increases until the fan arrives at maximum speed. At a speed of 262 revolutions per minute the fan moved 151 cubic feet of air per revolution; at 346 revolutions per minute it moved 152 cubic feet per revolution, and at 415 revolutions per minute it moved 165 cubic feet per revolution, a constant gain in feet of air per minute with each increase of speed.

The mechanical efficiency rises steadily with the speed, volume, and water gauge, reaching in many tests 75 per cent. to 80 per cent. of the total expended power, a result not reached by any other fan, regardless of make or cost.

The latest types of these fans are now being equipped with Hyatt roller bearings. This has proven of great value in still further increasing the mechanical efficiency, the saving being

from 20 per cent. to 25 per cent. over the best type of ring-oiling bearings, which permits of smaller sized motors or engines being used to produce the same results. The amount of oil required is reduced in similar proportion, actual tests showing a saving of 75 per cent., as they require oiling only once in 2 or 4 weeks.

The Richland Coal Co., of Wheeling, W. Va., writes the following to the manufacturer in reference to these bearings: "Replying to your letter of recent date relative to the new 7-foot roller-bearing fan which you sold us, my report is that this fan is now running at a speed of 348 revolutions per minute; is being driven by a 15-horsepower motor, and is taking about 12-horsepower current. We do not seem to have any notes as to the current consumption by the old fan. Our people are very much pleased with the roller-bearing feature, reporting that the fan only requires oiling once in 2 weeks and runs 22 hours every day; and to show how easily the fan runs when the belt is off, the current of air produced by the main fan outside causes the fan to revolve. This certainly shows there is not much friction on these bearings."

采 采

Fusible Signal Plugs for Air Compressing Machinery

A recognition of the necessity for making machinery automatic, of reducing so far as possible the cost of attendance, has called for the incorporation of devices safeguarding against abnormal operating conditions.

In the air compressor, which has reached a high stage of automatism, various contributory causes might produce unduly high temperatures, which should be vigilantly guarded against and which would not be apparent on the outside. High temperature in air compressing machinery and its appurtenances, such as pipe lines, air receivers, etc., may produce various undesirable conditions, such as increased friction and unequal expansion of the working parts, requiring more power to drive and

causing heavy leakage losses, so that the general efficiency of the plant is lowered.

It is essential that lubricating oils be employed in a compressor cylinder to reduce friction and prevent cutting and wear; but it is also a fact that such oils if subjected to high enough temperature will catch fire and burn, and as the interruption of proper cooling, the sticking of valves,

to serious consideration from users of compressed air.

Devices of a thermostatic nature are manufactured for this duty, but they usually involve other complicated apparatus, such as batteries, bells, wiring, etc.

The Hodges fusible signal plug, which is being marketed by the Ingersoll-Rand Co., is intended to give warning in a positive and unmistakable manner of a rise in temperature to a point which has been previously determined upon as the limit of safety—against the development of excessive strains, or other unnatural conditions.

The device is shown in Fig. 6 and consists of a body formed for readily screwing into a hole tapped for $\frac{1}{4}$ -inch pipe thread in the wall of the apparatus to be protected.

As there are no movable parts to the device, no attention is required from the operating engineer. The material used is unaffected by atmospheric conditions.

Fig. 7 shows the device in place in the discharge space of a single-stage compressor. It can also be placed to protect a receiver or other air container. With the device in place, a rise of temperature to a point for which the safety element is set melts it and opens a minute passage through the stem to the head, allowing a small amount of air to pass, producing a distinctive whistle that cannot be overlooked by any one in the vicinity; and this will persist until such a time as measures have been taken to reduce the primary cause of the threatened trouble. It is then but a moment's work to replace the plug with a new one and the machine is again protected against a similar recurring danger.

A few of the removable stems containing the safety element carried in stock will provide protection to a plant of considerable size.

Users of compressed-air machinery can readily understand that this device forms a desirable addition to compressed-air equipment and should be found at every point of possible danger throughout the plant.

The manufacturers supply two



FIG. 6

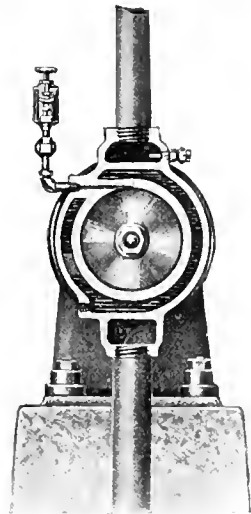

FIG. 7

etc., will tend to induce such temperature, it is imperative that proper precautions be taken.

Products of combustion are foul gases, while partial combustion results in carbon monoxide (CO) gas. One of the most undesirable conditions which might arise is the contamination of compressed air with these hurtful gases—especially is this true in connection with the use of air in closed workings, such as mines, tunnels, caissons, etc., where exhaust from drills and other pneumatic machinery is depended on for the supply of fresh air.

Instances are on record where explosions in discharge pipes and receivers have been traced to excessive temperature, and while the safety of such apparatus is unquestionable under proper supervision, safety devices looking to the prevention of such danger are entitled

kinds of these signal plugs, with 350-degree and 500-degree blowing point, respectively. The 350-degree plug is suitable for use in the discharge pipe of a single-stage compressor working at 40-pound gauge pressure; in the discharge side of a two-stage compressor working at 100-pound gauge pressure, or in the discharge side of a three- or four-stage compressor, delivering air at 1,000-pound gauge pressure. The 500-degree plug is for use in the discharge pipe of a single-stage compressor working at 100-pound gauge pressure.

來 來

Storing and Rehandling Anthracite Under Cover

By *Wm. E. Hamilton**

The ultimate exhaustion of anthracite in Pennsylvania will occur in 104 years, as estimated by Mr. A. D. W. Smith, of Wilkes-Barre, Pa., and Mr. William Griffith, of Scranton, Pa., who have made investigations for the United States Geological Survey. Anthracite will continue to increase in value, and therefore improved and more economical systems of handling, are being sought.

The features most to be desired in a plant to store and rehandle anthracite are the following: The least breakage of the coal, lowest operating cost, low first cost, per ton of storage capacity, least amount of labor employed, least amount of machinery involved, simplicity, and consequent freedom from breakdowns, greatest storage capacity, greatest strength in construction, protection against fire, either accidental or incendiary, protection against the weather.

The system herein described consists of cylindrical tanks having conical roofs and floors, and in the center of each tank a hollow tower containing a spiral chute, and a pivoted bucket conveyer which operates in connection with the chute and a track hopper. Although the plan is new, the details are not, but have been tested and proven. It is a combination of old and well-known

ideas and principles, and its simplicity insures its successful operation.

The first aim is to reduce the loss in value of the coal caused by degradation. This is an item, which, on a tonnage basis, often amounts to more than the cost of operation, and the cost of interest on plant investment, combined. A great deal of machinery, costly to install, costly to operate, expensive to maintain, and destructive to the coal (through its chipping and flaking by abrasion), is dispensed with by this method of handling. The number of transfers has been reduced to a minimum, and the fall of the coal at these points has been shortened to the least distance. The rolling, or sliding of the coal upon itself is less, by reason of the form of the retainer (see Fig. 8). The coal is carried on pivoted buckets, traveling on self-oiling wheels. The conveyer is 50 per cent. more durable and consumes less power than a scraper conveyer.

The operation is as follows: The coal is received from the mines in cars which are "spotted" over the track hoppers. From these hoppers it is carried by wheeled bucket conveyer to the top of the retainers or tanks, where it is discharged into the large hopper of a covered spiral chute; it glides down and fills this chute; then sliding gates in the chute are opened successively, to allow the coal to flow out into the retainer or tank.

The spiral chute has a capacity greater than that of the bucket conveyer, and may always be kept full. The angle of inclination insures the sliding of the coal, and there is no internal movement or working of coal within the chute, such as would cause grinding or abrasion; but the coal moves down the chute "en masse," sliding on the smooth surfaces, and not grinding on other coal.

The flow of the coal through the gates is regulated so as to keep the spiral chute filled, this being shown by its height in the hopper at the top of the tower. The buckets, after discharging into this hopper, travel on guides down through the center of the hollow tower and through the

coils of the spiral chute; and passing out of the retainer at the bottom, they return under the track hoppers and are again filled and passed on to their discharge.

At the commencement of the operation of storing coal, all gates of the spiral chute are closed, except the lowest one, the coal flowing out of this and filling the lower part of the retainer. As soon as the coal has reached its level of repose in the tank, this gate is closed and the next higher is opened. The gate-controlled openings are large, and there are eight to each spiral turn, so that the difference in height between one gate and the next is very small, in fact the top of one gate is higher than the bottom of the one next above it, so that there is no falling off of the coal. The gates are opened and closed one after another until the storage retainer is entirely filled, and the coal is stored to the top of the tank in a conical pile, of which the hollow tower is the center, and the steel wall of the retainer is the circumference. Thus in this construction the strains occasioned by this great weight of coal are equally distributed on the outer wall of the retainer.

In reloading out of storage, the preceding operation is reversed. Beginning at the top, the gates in the spiral are opened successively as they are uncovered by the lowering of the coal in the retainer; thus the coal is drawn from the top of the pile, and never from the bottom where it is under pressure of the overlying coal. The only labor required is for opening and closing the gates, and even this can be done mechanically.

The travel of the coal is retarded by the turns of the spiral, so that the pressure at the bottom of the chute, where the coal passes into the pivoted buckets, is very slightly greater than at the top; whereas, if this chute were vertical, straight, and smooth, when full of coal, a pressure of 2,000 pounds per square foot would be carried at the bottom of it, for each 50 feet of its height. The weight of coal in the spiral chute is practically uniform at every turn, as it is divided

*With the Jeffrey Mfg. Co

up and carried by every turn, and not by the coal at the point of discharge; and in reloading the coal, out of storage, there is none moved under pressure.

In this plan of piping the coal from the top of the pile, it is taken out of the center so that the pressure on the wall of the retainer is reduced equally in all directions, and it is

From records kept at a number of plants, through several years of their operation, the fact is disclosed that neither the first cost nor the operating expense are the principal items to be considered. The loss in value of the coal from its "degradation" is a cost greater than any other. This degradation has not been materially reduced in late years, as the plants

openings that give access to the coal where combustible material can be piled and fires started. It would be impossible to communicate any fire from the outside, or from the inside, to the contents of these retainers.

The circular tank or retainer is the strongest construction known. Likewise the cubical content is greater than that of any other geometrical

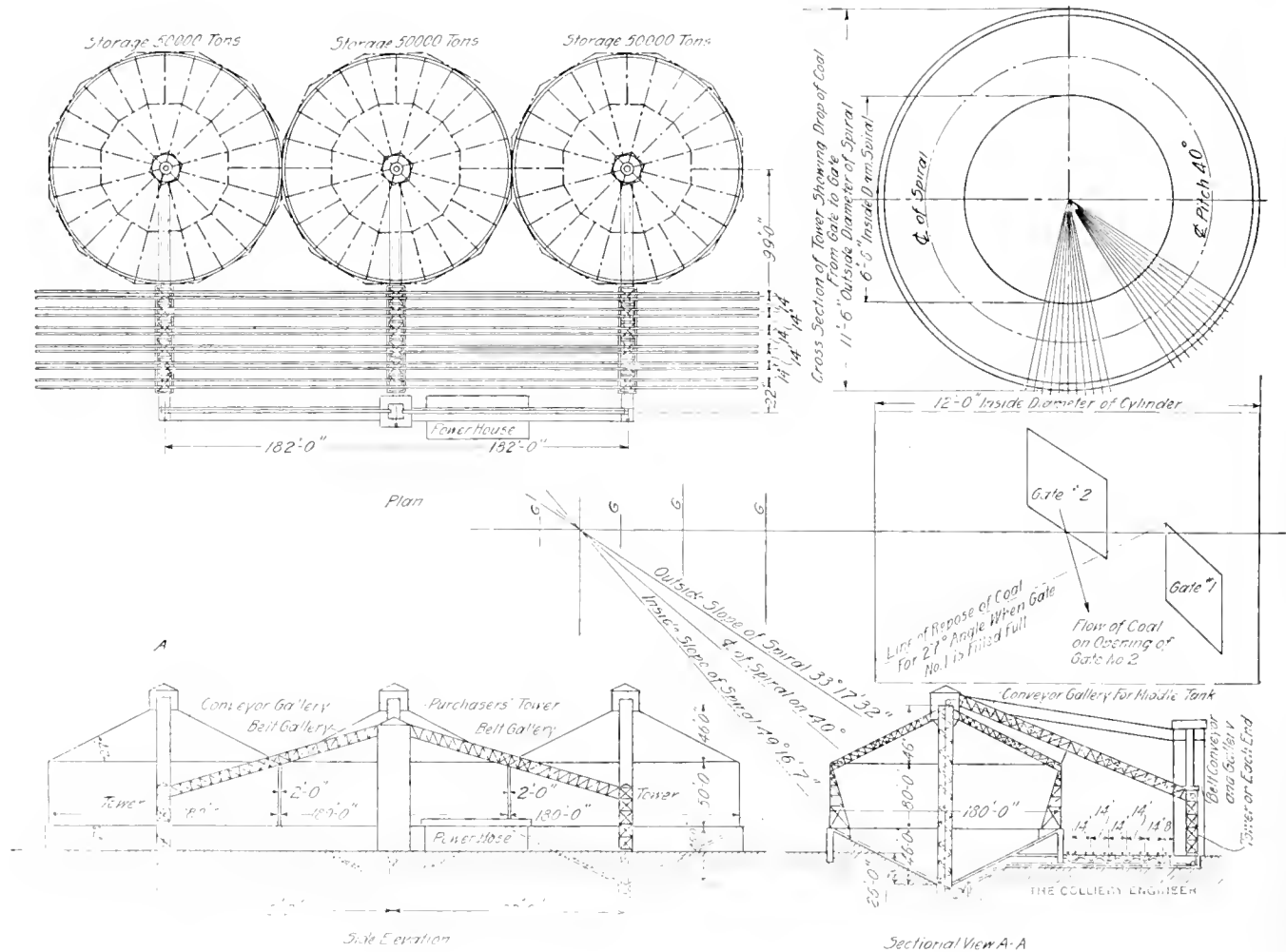

FIG. 8. PLAN AND ELEVATIONS OF COAL STORAGE APPARATUS

uniform at all times and stages of both operations—like the pressure of water in a tank. The "internal working" of a pile of coal when drawn off from the bottom is very apparent. A cone-shaped depression forms at the top and throughout the pile, one piece of coal is grinding against another, chipping and flaking, and breaking off the edges into particles too small to be of much commercial value—forming "buckwheat," "rice," and dust. Such internal working is all avoided in this system.

which have been installed have followed the original scheme of storing the coal in conical or rectangular piles and drawing it off either by tunnels, under the great pressure and weight of overlying coal, or by conveyers scraping against the side of the coal pile.

The system herein described provides protection against fire, either accidental or incendiary, no sparks nor flying embers can get into the enclosure, and, in case strikes and riots, there are no doors or other

form of building, with the exception of a sphere; and it affords the greatest possible storage capacity for the amount of material entering into its construction.

來來

The London Times states that extensive coal deposits have been discovered in Udi, South Nigeria. The test made by the Government, and analyses at the Imperial Institute are said to have given results equal to two-thirds that of the best Welsh coal.

TRADE NOTICES

Current 'o Scope.—Fairbanks, Morse & Co. have gotten out a little device which they call a "Current 'o Scope." It is an arrangement made out of two pieces of celluloid, between which a circular piece can be revolved by the finger. It is marked in such a fashion as to show, when the circular piece is revolved, how the currents travel in a three-phase, alternating-current induction motor, and how the so-called revolving field is produced by the action of the alternating currents. Each phase of the current is represented by a different color, the device being colored with green, red, and black. The top piece has holes punched in it so that the marks on the under piece show through.

The device is accompanied by a description of the action of an induction motor and shows how it may be exemplified by the Current 'o Scope. For any one who is not familiar with an alternating-current, three-phase, induction motor and is desirous of learning about them, this little device can be thoroughly recommended, for it is simple and the directions which go with it are clear.

"Merchant" Weight Pipe.—The National Tube Co. has announced that in the future they will not manufacture "merchant" weight pipe, but will confine themselves to the manufacture of standard weight pipe. The reason given for this is that full weight pipe is suitable for all purposes for which the merchant weight has been used, while the opposite is not true. In the past there have been legitimate uses for merchant pipe, that is, pipe lighter in weight than the standard, but it has been necessary in consequence that the jobber should keep in stock several weights of pipe, which has produced in the mind of the consumer an uncertainty as to the weight of pipe that he was receiving. With a standard weight for all piping there can be no question as to the weight of pipe delivered.

New Dry Battery.—The Western Electric Co. have recently put on the market a new dry battery which is called the Red Label Blue Bell battery. It is designed for intermittent service that requires rapid recuperation, and is intended as a general utility battery, having an initial amperage of 25 amperes on short circuit and being of the low internal resistance type. Some of the uses for which this battery is adapted are for the operation of call bells, for telephone pole changers, for railway telephones in furnishing transmitter current on train dispatching circuits, and as a selective signaling battery; it is also especially fitted for ignition service in general with all types of industrial gas engines, as starting batteries for automobiles, and with slow-speed gas engines, such as are used in motor boats and automobile trucks.

Forty-Fifth Anniversary.—Forty-five years ago, in 1868, the firm of Adam Cook's Sons was founded in Albany, N. Y., as the Albany Lubricating Compound and Cup Co. The first small plant in Albany was outgrown in 4 years, and the business was moved to New York. In 1872 larger quarters were secured along the river front at 231 West Street, New York City, but in 1881 it was found necessary to move to still larger quarters at 313 West Street. Additions were continually made to the plant to meet the growing demands for Albany grease. While the continuous spreading out of the plant provided ample room, it was finally decided that it would be better to concentrate the different departments and plan the manufacturing system according to modern principles and to bring under one roof all of the various departments of the business. After 30 years the West Street plant was abandoned and the present modern commodious plant at 708-710 Washington Street, was placed in service.

New Repair Department.—The Goodman Mfg. Co. announces the opening of a repair and supply department in Pittsburg, Pa., for the convenience of its many customers

in the territory nearby. The address will be: Pittsburg Repair and Supply Department, 700 Phipps Power Building. E. Kent Davis is manager, and the electrical repairing done in this shop will be of the same high-grade character as that done in the Chicago shop. A complete stock of parts for the short-wall coal cutter will be carried in stock.

Goulds Mfg. Co.—The annual meeting of the stockholders of The Goulds Mfg. Co. was held at Seneca Falls, N. Y., February 24. No change was made in the board of directors, and the following officers were reelected: President, N. J. Gould; Vice-Presidents, D. V. Colby, W. D. Pomeroy, W. E. Davis, W. E. Dickey; Secretary, H. S. Fredenburg; Treasurer, B. R. Wells; Assistant Treasurer, E. W. Medden.

Refillable Fuse.—Ackley Brake and Supply Co., of 50 Church Street, New York City, are manufacturers of the Monarch Refillable Fuse, for which they are sole agents. It is constructed in all the types and sizes as standardized in the old code type, and it may be refilled in a fraction of a moment by a "filler" adapted to a fuse of a given amperage and voltage. This fuse recommends itself for use in mines because of the impossibility of arcing at the time of a blow-out. The fillers, which are inserted by refilling, are surrounded by powder which suffocates the flame at the instant of arcing, thus obviating any possibility of an exploded cartridge casting out particles of burning fiber and molten metal.

A Flexible Hose That Doesn't Kink.—Troubles from kinking hose or flexible connectors in steam or pneumatic service have been so common that they are accepted as a matter of course, but many of them are avoided by the new coupling known as the J-M flexible metallic combination hose which has been introduced by the H. W. Johns-Manville Co., of New York.

This consists of a superior grade of durable rubber hose, protected against outward injury by a stout metal armor. The armor is made in the form of a ribbon, with crimped

edges, forming, when wound, a continuous, interlocking flexible spiral, which is said to be practically pressure-tight in itself, without the inner tube, and sharp bends are impossible. Consequently the inner tube cannot kink or flatten, and is always open to its full diameter.

Actual service tests show that the armor will resist a crushing strain of 300 to 800 pounds to each four turns of the spiral, while it is capable of withstanding the highest internal working pressures. It is claimed that this hose cannot be put out of service unless both the outer armor and inner tube are punctured at the same time. The inner tube is never subject to any pulling strain, and all the working strain comes on the armor, which is tested to resist an end pull or thrust of 1,000 to 2,000 pounds.

Another advantage of the new hose is that its exterior surface, unlike ordinary single types of hose, does not become excessively hot when used for steam service, drills, blowing out boilers, etc., and can therefore be more conveniently handled. A special booklet describing this will be sent on application.

CATALOGS RECEIVED

BURY COMPRESSOR CO., Erie, Pa. Calendar.

HEINE SAFETY BOILER CO., St. Louis, Mo. Superheating.

DENVER ENGINEERING WORKS CO. Denver, Colo. Richards Pulsator Classifier, Launder Type, 7 pages.

NEW YORK REVOLVING PORTABLE ELEVATOR CO., Jersey City, N. J. Bulletin No. 21, Motor-Driven Revolvers, 11 pages.

CENTRAL FOUNDRY CO., 90 West Street, New York. 25,000 Joints Under Test at One Time, 6 pages.

CHALMERS & WILLIAMS, INC., Chicago Heights, U. S. A. The Torpedo Conveyor, 4 pages.

THE ALDRICH PUMP DEPARTMENT, Allentown, Pa. Pump Data. Descriptions of Pumps of Various Types.

CROSS ENGINEERING CO., Carbon-

dale, Pa. Simplex Rivetless Chain, 8 pages; Perforated Metal and Coal Preparing Machinery, 39 pages.

THE JEFFREY MFG. CO., Columbus, Ohio. Bulletin No. 46, Jeffrey Swing Hammer Pulverizer for Laboratory Use, 4 pages.

ASBESTOS PROTECTED METAL CO., Beaver Falls, Pa. Permanent Roof Construction, 7 pages.

EDGAR ALLEN AMERICAN MANGANESE STEEL CO., McCormick Building, Chicago, Ill. Bulletin 57, Sheaves of Stag Brand Manganese Steel, 15 pages.

Temperature Control for Air Compressors

The following is a short description of the automatic temperature control for air compressors, which was described by Thomas W. Dawson, Assistant Chief Engineer of the H. C. Frick Coke Co., in his paper on "Welfare," presented December 18, 1912, at the meeting of the Coal Mining Institute of America.

In Fig. 1, 1 is the compressor; 2, the steam cylinder; 3, compressor throttle; 4, steam pipe leading to

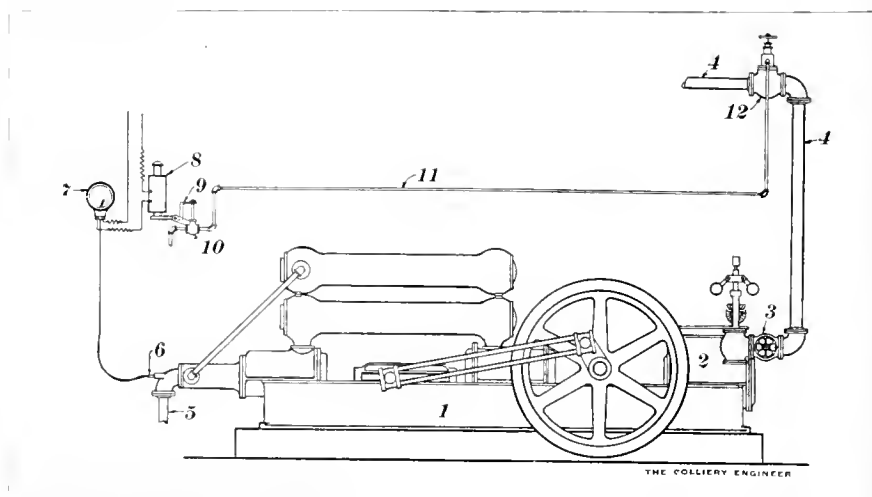

FIG. 1

CHICAGO PNEUMATIC TOOL CO., Fisher Building, Chicago, Ill. Bulletin No. 126, Compression Riveters, 8 pages; Bulletin No. 129, Hose, Hose Couplings, and Hose Clamp Tools, 8 pages; Bulletin 130, Lubrication of Pneumatic Tools, 8 pages.

THE GOULDS MFG. CO., Seneca Falls, N. Y. Bulletin No. 113, Rotary Pumps, 16 pages.

INGERSOLL-RAND CO., 11 Broadway, New York. Class "PE" Duplex Direct-Connected Electrically Driven Air Compressors, 40 pages; Class "PE" Direct-Connected Electric-Driven Air Compressors, 28 pages.

THE PLATT IRON WORKS CO., Dayton, Ohio. "Stilwell" Feed Water Heaters and Purifiers, 57 pages; Cylinder Gate Victor Turbines, 15 pages; Smith-Vaile Boiler-Feed Pumps, 35 pages; Smith-Vaile Air Compressors, Steam and Power Actuated, 39 pages.

compressor; 5, air discharge pipe from compressor; 6, thermometer fitting; 7, thermometer recording device; 8, electrical solenoid; 10, pilot valve; 11, small steam pipe; 12, a quick operating automatic steam valve.

When the temperature of the discharge air in pipe 5 reaches a predetermined abnormal point, it reacts on the thermometer 6 and the recording device 7, whereby an electrical circuit is closed and the solenoid 8 thereby energized. This energized solenoid in turn, by means of the tripping device 9, opens the pilot valve 10, releasing through the pipe 11 the steam pressure upon one side of a piston in the valve 12, whereby valve 12 automatically closes and stops the flow of steam through pipe 4 to the compressor, and the compressor is thereby automatically stopped.

The Colliery Engineer

Formerly
Mines and Minerals

Vol. XXXIII—No. 10

MAY, 1913

Scranton, Pa.

PUBLISHED MONTHLY AT SCRANTON, PA.

ESTABLISHED 1881

INTERNATIONAL TEXTBOOK CO., PUBLISHERS

T. J. FOSTER, President S. P. ALLEN, Secretary E. H. LAWALL, Treasurer
RUFUS J. FOSTER, Vice-President and Managing Editor
EUGENE B. WILSON, Editor

CHICAGO OFFICE: 1006 S. Michigan Ave.

Entered at the Post Office at Scranton, Pa., as second-class matter

Address all business communications to THE COLLIERY ENGINEER, Scranton, Pa.

Subscription Rates: \$2.00 per year to United States and all possessions, and Mexico; \$2.50 to Canada; \$3.00 to all other countries. Single copies 25 cents each.

Notice to discontinue or change of address should be sent to the Scranton office.

When notifying us of a change of address always give your FORMER as well as your present address.

TABLE OF CONTENTS

Editorial—	
Editorial Notes—Railway Strikes a National Menace—The Development of Alaska Coal Lands.....	533
Personals	536
Kentucky Mining Institute	536
Flushing Anthracite Workings	537
The Coal Fields of Ohio, by Wilbur Greely Burroughs.....	544
Effect of Coal Mining on the Surface, by M. Fayol	548
Scientific Management, by Wm. Archie Weldin	553
It Is to Laugh	554
Safe Timbering	555
Australian Mine Ventilation	557
Ode to the Mine Mule	557
Welfare Work at Coal Mines—	
Hookworm Disease in Southern Mines, 558—Who is Responsible....	560
Practical Talks on Coal Mining—	
Electricity in Mines, 562—Gases Met With in Coal Mines, 564—	
Mechanics of Mining	566
Book Review	568
Coal Mining Institute of America	568
Working Anthracite Culm Piles	569
Shaft Sinking, by Samuel Haines.....	571
The Letter Box—	
Mercurial and Aneroid Barometers—Heat Waves Visible—After-damp—Carbide Lamp Abuse—Use and Care of Safety Lamps—	
Law Regarding Mine Inspectors—Rope Turning—Changing the Hoisting Rope—The Influence of Drafts in Mine Explosions.....	572
Relations of Engineers to Mine Foremen.....	576
Hoisting Ropes	578
Steam Pipe Hangers	579
Prize Contest	580
Notes on Mines and Mining.....	582
Discipline in Mining, by S. J. Jennings.....	585
Obituary—	
Alexander Fulton—Stephen R. Krom.....	586
Examination Questions—	
West Virginia Mine Foremen and Fire Bosses (Continued)	587
Use of the Barometer in Mining, by F. Z. Schellenberg.....	590
Dumper for Mine Cars	591
New Mining Machinery—	
Storage Battery Gathering Locomotives, 592—Self-Starting Motor, 592—Mining With the Pneumoelectric, 593—A Portable Coal Unloader, 593—A Spike Puller, 594—Bristol's Recording Differential Pressure Gauges	594
Trade Notices	594
Catalogs Received	596
Cutting Props	596
Statement of Ownership, etc., of The Colliery Engineer.....	596
Squibs—	
Practical First-Aid Work, 381—Standard Mine Doors, 552—Specific Gravity Determination of Mineral Oils, 555—Gauge for Water Tank, 561—Speed of Hoisting, 571—Units of Measure, 579—Coal and Coke in British Columbia.....	590

THE article on "Safe Timbering" in this issue recalls an incident in Colorado, when two men using a well-designed prop puller recovered 210 mine props. The mine manager was very glad to pay these men at the rate of 4 cents per prop, and 1 cent for caps, as by doing so he made a marked saving in the cost of such mine timber, and the men also made good wages.

來 來

Railway Strikes a National Menace

A RAILWAY strike that ties up traffic throughout large areas of territory, not only disastrously affects the entire area involved, but to a greater or less extent it affects the whole country.

If such a thing as a nation-wide railway strike should occur, it would paralyze commerce and industry, and would directly and indirectly bring hunger and suffering to millions.

Any cause that disastrously affects commerce and manufacturing is particularly disastrous to the coal mining industry.

In the case of a railway strike, coal cannot be sent to market, and as a result the mines must be shut down.

The non-movement of freight trains will cut off from large centers of population the regular influx of food stuff, and suffering is sure to follow.

During the severe floods of the latter part of March the temporary interference with the movement of railway trains cut off to a large extent the milk supply of a number of towns, and helpless babes and children suffered. The non-arrival of other food stuffs created a scarcity that forced prices, already high, beyond the reach of thousands of working people.

The Railway Business Association, composed of upwards of 250 of the largest manufacturing concerns of the United States has issued a bulletin on this important subject, showing the immediate necessity of National legislation that will be effective in preventing such calamities as general railway strikes.

In its bulletin the Association says:

"The urgency of the situation leads the Railway Business Association to go outside its main function of conciliation between railways and the public and seek to arouse the public, the railway employes and the railway managers to cooperation and the President and Congress to action at the extra session. The federal Erdman Act, through which until recently strikes causing interruption to train service have been almost wholly prevented, has all but broken down at the point where, media-

tion failing, arbitration was attempted in the large-scale dispute involving many roads at once. The Eastern engineers' case was arbitrated outside the Act. In the Eastern firemen's case the roads agreed to arbitration under the Act only after earnest protest and because they believed this to be the only means of averting a strike. The firemen through their officials went on record as favoring amendments which would render the Act more applicable to present conditions.

"The Erdman Act should be amended forthwith or legislation substituted for it providing a form of voluntary arbitration so little open to valid objection as to deprive disputants of all reasonable excuse for declining arbitration under the law. To postpone remedial legislation is to invite widespread and perhaps national disaster at any moment."

The bulletin plainly shows the weakness of the present law in a clear and concise manner, and calls on all classes, railway managers, railway employes, and the general public to cooperate to obtain legislation which will place them squarely on the side of industrial peace.

Copies of the bulletin, known as "Bulletin No. 12," will be sent on request, by Frank W. Noxon, Secretary, Railway Business Association, 2 Rector Street, New York, to all who desire to help the work along by placing it in the hands of their Representatives or Senators, with a request for their aid in the enactment of fair and effective legislation.

采 采

The Development of Alaska Coal Lands

IF THE coal deposits of Alaska are to be properly developed, the coal mined in such a way as to supply a waiting market, and at the same time assure true conservation of the coal deposits, the United States Government must change the policy of the Interior Department of the two past administrations.

Competent geologists and mining engineers who have examined and reported on the Alaska coal lands agree in the following general conclusions: The strata in the coal fields have been so disturbed by volcanic action that the coal seams lie at all angles to the horizon, from flat to perpendicular. That the coal seams are broken by numerous faults, that in many tracts the coal lies in pockets of greater or less extent, and in some places it has been destroyed by heat from the volcanoes and lava emitted from them. At the same time they unite in stating that there are large bodies of good workable coal. Among the geologists who have so reported are William Griffith, of Scranton, Pa.; Prof. W. R. Crane, of Pennsylvania State College; and George Watkin Evans, of Seattle, Wash.

From the above general statements it is evident to practical mining men that the cost of mining is bound to be higher than it would be if the coal seams were regular in pitch and thickness, and free from numerous faults. The fact that the geological disturbances made the good coal, in many areas, pockety, and that more or less gas has been encountered in drift workings, but a few feet from the entrance, adds to the expense. In addition, the irregularity of the seams and the existence of many faults introduces, to a certain extent, an element of luck in the matter of securing a continuous output from mines that may be opened.

Even in localities where the seams are regular and there are transportation facilities to convenient markets, the mine operators must have sufficient areas of coal to warrant the expense of development and equipment. If there are no transportation facilities to convey the coal to markets large enough to absorb at least a moderately large output, there will be no development.

What the Alaska coal fields require are transportation facilities and such common-sense action on the part of the United States Government as will make it worth while for capitalists to develop and work them.

The federal laws that limit the patenting of Alaska coal lands to a maximum of 160 acres to any one person, and of a maximum of 640 acres to any one corporation, regardless of the number of men in it above four, are in themselves a hindrance. In addition, the price per acre established by the government is excessive. It is as high or higher than the price at which individual coal land owners in several states sell good undeveloped tracts in localities within comparatively easy reach of markets.

Then, to make matters worse, the Department of the Interior has formulated "regulations" governing the details of procedure of citizens patenting Alaska lands that are not in consonance with the enacted law, and which tend to restrict rather than encourage the rational development of the lands. If railroad lines are to be constructed in Alaska there must be assurance of enough business for them to warrant their cost. In the present state of affairs there is not enough freight to be carried to warrant the building of a road to tap the coal fields. If the coal fields were developed, or there was an absolute surety of their being worked on a moderately large scale in the near future, the coal tonnage would be the greatest factor in making their operation profitable. Besides, there must be an ample and continuous coal supply for the locomotives.

In the early development of Alaska's coal resources, and for many years thereafter, the coal tonnage will not be sufficient to yield a paying revenue to one railroad. Therefore, with reasonable restrictions, there should be no encouragement offered to more than one railroad line, until the industry grows to such proportions as to really require additional transportation facilities.

Under existing laws regulating common carriers, one railroad line will not be inimical to the true interests of producers and consumers.

To secure the development of the Alaska coal fields and the working of the coal in a manner that will supply the demand, and at the same time conserve the coal, the mining operations must be conducted by parties having large capital resources. Experience in every coal field in America shows that the working of mines by operators without sufficient capital to employ the services of competent mining engineers and efficient mine officials, to pay for best equipment and machinery, and to pay for proper dead work, has resulted in enormous

waste of coal in the ground. Such operators necessarily worked their mines in an unsystematic manner. They took out only the coal that could be mined at least cost, and often a comparatively small percentage of that. When they ceased mining, large quantities of good coal remained which could only be recovered at abnormally high cost, or which could not be recovered at all except at prohibitive cost in money or lives of employes. *Per contra*, operators or mining companies with ample capital and coal areas large enough to warrant the investment of such capital, have worked their mines, particularly in more recent years, in a manner that has resulted in the mining and utilization of from 75 per cent. to 95 per cent. of the coal in the ground, and they have done it with greater safety to the health and lives of the mine workers.

If the utilization and the rational conservation of Alaska's coal resources are to be accomplished, there must be greater liberality in the laws governing the taking up of claims by citizens willing to invest in coal lands in an otherwise unattractive territory, and the detailed regulations as to procedure in filing claims and completing patents must be made to conform with the enacted laws. That the present regulations do not conform to the meaning and spirit of the present narrow laws was recently proved in the United States District Court, in Chicago, by the acquittal of Albert C. Frost, and several associates, who were charged by the officers of the government with an attempt to obtain possession of coal lands by illegal methods.

In 1904, Mr. Frost became interested in the financing of a railroad to run from Seward, on the south coast of Alaska, north, a distance of 483 miles, to Fairbanks. That the road would run near the coal fields of the Matanuska Valley, was the most important factor in attracting investments in its securities. Mr. Frost and his associates realized that such a railroad, without assured coal tonnage of sufficient size, would not be profitable. There was another route into the same field from the Copper River country. To assure for his proposed road a comparatively large tonnage, and to prevent its division with a possible other road from the Copper River country, he, his associates, some of his employes, and some friends, took up claims, and complied fully with the terms of the enacted laws in trying to get patents from the government. But, while complying with the law, they did not strictly comply with the "regulations" formed by the Interior Department, which in a number of points are not in consonance with the law, and are not based on good common sense. Special government agents, acting under the "regulations," reported adversely to the claims of Mr. Frost and his associates. In the meantime, during the Roosevelt administration, these lands were withdrawn from entry, and steps were taken to prosecute Mr. Frost and his associates for conspiracy to obtain possession of the lands, by "dummy" entrymen. On March 16, 1911, they

were indicted. The case was tried during the past month, and after a long trial in which the testimony was very voluminous, and eminent counsel argued on both sides, a verdict of "not guilty" was returned by the jury, as the government failed to prove violations of the enacted law.

While the verdict frees the defendants from a serious charge, it does not return to them the money paid the government which yielded them nothing but trouble and expense. Neither does it make possible the construction of the road and the development of the coal lands, as they are still "withdrawn from entry."

THE COLLIERY ENGINEER is not an advocate of laws that will give away valuable natural resources to a privileged few, but it does advocate laws that will be liberal enough to permit the development, utilization, and rational conservation of such coal lands as the government owns.

In the formation of such laws, and of regulations regarding their enforcement, the officials of the Interior Department should have the assistance and advice of men skilled in coal mining and familiar with the conditions that must be met in developing new coal territory. The Federal Bureau of Mines, which is a part of the Interior Department, has connected with it a number of competent mining engineers and practical mine officials, whose experience and knowledge should be called on in this connection. It is to be hoped that the Alaska coal fields will, in the near future, be again open for entry, on more liberal terms than formerly, and that such terms, and the regulations governing the patenting of the lands will be largely based on advice from the practical coal mining men in the employ of the Bureau of Mines.

來 來

Flushing Anthracite Mine Workings

THE illustrated article on another page, which describes in detail the methods employed in flushing mine workings in the Schuylkill region of the anthracite fields, is the first comprehensive description of the methods employed and results obtained ever printed. The value of the system in preventing serious disturbances of the surface, and in making possible the safe extraction of practically all the coal in the seams is such that the article can be read with profit by all engaged in coal mining, whether anthracite or bituminous. There are many localities where surface protection is of small importance, but there are no localities in which the safe mining of the greatest percentage of the coal in the seam is not of prime importance.

In the anthracite regions the large quantities of waste material at the mines provide the material for flushing. In bituminous fields the gob stowed in the mines can be utilized, if supplemented by ashes, sand mixed with loam, and the country rock broken into suitable sizes by crushers, as is the slate, bone, etc., at the anthracite mines where flushing is practiced.

PERSONALS

William A. Soubrey, Outside District Superintendent for the Philadelphia & Reading Coal and Iron Co., in the Shenandoah, Ashland, and Mahanoy City districts, resigned on April 15. Mr. Soubrey has been in active service about the mines for over half a century and retires to private life. He has the distinction of being the first man to successfully jig buckwheat coal, and is one of the best posted men in the anthracite regions on the handling of coal on the surface and its preparation for market.

The following candidates successfully passed the recent examinations to obtain certificates as mine foremen and assistant mine foremen in the Fourteenth Anthracite District of Pennsylvania:

Foremen: Frank Pollard, John J. Panko, John J. Boyle, Joseph Yarworth, M. T. Chapman, William B. Motter, of Centralia; William F. Blowbert, Mahanoy Plane; and John Rudd, Shenandoah.

Assistant Foremen: John Hanna, Patrick Whalen, Edward J. Conners, of Shenandoah; John Coleman, Charles Whitmayer, Girardville; Anthony McGinley, Joseph Koch, George S. Wills, Centralia; M. J. Ryan, Luke Hoar, Lost Creek; and John McLaughlin, Connerton.

Charles E. van Barneveld, who for the past 14 years has been Professor of Mining and Metallurgy at the Minnesota School of Mines, has been appointed Chief of the Department of Mines and Metallurgy of the Panama-Pacific International Exposition. Mr. van Barneveld will be at the Headquarters of the Exposition after May 1.

David A. Thomas, chairman of the Cambrian Trust, will shortly return to the complete negotiations for the large tract of coal land in Kentucky that was mentioned in April issue. Mr. Thomas will probably stop for a while in Scranton as before.

Dr. Frederick Schniewind, who improved the Otto-Hilgenstock ovens by combining the underfiring system with the regenerative system, died at his home in Englewood, N. J., in March.

F. Julius Fohs, formerly of the Kentucky Geological Survey, and who, more recently, has been doing special work in the Broad Top field of Pennsylvania, is now making an examination of some of the phosphate mines in middle Tennessee.

Dr. A. H. Purdue, State Geologist of Tennessee, has been inspecting the phosphate field near Mt. Pleasant, and the bauxite deposits near Elizabethton.

Wilbur A. Nelson, Assistant State Geologist of Tennessee, has been correlating the coal seams at Bon Air and Clifton.

Frank Gilday, formerly State Mine Inspector of Kansas, is now connected with the Central Coal and Coke Co. At present he is establishing a first-aid movement in the vicinity of Pittsburg, Kans.

J. A. Jefferies has been appointed General Manager of the Williamsville Coal Co., with headquarters at Springfield, Ill.

J. F. Menzies, General Superintendent of the Northwestern Improvement Co., of the state of Washington, read a paper at the meeting of the Western Branch of the Canadian Mining Institute on mine rescue work as carried on by his company at their several mines in the state of Washington.

P. B. Ashbridge, who has charge of the first-aid work of the Canadian Pacific Railroad, read a paper before the Canadian Mining Institute on first-aid work as carried on by the St. John's Ambulance Society.

James Price, of Nanaimo, B. C., who for 37 years has been in the employ of the Western Fuel Co., was presented with a gold watch by the employes, as an appreciation of respect and good will.

George S. Rice, E. M., addressed the New York Section of the Amer-

ican Institute of Mining Engineers in March on "Flushing or Hydraulic Filling as Practiced in European Coal Mines."

J. B. Hornberger, Controller for the Pittsburg Coal Co., lectured before the students in the School of Mines, University of Pittsburg, on "Coal Mine Accounting and Costs."

Fred R. Thomas, formerly of Wilkes-Barre, Pa., has been appointed Superintendent of all the Northern Pacific Coal Co.'s mines in Kings County, Wash.

George D. McClellan is now Mine Inspector for South Dakota, having been appointed to the position by Governor Byrne. Mr. McClellan has been a resident of the Black Hills district for a number of years.

Governor Cary, of Wyoming, appointed George Blackner, of Uinta County, Coal Mine Inspector of No. 1 district, and W. E. Jones, Sheridan, Inspector of district No. 2.

Benjamin S. Hammil was elected President of the Meadowlands Coal Co. with headquarters at Pittsburg, Pa.

Prof. Arthur Lakes, of Denver, Col., who is well known to readers of *THE COLLIERY ENGINEER* for his specially illustrated articles on mining in the West, is now living near Ymir, B. C., where his son is manager of the Wilcox gold mine.

柔 柔

The Kentucky Mining Institute

The next annual meeting of the Kentucky Mining Institute will be held May 16 and 17, at Lexington, Ky. According to the present plan, the first day of the meeting will be devoted to the state-wide first-aid contest, followed in the evening with a banquet and discussion. The second day will be devoted to reading and discussion of papers, on mining topics. Special round-trip tickets at one way fare and 25 cents additional have been granted by the railroads, to be on sale May 15-17 and void after May 19, and it is expected that there will be a large attendance.

COAL MINING & PREPARATION

Flushing Anthracite Workings

Methods Employed in the Thick and Moderately Thick Seams of the Schuylkill Region of Pennsylvania

Written for The Colliery Engineer

THE filling of mine workings with culm, or fine coal, and other waste materials, by flushing it into the mine and depositing the material by the use of water, serves two main purposes. (1) The flushed material acts as a support to the superincumbent strata and minimizes surface disturbances; and (2) in a number of instances it permits the more complete extraction of the pillar coal.

It is estimated that, under certain conditions in moderately thick seams lying at considerable inclination, only about 50 per cent. of the coal remaining in pillars after first mining can be recovered if flushing is not practiced.

In flat seams more pillar coal can be taken out than in seams having considerable inclination. This is particularly so in the thick seams. In pitching-seam workings the roof rock, when it falls, slides down the pitch and fills up the chambers or other mine openings to a greater or less degree, while in flat seams it remains where it falls, and is removed, if necessary, with less trouble and expense.

When the mined areas have been flushed, enough support is given the roof in both pitching and flat seams to prevent the roof rock breaking in comparatively small pieces. When it does break, it moves in large masses, and finally comes to rest on the

flushed material. By flushing the mine workings practically all the coal under towns and villages can be taken out, without causing any great disturbance of the surface. The

flushing. The mixture of water and waste material is usually called "slush."

The first known use of the flushing operation was in the latter part of August, 1884, when the late John Veith, general inside superintendent of the Philadelphia & Reading Coal and Iron Co., employed it to extinguish a fire in the Buck Ridge slope, near Shamokin, Pa.

On August 20 a fire broke out in the main hoisting slope of the Buck Ridge colliery. This slope, which was in the bottom split of the Mammoth seam, had six lifts, three above water level, and three below water level, and was 440 yards long, varying in pitch from 35 degrees at the top to 45 degrees at the bottom. The upper 350 yards was on fire, with flames rising to considerable height above the mouth. The mouth of the slope was with difficulty covered with heavy planks and earth until pumps could be installed to furnish water for flushing. As soon as the pumps were in position and steam and water connections were completed, a small opening was made in the closed mouth of the slope and flushing began. In this instance the proportion of culm to water was very small, about 1,000 gallons of water to a cubic yard of culm, as the intense heat of the fire

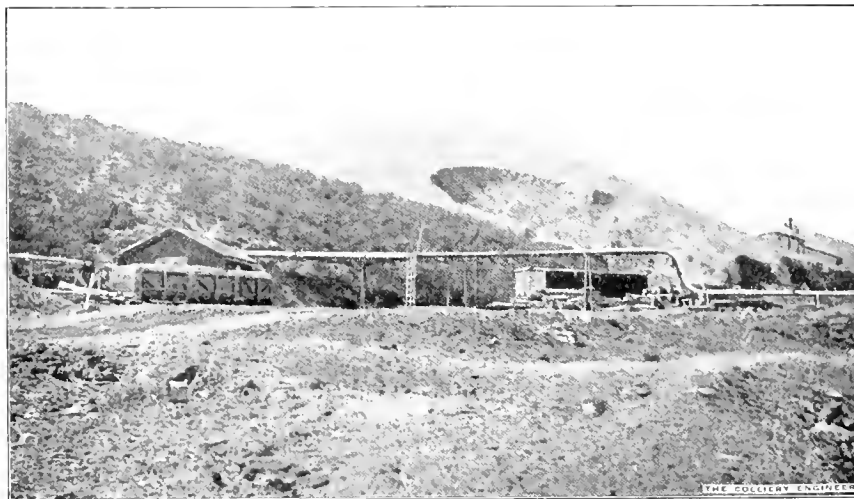

FIG. 1. CULM PILE BEING FLUSHED INTO HOLMES SEAM WORKINGS AT TUNNEL RIDGE COLLIERY

amount of subsidence in the surface will, if the flushing has been complete, be very slight. That there will be no movement of the surface when the pillars have been extracted and the mine flushed cannot be expected, but the movement that does occur is slight and occurs over large areas. In coal seams lying at considerable inclination, flushing can be made more complete than in flat seams. In the latter there is difficulty in filling the openings entirely, and there is naturally a little space left between the top of the opening and the top of the fill. It is estimated that in such cases where the superincumbent strata move in large masses, the amount of subsidence of the surface is about 10 per cent. of the thickness of the coal seam.

made necessary a large extra supply of water, and this extra supply naturally had an effect on the fire. Twenty-two thousand five hundred cubic yards of culm were put in the slope by this means, and 22,500,000 gallons of water were used. This extinguished the fire. The culm was then removed, the destroyed timbers in the slope were replaced, and operations at the colliery were resumed.

At the West Shenandoah colliery, Shenandoah, Pa., operated by the same company, a mine fire was extinguished last year by flushing. In this case bore holes were put down from the surface, penetrating the coal seam at a point where it was on fire, and also at points outside the fire zone, and slush was run in through them. The first bore hole was so located as to penetrate a gangway in the midst of the main fire. No attempt was made to control the flow of the slush after it reached the mine workings. It was allowed to flow as it would, an excess of water being used so as to carry it some distance outside the known limits of the fire. The burning area and the workings around it were flushed, so as to block off the fire as completely as possible. When enough of the workings were supposed to have been flushed, openings were made through the flushing, and when evidence of fire or an unflushed space was found, it was immediately flushed full and the fire was entirely extinguished. The slush, being largely fine coal mixed with mud and water, packs solidly when deposited and does not ignite. It is sometimes deposited on burning culm piles to shut off the air and smother the fire.

The credit for the second use of flushing, and for the first use of it to control the overlying strata, belongs to Frank Pardee, of Hazleton, Pa. In 1886, while assistant superintendent of the collieries belonging to A. Pardee & Co., he used the system to stop a squeeze which threatened the slope and breaker of the Laurel Hill colliery, at Hazleton. The squeeze seemed uncontrollable by other means, so he flushed two ad-

jacent breasts full of culm. These breasts were in a thick seam which had a steep pitch. By filling the two breasts, or chambers, he provided

a partly natural and partly artificial pillar consisting of three coal pillars, each 10 yards wide, and two culm pillars, each of the same width, or a solid block of 50 yards. When the squeeze reached this pillar the rock broke and the trouble was averted.

The third, and one of the most extensive uses of flushing, was at the Kohinoor colliery, at Shenandoah, Pa. Previous to 1884 this colliery was operated by R. Hecksher & Co., and, as was the custom in those days with individual operators working coal lands on lease, there was but little system used in the working of the coal, and the mine surveys were few and frequently very inaccurate.

On January 1, 1884, the Philadelphia & Reading Coal and Iron Co. obtained possession of the colliery. One of the first things done was the making of an accurate survey of the entire mine workings, the engineers carrying tidal elevations to each survey station or point sighted to, as is the present rule in good mine surveying. When the mine map was completed it was an extremely accurate one, and the data on the map and in the note books made it an easy matter to construct accurate geological cross-sections and a contour map of the bottom of the coal seam. At the same time it was found that the workings in the very thick Mammoth seam were in such condition that but comparatively little coal could be mined from them with safety, and that the surface and the improvements located thereon, in a large part of the western section of the town of Shenandoah, were likely to be seriously affected by subsidences of the surface.

The extremely wide openings, made by the former operators, were very irregular, as the chambers followed the varying, but generally very light, dip of the seam. The great thickness of the Mammoth seam (ranging from 40 feet to 60 feet) made it impossible to take the ordinary precautions as to timbering and removing the shattered and loose coal from the sides or ribs of the pillars, and rendered mining exceedingly dangerous to the men employed.

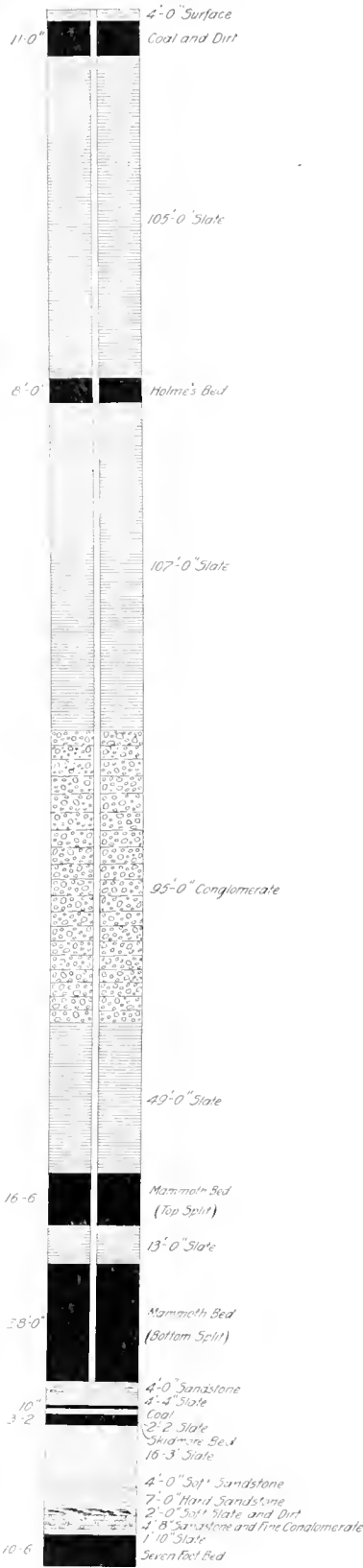

FIG. 2
Scale, 1 in. = 60 ft.

Of course, the removal of the pillars, even if it could be done with safety to the employes, would cause such a disturbance of the surface and destruction of property in Shenandoah, as to be a source of danger and great loss, even though the thickness of the strata from the surface to the top of the Mammoth seam averaged about 400 feet.

These conditions made it necessary to resort to some unusual means to recover at least a portion of the unmined pillars, which, in some places were very large, and to do it in such a way as not to endanger the lives of the workmen, or the surface.

At that time, the late R. C. Luther was Chief Mining Engineer, Geo. S. Clemens, now Chief Engineer of the Northern Division, was Division Mining Engineer, and the late John Veith was the general Inside Superintendent of the company. A general consultation was held by these officials and the late P. W. Sheaffer, one of the land owners, and after various schemes were discussed and found impracticable, it was decided to fill the mine workings by flushing the culm into them, from the breaker and the culm piles, with water. At that time neither of the gentlemen named knew of Mr. Pardee's prior use of the system for supporting the roof.

In a report on the flushing at Kohinoor, made by Mr. Clemens in 1898, he says:

"For the purpose of carrying out the scheme, 10 bore holes, each 8 inches in diameter, ranging in depth from 308 feet to 425 feet, were drilled from the surface to the Mammoth seam, at an average cost of \$2.30 per foot. The drilling was started in February, 1887, and was done with churn drills. A series of scraper lines or conveyers, comprised of eight sections, having a total length of 2,475 feet, and slush troughs 1,400 feet long, on trestles, which ranged from 0 to 31 feet high, were erected to convey the fine refuse or culm from the West Shenandoah and Kohinoor breakers to the bore holes sunk to the eastern workings of the Kohinoor colliery. In addition, there were three other scraper

lines with a total length of 900 feet, and 83 feet of slush trough, erected to carry culm to bore holes penetrating the western workings.

"An engine, 18-inch cylinder and 36-inch stroke, with rope wheels 14 feet in diameter, was erected to run the scraper lines, and a duplex pump with four working barrels

tances on lighter pitches. This of course required more water. In order to fill the openings as tightly as possible, and above all the lateral openings where the water could run off, still larger quantities of water were used, and it was found practicable to distribute the slush in such places on a dip of about 5 degrees. In the



FIG. 3. LAST TWO SECTIONS OF CONVEYER LINE AT NORTH MAHANNOY COLLIERY

each 9-inch diameter by 38-inch stroke, with 2,620 feet of 4-inch to 6-inch column pipe to furnish water for slushing, were also installed. This equipment, with two 90-horsepower boilers to furnish steam, comprised a distinct plant for this special work. There was also an underground slush course in the Holmes seam, overlying the Mammoth seam, from the east end of the scraper lines to the No. 3 bore hole. The relative positions of the Holmes seam and Mammoth seam are shown in columnar section, Fig. 2. This underground slush course was put in to avoid an overground structure through a thickly built portion of the western section of the town.

"On May 2, 1887, the flushing of culm into the first or No. 1 bore hole was started. As the openings to be filled were very large, the slush was run into the adjacent breasts through the gangways and cross-headings driven in the lower benches of the seam, so that comparatively little water was necessary. As these openings filled, cross-headings were driven in the upper benches of the seam to allow the slush to flow longer dis-

latter cases, approaches to the top of the filling and the bottom of the bore holes were provided by timbered traveling ways against the ribs. These were necessary to permit examinations, and to prevent blocking of the bore holes, so that they could be used for further flushing when the surrounding pillar coal was removed. In some places the top rock had fallen, leaving large spaces above the seam. These were also filled.

"In one case, close to No. 1 bore hole, the top rock had fallen for a height of 25 feet above the top of the seam. It was necessary in this case to blow down the rock between the bore hole and the fall, and the entire space was then filled to within 3 feet of the top of the hole, this 3 feet being left open for access to the bore hole.

"As all the water used in flushing had to be pumped from the mine, the filling of such places as required an excessive amount of water was reserved for dry seasons, when the regular pumps could handle the excess in addition to the ordinary drainage. The average amount of culm flushed into the holes was 565 cubic yards per day. The amount of

water used varied from 67 to 334 gallons per cubic yard of culm, or an average of 200 gallons per cubic yard.

"At times the entire output of culm from the two nearby breakers (Kohinoor and West Shenandoah) was handled by the scraper lines, and for several months the work was prosecuted day and night, the night

1,000,000 tons of prepared coal, most of which would have been lost if the flushing had not been done.*

"Before the flushing was completed on the Fourth Left East Gangway a very serious squeeze occurred, which made it impossible to examine the exact condition of the filling at some of the bore holes, but the filling pre-

solidly full. Then, with the top of the flushing as a floor, about 10 feet of the coal is top sliced to the end of the room, after which the room is again flushed and another slice of the top coal is taken. In this manner mining and flushing is alternately carried on until the entire thickness of the seam is taken out. When the chamber is driven on the bottom slate, the track is laid so that the ordinary mine car can be run to the face and the cut coal can be loaded directly in to it. When this opening is flushed full, this is not possible. Therefore, a chute is made at the mouth of the room and the coal is run to it in a buggy, or small car, pushed by hand, and is dumped by way of the chute into a regular mine car.

The total amount of culm so far flushed into the Kohinoor workings is nearly 1,000,000 cubic yards, and through the flushing nearly 53,000 mine cars of coal have been recovered; each car having a water level capacity of 108 cubic feet. Seventy-five per cent. of the coal now being obtained from this mine is from flushed areas.

The success of the flushing at Kohinoor colliery in supporting the surface, and in permitting the extraction of a maximum amount of the coal in the seams was such that the system has been employed by the Philadelphia & Reading Coal and Iron Co. at a number of collieries. As a description of the methods employed at all the collieries would necessarily be repetitions, this article will describe only a few of the typical cases.

The material used for flushing is sometimes the fine screenings from the breaker. At other times specially crushed slate and bone are mixed with the screenings. Sometimes the ashes from the boiler house are flushed in with the broken slate and screenings.

One of the simplest flushing operations in the Schuylkill region is at the Tunnel Ridge colliery near Mahanoy City, Pa., where an old culm bank, shown in Fig. 1, is being washed into the workings in the north dip of the Holmes seam in

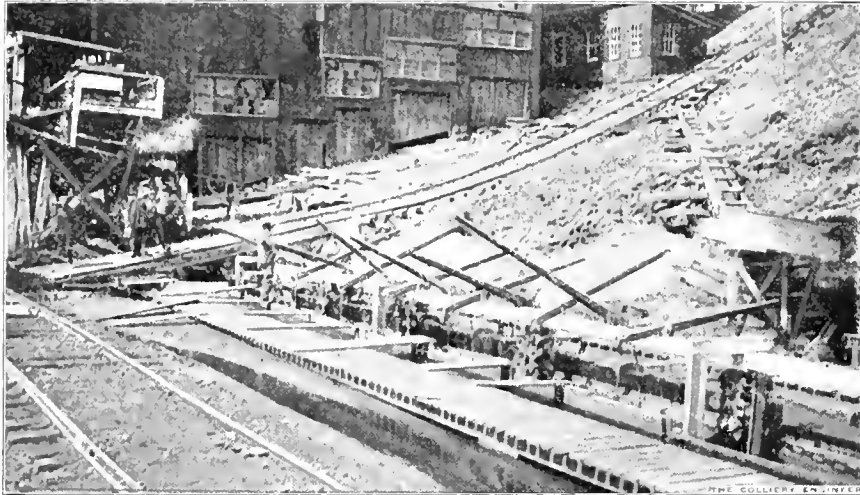

FIG. 4. SETTLING TANKS AT MAHANOH CITY COLLIERY

shift flushing in culm taken from the culm piles. A total of 700,000 cubic yards of culm was flushed through the bore holes into the Mammoth seam workings at an average cost of $4\frac{1}{2}$ cents per cubic yard.

"It was found advisable to not push the mining of coal too rapidly in the vicinity of the flushing, as the very thick coal seam required that extreme care be taken to avoid accidents to the miners.

"A set of miners worked a few weeks in one place, fired a few shots in the pillars, loaded all the coal available, then worked in another place until the first place became thoroughly quiet again. Large falls of coal frequently occurred in these places while work was temporarily stopped, and when the miners returned to them they frequently found enough loose coal to work a week or two without firing a shot. In this way, there was recovered to date of the report (1898), about 185,000 tons of prepared coal from the portions of the workings that had been flushed, and it is estimated that over four times this amount could still be obtained, making a total of about

visiously done arrested the squeeze and greatly minimized the damage.

"Later, gangways were driven eastward in the Skidmore seam, shown in Fig. 2 just below the Mammoth seam, to points under the robbing in the Mammoth seam, and chutes from 6 to 7 yards long were driven from them to the Mammoth seam. Through these chutes large quantities of Mammoth seam coal were recovered, and the new openings thus made in the Mammoth seam were flushed full.

"The deposit of slush, or culm, packed remarkably hard and firm. Gangways and headings were driven through it without forepoling, and by timbering with double timber (two legs and a collar in each set) and lagging with slabs or planks, it was not difficult to keep the gangways and headings open."

At the present time the Mammoth seam at the Kohinoor colliery is being mined on a flushing and slicing system. A room is driven in the bottom benches of the seam, and as soon as it reaches its limit it is flushed

* This estimate was a very accurate one, as in subsequent work fully as much coal was recovered as was estimated.

order to protect Mahanoy City. To get this culm into the mine, a slope 200 feet long was sunk and then a gangway was driven so as to strike the tops of the old breasts, down which the slush is poured. One man with a hose washes the culm from the bank into a wooden trough laid along the side of the hill to the head of the slope. From the troughs the slush is discharged into wooden pipes through which it flows into the mine. The building shown at the left of Fig. 1 is the engine house for this slope.

A similar method was used to flush the old Elnwood colliery workings in the south dip of the same seam. This colliery was almost directly across the Mahanoy Valley from the Tunnel Ridge colliery. As, at the Tunnel Ridge colliery, a gangway was driven that ran along the faces of the old breasts, and culm piped in this gangway was allowed to flow down the steep pitching breasts until all were filled.

In contrast to the short distance the slush is carried at Tunnel Ridge colliery and the ease with which it is done, is the distance it is carried at the North Mahanoy colliery, where six sections of conveyers are used to take the culm from the breaker to a distributing point, the last two sections of which are shown in Fig. 3. Here the dirt is elevated dry to the top of a hill where water is added to it and from there it flows through troughs and wooden pipes to bore holes, and down them into the mine.

At the Mahanoy City colliery the screenings as they flow from the breaker are caught in settling tanks (Fig. 4), so that the excess water flows away and only the dewatered culm is elevated to the distributing points. Here water is added and the slush is settled in V-shaped tanks 8 feet deep, placed on each side of a trough. Each tank has a bottom gate opening into the conveyer trough, through which the slush flows to a conveyer in the bottom of the trough. Two men attend to the gates, opening them when a tank becomes full of slush.

Two settling tanks are also used

at the West Shenandoah colliery; but here the purpose is to thicken the slush as it flows into the mine. In this case the chambers being filled have a pitch of 45 degrees and not as much water is needed to deposit the slush as if the pitch was less. Moreover, when there is less water to drain away, the pressure on the

can be flushed when the breaker is running. The composition of the slush is 50 per cent. screenings, 44 per cent. slate, and 6 per cent. ashes.

About 19 men are employed on the flushing at this colliery; two men take care of the conveyers, two men are employed in the crusher house, and about 15 men are employed

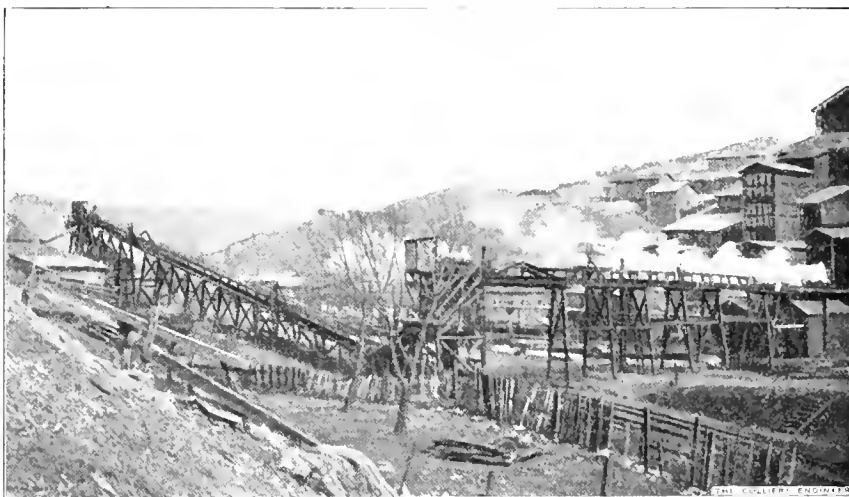

FIG. 5. CONVEYER LINES AT SHENANDOAH CITY COLLIERY

batteries in the mines is less. The proportion between water and screenings is made as nearly two to one as the men can guess with the eye.

At the Shenandoah City colliery all the waste material from the breaker is sent into the mine. The slate and screenings are brought out on separate conveyers; the screenings are dumped directly into the first of two flights of conveyers, shown in Fig. 5, which carry them across a railroad track and up to a distributing tower, shown in Fig. 6, where enough water is added to flush them into the mines through several bore holes; the slate is carried from the breaker to a crusher where everything over 2 $\frac{3}{4}$ inches in size is broken in a No. 3 Williams crusher, and then conveyed back to be mixed with the breaker screenings. The ashes from the boiler house are also mixed with the slate and screenings. When the breaker is running, the ashes are mixed continuously, any clinkers being broken with the slate. A concrete bin has been built into which a week's supply of ashes may be flushed, if necessary, when the breaker is idle, and from which the ashes

underground building batteries and taking care of the pipe lines.

The slush is generally run into the mine through 6- or 8-inch bore holes, though it may flow down slopes or shafts, and where there is a convenient opening on the outcrop it may be carried in through it. One bore hole can be used to flush several seams though it is better to have a separate bore hole for each seam, especially if the breaker is dependent upon the flushing to take care of the waste. Then if one bore hole gets blocked, another can be used. It is also more convenient for the inside working, causing less delays, as the changes in the flow of the slush are controlled by one man at the breaker.

The wooden troughs used to carry the slush to the bore holes may be lined with old sheet iron from the breaker or with split terra cotta pipes. The terra cotta pipes will last the longest of any lining.

The wooden trough branching to the right in Fig. 6 is terra cotta lined. At the end of the trough, the slush can flow two ways, one way leads down a slope where the slush flows in an open trough, the other way leads

to a bore hole a few feet away. From the bore hole the slush flows under pressure through a pipe line, 4,000 feet long, in the mine. Where it is necessary to get as much head as possible, or where the grade is too light for slush to flow in troughs, it may be carried in pipes on the surface.

The general practice is to use wooden pipe for conducting the slush inside, though cast-iron pipe is sometimes used. The life of a pipe is dependent upon the kind of material passing through it and the grade on which it is laid. Breaker screenings will not wear a pipe as quickly as ashes and broken slate. A 6-inch wooden pipe line at West Shenandoah colliery, which carried crushed slate for a distance of 1,500 feet on a considerable grade, was worn out after passing about 16,000 cubic yards, whereas wooden pipes carrying breaker screenings have lasted 1, 2, and 3 years. Wrought-iron pipe is often used where ashes are being flushed separately.

As long as the pressure remains in the pipe the slush can be carried up hill and down dale, but the pyrites in the slush is likely to separate and block the pipe where there is a sag and the velocity becomes low.

In flushing any place, the lower end of the chamber or opening is closed with a battery built of props and 1½-inch plank. In building this battery hitches for the ends of the timbers are cut in the bottom rock and in the top rock or top coal. Where the seam is mined all at one time the hitches can be cut in the bottom and top rock, but at places, such as in the Mammoth seam at Kohinoor, the top hitch is necessarily in coal. The depth that is given to the hitches will depend on the weight the battery must support and the character of the rock or coal. When the pitch of the seam is heavy, there is greater pressure upon the battery than where the seam is flat, necessitating the use of heavier props, and putting them closer together. On pitches of 20 or 30 degrees or more, 12- or 14-inch props, or even larger, are used. They are placed 2 feet

apart, with braces between to hold them in place. Care must be taken to place the props with their inside faces in line, so that the planks can be securely fastened.

A double layer of 1½ inch plank is placed on the inside of the row of props, and neatly hitched into the

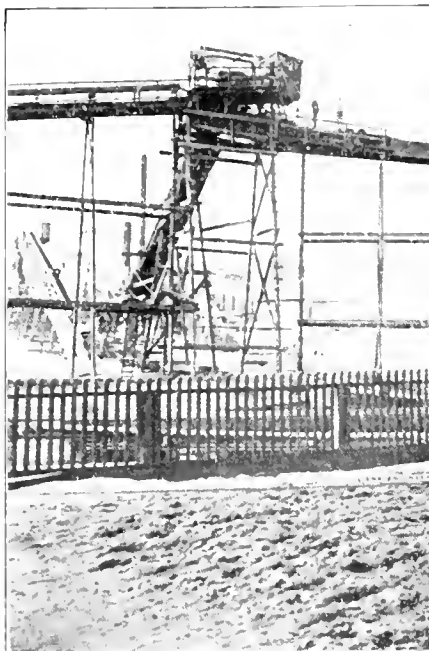

FIG. 6. DISTRIBUTING TOWER AT SHENANDOAH CITY COLLIERY

coal on each side, the openings or cracks being stopped with hay. Great care must be taken when there is much pitch to the seam, for, a small hole in the battery will allow a large amount of slush to escape.

In flat seams the batteries have comparatively little weight against them, and draining the water from the slush is not difficult. An opening a couple of feet wide may be left at the center of the battery across which a board can be placed as the chamber fills up, and over which the water will flow. Besides, the battery for a flat seam, if not too thick, can be made out of 6-inch props and 1-inch boards.

At the Alaska colliery near Mt. Carmel, where the coal seam has a pitch of 15 degrees or more, the slush is discharged alternately into one of two rooms. After flowing for an hour or two into one room, it is shut off to allow the slush water to drain through the cracks in the battery.

During this draining period the slush is flowing into the second room for 1 or 2 hours, or, until it is again turned into the first room.

At the Indian Ridge colliery, at Shenandoah, Pa., as well as at other collieries, the water drains off through wooden pipes placed in the batteries. These pipes are made of inch boards and are 4 inches square inside. On their sides saw cuts about a foot long are made, four series of slits being made in each board. These slits allow the water to pass, while holding back the culm. By the use of these, the slush in the chamber is dewatered and there is not so much weight on the battery, the culm at the bottom being packed tight. Three, four, or six pipes may be placed in a battery.

Another method where the seam has not much pitch is to place a couple of square board pipes up a breast and have an upright branch pipe into which the water can flow. When the dewatered material reaches the top of the upright, the pipe is closed with a board.

A chamber having a pitch of 5 degrees or more can be filled if the slush is poured in at the high end. If ashes are used alone a pitch of 10 degrees or more is needed, as ashes, being porous, allow the water to drain away quickly and they will not flow in a stream as readily as breaker screenings. The slush has more or less mud in it, and it is this, with the mixture of various sizes of materials, together with their low specific gravity, that makes it flush so well. Slush can be poured into a caved area and will fill the spaces between the broken rocks.

In filling the Holmes seam at the Tunnel Ridge colliery, no attempt is made to control the flow of the slush by means of batteries. The reason for this is that the gangway from which the breasts were driven has caved so that the mouths of the chambers are not accessible. Moreover it is not desired to rob the pillars there, the main idea being to support the town. Therefore, the slush is allowed to flow as it will. As soon as one breast becomes full, the slush is poured into the next breast.

That there may not be a sudden rush of water which might have become dammed behind the slush, a dam, with a relief pipe, is built in a tunnel leading to the old workings through which the water can escape.

It is easy to reopen a road through caved territory after it has been flushed. For the flushing affords fine support for the ground on each side of the road, as shown in Fig. 8.

Where the seam is flat the flushing pipes are fastened along the roof for the full length of the chamber.

are put into this mine each day, a series of three breasts are filled in about 9 or 10 days.

Screens, generally of 2 $\frac{3}{4}$ -inch mesh, are placed over the mouths of bore holes and pipes. Anything that passes through them will readily flow through 6-inch pipes.

The most common trouble in flushing is to have the pipe become blocked. This will happen if the pipe is not full of clear water without solids before flushing is begun, and if the pipe is not cleaned out with

every few weeks to distribute the wear evenly over the interior and thus lengthen the life of the pipe.

It might be expected that when roadways are cut through the slush it would not stay in place on the sides, but the contrary is true. Enough moisture is retained so that it will stand with a vertical side, and it will not require lagging unless it becomes watersoaked.

In drawing pillars after flushing, regular systems are followed if possible. One method is to take out

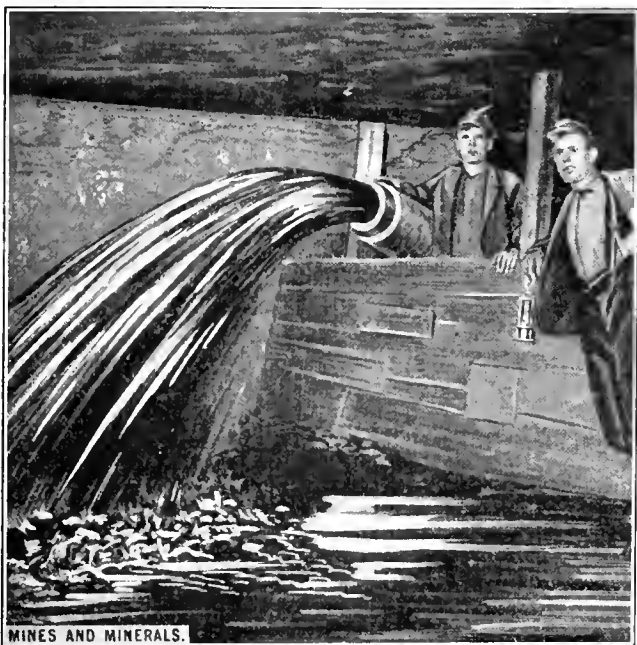

FIG. 7. FLUSHING CULM

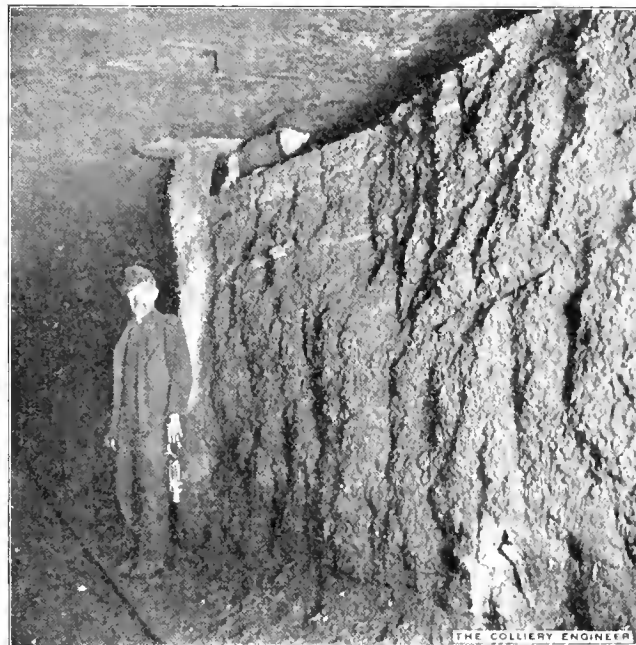

FIG. 8. ROAD DRIVEN THROUGH FLUSHED MATERIAL

Then as the chamber fills and the slush rises up to the pipe, a length of pipe is taken off and the flushing continued. In this case the seam cannot be filled completely, a little space always being left between the flush and the roof. The flushing should always be done from the highest point in the chamber.

At collieries where each breast is filled separately, the breakthroughs between breasts are closed with a battery. At Indian Ridge the slush pipe enters the top of a heading in the middle one of three breasts, and as that becomes full up to a breakthrough the slush flows into the breasts on each side until they fill to the breakthrough, when the center breast will begin to fill again. As an average of 592 cubic yards of slush

clear water after flushing is stopped. Water must be turned into the pipe and be flowing before the slush enters, and must be kept flowing after the slush is stopped. The slush should be so mixed that there is a constant uniform flow. Sudden rushes of slush are likely to block the pipe. To quickly locate a block, holes are bored in wooden pipes and closed with plugs. The pipe is likely to clean itself out below any block, and by knocking the plugs out the blocks can be located and the pipes need only be taken apart at the block.

Wooden pipes should be turned after being in one position for a certain length of time. On very light grades, it may be necessary to turn them only every 6 months. On steep slopes they had better be turned

every third pillar, and it is mined from the gangway advancing. In this case ventilation is maintained by means of a door on the gangway and a brattice up to the working face, as no breakthroughs can be maintained. As soon as the pillar is drawn, a battery is built and the place occupied by the pillar flushed. When one pillar has been drawn the next one is mined, care being taken that the pillars on which work is being done are three apart and that all rooms in between are flushed.

When the pillars are irregular, no system can be followed. Pillars in underlying seams can be taken out without disturbing those in seams above, but it is best to take them out simultaneously and have the rooms flushed in sections one over the other.

The Coal Fields of Ohio

A Description of the Location, Extent, and Quality of the Principal Coal Seams of the State

By Wilbur Greeley Barroughs*

THE coal fields of Ohio are situated in the 30 counties forming the southeastern portion of the state, being included in the Northern Appalachian coal field. Within the Ohio fields, the rocks of the Carboniferous system, in which all the coal seams are included, constitute

entirely removed by erosion; and still other areas where the coal seams are too thin, or too impure, to possess any commercial value. The Car-

strata, only a few low and gentle arches; and the faulting that has taken very slight.

The coal measures of this region are divided into the groups shown in Table 1.

There are at least 16 beds present in the series, and of these the more important ones will now be considered.

Coal No. 1, The Sharon Coal.—R. M. Haseltine in the Twenty-second Annual Report, Part 3, United States Geological Survey, states that this coal occurs chiefly in the northeastern portion of the state, and was probably formed in irregular depressions in the previously deposited conglomerate that forms the base of the Upper Carboniferous. Along the western margin of the coal measures, the No. 1 coal is separated from the conglomerate by about 50 feet of shale. In the northern portion of the field the coal usually has well-defined joints, and comes from the mines in large blocks. It is, therefore, sometimes called Block coal. In Jackson County, No. 1 coal has been mined under the name of the Jackson Shaft coal. Other names applied to this coal are Massillon, and Brier Hill coal.

Coal No. 2, Wellston Coal.—As seen from the accompanying section, Fig. 2, this coal is found between the two divisions of the Massillon sandstone of the Pottsville. Where both No. 1 and No. 2 beds are present the distance between them, according to Haseltine, ranges from 45 to 75 feet. In northern Ohio, No. 2 rarely becomes more than 2 feet thick. At Wellston, in Jackson County, it attains a thickness of 4 feet.

Coal No. 3, Lower Mercer Coal. This coal belongs to the Pottsville

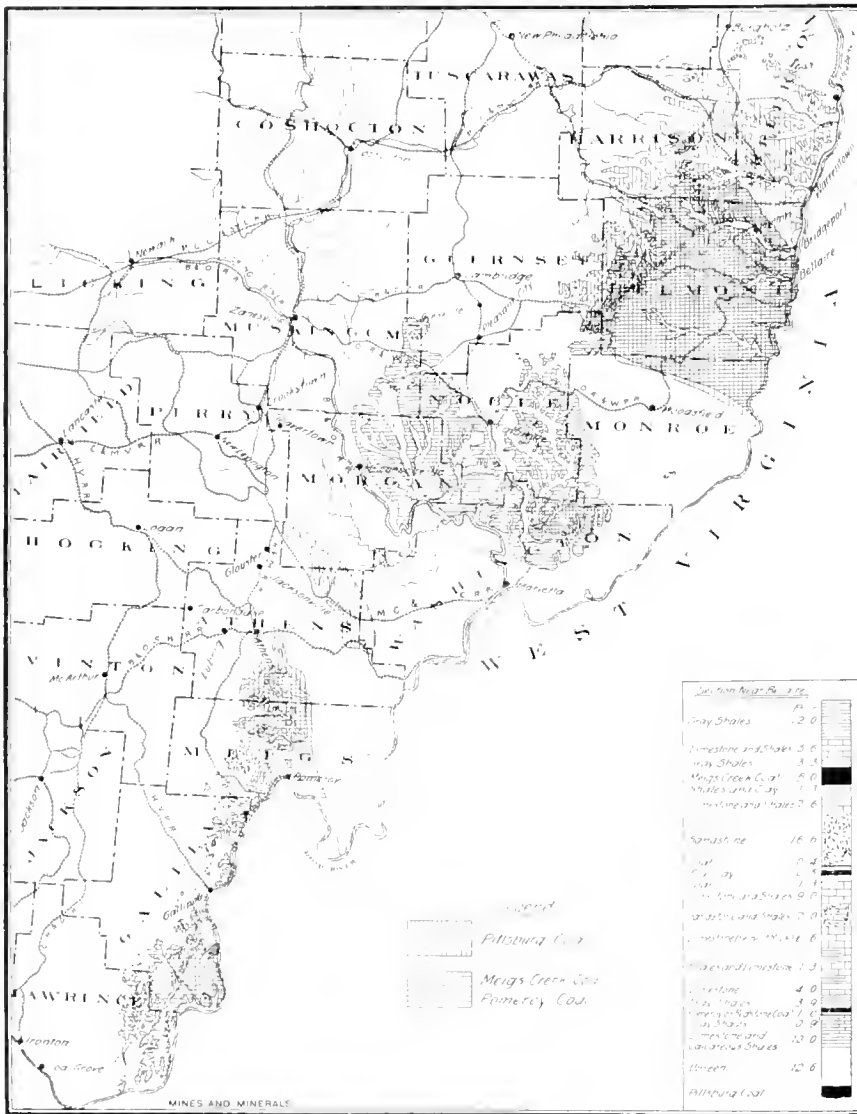

FIG. 1. MAP SHOWING COAL FIELDS OF OHIO

the surface rocks of about 10,000 square miles. This does not mean, however, that under any given point coal of economic importance can be found, for there are large areas within the general boundary of these coal fields, where, although the rocks are of Carboniferous age, coal seams never were formed; other areas where the coal beds that once existed have been

boniferous formations of these fields are regular and simple of structure, containing few, if any, folds in the

TABLE 1

	Classification		Feet
	Old	New	
Permian.....	Upper barren measures	Dunkard	950
Pennsylvanian.....	4. Upper coal measures	Monongahela	250
	3. Lower barren measures	Conemaugh	500
	2. Lower coal measures	Allegheny	600
	1. Pottsville conglomerate		300

* Geologist, Oberlin, Ohio.

formation. Where thick enough to justify mining, this seam is generally so mixed with slate as to make an unsatisfactory fuel.

Coal No. 3a, Upper Mercer Coal. This coal is of somewhat better quality than the Lower Mercer, but the quality is unreliable.

Coal No. 4, Lower Clarion (Brookville) Coal.—This seam is included in the Lower coal measures. It is of little importance.

Coal No. 4a, Upper Clarion Coal. This coal of the Lower coal measures, is important in the four counties of Vinton, Jackson, Lawrence, and Scioto. It is occasionally mined to a small extent in other parts of the state. The coal lies directly below the ferriferous limestone, or in some places, is separated from the limestone by a thin bed of shale. This Clarion coal being in the same regions geographically as the Wellston coal, forced it to compete with the Wellston coal, and thus has retarded its development.

LEGEND FOR FIG. 1

Geological Series.—The Pennsylvanian Series comprises the following: *I*, Pottsville Conglomerate; *II*, Lower Coal Measures, Alleghany; *III*, Lower Barren Measures, Conemaugh; *IV*, Upper Coal Measures, Monongahela. The Permian contains *V*, Upper Barren Measures, or Dunkard.

Local Names.—*A*, Coal No. 1, Sharon, Brier Hill, Jackson Shaft; *B*, Lower Massillon; *C*, Wellston, Quakertown; *D*, Upper Massillon; *E*, Lower Mercer, Flint Ridge Cannel; *F*, Upper Mercer, Bruce; *G*, Tionesta; *H*, Homeward, Piedmont; *I*, Lower Clarion, Brookville; *J*, Upper Clarion; *K*, Gray ferriferous, Putnam Hill; *L*, Lower Kittanning, Mineral Point, Leetonia, New Castle; *M*, Middle Kittanning, Hocking Valley, Straitsville, Sheridan; *N*, Upper Kittanning; *O*, Lower Freeport; Hatcher, Steubenville, Whan; *P*, Stilwell, often conglomerate; *Q*, Upper Freeport, Cambridge, Big Vein, Waterloo; *R*, Mahoning; *S*, Grof, Stripe vein, Brush Creek; *T*, Norwich, Patriot; *U*, Pittsburg; *V*, Pomeroy, Redstone in Pennsylvania and West Virginia; *W*, Meigs Creek, Sewickley in Penn-

sylvania; *X*, Macksburg, Waynesburg.

Strata.—1, Conglomerate; 2, Sandstone and shale; 3, Fireclay; 4, Coal No. 1; 5, Gray shale; 6, Sandstone; 7, Shale; 8, Fireclay; 9, Coal No. 2;

Fireclay; 21, Coal No. 4a; 22, Limestone; 23, Shale and sandstone; 24, Fireclay; 25, Coal No. 5 (Haseltine); 26, Gray or black shale; 27, Limestone; 28, Fireclay; 29, Coal No. 6; 30, Gray or black shale;

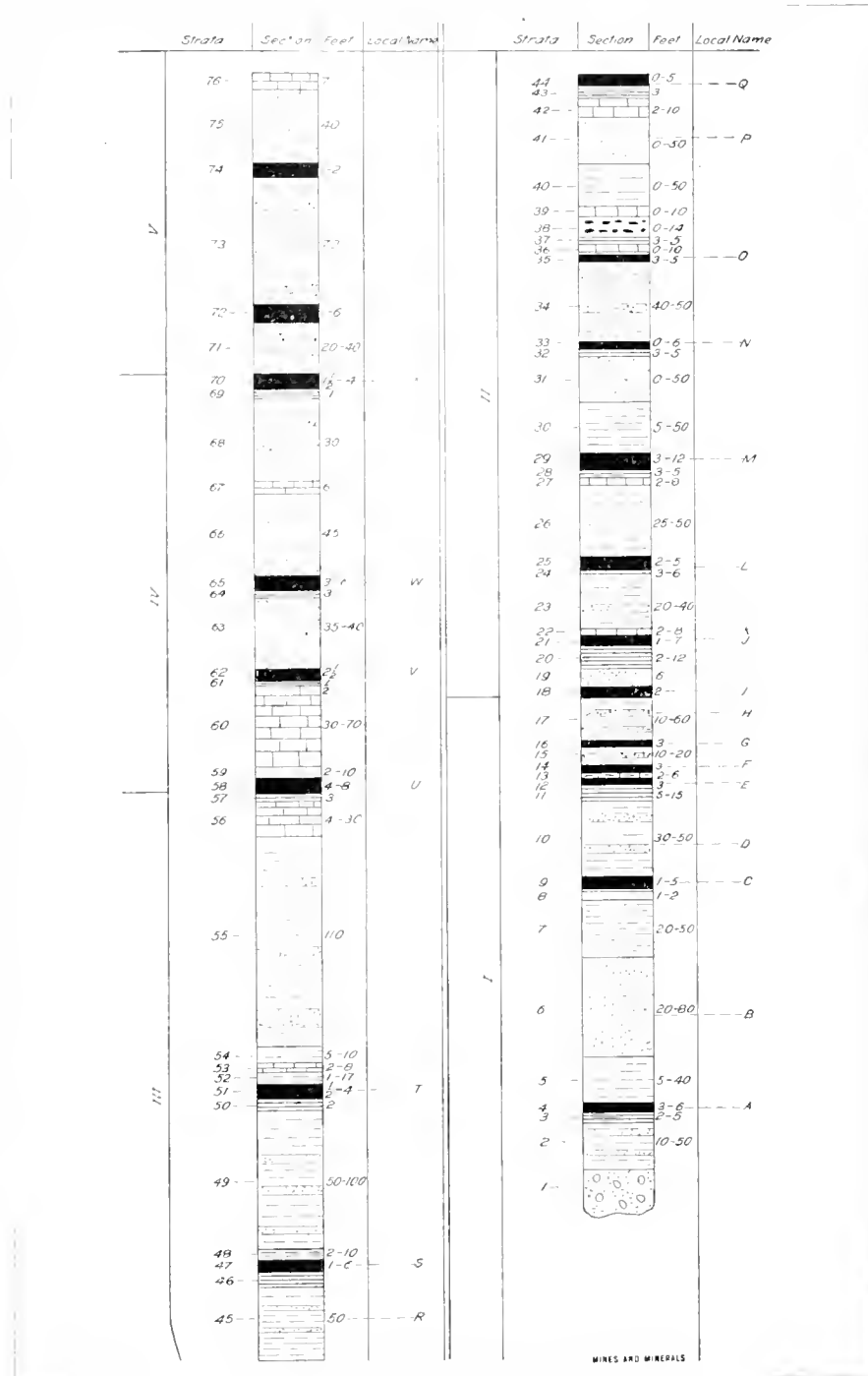

FIG. 2. SECTION OF OHIO COAL STRATA. FOR SIGNIFICANCE OF NUMBERS, LETTERS, ETC., SEE LEGEND ACCOMPANYING

10, Shale and sandstone; 11, Fireclay; 12, Coal No. 3; 13, Limestone, with iron ore; 14, Coal No. 3a; 15, Shale and sandstone; 16, Coal No. 3b (Haseltine); 17, Shale and sandstone; 18, Coal No. 4; 19, Sandstone; 20,

31, Sandstone; 32, Fireclay; 33, Coal No. 6a (Haseltine); 34, Shale and sandstone; 35, No. 6a (Orton), Coal No. 6b (Haseltine); 36, Limestone; 37, Fireclay; 38, Black band iron ore; 39, Buff limestone; 40, Gray shale;

41, Sandstone; 42, Limestone; 43, Fireclay; 44, Coal No. 7; 45, Sandstone and shale; 46, Fireclay; 47, Coal No. 7a (Haseltine); 48, Shale; 49, Shale and sandstone; 50, Fireclay; 51, Coal No. 7b (Haseltine); 52, Shale; 53, Crinoidal limestone; 54, Shale; 55, Shale and sandstone; 56, Limestone; 57, Fireclay; 58, Coal No. 8; 59, Black shale; 60, Limestone; 61, Fireclay; 62, Coal No. 8a (Bownocker, most recent data), Coal No. 9, Haseltine); 63, Sandstone; 64, Fireclay; 65, Coal No. 8a, (or 10, Haseltine). Coal No. 9 (Bownocker, most recent data); 66, Sandstone; 67, Limestone; 68, Sandstone and shale; 69, Fireclay; 70, Coal; 71, Sandstone and shale; 72, Coal; 73, Sandstone and shale; 74, Coal; 75, Sandstone; 76, Limestone.

Coal No. 5, Lower Kittanning Coal. This bed of the Lower coal measures, can be traced from Mahoning County southwest across Ohio to Lawrence County on the western side of which county it is important, being known as the New Castle coal. The Lower Kittanning seam is from 20 to 30 feet above the ferriferous limestone. In thickness this coal is generally less than 3 feet, although in a few places it increases to 4 or 5 feet. It is at its best in the northern part of Columbiana County, especially near Leetonia. The Lower Kittanning is a good coking coal.

Coal No. 6, Middle Kittanning Coal.—The area which this seam, also of the Lower coal measures, covers, coincides nearly identically with that of the Lower Kittanning. Edward Orton, former State Geologist of Ohio, states that so far as Ohio is concerned, this Middle Kittanning coal is in reality the Upper Kittanning seam, but that in the Pennsylvania scale this Middle Kittanning seam is identified as the first seam above the Lower Kittanning coal, while a distinct seam is found there, in some counties, at a somewhat higher place in the scale. Orton traced the outcropping No. 6 seam from the Pennsylvania state line in the Ohio Valley, through the Yellow Creek Valley, under the

divide that separates Tuscarawas water from Yellow Creek, to the Little Sandy. It can, also, be directly connected with the Pennsylvania series through the Mahoning Valley, as was first shown by I. C. White.

This No. 6 seam, extending entirely across the state from Columbiana to Lawrence counties is mined in a greater or less degree from the Pennsylvania line to the Ohio River.

The structure of the No. 6 seam in the Hocking Valley field, which field has for its only rival the Pittsburg field of eastern Ohio, is given by Doctor Orton as follows:

"In structure the Hocking Valley coal always has the three benches of the normal Middle Kittanning seam, with some addition of its own. In other words, the great deposit consists of the normal three-bench seam of the Middle Kittanning system covered and reinforced by a Hocking Valley supplementary seam, the latter consisting of one or two, or more benches. The supplementary seam is separated from the original seam by a thin shale parting which is often disregarded in mining, but which is for the most part distinctly recognizable when looked for. The supplementary seam of the Hocking Valley is, in the general view, counted with the upper bench of the normal seam, the whole being known as the top coal. It has a maximum thickness of 10 feet. All the thickness of the Hocking Valley seam in excess of 6 feet, and in many parts of the field in excess of 4½ feet, is to be credited to the supplementary seam. There are numerous irregular partings in this top coal when it becomes thick, only one of which is widely extended and measurably regular. A 4-inch black slate, known as the third slate, and charged with Sigillaria impressions, is found 8 to 9 feet above the bottom of the great deposit, everywhere throughout Monroe Township in the Sunday Creek Valley. As it now appears, it is the same horizon at which a constant layer of cannel coal is found throughout the western portions of the deposit. The coal above the slate

becomes a rider seam. It runs too high in ash in most of the field where it occurs to be fairly marketable. It reaches a maximum thickness of 4 feet, but most of it is left in the mines. The composition of the No. 6, coal throughout the Hocking Valley field is fairly uniform. Taken as a whole, it is an open burning coal, but the lower bench, burned by itself, is somewhat cementing. It is distinctly laminated and holds a moderate proportion of mineral charcoal. It ignites easily, swells slightly in burning, and leaves a white or gray ash. It is well approved for steam generation, and also, for rolling mill fuel. To household use it is admirably adapted, rivaling in this line of service the block coals of the Mahoning and Tuscarawas valleys."

The Middle Kittanning coal is of less value in Columbiana County than in any other county of the state in which it occupies as wide an area. Throughout the northern and central portions of this county, it is less than 1 foot thick. In the Ohio Valley, it is known as the Block Bed, and as the Hammondville Strip Bed. About East Liverpool, it is known as the Dry Run coal. Here its quality is so excellent that it is extensively worked in small mines, although but 20 to 32 inches thick, the 32 inches being of rare occurrence.

Coal No. 7, Upper Freeport Coal. The Freeport coal, Lower coal measures, can be traced across the state, and is similar in many ways to the Kittanning coals. It is less persistent in thickness, however, than the Middle Kittanning seam, and is of smaller value. J. A. Bownocker, present State Geologist of Ohio, says in Bulletin 9, of the Ohio Survey, that the best deposits of Upper Freeport coal are found in the eastern and northeastern parts of Ohio. The Cambridge field, including parts of Guernsey and Noble counties, forms one of the most valuable coal deposits in Ohio. In 1906, the output from this field was somewhat over 3,000,000 tons.

In the northeastern part of Lawrence, and the adjacent part of Gallia County, is an important coal bed.

This field is known as the Waterloo field. Due to lack of transportation facilities the coal of this field has been mined, up to that time, only for local use.

Between the Waterloo field and the Cambridge field, the coal seam is irregular. Very little of the coal is shipped, it mostly being mined by the farmers for their own use.

No. 8 Coal, Pittsburg Coal.—The Pittsburg coal of the Monongahela formation, of the Upper coal measures, is the most valuable coal seam in North America. It is important in the states of Pennsylvania, West Virginia, Ohio, and Maryland. White estimated the area of workable Pittsburg coal at from 6,000 to 7,000 square miles. Orton estimated that Ohio alone contains 1,250 square miles, but this included the Pomeroy coal, which Bownocker has determined lies above the Pittsburg seam.

Bownocker in Bulletin 9, of the Ohio Survey, states that the area in Ohio underlain by the Pittsburg coal, forms two distinct fields, an Eastern field, and a Southern field. The most important of these two fields is the Eastern field which includes nearly the whole of Belmont County, the southeastern part of Harrison, the southern part of Jefferson, the extreme eastern part of Guernsey, the northeastern part of Noble, the northern part of Monroe, and the northern part of Washington counties. The Southern field includes the southwestern corner of Morgan, the eastern part of Athens, the northern part of Meigs, and the southeastern part of Gallia counties.

The Pittsburg coal has a section which is similar over most of the area in Ohio and other states. The section is as follows:

	Feet	Inches
Roof coal.....	1	
Draw slate.....		10
Breast coal.....	2	3
Parting (shale).....		2 1/2
Bearing in coal.....		2
Parting (shale).....		1
Brick coal.....	1	5
Parting (pyrites).....		1 1/2
Bottom coal.....	1	3

The above section, taken at the Neff mine, No. 2, near Bellaire, Ohio, may be considered normal, and is

found in this order in Pennsylvania, West Virginia, Maryland, and Ohio. Geological Survey of Ohio, Bulletin No. 9.

The order is so persistent that as a general rule, this coal bed may be easily identified. Occasionally, however, the parting between the Brick and Bottom coals is wanting, but even then, there is usually a bedding plane between. Along the Ohio River, in Jefferson and Belmont counties, the Pittsburg seam is at its best for Ohio. Here the section is as given. Farther west, along the western border of Belmont County, and near the western margin of the Eastern field, the section is less regular. The main seam or the portion of it that is considered merchantable is generally from 4 to 6 feet thick.

Coal No. 8a, Pomeroy, or Redstone Coal.—Prior to 1907, the Pomeroy, of the Upper coal measures, was classed as Pittsburg, but this classification has been proven to be incorrect, the Pomeroy seam being shown to be higher than the Pittsburg. Since the Pittsburg coal is known as No. 8, and the Meigs Creek coal as No. 9, Doctor Bownocker has numbered the Pomeroy "8a." The Pomeroy coal is mined in Meigs, Gallia, and Lawrence counties. It is the equivalent of the Redstone coal seam of Pennsylvania, and West Virginia.

Bulletin No. 9, of Ohio Geological Survey, states that the Pomeroy is at its best in Meigs County, where it occurs above drainage, and in the southern part becomes one of the important coal beds of Ohio. In the northern part of this county, the Pomeroy is underlain by the Pittsburg, a thin bed of limestone usually separating the two seams, while further south, the Pittsburg coal entirely disappears.

The Pomeroy seam is overlain by massive sandstone, which sometimes is in direct contact with the coal, and occasionally is separated from the coal by shale beds of varying thickness. The sandstone, however, is very persistent, and is found over wide areas.

Coal No. 9, Meigs Creek Coal.—This coal, of the Upper coal measures, is considered to be the equivalent of the Sewickley of Pennsylvania. The late Prof. C. N. Brown gave this seam its name from the stream that drains the central part of the territory where the No. 9 coal occurs. This coal generally is found from 80 to 100 feet above the Pittsburg seam. Bulletin No. 9, of the Geological Survey of Ohio, states that while the Meigs Creek coal "is due in the hills all the way from Jefferson to Lawrence counties, it is found in workable quantities only in Belmont, Harrison, Monroe, Washington, Noble, and Morgan counties. The coal lacks the persistence and regularity of its neighbor, the Pittsburg, or No. 8, seam. Sometimes, it is divided into two parts or benches by a prominent bed of shale or clay, but more often this structure is wanting. Sometimes the seam is without any parting, but usually one or more bands of shale, clay, or pyrites is found. Both floor and roof are irregular, rising or dipping, and thus modifying the thickness of the seam. Especially is this true of the roof which in a short space may occasionally entirely cut out the coal.

"These features indicate that conditions were not uniform during the deposition of the coal and the rock which forms the roof. Probably these deposits were laid down in coastal swamps or marshes that were partially disconnected, the conditions of deposition being slightly different in the different basins. The absence of the coal where due may be a result of water too deep to permit of the coal plants flourishing, or just the reverse, that the water was so shallow the vegetation after falling was not properly submerged. The later appears more probable, for with deeper waters marine fossils might be expected."

The quality of the coal is inferior to the Pittsburg. In spite of this, however, the Meigs Creek seam is an important one, and its value will increase as the Pittsburg seam below becomes more and more exhausted.

Effect of Coal Mining on the Surface

IN VIEW of the present wide-spread interest

in the effect of coal mining on the surface in various American coal

fields, and particularly in the anthracite regions of Pennsylvania, a paper on the subject by M. Fayol, Director of the Commeny Mines, etc., published in the transactions of the Societe de l'Industrie Minerale for the year 1885, translated into English by Mr. H. F. Bulman of the British Society of Mining Students, is of peculiar interest.

In his translation, Mr. Bulman notes the fact that Mr. Fayol reviews the state of the question up to 1885 in an appendix, but that it seemed best to him to put this in the translation.

Mr. Fayol refers to the opinion of a commission of Belgian engineers, in 1839, that the working of a coal seam at a depth of 100 meters (109 yards) would not damage the surface.

In 1868, four engineers were commissioned by the Prussian government to collect information on the question of the "influence that mine workings may have on surface buildings, in the coal fields of England, Belgium, the North of France, and Rherish Prussia." According to these engineers, it was considered in Belgium that when the coal is entirely removed, the most careful "packing" gives no guarantee against damage to surface buildings; the packing only lessens the sinking; that the surface may be protected by leaving pillars, but in order to make this method effective, only half the area of the coal seams must be removed.

In England, the opinion was (1) that the working of the coal at every known depth may affect the surface, but that at depths greater than 400 meters (437 yards), it can only cause damage to certain buildings, such as cotton mills.

(2) That the surface may be effectively protected by leaving pillars of coal, or in the case of longwall working by "stowing."

Experiments Regarding Increase of Volume of Crushed Material and Extent and Direction of Movement of Broken Strata

M. Von Dechen, Chief Inspector of Mines in Prussia, agreed entirely with this opinion. Regarding what is called "The Law of the Normal," viz., that fracture of the strata takes place in planes at right angles to the inclination of the seam, passes through the perimeter of the area worked, and extends up to the surface whatever the depth, M. Von Dechen thought that with seams having moderate inclinations and regular strata, this was so, but not with highly inclined seams.

Experience at the mines of Montrambert and La Beraudiere, shows that the amount of sinking is about 30 per cent.* of the thickness of the seam. The movements produced by the working of a seam 2.10 meters thick (6 feet 10 inches), lying at an inclination of 35 degrees to 90 degrees made themselves felt at an angle of 45 degrees with the horizontal.

At another place the sinking of the surface varied from 25 to 35 per cent. of the thickness of the seam, at a depth of 70 meters (230 feet), of shales more or less hard and compact, covered by 30 or 40 meters (98 feet to 131 feet) of sandstone beds.

M. Fayol gives a summary of M. Dumont's memoir, and refers to the following points, which are not mentioned in the writer's extracts from this memoir in No. 2 of the present volume of the Journal of the British Society of Mining Students.

The inclination of the strata lessens the depth of the subsidence, but increases the area damaged.

Timbering hinders the beds forming the roof of a seam from breaking, and therefore prevents the increase in their volume, which takes place when they break. This increases, rather than diminishes, the subsidence at the surface.

* This is much less than what was found to occur by Mr. J. L. Dixon in his experiments. See No. 2, Vol. XII, of the Journal of the British Society of Mining Students. The difference is probably due to the different systems of working.

The period during which movement of the surface may continue is very uncertain. It is assumed to be from 10 to 12 years

in Belgium and at Sarrebruck. In other places it has been as long as 20 and even 50 years.

The draining of old workings, or the flooding of a mine may bring about fresh movement a long time after the original movement has ceased.

The Colliery Owners' Association published a reply to M. Dumont. They agreed with his conclusions as to horizontal seams, but as to inclined seams they thought "The Law of the Normal" would not hold good. The fracture of the lower extremity of the working will occur in inverted steps (*gradins renverses*) and the fracture at the higher extremity in "*gradins droits*" (*straight tiers*). The average inclination of these steps will fall between the normal to the seam and the vertical.

Regarding highly inclined seams, the Colliery Owners' Association stated that the fracture by crushing must be considered, and this, according to Coulomb, takes place at an angle of 45 degrees. Under the action of this new force, combined with that which tends to break the bed by bending, fracture will take place along a line intermediate between these two directions, which will be further from the normal as the inclination is greater.

They agreed with M. Dumont about the effect of faults and vertical strata in altering the direction of the planes of fracture, but they held that soft beds ought to be considered coherent strata, lying unconformably upon the coal measures, and that their effect would therefore be to alter to a vertical direction the planes of fracture. They quoted two examples to prove that this is so.

On the whole they thought that M. Dumont's theory was unsatisfactory, and often of no practical use, and that the only rule to follow was the examination of the special

facts which accompany each particular case.

Callon, like Dumont, believed in the law of the normal, which was promulgated in 1858 by Gonot, a leading Belgian engineer.

M. Haton de la Goupilliere, the professor of mining at Paris, expresses much the same opinion as Callon, but with some reservations. He says: "In working by a system

the other, the lower beam will bend more, and the upper less than if there was only one. If the number of beams is increased, the lower one bends more and more, but only up to a certain point, after which it remains stationary, whatever the number of pieces added. The lower beam is always bent the most, and the amount of bend gradually diminishes in the upper beams until at a cer-

flections, that is to say, the limit of the zone of subsidence had a height nearly equal to the distance between the points of support; this height was about one-third of the same distance for the ropes, and one-sixth for the iron bars. Wood and rocks also bend in a manner similar to the materials mentioned.

In the case of a roadway of a mine covered with beds of sandstone and shale, the lower bed may be much sunk and cracked, but the second bed will be less so, and the third still less; the zone of subsidence is very limited.

PLANE OF FRACTURE OF ROCKS

It is generally believed that the fracture of pieces tied together and loaded between their points of support, occurs perpendicularly to the length of the piece, that is to say, along a vertical plane, if the beams are horizontal.

This is an error, and it is this error which has given rise to the theory of the "Normal." In reality the fracture occurs along a plane inclined over the excavation. To prove this M. Fayol made the following experiment: He bound together in the direction of the stratification, blocks of sandstone and shale, so as to leave outside the support about half their length, as shown in Fig. 2. Then upon the projecting portion, a steady and increasing pressure was exerted, until fracture took place. Of the ten blocks tested, eight broke along a plane inclined as shown in Fig. 2.

INCREASE OF VOLUME

After breaking, rocks generally occupy more space. This increased space varies much according to the



FIG. 2

nature of the rocks, and may be considerable. The results given in Table 1 have been obtained by experiments.

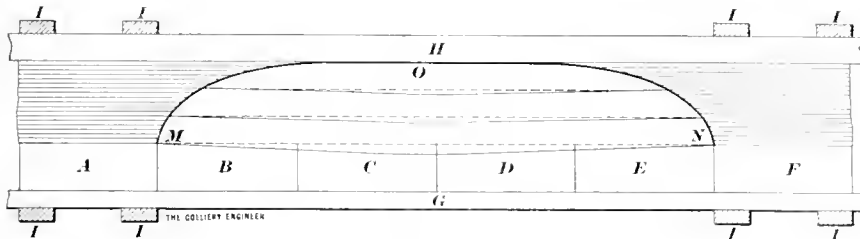

FIG. 1

which permits the roof to fall (foudroyage) the movement of the strata gradually gets less, and stops at a certain level; with longwall and stowing (remblayage) the movement is almost independent of the depth; the principle of leaving sufficient pillars can alone ensure the absolute safety of the surface. It is impossible that the law of the normal can be found completely verified in practice. . . The knowledge of the laws which govern the occurrence of fractures across strata is still enveloped in obscurity, and that is explained by the great number of conditions on which the result depends, and also by the difficulty and rarity of observations" (Cours d'exploitation des Mines, 1884).

M. Fayol, after long observations and numerous experiments, believes "that the movements of strata are limited by a kind of dome which has for its base the area worked out, and that the amount of movement is less as it is further from the center of the excavation. He describes his observations and experiments which have led him to his conclusion as follows:

BENDING OF PIECES TIED TOGETHER AT THEIR EXTREMITIES

A beam supported at its two ends will bend under its own weight, the deflection increasing as the points of support are further apart. If two similar beams are placed one above

tain height the beam remains horizontal. The limit of the deflected parts of the different superposed beams is a curve, which starts from the points of support of the lower beam, and rises up to the upper beam, which has not participated in the movement.

The following experiments were made: Iron bars 50 millimeters wide by 5 millimeters thick (1.9 in. x .19 in.) were placed one above the other horizontally on blocks of wood, A, B, C, D, E, F, in Fig. 1. These blocks rested on an iron table G. Upon the upper bar was placed a strong iron rule H. Then by means of stays I, and bolts, the rule and the table, and consequently the iron bars, were strongly bound together.

That done, the wooden blocks B, C, D, E, were removed over a length of 4 feet, and the bending of the iron bars was noted.

It was found that the deflection of the lower bar was 5 millimeters (.19 inch), of the tenth 3.25 millimeters, of the twentieth 1.75 millimeters, and that after the thirtieth bar there was no more bending. The limit of the deflections is the curve M O N shown in Fig. 1.

The same experiment was tried with flat aloof ropes, and with straps of canvas and india rubber in place of the iron bars.

With straps of canvas and india rubber, the curve of the limits of de-

The mixture of sandstone and shale commonly used for stowing, both large and small together, has an increase of about 60 per cent.

COMPRESSION

Strata when broken increase in bulk, which compared with solid strata, varies from 0 to 100, and even

respond approximately to the depths of strata of 546, 1,092, 2,730, and 5,460 yards.

Trials were made separately with the rocks reduced to powder, and broken to the size of grains, and with mixtures of grains and powder, but as the state of division of the material did not modify the effect to any

in depth, a compression of about 30 per cent., which leaves a volume about 12 per cent. larger than the volume of the rock *in situ*. The settlement is usually much greater in the middle of the excavations than at their circumferences.

(2) That the cracks and fissures caused by the movement of ground

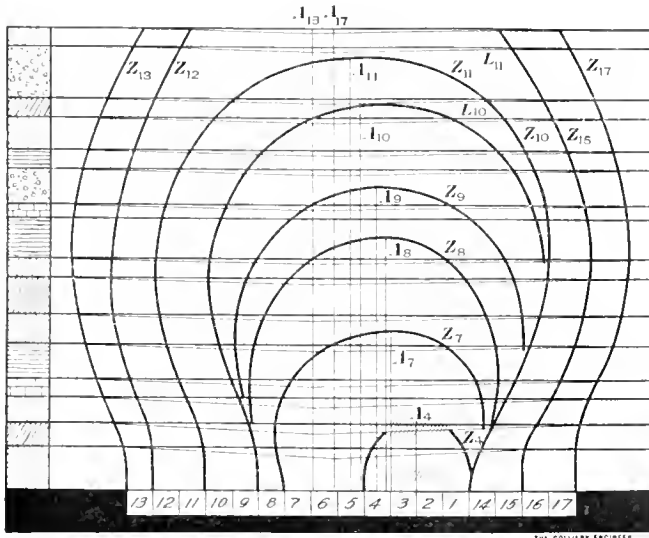

FIG. 3

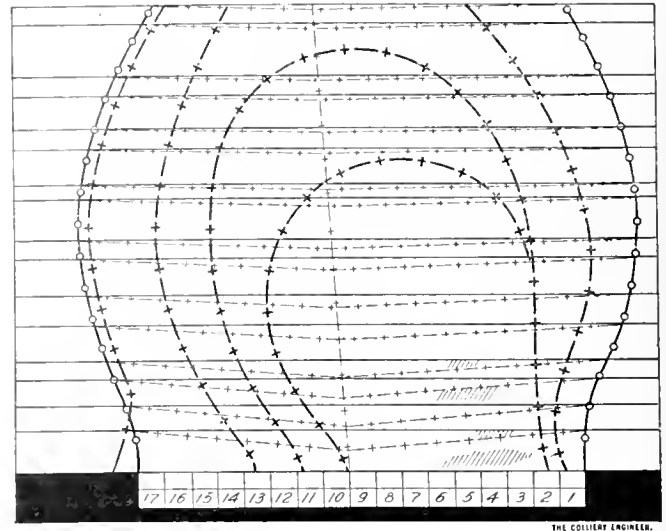

FIG. 4

150 per cent. The greater the increase in the bulk, the more easily are the rocks compressed, and their resistance to compression increases rapidly as their volume diminishes. Experiments were made to prove the amount of compression which rocks previously broken or crushed will undergo under various pressures.

The pressures mentioned corre-

extent, the average results are given in Table 2.

The conclusions may be drawn: (1) That the material which ordinarily fills the goaves of mines, always occupies a larger space than it had originally. After an expansion of about 60 per cent., it appears to undergo in workings of from 100 to 300 meters (109 yards to 328 yards),

above an excavation remain open in all or in part. The action of water may no doubt considerably modify these conclusions.

EXPERIMENTS ON THE MOVEMENT OF STRATA

Artificial beds of earth, sand, clay, plaster, or other materials were placed in a wooden box, one side of which was glass. The box may have various dimensions. That usually employed was .80 meter (2 feet 7 inches) in length, .30 meter (1 foot) in breadth, and .50 meter (1 foot 7 inches) in depth.

On the bottom of the box were placed, side by side, small pieces of wood of equal thickness, a few centimeters in width, and as long as the breadth of the box. Experiments were made both with one row of these little pieces of wood, and with several placed one above the other.

Upon them were laid successive layers of artificial strata, varying from 1 millimeter to several centimeters in thickness. To note the movement, small pieces of paper, 2 centimeters in length (about 3/4 inch),

TABLE 1

Nature of Rock	Relative Volumes					Mixture of Grains and Fine Dust
	Unbroken	Crushed to Powder	Grains 2 to 3 Millimeters (.078 Inch to .118 Inch)	Grains 10 to 15 Millimeters (.393 Inch to .59 Inch)	Grains 15 to 20 Millimeters (.59 Inch to .787 Inch)	
Clay	100	196	209	226	225	216
Shale	100	213	210	221	224	229
Sandstone	100	219	214	211	310	214
Coal	100	207	224	199	223	202

TABLE 2

Space Occupied Before Being Broken	Rocks Having Been Previously Crushed or Broken, the Space Occupied Under Pressure of			
	100 Kilograms Per Square Centimeter = 1,422 Pounds Per Square Inch	200 Kilograms Per Square Centimeter = 2,844 Pounds Per Square Inch	500 Kilograms Per Square Centimeter = 7,110 Pounds Per Square Inch	1,000 Kilograms Per Square Centimeter = 14,220 Pounds Per Square Inch
Clay	100	90	75	70
Shale	100	116	110	97
Sandstone ..	100	125	120	105
Coal	100	130	118	109

and 1 centimeter in width, were put into the planes of stratification, and on the glass were drawn in ink, strokes covering exactly the lines formed by the paper. These lines enabled the least movement to be followed.

By withdrawing the little pieces of wood, excavations were formed, and movement produced in the artificial strata.

Fig. 3 represents the movements by taking away in the order indicated by the numbers the upper row of wooden pieces, where there were three rows each 1 centimeter (3937 inch) in thickness.

The first bed (dry sand), which rests directly on the pieces of wood, falls in, as each pillar is withdrawn. The second bed only commences to sink, when a certain number of pillars have been taken away. The sinking is shown at first by a slight curve, which has its greatest deflection toward the center of the excavation. Then the third bed follows the second. The movement gradually extends in depth, and reaches the upper bed after the removal of the twelfth pillar.

After the removal of the seventeenth, the beds have become bent, as shown in the sketch, the limits of the deflection being the curves Z_{13} and Z_{17} . (The index figure of the curves is the number of the last pillar taken away; e. g., the curves Z_8 Z_4 , indicate the extent of the movements after the removal of pillars 4 and 8).

It is apparent that the zone of sinking is a sort of expanding dome, which grows in proportion as the excavation extends.

The bending of the first bed, hardly observable at first, is considerably increased. The second bed sinks rather less than the first, the third less than the second; the sinking of each diminishes regularly in proportion as it is higher above the excavation. This sinking, in the case of each bed, takes the form of a basin, whose center is on the vertical axis of the excavation.

The lines A_4 A_7 A_8 A_9 A_{11} A_{13} A_{17} are lines followed by the greatest

deflections of the sunken beds, after the removal of the pillars 4, 7, 8, 9, 11, 13, 17. These lines nearly coincide with the axis of the domes, which show the limits of the movement.

Throughout the experiments, after the removal of a certain number of the pillars, it was evident that the pressure of the superincumbent mass was strong at the center and weak at the circumference of the excavation.

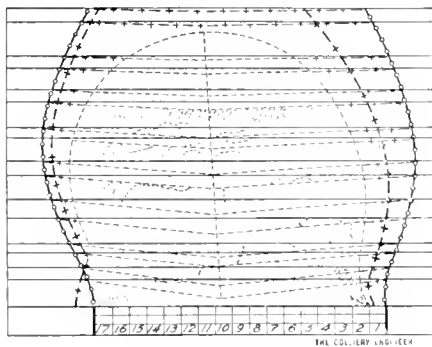

FIG. 5

The second row of wooden pillars was taken away in the order of the numbers on the sketch Fig. 4.

Thus the depth of the excavation was doubled. The lines drawn thus $o-o-o-o-o$ show the subsidence caused by the removal of the first row of pillars. Those drawn $+-+-+-+$ show the subsidence produced by the removal of the second row. The shaded portions denote cracks and fissures.

The sinking of the lower beds increased; some of them fell in; the broken ground occupied much more space. The disturbance was greater below, but not at the surface. The line of maximum deflection did not remain vertical, and some of the limiting domes were inclined.

Removal of the third row increased the disturbance caused by the removal of the two former; the fractures of the beds and the spaces between the strata are multiplied; some open more, others close. As before, the movement starts at the lower beds, and reaches the upper, as the excavation extends.

The zone of sinking caused by the removal of the third row as shown in Fig. 5 by the dotted lines is smaller both in depth and width than the

two preceding; but in other experiments the settlement produced by the taking of the second and third rows of pillars has been greater than that following the removal of the first.

Figs. 3, 4, and 5 show the position of the beds some minutes after the removal of each row of supports. It is a new state of stability, which continues if no more pillars are taken away.

Similar experiments were made with beds at various inclinations, and it was found that the line of greatest deflection was between the vertical and the normal, and that it departed further from the normal (that is, the perpendicular to the inclination of the beds) in proportion as the beds became more inclined. Whatever the inclination, the subsidence of each bed had always the form of a basin.

When horizontal beds were covered over by beds dipping at various inclinations, that is, resting unconformably on them, the zone of settlement took the direction of the inclination of the beds and its axis tended to become perpendicular to the beds affected.

The lines drawn through the maximum bend of each bed were no longer continuous, but in passing from one set of beds to another were broken and shifted in the direction of the dip of the new set. In all cases the sinking of each bed and of the surface was in the form of a basin.

An experiment was made with horizontal beds, which showed that a block of coal left between two worked-out places, may be of no use to protect the surface above it, because the zones of subsidence due to the excavations on either side, which, as already seen, take the form of domes, may overlap each other between the coal and the surface.

As the area of subsidence increases in proportion as the excavation is extended, it may be asked whether there is any limit in depth to the propagation of the movement, when the excavation extends indefinitely. To answer this, a mass of horizontal beds was isolated round about by a

space being left between them and the vertical sides of the box, and then the wooden pillars (in this case .03937 inch thick), were taken away from under the whole area of the mass. Being entirely free at the sides, it might be considered to represent a mass of strata lying over the middle of a working of large extent.

On taking away the pillars, the zone of sinking was seen to increase little by little, and to stop at a certain depth; the movement did not reach the surface. The expansion of the lower beds filled the space excavated and the upper beds rested on the fallen rock. The pressure exerted by the upper strata was very much greater in the middle than at the circumference, and in this case, too, the sinking of the strata was in the form of a basin.

The effect of faults was tested, by inserting in a mass of horizontal beds a thin plate of metal, placed at an inclination, and extending the whole width of the beds. This broke the continuity of the beds, and represented a fault without throw. Its tendency was to stop the movement from extending above it, though the sinking occurred as usual on its low side, leaving an opening in the plane of the cut, which extended to the surface.

OBSERVATIONS

The main seam of Comumentry, which is generally from 10 to 15 meters (33 feet to 49 feet) thick, is worked by horizontal slices of 2 meters to 2.5 meters (6 feet 6 inches to 8 feet) in height, taken successively in ascending order. Several slices (usually 7 or 8, sometimes only 3) constitute a stage of work (etage); according to circumstances a single stage or several are worked at one time.

The stowing is done, as well as possible, with coal measure rocks procured from quarries.

During the gradual advancement of the face of the working of a single slice or "lift," the roof bends down in a curve from the face, and lays itself on to the stowing behind, and becomes horizontal again where the stowing has quite settled, that is, has

been squeezed as far as it will go. This curve moves forward with the advancing face, and somewhat resembles a wave on the surface of water, being very sharp near the face, and gradually coming into line with the horizontal behind. In this movement the roof undergoes at first a drawing out, which cracks it, and afterwards a contraction. The cracks which are formed near the face, close partly behind, where the strata become again horizontal.

When the coal is very tender, the roof no longer bends, with the same regularity. In very hard coal, the movement is neither regular, nor continuous, the roof sometimes stands firm for a long time, hanging over the stowing; then it sinks all at once, and is divided into separate blocks by large fractures.

When several slices are removed in succession one above the other, the coal in the last slice has undergone a good deal of bending before it is extracted, and it is generally broken, the large coal forming a much smaller proportion of the whole than in the first slice. This is a grave defect in the system of working.

Just as in removing a single slice, the roof becomes horizontal, or parallel with the floor of the slice, when the stowing has quite settled, so in the same way, the roof of the seam in the end becomes parallel with the floor, when all the coal has been removed.

EFFECT ON THE SURFACE OF A WORKING OF SMALL EXTENT AND SHALLOW DEPTH

The seam was 1.3 meters (4 feet 3 inches) in thickness, and nearly level. It was worked on a kind of "stall" system, without stowing. Only some band stone, mixed with the coal, was left in the excavation, the roof of which was upheld by nothing but ordinary timbering. When the working had extended to a certain point (the total area being 350 square meters, a sinking occurred, and extended to the surface. The depth was 18 meters (19 yards 2 feet); the strata being composed of sandstone and some thin beds of

shale for half this depth, and the rest being artificial ground long since settled.

The working had gone on for 3 months before there was any movement of the roof underground. Then commenced to be heard the ordinary noises which accompany the disturbance of the upper mass. These noises went on increasing; 4 hours afterwards the roof underwent a perceptible lowering, broke the timber over the whole area of excavation, and then fell in with great noise.

At the same time when the fall took place underground, the surface suddenly sunk; a very pronounced basin 59 centimeters (1 foot 8 inches) in depth, and about 30 meters (32 yards 2 feet) in diameter was produced all at once; some cracks appeared at the circumference of the basin. The movement took place rapidly; in 3 minutes the lowering was .5 meter (1 foot 8 inches); during the succeeding 24 hours, it only increased .21 meter (8 inches), and since that, there has been no perceptible movement.

Points to be noticed are:

- (1) The settlement in the form of a basin.
- (2) The larger area of surface affected than area worked underground.
- (3) The irregularity, the discontinuity, and the number of fissures in the ground, following the circumference of the subsidence in a way which as a whole may be considered regular.
- (4) The absence of fractures in the middle of the basin.
- (5) The inclination of the fractures, which lean toward the center of the basin.

(To be continued)

采 采

Standard Mine Doors

In some of the Southern Colorado coal mines a standard size for mine doors is adopted. The idea in adopting a uniform mine door is based on the plan that when a door is of no further use in one part of the mine, it can be moved to another where a standard frame awaits it.

Scientific Management

The Possibility of Its Application to Coal Mining—A Consideration of Some of the Advantages and Difficulties

By *Wm. Archie Weldin**

IN THE December issue, "Superintendent" inquired as to whether "Scientific Management" has been applied to mi-

ning. In answer I would mention the extremely valuable and interesting paper entitled "Efficiency Engineering Applied to Mining," read before the American Institute of Mining Engineers by Mr. Glenville A. Collins, at a meeting held February 17, 1912, at Spokane, Wash.

In this connection, I am reminded of recent conversations with Mr. Fred W. Taylor, the eminent exponent of scientific management, and with Mr. H. K. Hathaway, a prominent efficiency engineer, engaged in introducing the "Taylor system." The following is given with their permission, in the belief that it will be of interest to all progressive mining men.

The question of applying scientific management to coal mining having been mentioned, Mr. Taylor stated that so far as he knew, his system had never been applied to mining, but that he believed it quite possible to so apply it. In fact he stated that great gains are to be made through the introduction of scientific management into the mines, and those who have the courage to go at it properly will find simply enormous profit in the application of these principles. However, there will be great difficulty in introducing it, not only because of the large amount of preliminary work to be done, but because it involves a revolutionary change in the attitude of employer and employe. There is also the difficulty that during a protracted period of preliminary work, large sums must be expended for which no results whatever would be apparent. It would only be after such period that results in the shape of reduced costs would begin to appear. He further said that he considered it impossible for the old and new systems to exist side by side. That it would be necessary in order to secure success, to plan to place the entire operation on the new basis.

Mr. Hathaway stated that judging from his experience in manufacturing establishments, and without inquiring particularly into the peculiar needs of mining, he believed that at least 3 years of work would be necessary before the system could be put on a self-sustaining basis. During this period a large sum would be expended, varying, of course, with circumstances, but probably amounting to at least \$10,000 per year, for a large operation. He judged that for the first year no benefit whatever would be apparent, and he feared (rightly, I think) that this would discourage most operators. For this reason, the writer was advised, that probably none of the recognized engineers now engaged in introducing the Taylor system would undertake such work unless the management were unanimous in favor of it, and willing to persevere in the face of apparent loss.

As to the method of procedure in introducing the system, it was explained that though certain principles underlie all scientific management, there are no set rules governing it. The system consists rather of the study of the needs of each case, and the development and application of special methods. Heretofore, it has been the practice of the efficiency engineer to proceed to the plant, and inaugurate the necessary studies.

On completion of these, he gradually builds up an organization, preferably of men selected from the employes, to operate the new system.

The writer was advised that in the case of coal mines, on account of special conditions, and the difficulty of securing the services of the well-known efficiency engineers, it would probably be best to detail a man, preferably a graduate engineer, thoroughly familiar with mining methods and management, and send him to study scientific management, under

some authority. At the end of a year or more, this man could return to the mine, and himself introduce the system, by methods

worked out by his tutors. This procedure would no doubt be far more likely to succeed than any other, but its success would depend very largely on the man selected, his ability to manage, and his tact. It would require exceptional diplomacy, patience, and perseverance on the part of this man, to secure the necessary confidence of the miners and the cooperation of the mine management, and to harmonize his work with existing conditions, without reducing the output of the mine.

As to the possible benefits of scientific management, no doubt they are very great, but the writer is inclined to think that the difficulties in the way of introducing it into mines, at least to the underground workings, are far greater than seems to be supposed. The essence of the system is greatly increased supervision. In one plant visited by the writer, he was informed that the number of so-called "non-producers" was four times greater under scientific management than before the system was adopted. One-fifth of the entire force were office men.

Aside from the difficulty of convincing operators, whose whole effort has been to reduce the proportion of clerks, engineers, etc., the mere physical difficulty to be encountered is great. Instead of large well-lighted rooms full of men working almost within touch of each other, as in machine shops and factories, we have in coal mines, men working in pairs, in separate chambers 100 to 200 feet apart, each surrounded by a small circle of light from his lamp.

These difficulties, however, become less as we look further into the matter. It must be remembered that for the bulk of the operations underground, time and motion studies need be made but once, as the processes are largely stereotyped, and are very simple compared with the work

*Asst. Chief Engineer, Buffalo-Pittsburg, Co.

of a mechanic. Also the mine car forms a ready means of keeping account of the performance of the men, as well as transporting this data to central points. The peculiar bonus plan, which is an integral part of the Taylor system, could as readily be adapted to mining needs as to shop conditions. The men are already accustomed to "piece work," with rather elaborate systems of figuring their pay, and miners are hardly more suspicious and antagonistic to their employers than other workmen.

The writer does not feel sufficiently well versed in scientific management or efficiency engineering to venture an opinion as to how far the science developed by Mr. Taylor and others can be at present utilized in mining, but he feels that in view of the known difficulties, it is advisable to go slow, until the principles are thoroughly understood, and the methods developed. The following quotation from Taylor's "Principles of Scientific Management" will point the moral. He states that the introduction of this system "involves such radical, one might almost say, revolutionary, changes in the mental attitude and habits both of the workmen and the management, and the danger from strikes is so great, and the chances for failure are so many, that such a reorganization should only be undertaken under the direct control (not advice, but control) of men who have had years of experience and training in introducing this system."

From the factory to the mine is quite a long step, and if in the former case, so much danger and difficulty are to be expected with the full benefit of methods and devices perfected during the whole experience of these men, how much more difficult must it be in the mines.

In view of the above, the writer believes there is little to be expected of immediate benefit from the Taylor system as applied to underground processes.

I would suggest that the repair shop be systematized first. This would apply particularly to large central shops, but no doubt even the smallest would be greatly benefited.

Here the work would be much more like that already done, and much valuable experience could be gained at minimum risk.

Another line of profitable effort suggests itself in accounting materials. Timber, rail, pipe, oil, etc., are used in enormous quantities at mines. This is not only a large part of the production cost, but it is much more subject to variation with good and bad management than in other industries. In manufacturing, the raw material largely enters into the finished product; there is usually no waste corresponding to the enormous quantities of posts, rail, and pipe lost in the gob of mines, the expensive frogs, switch points, etc., frequently seen lying forgotten "along the rib," or the amount of high-grade oil used where cheap oil would do, and even wasted by spillage and evaporation.

A large increase in the clerical work now done in accounting for this material would undoubtedly result in immediate gain, and this without any risk of precipitating a labor disturbance.

Such a system would begin in the purchasing department, where elaborate records would be kept showing which of several types or grades of certain materials give the most service, for the money, and just what stocks are on hand at each mine or part of a mine. The material would be accounted for by each department in turn at each stage of its career until its final value is extracted as scrap.

This system would hold responsible each man handling material and demand from him an accounting for what is entrusted to his care. One point in particular would be for a certain clerk to record the caving of each working place, and not only note whether track, pipe, and posts were withdrawn, but to credit that place with every piece recovered, and to charge it again to some other place.

This would involve nothing new or strange, but would be simply taking advantage of principles and extending the use of methods of management already well known.

Under the present system, or lack of system, supplies are often not or-

dered until some emergency discovers a shortage which cannot be made good soon enough to prevent heavy loss. It is generally almost impossible to secure authoritative data on the comparative life and service of different forms of track, wheels, etc. Even the percentage of coal or mineral recovered is hardly ever determined by methods at all reliable.

Many mines are well managed, but in general, it would seem that in coal mining as now conducted there is plenty of opportunity for increased economy, not only by the particular methods whose effectiveness has been so well demonstrated by Mr. Taylor and others, but by increased use of methods already known to us.

In particular, the writer would advocate an immediate and considerable, though gradual, increase in the amount of work done in keeping track of material, equipment, etc. This need not interfere with the introduction of the Taylor system proper; in fact, should be a great help to it, and it will undoubtedly justify itself in reduced costs. The Taylor system may then be introduced gradually, beginning with the shops, tippie, yard, etc. However, any such improvement to be effective must be worked out slowly and patiently.

采 采

"It Is to Laugh"

A Chicago trade journal recently published the following news item:

To Open a New Deposit

SCRANTON, PA., February 27.—(*Special Correspondence*.)—Following scientific inspection tours about the hills of Port Crane, N. Y., George Yates, a prominent mining engineer of this city, has predicted that that hamlet in a few years will be a hustling mining town and rival Wilkes-Barre and Scranton. According to Mr. Yates the hills which enclose the small village contain rich veins of coal. At present it is understood that only Scranton capital is interested, and that if the coal mining industry is set up in earnest in that village the entire output will be sold to the Delaware & Hudson Railroad Co.

It is the present intention of Mr. Yates to sink a shaft at the most likely place as soon as warm weather arrives. The discovery was made last summer by a son of Mr. Yates who was working for the Delaware & Hudson Railroad Co. at Port Crane. He sent for his father, who immediately went on and remained for several weeks. It is claimed by men who have had occasion to dig wells on farms in that village that in their boring they

had penetrated through thick veins of anthracite. Many farms in the neighborhood of the village have been leased by capitalists backing Mr. Yates.

There are only two points in the above "special correspondence" that are wrong. First, neither the Scranton City Directory or the telephone directory lists a George Yates as a mining engineer, and he is unknown to prominent members of the Engineers' Society of Northeastern Pennsylvania. Second, Port Crane is a village in Broome County, N. Y., and the geological formation of that territory is older and lower than the lowest Carboniferous measures. As the measures are those of the Devonian age, it is probable that some farmer, in sinking a well came across a bed of black Devonian shale, imagined he had coal, and somebody is exploiting the discovery (?) to catch suckers.

來 來

Specific Gravity Determination of Mineral Oils

By M. Rakousin

When dealing with small quantities of oil, a specific gravity bottle of small dimensions can be used, and the specific gravity of a sample of oil as small as 1 cubic centimeter can correctly be determined. But it may occur that less than 1 cubic centimeter is at the disposal of the experimenter. In such cases, the author recommends the following method: A specific gravity bottle of 5 cubic centimeters capacity is filled with about $4\frac{1}{2}$ cubic centimeters of water, and the weight taken; then the oil is poured into the bottle on top of the water, and the bottle again weighed. Taking d as specific gravity of the oil, n its volume and f its weight, then,

$$d = \frac{n}{f}$$

But n is equal to w (weight of water fully filling the bottle) less c (weight of water partially filling the bottle), while f is equal to p_2 (weight of bottle filled with water and oil) less p_1 (weight of bottle partly filled with water). Thus,

$$d = \frac{w - c}{p_2 - p_1}$$

Safe Timbering

Examples of Systematic Placing of Timbers By Which Many Accidents From Falls of Roof Are Avoided

PROBABLY nothing about a mine is so neglected as timbering. For a number of years it was claimed by the miners that the operators would not furnish them timber, consequently a law was passed compelling the mine foreman to see that the workmen are provided with sufficient props, cap pieces, and timbers, of suitable size,

and kind of roof above the coal bed; however, even with this precaution the accidents due to falls of roof are far in excess of accidents due to other causes. James Roderick, Chief of Department of Mines for Pennsylvania, dissects the fatal accident list for 1911, and locates where lives were lost in the mine. From the total of

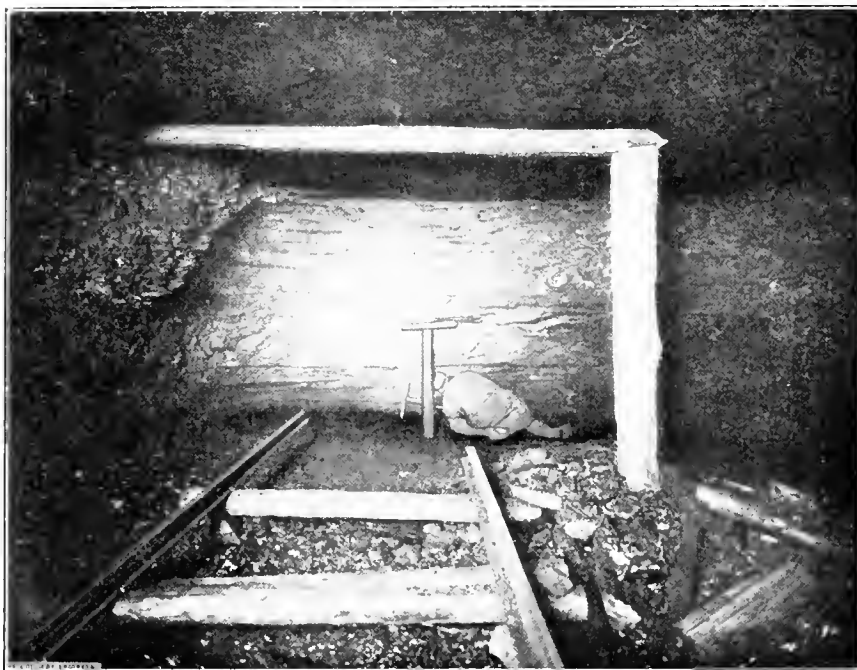

FIG. 1. FACE OF ROOM SHOWING SPRAG AND TIMBERING

"which shall be delivered at the working faces or so near thereto as they can be conveyed in mine cars when asked for by workmen, at least 1 day in advance. If for any reason the necessary timbers cannot be supplied when required the mine foreman shall instruct the workmen to vacate the place until the timber needed is supplied."

Since the number of deaths and injuries from roof falls do not materially lessen in the coal mines, the inference to be drawn is that miners do not use judgment in ordering timbers, or in placing them.

In England the law requires props to be stood at certain specified distances, regardless of the condition

308 lives lost by falls, 243, or over 79 per cent., were killed at the faces of rooms; 32, or 10 per cent., in entries; and 33, or 11 per cent., while removing pillars.

Of the 206 miners who lost their lives, 78.15 per cent. were killed at the face; 13.11 per cent. while removing pillars; and 8.74 per cent. by falls on entries.

Of the 70 fatalities among loaders, 90 per cent. were killed at the face of the workings; 4.29 per cent. in entries, and 5.71 per cent. while removing pillars.

In order to be injured by a fall of coal, there must be carelessness, yet 51 lives were lost in this manner in the bituminous fields of Pennsyl-

vania. In undercutting room coal or pillar coal, sprags should be used. These may be mere blocks 18 to 20 inches long or they may be sprags with a cross-piece as shown in Fig. 1. The coal shown in this cut is about 6 feet thick, known as the Mary Lee bed in Alabama. The timber sprag is used to hold the upper bench of coal which is separated from the

4½ feet specified, but no matter how good the roof may be, the place must be timbered on the 4½-foot rule. This company possibly was the first to practice a definite system of prop setting and road timbering in the United States; it is not the only company, however, which is endeavoring to reduce mining fatalities from roof falls by safeguarding its employees;

regions is a weak one, known as "checker." As soon as the last room in a panel is driven its full length, a start is made in drawing the pillars. A breakthrough is driven about 8 feet wide between it and the panel or barrier pillar. This stump is then drawn. The pillars are made generally 30 feet wide, though where the roof is especially weak, the pillars are made wider.

A line of props is placed in the center of each room, the company requiring that the distance between any two props shall not exceed 4 feet 6 inches. A row of props is set on each side of the breakthrough at the same distance apart. In drawing the stumps, the props again are set at definite intervals, a row of props being set along the inside next to the cave, and the others in rotation. A part of the stump is at first taken out so that when the props are drawn a fall will occur, generally this will be an area of about 16 feet square. Then the rest of the stump is taken out and the props drawn so that all the chamber ahead of the pillar is made to cave. In taking a slice 16 feet wide from the pillar and driving a room the same distance, from 35 to 40 props will be used.

About 75 per cent. of these props are recovered by drawing. A prop cannot be expected to hold all the weight of overlying strata; it can only be expected to hold the few feet of roof which lies immediately above a seam and which must be kept in place until mining is finished.

Nor can a prop be expected to stand a long time and remain sound. But where the pillars are drawn so soon as the rooms in a panel are finished, the props which have been used in the rooms will still be good.

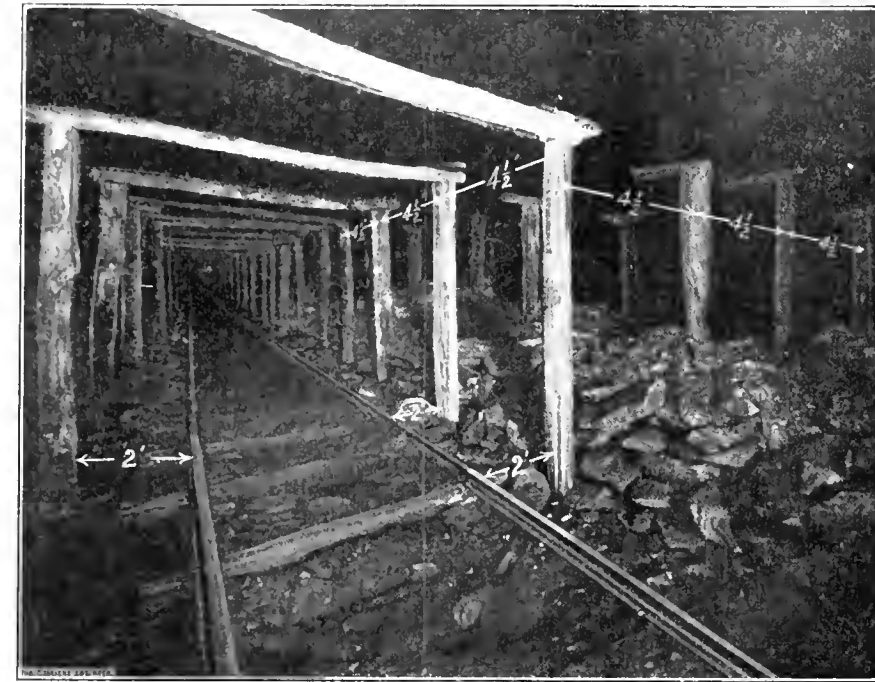

FIG. 2. SHOWING REGULAR TIMBERING

lower by a slate parting. The man at the face in a mining position is J. G. Meagher, superintendent of the Sayreton, Ala., mine, belonging to the Republic Iron and Steel Co. It will be noticed that the post and cross-bar over the track are substantial looking timbers. G. F. Morris, general superintendent of coal mines for this corporation, is greatly interested in "Welfare" work, which first of all includes the lessening of mine accidents, and it is to him that the writer is indebted for his methods and for Figs. 1 and 2. According to the timbering rules in operation at the Sayreton mine, timbers must be placed in working places 4½ feet apart whether roof is good or bad. Collars are placed on props over roadways and 2 feet clearance must be left on each side between the post and rails. Where the roof is very bad, timbers must be set closer than the

for instance, Mr. Dawson, of the H. C. Frick Coke Co., read a paper at the Coal Mining Institute of America from which is abstracted the following on prop drawing: "The introduction of this method of prop pulling had for its object the lessening of accidents when robbing pillars, which, in Pennsylvania, amounted to the loss of 33 lives in 1911, and the company by the care it has exercised has lessened the number at its mines.

This company in its mining operations requires the miners to stand props at definite intervals which must not be exceeded. The panel system of mining is followed; that is, a certain number of rooms are turned from an entry, and when worked the proper distance the room pillars are drawn. The rooms are narrow, being about 12 feet wide, for the roof above the Pittsburg seam in the coke

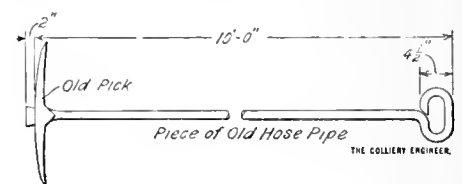

FIG. 3

To be sure, where the largest part of the coal is obtained from pillars, the majority of the props only have to

stand a few days before they are drawn.

Fig. 4 shows the method followed in withdrawing a prop by means of the Sylvester prop puller. This is a simple yet powerful device consisting of a notched bar, or rack, from 3 to 5 feet long and a block which slides along the rack when worked by the lever shown in the operator's hands. At the end of the rack is a swivel to which the anchoring chain is attached. When in use, another chain is attached to the block and to the prop to be withdrawn. The block contains a steel dog which engages with the notches of the rack bar and prevents the block from slipping back when pulled forward by the lever. The lever is attached to the block by a short connecting link while the end bolt fits into the slots of the rack when being pulled forward. As soon as the prop is down, it is pulled out from beneath the rock which has fallen or from beneath the dangerous roof. In order to avoid the dangers of going beneath the bad roof, a long-handled pick is provided, as shown in Fig. 3, with which the prop is dragged back. This pick or hook can be made out of an old pick fastened on to the end of a piece of pipe 10 feet long, with a piece of iron welded on to the center of the pick with which hammering can be done. Hooks of this description can also be used to take down roof in order to hasten caving.

Great care is taken to avoid accidents when drawing props and it is a rule at the Frick mines that no props may be drawn except in the presence of a fire boss or pillar boss.

采采

Australian Mine Ventilation

At Broken Hill, New South Wales, Australia, the Broken Hill Junction North Silver Mining Co. hereafter to be known as mine No. 1, is connected with the Broken Hill Junction Lead Mining Co., hereafter to be known as mine No. 2, by rock tunnels whose only object is ventilation.

In due course of time No. 1 installed fans driven by high-power motors, which showed it was pro-

gressive, and used the No. 2 mine as an upcast, which showed it had a cheek. As the smoke and impure air from No. 1 was injurious to the men and also interfered with work in No. 2, that company promptly closed the tunnels and prevented the circulation of pure air in No. 1 and impure air in No. 2; thereupon No.

dirty bird that fouls its own nest. His Honor suggested before No. 2 suit was entered that the company officials confer with a view to settlement, but counsel were not prepared to do so just then, either because their clients were on their "Bull Dog" or they saw a chance for graft to escape.

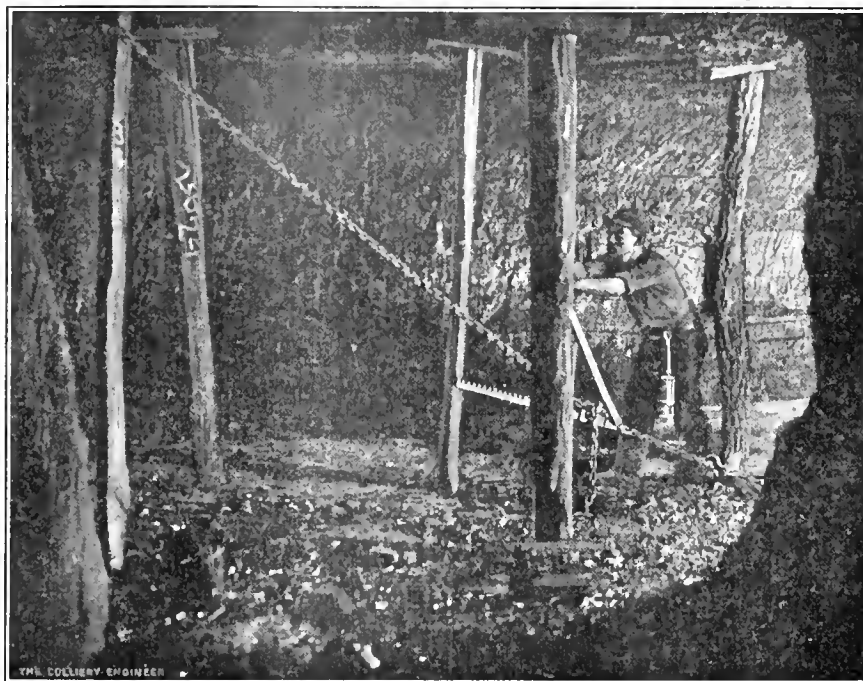

FIG. 4. PROP PULLING MACHINE

1 became peeved at No. 2 and brought suit to compel No. 2 to open the tunnels so No. 1 could fill No. 2 with bad air. Pending litigation the Inspector of Mines, who is some party in Australia, ordered the obstructions removed from the rock tunnels and No. 1 proceeded to fill No. 2 with bad air which caused No. 2 to become peeved to such an extent it brought counter suit and prayed His Honor for an injunction to restrain No. 1 from using ventilating machinery that fouled the air in No. 2. The use of the "blower fan" was not advisable in this instance, and since the exhaust fan would bring the bad air from No. 2 into No. 1 it was considered inadvisable to have a reversible fan on the premises but to follow out the common plan of taking everything in sight, and having it hold it, possibly in this case on the grounds that it is a

As matters now stand honoraria are even if ventilation is poor.

采采

Ode to the Mine Mule

Written for the Colliery Engineer by Cos L. Worker

Here's to the mule, the old mine mule.
The "blankety blank, blank, blank!"
Always ready for work, and hard as a nail—
Though often a tough old crank.

He's the subject of jeers and is cussed by the boys
Who clout him with sprags, bars, or whips.
Excluded is he from paternity's joys
But he's always the leader of "trips."

The motors of air, electric, and gas
Have usurped his olden time place—
But only in part, for he is the cuss
That must draw the car up to the "face."

The language, and words that he understands best,
That are lavished on him without stint,
That will make him pull hard, when he yearns
for a rest,
Are not those that look "good" in print.

His voice is not pleasant, his song it not sweet,
For beauty he ne'er won a prize,
But as to dynamics in his two hind feet,
No meter e'er measured their size.

L'envoi.—Contributed by an old acquaintance and friend:

His life was not easy, his joys were but few,
He died a hard death as a rule;
Still, we who have used him, misused and abused him,
Feel the loss of that same old cantankerous mule.

WELFARE WORK AT COAL MINES

Hookworm Disease at Southern Mines

By Dr. J. W. Prior*

IN presenting this paper upon hookworm disease we must consider first, the symptoms and diagnosis; second, the curative measures; third, the life history of the causative agent and the modes of infection, in order to arrive at what would be called the most practical side of the question; i.e., the means of prevention and the eradication.

The disease which is due to the presence in the intestinal canal of the parasite *Ankylostoma duodenalis*, or that which is found in America, *Necator Americanus* (the American hookworm), has had many titles, among them is that of miners' anemia. With other symptoms of hookworm disease, anemia is usually pronounced. This condition is due to the loss of blood and the presence of a toxin or poison produced by the worms and injected into blood stream. Those infected with hookworm have the appearance of general ill health, pallor of skin, and retarded physical and mental development, when the



FIG. 2. MAGNIFIED HEAD OF HOOKWORM ATTACHED TO WALL OF BOWELS

infection has taken place in early life. Most of the symptoms are not very pronounced in those cases with

* Professor of Anatomy and Physiology, State University of Kentucky, Lexington, Ky. Paper read before the Kentucky Mining Institute.

but little infection. There may be a loss of appetite, or at least it is capricious, occasional pains in the

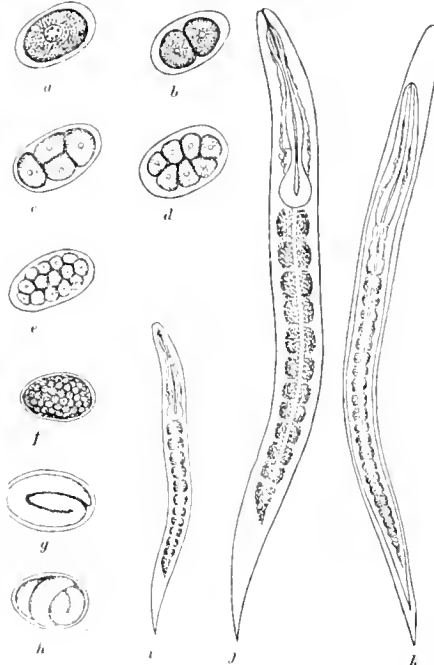

FIG. 1. DEVELOPMENT OF HOOKWORM FROM EGG a TO INFECTIOUS FORM k

abdomen, headache, lassitude, lack of interest in work, an indisposition to do anything that would require exertion. In what is termed a moderate case these symptoms and others are pronounced, and in a marked case the patient is not only incapacitated for work but the termination is often fatal.

The diagnosis is easily made if the worms are present in sufficient numbers to materially affect the health of the person, and in fact the disease is sometimes easily diagnosed when there are only a few worms present. Such is the case with those who are termed hookworm carriers. Any physician who is familiar with the use of the microscope should be able to detect the eggs in the feces. The technique is very simple, and once becoming familiar with the appearance of the eggs it should not be at all difficult to diagnose the presence of hookworm.

The treatment is as simple as the method of diagnosis, and is thoroughly effective in the majority of instances. I take it you would prefer to leave this part of the subject to the discrimination of your physician.

Now as to something of the life history* of the causative agent, the hookworm. The human is the host of this parasite, and the females lay their eggs in the small intestine. These are expelled with the feces and may be deposited anywhere. The conditions best suited to the development of the eggs are, absence of light, presence of oxygen, a temperature between 71° and 95° F., and a moderate amount of moisture. The eggs have been known to develop in mines at a temperature of 68° F. It is possible for the ideal conditions for development to be found within a mine. Freezing does not kill the eggs in all instances, but they are easily killed by drying. Under favorable conditions the eggs will develop in 24 hours and the larvæ will hatch out; in 2 or 3 days they shed their skins. This is called the first ecdysis. About 5 days from the time they are hatched, the organism passes through the second ecdysis, but this time it remains within the skin, is encysted. It is now in condition to infect the

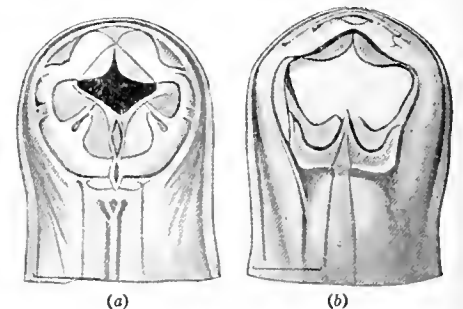

FIG. 3. HEAD OF HOOKWORM, MAGNIFIED

human. It will then be seen that the eggs do not develop within the person infected, nor is the person reinfected from this source.

* Hookworm Disease, Doctor Bass, 1910.

Fig. 1 shows the newly laid ovum with the usual histologic appearance of other ova, yet having its own characteristic features of identification. Like other ova, when developing, it shortly becomes two cells; to do this it goes through the process of mitosis, then becomes four, then eight, etc., to the stage just preceding the formation of the embryo. A little later we see the embryo within the shell, then shortly after leaving the shell, and later on the larvæ are in condition to infect the human.

The mode of infection is always by the mouth indirectly or directly. It has been said that flies transport the larva to the food and have thus been the means of infection. It is just possible that this is true, but it is the rare exception that hookworm disease is communicated through the medium of flies, but we know that typhoid fever is frequently communicated this way. It would be difficult to exaggerate the conditions of many of the closets to be seen on farms and in fact in many towns. Do you believe that the flies make daily visits between the filth in these privies and your dining room and kitchen? It is a disgusting fact—you have but to examine a fly that you have extracted from your cream pitcher to find that its legs are covered with feces, and can you proceed calmly to drink this mixture? The indirect method of infection is the rule, that is the infection takes place through the skin—this has been demonstrated in the following way: Dr. Claude A. Smith placed mud containing encysted larva on the arm of a man and allowed it to remain 1 hour. In 8 minutes he complained of itching, a dermatitis developed. A section of the skin while inflamed would show the larva present. The dermatitis or inflammation of the skin has been called "ground itch," "dew poison," or "toe itch."

When the larvæ are brought in contact with the skin and remain a sufficient length of time, they bore through the skin and get into the circulation, and finally reaching the lungs they are unable to pass through the capillary blood vessels and they

bore through these into the air cells and thus get into the bronchial tubes. They finally reach the mouth by coughing or the natural flow of mucus from the air passages, and many of them are swallowed and, passing through the stomach unchanged, they enter the small intestine, where they undergo complete development; that is, after 4 or 5

the victim, we can readily understand the gravity of the condition, and when we know that each female may produce thousands of eggs daily, and that in some cases millions of eggs are passed daily with each stool, we can appreciate the tremendous opportunity for infection and the necessity for a realization of the true condition.

Now to the more practical side of



FIG. 4. A HOOKWORM-AFFLICTED FAMILY. NOTE SWELLING OF FACE AND LEGS OF LITTLE GIRL. TWO DEATHS HAVE BEEN CAUSED IN THIS FAMILY BY THIS DISEASE

days another ecdysis begins and they acquire a buccal capsule which enables them to fasten on the mucous membrane by sucking in a plug of the epithelium. Fig. 2 shows an enlarged view of the head of the hookworm attached to the wall of the bowels. Fig. 3 (a) is a view of the head looking directly into the mouth, showing the two jaws, and in the middle is seen the hollow tooth similar to the poison fang of a snake. Fig. 3 (b) is the same head at a deeper level and shows the fang-like tooth more plainly.

In 4 or 5 days more the last ecdysis begins and the last skin is shed. The worm is now about one-fifth of an inch long and grows rapidly to its full size and length, that is about five-eighths of an inch. When we take into consideration that in many cases there are thousands of these parasites present, sucking the blood from and injecting their poison into

this question, that is, the means of prevention and the eradication of hookworm disease. The State Board of Health is at present making a campaign in a number of counties against hookworm disease and their health officers are doing a grand work. If you men will give them your hearty support and but carry out their directions, great good will be accomplished, not only in the eradication of the hookworm, but in the prevention of contagious and infectious diseases.

In the first place you must not only believe that these facts concerning this disease are true, but you must realize that the success or failure rests with you, and it will be due only to your continued efforts that the disease will be completely eradicated.

Granting that you have a physician in your camp that can make the diagnosis, every member of the camp and their families should be examined

for this disease, and it must be definitely settled. Every case found must be treated and the examination followed up for months, to determine if all worms have been destroyed.

The sanitary condition of the mines and the camp must be carefully guarded. If some part of the mine has been used as a filth room, it must be cleaned and disinfected. If it has been the custom of your men and boys to relieve themselves at any time that nature calls and at any place they have thought convenient, they must understand and be willing to comply with any reasonable rule that you know will meet the circumstances existing and they must be made to understand there are no exceptions.

Sanitary closets must be provided. The State Board of Health will gladly give you full information as to what will be best suited to each locality. The principal point I wish to impress upon you is that hookworm disease may be found in every county in the state; that it is easily diagnosed and easily cured; that you can use positively effective means of prevention and eradication.

This is an economic question of great importance to the state of Kentucky, and you can well imagine what the conservation of life and the increased efficiency of labor would be if hookworm disease were eradicated.

In conclusion I will say to the miners of Kentucky: Believe what the physician tells you in regard to preventable diseases, carry out his instructions to the letter, make an unceasing warfare upon all disease-carrying insects, build sanitary closets, screen your kitchen and dining room, require that your stables be cleaned every day and see that the manure is scattered. See that your garbage cans are made inaccessible to insects—in fact, make it impossible for the propagation of disease-carrying insects, by destroying the breeding places of these pests. In other words, get to the root of these matters, not the surface.

Does this condition seem ideal? It may be, but I think it possible.

Who Is Responsible?

By William H. and J. T. Reynolds*

THE other day in a mine in which we happened to be, there occurred an incident which is unfortunately of almost daily occurrence in every large mine in the bituminous field. The foreman, who, like many another who will read this, has a little more than a man's job on his hands, and, even with the industrious assistance of a good fire boss, more than he can rightfully or lawfully accomplish in a way he would like to, entered a room in which a miner (?) was loading a car. A glance at the roof above the man showed a slab of slate in a dangerous condition and entirely unprotected. The foreman spoke to the man, and he stopped for a moment, while the official drew his attention to the danger—in English. The workman smiled sycophantly, nodded his head rapidly, and grunted something which the foreman did not understand. Evidently he hadn't grasped a word of what had been said, for he returned to his shoveling. Then ensued a ludicrous pantomime such as is often seen in bituminous plants. The foreman looked about for a sledge and not seeing one went through the motion of setting a post, and pointed to the roof. The miner grunted again, this time in a way to indicate he understood, dropped his shovel, and apparently went in search of the sledge.

The foreman went out, being, as we have said, a man of many parts, and, from what he said later, every one of them was calling him at that moment. He was scarcely a hundred yards away, however, when some one came running after him to tell him the man whose room we had just left was under the slate.

After they had put him in a car and started out, the question came up as to the real responsibility for such accidents as this. The foreman frankly acknowledged that in a sense of real justice he was the culprit. "I always am," he added. "The fact that there are a score of other jobs awaiting me this very minute

shouldn't cut any figure, of course. I, being foreman, should have stopped in his place and taught him the simple rudiments of mining, which every man, if I had my way, would know before he was set on. But I have my orders and have to obey them. We are behind with our contracts now, and every man who applies gets a job."

"Even if he's never seen a coal mine before?"

"Yes," he continued, as we crawled into another room where another recent vineyard worker was busily engaged digging coal, "because if we don't, the mine above, needing 'em as badly as we do, would set 'em on."

In reply to a more personal question this foreman told us that only a day or two before he had set the injured man on, after casually inquiring of his "cousin," who had brought him with half a dozen other "cousins" to the pit, if he had any experience in coal mining before. "Oh, yes, Meester Boss; oh, yes sir, heem digga coal in my country." "I know of lots of such accidents and worse ones, which I am positive would not have happened if the men had only known how to take care of themselves, but until there's a law to compel every applicant for a job to at least know when, how, and where to set a post, charge and drill a hole properly, care for a safety lamp if need be, and the few simple rules which one at least expects of a miner, we shall continue to have these accidents of ignorance, as well as the list caused by carelessness. And until there shall be some kind of preliminary examination for miners, all who come will continue to be set on as long as men are needed as badly as they are at present."

After having parted from the foreman, the truth of his words, and several other things he had not said, which likewise had bearing on this subject, hammered themselves into our brain. One of the most pertinent was that in the formation of such a law as we have mentioned, our present legislative body would have the advantage of its predecessor. It will, when such an act comes up, consider

* Late Member United States Rescue Service.

wisely the state's long and regrettable experience with certain bad features of the anthracite law governing the granting of miner's certificates. This law has filled the mines of the East, which, of all mines need practical and experienced men the most, with Italian and Slavish stock who know but little of mining, and has kept out the sturdy German and English miners whose long experience in the mines of their own countries would be of inestimable benefit in whatever mines they might be employed. The English or Welsh miner, who since a boy has worked in the anthracite and bituminous mines of his own land, and not only understands the best methods known to mining practice, but is one with his superiors in the matter of language and understanding and appreciation of the laws which govern him, is, with his family, a better acquisition for the Commonwealth, than the man whose sole merit lies in the fact of his having left the farm or the vineyard sufficiently long to satisfy the time clause of the examination. But the German or English miner who has spent his life in the pits of his native land has too much independence of character to work for 2 years as an apprentice to a man who knows far less of the trade than he does. The fact that an applicant had learned the trade of coal mining, and could prove to an examining board that he had learned it, should be quite sufficient. But under this act, it is not; hence, this most desirable class emigrate to those parts of our country where experience counts for something, and Pennsylvania's loss is some other state's gain.

The knowledge of these facts should aid in the formation of a better and fairer miner's certificate law for the bituminous as well as the anthracite regions. In a few instances large corporations have found it for their interests and that of their employes to formulate and put into practice for their own mines, what is in substance the same law we suggest as being applicable to the whole bituminous region. Seeing the need,

they have applied such rules to their own plants. For the better control of the 99 per cent. who will not, unless compelled by legislative proceedings, take any such measure, this chasm which now stands between safety and danger should be bridged by some definite legal precaution. Either before a board of examiners or else by an elected or appointed committee at each mine, the men who desire to become miners should qualify by answering a few simple questions relating to the timbering of roof, and, if a gas mine, by telling the necessary precautions to be taken to guard against accident to safety lamps, the proper method of placing and charging of shots, and such other questions as might be essential in the particular field in which he desires to labor. In the matter of examination of applicants, there can be no question of the moral right of the miners themselves serving through their elected representatives in this matter, for one ignorant employe, let alone many, passed into service underground, can, where gas and dust are produced in explosive quantities, destroy by a single act not only his own life but those of his fellows. If the carelessly employed ignorant miner stood the chance of killing only himself, that would be bad enough, and worthy all possible precaution to prevent, but when he has in his keeping the lives of every day laborer, miner, and official in the same mine, and the possible destruction of valuable property, too much care cannot be taken.

As matters now stand in the bituminous region the utmost care is taken to safeguard against a non-competent foreman or fire boss, yet, except in a few instances, we allow anything which has muscle and two arms to work in the same mine, totally regardless of fitness. Yet no matter how scrupulous the fire boss or the foreman, how far can his knowledge and supervision actually extend throughout the entire working day? To one conversant with the conditions of a large mine it is obvious that the only time the gen-

eral safety can be conserved is before the men are given employment, and even then there will be accidents a plenty. At best the mine officer can devote but a few minutes every day to each working place, and the utmost he can give to individual welfare is a cursory examination and suggestion. If he sees gross carelessness he can discharge or arrest, it is true, but haste and ignorance are creating danger zones in other places while he is looking after one. Take the general safety of a mine as you will, it is a matter of individual care. No mine generating gas or dust is safer than its most ignorant or careless employe will allow it to be, hence, care should be taken against individual ignorance as much as possible.

It is the nature of the miner to take risks, particularly when so doing tends to the increase of his pay; and the time he should devote to taking down or properly timbering his slate is used to take out or load coal; or the better "squaring up" of his bearing-in is left to the chance of a little extra powder and a possible blown-out shot in order to give him time to drill a hole which should go over until the next day. Until the entire subordinate personnel is educated to the great truth that it does not pay to take chances over and above those natural to the occupation, the best we can do is to eliminate the careless and disobedient and remove those chances of accident which come through sheer ignorance, by not allowing any man to work as a miner alone until he shall have proved himself capable of at least looking after his own welfare.

來 來

At the Santa Fe water station, at Trinidad, at night, a red lantern is set along side the mark which indicates that the tank is full, say, at 36 feet. Attached to the traveling board, or indicator, is another lantern. As water is pumped into the tank the lantern on the board sinks and when it and the red, fixed lantern are in a horizontal line, the tank is full.

PRACTICAL TALKS ON COAL MINING

For men who desire information on Coal Mining and related subjects
presented in a simple manner

THE flow of electricity from one terminal of a voltaic battery through a conductor or circuit to the other

terminal is known as a continuous current of electricity because it always flows in the same direction and does not vary in an abrupt or pulsatory manner. It is also known as a direct current because it always flows in the same direction through the circuit, that is, from a copper, or carbon, terminal through the conducting wire to the zinc terminal.

A pulsating current is one that flows in one direction only, but is continually rising and falling in value, due to periodic, that is regularly recurring, variations of the difference of potential, or to other regularly varying conditions. Both continuous and pulsating currents are direct currents because they flow constantly in one direction. Alternating currents, which will be considered later, periodically change their direction of flow in the circuit, first flowing in one direction in a given conductor and then in the opposite direction in the same conductor.

Electricity flowing as a current differs from static charges in three important respects: its potential is much lower, its actual quantity is greater, and its motion is continuous.

A substance charged from a strong voltaic battery possesses the property of attracting light substances to a degree detectable only with very delicate instruments. The potential of a current of electricity is com-

Electricity in Mines

The Flow of Electricity—Some Differences Between Static Charges and Currents—Circuits—Electrical Units

By H. S. Webb, M. S. (Continued from April)

paratively so small that a voltaic battery composed of 10,000 cells is not sufficient to produce a spark more than $\frac{1}{2}$ inch long in air, whereas a small, rapidly moving leather belt in transmitting power may produce static sparks more than 1 inch long. The length of the spark affords a means of estimating potentials, a high potential being capable of producing a longer spark than a low potential; but the length of spark gives no means of estimating the current strength, or the quantity, of electricity flowing. The quantity of electricity produced by a voltaic cell no larger than a thimble would be found greater than that from a large, rapidly moving belt giving static sparks several inches in length.

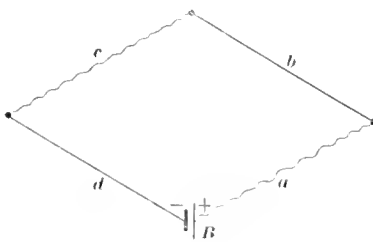

FIG. 1

Circuits.—A circuit is a path composed of a conductor, or of several conductors joined together, and through which an electric current flows. The current may be traced from any point in the circuit along the conducting path back to the starting point.

A circuit is broken, or open, when

its conducting elements are disconnected in such a manner as to prevent electricity from passing through the circuit.

A circuit is closed when its conducting elements are so connected as to allow electricity to flow through the circuit. A circuit in which the earth, or ground, forms part of the conducting path is called a grounded circuit. An external circuit is that part of a circuit that is external to the source of electricity. An internal circuit is that part of a circuit that is included within the electric source. In the case of a voltaic cell, the internal circuit consists of the two metallic plates and the electrolyte. The external circuit is any conductor and electrical devices forming a conducting path between the terminals of the cell.

Series Circuits.—When two or more conductors are so connected that the same current must pass through all, one after the other, the conductors are said to be connected in series. For example, Fig. 1 represents a closed circuit consisting of a simple voltaic cell *B* and four conductors *a*, *b*, *c*, and *d* connected in series. A heavy short and a longer lighter line, as shown at *B*, are a common method of indicating a voltaic cell. In order that the current, due to the cell *B*, may pass through any one of the conductors it must pass through all, one after the other. An open circuit, or break, in any conductor or between conductors anywhere in this series circuit will prevent any flow of electricity.

Parallel Circuits.—When two or

more conductors are so connected that each constitutes an independent path by means of which the current can pass between two common points, the conductors are said to be connected in parallel, or multiple. An example of a parallel circuit consisting of two branches *b* and *c* is shown in Fig. 2. The current from the battery *B* flows first through the conductor *a*, then it divides between the branches *b* and *c*, and finally unites and passes back through the conductor *d* to the battery *B*. The two branches *b* and *c* represent conductors or paths that are connected in parallel or multiple. An open circuit in either conductor *b* or *c* will not stop the current through the other conductor, because each conductor constitutes an independent path between the two points where the conductors *b* and *c* are joined to the main conductors *a* and *d*. The arrows indicate the direction of the current. Incandescent electric lamps in residences, stores, offices, and mines are almost always connected in parallel across the main wires that extend to a transformer, to a dynamo, or other source of electricity.

ELECTRICAL UNITS

Quantity of Electricity.—In order to make calculations of any kind, suitable units must be provided. It is not very often that one can tell exactly how much water a tank contains by merely looking at it. To determine the quantity of water in the tank, it must be measured in some manner, such as by drawing off the water into a gallon measure. The number of times the gallon measure is filled until the tank is emptied, gives the number of gallons of water that the tank contains. Thus, the gallon is a unit by means of which any quantity of water may be measured.

Unfortunately, perhaps, we cannot make a vessel in which we can put electricity and see it measured; nevertheless, we can construct devices that will measure electricity by noting the effect that it will produce.

When electricity flows from one piece of silver through a solution of

silver nitrate, which is a substance composed of silver, nitrogen, and oxygen dissolved in water, to another piece of silver or other metal, the electricity causes the second piece of metal to gain in weight. It has been experimentally determined that silver is deposited upon the second plate and furthermore that the

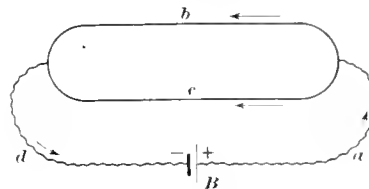

FIG. 2

amount of silver deposited is a measure of the quantity of electricity that is supplied to and passes through the solution. The quantity of electricity that deposits exactly .001118 gram, or .01725 grain, of silver on the one plate is universally considered to be the unit quantity of electricity. This unit quantity of electricity is called, by universal consent, the coulomb, named after Charles A. Coulomb, a celebrated French mathematical physicist, who lived from 1736 to 1806.

If a quantity of electricity passing through a solution of silver nitrate deposits .00559 gram of silver on one of the plates in the solution, then $.00559 \div .001118 = 5$ coulombs of electricity have passed through the solution.

It should be distinctly understood that no reference has been made to the time that it has taken any quantity of electricity to flow through the solution. A coulomb is a certain quantity of electricity and it is still a coulomb whether it takes an hour or a second for it to deposit .001118 gram of silver on the plate.

Strength of An Electric Current.—In electrical work it is generally more useful to know the rate at which electricity is flowing through a circuit at a given instant, rather than the total quantity of electricity that has passed through the same circuit in the given length of time. It is, furthermore, very convenient to have a separate unit with which to measure this rate of flow of electricity. Sim-

ilar units are used in other branches of science. For instance, the word knot is used to express the rate at which a vessel is moving; for when it passes over 1 nautical mile (6,080 feet) in 1 hour it is said to be making a speed of 1 knot. In a similar manner the one word ampere is the name adopted for the unit with which to measure the rate of flow of electricity. This unit strength of electric current is secured when electricity flows steadily past a given point in the circuit at the rate of 1 coulomb in a second. That is, a steady, or uniform, current produced when 1 coulomb of electricity passes through a circuit in 1 second, is an ampere. Thus, the element of time is involved in the ampere. If a steady flow of current causes the deposition of 1.118 grams of silver out of a silver nitrate solution upon one of the two plates therein in 10 seconds, the amount of silver deposited per second is $1.118 \div 10 = .1118$ gram; and, hence, the strength of the uniform current passing constantly through the solution during this time is $.1118 \div .001118 = 100$ amperes. That is, the rate of flow of electricity is 100 amperes, or 100 coulombs per second.

The ampere is generally defined as the unvarying current, which, when passed through a solution of nitrate of silver in water, made in accordance with standard specifications, deposits silver at the rate of .001118 gram per second. This unit is named after Andre Marie Ampere, a French physicist, who lived from 1775 to 1836.

EXAMPLE.—If 50 amperes flow through a circuit for 2 minutes, what quantity of electricity has been developed and how many grams of silver would it deposit from a silver nitrate solution?

SOLUTION.—50 amperes is equal to 50 coulombs per second. 2 minutes are equivalent to $2 \times 60 = 120$ seconds; hence, $50 \times 120 = 6,000$ coulombs have been developed. This quantity of electricity would deposit $6,000 \times .001118 = 6.708$ grams of silver.

For measuring very small electric

currents, it is convenient to have a smaller unit, in which case the milliampere unit is used. Milli is French for $\frac{1}{1000}$; hence, a milliampere is equal to $\frac{1}{1000}$ ampere. Consequently 1 ampere is equal to 1,000 milliamperes.

An idea of current values commonly used in electrical circuits may be obtained from the following cases: A 16-candlepower incandescent carbon-filament lamp requires a current of about $\frac{1}{2}$ ampere when burning at

normal brightness. A 20-foot trolley street car equipped with two motors takes from 20 to 40 amperes, when traveling at full speed on a level. An arc lamp circuit requires from 6 to 10 amperes, depending upon the kind of a lamp used. The current employed in electrically welding rails is sometimes as high as 30,000 amperes. An ordinary telegraph line circuit uses from 18 to 30 milliamperes.

(To be Continued)

Gases Met With in Coal Mines

Three Forms of Matter—Effect of Heat—Thermometers—Gay-Lussac's Law

(Continued from April)

THESE are three forms of matter—solid, liquid, and gaseous. Which of these forms matter takes depends upon the freedom or ease of movement or motion between the different molecules of which it is made up. In solids the molecules are more or less fixed and there is but little motion between them; in liquids, the molecules move freely but still display cohesion; in gases, the movement of the molecules is greatly increased, cohesion is entirely overcome, and the molecules tend to fly apart from one another; that is, they exert repulsion. Most bodies naturally take any one of the three states of solid, liquid, or gas, depending upon conditions of heat and pressure. Water is an example of the three states matter may assume under changes of temperature. As ice, its molecules do not move at all freely and it is a solid; when heat is applied the movement of the molecules becomes more rapid the force of cohesion is lessened and the ice melts into a liquid known as water; if the application of heat is continued the vibration of the molecules becomes more and more rapid until cohesion is entirely overcome, repulsion taking its place, and the liquid water flashes into gaseous steam. Just the reverse is the case if the heat

is removed. Suppose we are firing an outside boiler in the middle of winter. When the fires are drawn, the vibrations of the molecules in the steam lessen until a point is reached where repulsion stops and cohesion begins and the steam condenses into water. If no care is taken, the cold outside air causes a further withdrawal of heat, the motion of the molecules in the water in the boiler becomes less and less, until finally it is so slight that the liquid water freezes into solid ice. It will be seen that in all these states from ice, to water, to steam, and back again from steam, to water, to ice, there has been no change in the substance. It is water, whether we see it as ice or steam or as what is commonly called water. In other words, the change has been among the molecules and is a physical change, and not in the atoms, which would be a chemical change.

Heat is produced in many ways: by friction, as when a brake-shoe bears heavily on the wheel; by percussion or striking as when a blacksmith hammers a bar of cold iron; by chemical action, as when water is poured on lime; by electrical action, as in an electric lamp or in the short circuit of a broken live wire; by combustion or burning

(which is really a form of chemical action) as with coal or wood in a fire; by the rays of the sun and stars; by the interior heat of the earth and by living beings, which is known as animal heat. Heat, therefore, does not always mean that there must be flame and smoke.

Heat is transmitted or carried in three ways, known as radiation, conduction, and convection. In the case of a stove the heat is radiated through the air to a person standing nearby, and in the case of a bar of iron stuck in a fire the heat is conducted through the solid iron to the hand of the man holding it. In the first case the molecules of the air and in the second the molecules of the iron are made to vibrate more rapidly than usual, and coming in contact with the body or the hand cause its molecules to vibrate more rapidly and thus give the feeling of heat. In convection, which is shown only when heat is applied to liquids and gases, the process is a little different. Here there is an actual movement of the material being heated, as any one can see when water is boiled in a glass, when the water rises from the bottom near the fire to the top of the glass where the water is cold, and in this movement carries its heat with it.

Temperature is a term used to express the intensity or degree of heat, or the rapidity of vibration of the molecules. Temperature is generally measured by a thermometer which consists of glass tube of small bore, which tube is filled with a metal known as mercury or quicksilver. Mercury is very sensitive to slight changes in temperature and expands or contracts rapidly as heat is applied or withdrawn. There are two thermometers in general use which differ in the way they are graduated or marked. In the centigrade thermometer which is in general use in all countries except Great Britain and its colonies and the United States, although used by chemists and scientific men in both countries, the freezing point of water is taken as zero and the boil-

ing point of water is taken as 100, the distance between these two points being divided into 100 degrees on the scale. The zero point of the Fahrenheit thermometer is taken as that of the lowest artificial temperature the maker, Fahrenheit, could produce. Starting with this as the zero point, or 0°, the temperature of freezing water is 32° and the boiling point of water, 212°.

	Freezing Point	Boiling Point
Centigrade thermometer.....	0°	100°
Fahrenheit thermometer.....	32°	212°

From experiments and calculations it has been determined that at 460° below zero on the Fahrenheit thermometer scale, or 273° below zero on the scale of the centigrade thermometer, all motion between the molecules of a body ceases. This point is called the absolute zero, and temperatures measured from this point are called absolute temperatures. Absolute temperatures are extensively used in all calculations referring to the volumes of gases and the changes taking place in them under varying temperatures.

For converting ordinary temperatures to absolute temperatures use the following rules:

For the Fahrenheit scale:

Rule I.—Add 460° to the Fahrenheit thermometer reading, and the result will be the absolute temperature, Fahrenheit.

For the centigrade scale:

Rule II.—Add 273° to the centigrade thermometer reading, and the result will be the absolute temperature, centigrade.

Expressed by formulas, these rules for finding the absolute temperature are as follows:

For the Fahrenheit thermometer scale:

$$T_f = 460^\circ + t_f \quad (1)$$

in which

T_f = absolute temperature (F.);

t_f = ordinary temperature (F.).

For the centigrade thermometer scale:

$$T_c = 273^\circ + t_c \quad (2)$$

in which

T_c = absolute temperature (C.);

t_c = ordinary temperature (C.).

In ordinary work we deal with one thermometer only, so unless anything is said to the contrary T without a subscript signifies absolute temperature and t without a subscript means the ordinary temperature and should be reckoned according to the scale of the thermometer we are using. In the United States this will be, as stated, the Fahrenheit scale. The words centigrade and Fahrenheit are generally abbreviated to the letters C and F although Cent. and Fahr. are sometimes used. Thus 96° C. means 96 degrees centigrade, or as indicated by a thermometer graduated or marked according to the centigrade system; and 52° F. means 52 degrees Fahrenheit, or as indicated or marked by a thermometer graduated or marked according to the method devised by Fahrenheit.

The volume of any body, whether it is a solid, liquid, or gas, is always changed if the temperature is changed, and nearly all bodies expand or grow larger when heated and contract, or grow smaller, when they are cooled. In this series of articles we are dealing entirely with gases and will not consider the expansion of solids, like iron, or liquids, like water.

The volume of a given weight of gas depends on its temperature and the pressure to which it is subjected. The relation between the temperature, volume, and pressure of a gas is a most important one, and is given in two laws, known as Gay-Lussac's or Charles' law, and as Mariotte's or Boyle's law, which will be considered in order, the former being probably more used.

Gay Lussac's Law.—The pressure remaining the same, the volume of any given quantity of gas is proportional to its absolute temperature.

Expressed as a proportion, this law is,

$$v : v_1 = (460 + t) : (460 + t_1), \text{ or}$$

$$\frac{v_1}{v} = \frac{460 + t_1}{460 + t}$$

hence, $v_1 = v \left(\frac{460 + t_1}{460 + t} \right)$

In this formula v is the original volume of the gas at the original absolute temperature, t ; and v_1 is the volume of the gas at the higher or lower absolute temperature t_1 .

EXAMPLE.—If while passing through a mine 10,000 cubic feet of air is heated from 30° F. at the intake to 60° F. at the fan, what is the increased or expanded volume of the air?

In this problem the original absolute temperature, t , is $460^\circ + 30^\circ = 490^\circ$, and the original volume, v , is 10,000 cubic feet. The higher absolute temperature, t_1 , is $460^\circ + 60^\circ = 520^\circ$, and the volume at the higher absolute temperature, v_1 , is what we have to find. Hence we can use the formula just as it stands and we have,

$$\begin{aligned} \text{volume at } 60^\circ = v_1 &= 10,000 \left(\frac{460 + 60}{460 + 30} \right) \\ &= 10,000 \times \frac{520}{490} = 10,612 \text{ cubic feet} \end{aligned}$$

Before taking up the second law, that known as Mariotte's or Boyle's law, it will be necessary to say a little about the atmosphere.

The atmosphere, or as it is very commonly called, the air, surrounding the earth is acted on by gravity, causing it to exert what is known as atmospheric pressure. The pressure on each square inch of any surface on the earth, due to the pressure, or as is commonly said, the weight, of the atmosphere, is 14.7 pounds at the level of the ocean and gets less as we rise above that level. As air is a gas, this pressure is transmitted equally in all directions; in other words, the pressure of the atmosphere is not only exerted downward as is weight, but sidewise and upwards as well.

The pressure of the atmosphere is measured by means of an instrument called a barometer, of which there are two very different kinds. The best is the mercurial barometer, which consists of a glass tube about 3 feet long filled with mercury (quicksilver). The upper end of the tube is closed and the tube is

turned upside down and the open lower end placed in a bowl or cistern of mercury. When this is done, the mercury in the tube will fall and, at sea level, will come to rest with its surface about 30 inches above that of the mercury in the bowl or cistern. This 30-inch column of mercury in the tube is supported by the pressure of the air on the surface of the mercury in the cistern. When the condition of the atmosphere changes, the pressure of the air upon the mercury in the cistern increases or decreases, and the mercury in the tube rises or falls accordingly. The scale of the barometer is divided into inches, tenths, hundredths, and, by means of a device known as a vernier, may be read to thousandths of an inch. The word barometer is frequently written Bar., and "Bar. 29.986," means that the height of the column of mercury in the tube of the barometer is 29.986 inches.

As a cubic inch of mercury weighs about .49 pound at ordinary temperatures, the pressure of the atmosphere in pounds per square inch may easily be calculated when we know the height in inches of the column of mercury in the barometer. This is commonly called, "height of the barometer," "barometer reading," or, simply, "barometer."

EXAMPLE.—What is the pressure of the atmosphere in pounds per square inch on the summit of a mountain where the barometer reads 21.500 inches?

As a cubic inch of mercury weighs (approximately) .49 pound, a column of it 21.500 inches high weighs $21.500 \times .49 = 10.535$ pounds. This is also the pressure of the atmosphere, since it is the atmospheric pressure which causes the mercury column to have a height of 21.500 inches.

Water, or any other fluid, can be used in the tube of the barometer just as well as mercury. The reason that water is not used is because of its light weight, which is so much less than that of mercury that it rises, at sea level, to a height of nearly 34 feet in the tube.

As the pressure of the air at sea level is 14.7 pounds, or roughly 15 pounds per square inch, in dealing with steam and other gases it is not uncommon to speak of a pressure of

(To be Continued)

14.7 or 15 pounds as an atmosphere. Thus a pressure of 3 atmospheres means a pressure of 45 pounds per square inch and one of 6 atmospheres means one of 90 pounds.

Mechanics of Mining

An Explanation of the Principles Underlying Calculation Relating to Engines, Pumps, and Other Machinery

By R. T. Strohm, M. E. (Continued from April)

ALTHOUGH the lever, in its simple or in its compound form, enables a small force to move a much greater load, it cannot always be used conveniently; for the load moves only a short distance during the time in which the force moves through a correspondingly greater distance. Thus, if a load were to be lifted to a great height, a plain lever could not easily be used, as it would be necessary to lift the load as far as could be done at one setting of the lever, and then

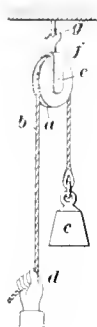

FIG. 10

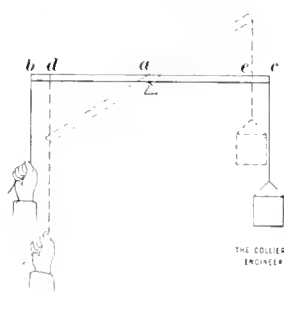

FIG. 11

to block the load in that position while the fulcrum of the lever was being raised to a higher point, so that the lifting could be continued. This repeated process of holding the load and shifting the lever would occupy a great deal of time and require much work, and therefore would be too slow for the lifting usually required to be done.

If a load is to be lifted to a considerable height without stopping, some form of pulley arrangement is commonly used. A very simple case of this kind is shown in Fig. 10. The pulley *a* is simply a wheel with a groove in its outer edge in which fits the rope *b* to which the load *c* is fastened and on which the lifting force *d*

is exerted. The pulley has an axle *e* that turns in bearings in the frame *f*, which in this particular case is fastened to a stationary overhead support. The pull *d* on one end of the rope is transmitted to the other end and causes the weight to rise. The pulley, meanwhile, turns on its axle. Thus, the whole purpose of the pulley is to change the direction in which the force acts. In this instance the straight downward action of the force *d* is changed by the pulley into a straight upward pull on the load.

In a lever, the lengths of the force arm and weight arm change as the lever swings on its fulcrum. For example, consider the lever shown in Fig. 11, having its fulcrum at *a*. When the lever is level, the force arm is the perpendicular distance *ab* from the fulcrum to the line of direction in which the force acts, and the weight arm is the perpendicular distance *ac* from the fulcrum to the line of action of the weight. When the lever has swung on its fulcrum to the position shown by dotted lines, the force arm is shortened, and is equal to *ad'*, which is the perpendicular distance from the fulcrum to the new line of action of the force. The weight arm, in the meantime, has shortened to the distance *ae*.

A pulley may be likened to a simple lever whose force arm and weight arm are always equal and whose lengths never change. For example, take the pulley shown in Fig. 12. Every point on its outer edge, against which the rope bears, is at the same distance from the center *a* on which the pulley turns, because the pulley

is circular in shape. Consequently, the perpendicular distance from the center *a* to the point *b* on the line of action of the force is equal to the perpendicular distance from the center *a* to the point *c* on the line of action of the weight; that is, the force arm is equal to the weight arm. No matter to what position the pulley may be turned, this is always the case.

It has been shown that when the force arm and the weight arm are equal, the force must be equal to the load, to balance it. Therefore, as a pulley is a lever with equal arms, it is true that the force must equal the load. In Fig. 10, if a load of 20 pounds is hung at *c*, a pull of 20 pounds must be exerted downwards at *d* to balance it and to keep the pulley from turning.

The kind of pulley shown in Fig. 10 is called a fixed pulley, because the frame *f* that holds it is fastened to a stationary support and therefore does not move up or down. With a single fixed pulley supporting a load, as shown in this illustration the pull on each part of the rope is equal to the load or weight. Thus, if the weight *c* is 20 pounds, the part of the rope from the weight to the pulley is under a pull of 20 pounds; also, the part of the rope from the pulley down to the face *d* is under a pull of 20 pounds. Now, if the force *d* pulls

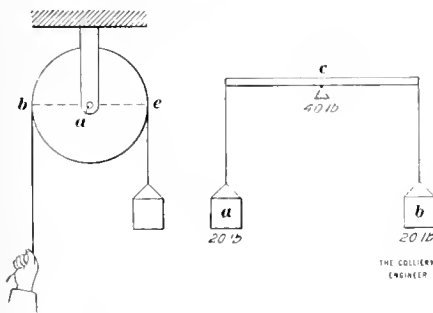

FIG. 12

FIG. 13

downwards with a force of 20 pounds at one side of the pulley, and the weight *c* acts downwards at the other side of the pulley, the total downward pull is $20 + 20 = 40$ pounds; that is, the downward pull of the hook *g* on the stationary support is 40 pounds, or twice the amount of the weight *c*.

This fact may be shown in a different way by considering the fixed

pulley as a simple lever with its fulcrum at the middle, as shown in Fig. 13, and with a weight of 20 pounds hung at each end. The weight *a* pulls downwards with a force of 20 pounds, and the weight *b* pulls downwards with an equal force, so that the total force pulling downwards on the lever is $20 + 20 = 40$ pounds; therefore, the pressure on the upper edge of the fulcrum *c* is 40 pounds. In other words, if a weight is supported by a rope or a chain passing over a single fixed pulley, as in Fig. 10, the pull on the stationary support is twice the amount of the weight.

Suppose, now, that the left-hand part *b* of the rope in Fig. 10 is tied to the ring that supports the weight *c*. The arrangement will then be like that shown in Fig. 14; that is, the weight *a* will be supported by both parts *b* and *c* of the rope, and therefore each will take half of the whole load. The downward pull on the rope *b* will be 10 pounds and the downward pull on the rope *c* 10 pounds, and the total downward pull on the axle of the pulley will then be $10 + 10 = 20$ pounds, or the amount of the weight *a*. The pull on the stationary support *d* is the same as that on the pulley axle, or 20 pounds.

By comparing Figs. 10 and 14, then, it will be seen that the pull on the fixed support is least when the two ends of the rope are tied to the weight, as in Fig. 14, and that by untying the end *b* and pulling on it with sufficient force to balance the weight, the pull on the stationary support is doubled. This shows that when a sheave is put at the top of a head-gear, with the hoisting rope running down a vertical shaft at one side and straight down to the hoisting engine on the other side, the axle of the sheave and the head-gear itself must be strong enough to stand twice the downward pull due to the load. For the sheave corresponds to the fixed pulley shown in Fig. 10, and the head-gear forms the stationary support.

If the frame of the pulley is fastened to the weight instead of to the stationary support, the pulley is

called a movable pulley. An arrangement of this kind is shown in Fig. 15. The weight *a* is hung on the hook *b* attached to the pulley frame *c*. The pulley *d* is held up by the rope, one end of which is tied to the stationary support *e*, the other end being pulled by the lifting force *f*. With this arrangement, the downward pull on the axle of the pulley is equal to the weight *a*. Suppose that the weight *a*

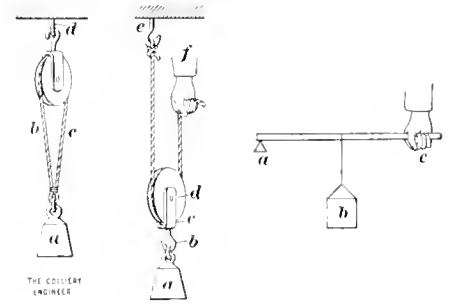

FIG. 14

FIG. 15

FIG. 16

is 20 pounds. Then the total upward pull required to hold up the weight *a* must be 20 pounds. It is plain that two parts of the rope hold the load, and therefore each takes half of the total pull; that is, the upward pull of the rope fastened to the hook *e* is 10 pounds and the upward pull of the force is also 10 pounds. In other words, with one movable pulley arranged as shown in this illustration, a given weight can be held up by a pull on the free end of the rope equal to half of the weight, and the pull on the stationary support is likewise equal to only half of the weight.

So far as the pull on the stationary support and the strain on the rope are concerned, the arrangement in Fig. 15 is better than that in Fig. 10. For in Fig. 15 the pull on the free end of the rope is just half of the corresponding pull in Fig. 10, and the pull on the support in Fig. 15 is but one-fourth of that in Fig. 10; yet the load is the same in both cases.

This advantage, however, is not gained without a corresponding disadvantage. With the arrangement shown in Fig. 10, the force *d* and the load *c* move at the same rate; that is, if the force *d* moves down 1 foot, the load *c* rises 1 foot. But with the arrangement shown in Fig. 15, the force *f* must rise 2 feet in order to lift

the load 1 foot. Thus, although the force required in the second case is only half of that in the first case, it must move twice as far to accomplish the same result.

The pulley in Fig. 15 is like the lever shown in Fig. 16, which has the fulcrum *a* at one end, the load *b* at the middle, and the lifting force *c* at the other end. The fulcrum of the lever corresponds to the fixed end of the rope, the load corresponds to the weight hung from the movable pulley, and the force *c* corresponds to the pull on the free end of the rope. As the force arm is twice as long as the weight arm, the force *c* needs to be only half as great as the weight *b*; but the weight will rise only half as far as the force *c* moves upwards, because it is only half as far from the fulcrum. This shows why, in Fig. 15, the load *a* rises only half as fast as the force *f*.

(To be continued)

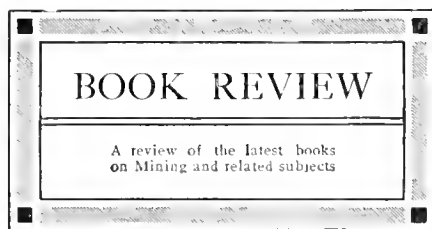

BULLETIN No. 61. "CHARACTERISTICS AND LIMITATIONS OF THE SERIES TRANSFORMER," by H. R. Woodrow and A. R. Anderson, has just been issued by the Engineering Experiment Station of the University of Illinois. This bulletin presents the results of a theoretical investigation of the characteristics and limitations of the series transformers more particularly in connection with its use in recording transient currents. Copies of Bulletin No. 61 may be obtained upon application to W. F. M. Goss, Director of the Engineering Experiment Station, University of Illinois, Urbana, Ill.

BIRMINGHAM DISTRICT MINERAL LAND REFERENCE, is a book giving the names of owners of fee simple and mineral lands in the counties of Marion, Winston, Cullman, Blount, Etowah, Fayette, Walker, Jefferson, St. Clair, Tusca-

loosa, Bibb, and Shelby, in the state of Alabama. It is compiled and published by Alabama Mineral Map Co., of Birmingham, Ala. Price \$100. In addition to the price the company furnishes data and maps to subscribers, somewhat on the order of a mercantile agency.

THE SOUTH AFRICAN MINING DIRECTORY. Published by S. A. Mining Directory, Ltd., Johannesburg. 200 pages. This directory is published monthly, giving a list of all of the mines of the Rand and Rhodesia and the colliery districts of the Transvaal and Natal, with a full list of the officials of each mine.

THE ANNUAL REPORT OF THE SUPERINTENDENT OF COAST GEODETIC SURVEY FOR THE YEAR ENDING JUNE 30, 1912, together with Progress Sketches, has just been issued. Aside from Hydrographic Geodetic, Magnetic, and Tidal work, the contents include International Boundaries; Special Surveys; Dangers to Navigation; Triangulation of the Yukon River; and Details of Field Operations. Among the illustrations we find Distribution of the Principal Astronomic Stations occupied to June 30, 1912; Routes of Geodetic Spirit Leveling; Position of Gravity and Tidal Stations; Magnetic Stations; sketch of general progress in Alaska, Hawaii, Porto Rico, Canal Zone, and the Philippine Islands.

采 采

Coal Mining Institute of America

The Coal Mining Institute of America expects to make its summer visit to the anthracite regions. The program is not yet completed, but it is roughly as follows: Members will leave the bituminous field from Pittsburg at 8:50 Monday evening, June 16, special sleeping cars being furnished. The train will take up passengers between Pittsburg and Tyrone and will arrive at Wilkes-Barre at 8:59 on Tuesday morning, June 17. Those who desire to make the interesting trip during the day may leave Pittsburg

at 7:50, on Monday morning, and arrive at Wilkes-Barre at 7:50 P. M.

The meeting for organization purposes will be held in Wilkes-Barre at 10:30 A. M., June 17. Luncheon will be at 12 o'clock. In the afternoon a trip will be made to nearby collieries, and in the evening, after the Institute banquet, H. G. Davis, district superintendent of the Delaware, Lackawanna & Western R. R. Coal Department, will deliver a lecture on sociological work which has been done by the company. The address will be illustrated by stereopticon.

The following Wednesday, the 18th, the visitors will pass over the scenic Wilkes-Barre & Hazelton third-rail system to the latter town and view the anthracite strippings and collieries in that district. In the evening, the Institute will invite the members of the local District Mining Institutes to meet them at Wilkes-Barre. Addresses will be delivered on soft-coal methods of mining and sociological work in the bituminous region, illustrated by the stereopticon and possibly moving pictures.

On Thursday, the 19th, a trip will be made to the anthracite collieries in the Wyoming Valley, and, if time will permit, the members of the Institute and their wives will be taken by special train on the "Laurel Line" to Scranton to visit the International Correspondence Schools and be entertained with a luncheon as guests of the officers of the International Textbook Co. From 3 to 5 o'clock a session will be held at Wilkes-Barre for a discussion on the impressions received while visiting the anthracite operations.

At 6:20 the train will leave Wilkes-Barre for Pittsburg and other points in the bituminous coal field. It may be added that the members are invited to bring their wives with them if they so desire. Several of the leading anthracite companies have, by their executives, expressed themselves much pleased to have an opportunity to show their hospitality to the members of the visiting institute.

Working Anthracite Culm Piles

The Employment of Hydraulic Methods in Connection With Special Forms of Conveyer Lines

Written for The Colliery Engineer

IN the early days of the anthracite industry, lump coal, steamboat, egg, and stove coal, with some chestnut, were the chief products shipped to market. Lump coal was in demand for blast furnace and locomotive use; steamboat coal was considered the only proper fuel for river and sound steamers, and nothing below chestnut would be used by housekeepers, even the mine owners burned pea coal to raise steam.

With the introduction of the Wooten camel-back engine a complete change in locomotive fuel took place; and with the introduction of the McClave grate and argand blower, smaller sizes of coal were used at the mines and in steam-raising generally, until at present, bird's-eye, which passes through a hole $\frac{5}{16}$ inch in diameter, finds a market.

Anthracite is brittle, and the more times it is broken down to produce domestic sizes the greater is the waste. In former years the small, unsalable sizes amounted to about 25 per cent. and these with rock, coal and rock, or small coal, were allowed to accumulate in piles. If it was possible to keep the large rock comparatively free from coal it was stacked by itself in a rock pile, or if there was a way to stack small coal by itself it was allowed to accumulate in culm piles.

Large quantities of culm were lost in preparing coal by the wet method, it going into streams and eventually into the rivers. In some places the culm piles are 100 or more feet high, one-quarter mile in width, and from three-fourths to 1 mile long. Unfortunately a number of these piles have been destroyed by taking fire, but many of them are left, and are being worked for market, and the small sizes, formerly called culm, are being saved at the breaker instead of being stacked as heretofore. The recovery from the culm banks and the small sizes

obtained from freshly mined coal constituted about 40 per cent. of the total quantity of anthracite sent to market in 1911, or 20,414,077 long tons. Of this quantity 3,171,678 tons were recovered from culm piles. By further calculations it can be



FIG. 1. SCRAPER LINE NEAR NANTICOKE, PA.

shown that by the use of modern steaming devices 21.3 per cent. of fine coal that would in former years have gone to the culm piles now goes to market.

The first washery was installed in 1890 and recovered 41,600 gross

tons of coal. In 1907 the output from washeries was 4,301,082 tons.

In some instances the fine material less than five-six-

teenth inch is used at the mines under modern water tube or flue boilers, thus effecting a further saving. At one plant the saving due to this procedure amounted to over \$10,000 in one year.

There are mines near Scranton where the finest coal and sludge is flushed from the breaker or washery to bore holes going into the mines, and made to fill old workings and support the roof above the excavations. Where no arrangements are made for flushing, the sludge is caught in settling dams to prevent its polluting the streams as heretofore.

Since the reclamation of coal from culm and dump piles in the anthracite regions has been underway, the hydraulic method of excavating and transporting material has proved its superiority over steam shovels.

These old culm and dump piles contain from one-quarter to one-third, in some cases possibly more, good coal, which in former years was considered waste, but which is now being reclaimed by hydraulic sluicing and washing. The method followed is to construct a washery, at some point convenient to the pile, and by means of elevators carry the material to the top, where it is screened into sizes, and freed from slate by jigs and mechanical slate pickers.

In order to do away with the use of steam shovels and cars to load and carry the material to the washery, it is customary to break the culm loose from the banks by streams of water and direct the culm and water through sluice boxes lined with sheet iron to the scraper line leading to the washery. In some cases the scraper line is quite long and horizontal, and made to swing toward the culm bank as that is removed, as shown in Fig. 2; in

other cases the sluice delivers material direct to an elevator boot at the foot of the washery; and still again, to an inclined scraper line leading to the top of the washery, as shown in Fig 1. The latter illustration is the washery of the Susquehanna Coal Co., at Nanticoke, where the mate-

gradually raise them, eventually bringing such pressure to bear on the castings as to crack them. Before the break occurs the plate may be raised sufficiently to have the flights, as they move along, catch on the raised plate, thus putting extra strains on the scraper

Attention is called to the extension of the link pin at both ends because it fits in grooves in the sprocket wheels and all pulling strains due to moving the material and the apparatus come on these projections, a feature which minimizes wear and consequent breakage of links as in cases where the links engage the sprocket-wheel projections and receive the pull of the load. The pin *a*, Fig. 4, has a square shoulder slightly oval which passes through the opening *b* in the links, after which the pin is given a half turn so that the shoulder stands at right angles to the oval opening *b*, and binds the links together, thus making a rivetless joint and completing the chain. Inside the collar the pin is forged square to fit into the recess *d* of the outer link. The pull thus comes on a squared surface and any wear at this place can be compensated by simply turning the pin half way around so as to present a new squared surface to the link recess. The outside links are so extended on each end as to form a "lip," covering the recess formed by the chain when in operating position. This lip prevents dirt or other



FIG. 2. HYDRAULICKING CULM TO CONVEYER LINE

material is broken loose from the bank by water nozzles, and sluiced to the scraper line. Back of the washery is seen the No. 5 Colliery dump pile, which is 1 mile long and over one-quarter mile wide on the top. The scraper line shown in the illustration serves another large culm bank made up of material from No. 7 colliery and this also is to go through the washery.

Between the centers of the sprocket-wheel shafts of this conveyer there is a distance of 374 feet, with the trough pitched at an angle of 3 inches to 1 foot. The arrangement possesses a number of new features which will appeal to every one who uses or intends to make use of trough conveyers. The trough is of wood, lined with cast-iron plates cast in semihexagonal segments and biased as shown by the heavy lines in Fig. 3. It is well known that when cast-iron plates are bolted inside wooden troughs to act as lining, especially if laid so as to have parallel joints at right angles to the length of the trough as shown by the dotted lines, the fine material will get under and

chains and sometimes causing them or some of the fastenings to break. When the plates are laid in the trough so the joints are diagonal to the length, as shown by the full lines, the flights slide over the joints a little at a time and move the material gradually across the joints, and so do not force it under the plate nor does the flight catch on the joint. The scraper conveyer in Fig. 1 is designed for a capacity of between 1,800 and 2,000 tons of material daily, consequently, the chains must be strong and constructed so that in case of a pin, bolt, rivet, link, or flight breaking it may be quickly repaired. The Cross Engineering Co. have constructed the rivetless chain which is eminently suited for this kind of work, for after 5 months operation not 1 penny has been spent on it for repairs.

The flights shown are backed and bolted to bracket castings, which in turn are constructed so as to fit between two links to which they are rigidly fastened by bolts. The flights are 3 feet apart but only the lower one in the illustration shows a bracket.

gritty material from working in on the bearing parts of the inside links and the pins. On the up trip the chain is suspended by the flights resting on the trough floor; on the down trip the chain and flights rest on two shoes bolted near the center of the top of the flights. These

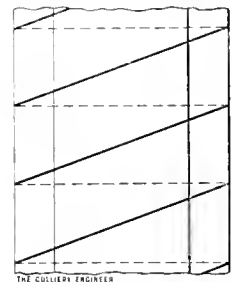
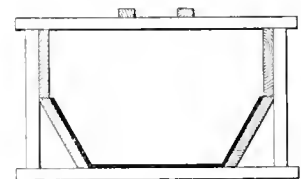

FIG. 3

shoes slide on rails laid on ties of the framework above the lower flights and are lubricated to prevent wear and reduce the noise caused by friction.

During the last few years considerable attention has been given to dredging for coal and culm that has

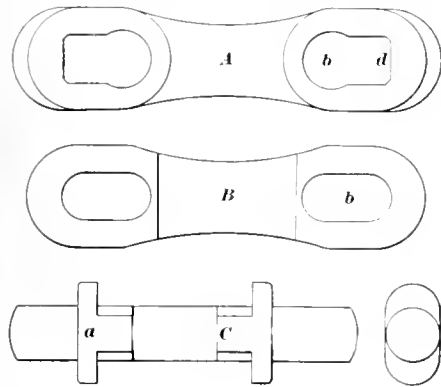

FIG. 4

been washed into the Susquehanna River. The dredges may be noticed by travelers from the cars as far down as Harrisburg. During the year 1912 approximately 80,000 tons of coal was recovered in this way and in 1913 probably 100,000 tons will be recovered.

采 采

Speed of Hoisting

Mr. Tom Johnson's paper still affords topics for fruitful discussion at the meetings of the Chemical, Metallurgical, and Mining Society. One of his contentions that has elicited a great deal of difference of opinion was that "it should not be impossible to hoist 5,000 tons of rock per 24 hours through two compartments, 6 ft. x 5 ft., from a depth of 3,000 feet." Some interesting data on this point were brought before the last meeting of this Society by Mr. A. Richardson. To hoist a maximum amount of ore, it is necessary to have quick loading from large and perfectly equipped boxes serving several levels, fast winding with powerful engines, well-maintained shafts, and expert drivers. With those factors granted, the question becomes merely one of winding speed. As far back as 1878 the California Gold

and Silver Mining Co. was hoisting from a depth of 2,500 feet in 45 seconds, an average speed of 3,333 feet per minute. The No. 111 Tamarack has done 4,800 feet in 1 minute 15 seconds, or 3,880 feet per minute, the maximum speed during the wind being over 5,000 feet per minute; this hoist has made forty trips in one hour with three tons of ore per trip. The Calumet and Hecla has wound from 4,900 feet at an average speed of 3,500 feet per minute. At Kimberly, 4,000 short tons have on several occasions been hoisted in a little over 11 hours from 1,560 feet; with this engine the acceleration period occupies 16 seconds, the retardation period 13 seconds, the maximum and constant speed period 13 seconds, equivalent to 3,770 feet per minute, the average speed being 2,230 feet per minute for a winding period of 42 seconds; the loading and dumping together occupy 5 seconds, so that each trip takes 47 seconds.—S. A. Mining Journal.

采 采

Shaft Sinking

By Samuel Haines*

I have noticed in MINES AND MINERALS from time to time, different methods relative to drilling holes in drifts to accomplish the greatest amount of work, although it is very seldom that we see anything in regards to shaft sinking. When a company commences work on a new property the main work of that company is in sinking the shaft, and it is up to the superintendent in charge to see that the best results are obtained, and this is only possible when the men working in the shaft do their work in an efficient and practical manner. In my experience in shaft sinking I have seen different methods used in taking out a sink or cut, but none more effective, or accompanied with better results than the "sink" outlined in the following plan:

The plan, Fig. 1, represents a shaft 12 ft. x 20 ft., rock measurement. The idea is to get the powder down where it will do the greatest amount

*Negaunee, Mich.

of work. A glance at the above illustration will readily show that this is obtained by drilling the holes as represented.

The collar of holes marked No. 1 covers an area of 6 feet square, the holes being drilled at an angle of 65 degrees slanting toward the center of the shaft, and about 7½ feet deep; holes No. 2 are drilled to a depth of 7½ feet at an angle of 65 degrees, also No. 3 are drilled as side holes in same direction and to same depth. Holes 4 and 5 are next drilled to a depth of 6½ feet at an angle of about 75 or 80 degrees, holes 6, 7, 8, and 9 are end holes and are 6 feet deep. Holes 8 and 9 would not be required in a shaft of smaller dimensions than this.

Holes 1, 2, and 5 can be readily drilled without moving the arm on the bar, holes 3 and 4, by simply turning the machine over on the other side of the arm; by swinging the machine over to the other side of the bar, holes 6 and 8 can be drilled, then by swinging the machine over the arm again holes 7 and 9 can be drilled; thus getting the maximum amount of drilling with the

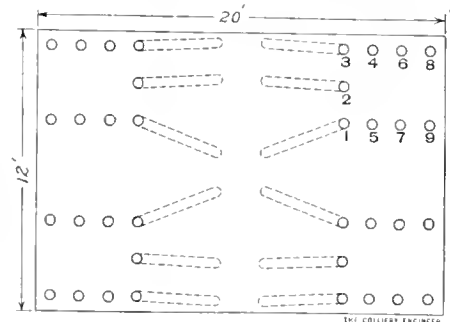

FIG. 1

minimum amount of handling the machine, incidentally saving time. We used this cut or sink regularly in the Negaunee mine shaft, and are using it at present at the Isabella mine, Palmer, Mich., with splendid results in very hard working rock. In my judgment it is one of the best cuts that can be used in shaft sinking, and will accomplish the greatest possible results with least powder, as the powder is placed down where it can be most effective. The four holes numbered one must be blasted with a battery.

THE LETTER BOX

Readers are invited to ask or answer any question pertaining to mining, or to express their views on mining subjects in this department. All communications must be accompanied by the name and address of the writer—not necessarily for publication.

The editors are not responsible for views expressed by correspondents.

Mercurial and Aneroid Barometers

Editor *The Colliery Engineer*:

SIR:—Textbooks, mining journals, United States Weather Bureau, and others are authorities for the statements that mercurial and aneroid barometers indicate the changes in pressure from 3 to 6 hours in advance of its effect in the mine. The barometer is subject to any changes of atmospheric pressure, and from the principle upon which it is constructed it can only indicate a change that is taking or has taken place, and cannot forewarn of a change that might be about to occur. Now as gases respond immediately to any increase or reduction of pressure, by contracting or by expanding, the question that presents itself is: Why does the barometer indicate the fall in pressure in advance of its effect in the mine when both are subject to the same changes?

NOT SIGNED

NOTE.—The author of the above is referred to a short article on "Use of the Barometer in Mining," by Mr. J. C. Schellenberg, on another page of this issue.—EDITOR.

Mercurial and Aneroid Barometers

Editor *The Colliery Engineer*:

SIR:—In regard to the question by "Not Signed" dealing with the statement that instruments for indicating atmospheric pressure show changes 3 to 6 hours in advance of the effect upon coal mines, would reply as follows:

The barometer indicates the existing atmospheric pressure, and the column of mercury changes in height simultaneously with atmospheric pressure variations. In the case of a coal mine, however, a certain amount of lag enters into the case, as some time is required in order to allow the air in the most remote portions of the mine to change in density until

it reaches the same condition as the outside air.

When the barometer is high there is actually more air in a mine than when the atmospheric pressure is low, and this can be clearly understood when it is considered that the space within the mine does not change (disregarding mining operations) but the density of the air does.

As an illustration, with the barometer at 30 inches and a temperature of 70° F., the weight of a cubic foot of dry air is .07495 pound, and 13.34 cubic feet of air weigh 1 pound. With the barometer at 29.9 inches, 1 cubic foot of dry air at 70 degrees weighs .0747 pound, and 13.38 cubic feet weigh 1 pound. In other words, when the barometer rises from 29.9 inches to 30 inches, one-third of 1 per cent. more air must flow into the mine in order to permit the density to be increased sufficiently to balance a column of mercury 30 inches in height.

In the case of a mine containing 30,000,000 cubic feet of air a change of $\frac{1}{10}$ inch in the barometric pressure will cause an inflow or outflow of 100,000 cubic feet of air and the rapidity with which the interior of the mine changes to the same condition as the outside atmosphere varies with the size of the mine, the extent of the worked-out portions, and the areas of the various passages.

AMERICAN BLOWER CO.

T. Chester, Chief Engr.

Detroit, Mich.

Heat Waves Visible

Editor *The Colliery Engineer*:

SIR:—The following is in answer to the question asked in March number in regard to whether heat waves are

visible or not, these being apparently seen when a current of warm air strikes a body of cold air.

The characteristic appearance produced when air at different temperatures is mixed varies in perceptibility in accordance with the difference in temperature. The apparent visibility of transparent hot gases ascending from the top of a chimney is due to the variation in light intensity caused by the refraction of light rays in passing through mediums of different density.

The action is, of course, the same as the apparent bending of a straight stick partly immersed in water, as the portion submerged appears bent out of line, due to the deflection of the light rays when emerging from the water to the air.

The heat waves referred to can apparently be seen issuing vertically from a hot radiator in direct sunlight, but the apparent visibility is due to an optical illusion. The same effect can be noticed upon pouring hot water into a receptacle containing cold water and lined with white enamel.

T. CHESTER

Detroit, Mich.

Afterdamp

Editor *The Colliery Engineer*:

SIR:—In C. K. Gloman's "Chart Classifying Mine Gases," accompanying *THE COLLIERY ENGINEER* for April, I notice that he treats afterdamp as a single gas with the formula $CO_2N_{7.5}$. To quote him: "The symbol of afterdamp is $CO_2N_{7.5}$. There is present, therefore, in each molecule of afterdamp one atom of carbon, C, two atoms of oxygen, O_2 , and seven and one-half atoms of nitrogen, $N_{7.5}$. From this it follows that the molecular weight of afterdamp must be the sum of the atomic weight of the atoms comprising the molecule."

As is well known, afterdamp consists of a number of different gases, mechanically mixed, chief among them being carbon dioxide, CO_2 ; water vapor, H_2O ; nitrogen, N_2 ; carbon monoxide, CO ; oxygen, O_2 ; and occasionally traces of nitrous oxide, N_2O , and unburned marsh gas, CH_4 . The kinds and quantities of the gases

forming the afterdamp depend on the kinds and quantities of the compounds from which they are produced. The composition of the afterdamp produced by an explosion varies with different mines, as well as with different parts of the same mine.

In the complete combustion of any hydrocarbon, the resulting products are carbon dioxide and water. In the combustion of marsh gas, the gases distilled from coal dust, etc., in a mine explosion; the nitrogen present does not enter into the reaction (except such quantities as may be required to form traces of nitrous oxide) and remains free as before the explosion, and if it did it would not be in fractional parts of an atom. There is no such chemical compound as $CO_2N_{7.5}$.

ROBERT S. WHEATLEY

Salineville, Ohio

Carbide Lamp Abuse

Editor The Colliery Engineer:

SIR:—In his recent report for 1912, W. E. Jones, State Inspector of Coal Mines, District No. 2, state of Wyoming, makes the following comment upon the use of carbide lamps, which, in view of what has been said by some of your readers, may be of interest:

"I had made a test of the carbide lamp at the time the last report was submitted and found that while it would burn in an atmosphere that extinguished an oil flame, yet I could and did stay for some little time in an atmosphere that extinguished the carbide light, and conversed with the mine boss without either of us suffering from any noticeable effects. This led me to believe that the danger from the use of this lamp, as alleged by some eastern inspectors, was largely theoretical and imaginary. But during the past year my attention was attracted to abuses of it. Where the air was dull this lamp was introduced as a substitute for air. In one instance I walked into a working place where my oil lamp would have been extinguished had I not retreated immediately. Yet a miner worked there daily, using, of course, a carbide light. There was not enough blackdamp to 'knock him

out,' but he must have suffered from the effects, and his health was being steadily and stealthily destroyed. The carbide lamp is a good one if not abused, but a very poor one if undue advantage is taken of it. I would not condemn the lamp on account of its abuse in some cases; on the contrary, I recommend it for general use at the faces where open oil lights are being used. And it must be up to the mine inspector and mine officials to see to it that the abuse is eliminated."

E. W. JONES,

Scranton, Pa.

Use and Care of Safety Lamps

Editor The Colliery Engineer:

SIR:—Two disasters have occurred within recent months, due to defective safety lamps. Now all lamps should have a double gauze, but the objection to the two gauzes is the necessity for taking apart at the end of each shift, the glass, and inner and outer gauzes, and depending for this work on men or boys who only think of how many lamps they can assemble in the shortest time, and then take things easy

After being assembled, all lamps should be carefully tested by blowing around the top of the glass near the top asbestos gasket, and only one gasket should be used, not two or more as is often the case if the glass is too short. With all lamps of this class, dependence is placed entirely on the lamp man and his assistants. These should be intelligent, careful, and above all, sober men, who would be above going into the lamp room in the morning with a swelled head and a muddled brain, to clean and fit the lamps together.

Now I have a lamp of the two-gauze type and glass globe, in which the inner gauze remains stationary after being tightened by the screw plate under the glass cylinder, the same as in the case of a single-gauze Clanny, but my outer gauze can be safely fastened on over the inner gauze. The lamp burns mineral, colza, or pure miners oil. The shield is locked by a spring and cannot be opened until the bottom of the lamp is unlocked and unscrewed. The

lock has a lead seal with the company's initials stamped on it before leaving the lamp room, and the lamp man examines each lamp he receives at the end of the shift, to see that the lead seal has not been tampered with. The lamp, on being given out of the lamp room at the commencement of each shift should be carefully examined, cleaned, and lighted, also numbered, and a correct register kept of the person who takes the lamp. Thus: J. R. Watkins, miner, Lamp No. 1.

The shield need only to be partly fastened until the lamp is again tested by the fire boss. The outer gauze should then be taken off, and the inner gauze examined. It is easier to detect a small flaw in the gauze with a light inside the lamp; therefore, the fire boss can see any defects in the inner gauze or outer gauze. The miner should next test the lamp by carefully blowing around the top and bottom of the glass cylinder, then screwing on the outer shield, which locks with a spring. The lamp is now in a safe condition, having been examined by lamp man, fire boss, and the miner. All men who use safety lamps should be specially trained in their care and use. If the lamp is damaged it should be immediately extinguished, if not damaged it can be relighted in the mine by means of electricity, but no seals should be given to any person outside of the lamp-room staff.

Many locks that pretend to lock lamps can be opened and closed without the management being any the wiser. The lead seal can be easily cut off and the lamp opened, but it cannot be refastened, as the miner has no lead seals and no stamp to put initials on the seal. One man of good standing should be employed as lamp inspector, to carefully examine the locks as each man gives his lamp in at the lamp room, and any marks of any kind found on the lead seal should be recorded, and a careful investigation made. If the seal has been tampered with, then the person should be sent to prison for 2 months without the option of a fine. This punishment would soon cure the lock openers of their habit.

The lamp that has a match igniting arrangement inside, in my opinion, is not a safe lamp, as the average miner who may have stuck his pick point through the glass, or knocked the lamp from the prop, would immediately on picking it up, begin to turn his match arrangement to get a light, instead of calling for his partner and carefully examining to see if it has been injured. I have seen instances of this kind.

The miner cannot be too careful of the lamp that gives light for him to work by and he should bear in mind that a very small defect can also bring speedy death to himself and coworkers.

J. R. WATKINS,
Superintendent of the Issaquah and Superior Coal Co.
Issaquah, Wash.

Law Regarding Mine Inspectors

Editor The Colliery Engineer:

SIR:—The matter brought up by Mr. Hooper in the March number is one that has engaged the attention of the coal mining craft ever since the writer can recollect anything about coal mines. Many theories have been advanced by as many interests regarding a method of selecting mine inspectors and determining their qualifications. But like "busting the trusts," the question does not seem so easy of proper solution after all. The miners would perhaps dispose of it to their immediate satisfaction by providing that the inspector be elected by themselves. But this solution, if possible, would be unwise. It is impossible, of course, since this is a government regulated by citizens unaided by aliens. It would be unwise by reason of the fact that the foreigners especially would be unable to discriminate intelligently between conscientious and capable men on the one hand and catering demagogues on the other. An election by the legal voters of the district or state, would be equally unsatisfactory, since the general public is incapable of judging in the remotest degree the qualifications of candidates. The good people of Ohio probably thought the matter properly solved when provision was made

whereby the appointments would be equally divided between the two dominant parties, and this scheme has been heralded as a non-partisan arrangement. But the term bipartisan fits it better; in fact, fits it exactly. There is no elimination of partisan politics in this scheme, it is merely a division of the spoils.

Neither does Mr. Hooper's proposed remedy appeal to me as a practical solution. It only prescribes a penalty against the chief without giving him the slightest chance for defense, except as the governor saw fit to grant it. This, indeed, is a most arbitrary method of determining a man's qualifications, unjust, and totally inadequate. For instance, in a certain western district, during the year 1912 the inspector reported a man killed for every 157,150 tons of coal produced. It is generally conceded that this inspector is a clean, conscientious, capable, and strict official. An explosion occurred in his district, killing several, and so far as the writer is aware no one has attached any blame to the inspector. And it is certain that he still retains the confidence and good will of the miners as well as the respect of the mine operators. But if this had occurred in Alabama, with Mr. Hooper's proposed amendment in force, the chief would have been outlawed from office automatically, although innocent of any wrong doing, and the governor would have it in his power to replace him with some other person more to his personal liking or political advantage, as it suited his own purpose, just as the "compromise" gives it to him absolutely. An explosion or other disaster may happen in spite of the vigilance of the chief or even of the district inspector, the cause of which may be clearly beyond either's power to prevent; and it is certainly unnecessary to enumerate here the numerous ways by which they may occur. It would, therefore, be unwise, unjust, and even cruel, to penalize or cast reflection on a public official in no wise responsible for such accident or record.

The proposed law for the anthra-

cite region in Pennsylvania, as explained by Hogan, is a much better plan, though somewhat inconsistent, perhaps, in providing that the majority members shall consist of men less able to examine such applicants than the minority of the board. In my humble opinion two former mine inspectors, themselves sworn not to become candidates for mine inspector, should be substituted for two of the mining engineers, and the five miners should be reduced to three, making a board of seven instead of nine. These ex-mine inspectors will have had actual experience in the particular duties for which the candidates are endeavoring to qualify and they would thus be especially qualified to examine such candidates.

We are surely all agreed that mining laws are made to protect those engaged in mining, and we are equally agreed, I think, that mine inspectors ought to be taken out of the domain of politics, either partisan, bipartisan, or non-partisan. But how to do it is another matter. Neither miners nor operators ought to be permitted to influence an appointment, for both are subject to the mining laws to be enforced by the inspector. And the one is as unwilling at times to abide by the laws affecting him as the other is to obey those affecting himself. The old adage that "familiarity with danger breeds contempt for it" is as applicable to the one as to the other. Both take unwise risks; the one, because, perhaps, proper precaution entails some labor or inconvenience; the other, because it costs time or money. An inspector should therefore be obligated to neither and should be entirely independent of both.

But the personnel of mine inspectors, if I read the signs of the times aright, is gradually improving, just as the standard of mine bosses is looking up. And the methods of selecting mine inspectors are as certainly approaching a proper solution, thanks to the mining journals and a quickened public conscience. Personally, the writer has no better solution for the present than the one mentioned and indorsed by Hogan,

together with the amended suggestions herein made. COLLIER

Rope Turning

Editor The Colliery Engineer:

SIR:—In your March number, "Superintendent" asks how to change a haulage rope end for end. This can be accomplished by running the rope off the drum except turns sufficient to turn the rope. Then make a temporary splice of both ends, and run

operation, as shown in Fig. 3, is to carefully wind the rope around the drum until *a* reaches that point, after which *a* is again dead ended, and then the clamp is taken off at *d*.

As shown in Fig. 4, the car is then lowered until the drum is nearly empty, after which the car is anchored in some manner so that it cannot move. The *b* end is next detached from the drum, and the *a* end attached; then the rope is carefully

have men take the end out behind the hoist, not coiling but taking it out and laying it straight on the ground.

When the skip is near the top, stop and block it, and then take two or three short ropes and fasten on to the cable and tie to timbers along the shaft, as shown in Fig. 6 (a).

Now take the cable off of the skip, and taking three pieces of tiller line about 12 feet long make a loop in

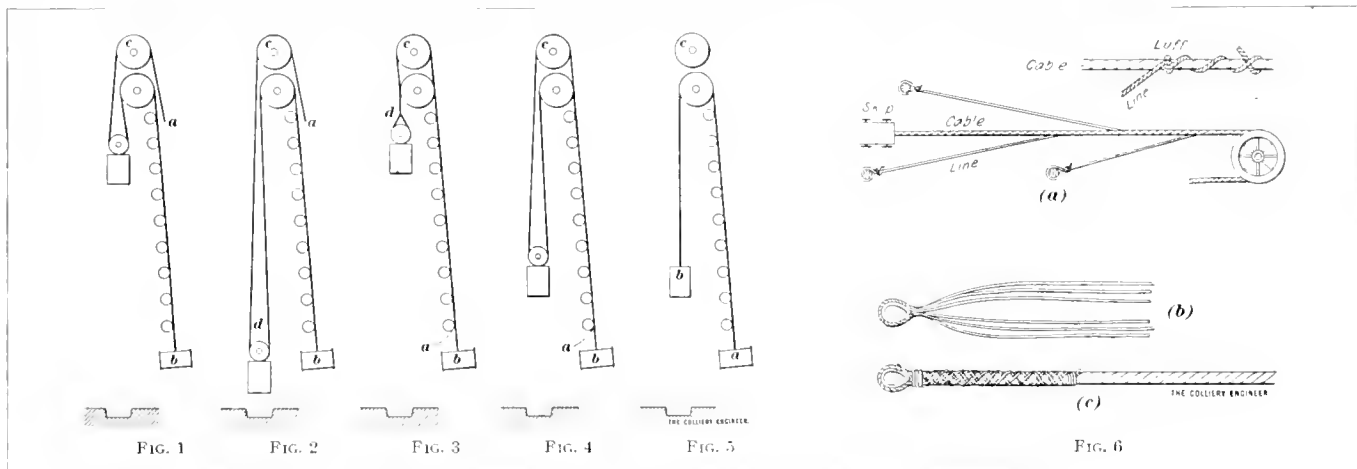

the splice around through the sheaves to the trip; then run the rope off the drum-fastened end. Afterwards the trip end can be put under or over the bull wheel, as the case may require.

JAMES A. CAMPBELL
Glace Bay, Cape Breton, Can.

Changing the Hoisting Rope

Editor The Colliery Engineer:

SIR:—In your March issue, "Superintendent" asks to be told how to change his hoisting rope end for end with the least trouble and expense. I submit the following as being the best scheme I have seen to do this:

In Fig. 1 a temporary sheave is placed at *c* and another is attached to the front of the car. The *a* end of the rope is threaded through the sheave on the car and passed around the sheave at *c*, and dead ended. Next, as shown in Fig. 2, the car is lowered until only two or three laps of rope remain on the drum *b*. The ropes at *d* are securely clamped together and the *a* end is firmly bound to main rope with soft wire. The next

wound until the *b* end has been drawn to the car. The sheave is now detached from in front of the car, as in Fig. 5, and the rope attached. Assuming that sheaves of proper size and strength have been placed at *c* and on one end of car, two men should do this job in a comparatively short time and without damage to the rope.

BERT LLOYD
Trinidad, Colo.

Editor The Colliery Engineer:

SIR:—In answer to "Superintendent's" query in March issue of THE COLLIERY ENGINEER, I believe this will fit his case: Procure a strong rope long enough to reach from the hoist to the bull wheel. Lay the coil by the hoist and take one end down to the bull wheel. Now, having the skip at the bottom of the incline and not much cable on the drum, undo the clasp at the end of the cable and taking the end, but leaving enough turns on the drum to hold the strain (about one-half of the drum width, single layer), start the engine to pull the empty skip up the incline and

the middle or place an eye in, as shown in Fig. 6 (b). The eye should be small enough to go through the sheaves. Next place the end of the cable close to the eye, and lattice, or braid, ropes around cable, three going one way and three the other, till the cable is laced back several feet, as shown in Fig. 6 (c).

The ends should be finished off by winding around and tucking away. Now fasten the end of a light line into the eye, and with blocks along the way to prevent fouling or rubbing of the light rope, start the engine and pull in the cable with the light rope attached. Having got the end of the light rope to the drum, unfasten it from the end of the cable and run the cable off the drum altogether. Now bring up the other end of the cable and place it on the drum with a few turns put on the way it will run when fixed permanently. Now lattice, or lace, thongs on this end as before, and then taking the other end of the light line take a few turns around the drum in the opposite way to which the cable is run-

ning and start the engine, and the cable will again go out through the sheaves. When at the other end, make fast with ropes as before, take off the light rope and fasten to the skip, then lower slowly until bottom is reached, when the cable can be made fast to the drum again, and the change is made. Circumstances alter cases, but according to the sketch shown I do not see any other way to change this. With a rope long and strong enough and the thong latticed, or braided, back far enough, there should be no hitch at all.

FRED W. DAVIS

Garfield, Utah

The Influence of Drafts in Mine Explosions

Editor The Colliery Engineer:

SIR:—I have read the article by Messrs. Reynolds and Reynolds about "Stopping Ventilation at Firing Time" appearing in the April issue of *THE COLLIERY ENGINEER*. The gentlemen have generously designated me a leader of the Ventilation Reduction Party. Had they read carefully my articles regarding dust explosions that have appeared in the past in *MINES AND MINERALS* and other mining journals they probably would not have conferred that distinction on me.

I have stated repeatedly and plainly that local conditions must determine whether slowing down or stopping the fan at firing time is permissible or not, and at no time did I advocate the practice for general use. I indorsed the practice in Iowa because conditions permitted it and because I realized that it was based on a sound principle, namely, that combustion is retarded by draft restriction and is promoted by an increase in draft through the improvement of draft facilities of whatsoever kind. I have indorsed the method, not because I considered it a sure prevention of dust explosions, for I knew it was not, but mainly because through its advocacy I hoped to arouse a due appreciation of the dangerous properties of draft in a mine in connection with flame

and to hasten the realization of the truth that the magnitude of an explosion is measured by the availability of the air supply rather than the character and amount of the dust present, and if Messrs. Reynolds and Reynolds should see fit to confer upon me the title of leader in that direction I shall accept the honor with thanks.

From my own observations and the experience and experiments of others, I found that the presence or absence of draft largely determined the explosion or non-explosion of the dust. I found also plain and conclusive evidence that in order to produce a dust explosion in a mine the draft produced by the heat from a shot must be sufficiently strong and concentrated to pick up and carry the dust along to the flame. It becomes evident therefore that with the fan stopped and in the absence of natural draft the flame of a shot receives no outside assistance in its production of draft, and consequently there is an increased margin of safety; because a larger flame and one of longer duration would then be required to produce the necessary dust-laden draft toward the flame to make an explosion possible. There are many cases where stopping the fan at firing time may not be permissible, but that does not affect in any way the soundness of the principle involved. I do not object to the rejection of the practice, but I consider it a serious mistake to disregard the principle, known to be correct, because the method of its application may be objectionable under certain conditions.

In my judgment, the final solution of the dust-explosion problem will not be reached until there is a general and full understanding and recognition of the influence of draft in explosions, and I note with disappointment the recently expressed personal opinion by the chief mining engineer of the Bureau of Mines that the movement or non-movement of the air is of relatively small importance in the initiation of a

dust explosion. I am disappointed because the opinion appears to me to be an indication that we are moving away from the desired goal and not toward it. Thirty-five years ago Peckham and Peck proved that an increase in draft facilities apparently increased the explosion's force (*MINES AND MINERALS*, September issue, 1908) and they showed further that the presence of drafts produced explosion of the dust, and that in the absence of draft such explosion did not occur. Nothing has been developed in the last 35 years to permit us to question the correctness of the findings and conclusions of Professors Peckham and Peck. On page 116 of the Bureau of Mines' Bulletin 25, on the "Explosibility of Coal Dust," the results of experiments regarding the ignition of dust in the absence and presence of draft are given. It is stated there that with the most explosive dust in suspension and in contact with the flame no explosion resulted in the absence of draft; but when draft was supplied and the dust was blown into the flame, explosions resulted. The comment on the experiments is given as follows: "This shows the great importance which the method of introducing the dust can exercise on the character of the explosion." In view of this am I wrong in insisting that the important feature of draft influence should receive immediate and careful attention? Such proofs as the above and the many others that could be cited show that the movement or non-movement of the air is of paramount importance in the initiation of a dust explosion and that therefore the continued ignoring or minimizing of this fact must necessarily defer the solution of the explosion problem indefinitely.

In view of the fact that the fundamental principles governing the occurrence of dust explosions are apparently yet unknown, it seems unprofitable to discuss the merits of methods of prevention at this time. More than a year ago Mr. Rice, chief mining engineer of the

Bureau of Mines, stated that efforts were then being made at Bruceton to determine how and why coal dust explodes. Up to the present, so far as known, the matter has not been determined and it is evident that the value of proposed methods of prevention cannot be judged with intelligence and fairness until that important point is definitely settled.

JOHN VERNER

Chariton, Iowa

來 來

Relation of Engineers to Mine Foremen

At the March meeting of the Shamokin and Mount Carmel Mining Institute, John F. Bevan, engineer of the Philadelphia & Reading Coal and Iron Co., delivered an address on the subject "Mining Engineer, Mine Foreman, Assistant Mine Foreman, Their Relation to Each Other and Other Employes." The following is an abstract from his address:

The coal beds in this district are folded, with saddles and basins succeeding each other, and with the intervening strata varying in thickness and quality, thus making coal mining one of the most complicated of problems.

Years ago only one or two seams of coal were mined and so far as output was concerned, the one seam appeared to be inexhaustible.

The continued mining for the last 40 years has brought on conditions where careful thought must prevail in order to secure the best results. The engineer, with the maps showing developments from the infancy of mining, is in a measure able to pierce the undeveloped and anticipate the irregularities to be met. His maps reveal the possible future contour of the gangway; the opening of rooms; the proper precautions needed in connection with them; information as to the advisability of mining at specific points, and the various obstacles that are to be overcome.

The basis of the engineer's infor-

mation comes from the foremen who are in daily touch with actual developments.

In the entire anthracite field, there is no part more complicated or where the questions of openings, ventilation, and protection, are so vital as in the Shamokin and Mount Carmel field. Foremen schooled where mining conditions are so complex and showing a desire to learn more, cannot belong to any other than the best of their class in the business.

To the foreman and his assistants is entrusted the responsibility of protecting the mine and the mine workers, consequently their eyes are trained to note the defects in top or bottom where openings have been made; their ears are trained to hear and understand nature's warnings. To these responsibilities are added the executive duties of the colliery, which are in themselves no light burden to carry.

The work of the foreman can only be successfully accomplished by the aid and assistance of the mine engineer, and the latter is only of consequence in so far as he is able to assist the foreman. The knowledge gained by both is essential to the science of mining, and it is only valuable when both go hand in hand in the execution of the work. The exchange of ideas and knowledge makes each the wiser, and close business association between these two kinds of mining men will surprisingly advance the welfare of all.

The foreman securing knowledge from the engineer, learns to pierce the undeveloped, and in this he takes pride, when he is able to say this or that is the proper way of doing the work.

It has been my pleasure to instruct assistant foremen in sketching the territory under their supervision, thus enabling them to determine the best method of working. At first they thought this an imposition, and objections were raised by some of them. Those who thought otherwise were encour-

aged and the progress made was marvelous. Today some of these men are doing excellent work, and with all the labor involved would not discontinue it.

In intercourse, the foreman should remember that the engineer, unless informed, cannot know what is being done, and no other than the ordinary work of mining should be done without his advice, for the data at his command place him in a position where the wisdom or the fallacy of the proposition can be seen.

The engineer should carefully note the information given him and promptly advise to save time and labor. He should study the needs and demands of the mine and should reduce to a minimum by plans, advice, and suggestions, the moves made to accomplish a valuable end. He should remember that a useless move is wasted energy, for neither the operator nor the workman is the gainer.

The foreman should heed the advice of the engineer, and the plans submitted to him should be carried into execution as outlined. Any suggestions given by the engineer to rectify conditions should receive the careful consideration of the foreman, as the latter, being in daily touch with the work, may have some better plan to suggest.

While the greater part of the engineer's time should be devoted to underground matters, the wants of the outside foreman should also receive attention. His tracks should be laid with care, his trough lines on uniform grades, conditions at the breaker should be such as to obtain the best system of handling coal and supplying the cars.

The outside foreman's suggestions should receive immediate attention from the engineer.

While the present relations between the engineer and foreman are close, each should realize his part in mining, and his dependence on the other, so that with clasped hands and ideas they may accomplish greater things than they hitherto have done.

Hoisting Ropes

Causes of Loss of Strength—Proper Tensile Strength of Wire—Protection and Lubrication

By W. D. Lloyd*

In a paper before the Midland Institute of Engineers, England, W. D. Lloyd gave the following facts: The conclusions drawn

from a series of tests with worn wire ropes are that steel wire, however much it is fatigued by constant use, will hold its full load up to the moment when it parts, the only factors which appear to make any difference being actual loss of sectional area by friction or corrosion.

The main factor which determines the life of a winding rope is fatigue. The actual loss of strength caused by wear due to friction is usually comparatively slight, except perhaps in exceptional cases or with badly designed plant. Loss of strength by corrosion should not occur at the majority of pits if the ropes are properly lubricated from the day that they are put on. Fatigue is not caused altogether by the actual lifting of the weight, and imparting to it the required acceleration, but principally by vibration; this may be increased by numerous causes among which may be mentioned uneven coiling of the rope, flats on wooden-lagged drums, variations in the diameter of conical drums, uneven running of engines, valves hanging or sticking, vibrations of the cage due to the conductors (particularly where wooden guides are used), and last, but not least, want of care by the engineman in the handling of the engines. It should be remembered that vibration in a rope travels in waves, which must act in the same way as all other waves; that is, at any point where they are arrested they are reversed and travel back for a certain distance in the opposite direction. In a steel-wire rope, the points where the waves are reversed, and where they meet each other when traveling in opposite directions, are the points where the wire will be most quickly fatigued. This is the reason why a rope generally shows signs of wear in lengths between the pulley and the drum at the start of the wind, and between the rope socket and the pulley at the

end of the wind, particularly in the latter, because the waves of vibration of the rope in the shaft as the cage is brought to bank are in a rapidly decreasing length, which may be in some cases reduced at the end of the wind to about 7 feet.

As is well known, the best steel wire may be drawn until it is capable of withstanding a very high tensile strain, but the higher the breaking strain of the wire the less able it is to stand fatigue and bending. In making inquiry into the life of the winding ropes it was thought that the cause of the unsatisfactory working of some particular ropes might be partly due to the wire having been drawn to give too high a tensile strain. On looking into the matter, it was found that until the last few years, owing to the difficulty of obtaining accurate testing machines, the tests of wire used were unreliable; but the following figures for the last few ropes are interesting and confirm this opinion:

Year	Breaking Strain of Wire in Tons Per Square Inch	Torsions in 8 Inches
1904	110	
1905	113	28
1907	114	26
1909	118½	23

In conclusion the writer is of the opinion:

1. That neither the rope nor the socket that yields the best results in the testing machine will necessarily give the best results for actual work.

2. That, in order to obtain good results, even the best quality steel should not be drawn for winding purposes to more than 105 to 110 tons per square inch breaking strain; that wire of a diameter of .135 inch, No. 9½ standard wire gauge, is the very largest size that can be drawn satisfactorily to over 110 tons per square inch; and that better results and greater safety will be obtained by

using more wires of a slightly smaller diameter, made of the best material, but not drawn to over 105 to 110 tons per square inch,

even if the factor of safety is nominally decreased to 8 to 1, than to have the wire drawn to 115 to 120 tons per square inch in order to obtain a so-called factor of safety of 9 or 10 to 1.

3. That in testing fatigued ropes the tensile test is of little use, except that probably some information may be gained by observing the modulus of elasticity, as this decreases with fatigue; or, in other words, fatigued wire will generally give a short fracture, while new wire will show a certain amount of elongation at the point of fracture. Of the mechanical tests, bending will give some information when the rope is much fatigued, and is probably more reliable than the torsion test, which is often upset by the wires having lost their uniform section by wear, by corrosion, or by crushing. None of these tests will give any really useful information as to the load which a fatigued rope is fit to carry. By comparing properly prepared specimens of steel wire under the microscope, a practiced observer can detect signs of fatigue by the alteration in the structure of the steel; but it is doubtful whether such examination could be employed by a colliery manager in determining the safe life for a winding rope.

As regards rope sockets, the writer maintains that the old form of socket, though old fashioned, if properly put on, is still the safest; and that, in addition to resocketing ropes every 6 months, the rope ends cut off should be carefully taken to pieces and examined for corrosion and internal broken wires.

A thorough study of hoisting ropes has recently been published in *Glückauf*, which may be summarized as follows:

(1) The protective efficiency of lubrication has not been clearly proved except in dry shafts. This

suggests the conclusion that the present lubrication process for wet ropes leaves room for improvement, though it is certain that all known lubricating agents rapidly disintegrate in shafts with acid or salt water. Future experiments in this direction may provide a remedy. (2) Galvanizing or coating with zinc does not appear to have had a really protective efficiency in wet shafts, the reason being probably that zinc coating has but little power of resistance to salt water. It is also suggested that the wires have suffered by the galvanizing process, for, though it has been proved by Winter and others that that process, when properly and carefully executed, does not unfavorably affect the ropes, it is also well known that it often reduces the tensile strength of the rope by 50 per cent. and even more. (3) The efficiency of ropes in dry shafts stands in the proportion of 100 to 60 or 70 as compared to wet shafts, which, in view of the high prices of ropes, means a substantial economic advantage for dry shafts. (4) Tensile strength between 160 and 180 kilograms per square millimeter does not unfavorably affect the flexibility or hauling strength of the ropes, while ropes of more than 180 kilograms per square millimeter have given substantially lower efficiency figures. (5) The greater or less strain, as expressed by a higher or lower safety factor, put upon ropes has had no influence upon their efficiency. It may therefore be assumed that the advantages of a higher safety factor are neutralized by its disadvantages, namely, greater rope thickness combined with reduced flexibility and greater dead weight.

采 采

Units of Measure

Original, or "makeshift," methods of doing things can be seen and heard almost every day in the copper mines of upper Michigan. William was up in the stope at a freshly broken face, from which place he called Tom, standing on the level, "Tom, is there?" "Ase, ase wat do 'ee want?" "Go up top and fe'ch

down bit stull." "'Ow long of a stull do 'ee want?" "A middlin' long un." "Can't 'ee measure 'im?" William measured in his own fashion and called back, "Tom, the bit stull I wanted ha measures as long as a pick an' a pick 'andle, a gad an' a gad 'andle, taw bluddy wedges an' a big flat rock."—*Mines and Methods.*

采 采

Steam Pipe Hangers

A use which can be made of old scrap rails is that of supporting steam lines. There is a variety of

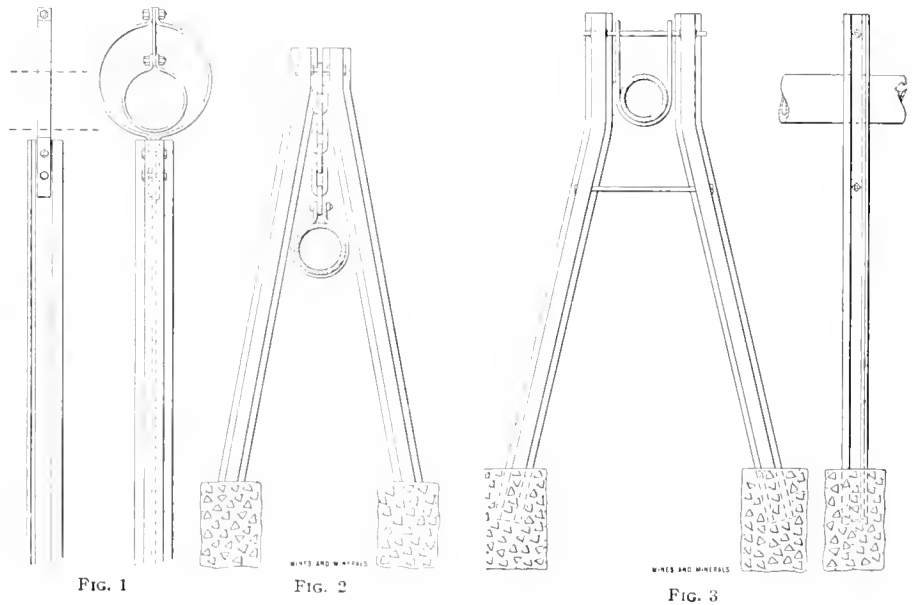

ways in which this may be done, a few of which are shown in the accompanying sketches.

The simplest form, where the steam line is not heavy, is shown in Fig. 1 where a rail is used as a single post. The rail may be merely set in concrete in the ground or may be placed in concrete so as to stand more firmly. At the top of the rail are placed two semicircular pieces of heavy strap iron with straightened ends, which clamp on each side of the web of the rail and are bolted through the web. At the other end, these pieces are bolted to a straight piece of iron which hangs down and is in turn bolted to the strap which passes around the steam line. In this way the steam line hangs in the circle made by the two semicircular

pieces and is thus allowed to move freely with the expansion and contraction.

Another pipe carrier, shown in Fig. 2, consists in making an A frame by bending two rails so that they will be parallel for a few inches at one end. The rails are bolted together at these ends. Sometimes a short piece of pipe is placed between the rails through which the bolt passes and against the ends of which the rails are tightened by the bolt. The steam line is then supported by means of a strap around the pipe and a chain or a bar of

iron, which is bolted to the strap and passes around the bolt holding the rails together.

A variation of this latter form can be made by bending a longer part of the end of the rails so that they will be parallel as in Fig. 3. Then the steam pipe is supported by an V-shaped piece of flat iron bored at each end so that the bolt holding the ends of the rails can pass through it.

The use of rails to support steam lines is common in the anthracite region of Pennsylvania where steam is carried sometimes for a distance of a mile through pipes supported in this manner. Any rails which are too poor for track purposes can be used as long as they have the requisite length.

PRIZE CONTEST

For the best answer to each of the following questions we will give any books on mining or the sciences related thereto, now in print, to the value of \$3.

For the second best answer, similar books to the value of \$2 will be given.

Both prizes for answers to the same questions will not be awarded to any one person.

1. The name and address in full of the contestant must be signed to each answer, and each answer must be on a separate paper.

2. Answers must be written in ink on one side of the paper only.

3. "Competition Contest" must be written on the envelope in which the answers are sent to us.

4. One person may compete in all the questions.

5. Our decision as to the merits of the answers shall be final.

6. Answers must be mailed to us not later than one month after publication of the question.

7. The publication of the answers and names of persons to whom the prizes are awarded shall be considered sufficient notification. Successful competitors are requested to notify us as soon as possible as to what books they want, and to mention the numbers of the questions when so doing.

8. In awarding prizes, other things being equal, a carefully written and arranged answer will be given the preference.

9. Employees of the publishers are not eligible to enter this contest.

Questions for Prizes

21. In a mine worked by room and pillar in the panel system, do you consider it good mining practice to work a proportion of the pillars along with the solid working? Give the reasons for your answer.

22. Working by room and pillar, what percentage of coal would you leave in the pillars at depths of 300, 500, and 700 feet, respectively?

23. A mule serves a panel of 12 rooms in 6-foot coal. The parting is 100 feet from the first room, and all loaded cars, holding 2 tons each, go to it. Assuming the length of the rooms to be 400 feet when worked out, that the rooms are 20 feet wide, and the pillars 30 feet wide, what distance will the mule travel to collect 160 tons of coal in 10 hours?

24. On a straight track in good condition, having 1-per-cent. grade, a mine locomotive can haul 14 times its weight. The haul is 4,000 feet, and the number of loaded cars to be hauled daily is 600 in an 8-hour shift. (1) How many cars should be in a trip, the total weight of car and coal being 4,200 pounds, and having a frictional resistance of $6\frac{1}{2}$ pounds per ton of 2,000 pounds? (2) What should be the weight of the locomotive? (3) The law allows a speed of 10 miles an hour, what speed will the locomotive require?

Answers for Which Prizes Have Been Awarded

QUES. 13.—*Horsepower of Engine.* Calculate the horsepower of an engine that is capable of hauling a trip of 15 cars, each weighing 1,200 pounds, and having a capacity of 3,000 pounds. The haulage road has a uniform grade of 1 per cent. against the load, and is 4,000 feet long. It is desired to get out 600 cars a day. Assume the coefficient of friction as $\frac{1}{40}$.

No answers to this question were correct, a very essential part being left out. The question is, therefore, left open for better answers than have so far been received.

QUES. 14.—*Tracks in Rooms.* What is the maximum pitch on which tracks can be laid in rooms and cars handled with safety? What methods are adopted for handling the coal in the rooms on steep pitches? Answer briefly.

ANS.—In rooms or chambers where animal power is used for the haulage, the answer to this part of the question is not so much the grade, but how long will the stock do the work without giving out. So it may be more economical to use some kind of mechanical haulage. In moderately thick seams, pitching more than 4 degrees and not more than 18 degrees, the rooms are usually driven across the pitch, securing a grade of track low enough to make easy the

haulage of mine cars to the face. Where the pitch does not exceed from 4 degrees to 8 degrees, rooms are turned off the entries or gangways at right angles, using animal power.

In some of the western and north-western states, rooms are turned off the entries at right angles where the pitch is from 8 degrees to 20 degrees, and the haulage is done with McGinties. The loaded cars going down pull the empty cars up the pitch by means of a rope, the sheave wheels being placed between the rooms, having a face sheave to run the rope around at the face. Another method is to use a rope around a small bell-mouth wheel, using some kind of a guard to keep the rope from flying off, and fastened to the motor which works on the entry on the same principle as the reel motor. Sometimes a mule will do this work. Loaded cars are at times let down easy grades by means of a rope which is given one or two turns around a prop at the face, thereby keeping the car under control unless the rope breaks.

I would not say this is the safest plan. In the mining parlance the term "steep" is supposed to mean dips or raises more than 30 degrees, because 30 degrees is about the limit on which rooms can be worked empty. From 35 degrees down to 25 degrees, coal will run by gravity, but not so violently as to require a battery or other obstruction to

prevent it from rushing on to the entry or gangway; pieces of planks at times are sufficient to control it. In one part of the eastern bituminous coal fields of Pennsylvania coal would run on a less pitch than is given here, provided it was dry; but as the second part of the question refers only to steep pitches, the miner must have something to stand on to perform his work. Where the coal is soft and the seam thin, so that the top may be propped, mining is sometimes done on platforms or planks, but where solid shooting is done at over 30 degrees, everything would be swept down and out on to the entry, so this is not practical. The breasts must, therefore, be kept full of coal to allow the miner to perform his work at the face and it also acts as a support for the roof. There being two rows of props about 3 or 4 feet from the ribs, they are clad with plank on the inside and used as a manway and as a travelingway to the face and for intake and return airways, the whole width between being kept full of loose coal. The manway is used to get up timber and is supplied with cleats across on one side to get up and down when the pitch is from 40 degrees to 60 degrees to the face. Coal is only drawn out by the loader as required to let the miner perform his work. At times these breasts become choked and where booming sticks are not used men known as starters must shoot the pieces which block the breast. At times starting can be done by hammering on the planks of the manway. This starting being very dangerous, only the most experienced men are used to perform this work, for at any time the loose coal may start and rush down the pitch. The coal is prevented from rushing on to the entry by means of a narrow chute, usually driven from 6 to 8 feet wide and 10 or 15 yards long, and rigged with a strong battery built of logs, through which the coal is drawn from the breast. In the Mammoth vein, in the anthracite region, where the coal is hard, these batteries are dispensed with, the chutes being driven very narrow, about 6 feet, one on

each side of the breast. A manway is taken up from the gangway to the pillar heading as a travelingway no larger than necessary to get up timber, and is closed by a trap door to maintain ventilation. After the pillar heading is open, the chute heading is used to store timber. The breast is 10 yards wide and 7 feet high. It is driven in the lower bench of the seam. The plan of chutes and batteries is varied to suit conditions due to the pitch, nature of the top coal, the quantity of gas likely to be met with, and the volume of air necessary for its removal.

M. J. RAFFERTY,
Ehrenfeld, Pa.

Second Prize, Joseph Zelinek, Box 227, Alba, Tex.

QUES. 15.—*Size of Airway.*—Are two airways 8 feet square equal to one airway 8 by 16 feet; and which will pass the most air and why, the pressure per unit of area being the same in both cases?

Ans.—Although the combined areas of the two 8'×8' airways are equal to the 8'×16' airway, they will not pass as large a volume of air per minute under the same pressure per square foot, assuming the length of all three airways to be the same. This is due to the rubbing surfaces in the two small airways being together more than the rubbing surface in the large airway for a unit of length.

Applying Newton's law, that for a body at rest or in a state of uniform motion, action and reaction are equal and opposite, then at any point in the airways the pressure on the air column is equal and opposite to the resistance offered by its passage. This resistance or friction varies as the area of the rubbing surface and the square of the velocity, or $R = k s v^2$, in which R is the total resistance; k , the coefficient of friction, or unit resistance of the walls of the airway to the movement of air; s , the area of rubbing surface; and v , the velocity of the air-current.

Let p = the pressure of air per square foot and P the total pressure, then $P = p a$, in which equation

a represents the area of the airway. Then, by Newton's law,

$$P = R \text{ or } p a = k s v^2 \quad (1)$$

As the pressure per square foot is the same in both cases, the velocity must be greater in the large area if it passes more air in a given time. Let v_1 = the velocity in the small airways and v_2 the velocity in the large airway, then by substituting the numerical values in equation (1),

$$2 (8 \times 8) p = 2 (4 \times 8) k v_1^2 \quad (2)$$

$$(8 \times 16) p = 64 k v_2^2 \quad (3)$$

Solving equations (2) and (3) simultaneously

$$v_1^2 = 48 \text{ or } v_1 = \sqrt{48} \text{ and } v_2 = 1.1547 v_1^2 = 64$$

This proves that the velocity of the air is greater in the large airway; and since the quantity of air passing a given point in a minute is equal to the area of the cross-section of the airway multiplied by the velocity in feet per minute, the relative quantities of air passing the airways may be found as follows:

Let Q_1 and Q_2 represent the cubic feet of air passing through the airways having velocities corresponding to v_1 and v_2 , then,

$$Q_1 = a_1 v_1 = 2 \times 64 v_1 = 128 v_1$$

$$Q_2 = a_2 v_2 = 128 v_2 = 128 \times 1.1547 v_1, \text{ or}$$

$$\frac{Q_1}{Q_2} = \frac{v_1}{1.1547 v_1} = Q_2 = 1.1547 Q_1$$

which proves that an 8'×16' airway will pass 1.1547 times as much air as two 8'×8' airways of the same length when the pressure per square foot and lengths of all airways are the same.

DANIEL B. GREGG.

Golden, Colo.

Second Prize, R. S. Cothran, Wrights, Calif.

QUES. 16.—*Standing Props.*—How would you stand a prop in a seam of coal 6 feet thick, which has from 1 foot to 2 feet of slate above it (1) when the seam is flat; (2) when the seam pitches 30 degrees; (3) when the seam pitches 70 degrees? Give details and reasons for your answer.

There were numerous answers to this question, all of which lacked one or more of the essential details to make them correct. This question is therefore left open for another set of answers.

BRITISH Columbia—

A meeting of the Western Branch of the Canadian Mining Institute was held on March 4

and 5, at Nanaimo, B. C. Thomas Graham, Chief Inspector of Mines, acted as chairman in the absence of M. E. Purcell, chairman of the Western Branch. Thomas Stockett, general manager of the Western Fuel Co., made the address of welcome, and spoke of the coal mining district of which the city of Nanaimo was the commercial center. Coal mined in this district is bituminous and occurs in the Upper Cretaceous, which is locally called the Cowichan group. The area is extensive and the total tonnage of coal is very large. The coal from the mines is loaded into barges and shipped into various Puget Sound ports, and a considerable portion of it is shipped to San Francisco.

Mr. Stockett, in his address, stated that the No. 1 mine has been shipping continuously for the past 30 years and was good for another 30 years at the present rate of production. Following Mr. Stockett's address, Mr. Geo. Watkin Evans, of Seattle, read a brief paper on the coal field of northern British Columbia, known as the Ground Hog anthracite field. Mr. Evans' paper covered the geology and also the commercial value of the field. He said that some men in discussing the field recently in the public press had compared it with the famous anthracite fields of Pennsylvania, and at the same time mentioned that their estimate of the tonnage in the Ground Hog field was 200,000,000. Mr. Evans called attention to the fact that the Pennsylvania anthracite fields had originally 21,000,000,000 tons, and he wondered where there was any grounds for the comparison. He stated that at present it was impossible to estimate with any accuracy the tonnage of the Ground Hog field. In portions of the field where the geology had been worked in detail, the tonnage could be reasonably guessed at,

Notes on Mines and Mining

Reports on Conditions and Other Matters of Interest in Various
Coal Fields

By Special Correspondents

but for the entire field it was at present a waste of time to give tonnage estimates. He discussed the quality of the coal and also called attention to the severe folding and faulting in some portions of the field. In conclusion he stated that he did not consider the British Columbia field in the same class as the Pennsylvania field, either in quality of coal or probable mining costs. He did believe, however, that in the Skeena, Nass, and Clappan watersheds there would probably be found coal enough to warrant a railroad being built into the district, and that there would be found a sufficient market for a reasonable amount of this grade of coal. He regarded the field as a very valuable asset to the province of British Columbia, one that should be exploited along sane lines, and not be bolstered up by wild and extravagant statements. Some portions of the field looked favorable while other portions were absolutely valueless.

An interesting and valuable paper was read by Mr. E. Jacobs, secretary of the Western Branch, on the "Methods of Mining Coal Under Various Conditions." This paper was prepared by Mr. Alexander Sharpe, who was ill and unable to be present.

The evening session opened with an address by Mayor Shaw, after which a very instructive paper was read by Mr. Henry Clark, of Victoria, the Canadian representative of a well-known English firm, the designers and builders of head-frames and other equipment for modern coal mines. Mr. Clark showed on the slides photographs of head-frames built in Japan, South Africa, Wales, and England. He described each type of head-frame and equipment, and also called attention to correct and incorrect design.

The morning of the second day of the session was devoted to visiting

the Reserve mine, which is being opened by the Western Fuel Co. This shaft was then down over 900 feet and expected to

reach the coal by the end of March. When equipped and in operation this shaft will hoist 1,500 gross tons in 9 hours, and will be modern in every way. Mr. Matthew Guinness, of Nanaimo, who has taken active part in mine rescue work, read a paper on "How to Prevent Mine Accidents."

NORTHWESTERN CANADA

The Canmore Navigation Coal Co., Ltd., whose head offices are at 11 Victoria Street, London, E. C., England, is opening a coal area of about 1,300 acres adjoining the property of the Canmore Coal Co., at Canmore, Alberta. Mr. W. H. Wain, 41 The Parade, Cardiff, Wales, is the consulting engineer for this concern. The field work is in charge of Mr. Geo. H. Burd, who is now at Canmore directing the exploration and development. There are a series of veins on the property dipping about 30 degrees to the west. The coal is a steam coal of the following composition:

PROXIMATE ANALYSIS		Per Cent.
Fixed carbon	81.96
Volatile matter	14.71
Ash	1.90
Moisture	1.43
ULTIMATE ANALYSIS		Per Cent.
Carbon	87.33
Hydrogen	4.17
Oxygen and nitrogen	5.42
Sulphur	1.18
Ash	1.90
Specific gravity, 1.34.		
Heating value, 8,292 calories.		

The installation of a plant for an output of 1,000 tons a day is planned, and a railroad about 1½ miles long to connect with the main line of the Canadian Pacific Railway.

The MacCullough and McGillis Land Co., of Calgary, Alberta, is preparing to open up an area of about 160 acres at Threehills, Alberta, on the main line of the Grand Trunk Pacific Railway from Calgary to Edmonton. It is proposed to install a plant with an output of 250 tons a day. The coal at this point is about 200 feet below the surface. The seam lies horizontal and is a

little over 4 feet thick. This coal has a composition as follows: As mined, moisture, 12.43; volatile, 30.75; fixed carbon, 47.35; ash, 9.47; sulphur, .56; British thermal units, 10,066. Dry, volatile, 35.11; fixed carbon, 54.07; ash, 10.83; sulphur, .64; British thermal units, 11,493.

An interesting case is to be tried involving the right of way of railroads over coal lands. The Canadian Northern Railway right of way passes over some coal property of Robert Jackson, at Nevis, Alberta. The seam at this point lies but 20 feet below the surface and the railroad company contends that having paid for the surface rights they are not obliged to pay for coal under their right of way. As a general rule this might hold, but in the present case the attorneys, with the writer as consulting engineer, assert that inasmuch as the property is an ideal one for quarrying by steam shovels, the railway has no right to obstruct this, the cheapest method of mining the coal. The coal mining regulations lease coal lands entirely separate from the surface rights, under a payment of \$1 per acre per year and a royalty of 5 cents per ton mined.

The city of Calgary, during the coal strike of 1911 and 1912, went into the coal business, securing \$122,119 worth of coal from United States mines mostly, a total of about 29,646 tons. The freight on this amounted to \$182,305. The total sales to date have amounted to \$194,491. The city is out about \$90,000 so far, and has on hand about 1,400 tons, which it is selling with much difficulty. There is considerable sentiment here in favor of the city owning and operating its own mines and this may eventually be done.

The provincial legislature of Alberta, at the session just now ended, has passed a new mines act.

The output of coal of Alberta for the year 1912 amounted to 3,500,000 tons. About 7,000 persons were employed in 1912 in the coal industry, and there are about 246 mines in operation in the province. Large dis-

coveries of coal have recently been made in the Brazeau district of Alberta. This field will be developed very fast.

The government is considering the establishment of mine rescue stations in various parts of the province. They aim to educate the mining public in the operation of apparatus for the saving of life and the protection of property. A car has been placed at their disposal for this work by the Canadian Pacific Railway, and with trained men and modern methods it can be rushed to the place of an accident.

J. H. S.

ILLINOIS

The miners employed at the Henrietta mine, Edwardsville, Ill., entered the mine at midnight and stripped it, taking out the piping, the mules, coal cars, and even taking up the track. When the company failed to meet the pay roll, the men ran an attachment on the property.

INDIANA

Shot Firers' Bill.—The Indiana Senate refused to pass the shot firers' bill which had passed the House almost without opposition. The coal operators paid no attention to the bill while in the House. In the Senate they had very little difficulty convincing the members that the bill was unfair and that the majority of the miners themselves did not care for it. The legislature adjourned before any bill was enacted that had serious bearings upon the coal industry in Indiana.

Senator Kolsem, of Terre Haute, Ind., introduced a bill in the Indiana Legislature, the object of which was to safeguard the coal miners. Governor Ralston signed this bill which has reference to the number of men who shall work in any mine not having two shafts; and requires that the roads between the two outlets of any mine shall be separated by at least 200 feet of strata; that it is unlawful to erect any inflammable structure or building nearer than 35 feet from the mouth of a mine opening; that the ventilating fan shall not be located directly over

the air-shaft, and all fans hereafter installed shall be arranged so as to enable the operator, when desirable, to reverse the air-current.

KANSAS

With two exceptions, all of the coal mines in the state of Kansas have filed declarations with Charles H. Sessions, Secretary of State, that they will agree to the provisions of the Workmen's Compensation law. The exceptions are The Central Coal and Coke Co. and the Cherokee-Pittsburg Coal and Mining Co.

KENTUCKY

The Pond Creek Coal Co. has just issued its annual report for the year ending December, 1912. The company was organized November, 1911, and owns approximately 31,000 acres of coal lands and surface rights. On March 11, 1912, the first mine opening was begun and at present there are seven mine openings. The highest daily capacity of any mine up to date is 200 tons. The properties are in Pike County, Ky., about 10 miles from Williamson, W. Va. The Norfolk & Western Railroad began the construction of a coal road to Pond Creek from Williamson in May, 1912. This road reached the first mine opening November, 1912. The first shipment of coal was made on that date. During the month of November 11,902 tons of coal were shipped; in December, 24,119 tons; in January, 1913, 35,142 tons; in February, 28,313. The coal shipped was the result of development work, the mines not being, as yet, on an operating basis. During the year 1912, 310 dwelling houses and machine shops, blacksmith shops, and temporary buildings were built and mine equipment was purchased. The power plant is sufficiently advanced to permit the mines to be operated to some extent by electric power. The coal is from 5 to 7 feet in thickness. During the coming year the shipments from the mines will be materially increased, and it is expected that eventually they will reach 10,000 tons a day.

MONTANA

In 1912 there were 3,598 men and boys employed in and around the coal mines in Montana. In this year 10 fatal accidents occurred, or 2.78 per thousand employed; in 1911, the fatal accidents amounted to 3.44 per thousand employed. There were 66,889 tons of coal mined for each death. The total number of tons mined during the year was 6,057,186. Fifty per cent. of the accidents were due to falling roof; 20 per cent. to moving cars and motors; powder blasting caused 20 per cent. of the deaths; 10 per cent. were said to be due to carbon monoxide.

Among the recommendations made for the good of the industry in Montana by Joseph B. McDermott, inspector, are found the following:

Examination of miners and superintendents, managers, and operators having anything to do with the operation of coal mines.

Two grades of certificates for mine foremen; one grade of certificate for fire boss.

To empower examining boards with the right to revoke certificates for drunkenness or inattention to duty.

To cut out all shooting during working hours when men are in the mines.

To drive at least two entries parallel, and make breakthroughs every 60 feet; escape roads to entries to be made from 1,500 to 2,000 feet apart, or refuge rooms with bore holes to the surface. The refuge rooms to be properly equipped with iron doors and provisioned, with communication facilities installed between refuge room and the surface.

All stoppings, either main or cross-section, to be made of brick, blocks, masonry, or concrete, or any non-perishable material.

NEVADA

A newspaper report states that the Nevada Coal and Fuel Co., at Coal-dale, Nev., is shipping coal of good quality. This company secured United States patent for a large area of coal lands and has done considerable development work, going to a depth of 150 feet on a 500-foot slope.

At this depth there was a down throw of 30 feet, and then a 7-foot bed of good coal was picked up.

NOVA SCOTIA

The Inverness Railway and Coal Co., of Inverness, Cape Breton Island, Nova Scotia, has ordered a duplex engine whose cylinders are 34 in. \times 72 in., and each of the two drums can be operated independently of the other. The load which the hoist is to lift consists of a train of 12 cars, each weighing 1,150 pounds, and containing 2,240 pounds of coal. This load must be pulled up a 10,000-foot incline which varies in slope from 16 degrees at the surface to 35 degrees at the bottom. The stress produced in the hoisting rope by this load is approximately 41,000 pounds, and this, together with the length of the cable, is the feature which makes the hoist probably the largest ever constructed for coal mining.

OKLAHOMA

The Oklahoma legislature passed a law requiring that coal be undermined at least 6 inches beyond length of drill hole before being shot. The law will be effective April 1, 1914, at which time the present contract between miners and coal operators will end. At present the coal is shot from the solid and miners are paid on the mine-run basis.

PENNSYLVANIA

Governor John K. Tener has re-appointed James E. Roderick Chief of Department of Mines for Pennsylvania.

Seven miners in Indiana County, Pa., were arrested on the charge of violating the bituminous mine law, and were fined \$1 and costs. The violation consisted of negligence in placing sprags under coal when undermining it, and failure to carefully inspect mine roofs after blasts.

To encourage their employes to keep their premises clean and attractive, the Berwind-White Coal Mining Co. proposes to award three prizes to the tenants of the company who have the best and neatest looking place between April 1 and December 1, 1913. The first prize will be \$25; the second \$15; and the third, \$10.

The Connellsville coke production of the first quarter of 1913 was more than the best previous records, as shown by the following tabulation:

First Qr.	Production	Shipments
1913.....	5,350,365	5,304,017
1912.....	4,909,709	4,855,033
1911.....	4,242,574	4,174,220
1910.....	3,526,521	5,662,145
1909.....	3,381,070	3,534,651
1908.....	2,128,608	2,393,591
1907.....	5,322,013	5,025,600

WEST VIRGINIA

The Consolidation Coal Co.'s report indicates a prosperous year. After all deductions, including 6 per cent. dividend on the stock, amounting to \$1,358,865, the balance to profit and loss was \$1,144,492. The net production of coal was 10,347,100 tons, an increase of 1,127,369 tons over the preceding year. President Jerre H. Wheelwright informed the stockholders that the Louisville & Nashville had ordered 3,000 steel railroad cars, and the Baltimore & Ohio 2,000 steel cars to take care of the company's Elkhorn field, of Kentucky. Considering that these companies together spent about \$40,000,000 since April, 1911, to reach this field, they are bound to furnish transportation at reasonable rates to this company.

The Pocahontas Consolidated Collieries Co.'s report for the year 1912 is as follows: Total income, \$1,246,166; net earnings, \$916,459; surplus after charges, \$491,858; preferred dividends, \$164,451; common dividends, \$180,800; surplus, \$146,607; total surplus, \$2,233,360. Semi-annual dividend of 2 per cent. and extra dividend of 1 per cent. were declared. Old directors were re-elected and one change in the executive office was the election of George W. Woodruff as secretary in place of J. Walter Graybeal, who becomes assistant secretary.

According to the annual report, the properties of the Island Creek Coal Co., Holden, W. Va., were operated continuously during the year 1912, and produced 2,039,837 tons. Net capital expenditures for the year amounted to \$534,522.44. During the year 126 houses were constructed, 38 houses were completed, a new

hospital and its equipment installed, new store buildings at mines 7 and 8, and a Catholic church and parsonage were erected, besides new mine equipment including twelve 6-ton locomotives, two 15-ton locomotives, and mine machines, mine cars, etc., were purchased. The expenditures also include payments on account of dock at Superior, Wis., and construction and equipment of a new dock at Duluth, Minn. On August 1, 1912, the first dividend was paid upon the company's stock, at the rate of \$2 per share, also an extra dividend of \$3 per share. At the same time an opportunity was given the stockholders to reinvest the \$3 paid in the company stock at \$50 per share. Notwithstanding the large net expenditures at Duluth and elsewhere, the net quick assets of the company remain substantially intact.

The annual shipment sheet of the Pocahontas Flat Top coal field for 1912, published by the Crozer Land Association, Elkhorn, W. Va., shows an increase of 2,207,204 tons in coal shipments and a decrease of 10,584 tons in coke shipments. The total quantity of coal shipped from this field since 1883 is 127,555,046 tons, and the total coke 25,505,573 tons. With the exceptions of the years 1895, 1896, 1897, 1901, and 1908, this field has increased its output of coal. The coke output has gradually decreased since 1909, owing to the United States Coal and Coke Co., which made 721,000 tons of coke in 1909, making but 54,000 in 1912. Eliminating this company, there has been but a slight decrease in coke production in the last 10 years.

The Dixon-Pocahontas coal properties in McDowell County, W. Va., are stated to have been sold to the Lake Superior Corporation, which owns the Cannelton coal properties in the Kanawha field. The sale covers 2,500 acres of Pocahontas coal. The price paid for this land is said to be \$500,000. At present there are two mines on the property and a third will be added. The Lake Superior Corporation manufactures iron and steel in the vicinity of Sault Ste. Marie, Canada.

Discipline in Mining

Samuel J. Jennings, mine inspector, of Pittston, Pa., delivered an address to members of the Pittston Mining Institute in which he pointed out the numerous chances for accidents in anthracite mines. To avoid confusion he took one district with which he was familiar and which furnished the following statistics:

In one of the anthracite districts with which I am familiar, the proportion of fatal accidents for the year 1911 is as follows:

	<i>Per Cent.</i>
Falls of roof and coal	59.53
Cars	21.43
Powder and dynamite	14.28

These three causes claimed 95.24 per cent. of all fatal accidents in the district. The non-fatal accidents were of the following proportions:

	<i>Per Cent.</i>
Falls of roof and coal	48.57
Cars	20.00
Powder and dynamite	14.28

The same three causes claimed 82.85 per cent. of the non-fatal accidents. For the year 1912 just closed the proportion of fatal accidents is as follows:

	<i>Per Cent.</i>
Falls of roof and coal	59.53
Cars	14.29
Powder and dynamite	25.00

The three causes claimed 92.86 per cent. of all the fatal accidents in the district during the past year. The non-fatal accidents were of the following proportions:

	<i>Per Cent.</i>
Falls of roof and coal	48.74
Cars	30.00
Powder and dynamite	10.26

The three causes claimed 89 per cent. of all the non-fatal accidents during the year. It is a fact worth observing that only two deaths occurred in the district during the year from other causes than those just mentioned.

Owing to the length of his address only an abstract can be given:

From such records it is plain what class of accidents are most liable to occur and therefore should be made the center of strict discipline. The mine worker places implicit faith in the report of the fire boss, but he should also examine his working place before commencing work. During the mining day, conditions at the face are changing; after each shot gas may be released in dangerous quantities,

also roof and sides may have developed conditions that are unsafe unless rectified by prompt timbering.

In the district mentioned 1,414,322 pounds of dynamite and 2,704,300 pounds of powder were used in 1 year. There are 2,800 miners, each of whom on an average fires five shots, or 14,000 shots daily. The serious accidents from explosives occur in a number of the following ways:

The illegal use of a combination of explosives together with a detonator when firing a hole.

Using a needle, for the purpose of saving fuse.

The firing of holes with a short piece of fuse which is lighted before being pushed back into the hole.

Firing with a detonator and common squib.

Tampering with and shortening squibs, to save time.

Failing to give proper warning when firing.

Careless handling of explosives and detonators.

Storing explosives in too large quantities in the mine.

Storing several kinds of explosives in large quantities with detonators in the same box with the tools.

Allowing as many as five or six tool boxes containing explosives in the same small space or cross-heading.

Spreading dynamite on the floor in a cross-heading where persons travel, for the purpose of thawing it.

Approaching, opening, and removing powder from box with lighted lamp on cap, and often with lighted cigarette or pipe in mouth.

Making up charge of powder near lighted lamp.

Storing powder and dynamite along the roadways and chambers, because of not having a box to keep it in according to law.

Carrying detonators in squib boxes with squibs in side pocket at thigh.

Reopening a hole that misfired containing a detonator and mixed powders.

Thawing dynamite with the use of a lighted mine lamp.

Playfully exploding detonator to hear report.

Cleaning out blasting barrel with squib when powder was exposed.

Allowing laborer to use dynamite.

Allowing powder to be carelessly transported inside the mine in cars.

Carrying dynamite on the person for the purpose of thawing it.

Going back to the face after firing a shot with naked light when forbidden to do so.

In the district 7,000 mine cars move along the gangways and into rooms, some of them showing several times a day at the surface. The haulways may become crowded along the sides with material and refuse and so increase the dangers from passing cars.

Persons often ride between the cars and on loaded cars on slopes, all of which is against law and tends to increase the number of accidents. Records of these accidents are as follows:

Allowing gobs too close to roads on haulageways.

Allowing sides of haulageways to become close by allowing an accumulation of refuse.

Riding between cars on haulageways.

Riding upon loaded cars on slopes and planes.

Walking out on slopes and traveling upon them when trips are being hoisted.

Traveling upon slopes instead of using traveling ways.

Sitting upon front bumper of car in motion with foot on rail.

To enforce discipline and familiarize all mine workers with what they must and must not do, is a question too serious to pass over without suggestions. First, the miner must study the mine laws, and then a system must be evolved whereby detection of misdeeds would be sure. When once discovered, the offender should be taught just what the extent of such actions would mean to him if he should continue in the practice.

We are much too sympathetic in dealing with questions of punishment for minor offences. It is on account of these minor actions that most men become the victims of

serious or even fatal accidents. There ought to be an existing influence in every mine which would make each man think of the safety of every other man in the mine. There may be a time when an employe, going to his work or even when he is at work, may observe another employe violating the rules and in doing so he is liable to become injured.

Men in some occupations may frequently become so accustomed to doing certain things every day, that they grow away from the idea that danger may accompany their acts. In many instances dangerous practices increase in magnitude at the time when men become familiar with dangerous conditions to such an extent that the danger is lost sight of. In other words, dangerous practices are multiplied and more risks are taken because of the success which they have experienced in taking former risks.

OBITUARY

ALEXANDER FULTON

Alexander Fulton, who died at his residence in Shamokin, Pa., on April 15, was for many years prominently identified with the anthracite mining interests of the Shamokin region as a superintendent and successful operator, until the collieries he was interested in were acquired by the Philadelphia & Reading Coal and Iron Co., nearly 25 years ago. Since that time he lived a retired life in Shamokin where he was regarded as one of the most respected citizens.

He was born at Hamilton, near Glasgow, Scotland, on May 9, 1829. In 1848 he came to America with his parents and settled in Schuylkill County, Pa., and began work in the mines. Shortly after locating in this country as a young man, Mr. Fulton became acquainted with the late Hon. William Connell, of Scranton, Pa., and Andrew Robertson, of Pottsville, Pa., two young men in the same walk of life, who had come to America about the same time.

All three remained intimate personal friends until the death of Mr. Connell made the first break in the trio of self-made men, who through their later strong financial positions and high characters were for years leading individual anthracite operators and most prominent citizens of their several communities.

Mr. Fulton was a man of strong physique, and in his younger days was exceedingly active. For a time, in early life, he worked as a miner in western ore mines, and though of a kindly disposition he was a leader in the sports of the camp, and had quite a reputation in friendly fistic bouts. At this time he became acquainted with the late Samuel L. Clemens (Mark Twain).

When Mr. Clemens wrote his "Roughing It" in which is the very humorous account of "Buck Fanshaw's Funeral," he used, and of course exaggerated, Mr. Fulton's old time personality as the original of the character "Scotty Briggs."

Many years ago Mr. Fulton connected himself with the Presbyterian Church, and for nearly or quite 50 years he was a Ruling Elder of the First Presbyterian Church, of Shamokin.

STEPHEN R. KROM

Stephen R. Krom, the originator of the belted high-speed type of crushing rolls, died at his home in Plainfield, N. J., March 21, 1913. To Stephen Krom belongs the credit of being the pioneer in introducing the belted high-speed roll which had its origin and development in this country. This notable contribution to ore dressing consisted in the use of single bedplate supporting the roll shafts, and to which levers holding the movable roll bearings were pivoted. He also made use of steel tension rods to support the crushing strains, and of hammered steel tires for the crushing surfaces.

He was a member at various times of the American Institute of Mining Engineers, the Institute of Mechanical Engineers, and a life member of the American Institute.

ANSWERS TO EXAMINATION QUESTIONS

Questions Asked at the Examination for Fire Bosses and Mine Foremen, Held in West Virginia, 1912

(Continued from April Issue)

QUES. 7.—What dangers arise in dusty mines from the blasting of coal and the lack of judgment in placing holes in blasting in mines? Would you consider it safe to permit blasting to be done in mines generating explosive gases? If so, what per cent. of gas would you consider safe and under what restrictions would you permit blasting?

Ans.—All explosives used in mines give off more or less flame when ignited. Similarly, the dusts of all bituminous coals, especially when in a finely divided state and dry, give off more or less gas when subject even to a low degree of heat. This may be supplied by that of burning or exploding powder, and if sufficiently great and long continued may distil off so much gas from the coal that its rapid burning in the confined passages of a mine will result in what is known as a dust explosion. The amount of flame given off by the exploding powder will depend largely upon its composition and upon the way it is used. The smallest amount of flame and of the shortest duration is given off by the so-called permissible, or safety, powders tested and approved by the United States Bureau of Mines, and the longest and most enduring flame results from the ordinary black powder. A properly balanced shot, that is, one that is so placed and charged that the powder in it is just sufficient to do the work of bringing down the coal, will be more nearly flameless than an ill-placed or overcharged one. Even if the hole is properly charged, if it is placed near a crack, crevice, or joint, the gas will expand into this opening and will

burn with a large amount of flame, often sufficient to ignite and explode the fine dust always present in a coal mine. The danger is much greater if the shot is too tight and is so placed that the powder in it cannot bring down the coal. In this case a blown-out shot will result, and any dust in the place will be stirred up and thrown into the air. In this condition the possibilities of an explosion are greater because, being separate and distinct, each grain of dust is surrounded by flame and naturally gives off the greatest amount of gas in the least time.

Even in the best of mines, shot firing is always a dangerous operation, so that it may be said that blasting in gaseous mines is not absolutely safe under any circumstances. However, by proper precautions, the danger may be reduced to a minimum.

The percentage of gas in which shot firing may be carried on depends upon many things, the chief of which is the presence or absence of the finely powdered dry and explosive dust, so common in the mines of West Virginia. If explosive dust is not present (something that is practically impossible), or if the mine is so wet throughout that the dust is in the state of mud, if permissible, short-flamed powder is used, and if the holes are properly placed and properly charged, there is no theoretical reason why shot firing should not be safe(?) until the proportion of gas reaches the burning point of 1 of gas to 17 of air, or about 5.5 per cent.

On the other hand, as explosive dust is always present, theoretical conclusions are of little practical value, and only actual experience is a

guide as to the percentage of gas in which shot firing may be safely undertaken when dry dust is found in the workings. Our knowledge of what proportionate mixtures of gas and dust are dangerous is not definite and certain; in fact, it is only of recent years that any information upon this subject has become obtainable. In the light of our present knowledge in dry and dusty mines generating explosive gas the proportion of such gas in the return air-current should be kept well below 1 per cent. by increasing the volume of fresh air supplied to the workings. One per cent. is the limit allowed by several of the large companies under the conditions prevailing at their mines. But, since the explosibility of dust varies with the seam and since the seams vary in different localities, this may be too high under some conditions and comparatively a safe amount under others.

In addition, then, to keeping the proportion of gas at 1 per cent. or below, care should be taken to prevent the formation of dust and to render harmless that which is unavoidably formed. The amount of dust made may be materially reduced by abolishing shooting off the solid, that is, by requiring the seam to be undercut or sheared by pick or machine before it is shot down, by properly placing the holes, and by using in them the proper amount of powder, and by using tight cars which do not leak and allow the fine coal and even lumps to fall on the roadway, where it is soon ground into powder by the feet of passing men and mules. All dust made in mining operations should be loaded out and

taken from the mine; the headings, the roof and ribs, as well as the floor, should be thoroughly watered, so that the dust may not be blown about through the workings and may be at the same time so wet that it will not burn; the rooms should be wet down a distance of from 60 to 80 feet back from the face, and short-flamed powder with unflammable clay tamping should be used in the holes, which should be fired after the men have left the mine either by practical, experienced shot firers, or by electricity. See also the answer to Ques. 6 in the April issue.

QUES. 8.—If you had a large quantity of explosive gas in a gob or worked-out part of a mine that is being carried into another part of the mine where men are working, state how you would control your air-current so that these men would be safe, and if you found it impossible to keep this gob clear of gas, how would you take care of it to make the mine safe? Show this by a sketch as well as by writing.

ANS.—Such accumulations of gas should be removed by a separate split of air when it is possible to do so, as shown in Fig. 1. In this case a common condition has been assumed, one in which a number of rooms near the mouth of the entry have been worked out and have had their pillars drawn back to the entry stumps and beyond which are a number of rooms being worked. Airtight concrete stoppings are built in the breakthroughs *f* and *g*, between the new work and the old, and similar stoppings are built at the mouths of the abandoned rooms *d*, *c*, and *b*, along the heading. An overcast is built at *d* connecting the old work directly with the return and a regulator placed at *a* to adjust the amount of air entering the gob, which is thus ventilated by a separate and distinct split, none of the gas in it entering the new workings beyond *d*. After the room *h* is worked out it may be used as a return for the air from the gob by building the overcast at its mouth, by building brattices in the cross-cuts between it and room *k*, and by tearing down the brattice at *f*

or any brattice in by *f*. By this means the air will be carried nearer the face of the old workings and their ventilation be more thorough. In some cases, if the gob is packed so tight that air cannot be drawn or forced through it, bore holes may be sunk from the surface, and the gas conducted to daylight through them. Finally, no attempt may be made to remove the gas from the old works either through pipes from the surface or by a separate split of the ven-

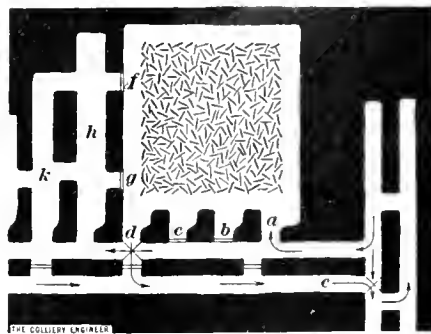

FIG. 1

tilating current. In this case, airtight stoppings are built at *a*, *b*, *c*, *d*, *g*, and *f*, and a large pipe is placed at *d* connecting the gob with the return. Through this pipe the gas from the abandoned workings slowly passes into the return as it is generated.

QUES. 9.—Under what conditions would the use of open lights be safe in gaseous mines, and under what conditions would you forbid the use of open lights in such mines?

ANS.—The answer to this question depends upon whether the mine is gaseous throughout or only in part. If the mine is ventilated by a number of splits in some of which no gas is found, in such splits open lights may be safely used, as there is no way in which gas can be drawn in upon them. The use of open lights should be prohibited in those splits where gas is found in dangerous quantities, and what is a dangerous amount of gas depends in some measure, as explained in the answer to Ques. 7, upon the amount, nature, and dryness of the coal dust present. Even if gas is not found in a particular split, if it is being driven

toward old workings known or supposed to contain gas and which may be tapped unexpectedly, open lights should be forbidden.

This is the common practice, to allow open lights in those splits where gas is not found and to prohibit their use in those splits where gas is found; but common prudence would indicate that safety lamps should be used in all parts of a mine, if explosive gas is found in any part, as it is always possible that a supposedly non-gaseous split may suddenly become a gaseous one. Portable electric lamps for miner's use are now so low in first cost, so low in cost of upkeep and repairs, are so clean, give so good a light and are so eminently safe in explosive mixtures of gas and dust, that their use cannot be too highly recommended under any and all conditions.

QUES. 10.—Why should the circulation of air in mines be maintained continuously, and not during the day only? What special requirements do you consider should be observed in the erection of a ventilating furnace or a ventilating fan? In event of an explosion destroying your ventilating apparatus, state what temporary measures you could take to restore ventilation to permit a rescuing party to enter the mines to recover the injured or dead.

ANS.—Explosive and poisonous gases, if given off at all, are generated as freely by night as by day. When the fan is not running, these gases accumulate in the workings and more or less time is required after the fan is started to restore the mine air to its normal condition. From this it follows that if the fan is shut down over night and only started up a short time before work begins, dangerous amounts of gas, which have accumulated during its idleness, may not be removed before the men enter their working places, and an explosion is possible from a naked light coming in contact with the accumulations of gas.

There are no special requirements to be observed in the erection of either a fan or furnace that do not apply with equal force to all classes

of machinery. All ventilating apparatus should be of ample size to perform the work required of it. This work is to supply from 100 to 200 cubic feet of air per minute (the quantity varying with the legal requirements of the different states) for each man employed underground. In addition, there must be a sufficiency for the mules and lights, and enough more "to dilute, render harmless, and carry away all explosive and noxious gases." The apparatus should have ample reserve power so that in event of an emergency or after the workings have been extended, it may be able to supply more air than required when it was first erected. The fan or furnace should be substantially built of good materials and, as far as possible, be situated where it will receive the least damage from an explosion.

The latter part of this question is very comprehensive, opening up as it does the entire subject of rescue work under the very great variety of conditions possible at different mines. In a general way the question may be considered from the view point of when oxygen breathing rescue apparatus is available and when it is not. If "helmets," as they are commonly called, cannot be had, and the afterdamp is suffocating from the presence of carbon dioxide, or poisonous from the presence of carbon monoxide, no rescue or recovery work can be done until the ventilation is restored. If the fan and fan drift are destroyed, the former must be repaired or replaced with a new one, and the drift cleaned of falls. The work of rebuilding the brattices is then undertaken, beginning with the one nearest the fan and proceeding in by. As soon as the rebuilding of a brattice restores the circulation to that point, the work of cleaning up the falls is undertaken; and the work of replacing brattices and cleaning up falls goes on simultaneously. When the rebratticing has enabled the fan to remove the afterdamp, the work of rescuing the living and recovering the bodies of the dead may be begun.

If oxygen breathing apparatus is

to be had, the work of exploration and rescue is begun as soon as the helmet crew reaches the mine, and is carried on independently of other crews who are engaged in the work of restoring the ventilation, as just described. In most recent mine explosions the rescue crew wearing helmets and carrying portable electric lamps have located the living long before much more than a start has been made toward restoring the ventilation. In numerous cases where large amounts of carbon monoxide have been present in the afterdamp, the brattices have been rebuilt by men wearing helmets.

QUES. 11.—What is meant by the diffusion of gases and how does it affect the character of gases when they come in contact with each other? How are gases caused to expand out of the strata and at times to overflow the workings in a mine? Explain how the condition of the weather and direction of the wind may affect the production of gases in coal mines.

ANS.—By diffusion of gases is meant the slow and perfect intermixture of two or more gases when they are brought into contact with one another. It does not mean what is called the mechanical mixture of gases, as when they are shaken up together in a jar or swept along by a ventilating current of air, but the slower intermixture which takes place, for example, in the still air of a room in a mine when methane is gradually given off from the pores of the coal. Through the action of diffusion, gases which would naturally arrange themselves in layers in the order of their relative specific gravities are in the end intimately mixed. Thus, the atmosphere is composed mainly of three gases, in the order of their specific gravities and beginning with the heaviest, carbon dioxide, oxygen, and nitrogen. Because of diffusion these gases are uniformly distributed and intermixed throughout the atmosphere, but were it not for this property of diffusion the earth would be surrounded by a shell or layer of carbon dioxide with a specific gravity of 1.529; then with a layer of oxygen

with a specific gravity of 1.1056, and finally with a third layer of nitrogen with a specific gravity of .9713. Similarly, methane, which by reason of its very low specific gravity (.559), is naturally found near the roof, is, in the course of time, evenly and uniformly mixed with the mine air; and carbon dioxide, with its specific gravity of 1.529, and so found near the floor, is also intimately mixed with the atmosphere. The velocity with which gases diffuse into one another varies inversely as the square roots of their densities. Thus, the specific gravity of air being 1 and that of methane .559, the relative velocities of diffusion are as $\sqrt{1} : \sqrt{.559}$ or as 1 : .748; that is, 1,000 volumes of methane will diffuse into air in the same time that 748 volumes of air diffuse into methane.

Gases may be liberated in various ways. A certain amount of gas is contained in the pores of the coal, and this is naturally given off as the headings and rooms are driven and fresh faces are exposed. Gas in pockets, fissures, or blowers may be suddenly given off by a shot opening up the cavity containing them. A derangement of the ventilating apparatus in the case of a blowing fan generally tends toward the flow of gas into the workings. This will happen when the fan is slowed or shut down, or when the air is short-circuited through an open door or broken brattice. In any of these cases, there is a lowering of the pressure, as shown by a lower water gauge, and under this lessened pressure gases expand and flow out of the pores and cracks of the coal and from the gobs into the workings.

Any surface conditions of weather which tend to lower the pressure of the air in the mine workings operate to release unusually large amounts of gas not only from the pores of the coal but more particularly from old and abandoned workings. The chief of these weather conditions is a fall in the barometer, which means a decrease in the atmospheric pressure. It is apparent that when the pressure is reduced there is less resistance to the expansion of the mine gases, and

increased volumes of them must escape into the workings from the coal and the gob. The Weather Bureau at Washington is now sending out what are called in England, barometer warnings, which call attention to approaching falls of the barometer with attendant influx of gas into the workings, so that means may be taken to increase the ventilating current where necessary. The effect of changes in the direction of the wind upon the escape of gases is not of great importance where there is proper ventilating apparatus. In some cases the wind may blow in such a way across a shaft or drift mouth as to increase the mine pressure and thus force the gases back into the workings; or it may blow in such a way as to help reduce the pressure and thus afford an opportunity for the gas to escape. The effect of the wind is much more marked upon furnace than upon fan ventilation; and upon natural ventilation than upon either.

QUES. 12.—How many years experience have you had in mines generating explosive gases? Give the names of the mines and the companies for whom you have worked in this or any other country where explosive gases are generated in such quantities as required a fire boss or the use of a safety lamp. In what capacity did you work while getting this experience?

Ans.—This question must be answered from the applicant's own experience.

(To be continued)

采 采

Coal and Coke in British Columbia

From the preliminary report of W. F. Robinson, Provincial Mineralogist, it is learned that 3,066,000 tons of coal were mined in British Columbia in 1912. This is almost equal to the production in 1910, the production for 1911 being low on account of labor troubles which also affected somewhat the production in 1912. Of this output 1,553,000 tons were from the Vancouver Island

mines; 214,000 from Nicola and Similkameen; and 1,299,000 tons from the Crows Nest region. The latter region was the only one to produce any coke, 395,000 tons of coal being made into coke, producing 264,000 tons; the coke yield being about 67 per cent. of the coal.

采 采

Use of the Barometer in Mining

By F. Z. Schellenberg

In view of renewed interest in the subject of the barometer in mining operations, I would say that on December 18, 1901, I read a paper on the use of the barometer, before the Central Mining Institute of Western Pennsylvania, now the Coal Mining Institute of America. As that paper will answer some inquiries being made by readers of *THE COLLIERY ENGINEER*, I herewith submit it for publication.

I advise the men responsible for safe conditions in the gaseous mines to consult the charts issued daily under telegraphic direction of the Weather Bureau, at Washington, and sent regularly to all postmasters that want them.

Following the map indications day by day will, on experience, teach one the prognostics for his locality. Thus, on the approach of the low barometer area anticipated, there will be no surprise that the coming events cast its shadow before, by increase of gas exudation into the mine working from the newly opened faces of the strata, hours before the local barometer gives a plain sign of lowering atmospheric pressure. Also, the persistence of high barometer makes tense the penning in of the gases in the solid strata and in lurking places, so that a fall of the pressure—and it may be locally sudden with thunder storm and veering of the wind—may give the extra gas, so ready to come, quick release. That the barometer in the mine is slower than the gas, is what has brought it into general disrepute among coal

miners; a mercury column barometer or a little, dry, fettered-air barometer, (the aneroid) cannot be as subtle to show changes in the pressure of the air as is the big open gas barometer, which the mine itself is. Now, surely, being posted daily by the map, with its pictured tracts of different densities as parts of the atmosphere, moving across the entire continent, will give to an earnest guardian of the mine, intelligence to become more than merely fitfully weatherwise. Here at 900 feet above sea level, the mercury column ranged in the year 1900 from a normal of 29.1 inches to the extremes of 29.7 and 28.3, the difference between which is equal to 19 inches water gauge or 100 pounds pressure per square foot on all open surfaces. On the weather maps, the readings of all points are marked there as of sea level and 32° F., in order to correlate more simply. The Weather Bureau is under the United States Department of Agriculture, but probably its value thus far has been greatest to those on the coasts, who are concerned in the safety of ships; next, to river men and railroad men, and last to farmers. As I suggest, it would benefit coal miners.

When Morse harnessed the new force, electromagnetism, and invented his alphabetic code, so that a telegraph could be of common use, it was regarded as of importance, first for transmitting intelligence over the country about the weather, particularly the standing of the thermometer at distant points; its great commercial use was not seen. Of course the telegraph had to be brought home to some to tell them anything about it; for instance, the wiseacre on the National pike, who was gazing with others in the village at them stringing the first wire on the poles said: "It may do for small packages, but for large bundles, never!" It took 25 years longer to start the Weather Bureau, in 1870.

Now, it may be in order for the mine foreman to prove his appre-

ciation of such government socialism, by taking others' observations and giving his own. He may invent the means of making practicable the sensitive reaction of his mine with the atmosphere, to tell earlier about the state of this as to pressure than does any present barometric device. But I do not think of him playing with his gas—he may have too much of it, or too little—but rather think of him and the bright ones in the colony around him, devising a pair of large, stationary aneroids, as instruments of precision. There is no telling what new way the men of the coal mines may pioneer in their provisional efforts; they invented the railroad and the locomotive.

An aneroid would read as close as water gauge does, if its divisions of scale corresponding to inches of mercury column, were 13.6 inches long. A semicircular scale the scope of 3 inches of mercury, and as delicate as water gauge, would be about 26 inches in diameter.

It has been suggested to have a large water or glycerine column barometer placed in schoolhouses. For it, a metal tube running up from a cistern in the cellar and having a glass part at the top to be read from the stair landing, would be safe and cheap. It would move feet to the mercury's inches or tenths and its head of column could be reflected on to a convenient scale, within or without the building.

Glycerine does not evaporate ordinarily and would give 26 feet height. The tubes for such liquids must not be small, or capillarity will add to the height of column.

The whole subject of the weather is, of course, not easy in its problems with the ever varying factors of pressure, temperature, and humidity of the air and also the direction and force of prevailing wind, at the scattered points of observation on land. The faithful watchman should have honor and encouragement from thoughtful men against the vacuous scribblers in ridicule, to whom every forming science is both mystery and child's play.

We are coming to replace man's superstitions with the knowledge of the natural laws, even in reckoning with the elemental forces in the grand arena of our universe.

來 來

Dumper for Mine Cars

Translated from Gluckauf

The arrangement as shown in Fig. 1 consists of a frame constructed of flat bar irons *a* and *b*

suspended above the edge of the rail upon a pivot *l* and can be tipped on either side.

This dumper has been in use since January, 1912, in shafts Nos. 2 and 7 of the Bergwerks-A. G. Consolidation Co., and has the advantage over other dumpers in that its position can be easily and quickly changed by only one man. As the end pieces *d* are open when the contrivance is not in operation, the work of hauling is not interfered with. There

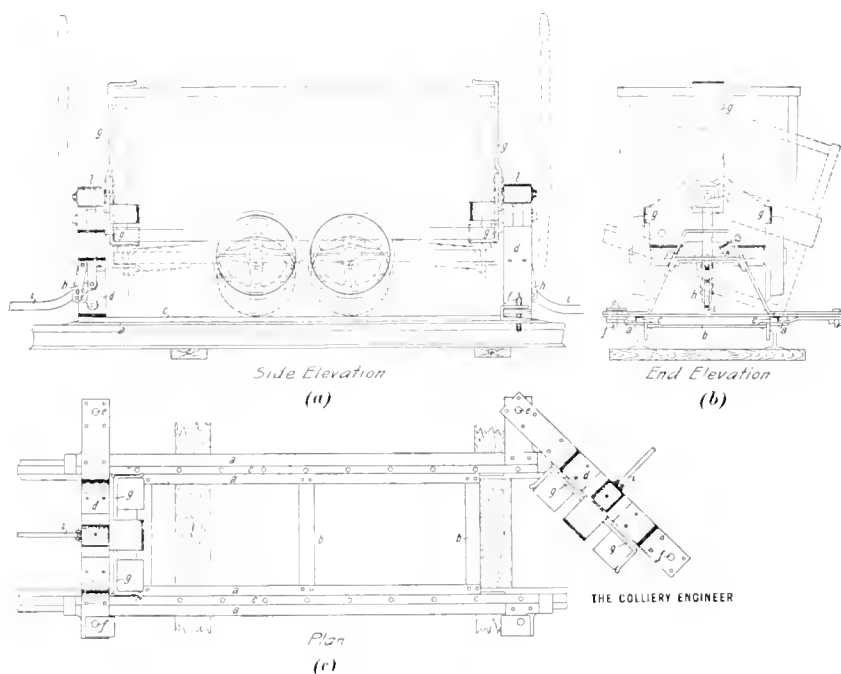

FIG. 1. DUMPER FOR MINE CARS

which are placed longitudinally on the rails so that the tops of the rails are covered, as shown in Fig. 1 (a) and (b). In order to give the necessary height for the car lifting part of the apparatus, special square bar irons *c* are placed upon flat iron *a*, being tapered at the end, that the car may mount them easily. The end pieces *d* are placed on the frame so that the car will just fit in between them. They are pivoted at *e* and fastened to the frame by a bolt *f* at the opposite side. These end pieces catch the car by means of flat irons *g* which project out from them. When the car is in position it can be raised by means of lever contrivances *h* and *i*. The car then, through the action of the levers *i*, is

is another advantage, the center of gravity of the car remains above and between the rails when dumping is going on, (as shown by the dotted lines in *b*). Therefore no special contrivances for support are necessary. This way of dumping prevents, above all, a violent shaking of the timbering and neighboring layers of rock, because the recoil is caught by the frame and track.

The arrangement may be used for seams of any thickness or any angle. Where the dip of the seam is great and the seam is small, the pivot *l* in the end pieces would have to be raised a few centimeters, in order that the contents of the car might be emptied down through the track.

NEW MINING MACHINERY

Storage-Battery Gathering Locomotives

One of the latest applications of the storage-battery electric haulage locomotive is for gathering work in coal mines. One of these machines manufactured by the General Electric Co. was recently installed in the Glendower colliery of the Philadelphia & Reading Coal and Iron Co. The

of the locomotive frame in a wooden case.

The mechanical design of the machine is in accordance with the latest modern practice. The end plates are faced with wooden bumpers, to which suitable couplers are attached. A seat for the operator is provided in the rear.

The journal boxes are fitted with

speed and torque characteristics are steeper than in the ordinary series motor, thereby tending to limit the overload which can be thrown on the batteries.

The motors are dust and moisture proof, nevertheless are accessible for inspection and repair. One motor is mounted on each axle and drives the axles through double reduction gear-

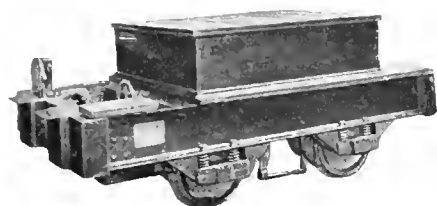

FIG. 1. STORAGE-BATTERY LOCOMOTIVE



FIG. 2. LOCOMOTIVE FRAME

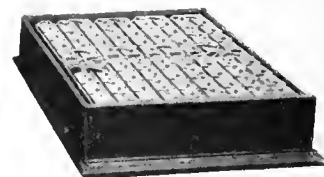

FIG. 3. STORAGE-BATTERY CELLS

locomotive designed especially for the service and built for hauling six cars is equipped with two 85-volt motors and controller. The batteries employed are Edison 70-cell and have a 300-ampere-hour capacity with a discharge rate of 60 amperes for 5 hours. They will run at the full rated drawbar pull and speed, for 9 miles with one charge of the batteries. Under an assumed car and track friction of 30 pounds per ton on level track, this rating is equivalent to 300 ton-miles on one charge. The machine is fitted with the usual ampere-hour meter indicating the amount of charge and discharge, headlight, and gong.

The locomotive is built to conform to the following specifications:

Total weight.....	8,000 lb.
Length overall.....	8 ft. 9 in.
Width overall.....	5 ft. 3 in.
Height over platform.....	2 ft. 4 in.
Height over battery compartment.....	3 ft. 9 in.
Wheel base.....	44 in.
Diameter wheels.....	20 in.
Track gauge.....	44 in.
Rated drawbar pull.....	1,000 lb.
Speed at rated drawbar pull.....	3½ m. p. hr.

The batteries are designed for the particular service, and the plates are made specially to give the high service efficiency. The cells are grouped in 18 trays and are mounted on top

roller bearings, which assures efficient mechanical transmission of power and consequent economy in battery current consumption. The weight of the car is supported from the journal boxes by two coiled springs.

Brake tension is effected by means of a square-threaded brake spindle. A square-threaded nut travels on the spindle and carries an equalizing bar, to the ends of which are connected chains leading from the brake levers. This device admits of locking the brakes automatically in any position left by the operator.

The controller is of the drum type, and with the mechanism, is enclosed in an iron case provided with removable sheet-steel covers.

The motors are series wound, totally enclosed, and of the familiar automobile type. They are designed to operate with the maximum possible economy in the use of battery current. They have high efficiency, large overload capacity and operate with practically sparkless commutation. High efficiency is obtained by designing them with a small air gap and running the iron at low densities. By reason of the latter provision, the

ing. As slow-speed service is ordinarily required of a storage-battery locomotive, the use of double reduction gearing affords such speeds with minimum rheostatic losses; and due to the large gear ratio from armature shaft wheel tread, very high tractive efforts are obtained at comparatively small current inputs to the motors.

采 采

Self-Starting Motor

Electric motors have proven so satisfactory that they have come into universal use as prime movers for driving pumps and fans independently located throughout the mine. In any mine a number of small units may be employed, none of which would be large enough to require constant attendance, so that one man frequently looks after several units, going from one to the other. Under these circumstances a pump will be oiled and started by the runner, who will then go on to the next place, leaving the motor to run unattended for a period of time. One great disadvantage in working the pumps in this manner is the chance that the power may go off, necessitating that

the runner go over his route again starting all the motors. Moreover the power may go off at a time when the runner is traveling from one unit to another and not likely to learn the fact, with the result that he finds, on his return to stop the motor, that it has not been running.

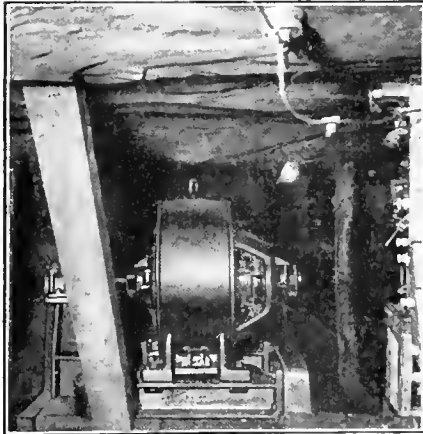

FIG. 4. SELF-STARTING MOTOR UNDERGROUND

Improvement, however, has been made in direct-current motors which overcomes this difficulty, making them self-starting. It has been possible heretofore under some conditions to start motors from the power house, but usually they had to be started by hand.

With the new self-starting direct-current motors, this inconvenience is done away with. When the power fails, the motors stop, it is true, but as soon as the power comes on again, they start automatically and settle down to work as though nothing had happened. Moreover, starting boxes are rendered unnecessary, and the wiring is of the simplest possible character. An occasional visit of inspection is now all they require.

The electrical characteristics of the self-starting motor differ but little from those of the usual type, the only alteration being in the use of a heavier compounding winding which reduces the flow of current when starting. Mechanically, there is no change. Self-starting motors are made by the Westinghouse Electric and Mfg. Co., East Pittsburg, Pa., in ratings up to 20 horsepower for the voltages usually employed in mine work. They can be supplied for all kinds of pump and fan service.

Mining With the Pneum-electric

In order to obtain the advantages of generating and transmitting power by electricity, chain machines have been extensively used under conditions where the puncher method of mining is really preferable. This is because electricity has not heretofore been successfully applied to a machine which strikes a blow by compressed air. Now that an electrically operated compressed-air puncher is available, the benefits derived from the puncher method of mining need no longer be sacrificed for electrical transmission of power. The Pneum-electric Machine Co., Syracuse, N. Y., recently made some calculations and issued a statement regarding work done and the power required by the Pneumelectric Coal Puncher, a machine in which an electric motor and an air cylinder are in the same frame, the air being both compressed and utilized within the same cylinder. Assuming ordinary working limits, the calculation for the Pneumelectric puncher is as follows:

Average width of cut, feet	5
Depth of cut, feet	5
Time of cut, minutes	15
Amperes at 220 volts	25
Watts = 25 X 220	5,500

These results show that for undercutting an area 5 ft. X 5 ft., or 25 square feet, there will be required 15 X 5,500 = 82,500 watt minutes. This total reduces to 330 watt minutes per square foot of undercutting. A similar calculation for the chain machine shows that the power for the two types does not differ materially. With the chain machine the cut is uniform, about 3 3/4 inches in height, and the coal thus cut out is very small, almost all of it being unmarketable. To be sure the amount of coal cut out of this kerf is not great, and this is one of the advantages claimed for the chain machine.

With the Pneumelectric the undercut, compared to that of the chain machine, is about three times as high in front and but slightly less at the back. In other words, the amount of coal cut out is about two and one-half times as much as with the chain machine, the power being practically

the same, as has been said. But of the coal thus cut out by the Pneum-electric, more than half is 3/4 inch or over-size coal, all of which is marketable and not "dust." A still greater advantage resulting from the wedge-shaped undercut is the greater space through which the coal can fall when it is shot. With the wedge-shaped kerf, less powder is required to dislodge the coal, and therefore the coal is not as badly shattered as when shot after undercutting with a chain machine. By measuring and inspecting the entire body of coal mined there is found to be a material difference in the results obtained with these two types of machines, the relative amounts of marketable coal showing greatly in favor of the puncher.

采 采

A Portable Coal Loader

The accompanying illustration shows a machine that is primarily intended for a wagon loader in retail coal yards. Its efficiency and convenience have been thoroughly proved in actual use. As at many collieries it occasionally becomes necessary, for various reasons, to temporarily store coal, which later must be loaded in cars for shipment, it is evident that this machine can be

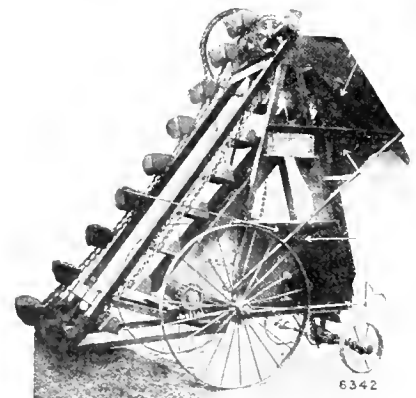

FIG. 5. PORTABLE COAL LOADER

used to great advantage when this stored coal is piled on the ground.

In retail coal yards experience has shown that one man operating the loader and helping the coal to the foot of the machine, can load a ton of coal per minute. By increasing the size of the machine there is no

doubt but that a similar machine can load coal into a car faster than that, with a great saving in labor as well as of time. The machines are run either by engines or electric motors. They are easily moved from one station to another and handle the coal with least possible breakage.

The Link Belt Co., of Chicago, Ill., are the manufacturers. They have told the story of its advantages in a book "Link-Belt Wagon Loader," and will gladly send a copy on request.

來 來

A Spike Puller

A new device for pulling spikes is shown in Fig. 6. Among the advantages claimed for this, are that it does not bend the spike or damage the tie and the spike is in condition to be used again; it is easily applied to the head of the spike and as it pulls straight up it is much more easily operated than the old-fashioned claw bar; it will pull spikes between frogs, guard, and side rails, as readily as on single rails, and on account of its light weight, only 12 pounds, it is readily handled. These advantages and the fact that all the effort applied is exerted on pulling the spike instead of bending it, enable a man to do nearly twice the amount of work possible with the ordinary claw bar. It is patented and manufactured by J. E. Jones, Carneyville, Wyo.

來 來

Bristol's Recording Differential Pressure Gauges

A comprehensive new line of recording differential pressure gauges has been developed by the Bristol Company, of Waterbury, Conn. Some of these recorders have been in successful service continuously since the preliminary models were first sent out in 1908, and the design and construction of the line of these latest instruments is based on results obtained in actual service during the last 4 years. These recording gauges are designed for use in connection with Venturi meters, Pitot tubes, orifices, combinations of orifices and Pitot tubes, etc. thereby to record

velocities and volumes of air, gas, steam, water, and other liquids flowing through mains and pipes. These recorders may also be used to advantage for recording differences and variations of liquid level in steam boilers, pressure tanks, filter beds, process kettles, etc.



FIG. 6. SPIKE PULLER

The fundamental principle employed in the construction of this differential pressure gauge is that one pressure is applied to the inside of the operating tube while the other is applied to the outside of the same pressure tube within a closed casing. In order to record the movement of the pressure tube it becomes necessary to transmit its motion to the outside of the pressure tube casing.

As the differential pressure to be recorded is usually small as compared with the static pressure, the operative force is correspondingly small, and it is quite evident that it will be impractical to use a stuffing-box around a shaft passing through a pressure casing, on account of the friction which would be produced. To avoid the use of a stuffingbox a unique patented frictionless sealing device is employed, which does not produce appreciable resistance to the rotation of the shaft which operates the recording pen arm, and at the same time leakage of even high pressures from the pressure casing is prevented.

This company also makes a device by which should a pressure causing a differential greater than the gauge

is intended to record be accidentally admitted to one side of the tube, a connection is automatically opened that allows the same pressure to act on the other side also, thus preventing the destruction of the tube.

A complete description of any or all of these devices may be obtained by application to the manufacturers.

TRADE NOTICES

Superheating.—As a catalog the Heine Safety Boiler Co., of St. Louis, Mo., has issued the article on "Superheating," by C. R. Meier, which was read before the Engineers Society of Pennsylvania. It contains a number of notes that steam users will be pleased to have in this form and can be obtained from the boiler company.

Steam Scale.—The De Laval Steam Turbine Co., Trenton, N. J., has devised a steam scale to overcome the difficulties in connection with the Mollier diagram. This steam scale is a graduated measuring rule bearing four different scales. The first having a uniform graduation may be applied to an accompanying chart and measure directly the British thermal units available between a given initial and final condition of the steam. The second edge of the rule bears a scale showing the resulting velocity of the steam in feet per second when expanded through a nozzle. The third edge shows the duty in millions of foot-pounds, in 1,000 pounds of steam; while the fourth edge gives the steam consumption in pounds per horsepower hour. Copies of these scales and chart will be sent to those interested by the De Laval Steam Turbine Co. On the back of the chart concise directions are given for its use.

The Bureau of Foreign and Domestic Commerce, of the Department of Commerce, Washington, D. C., has issued a bulletin calling attention to the foreign trade promotion work of the Bureau. The Bureau is charged with the duty of "developing

the various manufacturing interests of the United States and markets for their products at home and abroad, by gathering and publishing useful information, or by any other available method." In this work the Bureau has the cooperation of American consular officers. In addition it is provided with a corps of commercial field agents who submit comprehensive reports with respect to foreign markets for specific lines of products. The office is a clearing house for the dissemination of the reports submitted by these officers. Trade reports are published in a daily bulletin, in special monographs, and in circulars. Information concerning foreign customs tariffs, port charges, consular regulations, etc., is collated and published, especial effort being made to keep manufacturers advised of current changes in such rates and regulations.

Statistics relating to imports and exports of this country are compiled by the office, and are published in monthly, annual, and special bulletins. The resources of the Bureau are at the service of American manufacturers and exporters, and its publications are furnished, as far as available, upon request.

Electric Hand Lamp.—The Hirsch Electric Mine Lamp Co., whose electric mine lamp has been illustrated and described in former issues, has put on the market a new hand electric lamp for use in thin coal seams, or any other place in which a hand lamp is more practical than one on the cap. The hand lamp is almost identical with the cap lamp, differing only in the attachment of the lamp and reflector directly to the battery, which is provided with a handle.

Economical Burning of Coal is the title of a catalog recently published by the Valley Iron Works, of Williamsport, Pa. In it the methods of obtaining complete and economical combustion of different kinds of fuel and the importance of having a grate suited to the kind of fuel used are explained. The firm makes shaking and other grates for use

with fine or coarse anthracite or bituminous coal, and these are described in the catalog, which also contains testimonials from users of these grates. The catalog contains much of value to fuel users and will be sent on application.

Pipe Information.—A bulletin entitled "Characteristics of 'National' Steel Pipe," recently issued by the National Tube Co., Pittsburg, Pa., contains a large amount of boiled down information about pipe which the average consumer wants to know. The headings are as follows: Uniformity, Chemical Composition, Physical Properties, Bursting Strength, Threading, Improvements, Full Weight Pipe, Spellerizing. Very full information is given under Corrosion, with particular reference to tests that have been made by different persons. Much information is now available relative to the subject of corrosion of wrought iron and steel pipe and from reference to authorities indicated it is seen that steel pipe has been establishing a record for itself.

The specifications given will be of interest to the average user of pipe for they are fair to the manufacturer, at the same time protecting the interest of the consumer. The list of publications is also quite complete and these publications are sub-divided under classification with particular reference to the product. This bulletin is a distinct addition to the literature relative to tubular goods and all using such will find it to their advantage to write to the company for a copy.

Western Electric Co.—Some people entertain the idea that the entire business of the Western Electric Co. consists in sales to the American Telephone and Telegraph Co. and the associate companies. The annual report for 1912, however, states that the company has 24,000 customers other than telephone companies and has wide activities in fields other than the telephone industry. The Western Electric Co. "furnishes equipment for every electrical need" and sells to railroads,

electric-power central stations, street railways, electrical contractors and dealers, manufacturers, and now also to a limited extent through its own retail stores, to individual consumers. The line of equipment handled embraces everything electrical, from the largest generating plant to the simplest of electric household devices. The company's sales to customers other than companies of the Bell system have steadily increased during the past 10 years and are in great measure responsible for the addition to the American factory at Hawthorne, Ill., and the Antwerp and London factories abroad.

Centrifugal Pumps for Mine Service.—The Weinman Pump Mfg. Co., of Columbus, Ohio, has ready for distribution a new centrifugal pump bulletin, which contains valuable pumping data. This company has specialized on pumps for mine service for 50 years and is in position to make prompt shipments of mine pumps complete, either steam, electric, or gasoline-engine driven, as they carry a large stock of motors and gasoline engines, in addition to pumps. The Weinman centrifugal pump is built in single and multi-stage types and is therefore adaptable for extremely high or for low heads. The impeller of this pump is of the enclosed type, which is the means of increased efficiency, and the centrifugal pump is fast being adopted in coal mines, wherever possible. The Weinman pump is reliable and quiet in operation, has no valves or gears, and gives large output with minimum amount of repairs and attention, and requires considerably less space than any other form of pump. A high-grade ball thrust bearing is located in the main bearing oil cellar and is therefore entirely immersed in oil at all times. The engineering department of this company may be consulted freely, either regarding pumps now in operation or new pumps to be purchased, and will be pleased to give customers the benefit of their many years' experience in this field.

Not Damaged By Flood.—A recent letter from an official of the Jeffrey Mfg. Co., of Columbus, Ohio, to the Managing Editor, states that the company's plant was not damaged by the floods that caused so much loss and suffering in the central states a few weeks ago, as the works are located some distance from the points reached by high water. The organization of the Jeffrey forces was, however, crippled for a time on account of the anxiety of the individual members to aid the less fortunate. Every available man in the organization was sent out with the relief crews, some of them working day and night, until the work was well in hand and no known person was without food or shelter.

The letter, dated April 5, stated that "The majority of our men are back at their work again, and we are working full force and are pushing our orders and estimates with every possible despatch; and expect train service, mail, express, and freight shipments to resume their normal conditions within a few days."

CATALOGS RECEIVED

ROBERTS & SCHAEFER Co., Chicago, Ill. Reinforced Concrete, 32 pages.

CHICAGO PNEUMATIC TOOL Co., Fisher Building, Chicago, Ill. Duntley Track Drill, 8 pages.

NEW YORK BLASTING SUPPLY Co., 11 Broadway, New York. High Explosives, 4 pages.

SULLIVAN MACHINERY Co., 122 South Michigan Avenue, Chicago, Ill. Sullivan Diamond Core Drills, 31 pages; Sullivan Hammer Drills, 31 pages.

SCOTT DRILL Co., St. Louis, Mo. Gasoline Rock Drills, 11 pages.

GENERAL ELECTRIC Co., Schenectady, N. Y. Index to Bulletins, 11 pages; Type US-13 Roller Bearing Trolley Bases, 1 page; Circuit Breakers for Railway Service, Type MR, 2 pages; Thomson Watthour Meter, Type 1-10, 6 pages; Electrically-Operated Remote Control

Switch Type R, Form C2, 4 pages; Price List No. 5268, G E Steam Flow Meters, 7 pages; Polyphase Induction Motors, 21 pages; Edison Mazda Lamps for Standard Lighting Service, 26 pages; Electric Fans, 34 pages.

THE INDUSTRIAL INSTRUMENT Co., Foxboro, Mass. Bulletin 74, Foxboro Recorders; Foxboro Thermometers and Thermographs, 39 pages.

THE GOULDS MFG. Co., Seneca Falls, N. Y. Centrifugal Pumps, 8 pages.

BAUSCH & LOMB OPTICAL Co., Rochester, N. Y. Engineering Instruments, 155 pages.

來 來

Cutting Props

Five men are able to cut all the props which are used at a colliery producing 90,000 tons of coal monthly by means of an American circular saw 4 feet in diameter, mounted on a swinging arm. With a saw of this diameter the largest props which are likely to be used, can be cut. The general run of props are from 6 to 10 inches in diameter and a dozen of these are cut at one time.

The power for the saw is supplied by a small steam engine to which the saw is connected by belts and a clutch. The logs are rolled down from the lumber yard, which lies on a gentle slope in front of the saw, on to a platform and placed so that the logs are even with each other at one end. The saw will then cut props of a certain desired length from one end of the logs and, as the logs are unequal in length, odd lengths from the other ends. The platform is marked with the foot marks so that the odd lengths can be quickly marked and sorted. Ten or twelve logs are placed on the platform to be cut at the same time.

The engine also supplies power to drive an endless rope which moves the trucks on which the props are loaded as soon as cut. The trucks run on a track in front of the plat-

form and are moved by means of the rope to a place where the props may be unloaded in piles according to the lengths.

A supply of props is kept on hand so that all orders sent out from the mine can be promptly filled. The five men who do the cutting also do the loading and even have some time to do other work.

來 來

Practical First-Aid Work

A short time ago while taking some pictures of an underground stable, the foreman, who set off the flash-light sheets, burned his hand badly. Five years ago he would have had to have waited for a cage and after reaching the surface waited from 1 hour to 5 hours for treatment, depending upon the whereabouts of the company physician. In the case in question a trip to the foot of the shaft, less than 200 feet away, where first-aid materials were handy, enabled the sufferer to care for himself and return in less than 5 minutes. "The world do move."

來 來

Statement of the Ownership, Management, etc., of THE COLLIERY ENGINEER, published monthly at Scranton, Pa., required by the Act of August 24, 1912.

NAME OF	POST-OFFICE ADDRESS
Managing Editor, Rufus J. Foster	Scranton, Pa.
Editor, E. B. Wilson	Scranton, Pa.
Business Manager, P. G. Moore	Scranton, Pa.
Publisher, International Textbook Co.	Scranton, Pa.

Owners: (If a corporation, give names and addresses of stockholders holding 1 per cent. or more of total amount of stock.)

T. J. Foster	Scranton, Pa.
Rufus J. Foster	Scranton, Pa.
Elmer H. Lawall	Wilkes-Barre, Pa.

Known bondholders, mortgagees, and other security holders, holding 1 per cent. or more of total amount of bonds, mortgages, or other securities:

NONE.
(Signed) International Textbook Company.
RUFUS J. FOSTER,
First Vice-President.

Sworn to and subscribed before me this twentieth day of March, 1913.

[SEAL] FRANK LAMBADER,
Notary Public.

(My commission expires Feb. 8, 1917.)

The Colliery Engineer

Formerly
Mines and Minerals

Vol. XXXIII—No. 11

JUNE, 1913

Scranton, Pa.

PUBLISHED MONTHLY AT SCRANTON, PA.
ESTABLISHED 1881

INTERNATIONAL TEXTBOOK CO., PUBLISHERS

T. J. FOSTER, President S. P. ALLEN, Secretary E. H. LAWALL, Treasurer
RUFUS J. FOSTER, Vice-President and Managing Editor
EUGENE B. WILSON, Editor WM. Z. PRICE, E. M., Asst. Editor

CHICAGO OFFICE: 1006 S. Michigan Ave.

Entered at the Post Office at Scranton, Pa., as second-class matter

Address all business communications to THE COLLIERY ENGINEER, Scranton, Pa.

Subscription Rates: \$2.00 per year to United States and all possessions, and Mexico; \$2.50 to Canada; \$3.00 to all other countries. Single copies 25 cents each.

Notice to discontinue or change of address should be sent to the Scranton office.

When notifying us of a change of address always give your FORMER as well as your present address.

CIRCULATION THIS NUMBER 12,500

TABLE OF CONTENTS

Editorial—

Editorial Notes—A Correction—Cincinnati Mine Explosion—The Regulation of Oil and Gas Wells in Coal Regions—American Institute of Electrical Engineers—Canaries in Coal Mines..... 597

Illinois State Mining School 600
West Virginia Coal Mining Institute 600
Quarrying Coal at Tofield, Alberta 601
Description of Tonnage Map, by Carel Robinson..... 603
Repairing a Large Rope Sheave, by H. L. Handley..... 604
Longwall Mining in Illinois, by S. M. Dalzell..... 606
The Transportation Problem, by R. W. Ropiequet..... 609
No. 2 Mine of United Coal Mining Co., by C. M. Moderwell..... 612
Gas Power for Collieries, by Sydney F. Walker..... 613
Rock Dump for Slopes, by John Bamling..... 616
Effect of Coal Mining on the Surface 617
Reversing an Air Current, by Bert Lloyd..... 622
Concrete in Mine Construction, by A. F. Allard..... 623
Fire Protection of Mines, by G. E. Lyman..... 624
Organization as Affecting Mining, by A. J. Moorshead..... 627
Practical Talks on Coal Mining—

Electricity in Mines, 629—Gases Met With in Coal Mines, 631—
Mine Ventilation, 632—Mechanics of Mining 633
Personals 635

Obituary—

William L. Sheaffer—J. Shephard Clark—Frank O. Briggs..... 635
The Cincinnati Mine Disaster, by Wm. Z. Price..... 636
Book Review 643

The Letter Box—

Pulling Pillars—Location of Regulators—How to Mine—The Motive Column—Size of Pillars—Carbon Monoxide—Use of the Barometer in Mining—Use for Old Wire Rope..... 644
Prize Contest 646
Notes on Mines and Mining 649
Catalogs Received 650

Examinations—

For Mine Foreman and Assistant Mine Foreman, Pottsville Pa., March, 1913 651
Use of High Explosives in Northern Mines, by F. H. Gunsolus..... 655

New Mining Machinery—

Langerfeld Coal and Slate Separator—Steam Hammers—Mining Machinery Exhibit—Gould Triplex Mine Pumps..... 656
Trade Notices 659

Squibs—

New Geographical Map of Illinois, 603—Mine Timber Decay, 605—Briquet Production in 1912, 612—A Long-Lived—Leather Belt, 616—Standard Size Mine Doors, 628—Jellico, 628—Arkansas Anthracite Mines 635

THE one thing wrong with the "minimum wage," as proposed by impractical so-called reformers and politicians, is that it results in a maximum wage for a minimum of ability, and a minimum wage for a maximum of ability.

來 來

IMITATION is the strongest proof of the value of an idea, a method or an appliance. Imitations, however, like counterfeit money, are never as good as the originals. If the originals were not good they would not be imitated.

來 來

CARBON monoxide can be detected in the mine air by its effect on the flame of a lamp, which, in the presence of the gas, grows brighter and elongates with a slight blue cap. This statement is absolutely true and can be proved to his personal satisfaction by any man, but he probably will die before he can tell any one else of his experience.

來 來

A COMMENDABLE campaign, having for its object the decrease in coal-mining accidents in Alabama is being carried on by the Mine Casualty and Mining Institute Committee of the Alabama Coal Operators Association. It consists in issuing monthly a safety pamphlet prepared by the secretary, James L. Davidson, and approved by the committee before publication. The different subjects treated inform the reader how and why accidents occur in particular instances, and the precautions necessary to prevent them. No attempt is made toward technicality other than the statements of fact that accidents are liable to occur from such a cause if such a matter is neglected.

來 來

WHEN a prominent mine manager was recently complimented on the arrangement and equipment of a new mine, on which he had spared no expense to secure safety and economy, his friend spoke of it as a "model mine."

The mine manager threw up his hands and exclaimed: "For God's sake don't call it that. Have you never noticed that shortly after a mine gets a reputation as a model mine it is usually the scene of a great disaster?" He then instanced several such cases in recent years. When asked, if he was superstitious on the subject, he replied: "No, not at all. But when a mine gets a repu-

tation as a model one, particularly as regards safety, the officials and workmen are likely to presume too much on the means taken to eliminate danger, forget the personal element, get careless, and an accident follows. I believe in removing or minimizing every source of danger, but I want my subordinates and the mine workers to constantly be on the alert, and to be just as careful as they would be in a less well protected mine."

來 來

A Correction

IN THE article on "Flushing Anthracite Workings" in our last issue, credit for the report on the Kohinor colliery flushing, from which extracts were made, was given to Mr. Geo. S. Clemens. Mr. Clemens informs us that the report was made by Mr. John H. Pollard, then assistant engineer, and now Division Superintendent of the Mahanoy City Division of the Philadelphia & Reading Coal and Iron Co., who was in charge of the work, under the personal supervision and direction of Mr. Clemens.

來 來

Cincinnati Mine Explosion

ON APRIL 23 the Cincinnati mine of the Monongahela River Consolidated Coal and Coke Co. was visited with a disastrous gas explosion that caused the death of 96 persons. This is the first great explosion in the coal mines of Pennsylvania since November 28, 1908, when the Marianna mine blew up.

For some time after the accident it was not possible to obtain definite information as to the conditions existing and the cause of the explosion, but all kinds of rumors were freely advanced, such as that there was a leak from a gas well; that a driver with a naked light went into an entry where he should have gone only with a safety lamp; that the fire boss caused the explosion, etc., etc., all usually ending in adverse criticism of the management of the mine.

To make sure of the actual cause being established beyond doubt, Chief Roderick, of the Department of Mines of Pennsylvania, appointed two independent commissions to investigate the explosion. In all, there were five investigations, one made by the Mine Inspector of the district, one by the United States Bureau of Mines, one by the company, and two by special commissioners at the instance of Chief Roderick. Their reports will be found elsewhere in this issue.

It is probable that none of the officials of the company knew the cause of the accident until after the special commissioners appointed by Chief Roderick gave the findings of their investigations to the coroner's jury, but because those in charge at the mines were unwilling to give out guesses for publication, they were severely and unjustly criticized by some of the daily press.

One persistent rumor circulated was to the effect that a driver set off the gas with a naked light. This was based upon the fact that the men in No. 6 butt entry driven from No. 14 face entry used safety lamps, but

they were not used elsewhere in this section of the mine; in fact only two entries, which in advancing had cut clay veins, gave off gas. When the driver went into No. 6 butt entry it was his duty to change his open light for a safety lamp, and it was claimed by some that the explosion was due to his not using the safety lamp. The conditions found upon careful investigation, however, showed that the explosion was not so caused.

At the place where a gas explosion originates, comparatively little damage is done, but as the heated gases expand, they rush toward the nearest outlet. According to the report of the second commission of unbiased men the debris was blown from No. 14 face entry toward the face of No. 6 butt entry, which is one reason for believing the explosion did not originate in this entry; but more conclusive is the evidence of force and lingering heat which was found to have prevailed in this entry.

Knowing the phenomena which attend explosions of this kind the special committees, working independently of each other, sought some place in the affected zone where conditions were favorable to the propagation of an explosion. In butt entry No. 12, driven at right angles to face entry No. 14, they found that the miner had broken into a clay vein which, like the one in No. 6 butt entry, gave off gas. This entry was bratticed to force the air past the last breakthrough to the working face and so furnish the miners fresh air. At the face of this entry there was little evidence of heat and no evidence of force to mention, until the explosion got fully under way some distance from the face. As there had never been any gas detected, even so late at 10 A. M. on the day of the explosion, the miner did not use a safety lamp; however, when he broke into the clay vein gas flowed into the entry and naturally the explosion was originated.

It is probable that in Western Pennsylvania and elsewhere care must be taken to prevent miners shooting clay veins, and when such are discovered precautions should be taken against an inrush of gas, for even although most clay veins do not give off explosive gas, it is evident that some do and that they are in places a menace to life.

It would appear from this newly-discovered form of danger that as fast as one cause of accident is guarded against a new one arises; further, that this accident cannot be attributed to imperfect ventilation, and that the management of this mine took every known precaution to guard against accidents.

來 來

The Regulation of Oil and Gas Wells in Coal Regions

AT conferences of State Geologists, representatives of the United States Bureau of Mines, State Mine Inspectors, coal mine operators, and oil and gas well operators, held at Pittsburg, Pa., on February 7 and 8 and March 11, a report was formulated in the shape of a proposed law, to be developed in legal form to meet special local conditions in each state.

The suggested law has many points of real value,

and if it, or a proper modification of it to suit local conditions, is enacted in each state, with the exception of one part, it will undoubtedly add to the protection of mine workers and mine property. The exception we make, is that part of the proposed law providing for Well Inspectors. Such officials will be of no practical value, will be a source of unnecessary expense, and as they will not be technical mining men, they will be a hindrance rather than a help in carrying out the intention of the proposed law.

All its provisions can be enforced by the Chief Mine Inspectors and their assistants, if the law is so framed as to conserve the rights of the oil or gas well operators.

The dangers incident to oil and gas wells in coal mining regions are familiar to competent State Mine Inspectors, and, given proper laws, those officials can and will see that a maximum of safety is secured.

來 來

American Institute of Electrical Engineers

THE recent meeting of this society at Pittsburg was largely attended, and the goodly number of coal miners present were interested in those papers presented by the electrical engineers connected with coal mines. The other papers were of more interest to those engaged in promoting commercial power plants than to miners; in fact, the advocates of central station plants were live wires connected with direct-current generators whose combined amperage had a voltage of such intensity they succeeded in convincing themselves that under certain conditions the power factor could be purchased at the operators' switchboard for less than the cost of production at the central-station switchboard.

The explanation furnished for this anomaly was the same offered by the Baxter Street merchant who could sell goods below cost because he sold so many of them. During the discussion on "the calculation of load factor" the central station advocates were transformed from direct to non-synchronous polyphase alternating currents, each having from one to four methods for the calculation in which the peak-load time varied from 1 minute to 1 hour. The operators, although dazed, were somewhat relieved by Chairman Wood's remark "that coal operators would hesitate to deal with central station men except on the basis of so many mills per ton of coal mined."

The mining industry will be in the future, as in the past, one of the best markets for the electrical engineer's knowledge and the electrical machine manufacturers' wares. However, the latter individuals, by assuming a knowledge of mining conditions which they do not possess, have made bad mistakes which should not be duplicated. This point was brought out in various ways in the meeting by those who knew something of mining conditions, and realized the injury unintentionally done to the industries in the past. At a recent meeting of the Electrochemical Society there were a number of practical men invited whose questions somewhat embarrassed the members. After one paper which dealt with the deposition

of metals in grams per square centimeter of surface had been read, questions were invited. The practical man wanted to know how to calculate the cubic centimeters of surface on 4 gross of forks? The question box at Pittsburg did not prove so embarrassing at least to Chairman Wood.

來 來

Canaries in Coal Mines

CONSIDERABLE humorous comment has been made on the use of canaries, by the officials of the United States Bureau of Mines, for the purpose of detecting carbon monoxide, or "whitedamp," in mine air, after a mine fire or a serious explosion. But "there's a reason."

It is a well-known fact that chickens, birds, or small animals such as mice, guinea pigs, etc., will succumb to the effects of carbon monoxide, when that gas is present in the mine air in percentages considerably below what is necessary to seriously affect a man.

The effect of carbon monoxide on the flame of a lamp is observable in a laboratory where it is possible for the experimenter to take such precautions as will protect him from inhaling the air containing the small percentage of gas necessary to show increased brightness and length of flame, and the slight blue cap. It can also be detected in the same manner by well-trained men wearing oxygen helmets. But, if a man is unprotected and enters a body of air containing enough carbon monoxide to show its presence in the lamp, he will probably succumb to its effects before he can escape from its dangers.

Therefore the most practical and safest manner of detecting the presence of the gas is to take birds or small animals into the mine and note the effect of the mine air on them. If they succumb, it is time for the men to retreat or to put on helmets, as the probabilities are that if they continue further they will encounter the gas in sufficient volume to cause quick death.

The reason the Bureau of Mines officials use canaries instead of other birds or small animals is because canaries are purchasable in almost every town of considerable size and at comparatively reasonable prices. Other, native, and less valuable birds might be trapped, or mice or guinea pigs might be used. But, it must be remembered the birds or small animals must be kept in the rescue cars so as to be always ready for use. Non-singing birds, mice, and guinea pigs are usually dirtier than canaries, and require as much or more care, and it is natural that the men composing the rescue corps should either be prejudiced against them, or have so little regard for them as to cause them to be neglected. With the canaries, there is a different feeling. The little songsters are attractive. They win the affections of the men and are well cared for. As a result, they are ready when needed, and they have on numerous occasions proved their value in warning rescue corps of the presence of carbon monoxide in the mine air.

Illinois State Mining School

The dedication of the Mining Laboratory of the University of Illinois took place May 9, 1913, on which occasion a large number of invited guests were entertained by the University.

At the Fuel Conference held at the University of Illinois in March, 1909, two resolutions were passed, one favoring the establishment of a Department of Mining Engineering at the University of Illinois, and another calling for other fuel conferences in the future. The dedication of the Mining Laboratory offered a particularly appropriate time for a second conference, which was held on May 8, 9, and 10.

Prof. H. H. Stock, ably assisted by Messrs. Lincoln, Andros, and Lander, who drafted the students as demonstrators, succeeded in explaining the different machines for mining and preparing coal for market and ore for metallurgical treatment. The laboratory has excellent facilities for practically teaching young men to become mining engineers. Eastern people who have not visited this institution will be surprised to know that it has 5,000 students, and has a campus about 1 mile long and one-quarter mile wide.

The great state of Illinois is proud of this college and furnishes sufficient appropriations to make it one of the foremost institutions of learning in the United States. Space will not permit going extensively into the advantages supplied for the education of the young men of Illinois, but we wish the legislature of Pennsylvania would send a Commission to examine the Illinois Mining School, for then Pennsylvania State College would have a suitable building for its mining students instead of its present shack.

Professor Stock taught mining in Pennsylvania State College, afterwards was editor of *MINES AND MINERALS*, now *THE COLLIERY ENGINEER*, leaving Scranton to occupy the first Professorship of Mining in the University of Illinois. The

papers read at this meeting were excellent and the discussions which followed added to their interest. Mr. Francis S. Peabody, President of Peabody Coal Co., Chicago, talked on "Conservation and Commercialism."

Mr. A. J. Moorshead, President Madison Coal Co., St. Louis, which operates in Illinois, discoursed on "Organization as Affecting Mining." Dr. E. W. Parker, Chief Statistician, United States Geological Survey, Washington, D. C., informed the audience with some figures that Illinois was a fair mineral producer.

Mr. R. W. Ropiequet, Past President of the Illinois Coal Operators Association, Belleville, Illinois, discussed "The Transportation Question from the Standpoint of the Coal Operator." The subject, "Safety First," was discussed by Joseph Pope, President United Mine Workers, District No. 12, Ill.; by Thomas Moses, General Superintendent Bunsen Coal Co., Westville, Ill.; and by John Dunlop, State Mine Inspector, Peoria, Ill. The discussion was led by Mr. Martin Bolt, Chief Clerk of the State Mining Board of Illinois.

"Modern Practice In Illinois Mines" included illustrated lectures on the Buckner mine, by President C. M. Moderwell, Saline No. 3 Mine, by General Superintendent W. R. Johnson, Valley Mine No. 5, by S. M. Dazell, President.

A. E. Allard, Chief Engineer Bunsen Coal Co., gave an illustrated lecture on "Concrete in Mine Construction."

Carl Scholz, President Coal Valley Mining Co., well-known as a mining engineer, gave an illustrated lecture on "Steel in Mine Construction," in which he explained a new system of lining shafts with steel timbering and fireproof lagging.

John A. Garcia, Consulting Engineer, Chicago, read a paper on "Modern Steel Tipple Design."

Professor Stock read H. M. Wilson's paper on "The Fireproofing of Mining Plants," as Mr. Wilson, Chairman of the Mine Fire Commit-

tee of the National Fire Protection Association, arrived too late for the meeting. "Fire Protection in Mines," was amply covered by John P. Ruse, General Superintendent Superior Coal Co. Duncan McDonald, Secretary United Mine Workers, Springfield; G. E. Lyman, Mining Engineer, Madison Coal Corporation; James Taylor, State Mine Inspector, Peoria. The discussion was led by E. T. Bent, President Oglesby Coal Co., Chicago. Resolutions were passed to renew the Mining Conferences from time to time, that benefit may accrue to the coal operators of Illinois. The high class of papers read and the general air of satisfaction which prevailed throughout this meeting speak volumes for Professor Stock's success and the future of coal mining in Illinois.

來 來

West Virginia Coal Mining Institute

The West Virginia Coal Mining Institute will hold its summer meeting at Morgantown, W. Va., June 24, 25, and 26. Papers will be read on the following subjects: "Gasoline Motor Haulage in Mines"; a "New Type of Undercutting Machine"; "Welfare Work in West Virginia"; "Qualifications of a General Manager from a Superintendent's Point of View"; "Hydro-Electric Power in Mining, a Description of the Cheat River Installation."

Approximately one-half the session will be spent in visiting different points of interest. On June 25, there will be an automobile trip to Sabraton to inspect the American Sheet and Tin Plate Plant, also the large glass industries. In the evening, the Morgantown Board of Trade tenders a banquet. On June 26, mines in the Connellsville coking district will be visited, a feature which will allow of comparison between Pennsylvania and West Virginia practice in coking and mining.

The committee has made every endeavor to insure the members of the Institute an enjoyable time as well as intellectual feast.

COAL MINING & PREPARATION

Quarrying Coal at Tofield, Alberta

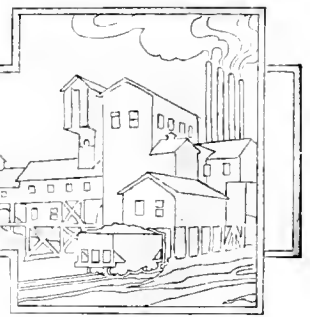
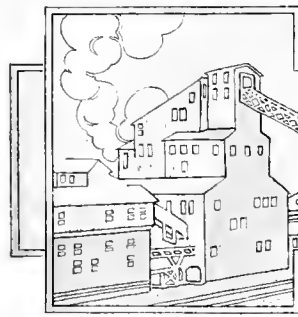

IN THE vicinity of Tofield, Alberta, Canada, the coal beds of the Kootanie, Belly River, and Edmonton formations are of unusual interest to the geologist, miner, railroad owners, and inhabitants.

To geologists, because the coal is in a transition state between lignite

Methods of Mining Coal From Beds so Situated That They May Be Stripped and Loaded Directly Into Railroad Cars

By Joseph H. Sinclair, M. S.

113, latitude about 53° 15', 40 miles southeast from Edmonton, near Beaver Lake. It has an elevation of 2,200 feet above sea level in what is known as the Great Plains of the Rocky Mountains, the usual fea-

ture of the Belly River crossing, beds of lignite, show thicknesses of 6, 12, and 13 feet, out-

crop in the Edmonton series, and on the Saskatchewan River one bed attains a thickness of 25 feet of workable coal. In the immediate vicinity of Edmonton a persistent bed of lignite, 5 to 6 feet thick, is



FIG. 1. THE TOFIELD COAL BED

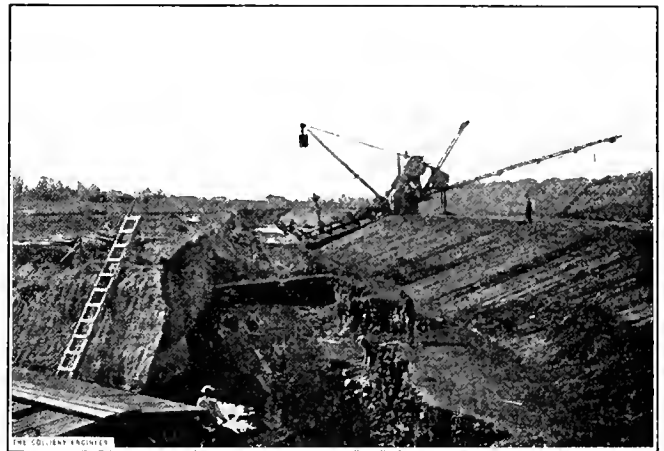

FIG. 2. STRIPPING TOFIELD COAL BED WITH SCRAPER LINE

and bituminous, or what the United States Geological Surveyors have termed subbituminous. To miners, because it offers thick beds, with comparative easy mining and none of the dangers that are encountered in underground mining.

To railroad owners, because it furnishes a cheap fuel that can be stored without much danger of spontaneous combustion and as the moisture evaporates it becomes a better fuel for steam purposes.

To the inhabitants, because the coal can be stored for use in winter in a climate that requires fuel for comfort.

Tofield is located on the Grand Trunk Pacific Railway, longitude

tures of which are fertile undulating table lands. The rocks in this vicinity belong to the Edmonton series, or Edmonton coal fields, the coal beds being assigned to the Laramie formation, which is either in the upper members of the Cretaceous period or the lower members of the Eocene, Tertiary period. According to the Canadian Department of Mines the Edmonton rock series extend from the International Boundary and have a breadth through Tofield of about 140 miles, covering, so far as known, an area of 35,000 square miles. The Edmonton series is essentially a lignite-bearing formation, which rests conformably on the Pierre shales. To the west of Edmonton at the Pem-

above the level of the river, and is nearly horizontal.

The coal in Saskatchewan Province, to the east of Alberta, is lignite and as it goes west becomes subbituminous, and further west coking coal;* evidently it shades imperceptibly from one kind of coal to the next. The Cretaceous formations consist chiefly of sea deposits; there are three horizons which show land conditions and evidences of plant life, and in these coal seams are found.

A marine invasion of the central

* Mr. Sinclair sent the Editor a sample of Tofield coal which is evidently subbituminous and not lignite, for the following reasons: It does not air slack but dries hard and becomes brittle; it gives a black streak, and while it does not coke it gives off an odor of burning rubber (and no acetic acid is obtained from the volatile matter).

* Mining Engineer and Geologist, Calgary, Alberta.
33-11-2

part of the continent during Cretaceous time was preceded in the then existing low trough of the present Rocky Mountain area by an abundant flora, so that the early Cretaceous is coal bearing.

These beds, known as the Kootanie series, were subsequently covered by a series of marine shales deposited by an invasion of the sea;

show an increasingly changeable climate, and probably an increasing altitude.

The last deposits of the Cretaceous and the early ones of the Tertiary, form the third coal horizon, and include the Edmonton and the lower Laramie.

The three coal horizons thus found are: Edmonton, Laramie for-

seem to be available theoretically 174,000,000 tons. One company, the Tofield Coal Co., owns 1,400 acres of coal land and there are other companies in the field.

Fig. 2 shows the operation of stripping the coal by means of a scraper line and distributor. Provided the stripped material was loaded into cars which could be

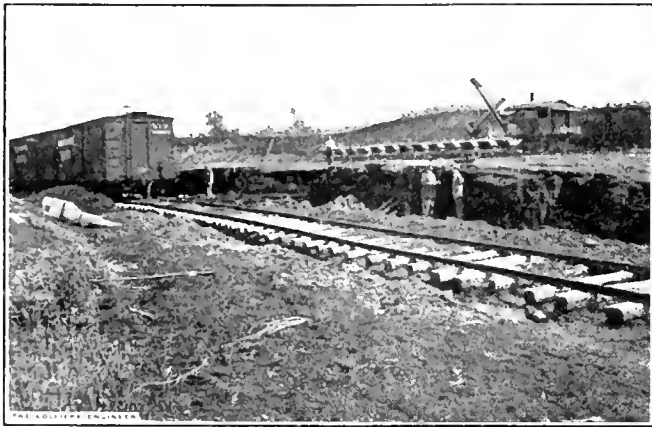

FIG. 3. LOADING COAL FROM BED INTO BOX CARS

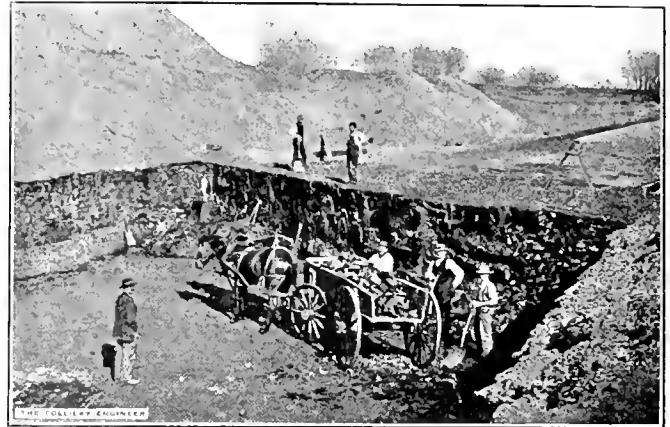

FIG. 4. STRIPPING COAL FOR DOMESTIC USE AT TOFIELD

but a shallowing of this sea over the western part also brought about land conditions again in later Cretaceous times, and vegetation spread eastward, and was in turn buried by shales in another invasion of the sea.

The second flora is preserved in the beds of the Belly River formation, and in places forms important coal deposits about in the center of the Cretaceous period.

At the close of Cretaceous times, when the continent finally emerged from this sea invasion, and while the land surface oscillated slightly at or near sea level, another mantle of vegetation covered the low ground which was afterwards submerged. Coal seams were again formed, and in the rocks which succeeded these coal beds, impressions of leaves, stems, and petrified wood.

formation; Belly River formation; Kootanie formation.

In the upper of these formations, the Edmonton series, is found the coal seam at Tofield. There is but one seam known, or at least worked, and this has a thickness of about 10 feet.

The analysis of the coal at Edmonton is given in Table 1.

The analysis of the Tofield coal was made from a dried specimen several weeks after it was quarried, so no account was taken of the moisture in the sample. In Fig. 1 is shown the Tofield bed under a rich prairie loam on a dry subsoil, which sometimes is from 12 to 15 feet deep. The coal area immediately about Tofield is estimated at 20,000 acres. Taking a value of 50 cubic feet to the ton with an average thickness of 10 feet, there would

hauled so as to fill in back of the coal excavation the same as when a steam shovel is used, the plan has merits, but where the dirt is wasted back of the stacker it becomes only a question of time when it must be rehandled. In this case the coal is broken from the bed as before, loaded into barrows, and wheeled into the car.

Fig. 3 shows the coal with a thick cover being stripped by a steam shovel, at work on top of the coal beds. Here the coal is broken from the bed with bars from above and by picks at the face into sizes which are shoveled into the cars without further preparation. As the face advances the track is shifted in order to make loading economical. As the bed is pure coal a steam shovel could be used to load gondolas were they obtainable, and were it not policy to ship in box cars.

Fig. 4 shows a coal bed where the coal has been stripped for domestic consumption. In this case powder is used to break the coal and coke forks are used to load the lumps into the wagon.

TABLE I. ANALYSES OF EDMONTON COAL

	Moisture	Volatile	Fixed Carbon	Ash	B. T. U.
Parkdale Coal Co.	17.3	28.7	42.8	11.2	8,940
Standard Coal Co.	15.3	31.2	46.0	7.5	9,610
Strathcona Coal Co.	16.1	30.9	41.1	11.9	9,050
Tofield Coal	10.7	53.82	31.3	4.15	

While wages are higher in this new country the cost of stripping per ton of coal is practically the same as in Arkansas, Kansas, and Oklahoma.

According to Barry Scobee, the cost of stripping in Kansas* is about 6 cents per cubic yard where the coal is but 30 inches thick and the covering 20 feet. In Tofield the cost of stripping might be twice as much and the price per ton be reduced on account of the thick coal.

As a commercial proposition, stripping depends upon the thickness of the coal bed and the cover, the facilities for digging and wasting the dirt, and finally on the value of the coal as a fuel.

The cost of stripping 97,854 yards of material over a seam of anthracite at a certain mine in the eastern United States was \$1 per ton of material stripped or \$.516 per ton of coal obtained. The average depth of the stripping was 75 feet, and about two-thirds of the material removed was rock. The cost of stripping a bank 15 to 18 feet high in Western Pennsylvania was \$.30 per cubic yard of stripping. It is fair to assume, therefore, that the coal at Tofield can be placed in the cars at a cost not much over 35 cents per ton.

采 采

New Geographical Map of Illinois

This map, 36 in. x 50 in., is mounted on cloth and reinforced top and bottom so it may be hung on the wall or made into a roll as desired. The map has been compiled from a number of sources, and changes will be necessary from time to time in order to make it conform with the geological data being gathered as developments progress. The Illinois Geological Survey invites suggestions and corrections, and if any errors are discovered a favor will be conferred by reporting them to Director F. W. DeWolf, Urbana, Ill.

* THE COLLIERY ENGINEER, March, 1913, page 406.

Description of Tonnage Map

By Carel Robinson*

Several years ago after leaving my university and while serving an underground apprenticeship, I served a term as a boss driver. All of the details of the work were then immediately before me, and it was my endeavor to so adjust the several elements of the haulage system as to balance properly. For example, if one of the drivers could haul more coal than he was getting, I would induce more loaders to begin working in that section of the mine. On the other hand, if in some other

mine I could supervise the haulage in a general way and keep in fairly close touch with the methods of handling the work. Later, however, with three mines and a good deal of outside work to look after,

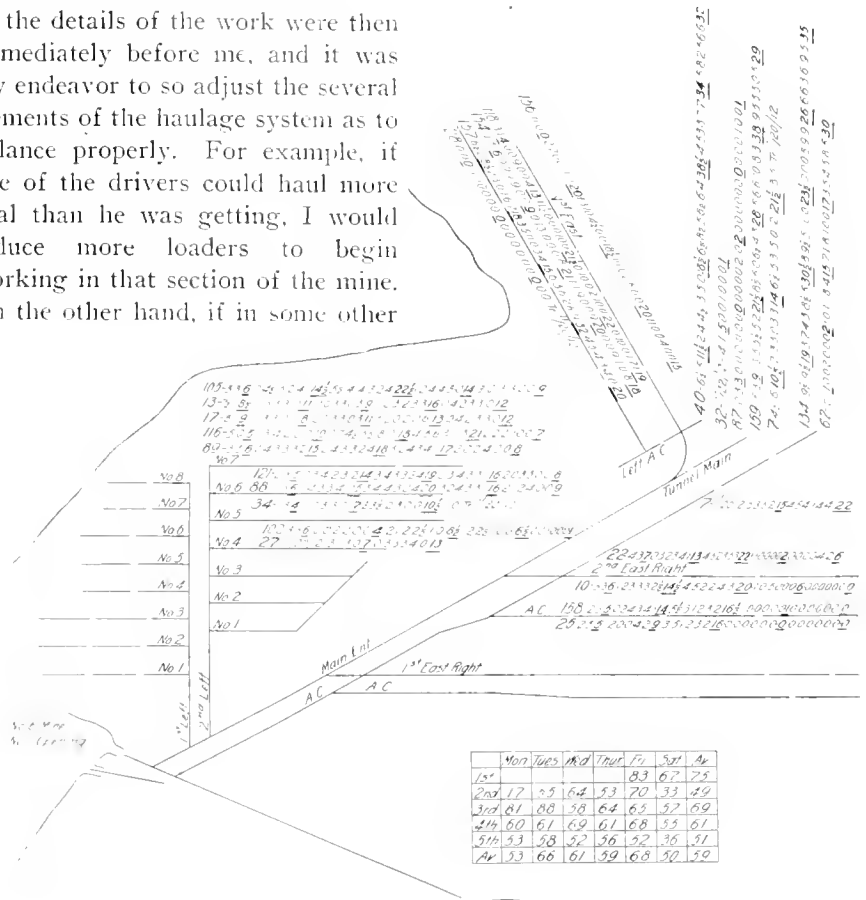

FIG. 1. TONNAGE MAP

section of the mine the drivers or motormen were working up to capacity, I would object to more loaders starting in that section unless we could get enough additional tonnage to justify another driver or motor. Knowing the character of the haul, grades, length, condition of track, etc., I could tell pretty closely what a driver or motorman should do in a day. Devoting all of my attention to the haulage in one mine, I could keep posted as to details and adjust the methods of handling the work to the constantly changing conditions.

Later as superintendent of one mine, I delegated the direction of the haulage to a mine foreman and he to his boss driver. With one

I found it physically impossible to get around over the work and keep in close personal touch with it. I could not possibly check the work performed by the several foremen nor advise with and give them the benefit of my own experience. In the office I could check the total cost, and underground I could follow the general system, but there were many important parts that I could not get completely and accurately as I had done when underground constantly. I therefore wanted some system that would enable me to dig out the details wanted and, at the same time, give a broad view of the situation. To accomplish this we developed what we call our tonnage map.

The straight lines shown in Fig. 1

* Mine Manager.

make a skeleton map of the mine. The large numbers are the check numbers of the men working in the several places, and the small numbers show the number of cars from each place each day, and those underscored show the total on Sundays.

On the first day of each month a draftsman makes the skeleton map of the mines. Also on the first of the month the mine foreman sends in a list of the check numbers working in his mine and the name of the place from which the coal on that check will come.

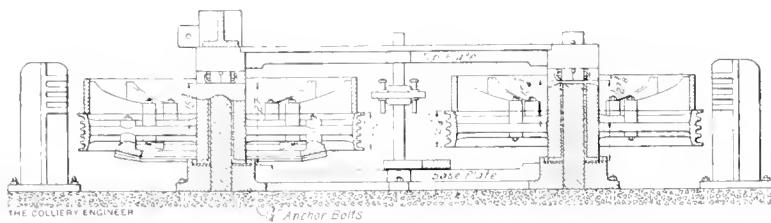

FIG. 1. LONGITUDINAL SECTION OF ROPE SHEAVE

This is entered on the tonnage map. The tippie clerks send in carbon copies of their daily weight sheets and the cars on each sheet are entered on the tonnage map daily just as they are entered on the pay roll by the pay-roll clerk. When no coal is loaded on any check a cipher is marked on the tonnage map. This with the totals each Sunday make it easy to check tonnage produced in any place or any section any day.

In addition to the haulage, we have found these maps very useful for other purposes; for instance, we pay about 3 cents a ton more for coal from narrow places than we do for coal from wide places. The rates for coal that are turned in by the mine foremen are checked on the tonnage map, and several times we have caught mistakes in rates promptly. It also enables us in the office to keep close tab on the pillar work to see that the proper tonnage is coming from the pillars, investigation underground can be made promptly, where otherwise bad practice might go for several days before it would be caught.

Repairing a Large Rope Sheave

Method of Reenforcing the Wheel by Which Breakdown and Delay of Operations Were Avoided

By H. L. Handley

THE New Mexico-Colorado Coal and Mining Co. is operating an endless-rope tramway 1 mile long at Yankee, N. Mex. The grades on this tramway are very irregular, varying from a level grade to a grade of 21 per cent. in favor of the loads. The average grade is 11.2 per cent.

rope to be wound screw fashion around them, it being fed in on one side of the machine and out on the other. The manufacturers of this machine claim that after 35 years' experience in the manufacture of drums and sheaves for inclined planes they have found this to be the best endless and tail-rope haul-

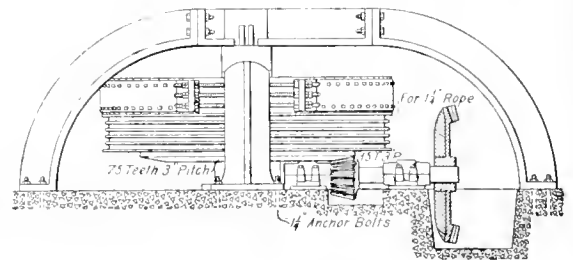

FIG. 2. REAR VIEW

The cars are fastened on to the rope by means of screw grips. Two cars are run in each trip and trips are spaced 400 feet apart. There are 26 loads and 26 empties on the tramway at all times. The empty cars weigh about 1,700 pounds and the capacity of each car is 3,000 pounds of coal, making a load of 61.1 tons traveling with the rope down the hill and a load of 22.1 tons traveling up the hill. The rope is $1\frac{1}{4}$ -inch Hercules patent flattened strand which weighs $14\frac{1}{2}$ tons. The weight of pulling load on the drum is 97.7 tons, making the actual load carried by the drum 10.8 tons.

The drum consists of two cast-iron sheave wheels 81 and 91 inches in diameter, respectively. The front sheave has four grooves and the back one five grooves. The sheaves are mounted tandem, allowing the

age apparatus, and that sheaves mounted with the shafts vertical give much better service than those with the shafts horizontal. This may be the case when the tramway works entirely by gravity, but the writer is at a loss to understand why a machine should be mounted in this way when power is to be applied to the machine at any time. The engineers contended that this installation would need power for its operation at certain times when the conditions were not favorable and it has been demonstrated that power is needed at most times for the purpose of bringing the machine into motion. However, the tramway will operate by gravity when once brought into motion and will work by gravity for several hours when the conditions are very favorable. It is a lamentable fact that the conditions cannot be governed by mere man.

When received from the factory the machine did not have the large semicircular brace over the top end of the rear shaft shown in Fig. 2 and no means were provided for preventing lateral motion in the rear

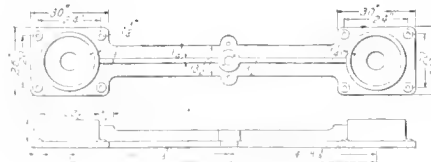

FIG. 3. BASE PLATE

shaft. It will readily be seen that any motion in the top of the rear shaft would cause the large rack to raise out of mesh; also the bedplate was entirely too light to prevent this wobbling when power was applied. The brace was bought after three teeth had been broken from the rack. A piece of the rack was broken out, new teeth dovetailed in and the piece replaced by means of splices on the back of the rack. The brace was then put on and the gears have given no further trouble.

After the machine had been in use about 3 months a fracture appeared in one of the spokes next to the rim. The machine was kept in use and the second day two other spokes broke at about the same places in the spokes. It was then ordered that the machine be stopped for repairs and triangular pieces of $\frac{5}{8}$ -inch boiler plate, *a* Fig. 4, were cut and placed around the circumference of the wheel. These pieces were bolted with their apexes to the spokes and their sides to the lugs on the rim. This formed a wheel of smaller diameter inside the rim and had the effect of transferring the stress from the rim to the spokes closer to the hub of the wheel. The spokes, however, continued to break until there were none left. This did not seem to have any bad effects on the working of the machine, only relieving the internal stress in the rim. The rim had expanded until the fractures in the spokes had each opened up about an eighth of an inch. These cracks opened and closed as the wheel revolved, owing to the shifting of pressure on the rim. It was anticipated that the rim would give way on account of this continual working, but it was desirable to work the machine as long as possible so as to avoid shutting the plant down to change wheels. The wheel was not considered dangerous, as the speed was never more than twenty revolutions per minute.

The machine ran in this way for about 4 months and in the meantime the spokes on the front wheel

gave way in the same manner. Similar plates were placed in the front wheel and it has given no further trouble.

When the rim of the rear wheel started to give way it was simply by

A new wheel which was already on the ground was put into place. Before placing this wheel, the rim was sawed square across the face and lugs bolted on. The wheel now acts the same as a split-rim wheel.

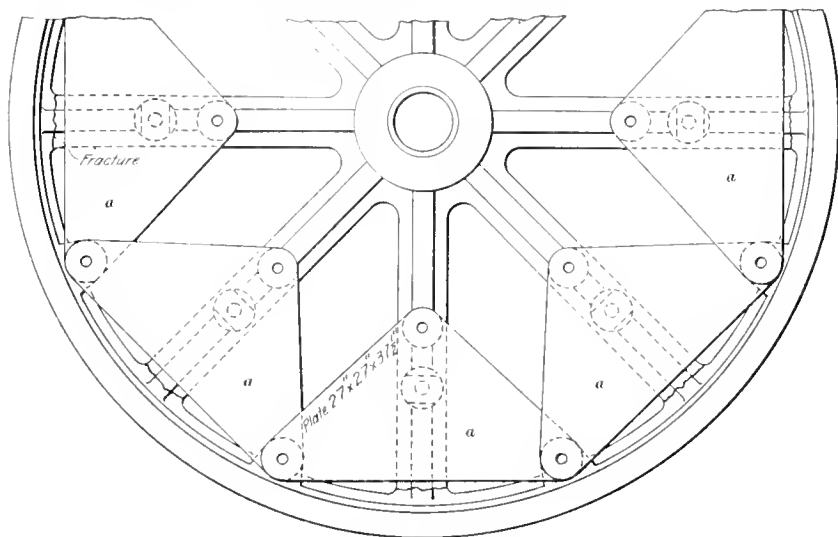

Plan of Rear Wheel

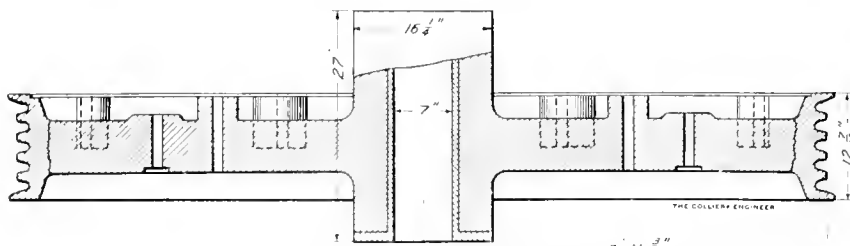

Cross Section of Rear Wheel
FIG. 4. SHOWING BRACES

fracture square across the face of the rim. The machine was put back in motion and in about 2 hours another fracture appeared across the rim about 2 feet from the first. The machine was then shut down for repairs and patches were placed over the breaks. Things then worked nicely for about 6 weeks without mishap. At this time three more fractures occurred in the rim; however, the wheel continued to run and hold its weight. It was deemed advisable to make further repairs on the wheel. Babbitt was poured into the cracks at the ends of two of the spokes when the rim was farthest away from the spoke. This lengthened the rim so that one of the patches was torn off and the wheel went to pieces. No damage was done but the wheel was only a mass of small pieces.

This tends to relieve the stress between the rim and spokes. The machine is now working without further trouble.

來 來

Preventing Timber Decay

At mines where the air is heated and saturated at the intake and in instances where the intake air is saturated by water spray, the life of the entry timbers is shortened to 8 or 9 months and even less in some cases. Timber sets, two legs and a collar, are expensive when the cost of timber, the work, and framing is considered. Therefore, the necessity of treating the timber with some efficient preservative, like creosote, to resist decay is apparent if economy is an item. Warm, dry air induces "dry rot," and warm, moist air induces "wet rot."

Longwall Mining in Illinois

A Description of the Methods in Use at the Mines of the Spring Valley Coal Co.

By S. M. Dalzell*

IN THE northern coal fields of Illinois, on account of the thin vein, the coal is usually mined by the longwall method. One of the largest and best known coal companies in this field is the Spring Valley Co. This company, whose property comprises over 33,000 acres of coal in Bureau,

*General Manager, Spring Valley Coal Co., Chicago, Illinois. Read at the Mining Conference in connection with the dedication of the Mining and Transportation Buildings at the University of Illinois, May 9, 1913.

LaSalle, and Putnam counties, operates four large mines in the vicinity of Spring Valley.

The vein worked is known locally and commercially as the Third vein, but its position in the geological series is that of No. 2. It averages 42 inches in thickness and has no

distinct partings, but mines in rectangular lumps, which stand a large amount of rough handling without breaking.

The vein is immediately underlaid with a seam of fireclay from 6 to 24 inches thick, and the coal is undercut in this clay so that the full thickness of the vein is available for commercial purposes. The accompanying plan shows the method of opening the mine, it being known

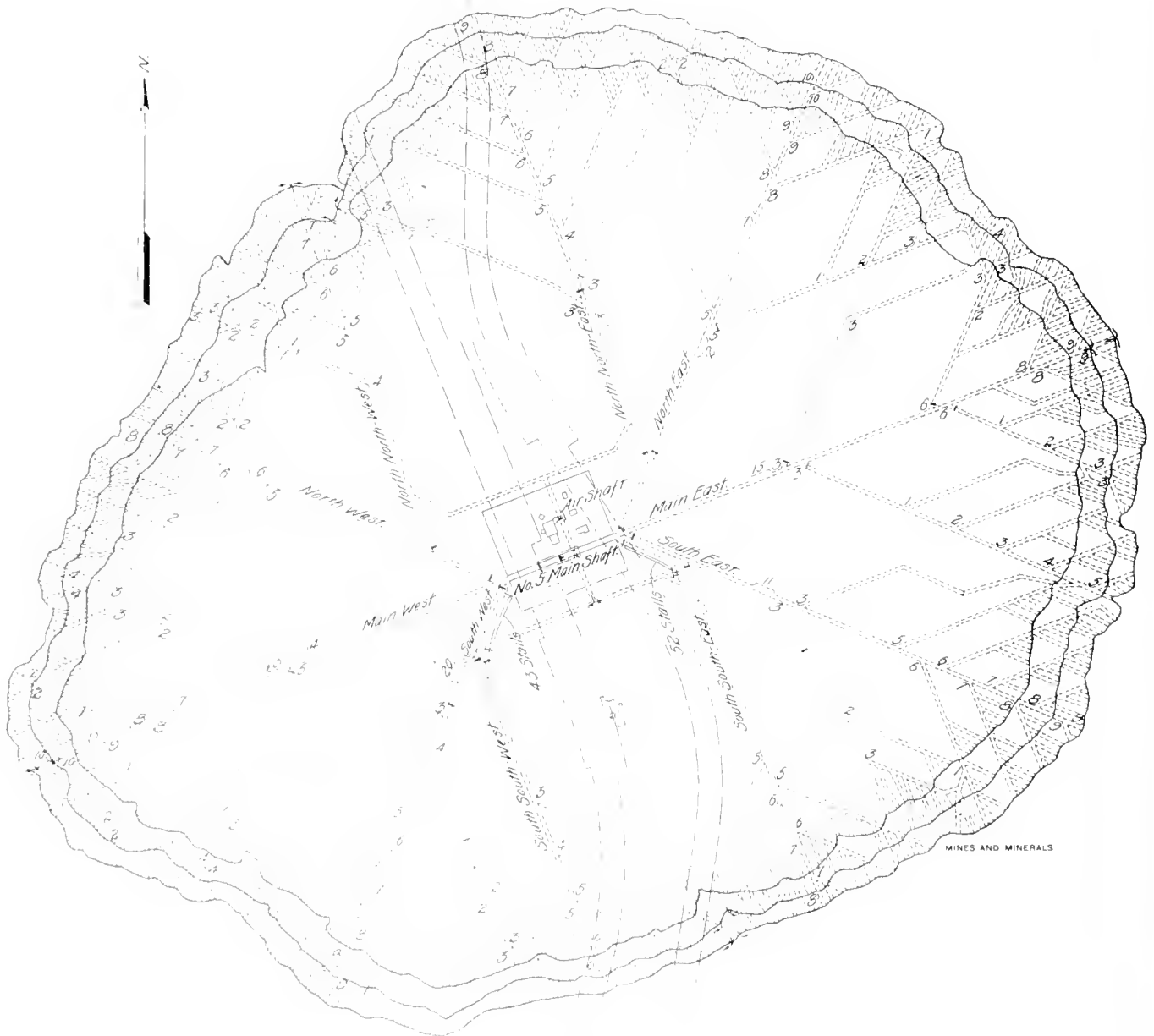

MINES AND MINERALS

PLAN OF SPRING VALLEY MINE

as the Scotch system. The object is to mine the coal in as near a circle as possible. To this end, after leaving the shaft pillar, permanent entries are laid out to the north, east, south, and west; and further divided by entries between at an angle of 45 degrees. As the mine advances, these permanent entries are further subdivided so as to have a permanent road at intervals of from 1,000 to 1,200 feet for the purpose of ventilation and haulage.

From the permanent entries temporary loads are turned off right and left at an angle of 45 degrees, and at intervals of 225 feet. There is no specified distance for the length of these roads. The road advances until it intersects another road from one of the other permanent entries, and at this point one of the roads is stopped, the length of haul, conditions of roadway and other local conditions determining which one is to be advanced.

From these temporary roads rooms are turned off at an angle of 45 degrees at intervals of 60 feet and driven through to the road ahead, or about 200 feet in length. This gives each miner a working face of 42 feet, or 21 feet from the center of his room in both directions.

Longwall mining contemplates the removal of all the coal on the first attack, thus leaving no pillars of coal to be recovered by robbing. In place of pillars, pack walls of gob are built up from refuse in mining, to sustain the roof. As the miner's contract calls for the brushing of 24 inches of roof, there is always plenty of material for this purpose. In fact, the excess of this material accumulated in actual mining, together with that caused by falls in the permanent entries, all of which has to be hoisted on top and dumped, adds considerably to the cost of mining.

In this district, as has been said before, the coal is undercut in the fireclay immediately under the coal. It is only necessary to make this cut from 8 to 18 inches. The miner

makes his undercut along his entire face, supports it with sprags and leaves it to stand over night. In the morning the sprags are knocked out, and under normal conditions the roof pressure is sufficient to bring down the coal, it falling out in large blocky lumps. If it does not thus fall, the miner brings it down by means of an iron wedge driven into the face of the coal, so no shooting is necessary.

The road is in the center of the room and the miner has to bring his coal a maximum distance of 21 feet. The mining and rock are thrown back on to the building.

At the angle between the rooms and entries, a cog or cribbing is built of timber, triangular in shape with a base of about 6 feet. About this, the pack wall or building (as it is called locally) is formed and carried ahead as the face advances. Between the building and the face, a row of props is placed to support the roof while the undercut is being made. On account of the roof conditions, this space is not of sufficient width to permit the use of mining machines and consequently none are used by this company. The props are allowed to remain in and the building is built in around them.

The mine is ventilated through the permanent entries as intakes and returns. The air is all carried directly to the face by different splits of sufficient number to give all the working places an equal quantity of air, and travels along the face of the coal to the return. All overcasts are made of brick and steel in a substantial manner and have an area of about 42 square feet.

Ventilation is induced by a 12½' × 5' blowing fan, of the Capell patent, direct connected to a 15" × 15" engine and furnishing at 140 revolutions per minute 110,000 cubic feet of air per minute at 1½-inch water gauge, equivalent to a ventilating pressure of 7.8 pounds per square foot. All the fans of this company have a recording chart which shows the water gauge for 24 hours. These fans can be used

as exhaust fans should the occasion arise and are incased in brick and steel housings.

Each mine is equipped with a complete telephone system of its own, consisting of from 12 to 14 phones. There is also another system connecting all the mines to the central office at Spring Valley; so that in case of serious accident or fire, not only could all the miners in that mine be quickly informed, but help could be immediately summoned from all the other mines.

In order to reduce the danger from fire to a minimum (which is the chief source of danger in this field, there being no gas), all the timbers have been eliminated on the shaft bottoms. Solid masonry walls support the 15-inch I beams forming the roof. These I beams are 15 feet long, 4 feet center to center, and extend to a distance of about 250 feet on each side of the shaft. As a further precaution, the bottoms and stables are lighted with electricity.

As the Third-vein field lies at a depth of about 400 feet, the coal is all hoisted from shafts. At No. 1 and No. 3, double-deck cages are used, but at No. 4 and No. 5 tandem cages are used, the latter proving much better in every way. As in most essential particulars the equipment of all four of the mines is the same, a description of one will do for all. The following applies more directly to No. 5, which is the most modern plant.

The hoisting shaft is 13 ft. 8 in. × 17 ft. 4 in. outside, and 12 ft. × 16 ft. inside. The wall plates are 6" × 8" sticks placed skin to skin, with 6" × 8" buntions to separate the shaft into two compartments 5 ft. 7 in. × 8 ft. The escapement, or air-shaft, 9 ft. × 13 ft., has two compartments; the airway being 6 ft. ¾ in. × 7 ft. 10¼ in., and the stairway 5 ft. × 8 ft. Between the airway and stairway a partition is constructed of 1-inch rough boards nailed to the buntions and covered with ¾-inch matched boards.

The top of the hoisting shaft out-

side of the shaft timbering, is surrounded by a 2-foot masonry wall, which goes down to bed rock.

The cage guides are of standard 60-pound steel rails.

The tower is steel and is equipped with steam transfer tables and Ramsey pushers. To those who are not familiar with the operation of this combination, a short description may be interesting.

The manner in which the cars are moved is as follows:

When either cage, the right one for example, reaches the top with a loaded car, an empty car is already in position on the right transfer table, immediately behind the cage. The tracks on the transfer table and those of the cage are directly in line with those of the tippie. On the same line and directly in the rear of the empty car is the pusher, and as soon as the cage is brought to rest, steam is let into the pusher cylinder. This piston moves forward and pushes the empty car against the loaded one, which is in turn pushed off the cage and the empty car takes its place ready to descend. This arrangement is duplicated for the other cage which is now at the bottom of the shaft, and the transfer table which is at the outer left-hand side of the building, ready to receive an empty car on its return from the tippie. The loaded car which has just been pushed off the cage moves forward with the momentum given by the pusher; passes onto the tippie and is dumped. It then passes over a Phillips cross-over dump and is switched on to one end of the return tracks which pass to the rear on each side of the cage frame. The empty car moves along the track until it passes on to the transfer table, which is now in the lower and outer position near the side of the building. As already stated, the transfer tables are in duplicate, one on each side of the center line of the building which is parallel to the tracks leading from the cage to the tipples. The transfer tables move on tracks at right angles to the tippie tracks. When

either transfer table is in the position first described, it is at an elevation of about 3 feet above, and a distance of about 12 feet inward, toward the centers of the building from where it receives the empty car on the return track. The tracks on which the transfer tables move are therefore on an upward grade from each side of the building toward the center.

Both tables are operated by a steam cylinder, underneath the transfer tracks, which has a through going piston rod. A continuous wire cable, to which the transfer tables are attached, runs around a sheave at each side of the building, returning underneath toward the center, and has its end attached respectively to the opposite ends of the piston rod. As the piston moves from one end of the cylinder to the other, the transfer tables are moved one up to its position behind the loaded cage, the other down to its position on the return track.

Both the transfer tables and the pusher are operated from the same position by the cager.

The cars, in passing from the cage to the tippie, pass over a double cross-over or diamond switch, whose latches are controlled by a lever placed near the tippie, so that the man at the tippie can send a car to either one of the two tipples at will. While there are two rock tracks outside of the return empty tracks, the rock is generally sent over on the same track all at one time, as it causes less confusion on the tippie when handled in this manner. The rock is dumped into a special car and hauled up an incline by wire rope and dumps automatically by means of a trip placed in the center of the track.

The cages are hoisted with $1\frac{3}{8}$ -inch crucible steel rope over 10-foot head-sheaves and furnished with Humble detaching hooks. These hooks are for the purpose of preventing the cage from being pulled over the head-frame in case of an overwinding. They consist of four steel dogs interlocked in a steel

frame by means of a copper rivet. To the upper end of the hook the rope is attached, and the cage to the lower dogs. These lower dogs extend out from the body of the frame about 3 inches in the form of a door latch. In action, this hook passes through a circular plate, the diameter of the frame of the hook. The latches or projecting jaws are pressed together by the pull on the rope forcing them up through the circular plate and in coming together they cut the copper rivet. This releases the upper dogs, which in turn open up to release the rope, which passes out over the sheave, this action on the part of the upper dogs throws their lower ends out beyond the sides of the frame in the same position as were the lower dogs in the first position. As the rope releases, the cage drops back but these projections of the upper dogs will not allow them to pass through the hole in the plate and the cage is held there until the rope is again attached. We have had several cases of overwinding and in all cases the hooks worked satisfactorily.

Shaker screens made by the Link-Belt Mfg. Co., are used for the screening of coal, which deliver four sizes of coal known commercially as chunk, lump, egg, and screenings, loading on three tracks and also delivering to a Link-Belt box-car loader when desired.

The hoisting engine is a first-motion, double-cylinder, Corliss engine made by the M. C. Bullock Mfg. Co., of Chicago. The cylinders are 24 in. \times 42 in., with an 8-foot oak-lagged drum, provided with a steam brake, steam reverse, and a brake spider 7 ft. 5 in. \times 12 in.

The steam plant consists of six 72" \times 18' return tubular boilers with a rating of 150 horsepower at 125 pounds gauge pressure. They are all connected to a brick stack 100 feet high with an internal diameter of 7 feet. All of the engine and boiler houses are of brick or stone masonry.

In addition to the regular black-

smith and carpenter shop at each mine, the company maintains a well-equipped machine shop capable of taking care of all the necessary repairs to engines, boilers, pumps, etc. This shop, which is located at Spring Valley, is also connected by telephone to all mines; so that no time is lost from when a break-down occurs until the men are on the way to make the repairs.

In connection with the mines, the company operates a coal washer of 1,000 tons daily capacity. The raw screenings from all the mines are shipped there and run through the washer. The washer was built by the Link-Belt Machinery Co., and gives a yield of 65 per cent. washed screenings with 11,000 British

thermal units, from raw screenings having 8,870 British thermal units.

The company uses these washed screenings principally for fuel at its own plants and finds them a very satisfactory fuel. They are easily handled and do not clinker badly.

The Spring Valley Coal Co. was among the first to take up first-aid work. They have had a rescue station at Spring Valley for several years, and they sent a team to Washington and to Pittsburg to take part in the national exhibitions in first-aid and mine rescue at those cities. Recently another rescue station has been established at the No. 5 mine and equipped with the latest and most up-to-date apparatus for this work.

after the combined intellectual business ability may be unitedly applied to the furtherance of these practically joint interests.

For an Illinois industry with its millions of investments, employing over 80,000 men, an annual tonnage of over 50,000,000 tons of freight (even under the present circumscribed transportation facilities) or almost one-third of the total freight traffic of the state, and which is absolutely dependent upon the carrier for existence, is certainly entitled to the fullest consideration on the part of the carrier, a consideration which, it seems to the coal man, it does not receive.

Here are the great fields of coal, here the mines with their vast investments, here all the facilities for production; yonder the market and the consumer; between these, the only instrumentality by which the products can reach the market, the carrier. And lo! when the demand arises, and with it the opportunity of securing some return on the investment, the facilities for transportation can best be expressed, by what in our school days we called the unknown quantity "x," and the algebraic equation is not solved until the demand has ceased, the "period of full car supply" bobs up, and the facilities again become adequate (when they are not required).

As a result, the operator is compelled to be satisfied with a very low per cent. of car supply, his mines are thrown idle a goodly part of the time, his organization demoralized, and the investment becomes a liability instead of an asset.

Brethren, these things ought not thus to be.

His investment has been based largely upon the carrier's promises of adequate transportation facilities. Contracts have been entered into upon the same theory. Or, perchance the operator, unsophisticated as he is, has presumed upon the fact that under the common law, emphasized by statutes of the nation and state, it is the duty of the carrier to provide transportation facilities.

The Transportation Problem

From a Coal Operator's Standpoint—Present Conditions and Hoped For Improvements

By R. W. Ropiequet*

SINCE the prayer of "Bobby" Burns, "Oh wad some Power the giftie gie us, To see ourselves as ithers see us," is so seldom answered, this revelation is generally left to the kind office of friends. "Faithful are the wounds of a friend," says the wise man. And where is friendship warmer and more ardently expressed than that between coal operator and carrier? It may not be amiss, therefore, that at this love feast the operator assume the kind office of a reflecting mirror unto his transportation friends.

For the ardency of the friendship between these two is only exceeded by the reciprocity of their counter estimation. A few years ago the writer was privileged to listen to the frank expression of the transportation fraternity, who, in the spirit of brotherly kindness, expressed the opinion that the untoward conditions prevailing in the mining indus-

try were largely due to lack of management and that if the same ability were applied to this as there is to transportation the result would be more satisfactory.

Whilst the coal operator with the same kindly feeling answers in the words of that popular operetta that moved men's hearts in the days gone by:

"You're very, very good,

And be it understood,

We return the compliment."

For the coal man is perfectly satisfied that if the same business ability and acumen were bestowed upon transportation problems that are necessarily applied to mining, the ills that now beset the mining industry because of those problems would "Fold their tents like the Arabs, and as silently steal away."

Pity 'tis that these abilities should be thus wasted in misapplied channels and that the managements cannot be exchanged. But since 'tis so, it is promising indeed that the great state of Illinois has thus housed them in one structure, so that here-

* General Mgr. Royal Coal and Mining Co., Belleville, Ill. Address delivered at the dedication of the Transportation Building and Locomotive and Mining Laboratories of the University of Illinois, May 9, 1913.

And resting upon these, "With hopes triumphant over his fears," he has made his investment, opened up his mines and taken contracts, only at last to realize the full import of that

"Hope springs eternal in the human breast

Man never is, but always to be, blest."

And that while cars are "the substance of things hoped for" they remain "the evidence of things not seen"; and after many months of weary struggle, "kicking against the goads" he is forced to content himself with a theory of a "non-discriminatory proportionate distribution of available equipment in times of car shortage," and non-discriminatory phase forgotten when applied to specially favored, temporary, whole output mines. 'Tis true that the misery is equalized, but that does not make it less. It simply "rubs the sore where you should apply the plaster." "Misery may love company," a philosophy I am forced to admit quite prevalent amongst coal men, but when you ask for bread and receive a stone, gnawing the stone will not lessen the gnawing pains of hunger; and while the fact that your neighbor is hungry may help you, philosophically, if you are so inclined, it does not remove your own distress, and to this consolation aptly apply the words of Tenyson:

"You say that other friends remain
That loss is common to the race
And common is the common
place
And cheap the chaff, though meant
for grain."

My friends, when, due to the inadequacy and sometimes well nigh total failure of transportation facilities, the coal industry lies prostrate, thousands are out of employment, dependent communities suffer, and the coal operator stands continually on the brink of the chasm of insolvency with the roar of impending financial annihilation drowning out all their sounds, and feels the very

ground crumble under his feet as he impotently struggles to maintain his foothold—is it to be wondered that from his heart and lips there rings the cry that has come down the ages:

"Man's inhumanity to man makes countless thousands mourn."

This is not the portrayal of a nightmare, but an actuality, that so long as the transportation fraternity will hug the delusion that their duty to the coal shipper is to be measured by the single standard of the "Period of full car supply," which, to use the graphic language of Commissioner, now Secretary, Lane, "connotes the period of slack demand," and that at other periods, periods of ordinary business activity, the principle of a "proportionate, (no matter how small the proportion may be) distribution of available facilities" will satisfy the legal and moral responsibility of the carrier, so long can the coal operator look for a continuance of this blessed condition, consoling himself solely with the promise, "Blessed are they that mourn for they shall be comforted."

And the rays of light presaging the coming day of comfort already tinge the horizon.

"The morning light is breaking
The darkness disappears."

The operator who in the simplicity of his faith rested on "ask and ye shall receive, seek and ye shall find," has gone a step further—"Knock and it shall be opened unto you." And he has knocked; and the courts including the highest tribunal in the land are emphasizing the duty of the common carrier to furnish adequate transportation facilities. Whilst the carrier, awakened from his Rip Van Winkle sleep induced by imbibing the potions of legal and economic principles furnished him by the ghosts of yesterday, is arousing himself to meet the necessities of today. To complete the hymn: "The sons of men are waking to penitential tears."

Realizing that the "peak of the load" so far as the coal traffic is

concerned, is synonymous with the canon of "no car supply" (and to the operator "slough of despondency" and that the beautifully euphonious "unforeseen emergency," cannot fairly be applied to annually regularly-recurring periods of business activity, our friends of transportation have awakened to the fact that to have a maximum of transportation facilities sufficient only to meet merely the minimums of transportation necessities, and these based upon a period of business inactivity, will meet neither their legal nor moral obligations to the shipping public.

And the coal operator, like one of old standing upon the mountain top, can look into the promised land and if, perchance, like him of old, the operator of today may pass away before his foot shall touch the land of promise, he may at least rest in the assurance that those to follow may be able to devote their time and attention to the operation of their industries and not be compelled to wear life away sitting in the ante-room of the mighty, awaiting the opportunity to secure a few crumbs of comfort doled out charitably by the hands of the transportation potentates.

Give unto the coal operator the power of these potentates and this day will be hastened.

What principles would he apply to the adjustment of the transportation problems affecting his own industry?

First, foremost and all the time: Service! Action, action, action, may be the secret of eloquence, but service, service, service, is the fundamental basis of transportation.

The operator would recognize:

"Let him that would be greatest among you be one that serves."

That it is the duty of the common carrier, inherent in the privileges granted it as a quasi-public corporation, indeed, the actual consideration for the granting of these privileges, to supply transportation facilities to meet the ordinary and usual demands of the shippers de-

pendent upon it; and failure in this regard should be called to account by those from whom these privileges have been received, and the carrier be compelled to perform them; and that the victims of this failure and delinquency ought not to be relegated to seeking relief in the courts.

The coal operator wants cooperation not strife, cars not damages, service not law suits. The state has placed upon the operator great burdens in the conducting of his industry. The carriers have received from the state great privileges and with them there has been placed upon them corresponding obligations to meet the transportation necessities of their shippers, including even coal operators.

As the state compels the coal operator to meet the statutory requirements, so the state should also compel the carriers to meet the requirements imposed upon them by statute.

Then, based upon this one all-inclusive principle of service, were he the transportation potentate, the coal operator would furnish transportation facilities reasonably adequate to meet the transportation requirements of the shipper at the times when these requirements usually arise; the duty to furnish these facilities not to be measured or limited by the demands in periods of business inactivity or non-activity.

Second. The principle of "unforeseen emergency" would apply to emergencies that could not and should not have been foreseen; using the bone of "proportional distribution of available equipment in times of car shortage," only as a regulation between and as affecting the victim of the shortage, and not as a cloak of charity to cover the multitude of transportation sins of the carrier.

Third. As a carrier, he would perform the statutory duties of providing the necessary transportation, and if habitually unable to perform these, give back unto those from whence they were received the com-

mission, the trust, the privileges granted by the state, the granting of which were conditioned upon the performance of this duty.

Fourth. Make rates or charges for services based upon scientific principles and not upon a hit-and-miss plan, taking as fundamental if you will "what the traffic will bear"; that is, rates based on giving to the shipper the service to which he is entitled, so as to freely move his product, with the least possible burden on the consumer, and permitting the carrier to secure a revenue commensurate with the cost and character of the service rendered; not however, robbing Peter to pay Paul, and making the low-grade traffic, such as coal, bear the burden of other traffic, and especially not that of the favored traffic shipped by great interests controlling the carrier, nor the frills, fads, fancies, and follies of railroad eccentricities and speculation.

Fifth. Not to place upon the shipper the consequences of the excessive "borrowing" propensities of other carriers, so often used as an excuse by the carrier for its failure to perform recognized duties; which since the remedy lies altogether in the hands of the carrier, should to said carrier be charged; and if unable to remedy this situation, place it in the hands of the regulating bodies of the country for its solution.

Sixth and finally, to use the words of the Interstate Commerce Commission, so far as the coal traffic transportation facilities are concerned, at least, he would nationalize them.

Secure a careful, impartial, and scientific investigation of the actual needs for transportation of the various sections based upon the consumptive requirements of the fields to which these naturally contribute, and the various periods when these needs arise, and ascertain how many cars will be required, approximately, at these various times by each of the different carriers and by all of them unitedly.

This united requirement he would fairly proportion between the various carriers, each to be required to secure and furnish its proportionate number, all of the equipments to move freely, nationally, as in the case of other equipment, and under rules prepared and enforced by the Interstate Commerce Commission; the distribution between the various divisions to be made by one central authority, and based upon the requirements as shown by the investigation and upon the theory of distribution now prevailing in times of car shortage; applying to this problem the same unity of action that is now evidenced in rate making, and which, we are reliably informed is not the result of any combination.

This may be but the dream of an operator, but it would appear to meet some of the conditions, overcome the effects of the borrowing propensities of the various carriers, would demand of each and all of the carriers no more equipment than would be reasonably necessary to move the products of the mines at the time the transportation is required; would obviate to a large extent the waste of idle cars, which must result when the duty is individualized; render stable the productions of coal and its movement to the market; insure to the producers and carriers the placing of the production and movement on foundations of uniformity and stability; permit scientific rate making and a fair return on the investment of both carrier and coal operator, without placing upon the consumer as much of a burden as he is now subjected to because of the speculative conditions inherent in and necessarily produced by the unstable and irregular transportation, and therefore production conditions, as they exist today.

This may be but the vision, the fabric of a dream, utopian, impracticable and non-conducive to the desired result. If so, let the men of transportation, learned in its science and practice, produce the remedy; the present plans certainly are inefficient.

And now, in behalf of the coal operator, permit me to express the wish and hope that the present occasion may be the harbinger of a new day, the commencement of a new era in transportation; and that the housing of the coal industry in the transportation building, by this great state, may be emblematic of the gathering under the all-protecting wing of Transportation, of the coal industry, and that again to invoke the spirit of the Scottish bard:

"That coal and rail the world o'er
May brothers be for a' that."

采 采

No. 2 Mine of United Coal Mining Company

*By C. M. Moderwell**

The No. 2 mine of the United Coal Mining Co., is located about 3 miles east of the village of Christopher. This location was selected because, while not exactly in the center of the field which it is to develop, it is as near to the center as the nature of the surface would permit.

The railroad tracks forming the working yard run in an easterly and westerly direction, with the empty storage tracks on the west. The connection from the Illinois Central is made by a spur coming in from the north which forms a Y, connecting both empty and loaded yards. The C. B. & Q. comes in from the south in the same manner. The mining plant is located within this double Y, which makes a convenient arrangement for the handling of empties and loads and also for the receiving of mine supplies.

The tracks are equipped with railroad track scales on the empty side and also with scales for weighing the loads.

The mine was planned both above and below ground to produce ultimately 4,000 tons of coal in an 8-hour day. Each unit of the plant was carefully planned with a view

to not only meeting the large capacity required, but to enable this amount of coal to be hoisted, screened, and prepared for the market in the best possible condition and at lowest expense.

The tippie is of the four-track variety and is equipped with a steel rescreening plant with a bin capacity of 1,000 tons and a screening capacity of 1,800 tons daily. The steel tippie is complete with weighing, screening, and loading equipment. A combined power plant includes hoisting engines, electrical equipment, water-tube boilers, boiler house coal conveyer, including overhead steel storage tanks for delivering coal to automatic stokers, ash handling equipment with an ash tunnel under the boilers and steel ash car and hoist for delivering ashes into a hopper located outside of building, the usual repair and blacksmith shops, supply house, etc. There is also an auxiliary air plant in a separate compartment for hoisting men and material during working hours.

The ventilating plant consists of a Clifford-Capell 16-foot fan housed in steel, direct-connected to a Chuse four-valve engine housed in concrete. There is also a complete water system, consisting of a reservoir, electric driven pump, elevated steel tank, and distributing system. The entire plant is of concrete, steel, and brick construction, and is as near fireproof and permanent as possible.

The mine is laid out underground to fit as nearly as possible the conditions found in the No. 6 seam in Franklin County. It is being worked on the panel system and it is proposed to take the pillars in retreating. The seam of coal averages about 10 feet in thickness and about 2½ feet is left up for roof in the first mining. This top coal is taken down when the pillars are drawn.

As the Franklin County field is a comparatively new one, the experience of the operators in that field does not permit of a statement as to

the amount of coal recovered, but it is supposed that the total recovery will be about 80 per cent. of all the coal in the ground. If commercial conditions justify, it might be possible to recover more of the coal.

The mine at the present time is producing about 2,500 tons per day, but has something like 200 rooms turned which will be available for quick development when needed.

Underground the cage room on the loaded side is equipped with a Jeffrey car haul which brings the trip down to an automatic car stop which releases the cars one at a time as they are caged. The main haulage roads are laid with 50-pound steel, the cross-entries with 30-pound, and the rooms with 20-pound. A 4-ton car is used and the mine is equipped with electric motors, both haulage and gathering. Overcasts are built of steel and concrete and permanent stoppings are built of brick.

The life of the mine is estimated at 30 years, and in that time it is expected that about 1,500 acres will be worked out. On the basis of 200 working days, it is expected the ultimate capacity of the mine will be 700,000 to 800,000 tons.

NOTE.—An illustrated description of this mine was published in the issue of this journal for October, 1912.

采 采

Briquet Production in 1912

According to E. W. Parker, of United States Geological Survey, there were 19 briquet plants in the United States in 1912. In 1907 the production was 66,524 tons, in 1912, 220,064 tons. The largest producer is the Berwind Fuel Co., Superior, Wis., which has a capacity of between 35 and 40 tons an hour and last year produced a little over 50,000 tons of briquets. In manufacturing briquets, seven concerns used anthracite culm, nine used bituminous or semibituminous slack, one used oil residue, one mixed anthracite culm and bituminous slack, and one used peat.

* President United Coal Mining Co., Chicago, Illinois. Paper read at the Mining Conference held at the University of Illinois, May 9, 1913, in connection with the dedication of the Transportation Building and the Transportation and Mining Laboratories.

Gas Power for Collieries

Use of Coke Oven Gas in Large Engines at Bargoed Colliery—Methods and Apparatus for Cleaning the Gas

By Sydney F. Walker*

IN BRITISH collieries the cost of producing and marketing the coal is so steadily increasing, owing to a variety of causes, that colliery managers and mining engineers are obliged to look more and more into costs to economize in production. As in the majority of cases where any product is produced for the market in large quantities, the tendency is not to consider the value of that which is used about the works. This applied particularly to the use of coal for supplying the furnaces of

changed; indeed the whole system of marketing the coal has been changed, as 25 years ago small coal, practically unsaleable, ranged in value from 12 cents per ton up to a little over 50 cents; and now, with the revolution that has taken place, small coal is not of much less value than lump coal. The adoption of the mechanical stoker in works where steam power is employed, has

side collieries situated nearby.

In deciding the question of the most economical source of power for driving the electric generators, steam has to compete with gas in two forms: that produced from coke ovens, and that from producer plants. Coke-oven gas has the advantages, that it is a waste product, and has a much higher calorific value than producer gas. The stand-

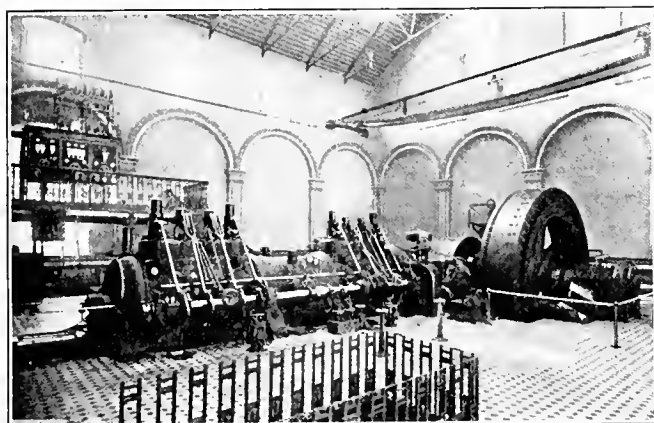

FIG. 1. TANDEM GAS ENGINES AT BARGOED COLLIERY

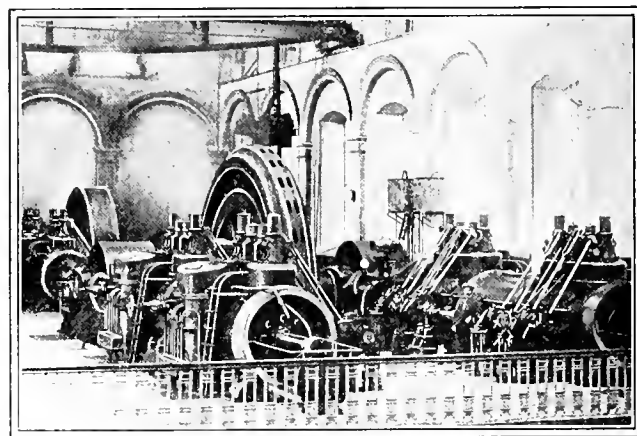

FIG. 2. TWIN TANDEM GAS ENGINES 2,400 HORSEPOWER AT BARGOED

colliery boilers. For many years, no account was kept of the coal used under the boilers, and the only step in the direction of economy was to use the poor coal when there was a brisk demand for the saleable coal. Even this policy appeared doubtful to many colliery managers; because a certain group of boilers, when fed with inferior coal, would not furnish the same supply of steam as when fed with good coal. When the coal with which the boilers were fed was unmarketable, and therefore consisted largely of incom-bustible material, the effect was serious, and as the boilers were rarely installed to do more than the ordinary work of the colliery, the result was a loss of steam, a loss of power, and a loss of coal output.

All this has been gradually

largely contributed to this effect. There is also an increasing demand for coke; and a number of collieries in the United Kingdom have constructed modern by-product coke ovens, which use large quantities of small coal.

Among other things, the colliery manager has to examine closely into the cost of the power employed in working his colliery. In the majority of mines in the United Kingdom, electric power has been adopted, partly because of the convenience and economy with which it can be transmitted, and partly because of the greater facilities a central electric generating station affords for economies in the consumption of fuel. In many districts a number of collieries are owned by the same firm, scattered over a moderately wide area, and it is becoming

ard calorific value of coke-oven gas is from 400 to 500 British thermal units per cubic foot. At the Bargoed collieries, belonging to the Powell-Duffry Co., in Monmouthshire, the calorific value of the gas produced is 460 British thermal units per cubic foot. Producer gas ranges from 120 to 150 British thermal units per cubic foot. The difference in the calorific values of the gases is due to the comparatively large quantities of hydrogen and methane present in coke-oven gas; while producer gas depends almost entirely upon carbon monoxide. In the coke-oven gas produced at Bargoed, there is 63.4 per cent. of hydrogen, 23 per cent. of methane, and 5.2 per cent. of carbon monoxide.

Producer gas may be obtained from anthracite, coke, or from the absolutely waste products of the

*Bloomfield Crescent, Bath, England.

colliery. An important question arises here, whether it is better and cheaper to buy anthracite costing from 8 to 9 dollars a ton in the Midland and Northern colliery districts of the United Kingdom, or to use the colliery refuse. Anthracite and coke can be employed in the suction producer; while the refuse can only be used in the pressure gas producer, and only then, when the plant is carefully designed for the purpose. On the other hand, the refuse is as much a waste product, as the surplus gases from the coke ovens.

In the case of the coke-oven gases, about half the total gas which is formed in the coking process, is available for outside use. One-half of the gas is employed in heating the ovens themselves; and the other half is available for power, only when the regenerative method is adopted, that is, when the gases that are to heat the ovens, are burned with pre-heated air that has passed through brick chambers that have received heat from the combustion of gases in the coke-oven heating chambers.

There are two methods of estimating the money value of the coke-oven gas: By taking its actual cost; and by comparing it with coal used for steam raising. The actual cost of by-product coke-oven gas is the cost of cleaning it. To estimate its value, compared with coal, the management at Bargoed colliery took small coal, such as they would employ in their boiler furnaces, whose money value ranges from \$1.25 to \$2.50 per ton; and whose calorific value is about 12,000 British thermal units per pound. Approximately, this makes 60,000 cubic feet of the Bargoed gas equivalent in heating value to 1 ton of small coal. But this is on the supposition that the efficiency of the small coal when burnt in the boiler furnace, and when used to produce power in a steam engine, is the same as that of the gas when burnt in the cylinder of a gas engine. As is well known, the efficiency of a gas engine may be taken as 30 per cent., while the combined efficiency of an engine and boiler plant, the boiler using small

coal, would rarely exceed 10 per cent. This would make 20,000 cubic feet of the gas, equal in heating value to 1 ton of small coal; and therefore the money value of 1,000 cubic feet of the gas would range from 12 to 24 cents. The actual cost of the gas is a very much smaller quantity. The reason for the high calorific value of the coke-oven gas at Bargoed is, the large quantity of volatile matter contained in the coal from which it is formed.

Two great drawbacks to the working of gas engines with either coke-oven gas, blast-furnace gas, or producer gas, are the possibility of tar depositing on the valve seats, and of acid finding its way into the engine cylinders, and acting chemically upon the cylinder walls, the piston packing, etc. At Bargoed, so thorough has been the removal of the sulphuretted hydrogen, and of the tar, that no trouble whatever has arisen since the plant has been put down, from either of these causes.

Some difficulty was experienced by the management of Bargoed colliery in getting a firm of gas-engine builders to construct engines of the size that were required, to use the gas that contains 63 per cent. of hydrogen, which is a very high figure; and which makes it liable to what is known as back firing but which is really preignition. In the working of the gas engine, compression of the mixture of gas and air is a necessity, so that the molecules of the gas shall have at hand the requisite atoms of oxygen for combination. Experience shows that the power obtainable from any cylinder, increases with the compression. If it were not for the possibility of preignition, compression might be carried very much further than it is. Where the gas, as at Bargoed, is so rich in hydrogen, the danger of preignition, or ignition before the compression stroke is complete, is very much increased. In the engines made for Bargoed, the difficulty was overcome by having a comparatively low compression, six to seven atmospheres; and it is stated that preignition very

rarely occurs. On the other hand, the engine will not take any considerable overload. It is well known that the gas engine can rarely be made to accept much overload; that is one point in which it is not so good natured as the steam engine. The steam engine is a willing horse; you can press it very much beyond the power it is made for, in fact up to destruction; the gas engine you cannot.

The first engines made were guaranteed to furnish 1,200 brake horsepower at 100 revolutions per minute, and to drive an 825-kilowatt alternator continuously, with an overload of 9 per cent. When under test, the engines consume 31 cubic feet of the gas at its average calorific value, per kilowatt hour; or 21.3 cubic feet per boiler horsepower. The engine consisted of a pair of cylinders arranged in tandem, as shown in Fig. 1, with the alternator as a flywheel.

It is interesting to note, that it was found quite practicable to run the alternator driven by the 1,200-horsepower gas engine in parallel with an alternator running at another colliery $1\frac{1}{2}$ miles away, driven by a reciprocating steam engine; and also with a third alternator at the same colliery, $1\frac{1}{2}$ miles away, driven by an exhaust steam turbine. For running alternators in parallel, it is absolutely necessary that the two or more machines working together, should be exactly in step; that is to say, that their currents should rise and fall with exact synchronism; and in the early days of gas-engine driven alternators this was found difficult to arrange.

A second engine, shown in Fig. 2, has since been supplied at Bargoed, of just twice the power of the first engine. It runs at 100 revolutions per minute, and consists of four cylinders, two cylinders in tandem on each side of the alternator, which acts as a flywheel.

One or two points in connection with the gas engine are worth noting. The cylinders are all horizontal, but their pistons are fitted with tailrods, which run on guides,

so that the weight of the piston is taken off the cylinder walls. This again is one of the troubles with both gas and steam cylinders, particularly when of large size, if they are fixed in a horizontal position. The weight of the piston tends to wear the lower part of the cylinder, and create windage in the upper part.

Another interesting case where gas is employed for working the bulk of the machinery, is that at the Aber colliery in the Ogmore Valley, in Glamorganshire. The coal employed is absolutely unsaleable. It contains from 25 per cent. to 30 per cent. of ash; and considerable difficulty has even been experienced in handling it in a producer plant. The coal as it comes from the pit is screened in the usual way by one of the latest modern appliances, the poor fuel being removed, partly by hand picking, and partly by gravity and centrifugal force. This is carried by a conveyer across the valley to a large bunker hopper, above two gas producer furnaces, of the pressure type. A measured quantity of the fuel is fed into a hopper forming part of the cover of the furnace, as shown in Fig. 3, and from the hopper into the furnace, periodically.

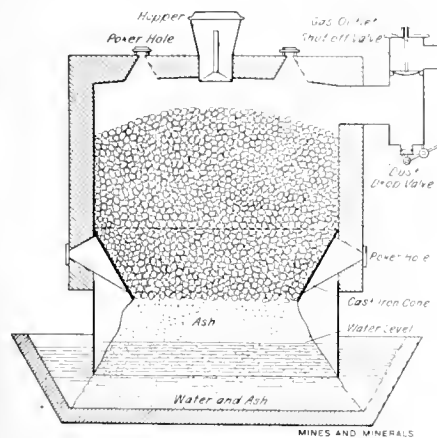

FIG. 3

Combustion is maintained by air forced in at a pressure of 8 inches of water gauge, mixed with steam delivered from a boiler at 80 pounds per square inch. A small steam pipe from the boiler is turned into the air pipe leading to the producer. The furnace is stoked from the top by means of a number of holes,

through which pokers can be passed. There are poker holes also below about the level of the grate. The furnace stands in a water seal. From the producer, the gas passes first into a large vertical delivery pipe, having an outlet valve at the top, and a drop valve at the bottom.

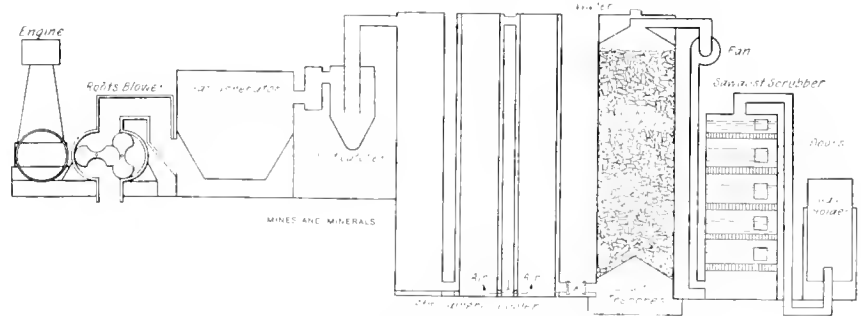

FIG. 4. APPARATUS FOR CLEANING GAS FOR ENGINES

One of the greatest difficulties experienced in connection with this gas plant was the large quantity of dust that was made. It is a difficulty which is experienced when converting all inferior coal to gas. All inferior coals contain large quantities of stone, which becomes dust in the furnace, and which has to be removed before the gas can be employed in the engine. The whole of the apparatus between the furnace and the engine is designed to remove the dust, the tar, and the ammonia. As the gas passes from the producer, it will be seen in Fig. 4 that it is made to turn twice at right angles, and that this naturally tends to throw down the dust on to the drop valve below. The drop valve is opened periodically, and the dust allowed to fall into a receptacle. The gas next passes to a dust separator, somewhat similar to those employed in flour mills, but made larger, and with stationary spiral ribs, in place of the fan usually employed in flour mills. The whirling motion given to the gas in the conical-shaped separator throws down a still further quantity of the dust which can be removed through a door at the bottom. The gas then passes out at the top of the conical separator, through the pipe shown, and thence through a series of coolers. They all consist of vertical pipes,

but the first pipe is exposed only to the cooling action of the atmosphere; the remaining six having cooling water passing down inside. Each of the other six is of the usual annular form employed in gas works. Each has two concentric tubes, one inside the other; and the

gas passes through the annular space between the tubes, water passing down the inside tube, and the outside tube being exposed to the action of the atmosphere. There are two sets of cooling apparatus, one for each producer.

From the coolers, the gas passes to the scrubbers. When the plant was first put down, coke was employed in the scrubbers, as in so many other cases; but it was found to clog so quickly that wooden grids suspended horizontally inside the scrubber, were substituted. A spray of water passes continually down over the wooden grids, and the gas passes up through them. The water absorbs the ammonia and the tar. From the scrubber, the gas passes to a dryer. In the process of cleaning the gas, it naturally takes up a certain amount of water vapor.

Evaporation, as is well known, takes place from water at all temperatures, and depends really only upon the relative vapor pressures, in this case that of the watery vapor already present in the gas, and that of the vapor issuing from the water. Water must not be allowed to enter the engine cylinder, any more than ammonia; and so the drying apparatus is added. The dryer consists of a cylinder about 7 feet high and 7 feet in diameter, at the bottom of which there is usually a certain depth of coke, but sometimes other

material such as brick ends may be employed in place of coke. Immediately above the coke are four layers of excelsior, practically wood shavings, separated by perforated diaphragms. Above the wood shavings is a layer of sawdust, and above the whole, a canvas cover, underneath the iron cover of the cylinder. The gas passes through the successive layers of drying materials,

a box of tubes, something on the line of a feedwater heater. From the boiler, the gas passes to an expansion and silencing chamber, and thence to a chimney. It was hoped that the steam generated in the boilers heated by the exhaust gases, would be sufficient to furnish that required for the producer. This has not been accomplished, and steam at present is generated in a separate

Rock Dump for Slope

By John Bamling

Some time ago I needed an apparatus for handling, or dumping, rock and bone that comes out of mines, particularly a slope. We have to handle a large quantity of rock and I was anxious to dump it quickly, because it was expensive to handle with a shovel as well as tying up many of our cars. Our master mechanic and I devised an arrangement (I may have gotten the idea from the columns of MINES AND MINERALS) which answers our purpose very well, as it dumps on either side of the track as well as in front.

The place we had for a dumping ground, was low, so that it was desired to dump on all sides. The dumping service is made out of 40-pound rails, mounted on a turntable *a*, Fig. 1. The part marked *b* is a 2-inch square axle fastened to the part *c* which is a casting that is free to turn in the parts *d* and *f*. The casting *d* is threaded so as to fasten on to the part *f*, which is a piece of 10-inch wrought-iron pipe. The part marked *e* is a casting which fastens on to *f* and also is bolted to the cross-tie *g*. The cross-tie is made of 1" x 4" wrought-iron and has a clamp *h* which bolts to it on the under side. This clamp can be loosened quickly when it is desired to move the whole arrangement forward.

來 來

A Long-Lived Leather Belt

A driving belt supplied 32 years ago for driving the machinery at the works of Vernon & Guest, engineers and machine toolmakers, of Smethwick, England, has had a remarkable record. It has been running from 9 to 12 hours a day, at the rate of 1,800 feet a minute, and it is calculated that the distance traveled is equivalent to 74 times round the world. Several other belts, 6 inches to 8 inches in width, running in the neighborhood and supplied by the same firm, have been in practically continuous operation for the past 25 years.

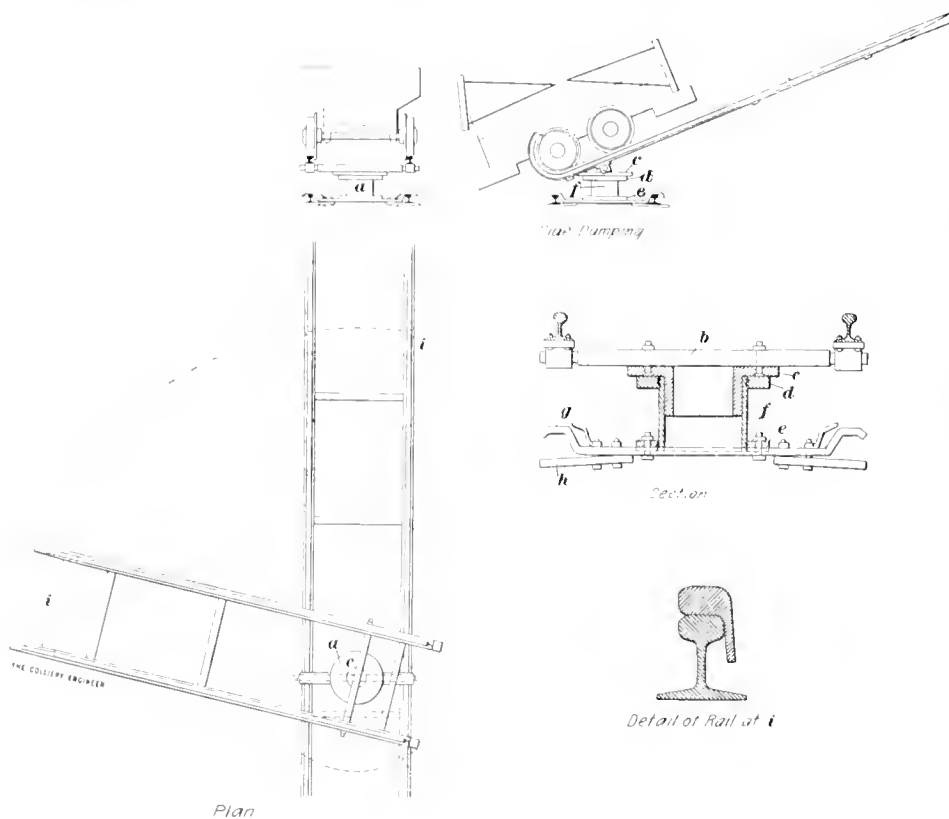

FIG. 1. ROCK DUMP FOR SLOPE

emerging, it is claimed, practically free of water vapor. It is then carried into a gas holder by means of a large gas main, to which is fitted a water trap, in case any watery vapor should have escaped. The gas engines draw from the gas holder.

It is well known that at least 30 per cent. of the heat liberated in the cylinder of the engine, passes out with the exhaust, and many attempts have been made to recover this heat by causing it to heat water, or generate steam. At the Aber colliery, a water-tube boiler is connected to each engine, the exhaust gases passing round the boiler tubes while the water inside the tubes is kept in circulation. The boiler is practically

boiler. The calorific value of the gas obtained is given as 140 British thermal units per cubic foot, which is fairly high. The running costs, however, of the plant have not come out very well, for the reason that the power required for the motors employed about the colliery is comparatively low. At present about 32,000 British Board of Trade electrical units are generated per week, at a cost of \$.87 per unit. The Board of Trade electrical unit is the kilowatt, 1,000 watts for 1 hour. The cost does not compare favorably with town generating stations, and very unfavorably, indeed, with cases such as at Bargoed, where the gases from the coke ovens are employed.

Effect of Coal Mining on the Surface

THE following observations were made in a seam 14 meters (nearly 16 yards) thick, and inclined at an angle of 34°, worked by horizontal slices in ascending order:

Experiments Regarding Increase of Volume of Crushed Material and Extent and Direction of Movement of Broken Strata

(Continued from May)

The slices, or lifts, were 2.5 meters (8 feet 2 inches) in height, and the stowing consisted of sandstones and shales, as got from a quarry. The depth from the surface of the seam at the level in question was 98 meters = 107 yards. Figs. 6 (a) and 6 (b) illustrate what occurred.

It was observed:

1. That during the removal of the first slice, the lowering of the surface gradually grew greater, and was further increased considerably by the working of the second.
2. That the movements of the surface were subsidences in the shape of a basin.
3. That the area of subsidence was about four times larger than the area worked.
4. That the maximum sinking was 1.03 meters (3 feet 5 inches) or one-fifth of the height of the excavation.
5. That the movements of the ground appeared at first at a certain horizontal distance in advance of the working face, and that this distance remained nearly constant.
6. That the subsidences increased during a certain time whilst the working proceeded.
7. That the second lift caused a total subsidence almost equal to that of the first lift. This subsidence was 1.0 meter (1 foot 11 inches) for the second; in all 1.25 meters (4 feet).
8. The area of subsidence cannot be determined, either by normals or verticals to the area worked.

ANOTHER OBSERVATION

An irregular deposit of coal lying at a depth of 58 meters (63 yards) was worked by slices or lifts in ascending order, with stowing, as before. Five lifts were removed and it was observed:

1. That the lowering of the ground was continually increasing in depth and in extent, in proportion as new lifts were taken.

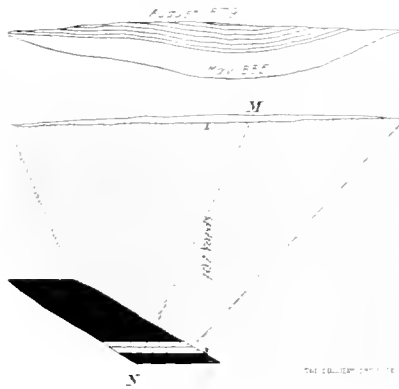

FIG. 6 (a) SECTION THROUGH C'D OF FIG. 6 (a)



FIG. 6 (b) SECTION THROUGH M-N OF FIG. 6 (b)

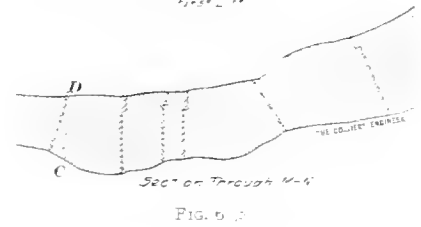

FIG. 6 (c)

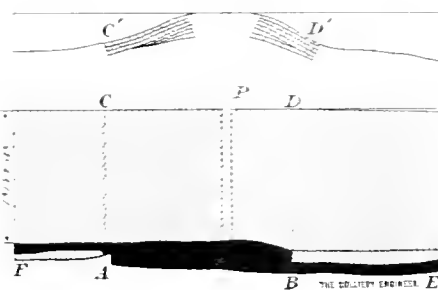

Fig. 7

2. That the area of subsidence was very much greater than the area worked out.
3. That the maximum subsidence was one-tenth of the height of the excavation.
4. That there was no connection between the area of subsidence, and the normals or verticals to the area worked.

THE EFFECT OF LEAVING A PILLAR OF COAL TO PROTECT THE SURFACE

The pillar AB shown in Fig. 7, was left to protect the shaft P, and the buildings which cover a part of the surface CD. The seam has a thickness of 18 to 20 meters (20 yards), a depth 120 meters (131 yards). On the two sides, BE and AF of the reserved block there has been worked a thickness of coal of 8 meters.

The ground has sunk in the shape of a basin on the two sides and the movement has made itself felt up to the middle of the surface CD. Masonry in regular courses and originally horizontal had taken the curvilinear inclination shown at C' and D'. The curve of the ground in the neighborhood is similar to that of the walls.

The same thing occurs around all pillars which have been left in the midst of areas of goaf, whether to preserve shafts, or for any other reason. Whatever be the inclination and the thickness of the seam, the subsidence occurs in every direction by regular curves around the pillar, and often reaches as far as the very center of the pillar.

Workings Which Have Not Caused Any Settlement of the Ground.—In general, the movement appears at the surface only when the workings have been developed to a certain extent, an extent which must be greater as the excavation is deeper, and the seam thinner. If the area worked is limited, or if, though extended, it is divided by sufficient pillars, the surface is not affected.

The removal of a block of coal

previously left in the middle of an area of goaf had been found to produce serious results on the surface, and at great distances.

FRACTURES OF GROUND, CRACKS, FISSURES, ETC.

These are generally found at the circumference of the surface affected. The basin of subsidence is usually concave at the bottom, and convex at the edges; it is at this convex part, submitted to elongating strains, that the cracks are found. When the subsidence extends, the cracks first formed close, and new ones are formed on the outer edges of the new subsidence. Cracks of the ground are generally disposed in multiple lines, discontinuous, meandering, irregular. They are sometimes very wide. As a rule they are not deep. Long and rectilinear cracks at the surface, and those which continue without interruption from the surface to the excavation are exceptional.

Different kinds of strata cause deviations and alterations of slope in fractures. Generally, the fractures in sandstone are wider, and further from one another than in shales.

CONCLUSIONS

Underground workings have very varied effects on the movement of strata; sometimes the excavation extends considerably before provoking the least subsidence; sometimes the subsidence follows step by step, so to speak, with the excavation; in certain cases the roof falls in all at once in enormous blocks,* in other cases it sinks gradually as it is lowered without breaking; gen-

erally, hard and thick rock roofs fall in large blocks, whilst soft and laminated rocks sink in a slow and regular manner.

When the roof of an excavation sinks, it first bends, and then breaks, if the excavation is of sufficient extent and height. The movement generally reaches a part of the upper mass, and sometimes extends up to the surface. After the cessation of working, the surface soon takes a new state of stability.

ZONE OF SUBSIDENCE

The shape and dimensions of the zone or area which sinks, depend on a number of circumstances; notably on the inclination of the seams, on faults, and other geological peculiarities; on the nature of the rocks; on the thickness of the beds; on the dimensions of the excavation, its depth below the surface, and the manner in which it has been made; on the amount and quality of the stowing put in. The action of water, which may be important, is not here taken into account.

In stratified deposits, the zone of subsidence is generally limited by a sort of dome, which has for its base the area of excavation.

M. Fayol adds in a foot-note that it appears to him probable that the same thing occurs in all rocks. He has proofs of it in soft unstratified deposits, but not in granite and similar rocks. The dome may be regular, irregular, elevated, swollen, flattened, etc.

INFLUENCE OF THE INCLINATION OF SEAMS, OF FAULTS, AND FRACTURES OF STRATA

If the beds are horizontal, the dome is arranged symmetrically

round its axis, which is vertical. Each of the beds included in the dome sinks in the form of a basin; the extent of the movement diminishes in proportion as it is further from the center of the excavation. If the beds are inclined the dome is no longer symmetrical, and its axis is inclined.

In proportion as the seams become more inclined, the axis of the dome is inclined also, and tends toward the horizontal; at the same time the height of the zone of subsidence tends toward zero. The axis of the zone of subsidence is quite independent of the vertical and of the "Normal" to the strata. Vertical, "Normal," axis of figure of dome, line of maximum subsidence, all these coincide, when the beds are horizontal; they are distinct, when the beds are inclined.

When the zone of subsidence crosses several groups of beds at varying inclinations, the axis of the dome is deflected in passing from one group to another, and approaches to the normal of the group in which it is. Thus, for example, in beds disposed in the shape of a fan commencing with the horizontal, the axis of the zone of subsidence starting from the vertical arrives by degrees at the horizontal. The direction of the axis of the zone of subsidence must not be confused with that of the limits of this zone (i. e., the circumscribing lines of the dome). Sometimes the axis of the zone of subsidence approaches in a remarkable manner the perpendicular to the strata, and it is this perhaps which has given rise to the theory known under the name of the "Normal."

This theory is not correct. It rests on the following hypothesis: That the fracture of the beds takes place at the perimeter of the excavation, and perpendicularly to the strata. No working of coal would be possible, if the fracture of the upper beds occurred at the perimeter of the excavation, and continued without weakening up to the surface; no mode of support would

*A striking instance of the truth of the remark occurred at Byer Moor colliery. Pillars 50 yards by 35 yards were worked by "bordways lifts," 8 feet wide, the section of seam averaging 5 feet in thickness; depth 6 ft in surface about 70 fathoms. The roof is solid "Post" (sandstone) for at least 4 fathoms up from the top of the seam. An area of about 2,500 square yards of goaf was made during a period of 3 months without any fall occurring. One day a very heavy fall took place. Warning sounds were heard about half an hour previously. The mechanical effects of the fall were similar to those of an explosion, but in a much less degree. A hewer 150 yards off had his candle extinguished, and small coals blown about. Sixty yards off two prutter boys had their caps blown off, and light extinguished. Neater, at hand an empty tray was blown off the rails; 200 ft in another place, which formed a barrier to some extent to the full force of the rush of air, a hewer was driven some 4 or 5 yards by the

back rush, and knocked over, and a full tub of coals, weighing at least 13 hundredweight, was moved some distance along the rails. The hewer happened to be a few yards back from the face, and was caught by the back rush. The face of his working place was exposed to the full force of air, as aforesaid, and stopped it, so that the air must have been violently compressed against the face, and therefore the reaction was stronger than elsewhere. Fortunately, there is no gas, and no harm was done. It is worthy of notice that the plane of fracture at the outskirts of the fall, was not vertical, but highly inclined over the excavation, in accordance with M. Fayol's statement.

A similar fall on a much larger scale occurred at the same colliery a good many years ago, but the writer has been unable to obtain particulars about it, beyond the fact that its effects were felt at the bottom of the shaft, where lights were blown out, at a distance of more than 1,000 yards from the fall.

sustain such a load; very fortunately, on the contrary, the roads at the perimeter, those at the working face, are as a rule easily kept open, when the roof has already settled down at a certain distance behind.

Fractures commence rather at the center of excavations; they are multiplied in proportion as the working face advances, and they cut up the superincumbent mass. The upper beds give way one after the other, but they do not break at the same line, as Gonot and Callon supposed.

Faults and fissures, which destroy the continuity of the beds, exert a considerable action on the inclination of the zone of subsidence; they are planes of easy sliding, along which certain movements take place more readily than elsewhere.

INFLUENCE OF THE NATURE OF THE STRATA

The nature of the strata affects the zone of subsidence variously: the hardness, elasticity, plasticity, compressibility, etc., are so many conditions which affect the result; if the ground is hard and brittle, it increases in volume very much more than if it is plastic; if it is firm and cohesive, it only yields under forces very much greater than those which suffice to draw away soft ground; if it has elasticity, it transmits to greater distances the pressures which it receives. The compressibility of rocks, after expansion, is also variable. Therefore, over identical excavation, domes are formed more or less lengthened or heightened, inflated, flattened, etc.

INFLUENCE OF THE DIMENSIONS OF THE SURFACE OF THE EXCAVATION

Above small excavations, confined domes of subsidence are formed, which increase in width and height as the empty space extends. If the roof could bend freely in proportion as the area of excavation is developed, the zone of subsidence would grow indefinitely. But allow that, the height of the excavation must be infinite. Now in practice a sinking roof is not long in support-

ing itself on the floor of the seam; and soon after the zone of subsidence ceases to extend in height; the stoppage takes place when the contact of the roof and floor is established over a certain length.

The height of the zone of subsidence of an excavation of a given height does not extend after a certain point, whatever be the extent of the area of excavation. The height of the zone of subsidence will be 10

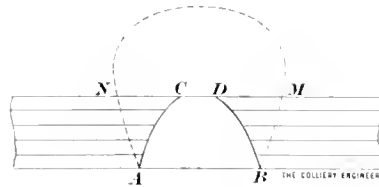

FIG. 8

times, 100 times, 1,000 times that of the excavation if the average expansion of the upper mass is one-tenth, one-hundredth, one-thousandth; but the upper movement stops, when the total expansion is equal to the space of the excavation.

INFLUENCE OF THE HEIGHT OF THE EXCAVATION

The height of an excavation does not act in a similar manner to the area; whilst the zone of subsidence increases, as far as the limit, in proportion as the excavation extends, it does not always increase when the excavation is of greater height. The subsidence and disturbances which are produced in the upper mass increase, but their area does not always extend.

However, the observations made show, that the zone of subsidence is developed more often in breadth and in height, when the height of the excavation increases, but this extension is far from being in constant agreement with that of the excavation.

An excavation of sufficient height relatively to its breadth or relatively to the depth from the surface, may give rise to peculiarities called in French "cloche" (a bell-shaped cavity), and "fontis" (a conical funnel-shaped cavity).

The "cloche" is a sort of arch

more or less irregular, which the roof, in falling, leaves in the upper mass. This occurrence is easily understood; we have seen that the first bed forming the roof breaks usually along a plane inclined over the excavation; the second bed is thus laid bare over a more restricted area, and if it breaks in its turn, it is still along inclined planes, which make smaller still the empty space; the points of support of the roof approach nearer and nearer; finally a bed is reached which does not fall, and the "cloche" is formed. If the ground line cuts the "cloche" one has a "fontis."

In this case the "fontis" may be a sort of frustum of a right cone $ACDB$ as in Fig. 8. If the strata be soft, and the height of the excavation be great relatively to the height of strata covering it, the frustum of the cone is reversed as shown by $ANMB$. A "fontis" may take all shapes comprised between the right cone $ACDB$, and reversed cone $ANMB$.

Instances of this species of fall, a "fontis," have occurred recently at Byer Moor colliery, in working the Busty Bank seam near its outcrop. At the place in question its section is from 9 feet to 10 feet thick, including from 2 feet to 2 feet 6 inches of fireclay in the middle, and there are 10 feet to 14 feet of cover, consisting mostly of clay. In working away the pillars, after removing the timber in a "lift" which has been driven as far as required, a fall usually takes place that reaches to the surface, but it sometimes reaches the surface at a point not vertically over the excavation. The soft strata run into the empty space, and then a clean break occurs, leaving an open hole, like a little pit as shown in Fig. 9.

When a "cloche" occurs above an ordinary excavation, at great depths, its consequences are hardly perceptible in the general subsidence. The material which falls first is the most disintegrated; that at the summit of the "cloche" is sometimes scarcely disturbed.

INFLUENCE OF THE DEPTH OF STRATA WHICH COVERS THE EXCAVATION

In working the same seam, one does not usually notice much difference between the movements of the roof caused by similar excavations at depths of 50, 100, 200, and 400 meters: whether it results in "cloches," falls, or subsidences, the movement of the roof seems to depend very little on the depth of the excavation.

We have seen, however, that the deflection of the first bed increases up to a certain point with the superincumbent load, and that this deflection is generally in direct ratio to the height of the dome of subsidence. But the fracture of the roof is caused more often by the weight of the first beds than the pressure of the upper masses, and much before this pressure can have produced its entire effect. It is probably for this reason that it is difficult to estimate the influence of the depth.

INFLUENCE OF THE MANNER IN WHICH THE EXCAVATION IS MADE

It is known that the subsidence is in proportion to the increase in volume of the superincumbent mass, and that the increase in volume depends on the state of disintegration of the rocks. Now it is plain that the disintegration of the beds forming the roof depends very much on the way in which the excavation is made; the working of a seam 5 meters (16 feet 5 inches) thick, for instance, will not produce the same effects, if all removed at one time, or in successive layers of 1 meter. The zone of subsidence is the most reduced, when the mode of excavation is such as to cause the greatest disintegration of the roof.

EFFECT OF STOWING

If the excavations were completely filled with incompressible material, there would be no subsidence. But ordinary stowing is not in this condition; the material employed is more or less compressible, and never fills the excavations in a perfect manner.

When the roof settles down, the

stowing opposes a resistance, which, weak at first, increases rapidly, and soon stops the movement. The influence of the nature of the stowing and its more or less careful execution is easy to recognize in mines.

The following facts have been observed at Commentry:

(a) Certain seams, from 3.28 feet to 6.56 feet in thickness, which were very difficult to keep open,

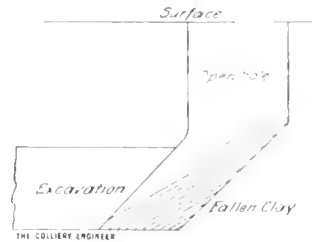

FIG. 9

when worked without stowing, have hardly required timbering, from the time they were stowed.

(b) The cost of timbering was high, and the roof always on the move near the working face, in a district of the main seam; for clay rock, which had been used for stowing, was substituted a hard rock not easily compressible; at once the roads became steady, the roof lowered very much less, and the expense of timbering considerably lessened.

(c) In the seventh and last lift of a stage of work having for roof the stowing of the stage above, the stowing was done imperfectly; the place was constantly falling, and absorbed a great deal of timber. Great pains were then used with the stowing, no smallest space being left. Soon the pressure was hardly felt at the work face; all the timber put in could be drawn.

With good stowing, one can therefore considerably lessen the movements of the roof.

Let us consider an excavation of 1 meter (3 feet 3 inches), in height. If it is left empty, the first beds of the roof will fall, expanding in volume, and will then support the superincumbent mass. Suppose that the five first meters fall, and fill the empty space at an average

expansion of 20 per cent., and that this fallen material retains after the settlement of the upper mass a permanent increase in volume of 10 per cent., i. e., in all .5 meter (1 foot 7½ inches). Suppose again that the upper strata expand, on an average, in settling down, 1 per cent. The height of the zone of subsidence will be $5 + 50 = 55$ meters (180 feet).

If it is stowed, the beds will not fall; the upper mass will sink gently upon the stowing. Allow an average expansion of ½ per cent. only, and a compression of .4 meter (1 foot 4 inches) for the stowing. The height of the zone of subsidence will be $.40 \times 200 = 80$ meters (262 feet), that is to say, 82 feet higher than in the case of no stowing.

It is true that to obtain this result, it has been necessary to suppose that the average expansion of the upper mass is 1 per cent. in the former case, and ½ per cent. only in the latter.

If the same average expansion of ½ per cent. is allowed, the zone of subsidence would be 344 feet without stowing, and 252 feet with stowing. Now there is no reason to suppose different expansions in the two cases.

The following calculations appear more probable: The excavation being 1 meter (3 feet 3 inches) in height, if it is not stowed, it may be:

First, that the roof sinks without breaking. Then with a mean expansion of ½ per cent. the height of the zone of subsidence will be 1 meter $\times 200 = 200$ meters, or 656 feet.

Second, that the roof breaks. Suppose that 5 meters fall, and increase in volume 20 per cent. and that the settlement or compression of this fallen material be .80 meter (2 feet 7 inches), the height of the zone of subsidence will be 5 meters $+ .80 \times 200 = 165$ meters, or 541 feet.

If it is stowed, and the stowing squeezes .4 meter the height of the zone of subsidence will be .4 meter $\times 200 = 80$ meters, or 262 feet.

For a settlement of .3 meter this would be only 60 meters, or 197 feet.

The stowing would diminish by one-half or two-thirds the height of the zone of subsidence, and consequently the extent of the subsidence at a given height.

DAMAGE TO THE SURFACE

On the surface, above underground workings there is sometimes a complete absence of movement, sometimes subsidence more or less considerable.

Above excavations without stowing at depths less than 100 meters (328 feet) and in seams from 1 to 2.5 meters (3 feet 3 inches to 8 feet 2 inches) in thickness, we have seen subsidences varying from 0 to 80 per cent. of the height of the excavation; above excavations with stowing, at depths between 164 feet and 820 feet, we have seen subsidences varying from 0 to 50 per cent. of the total height of the excavation.

At some points, above the main seam at Commentry, where the working had removed from 65 feet to 82 feet thickness of coal, the subsidences of the ground have reached more than 33 feet in depth.

In general the disturbance of the ground is a subsidence in the form of a basin, analogous to that presented by each of the beds included in the region affected. The subsidence is greater as the excavation is nearer the surface.

With horizontal seams, the point of maximum subsidence on the surface coincides vertically with the center of the excavation; the limits of the subsidence are placed symmetrically in relation to this point, sometimes wider, sometimes narrower than those of the excavation.

With inclined seams, the point of maximum subsidence of the ground is no longer on the vertical to the center of the excavation, nor on the line of maximum subsidence of the various beds. Whereas with horizontal seams, the basin of the upper bed coincides with the subsidence of the ground; with inclined beds, there may be a considerable distance between the maximum subsidence of

the ground and the greatest deflection of the upper bed.

The theory of the dome, as has been already said, explains different observations sometimes contradictory in appearance, which have been made on subsidences of ground.

In Fig. 10 is shown how the position of surface movements varies with the height of the ground above the excavation.

AB is the excavation; $ABCD$ the zone of subsidence.

At the level S , the ground is above the zone of subsidence; it undergoes no movement.

At the level S_1 , a small subsidence occurs, limited on the right by a Normal BC , starting from the highest point of the excavation.

At the level S_2 , the limit of the subsidence coincides on the left,

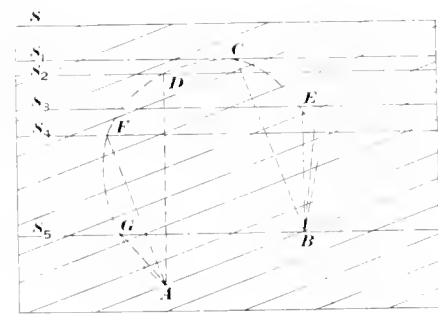

FIG. 10

with the vertical AD starting from the lowest point of the excavation.

The limits of the subsidence coincide on the right with the vertical BE , at the level S_3 ; on the left, with the Normal AF , at the level S_4 ; and at the level S_5 , with a line inclined at 45 degrees starting from the lower side of the excavation.

CRACKS AND FISSURES IN THE GROUND

The subsidence is generally accompanied by cracks which occur about the perimeter of the depression; they are rare or hardly visible about the middle of the basin.

The fissures usually lean toward the middle of the basin, and therefore over the excavation; they are directed toward the center of the curve of the portion of ground on which they are found. This ar-

rangement allows us to a certain extent to say, on the inspection of fissures, on what side the excavation is; but it does not allow us to fix either its extent or depth.

The cracks are generally discontinuous, numerous, crooked; they are distributed irregularly inside and upon the borders of the zone of subsidence. Rarely do they continue without interruption over a great length either in a vertical direction or horizontal. The width of the cracks may attain several meters. Sometimes between two neighboring cracks, a block of ground, in the form of a wedge, falls in, leaving an enormous gaping hole. Cracks sometimes form the limits of a reciprocating movement caused by subsidence at another point. In place of a subsidence, there is then, on one side, an uprising.

In spite of these various circumstances, one finds nearly always, taking it as a whole, the depression in the form of a basin; and even on ground the most disturbed by underground working, frequently one would not distinguish the subsidence from natural undulations of the ground, if the cracked and damaged buildings did not call attention.

SUBSIDENCES OF GROUND

It results from all that precedes, that subsidences of the ground depend on the area and height of the excavations, and on the depth of these excavations below the surface; that they depend also on the nature of the strata, on the arrangement of the seams, on geological circumstances, and yet other elements, without speaking of the action of water, which we have symmetrically kept apart in this study.

This allows us to understand the difficulty, if not the impossibility, of foreseeing the subsidences of the surface, to which a working may give rise. It is this, which it is most important to know. As already stated, it will probably be arrived at by analogy, after having classified and compared a great number of facts.

M. Fayol then points out, for the special purpose of arousing observations and comparisons, a sort of practical rule to which they have been led at Commentry, in strata where sandstone predominates, and for seams having an inclination of less than 40 degrees.

Height of the Zone Subsidence.
 (1) When the area worked is vast, so to speak, infinite, the height of the dome does not exceed 200 times the height of the excavation. The height of the excavation is the thickness of the seam in the case of a working without stowing; it is only the squeezing of the stowing or subsidence of the roof, in the case of the goaf being stowed.

(2) When the area worked is limited, the height of the dome is included between twice and four times the breadth of the area worked out; it is about twice for excavations less than 0.50 feet high; greater if the excavations are higher.

Amount of Subsidence.—The surface subsidence is less as the excavation is deeper.

Above a working without stowing, of a seam of 1 meter (3 feet 3 inches) for instance, the subsidence would not make itself felt at more than 200 meters (656 feet) in height; and if the dome of the movement attained this maximum, the subsidence, nil at 200 meters above the excavation, would be about from .40 to .50 meter (1 foot 3 inches to 1 foot 7 inches) at 100 meters (328 feet) height.

If the same seam was worked with stowing, the movement would not extend more than 80 meters (262 feet) in height (supposing a compression of the stowing of 40 per cent.). At 80 meters (262 feet) above the excavation, the subsidence would be nil; at 50 meters (164 feet), it would only be from .10 to .15 meter (1 inches to 6 inches).

If the area worked was reduced to 40 meters (131 feet) in breadth, with or without stowing, the zone of subsidence would not exceed 80

meters (262 feet) in height. But at 50 meters (164 feet) above the excavation, the subsidence would be, in the first case, with stowing, from .10 to .15 meter (4 inches to 6 inches), and, in the second, from .30 to .35 meter (12 inches to 14 inches).

The working of a seam 4 meters (13 feet) thick would produce the following movements:

	<i>Maximum height of the zone of subsidence in yards</i>
Area of excavation unlimited, without stowing.....	574
Area of excavation unlimited, with stowing (compression 40 per cent.).....	350
Area of excavation limited, 164 feet in breadth without stowing.....	219
Area of excavation limited, 164 feet in breadth with stowing.....	109

It is not claimed that these figures are precisely accurate. They appear to be only applicable, in some degree, to strata consisting for the most part of sandstone, and having an inclination less than 40 degrees.

MEANS EMPLOYED TO PROTECT THE SURFACE

Subsidences of the ground may be prevented by thoroughly filling the excavations with incompressible material. But this process is costly and sometimes impracticable. It is more easy to protect the surface by leaving pillars in the middle of the portions worked. This process has been recognized everywhere as efficient, and it is the most generally employed. A knowledge of the laws which govern the propagation of the movement of strata, will very much facilitate the determination of the plan to follow in working in order to protect any portion of the surface.

As one penetrates further into the ground, one may increase the dimensions of the pillars worked, and the proportion of the area worked relatively to that of the blocks left, keeping account of the height and breadth of the zones of subsidence, so that the different zones remain distinct, the one from the other.

This general rule is susceptible of many combinations according to the thickness, inclination, number, and depth of the seams.

Reversing an Air-Current

By Bert Lloyd

As a rule those fans that have a reversible arrangement in their make-up also have considerable added to their first cost on that account, in return for which a greater efficiency and ease of operation is secured. When the reversing arrangement consists of several doors, including one to throttle the throat of the fan, the cost of installation runs up, and in addition to the inevitable loss by leakage, the fan usually has to be stopped while the change is being effected.

The accompanying sketch is of the arrangement which I think is an improvement over existing methods.

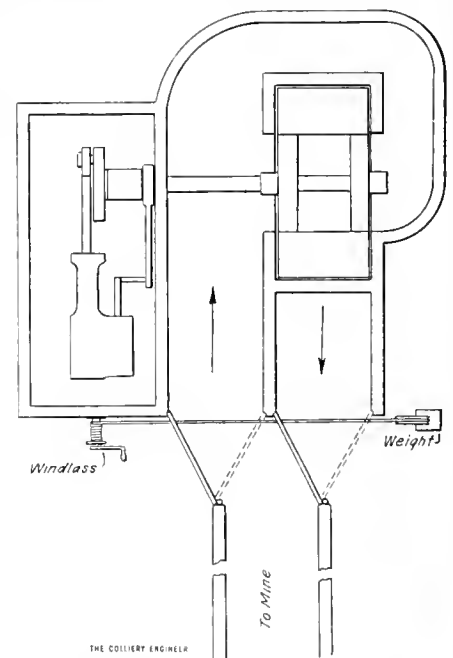

Two doors are built as near the fan as may be convenient and by the aid of a windlass one man may open one door and close the other, thus almost instantly reversing the direction of the air-current, while the fan is going full speed.

A windlass at one end of the chain, or a wire rope, and a weight at the other actuate the doors in either direction. The windlass, being in the open air, is accessible at all times. In addition to the increased efficiency, ease and speed in operation, this system offers a comparatively low cost of installation.

Concrete in Mine Construction

By A. F. Allard*

Within the last few years a great many important advances have been made at the modern coal plants in the use of concrete for buildings, shaft lining walls, and constructions inside of the mine. The appearance of the up-to-date plant is wonderfully improved with its concrete mine buildings, consisting of the power plant, hoist house, repair shop, miner's bath house, fan house, supply house, powder house, and outside stable. These fireproof structures, with reinforced concrete walls, concrete floors, and cement roof covering, are permanent and involve little or no expense for upkeep during the life of the plant. The boiler house, with its reinforced concrete chimney towering to a great height, is substantial and attractive in appearance as compared with an installation of steel stacks which are subject to deterioration from rust and require frequent painting and attention, while no expense for maintenance after first cost is necessary on a concrete stack. The coal storage bins and water supply tanks erected of reinforced concrete, instead of wood or steel, mark the advance made in the use of concrete for these structures. This material now replaces the wooden walks and platforms of the steel tippie and the members themselves are protected from rust and mine gases with a covering of the same material. Swimming tanks built of concrete prove a source of amusement and recreation for the employes at a coal mining plant. The house site of the miner's home is made bright and clean looking with concrete sidewalks, street curbing, and gutters. House foundations and outbuilding vaults of this material are waterproof and sanitary.

Those who have had to deal with the growing scarcity and steadily

increasing cost of large size timbers for inside mine construction, will welcome concrete as a substitute for this material, not only at new plants, but for the renewal of wooden structures at mines in operation. By its selection, the mine owner will be amply compensated for the increased first cost of the installation as compared with wood, when the stability, permanency, and fire-proof qualities of the concrete are taken into consideration.

As a fireproof and permanent material for the lining of shaft walls, concrete is without a rival, and its adaptability for this class of work is well recognized, judging by the large number of concrete shafts now being constructed. In fact, we have hoisting and ventilating shafts completed from top to bottom without a piece of timber; the lining walls, cross-buntons, and division wall of the air compartment are of concrete, with guides and stairways of steel. The method of sinking mine shafts by means of the concrete caisson with a steel cutting edge or shoe, through soft and water-bearing strata, has come into prominent use, for by its weight, penetration to great depth is possible, rapid sinking progress is made, the flow of water met with is reduced and a great saving in cost of labor and material is obtained by the omission of timber curbing.

From comparative cost data, I find the price per vertical foot of a completed concrete-lined shaft to be about one-third more than that of the wooden structure; this amount is in the first cost only, for after a few years' time renewal of timbers would be necessary in the latter.

There are numerous designs for concrete shafts including rectangular, circular, elliptical, and the straight sides with circular end walls; the latter is a very economical section, utilizing the end spaces for pipeways or stairways, and reducing to a minimum, excavation and concrete yardage. The circular end walls have great

strength to resist the strata and water pressure, forming a continuous concrete arch from top to bottom; the side-wall pressures are taken care of by the thickness of concrete lining, depending upon the nature and depth of strata penetrated. Generally self-sustaining strata, such as rock, slate or good shale require a wall of from 6 to 9 inches in thickness, which is sufficient for the anchorage of the buntons, while a heavy fireclay or wet sand seam would require a much thicker wall.

In the western iron and coal districts, a number of reinforced concrete shafts have been sunk through by means of the pneumatic caisson or compressed air system. This process has proven effective in wet strata for obtaining dry shaft walls; also for making a water-tight joint when the concrete caisson reaches the bed rock. Air pressure is provided in the working chamber to displace the water encountered, and the pressure is maintained until the concrete has set.

The construction of shaft-bottom landings of plain and reinforced concrete includes the single or double-track entry, providing storage room for loaded cars, space for empty car lift back of the shaft, and room for empty car storage track, together with the necessary chutes. For this work, I have used three different designs in concrete construction for supporting side walls and mine roof which have to bear excessive loads and sustain the crushing effect induced by the displacement of the roof strata; they are:

First. The rectangular section supporting I beams on concrete side-walls and covered with reinforced concrete slabs, having a thickness of 3 or 4 inches. The depth of beam is usually 6 or 8 inches for single track span and from 12 to 18 inches for that of double track, the size and weight of beams selected depending upon the nature and condition of the roof; I have placed the beams on 4-foot centers, covered with slabs 2 feet in width.

*Chief Engineer, Bunsen Coal Co., Danville, Ill. Paper read at Mining Conference in connection with the dedication of the Transportation Building and Transportation and Mining Laboratories, University of Illinois, May 10, 1913.

Second. The poured concrete arch with concrete side walls.

Third. The concrete-block arch, which is composed of concrete blocks previously molded in steel forms with joints cut on true radial lines. The blocks are laid up in the arch crown from each side wall with cemented joints and are supported on a light frame template until the key piece is placed, and one section of the ring is completed. Provision is made in molding to provide blocks of different lengths for breaking of joints on the alternate courses. Blocks 6 inches thick for single and 8 inches for double-track spans and about 18 inches long, make a convenient size for the men to handle. This method of arch construction saves considerable cost over that of the solid poured section, for it eliminates the cost of expensive forms and time necessary for the transporting and placing of the wet mixture.

The rectangular section is a convenient form at back of the shaft where it is necessary to provide clearance room for the empty car lift and where going up into the roof with an arch of large span would prove expensive. The poured arch section is generally adopted for a distance of from 10 to 15 feet on each side of the shaft, the work connecting into and supporting the shaft walls. The continuation of the arch with concrete block construction for the main landing and empty run-rounds, makes an ideal and fireproof shaft bottom. For permanent work inside, we have the mine stables, including the stalls and feed-boxes, pump and motor rooms, overcasts and stoppings, constructed of concrete; this material being especially suitable where an air-tight seal and safe job are necessary, the cement grout completely filling all crevices.

Bore holes are made secure and permanent with cement lining, the pipe casing being subject to rust from mine gases or the discharge of sulphur water.

Wherever possible, all wooden

structures in the mine should be replaced with concrete, the most substantial and one of the best known fireproof materials. By its use, the great danger of disastrous mine

fires, caused by the ignition of dry timbers, is lessened, and the high standard of the mine is increased by the number of its concrete structures.

Fire Protection of Mines

From the Standpoint of the Mining Engineer—Preventing Start of Fires—
Providing Proper Equipment and Organization for Combatting Them

*By G. E. Lyman**

THE subject of fire protection of mines is a matter of such vital importance to every individual connected therewith in any capacity, from the chief executive at the head of the organization to the trapper boy at his door, that it is impossible to draw any line at which the interest of the mining engineer should properly begin or end. The broad, humanitarian features involved will alone make the question command the earnest attention of all, and the engineer realizes that every step taken in this direction is not only in keeping with the spirit of the day, but is a policy that pays well in dollars and cents.

If there is any line of effort in which the energies of the mining engineer should be especially centered, it may be said to lie in these directions:

1. The adoption of every possible means of preventing a fire getting started, both above and below.

2. The planning and installation of the best and most complete fire-fighting equipment possible to obtain, including every possible provision for rescue and escapement, so frequently needed in fires below.

3. The organization of a competent fire-fighting corps whose discipline and efficiency shall be maintained by frequent practice.

The labors of our Commission for the revision of the mining law have given Illinois some advanced legislation in this direction, making compulsory many preventive measures in new developments, and the instal-

lation of certain fire-fighting equipment in old mines. The conscientious engineer will recognize that no statute, however broad, can take care of every detail in widely differing conditions of operation, and after satisfying himself that the law is fully complied with, he will make a further careful study of the individual conditions to be met and endeavor to provide such additional safeguards as he can devise for the better protection of life and property.

One of the first things he would consider in planning the surface plant of a new development would be the design of fireproof structures throughout, making them of brick, masonry, or reinforced concrete, with modern structural steel tipples, making the floors of these, as well as the bin linings, concrete or some equally fireproof material, so that it would be well nigh impossible for a fire to occur on top.

The fan would be housed in such a manner as to have nothing inflammable about it, outside of the oil in the journals, and would be set back a sufficient distance from the shaft to eliminate chance of injury even though the entire shaft lining should be burned out.

Boiler and power houses being fireproof throughout, would insure the operation of every detail of the equipment through an emergency which fire alone could cause.

However thoroughly fireproof the plant might be considered, it would yet be the part of wisdom to install a water system with an ample number of fire-plugs at convenient

*Chief Mining Engineer, Madison Coal Corporation. Read at the Mining Conference in connection with the dedication of the Mining and Transportation Buildings at the University of Illinois, May 9, 1913.

points in and about the buildings, with hose connected ready for instant use. Some of the most disastrous fires have been where the contents of fireproof buildings were consumed.

In handling an old plant the need of the water system just mentioned is doubly apparent and altogether too obvious to require comment. Regular fire drills and actual use of the equipment at frequent intervals are essential to its maintenance in proper condition. If possible, the system should be connected to a powerful pump, as well as an independent head, so that it may be thoroughly reliable.

In certain places, like wooden fan houses and tipples, means of flooding the structures through automatic sprinklers, as well as perforated pipes handled by valves outside the buildings, may save great losses.

The value of steel doors to cover the shafts in case of fire is too obvious to dwell on at length.

The practice of allowing waste and other such material to accumulate is extremely dangerous, and the time required in frequent inspections, with the idea of eliminating this practice, is well spent.

The condition of the electrical wiring, above and below, and the cables in the shafts is important.

Within the mine itself much can be done toward preventing fires, by the elimination of everything combustible as far as possible, especially around the bottom and in the stables, oil houses, etc. The replacing of heavy lagging and timbers near the bottom and in permanent entries, with steel and concrete, will be a matter of economy in maintenance in a long-lived property, which justifies the expenditure required entirely aside from its value in eliminating the chance of fires. Such work is required by the Illinois law in new mines, within a certain area near the bottom, but its application to a modern mine can be economically extended much farther.

The fireproofing of shafts is a

wise requirement, and one entirely in keeping with modern development.

The fires which cause great loss of life below are generally of fan houses, tipple, shaft linings, stables, or other like critical points, which by their volume and fierceness poison the entire mine atmosphere so rapidly as to render it difficult to get the men out. Here is where the value of good fire-fighting equipment, backed up by organization and discipline, becomes apparent. The first few moments are the vital ones, and in ninety-nine times out of a hundred an organized force, not allowed to grow stale through lack of practice, can quickly extinguish a blaze at the start. In fires of this character the value of adequate and well maintained escapement ways becomes apparent, and they should be made familiar to the men by frequent travel of them.

The writer is a firm believer in the value of perforated sprinkling pipes in the stables and other critical points, to be operated by outside valves, in addition to the automatic sprinklers required by law.

The water supply for the underground system should be not only connected to a standing head on the surface as required by law, but also to the pumps on both surface and bottom, so as to provide for all possible emergencies.

Where the coal seam itself is of such a character as to fire easily, a special study of conditions will be necessary to determine the most practicable precautions to take, and the details of such special methods of shooting, caring for machine cuttings, gob, etc., as may be determined therefrom, must be most rigidly enforced by the management. Fires on the inside, such as gob fires, both local and extended, and fires of the seam itself, generally offer less danger to life than to property, although the dangers to be encountered by the limited number who attempt to control them are often of the gravest character. Opinions as to the proper methods of attack-

ing such fires differ widely, and their discussion can not properly be attempted here, but as to the necessity of the best and most complete equipment for handling them there is no room for argument. Every mine should have available, in addition to the usual small chemical extinguishers, a couple of large capacity mounted on trucks, which can be rapidly taken to the scene of action.

Iron dump cars, to be used in loading out a fire and disposing of it in that way, form useful equipment, and during ordinary operation can be used to advantage in handling dirt and refuse from roads and air-courses, so as not to be idle capital.

When pipe lines run over the mine extensively, as in cases where long distance pumping is done from many sumps, it is an easy matter to arrange the connections so that the pump pressure can be turned into the suction lines. The writer has seen this done to most excellent advantage, and is a firm believer in its desirability. In cases of sufficient emergency, even air transmission lines may be thus pressed into service.

Oxygen helmets will often enable explorations of a fire territory to be made that could not be attempted otherwise, and may even permit of taking lines of hose or chemical extinguishers to the very seat of the trouble. It becomes necessary, therefore, for any mine desiring the most adequate fire protection to have its own equipment of helmets, pumps, supply tanks, and all accessories, including pulmotors and first-aid supplies. The time lost in getting one of the state rescue cars on the ground may allow the fire to make such headway that nothing but walling off the territory can be done. The saving to a company in a single bad fire alone could easily pay for the cost of its own rescue station and helmet equipment, while a group of mines operated by individuals could divide the expense of a common station between them and

make the burden very reasonable. Their object would not be to supplant the state rescue cars in any sense, but merely to take advantage of the first vital moments, and often by such action not only avert a serious calamity, but nip in the bud what might otherwise develop into a difficult and dangerous job for the state corps. Such individual stations would, of course, be in charge of competent men who had received thorough training at the state stations.

A frequent and often serious source of trouble in fighting large fires in the workings is the lack of accurate maps, and the consequent difficulty of determining the best way of walling off the territory affected. Only too often it happens that some unrecorded opening into the fire area supplies air sufficient to keep it alive, and at the same time it is very difficult to locate. An accurate map would indicate at once the best way to wall off the fire and lose the least amount of territory thereby.

Where companies maintain their own engineering departments this question of maps should, of course, give no trouble. But where it is the practice to have an outside surveyor extend the map annually to comply with the law, accuracy in details can not be expected. Granted that the man doing the work is thoroughly competent, there will be portions of the mine inaccessible to survey. Accurate, detailed mapping requires frequent extensions, and the remedy for individual operations is for a few to go together and secure the exclusive services of a competent engineer and furnish him adequate help and facilities for handling their work in a manner commensurate with its importance.

Even where an adequate engineering department is maintained and frequent map extensions made, places will frequently be found which cannot be entered for survey. The writer's experience has indicated that this situation can best be met by a system of monthly or

semimonthly reports, showing the depth of every working place which has been closed since the last report was rendered, the number of cross-cuts right and left, and other pertinent information. In the writer's practice these reports are not allowed to be used in extending maps unless the engineers are unable to enter the place and measure it themselves. In such cases the desired information is obtained from the reports, and the place shown on the maps in dotted lines, thus differentiating it sharply from the work of the engineering department, and placing before the mine management a visible reminder of their responsibility for that portion of the map. As the average number of places closed monthly in even a large mine is not great, it consumes little time to handle the report carefully, and the writer has found that it is possible to bring about a feeling of joint responsibility for this part of the work with the mine management which is helpful in many ways.

There are few room-and-pillar mines which cannot be advantageously worked on the panel system, or some modification of it, which will permit the walling off of any fire territory with the least possible disturbance to the balance of the mine. The importance of having the maps show faithfully every connection between adjacent panels is obvious, and in the modern mining organization no departure in working plan from the projects furnished the management for their guidance will be permitted without the matter being properly taken up for consideration and authorization if found necessary or advisable.

It is not uncommon to see a mine entirely, or nearly shut down on account of a fire which should ordinarily have been closely confined in its effects, and this is due to having the workings so cut together that isolation is difficult and the ventilation hard to control. The writer believes that the main air-courses in either direction from the shaft

bottom out to the limits of the workings should be considered just as important as the shaft itself, and be just as carefully maintained. This, in connection with a powerful fan, will enable the circulation of a great volume of air at comparatively low velocity and pressure, which will permit a considerable increase in the number of splits, thus reducing the amount of territory affected by a fire in any one portion of the workings. The maintenance of an abnormally excessive amount of ventilation is not advocated, but the use of main air-courses of more than ordinary capacity and excellence is strongly urged, so that the ventilation of the side entries can be treated as individual problems, as much air being diverted into each one from the main air-course—the arteries, so to speak, of the mine—as its individual requirements may demand. With this method of ventilation established, there should be small necessity of ever sealing up more than one entire cross-entry at the most. There are probably very few of us who have not known of instances where large mines were ventilated on two or three splits, and where a comparatively small fire caused the sealing off of perhaps half the workings.

Great emergencies come infrequently to most of us, fortunately, but that very fact is likely to cause us to neglect, or view indifferently the need of a well-disciplined organization to meet the crisis when it confronts us. Organization, discipline, efficiency (both of men and equipment), and all the things connected therewith, form too broad a subject to more than mention the need of here. When a great crisis confronts a mine, be it fire or anything else, and when brave and skilful men are ready to attack it, if organization and all it implies be lacking, the work starts under a terrible handicap.

In concluding, the writer wishes to state he realizes that in the brief limits of this paper he has simply passed in a very superficial man-

ner over some of the many points involved in such a broad subject. The views of all of us are naturally influenced by individual experience, and others may have gathered

widely divergent views from their own experience and observation. The more such which can be brought out, however, the greater the light shed on the subject will be.

Organization as Affecting Mining

Importance of Sufficient Capital, Ample Plant, Capable Officials and Enough of Them, and Proper Discipline

*By A. J. Moorshead**

BEFORE touching on the subject matter of his address Mr. Moorshead expressed the satisfaction of those engaged in coal mining in Illinois with the interest shown by the faculty in the establishment of the Department of Mining Engineering; and to emphasize its value to the state he illustrated the magnitude of the coal mining industry with the following figures:

Production of coal in Illinois for year ending June 30, 1912	Tons
Used for power and wasted at the mines	57,514,249
Taken by railroad locomotives at mine chutes	2,471,326
Sold to local trade at mines	924,854
Leaving a total to be shipped in cars of	2,615,678
	51,592,582

Assuming 46 tons to the car, this amount required 1,120,000 cars. Allowing 40 feet for the length of each car, this means a string of loads 8,500 miles long.

Mr. Moorshead gave these data, somewhat amplified, to show the necessity of a thoroughly organized mining department in the State University upon which dependence can be placed to solve the problems of safe and economic mining.—EDITOR.]

"Organization as affecting mining" is a very broad subject, and so vitally affects the interests of the corporate and operating bodies that it enters into every phase of the business, and upon it hinges the success or failure of all enterprises. Organization is of little value without harmony, and the application of firm and fair discipline must be exercised to secure it. Otherwise the maximum of success is unobtainable,

and especially is it true in connection with the dangerous occupation of coal mining. Therefore, organization and discipline must be linked together, and are inseparable for all well-governed bodies.

In order that the student particularly may form a clearer idea of what organization means, the subject must be divided into several classes, and in the order in which they apply to mining:

First. In this great competitive age, when the tendency of all new mining companies is to produce a high tonnage and place a well-prepared product on the market, great care should be exercised in the preparation of complete plans covering both surface and underground construction, and the necessary capital secured not only for the building of a completely equipped plant, but also enough surplus for an easy working fund with which to conduct the business. Otherwise serious embarrassments, if not complete failure, will be certain to follow.

Second. In the selection of a capable working force, care must be exercised in securing supervising officers who not only possess the necessary qualifications for intelligent work, but whose habits will inspire confidence no less among the employes than in the executive. Such officials should be trained in discipline to a degree that will not only demand respect, but when dangers arise and serious disaster is likely to occur, they will be prepared to meet the emergency with organized action, and prevent or minimize what otherwise might

become a very serious catastrophe. On the character of the supervising forces and their training and discipline depend the strength of the organization and its success.

Third. A particularly vital necessity in organization, from the standpoint of both safety and economy, is the proper location of the property. All shafts and slope and drift entrances should, together with buildings, be placed well above the highest flood line record, and scarcely too much attention can be given to drainage. Reservoirs must be established where not only good boiler water can be obtained, but of ample size to impound sufficient to take care of the power and washer for a period of not less than 90 days to carry the plants through times of drought, which so often occur in Illinois. Tracks for the railroad cars should be on sufficient grade to move both empties and loads by gravity and of sufficient capacity to take care of the mine's output for 12 hours of operating time.

All power houses, machine, and carpenter shops, as well as supply houses, should be placed on building lines and conveniently arranged together with the tracks to keep cars containing material out of the way of the operating tracks of the mine.

Fourth. In the arrangement of the underground working forces, sufficient supervising officers should be employed to keep in direct contact with the various classes of labor, and the most safely efficient practice will be found in having not to exceed three gangs for work on the roadways—one for track repairs, another for timbering, and the third for keeping the haulageways and air-courses clear. To this must be added special organized gangs for any particular class of underground improvements, such as making concrete stoppings, etc., with a gang leader or foreman to have charge of each of these separate bodies. This plan has, from actual practice, been found by far the most economical, both in point of safety as well as

*President and General Manager, Madison Coal Co., St. Louis, Mo. Address delivered at the Fuel Conference at the University of Illinois during the dedication of the Transportation Building and the Locomotive and Mining Laboratories, May 8 and 9.

service performed, compared with the old method of having many scattered gangs working without leaders, and whom the mine manager or his assistants seldom see.

One or two inspectors on the day shift should be employed (as the size of the mine may require) to travel the haulageways and air-courses for the purpose of inspecting all trap doors, track, switches, electrical circuits, and roof. The inspectors should also test the air and locate defective stoppings, as well as watch for reckless drivers and report all irregularities to the mine manager.

Sufficient assistant managers should be employed, whose duties would require them to be at the face of rooms and entries only, to see that the ventilation is properly maintained and that all the miners are supplied with sufficient timber and that they are properly timbering for their own safety, as well as the proper care of their working places, and they should also, when necessary, give instructions for more effective drilling and shooting, both from the standpoint of safety and the making of the maximum quantity and quality of coal per shot.

It is, I believe, a fair statement to make, that in altogether too many mines the underground managing force is totally inadequate for the number of men employed and tonnage produced, and I have, myself, known of many instances where the mine manager was without assistants, and he became in fact a mere timekeeper and was unable to do much more than keep time and seldom saw an air-course unless a fall baffled the air and interfered with the ventilation, or visited the face except when some trouble called him there.

Wherever such conditions exist, the organization is seriously incomplete, and the owner of the property is permitting an unwise economy to be practiced, because leakages and mistakes must in such cases be bound to occur, and in an indirect

manner the mine owner is losing a far larger sum than the yearly salaries of several assistants.

Fifth. It is a waste of money to provide equipment without a properly organized, efficient force to handle it, and this is particularly true of fire fighting and rescue appliances. Each and every man on the surface, and all supervising officers in the mine, as well as all employes working around about and in the vicinity of the shafts in the mine should not only have specific duties to perform, but should, through systematic drilling, be prepared to act in unity, because by quick, energetic action, and complete discipline alone can even a fair degree of success be expected.

Sixth. Harmony, together with firm and fair discipline, is necessary for the success of all institutions, but more particularly is it applicable to coal mining, because most of the men underground are for the greater part of the working time beyond the observation of the managing forces. Consequently, the system to control men, both from point of efficiency, as well as safety, must be most thorough and particularly adapted to the workers in a coal mine.

The views which I have given with reference to underground supervision are practiced by the corporation I represent, and only modified as may be forced by the interpretations of our labor contract.

The points which I desire to make clear are:

That success cannot be expected from any institution undercapitalized.

That a mine must be well equipped in every respect to produce the best economic results.

That all supervising, as well as other employes that can be controlled, must be temperate in their habits.

That efficient and adequate equipment can be of but little value without a skilful and well-organized force to use it.

That systematic drilling is nec-

essary to get the best results and make the force an efficient one.

That discipline is the greatest necessity for the maintenance of a good and dependable organization, and, whenever employed, it is always manifest and plainly observable, but should always be administered with fairness as well as firmness.

That harmony is, for the best results, so necessary that disturbing influences should be removed without hesitation.

That the best of results and greatest success in all things can only be secured, in the conservation of life and property and from the standpoint of investment, by thorough, systematic organization.

來 來

In some of the Southern Colorado coal mines a standard size for mine doors is adopted. The size naturally varies at different mines, however, the usual size door is 7 feet wide by 6 feet high. The doors are hung on concrete frames and covered with sheet iron. At the Cokedale works, double doors, 3 feet 6 inches wide, hinged at each side of the entry, are used at the foot of steep grades. In case a trip or even a single car runs away on the slope, these doors, instead of being shattered as a single door would be, are opened by the impact of the car and it passes through them without destroying them. The idea in adopting a uniform mine door is based on the plan that when a door is of no further use in one part of the mine, it can be moved to another where a standard frame awaits it.

來 來

Col. R. B. Hutchcraft, of Lexington, Ky., states that what is now called Jellico mountains were originally named Tellico mountains after a tribe of Indians who camped at a place now known as Tellico in McMinn County. When a surveyor made a map of the county he named the mountains Tellico, but the settlers assuming the *T* was a *J* changed the name to Jellico.

PRACTICAL TALKS ON COAL MINING

For men who desire information on Coal Mining and related subjects presented in a simple manner

FOR measuring ordinary electrical currents, instruments called ampere meters, or more commonly ammeters, are used.

For measuring small currents milliammeters are used. Ammeters and milliammeters are made in portable forms to carry to any point where it is desired to measure a current, or for permanent connection in a circuit at some one point, as on a switchboard in an electric power station. Ammeters measure the current strength directly in amperes, and milliammeters measure the current strength directly in milliamperes. Current flowing through the coils of wire in such instruments causes small magnetic needles or suspended coils of wire to rotate against either springs or the force of gravity. Most ammeters are provided with a light index pointer that moves over a scale, or dial, graduated so that each division on the scale represents 1 or more amperes or a fraction of an ampere. Fig. 3 shows the general form of a portable ammeter. The strength of a current flowing in a circuit can be measured directly, in amperes, by opening the circuit and connecting the two ends thus formed to the binding posts *p* and *p'*. The current, in direct-current circuits, must enter the instrument through the binding post marked with a positive sign (+); otherwise the pointer will be deflected in the wrong direction, a condition liable to damage the instrument and cause error in subsequent readings.

Resistance.—It has been stated that

Electricity in Mines

Measuring Currents—Resistance—Measurements of Sectional Area of Conductors—Resistances of Different Materials

By H. S. Webb, M. S. (Continued from May)

all substances resist the passage of electricity, some more than others. Electrical resistance, which is one of the most important properties of an

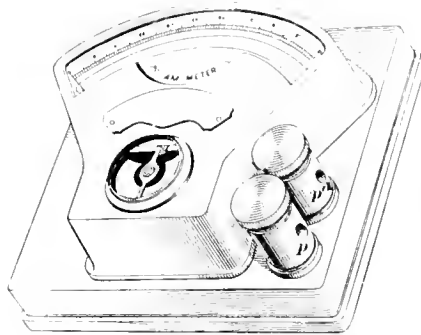

FIG. 3

electric current, is that property of matter, varying with different substances, in virtue of which it opposes or resists the passage of electricity. The unit of electrical resistance is defined as the resistance offered to an unvarying electric current by a column of mercury at the temperature of melting ice (32° F.) weighing 14.4521 grams, of a uniform cross-sectional area and of a length of 106.3 centimeters. Scientific experimenters can accurately construct a column of mercury of the size mentioned and can also construct a resistance of a suitable kind and size of wire exactly equal to the resistance of this column of mercury. Such unit resistances made of wire can be purchased of any reliable maker of electrical instruments. The unit of

electrical resistance is called the ohm, after George Simon Ohm, a German mathematician, who lived from 1789 to 1854. A round

copper wire 1,000 feet long and having a diameter of .102 inch (known as No. 10 B. & S. gauge) has a resistance of nearly 1 ohm at 68° F. The fine carbon filament of an ordinary 16-candle-power incandescent lamp has a resistance of about 220 ohms when the lamp is lighted.

The resistance of a given conductor at a given temperature is always the same, irrespective of the strength of the current that may be flowing through it or the electromotive force that sends the current through the conductor. The resistance of a conductor is a property of the conductor itself, depending on its length, sectional area, the material of which it is made, and its temperature. In most cases, a continual flow of current through a conductor tends to increase its temperature, at least until the radiation of heat from its surface is equal to the heat produced in the conductor by the current; hence, the conductor tends to become warmer, and on account of their increase in temperature metallic conductors increase in resistance. But if means are provided to keep the temperature constant, neither the strength of the electric current nor its duration will have any effect upon the resistance of the conductor.

Change of Resistance With Change of Length.—If the length of a conductor be doubled, its resistance will

be doubled; if its length be halved, its resistance will be halved; an increase in the length of a conductor will cause an increase in its resistance; a decrease in the length will cause a decrease in its resistance.

To find the resistance of a conductor after its length is changed, its original length and resistance being known, use the following rule:

RULE.—Divide the original resistance, in ohms, by the original length, in feet, to get the resistance of 1 foot; then multiply the resistance per foot by the changed length in feet. The result will be the resistance required.

EXAMPLE.—A conductor 1,112 feet long has a resistance of 67 ohms; what will be the resistance of 519 feet of the same conductor?

SOLUTION.—

$$\begin{array}{r} 67 \text{ ohms} = 67 \\ 1,112 \text{ feet} = 1,112 \text{ ohm per foot} \\ 67 \times 519 = 34,773 \\ 1,112 = 1,112 \\ \hline 31 \text{ ohms.} \end{array}$$

Measurement of Sectional Area of Conductors.—The sectional area of a conductor is the area of the surface made by cutting the conductor in a plane at right angles to its length. Thus, in Fig. 4, *c* represents the sectional area of a round, solid conductor *ab*. Fig. 5 represents the sectional area of a square metal bar 2 inches by 2 inches; its sectional area is, therefore, 2 in. × 2 in. = 4 square inches.

To find the sectional area of any circular conductor, use the following rule:

RULE.—Multiply the diameter of the conductor by itself, and then multiply this product by .7854.

EXAMPLE.—What is the sectional area of a conductor whose diameter is .114 inch?

SOLUTION.—

$$\begin{array}{r} .114 \text{ in.} \times .114 \text{ in.} = .012996 \text{ square inch.} \\ .012996 \text{ sq. in.} \times .7854 = .010107 \text{ square inch.} \end{array}$$

In electrical work, it is customary to express the sectional area of conductors in terms of a unit called the circular mil. This unit is the area of a circle of which the diameter is

1 mil or $\frac{1}{1,000}$ inch. One inch equals 1,000 mils; therefore, if the diameter of a conductor is 1 inch, its diameter is 1,000 mils; if the diameter of a conductor is $\frac{1}{2}$ inch (.5 inch) or $\frac{1}{4}$ inch (.25 inch), it can be expressed as 500 mils or 250 mils.

If a length is expressed in inches or in a fraction of an inch or in



FIG. 4



FIG. 5

both, and it is desired to express it in mils, use the following rule:

RULE.—Multiply the value expressed in inches, a fraction of an inch, or both, by 1,000.

EXAMPLE.—Express in mils: (a) 5 inches; (b) 1.5 inches; (c) .75 inch; (d) .46 inch; (e) .11443 inch; (f) .003145 inch.

SOLUTION.—

$$\begin{array}{r} (a) 5 \times 1,000 = 5,000 \text{ mils.} \\ (b) 1.5 \times 1,000 = 1,500 \text{ mils.} \\ (c) .75 \times 1,000 = 750 \text{ mils.} \\ (d) .46 \times 1,000 = 460 \text{ mils.} \\ (e) .11443 \times 1,000 = 114.43 \text{ mils.} \\ (f) .003145 \times 1,000 = 3.145 \text{ mils.} \end{array}$$

As inches multiplied by inches gives square inches, so mils multiplied by mils gives square mils. Thus, 2 inches × 2 inches = 4 square inches; but since 2 inches equals 2,000 mils, the expression may be written, 2,000 mils × 2,000 mils = 4,000,000 square mils. The expression .5 inch × .5 inch = .25 square inch, might correctly be written, 500 mils × 500 mils = 250,000 square mils, because .5 inch = 500 mils.

If an area is expressed in square inches or in a fraction of a square inch, and it is desired to express the area in square mils, use the following rule:

RULE.—Multiply the value expressed in square inches, or in a

fraction of a square inch, or both, by 1,000,000.

EXAMPLE.—Express as square mils: (a) 4 square inches; (b) .375 square inch; (c) 2.0095 square inches.

SOLUTION.—

$$\begin{array}{r} (a) 4 \text{ sq. in.} \times 1,000,000 = 4,000,000 \text{ square mils.} \\ (b) .375 \text{ sq. in.} \times 1,000,000 = 375,000 \text{ square mils.} \\ (c) 2.0095 \text{ sq. in.} \times 1,000,000 = 2,009,500 \text{ square mils.} \end{array}$$

The square mil is not much used as a unit of area, but an understanding of it leads to an understanding of the circular mil.

To find the sectional area of any solid circular conductor in circular mils, use the following rule:

RULE.—Multiply the diameter, in mils, by itself.

EXAMPLE.—The diameter of a trolley wire is .3648 inch; what is its area in circular mils?

SOLUTION.—

$$\begin{array}{r} .3648 \text{ inch} = 364.8 \text{ mils.} \\ 364.8 \text{ mils} \times 364.8 = 133,079 \text{ circular mils.} \end{array}$$

Multiplying the diameter, in mils, by itself really gives the area of a square, one side of which is equal to the diameter of the round wire, expressed in square mils; but the same number gives the square of the diameter which is called the area of the round wire in circular mils. The only reason for using the circular mil as a unit is that most conductors used in electrical work are round, and it is very convenient to have a unit in terms of which to express sectional areas without much calculation. Where circular sectional areas are to be compared with those that are not circular, both must be reduced to either square or circular mils.

(To be Continued)

來 來

The coal production of West Virginia for the year ending June 30, 1912, was 59,581,774 gross tons, an increase of 5,548,588 tons, or 10.26 per cent. over the preceding year. The coke production was 1,993,697 net tons, a decrease of 701,350 tons.

Gases Met with in Coal Mines

Measurement of Atmospheric Pressure—The Barometer—Mariotte's Law—Diffusion of Gases

(Continued from May)

THE other form of barometer is known as an aneroid barometer, or aneroid, and somewhat resembles in appearance a steam gauge or an old fashioned thick watch with a single hand. On account of its small size and lightness, the aneroid is much used by engineers on exploring work. The instrument consists of a cylindrical metal box from which all the air has been exhausted. The face of the box is of very thin metal, so that when the atmospheric pressure is increased the face is pressed inwards, and when it is decreased it is forced outward. These movements of the face are conveyed by means of a number of levers to an index hand that moves over a scale graduated on the outer rim of the box. This scale is graduated in inches and decimal fractions just the same as the tube of a mercurial barometer, so that the two instruments give readings in inches and fractions.

A vacuum is strictly an empty space, but is commonly taken to mean a space from which all air has been exhausted. It will be plain that if all the air has been exhausted from a space, there will be no pressure to offset the weight of the column of mercury in the tube, and in a vacuum a barometer will read zero. Pressures measured from a vacuum or from a barometer reading of "0.00 inches" of mercury, are called absolute pressures, and the pressure of the air as measured by a barometer is, of course, an absolute pressure.

Another instrument very commonly used to measure the pressures of gases is known as a gauge, a familiar example being the steam gauge used on the boilers at every mine. Pressure measured by a gauge is known as the gauge pres-

sure, and is different from the pressure recorded by the barometer. When there is no fire under the boiler and consequently no steam in it, the steam gauge reads 0, but since the inside of the boiler is always sustaining the pressure of the atmosphere which amounts to 14.7 pounds per square inch, the 0 of the steam gauge really means that the boiler is sustaining a pressure of one atmosphere or 14.7 per square inch. So to reduce gauge pressures to absolute pressures we must add 14.7 pounds to the gauge reading.

EXAMPLE.—When the steam gauge reads 120 pounds, what is the absolute pressure?

For the reasons stated, the absolute pressure is $120 + 14.7 = 134.7$ pounds per square inch.

We are now able to take up the second law of gases which expresses the relation existing between the pressure and volume of any gas when the temperature is not changed and which is known as Mariotte's or Boyle's law.

Mariotte's Law.—The temperature remaining the same, the volume of any given quantity of gas is inversely proportional to its absolute pressure.

Expressed as a proportion, this law is $v : v_1 = p : p_1$, or $v_1 = v \frac{p}{p_1}$, in which v is the volume of the gas at the original pressure, p ; and v_1 is the volume of the same gas at the new pressure, p_1 .

EXAMPLE.—What is the volume of 10,000 cubic feet of air measured originally at the usual atmospheric pressure of 14.7 pounds per square inch, after the pressure has been reduced to 7.35 pounds per square inch, there being no change in the temperature?

As these are atmospheric pressures they are also absolute pres-

ures, and, thence, may be used as given. Hence we have $v = 10,000$ cubic feet, $p = 14.7$ pounds and $p_1 = 7.35$ pounds which are substituted directly in the formula, and volume at 7.35 pounds pressure $= v_1 = 10,000 \times \frac{14.7}{7.35} = 20,000$ cubic feet.

In dealing with gases it most always happens that both the temperature and pressure change, so that both of them have to be reckoned with. By combining Gay-Lussac's and Mariotte's laws it is possible to get a formula that will show the change in the volume of gas when both the temperature and pressure vary. Such a formula is the following:

$$v_1 = v \left(\frac{T_1 p}{T p_1} \right)$$

In this formula v is the volume of the gas at the absolute temperature, T , and absolute pressure p at which it was first measured; and v_1 is the new volume of the gas at the new absolute temperature T_1 and new absolute pressure, p_1 .

EXAMPLE.—A certain gas is found to occupy a volume of 1,000 cubic inches when the pressure is 10 pounds per square inch and the temperature 40° . What will be the volume of the same gas when the pressure is 30 pounds per square inch and the temperature 140° , the pressures being absolute.

The original absolute temperature is $460^\circ + 40^\circ = 500^\circ$, and the new absolute temperature is $460^\circ + 140^\circ = 600^\circ$. Thence we have, $v = 1,000$ cubic inches, $T = 500^\circ$, $p = 10$ pounds, $T_1 = 600^\circ$, $p_1 = 30$ pounds, and we have to find the new volume, v_1 . For this purpose the formula may be used without change, and substituting $v_1 = 1,000 \times \frac{600 \times 10}{500 \times 30} = 400$ cubic inches

By diffusion is meant the gradual intermixing of gases when they are brought in contact. This diffusion is due to the power of the molecules of the gases to move freely among each other. Diffusion must not be confused with mechanical mixture, both of which are commonly

displayed in mines. As an illustration of mechanical mixture we have the mixing of carbon dioxide given off by a mine fire with the air as the fumes are driven along by the ventilating current. Here the smoke rolls over and over and the air and gas are mixed just as water and milk may be mixed by shaking them together in a glass. As an illustration of diffusion we may take

methane or marsh gas as slowly given off from the working face. Here, while the lightness of the gas causes it to rise to the roof, yet the property of diffusion it possesses causes it gradually to mix with the air in the room without the assistance of any moving ventilating current. This subject will be more thoroughly discussed under the head of chemistry of gases.

(To be Continued)

Mine Ventilation

Introductory—The Quantity of Air Required—Definitions—Mine Laws and Their Requirements

MINE ventilation is not the difficult and complicated subject many would have us believe, but that it is a subject beyond the understanding of the average man is unfortunately a very general opinion. This belief has arisen from the fact that many textbook writers of little practical experience have buried the important facts that every miner should know under an avalanche of complicated formulas and long drawn-out theoretical discussions. These formulas and discussions, while possibly of interest to the teacher and, in some few cases, to the highly skilled engineer, are of no use to the practical man and only serve to make difficult and distasteful a subject that should be simple and interesting. It is pleasant to note that in recent years most of the boards appointed to examine candidates for the position of fire boss are taking the true and broad view that a man can serve efficiently and faithfully in that capacity, even if he never heard of an equivalent orifice or a mine potential; is incapable of designing a fan; and cannot juggle with fifth powers and cube roots like a professor of mathematics. The questions asked at recent examinations in such advanced states as Pennsylvania (both anthracite and bituminous), West Virginia, Alabama, Utah, and some few others, have been models of plain common sense,

the answers to which were within the abilities of any intelligent men. Such examinations are well designed to bring out the practical knowledge and experience of the candidate and indicate the broad training, good judgment, and sound common sense of the examiners. It is unfortunately true, however, that too many examining boards are composed of members who delight in asking useless and even impossible questions; questions which serve to confuse and mislead the candidate, answer no useful purpose, and display the half-baked knowledge and even ignorance of those who ask them.

The Quantity of Air Required for Ventilation.—The quantity of air passing through a mine, is always expressed as a certain number of cubic feet per minute. Thus, if it is said, "the ventilation is 50,000 feet," which is a frequently used, short way of stating the fact, it means that each minute 50,000 cubic feet of fresh air enter the mine at the intake and 50,000 cubic feet leave it through the fan at the mouth of the return. This statement is not quite exact, because the volume of air leaving the mine is a little greater than that entering it, having been increased by that of the gases given off by the workings while the current was passing through them. This quantity of air, 50,000 cubic feet, will occupy about the same space

as a two-story house 12 feet wide and 20 feet deep, which gives some idea of the quantity of air used each minute in ventilating a moderate sized mine.

Most all coal mining states have mine laws which, among other things, fix the amount of air which must be circulated each minute through the coal mines within their borders. These laws are by no means uniform in the different states, so that a fire boss leaving a position in, say, Ohio, to take one in Pennsylvania, will do well to secure a copy of the laws of his new state, that he may become acquainted with the regulations under which he is about to take up his duties. These laws determine the quantity of air to be circulated by stating a certain amount that must be supplied per minute for each man, and usually for each draft animal, both when the mine does not generate gas, that is, when it is non-gaseous, and when it generates gas, or is gaseous. While not generally named, the gas in question, is understood to be methane, marsh gas, light carbureted hydrogen, CH_4 , by whatever name it happens to be locally known, and which gas, when mixed with air in the proper proportions, forms an explosive mixture known as firedamp.

Definitions.—By mine ventilation is meant the act, process, or method of supplying a mine with fresh air. Its study includes that of the various methods and appliances for producing a current of air in a mine and for conducting a sufficient quantity of air through the entries or gangways and through the rooms, chambers, or breasts. To understand the principles of ventilation a man must have a good practical knowledge of the gases met in mines; of the effect of changes in temperature and pressure upon them; of certain instruments, such as the water gauge, anemometer, etc., used to measure the pressure and velocity of air-currents; of the various systems of mining and the best method of conducting the air-

current in each of them; together with a fair knowledge of the machines and appliances used to produce a circulation of air.

The object in ventilating a mine is to supply enough air to the workings to dilute and thus render harmless the injurious, explosive, or poisonous gases given off by the coal and the enclosing rocks, and to sweep away these gases as well as those resulting from blasting and

the burning of oil in lamps and those given off by the breathing of men and mules. If this fresh air is not constantly supplied and the bad air carried away, the mine air will rapidly become more and more impure, until the proportion of oxygen in it will be so small that lights will go out and men cannot breathe, or if methane is given off by the coal a gas explosion will result.

(To be Continued)

Mechanics of Mining

An Explanation of the Principles Underlying Calculations Relating to Engines, Pumps, and Other Machinery

By R. T. Strohm, M. E. (Continued from May)

IN the preceding article it was shown that a single fixed pulley simply changes the direction of a force, but that a single movable pulley changes the amount of the force so that the force required to raise a given weight is only half of the weight. There are many possible arrangements of fixed and movable pulleys for lifting loads, but in every case the following law holds good:

The force multiplied by the distance through which it moves is equal to the load multiplied by the distance through which it moves.

To show that this is true, consider the two cases shown in Fig. 17 (a) and (b). In the first of these, a single fixed pulley is used and in the second a single movable pulley is used. Suppose that the weight in each case is 20 pounds. It has been shown that with a single fixed pulley, the force must equal the weight raised, and also that the force and the weight move at the same speed. The force is then 20 pounds. Suppose that this force moves downwards 1 foot. The weight then moves upwards 1 foot, and $20 \times 1 = 20 \times 1$, which proves the law just stated. In the case of the movable pulley, the force required is only 10 pounds, but the weight is raised at only half the speed at which the force moves. Suppose

that the force moves upwards a distance of 2 feet. The weight will then rise 1 foot, and according to the law given above, $10 \times 2 = 20 \times 1$, which again is true.

The cases thus far described are fairly simple, as they include only a single pulley. Very often, however, two or more fixed or movable pulleys are used, and then the matter becomes a little more difficult to understand. For example, take the case shown in Fig. 18, in which the weight *a* is hung from the movable pulley *b*. The rope is fastened to the stationary hook *c*, passes under the pulley *b*, and then over the fixed pulley *d*, and the lifting force is applied at *e*, in a downward direction, however.

The effect of a pull at *e* is to cause an upward movement of the rope at *f*, at the same rate as the downward movement of the force *e*; for, as already stated, the fixed pulley simply changes the direction of a force without changing its amount or its rate of motion. The upward pull at *f* acts on the movable pulley *b* and raises it with the load *a*. But as the pulley is movable, the load rises only half as fast as the rope moves upwards at *f*. The rope moves downwards at *c* just as fast as it moves upwards at *f*; therefore, to raise the load 1 foot, the force *c* must move downwards 2 feet.

The upward pull at *f* is half the weight *a*, and if the weight of the load is assumed to be 20 pounds, there must be an upward pull of 10 pounds at *f*. But the pull at *c* is equal to that at *f*, because the fixed pulley does not change the amount of the force; consequently, a downward pull of 10 pounds at *c* will balance a weight of 20 pounds at *a*. Considered from the standpoint of the pull required, this arrangement has no advantage over that in Fig. 17 (b), as the same force must be used in both cases; but in the case in Fig. 18, the force can act downwards, which may be more convenient than having it act upwards.

With the arrangement shown in Fig. 18, the law given previously still holds true. For, with a weight of 20 pounds, a force of 10 pounds is required, and the weight moves 1 foot while the force moves 2 feet; therefore, $10 \times 2 = 20 \times 1$.

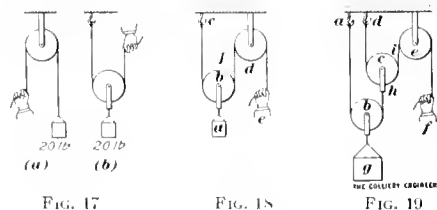

FIG. 17

FIG. 18

FIG. 19

The combination of pulleys in Fig. 19 includes two movable pulleys instead of one, and there are two hoisting ropes. One rope is fastened to the hook *a*, passes beneath the movable pulley *b*, and is attached to the frame of the movable pulley *c*. The pulley *c* is held up by the second rope, one end of which is fastened to the hook *d*, the other end being carried over the fixed pulley *e*. The lifting force is applied at *f*, and the weight *g* is hung from the pulley *b*.

To illustrate the action of this combination of pulleys, suppose that the load *g* weighs 40 pounds. It is supported by the two parts of the first rope, attached at *a* and *h*, and each part takes half of the load, or 20 pounds; therefore, the downward pull on the frame of the pulley *c* is 20 pounds. The pulley *c*, in like manner, is supported by the two parts of the second rope, and each

part takes half of the load on the pulley, or 10 pounds; that is the pull on the hook *d* is 10 pounds and the downward pull on the rope at *i* is 10 pounds. To balance the pull at *i*, the force *f* must act downwards with a pull of 10 pounds. The force of 10 pounds at *f* will hold up 40 pounds at *g*, when two movable pulleys are used, but when only one is used, as in Fig. 18, a weight of only 20 pounds is supported. The effect of adding the extra movable pulley, therefore, is to enable the lifting force to hold twice as great a load.

The advantage of raising a heavy weight by using a small lifting force is obtained at the expense of a slower speed in lifting. Thus, suppose that the force *f*, Fig. 19, moves downwards 4 feet. The pulley *c* and its frame will then rise 2 feet. And if the end of the rope attached at *h* is raised 2 feet, the pulley *b* and the load *g* will be lifted 1 foot. In other words, the force must move 4 feet to lift the load 1 foot in the same time; or, the load moves at only one-fourth the speed of the lifting force.

If the same force of 10 pounds is assumed to be applied in Figs. 17 (a), 18, and 19, it will lift loads of 10, 20, and 40 pounds, respectively; but the speed of lifting in Fig. 18 will be only half of that in Fig. 17 (a), and the speed of lifting in Fig. 19 will be only one-fourth of that in Fig. 17 (a). The effect of adding each movable pulley, therefore, has been to cut down the speed of lifting, although it has enabled a smaller force to lift a greater weight. In Fig. 19, as in the other cases, the force times the distance it moves is equal to the weight times the distance it moves in the same time; for $10 \times 4 = 40 \times 1$.

By adding other ropes and movable pulleys, the speed of lifting will be still further lessened, and a smaller force can be used. However, it is inconvenient to have so many separate ropes and pulleys, and the usual way is to use a single rope and to attach the fixed pulleys and the movable pulleys each to a

single frame. Such an arrangement is shown in Fig. 20.

The load *W* is hung from the lower frame that carries the three movable pulleys, and the three fixed pulleys are held in the upper frame attached to the overhead support. The rope is fastened to a hook at

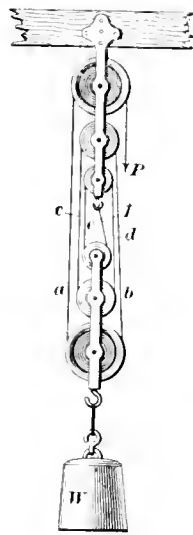

FIG. 20

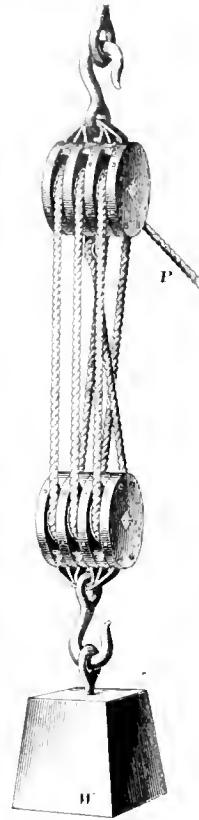

FIG. 21

the bottom of the fixed frame and is then carried around the movable and fixed pulleys, as shown, the lifting force being applied at the free end *P*, in the direction indicated by the arrowhead.

The load is supported by six parts of the rope, as at *a*, *b*, *c*, *d*, *e*, and *f*, and each part therefore takes one-sixth of the whole load. Suppose that the weight *W* is 60 pounds. Then the pull in each part of the rope is 10 pounds, and as the upper fixed pulley merely changes the direction of the force, the pull at *P* is the same as that in the part *a* of the rope, or 10 pounds. Therefore, with this arrangement of three movable and three fixed pulleys, a load of 60 pounds can be lifted with a force of 10 pounds.

But, as before, the power to lift

a load 6 times as great as the lifting force is obtained by having the load rise only one-sixth as fast as the force moves. This can be shown in a very simple way. Suppose that the weight *W* and the frame of the movable pulleys are pushed up 1 foot. Then each of the parts *a*, *b*, *c*, *d*, *e*, and *f* of the rope will have 1 foot of slack, and there will be 6 feet of slack in the whole rope. To take up this slack, the end *P* of the rope will have to move downwards 6 feet, when the parts of the rope will again be tight between the fixed and movable pulleys. This means that the force at *P* must move downwards 6 feet to raise the load *W* 1 foot; or, the load moves at one-sixth the speed of the lifting force.

The arrangement of pulleys in Fig. 20 takes up considerable space, and the ordinary way is to put the movable pulleys side by side in the same frame, and to arrange the fixed pulleys in the same way. Such a combination is shown in Fig. 21, and is familiarly known as block and tackle. There are three pulleys in the movable block holding the load, and three in the fixed block, so that the combination has the same effect as that in Fig. 20; that is, the weight that can be lifted is 6 times the lifting force applied at the free end of the rope, and the weight rises at one-sixth the speed of the lifting force.

There may be more or fewer than three pulleys in each block; but in any case the force required may be found by the following simple rule:

The force that must be applied at the free end of the rope in a block and tackle is equal to the weight lifted divided by the number of parts of rope leading away from the movable block.

For example, suppose that a block and tackle has five movable and five fixed pulleys, and that a load of 1,200 pounds is to be raised. As there are five movable pulleys, there would be ten parts of rope leading from the movable block, and the force required, according to the rule, would be $1,200 \div 10 = 120$ pounds.

In all that has been given in the preceding paragraphs, the effect of friction has not been considered. To turn each pulley on its axle requires some force, and consequently the lifting force will need to be greater than that found by the rule, to overcome the friction in addition to lifting the weight. The greater the number of fixed and movable pulleys, the greater will be the friction.

(To be Continued)

PERSONALS

F. McN. Hamilton has been appointed State Mineralogist of California State Mining Bureau, with office in the Ferry Building, San Francisco.

George Hill has been appointed Chief Mine Inspector of the State of Missouri. The last legislature in Missouri passed a law creating a Mining Department with a Chief Mine Inspector, and under him six Deputy Inspectors; two for the coal mines and four for the lead and zinc mines. Mr. Hill's office will be at Jefferson City.

J. F. Callbreath, Secretary American Mining Congress, states that a large part of the work of the organization is being done in the Munsey Building, Washington, D. C.

Dr. J. A. Holmes, Director United States Bureau of Mines, delivered the Class-Day address to the graduates of the Michigan College of Mines, Houghton, Mich.

H. W. Scheiler, of Lincoln, Ill., is now County Mine Inspector of Logan County, Ill.

In consequence of the retirement of James Barrowman from the office of Secretary of the Mining Institute of Scotland, the Council have appointed George L. Kerr as Secretary. Mr. Kerr has also been appointed to the office of Treasurer, with offices at 39 Elmbank Crescent, Glasgow.

W. M. Nixon, Secretary of the National Coal and Coke Co., and also connected with the Nixon

Mining Drill Co., kept open house during the Confederate reunion at Chattanooga, Tenn., in May. The reunion commemorated the semi-centennial of the famous battles of Chickamauga, Missionary Ridge, and the "battle above the clouds" on the heights of Lookout Mountain.

John M. Sherrerd, formerly connected with the Taylor Iron and Steel Co., of High Bridge, N. J., is now with The Titanium Alloy Mfg. Co., of Niagara Falls, N. Y.

Charles T. Malcolmson has organized the Malcolmson Briquet Engineering Co., with offices in Old Colony Building, Chicago, Ill.

The Hon. William C. Redfield, having been appointed a member of President Wilson's cabinet, has resigned his position as vice-president and director of the American Blower Co.

At a recent meeting of the geological members of the American Institute of Mining Engineers, Waldeman Lindgren was made chairman of the Committee on Economic Geology. This committee aims to encourage contributions and promote discussions on the subjects of economic and mining geology.

Eugene Haanel, Ph. D., Director Mines Branch Department of Mines, Ottawa, Canada, announces that the government laboratory for the experimental tests of Canadian ores will be completed about July 1, 1913.

OBITUARY

WILLIAM L. SHEAFER

William Lesley Sheaffer, who died at his residence in Pottsville, Pa., on April 23, was one of the most prominent men connected with the mining industry in the Schuylkill region. Though not engaged in actual mining, he was interested in the anthracite industry through ownership in valuable coal lands, and he took great interest in all matters pertaining to the industry as well as in all matters to the benefit of his native county (Schuylkill).

He was born in Pottsville, Pa., on February 19, 1859, and was a son of the late Peter W. Sheaffer, who in his life time held a high reputation as a coal geologist and mining engineer.

Mr. Sheaffer graduated from Lafayette College as a mining engineer before he reached his twentieth year, then took a post-graduate course of a year and was awarded the degree of Master of Science. He then entered his father's office and was associated with him until the latter's death in 1891, when he became one of the executors of his estate, which consisted largely of valuable coal lands.

Mr. Sheaffer was a man of pleasing personality, broad charity, and full of public spirit.

Owing to the absence of necessity for activity as a mining engineer, aside from employing his profession in his own and his family's interest, he did not seek to obtain prominence in it, though he was eminently qualified to rank as a leader, had he so desired, or necessity demanded.

He was a member of the American Institute of Mining Engineers, and was for 20 years a trustee of Lafayette College.

J. Shephard Clark, founder of El Comercio, died in New York City April 26.

Hon. Frank O. Briggs, Ex-United States Senator for New Jersey, and First Assistant Treasurer of John A. Roebling's Sons Co., died at his home on May 8.

Samuel L. Moyer, First Vice-President of the Lunkenheimer Co., died at his home in Cincinnati, on May 3.

來 來

The anthracite mines at Russellville, Ark., have resumed operations after being idle for over 2 years. Mr. J. P. Quirk and C. S. Whortley, of Detroit, who bought the property for \$183,000, have leased it to Mr. Barrett, of Kansas City, who has put 100 men at work.

THE Cincinnati mine,

which is one of the oldest bituminous mines in operation, is situated on the west bank of

the Monongahela River, about 27 miles southeast of Pittsburg, on the Monongahela Division of the Pennsylvania Railroad.

The explosion at this mine, which resulted in the death of 96 men, occurred April 22, 1913, at about 12 o'clock, noon.

The mine has been operated for about 70 years by various concerns, and about 15 years ago it passed from the hands of C. M. Jutte & Co. into the possession of the Monongahela River Consolidated Coal and Coke Co., the present owner and operator.

There are two entrances to the mine, the Mingo slope, and the main haulage road leading from the pit mouth.

The Mingo slope is near Mingo station on the Pittsburg & Charleroi Street Railway, is about a mile and a half over the hills from the pit mouth, and is used only as a traveling way for men and mules, and as an inlet for the air. It was constructed at the recommendation of Henry Louttit, state mine inspector, shortly before the mine passed over to the present owners. The slope at first was a bad one of a varying pitch, but during recent years it has been graded at a pitch of 20.5 degrees throughout the 500 feet of its length.

The main haulage road is used for head and tail-rope haulage from the pit mouth to the main parting, which is a distance of about 6,800 feet; from there, the mine cars are distributed and collected by motors and mules.

The seam worked is the Pittsburg seam and varies from 5 to 6 feet in thickness. The roof is usually 6 to 7 feet above the rail due to the draw slate above the seam, which is shot down.

No analysis of the coal at the Cincinnati mine could be obtained, but coal from the surrounding mines has

The Cincinnati Mine Disaster

Account of the Accident—The Method of Mining—The Rescue Work, and Reports of the Mine Inspector and the Commissioners

By William Z. Price

the following composition: Moisture, 3.05; volatile matter, 33.50; fixed carbon, 56.55; ash, 6.02; sulphur, .96. Specific gravity, 1.32.

Mining is done by the advance-and-retreat room-and-pillar system, as shown in Fig. 1, which is thus explained. A, B, and C represent the three stages through which the mining passes. There are four parallel face entries driven, and two parallel butt entries, off which the rooms are driven.

A represents the first stage and it shows the rooms being driven on the "advance" and the pillars being drawn back to the entry after the rooms are finished (dotted portion).

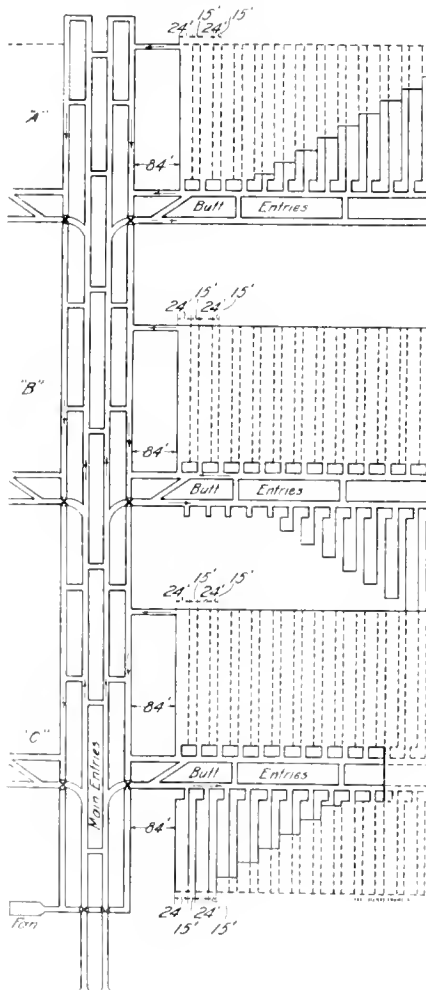

FIG. 1. METHOD OF MINING

The air-current is indicated by arrows, and after sweeping through the room faces it goes on over the "robbed out" area

into the return airway.

B the second stage, shows all the rooms driven their prescribed distance and the ribs drawn back to the stumps on the "advance" entry, and also rooms being driven and rib drawing off the "retreat" entry.

C, the last stage, shows that all rooms have been driven off both entries, and in addition the robbing of all pillar stumps; the ventilation still working as before, the air going to the working faces, then sweeping over the gob into the return. The advantage of this system is that fresh air always goes to the working faces and the gob is always ventilated by the return.

The mine covers approximately 1,100 acres, of which about 590 acres comprise live workings. This, of course, means that an efficient ventilation system is required to circulate the amount of air prescribed by law. It is reported that an explosion occurred at the mine about 20 years ago, but no record of it is in evidence. The mine is ventilated by an exhaust fan of the Capell type, electrically driven by a direct-current motor through gears. The fan is 12 feet in diameter, with blades $3\frac{1}{2}$ feet wide and 3 feet deep, and averages 156 revolutions per minute, developing a water gauge of 3 inches.

According to the latest published report of the State Department of Mines, there was 129,000 cubic feet of air per minute entering the mine, 56,850 cubic feet circulating in all the splits, and 132,000 cubic feet passing out at the outlet. The gob is ventilated, as previously explained, on the advance-and-retreat system and the large quantity of air which enters the mine and does not show in the splits must circulate through some of the mined-out workings. The state mine inspector measures the quantity of air in the different splits at the inside breakthroughs. The fan has

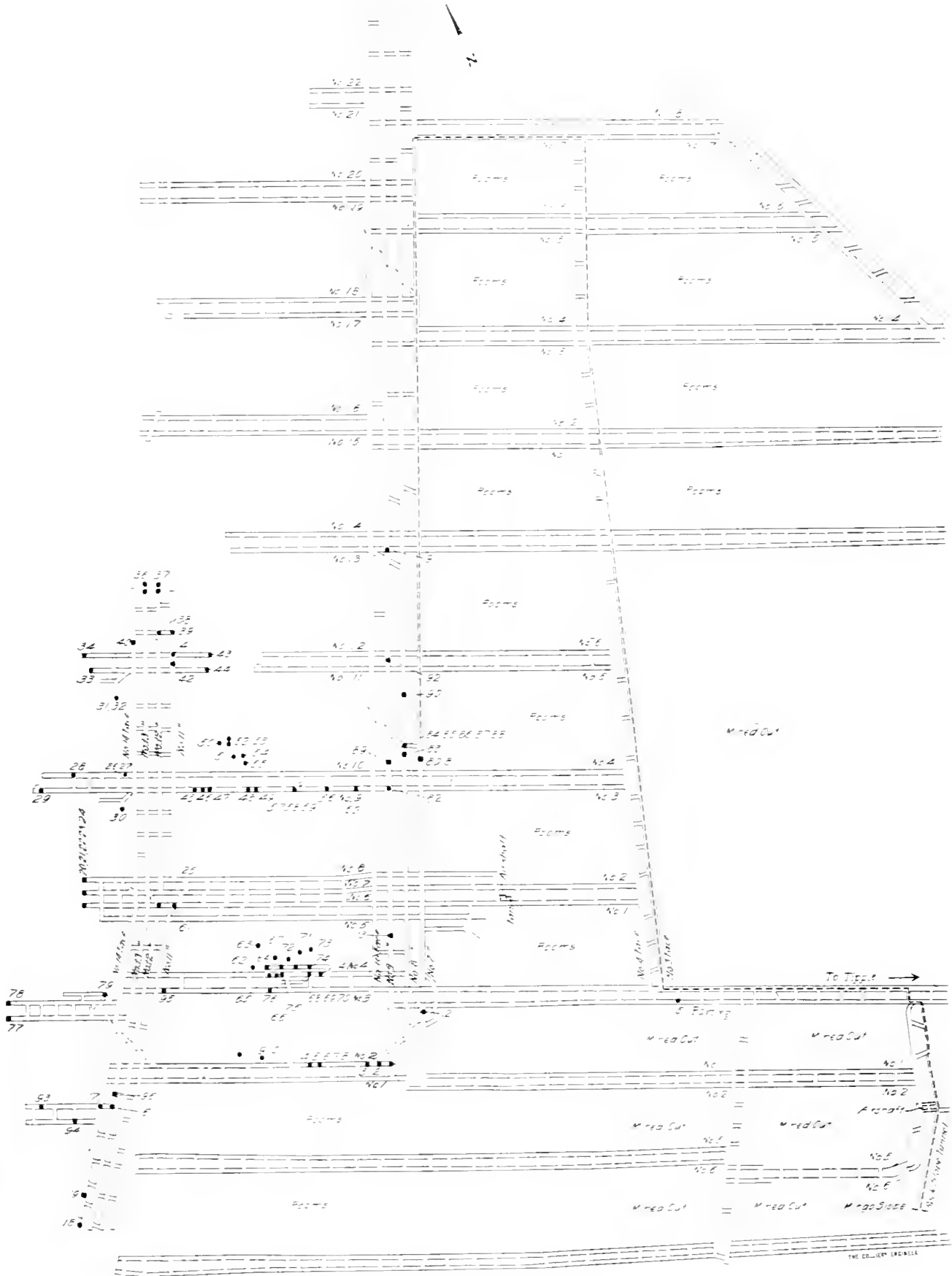

MAP OF CINCINNATI MINE

a capacity of about 200,000 cubic feet, but 129,000 was found to be sufficient.

The coal is mined by machines and by pick work. There are nine electric coal-cutting machines in use. Both open and safety lamps were used in the mine but in all entries wherever gas was found the men worked with safety lamps. In driving rooms the miners used open lamps, but everywhere that pillars were being drawn, the Wolf type of safety lamp was used.

The mine has never been considered a dusty one, but precautions were taken in the shape of two sprinklers and calcium chloride in abundance.

Out of the 96 men killed, a few were killed by the force of the explosion and by burns, but the majority died from the effect of the afterdamp. This afterdamp came back so strong at the intersection of Nos. 9 and 10 butt entries and the face entries, that it overcame 12 men there; these men in their excitement, akin to a stampede, rushed away from friends who escaped by the route indicated by the dotted line on the map and ran right into the foul atmosphere. The accompanying map of the mine workings shows the position of the bodies of these men when found. The numbers on the map indicate the order in which the bodies were found. Two men were found alive in No. 20 butt entry where they had been for about 2½ days. These men were not working there but lost their way and went up the cross-cut from No. 8 face to No. 19 butt. The supposition that more men were alive was not a well founded one, other men would have lived there had they remained, but they escaped across No. 18 butt to No. 4 face and out to the slope.

During the period immediately after the explosion, six state mine inspectors, Messrs. Bell, Cunningham, MacGregor, Pratt, Burns, and Howarth, arrived at the mine to assist the mine inspector of that district, Mr. Alex. McCaneh. James E. Rodrick, Chief of the Department of Mines, and five other state mine inspectors, arrived the following morning. The company officials,

however, were able to cope with the situation and directed all the rescue work and the reconstruction of the ventilation, with the assistance of the state inspectors.

Probably the first intimation of the disaster came to Gorley Stokes, a trip rider. The trip was on its way inside and he was riding in the second car when the explosion took place, he was knocked down but not hurt and his cap and lamp were blown into the third car. He jumped out and gave the signal to the engineer to stop, which he did; then after finding his cap and lamp he started in toward the parting; when he got near the old mine foreman's shanty he heard the telephone ringing and upon answering it found it was the fan runner who said he needed help, that there had been an explosion no doubt, for the explosion doors were blown off the fan house, and the fan was stopped for 8 minutes before it could be started again. Stokes then called up the engine house outside and asked for help. He then found Emil Leroy, his partner, on the parting, (15) with his face down and hand fast under a roller, and he was unable to get him loose. Just then four men came by on their way out; they hurried on, however, and bade him do the same. But after finally getting the cable lifted, Stokes released Leroy, only to find him dead.

The mine foreman, one of his assistants, and a miner, were found in No. 6 butt off No. 14 face; each had a safety lamp; the bodies of these men were found close to the face, where they had gone to investigate a report that gas was being generated in that entry.

It is interesting to note that Mine Inspector Alex. McCaneh made his last examination previous to the explosion on March 7, 8, and 10, 1913, just 6 weeks prior to the explosion. At that time he found 111,000 cubic feet of air entering the mine and 59,280 cubic feet in the eight splits; he found also that the volume of air per man varied in the different splits from 200 to 700 cubic feet, averaging over 400 cubic feet, an excess of the 200 cubic feet prescribed by law.

Mr. McCaneh was at the Ellsworth No. 1 mine at the time of the explosion, and as soon as the mine ventilation was restored and the rescue work finished, made his examination. He claims from his investigations that the point of the initial explosion was on No. 12 butt entry off No. 14 face, it then traveled north to the faces of the face entries and south to all openings on the east and west until it reached the big parting where the force seems to have been spent. There were practically no evidences of an explosion in any other part of the mine.

No. 12 butt entry had been driven about 300 feet and had two breakthroughs; these openings are made about every 120 feet. At the face of No. 12 butt entry, he found a clay vein, running almost at right angles to the course of the entry, exposed by a shot, with a heavy feeder of gas.

Mr. McCaneh believes that the miner working in the entry had fired his tight shot in the morning and later in the day had fired the butt shot which evidently exposed the clay vein and allowed the gas to escape. As it was almost noon the miner evidently went back to eat his lunch and then in going back to the face of the entry he fired the gas; the miner's cap and lamp were found about 12 feet from the face and his body about 30 feet from the face.

There were about 15 loaded mine cars out in the face entry, the first car was not damaged, but the coal on the top was blown into the air and by the time the end of the string of cars was reached the force was so violent that the last car was smashed to pieces; the first force having been no doubt augmented by the coal dust blown in the air.

In reviewing the work done by the rescue parties, many deeds of valor were performed, but specific cases cannot be named for fear of slighting many other acts of bravery that were crowded into the succeeding hours of the explosion. When one man came out exhausted, there were 50 eager to take his place. Too much cannot be said in praise of the efficient manner in which the company

handled the work; men and supplies were to be had in abundance.

Three helmet men in No. 2 butt entry begun to feel the effects of the afterdamp and one, James McColligan, of Jacobs Creek first-aid corps, collapsed, his companions tried to carry him along, but growing weaker they were compelled to leave him and he died there.

William Lauder, a company mine inspector, had charge of the inside work, and directed gangs of workmen in the construction of stoppings, doors, brattices, etc., as well as participating in the rescue work; the latter was conducted from the Mingo entrance, the rescuing parties being made up of first-aid corps, mine foremen, fire bosses, and miners.

The following is an extract from the report of George S. Rice, Chief Mining Engineer of the United States Bureau of Mines, describing the exploration, made after the explosion:

REPORT OF GEO. S. RICE TO BUREAU OF MINES

Late Wednesday afternoon, April 23, rumors of the disaster reached the Pittsburg station of the Bureau of Mines. Rescue Car No. 6 was immediately sent to Finleyville; George S. Rice, chief mining engineer, and Messrs. Mason, Salisbury, Price, and C. O. Roberts went by train. There were no railroad connections to the Mingo entrance, so the rescue apparatus and supplies had to be taken by wagon several miles to that entrance. Mr. Fritchman, of the Pittsburg Coal Co., who was in charge of that entrance, stated that there were already large parties of rescuers in the mine, and among them the rescue corps of the Pittsburg Coal Co., with breathing apparatus, so that other rescue corps would not be needed for a while. Shortly after 8 P. M. there was a call for a pulmotor to revive some rescue men that had been overcome, and a party of Bureau men went into the mine at 9:05 P. M. with breathing apparatus and a pulmotor. Some of the men who had been overcome soon reached the outside and were given oxygen treatment by another pulmotor of the Bureau's equipment.

The party going underground proceeded to the second butt off the 8th face entry, where the rescue men had been taken who had been overcome. All had recovered but one. He had been given first-aid treatment by two doctors for over an hour without results, and the pulmotor was then tried for an hour and a half, but without success.

The Bureau rescue corps, using breathing apparatus, then made advance explorations in the Nos. 11, 12, 13, and 14 face entries and Nos. 1 and 2 butts off 14th face entry to put out any fires which might have started, and to locate men overcome, or bodies. As the explosion had been strong in this section of the mine there was little chance of men being alive. It was, however, important to determine whether fire existed. A smoldering fire had been put out in the 8th face entry at the mouth of the second butt. In the 14th face group of entries there was much gas, so that if fires existed it was important that they should be put out before ventilation was restored.

Meantime additional supplies had arrived from the Mine Rescue Car, and Messrs. Paul and Deike, the former in general charge of all Bureau rescue operations, also arrived at the Mingo entrance. Mr. Riggs, a volunteer, who had received training with rescue apparatus, Mr. Deike, and two members of the Pittsburg-Buffalo rescue crew, all equipped with oxygen breathing apparatus, together with Messrs. Paul and Rice, entered the mine at 12:05 and proceeded to the second butt entry off the face. Shortly afterwards it was desired to make certain changes in the ventilating current, and the Bureau's rescue corps went out of the mine for a short rest. They were called, and again entered the mine at 3:25 A. M., Thursday. Advance explorations using the helmets were made in the 3d, 4th, 5th, 6th, 7th, and 8th butt entries off the 14th face entry, to insure there being no fire before ventilation was turned into each entry successively.

In order to allow this advance exploration work with breathing appa-

ratus to proceed consecutively it was deemed necessary to call additional men from the Pittsburg station, so that there could be a corps on each shift, and with additional apparatus they reached the Mingo entrance Thursday noon. Thursday at 4 P. M. the Bureau corps in charge of Mr. Paul, together with five others, went into the mine, and proceeded to the mouth of No. 9 butt entry off the 14th face. Exploration was then made to the head of the 9th and 10th entries.

There was considerable difficulty on account of water in these entries, and at different times the crews retreated to the base to adjust the breathing apparatus of three of the men. The latter were slightly affected, but were able to retreat to fresh air with the assistance of other members of the crew. Finally, however, the faces of these entries were reached, and many of the bodies in these entries were located. Finding that there was no fire, brattices were put up in the breakthroughs, and ventilation sufficiently restored to get out the bodies by men not using breathing apparatus. At 10:30 P. M. the exploration having been completed, the air was short-circuited straight up No. 14 face to the 11th and 12th butt entries, which were explored by the men with breathing apparatus. No fire being found, the brattices were carried up into them by men without breathing apparatus, in order to recover the bodies. At this time the oxygen for the apparatus having been exhausted, it was necessary to return to the outside, and during the night, ventilation having been established by bratticing through the entries off the 14th, breathing apparatus was not necessary to complete the exploration in these entries. The entire exploration and removal of bodies in that district of the mine was completed by noon Friday, and then the ventilating current was turned into the entries off the 8th face.

The Bureau's rescue corps and the rescue car remained on hand until the following Thursday (May 1), but there was no further need for their services.

The victims of the disaster were divided by nationalities as follows: Americans, 38 (19 colored); Russian, 21; Italians, 12; Austrians, 9; Scotch, 5; English, 5; Belgians, 2; Hungarian, 1; Lithuanian, 1; Welsh, 1; and French, 1. One hundred and thirty-one children were made orphans, while 51 women became widows. The number of children by families vary from one to 10.

REPORTS OF THE COMMISSIONERS TO
CHIEF OF DEPARTMENT OF MINES

In order to ascertain the cause of the explosion at the Cincinnati mine which caused the death of 96 men, on April 23, Chief of the Department of Mines of Pennsylvania, J. E. Roderick, appointed two commissions which examined the workings independently of each other. Through the courtesy of Chief Roderick we are able to give the readers of THE COLLIERY ENGINEER the conclusions of these commissioners.

The first commission was composed of Thomas K. Adams, I. G. Roby, C. P. MacGregor, Joseph Williams, and Arthur Neale, all mine inspectors, from other districts than the one in which the explosion took place. This commission reported virtually as follows:

"In compliance with your request of April 26, we investigated and examined the Cincinnati mine of the Monongahela River Coal and Coke Co., and submit to you the following report as to what in our belief was the cause of the explosion which occurred at this mine on April 23.

"We have carefully examined that portion of the Cincinnati mine which was affected by the explosion, and also the surrounding parts of the mine not directly or seriously affected thereby. In this instance, as in all other serious and widespread mine explosions it is difficult to determine with absolute surety the origin or the cause of the explosion, but we have concluded that the initial explosion probably occurred in No. 12 butt entry driven off from 14 face entry north, where a shot

ruptured a clay vein and allowed the gas back of it, under considerable pressure, to escape. In this instance a tight shot, Fig. 2, had evidently been first fired and loaded out, exposing but not penetrating the clay vein. Subsequently when the butt or second shot, which penetrated the clay vein, was fired a strong gas feeder was tapped. This gas feeder can be heard blowing off even now.

"The man working in No. 12 butt entry was probably using an open

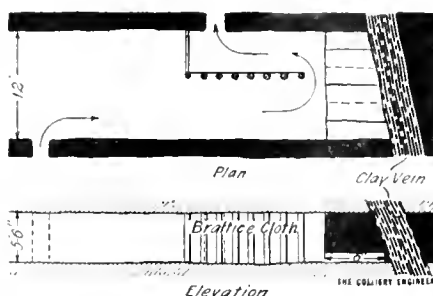

FIG. 2. FACE OF NO. 12 ENTRY

light, as his working place had not been generating gas before the clay vein was tapped. It is our belief that the gas was liberated by the shot, and being ignited by the miner's lamp, the explosion resulted. We could find no gas being given off in any entries in this section, with the exception of No. 6 butt entry, which had also penetrated a clay vein 3 or 4 yards. We do not think this latter clay vein had anything to do with the origin of the explosion.

"The initial explosion was augmented by the gas driven from the coal by the intense heat which is shown to have existed by the condition of the entries through which the primary explosion passed. The brick air stoppings were built to within one breakthrough of the face of the several entries, and the mine was kept in a clean, orderly condition. We further report that in the area unaffected by the explosion we found the mine in an excellent condition.

"We entered the mine by way of the traveling slope, located near the active workings, and proceeded along the main haulage road. We

found the force of the explosion ceased near the mouth of the No. 4 face entry. We found the overcasts blown down on the main haulage road. We traveled up No. 2 butt entry and Nos. 11, 12, 13, 14, face entries and examined them carefully, and noted the conditions existing in Nos. 11, 12, 13, and 14 face entries south, and Nos. 1, 2, 3, 4, 5, 6, 7, and 8 butt entries off No. 14 face entry, and found such evidences of the effects of the explosion as the destruction of the stoppings, doors, and mine cars. We also found coke dust and other evidences of heat on the side walls, from No. 1 butt entry to the face of the several face entries, with little injury to the roads from falling roof.

"On April 29 we went to Nos. 9, 10, 11, and 12 butt entries off No. 14 face entry; to the north face entries Nos. 11, 12, 13, and 14; to butt entries Nos. 9, 10, 11, and 12 off of No. 11 face entry and saw the results of the force of the explosion in those entries, also found much coked dust resulting from the heat between No. 10 butt entry and faces of the north face entries, and face of No. 12 butt entry.

"On the 30th we traveled much of the ground examined on the previous days to make a more minute inspection and note carefully the existing conditions, so as to better ascertain the direction in which the force of the explosion traveled; to determine the point at which it originated, and the cause thereof. We also examined that portion of the mine not affected by the force of the explosion and where a number of the men lost their lives by after-damp, and also from where a large number of men escaped shortly after the explosion, and in which two men were found alive 55 hours after the explosion had taken place.

"After carefully examining all of the damaged portion of the Cincinnati mine and noting carefully all the evidences of the explosion, we unanimously agree that it originated at the face of No. 12 butt entry being driven west off No. 14 face

entry north and was caused by the naked light of a miner igniting a body of gas which had suddenly issued from the clay vein uncovered by the shot, and which had accumulated in the entry.

"The force of the explosion traveled down No. 11 and 12 entries, passed entries Nos. 14, 13, 12, and 11, proceeded southward to Nos. 8, 7, 6, 5, 4, and 3 butt entries, then to Nos. 2 and 1 butt entries, where it cushioned against the faces of Nos. 11, 12, 13, and 14 face entries south, and was exhausted in an easterly direction toward the mouth of the mine. According to our observations there is a probability that a secondary explosion took place, one at the face of Nos. 5, 6, 7, and 8 butt entries, off No. 14 face entry, owing to the fact that much gas was being produced at the face of No. 6 butt entry from the very strong gas feeder. Another explosion seems to have taken place in Nos. 3 and 4 butt entries, off No. 14 face entry; at any rate it is apparent that the explosive force was much increased at these points."

REPORT OF THE SECOND SPECIAL COMMISSION

The second special commission consisted of W. R. Calverly, general manager of the Berwind-White Coal Co., J. H. Sanford, mining engineer, operator and competitor of the Monongahela River Coal and Coke Co., and R. M. McKinney, mining engineer, not connected with any company. These men reported their investigations to Chief Rodrick as follows:

"We entered the Cincinnati mine of the Monongahela River Consolidated Coal and Coke Co., April 30, by way of the Mingo rock slope. This slope is driven on about a 20-degree dip to the coal bed, which is about 200 feet below the surface. We proceeded from this slope along the rock tunnel to the main haulage road, which at this point is about $1\frac{1}{4}$ miles from the river front where the tippie is situated. We proceeded along this haulage road about 7,000 feet to where was found

the first evidences of the explosion, and then continued to where the body of the parting boss had been found in a manhole, at the parting. Even beyond this point, a considerable distance, the guards used to protect the men from the trolley wire had not been disturbed, except for a board here and there. Some of the electric bulbs were intact in the course of the explosion, from which it would appear that the force was not great to this point.

"Proceeding to the junction of No. 3 and No. 4 butt entries with the lower north main entries Nos. 7, 8, 9, and 10, evidences of great force and fire were plainly visible. At this point the machine boss had his workshop in a breakthrough which extended from one entry to another, being brick lined with 9-inch walls on each end. These walls were destroyed and it was at this particular junction there was more evidence of fire than in any other of the lower face entries. From this place we proceeded by way of No. 8 face entry to Nos. 5, 6, 7, and 8 butt entries which are driven beyond the main entries, in a westerly direction. We traveled these butt entries 2,000 feet until they intersected with the four upper face entries, Nos. 11, 12, 13, and 14. We then proceeded along No. 11 face entry to butt entries 11 and 12 which are being driven in an easterly direction to meet Nos. 11 and 12, which are being driven from No. 10 face entry. We proceeded to the extreme end and examined carefully the working places of Nos. 11, 12, 13, and 14 face entries. There was no evidence of fire within some 25 or 30 feet of the face of these entries and no disturbance was observed.

"Paper, fuse, and explosives were lying just as the workmen had placed them, even dinner buckets were not disturbed. Going back to where Nos. 11 and 12 butts west start from No. 14 face, there was evidence of fire having played a conspicuous part in coking the face of the coal. The heat must have been very intense at this point and the

flame must have lingered some time, because the coking effect was evident almost from the top to the bottom of the coal bed. We proceeded up to the face of No. 12 butt and noticed that the face of the clay vein had evidently been shot and not disturbed afterwards. From this point we retraced our steps and passed through the breakthrough to the face of No. 11 butt entry, then back along No. 14 face, crossed over the face entry and went into Nos. 9 and 10 butts, traveling toward No. 10 face entry. After traveling 1,000 to 1,200 feet we could go no farther on account of an accumulation of water in a swamp, so we went to the faces of Nos. 9 and 10 butts off face entry No. 14, thence back along No. 14 to Nos. 8, 7, 6, and 5 butt entries, where there is an intersection of the north and south face entries.

"We traveled along No. 14 south, walking to the face of Nos. 3 and 4 butt entries east, up the face of Nos. 1 and 2, butt entries, and to the face of Nos. 14, 13, 12, and 11 south face entries. We then traveled to the lower face entries by way of Nos. 3 and 4 butt entries. This was the extent of our travels on Wednesday.

"On Thursday morning we again entered the mine following the same course to the intersection of Nos. 3 and 4 butt entries with Nos. 5, 6, 7, and 8 face entries, proceeding along these face entries to Nos. 9, 10, butt entries, which we traveled until stopped by water which prevented our going through the upper face entries to these entries. Going back down we traveled along No. 10 face entry to the faces of Nos. 11 and 12 butt entries. We were then in a section that had not been affected by the force of the explosion, although afterdamp would have entered and traveled some distance in these face entries. We proceeded, however, to the extreme end of this section of the mine and up Nos. 19 and 20 butts to the face entries, which were being driven off of these two butts north and south at the time of the explosion. Having satisfied

ourselves as to the condition of this section, we retraced our steps, again traveling from No. 8 butt to the upper face entry and along No. 11 face north. We examined every detail that we thought might have a bearing upon determining positively where this explosion got its initial start.

"When we arrived at the face of No. 12 butt, off No. 14 face, it was plainly evident that this was the point where the explosion originated, and as previously stated, where the clay vein had been shot and gas had been given off freely evidently the tight shot had been fired and loaded out, exposing but not penetrating the clay vein. When the butt shot was fired it penetrated the clay vein and tapped a strong gas feeder, as gas could be heard blowing out of the fissures when we made our examination, which, of course, was a week after the explosion.

"It is fair to assume that when the butt shot was first fired gas was given off more freely than at the time we made our examination. It would appear to us also that prior to the butt shot being fired the entry was not making any gas. When the workman charged and lighted this shot he would naturally walk back from the face and stand in some protected place until the shot went off. It being noontime, it is probable that the man would sit down and eat his lunch while the smoke was clearing out of his working place. An empty car was standing right up to the face entrance, and it is fair to assume that the man when returning to his working place pushed this empty car ahead of him to the rise. Of course, the man pushing the car would naturally have his head down low, and when he reached the end of the rails and stood erect with a light on his head he would ignite the gas that had accumulated during his absence. His cap and lamp were lying about 10 or 12 feet from the face, but his body was found about 30 or 35 feet from the face.

"The entry was bratticed to within 18 or 20 feet of the face. It appears to have been the custom in most of the entries. (See Fig. 2.) The last 10 or 12 feet of this brattice had evidently not been disturbed by the explosion, while the brattice further out was blown down. There was evidence of fire at the face of this entry where the coal had been blistered, and also where the flame had come in contact with the side of the entry. From this place we traveled back to the breakthrough and passed through it into No. 11 butt, which is parallel to No. 12. In No. 11 butt we examined everything carefully and found that no gas was being given off in this entry. There was no evidence of flame having come in contact with the coal within 20 or 30 feet of the face, while all through the breakthrough and a considerable distance up the entry there had evidently been intense heat and flames. This was plainly evident because on the sides of the entry the surfaces of the coal were coked. It seemed to us to prove, as we traveled away from the face of No. 13 butt, toward No. 14 face entry that the force of the explosion increased and the destruction had become greater.

"At the face of Nos. 9 and 10 entries mine cars were badly wrecked, the line of force having traveled from No. 14 face entry toward the face of Nos. 9 and 10 butt entries. We retraced our steps to No. 8 butt, where we made a thorough examination, because in No. 6 butt gas had been previously reported, 12 feet from the face where a clay vein had been cut, and where in all probability gas was liberated. Here the face had been cut and the tight shot loaded out, and it was evident that coal had been drilled preparatory to shooting out the butt. This entry had been worked with safety lamps, and this is the entry in which, we understand, the mine foreman and his assistant and the men who were working the entry, were found. This would show conclusively that the direction of the

force was down the 14 face entry up to the face of these butt entries, as we noticed upon our examination that the debris had been scattered along the entry right up to the working face. From this point we traveled south because the direction of the explosion was certainly toward the face of these entries. We examined this section thoroughly for gas and only discovered it at the face of No. 12 butt where we are positive almost that the explosion started. The face of No. 6 butt, as previously stated, was some 12 feet beyond the clay vein, and water was being given off from this vein, but no great amount of gas, as the gas was escaping through the water, and the noise was more in evidence than the gas itself. We also noticed that a little gas was given off in No. 4 butt entry. The explosive force was in the direction of the lower face entries and the damage appeared similar to that in Nos. 9 and 10 as far as Nos. 3 and 4 butts, where its energy decreased by getting relief up the air-shaft and along the main haulage roads. As previously stated there was no damage done to the lower main section beyond No. 11 butt and it appeared that all the workmen in this section escaped with the exception of a few men who panic stricken rushed along the main traveling road into the after-damp, against the advice of the assistant mine foreman and others. Two men working at the face of Nos. 11 and 12 butts, off No. 8 face, north, escaped 3 or 4 hours after the explosion occurred by way of the lower return airway.

"In that part of the mine unaffected by the explosion we find the conditions have not been changed from what they were prior to the explosion. There was ample ventilation and it was conducted around all of the working faces. We noticed that brick stoppings were erected in practically every instance to the last breakthrough, except, of course, those used for haulage purposes. The roads were moist

and practically free from dust, and clean and free from obstructions. We also noticed in this section that drums of calcium chloride were placed in convenient places and used for sprinkling the roads. In that part of the mine which you might term the 'upper face section' the force of the explosion was very destructive; all of the stoppings were blown out as were the overcasts. These overcasts and stoppings were built of bricks.

"In this section of the mine we also noticed three drums of calcium chloride containing 250 pounds each, which were not opened, and this would indicate that ample quantities of this safety factor had been provided, since some of the drums were partly used. We think we can give to this calcium chloride some of the credit for the explosion not being more destructive than it was, because it seems as if every precaution that must be observed in exploiting our coal fields against dangers which arise, had been taken.

"There is no doubt but that the initial explosion was augmented by the gas given off from the coal by the intense heat. This was shown by the condition of the entries through which the primary explosion passed. We are satisfied, too, that in a brisk air-current some coal dust will be held in suspension, which coming in contact with the flame of the explosion will add to the volume of the gas and increase the energy.

"We are of the opinion that little gas is given off in any of the entries in this section, because at the time of our visit, with the ventilation disarranged and air stoppings and overcasts temporarily built of wood and brattice cloth, the entries were free from gas. As you will notice by reference to the map, Nos. 9 and 10 butt entries are driven a considerable distance from face entry No. 14. The same is true of Nos. 3 and 4 butt entries and the four face entries 11, 12, 13, and 14, north and south, off Nos. 5, 6, 7, and 8 butts. Leaving this section and going to

19 and 20 entries, off the lower face entry 8, north, some distance away, there was no evidence of gas to justify the use of safety lamps. We feel that no one will seek to dispute the fact that the section of the mine unaffected by the explosion was found in excellent condition viewed from every standpoint."

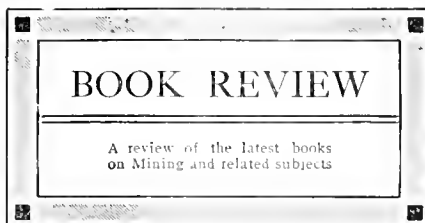

MAP OF WEST VIRGINIA COAL FIELDS.—This map has been compiled by Clark & Krebs, Charleston, W. Va., and shows the property lines, location, and ear allotment, of the mines in the New River, Kanawha, Coal River, and Guyandotte River coal fields in West Virginia. The map is large and one which will be appreciated by every operator in West Virginia. Price is \$5.

ENTROPY - TEMPERATURE AND TRANSMISSION DIAGRAMS FOR AIR, by Prof. C. R. Richards, has just been issued as Bulletin No. 63 of the Engineering Experiment Station of the University of Illinois.

This bulletin presents the theory and use of three graphical charts, by the aid of which all problems pertaining to the compression, expansion, and transmission of compressed air may be solved with a minimum of labor and with a degree of accuracy which is satisfactory to engineering work. Copies of Bulletin 63 may be obtained upon application to W. F. Goss, Director of Engineering Experiment Station, University of Illinois, Urbana, Ill.

VIRGINIA GEOLOGICAL SURVEY. Dr. Thomas L. Watson, Charlottesville, Va., Director, has issued Bulletin No. V on "The Underground Water Resources of the Coastal Plain Province of Virginia." The book is by Samuel Sanford and was prepared in cooperation with the United States Geological Survey.

The California State Mining Bureau, T. McN. Hamilton, State Mineralogist, has just issued Bulletin No. 63, "Petroleum in Southern California." The book covers the Ventura, Los Angeles, Orange, San Bernardino, and Santa Barbara County oil fields. It gives various methods of analysis of the typical oils in the several fields, the history of the development, and describes the operation of the wells in the different localities. The book contains 430 pages, is bound in cloth, and can be had for \$1.72 by applying to the State Mining Bureau, San Francisco, Cal.

GAS POWER. A recent addition to the Wiley Technical Series is the book termed "Gas Power." The authors of this book, Prof. C. F. Hirsfeld and T. C. Ulbricht, M. M. E., are able to express their knowledge in a way that does not cause the layman a headache when he wants to read about gas engines. Internal-combustion engines are explained, from gas to petroleum, in a way that permits automobile owners, chauffeurs, and attendants at vocational schools to understand the mechanism without having recourse to mathematics.

Chapter I deals with the Heat Problem; Chapter V, Four and Two-stroke Engines; Chapter VIII, with Ignition Systems; Chapter IX, with Carbureting and Carbureters; Chapter XII, with Modern Gasoline Engines; Chapter XV explains the Rating of Internal-Combustion Engines as practiced in this country; Chapter XVIII is on the Practical Operation of Internal-Combustion Engines. In all there are 193 pages and index, 60 illustrations and 18 chapters in the book, and it has been carefully edited by J. M. Jameson, of Pratt Institute. The price is \$1.25 net. The publishers, John Wiley & Sons, New York City.

THE MINING WORLD INDEX OF CURRENT ENGINEERING LITERATURE, Vol. 2, has just been issued. It represents the second half of the year 1912, and is an international bibliography of mining and the

mining sciences compiled and revised semiannually from the Index of the World's Current Literature, which appears weekly in *Mining and Engineering World*, of Chicago. The index has been compiled continuously since the beginning of 1911. There are seventeen chapters in this book, having the following headings: Gold and Silver; Copper; Lead and Zinc; Iron and Steel;

Alloys; Tin, Nickel, Cobalt, and Aluminum; Miscellaneous Metals and Ores; Fuels and By-products; Petroleum and Natural Gas; Non-Metals; Prospects and Prospecting; Haulage; Milling and Reduction; Metallurgy and Chemistry; Power and Machinery; Miscellaneous. In addition to the subject index there is an index of authors. The price of the Index is \$2.50.

should be left for pillar coal. That is to say, for every room width of 24 feet, a pillar 76 feet wide must be left to support the roof. Of course, this is only approximate. If the top is strong and bottom soft, or bottom strong and top soft, or both soft, or both top and bottom strong and unyielding and coal soft and tender, larger pillars are needed. As this seam is 900 feet deep there is great pressure on the pillars, and as the pressure increases to the dip, pillars 90 feet wide will be safe. That is to say, 90 feet wide by 100 feet long, longest side parallel to the dip or right angle to the strike of the seam.

PAT. J. LYNCH

New Waterford, N. S., Canada

THE LETTER BOX

Readers are invited to ask or answer any question pertaining to mining, or to express their views on mining subjects in this department. All communications must be accompanied by the name and address of the writer—not necessarily for publication.

The editors are not responsible for views expressed by correspondents.

Pulling Pillars

Editor The Colliery Engineer:

SIR:—I should like to hear from those of your readers who can furnish a safe method of pulling anthracite pillars. While the methods will vary in flat and pitching beds, the answers in either case might aid in securing greater safety for the miners and also be of benefit to the operators.

CHAS. H. BLEAKELY

Olyphant, Pa.

Location of Regulator

Editor The Colliery Engineer:

SIR:—I would like to have the opinion of some of your readers as to which is the best location for a regulator, at the intake of the split or at its outlet? And which would give the best results, and why?

J. B. WILLIAMS

Carbondale, Pa.

How to Mine

Editor The Colliery Engineer:

SIR:—We are working a coal bed that has bedding and cross-joints. The coal itself has slaty cleavage and practically no cleavage, so that when shot it prefers to break in slabs.

If black powder is used, owing to the joints it is not as effective as it should be.

If dynamite or quick explosives are used the coal is shattered into small

parallelopipedons or rhombohedra shaped pieces. I should like to have some of your readers who have had experience with similar coal beds in the Western States tell how they place the holes and what kind of powder they use.

J. A. S.

Edmonton, Alberta

The Motive Column

Editor The Colliery Engineer:

SIR:—I wish some information on the Motive Column. What does it mean? How does it originate? What part does it play on the down-cast or upcast airway? Does any such thing exist or is it only imaginary? The views of your readers are requested in answer to these questions.

COAL MINER

Cape Breton, N. S.

Size of Pillars

Editor The Colliery Engineer:

SIR:—In reply to the question in April issue on width of pillars, by Charles H. Robinson, with reference to Dunmore No. 4 seam, 5 feet thick, 900 feet below surface, width of room 24 feet: First, a knowledge should be obtained of the geological features of the strata both overlying and underlying the seam, and the nature of seam. However, under fair conditions two-thirds of the solid coal

Carbon Monoxide

Editor The Colliery Engineer:

SIR:—Will you kindly inform me through your journal, which of the following statements is correct:

In the I. C. S. pamphlet instruction paper on "Mine Gases," page 2, paragraph 3, the statement is made that "carbon monoxide is combustible, but of itself does not support combustion."

In the book "Examination Questions and Answers," the answer to Ques. 312 states: "It is combustible and also supports combustion."

This question was brought up in the Mining School of the Wilkes-Barre District Mining Institute, and we will be very glad to have the matter explained.

E. C. L.

West Pittston, Pa., April 17.

The statement quoted from the I. C. S. Instruction Paper that carbon monoxide does *not* support combustion is correct.

The contradictory statement was made in the first 1,000 copies of "Examination Questions and Answers," but was corrected in all subsequent issues. A similar incorrect statement was made in some editions of "The Coal and Metal Miners' Pocketbook." Previous editions of the pocketbook stated that carbon monoxide is *not* a supporter of combustion. The statements that it is a supporter of combustion were made by a writer

formerly in the employ of the publishers of *THE COLLIERY ENGINEER*, who, while an able mining writer, and as a rule accurate, in this instance expressed an opinion of his own, which is in direct opposition to the actual experience of chemical authorities whose works are regarded as standards all over the world.

EDITOR

Use of the Barometer in Mining
Editor The Colliery Engineer:

SIR:—I have received the following letter relative to my paper on the use of "The Barometer in Mining," published in your May issue:

MR. F. Z. SCHELLENBERG, C. E.,

Pittsburg, Pa.

DEAR SIR:—I have read with interest your paper on the use of the barometer in mining, as read before the Mining Institute, and as a former official of the Weather Bureau, it has had special interest to me.

You suggest the use of an aneroid with very open scale, and I do not know but such an instrument would prove useful if kept in a place where temperature changes are very slight. But of course you know that it is very difficult to make an accurately compensated aneroid. The temperature error is also very marked in all forms of liquid barometers and in many of them the vapor tension in the vacuum chamber vitiates the reading. This is probably the reason that glycerine is so frequently used for an open-scale liquid barometer as you suggest.

The Germans have a style of mercurial barometer that can be read very accurately. It is a siphon instrument with a hole in the tube at the bend, to which is attached a leather sack. This is suspended by an inverted screw and by raising or lowering the screw the open end of the siphon can always be brought to the same level. The tube is so bent that the open end is directly underneath the vacuum end of the instrument and of identically the same size. In use, the setting screw is turned until the meniscus of the open end meets a setting gauge at the zero point and this setting gauge is identical with the one at the top of the scale. The upper setting is made

with a micrometer screw passing around the case containing the tube and graduated to hundredths of a millimeter. With similar fittings above and below, the personal equation is removed and the instrument is capable of very accurate use, the greatest errors being due to irregularities in the temperature of scale and mercury, which are practically unavoidable. The instrument is called the Fuess and is made in Berlin.

Prof. C. F. Marvin designed a very ingenious and accurate instrument in the shape of a recording mercurial barometer, but it is expensive and some care is necessary to adjust it to work properly. It operates on the principle of the platform scale. A lever is balanced on a fulcrum in a manner similar to a platform scale or steelyard, and from the point where the object is to be weighed there is suspended a glass tube an inch in diameter made and filled in a manner similar to a mercurial barometer, the open end of which dips into a cistern on the floor underneath. A counterpoise weight is on the long arm of the lever which is fed out to make a perfect balance. In the recording instrument, an electrical connection is made which thus feeds the weight out on the arm, and a pen attached to the weight records the movement on a revolving cylinder similar to those used in a chronograph. The instrument would be simplified, however, to thus weigh the barometer tube without the recording device. You will observe, of course, that this gives the direct weight of the barometer column and thus avoids the temperature correction, and by proper adjustment of the position of the lever and size of the counterpoise weight, as open a scale can be obtained as may be desired.

The one I saw in operation made a very perceptible movement by the swinging of a door in a room. I think this style of instrument would be much more desirable for mining use than anything else I could suggest.

For the construction of such an instrument, I would suggest using the upright support of a platform

scale, and from the point where a connection is made to the platform, suspend a large mercurial tube, and whenever a reading is desired, balance the tube suspended in the mercury cistern by the counterpoise on the beam. All errors by this means due to impurities in mercury and temperature will apparently be obviated.

W. H. HAMMON

Pittsburg, Pa.

Use for Old Wire Rope

Editor The Colliery Engineer:

SIR:—There are few coal mines that do not have more or less old wire rope that is listed as "scrap," which is absolutely useless for anything but fencing. I think this rope could be made most valuable by stringing it through all the traveling ways throughout the mine.

By attaching it to props alongside the traveling way, say 3 feet from the floor, excepting where it passed across haulageways and would be placed underneath the rails, a definite guide would be provided even to the greenest of men, to show them either into or out of the mine.

In some mines, the traveling ways are veritable labyrinths, through which a stranger to the mine cannot expect to find his way, unless accompanied by a guide. Signs along the road, pointing the way out, are all right so long as they can be seen, but should a man's light become extinguished and he have no means of relighting it, the rope then may easily be the means of keeping him from wandering into places where CO_2 would quickly overcome him.

In the month of February, this year, two men met death in a mine in Las Animas County, Colo., by wandering in old workings, looking for the air-shaft.

A new man could be directed to "follow the rope" either going into or coming out of the mine and he would be dull witted, indeed, if he allowed himself to become lost, no matter how many turns he had to make or how many old workings he had to pass in his journey.

BERT LLOYD

Trinidad, Colo.

PRIZE CONTEST

For the best answer to each of the following questions we will give any books on mining or the sciences related thereto, now in print, to the value of \$3.

For the second best answer, similar books to the value of \$2 will be given.

Both prizes for answers to the same questions will not be awarded to any one person.

1. The name and address in full of the contestant must be signed to each answer, and each answer must be on a separate paper.

2. Answers must be written in ink on one side of the paper only.

3. "Competition Contest" must be written on the envelope in which the answers are sent to us.

4. One person may compete in all the questions.

5. Our decision as to the merits of the answers shall be final.

6. Answers must be mailed to us not later than one month after publication of the question.

7. The publication of the answers and names of persons to whom the prizes are awarded shall be considered sufficient notification. Successful competitors are requested to notify us as soon as possible as to what books they want, and to mention the numbers of the questions when so doing.

8. In awarding prizes, other things being equal, a carefully written and arranged answer will be given the preference.

9. Employees of the publishers are not eligible to enter this contest.

Questions for Prizes

25. The capacity of a room is 6,548 cubic feet and it has the following atmosphere: Air, 92.90 per cent.; marsh gas, 7.06 per cent.; carbon dioxide, .04 per cent. How many cubic feet of oxygen, nitrogen, marsh gas, and carbon dioxide will there be in this room, the temperature being 65° F. and the barometric pressure 29.925?

26. It is desirable to remove all the coal from a 5-foot seam below a concreted reservoir, containing water for public purposes. Indicate a system of working the coal to do as little damage as possible to the reservoir. Seam is 560 feet below reservoir.

27. In boring a hole through a coal barrier 140 feet wide in a 5-foot seam, what is the greatest difficulty you would expect to meet, and how would you overcome it, the head of water being 120 feet?

28. An entry 3,000 feet long falls 350 feet 6 inches. (a) What is the gradient of the road? (b) What kind of haulage would you install on such a road to get up 800 tons a day? Give reasons for and describe the salient points of the installation.

Answers for Which Prizes Have Been Awarded

QUES. 17.—*Diameter of Collar.*
The diameter of a collar, 8 feet between supports is 10 inches; what should be the diameter of a collar 16 feet between supports, the weight increasing in proportion to the length?

Ans.—The strength of any beam or collar is dependent upon its maximum bending moment. The general formula for the maximum bending moment of a circular beam or collar is $M = \frac{S_t I}{c}$ where S_t is the tensile stress per square inch and I is the section modulus. For a solid circular beam

$$I = \frac{\pi d^3}{32} \text{ and } M = S_t \frac{\pi d^3}{32} \quad (1)$$

d represents the diameter of the beam.

For a collar which is uniformly loaded and supported at both ends as in the above problem

$$M = \frac{Wl}{8} \quad (2)$$

Where W is the total weight on the collar and l is the length of the collar. Then equation (1) and equation (2) are equal; hence,

$$\frac{Wl}{8} = S_t \frac{\pi d^3}{32} \quad (3)$$

Let

W_1 = total weight on the 8-foot collar;
 l_1 = the length of the 8-foot collar;
 d_1 = the diameter of the 8-foot collar.

Substituting these values in equation (3)

$$\frac{W_1 l_1}{8} = \frac{S_t \pi d_1^3}{32} \quad (4)$$

Also let

W_2 = the total weight on the 16-foot collar;

l_2 = the length of the 16-foot collar;
 d_2 = the diameter of the 16-foot collar.

Substituting these values in equation (3)

$$\frac{W_2 l_2}{8} = \frac{S_t \pi d_2^3}{32} \quad (5)$$

But by the condition of the problem $W_2 = 2W_1$ and $l_2 = 2l_1$

$$\text{Then } \frac{W_2 l_2}{8} = \frac{2W_1 \cdot 2l_1}{8} = \frac{4W_1 l_1}{8} \quad (6)$$

But by equation (4)

$$\frac{4W_1 l_1}{8} = \frac{S_t \pi d_1^3}{32}$$

and by equation (5)

$$\frac{W_2 l_2}{8} = \frac{S_t \pi d_2^3}{32}$$

Substituting these values in equation (6) we have $\frac{S_t \pi d_2^3}{32} = 4 \frac{S_t \pi d_1^3}{32}$;

as $\frac{S_t \pi}{32}$ is constant to both terms of the equation the above reduces to $d_2^3 = 4d_1^3$. As d_1 is 10 inches $d_2^3 = 4 \times 10^3$ or $d_2^3 = 4,000$. Hence, $d_2 \sqrt[3]{4,000} = 15.87+$.

Ans.—Use a collar whose diameter is at least 15.87+ inches.

NOTE.—From equation (3) we learn that the strengths of beams or collars vary directly as the cubes of

their diameters and inversely as their lengths.

MILTON R. EVANS,

92 Division St., Kingston, Pa.

Second prize, W. E. HOBSON, 315 Maxwell St., Lexington, Ky.

QUES. 18.—*Weight of Rope.* What weight of rope will be required to hoist 7 gross tons from a shaft 400 feet deep?

ANS.—It is desired to hoist 7 gross tons or 15,680 pounds from a shaft 400 feet deep.

Doubling the load for shock gives 31,360 pounds. One-tenth of the load, or 1,568 pounds ought to be allowed for friction. If it is assumed that the rope will weigh 3 pounds per linear foot, the weight of the rope may be taken at 1,200 pounds. The sum of these loads, 17,064 net tons, represents the total maximum load on the rope. The proper working load of the plow-steel rope 1½ inches in diameter is 19.2 tons, while that of a rope 1¾ inches in diameter is 16.4 tons. Safe practice demands the use of the larger size rope.

For a 1½-inch rope, a drum 8 feet in diameter should be used, and to allow for three coils around the drum when the load is at the bottom of the shaft, $8 \times 3.1416 \times 3 = 75.3984$, or say 76 feet of rope must be allowed for this purpose.

Assuming that the sheave is placed 50 feet above the collar of the shaft and that the hoist engine is located at a distance of 50 feet from the center of the shaft, then the distance from sheave to drum will be $\sqrt{50^2 + 50^2} = 70.7$ feet, or approximately 71 feet.

The total length of rope required will be 400 feet in the shaft, 50 feet from collar to sheave, 71 feet from sheave to drum, 76 feet around the drum; a total of 597 feet.

A 1½-inch plow-steel rope weighs 3.55 pounds per linear foot, therefore, the total weight will equal $3.55 \times 597 = 2,119.35$ pounds.

M. D. COOPER,

Ellsworth, Pa.

Second prize, Michael H. Galda, Box 243, Kulpmont, Pa.

QUES. 19.—*Blasting Coal.*—Explain the principle involved in the use of powder in blasting coal, stating why common black powder is better for this purpose than high explosives, such as dynamite or other nitroglycerine compounds.

ANS.—Practically every miner is familiar with the method of blasting coal. He knows that first of all a hole is bored into the material to be blasted, then into this hole is placed a quantity of powder; next, the hole is tamped, then the powder ignited, and immediately, or almost so, there follows an explosion; and when next he is enabled to go to the place of blasting, there is a portion of the coal forced away from the mass, and more or less broken up. Here, there are two things to be explained; first, why does the powder explode; then, why does it have the effect of forcing away and breaking up the coal?

First, why does the powder explode? Because it contains all of the ingredients necessary for complete and rapid combustion. Now, what are these necessary ingredients?

Well, we all know that there are certain substances, which, when once ignited, will, under ordinary circumstances, burn. These are known as combustible substances; but before they will burn the presence of air is necessary.

The reason for this is found in the nature of oxygen, which gas forms about one-fifth portion of the air in volume. It has been proved by experiments that all ordinary combustion is caused by the combination of the combustible substance with this oxygen obtained from the air.

But the air is not our only source of oxygen, and it is a fact that oxygen will support combustion, no matter from what source it be obtained, and while an ordinary combustible obtains its supply of oxygen from the air, an explosive contains oxygen within itself, usually in the form of a nitrate. Another fact is that, if we take our com-

combustible substance and divide it into particles, then intimately mix it with its supply of oxygen; the finer the particles, and the more intimately mixed, then the more rapid will be the combustion. And in these two facts we find the reason for the explosion of the powder; since all the powder used in coal mines depends for its explosive power upon the union of combustible substances with a supply of oxygen, in such a manner that each particle of combustible substance is in contact with a source of oxygen; and also the right proportions of each; so as to cause a complete and very rapid combustion. For instance, common black powder consists of a mixture of charcoal, sulphur, and one of the nitrates, either of potassium or sodium. The charcoal and sulphur are combustible, while the nitrate contains a large proportion of oxygen, which it will readily give up to support combustion. When the powder is first ignited the nitrate commences to give up its oxygen, and the charcoal and sulphur will burn the more rapidly. This burning ignites the surrounding powder, and so causes it to burn. As the ingredients are so intimately mixed that every particle of charcoal and sulphur is in contact with a portion of the nitrate, the burning of the powder is so extremely rapid as to take the form of an explosion.

Now, we will turn to our second question: Why does the explosion of the powder have the effect of forcing away and breaking up the coal?

The explosive owes its power to the expansive action of large volumes of gases that are formed during the combustion. The burning of the charcoal and sulphur yields a large volume of gases, and there is also a large amount of heat produced.

It is well known that the effect of heat on gases is to cause them to expand, and as the heat produced is enormous, there is a correspondingly enormous expansion of the gases that have been formed; and

since there is no room for the expansion, a great pressure is generated and brought to bear upon the surrounding strata.

We have already noticed that the explosive power of powder depends largely upon the fact that the different ingredients are so arranged

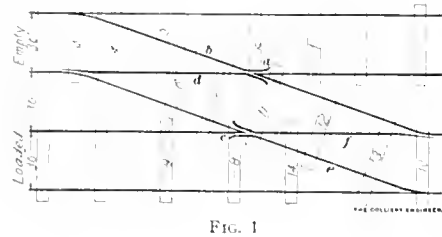

that every particle of combustible matter is in contact with a source of oxygen. But there are certain explosives in which the combustible materials and the oxygen are so arranged as to be both a part of the same chemical substance. In such explosives the association of the two is, of course, much closer than in black powder and the explosive action is in consequence much more rapid. We may notice that the various nitroglycerine, and also the ammonium-nitrate compounds are of this nature.

As a result of this more rapid explosion, we get a more shattering effect in the immediate area, but this area is not so large as would be the case were a slower explosive used.

For this reason black powder is better for blasting coal than the quicker explosives. Black powder, because of its slower explosive action, spreads better, and so brings down a larger area of coal, but has not the same shattering effect as dynamite and other explosives of that class, and so we obtain a greater percentage of the larger coal.

This is the one great advantage possessed by black powder in the blasting of coal, though there may be others of very minor importance. For instance, it is possible to ignite black powder by a simple squib or fuse, whereas the quicker explosives require the use of a detonator.

There can be no doubt, however, that the greater dangers attending the use of black powder in coal mines are more than enough to discount all its advantages.

THOMAS C. WAKEFIELD,

106 S. Twentieth St., Herrin, Ill.

Second prize, R. Z. Virgin, Colliers, W. Va.

QUES. 20.—Laying a Cross-Over Switch.—Explain each step in the laying of a cross-over switch between the loaded and empty tracks, on a mine haulage road. Show the method of locating the frog in each track, and give the proper frog angle that should be used, the frog distance, the degree of curvature of switch rails, etc.

Ans.—The following steps are to be taken when laying a cross-over switch between empty and loaded tracks:

1. Line the outside rails on both the loaded and the empty tracks, making sure that the distances of spread are equal.

2. Then the gauge of tracks and space between the two tracks must be figured out before an intelligent start can be made.

3. Assuming the track gauge to be 36 inches and the space between tracks to be 36 inches the frogs can be made to a 20-degree angle. Laying the switches can now commence from either the loaded or the empty track and this will give a switch-rail curvature of 20 degrees.

4. Having decided on the location of cross-over, commence on the

permanently. This having been done, place ties 3, 4, 5, 6, and 7 in position, and then the switch rail marked *b* is permanently spiked.

5. By the use of the track gauge from the point of frog on the empty track and the line rail on loaded track, the frog marked *c* is located and ties 8 and 9 are placed in position, after which frog *c* is permanently spiked.

6. Commence on the short arm of the frog marked *c*, and line the rail around to connect with the empty track; then by placing the switch rail marked *d* in position that end of cross-over is finished.

7. Now place ties 10, 11, 12, 13, and 14 in position and spike the switch rail marked *c* in place; then commence on the short arm of the frog marked *a* and line the rail around to connect with the loaded track, finally by placing switch rail marked *f* in position the cross-over is finished. This will give a good cross-over switch with a frog angle of 20 degrees and a switch curvature of 20 degrees.

First prize, ALEXANDER McALISTER, Box 108, Croweburg, Kans.

SECOND PRIZE ANSWER

The best type of cross-over is that having the turnouts connected by a tangent from the frog on the loaded track to the frog on the empty track. If choice is given in location of the cross-over, it should be so fixed as to cut the least possible number of rails. If *A* Fig. 2, were the end of a rail on the loaded track, measure

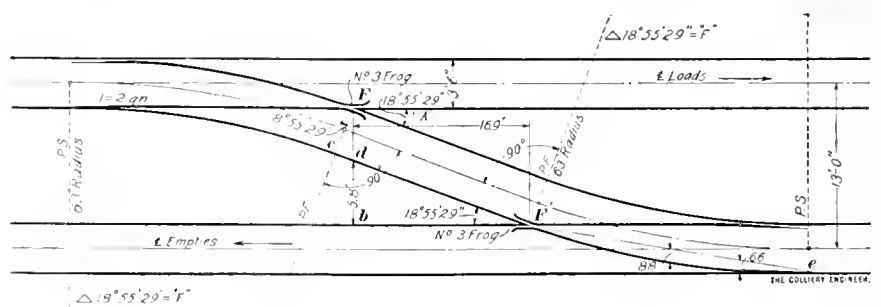

FIG. 2

empty track to break road and place ties 1 and 2, as shown in Fig. 1. Next place the frog marked *a* in position, and having gauged it to the outside rail it is to be spiked

from it toward the point of switch a distance equal to that between the heel and the frog point. Mark this point on the web of the rail opposite, and from this measure off the dis-

tance of the lead straight rail to the point of switch. The length of the lead equals twice the product of the frog number and the gauge, or $l = 2gn$.

The next point of the cross-over to be determined is the other frog point. $Fd - db = 9.5$ feet and Fd

$= \frac{3.5'}{\cos 18^\circ 55\frac{1}{2}'} = 3.7$ feet. Therefore, $db = 9.5' - 3.7' = 5.8'$. $bF' = 5.8' \times \cot 18^\circ 55\frac{1}{2}' = 16.9$ feet, or the distance between frogs on the loaded track; which measure off and mark at a point on the empty track rail opposite. Having established the point of frog $P.F.$, locate the point of switch $P.S.$, in the same manner as was done on the loaded track. Lay the switch ties which are to be of the proper lengths, and tamp

them. Set the frogs and connect them with the straight rails. Next stretch a string from the point of frog to the inside of the rail at point of switch, as $F'e$; divide this length into four equal parts, measure off the ordinates, and mark on the ties the distance from the string to the outside of the rail flange.

The middle ordinate equals $m = \frac{c^2}{8R}$, c being assumed as equal to the lead. The quarter ordinates are equal to three-fourths m . Spike the curve lead to these marks and then fix the other rail according to gauge. The most important point in laying a cross-over is to have the connecting rails tangent at the frogs. JAMES R. WALTHOUR,

Fairmont, W. Va.

Notes on Mines and Mining

Reports on Conditions and Other Matters of Interest in Various Coal Fields

By Special Correspondents

ROCKY Mountain Coal Mining Institute.—The next meeting of the Rocky Mountain Coal Mining Institute will be held in Salt Lake City. A special train, consisting of a baggage coach, dining car and Pullmans, will leave Denver at 9 P. M., June 9, arriving at Rock Springs the following morning, where the day will be spent in viewing the most important properties, arriving in Salt Lake City on the morning of the 11th.

The Institute will hold a session at 10 A. M. The afternoon will be devoted to a trip to the Bingham copper properties. The morning of the 12th will be devoted to the Institute business, reading of papers, etc., and in the afternoon a visit to Salt Air will be made. The 13th will be devoted to any Institute business which may remain incomplete, to auto rides about Salt Lake City, and to a grand concert in the Tabernacle.

The party will leave Salt Lake City on the return journey, by way

of the Denver & Rio Grande, sometime during the night of the 13th, and will stop over at one or more important coal properties on the return journey. It is proposed also to spend three or four hours in Glenwood Springs, to give the members an opportunity to indulge in bathing in one of the finest pools in the West. From this point will be a daylight ride through the Grand River Cañon and the Grand Cañon of the Eagle River, so that the beauties of this wonderful portion of the state may be seen by those who have not yet had the opportunity of traveling over the line in daylight.

PENNSYLVANIA

Pulverized coal, coke, and refuse is being used with success as a fuel in several metallurgical works. The coal is pulverized so fine that 98 per cent. of it will pass a 100-mesh sieve. It is introduced into the furnace through an air-blast pipe at about 1 foot from the pipe nozzle in such quantities that there

will be four times as much air for combustion as theoretical conditions call for. If the method of feeding the coal is steady and regular the length of the flame is easily controlled. George E. Gay, Mining Engineer of Uniontown, Pa., has installed such a plant at Mt. Brad-dock, Pa., which is giving such satisfaction he considers it the acme of fuel economizers.

WEST VIRGINIA

The Workman's Compensation Law. The Workman's Compensation Law passed by the last legislature of West Virginia becomes effective October 1, 1913. It is to be administered by a commission appointed for that special purpose, of which the State Treasurer is custodian, and their salaries and expenses are to be paid from the state treasury. The law is available to any person or persons employing men for profit (except for domestic and agricultural purposes). The premiums are required to be computed on the gross pay roll for the preceding year, the assessments in no case to exceed \$1 on each \$100, 90 per cent. of this assessment is to be paid by the employer and 10 per cent. by the employe.

The benefits accruing from this fund are to be based on the average weekly wage of the employe. No benefits are allowed for one week after injury, except for nursing and hospital expenses, and any employe receiving benefits for a longer period than he is really entitled to them or in any way attempting to defraud the commission shall be liable to a fine of \$500, or 12 months imprisonment, or both. The commission may, if deemed advisable by them, insure in any liability company doing business in the state any class or portion of the liabilities of the fund for any length of time desired and apply so much of the funds as is necessary toward the payment of premiums for such insurance. They also have the power of investigating all claims, and their decision shall be considered final, except in such cases where a claim is

refused. The claimant may then apply to the Supreme Court of Appeals for a rehearing and if his plea be substantiated 30 days prior to a session of that court the case shall be placed on the docket for that term, the fees of the claimant's attorney to be fixed by the court and in no case to exceed \$100. All costs of trial to be paid by the unsuccessful party to the suit.

The commission is obliged to make an annual detailed report to the Governor covering all claims paid, causes of accidents leading to the injuries meriting such awards, etc.

In compensating the employe for injury, the following regulations are made: Medical, nurse, and hospital expenses to the extent of \$150 in addition to such award as the employe shall be entitled to and in case death ensues, funeral expenses not exceeding \$75 are allowed.

In case of temporary disability, the employe is to receive, during such time, 50 per cent. of impairment of earning capacity, not in any case to exceed \$8 per week nor to be less than \$4 per week for a period of not more than 26 weeks, except in the case of loss of limb or eye, then the period shall be extended not to exceed 156 weeks.

In the event of permanent disability, compensation shall be 50 per cent. of average weekly wage, to be paid until death, but must not be more than \$6 per week nor less than \$3 per week.

If the injury be such that death ensues within 90 days, the following additional regulations are made: In the event of no surviving parents or dependents the disbursements shall include only medical nursing and funeral expenses. If the deceased be a minor, unmarried, and leave dependent parents, the father shall receive 50 per cent. of the average weekly wage of deceased, not to exceed \$6 per week for the period between death and the time that the deceased would have been of age.

If deceased leaves a widow, her compensation shall be \$20 per

month until death or remarriage, and \$5 per month additional for each child not old enough to be lawfully employed in any occupation, this to be paid until such child or children shall have attained such age, provided the total shall not exceed \$35 per month.

If there be no widow, or dependent children surviving, partially dependent persons shall be imburged to the extent of 50 per cent. of the average monthly support received from the deceased for the last 12 months preceding death, this to be continued so long as the commission deems necessary, not in any event to exceed 6 years in time or \$20 per month in money.

All benefits before payment are exempt from any claims of creditors or attachments and any employer not availing himself of this law shall be liable to his employes, and in the event of legal proceedings shall be denied the defense of the fellow-servant rule, assumption of risk, or contributory negligence. And an employer subject to, and taking advantage of this law shall not be required to defend himself in damages at common law or statute in the event of injury or death to his employes.

CATALOGS RECEIVED

ALBANY LUBRICATING Co., 708-710 Washington Street, New York. The Bearing, 14 pages.

AMERICAN BLOWER Co., Detroit, Mich. Small Electric Fan That Ventilates, 12 pages.

CHICAGO PNEUMATIC TOOL Co., Fisher Building, Chicago, Ill. Boyer Railway Speed Recorder, 20 pages.

T. H. PROSKE, 3309 Blake Street, Denver, Colo. The Imperial Drill Sharpening Machine, 15 pages.

C. S. CARD IRON WORKS Co., Denver, Colo. Catalog No. 16, Mine Cars, Coal Handling Machinery and Equipment, 72 pages.

CHUSE ENGINE AND MFG. Co., Mattoon, Ill. Chuse Non-Releasing Corliss Engines, 24 pages.

THE BRISTOL Co., Waterbury, Conn. Bulletin No. 169, Bristol Counters, 3 pages.

BUFFALO FOUNDRY AND MACHINE Co., Buffalo, N. Y. Bulletins Nos. 1007A, 1008A, 1009, 1010, Bell Steam Hammers, 10 pages.

ASBESTOS PROTECTED METAL Co., Beaver Falls, Pa. Bulletin No. 51, Asbestosteel Concrete Roof and Floor, 11 pages; Bulletin No. 52, Asbestosteel Lath Construction, 10 pages.

THE GARLOCK PACKING Co., Palmyra, N. Y. Garlock Packings, Catalog O, 140 pages.

ARMSTRONG CORK Co., Pittsburg, Pa. Circular, Insulate Your Steam Lines.

STURTEVANT MILL Co., Boston, Mass. Circular, Sturtevant Machinery.

AMERICAN CONVEYOR Co., Chicago, Ill. American Hoist Conveyor Plants, 4 pages; Locomotive Coaling Station, 4 pages.

THE C. O. BARTLETT & SNOW Co., Cleveland, Ohio. Bulletin No. 40, Garbage Disposal Machinery, 20 pages.

DAVIS INSTRUMENT MFG. Co., Inc., 110 West Fayette Street, Baltimore, Md. American Anemometers. Circular.

JOSEPH DIXON CRUCIBLE Co., Jersey City, N. J. Graphite for the Boiler, 16 pages.

THE DENVER ENGINEERING WORKS, Denver, Colo. Bulletin No. 1059, Richard Pulsator Classifier, Launder Type, 7 pages.

THE LAGONDA MFG. Co., Springfield, Ohio. Cleaning Locomotive Arch Tubes, 4 pages.

THE HESS-BRIGHT MFG. Co., Philadelphia, Pa. Circular, Pulley Mounting for Rope Drive or Hoisting Sheave; Circular, Ball Bearing Arbor of Heavy Duty Wood Shaper.

MYERS-WHALEY Co., Knoxville, Tenn. Shoveling Machines, 22 pages.

WILLIAMS PATENT CRUSHER AND PULVERIZER Co., St. Louis, Mo. Williams Crushers. Coal Catalog, 46 pages.

VULCAN IRON WORKS Co., Denver, Colo. Catalog No. 5, Mining Machinery, 79 pages.

ANSWERS TO EXAMINATION QUESTIONS

Questions Asked at the Examination for Mine Foreman and Assistant Foreman Held at Pottsville, Pa., March 25 and 26, 1913

QUES. 1.—(a) Are you a miner?
(b) How long are you a miner?
(c) Where did you mine coal, under what foreman did you work, and how long under each?

ANS.—To be answered according to the experience of each candidate.

QUES. 2.—What are the qualifications of a mine foreman, assistant mine foreman, and fire boss? What are the duties of these officials?

ANS.—The legal duties, qualifications, and duties are set out in the mine law. What may be called the moral and educational qualifications and duties have been discussed in this column within recent months.

QUES. 3.—In the matter of preventing accidents, are there any further responsibilities on the foreman and his assistant, after giving instructions to set a prop or take down some bad top? Explain fully.

ANS.—After issuing orders to take down bad top or to set props and having seen to it that the right kind, quality, and length of timber is on hand, there is little the foreman can do except to discharge any miner who wilfully risks his own life and that of his laborer by working in a dangerous place. General Rule 14, requires any one in charge of a place to keep it properly timbered and to permit no work in it except that necessary to make it safe. Rule 58 makes it "an offence against this act" to violate Rule 14 and all other rules. Article XVII, relating to penalties, provides that a person guilty of an "offence against this act" and in default of payment of "any penalty or cost" may be imprisoned for not less than 30 days nor more than 3 months.

QUES. 4.—There were 41.14 per cent. killed by falls of roof, slate, and coal during 1911; can you give any method by which these fatalities may be reduced?

ANS.—As to origin, accidents are commonly divided into two classes, avoidable and unavoidable. The first class are caused by carelessness or indifference, neglect of orders, etc., on the part of the victim or some one working with him, and in some comparatively few cases to ignorance. The statistics prepared by the Department of Mines, at Harrisburg, for the anthracite mines, show that carelessness, disobedience of orders, and the like were responsible for rather more than 2 out of every 3 fatalities from roof falls, for 7 out of every 10 accidents due to mine cars (Ques. 5), to 8 out of every 10 accidents due to handling explosives (Ques. 6), and for 9 out of every 10 deaths due to gas (Ques. 7). Dividing these further, about 1 in each 50 is due to ignorance and 49 in 50 to carelessness, etc. The small number of accidents due to ignorance may be diminished by personal instruction given to the men at the face, attendance at night school, the placing of the incompetent with the competent in a breast until the former have learned their duties, etc. All these methods have been tried and are being tried by the companies and with great success. But it does not seem possible to reduce the terrible number of accidents due to carelessness and disobedience of positive orders. It is impossible to have a foreman over every worker all the time to see that he does not do

things that his own intelligence tells him are wrong. Just as long as men in order to save a little time or work will jump on moving trips, will go back on a hung shot, will load out one more car before fixing the top, will not bother to light their safety before going to work, etc., etc., and just so long as men lightly value their own lives and those of their fellow workers and disregard the happiness and the welfare of their families, just so long will the list of avoidable accidents be as great as now. The mine foreman can do nothing but argue, or discharge if the man is caught in the act. An arrest might be made as explained in the answer to Ques. 3, but it is highly improbable that a conviction would follow.

Of the deaths due to roof falls, some 30 per cent. are classed as unavoidable, which merely means that they are not due to carelessness on the part of the victim. In some instances they are due to the mine foreman setting men to work in places which have not been made safe, to the failure to provide suitable timber, to poor systems of timbering, but there are always some that could not have been foreseen and, hence, are really unavoidable. A uniform system of timbering will go a long way toward diminishing the number of unavoidable(?) accidents due to roof falls and will materially reduce the avoidable accidents due to the same cause. In this system of timbering, known as systematic timbering, posts are set at regular intervals apart, and are actually set at those distances, whether the roof at that particular

place and time appears to need support or not. The size of these props and their distance apart should be determined by the foreman to suit local conditions. In addition to this, during times of particular danger, as during pillar drawing, the approach of a squeeze, etc., more frequent visits should be made by the foreman to the working places that he may give the miner the benefit of his greater experience.

QUES. 5.—There were 14.96 per cent. killed by mine cars in the anthracite coal region in 1911; what method would you adopt to avoid these accidents?

ANS.—In regard to diminishing the 70 per cent. due to carelessness (see answer to Ques. 4), the remaining 30 per cent., classed as unavoidable, may be largely reduced if separate traveling ways are provided and these are kept in good condition. Those gangways upon which traveling must be done should be well ditched, cleaned, and drained, should have at least 2½ feet clearance between the car and the rib, and should be provided with a series of safety holes in the rib at regular intervals, which holes should be whitewashed as often as they begin to discolor and should be kept clear of rubbish.

QUES. 6.—There were 14.31 per cent. killed in the anthracite coal region by premature blasts and reckless handling of explosives in 1911; what method would you adopt as foreman to reduce these fatalities?

ANS.—In regard to diminishing the more than 80 per cent. due to carelessness (see answer to Ques. 4), the remaining 20 per cent., or less, may be diminished by the use of first-class brands of powder only, by the use of permissible powders such as have passed the tests of the Bureau of Mines, by the introduction of proper devices for thawing frozen dynamite, by the introduction of electric shot-firing systems, and in general and as far as possible having all handling of explosives done by men skilled in their use.

QUES. 7.—There were 5.53 per cent. killed in the anthracite coal region by explosions of gas in 1911; what method would you adopt to reduce these accidents?

ANS.—In regard to reducing the more than 90 per cent. due to carelessness (see answer to Ques. 4), of the remaining 10 per cent., probably

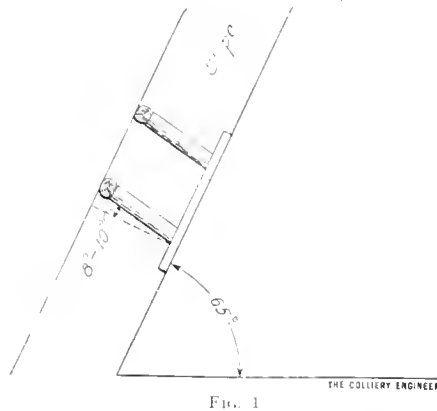

a greater proportion of these are really unavoidable than in the case of accidents due to almost any other cause. Gas is invisible and concealed in the pores of the coal, and it is impossible to foretell when a pocket or blower will be encountered. Something may be done by improved ventilation in those mines where this is neglected, and in others by more carefully and thoroughly conveying the air to the face.

QUES. 8.—How would you timber a slope, dip 65 degrees, with a good top and a bad bottom, vein 10 feet thick? State at what angle you would set the timber.

ANS.—As the top is good, it may only require an occasional support. As the floor is soft this post cannot be stood upon it nor can two posts be used in the ordinary way as legs to support a collar. If the roof in the center of the slope needs support, a cross-bar must be used. This may be set in hitches in the coal, may be supported upon two short legs set in the coal, or a complete framed set may be used. The legs should have an inclination up hill of some 8 to 10 degrees from the normal, that is, should be set with a pitch of 57 to 55 degrees, in

order to resist the tendency of the roof to slip down hill as shown in Fig. 1.

In regard to the bottom, or mudsills, these may extend across the slope at right angles thereto in the usual way, or they may be set parallel to the dip, one sill serving as a support to several legs. The chief trouble here is not so much from roof falls as from a possible creep. The slope should be driven as narrow as possible and very wide pillars should be left on either side between it and the first breast, so that a squeeze from the workings may not ride over and close the slope.

QUES. 9.—State where the air-current should be measured, when and by whom, and how you would proceed to measure it?

ANS.—These measurements are to be made once each week by the mine foreman or his assistant at (1) the mouth of the intake and return airways; (2) at or near the face of each gangway, and (3) at the nearest cross-heading to the face of the inside and outside breast where men are working. The quantities of air in circulation are measured by an anemometer or other approved means and the quantities found in circulation are to be entered in the colliery report book. The use of the anemometer has been described several times recently in these columns.

QUES. 10.—What are the requirements of the mine law in regard to explosives? (a) Care of explosives? (b) How should they be handled? (c) How should they be kept in mines? (d) What are the rules governing their strength? (e) How would you thaw dynamite?

ANS.—The principal question and subquestions (a), (b), and (c), are so plainly stated in the law that they need not be repeated here. (d) We are unable to find anything in the present anthracite mine law regulating the strength of explosives. (e) The mine law does not treat of the methods to be used in thawing dynamite. Small quantities may be

packed in fresh manure until softened, or the stick may be placed in a dinner bucket which in turn is placed inside a larger kettleful of water, which is heated to 130° to 150° by being placed on a hot stone, a radiator, etc. The temperature may be estimated by the hand or better by a thermometer which may be of the cheapest. In event that a large amount of explosive has to be thawed, a "thaw house" is necessary. This is a small frame building, with the sides banked with earth or manure and heated by steam. Shelves are built around the house upon which several days' supply of explosive may be stored and where it should be kept 2 or 3 days at a comparatively low temperature.

Ques. 11.—What is the maximum velocity of air allowed by law and why is the speed limited?

Ans.—The speed of the air-current is limited to 450 feet per minute in all places except on the main intake and return, where gauze safety lamps are used, because at a higher velocity there is danger of the flame being blown through the meshes of the gauze and igniting any gas that may be present.

Ques. 12.—What does the mine law require when you are approaching abandoned workings likely to be filled with water? How would you drive a breast to comply with the law? Explain fully.

Ans.—The law requires that the place be not over 12 feet in width, and that there shall be constantly kept at a distance of not less than 20 feet in advance of the face at least one bore hole near the center of the working and sufficient flank bore holes on each side. Such a breast is shown in Fig. 2. One hole is driven from the center of the face and other ones from each corner. Side holes are driven at points back of the face to make sure that the narrow breast is not being driven up through the center of a pillar.

Ques. 13.—Are there any conditions where the mine law requires a working man to make a report; if

so, what are the conditions and to whom is the report made?

Ans.—This is fully answered in General Rule 24.

Ques. 14.—Under what condition does the law require the workmen to be removed from the mine?

Ans.—This is fully answered in General Rule 8.

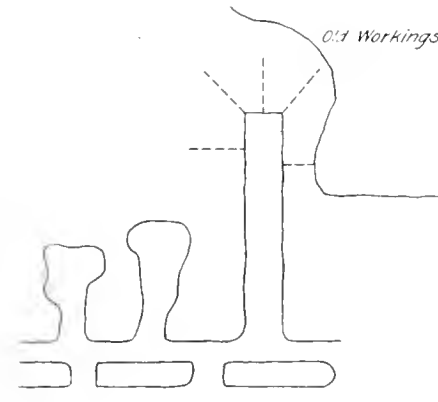

FIG. 2 THE COLLIERY ENGINEER

Ques. 15.—What are the requirements of the mine law with regard to doors in the mine?

Ans.—This has been modified by the legislature to a slight extent. As the law now stands all doors must be so hung that they will close automatically; that is, they shall open against the current, so that they may blow shut. That all doors, except such self-acting doors as have been approved by the district mine inspector, shall have an attendant to open and close them. That all main doors must be so placed that when one is open the other is closed; that is, doors must be in pairs if on any main airway, only one of them being allowed to be open at one time. An extra main door or safety door must be provided and kept standing open in such a position as to be out of harm's way, but fixed in such a manner that it can be closed at once if either main door gets out of order or is broken. All main doors shall be set in stone or brick frames which shall be laid in mortar or cement; but the district mine inspector may permit, in writing, other methods of hanging them.

Ques. 16.—How does the mine

law provide for an employe to learn its rules and provisions?

Ans.—According to General Rule 54 an abstract of them and the act of the legislature making them must be posted in one or more convenient and conspicuous places near the mine. The rules must be printed in plain type and as soon as worn so that they can no longer be easily read or are destroyed, they must be replaced by a new set. It is a misdemeanor to damage a set of rules.

Ques. 17.—Why is ventilation necessary?

Ans.—The ventilation of a mine, that is, the continuous supply of fresh air from the outside and its conveyance through the workings, is necessary to dilute and thus render harmless and to carry away all impure, poisonous, and explosive gases given off by reason of operating the mine. These gases originate from (a) the breathing and perspiration of men and animals, (b) the burning of oil in lamps, the burning of powder, gas, coal gob, or any other combustible substance, (c) the slow combustion or oxidation and decomposition of timber, animal matter, iron pyrites, and other minerals, and the coal itself, and (d) from the pores of the coal or from blowers, feeders, or bleeders. To these might be added various afterdamps due to explosions.

Ques. 18.—The anemometer makes 120 revolutions per minute in an airway that measures 8 feet 6 inches at top, 10 feet 6 inches at the bottom, and 7 feet high. What quantity of air is passing?

Ans.—The area of the airway is found by multiplying its height by its average width, thus, Area = $\frac{8.5+10.5}{2} \times 7 = 9.5 \times 7 = 66.5$ square feet. The volume of air passing is equal to the area of the airway multiplied by the velocity of air in feet per minute as measured by the anemometer, in this case 120 feet, as the instrument makes 120 revolutions a minute. Hence, volume = area \times velocity = $66.5 \times 120 = 7,980$ cubic feet per minute.

QUES. 19.—If the current in an airway 6 feet square is maintained with a 1-inch water gauge, what pressure per square foot is required if the same quantity is passing through an airway 5 feet square, the two being of the same length?

ANS.—1 inch of water gauge is equivalent to a pressure of 5.2 pounds per square foot. In terms of the length, perimeter, quantity, and area, the pressure in the larger

airway is $P = \frac{k l O q^2}{A^3}$, and in the smaller airway is, $p = \frac{k l o q^2}{a^3}$. Since the coefficient of friction (k), length (l) and quantity (q) are the same in both airways we have for the ratio between

the pressures, $P: p = \frac{O}{A^3} : \frac{o}{a^3}$, or $p = P$

$\times \frac{o}{O} \times \left(\frac{A^3}{a^3}\right)$. The perimeter of the larger airway is $O = 4 \times 6 = 24$ feet and its area $A = 6 \times 6 = 36$ square feet. The perimeter of the smaller airway is $o = 4 \times 5 = 20$ feet and its area is $5 \times 5 = 25$ square feet. Substituting, $p = 5.2 \times \frac{20}{24} \times \left(\frac{36^3}{25^3}\right) = 5.2 \times \frac{20}{24} \times \frac{46,656}{15,625} = 5.2 \times 2.488 = 12.9376$ pounds per square foot. This is equal to a water gauge of 2.488, or, say, 2.5 inches.

QUES. 20.—If a water gauge registering 2 inches passes 15,000 cubic feet per minute what quantity will an 8-inch water gauge pass per minute?

ANS.—The quantities passed are proportional to the square root of the ratio of the water gauges. Thus, if the greater water gauge and quantity are I and Q , and the lesser water gauge and quantity are i and

q , $Q = q \sqrt{\frac{I}{i}} = 15,000 \sqrt{\frac{8}{2}} = 15,000 \times 2 = 30,000$ cubic feet.

QUES. 21.—Which should be the largest, the inlet airway or the outlet, and why?

ANS.—The outlet airway should be the larger, because the volume of air leaving a mine is generally greater than that entering it. This increase in volume is chiefly due to

the expansion of the air brought about by the mine generally being warmer than the outside air. As the average temperature of the United States is about 50° and the average mine temperature is, say, 65°, during the fall, winter, and spring months the outside air will usually be colder than the mine and, hence, will be expanded, but in the summer it will be warmer than the

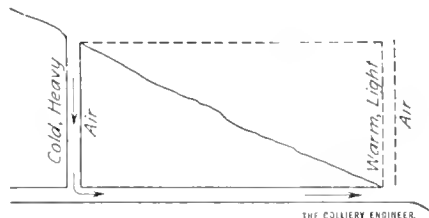

FIG. 3

mine and will be contracted in volume. On the other hand, the gases given off by the operation of mining from the causes given in the answer to Ques. 17, will of course add to the volume of the air regardless of the difference between the inside and outside temperatures.

QUES. 22.—A mine has openings, one 200 feet higher than the other at the surface, the outside temperature being 80° F. and the inside temperature 45° F.; in what direction will the current flow and why?

ANS.—As the weight of a given volume of air at 45° is greater than that of the same volume of air at 80°, the flow will be by way of the higher opening through the mine and out the lower opening as shown in Fig. 3. The pressure producing the ventilation may be found from the formula

$$p = 1.324 B D \frac{T-t}{(460+t)(460+T)}$$

in which

B = the pressure of the barometer which may be taken as 30 inches;

D = the depth of the downcast = 200 feet;

t = the temperature of the downcast = 45°;

T = the temperature of the outside air = 80°.

Making the necessary substitutions, we have, $p = 1.321 \times 30 \times 200$

$\times \frac{80-45}{(460+45)(460+80)} = 1.02$ pounds approximately.

QUES. 23.—In what proportion is the friction of air increased compared with the velocity of the current?

ANS.—The friction increases in proportion to the square of the velocity; thus, if the velocity is doubled, the friction is increased four times.

QUES. 24.—What method of ventilation reduces the danger of explosion, also the friction.

ANS.—These results may be accomplished by what is known as splitting the air-current; that is, instead of taking the air in one continuous current throughout the mine, each district of the mine is ventilated by a separate branch of the main current known as a split.

In this way, with the same power applied to the fan, the quantity of air in circulation is increased in proportion to the number of splits and thus more air being supplied, there is less liability to explosion. As there is less rubbing surface there will be, of course, less friction.

QUES. 25.—What are the four principal gases found in coal mines, what are their specific gravities and where are they found?

ANS.—The principal gases met in mines are nitrogen, oxygen, methane, and carbon dioxide. Nitrogen, specific gravity .971, forms about four-fifths of the air and is, consequently, found everywhere throughout the mine. Oxygen, specific gravity, 1.106 forms about one-fifth of the air and like nitrogen is found throughout the mine. Methane, specific gravity, .559 is given off by the coal in most anthracite mines, and being much lighter than air is commonly found near the roof of flat workings and at the face of those driven to the rise. Carbon dioxide, specific gravity, 1.529, being much heavier than air is usually found near the floor of flat workings and at the face of those driven to the dip.

(To be Continued)

Use of High Explosives in Northern Mines

*F. H. Gunsolus**

It would seem that the miners in cold countries would not encounter many problems of different character from those met with elsewhere in the use of high explosives, and to a certain extent this is true. On the other hand, there are certain conditions which those who use explosives in high latitudes encounter which require certain precautions not needed where temperatures do not reach such a low point.

One of these conditions is known as the "sweating" of dynamite. When a shipment of a carload of dynamite is made from a factory to a mine in the middle of winter, it frequently takes 2 weeks or more to travel to its destination, during which time it is exposed to zero weather for several days at a time, and is not only frozen but remains very cold for a considerable time after it is moved to a warmer temperature either in the mine or in the thawing house.

Dynamite itself is a very poor conductor of heat, and by placing an open box in a room having a temperature of say 60° F. it takes quite a long time for the outer portions of the dynamite to thaw, while the explosive in the middle of the box remains frozen and cold for a very long time, just as though it were packed in sawdust, which it really is. A great many mining companies thaw their dynamite by no artificial heat, merely taking it down into the mine and storing it in underground magazines and allowing it to thaw either in the boxes or by opening the cases and spreading the dynamite out. When the dynamite is received after having been exposed to zero temperature for several days, it is, of course, very cold and the moisture from the humid mine is deposited upon it in large quantities. Sometimes so much moisture gets into the dynamite in this way as to not only lower its sensitiveness, but also to make it

very much less efficient and cause misfires, blow-outs, and burned-up charges, which are dangerous, inconvenient, and disagreeable.

This may also apply to the blasting caps, which are even more susceptible to moisture than the high explosives, from the fact that they are exposed at one end and that end is the one where they are ignited. If you take a blasting cap from a temperature of zero down into a hot, humid mine and leave it several days, it will frequently absorb so much moisture that either the fuse will not explode it at all, or if it does, it will be so weakened that only a partial detonation of the dynamite will take place, or it may only set fire to the dynamite, causing a burned-out charge.

The remedy for both these conditions is simple enough. When the weather has been cold during the transportation of the dynamite, the dynamite should not be taken directly into the mine but should be kept on the surface long enough for it to warm up so that moisture will not be deposited upon it. The blasting caps themselves do not require thawing, of course, but underground storage is certainly not to be recommended for them, both on the grounds of the possible loss of efficiency and on account of the danger of carrying such caps around in the mine in any quantity over and above what is actually required at the time. So many accidents happen to women and children due to miners carrying blasting caps around loose in their pockets and being found by children in the miners' homes, that a considerable amount of care in preventing the taking of these away from the work is well worth the trouble.

In thawing the dynamite it is much better to warm it gradually, say for several days at a temperature of 70° F. or 80° F. than to attempt to thaw it quickly in a few hours at a temperature of 100° F. or over. Not only does the high temperature increase the sensitiveness of the dynamite, but it also

makes the nitroglycerine less viscous and more likely to leak and run out of the cases, and leaky dynamite and leaky nitroglycerine are dangerous things to have anywhere.

The gelatin dynamites do not become affected by moisture as readily as the granular dynamites, and this is a great advantage in their use where there are low temperatures outside and high humidity and water underground.

Even the fuse requires a little attention when used in northern mines, as it becomes brittle and hard when very cold and when uncoiled in this condition the waterproofing compounds will crack underneath the outer covering, so that they cannot readily be seen but these cracks will admit moisture or water and will also cause the fuse to spit out sideways and render it liable to ignite the dynamite and cause burned-out charges again. It is frequently necessary to lead the fuse down toward the bottom of the charge in cases where there is liability of blowing off the collar of one hole from the explosion of another timed to take place before it. When the fuse travels down the bore hole alongside the powder, if the later is taken out of its wrappers or split or the paper shells slit, the liability of ignition is very much increased. In these cases it is preferable not to remove the powder from its wrappers nor to slit it but to load it in its paper covering entire. It is almost impossible to ignite dynamite from the side spit of the fuse through the paper wrapper. Fuse should not be exposed to high temperatures for any length of time, as this sometimes causes the waterproofing composition to melt and run into the powder train and make the fuse go out. The temperature of 70° F. or 80° F. should be maintained where fuse is stored in large quantities. It should not be stored in humid mines at all, as the powder will absorb enough of moisture at the ends and in the sides in a few days to make its burning through rather uncertain.

* E. I. du Pont de Nemours Powder Co.

NEW MINING MACHINERY

Langerfeld Coal and Slate Separator

By Arthur Langerfeld*

The cleaning of the coal in the Spencer breaker, in Dunmore, was recently changed from hand picking to mechanical separation, and all the

for the time during which no coal comes into the breaker and for the time during which coal does not come to the full capacity of the machines. The actual output of clean coal depends therefore on the quality of the coal fed in, and on the

size and only 2 or 3 per cent. of salable bone.

The separation of valuable bony coal is an economy, because it increases the car average or quantity of salable coal obtained per mine car dumped in the breaker. This econ-

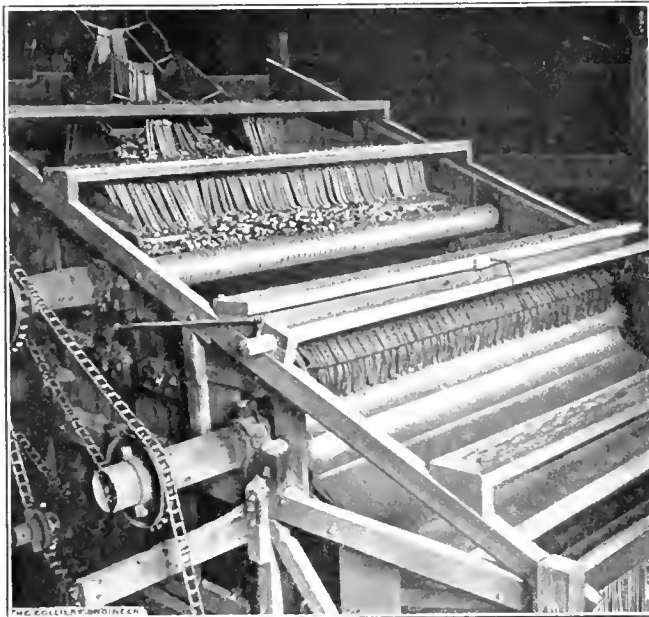

FIG. 1. TOP OF LANGERFELD COAL SEPARATOR

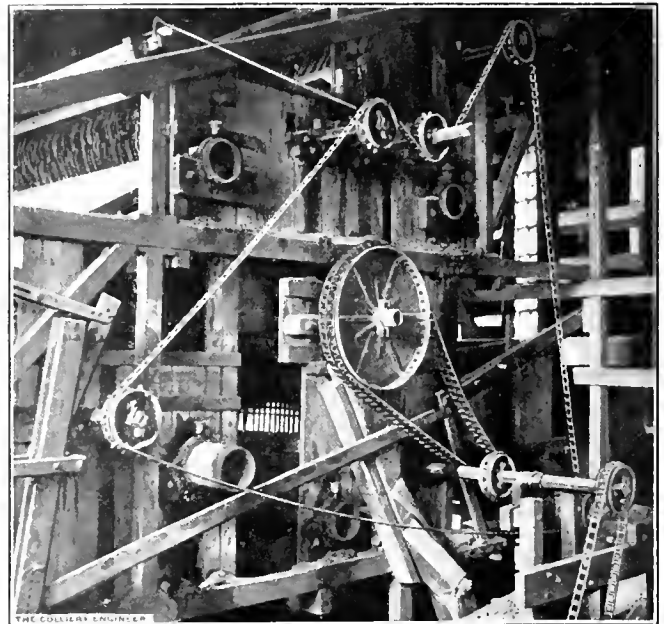

FIG. 2. DRIVING GEAR OF LANGERFELD SEPARATOR

stove, chestnut, and pea coals are now cleaned entirely by Langerfeld separators. There is only a small quantity of egg coal made at this colliery and therefore no machine for this size was installed. There are two sets of these separators. Each set consists of three machines; one stove coal separator of 200 tons capacity, one chestnut separator of 200 tons capacity, and one pea coal separator of 100 tons capacity. The capacity of each set being 500 tons, the intake capacity in 9 hours of steady running while feeding to full capacity is about 1,000 tons. The output of clean coal would therefore be 1,000 tons, less the refuse deducted from the intake capacity, besides the allowance made

time during which the machines are fed to full capacity. The economy that has been effected by the installation of these separators was not only the wages of the boys who were employed to pick slate by hand, but also a saving of the salable bone and coal that was formerly sent to the dump with the slate. This double saving is brought about because these machines are adjustable and they make a four-part separation: viz., coal clean enough to pass inspection; bone with little coal of the size and very little slate, suitable for reducing to one size smaller; slate or bad bone with hardly any coal of the size and with very little rock, suitable for reducing two sizes smaller; and rock with only about 1 per cent. of coal of the

omy is brought about by running separated bony coal to rolls set to reduce it to the next smaller size, and then running this broken bone back in the screens together with the run of mine. This increases the quantity of material going to the separators and reduces the quantity going to the refuse dump. Ordinarily this process would make the cleaning of the coal too difficult because the quantity to be cleaned is not only increased, but it is also made dirtier, and especially high in bone. Bone is far more difficult to separate from coal than slate, and coal is condemned for too much bone as well as for too much slate. The standard specifications provide that stove coal must not contain over 3 per cent. of bone if there is 4 per

*Scranton, Pa.

cent. of slate in it, and it is customary to allow 2 per cent. more of bone for each 1 per cent. of slate there is in it less than the 4 per cent. allowed; therefore, in case there is no slate at all, there could be 11 per cent. of bone. The standard limitation for chestnut is 5 per cent. slate and 5 per cent. bone; and it is similarly customary to allow 2 per cent. bone for every 1 per cent. slate below 5 per cent., so that in chestnut containing no slate there could be 15 per cent. bone. For pea coal there is no provision for the bone allowed, and allowance of slate is 10 per cent. It is customary to also allow about 10 per cent. bone in this size so that in case there is no slate in the car of pea coal, it would be allowable to contain 30 per cent. bone. In practice there is seldom less than 5 per cent. slate in pea coal, so that 20 per cent. bone is the limit in this case.

Much of the anthracite now sold is paid for on the heat unit basis; that is, the number of British thermal units it contains.

It is said that some bone actually gives more heat than some coal. The peculiar construction of the Langerfeld separators classifies this kind of bone as coal, by reason not only of the gravity of the pieces fed in but also by the difference in frictional resistance, which has been found to be almost exactly in proportion to the percentage of carbon in the coal or bone. This classifies the pieces at their heat-giving value rather than by their appearance or gravity, and makes this kind of separation economical both for the coal company and for the public.

These separators contain seven different parts, and as each part has a definite function it can be adjusted to do its work without materially interfering with any of the other parts. The first part separates the material into two streams, one containing the largest and thickest pieces, the other containing the smallest and thinnest pieces, thus the first step in the process is not a separation by quality but by thick-

ness. This first step or classification differentiates in quality, because most slate is thin or flat and most of the coal is thick or lump shaped; but there are some seams from which the coal splits as thin as slate, and for this reason a separation depending only on the difference in thickness is unreliable and not economical. The next two parts in the separator feed the two streams of material piece by piece, into frictional differentiators. The feeders are the most novel feature in the separator, as they feed each piece separately, spaced apart both lengthwise of the machine and crosswise, so that no collision takes place between pieces as they slide down on the differentiating slides. In all other separators or pickers the coal is fed either in dashes or in a continuous stream, so that the pieces collide and interfere with each other in their separation and spoil results to that extent.

The first separation is made in two parts of the machine. In one all the lump-shaped pieces of coal are taken out, and in the other the best pieces of flat coal. What is left in the separator after this first separation is one lot of lump-shaped rough coal, bone, and rock, and one lot of small or flat pieces of rough coal, bone, and slate. Each one of the two classes is then fed into the system of differentiators, consisting of two reverse slides and an intermediate inverter so arranged that each piece slides first on one of its sides and then on its opposite side. In this way each piece acquires a velocity in proportion to the average quality of two of its sides and therefore is separated with twice the accuracy that can be attained in any of the other ways used in pickers or separators. This makes it possible to make a good bone separation, and in this part of the machine both rough coal and most of the bone are separated. What is left is a mixture of some lump-shaped rough coal, some bone, and nearly all of the rock, in one part, and some small or flat rough coal,

some bone, and nearly all of the slate in the other part. In the next two parts of the separator each one of these classes is again fed to differentiators and only the worthless rock and slate are taken out. The remainder of the materials may be classed as bone, or they can be fed back into the separator for a still better distribution. The quantity of this bony mixture is so small a part of the entire material that, if re-fed, it does not materially reduce the intake capacity. It has been suggested that such refeeding would cause accumulation, but in practice this is true only to a small and limited extent, because from it a piece goes through the separator a second time and the chances are that it will come out in one of the eight discharges. In this way hardly any of the salable stove coal bone is lost, but goes to the rolls to make chestnut. Nor does any considerable quantity of chestnut size bone go to the dump, because it goes to the rolls to make pea; but pea size bone may be burned at the colliery or go to the buckwheat rolls, and finally go to the pockets for a smaller size. Results have proven that these separators pay for themselves in a short time. Nor is their cost any greater than first cost of as many separators, pickers, or jigs, as would be required to handle the same quantities, and give anywhere near the same results.

Another economy was effected in this breaker by saving the expense of loading and hauling slate or refuse, there being no slate pockets. The six separators are set in line and a conveyer runs under them the full length of the breaker. All of the separated refuse drops into this conveyer and is taken out by it to an elevator. From the head of this elevator the refuse runs down a chute to the dump.

The only attention that is given to the separators is to set them for wet and dry coal and to adjust them so that the coal will be clean enough.

The cost of cleaning coal by these separators is less than 1 cent per ton

for dry coal, including allowance for repairs; but in wet breakers the cost is somewhat higher, because the water adhering to wet coal contains some acid which corrodes the metal parts of the machines.

The room required for these separators is less than was heretofore required for picking chutes for boys, or for as many jigs or other pickers as are needed for the same tonnage.

來 來

Steam Hammers

Of the labor-saving machines, none is of greater convenience than a steam hammer with which to do much of the blacksmith work formerly done by men with sledges.

Fig. 1 shows a "Bell," steel-frame, "combined" steam hammer made by the Buffalo Foundry and Machine Co., which has features that especially adapt it to the various needs of a mine repair shop.

The main frame is an open-hearth steel casting. The bedplate part is of ample surface, flush on the bottom, and extending up from this heavy part is the square-shaped anvil block with dovetail slot finished in it into which is keyed the lower die. This anvil block part is set so as to bring the dies at a 45-degree angle with the main frame casting, so that long work will clear the column both ways of the die and for the full size of die face. There is a hole cored in the center of the anvil block, so that longer work may be placed in this hole when it is desired to upset it. Extending up from the bedplate at the back corner of the anvil block is the column, which is of heavy I-beam construction. Extending out from this column is the heavy section which forms the faces to which the slides or guides are bolted. This section, tapering in above the slides and the column, extends up to the projecting flange to which the cylinder is bolted. The metal throughout is carefully proportioned to resist the shock of hammering and the many shearing strains. Experience has

proved that there is no breakage due to the main frame being in one piece with the anvil block, when made of steel.

The cylinder casting is in one piece with piston and throttle-valve chests, has extra heavy flanges, top and bottom, which latter is reinforced by heavy vertical ribs. The cylinder is dowel pinned and through bolted to the main frame with fitted bolts in reamed holes. The exhaust outlet being lower than the bottom of the cylinder, there is automatic drainage of water from condensation from the cylinder thus preventing damage by freezing.

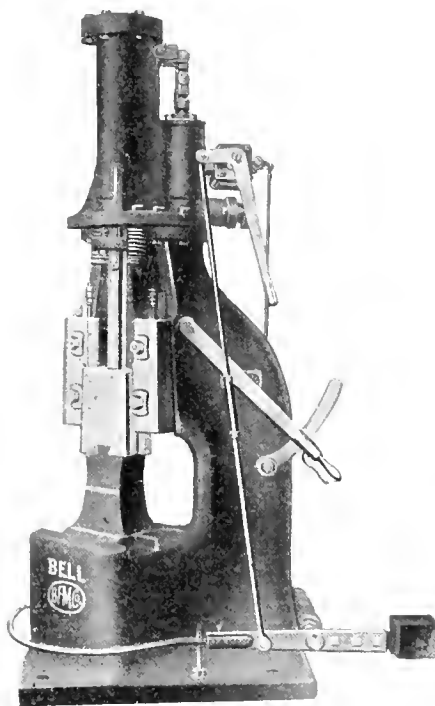

FIG. 1. BELL STEAM HAMMER

The hammer head of hammered steel is set at an angle of 45 degrees with the main frame. This hammered steel forging is finished from the solid and has milled V grooves, with ample bearing surface which works in V shaped slides or guides, which are bolted with through bolts and spring washers to the main frame. The guides are made adjustable by a taper gib, to take up the wear between them and the hammer head or ram. Into the taper hole bored in the hammer head is fitted the lower end of the piston rod. The jam of this taper

constitutes the real holding of the rod in place. The piston rod is a solid steel forging with the piston head forged solid thereon, and into the piston part are fitted weldless forged-steel snap piston packing rings. By removing the buffer springs and piston-rod gland, which is in halves bolted together, the falling parts can be raised without disconnecting, so that the piston will project above top of cylinder to permit of the examination of the piston rings or the inserting of new ones. At the bottom of the tapering V slot in back of the hammer head is planed a taper dovetail slot into which is inserted the cam-plate or wearing strip. This plate has a corresponding taper dovetail projection to fit the slot and is securely held in the dovetail slot by the jam of the taper. The width of this plate corresponds to the width of the bearing face of the cam. This construction is a valuable improvement and does away with the necessity of making repairs in an inaccessible place, to any rivets or screws which are commonly used in other constructions. It is now a very simple matter to drive the cam-plate up out of the slot if repairs or renewals become necessary.

The valve motion is extremely simple, with few working parts, carefully fitted to give very accurate and sensitive control to the blow and not connected except by sliding contact with the hammer head. It is free from all shock or jar of the blow, takes up its own wear, is of the most durable and efficient construction, and requires no attention except for proper lubrication. The downward movement of the valve is by gravity alone. It is moved up by the thrust of a bevel slot in the hammer head against the cam.

In operation the cylinder takes steam at top and bottom of stroke, through ports arranged to give the maximum force of blow. Perfect control is maintained by the operator for doing work requiring hand operation, or continuously sustained

automatic action may be obtained with close and sensitive regulation by the throttle valve through the foot-treadle connection.

These hammers are rated entirely by the actual scale weight of the falling parts, no consideration being given to the added force of blow from steam or air pressure on top of the piston.

Recently a carload of 300-pound hammers of this style was shipped to the Philadelphia & Reading Coal and Iron Co., at Pottsville, Pa., and the manufacturers state that many of them are in use in other mining regions.

來 來

Mining Machinery Exhibit

An Industrial Exposition was held at Wilkes-Barre, Pa., May 10 to 17, at which, among the many exhibits of the business interests of the city, machinery relating to mining naturally occupied a prominent place.

One of the most striking of these was that of the Howells Mining Drill Co., of Plymouth, Pa., who showed drills of various types for boring coal, salt, rock, etc., one of them in operation on a 10,000-pound lump of anthracite which was taken from the Woodward mine, of the D. L. & W. Co. Electric power was in use to operate the drill and the cuttings together with the "Great Nubian Mystery" were given away as souvenirs. The recipients surely will understand the meaning of "black art."

The Hazard Mfg. Co. had an exhibit showing the process of manufacture of insulated cables from the raw rubber to the finished cable.

The Vulcan Iron Works had a steam locomotive, such as is used about mines, mounted so that the wheels could revolve, and also a miniature one about 2 feet long; both of these attracted much attention.

The W. H. Nicholson Co. exhibited sections and models of the Wyoming steam trap and Wyoming eliminator which showed plainly

the manner in which they operate. Also a number of other of their specialties were shown. The Star Electric Fuze Works showed blasting fuse and batteries.

A mining exhibit was made jointly by the Lehigh and Wilkes-Barre Coal Co., the Lehigh Valley Coal Co., the Susquehanna Coal Co., The Delaware and Hudson Coal Co.

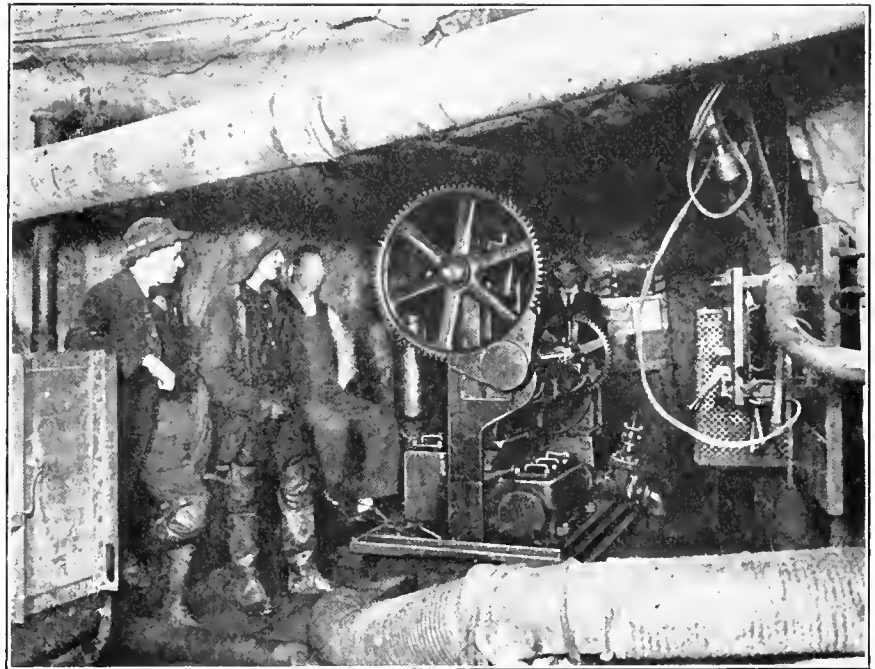

FIG. 1. GOULDS' TRIPLEX PUMP USED UNDERGROUND ON CATSKILL AQUEDUCT

and the D. L. & W. Co. In this was a timbered heading showing the coal face and loaded car. Next to this was a Goodman electric mining machine and other machinery used in the preparation and handling of anthracite. There was also a First-Aid booth in which the use of oxygen helmets and other apparatus was demonstrated.

來 來

Goulds Triplex Mine Pumps

A Goulds electrically driven triplex mine pump was used at the Flatbush and Third Avenue, Brooklyn, part of the Catskill aqueduct, is shown in Fig. 1. This is one of eight pumps of this type used in the Holbrook, Cabot & Rollins contract, extending from Cooper Square, New York, a distance of 5 miles into Brooklyn.

This pump is situated 500 feet below the surface and has a capacity of 300 gallons per minute. The pumps are driven by two-phase, 50-cycle, General Electric induction motors, and replaces air lifts which were first tried at this station.

Two of the pumps have a capacity of 300 gallons per minute and are 8 in. x 10 in. in size; six have a

capacity of 100 gallons and are 5 in. x 8 in. in size. On the Mason & Hanger contract, at Cornwall-on-the-Hudson, there is a 7 in. x 12 in. Goulds triplex pump direct-connected to a 50-horsepower motor in use, and two Goulds belt-driven triplex pumps, size 5 in. x 8 in. These pumps seem to be giving general satisfaction where used.

TRADE NOTICES

Matheson Joint Pipe.—National Tube Co. has issued a new edition of the Matheson Joint Pipe Booklet. This book contains 40 pages and numerous illustrations showing scenes where the Matheson Joint Pipe is being installed. The various advantages of this pipe are enumerated in the text and several new values are

brought out. The duo-tone illustrations are especially good. Address National Tube Co., Pittsburg, Pa.

Removal.—The Orenstein-Arthur Koppel Co. have removed their general offices to the new office building at Koppel, Beaver County, Pa., according to plans mentioned in this department some months ago.

New Type of Jigs.—Cory & Co., who have offices in the Oliver Building, Pittsburg, Pa., and are designers and contractors for coal washing plants, are placing on the market jigs of the submerged-displacement type, which are considered a notable advancement in coal washing practice.

New Office.—The Exeter Machine Works, of Pittston, Pa., manufacturers of elevating and conveying machinery and hoists, have opened an office in Pittsburg, at 945 Oliver Building. This will be in charge of Mr. T. C. Webb.

Westfalia Rescue Apparatus.—S. F. Hayward & Co., 39 Park Place, New York City, announce that they are now the exclusive American agents for the complete line of Westfalia mine rescue apparatus and oxygen reviving apparatus, formerly sold by the Westfalia Engineering Co., of 42 Broadway, New York, and will carry a complete stock of all the different types and spare parts for the Westfalia apparatus, insuring prompt delivery of all orders for new apparatus and immediate shipment of repair parts.

Trade Press Convention.—President H. M. Swetland of the Federation of Trade Press Associations in the United States, has announced that the eighth annual convention will be held at the Hotel Astor, New York, September 18 to 20, 1913. The Federation includes the New York Trade Press Association, the New England Trade Press Association, the Chicago Trade Press Association, the St. Louis-Southwestern Trade Press Association, the Philadelphia Trade Press Association, and a number of unaffiliated publications, the total membership being 236, representing over 75 different trades, industries, and professions.

President Swetland has appointed as chairman of the committee on

arrangements, William H. Ukers, who was largely responsible for the highly successful grocery-trade press convention held at the Hotel McAlpin, New York, last January. Mr. Ukers is arranging a program for the Federation Convention which will provide papers and addresses on topics of interest to manufacturers, sales managers, and advertising men, as well as to trade-paper editors and publishers.

Two sessions will be held daily. There will be editorial, circulation, advertising, and publishing symposiums, under competent leaders. Many of the leading editors, business managers, buyers, and sellers of advertising and authorities on modern merchandizing methods will take part.

On Friday afternoon, September 19, there will be a mass meeting with addresses by representative business and professional men, on subjects of timely interest to editors, publishers, and advertisers. Distinguished guests and worth-while speakers will be at the annual banquet, which will be made a memorable social occasion.

Invitations are being extended to manufacturers, sales managers, advertising men, trade-paper publishers, and all others interested in the idea of business promotion through trade-press efficiency, which is to be featured at the convention.

Chicago Office.—Scottdale Foundry and Machine Co., with works and general offices at Scottdale, Pa., have opened a Chicago branch office in charge of Mr. Carl Heim, at 327 S. LaSalle Street, Chicago, Ill.

Change of Address.—The Montreal, Canada, office of the Sullivan Machinery Co., hitherto located at 403 Lagachetiere Street, West, is now situated at Room 806, Shaughnessy Building, St. Paul and McGill Streets.

Announcement.—The Roberts & Schaefer Co., of Chicago, have now associated with their organization Mr. Willis E. Holloway and Mr. Paul W. Holstein. Mr. Holloway has had 15 years of experience in the designing and installing of coal handling equipments and conveying machinery, and has given special attention to outside mine work such as

coal-tipple construction and designing of screening equipments. Mr. Holloway will have charge of the marketing of the new "Marcus" combination screen and picking conveyer which the Roberts & Schaefer Co. have recently acquired. Mr. Holstein is a contracting engineer of large experience on coal tipple and coal-washing plant construction, and will now have charge of this branch of the Roberts & Schaefer Co.'s business principally in the West Virginia field. Mr. Trevor B. Simon, mining engineer, is also now associated with Roberts & Schaefer Co.

The Goulds Mfg. Co., of Seneca Falls, New York, have issued an interesting little book on Electric Pumping.

Electric Supplies in Emergencies. The test of an organization comes in an emergency, such as arose in April in the vast territory covered by floods and storms. The first unusual demand for special service came to the Western Electric Co. for 8,000 poles, 25,000 cross-arms, 100,000 pins, 32,000 feet of telephone cables. On the date the order was placed, 20 carloads of poles, 100,000 pounds of copper wire, and all of the cables went forward. Twenty-five thousand cross-arms went to Michigan, and the poles went forward from the yards in Michigan and the balance from Chicago.

The next call was for cables for the Chicago district to the Western Union Co. This was an order for 235,000 pounds of wire, and was sent forward by express from New York. Almost every other passenger train leaving the East for Chicago carried supplies.

When the floods began in Indiana and Ohio the Western Electric Co. was obliged to call upon its distributing houses, Cleveland, Pittsburg, Indianapolis, and Cincinnati, then Boston, New York, Philadelphia, Richmond, Atlanta, Kansas City, St. Louis, Minneapolis, and Dallas, in order to replace the depleted stocks in the East. Telegraph orders were issued to send East from Washington, 50,000 cross-arms.

The Colliery Engineer

Formerly
Mines and Minerals

Vol. XXXIII—No. 12

JULY, 1913

Scranton, Pa.

PUBLISHED MONTHLY AT SCRANTON, PA.
ESTABLISHED 1881

INTERNATIONAL TEXTBOOK CO., PUBLISHERS

T. J. FOSTER, President S. P. ALLEN, Secretary E. H. LAWALL, Treasurer
RUFUS J. FOSTER, Vice-President and Managing Editor
EUGENE B. WILSON, Editor WM. Z. PRICE, E. M., Asst. Editor
CHICAGO OFFICE: 1006 S. Michigan Ave.
Entered at the Post Office at Scranton, Pa., as second-class matter
Address all business communications to THE COLLIERY ENGINEER, Scranton, Pa.

Subscription Rates: \$2.00 per year to United States and all possessions, and Mexico; \$2.50 to Canada; \$3.00 to all other countries. Single copies 25 cents each.

Notice to discontinue or change of address should be sent to the Scranton office.
When notifying us of a change of address always give your FORMER as well as your present address.

CIRCULATION THIS NUMBER 12,700

TABLE OF CONTENTS

Editorial—
 "Huckleberry Miners"—Forest Fires—Coal Mining and Mining Schools—Assessment of Coal in the Ground—Rescue Work in Mine Disasters—Masonry vs. Wooden Air Stoppings—Carbon Monoxide Is Not a Supporter of Combustion—Alaska Railroad Construction..... 661

Personals..... 664
 An Ideal Method of Mining, by J. C. Edwards and H. M. Gibb..... 665
 Assessing and Taxing Coal in the Ground, by Wm. Griffith..... 669
 A Notable Scottish Colliery..... 671
 The Pishel Coking Test, by Max A. Pishel..... 674
 Bath House at Cameron Colliery..... 679
 Specifications for Lubricating Oil, by A. D. Smith..... 681
 Checking Inspector's Work..... 683
 Three-Two Method of Rope Splicing, by Alex. Wilson..... 684
 Imperial No. 3 Mine Explosion..... 685
 Briquetting Coal..... 687
 Photographing Blueprint Maps..... 689
 Coal Mine Fires..... 690
 The Earning Power of Chemistry, by Edmund M. Chance..... 693
 Conservation and Commercialism, by Francis S. Peabody..... 694
 Insurance on Mine Property, by W. H. Charlton..... 696
 Notes on Mines and Mining..... 697
 International Engineering Contest..... 699
 Panama-Pacific Exposition..... 699

The Letter Box—
 Shaft Sinking in Wet Ground—The Cement Gun for Preventing Dust—
 The Law Regarding Mine Inspectors—Cincinnati Mine Explosion—
 Scientific Management Applied to Mining..... 700

Correction..... 702

Obituary—
 Woodward Leavenworth—Orran W. Kennedy—Wm. H. McQuail..... 702
 The Scott Colliery Disaster..... 703
 Kentucky Mining Institute..... 704
 A "Near-Doomed" City..... 704
 Prize Contest..... 705
 The Combustion of Oxygen and Coal Dust in Mines, by James Ashworth..... 709
 Book Review..... 710

Practical Talks on Coal Mining—
 Mine Ventilation—Mechanics of Mining—Electricity in Mines..... 712
 Reinforcing Collars..... 717

Examinations—
 Mine Foremen, Pottsville; Mine Inspectors, Pottsville, 1913..... 718
 Safety First, by John Dunlop..... 721

New Mining Machinery—
 Electric Sinking Pump—New Type of Mine Trolley—Timber Setting
 Derrick—Power-Driven Auger Drills..... 723

Trade Notices..... 725
 Catalogs Received..... 726
 Underground Seismograph..... 726
 Hogs as Indicators..... 726

Squibs—
 Natal Coal Output, 1912, 670—As Applied to Family Affairs, 679—Western
 Mining Camps, 680—United States Geological Survey Fire Sale,
 680—Russian Coal..... 722

"Huckleberry Miners"

OUR cover picture illustrates a familiar scene in many coal fields in the Appalachian regions. It depicts a group of wives and daughters of foreign-speaking mine workers returning from a berry-picking expedition. Last year some of the pickers near McAdoo, Pa., where the United Mine Workers are particularly strong, formed a union against cut prices, and pickers who sold below the standard were chased from the bush and their berries were confiscated.

來 來

Forest Fires

RURAL mail carriers are now ordered to report to the proper authorities all forest fires detected along their routes. Frequently careless huntsmen start fires in leaves and dried grass that end in considerable loss of property. It is the duty of every citizen to be careful in this regard and to aid in every way in extinguishing forest fires, even although on another person's property. Money lost can be regained sometimes, but trees, not in our generation.

來 來

Coal Mining and Mining Schools

OF THE large number of students recently awarded degrees as Mining Engineers or Bachelors of Science in Mining Engineering, the majority have taken metal mining and metallurgical subjects for their theses, although coal mining offers as many varying subjects on which to display erudition. This seems a pity, since the chances for young men in coal mining are more numerous, likewise the positions more stable, and advancement surer. This is not altogether the fault of the students, for the study of coal mining is not given the prominence it deserves in our mining schools.

來 來

Assessment of Coal in the Ground

ON ANOTHER page we publish an article on the assessment of coal in the ground, by William Griffith, of Scranton, Pa., whose reputation as a competent and conservative mining engineer and geologist is such as to commend it to careful consideration. Mr. Griffith treats specially of the assessment of coal in

the northern anthracite field. His suggestions apply with equal force to the question of assessments in other portions of the anthracite regions of Pennsylvania. With necessary changes of ton values, his proposed method of computing the value of the coal in the ground for assessment purposes is equally rational for application in the bituminous fields. We commend this article to the careful consideration of all who are interested in sound methods of arriving at a proper assessment of the coal in the ground, so that the burden of taxation may be equitably distributed and that the taxes may not be of a nature that makes them practically confiscatory.

來 來

Rescue Work in Mine Disasters

THE number of coal mining accidents in recent years, resulting in comparatively large death lists, has impressed on mine owners, mine officials, and mine workers the necessity of an ever-ready rescue corps.

Some mining men have proposed that all men working underground be trained in rescue work. This is not advisable. A few well-selected men, including the working officials, trained to a high degree of efficiency, can do more and better work than a much larger number who have been partly trained.

We do not mean that training in rescue work should be denied the majority of mine workers. On the contrary, every mine worker should be instructed in a general way how to meet emergencies. Every underground workman cannot be, in fact, he should not be, a member of a rescue corps, but he should be taught how to take care of himself. He should be compelled to learn the local conditions surrounding his work, the various routes to the surface from his working place, the direction in which the air travels in the main entries, to be amenable to rational discipline, and above all, when something does go wrong, to proceed cautiously, remembering that the shortest way out may not be the safe one.

The keynote of rescue work is a high degree of courage without recklessness; so in organizing a rescue corps, the members should be selected carefully. Men of strong physique, of known courage and superior natural intelligence should be chosen.

Rescue corps formed indiscriminately from the crowds of mine workers willing to risk their lives in efforts to save those of their comrades are never as effective as smaller corps of trained men. Moreover, they sometimes impede proper work and often tend to increase loss of life.

In several recent disasters the effectiveness of trained men was strongly in evidence. The rescue corps moved with precision and accomplished all that could be done to rescue lives and recover bodies in a much shorter time, and with less liability of danger to themselves, than would have been the case if only partly trained volunteers had done the work. A striking example of this is noted on another page in connection with the Scott colliery accident.

When one considers that well-trained men sometimes get "rattled," as has been the case several times in individual instances when using oxygen helmets, and they in their excitement overexert themselves with disastrous results, the necessity of extreme care in the selection of men for this work is strongly emphasized.

But men not selected for rescue work can be impressed into a service equally as important; this is easily understood when we realize that all openings should be carefully guarded. An experienced man should be at the mine entrance to examine all safety lamps before they are taken into the mine, another should record all persons going into or coming out of the mine, and others should provide proper food and shelter for parties engaged in rescue work and see that all ventilating appliances are in readiness for operation when required.

來 來

Masonry versus Wooden Air Stoppings

WHILE there must be a reason for the ignition of gas and coal dust in a mine, it is extremely difficult to locate the cause when only a horse is in the mine.

Mr. James Ashworth states, on another page, that one of the most violent explosions on record occurred under just such conditions, at the Killingworth colliery, in New South Wales. The readers of this journal will remember that we have advocated that sliding doors be placed in the pillars on each side of the entry breakthroughs, so that in case of an explosion, the time now lost in building brattices, which is of the utmost importance if life is to be saved, can be reduced to a minimum. Mr. Ashworth also quotes Mr. Blackett, who suggests that the violence of an explosion might be reduced and its progress to some extent arrested, if the air stoppings gave way and allowed the force to expand. To those who have seen the havoc wrought by explosions on expensive brick and stone stoppings in breakthroughs in this country, it must be an open question that Mr. Blackett propounds.

It will be remembered that at Lievin experiment station 36 feet of the gallery burst and it had a resistance to bursting pressure of 570 pounds per square inch. The only object in having strong stoppings is to prevent short circuiting of the air-current in case of an explosion, and in almost every instance they have failed to come up to the expectations by being blown down. It would seem, therefore, that air-tight stoppings that could easily be blown out, supplemented with the sliding doors mentioned offer a superior method for quick mine recovery and possibility for saving life.

A further advantage to be derived from sliding doors, if placed in entries as suggested, would be that the imprisoned men could themselves shut out the afterdamp and prevent its killing them before the rescue parties have had time to restore the ventilating current, and come to their aid.

Carbon Monoxide Is Not a Supporter of Combustion

IN ANSWERING the query of a correspondent as to whether carbon monoxide is a supporter of combustion or not, in our June issue, the editor said, "the statement in the I.C.S. Instruction Paper that carbon monoxide does not support combustion is correct." He also called attention to an incorrect statement in the last, or 1911, edition of the Coal and Metal Miners' Pocketbook, and in a kindly and impersonal manner explained the misstatements in the first edition of the book "Examination Questions and Answers" and in the Pocketbook by saying they were made by "a former employe of the publishers who, while an able mining writer, and as a rule accurate, in this instance expressed an opinion of his own, which is in direct opposition to the actual experience of chemical authorities whose works are regarded as standards all over the world."

In a recent issue of a contemporary, with which he is now connected, Mr. J. T. Beard, over his own signature, correctly assumes that we referred to him as the author of the erroneous statement.

In commenting on our answer to the correspondent, Mr. Beard first says that his statement "is not one of opinion, but of *fact*," and in the same paragraph he says: "The statement, although correct, was modified later, at my own suggestion, in the I.C.S. coal mining textbooks." If, as Mr. Beard claims, it is a fact that carbon monoxide supports combustion, why in the world would *he suggest* a modification which flatly contradicts what he claims is a fact?

The statement that carbon monoxide supports combustion, made by Mr. Beard in the first 1,000 copies of the book "Questions and Answers," was corrected in all subsequent editions by Prof. H. H. Stoeck, then editor of this journal, and now head of the mining department of the University of Illinois.

The last, or tenth edition of the Coal and Metal Miners' Pocketbook, also contains Mr. Beard's statement, as did several previous editions, but the earlier editions stated correctly that carbon monoxide will not support combustion. The statement made by Mr. Beard that it will support combustion escaped the notice of the writer until very recently.

In support of his claim that carbon monoxide will support combustion, Mr. Beard says: "While carbon monoxide has no available oxygen and therefore cannot support the combustion of carbon, the gas (*CO*) will support an oxygen flame, which will burn in an atmosphere of pure carbon monoxide, although it would not burn in air."

This statement is proof of the fact that carbon monoxide is combustible, but is not proof that it supports combustion, because the so-called oxygen flame is not burning oxygen, but is the flame of the carbon monoxide burning in the presence of oxygen, or in other words carbon monoxide combustion supported by oxygen.

We suppose that "by the same token" Mr. Beard will claim that carbon dioxide supports combustion because an acetylene gas flame has been known to burn in an atmosphere so strongly charged with carbon dioxide that an ordinary flame would not burn in it.

來 來

Alaska Railroad Construction

MR. FALCON JOSLIN, of Fairbanks, Alaska, chairman of the Alaskan Committee of the American Mining Congress, president of the Tanana Valley Railroad, a pioneer connected with many Alaskan business enterprises and perhaps more familiar with Alaskan conditions from a practical standpoint than any other man, has reviewed Governmental Aid to Railroads. His statements have been incorporated in Senate Bills, Nos. 48 and 133 of the 63d Congress, inserted in the records of May 3, and printed in Part 7, May 12, 1913. If those interested in conservation and the development of natural resources will write to Senator Key Pittman, Washington, D. C., for these remarks, they will be enlightened on many subjects relative to the governmental help afforded railroads entering a new and uninhabited country. Every railroad constructed into undeveloped country must be operated at a loss until the business along its line has been developed sufficiently to make its operations profitable. The Union Pacific and the Northern Pacific railroads were not only subsidized but given land grants. The Union Pacific never paid the interest on the bonds which the Government issued in its behalf, and the Government sold the railroad upon terms anything but advantageous.

The withdrawal of the coal lands in Alaska from private entry has taken away the only possible recompense for investment and no railroad construction is possible under present conditions. Mr. Joslin simmers down the discussion "to state ownership or private ownership," each of which have certain objectionable features. Those who do not believe in government ownership of railroads and those who do, will have an opportunity to defend their theories, but in the end Alaska must have railroads. Over 99 per cent. of Alaska is public domain that cost 2 cents per acre. Its present population of 35,000 white and 30,000 Indians produces an annual trade of \$60,000,000. It is estimated that Alaska has 64,000,000 acres of agricultural land that is highly productive, for at the United States experimental farms at Fairbanks, in 1912, 115 bushels of oats; 67 bushels of wheat; and 260 bushels of potatoes were produced to the acre without fertilizer and under the natural conditions of soil and climate.

In view of the strong public feeling against granting any kind of assistance or subsidy to private corporations, and the objections to public ownership of railroads, the future of Alaska offers a difficult problem, which should, however, be solved soon, since the people of Alaska import over \$1,000,000 worth of coal yearly and miners dig stumps for fuel.

PERSONALS

William Nicholson, mine inspector of the Eleventh District of West Virginia, has resigned his position to become superintendent for the Jewell Ridge Coal Co., at Richlands, Va.

Arthur Swartley is to be sent out by the new State Bureau of Mines to collect information on Oregon mineral production from those who have failed to report. Within the next few weeks he will go to Portland, Astoria, Baker, and Enterprise.

J. F. Healy, general manager of the operating department of Davis Colliery Co., resigned his position on the first of June. He contemplates opening a consulting office in Charleston, W. Va.

Mr. Cunningham, consulting engineer, Huntington, W. Va., attended the meeting of the Kentucky Mining Institute at Lexington.

C. F. Fraser, mining engineer, Taylor Coal Co., Beaver Dam, Ky., wrote a paper on "Mining Laws of Kentucky," to be delivered at the Kentucky Mining Institute in Lexington on May 17. On May 10, Mr. Fraser and three other men entered an abandoned working and were smothered to death by carbon dioxide. Mr. Rash, president of the Institute, and general manager of the St. Bernard Coal Co., read an obituary at the Institute meeting, in which he dwelt on the excellence of Mr. Fraser as a man and a friend.

J. B. Atkinson, H. M., Chief Inspector of Mines for the Newcastle, England, district, resigned his post, effective May 31, in order to establish a practice in Newcastle as a consulting mining engineer. Mr. Atkinson held his first appointment as assistant inspector in the Durham district, then he was transferred to Northumberland. Later he was appointed Chief Mine Inspector in the east of Scotland, where he remained for 12 years, returning to Northumberland 11 years ago, on the death of Mr. Hedley.

Harry William Shaw, who recently received a degree of B. S. in mining

engineering at the University of Missouri School of Mines, had as a thesis, "Methods of Mining and the Preparation of Coal in the Belleville, Illinois, District."

Eugene Haanel, Ph. D., Director of Mines Branch, Department of Mines, Ottawa, Canada, announces the completion of a modern laboratory for the experimental concentration and metallurgical tests of Canadian ores and minerals.

George Watkin Evans, consulting coal mining engineer of Seattle, has been selected to make an examination as to the commercial possibilities of Matanuska coal field, of Alaska, for the United States Bureau of Mines.

From advices received from John T. Davis, vice-president and general manager of the Davis Colliery Co., R. B. Isner is now assistant general manager, and J. W. Biscoff is now general superintendent of the Davis Colliery Co., with headquarters at Elkins, W. Va.

Mine Inspector P. J. Walsh, of the Ninth Bituminous District of Pennsylvania, announced that the following men passed examination for mine foreman and assistant mine foreman:

Mine foreman: Isaac L. Davis, Andrew Guidas, and W. E. Mitchell.

Assistant mine foreman: Joseph Burns, Milton Wheeler, Elmer Swink, E. J. Rowan, Thos. Fazenbaker, and John Metcalf.

H. L. Watson, formerly sales engineer with the Allis-Chalmers Mfg. Co., of Milwaukee, has accepted the position of sales manager for the DeLaval Steam Turbine Co., of Trenton, N. J.

John Gibson, Jr., superintendent of all operations of the United Coal Co., in Somerset County, has been appointed general superintendent of Pennsylvania, Maryland, and West Virginia. He is succeeded at Somerset by Mine Inspector Richard Maize, Jr.

E. F. Mullen, for many years engineer for the Jeffrey Mfg. Co., and Heyl & Patterson Co., has joined the engineering staff of the Link-Belt Co. Mr. Mullen has had extensive

experience in designing and construction of tippie equipment and general coal handling machinery, particularly in the West Virginia and Pennsylvania coal fields.

Dr. M. J. Shields, M. R. C., U. S. A., the originator of first-aid instruction in the anthracite regions, is continuing the good work in charge of American Red Cross Car No. 3, and has recently been over the lines of the Texas Pacific Railway and other railroads in the Southwest, giving instruction to the employes.

Edward M. Chance, who for a number of years has been connected with the Reading Coal and Iron Co., as chemist, has opened an office and laboratory at 61 South Pennsylvania Avenue, Wilkes-Barre, Pa., where he will practice his profession of analytical and consulting chemist.

Prof. Regis Chauvenet has been appointed president of the Colorado School of Mines, Golden, Colo. Mr. Victor Alderson, former president, having resigned.

Dr. Felix Adler, of Columbia University, and head of the Society for Ethical Culture, accompanied by Messrs. H. H. Jones and A. W. Bing, of New York City, the latter also members of the society, inspected several breakers and mines in the vicinity of Scranton, on June 9, to examine at close range the labor-saving devices of the coal mining industry and to look into child labor conditions as representatives of the National Child Labor Commission.

John Hawthorne, of Hillsboro, Pa., a prominent young bituminous operator, had his right hand blown off in the Bessemer Coal Co. mines at that place, by striking a stick of explosive against a projecting hanger.

H. M. Wilson, of the United States Bureau of Mines, announces the American Mine Safety Association will hold its first convention in Pittsburg in September.

Robert H. Seip, mining engineer with the North American Smelting Co., Ltd., a Canadian corporation, has accepted a similar position with the Consolidation Coal Co., at Jenkins, Ky.



COAL MINING & PREPARATION

An Ideal Method of Mining

For Winning the Largest Percentage of Coal, the Use of Machines, and for Concentrating the Workings

By J. C. Edwards* and H. M. Gibb†

THE ideal coal mine of today would be one in which: The largest percentage of coal can be won, and at least 90 per cent. of this portion won by machine. The cutting and loading would be concentrated, thus offering the principal requirements for economical haulage. The ventilation would reach a degree of safety that would protect

Many operators seem to be satisfied with this percentage, seemingly giving more attention to the daily tonnage output produced than to the amount of coal mined per acre. One reason for this condition of affairs seems to be due to the keen competition among

it can readily be seen that the operator must increase the daily output at the mines, so as

to receive a fair profit on his investment, and as a natural consequence this is accomplished at the sacrifice of the mineral wealth of the property.

The system of mining generally in use in the bituminous field is known as "room-and-pillar work." The

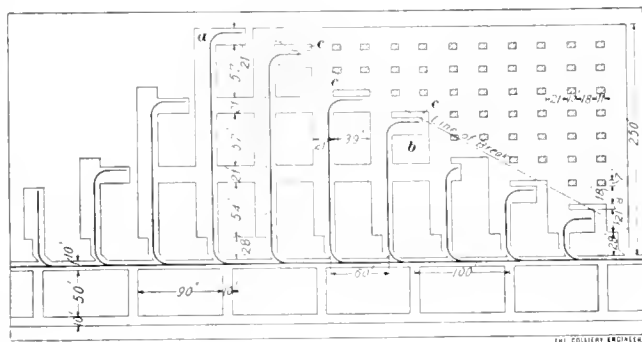

FIG. 1. EXTRACTING PILLARS UNDER DRAW-SLATE

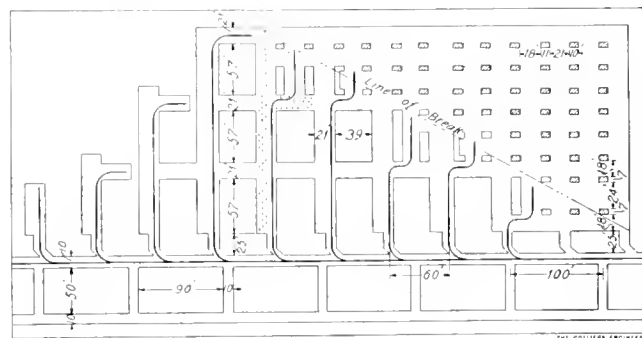

FIG. 2. EXTRACTING PILLARS WHEN THERE IS NO DRAW-SLATE

the miners so far as possible from accidents due to indifferent methods of ventilation. The least number of headings would be necessary for development, thus reducing the costs for heading yardage, breakthroughs, cross-overs, tracks, pipe lines, air stoppings, maintenance, etc. The mining laws and agreements with the District Union could be carried out.

The large amount of coal wasted, due to improper methods of mining, is one of the serious problems that confronts the operator, especially one who is about to open a coal property that has been purchased at the prevailing price per acre.

In those mines in the bituminous field with which the writers are familiar, about 70 per cent. of the total coal in the ground is removed.

coal operators, which makes the margin of profit so small that it forces an increase in the daily output in order to obtain a reasonable interest and amortization on the money invested. In the past 10 years, the miners' wages have increased from 25 to 30 per cent.; besides in addition to this, the revision of the mining laws, while adding safety to the miners' work, has increased the cost of production about 5 per cent., although the price of coal in the market in the same length of time has increased but from 3 per cent. to 5 per cent. From this

thickness of the pillars between the rooms varies, but the room centers most in use are 33 feet, 36 feet, 39 feet, and 42 feet. With 33-foot room centers, the pillar is lost entirely. With 36-foot room centers, about 50 per cent. of the pillar is recovered, and with 39-foot to 42-foot pillars from 60 to 70 per cent. of the pillars are recovered. The small percentage of pillar coal mined is due to hurry-up methods which generally demand the use of picks to recover any portion of the pillars.

The most of our so-called miners are in reality foreign laborers or men who have little or no experience in pick mining, therefore, if a larger percentage of coal is to be saved, it must be by machines. In order to operate machines successfully on room pillars, the latter must be made wider. As the per cent. of coal recovered

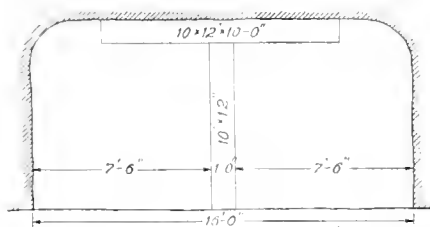

FIG. 3
665

* Chairman Efficiency Committee.
† Resident Manager of the Pittsburg-Buffalo Coal Co., Marianna, Pa.

plays a material part in the absolute cost of coal per ton mined, any method that would win 90 per cent. or more of the coal from the ground would be an exceedingly important advance in mining and of great helpfulness to all coal mining men. A method of mining which would recover 90 per cent. of the coal would not only materially reduce the cost of coal per ton mined, but would also lengthen the life of the mine, so that, in the writers' opinion, too much attention cannot be given to methods of mining.

The accompanying drawings show the writers' system of mining coal, with a cover from 300 feet to 500 feet. This method is adaptable to either a drift, slope, or shaft, opening, with locomotive, tail-rope, or endless-rope haulage. Fig. 4 shows the method used for either a slope or drift opening, dumping over the same tippie. A solid 50-foot pillar of coal separates the two sets of main entries, thus making two distinct mines. Three entries make up a set of main entries.

The inside entries are for the loaded cars; the middle entries are for the empty cars, and the outside entries are airways. The loaded and empty haulage roads are driven the regulation width, 10 feet; the airway, however, is driven 16 feet wide. Fig. 3 shows the system of timbering adopted in supporting these airways. Where the roof is good, a piece of 8"×10" timber 10 feet long is used as a collar, with a 10"×12" timber post supporting it in the center. Where the roof is poor, the airway is timbered in the usual way. In all instances, timbers are set on 3- or 4-foot centers. By driving this airway 16 feet wide, the expense of driving a fourth main entry 10 feet wide is saved.

The writers contend that in our present mining practice, not enough attention is given to the airways. Any attention given to the airways seems to hit a continuous sore spot, from a cost standpoint; for instance, where a roof fall occurs it becomes necessary to open the nearest stopping (which is of brick or concrete) and lay a track so that the fall can

be cleaned out. This is a slow and expensive operation. The main airways should be timbered so that the roof falls will be prevented, or at least reduced to a minimum. The extra expense of removing roof falls and driving a fourth main entry would be well spent by the operator in timbering a 16-foot airway. The loaded and empty car-track system is also adopted on the cross-entries, which are driven "face on."

The panel system of mining shown in Fig. 4 is known as "the half advancing and half retreating system." The cross-entries are driven in pairs so as to serve two panels.

The panels are blocked out every 500 feet by entries driven "end on" in pairs, and from these "butt entries" rooms are turned every 60 feet and worked face on. The rooms are driven 21 feet wide and this leaves room pillars 39 feet wide.

The butt entries 2, 4, 6, etc., up to 12, which are on the side toward which the development of the panel is progressing, are termed "advance headings," and those butt entries 1, 3, 5, etc., to 11, which are on the main entry side of the panel, are the "retreat headings." Rooms turned from the advance heading are driven 255 feet long, and rooms turned from retreat heading are made 245 feet long. All breakthroughs are driven 21 feet wide and offsetted, as shown in Fig. 1, which also shows the method of extracting room pillars where draw slate is encountered.

In driving the breakthroughs between the rooms, the track is laid on the far side and the slate is gobbled on the near side, or the side toward the cross-entries. When the breakthrough *a* at the face of the room is completed, the curve and two 15-foot sections of track are removed; a cut is then taken out of the pillar, as at *b*, "working on the butt," thus leaving a 10-foot pillar *c*. This cut, made 21 feet wide, is driven the length of the pillar, 39 feet, thus leaving a pillar 10 feet wide and 39 feet long. A cut 21 feet wide is next made through this pillar *c*, which leaves a 9'×10' block of coal, or stump pillar, at each end of the cut, to be mined with

picks. This operation is repeated until the room pillars are extracted as far as the entry pillar. The tracks in all the rooms are in 15-foot sections, so that by removing two sections, previous to taking out the first cut in the pillars, the tracks are always in the proper position. The rails used on the turns are fastened together by steel ties, so they can be readily detached or assembled as desired. In cases where coal cutting is done by compressed-air machines, the pipe line is standardized in 30-foot lengths, tees with one end plugged being used for jointing. By removing one section of the pipe line to every two sections of track the machine runner always has the proper conveniences to do the cutting.

In Fig. 2 is shown the method of extracting room pillars where there is no draw slate to contend with. Instead of driving on the butt across the rib, a 21-foot cut is driven in the face, thus splitting the pillar and leaving a 9-foot pillar on each side of the cut. When these pillars are attacked a 21-foot cut is made in both the right and left pillars, which leaves 9'×10' stump pillars, one on each end of the cuts. These are worked out as in the previous case by pick miners. The operation is repeated on each room pillar until all are extracted, to the first cross-cut or entry break.

In both systems of mining, 90 per cent. of the coal is won by machines.

In developing a panel on the butt entries by this system, a chain breast machine is used. The method is shown in Fig. 5. When room 14 is turned, room 2 is finished and in readiness for work to commence on the pillar between rooms 1 and 2. To make the pillar cut, the short-wall machine is brought into use and both machines continue in use until the last room on the retreat heading is completed. The short-wall machine is left on the heading to finish the pillars, while the breast machine is transferred to another pair of butt entries under development.

The rooms on the advance heading are 250 feet long and on the retreat heading 240 feet long—this in lieu

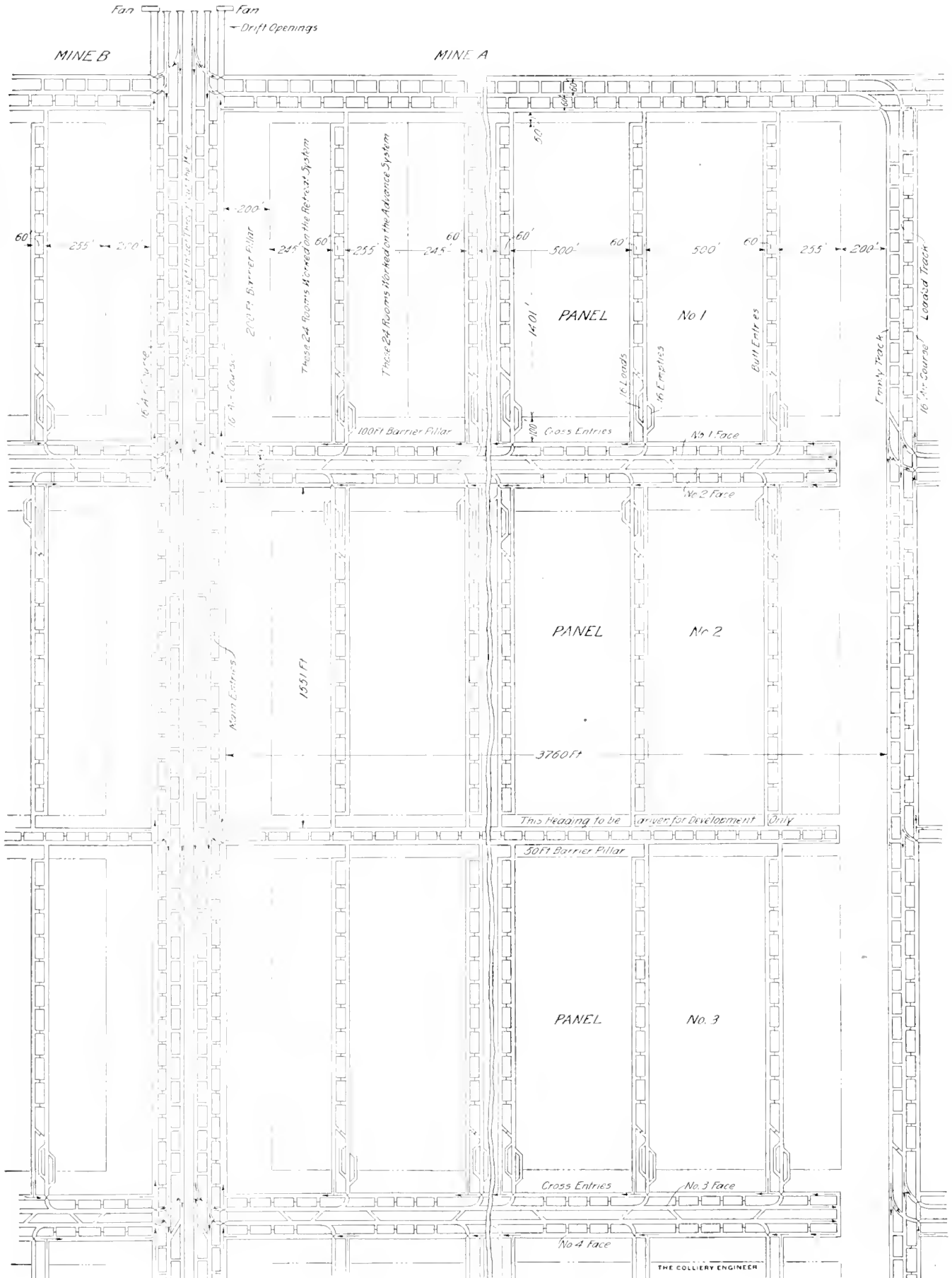

FIG. 4. PLAN OF PANEL SYSTEM OF MINING

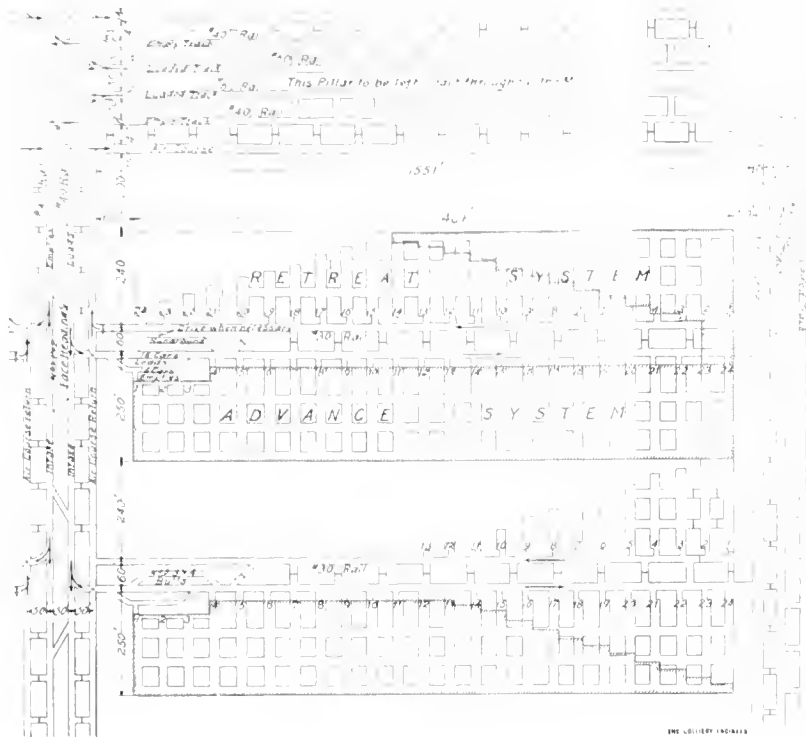

FIG. 5. PLAN OF DEVELOPING A PANEL

of the fact that the chain pillar and entry stumps are brought back with the ribs on the retreat heading.

The most important features in economical coal mining are concentration in mining, in loading, and in haulage. The cutting and loading in this system of mining are concentrated from the time the butt entries are started until the last room is finished; however, the success of the system depends entirely upon the regularity with which the rooms are opened and the pillars drawn. In case one of the pillars is idle for any length of time a man from one of the headings works on the pillar in question temporarily, until the regular man returns to work. When the butt entries in this system are fully developed, there are from 18 to 20 working places, or practically enough to keep one locomotive busy. A feature of the haulage in this system is the individual side tracks on each pair of butt entries. Note that the arrangement consists of three tracks, one for loaded cars, one for empty cars, and one for a run-a-round for the locomotive. The side tracks are designed to allow the gathering locomotive to either pull or push the loaded and empty cars, so that the

main haulage locomotive can either push or pull the loaded or empty cars from the side tracks. It will be noted that the gathering locomotive is not confined to the one pair of butt entries, or one pair of cross-entries, and further examination of this side-track plan will show that it has distinctive advantages over those now in general use; for instance, the main haulage roads are in the center with the airways on the outside. These haulage entries are connected, one with the other, by a series of cross-overs, so that individual tracks can be used for the loaded or empty cars. These cross-overs also serve the purpose of side tracks without any additional cost during the life of de-

velopment of the mine. An excellent feature connected with these cross-overs, is that in case of a wreck, the locomotive can cut loose from the end of a trip and leave it for the company to clean up. While this is being done, the locomotive can continue to do its work by passing this wreck via the cross-overs, an arrangement which removes one of the most serious delays in haulage and will be most appreciated by those in direct touch with this portion of mine work.

It is unnecessary to dwell upon the importance of ventilation, as all mining men realize this. The retreat entry in this system of mining is the intake, and the advance entry, the return; thus it will be seen that the fresh air first passes over what is termed the live work and afterwards over the pillar or gob work, before it is directed to the main return airway, thus each pair of butt entries is an individual air split. This is an important feature where naked lights and electric haulage are used.

In a mine where safety lamps and compressed-air haulage are required, two or more pairs of butt entries can be used on the same split, thus saving the overcasts which would have to be built when using each pair of butt entries, as a separate split.

Shaft mines in general would be worked on the same system. In Fig. 6 is shown a shaft bottom, designed for this method of mining, the idea being that all the coal hoisted from the two shafts is to be dumped over the same tippie. Each of these shafts has two shaft bottoms, one for each section of the mine, because the shafts are sunk at or near the

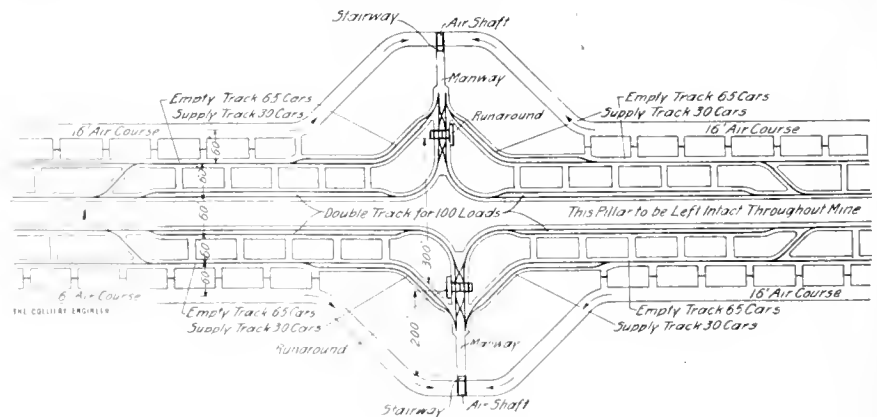

FIG. 6. PLAN OF SHAFT BOTTOM

center of the coal property, and the areas to be mined for each shaft will be about equal.

The shaft bottoms are each designed for a coal capacity of 2,500 tons daily, or a total of 5,000 tons. The loaded track on each section holds 100 loaded cars; the empty track holds 65 empty cars, and the supply track 30 cars. The loaded and empty tracks at the shaft bottom proper are a continuation of the loaded and empty tracks in the main haulage entries. In landing the loaded trip at the bottom, the locomotive cuts loose from it shortly before reaching the point A, and is switched through the cross-over to the empty track while the cars pass on to the shaft bottom. The brakeman stops the trip and spots it properly at the shaft bottom. As all the breakthroughs are open between the loaded and empty tracks, the brakeman passes through the nearest one, to the empty track where he meets the motorman. They couple to the empty trip and leave for their destination, via the empty track. This method reduces the time lost in changing trips to a minimum. In case there are any supplies on the supply track, for the butt entries that the locomotive driver intends to pull in on the next trip, they are run on to the main entry empty track and placed as the first or second part of the trip, as the case demands. This is done by the boy who couples up the empty cars. The loaded cars are fed to the cages by chain hauls, using automatic car stops on the loaded sides. Care is taken to provide sufficient grade so that when the cage lands, the loaded car will start itself. The empty car passes from the cage to a kick-back and thence by gravity to the empty track. Care should be taken that the car is returned to the section from whence it came; which can be done by the use of cross-overs on both sides of the shaft.

The adoption of this system would mean a big saving in the amount of heading work, track work, room piping, room necks, etc., necessary for the development of the mine.

The system has been adopted by

the management and chief engineers of the Pittsburg-Buffalo Co. for future work in their Marianna and Hazel mines of Pennsylvania; also the Annabelle mine of the Four State Coal Co., West Virginia.

來 來

Assessing and Taxing Coal in the Ground

*By William Griffith, E. M. and Geologist**

There would seem to be no recognized standard of value for coal content of lands at the present time among the engineers and county authorities of Lackawanna or Luzerne counties, and this lack of a recognized standard results in much confusion, litigation, and expense. The commissioners of Lackawanna County have variously estimated the value of coal at from \$65 to \$300 per foot-acre, and recently in Luzerne County one group of engineers employed by the land owners estimated the value of a certain tract of land at or around \$700 per surface acre, while another group employed by the county authorities estimated the same land at about four times this value; thus indicating to the curious public that the judgment of experts on these questions is about as variable as the weathercock on the barn, being easily influenced one way or the other, according to the interests of the people who employ them.

Recently a representative of one of our large coal mining companies testified in the Lackawanna County courts that his company considered the coal in the ground worth to them 50 cents per ton. And I presume that at the pending tax appeals other representatives of the same company will aver that the coal is not worth 25 cents a ton.

All this indicates a sadly mixed state of affairs with reference to coal values, and it would seem that the adoption of some sane method of arriving at the standard of value would be proper at this time. In fact, the tendency, outside of the anthracite region, is in this direc-

tion. Not only have authoritative textbooks been written upon this subject, based upon sound principles of finance and engineering, but recently the Department of the Interior of the United States government, through the Geological Survey, has established rules for fixing the value of the coal lands of the public domain, based upon such standards and principles, from which to estimate the value of each particular property, according to the varying conditions which obtain. The writer has used a similar basis of valuation for many properties that he has been called upon from time to time to value, either for the purchaser or seller, or for financial interests to form the basis of value behind bond issues or other obligations, and has universally used the royalty rate as a proper standard of such valuation.

The supreme courts have declared that a perpetual lease is a sale and that the royalties are instalments on the purchase price. Therefore, the royalty represents the value of the coal in the ground, to be paid for as it is mined, and is a fair and equitable standard of value for estimating the worth of the coal; better to our mind than outright sales, because the sales of coal land in this locality are not frequent, and the deeds and records of such transactions usually cover up the actual selling price so that it cannot be ascertained. Of course, the royalties years ago were small—about 15 cents per ton. Later they increased to about 25 cents a ton for prepared coal. Still later about 35 cents was a going royalty, and at the present time it is from 50 cents to 75 cents; but the properties covered by high royalties of this kind are very few, and the tonnage contained is light, representing small comparative values.

The real question therefore would be to definitely determine a proper, fair average royalty applicable throughout the county. Having fixed such for the county, or for any particular coal property in question,

*Scranton, Pa.

the present value of the coal in the land is a matter of nearly the same degree of certainty as we find expressed in the proposition that two times two are four. Of course, each property becomes a problem in itself, but having a basic standard, deductions or allowances may be made to conform to the various conditions that are known to be peculiar to each property.

An illustration will perhaps best serve to explain the method of arriving at coal values from the royalty rate as a basis of calculation: If we have on the table before us 100 gold eagles, their value would be manifestly \$10 each, or \$1,000; but if a condition be attached to the possession by which the gold shall be deposited in the vault, and only one gold eagle, or \$10 be used each year, then the present value is materially changed, and would be the present worth of \$10 per annum, at say 6 per cent. interest for 100 years, which would be \$166.17. Thus we note that the element of time affects the present value in a very material way. And the same would be the case in connection with coal. If, for example, we have a coal property which produces a royalty of \$10 per year, and we know that the quantity of coal in the land is sufficient to continue this production for 100 years at the same rate, then the present worth of that coal would be \$166.17. Again, Lackawanna County contains approximately 600,000,000 tons of coal, and it is being mined at the rate of 18,000,000 tons per year. At this rate it would be exhausted in approximately 33 years. If, for example, the average royalty rate for a composite ton (that is to say, a ton composed of the various percentages of different sizes ordinarily produced at the breakers) be assumed at 25 cents, the present value of one such ton per year for 33 years (that is, 33 tons), at legal interest, 6 per cent. would be \$355.75, and the present value of 1 ton of coal in the ground, on the above basis would, therefore, be \$355.75 divided by 33 or about

10.8 cents. At the various royalties mentioned below the values would be according to the following tabulation:

Average Royalty Rate for Composite Ton	Present Value of One Ton of Coal in Ground
25 cents per ton	10.8 cents per ton
30 cents per ton	12.9 cents per ton
35 cents per ton	15 cents per ton
40 cents per ton	17 cents per ton

If it is desired to express this in foot-acres, we simply multiply the above value per ton by the number of available tons in 1 foot-acre. If, for example, we assume that a fair and reasonable yield for the coal lands of this county is 1,200 tons per foot-acre, then, at the above royalty rates, the present value of the average foot-acre in this county would be as follows:

At 25 cents per ton royalty, \$130; at 30 cents per ton royalty, \$155; at 35 cents per ton royalty, \$180; at 40 cents per ton royalty, \$204. It would seem to us that a fair and reasonable royalty as between land owner and taxing authorities should be somewhat around 30 cents to 32 cents per ton for the average composite ton, because the major portion of the coal now being operated under royalty is being paid for at approximately this price.

Then, of course, the question arises as to whether it would be more equitable as between all parties to value the coal at the actual rate which is now being paid for it, or whether it should be valued at a higher rate, in view of the new leases. These are questions to be determined, but having them once settled for each county, there would then be a standard which would be a basis upon which the value of all properties could be estimated, these values of course varying according to the conditions known to exist on the several properties.

It will be noted that this method of ascertaining the taxable value of coal places the greater burden of the tax upon the coal in the going properties, which will be sooner exhausted. For example, at the royalty rate of 30 cents per ton, other things being equal, the coal in a property which will be exhausted

in 10 years, would have a present value of 22 cents per ton, whereas at the same royalty rate the coal in an adjoining property which had a life of 60 years would have a present value of 8.1 cents per ton. To our mind, this is as it should be, because it is manifestly unfair to tax the unremunerative ton year after year at full rate for 60 or 100 years, whereas the remunerative ton of coal which is mined this year escapes with but the one tax. And, along the same line, virgin properties which are held for future mining, should to our mind, be considered in the same manner as we now treat unremunerative, unseated lands, by imposing simply a nominal tax until such time as they become productive. For purposes of conservation, the forestry associations have for years been endeavoring to secure the removal of the tax upon standing timber, until such time as it is cut. They are now about to realize the fruits of their long efforts through the passage of such a law by the legislature. The same legislation should be enacted to cover the anthracite coal in the ground. It should only be taxed in a nominal way until it is mined. Each ton should be taxed once and once only. Perhaps the better way to accomplish this would be to eliminate the taxation of coal as real estate, except in a nominal way, and lay a tax upon each ton of coal as it is mined, as is being advocated by the Scranton Board of Trade.

Although these latter suggestions cannot be applied through our present antiquated and unfair laws in the taxation of coal, and are somewhat aside from our subject, they are, nevertheless, important matters for immediate legislation, which should be vigorously pressed.

來 來

Mr. Otto Siedle, of the St. George Coal Co., Natal, South Africa, states that the output of coal for 1912 was 2,470,773 tons. He further states that the coal industry of Natal could be materially increased if the Government furnished sufficient rolling stock.

THE history of mining in the Newbattle coal field in Scotland is closely associated with that of Newbattle

Abbey, which was founded in 1140 by the king of Scotland. The remnants of monastic coal workings are to be found on the bank of the River Usk, which indicate that the coal was even then obtained by a system of quarrying. It is impos-

A Notable Scottish Colliery

First Worked Before the 13th Century. Now Equipped With Most Modern Machinery Giving Large Output.

By Special Correspondent

undertook to drive conduits through his coal field of Preston Grange in order to carry to the sea the water from the Abbot of Dunfermline's coal fields of Inveresk and Pinkie. After the Reformation the Newbattle coal field was worked by the

made to supply their own needs and those of their neighbors, with the state of progress exemplified in the Lady Victoria pit provided with machinery capable of drawing 1,500 to 2,000 tons of coal per day. Some of the books in the present colliery offices date back to 1744. From a page at that early date we learn that the output for the week June 4, to June

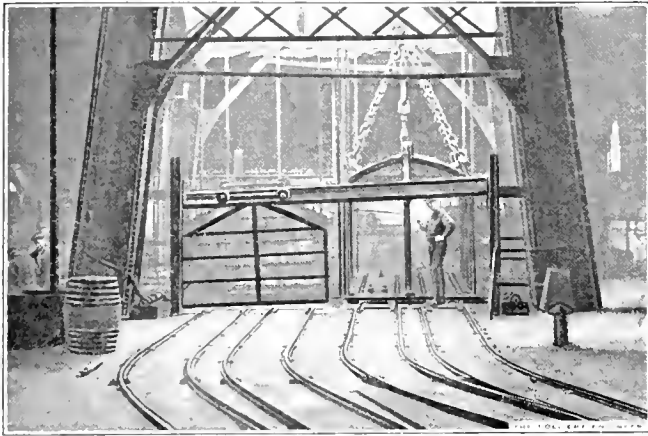

FIG. 1. PIT MOUTH, LADY VICTORIA MINE

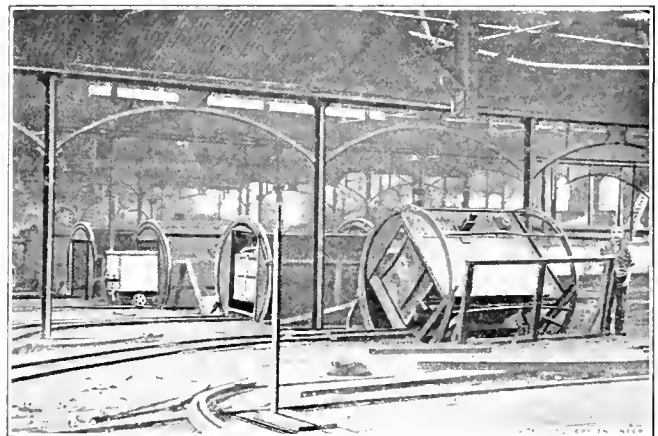

FIG. 2. ROTARY TIPPLES

sible to say when the monks began to dig coal, but from the fact that between the years 1210-1218 they received a grant from Sehr de Quincey of a coal heugh between the rivulet of Whitrig and the boundaries of Pinkie and Inveresk, it is fair to assume that they were fully aware of its nature at an early date.

Even before they obtained this charter it is probable that they had already discovered coal in the neighborhood of the Abbey and become acquainted with its valuable properties as fuel. The coal seams in Newbattle were worked until the period of the Protestant Reformation in Europe by a long line of abbots, who may be described as the first coal operators and mining engineers in Scotland.

By 1531 the mining industry under their direction must have assumed definite commercial properties, as in that year Abbot James entered into a contract with the monks of Dunfermline by which he

Lothian family until 1890, when the Marquis of Lothian granted a lease to the Lothian Coal Co., which now holds about 1,300 acres of coal lands. This area is reached by pits at Whitehill, Polton, and Newbattle; the seams in the lower series exist under nearly all of this area, but those in the upper are more limited in extent. The former are worked from Newbattle collieries, the latter only from Whitehill and Polton.

The Lothian Coal Co., of Newtongrange, Midlothian, is located about 9 miles southeast of Edinburgh and comprises the Lady Victoria and Lingerwood pits and the Easthouses Incline. The sinking of the Lady Victoria pit, which, begun in 1890, occupied more than 4 years, is the last link, in this twentieth century, of the evolution of mining engineering begun in Newbattle by the monks at the end of the twelfth or beginning of the thirteenth century. It is interesting to contrast the primitive workings of the monks

11, 1744, at the then Bryans pit, was 666 loads, a load being about what a woman carried on her back up the pit. The wages paid twelve men putting out the above loads at 1½d. per load, was £4 3s. 3d., the average wage per week being about 7 shillings, out of which they apparently had to pay their own bearers.

Before the introduction of machinery the output of coal was small, but when the introduction of the steam engine revolutionized the face of the earth, and railways and steamships, manufacturing industries, and other fuel consumers increased the demand, a great change took place in the type of operation made necessary in coal mining. For example, coal used to be conveyed to Edinburgh by a railway, the trucks of which were hauled by horses within comparatively recent times. The introduction of gas lighting into Edinburgh gave a tremendous impetus to the coal trade of Newbattle, as there is

the famous seam of cannel coal which had been previously very little in demand. Here again there is a rather curious indication of the reflex action of modern progress. The cannel seam was first of comparatively little value. When the flat-flame gas burner came into existence cannel coal was eagerly sought after. Now that the introduction of the gas mantle has rendered possible a satisfactory gas from a low-priced coal of small illuminating power, the cannel seam

workings consists of an arched tunnel lined throughout with brickwork. It ranges in height from 35 feet to 15 feet, and the roads to the various coal seams in the field branch off this main tunnel. Various coal-cutting machines are in operation in the workings, and the water accumulating in the various sections is forced to the bottom of the shaft by pumps, some of which are driven by electricity and others by compressed air. Electricity for driving coal-cutting machines and

double-deck cages for conveying the minerals to the surface. Each cage is capable of carrying twelve hutches of coal equal to 6 tons, or to ascend or descend with 48 men. In the shaft the cages are kept in position by rigid thick wire rope guides, and a wire cable attached to the bottom of each cage and hanging in a loop down the shaft, supplies the compensating balance to the dead weight of the winding ropes. In this way and with the weight of one cage and its hutches balancing that of the other cage and its contents, the net load which the engine has to raise to the surface is only the 6 tons of coal in the full hutches. Both at the bottom and at the top of the shaft, arrangements are made for loading and discharging the two decks of the hutches simultaneously, so that time is saved and wear and tear on the plant is reduced to a minimum. Fig. 1 shows a view of the pit mouth. Fig. 2 shows the rotary tipples, while Fig. 3 gives a general view of the surface arrangements at the Lady Victoria pit. It will be seen that the pulley frame, over which the winding gear is carried, is a massive structure of steel 85 feet high, and the winding wheels are each 19 feet in diameter. The whole of the overhead machinery and works are enclosed in substantially built brick structures and the floor is supported from the ground level by substantial brickwork, and is laid in chequered plates. The roof, consisting of galvanized iron sheet and glass, is carried on steel columns; the area covered by the works, storage ground, and railway siding is about 32 acres, the railway tracks including about 4 miles of line. The magnitude of the undertaking will be realized by the fact that in order to accommodate the workers connected with the pit it has been necessary since 1890 to build about 535 houses which form a decided contrast to the miners' houses built in bygone days.

The hoisting engine has two horizontal cylinders 40-inch diameter by 7-foot stroke, steam jacketed,

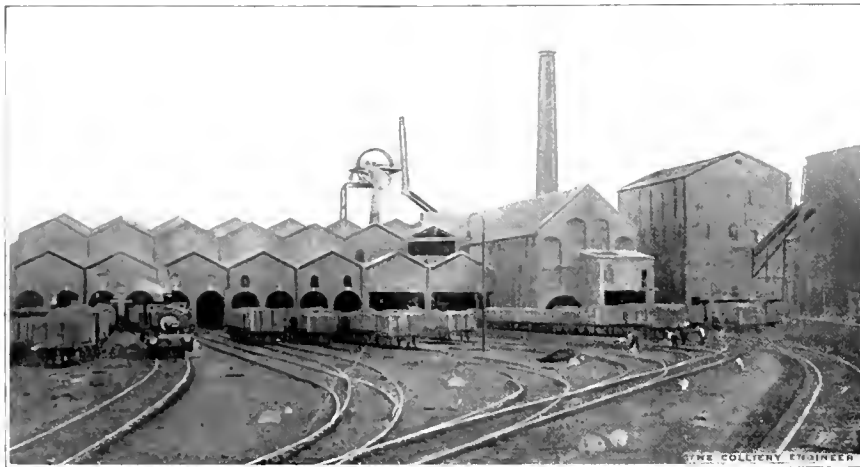

FIG. 3. SURFACE ARRANGEMENTS, LADY VICTORIA MINE

has dropped back again into its position of comparative inferiority. Until comparatively recently, pumping was not necessary, as the workings had not gone below the level of natural drainage, and in the memory of the oldest inhabitants, the coal used to be carried in baskets on the backs of women up the pit by winding stairs. The horse gin supplanted female labor, and was in its turn supplanted by the use of steam.

At the present time the Lady Victoria pit exemplifies some of the most modern British practice. The pit has a depth of 1,650 feet, this being one of the deepest pits in Scotland. The pit head is furnished with special appliances for saving labor and expediting work. The shaft is circular in form, 20 feet in diameter, and is lined with brick from top to bottom. At the bottom of the shaft siding accommodation is provided for dealing with a large coal output. The approach to the

pumps is taken underground by means of three double-armored insulated cables to a switchboard situated at a convenient point underground, and a distribution system conveys the current from this point to the various machines. A small proportion of the electric current is also utilized for lighting the bottom of the shaft, pumping stations, and other important points underground. Ventilation is effected, in connection with the neighboring Lingerwood mine, by means of a Guibal fan, 30 feet in diameter, and in order to avoid any possibility of breakdown in the ventilating arrangements, a duplicate fan is installed. The coal is hauled to the pit bottom by means of an endless-rope haulage, three Clifton wheels being fixed on a horizontal steel shaft in the pit bottom, and the power to drive the haulage is transmitted from a steam engine on the surface by means of a steel wire rope. In the shaft there are two

over which there is a covering of non-conducting composition, the jacketing being finished with blue polished steel sheet. The valves are of the Cornish type 10-inch diameter for steam and 12-inch diameter for exhaust. After the second revolution of the engine the variable expansion gear controlled by governors comes into operation. The drum is cylindrical and is 21 feet in diameter by $8\frac{1}{2}$ feet wide, built in three sets of eight arms and bosses, each set being cast in halves. The circumference is clad with steel plates $\frac{3}{4}$ -inch thick in lengths of 8 feet, butt jointed, and overlaid with a cleading of oak 8 ft. \times 6 in. \times 5 in. thick. A brake ring is cast in each side and a double-breast brake acts on each ring. The brakes are operated by a 12-inch steam cylinder placed directly in front of the drum. The levers for controlling the steam to the cylinders, steam brake, and reversing engines, are placed at the outside of the right-hand cylinder and convenient to the engineman. An overwinding arrangement worked by bevel gear from the crank-shaft automatically shuts off the steam from the engine and applies the steam brake. In the event of inattention on the part of the engineman this arrangement comes into action when the cage is about 60 yards from the pit head.

The electric plant is also somewhat extensive. It consists of four single-cylinder engines each $15\frac{1}{2}$ -inch diameter by 33-inch stroke driving two dynamos of 300 horsepower and one dynamo of 100 horsepower generating direct current at 500 volts. Owing to the great distance to the workings from the pit head and the consequent drop in voltage, this plant is now only occasionally run over a week-end. A 1,000-kilowatt mixed-pressure Curtis turbine and three-phase alternator with a speed of 3,000 revolutions per minute generates current at 3,300 volts. During the day the winding and haulage engines exhaust into an accumulator which supplies the turbine with exhaust

steam at pressure of $1\frac{1}{2}$ to 2 pounds above atmosphere. In the event of exhaust steam not being available, an automatic controlling arrangement worked by the turbine governor admits live steam from the boilers. A condensing plant is in operation in connection with the turbine set, giving 27-inch vacuum at full load. About 3,000 gallons of water per minute are circulated through the condenser by a centrifugal pump, the temperature of the circulating water being lowered in a cooling tower.

The hauling engine was made to sink the Lady Victoria shaft, and after that had been finished it was converted into a haulage engine. The cylinders are 25-inch diameter by 5-foot stroke and the valves are of the positive type. The power is transmitted by a 3-foot diameter by 20-inch wide cast-steel pinion on the crank-shaft and 14-foot spur wheel on the second-motion shaft. An endless rope drive wheel, 12 feet in diameter, which is of cast iron with renewable cast-iron segments round the circumference, is keyed to the second-motion shaft and also bolted to the spur wheel with fitted bolts. The endless rope or band rope made of special steel $1\frac{3}{4}$ inches diameter and 1,400 yards in length, makes $4\frac{1}{2}$ turns round the drive wheel, then goes down the pit to the driven wheel 10 feet in diameter at the pit bottom.

Particular attention has been given to the handling of the coal as it reaches the pit head. Fig. 2 shows the tipples. The mine cars containing the coal as they come off the cage, run by gravity to the weighing machine and then pass to the various tipples. These are belt driven and make a complete revolution, depositing the coal in a heap on a slightly inclined distributing jigger plate. The coal is slowly pushed forward to a perforated jiggling screen lying at a steeper gradient, through which the dross falls into a scraper conveyer traveling at right angles to the screen. The larger coal passes over the end of

the screen to an endless belt of steel plates about 35 feet long and traveling at about 60 feet per minute from which any foreign material in the coal is picked out by hand.

The dross from the various screens is carried by the scraper conveyer to a dross pit about 21 feet below surface level and alongside the washer. The dross is lifted out of the pit to a height of about 60 feet and deposited on a distributing plate from which it passes to a series of inclined screens with perforations varying from $\frac{1}{4}$ -inch diameter at the top to $2\frac{1}{2}$ inches at the bottom. The object of the screens is to separate the coal into the various sizes required and then wash each size separately, and for this purpose the coal is divided into five sizes. The three larger sizes are washed in plunger tanks, the two smaller being washed in feldspar jigs. As a certain amount of breakage occurs in the plunger tanks, the nuts after being washed are again passed over the screen for a final separation. The dirt washed from the coal falls into an inclined tank underneath the floor and is carried by a scraper conveyer outside the building and deposited in a wagon. The water which has washed the coal runs in a cast-iron pipe to a silt recovery tank with a capacity of about 60,000 gallons and deposits therein the fine coal which it carries. The quantity of water required to wash the coal is about 1,000 gallons per minute. An endless chain, carrying perforated steel buckets and moving at a slow speed, removes the deposit of fine coal from the tank and this coal is used for firing the boilers at the mine.

In concluding this description of what is probably one of the largest and most up-to-date collieries in the Scottish area, our thanks are due to the Lothian Coal Co., Ltd., for the information supplied, and it may be stated that the high state of mechanical perfection shown in the colliery, is indicative of the care and skill which now characterizes British coal mining.

The Pishel Coking Test

Method of Determining the Coking or Non-Coking Quality of a Coal by Its Adherence to the Mortar When Pulverized

By Max A. Pishel

IN the spring of 1908, while studying the physical properties of coal, especially with reference to the color of the streak and the powder, the writer observed that some coals, while being pulverized, adhered much more strongly to the pestle and mortar than others and that the best coking coals were the ones which adhered most, whereas the non-coking coals adhered very slightly or not at all. This phenomenon gave promise of affording a simple, inexpensive, and yet rapid, method of distinguishing coking from non-coking coals, without the necessity of using an improvised rick, or the better but more expensive way of sending the coal to a coking plant for a test in a regular coke oven.

Accordingly the writer experimented systematically with all the coals in the study collection of the United States Geological survey; a collection embracing 150 different samples ranging from lignite to anthracite and including some of the best known coking coals of the country.

For years geologists, mining engineers, and coal miners had sought in vain for just such a test. In the light of these facts, the author considered it worth while to bring the test before the public and he published* it in the hope that others would make application of the test and thereby determine its value in a practical way.

Since then, other men, particularly the coal geologists of the United States Geological Survey, have applied the test to many different coals and the results obtained serve to substantiate the first conclusions that by this simple method, coking and non-coking coals can be differentiated. G. B. Richardson† who examined the Trinidad coal field of Colorado, had an exceptional opportunity to prove the value of the test as the coals in that field range from coking in the southern to non-coking coals in

the northern part of the field. Mr. Richardson makes the following statement, regarding the test:

"The observations of M. A. Pishel that, when ground to a powder, coking coals show a pronounced adhesive quality, whereas non-coking coals do not, holds good for samples from nearly 40 mines in the Trinidad field that have been examined. Tests show that specimens of the high-grade coking coals from the southern part of the field adhere distinctly to the pestle when ground in the mortar. The adhesiveness decreases in samples obtained farther north and coals from the north end of the field show practically none under similar conditions."

E. Eggleston Smith,‡ while examining the coals in the state of Washington, applied the test to nearly 100 different coals and reported not a single failure. Mr. Smith carried on experiments in which he tried to powder the coals on smooth and rough surfaces and in mortars composed of different materials. Regarding these experiments, he makes the following statements: §

"Porcelain, glass, earthenware, and iron mortars were used, and the powder of coking coal adhered to all; the powder adhered to a piece of flat glass just as well as to a mortar, but it was more difficult to reduce the powder to the proper degree of fineness on the flat surface. It appears that a powder must be a certain degree of fineness in order to show the property of adhesion. Pocahontas (W. Va.) coal, powdered both on smooth and rough surfaces, was found to adhere provided the surface was not too soft or too rough to admit of the reduction of the particles to the proper size. In general, a hard, smooth surface is preferable, because

the use of such a surface insures a finer and more uniform powder."

Mr. M. R. Campbell, Geologist in charge of the Sec-

tion of Western Mineral Fuels of the United States Geological Survey, who applied the test to perhaps more coals than any other person, has not reported a single failure.

Many others have tested coals by means of it, but only two cases reporting the failure of the test were brought to the attention of the author. James W. Hodge, of Big Stone Gap, Va., reports of having tested two samples of splint coal, one from Keokee, Va., and the other from Roda, Va. The adherence of the former was said to be poor whereas that of the latter from medium to poor. Mr. Hodge states that both coals had been successfully coked for a number of years but that they are not coked at present. He did not say whether the coke produced was good or poor, nor did he give any reasons why the coals are not coked any longer. It is possible that the coals make only an inferior grade of coke, for it does not seem likely that a mining company would discontinue the operation of 100 coke ovens if it could produce good coke. It is also possible that the beds from which the above samples were taken are made up of different grades of coal some of which make much better coke than others, and that Mr. Hodge accidentally tested some of the poorer grade. At any rate the above cases are exceptional and do not even prove that the test failed in splint coal.

Conversation with coal mine operators, mining engineers, and coal miners shows that this test is very little known by practical men. In view of the above facts, the author concluded that a second publication of it was not only justifiable but also desirable. He, therefore, takes this opportunity of presenting for a second time a statement of the method used in conducting the test, and the results obtained on the samples referred to above, together with some additional data which were produced by the

*"A Practical Test for Coking Coals," *Economic Geology*, Vol. 3, 1908, pages 265-275.

†"The Trinidad Coal Field, Colorado," U. S. Geological Survey, Bulletin 381, pages 379-384, 1910.

‡"Coals of the State of Washington," U. S. Geological Survey, Bulletin 474, 1911.

§Smith, E. Eggleston, "Coals of the State of Washington," U. S. Geological Survey, Bulletin 474, 1911, page 31.

writer and are the results of the test on coals added to the Survey collection at a later date. The writer takes the liberty to incorporate with these, the results of the test obtained by Mr. Smith on coals of Washington, published in the report cited previously.

The method of conducting the test is as follows: Pulverize in a mortar a small quantity of the coal to be tested until it will pass through a 100-mesh sieve. Pour out the loose material and note the amount that adheres to the mortar. With some coals the mortar and the pestle will be deeply coated with coal dust which adheres so strongly that it can be removed with difficulty; with other coals, there will be only a thin film of coal dust adhering to the mortar and pestle; while with still others both mortar and pestle will be nearly as clean after the operation was completed as they were before it began.

The degree of adhesion depends on the grade of the coal with reference to its coking qualities. If it adheres strongly the coal will make a good coke; if it adheres only partly the coal will make an inferior grade of coke, and if it does not adhere the coal is to be regarded as non-coking. The illustration, Fig. 1, serves perhaps better than a written description in showing the reader the difference of the conditions of the mortar after a charge of each of a number of different coals was ground and the loose portion poured out. One-half of the gummy powder which adhered to the mortar was removed so as to make the other half more prominent.

Illustration A shows the adherence of the powder of a coal from the Pratt mine No. 4. This coal is reported to be one of the best coking coals in Alabama and it can be seen that it covers the mortar and pestle with a heavy coating of soot, i. e., adheres excellently.

Illustration B shows the adherence of the powder of a coal from the Utah Fuel Co. mine No. 2, Sunnyside, Utah. This coal makes a very good coke. It will be noted its adherence is good.

Illustration C shows the adherence

of the powder of a coal from the Cambria Fuel Co., Cambria, Wyo. Coke from this coal has been used in the smelters in the Black Hills, but it is not first-class coke. It will be observed that the coating of soot is

from the Green Valley mine of Jasonville, Ind., had been ground. This is considered to be a good type of non-coking coal. It will be noted that the amount of adhesion is slight.

Aside from the adhesion of this gummy soot to the mortar and pestle some coals exhibit a tendency to pack together or cohere. Although it seems to be more noticeable in coking coals, this tendency to pack was observed to a lesser extent in some of the non-coking type. Hence it is thought that this behavior depends entirely on the moisture content of the coal and has nothing to do with its coking qualities; however, sufficient work has not been done to prove this point.

In the following tables are given the results obtained by the writer and Mr. Smith, in testing the various coals. The scale of adhesion used in describing the test is as follows: none, poor, medium, good, and excellent. The coking coals range from medium to excellent, whereas the non-coking coals range from medium to none. Those marked medium are doubtful and possess the coking qualities only in a small degree. If they do produce coke it is probably of such poor quality as to have very little value for commercial purposes. In the column headed "Coking Quality" is stated whether or not the coals tested are coked in actual practice. Information with reference to their coking qualities could not be obtained on some of the coals; however, those of which the coking quality is not given and ranging in adherence from poor to none, are supposed to be non-coking.

When studying the above results, the reader should bear in mind that most of the coals tested were obtained from small samples, 2 quarts or less. A large number of these samples were prepared by the mine owners or operators, who as a rule pick out the best coal, hence are not always representative of the coal bed from which they were obtained.

The condition of the coals at the time they were tested may be considered to have been the same as it

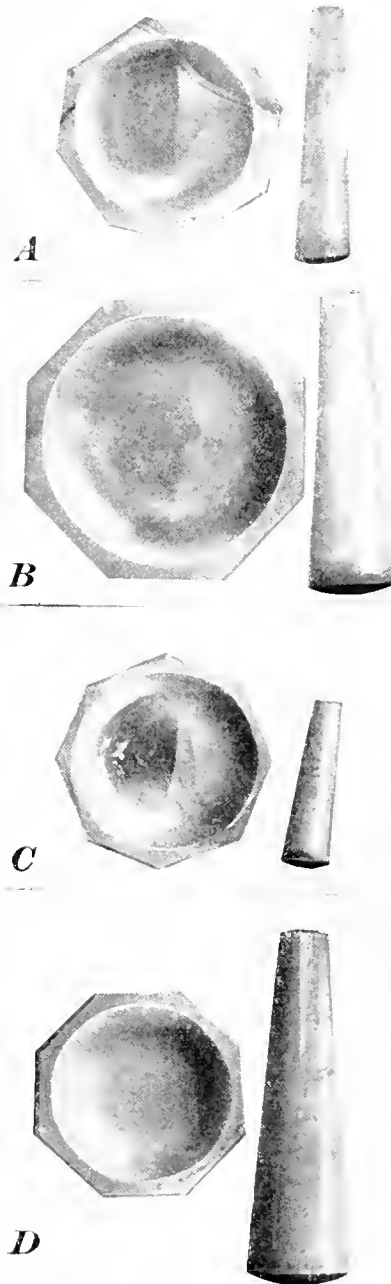

FIG. 1

comparatively thin and, when compared with the behavior of the coals previously mentioned, its adherence is medium.

Illustration D shows the condition of the mortar and pestle after a coal

(Continued on page 678)

TABLE SHOWING RESULTS OF COKING TESTS ON 250 COALS

State and Name of Mine or Operator	Locality	Kind of Coal	Coking Quality	Adherence to Mortar When Ground	Remarks
Alabama					
Aldrich mine	Aldrich	Bituminous		Poor-medium	Montevallo bed
Braehad mine	Braehad	Bituminous		Poor	Lucile bed
Belle Ellen No. 2 mine	Belle Ellen	Bituminous	Has been coked	Good	Coke bed
Carbon Hill mine	Carbon Hill	Bituminous		Poor	Jagger bed
Chickasaw No. 5 mine	Carbon Hill	Bituminous	Coked in laboratory	Medium-good	Coke bed
Daley mine	Daley	Bituminous		Medium	Much crushed bed
Empire mine	Empire	Bituminous		Good	
Jones & Read mine	Blockton	Bituminous		Medium	Coke bed
Lookout Fuel Co.	Lahusage	Semibituminous	Coked in laboratory	Good	
Mary Lee mine	Lewisburg	Bituminous	Is coked	Medium-good	Mary Lee bed
Mine No. 8	Horse Creek	Bituminous	Is coked	Good	Horse Creek
Piper No. 1 mine	Piper	Bituminous	Is coked	Poor-medium	Thompson bed
Pratt No. 4 mine	Pratt City	Bituminous	Is coked	Excellent	Pratt bed
Woodward Iron Co. No. 2	Dolomite	Bituminous	Is coked	Excellent	Pratt bed
Arkansas					
Red Rock	Burmah	Semibituminous		Medium-good	
Spadra Anthracite Coal Co.	Spadra	Semianthracite		Medium-good	
S. Anthracite Coal Co.	Russellville	Semianthracite		Medium-good	
California					
Stone Cañon Coal Co.	Stone Cañon	Bituminous		Poor	
Colorado					
Colo. Anth. Coal Co.	Deep Creek	Anthracite		None	
Sweeney "Tunnel"	Lav	Bituminous		Poor	
Collom mine	Axial	Bituminous		Poor	
Coryell mine	Newcastle	Bituminous		Poor	Allen bed
Coal Basin mine	Coal Basin	Bituminous	Is coked	Excellent	Sunshine bed
Book Cliff Coal Co.	Grand Junction	Bituminous		Poor	Cameo bed
Rollins mine	Delta	Subbituminous		None	
Fairview mine	Delta	Subbituminous		None	Middle bed
Watson mine	Cedaredge	Subbituminous		None	
Moseley prospect	Somerset	Bituminous		Poor	
Cooperative mine	Paonia	Bituminous		Medium	Coked elsewhere
Cornell mine	Tertio	Bituminous	Is coked	Medium	
King mine	Bowie	Bituminous	Is coked	Medium-good	Juanita bed
Phillip mine	Crawford	Anthracite		None	
Newman mine	Hotchkiss	Bituminous		None	
Simpson mine	Lafayette	Subbituminous		None	
Calumet Fuel Co.	Durango	Bituminous	Coked in laboratory	Medium-good	
Illinois					
Clover Leaf Coal Co.	Coffeen	Bituminous		None	Coal bed No. 5
Capital Coal Co.	Springfield	Bituminous		None	Coal bed No. 5
Donk Bros. C. & C. Co.	Donkville	Bituminous		None	High in ash, bed No. 6
Peabody Coal Co.	Marion	Bituminous		Poor-medium	
Indiana					
Parke County Coal Co.	Heckland	Bituminous	Coked in laboratory	Medium-good	Bed No. 6
Johnson Coal Co.	Williamsport	Bituminous		Poor-medium	
Crawford Coal Co.	Brazil	Bituminous		None	Brazil block coal
Mutual Mining Co.	Cannelsburg	Bituminous		None	Cannel coal
Iowa					
Johnstone Coal Co.	Clayworks	Bituminous		None	Cannel coal
Inland Fuel Co.	Chariton	Bituminous		Poor	Lower bed
Centreville Block C. Co.	Centreville	Bituminous		Poor	Lower (Mystic) bed
Anchor Coal Co.	Laddsdale	Bituminous		None	Middle bed
Kansas					
Western C. & M. Co.	Yale	Bituminous		Excellent	Weir-Pittsburg bed
M. K. & T. Ry. Co.	Mineral	Bituminous		Good	Weir-Pittsburg bed
Kentucky					
East Kentucky Coal Co.	Lesley	Bituminous		Poor	Cannel coal
Prospect	Jackson	Bituminous		Poor	Cannel coal
Prospect	Big Black Mountain	Bituminous		Good	Splint coal
Pike Coal Co.	Heller	Bituminous	Has been coked	Medium	Lower Elkhorn bed
Straight Cr. C. & C. Co.	Pineville	Bituminous	Is coked	Good	
Central C. & I. Co.	Central City	Bituminous	Coked in laboratory	Poor-medium	Bed No. 9
St. Bernard Min. Co.	Earlington	Bituminous	Is coked	Medium-good	Coal bed No. 9
Wheatcroft Coal Co.	Wheatcroft	Bituminous	Coked in laboratory	Medium-good	Coal beds Nos. 9, 11
Maryland					
Carlos mine	Carles	Bituminous	Is coked elsewhere	Good	Pittsburg bed
Michigan					
Consolidated Coal Co.	Saginaw	Bituminous		Medium	
Missouri					
Mendota Coal Co.	Mendota	Bituminous		None	Mystic bed
Montana					
Kendrick mine	Miles City	Lignite		None	
Hedges mine	Miles City	Lignite		None	Kircher bed
Weaver mine	Miles City	Lignite		None	Weaver bed
Dominy mine	Miles City	Lignite		None	Dominy bed
Bear Creek Coal Co.	Bear Creek	Subbituminous		None	Coal bed No. 2
Bear Creek Coal Co.	Bear Creek	Subbituminous		None	Coal bed No. 3
Bear Creek Coal Co.	Bear Creek	Subbituminous		Poor	Coal bed No. 4
Washoe Copper Co.	Bear Creek	Subbituminous		None	Coal bed No. 1
International C. Co.	Bear Creek	Subbituminous		None	Coal bed No. 5
Northwestern Imp. Co.	Red Lodge	Subbituminous		None	Coal bed No. 1 1/2
Northwestern Imp. Co.	Red Lodge	Subbituminous		None	Coal bed No. 6
Clife mine	Glitedge	Bituminous		Poor	
Lester mine	Green	Bituminous		None	
Spring Creek mine	Lewistown	Bituminous		None	
Cooper mine	Moore	Bituminous		None	
Havre Coal Mining Co.	Havre	Subbituminous		None	Resembles cannel coal
Montana Coal and Coke Co.	Electric	Bituminous	Is coked	Medium-good	
Montana Coal and Coke Co.	Aldridge	Bituminous	Is coked	Medium-good	Coal bed No. 1
Western Coal and Coke Co.	Lombard	Bituminous		None	Badly crushed
Badger mine	Como	Lignite		None	
New Mexico					
American Fuel Co.	Gallup	Subbituminous		None	Coal beds Nos. 1 and 2
Burns-Briggs mine	Lumbarton	Bituminous	Coked in laboratory	Good	Coal bed No. 1
Hilton mine	Carthage	Bituminous	Is coked	Good	Carthage bed
Madrid mine	Madrid	Anthracite		None	

¹These coals were obtained from a thin bed known as Coke bed from which coke has been made at a number of places.

²One piece of nut size taken from a two-part sample adhered very slightly, whereas another from the same sample adhered strongly, indicating a good coking coal. It seems probable that the bed is made up of different grades of coal, some of which make very much better coke than others.

³This coal is the same as the Hartsborne coal of Oklahoma, which is coked a few miles west of the Arkansas state line.

⁴These coals behave alike and in appearance are very much the same. They are brittle and high in fixed carbon. When ground they behave very much like charcoal, soiling the mortar in the same way. Apparently they are on the boundary line between coking and non-coking coals. Stratigraphic position of Hartsborne bed.

⁵According to the tests these coals should coke, and it is reported that coke has been made from this bed in the vicinity of Pittsburg, Kans.

⁶The Michigan coals are generally regarded as non-coking, but from the results obtained in the mortar they would probably make a poor coke.

TABLE SHOWING RESULTS OF COKING TESTS ON 250 COALS—Continued

State and Name of Mine or Operator	Locality	Kind of Coal	Coking Quality	Adherence to Mortar When Ground	Remarks
New Mexico					
St. L. R. M. & P. Co.	Brilliant	Bituminous	Is coked	Good	
St. L. R. M. & P. Co. Mine No. 3	Brilliant	Bituminous	Is coked	Good	
St. L. R. M. & P. Co. Mine No. 5	Brilliant	Bituminous	Is coked	Medium-good	
St. L. R. M. & P. Co.	Van Houten	Bituminous	Is coked	Excellent	
North Dakota					
Black Diamond mine	Williston	Lignite		None	
Wasburn Lig. Coal Co.	Wilton	Lignite		None	
Consolidated Coal Co.	Lehigh	Lignite		None	
Ohio					
Gallia Mining Co.	Clarion	Bituminous		Poor	Coal bed No. 4
Gosline & Barbour mine	Shawnee	Bituminous		None	Middle Kittanning bed
Pitts.-Beimont Coal Co.	Neffs	Bituminous	Coked in laboratory	Good	Pittsburg bed
Superior Coal Co.	Wellston	Bituminous		Poor	
Pennsylvania					
N. Anthracite Coal Co.	Lopez	Semianthracite		Poor	"B" bed
Phoenix Pls. Coll. Co.	Minersville	Anthracite		Poor	
P. B. C. & E. Co.	Ehrenfeld	Bituminous	Coked in laboratory	Good	Lower Kittanning bed
P. B. C. & E. C. Co.	Wehrum	Bituminous	Is coked	Excellent	Lower Kittanning bed
Nineveh Coal Co.	Seward	Bituminous	Is coked	Good	Lower Kittanning bed
Old Colony No. 2	Ligomier	Bituminous	Coked in laboratory	Excellent	Pittsburg bed
Jamison No. 2	Hannastown	Bituminous	Is coked	Medium-good	Pittsburg bed
Mine No. 2	Elisworth	Bituminous	Is coked	Excellent	Pittsburg bed
Rhode Island					
Stripping	Cranston	Graphitic anthracite		None	
Tennessee					
Fork Ridge Coal and Coke Co.	Fork Ridge	Bituminous	Coked in laboratory	Good	Mingo bed
Southern Coal and Coke Co.	Gatlift	Bituminous	Coked in laboratory	Good	Regal block bed
State mine	Petros	Bituminous	Coked in laboratory	Excellent	Brushy Mountain bed
Willow mine, No. 5	Oliver Springs	Bituminous	Is coked	Good	Dean bed
Texas					
Chaffin mine	Waldrip	Bituminous		Poor	
Am. Lig. Briq. Co.	Rockdale	Lignite		Poor	Packs
Utah					
Kraft's mine	Mt. Carmel	Subbituminous		None	Packs slightly
New Harmony Coal Co.	New Harmony	Semianthracite		None	Packs slightly, bed No. 6
North Star mine	Vernal	Bituminous		None	
Old Joe Coal Hole	Kannarville	Bituminous		None	Packs slightly
Pleasant Valley Coal Co.	Clear Creek	Bituminous		Medium	Clear Creek bed
Pleasant Valley Coal Co.	Winterquarters	Bituminous		Medium-good	Winterquarters bed
Utah Fuel Co.	Castlegate	Bituminous	Has been coked	Medium-good	Castlegate bed
Utah Fuel Co.	Sunnyside	Bituminous	Is coked	Good	
Utah Fuel Co., Mine No. 1	Sunnyside	Bituminous	Is coked	Good	Lower bed
Utah Fuel Co., Mine No. 2	Sunnyside	Bituminous	Is coked	Good	Upper bed
Utah Fuel Co., Mine No. 1	Sunnyside	Bituminous	Is coked	Good	Upper bed
Virginia					
Swansea mine	Tom Creek	Bituminous	Is coked	Good	Upper Banner bed
Merrimac mine	Christiansburg	Semianthracite		None	
Belle Hampton	Belspring	Semianthracite		Poor-medium	"Little bed"
Belle Hampton	Belspring	Semianthracite		Poor	"Big bed"
Baby mine	Pocahontas	Semibituminous	Is coked	Excellent	Pocahontas No. 3
Virginia Iron C. & C. Co.	Georgel	Bituminous	Is coked	Excellent	Upper Banner bed
	Coal Bed	Kind of Coke			
Washington					
Big Six Coal Co.	Near Palmer	Pocahontas		Good	Has been coked
Black Carbon Coal Co.	Pittsburg	Black Carbon		Poor	
Carbon Coal Co.	Bayne	No. 1	Good	Good	Cokes on forge
Carbon Coal Co.	Bayne	No. 2	Good	Good	Cokes on forge
Carbon Hill Coal Co.	Carbonado	No. 1 coking	Good	Good	Has been coked
Carbon Hill Coal Co.	Carbonado	No. 2 coking	Good	Good	Has been coked
Carbon Hill Coal Co.	Carbonado	No. 3 coking	Good	Good	Has been coked
Carbon Hill Coal Co.	Carbonado	Wingate	Good	Good	Has been coked
Carbon Hill Coal Co.	Carbonado	No. 1 north		Medium	
Carbon Hill Coal Co.	Carbonado	No. 5		Medium	
Carbon Hill Coal Co.	Carbonado	No. 9		Good	Cokes on forge
Carbon Hill Coal Co.	Carbonado	No. 11		Good	Cokes on forge
Coast Coal Co.	Pittsburg	Pittsburg		Poor	
Coast Coal Co.	Pittsburg	Lady Wellington		Poor	
Commonwealth Coal Co.	Wilkeson	Windsor	Good	Good	Has been coked
Denny-Renton C. & C. Co.	Kammer	No. 2		Poor	
Denny-Renton C. & C. Co.	Taylor	No. 4		Poor	
Denny-Renton C. & C. Co.	Taylor	No. 5		Poor	
Denny-Renton C. & C. Co.	Taylor	No. 6		Medium	
Denny-Renton C. & C. Co.	Taylor	No. 2	Good	Medium	
East Creek Coal Co.	Ladd	No. 3	Good	Good	Has been coked
East Creek Coal Co.	Ladd	No. 4		Poor	
Evans Creek Coal Co.	Montezuma	No. 2	Good	Good	Is coked
Evans Creek Coal Co.	Montezuma	No. 3	Good	Good	Is coked
Evans Creek Coal Co.	Montezuma	No. 4	Good	Good	Is coked
Gale Creek C. & C. Co.	Wilkeson	No. 1		Good	Cokes on forge
Gale Creek C. & C. Co.	Wilkeson	No. 2		Good	Cokes on forge
Gale Creek C. & C. Co.	Wilkeson	Queen		Good	Cokes on forge
Green River Coal Co.	Bayne	No. 1		Poor	
Green River Coal Co.	Bayne	No. 3		Poor	
Green River Coal Co.	Bayne	No. 5	Medium	Medium	Cokes on forge
Independent Coal Co.	Cumberland	Lower bench		Poor	
Independent Coal Co.	Cumberland	Upper bench		Poor	
Naval Coal Co.	Cumberland	No. 4		Medium	
Naval Coal Co.	Cumberland	No. 6 upper bench		Medium	
Naval Coal Co.	Cumberland	No. 6 lower bench	Good	Good	Cokes on forge
Northwestern Imp. Co.	Melmont	No. 2	Medium	Medium	Cokes on forge
Northwestern Imp. Co.	Melmont	No. 3	Medium	Medium	Cokes on forge
Northwestern Imp. Co.	Ravendale	No. 3		Poor	
Northwestern Imp. Co.	Ravendale	No. 4		Poor	
Northwestern Imp. Co.	Ravendale	No. 5		Poor	
Northwestern Imp. Co.	Ravendale	McKay		Poor	
Northwestern Imp. Co.	Ravendale	Upper McKay		Poor	
Northwestern Imp. Co. No. 3	Ronald	Roslyn	Good	Good	Has been coked
Northwestern Imp. Co. No. 2	Roslyn	Roslyn	Medium	Medium	Has been coked
Northwestern Imp. Co. No. 4	Roslyn	Roslyn	Medium	Medium	Has been coked

¹Before the opening of the Sunnyside mine, coke was made from Castlegate coal, but this has been discontinued owing to better results having been obtained from the Sunnyside coal. Winterquarters and Clear Creek mines are on approximately the same bed as that mined at Castlegate, and it seems probable from the tests that they would produce as good coke.

²All the coals of Washington as given in this table were tested by Mr. Smith. As he applied this test while in the field he had an excellent opportunity to check the results of the test with the results obtained in the actual coking practice. To show the reader how favorably they compared, the column "Kind of Coke" was added.

TABLE SHOWING RESULTS OF COKING TESTS ON 250 COALS—Continued

State and Name of Mine or Operator	Locality	Coal Bed	Kind of Coke	Adherence to Mortar When Ground	Remarks
Washington					
Northwestern Imp. Co. No. 5	Roslyn	Roslyn	Poor	Poor	Cokes slightly on forge
Northwestern Imp. Co. No. 7	Cle Elum	Roslyn		Poor	Strong sinter
Northwestern Imp. Co. No. 1	Cle Elum	Roslyn		Poor	Weak sinter
Northwestern Iron and Steel Co.	Ashford		Good	Good	Has been coked
Occidental Colliery Co.	Bayne	No. 1	Good	Good	Cokes on forge
Occidental Colliery Co.	Bayne	No. 2	Good	Good	Cokes on forge
Occidental Colliery Co.	Bayne	No. 3	Good	Good	Cokes on forge
Occidental Colliery Co.	Bayne	No. 6		Poor	
Occidental Colliery Co.	Bayne	No. 14 upper bench	Good	Good	Cokes on forge
Occidental Colliery Co.	Bayne	No. 14 lower bench	Good	Good	Cokes on forge
Pacific Coal and Oil Co.	Wilkeson			Good	Cokes on forge
Pacific Coast Coal Co.	Burnett	No. 2	Good	Good	Has been coked
Pacific Coast Coal Co.	Burnett	No. 3	Good	Good	Has been coked
Pacific Coast Coal Co.	Franklin	Gem		Poor	
Pacific Coast Coal Co.	Black Diamond	McKay		Poor	
Pacific Coast Coal Co.	Black Diamond	Upper McKay		Poor	
Rose-Marshall Coal Co.	Cumberland	Harris		Medium	
Roslyn Cascade C. Co.	Ronald	Roslyn	Good	Good	Has been coked
Roslyn Cascade C. Co.	Ronald	Lower		Good	
Roslyn Fuel Co.	Beekman	Roslyn		Good	Has been coked
Sunset Coal Co.	Cumberland	No. 1		Poor	
Sunset Coal Co.	Cumberland	No. 2	Medium	Medium	Cokes on forge
Sunset Coal Co.	Cumberland	No. 3		Poor	
Surface Exposure	Palmer Junction			Medium-good	
Tacoma Smelting Co.	Fairfax	No. 3	Good	Good	Is coked
Tacoma Smelting Co.	Fairfax	No. 7	Good	Good	Is coked
Tacoma Smelting Co.	Fairfax	Blacksmith	Good	Good	Cokes on forge
Tunnel-Sec. 21, T. 21 N., R. 7 E.	Bayne			Good	
United Collieries Co.	Snoqualmie	No. 3	Good	Good	Has been coked
United Collieries Co.	Snoqualmie	No. 4	Good	Good	Has been coked
United Collieries Co.	Snoqualmie	No. 5	Good	Good	Has been coked
Wilkeson C. & C. Co.	Wilkeson	No. 2	Good	Good	Is coked
Wilkeson C. & C. Co.	Wilkeson	No. 3	Good	Good	Is coked
Wilkeson C. & C. Co.	Wilkeson	No. 7	Good	Good	Has been coked
Kind of Coal Coking Quality					
West Virginia					
Elkins C. & C. Co.	Richard	Bituminous	Is coked	Excellent	Upper Freeport. Packs
Falling Rock C. C. Co.	Weir	Bituminous		Medium	Cannel coal
Glen Alum C. Co.	Glen Alum	Bituminous		Medium	Cannel coal
Greenwood Coal Co.	Lawton	Bituminous	Is coked	Medium	Quinnimont bed
Keeny Creek Colliery Co.	Winona	Bituminous	Is coked	Excellent	Sewell bed
Star Coal and Coke Co.	Redstar	Bituminous	Is coked	Excellent	Sewell bed
Piney Coal and Coke Co.	Stanford	Bituminous	Is coked	Excellent	Beckley bed
Raleigh C. & C. Co.	Raleigh	Bituminous	Is coked	Medium-good	Beckley bed
Wyoming					
Stillwell Coal Co.	Aladdin	Bituminous		None	
Cambria Fuel Co.	Cambria	Bituminous	Is coked	Medium-good	High in ash
Monarch C. M. Co.	Monarch	Subbituminous		None	Monarch bed
Smith mine	Sheridan	Subbituminous		None	Smith bed
Henn & Kahn mine	Sheridan	Subbituminous		None	
Sheridan C. Co. No. 1	Dietz	Subbituminous		None	Dietz No. 1 bed
Sheridan C. Co. No. 3	Dietz	Subbituminous		None	Dietz No. 2 bed
Roland mine	Carneyville	Subbituminous		None	Roland bed
Carney mine	Carneyville	Subbituminous		None	Carney bed
Groat mine	Carneyville	Subbituminous		None	
Evans mine	Carneyville	Subbituminous		None	
Moore's mine	Sheridan	Subbituminous		None	Monarch bed
Glen Rock Coal Co.	Glen Rock	Subbituminous		Poor	
Cole Creek Coal Co.	Big Muddy	Subbituminous		Poor	
Cody Coal Co.	Cody	Subbituminous		None	
Wiley mine	Cody	Subbituminous		None	
Allison mine	Cody	Subbituminous		None	
East Mine of Wiley	Cody	Subbituminous		None	
David Dickie	Meeteetse	Subbituminous		None	
Horse Creek mine	Meeteetse	Subbituminous		None	
Blake mine	Meeteetse	Subbituminous		None	
Black Diamond	Meeteetse	Subbituminous		None	
Mayfield mine	Meeteetse	Subbituminous		None	
Gebo mine	Thermopolis	Subbituminous		Poor	
Price & Jones mine	Thermopolis	Subbituminous		Poor	
Point of Rocks mine	Point of Rocks	Subbituminous		None	
U. P. Coal Co. No. 1	Rock Springs	Bituminous		Poor	Coal bed No. 1
U. P. Coal Co. No. 5	Rock Springs	Bituminous		None	Coal bed No. 5
U. P. Coal Co. No. 8	Rock Springs	Bituminous		None	Coal bed No. 7
Cent. C. & C. Co.	Rock Springs	Bituminous		None	Coal bed No. 7
Sup. Min. Co. B	Superior	Bituminous		None	Coal bed No. 7
Bethurem mine	Carroll	Subbituminous		None	Coal bed No. 7

(Continued from page 675)

was when the coals were taken from the mine, because they are kept in air-tight jars.

Mr. Smith, when testing the Washington coals, was especially careful to note whether or not the high ash content in a coal had any effect on the adhesion of its powder when ground; however, he could not detect any appreciable difference between coals high or low in ash with regard to this point.

Moisture when present in large

quantities interferes with this test, causing the coal to pack together and preventing its adherence to the mortar, hence the sample should be obtained in the dry part of the mine.

To make the test satisfactorily the sample should be as carefully prepared as one taken for chemical analysis, and should be taken in the same manner; i. e., by cutting a channel from top to bottom of the part of the bed to be sampled. In sampling for coking tests, each bench of the coal should be taken separately,

as here and there coal beds are found which are composed of benches, some of which will coke and others that will not. In case well-developed benches do not occur, the bed might be sampled 1 foot at a time, keeping each sample separate from the others and properly labeled. Each sample should be pulverized so as to pass through one-half inch mesh and then quartered down to a convenient size for handling and transporting.

About 5 years ago, when the author first published a description of the

test, he expressed the hope that every geologist and mining engineer engaged in practical work would apply it with a view of proving or disproving, as the case may be, its value as a practical test for coking coals. Since then a number of geologists have applied it in the field and the laboratory on all kinds of coals, some of which are coked in actual practice, but not a single failure, except the two cases referred to above, has been reported. It is possible that it may fail in exceptional cases; therefore, the author

went to town ma wanted \$10 for groceries and things; she pleaded in bituminous words, but pa gave her an anthracite look, and when he disappeared around the corner, ma wept bituminously."

來 來

Bath House at Cameron Colliery

Written for The Colliery Engineer

The bath house for the use of miners, shown in Figs. 1 and 2, was built during 1912 by the Mineral

sash windows, each having six lights. These windows are placed about 6 feet above the floor, being hung on hinges from the top, and are operated by means of a cord which serves to open the spring catch at the bottom and also to hold the window up or open.

An 18-inch Swartwout rotary ball-bearing ventilator, placed on the peak of the roof over the center of the room serves for the ventilation.

There are in all 112 metal lockers in this room, which means accom-

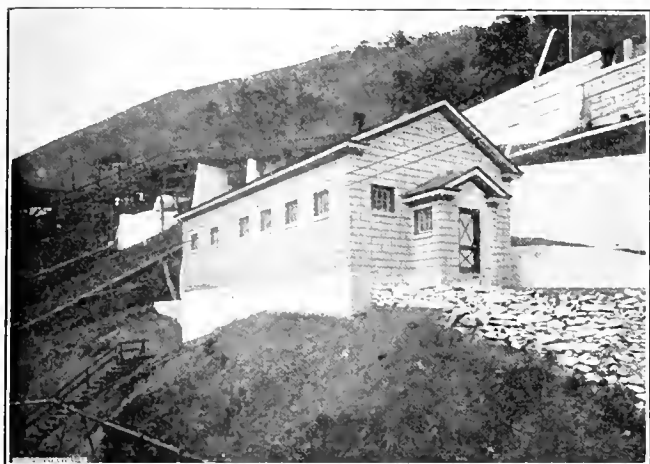

FIG. 1. BATH HOUSE, CAMERON COLLIERY

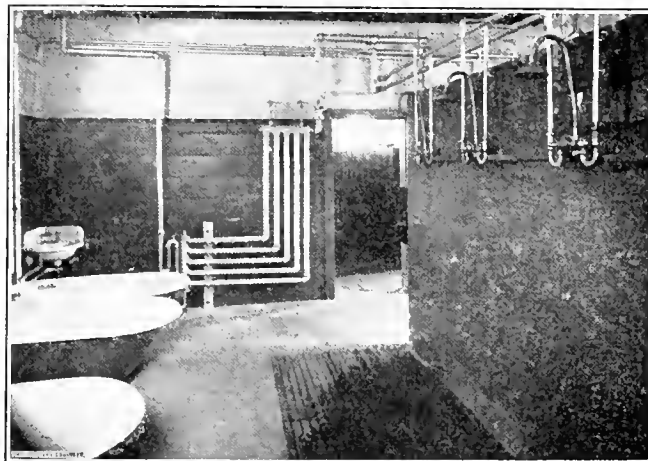

FIG. 2. INTERIOR OF BATH HOUSE

requests men working with coals to apply this test as occasion permits and publish any case of failure observed by them, giving the exact conditions under which it was applied.

Until now, practical men have failed to avail themselves of the use of the test. But in view of what has been said in the foregoing pages and the extreme simplicity of the test, which puts it within reach of all, it should be used by all men who have any occasion to determine coking and non-coking coals.

來 來

As Applied to Family Affairs

A teacher, after long explanations on coal, impressed the class that the term *anthracite* referred to hard coal and *bituminous* to soft coal. Then she said: "Tommy, let us see if you can form a sentence containing the words anthracite and bituminous?"

Tommy thought a minute, then said: "This morning before pa

Railroad and Mining Co., at their Cameron colliery, Shamokin, Pa.

Similar bath houses have been erected at both Pennsylvania and Richards collieries, near Mt. Carmel, excepting that there are no bath tubs in the latter.

The walls of the building are of plain face cement blocks, and are 8 inches thick. The gable roof is of slate and supported upon three intermediate wooden trusses, the rafters and sheathing boards being exposed.

The floor is of concrete and pitches gently to properly placed drains, so that slushing out with a hose may be easily accomplished.

The building is divided transversely by a cement-block partition wall into two rooms, one called the locker or dressing room, 23 ft. 8 in. x 5 in., the other the shower or bath room, which is 23 feet 8 inches wide by 18 feet 10 inches long.

The locker or dressing room is lighted during the day by 10 single-

modation for 224 men, as every locker can be used by two individuals at the same time. The lockers are numbered consecutively and every man has a key to his locker only, the locks all being different. There is of course a master key for the use of the attendant. The man using the locker pays a small fee for the key, which fee, however, is refunded to him when he returns the key permanently. All lockers have a cap shelf and six two-prong hooks. The bottoms and doors are perforated, which facilitates the drying and ventilating of clothes. Coils of pipe carrying exhaust steam are run under the bottom of the lockers, thus aiding the drying and ventilating process. Two single rows of lockers are placed against the side walls under the windows, and two double rows, i. e., two single rows back to back, are placed parallel to these, leaving equal spaces between all rows for passages. The lockers

are finished in dark olive green japan.

Good stout benches run the entire length of the lockers, in the center of the passages. These benches are securely held in place by having their supports imbedded in the concrete floor.

Four mirrors with aluminum combs attached to neat brass chains are conveniently placed.

The shower, or bath room, is entered by a single door from the locker room. There are six windows of the same description as those in the latter room, which furnish light during the day. Two ventilators placed on the peak of the roof, like the one in the locker room, are sufficient for the ventilation. A partition wall 7 feet high by about 14 feet long runs through the center of the room, from the back or end wall, toward the door; upon this are fastened 10 non-scalding Speakman showers, five on each side. These showers are supplied with hot or cold water as the bather may wish. There is a wooden slatted platform or grating under all the showers, even with the floor, which has a drain underneath. Ten ordinary porcelain-enameled bath tubs are arranged along the side walls, five on a side, and are supplied with hot and cold water. Two porcelain lined basins are also conveniently placed and likewise have hot and cold water. Mirrors, soap cups, towel racks, etc., are freely distributed. Over the entrance door in the shower room is placed a No. 5 Madsen automatic heater. This heater is supplied with exhaust steam and has a capacity of 750 gallons of water per hour delivered at 150 degrees. There is a regulating valve on same which may be set to any temperature desired, thus making it impossible for a man at the showers, tubs, or hand basins to get water hotter than that for which the valve is set, and thereby avoiding the chance of scalding himself. Faucets for attaching hose are supplied and by the latter's use a thorough slushing out of the entire

building is easily and quickly accomplished, and as all lockers, benches, tubs, in fact everything, are off the floor, being supported by legs, the building is easily cleaned.

The only entrance into the bath house is through a vestibule, or what is virtually a storm door, built of cement blocks. This vestibule is about 4 feet deep and 7 feet 5 inches on the inside, is lighted during the day by two, one-sash windows, same as used throughout the building. The drafts prevented from entering the locker room when the outside door is opened, make this vestibule almost indispensable. It is covered with a slate roof and in all respects is in harmony with the main building.

The heating of the entire building is by radiation, the radiators being of 2-inch light-weight pipe, which were made by the colliery mechanics, and designed for the use of exhaust steam.

The bath house may be used at night as it is lighted by electricity, the current for which is supplied by the colliery generating plant.

The drips from radiators, wastes from tubs, showers, hand basins and water drained off the floor, etc., are conducted into 4-inch terra-cotta drain pipes underneath the floor.

Inside the entire building is painted white above a horizontal line, about 7 feet from the floor; below this line in the bath room the finish is in bronze green enamel, and in the locker room drab paint.

The exterior is finished all over in white with red trimmings, the pointings being accentuated in black.

Notices of the rules to be observed are conspicuously displayed and are printed in several languages.

采 采

Western Mining "Camps"

Mr. R. C. Hills, of Denver, Colo., in a letter to the Mining and Metallurgical Society of America, says that coal mine operations today, especially in the Rocky Mountains where the bulk of the government owned coal land is situated, demands

the expenditure of a large amount of capital, and small operators cannot afford the equipment necessary to render a mine reasonably safe, employ qualified inspectors, provide rescue cars and apparatus with trained crews, adequate hospital accommodations with trained nurses, the maintenance of proper sanitary conditions and comfortable homes, schools and means of recreation.

He says that when we reflect that a 1,500-ton mine to have a life of 20 years must have 2,000 acres of 5-foot coal, and realize how difficult it is to obtain this acreage in one body, the reason why coal mine settlements in the West are called "camps," on account of the short life of the mines is at once apparent.

采 采

U. S. Geological Survey Fire Sale

As a result of the fire on May 18, in the Geological Survey building the Director has announced a "fire sale" of geologic folios. The entire basement, in which the folios were stored, was filled with dense smoke and many of the folios were burned, others scorched, and all more or less damaged by water. With the approval of Secretary Lane the Director announces that he will sell the entire remaining stock of some 150,000 folios, four-fifths of which are probably as near perfect as goods usually offered in a smoke or fire sale, at the nominal price of 5 cents each. The regular retail price of the standard folios is 25 cents, but a few unusually large folios have sold for 50 cents, and the regular price of the "field edition" of the later folios, a more convenient form for use in the field, is 50 cents. All these are now to be had at 5 cents each, but no wholesale rate applies. The stock includes probably 50,000 to 100,000 copies on which the real damage is practically negligible. Application should be made to The Director, U. S. Geological Survey, Washington, D. C., and remittance made by money order or in coin. Lists will be sent on application.

Specifications for Lubricating Oil

THIS is an age of efficiency and specifications, and we attempt to purchase lubricative efficiency by care-

fully determined standards. I say attempt and refer to lubricating oil especially, as most of you who have bought lubricants by specification have not always bought the lubrication you expected.

In an address before the Railway Club, of Pittsburg, a few years ago, I pointed out the difficulty of securing satisfactory lubrication entirely by specification, for the reason, that lubricating oils are highly complex mixtures of still more complex compounds, varying widely in different crudes, and that it is possible in many instances, particularly in oils flashing under 520° F., to produce mixtures from one or more crude bases falling within the limits of physical tests (as usually conducted) with an oil from another crude base, and yet the two be widely different in lubricating power.

Conversely, oils prepared from different crude bases may vary considerably in their physical constants and possess the same lubricating efficiency within a range say of 20° to 30°, while on elevation to somewhat higher temperature (possible to be reached in actual use), they rapidly differentiate, the one standing up well, the other falling off in lubricating power. In fact, an apparently superior oil, at the temperature at which the testing is made, will often prove to be inferior under the higher temperature of use. Yet again we have to contend with faultily designed bearings, too heavy thrusts for size of support, exposure to extra severe conditions, etc., where no matter what specifications for oil are drawn, it is impossible to secure efficient lubrication, and we must resort to grease, graphite, or other special lubricants.

Some of the Difficulties Encountered in Drawing Specifications to Insure Satisfactory Lubrication

By A. D. Smith*

Possibly some of you have had hitherto unexplained experiences which the preceding statements will make clear, and while it is possible to draw up specifications insuring the highest lubricative efficiency, it is also apparent from the foregoing that such specifications can only be framed from a knowledge involving the physical constants of various distillates, reduced oils, stocks, etc., refined from the different crudes; the market prices of these products; and very important, the actual conditions of use.

Quite naturally the average chemist or engineer does not possess such specific information; and if he seeks aid from treatises on lubrication, with a view to drawing up a set of specifications, he will find a table of physical constants derived from only arbitrary fractions bearing little relation to market products. Frictional values on arbitrary machines will sometimes be given, often misleading, as for example the comparison of cylinder oils on a Thurston testing machine, where no account of the action of steam, as would be encountered under actual conditions of use, is taken into consideration. Other specifications are given erring in being too broad, and sometimes where specifications are correctly framed otherwise, some minor constant is insisted upon, making special refining necessary without a corresponding increase in lubricating value.

The fact that a satisfactory oil is often obtained from loosely drawn or ill-advised specifications is merely incidental, and is more often due to the dealer or refiner trying to give satisfaction than following the letter of the specifications, and points to the fact that unless the buyer possesses in a great measure the specific knowledge referred to,

he is as likely to receive the more efficient oil at the lower price by buying by brand from a reputable dealer or refiner.

The question of buying by brand or specification in these days of tests and search for efficiency is an interesting one, and it is admitted that unscrupulous dealers take advantage of a customer by substitution of an inferior product under some high sounding name at a low price, or furnish a really good oil at a price far beyond its intrinsic value; but if purchasing by specification from this type of dealer or refiner does not result in the customer being worsted in the end, I would be very much surprised. On the other hand, a definite brand to the dealer or refiner of integrity means the acme of specialization in the art of refining, and, particularly where one high-grade crude only is refined, much care and pride are taken in maintaining a constant lubricating value. Buying by brand from such a refiner is protection to the customer, for he knows what to expect from the oil in question, and considering the value of this knowledge, he could well afford to pay a slight advance over bulk price of oils of questionable history, bought on the open market.

As a matter of fact, however, many established brands can be bought for slightly less than oils of somewhat similar inspection which have to be specially refined or mixed to meet some arbitrary specification, the reason being that it is cheaper to refine for a certain number of definite products (i. e., brands), by systematic formulas sufficient to take care of all ordinary situations, than to go into special work requiring additional supervision, inspection, tankage, etc. It is, however, often difficult to convince a customer of these facts, especially one who has been taken advantage of by an unscrupulous dealer; and for the benefit of such.

*Superintendent, Canfield Oil Co., Ceraopolis, Pa. From November, 1912, Proceedings of Engineers Society of Western Pennsylvania.

or those who wish to check deliveries, or who are otherwise interested in testing lubricants, the writer will give certain hints as to testing where liability to error exists.

Presupposing that testing will be done by chemists or other technically trained men familiar with the general methods of testing and the apparatus used, we will speak first a word about specific gravity, or as it is more familiarly called, simply gravity. Without, at this time, discussing the significance or often lack of significance of this test, attention is called to the different makes of hydrometers on the market, if it is intended to use this method in determining this constant, as it is to be noted that they often differ from each other as much as .5 degree; each claiming more-over to be correct. Without caring to enter into a discussion of the accuracy of any one make, it may be stated that the refiners as a rule use instruments of Tagliabue manufacture. In case of doubt or contention the true specific gravity should be taken preferably by bottle method, and referred back to Baumé values by tables agreeing with those adopted by the Produce Exchange of New York.

In the determination of flash test, it was customary up to a short time ago to use a thermometer scaled for total immersion without applying any correction for exposed stem. Scientifically speaking the test was inaccurate, but as no one thought of applying the correction, the error was universal with all, and the relative relation of tests of course unchanged. A few months ago a thermometer appeared on the market with its scale graduated for so-called bulb immersions; that is, a certain length and temperature for the exposed stem was assumed for average conditions and correction applied to the scale, so that a reading of this thermometer corresponds approximately to a reading of a thermometer scaled for total immersion with stem correction applied. The difference between the two at

600° F. may amount to 15°. As to the superiority of one kind over the other, I think any chemist will have some doubts, but this fact is apparent; namely, confusion and argument are likely to result unless both the refiner (or dealer) and the customer are using the same kind of instrument.

Two methods are in vogue for conducting the cold test; one is to chill gradually, and observe pour and solidification tests progressively downward, the other is to freeze solid and determine pour (and if a light filtered oil, cloud), upward. There is sometimes a difference of 15° in the cloud tests by the two methods, and it is well for a customer to know this fact.

To return to the consideration of specifications, it is manifestly impossible in a paper of this nature to attempt to give any lists of constants of different products from different crudes, even if it seemed desirable to do so; and bearing in mind how conditions of actual use should affect choice, we shall merely attempt to give an example of two sets of specifications that would insure a high-grade product without substitution. The one set is chosen as an example of how simple such specifications may be made, and the other as an idea of more specialized forms.

For the first example, we will consider a cylinder lubricant suitable for moderately high pressure steam, say at 125-pound to 150-pound pressure. The oil must suffer practically no loss from evaporation; it must not chemically decompose into products liable to attack the cylinder walls; it must be adhesive to the rings and walls of the cylinder, which means that it must not attenuate to any great extent within a range of 150° above 212° F. Such conditions are fulfilled to a great extent by Pennsylvania steam refined stocks, and for the illustration at hand, a stock of 225-230 viscosity, Saybolt, at 210° F. would be chosen. Purchased from a dealer or refiner of reputation, this would

be all the specification necessary, as the flash would necessarily be above 590° F., which would be high enough for the steam pressure described. Bought on the open market, the following specifications should be added to that of viscosity; namely, minimum flash of 590° F., color dark green, or instead of color specification a minimum allowance of two-tenths per cent. insoluble tarry matter in a mixture of 17 parts 88° gasoline to one part stock. The color specification answers as well, however, as no stock of dark green color would exceed two-tenths per cent. in tarry matter. As to flash the usual figure would be 600° to 605° F. for viscosity given, but to specify it, might require special refining on some kinds of Pennsylvania crude, so that the stock would remain longer in the still and be subjected to a higher temperature than it otherwise would be, without an increase but rather a decrease, in lubricating power. All grades of Pennsylvania crude should make at least 590° flash, hence this specification. It will be noted, gravity is not mentioned, as in this case it would have no significance whatever. About the only value it possesses as a constant is an indication of origin, in this instance unnecessary, as it would be impossible to produce a stock of the inspection given from any crude oil but Pennsylvania crude. The specifications as to color or tarry matter are suggested, not for being in themselves effective as to lubrication value, but significant of this property, that is, they signify the care used in refining, whether stock was overheated, or refined from dirty crude, etc., these factors affecting the lubricating value. It will thus be seen how, for some lubricants, simple specifications can be drawn, practically guaranteeing a definite lubricating value without shouldering unnecessary meaningless standards on the refiner. Where, however, we need oils of lower flash, possible to be made from different crudes, it becomes quite a problem

to write out specifications giving a reasonable latitude, and at the same time guaranteeing the lubricating efficiency desired, so that unless specially qualified, the consumer will profit but little in the end by so doing.

Take for instance, a case of a high-grade automobile oil, where a consumer, knowing something of the lasting, non-attenuating properties of a Pennsylvania neutral, desires such an oil. Consider the viscosity desired is 200, color lemon, then a gravity specification must be demanded of 31 Baumé minimum, together with a flash of at least 410° F. If a slightly cheaper oil is demanded of like viscosity, but allowable to contain a trace of carbon, say of a straw color, the gravity may be permitted as low as 30.5, flash the same; and again if this color is wanted at 225 viscosity, the gravity may be allowed as low as 30° Baumé, while if a lemon color with absolute freedom from carbon is wanted at this viscosity, 30.3 Baumé should be set as the minimum limit. Having previously stated that gravity was without significance as to lubricating power, it may seem strange that it is now emphasized, but here it identifies a crude base, and almost the slightest variation from the values given means a possible substitution. The flash test is set at 410° F. as a minimum, for the reason that on non-Pennsylvania neutrals it is extremely difficult to obtain a flash for this grade of oil as high as 410°. Again the cold test on any of the neutrals cited should not be below 20°, for while it is highly desirable to have a low cold test on automobile oils, it must be remembered that Pennsylvania neutrals are pressed from wax-containing media, and that it is hardly possible to press practically, in a large way, so that a better cold test than 20° can be obtained, hence the assumption is that an oil possessing a better test is a non-Pennsylvania product. When settled as to oil being of Pennsylvania origin, there remain

special tests to indicate absence of carbon (scarcely necessary in the lemon-colored oils), and chemical tests to determine whether the neutral was acid treated or otherwise, from all of which it will be seen that if an oil of certain base is wanted at about 400-500° flash, specification writing to get just the oil desired becomes a difficult task.

Just as it is not easy to substitute other than the desired grade of lubricant in specifications of the foregoing type, it is not difficult to find an oil from almost any crude base that will comply with many of the loosely drawn standards. For example, we sometimes see a set of specifications for an engine oil reading something as follows: Gr. 27°-31° Be.; flash, not below 390°; viscosity not below 230 at 70° F. Such specifications are of course utterly valueless, and the consumer buying on them would fare just as well by asking the dealer or refiner to give him anything he happened to have that might be suitable for an engine oil. Other specifications call for admixtures of animal oils when they had better be left out, as for example, in stocks intended for cylinder lubrication where superheated steam is used. Under such conditions, the cylinder is simply a digester to the animal oil, the glycerine salt is decomposed by the high heat and pressure, the volatile glycerine escapes with the steam and the free fatty acid remains to attack the metal, cause gummy deposits, etc.

What the outcome of the present tendency to purchase by specification will be in the future is certainly an interesting question, but it is quite apparent that nothing practical will come of it unless the refiner and scientific expert, either acting for the consumer or in the pursuit of pure science, get together. One thing is self-evident, if this takes place; namely, different sets of specifications for lubricants from different crude bases will have to be prepared, which, considering the variation in absolute lubricating value and growing scarcity of some of the

higher grade crudes will make the division in price wider than ever. It should also have the desirable effect of making price somewhat more of an index to quality than it is today. Conditions of actual use, new products to meet new demands, will of course continue to affect the choice of lubricants outside of their absolute value and worth, and it will not be until machinery is vastly more standardized than it is today that anything like universal purchase by specification will take place. With the idea of conservation in mind, and the gradually increasing use of superheated steam in this country, it may even take place in the not remote future that the government may prevent the exportation of Pennsylvania stocks, to provide for home industries, which course would bring the idea of specification strongly before the trade. At present, however, the situation seems to be specifications or brand, whichever you prefer, but the strong emphasis is laid on service, with testing at the end, and the main feature, as it should be, satisfactory work done.

采 采

Checking Inspectors' Work

Something new in the way of a check upon the inspectors has been introduced at Cokedale, Colo. Ordinarily the fire boss alone marks the date of his visit upon the face of each working place; thus "4-11" for his inspection made early on the morning of April 11. At Cokedale the system is as follows: Each shot firer, after all the holes have been fired, returns to the various working places to see if any traces of fire remain, if any posts have been dislodged, etc. If everything is in good shape he marks with blue chalk, say "4.10.9-05," meaning that the place was inspected at 9.05 o'clock on the night of April 10. The next inspection is made about 6 hours later by the fire boss who not only tests for gas, but examines the roof as well. His mark, in red

chalk would be, say "4.11.3-25," meaning that the place was found in good condition at 25 minutes past 3 o'clock on the morning of the 11th. During the day the regular inspectors make their rounds examining particularly the roof and timber conditions and with white chalk mark the hour and date, thus, "4.11.9-30," for half past 9 o'clock on the morning of the 11th.

This method of marking, combined with a system of written reports serves to keep a complete check upon the movements of all the inspectors.

柔 柔

Three-Two Method of Rope Splicing

By Alex. Wilson*

Rope splicing is at times one of the most important and urgent matters required underground. To become proficient in this line of work requires practice; therefore, it is not proposed to make every reader of this article a rope splicer, but it is hoped that every reader will be able to understand from the sketches and explanations how a rope can be spliced. Of the several methods of doing this work "the overlap or rapid method" of splicing as it is called, belies its name. The "one-in-one" method is probably the best for joining a new rope, and "three-two method" is probably the best for ropes that have been in use. All three methods give the same results so far as appearance goes, that is when the ropes are joined there will be six crossings and twelve ends in view, but there is a difference in the butting in each instance: In the "one-in-one" method there is a place known as the common center; that is to say, in a 30-foot splice the ropes are unwound 15 feet on each end, and when both ends are brought together the place where they meet is termed the common center or butt. As the "overlap method" and the "one-in-one" method are known to many readers-

of THE COLLIERY ENGINEER, particular attention is given to the "three-two" method.

The writer uses this method on ropes that have been in use. The tools needed by the rope splicers for this work are a round marlin spike sometimes termed a "needle," a round marlin spoon, a cold cut or hardy, a hand hammer, a sledge, a pocket knife, a piece of strong cord,

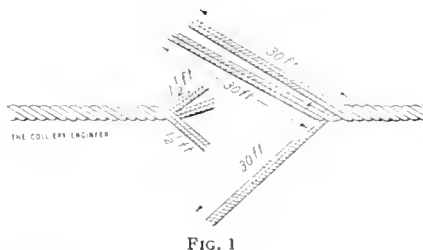

FIG. 1



FIG. 2

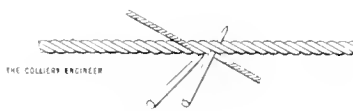

FIG. 3

a roll of friction tape, and sometimes a screw clip.

The first operation is to unlay one end of the rope that is to be spliced for about 30 feet, then unlay the other end for $1\frac{1}{2}$ feet, then cut out the core of hemp. After this operation the rope will look as in Fig. 1. Next take the rope with the short ends and place each end alongside of the long ends of the other rope, crossing them over each other; then pull the two ropes close together, see that the hemp cores exactly meet, and fasten one of the short ends to the rope to which the long ends belong; this prevents any displacing of the strands.

It will now be observed that the long ends are entirely free, and if they are in their proper position the interweaving of the strands may now be commenced. One of the double short strands is run off the rope while one of the double long strands is run in to the place from which the short strand came out. When about 7 feet 4 inches from the end of the double strand the oper-

ator stops and singles out the strands leaving two of the single ones at this point to form a crossing, the other two single strands are then worked 5 feet 8 inches further on, so that they form a crossing also; there is now $1\frac{1}{2}$ feet of the long strand still in view so that the other strand, which forms the crossing, is also cut off leaving $1\frac{1}{2}$ feet for hiding. The second and third double strands follow in the same way leaving 5 feet 8 inches between the crossings as shown in Fig. 2. It will now be observed that there is one crossing left exactly where the two ropes butted together, thus saving the trouble of running in two strands so that the short end to begin with is $1\frac{1}{2}$ feet; therefore, there is no cutting to do on that strand. The splice should now have 6 crossings and twelve ends in view as shown in Fig. 2. To hide the ends is the next operation, and this means taking out the center core so that the ends can be put into place that the rope may have a uniform appearance. The ends are all covered with a piece of friction tape and the marlin spike driven through the center of the rope where the two strands cross each other. The rope is then pryed open so that the core can be cut and taken out sufficiently far to allow the strand to bed itself in the rope. The spike is then brought back to the crossing again and driven through the center of the rope. The spoon is then placed alongside of the spike, the strand placed between the tools and held down by a helper in the direction it is to take in the rope. Now pull the spoon toward the body at the same time push the spike away from the body. The result of this operation will allow the strand to go into the rope where the core came out. The spike is then taken out, the spoon only being needed to keep the strand in place. The spoon is whirled round with the twist of the rope until the whole of the strand is bedded from view. The spoon is then taken out and the operation

*New Lexington, Ohio.

proceeds in the same way with all the rest of the ends. The position of the tools when hiding an end in a rope is shown in Fig. 3.

There is no need for tying the ends of the rope where the crossings are made, as shown in some sketches. All that is required is to have the strands crossed in such a way that they will lock with each other. The writer has seen 32 ropes put together in one afternoon in a rope splicing contest and none of the teams in the competition used a string or cord where crossings were made on the rope.

來 來

Imperial No. 3 Mine Explosion

Written for The Colliery Engineer

On Saturday, May 17, at 6:30 P. M., an explosion occurred at the Imperial Mining Co.'s No. 3 mine near Belle Valley, Noble County, Ohio. This shaft mine, 187 feet deep, is situated on the Cleveland and Marietta branch of the Pennsylvania Railroad, and gives employment to about 200 men and has a capacity of from 1,200 to 1,500 tons of coal per day.

In the May issue of THE COLLIERY ENGINEER the Noble County coal beds were described by Mr. W. G. Burroughs. The principal workable bed in this county is the Ohio No. 9, or Meigs Creek bed, which being from 80 to 100 feet above the Pittsburg bed, is correlated as the Sewickley bed of the upper coal measures of Pennsylvania.

According to the Ohio Geological Report, Bulletin No. 9, the Pittsburg bed in Noble County is quite thin and only worked in a small way in two places. From the same source of information, the Ohio No. 9, or Meigs Creek bed, averages about 4½ feet in thickness. It also varies in quality as the two following analyses show:

Moisture	5.35	3.12
Volatile matter	33.09	37.36
Fixed carbon	51.27	46.67
Ash	10.29	12.85

While the coal is not so valuable as the Pittsburg coal, it nevertheless, is a good domestic fuel.

Fortunately, at the time of the explosion all but 20 men were out of the mine. These, under the leadership of Harry Dudley, assistant superintendent, were engaged in repairing tracks, about 1¼ miles

who were at work in the mine at the time; and as the fan was not stopped it was hoped that those inside could be rescued. With this object in view a rescue party was formed and entered the mine, piloted by Henry Fairhurst, who lost his life in rescuing J. Roy Yeager. J. Roy Yeager, one of the party of track

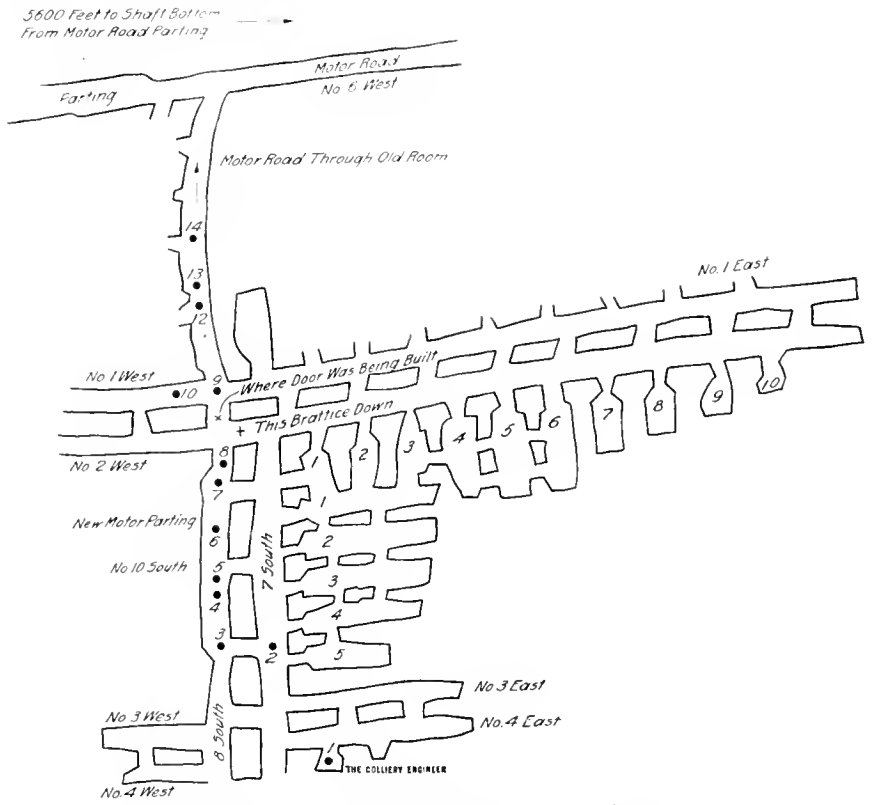

MAP OF PART OF IMPERIAL MINE WHERE EXPLOSION OCCURRED

from the shaft bottom. After the explosion and before the mine had been examined, the usual number of rumors were circulated as to the cause of the accident. John D. Thompson, who was in the mine at the time of the explosion, believed it was due to natural gas escaping from oil wells. Another stated that the cause of the explosion was probably due to a pocket of gas being opened and ignited from a miner's lamp, this setting off the coal dust. Samuel Soltis, fire boss of the mine, stated that he was not positive whether the last gas test was made on Friday or Saturday morning. The law requires a test to be made every day, and this mine was known to be a gaseous mine in places.

News of the explosion was brought to the surface by four men

layers, claims to have been thrown, by the explosion, about 300 feet, and as his thigh was broken he could not raise himself and had to lie on the floor. After a few hours of crawling he managed to get to within one-half mile of the shaft, where Fairhurst found him and placed him on a car. The fact that Yeager could not rise probably saved his life, for the cool, fresh air traveled along the floor of the entry. But Fairhurst, after putting Yeager in the car, was overcome. Others of the party seeing Fairhurst fall crawled to him, put him in the car beside Yeager, and brought them both to the surface. Fairhurst lived only a few minutes after reaching the open air.

Superintendent J. B. Morris, of the Caldwell mine, John Smalley, of

the Laura mine, and others formed a rescue party and penetrated the mine to the seat of the explosion, where they encountered the bodies of several victims. The accompanying map shows the part of the mine where the explosion occurred and the numbered dots the places where the bodies were found.

Immediately following the explosion, District Mine Inspector Abel Ellwood, of the 5th District, in conjunction with the General Superintendent, Thomas Matthews, of the Imperial Mining Co., made arrangements with the Pennsylvania Railroad Co. to run a special train from Cambridge to Belle Valley carrying rescue equipment and medical aid.

Some time after Henry Fairhurst and J. R. Yeager were brought to the surface, the rescue equipment from the Cambridge Collieries Co. arrived, but it was not used to rescue the men, who it was now known could not have survived the afterdamp. The bodies of those men who met death were found about $1\frac{1}{4}$ miles from the mine mouth. They were seriously burned and were found face downwards, as if they had tried to avoid the return flame, or back lash, which usually follows a gas explosion.

The back lash is probably due to the explosion wave moving toward the shaft and creating a partial vacuum back of it, into which the mine air rushes. In case there is not sufficient oxygen to consume all the gas on its forward movement, the flame rolls back into the mine air away from the shaft. This phenomenon can be illustrated by filling a fruit jar with illuminating gas, and then setting fire to the gas. When the jar is full of gas there will be no explosion, but the flame will roll about in the jar until it is burned out. The jar now contains a kind of afterdamp, and if a little lime water is placed in it, will become white, showing that the carbon dioxide resulting from the combustion of gas has formed carbonate of lime.

Chief Inspector of Mines J. C.

Davies, appointed the following inspectors as a commission to enter the mine and ascertain, if possible, the cause of the explosion: Thomas Morrison, 9th District; L. D. Devore, 10th District; Thomas F. Grogan, 11th District; Robert S. Wheatley, 12th District; and W. H. Werker, 8th District. Mr. Davies accompanied the investigating party.

Under date of May 20 this commission reported to Mr. Davies as follows:

"We have today completed an examination of the O'Gara Coal Co.'s Imperial No. 3 mine, located in Noble County, with a view of determining the cause of the explosion in that mine on the evening of May 17, 1913.

"This explosion occurred between 6 and 7 o'clock p. m., at which time 20 men were in the mine. Of this number 14 were killed and several of the others injured. The number of fatalities was latter increased to 15 by the death of Henry Fairhurst, who was overcome while attempting to rescue one of the injured men.

"As a result of our investigation it is our opinion that the explosion originated in the vicinity of No. 5 room off No. 7 south entry, and that it was produced by the ignition of a bed of firedamp in or near this room; the force of explosion seems to have radiated from this point.

"The direction of greatest force was from the vicinity of No. 5 room from No. 7 entry outward through No. 7 entry and through the breakthroughs into No. 8 entry. In No. 8 entry, opposite No. 4 and No. 5 rooms, a number of men were engaged in laying a side track and two machine men were cutting a skip from the east rib to No. 8 south entry. Ten of the victims were found along No. 8 entry, one in No. 1 east entry just west of No. 8 south; one in No. 1 room in No. 1 east entry; one in No. 7 south entry between No. 4 and No. 5 rooms; and one in No. 1 room in No. 4 east entry. None of them were mutilated to any considerable extent, and all except the one in No. 1 room in

No. 4 east entry were severely burned.

"Considerable marsh gas is generated in this section of the mine and an examination of the workings in the vicinity of the scene of the explosion, on May 19 and 20, showed traces of firedamp in most of them.

"This examination showed no dates marked in the working places later than May 16, indicating that these places had not been examined by the fire boss on the day of the explosion. Evidently, the ventilation had been cut off of this section of the mine for a considerable time, thus permitting a body of firedamp to accumulate and some of the workmen, presumably the one found between No. 4 and No. 5 rooms in No. 7 entry had entered No. 5 room with a naked light."

The verdict rendered by the Coroner was as follows: "After having heard the evidence, examined the bodies, and considered facts and circumstances, I do find that the deceased came to their death by a gas explosion in the Imperial mine located in Noble Township, Noble County, Ohio, caused by the gas coming in contact with an open lamp carried by one of the men working on the new motor road, this gas being forced down upon the men by a change in placing the new motor road, the change being the taking down of a brattice in the morning between 1 and 2 E, and hanging of a door which was completed a few moments before the explosion, about 6:50 p. m., under the direction of Harry Dudley, assistant superintendent of the Imperial mine. I also find that the said Harry Dudley ordered the regular fire boss to make no inspection of the mine Saturday morning, as directed in Section 925, Laws of Ohio, requiring the mine to be inspected for gas before the miners are allowed to enter, and then allowed them to enter without the regular fire boss's inspection." Signed.

W. E. RADCLIFF,

Coroner of Noble County, Noble, Ohio.

Briquetting Coal

THE mechanical state of coal used

for domestic and industrial purposes determines to a large extent its value to the consumer and operator.

This statement is exemplified by that coal which would otherwise be available for use being kept out of the market chiefly on account of its being too fine and small to be successfully consumed. Small pieces of

Forms of Briquets—A Description of the Shedlock System and Apparatus as Used in England

Written for The Colliery Engineer

material to pressure in what is termed a "briquet press."

The United States Geological Survey demonstrated that "lignite" could be successfully briquetted without binders; but anthracite, semianthracite, bituminous, and

The problem to be solved in the production of fuel briquets of a hard nature from coal or coke, is the approximation to the calorific value of the commercial coal from which they are made and the retention of form during the progress of combustion.

A typical process for this purpose is the Shedlock, used in England. The binding material and fine coal

to pressure in what is termed a "briquet press."

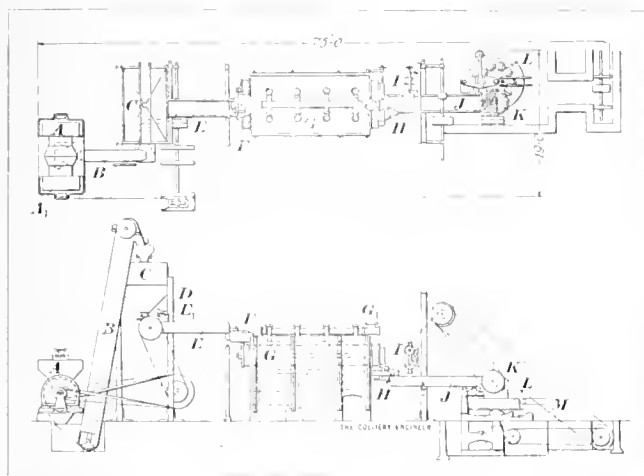

FIG. 1. BRIQUETTING PLANT

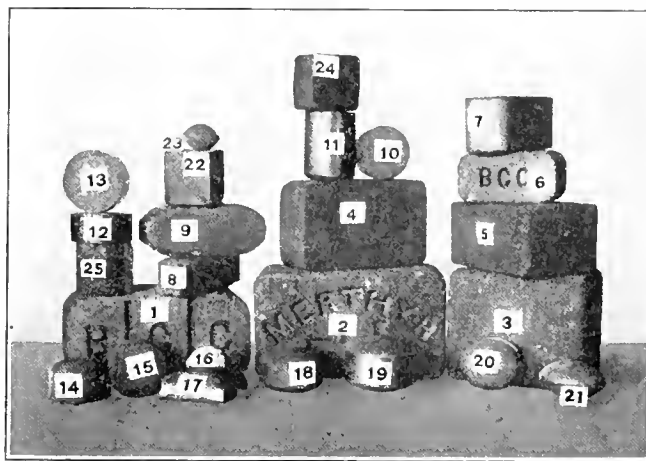

FIG. 2. SHOWING FORMS OF BRIQUETS

anthracite known as culm, often purer coal than that which is marketed, and slack or fine bituminous coal, are wasted, because they will not burn satisfactorily on ordinary grate bars.

Some use is made of these fine coals, but not to an extent that prevents large waste from accumulating; for instance, by special arrangements at the collieries a part of the material is consumed, another part is flushed into the mine, while a very small percentage of the whole is made into briquets and burned on locomotives. Again, bituminous slack if of coking variety is partly made into coke, partly shipped to market, partly sold to railroads in some instances at prices below the cost of production, and a large quantity wasted. In recent times an attempt has been made to briquet these fine coals, by mixing them with adhesive substances termed "binders" and then subjecting the

semibituminous slack must be treated with those materials which possess the following essentials, namely: Adhesiveness, combustibility, imperviousness to water; have practically no ash, and so far as possible smokeless. Up to the present time pitch is the favorite binder although it does not come nearly up to the requirements, as it gives disagreeable smoke and odor.*

In Europe briquets are made in large sizes for use in steamships and locomotives, and for storage in distant coal stations in hot climates. The largest forms of briquets shown in Fig. 2 are of foreign manufacture and must either be broken before firing or fired by hand. The smaller forms are suitable for domestic and boiler use in the United States, where to find favor briquets must be in sizes that can be readily shoveled.

after being intimately mixed, are treated in a closed gas-tight chamber, where sufficient heat is supplied to volatilize the lighter constituents and force the binding material into the pores of the finest particles. It is to be understood that it is not sufficient in such processes merely to coat the surfaces of the particles with the binder; thorough impregnation is essential. The gas produced in this chamber is used for heat or power, according to the local conditions, and the solid mixture retains the bulk of the calorific value of the original fuel. The mixture, after this treatment, is removed, and compressed into bricks that are claimed to occupy 25 per cent. less space for a given weight compared with ordinary fuel. As the bricks contain only the heavier constituents of the fuel, a minimum amount of smoke is given off in burning. The bricks are so homogeneous that they do not disintegrate when exposed,

*Mineral Resources United States, Part II, page 197. "Coal Briquetting," by E. W. Parker. Also United States Geological Survey Bulletin 316.

and retain their form when burning, producing a steady intense heat. They can be stored under water without excessive absorption of moisture. In some other briquetting processes pitch is used as a binder. In the Shedlock process a suitable liquid hydrocarbon is used as a binding agent and it is claimed that the cost of manufacture is nearly 20 per cent. less than for briquets made from pitch.

The process can be followed from Fig. 1, showing the general arrangement of the plant required. The coal or other fuel which must not exceed a 1-inch cube in dimensions, is fed to the disintegrator by suitable means from storage hoppers. Either a band conveyer or push plate conveyer may be used depending on the position of the storage bin with relation to the briquetting plant. The coal after passing through the disintegrator *A* is raised by means of an elevator *B* to the powdered storage bin *C* placed directly above the revolving plate feeder *D*. On the lower end of the hopper *C* there is an adjustable sleeve so that the amount of coal passing through the bottom of the hopper can be adjusted accurately. Just above the plate feeder is an adjustable scraper and as the plate revolves the mass of coal left on it after passing the adjustable sleeve is swept off in the required direction. As this stream of coal falls from the feeding plate *D* into the double-shafted mixer *E*, tar is sprayed over it by means of a spray tap *E*₁, and it is more or less coated by a very thin film of tar or other hydrocarbon used in the process. This mass is gradually worked by paddles throughout the length of the mixer and at the same time is formed into a homogeneous mass, which falls by gravity into a feeding pan *F*; at the other end a gas-tight seal is formed by the pan at one end of the calciners *G* into which the pan discharges through two openings connected with the two calciners. The calciners are supplied with a series of steel paddles and

paddle plates which, when rotated by means of worm gearing, gradually move the mass from one end of the calciners to the other. The volatile substances produced while the mixture is being heated are drawn by exhaust pipes fixed to the upper surface of the calciners which are connected to the main outlet pipe *G*₁. By means of suitable exhausting apparatus these gases are withdrawn as quickly as they are formed. On account of the various grades of coal which may be treated by this process and the time taken to produce the right kind of material before briquetting, the speed at which the paddles in the calciners rotate must be adjusted over a considerable range. For this reason the regulating device *I* is installed which will give the paddles double the normal speed required.

When the material arrives at the discharge end of the calciners it passes on to a second feeding plate *H*, placed there for the purpose of maintaining a column of material. The outlet of the coal is provided with another adjustable sleeve so that the amount of calcined material deposited on the revolving plate can be regulated so as to maintain within the outlets the amount of material required to prevent the ingress of air. As the plate feeder revolves and withdraws the material through the outlet, the calcined mixture is swept off by means of a scraper into a second double-shafted mixer *J*. This not only cools the charge but allows it to be thoroughly opened up so that any included gases and vapors can detach themselves from the hot mass. On arrival at the other end of the mixer the mass is in a fairly cool state and falls into the feeding pan *K* placed directly above the rotating table of the briquetting press *L*. Within the pan are a series of fixed points and rotating paddles so arranged that further mixing of the material is given at this stage. On the lower end of the rotating spindle are placed paddles which fill pockets of the press with the mixture when rotated under-

neath. The briquets are then compressed and are ejected from the press on to the band conveyer *M*, which carries them either to storage trucks or to wagons for shipment.

Alternative binders, such as lime, resin, and pitch, are of course adopted for the purpose of coal briquetting in addition to the binders mentioned, in order to agglomerate the coal dust. Of these, pitch is by far the most used, and the apparatus which is usually adopted for a coal-briquet plant utilizing pitch consists of an elevating or conveying means of transferring the materials from storage, the pitch being dealt with in a pitch cracker. The small coal and pitch are carefully mixed in the proper proportions in a mixer or measurer, from which they are passed to a disintegrator where the mixture is pulverized to small mesh. By means of chain elevators, it is then carried to a superheater and vertical heating plant, and heat is applied until the pitch becomes soft and unites with the coal. In this state the mixture is filled into molds on a briquet machine constructed on the Yeadon system, and there pressed into blocks which harden as they become cold. They are then transferred by means of endless conveyers to the storage pile or delivered to wagons. In France and Belgium briquets made in this manner have for a long time been utilized extensively, while the same development is now in progress in Germany to a large extent. Several plants have also been established in the South Wales coal area of Great Britain. The great danger in briquets made in this way, is that on burning the combustion may be attended with too much smoke and unpleasant smell; but where, as is the case with the Yeadon plant, the bricks are made of an extremely hard and durable nature by extreme pressure, it is found that not only is the life and burning quality of the fuel increased, and the briquets made of a weather-proof nature, but they are extremely durable in the fire and emit very little smoke and odor.

The amount of incombustible contained in briquets depends on the amount of ash in the initial coal, and if this exceeds 6 or 7 per cent. it is advisable that the small coal should be washed before being used in briquetting.

There is a fairly large range of apparatus available for the economic utilization of materials which have for a long time past been considered as waste products. The importance of the matter as regards the fuel resources of the civilized world may be judged by the small and slack coal dumped in the vicinity of collieries because there is no market for it. In addition to this, it was reported some time ago by a Royal Commission which investigated the condition of British coal fields, that about one-third of the coal of the seams remains below the surface. The production of smokeless briquets capable of withstanding the effect of climate variations such as moist air, goes a long way to solve the difficulty; and, moreover, it has been found that whereas large coal, especially that mixed with pyrites, will lose from 15 to 20 or 30 per cent. of its calorific value when exposed for 2 to 6 months to moist air, properly made briquets retain practically their original value. Within the next few years it is inevitable, owing to the economic changes which are taking place in manufacture, that this subject will come to the front even more prominently than at the present time, and it is therefore hoped that the above survey of the present conditions will provide a starting point for further investigations which would tend toward the cheapening of the cost of production.

來 來

Photographing Blueprint Maps

*By H. A. Williamson**

On several occasions the Drafting Department of the Consolidated Coal Co. has been called upon to reproduce maps on short notice. For instance, a large line print (blue lines

with white background) on a scale of 800 feet to the inch was sent in. This print covered topography and geography over a certain territory and was entirely too large and bulky to embody in a report on a portion of the territory shown. It was desired to have a smaller map showing the territory covered by the print, but on a scale of 2 miles to the inch, and, also, to have a map showing a portion of the print on a scale of $\frac{1}{2}$ mile to the inch, and it was necessary to

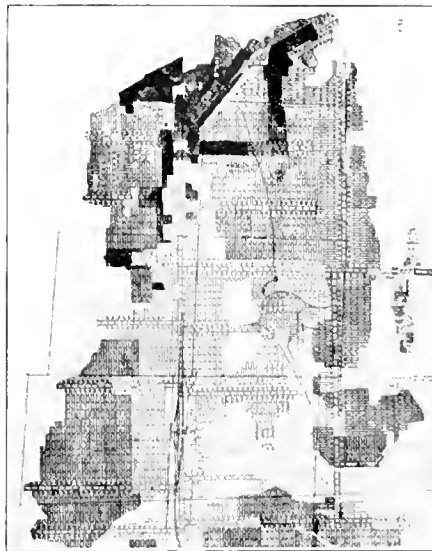

REDUCED MAP OF MINE

have twelve of each of these maps within 24 hours.

With our ordinary camera we made an 11"×14" negative of this print. We then placed this negative in our enlarging camera and made an enlargement of it on the scale of 2 miles to 1 inch. After making these we blocked out with black paper all of the negative, except the small portion that was needed, and made our smaller map on the scale of $\frac{1}{2}$ mile to 1 inch.

The apparatus and the method used in doing this was, briefly, as follows:

In making the negative the line print was placed on an easel, it first having been ironed and all wrinkles smoothed out as well as possible. The camera was placed just far enough away to get the entire print well within the limit of the 11"×14" plate.

A trichromatic plate was used,

and a process lens, with an orange filter, this combination making the blue lines strong on the negative. The exposure was 8 minutes and the plate was developed according to the method furnished by the manufacturer of the plates. Mercury vapor lamps were used to illuminate the print at the time of exposure. In making this reduction from the original print on to the plate no attention was paid to scale except that a strong black line exactly 6.6 inches long was placed on the print; the scale being 800 feet to the inch, this line would then represent 1 mile regardless of what reduction or enlargement had been made with the camera.

In making the enlargements the same lens was used, but without the orange filter. The negative was put in the enlarging camera and the mercury lamps again brought into service, this time at the back of the camera, throwing the light through the plate, then through the lens into the easel placed in the dark room. It was then a simple matter to measure the image of the black line (originally 6.6 inches long) on the easel and move the easel back and forward until this line was $\frac{1}{2}$ inch long when sharply in focus, which made the scale 2 miles to the inch. When this was accomplished the light was shut off and a sheet of bromide paper (a rapid brand giving sharp lines being used) of the proper size was placed in position on the easel and the exposure made; this operation being repeated until we had 12 prints.

We then blocked out the negative as before mentioned and moved the easel until the black line was exactly 2 inches long, making the scale $\frac{1}{2}$ mile to the inch, and made our prints as before.

Any one not familiar with enlarging methods can obtain, without cost, books giving complete information on the subject from any of the larger camera manufacturers. No special apparatus is necessary; any ordinary camera lens will do the work, and while we used vapor lamps sunlight can be utilized to accomplish the same result equally as well.

* Fairmont, W. Va.

Coal Mine Fires

IN A bulletin recently issued on "Coal Mine Fires," Geo. S. Rice, Chief Mining Engineer of the United States

Bureau of Mines, covered the causes of fires in coal mines and methods of prevention, in a very thorough manner, and J. Krzyanowski and St. Wysocki in a paper published in the Transactions of the Federated Institute of Mining Engineers, Great Britain, treat on methods of combating such fires. The two papers combined contain so much of value to coal mine officials that the most important features in each have been extracted and combined in this article.

The data extracted from Mr. Rice's bulletin are as follows:

1. Fires in entries or headings are started generally by open lights setting fire to dry timber or brattice cloth, usually at a siding where men gather to rest. Mules or horses may be fed at such places and hay may be littered around. At a ventilating door the trapper boy sometimes digs a hole in the rib at one side of the door in which to rest while waiting for trips to pass. Engineers of the Bureau have examined mines in which it has been noted that these resting places have been lined with loose hay. There have been fires that were said to have started in one or another of these ways.

To lessen the chances of such fires, safety lamps should be substituted for the open lights. English statistics indicate that there are vastly more accidents in open-light mines than in safety-lamp mines in the same districts.

2. Fires at the face may be caused by a blast setting fire to the coal or to small gas "feeders." Blasting is probably the most fruitful source of mine fires in this country, and largely because of the excessive use of black powder and dynamite in many coal fields. In certain western coal fields it is not uncommon for several fires to start in a mine every night from shooting. "Firebugs" or

Fires Classified According to Locations—Their Causes and Some of the Methods of Combating Them

"fire-runners" (firemen) are employed in these mines to put out the fires. Such fires break out more often in mines that "make a little gas" than in what are termed "gaseous mines," because more precaution is taken in the latter; yet a shot overcharged with black powder or dynamite is liable to set almost any bituminous coal on fire.

Permissible explosives as used under government regulations lessen the chance of fire. Inspection of the shots as soon as possible after firing and the placing of portable fire extinguishers in boxes at convenient points are wise precautions. A still wiser precaution is to have a complete system of water pipes throughout the mine with taps at intervals of not over 100 feet and with portable hose and nozzle at regular intervals of about 200 yards. This system has been employed in a number of mines. Although its first cost is considerable, it affords efficient fire protection; moreover, in bituminous coal mines it is convenient for laying coal dust, thus lessening the danger of explosions.

3. Fires in pillar workings, that is, where pillars are being drawn, start in much the same way as those in solid workings, but pillar fires originating from explosives are less frequent because smaller charges of explosives are usually needed for pillar coal.

Fires in pillar workings are harder to put out by direct attack than those in the solid coal on account of the falling roof; if stoppings must be used, they cannot be built so readily, nor made tight in the broken coal. In consequence, large areas may have to be enclosed or sealed.

4. Gob fires are frequent in the lignite and subbituminous coal of the Rocky Mountain fields, in the bituminous coal of the Iowa and

Missouri field, and parts of the Illinois field, also to less extent in many other coal districts of the United States.

Generally their origin is due to spontaneous combustion. In coal mining the terms "spontaneous mine fire" and "gob fire" are almost synonymous. These fires may start in abandoned or caved workings of any mine, and in the process of pillar drawing if the work proceeds slowly. Gob fires are particularly liable to occur in mines in which the coal absorbs oxygen rapidly. Such coal has a relatively low fixed-carbon content and a high moisture content. It is a debated question how far the sulphur content of the coal (visible as iron pyrite) is responsible for spontaneous fires. Formerly it was believed to be the chief factor; now it is generally thought to be only an auxiliary factor. In either case it is safer to load the "sulphur balls" into cars and send them out of the mine. If they are abundant they may be sold to manufacturers of sulphuric acid, as is done by certain mines in Illinois, Ohio, and other states, thus partly compensating for the cost of handling.

Machine cuttings left in the goaf of longwall workings are particularly liable to give trouble by firing spontaneously; moreover, in open rooms dry coal dust, if stirred up by a blown-out shot, is a source of danger from its liability to ignition. Therefore, all cuttings and fine coal should be sent out of the mine.

In the Illinois and Iowa coal fields, among others, the author has observed that where water drips on the gob there is especial liability to heat, probably because of alternate wetting and drying, which is a well-recognized cause of spontaneous firing in storage piles on the surface.

A gob fire probably originates in the following manner: The coal and the shale from the roof or partings disintegrate as the occluded gases escape; at the same time

oxygen is absorbed. At first oxidation is slow. In a goaf when the roof falls the heat is retained so that the temperature rises. With the rise in temperature more gas is liberated, and oxidation becomes more rapid. These reactions continue until the temperature reaches a dangerous point.

Fires often originate in the vicinity of timber. It has been suggested that timber acts as tinder; in other words, it probably ignites more easily than the coal itself.

The outward manifestations of a spontaneous gob fire are: first, that beads of moisture appear on the roof and upper part of the timber props, at the edge of the gob—the heat may or may not be appreciable; second, that the heat becomes perceptible and the drops of moisture disappear—thereafter the rise in temperature is very rapid. In the beginning of a gob fire the circulation of air is sufficient to carry off the heat developed in the gob, yet enough air is present to cause slow oxidation. These opposing conditions are not easily met, and gas, if present, causes difficult complications.

In pulling pillars or in longwall work, it is very difficult, and in some cases impossible, to ventilate the goaf sufficiently to keep it cool. On the other hand, the working places of the miners must be ventilated, and some of the air-current drifts into the goaf, thus providing sufficient air for the oxidation.

In some coal fields the fallen shale or slate roof fires spontaneously. In the Iowa field and in some parts of the Illinois field it is necessary to seal off rooms as soon as they have been finished or have been stopped by great falls, otherwise the material heats and fires quickly. It would be better if the pillars in such mines were extracted, so that there would be a complete closing down of the roof. Gob fires rarely occur in a tightly packed longwall goaf, and never where hydraulic filling or flushing is employed, as in Upper Silesia, Germany. This is one reason why this system has been used in the thick (20- to 40-foot)

coal beds of that district, where formerly gob fires were of frequent occurrence and difficult to extinguish.

Where the customary room-and-pillar system is employed in mines liable to gob fires, if the pillars cannot be quickly drawn, it is generally best to seal off promptly before the gob heats. A concrete or brick wall, coated with cement, should be used, a pipe with a gate valve being put through it near the top, so that temperature readings and samples of the gases may be taken. There is serious objection to sealing off rooms where the mine produces methane in any quantity, because a large body of standing gas, even behind a strong stopping, is a constant menace. In such a mine the pillar-and-stall method of mining, or some form of longwall, should be employed.

Fires from electric incandescent lamps are liable to be caused by allowing such lights to rest in contact with wood, or coal dust, or even the coal itself.

A more fruitful source of fires is the short-circuiting of improperly installed lighting or power cables. The remedy is to have all electric lights and wires installed and regularly inspected by a competent electrical engineer.

Trolley wires for an underground haulage road should be installed with great care and should be inspected often. Several serious mine fires, one of which involved the loss of a large Southern Illinois mine, are said to have been caused by the short-circuiting of trolley wires, which set fire to the wooden frames of doors. To protect against such short-circuiting, doors, when necessary along the trolley road, should be set in brick or concrete frames.

Another cause of fire along entries is the grounding of power lines or trolley-road returns. Many fires have originated from this cause. In this country, power lines in mines are seldom armored or even rubber covered; a fall of roof or a movement of timber may bring the bare charged wire in contact with either

wood or coal. If such lines are placed in entries not often traveled, as is frequently done, a fire may become serious before it is discovered.

The remedy is regular inspection at least twice a shift while the current is on, or the armoring of such cables. In long-lived mines it may prove economical in the end to have the power cables enclosed in conduits that lie in covered trenches.

Underground ventilating fans, especially so-called "booster" fans, to help the surface fans, are being used more and more. In Europe such fans are usually driven by compressed air, a safe but more expensive method than by electricity, which is used in this country. As it is necessary in most places to drive the fans all the time day after day, it is evident that in spite of daily inspection there is liable to be a time when an armature gets overheated and the insulating material takes fire. This is supposed to have happened in a large Ohio mine where the fire got beyond control, so that a large section of the mine had to be sealed off.

Generally such fans have been set in wood frames or there has been timbering near at hand which could be set on fire by the burning of the insulating material.

The remedy is to set such an electrically driven fan in a non-combustible frame, to line the passageway for some yards with brick or concrete, and then to inspect the fan often.

Great explosions of firedamp, and particularly of coal dust, nearly always leave fires in their trail along timbered entries or where the coal dust is thick. The using up of the oxygen and the damping effect of the carbon monoxide and dioxide produced by the explosion fortunately puts out most fires thus started. But if the ventilation is quickly restored in order to save life, or if there are areas not reached by the explosion and able to supply air, the fires are likely to revive. In a certain breakthrough between rooms, in an Alabama mine, the

burning dust from an explosion fell on a pile of fine coal, and the fire lay dormant for several days; then, when the ventilation was restored, it burst out actively.

The extract from Messrs. Krzyanowski and Wysocki's paper is as follows:

The writers consider mine fires due to the following causes:

(1) Fires due to inflammation of timber and other easily combustible materials, such as hay and lubricating oils. They cite several cases in which such fires have caused great loss of life and damage to property.* (2) Fires due to inflammation of coal; (a) by contact with a flame, and (b) by spontaneous combustion. (3) Fires caused by inflammation of coal dust. And (4) fires caused by explosions of firedamp.

The contrast between the precautions against fires which are taken in large establishments on the surface and in towns, with the general lack of such precautions in mines is surprising when one considers that in mines the risk of fire is greater than on the surface, owing to the profusion of inflammable materials and the constant use of artificial lights. The danger from the gaseous products of combustion is also much greater underground than on the surface.

The only means of defense actually available in most mines are: (1) Partial changes in the direction of the air-currents, where doors or ventilating appliances allow of such changes. (2) The modification of the whole system of ventilation, which is a complicated operation requiring much time. (3) The construction of wooden dams after the fire has broken out, in order to arrest the propagation of the products of combustion and to isolate the fire. These measures have been in use for nearly 4 centuries, and they are inadequate to meet the dangers of fires, owing to the incessant development of mines and the increased number of persons employed therein, nor are they in

accord with the progress made in mining science.

It is difficult to estimate, even approximately, the speed with which a fire is propagated in timbered mines. The speed varies with the state of the ventilating current and the physical condition of the mine and the timber; the amount and direction of the inclination of the roadways are also factors. It is possible, however, to estimate with some precision the route and the velocity of the gases of combustion, which is incomparably greater than that of the fire. In a given mine, the velocity of the ventilating current may vary greatly, according to the sectional area of the passages through which it moves. Assuming the average speed of the main air-current in mines as 400 feet per minute, it follows that the rate of advance of the smoke and gases from a fire may also be estimated at 400 feet per minute, between the fire and the point of exit of the current. Smoke advances against the air-current at the same speed as the fire, but the speed in this direction is insignificant, except in cases where the passage is vertical or highly inclined.

It follows from the foregoing observations that in a mine fire the persons in greatest danger are those between the fire and the point of exit of the air-current. If the length of the main air-current is taken at from 6,000 to 12,000 feet and the speed of the air-current is taken at 400 feet per minute, it follows that the current traverses 3,000 feet of the airway in $7\frac{1}{2}$ minutes, and traverses the whole route in from 15 to 30 minutes. This is about the speed and time in which the gases and fumes traverse the main airway when the fire occurs near the entrance of the mine. A more complete idea of the greatness of the risk in such circumstances is obtained by considering that the mass of noxious gases produced by the burning of the timber in a few feet of roadway, or by the inflammation of a limited amount of firedamp and coal dust, or by the combustion of a few hundred pounds of coal, would be sufficient to fill all the mine; and that

the fatal effects of these gases on men are produced, not at the end of 1 hour or one-half hour, but, according to the greater or lesser density of the poisonous mixture, at the end of some minutes.

Considering the rapidity of the progress of the smoke and gases in mines, it is evident that miners, surprised by the poisonous current, have no chance of escaping. The system of warning by word of mouth is not sufficient to reach the persons interested in all parts of the mine, or the warning only reaches them when the intake airway near their working places is saturated with poisonous gases.

The system proposed for dealing with fires in mines consists in the pre-establishment of dams capable of being instantly closed in case of fire, and situated in such places as to divide the mine into sections, which could be isolated by the closure of the dams. The dams would be fitted with doors of such size, that when open, as in ordinary times, they would not impede the ventilation. These dams are placed as near as possible to the points where currents of air divide or come together, so that access to one side of the dams may be easily maintained by ventilation. Where this is not practicable, special means for ventilation should be provided.

The dams may be made of wood or of brick, the openings being kept as large as practicable, so as not to impede the ventilation. The doors may be of wood or sheet iron, made as air-tight as possible, and there should always be a supply of mortar or moist clay at hand to make them quite air-tight.

Places which should be especially guarded, as being by their nature extra dangerous in case of a fire, are vertical shafts, timbered engine houses, stables, hay depots, and heavily timbered roads containing steam pipes.

The organization of the service for closing the doors in case of fire is to be entrusted to certain officials and special signals arranged for notifying them and those in danger.

*Pancrast mine; fire in engine room, 73 killed, February 7, 1911. Avondale shaft disaster. Cherry mine disaster, 1910, hay caught fire. 1912, Mt. Lyell, Tasmania, 42 killed; inside pump house.

WHEN the mine executive sees many of the great mining corporations of this country equipping

costly chemical laboratories, and employing a staff of trained chemists, he must often be faced with the query "what benefit do these companies derive from this work, that can offset the considerable expense incurred?" It will therefore, be the purpose of this paper to attempt briefly to answer this question by describing a few of the many ways in which chemistry can be of service to the coal mining industries.

The role of the chemist in the production of coal is that of helpful cooperation. It is his office to supply data to the executive and operating departments of the company with which he is associated, in the light of which these departments can work more certainly and efficiently. It is for the chemist to discover and call attention to what might be termed the invisible leaks. It may be granted that the mining executives have corrected, or removed all the causes of inefficiency, friction, or waste of which they have knowledge. This does not imply by any means that none remain, as there are many that only become visible in the searching light of chemical investigation. It is in the discovery and correction of these latter that the chemist is invaluable.

The work of the chemist in the coal producing industries may be divided into three broad classes. The purchase of supplies used in mining, the production, and preparation of coal, and the merchandising of the prepared product.

As is well known, almost all coal mining supplies are purchased by brand. Now, this means that when a substance giving satisfactory service has been secured, the market narrows down to one manufacturer, and a single brand, whereas there

The Earning Power of Chemistry

In the Coal Mining Industry—Economies Rendered Possible in Purchase of Materials and Sale of Product

*By Edmund M. Chance**

are doubtless many similar articles upon the market, which, because of competition, are much cheaper, and yet are of equal quality. To quote a case in point; it has been found by experience that a certain lubricating oil gave excellent results under the conditions obtaining at a certain colliery. Now, this oil was sold under a brand name at 45 cents per gallon. Under the old regime, the company was practically powerless, as they had absolutely no knowledge of the nature, or composition, of this oil, and therefore were unable to duplicate it in the product of another manufacturer. On submitting this oil to their chemist, it was a simple matter to determine of what constituents it was composed, and therefore by specifying that the oil should contain these constituents the whole market was thrown open, and the same oil precisely was obtained for 28 cents per gallon. Such instances may be multiplied indefinitely. The burning oils, particularly, are purchased empirically. Not only can the same product be obtained more cheaply under specification, but it is often by no means certain that the best product for the purpose is being used. Thus, in the case of miners burning oils, it is frequently possible to purchase more cheaply oils, which, while giving far less smoke and odor, give more light.

In the use of explosives in the mines, it is possible to move the coal more cheaply when an intelligent choice of explosives is made, than when the explosives are purchased by name only. It is necessary not only to know the chemical composition of the various explosives, but also their quantitative composition. When such a course is pursued, not only is fraud on the part of the manufacturer exposed at once, but

in many cases the advisability of substituting cheaper for the more costly explosives becomes at once apparent, and

many of the claims advanced by the powder companies on behalf of their more expensive powders become ridiculous.

There is one problem which the coal mining official has constantly before him; that is the question of the softening of boiler waters. He must raise steam with waters ranging in purity from waters of the purity of rain water, to a moderately strong solution of sulphuric acid containing sulphates of iron and alumina. In the average case, however, the problem generally is to prevent scaling, and corrosion when a water containing a moderate quantity of incrusting solids or a trace of free sulphuric acid is to be used. Now, we must complicate this problem by the many boiler compounds now upon the market. These compounds range in nature from comparatively pure carbonate, or hydrate of soda, to mixtures containing the refuse of various manufacturing processes. They are alike in only two particulars, the fact that their price is many times their value, and that they are all put upon the market as "cure alls." It is not to be understood that all of these so-called boiler compounds are without merit. On the contrary, some are very excellent indeed, although all are unreasonably high in price. The point is this—that each boiler water requires a boiler compound especially adapted to its needs. The water must be analyzed, and the treatment then prescribed. This treatment consists ordinarily in the addition of a certain definite quantity of quick lime, soda ash, or caustic soda to the water involved. And when this is done intelligently, following the direction of a competent chemist, it is very gratifying to observe how quickly the boiler troubles will disappear. When it is

*Consulting Chemist, Wilkes-Barre, Pa.

understood that the most costly of these materials (caustic soda) can be bought for less than 2 cents per pound, it will be understood what is meant when the statement is made that boiler compounds now on the market are unreasonably costly. In fact, the indiscriminate use of boiler compounds can well be compared to the use of nostrums, or widely advertised proprietary remedies, by those afflicted with organic disease.

Though the author realizes that the examples here cited of the benefits derived from the chemical control of the purchase of supplies under specification, are inadequate, yet space will not permit further detail.

In considering the application of chemistry to the production of coal, the control of mine fires will first be discussed. By exact air analysis, it is possible to accurately follow the extinction of a sealed-in mine fire. When the attack is to be made by flushing through bore holes, the analysis of the air issuing from cracks and fissures in the surface is not only invaluable in indicating the places at which the attack can be most advantageously made, but is also useful in determining the effect of the flushed material upon the fire.

In the mining of the coal, the advice of the chemist is useful in coping with the problem of explosives and mine illumination, as before mentioned.

The tendency of the day lies unquestionably toward the purchase of materials upon their real economic value. Now, in the past, coal has been bought and sold largely in the bituminous, and almost entirely in the anthracite, fields upon its appearance and trade name. This state of affairs is being rapidly replaced by the purchase and sale of this material upon its true value as a steam raiser, source of heat, gas, or coke, or its particular usefulness in the various arts. This being the case, it is of paramount importance that the coal operator should not only know exactly the properties his coal possesses, but should prepare it

so that it may best meet the conditions under which it is to be used. Now, in the anthracite field particularly, coal has been prepared to meet the arbitrary conditions laid down by a visual inspection. As unfortunately it is not possible to determine accurately the fuel value of anthracite by the eye, the preparation is more or less wasteful, as materials must be rejected because of their appearance, which, possessing a considerable fuel value, would not deleteriously affect the prepared product. When the preparation, however, is controlled by chemical analysis, only materials of low heating value are purposely rejected, and it is surprising to what extent the proportion of prepared sizes per mine car can be increased without decreasing the fuel value of the prepared coal.

When coal is sold under specification, the vendor must, for his own protection, have an absolutely accurate knowledge of the properties of his product. If an examination be made of the records of the United States Government of the purchase of coal under specification, it will become at once apparent that the vender who enters the market without this knowledge becomes liable to prohibitive penalties. In fact, one of the great sources of dissatisfaction with this method of selling coal lies in the fact that the seller is ignorant of the true quality of his coal, and therefore agrees to supply an article he does not possess.

Because of the wide variation in the intrinsic quality of the product of different collieries, it is often possible for a company by selling the product of certain collieries under specification, to reap a considerable premium, while the product of collieries preparing coal of average excellence is sold in the open market. It is often possible, also, by studying carefully the product of different collieries to secure a considerable premium for certain coals for special purposes without incurring any additional expense in preparation.

The writer appreciates fully how inadequately this paper has covered the subject set forth in its title. In extenuation, besides the lack of space, must be advanced the fact that but few general principles apply to the solution of the problems confronting the mining chemist. Each problem must be considered alone, and treated in probably a different way from all that have preceded it.

來 來

Conservation and Commercialism

By Francis S. Peabody*

The following is abstracted from Mr. Peabody's address, delivered at the dedication of the Mining and Metallurgical Laboratory of the University of Illinois:

The coal area of Illinois is approximately 35,000 square miles, or 22,000,000 acres. It extends north and south 280 miles; and east and west 180 miles in its widest part.

Conservation and commercialism, so far as coal mining is concerned, are correlative, the same elements entering into both; namely, human life, labor, natural resources, and money or capital.

Notwithstanding the similarity in the component parts which dominate conservation and commercialism, it seems impossible at this time to reconcile the two so that a successful commercial operation will work harmoniously with conservation.

The antagonistic relationship between commercialism and conservation begins with the first element, "human life." There is no question but that safety is the first consideration, and our last legislature passed laws for the safety of miners, which, while good, the Illinois operators would like to evade because they place burdens on them in the way of expenditures which their competitors in other states are free from.

The more restrictions that are put upon the operator for the safety of his men, the more his costs increase, and, if human, he will try to evade these additional costs, notwithstanding the fact that he knows the neces-

* President Peabody Coal Co., Chicago, Ill.

sity of the law; but competition forces him to spend as little money as possible in producing his coal.

The new laws passed by the last legislature, especially in regard to the construction of shafts, tipples, top works, fire appliances, etc., have put at least 40 per cent. additional cost upon sinking a new shaft compared with the shafts sunk before the law was passed, and these new laws have added an operating cost to all mines, whether sunk under the old law or under the new law, of almost 10 per cent. on the cost of production.

Reverting now from commercialism to conservation of human life. Operators should not hesitate to spend money to protect human life. This, however, is impossible under the present keen competition.

Safety appliances, fire apparatus, rescue rooms, danger signals, steel I beams, concreting dangerous places in entries, daily inspection of mine, etc., should be most carefully done and it is believed that by proper safety methods practically all danger to life and limb could be eliminated from coal mining. But these make considerable addition to the expense and so to cost of production.

Our state is one of the most advanced in regard to legislation for the protection of life; however, added laws will increase the difficulty, from a commercial standpoint, of mining coal in our state.

If there could be an Interstate Commission of Operators and Miners from Illinois, Indiana, Ohio, and Pennsylvania, appointed by the governors of those states for the purpose of recommending similar laws in each state the result would be beneficial to those states.

Commercialism from the miner's point of view differs unnecessarily from the operators. The miner has his labor for sale and is paid on the tonnage basis. He tries to produce a large tonnage regardless of the condition in which he delivers the coal to the owner. The miner, instead of undercutting his coal, shoots off the solid, thus shattering the coal so it is almost unmarketable; in some districts since this kind of mining has

been adopted by the men, screenings have increased from 20 to 40 per cent.

This is not all, as shooting off the solid knocks down timbers, causes at times windy shots that endanger the miner's life and the lives of his fellow workmen, damages the roof, and in case of an explosion, causes enormous loss to the company which employs him. It is evident that commercialism dominates the miner more than the operator who looks after life and property while the miner cares for nothing but an increased tonnage.

From the standpoint of conservation, the miner, instead of making every effort to load as much coal as possible regardless of consequences, should undermine the coal, should use only so much powder as is necessary to bring down coal when properly undermined, should use care in placing shots so as to avoid knocking down timbers or producing windy shots that are dangerous to him and his colleagues. Instead of trying to evade such laws as prohibit carelessness, the miners should live up not only to the state laws but to the rules of the operators for the protection of their men and their property.

The state should add to and increase the laws now in force for the protection of lives and the safety of men. The state should provide laws for the protection of property and should rescind the laws now in force which practically give miners now employed in the state of Illinois a monopoly of labor.

Although the state has passed laws for the protection of human life, it has not passed laws for the protection of property.

The legislature constantly caters to the laborer for political reasons and has made laws so that it is practically impossible for the operator to secure competitive conditions for the labor he hires. It, by the Mitchell bill, has restricted miners from outside coming into the state to work.

When trouble arises between the miners and the operators the officials of the state are loathe to intervene and property is destroyed. With the exception of the laws passed for the

safety of men, no laws have been passed for the safety of property or for the proper recovery of the natural resources in the ground.

Under the heading of Natural Resources, commercialism and conservation are again in opposition.

Because of the competition in the coal market every operator is trying to produce coal as cheaply as possible, and that means taking out the coal nearest the shaft. Under this method of mining, less than 60 per cent. is extracted, 40 per cent. being left to support the roof, air-courses, etc. If the operator should run his entries to the boundary lines of his property, as the most economical method of mining suggests, it would take a great deal of money and a long time before any return on the investment could be realized.

I have computed that the average return from 1 ton of coal in the ground, as figured in the selling price of the coal, is less than 2 cents per ton. The waste of natural resources following the present system of mining is enormous, and makes coal mining from the standpoint of human life much more hazardous.

The railroads, the largest of all the consumers of coal, utilize, it is estimated, less than 50 per cent. of the British thermal units in the coal burned in their locomotives. This means that 50 per cent. of the 60 per cent. taken from the ground is lost, practically making 70 per cent. waste of our natural resources.

This example would possibly carry through to all small consumers of coal, although some large concerns have taken great precautions to economize in its consumption.

The last item, capital, is the one that appeals forcibly to the operator. The present method of mining means small but quick returns on the investment, although state records show that many of the largest operations in the state have become bankrupt in the last 10 years, while the coal in the ground has appreciated in many districts two-, three-, four times in value; it is at the present moment practically impossible to induce capital to invest in the coal mining in-

dustry in Illinois, while millions of dollars can be secured for the purchase of the virgin coal land.

To be successful the coal operator should be prepared financially to drive the entries to the boundary of his property and work his mine so that the entire bed may be recovered.

來 來

Insurance on Mine Property

*By W. H. Charlton**

The methods of handling insurance on mine properties seem to depend a great deal on the activities and financial investment of the companies concerned. A majority of companies carry their insurance in the ordinary way, that is they place insurance on the different buildings and plant equipment and pay the premiums as they come due.

Another method is that followed by some of the larger companies who operate a number of mines and whose plant and equipment represent a considerable outlay of capital. Companies of this kind frequently carry their own insurance and maintain a separate department to supervise this feature of their work.

The general method followed in handling insurance is to open a suspense account for it. When insurance premiums are paid they are charged to this account and in the event of additional insurance being taken out during the year, or any change taking place which will effect the amount of the premium payable during the year, an adjustment of this account, which is prorated against "Operating Expense" each month, will be necessary to conform to the altered conditions.

The total amount of insurance premiums payable during the year should be anticipated and prorated, one-twelfth each month to "Operating Expense," and credited to "Insurance."

Whenever changes are made in the amount of insurance carried, an adjustment of the amount prorated against operations each month is necessary to maintain even rate of distribution for balance of the year.

Whenever a company suffers loss or damage by fire, either to buildings or equipment, the amount received from the insurance company to cover the loss is placed to the credit of the various accounts sustaining loss, according to the amounts allowed in the settlement of the insurance company.

As an example of the methods followed by a large company that carries its own insurance, a western corporation which is both an operating and holding company, is taken.

This company maintains its own insurance department, at the head of which is a manager under whom is an efficient force of inspectors to carry out the work of the department.

Examinations by the inspectors are made of the different properties of the various companies and the insurable value determined, all of which is reported in detail to the manager.

The amount of insurance and the rate thereon to be carried for each item of property and equipment is recommended by the manager in a statement to the president of the company affected, for his approval. If, in the president's opinion, adjustments in the schedule are necessary, it goes back to the manager with the modifications required pointed out, and the basis on which the changes are recommended explained.

The manager of the department requires a periodical inspection by his assistants of all property and equipment upon which insurance is carried, to ascertain if proper precautions are being taken against fire. Upon receipt of reports from the inspectors, the manager reports to the president of the company concerned any lack of what he considers efficient protection in the way of preventive measures. The advisability of carrying out the suggestions made is discretionary with the president.

In case of loss or damage by fire the mine office immediately notifies both the president and auditor, in order that proper steps may be taken to have the insurance department investigate and report on the loss or damage sustained.

The plan followed in creating the insurance fund and the methods approved for its disposition are as follows: After the amount of insurance to be carried is determined and the premium rate to be paid thereon established, each company will distribute monthly one-eighth of the amount of premiums payable during the months of April to November, inclusive, to its cost of "Operation," crediting such amount to the "Fire Insurance Fund." Quarterly each company remits to the treasurer of the holding company in cash the amount of the insurance fund so accumulated for that quarter.

The treasurer of the holding company credits each company with its contribution and invests the amount so received for the benefit of the fund, allowing each company annually or semiannually, credit for its proportion of the interest or dividends received on the fund, such interest or dividend, however, is to be reinvested by the treasurer of the holding company for the benefit of the fund.

In case of loss or damage by fire, the company sustaining the loss, will, after the matter has been adjusted with the insurance department, call upon the treasurer of the holding company for reimbursement out of the fund, the difference to be charged to the "Profit and Loss" account of the company sustaining the loss. This plan of carrying insurance is followed out on all risks of both the holding and constituent companies, and virtually makes each company its own insurer.

A variation of the above method is that followed by a coal company operating eight mines situated in widely separated districts. This company set aside each month an arbitrary sum until it had accumulated what it considered an adequate insurance fund, after which it proceeded to carry its own insurance under conditions somewhat similar to those mentioned, except that a regular insurance department is not maintained, this feature of the business being attended to by the regular officers of the company.

* San Antonio, Tex.

Notes on Mines and Mining

Reports on Conditions and Other Matters of Interest in Various
Coal Fields

By Special Correspondents

ARIZONA.—A Bureau of Mines has been established at Tucson, in connection with the Mining Department of the University of Arizona, to deal with the mining, smelting, and geological problems of the state. The bureau will educate the miner and prospector. If they cannot attend the university, the bureau will bring the university to them, by series of lectures, articles in daily and weekly mining papers, publication of items of interest—all popular style and progressive. The employer as well as the miner should profit by this educational work. The bureau will offer to the miner and prospector a place for determining samples; practical advice and instruction, and education on the economic side; an office of exchange and information. The same data will be of service to those outside the state who desire information on Arizona mining. Mine operators are invited to send the bureau their engineering, smelting, concentration, and economic problems.

COLORADO

In May, the Colorado School of Mines, at Golden, gave the double-hammer degree to 68 young men and the M. S. degree to one young man. This is probably the largest number of mining engineers graduated from any one institution in this country at one time.

At the recent session of the Colorado Legislature a law was enacted providing that mines shall be assessed upon the full valuation of their real estate and improvements, and upon 50 per cent. of their gross output, together with the value of their total net output.

ILLINOIS

The University of Illinois Bulletin, No. 29, Volume X, is devoted entirely to the Department of Mining Engineering. The new mining laboratory, a brick structure 42 feet wide and 100 feet long, is divided into a chemical laboratory, a drilling and blasting laboratory, a mine-rescue chamber, and a coal washing

and ore concentrating laboratory, all of which are illustrated in the bulletin. The offices and recitation rooms are in the Transportation Building adjoining. Those branches common to all engineering studies are taught in the proper departments of the University, thus leaving this department entirely devoted to mining.

Storing Coal Under Water.—The June issue of the *Western Electric News* contains an account of the manner in which the Western Electric Co. has solved the problem of storing and conserving the heating value of its fuel supply at the Hawthorne, Ill., plant.

A concrete pit has been constructed with a capacity of 10,000 tons of soft coal. This pit is divided into three sections and occupies an area of about 300 ft. × 114 ft. The pit is kept flooded with water, covering the entire coal supply.

Tests show that storing coal under water prevents the oxidation which occurs when it is left in the open and results in a saving of from 10½ to 22½ per cent. of the heat value. The loss of heat in coal stored under water is only 1½ per cent. Aside from this saving, there is the advantage that a much smaller size coal may be stored indefinitely without danger from spontaneously ignited fires. The large storage facilities also guard against shortage when the cold weather sets in and deliveries are uncertain.

MISSOURI

The junior class of the Missouri School of Mines spent 3 weeks in Colorado, beginning June 4. This is a required part of the curriculum. The class visited Colorado Springs, Colorado City, Pueblo, the Cripple Creek district, Leadville, Breckenridge, Valero, Montezuma, Waldorf, Silver Plume, Georgetown, and Idaho Springs. They were accompanied by Professors G. H. Cox, H. T. Mann, and C. R. Forbes.

The sophomore class did field work in mine surveying at Edwardsville, Ill., during the first 2 weeks in June, under the charge of

Prof. C. R. Forbes and Mr. E. S. McCandliss.

OREGON

Oregon Agricultural College.—Rowley Cruik, of Wellen, a junior at the Oregon Agricultural College School of Mines, won first prize, and C. W. Anderson, of Portland, a senior, won second in a contest in the class in rock and earth excavation for working out the best graphic solutions of the problem of the cost of earth work by means of various apparatus and for varying distances. They have made diagrams by which the average cost may be ascertained instantly, whatever the wages paid, for moving earth in any quantity to various distances—something extremely valuable to all contractors who have to do with this sort of work.

It has just been announced to the O. A. C. students that they are eligible to the four fellowships in mining and metallurgy, each \$675 a year, offered by the University of Utah.

PENNSYLVANIA

The Lehigh Coal and Navigation Co. will shortly begin the erection of a new steel and concrete breaker to replace the one in use for many years at their No. 11 colliery, near Tamaqua. The new breaker is to be equipped with the most modern machinery and will be one of the largest producing plants in the anthracite coal regions.

The consolidation of the Youghiogheny & Ohio and the Lorain & Ohio Coal Companies, two of the largest in the state, with big mines in the state of West Virginia, has been officially confirmed. The consolidated company will have 40,000 acres of coal in Belmont County and at present employs 3,000 men.

Announcement was made at Scranton early in June of the formal dissolution of the Temple Iron Co., by the companies controlling that corporation. This action was taken in

accordance with the recent decision handed down by the United States Supreme Court. There will now be seven distinct companies to conduct the affairs of the eight collieries.

Mr. A. F. Law, who was vice-president of the Temple Iron Co., is president of each of the seven companies, and Mr. F. H. Hemelright is general superintendent in charge of all the operations.

The labor situation in the Connelleville region is causing some concern, both coke drawers and coal miners are becoming scarce. This condition seems to be spreading to the Pittsburg district in spite of the long period of idleness.

TENNESSEE

The Tennessee Foreman's Society. E. F. Buffat, foreman, of Oliver Springs, Tenn., has presented us with the constitution and mine rules of The Society of Tennessee Mine Foremen. The central body is known as the Grand Mine, the subordinate bodies are known as Mines, which accounts for "Mine Rules"; the officers of the Mines are superintendent, mine foreman, foreman of rescue corps, foreman of first-aid corps, foreman of relief corps, time-keeper, weighmaster, mining engineer, gas foreman, roadsman, timberman, master mechanic, outside foreman, greaser, and trapper. The purposes of this society are the advancement of its members in social, intellectual, first-aid training, and the promotion of greater safety in mines. The society constitution reads nicely until it reaches the heading "Disasters," where it assumes that members of this society can take the mine-rescue work out of the hands of the operator, manager, or other company officials and do as the nearest high officer of the society pleases.

WEST VIRGINIA

"Shooting Off the Solid."—John Laing, Chief of the Department of Mines, makes the proud boast that "shooting off the solid" has been nearly eliminated in West Virginia. Interest is added to this statement by the fact that the United Mine Workers of America are making a

determined effort to secure the repeal of a law recently enacted in Oklahoma prohibiting this highly dangerous practice.

Government statistics show that more than 48 per cent. of deaths in coal mines are due to falls of roof. One of the principal causes of these falls is "shooting off the solid." A shot in the solid seam is also more likely to blow out the tamping so that the flames may set fire to coal dust or gas, thus causing an explosion that may wipe out scores of lives. In other words, reckless or lazy miners deliberately risk their own lives and the lives of others to save themselves a little labor.

This dangerous practice has been discouraged in West Virginia by a vigilant system of inspection backed up by relentless prosecutions of offenders. The 1911 report of the Chief of the Department of Mines shows that 105 miners were fined an aggregate of \$1,303 for shooting off the solid in that year. This vigorous enforcement of the law evidently had its effect in 1912.

The West Virginia Geological Survey, I. C. White, State Geologist, Morgantown, W. Va., has issued a new coal, gas, iron ore, limestone, and oil map. This new 1913 edition is the joint publication of the State Geological Survey and the State Semicentennial Commission. It contains a thorough revision of the coal, oil, and gas developments, several anticlinals being added, and others corrected from later observations. The valuable iron ore deposits of the state are also indicated on this map, and all the special features of previous editions corrected and brought up to date, showing the approximate areas of the several coal series, operating mines and their post office addresses, as well as the oil and gas pools. Scale 8 miles to the inch. Price, enclosed in strong envelope and delivered by mail, 50 cents each, but in combination with other publications see general circular of the Survey.

WASHINGTON

Joint Meeting of A. I. M. E. and C. M. I.—A number of mining men

of Spokane attended the fifteenth general meeting of the western branch of the Canadian Mining Institute, in Rossland, B. C., Thursday, May 22. This was a joint meeting with the members of the Spokane local section of the American Institute of Mining Engineers. The provisional program, announced by E. Jacobs, the secretary of the Western branch of the Canadian Mining Institute, included reading and discussion of papers, visit to mines of Rossland, and a visit to the smelting works and the electric lead refinery of the Consolidated Mining and Smelting Co., at Trail.

George Watkin Evans, mining engineer, Seattle, Wash., made a preliminary trip to Alaska in May to ascertain the needs and make plans for the expedition of the United States Bureau of Mines which leaves Seattle July 5. Mr. Evans will be in charge of the expedition, which will examine into the commercial possibilities of the Matanuska coal field.

Sixteen members of the College of Mines, University of Washington, traveled to Cle-Elum, Washington, on the annual inspection trip and visited the various coal mines of the Northwestern Improvement Co., the Roslyn-Cascade Coal Co., and the Roslyn Fuel Co., in the Roslyn District. Time was divided between underground and surface work. The various systems of mining and drawing coal, transportation methods, ventilation, and pumping, as well as the surface equipment and power arrangements were thoroughly gone over. Leaving Cle-Elum, the party drove to Liberty, a former prosperous placer camp 20 miles east of Cle-Elum. Here the various methods of drift mining were studied in detail. Recent lode development in the camp came in for a share of attention in the study of the prospects and deposits opened up by tunnel and shaft.

采 采

Most of the coke used on the Pacific Coast is imported from Germany or England or brought from the Eastern States.

International Engineering Congress

In connection with the Panama-Pacific International Exposition which will be held in San Francisco in 1915, there will be an International Engineering Congress, in which engineers throughout the world will be invited to participate.

The congress is to be conducted under the auspices of the five National Engineering Societies which, acting in cooperation, have appointed a permanent Committee of Management, consisting of the Presidents and Secretaries of each of these Societies, and eighteen members resident in San Francisco. Thus constituted, the personnel of the Committee is as follows:

Representing the American Society of Civil Engineers: George F. Swain, President; Charles Warren Hunt, Secretary; Arthur L. Adams; W. A. Cattell; Charles Dereleth, Jr.; Charles D. Marx.

Representing the American Institute of Mining Engineers: Charles F. Rand, President; Bradley Stoughton, Secretary; H. F. Bain; Edward H. Benjamin; Newton Cleaveland; William S. Noyes.

Representing the American Society of Mechanical Engineers: W. F. M. Goss, President; Calvin W. Rice, Secretary; W. F. Durand; R. S. Moore; T. W. Ransom; C. R. Weymouth.

Representing the American Institute of Electrical Engineers: Ralph Davenport Mershon, President; F. L. Hutchinson, Secretary; J. G. De Remer; A. M. Hunt.

Representing the Society of Naval Architects and Marine Engineers: Robert M. Thompson, President; D. H. Cox, Secretary; George W. Dickie; W. G. Dodd; William R. Eckart; H. P. Frear.

The Committee has effected a permanent organization, with Prof. William F. Durand as Chairman, and W. A. Cattell as Secretary-Treasurer, and has established executive offices in the Foxcroft Building, 68 Post Street, San Francisco.

The ten members of the Commit-

tee, consisting of the presidents and secretaries of the five national societies will constitute a committee on participation, through whom all invitations to participate in the Congress will be issued to governments, engineering societies, and individuals. The personnel of this Committee is as follows:

Committee on Participation: Chas. F. Rand, Chairman; Charles Warren Hunt, Secretary; D. H. Cox, W. F. M. Goss, F. L. Hutchinson, Ralph Davenport Mershon, Calvin W. Rice, Bradley Stoughton, George F. Swain, Robert M. Thompson.

The actual management of the Congress and the work of the securing and publishing papers will be in charge of the members of the Committee resident in San Francisco. The work of the resident members has been assigned to different subcommittees, and Chairman Durand has made the following appointments:

Executive Committee: W. F. Durand, Chairman, Ex-officio; W. A. Cattell, Secretary, Ex-officio; E. H. Benjamin, W. G. Dodd, A. M. Hunt. Finance Committee, W. G. Dodd, Chairman; Newton Cleaveland, R. S. Moore.

Papers Committee: A. M. Hunt, Chairman; A. L. Adams, H. F. Bain, G. W. Dickie, W. R. Eckart, C. D. Marx, C. R. Weymouth.

Publicity Committee: W. A. Cattell, Chairman; C. Dereleth, Jr.; W. S. Noyes, T. W. Ransom.

Local Affairs Committee: E. H. Benjamin, Chairman; J. G. De Remer, H. P. Fear.

The papers presented at the Congress will naturally be divided into groups or sections. During the Congress each section will hold independent sessions, which will be presided over by a chairman eminent in the branches of engineering covered by this section.

The papers, which will be collected and published by the Congress, should form an invaluable engineering library, and it is intended that this publication shall be in such form and at such cost as to

become available to the greatest possible number.

The various committees are now actively at work, and it is hoped that further and more definite announcements as to the membership fees, schedules of papers, etc., can be made in the very near future.

來 來

Panama-Pacific Exposition

Mr. Charles E. van Barnwald, Chief of Department of Mines and Metallurgy of the Exposition, has written an open letter to mining men in which he says:

Everybody will agree that the Panama-Pacific International Exposition is the nation's official celebration of the successful completion of the greatest task ever undertaken for the universal good. We welcome this opportunity to exhibit to the world our industrial and intellectual condition. A well-planned exposition is of incalculable value as an educator of the public mind, and no industry is in greater need of this service today than mining.

On February 15, 1911, President Taft signed the bill extending federal recognition and designating San Francisco as the official site for this great celebration. On February 2, 1912, a proclamation was issued announcing the forthcoming exposition and inviting the nations of the world to participate.

Construction work on the exhibit palaces is in full swing and all buildings will be completed by the end of June, 1914. The organization of the Division of Exhibits is completed, the last department to be organized being Mines and Metallurgy. The Department of Mines and Metallurgy deals with the natural mineral resources of the world, their exploration, exploitation, conversion into metal, their manufacture into structural forms and into raw material for various industries.

The responsibility of making a creditable exhibit in this department rests with the mining public and their suggestions will be gladly received.

THE LETTER BOX

Readers are invited to ask or answer any question pertaining to mining, or to express their views on mining subjects in this department. All communications must be accompanied by the name and address of the writer—not necessarily for publication.

The editors are not responsible for views expressed by correspondents.

Shaft Sinking in Wet Ground

Editor The Colliery Engineer:

SIR:—Will some of your readers kindly answer the following:

A shaft is to be sunk 280 feet deep, in which water will be struck at a depth of 100 feet in a formation of sandstone that extends to a depth of 175 feet from the surface.

What would be the most advisable method to eliminate the water or minimize the flow to such an extent that it will not interfere with the skip arrangement which will raise coal from the bottom bins to the top?

The water flows in such quantities as to impede the progress of sinking. How can the water be eliminated so that it will be hardly necessary to install pumps, as they are to be placed in the air shaft, 350 feet from the main shaft?

D. H. J. STOCKETT

The Cement Gun for Preventing Dust

Editor The Colliery Engineer:

SIR:—There have been many methods proposed for both the prevention and the laying of coal dust in mines. The idea of all these methods is to prevent, first, the origination of an explosion caused by excessive dust; secondly, to prevent an explosion originating at the workings from spreading to all parts of the mine.

Efforts in this direction have hitherto been applied to the establishment of dustless zones, but experiments have shown that an explosion usually carries sufficient dust with it to destroy entirely the dustless features of any zone unless it is a very large one. A very complete discus-

sion of experiments along this line will be found in Bulletin 20 of the United States Bureau of Mines, "The Explosibility of Coal Dust."

Calcium chloride, stone dust, and spraying have their advocates and have been found more or less satisfactory, as the experiments at Altofts and Lievin have shown. Calcium chloride is a little expensive when used alone, and can only be applied to the floor, stone dust irritates, and experiments by the Bureau of Mines have shown that a wet zone will not certainly stop a dust explosion after it has been fairly started.

To the mind of the writer, a very obvious method of preventing dust from forming has been overlooked. This is to use the cement gun or like device for coating the walls and floor of the mine with such a coating as would keep the fine coal produced by the continuous cracking of the seam from being distributed as dust. Several compositions of this sort have been recently patented, but it seems that concrete would do very well. It is not denied that the concrete will fall in course of time, so this interval must be determined in practice. The coat should be very thin, and as soon as it cracks off, which it will probably do in the course of 3 months, it can be easily renewed. If concrete is objected to on the score of expense, mud, mixed with a little calcium chloride to keep it moist is a substitute worth trying. Five per cent. of calcium chloride by volume would be about the right proportion to mix in with mud of the right viscosity to throw with the gun. The chloride is now worth

about \$14 per ton. It is needless to say that the floor should be especially well treated and the coal in the mine cars kept moist. By this means, an explosion would surely be confined to the working faces, and if spraying were adopted here, there should be absolutely no excuse for such a thing as a mine explosion.

Who will be the first to try this idea on a mining scale?

CHESTER TIETIG

Washington, D. C.

The Law Regarding Mine Inspectors

Editor The Colliery Engineer:

SIR:—I notice "Collier's" article in your May number in reference to the suggestion made by me in the March Letter Box.

I am well aware that there are two sides to the proposition.

You cannot get the best men for inspectors by examination. If so we would know in advance by their standing in schools and colleges what young men were going to be the great generals, lawyers, doctors, business men, etc., of the country.

What becomes of the first honor men of our colleges?

Take our Military Academy at West Point, how many of the first honor men ever achieved distinction as great generals?

There are two notable exceptions in the history of that Academy, Lee and Grant, one near the head and the other near the foot of his class.

On the other hand Forrest, considered the greatest military genius developed on either side, judging by results accomplished according to means at his command, had a very limited education, and no military training whatever.

While my suggestion might operate as a hardship on some inspector, he need not take the place, there would be no compulsion on him. These laws are made and large sums of money spent, not for the benefit of the mine inspector, but for the protection of the lives and health of thousands of men working in the mines.

I submit that the lives and health of these men are more important than a possible hardship to a mine inspector.

Take the record of Colorado and Oklahoma for the past 16 years, the state of Alabama for the past 9 years, and the state of Virginia for the past 5 years. Does "Collier" or any one believe that such a disastrous record would have continued, had such a law as I suggest been in force?
J. DE B. HOOPER

Cincinnati Mine Explosion

Editor The Colliery Engineer:

SIR:—I read with much interest in the June number the account of the Cincinnati mine disaster by Mr. W. Z. Price, also the reports of the two Commissions appointed by Chief of the Department of Mines, Mr. Roderick, and I was pleased to learn that the company did so much to make the mine a safe one. The Mine Inspector's Commission testify to this in the following words: "The brick air stoppings were built up to within one breakthrough of the face of the several entries and the mine was kept in a clean, orderly condition." The Special Commission of experts reported: "There was ample ventilation and it was conducted around all of the working faces. We noticed that brick stoppings were erected, in practically every instance, to the last breakthrough, except, of course, those used for haulage purposes. The roads were moist and practically free from dust, and clean and free from obstruction." The above point to one fact, namely, that the company did its full duty toward keeping the mine in good and safe condition.

The coroner's jury was one of more than ordinary intelligence and departed widely from the path usually trod by such bodies. It made recommendations to the company, to the legislature, and the Department of Mines, blamed the now deceased mine foreman (legally) for the explosion, because he had not compelled the use of safety lamps in the

district which exploded, and placed the blame (morally) on the law, or defects of the law.

To me it seems that the real cause of the explosion was entirely overlooked by the coroner's jury and was not mentioned by the double commission. The cause of the disaster was the failure of the mine foreman to obey General Rule 18. This rule has been a part of the law for 20 years. It reads as follows: "In the cutting of clay veins, spars, or faults, entries, or other narrow workings, going into the solid coal, in mines wherein explosive gas is generated in dangerous quantities, a bore hole shall be kept not less than 3 feet in advance of the face of the work, or 3 feet in advance of any shot hole drilled for a blast to be fired in."

Had this bore hole been kept in advance, the gas would have been tapped and drained off before a blast was fired in the entry. There would have been no accumulation of gas. It would have been diluted as fast as given off when it was known to be issuing from the hole. In other words the explosion could not have happened. Am I right?

The above lines are not written to criticise the conduct of any one. They are written in the interest of safety first.

A MINE INSPECTOR

Scientific Management Applied to Coal Mining

Editor The Colliery Engineer:

SIR:—A modern epigrammatist has said: "The man who says 'It can't be done,' is pushed out of the way by the man who is already doing it." The question of "Superintendent" in your December issue, and the article by Mr. Weldin in the May number, prompt a few remarks by one who has been engaged in "doing it" and who has been too busy to stand aloof and theorize concerning certain well-known principles whose chief exponents have been suddenly heroed by their admiring followers.

Efficiency engineering, by whatever name it is called, whether "sci-

entific management," "development of earning power," or the writer's favorite term "bug hunting," is neither mysterious nor wonderful, but combines simply the critical analyzing mind, with creative ability which assists toward mechanical improvement, and mature judgment which in an advisory capacity overcomes the serious objections mentioned by Mr. Weldin, by skilfully studying the psychology of the individual as well as the mechanics of the operation.

We differ radically, however, with the statement that there is a large amount of preliminary work to be done, and that the introduction of efficiency methods either involves revolutionary changes or protracted periods before any results can be attained. The paper of Mr. Collins, quoted by Mr. Weldin (and first called to his attention by the writer), in itself shows many opportunities for quick results, and illustrates lucidly the benefits to be derived by devoting 100 per cent. of one's time to the problem. Therein lies the secret of the success of scientific management—the wholehearted cooperation of those in authority with the engineer thus occupying his entire time in making the studies.

It has been the writer's observation that much adverse criticism is due to the attempts of worshippers at the shrine of efficiency to introduce certain systems as installed by Taylor, Williams, Emerson, and others in certain plants, into other operations where conditions were entirely different, without first studying the elementary factors involved. Scientific management does not consider what is to be done, so much as how to do it. The prime requisites, as have been stated, are an analyzing mind, and the ability to create a flexible adaptation of existing systems and to devise new ones.

Since the article in your May issue was written the author has had opportunity to observe the exemplification of this statement in work

done by staff members under his direction at one of the plants with which he is connected. The "essence of the system" lies not so much in "increased supervision" as in the improved relations existing between employer and employe, which tend toward cooperation by the employe. This great truth has been recognized by many of the largest corporations in the Pittsburg field, among them the Union Switch and Signal Co., the Pittsburg Coal Co., and the National Radiator Co.

To state that scientific management increases to any material extent the "non-producers" is simply to admit that at the plant to which he refers, the attempt to introduce it never passed the experimental stage, or was fostered by unskilled guardians. Properly applied, scientific management eliminates red tape, lost motion, unnecessary expense and "overhead," increases production, decreases cost, and automatically makes every operation and operator coactive toward maximum returns to employer and employe alike.

Nor is it obvious to those most familiar with the subject that there is so "much danger" involved in the application of what after all is plain, common-sense administration of any operation. Hundreds of industrial plants have been working under bonus systems of various kinds for months and years past, and it has been the experience of Williams, Emerson, and others engaged in their installation, that labor troubles have been erased from the list of worries which previously were a constant menace.

The writer is quite ready to agree from his own experience in mining that the Taylor system is not immediately applicable to mining, but unlike the impression to be gained from the article in question, he does not believe the Taylor system to be the *multum in parvo* of scientific management, but rather, one of its many applications, very adaptable to some operations.

The author referred to is quite correct, however, in suggesting the

repair shop as the first point of attack. To the stockholder, it matters not in what department the greatest saving is effected, and to the operator, a reduction in cost of repairs means cheaper coal. An apparently insignificant saving of 1 cent a ton means much to the average operator.

There are also many operations which may be standardized, such as hanging trolley wire, laying pipe and switches, and building brattices and trap doors. Careful supervision of cables and pipe lines, definite responsibility for keeping feed-wires within reach of working places, maintenance of machines in proper repair, and proper preparation of bits and picks, all receive consideration by the efficiency engineer. Time studies of haulage will develop many delays previously unknown, which can be eliminated. Conferences between the efficiency expert and the superintendent and engineer will bring out improvements in pumping or hoisting or screening.

In many cases by charting the existing organization, certain functional changes can be made which simplify responsibilities and make for efficiency. But greater than all these, is the fact that in the proper application of scientific management, is to be found the increased margin of profit which in many instances is becoming necessary to the further operation of certain mining properties, and also that the strongest hold upon labor may be secured by a fair division of the gains so made, thus putting each man "in business for himself," so that prosperity for employer and employe becomes a function each of the other. In no better or speedier or surer way will the misunderstandings and the stubborn arguments of capital and labor be amicably and automatically adjusted.

HENRY M. PAYNE,
C.E., Ph.D., Sc.D., Chief of Staff

來 來

Correction

On page 584, May issue of THE COLLIERY ENGINEER, it was stated

that there were 66,889 tons of coal mined for each death in Montana. It should have read that there were 314,380 tons of coal produced for each life lost. The total number of tons of coal mined during the year 1912 was 3,143,799 instead of 6,057,186 tons.

OBITUARY

WOODWARD LEAVENWORTH

Woodward Leavenworth, of Wilkes-Barre, died in that city May 26, age 59 years. At the time of his death he was president of the Red Ash Coal Co., and secretary of the Hazard Mfg. Co.

ORRAN W. KENNEDY

Orran W. Kennedy, general manager of the Orient Coal and Coke Co., died June 8, at Pittsburg, from pneumonia. Mr. Kennedy was born in Lawrence County, in 1854, and rose from the position of clerk in the transfer department of the Pennsylvania Railroad to general superintendent of the H. C. Frick Coke Co., which position he resigned January 1, 1904, to become general manager of the Orient Coal and Coke Co. Mr. Kennedy was prominent in Masonic circles, was president of the Fayette Title and Trust Co., at Uniontown, and owned extensive coal lands in West Virginia. He was buried at Pittsburg June 10, the Masonic lodge having charge of the funeral.

WM. H. MCQUAIL

William H. McQuail, an active coal mine operator and a prominent resident of Pottsville, Pa., died in that city June 5, 1913, aged 60 years. His death was due to pneumonia.

Mr. McQuail began life at the coal mines as a slate picker and subsequently became a contract miner, in which occupation he did considerable rock work in the Schuylkill Valley and for the D., L. & W. Co., at Scranton. Later he was appointed superintendent of the collieries operated by the Alliance Coal Mining Co. In 1887 he went to the Pocahontas coal field in West Virginia, and organ-

ized the Turkey Gap Coal and Coke Co., of which he was president and general manager, a position which he held until the time of his death. In 1898 he organized the Crane Creek Coal and Coke Co. to operate in the same field, but sold out to the American Coal Co.

來 來

The Scott Colliery Disaster

The explosion at the Scott colliery, operated by the Mineral Railroad and Mining Co., and located between Shamokin and Mt. Carmel, Pa., on the morning of June 7, was not nearly so serious as first reported in the daily papers, though the result would have been much worse had it not been for the prompt action on the part of the local officials and the excellent ventilation provided in the mine. Instead of 20 to 30 lives being lost, but two men were killed, and two seriously injured.

The accident occurred in the workings of the fourth lift east gangway from an inside slope in the Buck Mountain seam. This seam ranges from 5 to 8 feet thick and has an inclination in the neighborhood of the origin of the disaster of 32 degrees. To prevent any accumulation of gas there is a strong ventilating current in the workings and locked safety lamps are used. The accompanying sketch shows the location of the source of the accident, and reference to it will make clear the cause and effect.

The gangways or entries shown on the sketch have both been stopped at the boundary pillar. Chambers were opened from the gangways with single chutes to the first cross-headings and driven up the pitch from that point 8 yards wide.

On the morning of Saturday, June 7, the miner in breast No. 42 was taking a skip off the inside pillar of his chamber just above the first heading, and prepared and fired his shot. In the meantime, his laborer, who, by the way, was his son, was down on the gangway at point marked A. Miner in breast No. 42 went up to dress off his shot and afterwards came back to the

point B between breasts Nos. 42 and 43, where he had a box of dynamite which ordinarily contained 25 pounds, and the supposition is that only about one-fourth of it was used. The box of dynamite exploded from some, as yet, unknown cause, but it is the general opinion that the miner working in breast No. 42 in some manner or other was responsible for the explosion, as he was found at this heading very badly

violence, it is supposed that they were knocked down by the concussion and suffocated by the fumes of the dynamite carried to the main current in the gangway through the hole from chamber 36, the stopping of which was destroyed. Ten other men, overcome by the fumes of the dynamite, were found at various points along the same gangway outside of C C, these fumes being carried in the air-current, which, owing



FIG. 1. SHOWING PLACE OF EXPLOSION AT SCOTT COLLIERY

mutilated, necessitating the amputation of his leg. His son, the laborer, and the two miners from breast No. 44 were sitting on the gangway at point A on sketch when the explosion occurred and were only slightly injured by flying coal.

The theory of this being a dynamite explosion was fully justified by the fact that in the first heading, between breasts Nos. 42 and 43, all the timbers were broken out, and the corner of a pillar, as well as a hole 2 feet 6 inches deep in the rock in the bottom of this heading. There are no evidences of any damage to any other portion of the mine. There was no afterdamp or recoil, as there is usually with explosions of gas.

The arrows on the sketch show the original courses of the air-currents. At the points C, C, two men were found dead and another man with slight concussion of the brain. As there were not sufficient marks on their bodies to indicate death from

to the destruction of stoppings was temporarily deranged. The men were quickly taken out and resuscitated.

As soon as the accident occurred a trained rescue corps composed of the local mine officials, headed by Inside Foreman John Weir, entered the mine and their prompt work undoubtedly saved the lives of some, if not all, of the rescued men.

As soon as Division Superintendent Reinhardt, at Shamokin, received word of the accident, he started for the mine in an automobile, stopping at the Luke Fiddler colliery, 2 miles west of the Scott colliery, for oxygen helmets kept there in the company's central rescue station. On arrival at the Scott mine it was found that the helmets were unnecessary, as the excellent system of ventilation, though somewhat deranged, had cleared the workings of the deleterious fumes.

The successful work of the Scott

Colliery Rescue Corps proves the wisdom of maintaining such a corps at each colliery. The Mineral Railroad and Mining Co., operating in the Shamokin region, the Susquehanna Coal Co., operating in the Wyoming region, the Summit Branch Mining Co., operating in the extreme western end of the southern anthracite field, the Lytle Coal Co., and Wm. Penn colliery, in the southern field, are allied corporations, and they maintain at each colliery an efficient rescue corps, composed of mine officials and selected employees. These corps are regularly drilled and are always ready for service. A complete outfit of helmets, pulmotors, and other rescue apparatus is kept in first-class condition in central rescue stations when several collieries are in close proximity, and at isolated plants a complete equipment is provided for the use of each.

As quickly as possible after the accident occurred the United States Bureau of Mines Rescue Car, stationed at Wilkes-Barre, Pa., was ordered to the colliery, but as its services were not needed, the order was countermanded. Superintendent Charles Enzian, of the United States Rescue Car, was at South Bethlehem attending a meeting of the Alumni Association of Lehigh University when the accident occurred, and he hastened to the mine as quickly as possible after hearing of the accident. As the prompt and efficient action of the local officials had accomplished everything possible before he could reach the mine, he could do nothing but gather the data for his report to the Bureau, which will naturally commend the local rescue corps.

來 來

Kentucky Mining Institute

The third annual meeting of the Kentucky Mining Institute, held in Lexington, was attended by a large number of members and, owing to the attractions offered, by a large number of non-members who joined later. This institute has become a

flourishing society during the 3 years of its existence and is destined to become a potent factor in the coal industry of Kentucky.

The papers read and discussed are classical and valuable additions to mining literature. Owing to lack of space they are given by title only, but later on some of them will be printed in full in *THE COLLIERY ENGINEER*.

The first day of the meeting was given over to the state-wide first-aid contest, inaugurated and carried to completion by W. L. Moss, V. P., of the Continental Coal Co., of Pineville, Ky. Twenty-three teams took part in the competitive contests. At the regular session of the Institute, Mr. Rash, V. P., of the St. Bernard Coal Co., Earlington, Ky., and retiring president of the society, eulogized C. F. Fraser, mining engineer of the Taylor Coal Co., Beaver Dam, Ky., who was suffocated by gas just 1 week before the institute meeting, and at which he was to have read the paper on the program, entitled "Mining Laws of Kentucky." The memorial resolutions of regret and condolence were approved by the institute members and placed on the minutes.

A paper on "Calorimetric Tests Made on Kentucky Coals," by Dr. A. M. Peter, Chief of the Division of Chemistry, Kentucky Experiment Station, showed that the number of heat units in Western Kentucky coal was 14,846, against 15,066 heat units in Eastern Kentucky coal; this "may be" settles the relative value of the two coal fields, at any rate it shows neither are in the "punk" class. We would suggest that all the readers of *THE COLLIERY ENGINEER* join this society to obtain the benefit to be derived from the papers presented. The program of papers was as follows: "Workmen's Compensation," K. U. Meguire, President Snead & Meguire Coal Co., Louisville, Ky. "Welfare of Sociological Work," W. C. Tucker, General Superintendent, Wisconsin Steel Co., Benham, Ky. "Coal and Mineral Taxation," Messrs. Hewel Davies, President, Louisville, Ky., and W. H. Cun-

ningham, Secretary, Ashland, Ky., Mine Owners' Association of Kentucky. "Mineral Development of Western Kentucky Fluorspar District," C. S. Nunn, Manager, Kentucky Fluorspar Co., Marion, Ky. "How Best to Handle the Dry or Dusty Mine," David Victor, Chief Mine Inspector, Consolidation Coal Co., Fairmont, W. Va. "Shortwall Mining" (illustrated with stereopticon slides), Wilbert A. Miller, District Manager, Goodman Mfg. Co., Cincinnati, Ohio. Discussion of "How to Handle the Dry or Dusty Mine," Theo. Weinshank, expert on heating and ventilating, Weinshank & Fenstermaker, Indianapolis, Ind. "Mining Laws of Kentucky," Mr. C. F. Fraser, Mining Engineer, Taylor Coal Co., of Kentucky, Beaver Dam, Ky.

The officers elected for the ensuing year are: President, W. L. Moss, Pineville, Ky.; Secretary-Treasurer, T. J. Barr, College of Mines, Lexington, Ky.; Vice-Presidents, Central District, B. R. Hutchcraft, Lexington; Western District, C. W. Taylor, Greenville, and T. E. Jenkins, Sturgis; Eastern District, J. E. Butler, Stearns, and W. C. Tucker, Denton; Northeastern District, L. E. Abbot, Jenkins, and Henry La Viers, Paintsville.

來 來

A "Near-Doomed" City

In the July issue of the *Technical World Magazine*, Mr. George H. Cushing furnishes a sensational article entitled a "Near-Doomed City." The article is very inaccurate and would not ordinarily be noticed were it not that its contents discredit Scranton and distort the findings of the Scranton Mine Cave Engineers, Messrs. William Griffith and Eli Conner.

It will be read by thousands of people who, unable to distinguish between a technical article and a sensational one, will believe that Scranton is doomed to fall into the ground, when, as a matter of fact, if all the coal were removed from under Scranton proper, the greatest damage would be cracked walls.

PRIZE CONTEST

For the best answer to each of the following questions we will give any books on mining or the sciences related thereto, now in print, to the value of \$3.

For the second best answer, similar books to the value of \$2 will be given.

Both prizes for answers to the same questions will not be awarded to any one person.

1. The name and address in full of the contestant must be signed to each answer, and each answer must be on a separate paper.

2. Answers must be written in ink on one side of the paper only.

3. "Competition Contest" must be written on the envelope in which the answers are sent to us.

4. One person may compete in all the questions.

5. Our decision as to the merits of the answers shall be final.

6. Answers must be mailed to us not later than one month after publication of the question.

7. The publication of the answers and names of persons to whom the prizes are awarded shall be considered sufficient notification. Successful competitors are requested to notify us as soon as possible as to what books they want, and to mention the numbers of the questions when so doing.

8. In awarding prizes, other things being equal, a carefully written and arranged answer will be given the preference.

9. Employes of the publishers are not eligible to enter this contest.

Questions for Prizes

29. At a certain point *A*, a bore hole is put down 350 feet to a 6-foot seam of coal; at a point *B*, 2,500 feet due north of *A*, a bore hole locates the seam at a depth of 400 feet; at *C*, which is 2,000 feet west of *A*, a bore hole reaches the coal at a depth of 800 feet. What is the direction and the amount of dip of the coal, likewise the direction of its line of strike? Assume the elevation of *A* to be 1,850 feet, of *B*, 1,650 feet, and of *C*, 1,800 feet above mean tide.

30. Assuming that a tract of 3,000 acres contains the seam of coal in Question 29, which has 2 feet of draw slate above it, that the coal pitches uniformly and its maximum elevation is 1,600 feet, how would you mine the coal, giving details of the size of pillars, etc?

31. If 25,000 cubic feet of air per minute pass through a 6' x 10' airway, what volume of air will pass through a 4' x 5' airway, the length of the airway and the power remaining the same? What will be the effect on the water gauge? Describe briefly what is understood by mechanical and manometrical efficiency of fans.

32. A steam engine of 300 actual horsepower is used for hoisting 600 tons of coal up a vertical shaft in 8 hours. Assuming the engine to be

doing its best, making proper allowance for ordinary work such as the engine does in winding, find by calculation the depth of the shaft and state in detail all extra work taken into consideration in determining the efficiency of the engine.

Answers for Which Prizes Have Been Awarded

QUES. 13.—*Horsepower of Engine.* Calculate the horsepower of an engine that is capable of hauling a trip of 15 cars, each weighing 1,200 pounds, and having a capacity of 3,000 pounds. The haulage road has a uniform grade of 1 per cent. against the load, and is 4,000 feet long. It is desired to get out 600 cars a day. Assume the coefficient of friction at $\frac{1}{40}$.

Ans.— $(1,200 + 3,000) \times 15 = 63,000$ pounds = weight of loaded trip.
 $63,000 \times .01 = 630$ pounds = traction due to gravity.
 $63,000 \times \frac{1}{40} = 1,575$ pounds = traction due to friction.
 $1,575 + 630 = 2,205$ pounds = total tractive force of loaded trip.

Assuming a factor of safety for the haulage rope of 1 to 10, the breaking strain of a rope to haul the trip would be $\frac{2,205 \times 10}{2,000} = 11.025$ tons.

The strength of steel ropes varies as the squares of the diameters. A 1-inch steel rope has a breaking strain of 33 tons. The diameter of a rope whose breaking strain is 11.025 tons is

$1^2 : x^2 :: 33 : 11.025$; $x = .58$ or say $\frac{5}{8}$ inch. The empty trip on a down grade or dip of 1 per cent. would have a gravity force of $1,200 \times 15 \times .01 = 180$ pounds.

It would have a resistance due to friction of $1,200 \times 15 \times \frac{1}{40} = 450$.

As a force of 180 pounds will not overcome an opposing force of 450 pounds the trip will not run in by gravity but must be hauled in by a tail-rope.

Assuming a rope $\frac{1}{2}$ -inch in diameter for the tail-rope, the weight per foot of such a rope may be found by the same formula as for strength. A 1-inch rope weighs 1.6 pounds per linear foot.

$1^2 : \frac{1}{2}^2 :: 1.6 : x$; $x = .4$ pound per foot for tail-rope.

$1^2 : \frac{5}{8}^2 :: 1.6 : x^1$; $x^1 = .625$ pound per foot for head or main rope.

$4,000 \times .4 = 1,600$ pounds = total weight of tail-rope.

$4,000 \times .625 = 2,500$ pounds = total weight of main rope.

As the weight of the descending tail-rope will tend to partly balance the weight of the ascending main rope the traction due to gravity of the main rope will 1 per cent. of the difference of their weights or $(2,500 - 1,600) \times .01 = 9$ pounds.

The traction due to the friction of the ropes will be $\frac{1}{40}$ of the sum of their weights or $(2,500 + 1,600) \frac{1}{40} = 102.5$ pounds. $102.5 + 9 = 111.5$ = total tractive force due to ropes.

$2,205 + 111.5 = 2,306.5$ pounds = total traction of trip and ropes.

As there are 600 cars to be hauled, and each trip consists of 15 cars, $600 \div 15 = 40$ round trips.

Allowing 10 hours for a day's work, $\frac{60 \times 10}{40} = 15$ minutes per round trip.

Each round trip must travel $4,000 \times 2 = 8,000$ feet.

$8,000 \div 15 = 533\frac{1}{3}$ feet per minute = velocity.

$\frac{2,316.5 \times 533\frac{1}{3}}{33,000} = 37.44 +$ horsepower.

Ans. I. C. PARFETT,
Jerome, Pa.

Second Prize, A. E. Smith, Merritt, B. C., Canada.

QUES. 16.—*Standing Props*.—How would you stand a prop in a seam of coal 6 feet thick, which has from one foot to two feet of slate above it, (1) when the seam is flat; (2) when the seam pitches 30 degrees; (3) when the seam pitches 70 degrees? Give details and reasons for your answer.

Ans.—Before putting in any props, the roof should be carefully examined in order to find out where they will do the most service. As the roof in this particular case is slate which often contains points and cracks, it should be examined for these, as they are often a source of great danger to the miner. These cracks may be either inclined away from the working face, vertical, or inclined toward the face, and this determines the position in which the prop is placed.

As the pressure of the roof acts vertically downwards, undoubtedly props in a horizontal seam should be placed vertically, and as they are placed to prevent sagging and falling of the roof they must also be perfectly rigid. This rigidity is obtained by means of a slightly wedged soft-wood cap, 2 to 3 inches thick, and of greater width than the thickness of the prop. A soft-wood wedge is preferable to hard wood, because, as it gradually gets the weight, it yields and crushes without snapping as a hard-wood wedge

would do. In this way it forms, as it were, a hoop around the end of the prop and prevents the tendency to split.

To place the prop, it is stood vertically on one end which should be

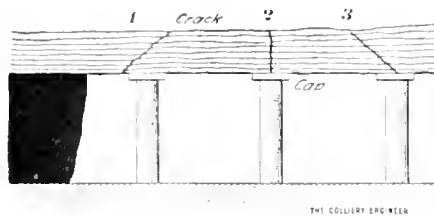

FIG. 1

cut at right angles to its length. Some miners prefer the butt end toward the floor while others reverse it. This, however, is to a large extent a matter of local practice. If the butt end is upwards the prop is more unstable yet it gives a bigger surface for the wedge to act upon, and as it is also the smaller end which is apt to split many prefer that it should crush at the floor rather than at the roof where the cap is. The prop should rest evenly on the floor which should be perfectly firm, and as the prop is slightly shorter than the distance it has to span, the wedge is placed in this space near the roof and driven with a heavy hammer until the whole is perfectly rigid.

Fig. 1 shows the positions of the props relative to the cracks in the roof. No. 1 is probably the most dangerous as the miner does not know of its existence until the coal has been undercut and the roof so

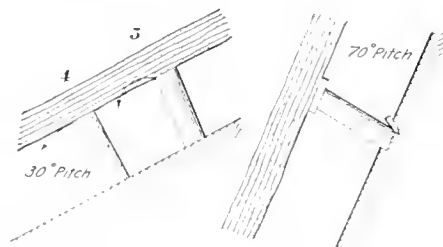

FIG. 2

FIG. 3

weakened. When the cracks are of this nature the timbers should be close to the face. In 3 the prop is placed when the crack shows itself, but the nearness of the face will not allow it to be placed as at 1. If necessary later, the point may be

further timbered as 1. The caps are always placed at right angles to the crack.

If the seam is inclined, the props are not fixed at right angles to the seam, but are inclined toward the rise, or "underset." The amount of underset varies from $\frac{1}{6}$ to $\frac{1}{18}$ of the angle of dip. The reason for this will be seen by reference to Fig. 2. Any movement of the roof will cause the prop to move in the direction shown by the arrow if the prop is put at right angles to the dip as at 4. Similarly a falling stone might dislodge it. On the other hand if it is placed a little toward the vertical and the ends of the prop cut to suit the slope of the seam at 5 it would tend to move in the direction of the arc 5 and so wedge tighter.

To fix the prop, the wedge is placed with the thin end pointing in the direction of dip and firmly knocked into position. Sometimes it is more convenient to place the cap on top of the prop and secure both by beating the top of the prop toward the dip with a hammer.

When a seam has an inclination of 70 degrees a prop has a greater tendency to fall out and it is better to secure the foot by cutting a "hitch" in the foot-wall as shown in Fig. 3, about 8 to 10 inches deep, and in this place the foot of the prop, and drive it into position as in the former case. The foot of the prop should also be wedged firmly by means of soft wooden wedges. The "hitch" should be cut wedge-shaped as in the sketch with the lower face cut so that the prop rests firmly on it.

WILLIAM H. JOPLING,

Mina de Sao Domingos,

Mertola, Portugal.

Second Prize, R. Z. Virgin, Colliers, W. Va.

QUES. 21.—In a mine worked by room and pillar in the panel system, do you consider it good mining practice to work a proportion of the pillars along with the solid working? Give the reasons for your answer.

ANS.—(a) Yes. The following are the reasons:

(1) If pillars be left standing for even a comparatively short time after the rooms are finished, the coal, on all exposed surfaces, to a depth depending upon the structure, deteriorates, owing to oxidation and the escape of the volatile gases as a consequence of disintegration. As the value of coal depends upon its possessing, in the highest possible degree, those qualities which make it a potential industrial factor, any method of production that will maintain these qualities is, certainly, the most practical considered from a financial and economic standpoint.

By working the panel entries to their boundary before opening any rooms and then starting a series of rooms at the extreme end, keeping the last two rooms in advance so that they will be finished first, the pillar between these two rooms can be extracted as soon as the rooms are finished. As each successive room is finished the pillar can be started back. As soon as there are a sufficient number of pillars extracted the entry stumps can be taken out. By this method all the coal will be taken out in the least time with the retention of its highest commercial value.

(2) By this method of working, which for want of a better name I would designate as "room and pillar retreating," a uniform daily output can be maintained in an entry from the time the first series of rooms are opened until nearly all the coal has been taken out. This I regard as an economical condition because it permits of a concentration of work to the least possible area to produce the required daily output of the mine. That concentration results in the expenditure of a minimum proportion of powder and labor is a well-known fact.

(3) A minimum amount of timber is required to sustain the working face and a large percentage of what is used can be recovered, as it is in use for a comparatively short time. If pillars are left standing for

a long time the posts in the rooms become so affected by the mine atmosphere that they are practically useless as supports. It is quite often necessary to retimber or re-post a room and remove roof falls before the pillar coal can be recovered.

(4) Dangers incident to falls of roof are materially decreased. A greater continuous amount of roof area is left unsupported for a given amount of coal extracted. This roof surface will fall more readily because the contiguous strata are supported by practically solid coal, thus causing an excess of breaking strain to be thrown upon the unsupported area. When the cave occurs the line of the break is clear cut, the contiguous strata not being characterized by lines of fracture. In extracting pillars and entry stumps it is desirable to have the cave as close to the line of extraction as possible as this decreases the pressure over the supporting coal.

(5) Creeps and heaves can be avoided by this method when the conditions are such as to make the occurrence of either possible or probable. Creeps and heaves are caused by a gradual and persistent subsidence of roof strata over insufficiently supported areas.

When a sufficient amount of coal is removed to make a roof fall, the weight of the overlying strata causes the roof to bend over this area. If the supporting coal under the contiguous strata be not sufficiently strong to resist this strain and cause the strata to break, the bending is communicated to adjacent territory, the supporting coal is crushed and a creep or heave results.

(6) The airways can be maintained in proper condition and the greatest efficiency of ventilation secured. The airways with their intersecting cross-cuts and the stoppings in such are not subjected to any undue stress of roof pressure, resulting in falls of roof, crushing of ribs and breakage of stoppings and a consequent decrease of ventilation at the working face. The

worked out portion is limited in its line of contact with the working faces, a line which can be swept by the ventilating current and the dangerous gases carried off in dilution without coming into contact with the workmen.

(7) Where machine mining is used a large proportion of the pillar coal can be cut and a decreased cost per ton effected. The pillars will present a comparatively solid face as they are worked before any undue stress is exercised to crush them.

I. C. PARFETT, Jerome, Pa.

Second Prize, H. J. Jakobe, Box 687, Lexington, Ky.

QUES. 22.—Working by room and pillar, what percentage of coal would you leave in the pillars at depths of 300, 500, and 700 feet, respectively?

ANS.—Various writers on coal mining have given rules in relation to the percentage of coal to leave in the pillars, which in my mind are similar to a large amount of other mining formulas, "impracticable." The amount to be left in pillars depends certainly upon the depth of bed, nature of the overlying strata, strength of the seam itself, and also on the method of working out the pillars. If the pillars have to support the roof for various lengths of time, I should then make some allowance in size, the longer they have to stand the larger I would have the pillars; then, again, if the pillars were never to be extracted, and there was no serious objection to an easy, even subsidence of the superincumbent strata, the pillars could be left very thin between rooms, if good pillars were left next to the main haulage roads and main airways. To make my answer as brief as possible, we will consider all the conditions to be normal, or in other words, average conditions, and pillars to be of such size as to hold the top steady. At a depth of 300 feet I should leave 33 per cent. in pillars; at 500 feet, 50 per cent.; at 700 feet about 60 per cent. These percentages, in my mind, would do very

well if pillars were worked out in the follow-up system. If the pillars have to be worked out by the retreating method or in other words the superincumbent strata must not move in the least, the pillars should be at least 10 per cent. larger, where I have allowed less than 50 per cent.; 5 to 7 per cent. larger where I have allowed from 50 to 60 per cent.; and I should allow 65 per cent. of coal to be left (not less) where the depth was 700 feet or more and no movement of the superincumbent strata could take place. These figures, in my mind, due to practical experience with moderate strata and moderate strength of coal, would give good results.

W. H. LUXTON,
Box 73, A. R. R. 3, Linton, Ind.

SECOND PRIZE ANSWER

In the Fig. 4 *A* represents a pillar of coal 1 foot in thickness between two adjacent rooms in a room and pillar method of working; *t* is the thickness of the seam in feet; and *y* represents the width of the pillar in feet. *B* represents the rectangular prism of surface strata, 1 foot in thickness that is supported by the pillar *A*. *h* = depth in feet of seam below the surface, and *dc* = the width of the prism in feet, which is the same as the distance between centers of rooms.

Let *x* = width of prism or *dc*, and *z* = weight of 1 cubic foot of the overlying strata in pounds.

Each square foot of the surface strata will exert a pressure equal to the weight of 1 cubic foot of the strata multiplied by the depth of the seam in feet or pressure per square foot of surface = *h z*.

As the prism has *x* × 1 or *x* square feet in its roof area, *h z x* = total weight of prism in pounds

As the total weight of the prism is supported by the pillar, if we divide this weight by the number of square feet in the top surface of the pillar, the quotient will be the weight in pounds supported by each square foot of pillar surface.

$y \times 1 = y$ square feet in surface of pillar.

Then $h z x \div y = \frac{h z x}{y}$ = weight or pressure in pounds supported by each square foot of pillar surface. Assuming that *z* = 160 pounds,

$$160 \div 2,000 = \frac{160}{2,000} \text{ tons per cubic foot of surface.}$$

Substituting this value of *z* = the above equation we have the load in

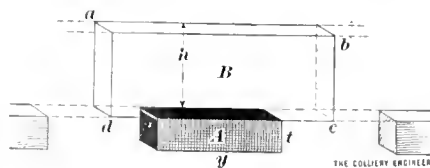

FIG. 4

tons on each square foot of pillar surface represented by the formula

$$L = \frac{160}{2,000} \times \frac{h x}{y} = \frac{160 h x}{2,000 y} \text{ tons. (1)}$$

It has been found by calculation based upon experiments that each square foot of pillar surface will support a pressure according to the following formula,

$$L = C \sqrt{\frac{y}{t}} \quad (2)$$

In which *L* = load in tons;

y = width of pillar in feet;

t = thickness of seam in feet;

C = a constant which has been found to be between 30 and 40, or 35.

As formulas (1) and (2) equal the same thing they will equal each other.

$$C \sqrt{\frac{y}{t}} = \frac{160 h x}{2,000 y}$$

Assuming the distance between room centers, or *x*, to be 60 feet and

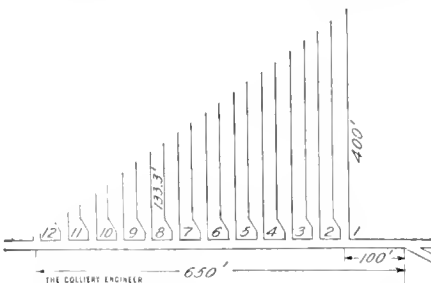

FIG. 5

the thickness of seam to be 5 feet, and substituting the other known values, our formula for a depth of 300 feet becomes

$$35 \sqrt{\frac{y}{5}} = \frac{160 \times 300 \times 60}{2,000 y}$$

Solving this equation $y = 20.38$ feet.

Then, $\frac{60 - 20.38}{60} = \frac{39.62}{60} = 66$ per cent. of coal to be taken out.

For the same thickness of seam and same distance between room centers, the widths of pillars for different depths are proportional to the cube roots of the squares of the depths.

$$20.38 : y' :: \sqrt[3]{(300)^2} : \sqrt[3]{(500)^2}$$

$$y' = 28.4 \text{ feet} = \text{width of pillar for 500 feet of depth.}$$

$$\frac{60 - 28.4}{60} = \frac{31.6}{60} = 52\frac{2}{3} \text{ per cent. of coal to be taken out.}$$

$$20.38 : y'' :: \sqrt[3]{(300)^2} : \sqrt[3]{(700)^2}$$

$$y'' = 35.86 \text{ feet} = \text{width of pillar for 700 feet of depth.}$$

$$\frac{60 - 35.86}{60} = \frac{24.14}{60} = 40 \text{ per cent. of coal to be taken out.}$$

I. C. PARFETT, Jerome, Pa.

QUES. 23.—A mule serves a panel of 12 rooms in 6-foot coal. The parting is 100 feet from the first room, and all loaded cars, holding 2 tons each, go to it. Assuming the length of the rooms to be 400 feet when worked out, that the rooms are 20 feet wide, and the pillars 30 feet wide, what distance will the mule travel to collect 160 tons of coal in 10 hours?

ANS.—In this problem I assume that the first room is just being completed and the twelfth or last room in the panel, just being opened, as shown in Fig. 5. Also that each room has the same output and all rooms demand the same number of cars. First room gets first car, etc.

There are 160 tons of coal to be gathered from this panel in 2-ton cars, which means 80 cars per day. This number is not a multiple of 12, therefore, some of the first rooms will have more cars than the latter ones. For the first 72 cars each room gets six and the last eight cars are given to the first eight rooms.

It is 100 feet from parting to first room neck and 650 feet to the last room neck, so the distance to the average room neck is $(650 + 100) \div 2 = 375$ feet; average depth of room 200 feet, making average dis-

tance from room face to parting 575 feet. The mule travels double this each trip or 1,150 feet, and there are 72 such trips = 82,800 feet. The average distance from parting to face of rooms in the first 8 rooms is $(100 + 450) \div 2 + (400 + 133\frac{1}{3}) \div 2 = 542+$ and doubled = 1,084 and eight such trips = 8,672. $82,800 + 8,672 = 91,472$ feet or $17\frac{1}{3}$ miles traveled per day.

W. E. HOBSON,
315 E. Maxwell St., Lexington, Ky.
Second Prize, I. C. Parfett, Jerome, Pa.

QUES. 24.—On a straight track in good condition, having 1-per-cent. grade, a mine locomotive can haul 14 times its weight. The haul is 4,000 feet, and the number of loaded cars to be hauled daily is 600 in an 8-hour shift. (1) How many cars should be in a trip, the total weight of car and coal being 4,200 pounds, and having a frictional resistance of $6\frac{1}{2}$ pounds per ton of 2,000 pounds? (2) What should be the weight of the locomotive? (3) The law allows a speed of 10 miles an hour; what speed will the locomotive require?

ANS.—Assume the grade against the loads. The rated speed of most mine motors is 6 miles an hour, which is fast enough. $4,000 \times 2 \times 60 \div (6 \times 5,280) = 15\frac{5}{8}$, say 16 minutes. Allow 5 minutes for switching and bringing the trips up to speed, $16 + 5 = 21$ minutes for one round trip. $8 \times 60 \div 21 = 22\frac{6}{7}$, say 23 trips. $600 \div 23 = 26\frac{2}{3}$, say 27 cars per trip. $4,200 \times 6\frac{1}{2} \div 2,000 = 13.65$ pounds friction per car. $4,200 \times .01 = 42$ pounds for each car due to 1-per-cent. grade. $42 + 13.65 = 55.65$ pounds total drawbar pull for each car. $27 \times 55.65 = 1,503$, nearly, total drawbar pull required of motor. $27 \times 4,200 \div 14 = 8,100$ pounds, weight required for motor. A Jeffrey motor, 4 tons, 35 horsepower, 6 miles per hour, has a drawbar pull of 1,520 pounds up a 1-per-cent. grade. This is slightly under weight but will do.

G. N. PFEIFFER
Box 332, Eagle Pass, Tex.
Second Prize, I. C. Parfett, Jerome, Pa.

The Combustion of Oxygen and Coal Dust in Mines

*By James Ashworth**

A paper on this subject has been read very recently by Mr. W. C. Blackett, the President of the North of England Institute of Mining and Mechanical Engineers, and has raised an interesting discussion. It is not the writer's purpose in these few remarks to consider this subject as a whole, but simply to select from it a few novel points. Mr. Blackett says: "It is quite possible that there are expedients which in certain circumstances would prevent ignitions, but these have not yet been tested, and would, as a matter of fact, be unnecessary, if incombustible dust were used, on the principle that the greater contains the less. It has, however, been found that the conditions to start a coal-dust explosion must be so exact that very little departure therefrom spells experimental failure. It will, he thinks, be eventually proved that without any concussion wave in the air, a large body of flame will be required to fire coal dust, while much less flame will suffice if there is also a wave."

Mr. Blackett also introduced into this paper a direct suggestion for a discussion on the topic, as to whether or not the stoppings put into the cutthroughs in a mine, should be put in so strongly that they could not be blown out by an explosion. He himself suggests that the violence of an explosion might be reduced and its progress to some extent arrested and brought to an end, if the stoppings gave way and allowed the force to expand.

In the course of the discussion Doctor Haldane suggested that a reduction of the oxygen content of mine air below the $17\frac{1}{2}$ per cent. as suggested by Doctor Harger would have a tendency to produce "mountain sickness."

The gentlemen discussing the paper did not, as also the author, favor the idea of any easy means of

reversing the air-current in a mine, but there was a general agreement that dusting a mine with incombustible dust, especially flue dust, was a better protection than watering and spraying. Probably the most interesting fact brought out by the discussion, came from Mr. H. W. G. Halbaum, who is well known as an introducer of matters which involve original thought. He did not belie his reputation and probably startled some engineers by stating that he had seen coal dust fired by a jet of compressed air without any flame being present. He had hoped that he might with the assistance of others get at what was at that particular time, an unaccountable occurrence. He had been in communication with Drs. Bedson and Wheeler, but he had not heard that any success has as yet been attained in reproducing the conditions and obtaining the same results by experiment on the surface. Mr. Halbaum further said that he had dropped any further investigations owing to the unfortunate fact that some of the British Home Office staff, who had been taken into consultation on the matter, thought that the interests of safe coal mining would be better served by getting up a case for the prosecution of the management rather than to give their time to the investigation of such extraordinary phenomena and the discovery of how to prevent their reoccurrence.

This appears to be a most regrettable action on the part of the government authorities, and is on a par with an extremely serious disaster which occurred at the Auckland Park collieries, Durham, England, in the Harvey seam, in October last. No person was in the mine, but an explosion occurred which wrecked the mine, especially No. 1 district, and burned and killed 45 horses. All that is known is that there was a very heavy fall of roof in the main gangway. This was at first thought to have damaged an electric cable which was buried under the fall. On cleaning up the fall this cable was found to be perfectly sound in

*Consulting Engineer, Vancouver, B.C.

every respect, and the cause of the disaster still remains a mystery, and thus adds one more to an accumulating list of colliery disaster mysteries.

Air percussion having been generally tabooed and treated as a myth, engineers have preferably accepted theories that required falling rocks to strike fire and thus exploded mixtures of gas and air. In the Auckland Park case, however, the roof was of too soft a "post" nature to support such theory.

Another "mystery" which has not excited much interest in coal mining circles was the explosion at the Killingworth colliery, in New South Wales. A Royal Commission investigated this case, and not one single expert or government official could put forth any theory which would reasonably account for the disaster. This again was a case in which no person was underground, and only one horse was killed and unburned. The force exerted was however greater than was ever before developed by a colliery explosion, thus a weight of material consisting of loaded mine cars, ropes, and cages, was forced up a vertical shaft 620 feet deep, and rolled up in a bunch in the head-gear. The weight of this was from 10 to 11 tons. The flame of the explosion went into every district of the mine, and the effects of air percussion were in distinct evidence.

Many experiments have been made to ascertain the lowest ignition point of mixtures of firedamp and air, and of coal dust suspended in the air, but every one of these have been higher heats than have been demonstrated by actual disasters, thus at the Frick works at Brookfield, the Bristol recorder at the moment of the explosion showed that the heat did not exceed 280° F.

The writer would like to see this class of investigation taken up and discussed in a practical way. Doubtless many of the readers of *THE COLLIERY ENGINEER* will assist such an inquiry by relating facts within their own experience.

It frequently happens after a man has seen some out of the way and extraordinary occurrence, that he is afraid to state the facts for fear of being told that he was suffering from some illusion.

Whilst referring to coal-mine mysteries the writer might draw attention to another case, which occurred at the Valley Field colliery, in Scotland, in 1911. Here two men were driving a level and in the course of doing so disclosed a fault running across the face, and a very strong blower of gas. This gas came off with such force as to bury the men in fine dust before they had a chance to escape. The body of one of the men was found to be blistered underneath his clothes. No inquiry appears to have been made into the cause of this blistering, and it will be interesting to know if there are any other similar instances known or recorded. Presumably there was sufficient heat to cause blistering of the skin, and if so the heat must have been the result of friction between the stream of escaping gas and the sides of the hole through the solid coal.

Taking this occurrence into consideration alongside the one quoted by Mr. Halbaum are we to assume that the friction of escaping gas or compressed air may under certain at present unknown conditions create a flame and thus initiate an explosion?

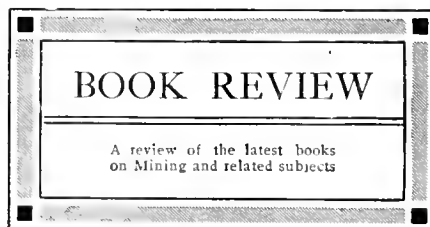

AGRICOLA DE RE METALLICA. Agricola wrote the first comprehensive book on mining and metallurgy, a task which occupied 25 years before it reached the printer's hands in 1553, and then it did not appear until a year after his death in 1555. Herbert Clark Hoover, A. B., and Lou Henry Hoover, A. B., have translated Agricola's wonderful De

Re Metallica from the first Latin edition of 1556. This translation is as near a reproduction of the original as it is possible to make it, even to vellum cover, size of type, illustrations, and paper. There are 640 13¼" × 18¼" pages in the book, including index. It abounds in information which shows the up-to-date reader how slowly the mining and metallurgical sciences have advanced.

Georgius Agricola, S. D., was born at Glauchau, in Saxony, March 24, 1494, when, through the aid of the printing press there was a revival of learning and an awakening from the physical to the intellectual efforts of man. Civilization increases in proportion to the ability of a people to make use of its natural resources, and from what we find in Agricola it appears that the rise of the Roman Empire was due to working its natural resources, and its fall to neglect to keep them working.

The real name of Agricola was George Bauer and it is presumed that his teachers Latinized his name as was the custom of the time.

Agricola graduated from Leipsic with the degree of B. A. in 1514. After studying philosophy, medicine, and the natural sciences in Italy and elsewhere, he became town physician at Joachimstahl. The S. D. after his name is assumed to mean "some doctor." Eckley B. Coxe owned one or two original copies of Agricola, and probably they are at Lehigh University, as he donated his library to that institution.

The book is published by *The Mining Magazine*, London, England, but can be ordered through *THE COLLIERY ENGINEER* on receipt of the price, \$6.25. The duty is \$1.35.

"CALCULUS" is the name of a book written by Messrs. William S. Franklin, Barry MacNutt, and Rolling L. Charles, of Lehigh University, South Bethlehem. By putting correct emphasis on the fundamentals the authors have embodied a humane element (or possibly chris-

tian fortitude would be better, since most college textbook writers on higher mathematics seem to think abstruseness shows erudition) that will cause enthusiasm among students rather than physical collapse. The knotty problem of calculus is presented so plainly that a slow thinker can see that calculus is not an artificial subject devised to give students the headache. The book contains 253 pages, 123 illustrations, and is so interesting one man says he received it in the morning and read it before dinner. Now if the book will appeal to an expert mathematician in this manner it should certainly appeal to mathematical professors at large.

DIGEST OF COMPENSATION LAWS. A digest of the various workmen's compensation laws that have been adopted in the various states has been prepared by the National Association of Manufacturers. The following appears in the Preface. "Workmen's compensation legislation has come to stay. To stand in the way of equitable laws is worse than folly. Humane as well as economic considerations demand the early adoption of workmen's compensation laws in every state of the Union. If the progressive elements among legislators, employers, wage workers, insurance experts, and the public at large do not settle this problem in an economic, efficient, and humane fashion, it will be settled for us with a vengeance by the demagogue and agitator. Thirteen states have already enacted workmen's compensation laws of one kind or another. There is little uniformity among these laws and their respective merits are problematic. Reasonable uniformity is an essential requirement to the future success of workmen's compensation legislation in the United States. There is nothing that will promote uniformity and progress more than a general knowledge of laws already enacted. This booklet, giving a complete but concise digest of details of each state law as compared with similar ones in the laws of

other states, should be in the hands of every progressive legislator, writer, employer, employe, insurance expert, and every student of this important problem.

During the two years past a large number of bills, concerning compensation to injured workmen, have been presented to the State Assemblies for enactment. As many as ten different employers' liability and workmen's compensation bills were thus presented at the 1911 session of one State Assembly. There were a total of about two hundred such bills presented at the 1911 sessions of the State Assemblies. Thirteen of the states have enacted compensation laws. Commissions have been appointed in a number of the states, for the purpose of drafting workmen's compensation bills to be presented for enactment at the next sessions of the State Assemblies.

It is quite evident, after a careful study of the large number of bills presented for enactment, that the persons who drafted those bills were, for the most part, uninformed, even as to the fundamental principles necessarily involved in the subject of workmen's compensation. As to the compensation laws enacted, there is but little uniformity between them. They all differ as to their minor features, but it is possible to divide them into two classes, to wit: those laws which provide state insurance: those laws which place the burden upon the employer to compensate the injured employe. So great is the volume, and so varied the subject matter of these laws that the busy legislator, lawyer, employer, and employe cannot spare the time to read them.

The purpose of this work is to give to such persons a synopsis of the important features of each law so arranged that a comparison of the laws can be made in a very short time.

Copies of this digest can be secured at cost; for a library edition the price is 25 cents, for paper cover, 15 cents, and for paper cover in quantities, 10 cents.

AIR COMPRESSION AND TRANSMISSION, by H. J. Thorkelson. Published by McGraw-Hill Book Co., New York City. 200 pages, illustrated, \$2 net. The book is written in clear, simple language and discusses in turn, the characteristics of air, fundamental definitions, energy equations, the various kinds of compression, classification of valves, the effect of altitude upon the power, volume, and capacity of compressors, results of compressor tests, air receivers, the measurement and compression of compressed air, closing with a chapter on the selection and care of air compressors.

The book is intensely interesting and valuable to any one connected with the design or operation of power plants or its transmission.

INDUSTRIAL ARTS INDEX.—The H. W. Wilson Co., compilers and publishers of biographies, indexes to periodicals and other reference works, Minneapolis, Minn., announces the second issue of the Industrial Arts Index.

This issue records the contents of thirty-five periodicals from January 1 to May 1, 1913, as far as they could be obtained. Thirteen new magazines which were not available for indexing in this number, have been selected and will be included in the next issue. The list of magazines to be indexed will ultimately be increased to one hundred.

LAKE SUPERIOR IRON ORE ANNUAL, 1913, contains the official figures on shipments by mines, ranges, and ports, together with complete statistics bearing on the Lake Superior ore shipments since 1844, and ore prices at the lower lake docks. This book, compiled by the *Iron Trade Review*, Cleveland, Ohio, sells for \$1, cloth bound, and \$2 in leather. From an examination of the cost tables it is evident that iron ore can be mined as cheaply in the East as in the Michigan and Minnesota districts, further if the magnetite ores of New York and New Jersey are compared with the Lake Superior ores the percentage of iron will be found favorable as well.

PRACTICAL TALKS ON COAL MINING

For men who desire information on Coal Mining and related subjects
presented in a simple manner

Mine Ventilation

The Quantity of Air Required—Mine Laws and Their Requirements—What
Constitutes a Dangerous Proportion of Gas

(Continued from June)

STRICTLY speaking, the proper ventilation of a mine requires that enough air be carried through it to sweep the faces of all the rooms and entries with a velocity sufficient to dislodge and carry away the gases as fast as they are given off by the freshly mined coal in order to prevent a dangerous accumulation of them in any one place. As the majority of mines do not give off methane to a dangerous extent, it is not necessary or customary to carry the air to the face of each room in American coal mining practice.

In Illinois the law requires in non-gaseous mines, 100 cubic feet of air a minute for each man and 500 cubic feet of air a minute for each draft animal, which is increased to 150 cubic feet of air a minute per man if the mine is gaseous. In Ohio, the requirements are 150 and 500 cubic feet of air per man and per mule, respectively, per minute in non-gaseous mines, and 200 cubic feet per man in gaseous mines. In the bituminous regions of Pennsylvania, the requirements per man per minute are 150 and 200 cubic feet in non-gaseous and gaseous mines, respectively; and in the anthracite districts of the same state, 200 cubic feet of air per minute must be supplied each man, whether the mine be gaseous or not. It will be noted that the Pennsylvania law makes no allowance of air for the mules, and such an allowance is really not necessary, because that made for the

entire number of men in the mine is so very much more than they can possibly consume, there will always be an ample supply left over for the mules.

It will be noted that the state laws recognize the difference between the amount of air required to ventilate a non-gaseous and a gaseous mine by increasing to the extent of 50 cubic feet of air a minute the amount of air to be supplied each man in workings of the latter class. This does not mean that a man requires for breathing this much more air in a gaseous than in a non-gaseous mine, but that this much extra air is supposed to be enough to carry off the increased amount of explosive gas. Thus, 100 men and 10 mules in a non-gaseous mine in Illinois must be supplied with $(100 \times 100) + (10 \times 500) = 15,000$ cubic feet of fresh air per minute; if the mine is gaseous, then they legally require, $(100 \times 150) + (10 \times 500) = 20,000$ cubic feet per minute. The difference, or $20,000 - 15,000 = 5,000$ cubic feet per minute, is supposed to be enough under ordinary conditions to dilute the methane below the explosive point. Of recent years it has become recognized that it is impossible to say just how many cubic feet of air per minute per man are necessary to carry away the methane given off by the mine. It is real-

ized that some mines will require a total, say, of 100,000 cubic feet of air a minute to carry away this gas, and in others 5,000 cubic feet will answer, so that, recently enacted laws, after fixing the minimum (the smallest) amount that may be circulated in each class of mine, have a clause attached which leaves the determination of the actual amount to be supplied to one or more of the state mine inspectors. Thus, quoting the 1911 law of Pennsylvania: "In a non-gaseous mine the minimum quantity of air shall not be less than 150 cubic feet per minute for each person employed. In a mine wherein explosive gas is being generated in such quantities that it can be detected by an approved safety lamp, the minimum quantity of air shall not be less than 200 cubic feet per minute for each person employed therein, *and as much more in either case as one or more of the inspectors may deem requisite.*" (NOTE.—The italics are ours.) In some laws, the part in italics is changed to read, "*and as much more as may be necessary to dilute, render harmless, and carry off any and all noxious gases.*" Hence the Pennsylvania law means that where no gas is given off there must be supplied not less than 150 cubic feet a minute for each man. There must not be less but there may be any amount more that the state mine inspector may think necessary. Similarly, if the mine is gaseous, the

law requires not less than 200 cubic feet for each underground employe, but the state inspector may increase this to any extent local conditions require.

One uncertainty in these laws is the distinction to be made between a gaseous and a non-gaseous mine. The bituminous mine law of Pennsylvania should be clear on this point as it is the most recently enacted; but it is, unfortunately, no plainer than that of other states. In Pennsylvania a mine is gaseous when "explosive gas is generated in such quantities that it can be detected by an approved safety lamp." But after this the law is silent and does not say what an "approved" safety lamp is, nor who shall use it and when and where. Now it is a well-known fact that safety lamps vary widely in the cap given by different amounts of gas. Some specially constructed lamps will give a larger cap with 1 per cent. of gas than others will with 2 per cent. As pointed out earlier in this series of articles, even 1 per cent. of gas is a dangerous amount if the mine contains a finely powdered explosive dust, and, as further shown before, this dust is present in practically all bituminous coal mines. Hence, under the laws of Pennsylvania, one lamp will show that the mine is non-gaseous and safe and another lamp, both of them "approved," will show that it is gaseous and unsafe.

Similarly, on the return airway many mines will show traces of gas when none can be detected in the workings. This does not mean that there is no gas in the working places, but so little that it cannot be detected by a lamp, and that when all the gas from all the workings is concentrated in the return, a very decided cap is visible.

Finally, men differ in the amount of gas they can detect with the ordinary approved safety lamp. It has been shown repeatedly that less than 2 per cent. cannot be detected by the average fire boss. The claim that as little as 1 per cent. may be detected is not founded upon actual

tests but upon the opinion of some one. As the amount of gas in the mine air can easily be determined by a chemist, opinions and guesses should have no weight in such important matters.

Owing then, to the uncertainties of the results obtained by the use of the ordinary safety lamp in the hands of the ordinary man, and to introduce a fixed standard of safety, what may be called the modern idea of ventilation has come into existence. According to the best modern practice in Europe and the United States, a mine should be supplied with sufficient air, whether it be 25 or 250 cubic feet of air per man per minute, to sweep away the powder smoke and the gases given off by men and animals, and as much more as may be necessary to keep the amount of methane in the

return air-current as determined by chemical analysis, well below 1 per cent. By the exact methods of chemistry it is possible to determine at any and all times just how much dangerous gas there is in the return and thus be entirely independent of the uncertain results afforded by the "approved" safety lamp. To sum up, modern methods of ventilation demand that enough air be supplied to keep the mine air of the same chemical composition as that of the pure outside air. As this is not always possible, enough air must be supplied to keep the composition of that in the mine such that it is not injurious to health when breathed and does not contain enough methane to lend itself to a dust explosion. And what is enough air is determined by the chemist and not by the safety lamp.

(To be continued)

Mechanics of Mining

An Explanation of the Principles Underlying Calculations Relating to Engines, Pumps, and Other Machinery

By R. T. Strohm, M. E. (Continued from June)

A MACHINE that is frequently used for lifting loads is the wheel and axle, a very simple form of which is shown in Fig. 22. It consists of two cylindrical parts *a* and *b* of different diameters but having their center lines in the same straight line. A rope *c* is fastened to the smaller part *a* and is

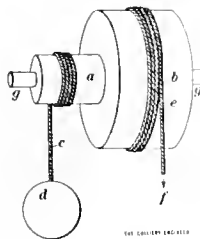

FIG. 22

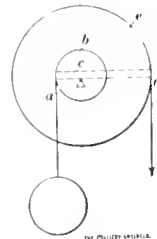

FIG. 23

wound around it several times, and the load *d* to be lifted is attached to the free end. Another rope *c* is fastened to the larger cylinder *b* and is wound around it in the opposite direction, and the lifting force is applied at the free end *f* of this rope.

The force of the pull at *f* causes the wheel and axle to turn in the bearings *g* on which the machine is supported. The rope *c* then unwinds from the larger cylinder and the rope *c* winds on the smaller cylinder, raising the load in so doing.

An end view of the wheel and axle in Fig. 22 is shown in Fig. 23 in the form of a simple diagram or outline. The load, pulling downwards at *a*, tends to turn the axle *b* to the left, around the center *c*, and the force acting downwards at *d* tends to turn the wheel *c* to the right. The effect is the same, therefore, as would be produced if a lever were used, as shown by the dotted lines. The fulcrum of the lever is at the center *c*, the load hangs from the end of the short arm, and the force is applied at the end of the long arm. The force required to lift a given weight therefore depends on the relative lengths of the arms of the lever. If the force arm is three times as long as the load

arm, the load lifted may be three times the force; or, if the force arm is five times as long as the load arm, the load may be five times the force.

The long arm of the lever is equal in length to the radius, or half the diameter, of the wheel, and the short arm of the lever is equal in length to the radius, or half the diameter, of the axle; consequently, if the diameter

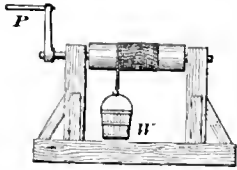

FIG. 24

of the wheel is three times that of the axle, the force required will be only one-third of the weight of the load. The advantage of the wheel and axle is that it enables a small force to overcome a much larger load.

As in the case of the lever and the pulley, however, the foregoing advantage is offset by a loss of time; that is, the load rises much slower than the force descends. Suppose that the diameter of the wheel is three times the diameter of the axle, and that these two parts, turning together, make one complete revolution. In doing so, one turn of rope is unwound from the wheel and one turn is wound on the axle. But the length of one turn of rope on the wheel is equal to the circumference of the wheel, or 3.1416 times its diameter; and the length of one turn of rope on the axle is equal to the circumference of the axle, or 3.1416 times its diameter. As the diameter of the wheel is three times that of the axle, the circumference of the wheel is three times that of the axle. Consequently, the length of rope unwound from the wheel in one turn is three times the length wound on the axle in one turn; that is, the force moves three times as far as the load moves in the same time, or the load moves at one-third the speed of the force.

The only purpose of the rope *e* wound on the wheel, Fig. 22, is to furnish a means by which the lifting force may act to turn the wheel; but it is not necessary to use a large cylinder and a rope to accomplish

this. Suppose that the one end support of the axle is lengthened and that a crank, or arm, is fastened to it; also that the wheel is removed and that it is replaced by a second end support for the axle. The resulting machine is then like that shown in Fig. 24, and is known as a windlass.

In the windlass, the force *P* that causes the load to rise is applied to the handle at the end of the crank. This force follows the crank as the latter turns, and therefore acts in a circle. However, if the length of the crank is equal to the radius of the wheel in Fig. 22, and if the axle and the load *W* in Fig. 24 are of the same size as the axle and the load in Fig. 22, the same force will be required in each case. For in each case the force will act at the same distance from the center of the axle; that is, the force arm of the windlass will be equal to the force arm of the wheel and axle, and the turning effort will be the same.

The windlass is one of the simplest and most commonly used forms of hoisting machine, particularly where weights are hoisted by hand power. The ease with which a given load may be raised may be increased by lengthening the crank to which the handle is fixed or by decreasing the size of the axle on which the rope winds. The first method increases the force arm and makes the force travel farther for a given rise of the load. The second method decreases the weight arm and makes the load rise a shorter distance for a given travel of the force.

If the wheel and axle or the windlass is so arranged that the force arm is longer than the weight arm, the speed of the load in rising will be less than that of the force, but the force required will be less than the load. This is the condition of affairs shown in Figs. 22 and 24. If it is desired to have the load rise much more rapidly than the force moves, then the force arm is made shorter than the weight arm.

A simple diagram of a hoisting engine using this principle is shown in Fig. 25. The steam in the cylinder *a* causes the rod *b* to move to and fro,

and by means of a connecting-rod *c* this motion is transmitted to the crank *d*, causing it to turn. The crank is fastened to the shaft *e*, to which the drum *f* also is fixed, so that the motion of the engine turns the drum in the direction of the arrow. One end of a rope *g* is fastened to the drum; and the rope is carried over a sheave *h*, the load *i* to be lifted being attached at the other end. The turning of the drum winds the rope on it and causes the load to rise.

The sheave *h* is merely a fixed pulley and alters the direction of the pull of the load but does not alter the amount of the pull. This pull, equal to the weight of the load *i* is exerted at the point *j* on the drum, and the distance from the center of the shaft *e* to the point *j* where the rope starts to wind on the drum is the load arm.

The force exerted by the engine acts on the pin *k* at the end of the crank, and the greatest length the force arm can have is the length of the crank, or the distance from the center of the pin *k* to the center of the shaft *e*. As the crank is much shorter than the load arm, the load will rise much faster than the pin *k* moves; but the force applied at the pin *k* to turn the drum will need to be much greater than the weight of the load. A hoisting engine in which the crank is fastened directly to the shaft that carries the drum, as in this illustration, is called a first-motion hoisting engine.

Another machine that uses the principle of the wheel and axle in

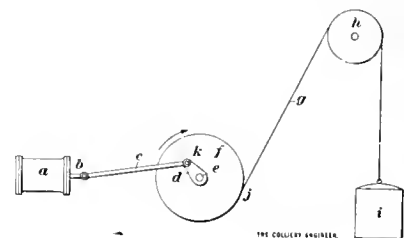

FIG. 25

connection with that of a movable pulley is the differential chain hoist shown in Fig. 26. Two iron pulleys of slightly different diameters are fastened on the same axle, so that they must turn together at the same rate, and this axle is supported by a

frame attached to a stationary support. An endless chain is passed over these pulleys, as shown, forming two loops, and a single movable pulley is placed in one of the loops. The weight to be raised is hung on the hook attached to the movable pulley, and when the right-hand part of the free loop is drawn downwards, the load is slowly raised. The grooves



FIG. 26

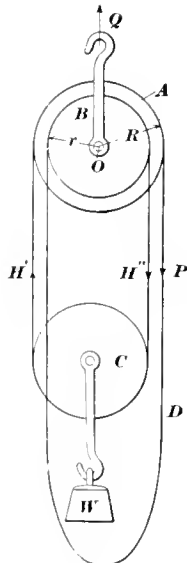

FIG. 27

of the upper pair of pulleys have notches and teeth in which the links fit, thus preventing the chain from slipping.

A diagram of the arrangement of the pulleys, chain, and load is given in Fig. 27. The load *W* on the pulley *C* is carried by the two parts *H'* and *H''* of the chain, each of which takes half of the load. The force is applied downwards at *P* on the part *D* of the free loop, and this causes the pulleys *A* and *B* to turn with the axle *O* held in the stationary frame supported at *Q*. Now, when the chain is drawn down at *P*, the part at *H'* is drawn upwards at the same speed over the larger pulley *A*, which turns with the chain. But the pulley *B* turns with the pulley *A*, and unwinds the part *H''*. If the part *H'* went upwards just as fast as the part *H''* went downwards off the pulley *B*, the pulley *C* and the load would not move. However, the pulley *A* is larger than the pulley *B*, for its radius *R* is greater than the radius *r* of the pulley *B*; therefore the chain

will wind up over the large pulley *A* somewhat faster than it will unwind off the smaller pulley *B*, and as a result the load will be raised.

Suppose that the diameter of the pulley *A* is 12 inches and of the pulley *B* is 11 inches, and that the force *P* moves downwards a distance equal to the circumference of the pulley *A*, or $3.1416 \times 12 = 37.6992$ inches. The pulleys *A* and *B* then make one complete turn, and 37.6992 inches of chain go up over the pulley *A* while $3.1416 \times 11 = 34.5576$ inches come down off the pulley *B*. This means that the total shortening of chain

between the upper and lower pulleys is $37.6992 - 34.5576 = 3.1416$ inches. As this is taken up by the two parts *H'* and *H''* of the rope, each is shortened $3.1416 \div 2 = 1.5708$ inches, and the load is raised this amount. While the force moves 37.6992 inches, the load moves 1.5708 inches, and as $37.6992 = 24 \times 1.5708$, the force moves 24 times as fast as the load; therefore, the load raised can be 24 times as great as the force applied at *P*, if the pulleys are 12 and 11 inches in diameter. If other sizes of pulleys are used, these values will change.

(To be Continued)

Electricity in Mines

Influence of Size of Conductor on Resistance—Resistances of Different Materials—Voltaic Cells

By H. S. Webb, M. S. (Continued from June)

IF the sectional area of a conductor be doubled, its resistance will be halved; if the sectional area be halved, the resistance will be doubled; an increase in the sectional area will cause a decrease in the resistance; a decrease in the sectional area will cause an increase in the resistance.

To calculate the resistance of a conductor after its sectional area has been changed, use the following rule:

RULE.—Multiply the original sectional area and resistance together and divide by the changed value of the sectional area.

EXAMPLE.—1,000 feet of copper trolley wire having a sectional area of 66,000 circular mils, has a resistance of .16 ohm; what will be the resistance of the same length of copper trolley wire having a sectional area of 133,000 circular mils?

SOLUTION.—

$$\frac{66,000 \times .16}{133,000} = .0794 \text{ ohm.}$$

In most cases, both the length and sectional area of a conductor are subjected to change; in such a case, each change affects the resistance as independently as if the other change

had not taken place, and their effects can be considered separately.

EXAMPLE.—The resistance of 1,000 feet of rail steel of 1 square inch sectional area is .085 ohm; what will be the resistance of 1 mile of steel rail of 6 square inches cross-section?

SOLUTION.—One mile equals 5,280 feet; hence, according to the rule, the changed resistance due to change in length is

$$5,280 \times \frac{.085}{1,000} = .449 \text{ ohm.}$$

According to the rule, the further changed value due to increase in sectional areas is

$$\frac{1 \times .449}{6} = .0748 \text{ ohm.}$$

Resistance of Different Materials. Conductors of the same dimensions and material have the same resistance, except in so far as it may be affected by impurities and temperature. Conductors of the same dimensions but of different materials have very different resistances. For example, 1,000 feet of pure copper wire having a sectional area of 8,234 circular mils has a resistance of 1.257 ohms at 20° C.; an iron wire of the same dimensions and

temperature might have a resistance as high as 8.75 ohms. The conductors used in railway work are copper, aluminum, iron or steel, German silver, and carbon. Assuming all pieces to be of the same dimensions and temperature, the piece of aluminum will have a resistance of from 1.7 to 1.8 times that of the copper; iron or steel, 6.5 to 8 times; German silver, 18 to 27 times; and carbon, 2,000 to 4,000 times. For an iron conductor to carry the same current as a copper one under the same conditions, its sectional area must be $6\frac{1}{2}$ to 8 times greater; aluminum, 1.8 times greater; and so on.

Change of Resistance With Change in Temperature.—The resistance of all conductors changes with the temperature. In the case of carbon and water or other conducting liquids, an increase in temperature causes a decrease in resistance; but with all metallic conductors, an increase in temperature causes an increase in resistance. In comparing the resistances of different substances, it is essential that they be compared at equal temperatures.

Wire Gauge and Table.—Wire used in electrical work is generally designated by its gauge number; the gauge almost universally used, in America, for copper wire is known as the American, or Brown & Sharpe (B. & S.), gauge. The sizes according to this gauge vary from No. 0000, which is .46 inch in diameter, to No. 40, which is .003145 inch in diameter, the higher the gauge number the smaller being the wire.

In complete courses and hand-books tables are given which show the dimensions, weight, resistance, etc., of the various sizes of bare copper and iron and other wires according to the various gauges.

A convenient size to remember as a standard is No. 10 wire gauge, which is a little over $\frac{1}{16}$ inch in diameter. For rough estimates, its area can be taken as 10,000 circular mils and its resistance as 1 ohm per 1,000 feet. If one remembers these

facts regarding No. 10 wire he will at once know that No. 7 wire, for example, has an area of about $10,000 \times 2 = 20,000$ circular mils and a resistance of about .5 ohm per 1,000

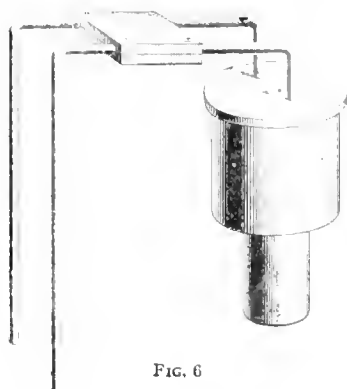

FIG. 6

feet; and that No. 13 has an area of 5,000 circular mils and a resistance of 2 ohms per 1,000 feet. These facts are easy to remember and are convenient when there is no wire table available. When exact calculations are to be made, tables should be used, as the above rules give areas and resistances that are only approximately correct.

Resistance of Conductors in Series. The resistance of two or more conductors connected in series is equal to the sum of their separate resistances. For example, if four conductors having separate resistances of 8, 12, 22, and 34 ohms, are connected in series, their total resistance will be $8 + 12 + 22 + 34 = 76$ ohms.

Standard Ohm Coils.—For commercial testing, the standard column of mercury, representing the resist-

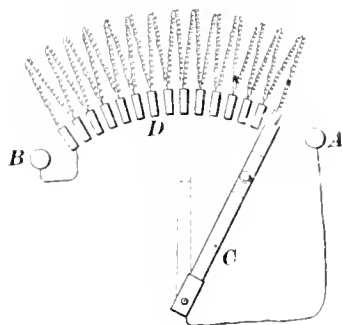

FIG. 7

ance of 1 ohm, has been replaced by a coil of wire, usually a platinum-silver alloy. The coil is carefully adjusted to offer a resistance of exactly 1 ohm at some convenient

temperature, and is enclosed in a metallic case, the connections to the two ends of the coil being made by two heavy terminals of copper wire passing up through the hard-rubber cover. Such coils are known as standard ohm coils. The commercial form is shown in Fig. 6.

Rheostats.—A device called a resistance box, or rheostat, is largely used for controlling the strength of electric currents. The resistance in these rheostats is usually made adjustable by the use of a sliding contact. Fig. 7 shows diagrammatically one form of a sliding-contact rheostat. The coils of resistance wire are connected to a row of contact pieces *D*, as indicated. The current enters the rheostat through the terminal *A*, passes through the movable arm *C*, and then through all the resistance coils between the contact piece on which the arm rests and the terminal *B*. When the arm rests on the right-hand contact piece, as shown by the full lines in the diagram, all the resistance is said to be in circuit; that is, the current passes through all the coils. By moving the arm to the left, toward the terminal *B*, as shown by the dotted lines, the coils connected to the contact pieces that have been passed over by the arm are said to be cut out of circuit, and the current passes through the remaining coils only.

The flow of electricity through a circuit is due to an electromotive force developed, usually at some one point in the circuit. This electromotive force, or electrical pressure, forces electricity to flow in the circuit, in spite of the resistance to its passage offered by the wires and other devices connected in the circuit. The electromotive force may be supplied by a dynamo, storage battery, primary battery, or other source of electric power. If the resistance of a circuit remains the same, a constant electromotive force will cause a uniform, or steady, current to flow through the circuit. The unit of electromotive force will maintain a current of 1 ampere in a circuit whose

resistance is 1 ohm. The unit of electromotive force is called the volt after Alessandro Volta, an Italian physicist, who lived from 1745 to 1827.

The maximum difference of potential developed by any single voltaic couple placed in any electrolyte is about 2.25 volts; in the common form of cells, the difference of potential developed averages from .5 to 1.75 volts. The electromotive force generally employed for operating ordinary surface electric cars is about 500 volts; a railway incandescent lamp requires about 110 volts pressure across its terminals to make it burn to full brightness. On some power-transmission lines, the pressure is as high as 50,000 or 60,000 volts, while the potential of a lightning flash may be several millions of volts.

Voltmeters.—Measuring instruments called voltmeters have been devised for indicating directly, in volts, the values of electromotive forces. The Weston voltmeter, Fig. 8, is based on the same principles as the Weston ammeter, and in appearance is quite similar to it. Its internal resistance, as in all voltmeters, is exceedingly high; the resistance of a Weston voltmeter for indicating up to 150 volts is about 19,000 ohms; while the resistance of a Weston ammeter, measuring strengths of currents up to 15 amperes, is only .0022 ohm. Owing to its great resistance, the current passing through a voltmeter is exceedingly small.

All voltmeters are provided with at least two terminals or binding posts p, p' , Fig. 8. Connections are made by separate conductors, called voltmeter leads, from these binding posts to two points between which the difference of potential or electromotive force is to be measured.

The Weston voltmeters usually have a third binding post p'' , which, when used with p' , corresponds with a second graduated scale situated directly under the main scale, one division of the upper scale having the value of two or more of the lower divisions. In Fig. 8, one division of the upper scale represents ten divisions of the lower scale. The major-

ity of voltmeters are also provided with a contact button b , which, when pressed, closes the circuit and allows the index needle to be deflected by the current. When the pressure on the button is relaxed, the circuit is opened, and the index needle returns to the zero mark.

Voltaic Cells.—A voltaic, or galvanic, cell is an apparatus for developing a continuous current of electricity. A voltaic, or galvanic, battery is a number of single cells properly connected together. A cell consists of two conducting elements immersed in a solution that acts chemically on one element only or on one more than on the other. If the two elements, or poles, of the cell are joined by a continuous metallic wire or circuit, an electric current will flow in one direction through the metallic circuit as long as the cir-

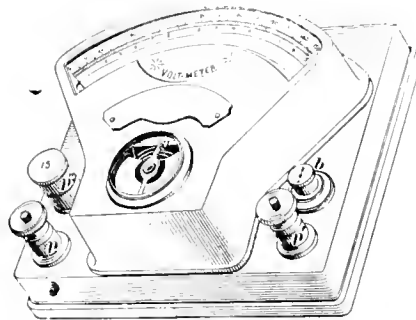

FIG. 8

cuit remains complete or closed, provided the chemical action is sufficient to maintain the electromotive force. The ends of the two elements that project and to which wires external to the cell are connected are called the electrodes. The electrodes are generally provided with screws and nuts, called binding posts, to which wires may be readily connected. Conductors and electrical devices connected together so as to form a closed circuit from one binding post to the other, outside of the cell itself, are called the external circuit. The path through the interior of the cell is called the internal circuit.

One element is usually zinc and the other carbon, copper, or some other metal. The binding post attached to the zinc is the negative terminal, or negative pole, of the cell and the other binding post is the positive

terminal, or positive pole, of the cell. The current always flows from the zinc element through the interior of the cell to the other element, then through the external circuit back to the zinc terminal. If this circuit is broken or open anywhere, no current will flow in any part of this circuit. The solution in the cell is called the electrolyte. In the most commonly used voltaic cells there is little or no chemical action when the external circuit is open, but as soon as the external circuit is closed so that current flows through the electrolyte, chemical action commences, the zinc is gradually consumed by forming a substance that is soluble in the solution and there is a tendency to form hydrogen gas around the carbon or copper element. It has been found that if the formation of hydrogen gas around the positive terminal can be prevented, there is developed a greater electromotive force in the cell. This is accomplished by surrounding the positive terminal with some other material, which is called a depolarizer, because it prevents the formation of an opposing electromotive force, or polarization as it is called, around the positive terminal. This depolarizer may be a solid substance or a solution of some kind.

(To be Continued)

來 來

Reinforcing Collars

Old wire ropes can be used to reinforce collars along roads where the ground is heavy and the renewal of timber is frequently necessary. This reinforcing is accomplished by fastening the wire rope to the under side of the collar by means of staples and also placing the rope around the ends of the collar and fastening it securely on top. Then when the weight comes upon the timber it will press the rope against the collar so as to hold it more firmly, and at the same time the rope is also caught between the leg and the collar. As the collar bends under the weight which it is supporting, the wire rope will be placed in tension and support the collar. It has been found possible to reduce the cost of timbering on some roads 50 per cent. by using this means.

ANSWERS TO EXAMINATION QUESTIONS

Examination for Mine Foreman and Assistant Foreman, March, 1913
and for Inspector of Mines, May, 1913, Held at Pottsville, Pa.

(Continued from June)

QUES. 26.—What are the dangers attending the use of explosives in the presence of each of these gases?

ANS.—Nitrogen, oxygen, and carbon dioxide being incombustible gases neither increase nor decrease the dangers due to handling explosives. The use of explosives when methane is present in the air is attended with danger in proportion to the amount of this gas present. As the dust of anthracite coal is not explosive, the presence of small amounts of this gas need not interfere with the use of explosives in the ordinary way. If greater amounts are present the flame of blown-out shots will begin to lengthen until, when the proper amount of methane is in the air, a gas explosion will result.

QUES. 27.—Under what circumstances may a body of gas fail to be removed after restoring the ventilation?

ANS.—By restoring ventilation, is meant the bringing of it back to the same condition in every way that it was before an explosion. Hence, if there was no standing gas before the explosion there will be none after the ventilation is restored. It is possible that bodies of afterdamp may be found in places which before were sufficiently ventilated, or it is possible that a mass of timbers may have been fired by the explosion, in which case impure gases will be given off by their burning.

QUES. 28.—Has a rising or falling barometer any influence on the ventilation of a mine?

ANS.—A falling barometer means that the pressure of the air upon the working face is less and this allows

more gas to escape from the pores of the coal into the workings. As the barometer rises and the pressure increases, less gas is driven off. The change in weight of the air due to changes in pressure and temperature has a small effect upon the quantity of air delivered by the fan. Anything that increases the weight per cubic foot of the air such as

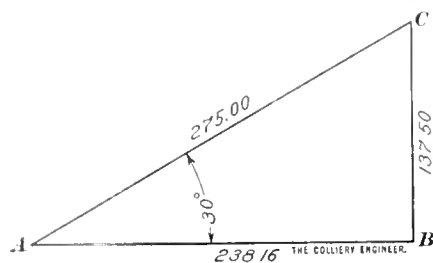

FIG. 4

rising barometer and falling temperature requires that more steam be turned on the fan engine to keep its speed the same, but if the air becomes lighter by reason of a falling barometer or rising temperature, less steam will be needed to keep the speed of the fan as before. In the first case more air will be delivered for the same speed and in the second case, less air.

QUES. 29.—A breast is driven up 275 feet on an angle of 30 degrees, how long would it be on the map, and how much higher would the face of the breast be than the gangway?

ANS.—The length of the breast is line AC shown in Fig. 4, and is equal to slope \times cosine angle of rise = $275 \times \cos 30^\circ = 275 \times .86603 = 238.16$ feet. As mine maps are commonly drawn to a scale of 100 feet to the inch, the length of this breast on the map will be $238.16 \div 100 = 2.38$

inches. The distance of the face above the gangway is represented by the line BC , and is equal to slope \times sine angle of rise = $275 \times .50000 = 137.50$ feet.

QUES. 30.—How much water will be discharged by a pump having a 10-inch water end and 4-foot stroke and making 48 strokes per minute?

ANS.—First find the area of the water end by multiplying the square of its diameter by .7854, then multiplying this by the length of the stroke in inches ($4 \times 12 = 48$ inches), and multiply this by the number of strokes per minute or 48. This gives the discharge in cubic inches per minute which must be divided by 231 to give the number of gallons. Expressed as an equation,

$$\text{Discharge} = \frac{10^2 \times .7854 \times 4 \times 12 \times 48}{231}$$

= 783 gallons per minute. This is the theoretical discharge if everything works perfectly. It is customary to make an allowance of some 15 per cent. for slip, etc.; that is, the efficiency is reckoned at 85 per cent. Multiplying the above theoretical discharge by .85, we have $783 \times .85 = 665$ gallons (about) for the probable actual discharge.

QUES. 31.—How many cubic yards in a tunnel 8 feet by 11 feet and 300 feet long, and what would be the cost of the tunnel at \$5 per cubic yard? Work out fully.

ANS.—The area of the cross-section of the tunnel is found by multiplying the height by the breadth, or $8 \times 11 = 88$ square feet. The number of cubic feet is found by multiplying this area by the length of the tunnel, or $88 \times 300 = 26,400$ cubic feet. The number of cubic feet

divided by 27, which is the number of cubic feet in a cubic yard, gives the number of cubic yards in the tunnel, or $26,400 \div 27 = 977.778$ cubic yards. The number of cubic yards multiplied by \$5, the cost per cubic yard, gives the cost of the tunnel, or $977.778 \times \$5 = \$4,888.89$. Expressed as an equation, $\text{Cost} = \frac{8 \times 11 \times 300 \times 5}{27} = \$4,888.89$.

QUES. 32.—What instruments are required by the mine foreman and his assistants to carry out fully the duties of their position?

ANS.—The anemometer and water gauge to measure the velocity and pressure of the air are the instruments generally accounted as necessary for the mine foreman. To these should be added a tape to measure the cross-section and length of airways, and a watch to time the revolutions of the anemometer. Other useful instruments are a clinometer to measure pitches, and a thermometer, barometer, and hygrometer for measuring the temperature, pressure, and humidity of the air. These instruments and their use have been repeatedly described in these columns in recent months.

Examination for Inspector of Mines Held in Pottsville, Pa., May 5 and 6, 1913.

QUES. 1.—Have you read the Report of the Department of Mines for the year 1913, anthracite region?

ANS.—Yes.

QUES. 2.—What was (approximately) the total production of anthracite for 1911 in gross tons?

ANS.—Approximately, 81,000,000 tons. Exactly, 81,176,050 tons.

QUES. 3.—What was the number of employes, inside, outside, and total, at anthracite mines for the year 1911?

ANS.—Inside, 126,037; outside, 47,301; total, 173,338.

QUES. 4.—How many lives were lost by accidents, inside, outside, and total, at anthracite mines during the year 1911?

ANS.—Inside, 615; outside, 84; total, 699.

QUES. 5.—What were the three highest causes inside and the two highest causes outside, of fatal accidents at anthracite mines in the year 1911, and what was the number killed and the percentage of total fatalities of these causes?

ANS.—Inside: Falls of coal, slate, and roof, a total of 253, or 41.14 per cent.; cars, 92, or 14.96 per cent.; explosions of gas, 34, or 5.53 per cent. Outside: cars, 26, or 30.95 per cent.; machinery, 22, or 26.19 per cent.

QUES. 6.—How many and what percentage of total fatal accidents in the anthracite mines during 1911 were due to electricity? (a) inside; (b) outside.

ANS.—Inside, 2 fatalities, or .32 per cent. of the total; outside, 1 fatality, or 1.19 per cent.

QUES. 7.—What is the number of the anthracite inspection district in which you are now employed, the name and residence of the present inspector and what was the average number of days which the collieries in that district worked during the year 1911?

ANS.—(For illustration only. To be answered according to the residence of the candidate.) Twelfth District, P. C. Fenton, Inspector, Mahanoy City. Average number of days worked, 261.

QUES. 8.—In consideration of the increasing use of electricity in anthracite mines, a mine inspector should have some knowledge on this subject. State to what extent you have studied the subject giving the names of textbooks used.

ANS.—To be answered according to the personal experience of candidate.

QUES. 9.—Name and define the four electrical units that are in common use.

ANS.—The four electrical units in common use are the ampere, volt, ohm, and watt. The ampere is the unit of strength of the electrical current, and expresses the rate of flow of the current per second. It corresponds to the expression of the flow of water through a pipe in gal-

lons per minute or the number of cubic feet of air passing in an airway per minute.

The volt is the unit of electromotive force, and corresponds to the head of water producing a given flow in hydraulics or the pressure procuring a given circulation of air in ventilation.

The ohm is the unit of resistance, and expresses the amount of resistance encountered by a current of 1 ampere under a pressure of 1 volt.

The watt is the unit of power, and expresses the power required to pass a current of 1 ampere under a pressure of 1 volt.

QUES. 10.—What is the practical working difference between a dynamo and an electric motor in their actual application to electric power?

ANS.—The dynamo converts mechanical power, as of a steam engine, into electrical energy; the motor converts electrical energy into mechanical power, which may be used to operate a pump, fan, haulage motor, etc.

QUES. 11.—Describe the danger that attends the use of electricity in and about mines, and state your suggestions to safeguard the workman.

ANS.—The sparking of brushes or the short-circuiting of the current will ignite bodies of gas, explosives, etc. The short-circuiting of the current will also ignite any combustible material such as hay, brattice cloth, wood, etc. Contact with a charged (live) wire, particularly if the current is alternating or of high voltage, will almost invariably result in death. The breaking of the bulb of the small portable electric lamps now in use may result in ignition of gas.

As a means of preventing accidents or of lessening the dangers due to the use of electricity, all currents should be direct and of not over 250 volts. All wires leading down shafts should be carefully insulated and placed in one corner thereof and away from the timbers. All underground structures such as stables, pump houses, shanties, etc., should be of concrete or steel. Oil,

explosives, hay, wood, brattice cloth, and other inflammable substances should not be stored where there is any possibility of their coming in contact with a live wire. Feed-wires should be insulated and carried in some gangway other than that used as a traveling road. Trolley wires should be firmly fixed to the roof or timbers so as to lessen their liability to fall and should be set in an inverted wooden trough, the sides of which project at least 3 inches below the wire. At places where men are compelled to cross the haulage road, the roof should be shot so that the trolley wires may be placed at such a height that men carrying drills, etc., cannot accidentally touch them. Parts of haulage motors and other machines which are apt to spark should, in very gaseous mines, be inclosed in wire gauze as is a safety lamp. Portable electric lamps, if used in gassy places, should be of low voltage and have their light increased by using a better filament, reflectors, etc.

As the majority of accidents are caused by the carelessness of the victim or of those working with him, the men should be cautioned again and again against the probable fatal results from handling wires carrying electric currents.

QUES. 12.—What do the anthracite mine laws of Pennsylvania generally provide for, and what do they apply to?

ANS.—They provide "for the health and safety of persons employed in and about the anthracite coal mines of Pennsylvania, and for the protection and preservation of property connected therewith." They apply to "every anthracite coal mine or colliery in the Commonwealth, provided the said mine or colliery employs more than ten (10) persons.

QUES. 13.—What is required by the mine laws of Pennsylvania to make a person eligible for the office of Mine Inspector?

ANS.—He must be a citizen of the state and at least 30 years of age.

"He must have a knowledge of the different systems of work in coal mines, and he must produce satisfactory evidence to the Board of Examiners of having had at least five years' practical experience in the anthracite coal mines of Pennsylvania. He must have had experience in coal mines where noxious and explosive gases are evolved." The fulfillment of the above conditions makes it possible for him to appear for examination. Before his name is allowed to be printed upon the ballots he must pass an examination into his qualifications and secure a certificate setting forth that he has correctly answered at least 90 per cent. of the questions asked, which certificate must be filed with the county commissioners.

QUES. 14.—Give nine of the principal duties of a Mine Inspector as prescribed in the various acts and amendments thereto in the anthracite mine laws.

ANS.—He shall take an oath or affirmation that he will perform his duties with fidelity and impartiality: He shall provide himself with the most modern instruments and appliances necessary for him to perform his duties: He shall inspect such collieries as the Chief of the Bureau of Mines may direct even if not in his regular inspection district: He must reside in the district from which he is elected and must give all his time and attention to the duties of his office: He must examine all the collieries in his district at least once every 3 months, and as often in addition as the necessity of the case or the condition of the mines may require: He shall see that every necessary precaution is taken to secure the safety of the workmen; that the provisions of the law are obeyed; and shall visit each working face to see that the ventilating current is properly carried to the working faces to properly ventilate them: He shall make a report every 4 months to the Chief of the Department of Mines, designating the gangway in which the working is situated, and the number of the

breast and the condition thereof; which report shall be placed in a weather and dust-proof case, with a glass front and is to be placed at some conspicuous place near each mine opening. In this report he shall certify that the employes are hoisted to the surface or given access thereto according to law: He shall attend every coroner's inquest held upon the bodies of those killed in or about the collieries in his district: He shall visit the scene of every accident for the purpose of enquiring into the particulars thereof: He shall make an annual report to the Chief of the Department of Mines of the Commonwealth enumerating the fatal and serious accidents in his district and the causes of each, the condition of the mines as regards the safety of the workmen therein and the ventilation thereof, the results to be set forth fully: He shall perform such other duties "as now are or hereafter may be required by law."

QUES. 15.—What are the principal requirements of the anthracite mine laws as to "Maps and Plans?"

ANS.—The map shall be made on a scale of 100 feet to the inch and shall show the workings of each seam and the tunnels and passages connecting them. It shall show in degrees the inclination of the strata and any material deflection therefrom as well as the elevation above tide of the bottom of each shaft, slope, tunnel, or gangway, and every other underground or surface point that the inspector thinks necessary. It shall show the number of the last survey station and the date of last survey; the boundary lines of the property and the nearness of the workings thereto; the location of any dam holding back water, with the tidal elevation, inclination of the strata and area of the working containing water. A copy of the map shall be given the district inspector (who may require each seam to be shown upon a separate sheet of tracing cloth), and one copy must be kept at the mine. Extensions of the workings must be added to the

map once every six months, and his copy returned to the inspector within two months of the date of the last survey. When a mine as a whole or any particular lift therein is about to be abandoned, a survey shall be made thereof as a whole and a duplicate and practically agreeing survey must be made of such workings as have been carried to the property line or which it is intended to allow to fill with water. If the owner of the property fails or refuses to furnish the inspector with a map or extensions upon a previous map, the inspector is authorized to have a map made at the expense of the mine owner. If the inspector has reason to believe that the mine map supplied him is materially inaccurate, it is his duty to apply to the Court of Common Pleas of the county for an order to have such a map made, and if such survey shall prove that the original map was inaccurate, the property owner shall pay therefor, but if the map prove accurate then the State shall pay for it. If the owner, operator, or superintendent knowingly furnishes the inspector with a false map, he may be punished by a fine not to exceed \$500 or imprisonment not to exceed 3 months. Maps in the hands of the inspector are the property of the Commonwealth and are to be transferred by him to his successor in office; and no copy of them shall be made without the consent of the owner of the property or his representative. The map in the inspector's possession shall be open to any miner or miners employed at that mine, if he or they have reason to believe that his or their working places are approaching dangerous accumulations of gas or water. The map shall be open to any interested citizen during business hours. Surveys of barrier pillars between adjacent properties must be made in duplicate, and must practically agree. All duplicate surveys, those of barrier pillars as well as of portions of the mine holding water, must be certified to and copies filed with the inspector, and in the case of bar-

rier pillars a certified copy of the duplicate survey must be filed with the owner of the adjoining property.

QUES. 16.—What are the principal requirements of the mine law in regards to boilers and machinery?

ANS.—Boilers must be kept in good order, must be inspected by a qualified person as often as once in 6 months, and a report of their condition shall be certified in writing under oath to the inspector within 30 days thereafter. Boilers shall not be placed within 100 feet of any structure devoted to the preparation of coal provided it has been built since June 2, 1891. Each boiler shall have a safety valve properly adjusted. Every boiler house shall have a steam gauge and another shall be placed in the steam pipe in the engine house where the fireman or engineer can readily examine it. The gauges shall be kept in good order and inspected once in each 6 months and their condition reported to the inspector in the same manner as the report upon the boilers.

All machinery used in or about the mines or breakers shall be protected by a covering or railing, and sides of stairs, trestles, and plank walks shall be provided with a hand and guard rail. However, these protections may be temporarily removed for the purpose of repairs or other operations, provided proper precautions are used. The breaker engineer shall be competent and sober and not under 18 years of age. Signal apparatus shall be placed at important points in the breaker so that the engineer may be signaled to stop the machinery when necessary. No person under 15 years of age shall be employed to oil machinery and no person of any age shall oil it while in motion. No person shall play with, loiter around, or interfere with machinery.

QUES. 17.—Give the duties of a fireman in charge of boilers for generation of steam.

ANS.—He shall keep a constant watch over the boilers and shall see that the pressure does not at any time exceed the limit allowed by the

outside foreman or superintendent. He shall frequently try the safety valve and shall not increase the weight upon it. He shall maintain the proper depth of water in each boiler and if this cannot be done, shall report this at once to whichever foreman is in charge and shall take such other action as may be necessary for the protection of life and property.

(To be Continued)

來 來

Safety First

By John Dunlop*

An abstract from an address entitled "Safety First," from the standpoint of the mine inspector, delivered at the dedication of the mining laboratory of the University of Illinois.

Not in the history of mining has as much consideration been given to the miner's safety as now. The employers of labor realize that their employes must be protected from accidents, and recognize their responsibility in the matter.

Commissioners have been appointed, State Inspectors of Mines in the United States have organized a society, the Federal Bureau of Mines has been established, all for the purpose of the prevention of accidents, and yet, after all the agitation, the many bulletins issued, and the passage of laws, accidents continue. The two principal causes of accidents are falling roof and mine cars.

During the last year 58 per cent. of the fatalities were from falling coal, rock, and clod; and 20 per cent. were due to cars. The surprising causes have varied very little within the last 12 years, and are just as persistent as those given, so that for every 250,000 tons of coal mined there is a life lost.

The number of non-fatal accidents is greater in the long-wall mines in proportion to the number of men employed than in any other mines, but there are fewer fatal accidents. This is accounted for by the

*State Mine Inspector.

height of the seam. If a piece of loose coal or shale is of sufficient weight that its fall will injure a miner in a thin seam it would in all probability kill a man where the seam is 5 feet and over.

To prevent accidents the state inspectors have recommended the employment of a face boss for each 100 men in a mine. The duties of such face bosses would be to visit the working places each shift and instruct the miners in making their places safe, and further to see that the men follow instructions and that timbers are furnished as required. I am fully convinced that where suitable face bosses are employed, the number of all accidents within the mines will be decreased.

The miners object to face bosses, classing them as dictators. During the past year, a number of the large companies have put on face bosses with results that are not as favorable as might be expected.

The official of a coal company that operates two mines furnished the following information: The employment of face bosses at our mines has not been in operation sufficiently long (1 year) to determine positively just what advantage is derived, as the conditions relative to personal injuries are so different from those of last year. The men, taking advantage of the compensation act, are reporting injuries and requiring medical aid when they would not have done so in similar cases a year ago. He presented the following accident list for 1912 and 1913. In No. 1 mine in 1912 there were 3,857 accidents; in 1913, 2,364. In No. 2 mine in 1912 there were 1,378 accidents and in 1913, 1,144. Therefore it can be taken for granted that his statement is correct when he says there are no more accidents but more accidents are being reported.

At his No. 1 mine, the number of accidents reported for the last three months show a decided decrease over those of the first three months of the fiscal year, which are as follows: July, August, and September,

1912, 72; October, November, and December 1912, 46; January, February, and March, 1913, 39.

It is commonly stated that the number of accidents in the coal mines is due to the large number of foreign miners employed; another reason is the change in the method of shooting followed; that is where more than 2 pounds of powder is used for one blast, all shots must be fired by men designated as shot firers. It is further said that the same care is not being exercised by the miners in preparing their shots as when they did their own firing, and that more powder is being used than is necessary, which is the cause of timbers being knocked down and making the roof dangerous.

It is true that fewer tons of coal are being produced per keg of powder from coal shot off the solid, but careful perusal of the reports of the State Inspector of Mines shows that 50 per cent. of the men killed from falling coal and slate are in mines where the coal is undercut by machines and less powder is used than where the coal is shot off the solid.

My own conclusions are that in mines where the coal is undercut, the proper placing of props is being neglected. Where electric mining machines are in use, the props must be placed at a distance from the face to allow clearance and, where the undercutting is 6 feet, the distance is too great, especially where there is a shale roof. Under conditions of this kind, which are general throughout the central and southern portions of the state, props should be placed before the coal is shot and, if face bosses are employed, it would be their duty to see that the place was properly timbered before allowing any shots to be fired. It must not be taken for granted that because the inspectors have recommended that face bosses be employed for each 100 men in the mine, they would be a panacea for all accidents.

The inspectors, by their close contact with mining and because they examine into the causes of all fatal

accidents, have come to the conclusion that closer supervision must be maintained if the number of accidents is to be decreased.

The prevention of accidents from cars was earnestly discussed by the Mine Investigation Commission, and after listening to suggestions of all kinds and considering the feasibility of having a law to prohibit drivers riding on the tail-chains, it was agreed that such a law would not be practical in all cases, so they recommended that in mines opened after the passage of this act, all mine cars should be equipped with bumpers which should project 4 inches beyond the ends of the car. This is only palliative and will not remedy the evil.

Not long ago, I investigated an accident which proved fatal to a driver. I found that he had attempted to go down a grade with a loaded trip without taking time to put in sprags. To prevent the trip running away he undertook to hold it by placing his back against the first car and bracing his feet on the ground. The trip pushed him down the grade, his feet slipped and he fell in front of the car which ran over his body. In this case, it was a matter of speed at the expense of safety.

To prevent accidents to drivers the motto must always be: "More caution and less speed."

We have mine laws which are as good and some much better than those in other states. These cover every phase of the work around the mines, and yet they do not prevent accidents. Observation has taught me that negligence engendered by familiarity with the surrounding conditions is the cause of most mine accidents

來 來

An offer has been made to the Russian Government by the collieries near Irjjustsk, Siberia, to furnish 540,000 tons of coal if a special freight of about 2 mills per ton mile is granted. The railroads are controlled by the government.

NEW MINING MACHINERY

Electric Sinking Pump

A Goulds vertical mine sinking pump, installed in a shaft at 123d Street and Seventh Avenue, New York City, in the Catskill Aqueduct, 475 feet below street level, is shown in Fig. 1.

This is one of seven pumps of this type used by the Pittsburg Contracting Co. on their contract extending from 177th Street, Bronx, a distance of 6 miles into Manhattan. The pumps are in shafts a mile apart.

In five shafts 3½"×6" pumps are used and in the other two 4"×6" pumps are used, delivering from 50 to 60 gallons per minute.

An interesting feature of these installations is that after the pumps were used normally in sinking the shafts, they were installed in a horizontal position, as shown in Fig. 1, and used as station pumps in the tunnel. Although built to be suspended in a vertical position for shaft sinking, they are giving excellent service in a horizontal position as station pumps.

The motors are three-phase, 60-cycle, 220-volt, 10-horsepower Westinghouse induction motors. Power is supplied by United Electric Light and Power Co., of New York City.

New Type of Mine Trolley

As a result of the demand for a mine trolley, differing from the standard lines, a new type, as shown

is less than can be obtained by a single-pole trolley.

With the standard single-pole trolley, where the wire hangs low

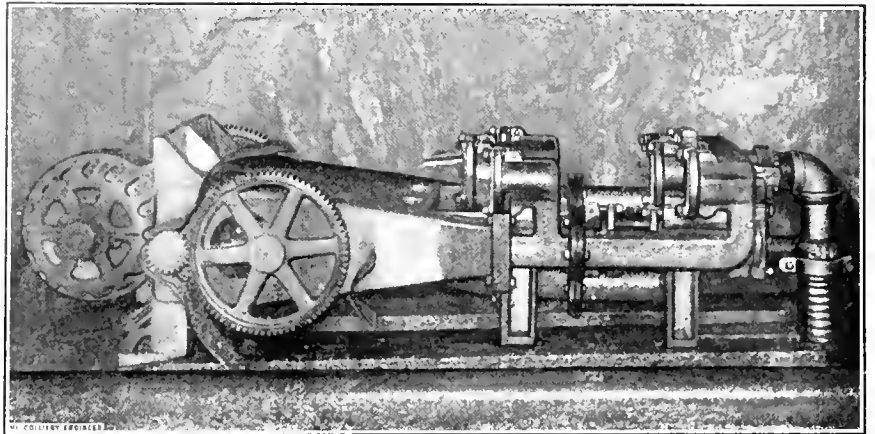

FIG. 1. GOULDS ELECTRIC SINKING PUMP INSTALLED AS A STATION PUMP

in Fig. 2, has recently been placed on the market.

The design is such that there is little variation in the contact pressure where the trolley wire is suspended at different heights. When the wire is 5 feet from the top of the rail, the trolley wheel pressure is approximately 26 pounds, while at 11 feet it is about 18 pounds. This shows a variation of 8 pounds through a range of 6 feet, which

and extreme pressure is exerted, the pole is often damaged when the wheel leaves the wire and strikes the roof. The new trolley under these conditions, owing to the slight variation in pressure throughout the wide range in height, will be less liable to break. This slight variation makes it unnecessary to resort to the heavy pressure for low trolley wires, with the result that the wear at the wheel and harp will be less than that caused by the single-pole trolley.

In coal mines where the condition of the roof is such that narrow entries are necessary, it is often impossible to run one of the longer single pole trolleys; whereas this trolley can be turned around in passages from 4 to 6 feet in width, with the socket located approximately in the center of the locomotive.

Where high cars are used trouble is often encountered with the single-pole trolley striking the car when the trolley wire is low. The new trolley is designed to overcome this objection, as the entire operation of

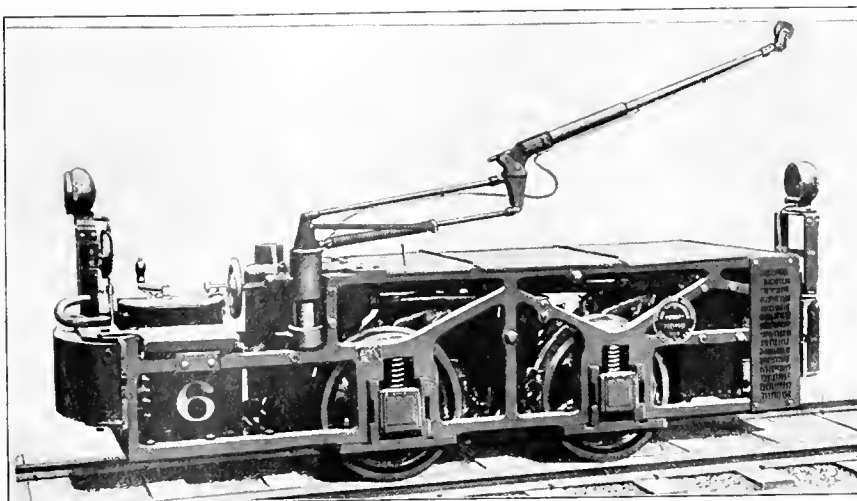

FIG. 2. WESTINGHOUSE MINE TROLLEY.

the trolley can be kept within a radius of 4 to 6 feet from the trolley socket. If the trolley wire changes in height and position over the track during the run, the trolley wheel will follow the wire throughout a 6-foot vertical change and a

Timber Setting Derrick

The placing of timber or steel mine roof supports is an expensive item in coal mining operations and often deserves more attention than is given to it. To aid in setting timber and steel supports, the Hercules

To make use of the machine it is set in the center of the entry and the approximate center of the timber is placed on the carrier. If not equally balanced the timberman can hold the stick in the desired position while it is being raised by his helper, if he sticks a pick point into and steadies it for a moment or so until the top is reached. The machine is made and patented by J. E. Jones, Centerville, Iowa.

來 來

Power-Driven Auger Drills

The accompanying picture, Fig. 3, shows the exhibit of the Howells Mining Drill Co., of Plymouth, Pa., at the recent Industrial Exposition at Wilkes-Barre, Pa., and illustrates the extent to which the auger type of drills has been developed.

Beginning many years ago with the manufacture of hand-power auger drills for boring coal, improvements were made from time to time; then power, either air or electricity, was added and the range of usefulness of the drills was extended, till now the air or electric drills are in use boring everything but the hardest rocks.



FIG. 3. EXHIBIT OF HOWELLS MINING DRILL CO.

wide horizontal range without stopping the locomotive.

When the locomotive is used for gathering purposes, where two single-pole trolleys are ordinarily required, the pole can be swung to operate satisfactorily on either side of the locomotive, whether the trolley wire be on the cross-cut or on the room side of the entry.

The trolley is designed to operate on a wire having a range in height of from 5 to 11 feet above the top of the rail; it being assumed that the locomotive trolley socket is about 3 feet above the rail. The trolley consists of two members which operate in sockets. By means of a latch or pin at the lower socket, the lower member of the trolley can be adjusted vertically and kept in a rigid position, and further, can be swung horizontally and fastened in any definite position required.

The trolley can be used for application to locomotives now in service, and is made by the Westinghouse Electric and Mfg. Co., East Pittsburg, Pa.

Mine Derrick shown in Fig. 4 has been invented.

The construction is such that supports of any size can be placed at desired height in a few minutes time and it can be operated by two men. Collars and legs are raised at the same time, except in places where trolley wires are in the center of the roadway. Where this is the case, the legs, of course, cannot be raised with the collar and probably 5 minutes extra time is needed for placing the collar.

By the use of this machine the liability to accidents is greatly lessened because no one is directly under the collar while it is being raised. The machine is designed for use on any pitch.

Where timbers are set from 2 feet to 8 feet apart, one man can move the machine into position to raise the next set in from 2 to 3 minutes. The construction of the machine is such that it can be knocked down and made ready to move to any part of the mine in a few minutes, and to do this will require but one timberman and his helper.

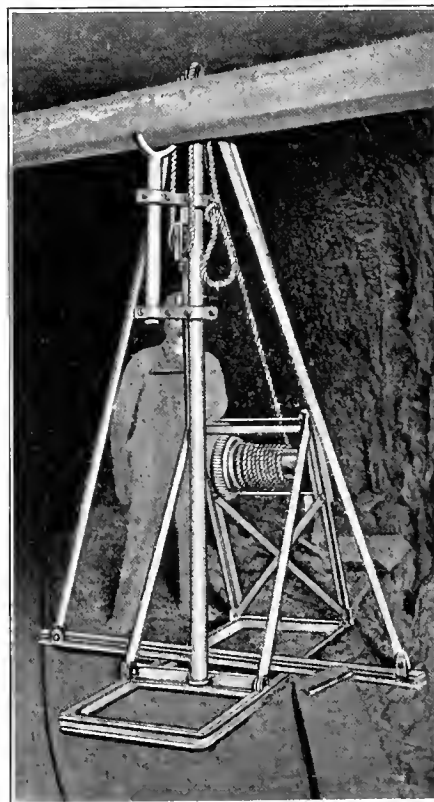

FIG. 4. HERCULES MINE DERRICK

In the exhibit was a 10,000-pound lump of anthracite in which a Spry, Type S, electric drill with 1½-inch bit was boring holes at a speed of 7 feet per minute. There was also an air-driven drill of a style of which the firm have shipped a number to the salt mines of Russia and which are working successfully. There was also a drill mounted on wheels for boring holes in the ground for use in the latest style of farming by dynamiting the subsoil.

The drills are made in a great variety of styles adapted for different purposes, and are the cheapest means for boring coal, slate, rock salt, gypsum, and similar material.

TRADE NOTICES

Automatic Mine Doors.—A booklet issued by the American Mine Door Co., of Canton, Ohio, describes different forms of mine doors adapted to various conditions of haulage. These doors have proved so efficient that former objections and legal restrictions to the use of automatic doors have been entirely removed and they are in use in many of the best equipped mines. The booklet will interest every man who is responsible for the placing of a door in a mine.

New Business.—Contracts for the following new plants have recently been received by the Roberts and Schaefer Co., engineers and contractors, of Chicago: From The Cleveland, Cincinnati, Chicago & St. Louis Railway, a \$50,000 contract for five Holmen coaling plants to be built immediately at Paris, Ill.; Lynn, Ind.; Anderson, Ind.; Lilly, Ill.; and Dayton, Ohio. Also a \$32,000 contract for two 400-ton capacity, reinforced concrete Holmen coaling plants to be built immediately at Chicago for the Indian Harbor Belt Railway Co. From the Denver & Rio Grande Railway Co., a \$22,500 contract for two Holmen type locomotive coaling stations for installation at Salida and Minturn, Colo. Also a \$15,500 con-

tract from the Rock Island lines for a fireproof Holmen type coaling station, at Hulbert, Ark. The Hazard Coal Co., of Hazard, Ky., has also contracted for the designing and building of a coal mining plant at Hazard, Ky., using the new Marcus combination screen and picking conveyor equipment.

Canadian Agency.—The Orenstein-Arthur Koppel Co., of Koppel, Pa., has given the agency for its products in Canada to the Canadian Fairbanks-Morse Co., Ltd., having offices in Montreal, St. John, Toronto, Winnipeg, Saskatoon, Calgary, Ottawa, Vancouver, and Victoria.

New Electrical Equipment.—The Northwestern Fuel Co., St. Paul, Minn., will add to its power plant a 500-kilowatt rotary converter, 500 kv-a. transformer and switchboard. The Delaware & Hudson Co. will place in operation a new 300-kilowatt motor-generator set and switchboard in its Baltimore Tunnel mine at Wilkes-Barre, Pa.; and also a motor-generator set with switchboard of the same capacity in its Pine Ridge mine at Parsons, Pa. The Consolidation Coal Co., Fairmont, W. Va., will install at Jenkins, Ky., 33 transformers of 25, 50, 75, and 100 kv-a. capacity; 11 motors of 75 and 150 horsepower, and nine induction motor panels. The H. C. Frick Coke Co., Pittsburg, Pa., has ordered a 7-ton electric locomotive. The Lehigh Coal & Navigation Co., Philadelphia, Pa., will add to the equipment of its plant at Lansford, Pa., a 100-horsepower motor, 125-horsepower motor, three 40 kv-a. and three 50 kv-a. transformers. The Bunsen Coal Co., Chicago, Ill., has ordered a 13-ton electric locomotive. The Lehigh Valley Coal Co., Orwigsburg, Pa., has ordered a new 8-ton electric mining locomotive. The Philadelphia & Reading Coal and Iron Co., Pottsville, Pa., will place in operation in its Suffolk colliery a new 8-ton electric mining locomotive. All the above equipment has been furnished by the General Electric Co.

Steel Derricks and Drilling Rigs.

The fourth edition of "Steel Derricks and Drilling Rigs," has been issued by the Carnegie Steel Co., Pittsburg, Pa. While intended as a catalog of the company's steel derricks and drill rigs it approximates a textbook on the subject.

"Dixon Graphite Brushes" is the title of a booklet issued by the Joseph Dixon Crucible Co., Jersey City, N. J. Dixon's brushes for dynamos and motors being composed almost entirely of high-grade graphite prevent sparking and wear of the commutator and their losses from friction on the commutator are less than with carbon brushes; moreover the commutator is always automatically lubricated, whereas with carbon brushes there are conditions under which applied lubrication is necessary. In addition to complete rules for using the brushes the booklet contains suggestions for using Dixon's lubricating rods for manufacturing arc light plungers, oilless bearings, dashpots, and for other applications where oil or grease lubrication cannot be conveniently employed. Dixon's graphite resistance rods which are furnished in a large number of combinations of size and electrical resistance are also described. The booklet will be sent on application.

New Plant.—Crawford & McCrimmon Co., of Brazil, Ind., builders of mine machinery, hoisting engines, fans, and mine pumps are starting construction of an entire new plant on a 9-acre tract. The buildings will be of the most modern steel fireproof construction. Considerable new machinery equipment is being installed and practically all contracts have been let.

Advertising.—Oliver W. Hull, formerly western advertising manager of the Hitchcock Publications of Chicago, has joined the Chamberlin Co.—Technical Publicity, Detroit. Mr. Hull's wide knowledge of manufacturing and selling problems in the field in which the Chamberlin Co. is engaged will prove a valuable acquisition to a rapidly growing force of men doing rather unusual things.

The Chamberlin Co. has always done business on a fee basis, believing that the agency should receive its compensation from the client, and not from the publisher as is the rule with general advertising agencies. The fact that the company has not lost an account since its organization is a tribute to the high character of its service.

CATALOGS RECEIVED

THE IMPROVED EQUIPMENT CO., 60 Wall Street, New York, N. Y. Bulletin No. 6, Silica Retorts and Settings for Gas Benches.

JOSEPH DIXON CRUCIBLE CO., Jersey City, N. J. Dixon's Graphite Brushes, 16 pages.

WEINMAN PUMP MFG. CO., Columbus, Ohio. Circular, Pumping Outfits.

INDEPENDENT POWDER CO., Joplin, Mo. Circular, Brands of Dynamite.

THE AMERICAN BRASS CO., Ansonia, Conn. Tobin Bronze, 33 pages.

ALBANY LUBRICATING CO., 708-710 Washington Street, New York. The Bearing, 18 pages.

CARNEGIE STEEL CO., Pittsburg, Pa. Steel Derricks and Drilling Rigs, 104 pages.

WHEELER CONDENSER AND ENGINEERING CO., Carteret, N. J. Performance of a Wheeler Counter Current Rain Type Jet Condenser, 15 pages.

STANDARD STEEL WORKS CO., Philadelphia, Pa. Rolled Steel Wheels, 56 pages.

THE WATT MINING CAR WHEEL CO., Barnesville, Ohio. Catalog "B," Steel Ore Cars, 20 pages. Catalog "F," Steel Mine Cars, 20 pages.

CHICAGO PNEUMATIC TOOL CO., Fisher Building, Chicago, Ill. Bulletin No. 128, Miscellaneous Equipment for Pneumatic Drills, 12 pages; Bulletin No. 132, Pneumatic Motors and Pneumatic Geared Hoists, 20 pages; Bulletin No. 133, Cylinder Air Hoists and Jacks, 12 pages; Bulletin

No. 34-L, General Pneumatic Engineering Information, 47 pages.

THE STARK ROLLING MILL CO., Canton, Ohio. Toncan Metal, 70 pages.

JOHN A. ROEBLING'S SONS CO., Trenton, N. J. Made at Roebbling's, 12 pages.

AMERICAN MINE DOOR CO., Canton, Ohio. Coal Mine Ventilation, 48 pages.

THE GARDNER GOVERNOR CO., Quincy, Ill. Circular GR 2, Gardner-Rix Vertical Air Compressors, 16 pages.

EDGAR ALLEN AMERICAN MANGANESE STEEL CO., Chicago, Ill. Gyrotory and Jaw Crusher Wearing Parts, 27 pages. Stag News, 16 pages.

THE BRISTOL CO., Waterbury, Conn. Bulletin No. 170, Bristol's Patent Electric Furnaces, 2 pages; Catalog No. 173, Bristol's Recording Differential Pressure Gauges, 4 pages; Bulletin No. 143, Bristol's Recording Differential Pressure Gauges and Recording Flow-Rate Meters, 16 pages; Catalog No. 1300, Bristol's Class III Recording Thermometers, 48 pages.

OSBORNE VALVE AND JOINT CO., The Rookery, Chicago, Ill. Circular, No Kut Valves and Steam Specialties.

THE OHIO BRASS CO., Mansfield, Ohio. Folder, Type D Trolley Frog.

ELECTRIC SERVICE SUPPLIES CO., 17 and Cambria St., Philadelphia, Pa. Protected Railroad Bonds and Appliances, 72 pages.

來 來

Underground Seismograph

At Nanaimo, B. C., the Western Fuel Co. takes great interest in the advancement of mining and encourages everything tending to the safety of the men in their employ. The company was the first in Canada to install a rescue station and has the distinction of having installed a seismograph 1,000 feet below the surface from which it is hoped to get information bearing on the theory of the relation of earth movements to mine explosions. During the past 10 years, the two

mines had 18 accidents underground, in one mine the mortality being only three in 8 years. In 1912 their ratio was only half of one per thousand.

來 來

Hogs as Indicators

When THE COLLIERY ENGINEER was MINES AND MINERALS and devoted to both coal and metal mining, it was customary to mention flowers, animals, birds, reptiles, and even insects whose action, habits, or characteristics were used by prospectors as indicative of mineral deposits. Recently the *Courier-Journal* interviewed Col. R. B. Hutchcraft, of Lexington, Ky., who in addition to being the Dean of Kentucky prospectors is one of the delightful old-school southern gentlemen who make it a point, even to personal inconvenience, to extend hospitality to strangers.

It seems that Colonel Hutchcraft had an opinion of his own regarding the "hawg" as an indicator, for while prospecting in what is now the Jellico field on the border of Kentucky and Tennessee in early days, he asked his host if there were any "hawg wallers" or "deer licks" in his vicinity. On receiving a reply in the affirmative he went for them with a pick and uncovered the Jellico coal bed. Colonel Hutchcraft carried a block of this coal on horseback 60 miles to Livingston where he formed a company that opened the first coal mine known as the Wooldridge, near Jellico. From this episode it will be seen that hogs are good indicators if they are incited to root for a living. Shortly after the Jellico coal bed was discovered Colonel Hutchcraft discovered the Blue Gem bed 119 feet below the Jellico bed. He was burning some of this coal one evening in the home of Colonel Wooldridge who asked what kind of coal it was. Colonel Hutchcraft seeing blue slaty looking traces on the coal which was burning remarkably well replied, "It is the 'Blue Gem' coal," and it still goes by that name.



