

COLOR
AND
ITS APPLICATION
TO PRINTING

E·C·ANDREWS

ornia
al



Digitized by the Internet Archive
in 2007 with funding from
Microsoft Corporation

William Huebner

Nov 9th 1918.

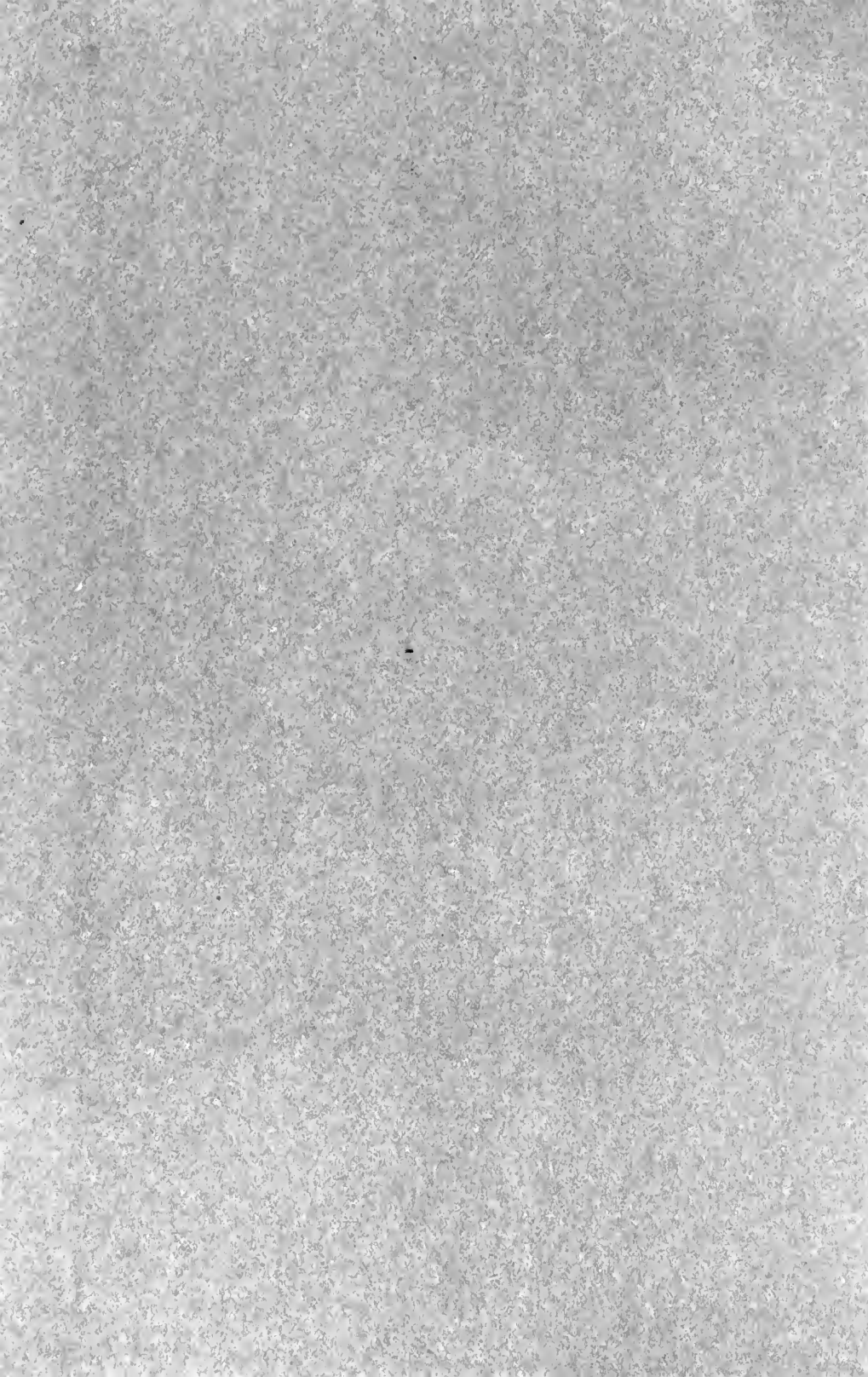

COLOR
AND ITS APPLICATION
TO PRINTING

COLOR
AND ITS APPLICATION
TO PRINTING

By
E · C · ANDREWS



PUBLISHED BY
THE INLAND PRINTER COMPANY
CHICAGO

Copyright, 1911,
by E. C. ANDREWS.

PUBLISHERS' PREFACE.

"Color and Its Application to Printing" appeared serially in THE INLAND PRINTER during 1910 and 1911, under the title "Scientific Color in Printing." The careful research and accuracy of statement evidenced in these articles received the warm commendation of the most eminent authorities in America on the problems of color.

The author, Mr. E. C. Andrews, brings a special fitness and experience to the work he has undertaken. A student at Princeton and a graduate of the University of Chicago, Mr. Andrews specialized in chemistry, and, though not officially on the faculty roll, was for a time in effect assistant instructor in chemistry in the University of Chicago. Entering commercial life, he was chemist for the Corn Products Refining Company, and thereafter connected himself with Philip Ruxton, Inc., of which organization he is the second vice-president.

Mr. Andrews has been unusually successful in simplifying the processes of arrival at color selection. His specialty has brought him in immediate contact with the difficulties that commonly beset the printer in obtaining cohesion and contrast in colorwork. In this way, the present work is not theoretical in its application, but eminently a practical work, in which all that has been set down in this connection has been proved and tested.

The student of color will find in these pages foundation principles accepted by modern authority. The analyses of the phenomena of the disintegration of white light into its color components and their representation by pigmentation open up a field of study which is not only deeply interesting but of the greatest value and importance to all manufacturers and users of color in the arts.

THE INLAND PRINTER COMPANY,
Publishers, Chicago.

AUTHOR'S PREFACE.

There is a story about a Chinaman who lost his dog and reported the fact to the police. By means of an interpreter the police official asked the color of the dog. Gesticulations and five minutes of wonderful gutturals followed. "Well, what on earth did he say?" asked the official. "Yellow," replied the interpreter. In the description of colors even the master of diction may be compared to the Chinaman. The variety of terms, in fact, the almost individual use of terms, and the desirability of reaching more uniformity are too self-evident to need comment. If this book helps the user of color, whether he be artist or printer, to take a step forward in that direction it will have served its purpose.

To A. H. McQuilkin, Arthur S. Allen and John M. Tuttle the author is indebted for the personal encouragement and inspiration which have placed his investigations in concrete form. From Henry Gordon Gale, of the University of Chicago, I received assistance on the subject of light; from Walter S. Sargent, of the University of Chicago; Henry Turner Bailey, editor of the School Arts Book, and A. H. Munsell, of Boston, Massachusetts, the work received the benefit of their long and rich experiences in the practical application of color and elucidation of color theory. Grateful acknowledgment is also made to Fred S. Bertsch and Oswald Cooper for the title-page and cover-design; to August Petryl for painting of spectra by means of a direct vision prism spectroscope; to L. O. Griffith for conventionalized flower-design, illustrating value arrangements on page 52, and to F. J. Trezise, the instructor in the I. T. U. Course of Printing, for advice and assistance in manifold ways. In a work of this character it is difficult to give acknowledgment for aid to authors where the actual verbiage has not been directly quoted. The works consulted in this connection, and to which the author is indebted in elucidating many problems, are: "A First Course in Physics," Millikan & Gale; "Text Book of Color," Ogden N. Rood; "Colour,"

AUTHOR'S PREFACE.

A. H. Church; "Color Harmony and Contrast," James Ward; "A Theory of Pure Design," Denman W. Ross; "The Principles of Design," Ernest A. Batchelder; "A Color Notation," A. H. Munsell.

It is important for the reader to consider that this work is not designed to take the place of a ready-reference chart, by which he or she may determine at once any color combination; but is intended to give a course of instruction in color which the reader must study and thus build into his own perceptions. The works which have been referred to will be found of the greatest value by the earnest student, whose investigations and notes have been arranged for by the insertion of a number of blank leaves in the back of the book.

E. C. ANDREWS.

CONTENTS.

CHAPTER.	PAGE.
PUBLISHERS' PREFACE.....	5
AUTHOR'S PREFACE.....	7
I. THE THREE ATTRIBUTES OF COLOR.....	13
II. LIGHT AND THE SPECTRUM.....	20
III. THE PROCESS OF COLOR PERCEPTION.....	33
IV. FALSE AND CORRECT COLOR BALANCE — HUE.....	40
V. VALUE	48
VI. CHROMA AND THE UNION OF HUE, VALUE AND CHROMA IN THE COLOR SOLID.....	62
VII. THE COLOR SOLID AS A BASIS FOR COLOR COMBINATIONS. . . .	69
VIII. THE LAW OF MODIFICATION OF COLORS DUE TO OPPOSITION..	75
IX. HARMONY BY BALANCED CONTRASTS — SEQUENCES — ANALOGIES OF HUE, VALUE AND CHROMA.....	90
X. THE WEIGHING AND MIXING OF INKS.....	97
XI. COLOR MATCHING.....	108
XII. PRESSROOM DIFFICULTIES.....	114
CLASSIFICATION OF TYPICAL COLOR COMBINATIONS.....	74
TABLE I. DIAGRAM OF POSSIBLE COLOR VALUES.....	58
TABLE II. ENLARGED DIAGRAM OF POSSIBLE COLOR VALUES.....	95
TABLE III. COMPARISON OF PARTS (METRIC SYSTEM) WITH POUNDS AVOIRDUPOIS	101
TABLE IV. CONVERSION OF OUNCES AND FRACTIONAL PARTS OF AN OUNCE INTO DECIMAL PARTS OF A POUND.....	104

LIST OF ILLUSTRATIONS.

PLATE I (frontispiece). Fig. A, Solar Spectrum from Diffraction Grating. Fig. B, Solar Spectrum from Prism. Fig. C, The Five Fundamentals — Red, Yellow, Green, Blue, and Purple. Fig. D, Correct Primaries and Secondaries. Fig. E, Incorrect Primaries and Secondaries.

PLATE II (opposite page 47). Fig. A, The Five Colors in Middle Chroma at Values of 70, 50 and 30. Fig. B, Middle-value Colors.

PLATE III (opposite page 64). Chroma in Five of the Fundamentals at Values Where Each Color Reaches Its Maxima of Chroma.

FIG.	PAGE.
1. Wave Form of Light.....	21
2. Coincidence of Two Wave-trains.....	22
3. Neutralization of Two Wave-trains.....	22
4. Apparatus for Producing Interference.....	23
5. Diagrammatic View of the Wave-lengths of Red, Yellow, Green, Blue and Violet.....	24
6. The Dispersion of White Light into Its Elements.....	27
7. Methods of Separating a Given Color in the Spectrum.....	28
8. Method of Reuniting the Colors into White Light.....	30
9. Method of Adding White Light to the Spectrum Hues.....	31
10. Illusion of Length.....	33
11. Müller-Lyer Illusion.....	34
12. Zöllner Illusion.....	34
13. Poggendorff Illusion.....	35
14. Diagrammatic Section of the Human Eye.....	35
15. Diagrammatic Section of the Retina.....	36
16. Circular Disks With Radial Slits.....	42
17. Milton Bradley Rotating Apparatus.....	43
18. The Decimal Circuit of Color.....	46
19. Decimal Value Scale, Neutral Axis.....	49
20. Front View of the Munsell Photometer.....	50
21. Rear View of the Munsell Photometer.....	51
22. Three Values in Two Arrangements.....	52
23. Use of the Correct Initial.....	54
24. Use of Incorrect Initial.....	55
25. Decimal-value Scale Balanced on Middle Value.....	56
26. The Color Solid.....	67
27. Contrasts of Five Values in Two Arrangements.....	70

LIST OF ILLUSTRATIONS.

	PAGE.
28. Red and Its Analogous Colors in Relation to Its Complement Blue-green and Its Analogous Colors.....	76
29. Yellow-red and Its Analogous Colors in Relation to Its Complement Blue and Its Analogous Colors.....	77
30. Yellow and Its Analogous Colors in Relation to Its Complement Purple-blue and Its Analogous Colors.....	78
31. Green-yellow and Its Analogous Colors in Relation to Its Complement Purple and Its Analogous Colors.....	79
32. Green and Its Analogous Colors in Relation to Its Complement Red-purple and Its Analogous Colors.....	80
33. Values in Contact and Separated.....	82
34. The Effects of the Opposition of Green on the Other Colors..	84
35. Square and Strip Used for Studying the Effects of Opposition	85
36. Three-color Combinations by Balanced Contrasts.....	91
37. An Analogy of Value Converged Toward Middle Value.....	92
38. A Blue Accent or Analogy of Hue.....	94
39. Equipment for Color Experiments.....	99
40. Suggestion for Formula Slip.....	100
41. A Decimal Value Scale by Weight.....	105
42. Comparison of the Twelve-step Sequence with the Decimal Sequence	109
43. Half-tone from Perfectly Coated Side of Sheet.....	114
44. Half-tone from Imperfectly Coated Side of Sheet.....	114
45. Half-tone Black "Picking".....	115
46. Half-tone Black Reduced with Soft Half-tone.....	116
47. Half-tone Black Softened with Reducing Varnish.....	117



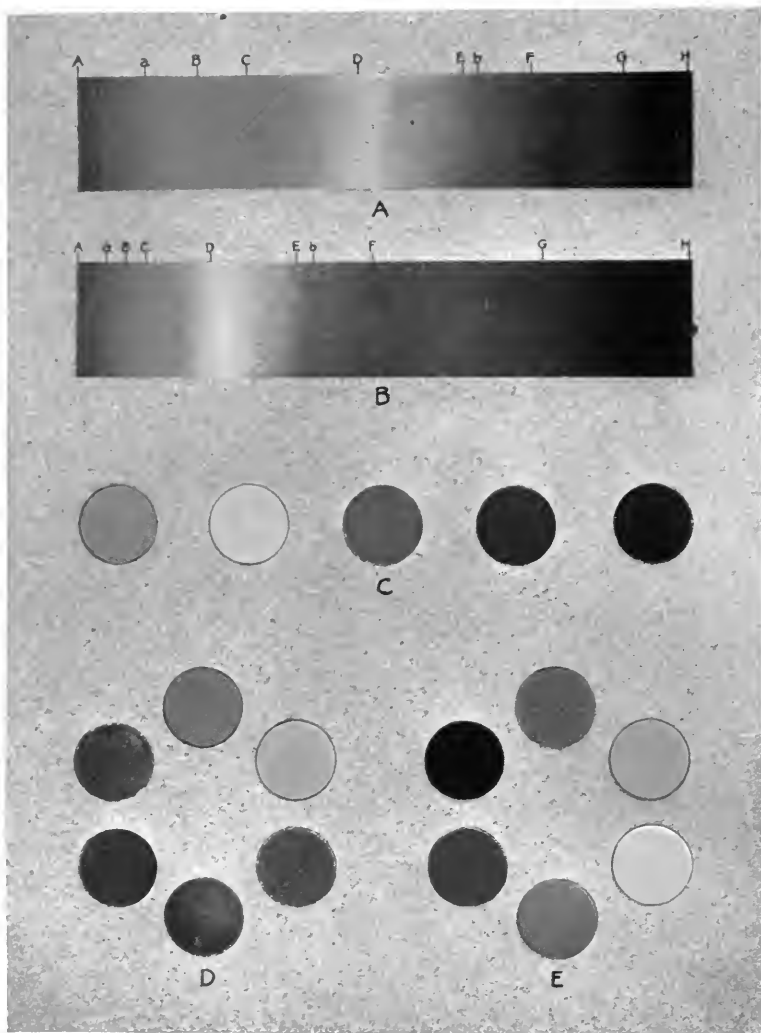

PLATE I.

FIG. A. Solar spectrum from a diffraction grating.

FIG. B. Solar spectrum from a prism.

FIG. C. The maxima or highest chroma of the five fundamental colors, equidistant in hue.

FIG. D. The correct primaries — red, green and purple-blue. (This color is an ultramarine made from lapis-lazuli, also called violet-blue.) Secondaries or complementaries — yellow, blue-green and purple. Complementary colors are opposite.

FIG. E. False color-balance, based on the old Brewster theory, which gives the primaries as red, yellow and blue; secondaries as orange, green and purple.

COLOR AND ITS APPLICATION TO PRINTING

CHAPTER I.

THE THREE ATTRIBUTES OF COLOR.

FEW printers have had instruction in either drawing or painting, and yet the successful color-printer of to-day—the man who gives the advertiser something more than a low price—has absorbed unconsciously a considerable knowledge of both these arts. In drawing, we think of lines and outlines—good type and rule composition printed in black. In painting, we think of areas or spots first of all, and of the composition afterward—a booklet cover in color. Composition in painting includes the position, the size (the artists' word for size is *measure*) and shape of the objects represented. In short, composition is the way a given space is divided up.

Let us forget composition for the present. What is a spot of color? In printing it is the effect produced on the eye by any pigment or mixture of pigments. Royal purple is a distinctive spot of color, royal purple plus white another, royal purple with black added to it a third, etc. In analyzing any spot of color two things are noticed. First, the quantity of light in it, or, in other words, how much it reflects light. This is called by artists its "value." If this definition is new to you, stop a moment and memorize it. Second, we notice the kind of light in it—its color; and then we notice the *intensity* of the color. If it is bright and stands out like vermilion we say it is a very *intense* color. Munsell calls this quality of color its *chroma*, a more exact term than intensity. Later on we shall take up these terms more in detail.

In white we have the greatest quantity of light of all pigments, the highest of all values. Notice the amount of light

in a freshly plastered room and then go into the same room after the walls are tinted or papered. Most printing, however, is done on white paper, and, therefore, white ink would show no contrast. It is for this reason that black is used in printing more than any other pigment. It is the greatest contrast to white, reflects the least quantity of light and is the lowest of all values.

When we say a color reflects light, there are a number of points to be considered. If the ink is opaque we have one kind of reflection. If semi-opaque another, and, when transparent, still another. Also gloss makes a difference, and although gloss inks are much sought after by the printer and advertiser, they are not often advisable. It is true that at the right angle they reflect light in large quantity, but, at another angle, gloss inks often glare. Take some job that you consider fine in this particular and look at it every day. You will soon tire of the gloss. Imagine one of your living rooms done in a gloss calcimine! The point to be considered is whether the color-scheme is to be used for advertising matter which is thrown away after reading or on the cover of a standard catalogue which is used for years. In the latter case, much may be learned from the mural painters. Such a composition should be restful, with little action, and the figures should be flat. The colors should be subdued and not too warm in tone.

Strange as it may seem, the gloss so many three-color printers seek to get in their reproductions is exactly what the artist in painting the original picture in oil endeavors to avoid. He depends for his effect not on reflected light, some of which, however, is bound to reach the eye, but upon the light which is reflected in a diffused way and, generally, has penetrated some distance into the pigments. In reproducing water-color sketches we must try to avoid gloss, but it is practically impossible to exactly match a water-color in printing-ink, although the pigments in the two colors might be identical. This is because the varnish medium of printing-ink always will show more gloss than the water medium, and, therefore, reflect the light in a different manner. Added to this is the fact that the water-color is often carried on very

much heavier than the color can be printed and maintain an even impression.

I spoke of the opacity or transparency of an ink making a difference in the kind of light it reflects, but said nothing of the color or the coating of the "white" stock upon which it is printed. This is a point not thoroughly understood by the majority of printers. There are certain light reds which show an extraordinary brightness and beautiful undertone on cream or "natural white" enameled papers, while on paper slightly toned with blue the beautiful effect is gone. "Natural" was the name originally given to untoned paper, which is yellowish in cast, but to-day both "natural" and cream-white stock is toned slightly red. When you expect to use a light red or Persian orange for initials and decorations, always insist on the red-toned stock, even if furnished by your customer. As the colors mentioned are the proper colors to be used with black half-tones and type, such jobs are not infrequent. The blue toner is also detrimental to all light tints containing red or yellow, especially if they are made with a transparent base.

Every printer knows how hard it is to match an engraver's proof. This is because the proof-paper has a greater luminosity than the No. 2 enamel or S. & S. C. that you are forced to use on the job, and also because the surface of your stock would "pick" with the heavy engravers' proving inks, even if you could afford to use them. When you get to No. 2 enamel you have more to contend with than merely blue toner. The lesser luminosity is due to impurities in the stock and in the coating, which you can not cover up. Your ink is not so saturated in color and will be affected by the color of the stock, and also the stock about the printed matter will show less contrast to the ink itself. When you have a No. 2 stock, the surface of which will stand heavy inks, part of this deficiency in luminosity may be overcome by using cover-inks, but the highest luminosity in most colors is obtained on No. 1 "natural white," with inks of a lake nature, where the undertone will reflect the purity of the stock. Such conditions somewhat approximate an engraver's proof, but let us hope that the day will come when the

COLOR AND ITS APPLICATION TO PRINTING.

engraver will pull his proofs on the same stock the printer expects to use and with inks of a price consistent with the job. If he must use expensive paper to show that the cuts are perfect let him pull these proofs in black and furnish his customer the color progressives on ordinary stock. Then, and not until then, will the printer have a fair show when dealing with a customer who has ordered his plates direct from an engraver.

The coating of stock is the cause of many pressroom difficulties, and, while the subject of this book is not the chemistry of inks or of paper, a little digression in this chapter may not be out of place. Coatings for enamel paper contain glue, clay, *blanc fixe*, satin white, etc., each manufacturer having special secret formulas of his own. In the first two items there is a great chance of variance. Glue runs from 7 cents a pound (in quantities) to the French glue at 40 cents. Just how much increasing the price would mean increasing the quality it would be hard for any one not a practical paper manufacturer to say. Clay is a general name given impure varieties of aluminum silicate, and ordinary clay often contains calcium carbonate, magnesium carbonate and iron hydroxids. The purest form of clay found in nature is kaolin, and from native clay to the choicest imported there is a wide range of price and quality. In England the fine clay is found almost exclusively in the county of Cornwall. It is probably a safe statement to say that imported clay is used by the leading paper manufacturers of the United States on all of their coated papers. *Blanc fixe* is artificial barium sulphate, and satin white an artificial white pigment consisting of a mixture of calcium sulphate and aluminum hydroxid. When you consider that these ingredients as well as others are mixed in various proportions, and competition is making a constant demand for a satisfactory coating at a low cost, is it a wonder that the printer occasionally has trouble fitting his inks to a given stock. The writer noticed during the extreme cold weather of a recent winter many instances where the coating of the stock seemed to "powder off" and the "softest" inks would pick. It would be an interesting experiment to artificially

freeze satisfactory stock and see whether it were possible to cause the coating to disintegrate. The point I wish to bring out is that the printer should not always ascribe his troubles to "the ink not being the same as last."

Much is being done by the various clubs throughout the country in educating the printer to what printing costs, but, after all, is this not merely an analysis of competition of price, a competition in which there is no bottom? On the other hand, there is the competition of ability, in which there is no limit. Why does your customer want to see proofs—why does he revise, and refuse to O. K. the original layout? Why does he deal directly with an advertising man, an artist or an engraver, and require you to submit your ideas to a middle man? It is because nine out of ten printers are not seeking more than to rent printing machinery. A prominent man, who has been connected with printing interests for more than thirty years, recently made the statement that he could teach the average bright boy to set type in three months' time. Setting type is not what pays, it is *how* it is set. *What* you say, *how* you say it, what stock you select, what colors you use, and, above all, whether you show a creative touch, a distinctive and personal element in your work. This creative element can not be cultivated by referring to tables, copied out of "Chevreul," and no set rule can be laid down for the best combination, as every color-scheme must be selected with regard to many requirements. To create, one must master, and to know color from the scientific standpoint often enables us to surprise even the artist at the grasp we have of the problems he solves with "feeling." When you can show a customer what he "ought to have," to advertise effectively, your profit will not be divided with the middle man, and, once in his confidence, even his office-blanks will pay a fair profit.

It seems to me, therefore, that a large number of printers ought to be interested, not only in a few simple rules for obtaining color harmony, but in the principal facts of the physical nature of light—how it travels, the difference in wave-lengths, which give rise to various color sensations, and the absorption, reflection and refraction of light on dif-

ferent surfaces. It is worth while to know something of the eye and color-vision, and something of the chemical nature of pigments. There are many points about the body, tack, opacity or transparency of an ink that are important for a printer to know, and, last of all, is the problem of harmonizing and grouping the various colors and their tints and shades. I repeat, there is no question but that the average printer can acquire a valuable practical knowledge of color harmonizing from scientific sources. Results without reasons save some reading, but it is easier to apply principles once understood, than to hunt for an example that just fits the piece of work under consideration.

In the following chapters I shall take up the divisions of our subject in the order mentioned, and review them briefly, laying especial emphasis on recent theories. First of all, let us define our color terms more accurately.

We stated that, in analyzing any spot of color, two things are noticed: (1) The quantity of light and (2) the kind of light, which may be either strong or weak. Whether we recognize the quantity or quality of light first, depends somewhat on the individual color-sense, and whether the color is intense or weak. A child notices the color, the kind of light, before he recognizes the quantity of light (the value). Last of all, he learns to notice the intensity of the color (the chroma). We can readily see that, in order to describe a color, we must mention three qualities: the color, the value, and the intensity (chroma). Notice that we are forced to speak of the "color of a color." To avoid ambiguity an exact term is necessary, and the best word that we can use in describing the kind of light in a spot of color is "hue." Please notice the following definitions from the Century dictionary:

Hue: "Color; specifically and technically, distinctive quality of color in an object or on a surface; the respect in which red, yellow, green, blue, etc., differ one from another; that in which colors of equal luminosity and chroma may differ."

Value: "In painting and the allied arts, relation of one object, part, or atmospheric plane of a pic-

COLOR AND ITS APPLICATION TO PRINTING.

ture to the others with reference to light and shade, the idea of hue being abstracted."

Chroma: "The degree of departure of a color sensation from that of white or gray; the intensity of distinctive hue; color intensity."

Henceforth, I shall use the terms "hue," "value" and "chroma" in describing any color. They may be called the three dimensions of color, as, by omitting any one of these three qualities, we leave the color undefined.

CHAPTER II.

LIGHT AND THE SPECTRUM.*

IN studying the laws of color we must first of all distinguish between color as the physicist describes it and color as we experience it — between objective and subjective color. For example, color as we see it is not a form of vibration, while color to the physicist is a form of wave-motion easily changed into other wave-motions, such as those of heat. Our sensation of color, therefore, is not a copy of an external fact, and we must not confuse the laws of one with the laws of the other.

In seeking for a basis for our color theory we naturally turn to the spectrum; but, first of all, it is best to know something of the physical properties of light itself. In "Light Waves and Their Uses," Prof. A. A. Michelson, of the department of physics, of the University of Chicago, who won the Nobel prize for his work on light, gives the following illustration of wave-motion:

"Doubtless there are but few who have not watched with interest the circular waves produced by a stone cast into a still pond of water, the ever-widening circles going farther and farther from the center of disturbance, until they are lost in the distance or break on the shore. Even if we had no knowledge of the original disturbance, its character, in a general way, might be correctly inferred from the waves. For instance, the direction and distance of the source can be determined with considerable accuracy by drawing two lines perpendicular to the front of the wave; the source would lie at their intersection. The size of the waves will give information concerning the size of the object thrown. If the

* NOTE.—While it is the intention in these chapters to present such subjects as light, the spectrum and the process of color perception, in a popular style, it is impossible to explain the underlying laws without reference to scientific experiments. If the individual reader is not interested in these subjects he may pass over Chapters II and III.

waves continue to beat regularly on the shore, the disturbance is continuous and regular; and, if regular, the frequency (that is, the number of waves per second) determines whether the disturbance is due to the splash of oars, to the paddles of a steamer, or to the wings of an insect struggling to escape.

“In a precisely similar manner, though usually without conscious reasoning about the matter on our part, the sound-waves which reach the ear give information regarding the source of the sound. Such information may be classified as follows:

1. Direction (not precise).
2. Magnitude (loudness).
3. Frequency (pitch).
4. Form (character).

“Light gives precisely the same kinds of information, and hence it is only natural to infer that light also is a wave-motion. We know, in fact, that is so.”

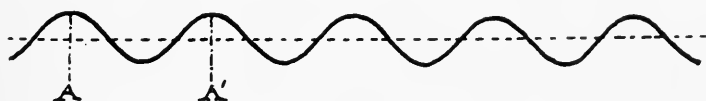

FIG. 1.

Fig. 1. shows a wave-form illustrating the way light travels. The *amplitude* of the wave is the distance from the highest point of the crest or the lowest point of the trough to the position of rest, which is shown as a dotted line drawn through the middle of the curve. The *period* of the vibration is the time it takes for one particle to execute one complete vibration,* that is, in the case of a cork floating on water, it is the time it takes for the cork to drop from the highest point of the crest of a wave to the lowest point of the trough and to return to the highest point of the crest again. This vibration is *up and down* and not along the wave. The *wave-length* is the distance between two consecutive crests, or two consecutive troughs, which equals the distance from A to A'.

* Some writers use half this distance for the period of vibration.

Most writers on color refer to the wave-length of light, but do not explain it at all, so I trust that a simple experiment will not be out of place. First let us consider what will happen if we superimpose two similar wave-trains of equal period and amplitude. If these two wave-trains coincide, the resultant wave-train will have twice the amplitude

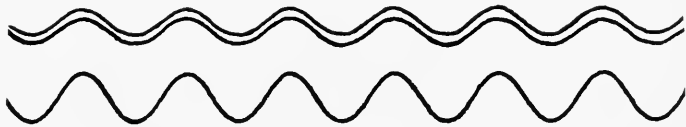

FIG. 2.

of the two wave-trains brought together, as is shown in Fig. 2. If these two trains are brought together with one a half a period ahead of the other, the two trains exactly neutralize each other and the resulting amplitude is zero. See Fig. 3.

These two cases illustrate the principle of *interference*, which is interesting to the student of color, as it is one of the means by which the wave-length of light is measured. Two of the commonest examples of the principle of interference are the soap-bubble and an oil-film on water, where we see



FIG. 3.

white light producing colored areas. A simple and satisfactory method of measuring the wave-length of light is shown in Fig. 4. Two pieces of perfectly smooth and carefully cleaned glass are held together at the top with a clamp, while at the lower edge is a single silk thread separating the two plates of glass and forming a very thin wedge of air between them. If we pass a beam of light through this

wedge the white light will be separated into bands which will resemble the bands of the soap-bubble in every way. If we now place a piece of red glass in the path of the light we no longer have the colored areas, but alternate bands of red and black. If blue glass is used, the bands are somewhat narrower and are alternately blue and black. In either case the waves reflected by the first surface of the air-film would be in advance of those reflected by the second surface. At



FIG. 4.

the top, where the two surfaces touch, there is no advance and the two wave-trains should coincide, giving a very bright band. A little lower down we should find a dark band, showing that the thickness of the film is such as to bring one wave-train half a wave behind the other one. Still lower down we should find a bright band again showing a retardation of one complete wave, etc. As a matter of fact, we do find just such an alternation of light and dark bands, with the exception that a dark band occurs at the top instead of a bright one. This discrepancy is easily accounted for by a knowledge of wave reflection, but it is not necessary to go into the matter here, as we are interested only in the number of bands which occur and in the distance between the plates of glass at the bottom, where the silk thread separates them.

If we find eight dark bands in red light we conclude that the retardation of the red light is eight waves at the thickest portion of the air-wedge, and, therefore, the distance between the plates of glass is four waves. Each wave that passes *through* the film must pass *back again*, in order to produce destructive interference, so that each half wave-length in the thickness of the wedge means a retardation of twice that amount.

If the distance is actually measured by a microscope and found to be, as in an experiment cited by Professor Michelson, two and seven-tenths microns (a micron is a thousandth part of a millimeter, or roughly about a twenty-five thousandth of an inch), knowing this distance equals four wave-lengths of red light, we have sixty-eight hundredths of a micron for the wave-length of that particular red light.

In the case of blue light there will be twelve bands, which gives us forty-five hundredths microns as the wave-length of blue. The wave-lengths of the principal colors are approximately as follows:

Red	0.68 microns
Yellow58 microns
Green53 microns
Blue48 microns
Violet43 microns

Fig. No. 5 represents the wave-lengths of the different colors diagrammatically, magnified about twenty thousand

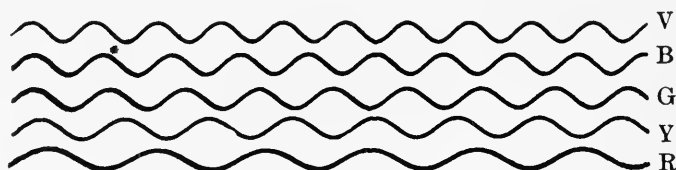

FIG. 5.

times. You will notice that in the experiment the wave-length of blue was found to be forty-five hundredths of a micron, while in the table it appears as forty-eight hundredths. What *is* blue? Even in dealing with light we are

unfortunately hampered by individual opinion when it comes to naming colors! Many would call the wave-lengths between .48 and .50 blue-green, and those between .59 and .61 yellow-red. The wave-length of the extreme red is .76 microns, while the extreme violet (this is not a pigment name) is about half as much, or .38 microns. Some authorities use the same figures as shown in the table for red and yellow, but give green as .52, blue as .46 and violet .42.

Few of the colored lights can be matched accurately in pigments, so the question of nomenclature is not important. The writer did take the trouble, however, to standardize the original sample of red shown in Fig. C, Plate I, and the pigment shows a wave-length of .63 microns. Why this red is used as the fundamental red instead of the deeper red of .68 microns will be taken up later.

We have said nothing about the rate at which light travels. We know that it travels much faster than sound, because the flash of a distant gun is *seen* before the report is *heard*, and a clap of thunder is always preceded by a flash of lightning. Galileo made an attempt to measure the time it took for the light of a lantern to travel between two hills near Florence, but the distance was so short he concluded it took no time at all.

In 1675, Roemer, by determining the exact moment of an eclipse of the brightest of Jupiter's seven moons, was able to predict the exact time an eclipse would take place six months later, when the earth was farthest away from Jupiter. When the time had elapsed, however, he found the eclipse occurred 996 seconds late, but, after another six months, when the earth was back at the point where he had made the original observations, the eclipse occurred exactly at the predicted time. Roemer inferred, therefore, that 996 seconds was the time taken for light to travel across the diameter of the earth's orbit, a known distance to astronomers at that time. Dividing this distance by 996 gave him 192,000 miles a second as the velocity of light.

Probably the two most accurate determinations of the speed of light are those of Michelson, of the University of Chicago, in 1882, and of Perrotin, of the University of Nice,

France, in 1902. Although using different methods, Michelson obtained 186,333 and Perrotin 186,345, results which are practically identical. In round numbers the velocity of light is 186,000 miles a second. If we divide the circumference of the earth, roughly 25,000 miles, into this number we realize that light travels around the earth seven times in a single second. It is said a bullet travels at the rate of about a half a mile a second, and sound, for example on a steel rod, at about three miles a second, so it is indeed hard for us to comprehend what a velocity of 186,000 miles a second means. This enormous value, however, becomes a definite and finite quantity when we consider the distances between the stars and the earth and the time it takes for their light to reach us. The light from Alpha Centauri, the nearest fixed star, started over four years ago, and if an observer on the pole star had a telescope sufficiently powerful to see the events on the earth he would now, December, 1911, be watching what occurred in June, 1857, four years before the Civil War!

Since light travels at the rate of 186,000 miles a second, and the wave-length of what the physicist calls red light is .68 microns, the *number of vibrations per second* of the little particles which send out the waves of light may be found by dividing the wave-length into the velocity. Therefore, in red light, the particles are vibrating at the enormous rate of over 441,000,000,000,000 vibrations per second.

The wave-lengths of light which run from the extreme red, .76 microns, to the extreme violet, .38 microns, are but a small part of the wave-lengths emitted by the sun, or any white-hot body. They are the wave-lengths to which the eye responds. Wave-lengths longer than .76 microns, although not capable of affecting the optic nerve, produce heat, and are easily detected by holding a radiometer or thermometer just beyond the red end of the spectrum. This position is known as the infra-red spectrum, and wave-lengths have been investigated up to 61 microns, which is eighty times the wave-length of the extreme red. At the other end of the spectrum there are wave-lengths shorter than that of violet, which can not be seen, but which can readily be detected by

a photographic plate. These rays are called the ultra-violet rays. Their heating power is small, but they are very active chemically, while the infra-red and red rays seem to have little effect on photographic plates. It is for this reason that dry plates are generally developed in a red light. The shortest wave-lengths in the ultra-violet spectrum that we know about are approximately one-fourth of the wave-length of the violet rays. The interesting point to the student of color is the fact that the spectrum, measured by difference in wave-lengths, is at least ten times as long as the part we see.

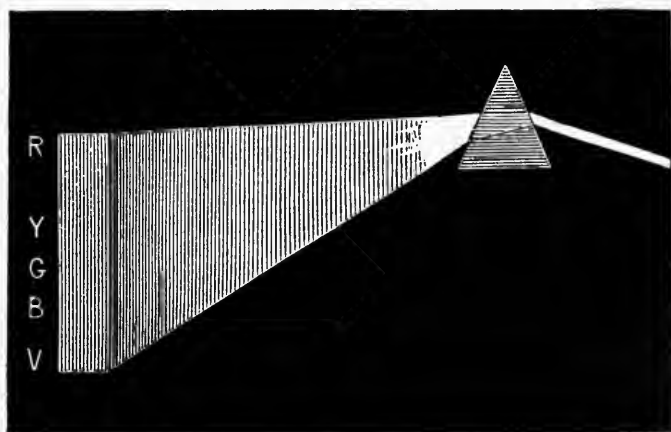

FIG. 6.

In making references to the spectrum, I take it for granted that we are all more or less familiar with the old experiment, supposed to have been first made by Newton — that of passing a small beam of sunlight through a prism, which separates the light into a long band of pure and beautiful colors. This is the *prismatic spectrum*, and, although white light consists of a mixture of all the wave-lengths between the two extremes of the infra-red and ultra-violet, the prism sorts out those we are capable of seeing and arranges them in their proper order according to wave-length. This separation of white light into its elements by refraction is called *dispersion*. Fig. 6 illustrates such an

experiment. The *order* of the hues is the important point to be memorized. Notice that red is at the top, and it is followed by yellow, green, blue and violet. The spectrum does not stop definitely just beyond red, but blends off gradually into a very dark red, which finally is imperceptible. At the other end, the violet blends into a faint grayish color, so that it is impossible to point out the exact spot where the visible spectrum ceases. Between the red and yellow there is a gradual blending to a yellow-red, then to yellow, then to a green-yellow, etc., to the violet.

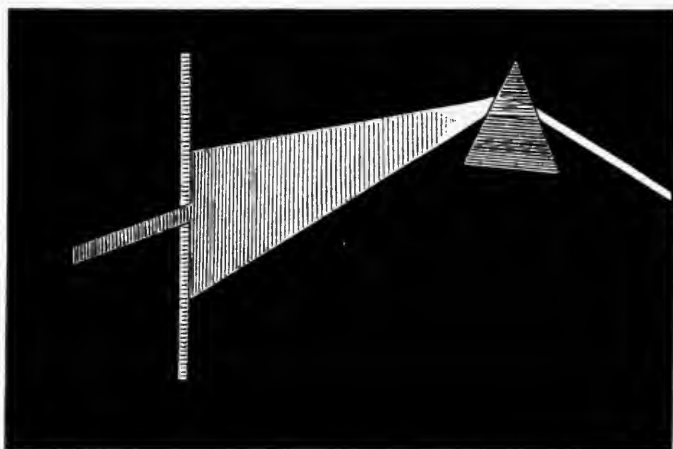

FIG. 7.

Although types of the natural colors, except the purples, are to be found in the spectrum, the hues from yellow-red to green are so much stronger in *chroma* than the blues and violets that, in order to study the latter colors, it is well to examine them separately. This is accomplished by using as a screen a piece of cardboard, with a narrow slit in it, as is shown in Fig. 7. One color, however, the pure yellow, occupies such a narrow region that it is only by magnifying the spectrum that it can be examined in this manner.

Fig. B, Plate I, shows the *prismatic spectrum* in colors, which was painted by means of a direct-vision prism spectroscope. For accurate measurements the simple prism, in

a darkened room, must be replaced by a spectroscope, as the beam of light is constantly shifting and the prism must be readjusted every few moments. You will notice the lines at the top of Fig. B. These indicate the position of lines which are visible in the spectrum known as Fraunhofer lines, from the physicist who first discovered them, and they serve to identify the exact position of a given hue.

Although the colors obtained from white light by means of a prism are arranged in order of their wave-lengths, the prism gives the red, yellow-red and yellow part of the spectrum less room than the difference in wave-lengths would demand, and it stretches out the blue and violet part far in excess of the difference in the wave-lengths. To overcome these discrepancies in the prismatic spectrum physicists have made use of a diffraction grating in connection with the spectroscope. A diffraction grating is a plate of glass, or a piece of speculum metal, ruled with very fine, parallel, equidistant lines, from fifteen thousand to twenty thousand to the inch. Detailed description of either the spectroscope or diffraction grating would be out of place here. For our purpose it is sufficient to know that the grating overcomes the inequalities of the prismatic spectrum and gives us what is called a *normal spectrum*, where each hue is allotted its proper proportion of the spectrum according to the difference in wave-lengths.

Fig. A, Plate I, shows this spectrum in colors. Yellow is about in the center, the reds and yellow-reds occupy more room, and the blues and violets have been reduced. The principal fixed lines in the *normal spectrum*, if we consider it from the top to the bottom, or from A to H, to consist of one thousand parts, are as follows:

A (top)	0	E	638.92
a	113.74	b	664.79
B	201.61	F	749.24
C	285.05	G	902.07
D	468.38	H	1,000.00

Red, according to Rood, runs from 0 to 330, yellow from 485 to 498, and between 330 and 485 there is a gradual blending of the red to a yellow-red, then to a pure yellow, etc.

Since the wave-lengths of the spectrum colors A to H run from .76 microns to .38 microns (a total change of .38 microns), the wave-length of any color may be obtained by figuring the distance from 0 (A) to the position of the color, and subtracting that proportion from the longest wave-length, or .76 microns. In the case of yellow the central position is at 491; therefore, the wave-length would be 491-1000 of .38 microns subtracted from .76 microns, or,

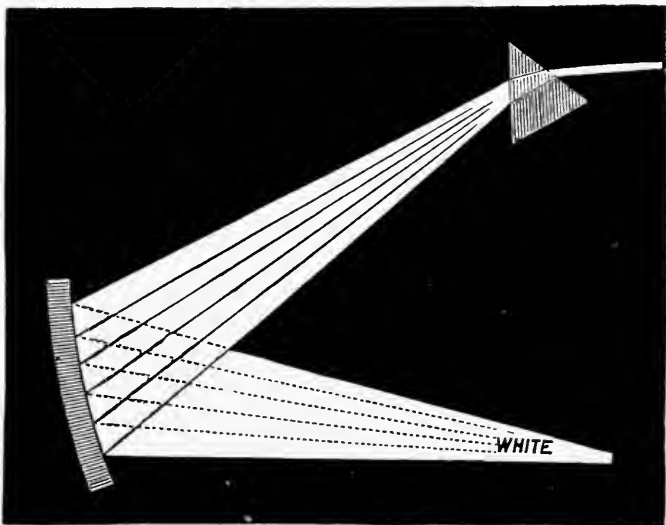

FIG. 8.

approximately, .58 microns. The point to be noted is that the physicist can do better in describing an exact hue than the artist or printer.

It will be noticed that when a beam of light is passed through a prism, in the manner shown in Fig. 6, the rays are bent around the base of the prism. This bending, or refraction, as it is called, is caused by the fact that light does not travel as fast in glass as in the air. When light travels obliquely, as in this case, from air into glass, it is bent *toward* the perpendicular to the first surface of the prism because its speed is less in glass; but when it leaves the

prism it is bent *away* from the perpendicular, drawn into the air, because the speed is greater in air. It will be noticed that the color which is bent the least is red, while violet is bent the most, and as red has the longest wave-length and violet the shortest, the bending must increase as the wave-length decreases. But, since the bending is due to a change in speed, it can be shown that the greater the change in speed the greater the bending. Therefore, blue and violet being

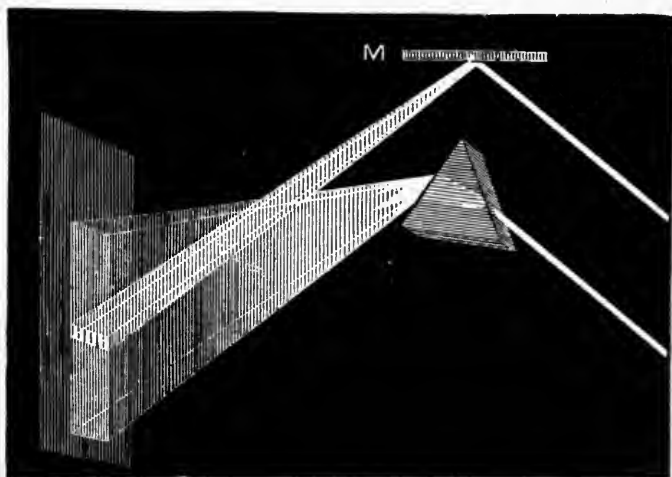

FIG. 9.

bent more than red shows that the speed of blue and violet in glass must be less than red.

The question naturally arises in witnessing the experiment of separating white light into its constituents by means of a prism, whether these colors, once separated, can be combined into white light again. Fig. 8 shows one method by which this may be accomplished. The colors from the prism are received on a mirror, so bent that all the rays concentrate when reflected on a single spot. If all the rays are properly united the spot will appear as pure white light.

The order of the hues in the spectrum, as we have said, is the basis for our sequence of hue in pigments; but when we search for pigments to match the spectrum colors we find it

impossible to obtain pigments which represent any one wavelength free from other hues. Pigments are also lacking in chroma and reflect some white light as well as their distinctive hue. Fig. 9 illustrates how white light, by means of a mirror, may be added to the spectrum hues in making comparisons with pigments. According to Professor Rood, vermilion and emerald green reflect approximately eighty per cent of their distinctive hue mixed with twenty per cent of white light, while artificial ultramarine blue, painted on white paper, reflects about twenty-five per cent of white light.

CHAPTER III.

THE PROCESS OF COLOR PERCEPTION.

MOST of us believe absolutely in what we see; so absolutely that when we print red on two stocks and in the one case it looks bright and pleasing, and in the other dull and of a different hue, we are sure the inkman must have made a mistake or wilfully substituted an inferior article. It was discovered a long time ago that our senses deceive us, and although the eye is the most highly developed of all our sense organs, it has certain weaknesses which must be understood if we are to account for the various effects of colors on one another.

As an illustration of one of the defects of perception, it is only necessary to test the eye with one of the so-called

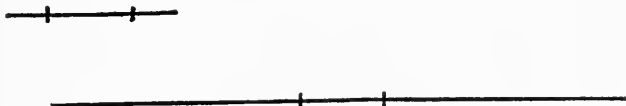

FIG. 10.

The portion marked off on the short line seems longer than the equal distance marked off on the long line.

geometrical optical illusions shown in Figs. 10 to 13. It is evident that if the eye is incapable of perceiving length and direction accurately, a little investigation of the process of color perception would be profitable.

In light and the spectrum we have been studying physical facts. These light vibrations are translated by the eye into certain physiological processes which in turn, by psychological processes, become our facts of sensory experience. This means that simple light vibrations of medium amplitude produce color sensations running from red, the lowest in vibration rate per second, to violet, the highest. Com-

pound vibrations produce either whites, grays, less saturated colors, or in the case of mixing red and blue vibrations the purples.

Between the physical series and the sensation we experience lies the physiological process of the eye and of the

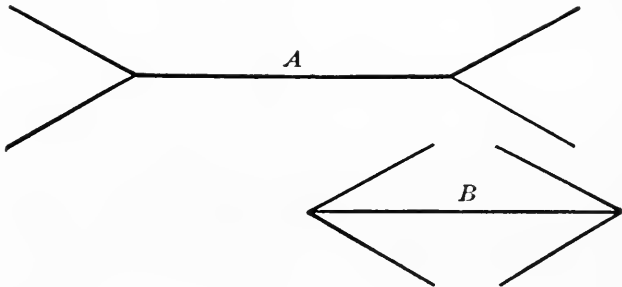

FIG. 11.

The length of the horizontal line A is equal to B, but it seems longer.

central nervous system. Before taking up the physiological process, a glance at the structure of the eye is necessary. In the lowest form of animal life, even before there is an organ of vision, the animal is affected by light. In certain parts of the jellyfish there are pigmented cells which absorb light, and in the higher forms there are "eyes" which are susceptible to changes of illumination only. Even the human eye, Fig. 14, is not capable of perceiving color at all points of the retina. If you look straight ahead and hold an object

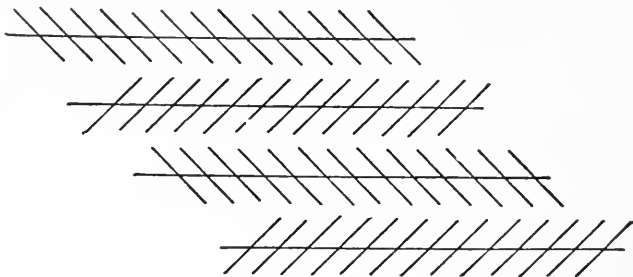

FIG. 12.

The long lines are parallel with each other.

COLOR AND ITS APPLICATION TO PRINTING.

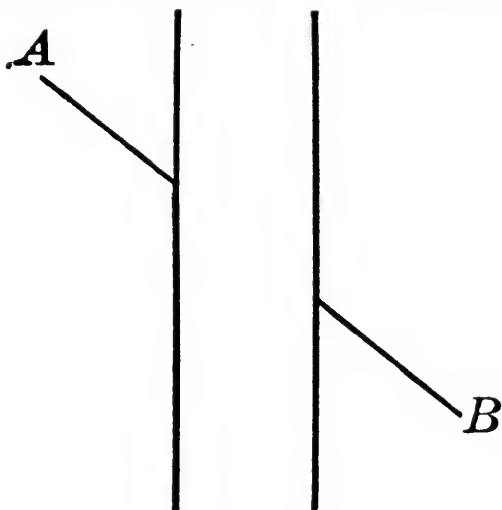

FIG. 13.

A and B are part of the same straight line.

in your hand with the arm extended horizontally at the side, you can detect movement, although you can not describe the color of the object. The eyes of some of the animals are very sensitive to movement at the extreme edge of the retina,

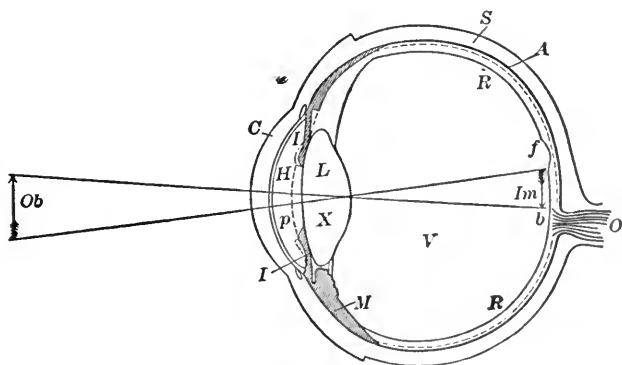

FIG. 14.

O, optic nerve; S, sclerotic; C, cornea; A, choroid coat; I, iris; R, retina; V, vitreous humor; H, aqueous humor; L, crystalline lens; X, optic center of lens; b, blind spot; f, fovea centralis; p, pupil; M, ciliary muscles; Ob, object; Im, image on the retina.

and this for them is of utmost importance, as movement or change in illumination invariably means danger. The human eye is supplied with six muscles, which makes it capable of rotation in any direction, but the movement from

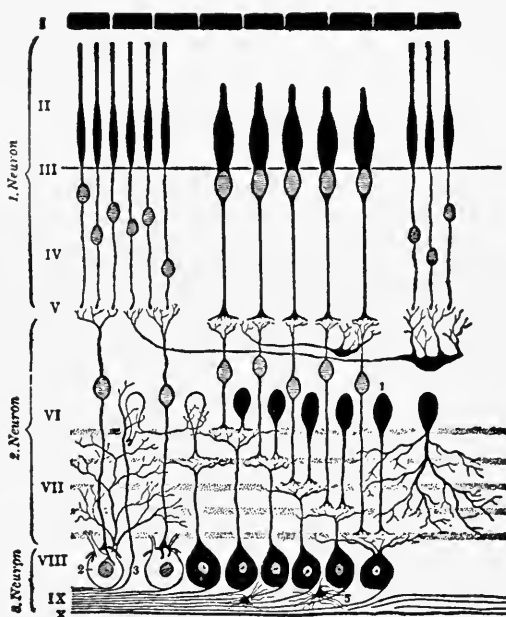

FIG. 15.

A diagrammatic section of the retina, after Greeff. I is the pigment epithelium, II is the layer of rods and cones. The rods are the small slender organs. In the retina the rods and cones are, throughout the larger part of the organ, mixed together; in the fovea only cones appear. III, IV, V, VI, VII show various intermediate structures between the rods and cones and the nerve cells which are situated at VIII. From the nerve cells at VIII the optic fibers pass out, as indicated at IX, toward the blind spot, where they leave the eyeball. X represents the limiting membrane of the retina. A ray of light entering the eye passes through the retina in the direction from X to II. The light does not produce any effect upon the cells or fibers until it reaches the layer of rods and cones.

right to left involves a simpler muscular action than the movement up and down. This is one reason why we are likely to overestimate vertical distances such as the height of a door. Beneath Fig. 14 the principal parts of the eye are indicated, but the retinal surface (R) is what interests the

student of color. The surface immediately back of the image (Im) to the choroid coat (A) is shown greatly magnified in Fig. 15. This cross-section of the retina, however, is turned so that the bottom of Fig. 15 is the part which the light strikes first, and travels back (up in the diagram) to the rods and cones shown at the top.

The rods are supposed to be cones in the process of development and are grouped at the outer edge of the retina. Since we perceive objects best when our eyes are focused directly upon them, and as the cones alone appear in the center of the retina, the cones are not only the center of clear vision but also the center of color vision. The area at the extreme periphery of the retina is totally color-blind and the area between the periphery and the center of clear vision is partially color-blind in that it is sensitive to a limited number of colors only.

According to the Young-Helmholtz theory of color perception, each minute portion of the color-sensitive-surface of the retina has three nerve elements; one set of these nerves is affected strongly by the long waves of red, the second by green waves, and the third by the short blue waves. In the perception of red, however, the other two nerves are affected to some extent. The same is true of the nerves especially designed for the reception of green and blue waves; they act on all three nerve centers, but more strongly on the set adapted to the reception of the given color. If all three sets are nearly equally stimulated at the same time, the sensation of white is produced.

In 1878 a theory was published in Vienna by Hering, advocating six fundamental sensations instead of three:

Black and white.

Red and green.

Blue and yellow.

According to this theory the retina contains three visual substances, and each pair of sensations above represents an assimilation or disintegrative process in one of the substances. Red light acts on the substance capable of receiving red and green in exactly the opposite manner from green, and when both red and green fall on the retina, in proper

proportions, the distinctive color disappears and a white or gray sensation results.

It remained for Mrs. Franklin, of Baltimore, to formulate a theory of "light sensation," which, in view of our increasing knowledge of the relation of chemical change to the physiological processes of the body, seems likely to explain the results of many experiments made by scientists. In fact, Prof. C. H. Judd, in his work on "Psychology," which, as it was published in 1907, represents the most advanced thought on this subject, does not even review the older theories, but presents Mrs. Franklin's theory as the simplest and most suggestive of all. He says:

"The primitive retina of the lower animals, and the periphery of the human retina, have only one chemical process with which to respond to all light stimuli. This single chemical process, when set up through the action of light, arouses in the central nervous system a process which is the condition of a gray sensation. This is the original undifferentiated type of retinal activity. As the evolution of the retina goes forward, this original chemical process, which may be called the gray process, is so subdivided that colors produce certain partial phases of the original chemical activity. The partial chemical activities produce each a specialized form of nervous process and a specialized form of sensory experience. The breaking up of the gray process into special color processes begins with a development, first, of the partial processes which correspond on the one hand to blue, and on the other hand to orange or yellow sensations. This first differentiation corresponds to the wide difference between the extreme ends of the spectral series. The original gray process does not disappear with the rise of the blue and yellow processes, but remains as the neutral and more general form of response. At this stage the yellow and blue processes are each called out by a great variety of stimulations. Thus, the yellow process is aroused by red light, orange light and green light, as well as by yellow light. As the development goes on, the yellow chemical process is subdivided into more highly specialized processes, corresponding to red and green. The result of this successive

differentiation of process is that the highly organized retina may, when stimulated by the appropriate form of light vibration, respond with specialized chemical processes to red, green, yellow or blue. If yellow and blue, which were the first forms of light to arouse differentiated processes, act at the same time on the retina, the partial processes which are differentiated out of the gray can not both be in action at once without being swallowed up in the original fundamental process of gray. If red and green act together upon the retina, the yellow process appears as the more fundamental form of chemical process. The facts of color-blindness can be explained by stating that the differentiation of chemical processes is not complete in the color-blind eye. Negative and complementary after-images are due to the physiological instability of the partial chemical substances left in the retina after a process in which a colored light has partially disintegrated the retinal substance."

CHAPTER IV.

FALSE AND CORRECT COLOR BALANCE — HUE.

IN discussing the Process of Color Perception I purposely avoided the use of the words primary and secondary or complementary, and Mrs. Franklin's theory coincides perfectly with our knowledge of the physical character of the wave-length of light, in that each wave-length may be properly called primary. In another sense, however, certain colors in light produce other colors by mixture and in this sense are more strictly "primary" than the resultant colors. Again, the word complement is in such general use in describing the relation of one pigment to another and is used incorrectly so often that a review of Brewster's false color theory is almost imperative.

Newton and his followers claimed that there were seven primary or spectral colors, namely, red, orange, yellow, green, blue, indigo and violet. But later this theory gave way to a theory of three primary colors. Unfortunately, however, the three colors selected by Sir David Brewster were red, yellow and blue, and owing to his scientific reputation this theory has met until recently with general acceptance. In 1802 when Doctor Young brought forward the theory outlined in the last chapter, but little attention was paid to it by the layman. Helmholtz and J. Clerk Maxwell repeated the experiments with better apparatus at their command and came to the same conclusion as Doctor Young. The experiments with this theory brought out the fact that although yellow existed in the spectrum as a color of definite wave-length it could also be produced by mixing red and green waves on the retina. Physicists now vary only in the selection of the exact hues. Violet-blue instead of violet as the third primary has the sanction of the best authorities. This color is represented by ultramarine blue obtained from

lapis-lazuli. Naturally, each of the three colors are interdependent on the other two, and when the blue tends toward violet the red must lean toward yellow-red. Fig. D, Plate I, shows the three primaries, red, green and ultramarine blue, and the corresponding secondaries, yellow, blue-green and purple. The secondaries are the complementary colors of the primaries, each being a mixture of two of the primaries in colored lights. Thus, yellow, as previously stated, is a mixture of red and green, the blue-green a mixture of ultramarine blue and green, and the purple a mixture of red and ultramarine blue.

The three primaries when mixed or when projected one on top of the other will produce white light, and likewise any pair which are complementary, such as red and blue-green, green and purple, and ultramarine blue and yellow. It also follows that any two colors or tints which produce white by mixing are complementary. Complementary colors in pigments produce white or gray when mixed by rotation.

I would suggest to those interested in witnessing the experiment of mixing colored lights that they try and locate an Ives Universal Colorimeter. This colorimeter is provided with three shutters which admit light through red, green and blue glass, and by means of an optical mixing wheel these lights are mixed together. Red and blue give the purples, blue and green the greens, and the introduction of the third color adds white light. In fact, the three shutters may be opened in such a manner that pure white is the result, a simpler way of proving that white light may be produced by mixing the primaries than by separating and projecting the hues by means of a prism.

Brewster's red, yellow and blue theory, illustrated in Fig. E, Plate I, is so closely associated in a printer's mind with the three-color process that the question naturally arises whether, after all, it may not be the correct theory, science to the contrary. It should be understood that painters have always known that approximate representations of all colors could be obtained from few pigments. In fact, red, yellow and blue will furnish a fairly complete palette, although more colors are desired for brilliant effects. This

fact furnishes the basis of the theory, but Brewster claimed that these three colors were the three fundamental kinds of light, three primary colors that would produce all hues of colored lights the same as in pigments. The artist may mix red, yellow and blue pigments in any proportion he desires, but the moment he uses the words primary, secondary or complementary he must be bound by scientific definitions as these terms refer to light. Brewster implied that the spectrum itself was formed by the overlapping of sets of red, yellow and blue waves, and furthermore that no other waves were present.

In the chapter on light and the spectrum we have seen that, objectively, color does not exist, and light consists of mechanical movements only. We have seen that the wave-lengths of the spectrum run from the extreme red, .76

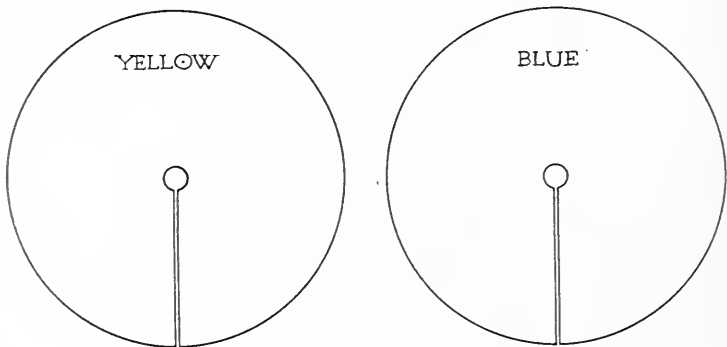

FIG. 16.

microns, to the extreme violet, .38 microns, a gradually decreasing scale with each color represented by its distinctive wave-length. But according to Brewster, green was formed by the overlapping of yellow and blue, which we know is not the case. It is a simple matter to test this experimentally by rotation, using Maxwell's disks. Fig. 16 shows two circular disks, with radial slits so that they may be fitted together in such a manner as to obtain various proportions of yellow and blue. Fig. 17 shows a Milton Bradley rotating apparatus with the two disks fitted so as to obtain



FIG. 17.

the proper proportion of each color to produce the resultant neutral gray. If too large a proportion of the yellow is exposed, the gray is yellowish. If too much blue, it is reddish; but in no proportion will there be a suggestion of green. The inner circles are black and white disks so combined that by rotation the resultant gray matches the gray produced by the yellow and blue on the outer disks. Brewster's theory falls at once, while the Young-Helmholtz and the later theories are sustained.

The next question which arises in the light of the experiment just made is, why do yellow and blue pigments when mixed together on the palette or slab produce green? In the first place the colors of pigments arise from absorption of light, and their distinctive color is due to the rays which they do not absorb. A yellow absorbs all of the wave-lengths of white light except yellow, this it gives out; a blue absorbs all except blue. When yellow and blue pigments are mixed together the mixture presents an intermingling of yellow and blue particles, and from these a small amount of yellow and blue light reaches the eye, but most of the light reflected from the yellow particles plunges part way into the blue particles and vice versa, each losing the rays which the other can not reflect. Now, as stated before, no pigment reflects any single wave-length free from all others; and yellow, besides reflecting yellow, reflects some green. Also blue reflects some green as well as its distinctive hue. Therefore, the only colored light which both pigments are capable of reflecting and which escapes absorption is green and *it* gives the mixture its color. In the light of this explanation we should expect a dull green, and as a matter of fact greens formed by mixing yellows and blues are not high chroma colors.

The harm of Brewster's theory does not end with the selection of red, yellow and blue as primary colors, since it follows the secondaries are incorrect also. The secondaries are formed as follows:

Orange = yellow + red.

Green = yellow + blue.

Purple = red + blue.

Placing the three primaries with the intermediate secondaries around a circle in the following order: red, orange, yellow, green, blue and purple, it is stated that opposite hues are complementary.

Red becomes the complement of green.

Yellow becomes the complement of purple.

Blue becomes the complement of orange.

Each of these statements is wrong when tested by rotation, as no two opposite colors unite to form a neutral gray or white. Besides, such an arrangement when tested gives a great excess of orange, showing that red and yellow occupy more than their proper proportion of the circle.

The tertiaries of Brewster are colors supposed to be formed by the union of three primaries in proportions different to those required to form white. But in reality the tertiaries are the dulled or broken colors, corresponding to the six primary and secondary colors. If red = R, yellow = Y, blue = B and Gr = gray, and we assume that we are dealing with pigments, the tertiaries may be represented thus:

$Y + 2R + B = R + Gr = \text{red-gray or russet.}$

$2Y + 2R + B = Y + R + Gr = \text{orange-gray or buff.}$

$2Y + R + B = Y + Gr = \text{yellow-gray or citrine.}$

$2Y + R + 2B = Y + B + Gr = \text{green-gray or sage.}$

$Y + R + 2B = B + Gr = \text{blue-gray or slate.}$

$Y + 2R + 2B = R + B + Gr = \text{purple-gray or plum.}$

From the above analysis it is clear that a so-called tertiary color can not present more than two of its constituent colors to the eye; the third is always neutralized by the equivalent quantity of the other two. Therefore, in reality, tertiary hues do not exist, although the colors obtained in this manner are useful in decoration to artists accustomed to a red, yellow and blue palette.

I mentioned that besides giving the wrong complement the Brewster theory allows yellow and red too large a proportion of the color circle. But by dropping out orange and using red, yellow, green, blue and purple as the five fundamental pigments (note that I do not use the word primary), this defect is corrected. Placing these around a circle and adding the intermediates, we have ten colors: Red-purple,

COLOR AND ITS APPLICATION TO PRINTING.

red, yellow-red, yellow, green-yellow, green, blue-green, blue, purple-blue, and purple.

This is an arrangement of pigments for the purpose of obtaining given relations useful in obtaining color combinations either in paints or printing-ink, and in the future it is

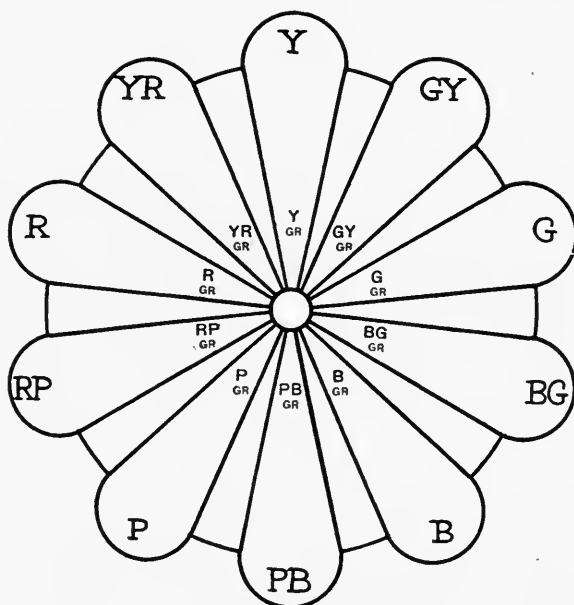

RP—Red Purple	G—Green
R—Red	BG—Blue Green
YR—Yellow Red	B—Blue
Y—Yellow	PB—Purple Blue
GY—Green Yellow	P—Purple
	Gr—Grey

FIG. 18.

to be understood that I am referring only to pigments and not to colored lights. This arrangement not only balances the circle, leaving no excess of orange, but gives a decimal notation for charting sequence of hue.

In Fig. 18 the ten fundamental colors are shown around the circle, each hue changing gradually to a more neutral gray as it nears the center. Opposite hues in Fig. 18 are

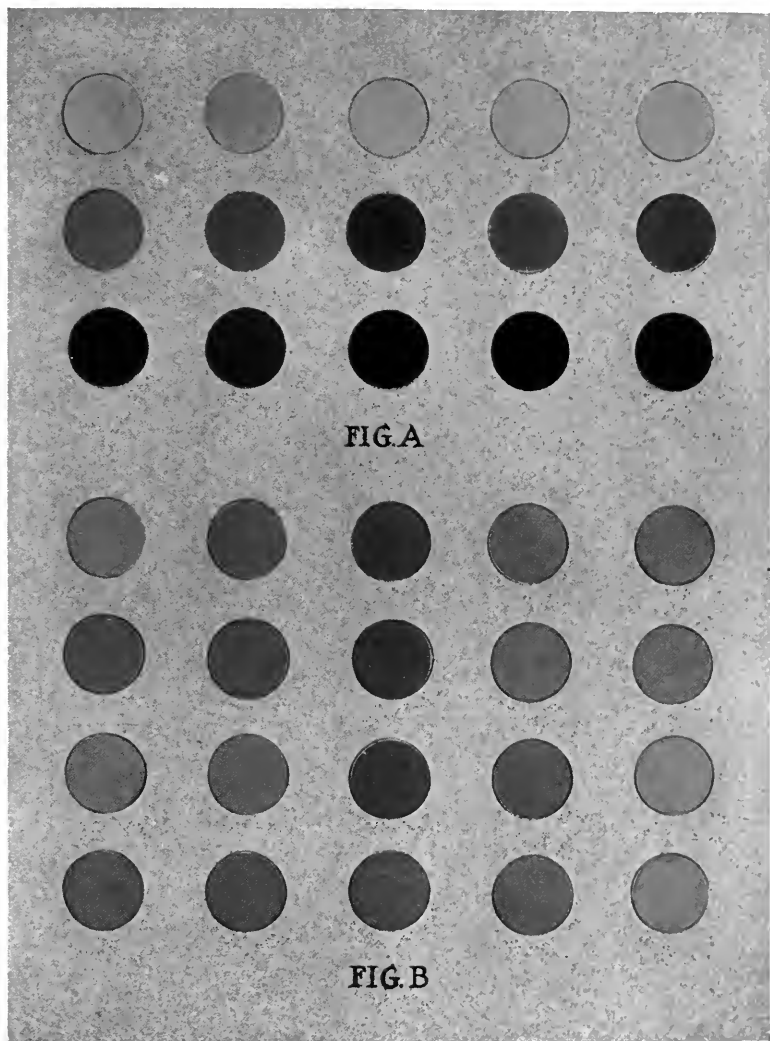

PLATE II.

FIG. A. The top row shows five of the fundamental colors — red, yellow, green, blue and purple, at a value of 70; the middle row shows these same colors at a value of 50, and the bottom row at a value of 30. All of these colors are in middle chroma.

FIG. B. All colors shown are in middle value. In the top row are the same colors shown in the middle row of Fig. A, but in higher chroma. The second row shows the same colors, but in lower chroma than Fig. A. In the third row the intermediates — red-purple, yellow-red, green-yellow, blue-green and purple-blue — are shown in high chroma, while the fourth row shows the same colors in a lower chroma.

complementary, thus blue-green (BG) is the complement of red (R), B is the complement of YR, etc. The *analogous* colors to red (according to the way the word analogous is used in this work) are shown on either side of it, YR and RP; and the *contrasting* colors (here again I use the word in what may seem a restricted sense) are the complement of red, BG and the colors on either side of it, namely, G and B.

It must be understood that if the ten colors are to present an even sequence of hue, when mixed by weighing like amounts of the adjacent colors, the five fundamental colors must not only be equidistant in hue, but equally strong in pigment coloring, equally strong in chroma. The second line of Fig. A, Plate II, shows five fundamental colors in middle chroma and also middle value, and Fig. C, Plate I, shows the same colors at their highest chroma. The printer is more familiar with these brighter colors, and in considering sequence of hue they will probably serve as better standards of equidistant hue than the middle-value colors.

CHAPTER V.

VALUE.

WHEN we say that a color is in middle value we mean that this color, judged solely by the amount of light it reflects (irrespective of its hue or chroma), shows the same contrast to black as to white. Value is the only attribute of the neutral grays from black to white, while colors possess the three attributes of hue, value and chroma.

Since "value" is common both to color and neutral grays, and as the proper relation of values constitutes ninety per cent of the balanced color-scheme, the importance of this subject will be appreciated. When an artist uses a neutral gray in a design he seldom knows in advance the exact value he desires, but mixes until the gray pleases him. He depends on intuition. If he endeavors to construct a gray scale he first establishes a middle gray by trying different proportions of untoned black and neutral white until the mixture shows the same contrast to white as to black. This point must be right or the whole scale will be wrong. Mixing the middle gray with white will give the steps between middle gray and white, and so with black until by subdividing the scale is complete. In experiments with printing-inks I have found that with proper impression a mixture of forty parts of neutral white and one part of Engravers' Hand Press Black will give middle value.

In Chapter X, I describe the construction of the neutral value decimal scale shown in Fig. 19, and suggest checking middle value by comparing it with Milton Bradley's white and black school paper until it shows no greater contrast with one than with the other. After middle value is determined accurately, the balance of the scale is gotten by substituting the proportion of black to white used in middle

DECIMAL VALUE SCALE
NEUTRAL AXIS

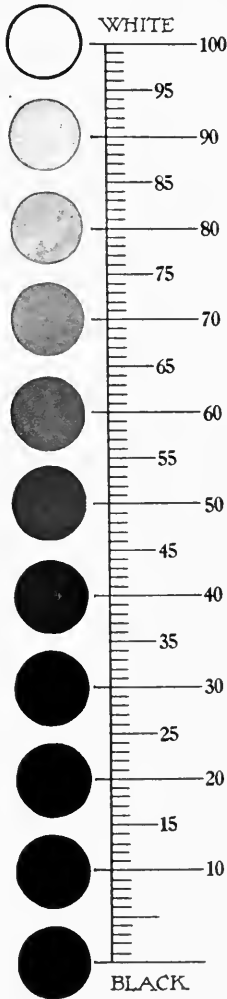

FIG. 19.

value in the other values according to relative proportion. Thus a 60-value gray would have a relative proportion of 60 of white to 40 of black; but if it takes 40 parts by weight of white to balance 1 part by weight of black, and produce middle value, a 60-value gray by weight would be composed of 2,400 parts of white to 40 parts of black. It follows that



FIG. 20.
FRONT VIEW.

the printed impression of the 60-value gray may vary as much as five per cent, so that the only accurate way of producing a scale such as shown in Fig. 19 is to test each separate sample with a photometer. Mr. A. H. Munsell has produced a satisfactory photometer for this work, and, as the instrument is comparatively rare, a word of description may be of interest. In working out this photometer for the Massachusetts Institute of Technology and the Harvard

COLOR AND ITS APPLICATION TO PRINTING.

Medical School, he realized that the existing darkroom photometers distorted color relations and that daylight was the natural basis for color measurement. The other photometers were also accurate only in certain registers, while the Munsell photometer measures the entire scale from white to black and is accurate to one or two degrees for most colors.



FIG. 21.
REAR VIEW.

Figs. 20 and 21 show this photometer, the front having two equal openings covered with translucent material admitting the light into the two halves of the cabinet, which is divided vertically. The rear view shows the eye piece (also divided vertically) and below it the rack, holding on the right the standard white (value 100) and on the left the sample to be tested. The two samples are reflected to the eye piece by means of a mirror. Below the eye piece on the right is a

dial which shuts off the light by means of a cat's-eye shutter from the right half of the cabinet and indicates at all times the relative size of the opening. Say that the reading of the dial is 50. Half of the light has been shut off the standard white in order to make it match in value the sample to be tested. The sample, therefore, has a value of 50. Each of these neutral black and white grays in Fig. 19 was tested by means of a Munsell photometer and then pasted on white cardboard and a half-tone made of the whole scale. Fig. 33, on page 82, shows the same scale with the values in contact,



FIG. 22.

and Fig. 27, page 70, shows the values of 10, 30, 50, 70, and 90 contrasted with each other, forming ten two-value combinations in two arrangements. The left upper part of the figure shows the darker value surrounded by the lighter, and the right lower part the lighter value surrounded by the darker. This process of arrangement in mathematics is called permutation, and in Fig. 27 we have twenty permutations, using two values at a time. With three values at a time, using the five values, 10, 30, 50, 70, and 90 as before, there are sixty possible permutations, sixty ways that the three values may be arranged.

Handling three values at a time is a difficult task for

the artist, to say nothing of the printer, but that arrangement or permutation does make a big difference is shown in Fig. 22. Notice on the left, the great contrast of black and white; the middle value of the leaves is lost sight of and we see only the flower. We realize that something is wrong, and, in seeking what it is, we do not sense the subject as a whole. On the right middle value is used as a background, and, therefore, the contrasts between the background and the flower, and the background and the leaves are equal. Instantly we grasp the idea and appreciate the beauty of the design.

It would be a waste of time to make experiments with sixty permutations, or even with ten combinations of three-value arrangements, as few of them would fit the requirements of the given design. If the printer can learn to use the ten two-value combinations shown in Fig. 27 he has accomplished much. One point about three-value combinations is well worth remembering, however. Areas, disregarding the question of their position, size or shape, *will balance if the contrasts which they make with the background are equal steps in the value scale.* In Fig. 22 on the right we have a contrast of middle value with black and white. We might have used 20 for the leaves and 80 for the flower, or 10 and 90, etc., according to the law of equal contrasts. If the nature of the design required four values, and black and white were used as two, the other two should be balanced on middle value, one as much above, as the other is below.

Let us look at Fig. 27 again and compare the various effects of opposition in the panels where the lighter value surrounds the darker. At the extreme left of the top line we have a contrast of 90 and 10, a difference of 80 in value. To the right of this panel we have 90 and 30 and below it 70 and 10, representing differences of 60 in value. Then we have 90 and 50, 70 and 30, and 50 and 10, in the three panels next to these two, showing differences of 40 in value, and lastly four panels representing differences of only 20 in value. These are the most harmonious combinations, because they have more in common—they are nearer alike;

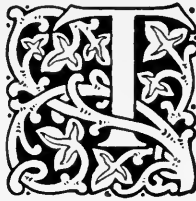

THE eye for composition is developed by experimenting, by choosing between one arrangement and another, rather than by applying mathematics. But in the case of rectangles it is found that the most pleasing proportion is, roughly, three to five. That is, the width of the rectangle should be to its height as the height is to the sum of the width and height — $a:b::b:a+b$ —and if a equals 1, b would equal 1.618. Socrates said that “if arithmetic, mensuration and weighing be taken out of art, that which remains would not be much.” What remains is the inspiration, the genius of the artist, but the advertiser often does without an artist because he is unable to find the ideal artist who combines business training with artistic feeling.

In all forms of advertising the space used is generally a rectangle. See that the width and height of the rectangle bear a simple ratio to each other — 2 to 3, 3 to 4, 4 to 5 — if it is not possible to use the ratio 1 to 1.618. If forced to use a square the base should be 3 per cent greater than the vertical side. This 3 per cent is the correction required to make the “square” appear more pleasing, as the eye overestimates vertical distances. In standard magazines the full page, as well as the quarter (the page divided once horizontally and once vertically), approach pleasing proportions. If there is one line more important than the rest of the copy, that line should be tried at such a position, that the space below is a trifle more than $2\frac{1}{4}$ times the space above. If there are two important lines, the first should



THE full-page advertisement naturally commands most attention. But in using smaller proportions of a page avoid running the rectangle across the page. It is best always in selecting advertising space to have the base of the rectangle less than its altitude. This rule also applies to general advertising matter.

As soon as the important statement, trademark, or catch phrase is located in the design, the subordinate facts should be so placed as to obtain "order" in the design. "Order" to the artist includes harmony, balance and rhythm. To be harmonious the different parts of the advertisement should have something in common; to be balanced there must be an equilibrium of attractions, or a balancing of one idea against another. To be in rhythm there must be a given direction in which the eyes are led naturally from one point to another in grasping the advertisement. In painting, or in drawing, the lines should bend, or lead, toward the center of interest. In type-composition this is possible only occasionally, but rhythm may often be obtained by adding a decorative element drawn to fit the requirements of the copy

Overornamentation and using great contrasts of type are two of the dangers in preparing advertising matter. As features are added we must be sure that they are not taking away from the simplicity of the composition as a whole. The beauty of the balanced advertisement depends more upon the typographical purity and the

next in point of analogy come the three combinations representing a difference of 40, while the 90 and 10 are nearly opposite in value, and, therefore, are the least harmonious. An analogy in color as well as in neutral gray is always a safe and easy way of getting harmony. Instantly you think of black type-matter on white paper, but in that, the value of the black, 0, affects the value of the type-matter only in proportion to the area of the total type-space it actually covers. The white paper showing through between every

Decimal Value Scale

Black = 0 Middle Value = 50 White = 100

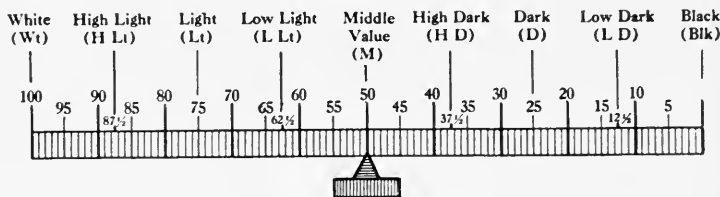

FIG. 25.

letter and even between different parts of the same letter raises the value of the type-matter just as if that proportion of white ink had been mixed with the black.

By using great contrasts in value, you can attract momentary attention to an advertisement, but by more closely related values you gain balance and *hold* the attention. In Fig. 23 notice how much more pleasing the lighter initial appears than the darker initial of Fig. 24.

Great contrasts should be avoided, not only in the values of a design, but also in the values of the type-faces of the reading-matter. To make copy forceful it is better to stick to one type-face, if the matter is short and to the point. If longer, gain the variety by slight differences in size of face, rather than by contrasting the large with the small. For example, if twelve-point Cheltenham is used for the body of the advertisement, then ten-point for the small display and fourteen-point for the large display is generally more effective than six-point for the small and twenty-four point for the large. Analogy

is the surest road to harmony in this, as in the handling of values.

In applying the rule of equal contrasts very often it is desirable to balance the values on some value other than middle value. For example, if buff stock is used instead of white, the value scale is limited by the value of the stock. If it is 80, the value scale runs from 0 to 80 and a three-value combination would balance on 40. A simple way of illustrating this rule is shown in Fig. 25. The values are arranged horizontally instead of vertically and are balanced on a fulcrum at 50, where the entire scale from 0 to 100 is used. If the stock is not white, but at 90, the scale is cut off at 90 and the fulcrum moved to 45, and conversely if the ink is not black but colored, of 30 value, we lose the lower part of the scale and the fulcrum must be moved to 65, half-way between 30 and 100. You will notice the abbreviations H Lt, Lt, LLt, M, HD, D, and LD. These are the older classifications of values, the value between middle and white being called Light, with High Light between that value and white, and Low Light between Light and Middle value. Dark is between Middle value and black, with High Dark above and Low Dark below it. These terms were also applied to values in colors. Yellow was supposed to reach its highest chroma at High Light; yellow-orange and yellow-green at Light; orange* and green at Low Light; red-orange and blue-green at Middle value; red and blue at High Dark; red-purple and blue-purple at Dark, and purple at Low Dark. Unfortunately this hypothesis is not borne out when the highest chromas of the various colors are tested with the photometer, as will be explained in the next chapter. My purpose in indicating the terminology of the old twelve-step theory of colors is to enable those familiar with it to connect this theory with the decimal scale of value.

It is obvious that any color may exist in all values except white or black, and in applying the rule of equal contrasts Table I is useful.

* NOTE.—This intermediate between yellow and red is commonly called orange, but orange is a variable color. The Century Dictionary defines orange as a reddish-yellow color, of which orange is the type. Many of our color names are derived from fruits and flowers and convey different ideas to each individual.

COLOR AND ITS APPLICATION TO PRINTING.

It illustrates color value on the even steps of 10, 20, 30, etc. Of course, color values occur on every step between.

DIAGRAM OF POSSIBLE COLOR VALUES.

100	(White)										(White)	100
90	RP	R	YR	Y	GY	G	BG	B	PB	P		90
80	RP	R	YR	Y	GY	G	BG	B	PB	P		80
70	RP	R	YR	Y	GY	G	BG	B	PB	P		70
60	RP	R	YR	Y	GY	G	BG	B	PB	P		60
50	RP	R	YR	Y	GY	G	BG	B	PB	P		50
40	RP	R	YR	Y	GY	G	BG	B	PB	P		40
30	RP	R	YR	Y	GY	G	BG	B	PB	P		30
20	RP	R	YR	Y	GY	G	BG	B	PB	P		20
10	RP	R	YR	Y	GY	G	BG	B	PB	P		10
0											(Black)	0

TABLE I.

The top row in Fig. A, Plate II, shows five of the fundamental colors, red, yellow, green, blue and purple at a value of 70, the middle row shows these same colors at a value of 50 and the bottom row at a value of 30. All of these colors are taken at what is known as middle chroma, and present an even sequence of hue, so that mixing equal parts of two adjacent colors produces a color of like value exactly midway in hue. The question of chroma is taken up in detail in the next chapter. For the present we are interested only in the value of the colors shown. All the colors in Fig. B, Plate II, are in middle value. The top row are the same colors shown in the middle row of Fig. A, and are in the same value, the only difference being that they are higher in chroma. The second row shows the same colors in a lower chroma than in Fig. A. In the third row, the intermediates, red-purple, yellow-red, green-yellow, blue-green and purple-blue are shown in high chroma, while the fourth row shows these same colors in a lower chroma.

You will notice that red and green possess the highest chromas at middle value, and almost every printer knows that this particular red is the right red to be used as a decorative or initial color on white paper with black type.

The question naturally arises why green of maxima chroma is not used as much as red. This is undoubtedly because of a long association of the warm colors with black

and the cool colors with white. White itself signifies coolness; we dress in white clothing in the summer, and invariably associate green shutters with a white house. If we were to print with white cover-ink on a black cover-stock, then we should have a case similar to the white house, and the green maxima would be more often chosen as an initial letter than the red.

Now let us take up the practical application of value in colors. Besides the maxima red and green we have the yellows, yellow-reds and green-yellows brought down to middle value by the addition of black, and the red-purples, blue-greens, blues, purple-blues and the purples brought up to middle value by the addition of white. The colors shown in Fig. B, and the second line of Fig. A, are only a small proportion of the possible hues and chromas in middle value, as intermediates in hue may be made by mixing adjacent colors, and all these hues may have chromas ranging from almost a neutral gray to their greatest intensity.

While red and green, since they are full chroma in middle value, are naturally better suited for small areas than the colors of lower chroma, all the colors shown in middle value make very interesting decorative colors with black, and will give the printer a far better guide than depending on haphazard and miscellaneous proofing. So far, we have considered white stock only. If the stock is tinted, and has a value, for example, of 80, the color midway in value naturally is lowered, and has a value of 40, as explained in balancing values in the gray scale. If you select any color above *that* value you must lower it or, in the case of purple, bring it up to *that* value. A concrete illustration of this point would be a deep red initial with black type, on buff stock, as compared with a light red initial on white stock.

Another very interesting example of the importance of value has been shown in certain numbers of the *Outlook*. The stock used was a light-green tint; on this was printed an extremely dark green or green-black, the ink being just as much above black in value as the stock was below white. It was not necessary to have selected green; any color of that low value could have been used.

Looking at Plate II again, let us summarize the different ways in which we may apply the rule of equal contrasts in colors:

Rule 1. On white stock, with black type-matter, any of the colors in middle value may be used as decorative or initial colors. The warm colors will probably be preferred by your customer, as black is generally associated with the warm colors. The cool colors are in just as good harmony, however. It is a matter of personal taste.

Rule 2. On white stock, with black type-matter, colors which are equidistant from white and black in value, that is, equidistant from middle value, will balance, namely, yellow at 70 and purple at 30, green at 70 and red at 30, etc. In a three-color combination of this sort, however, it is best to balance a warm color against a cool one, although in middle chroma any of the 70 colors may be used with any of the 30 colors.

Rule 3. On white stock, with a type-color of low value, a single decorative color should have a value midway between that value and white. If two colors are desired in addition to the dark type-color, the value of one should be as much *above* the value midway between the low value and white as the other is *below*.

Rule 4. On tinted stock of a high value, and with black for type-matter, a single decorative color should have a value midway between the value of the stock and black. If two colors are desired they should balance, as indicated in Rule 3.

Rule 5. On tinted stock of high value any color may be used instead of black for type-matter, providing that its value is as much above black as the stock is below white. Adding a decorative color is the same as in Rule 4.

Rule 6. If the colored stock is middle value it follows that any middle-value color may be used, providing that the chroma does not destroy the balance.*

* NOTE.—Some of the new imported stocks have such peculiarly high chromas that it is practically impossible to use them in connection with any of the ordinary colors sold by printing-ink manufacturers. Not long ago an officer of one of the most progressive paper houses in the United States picked up a sample of an Italian cover-stock, and said: "I wish you would try that stock in your advertising and see what you can do with it. In

Cover-white and cover-black, of course, may be used, and an additional decorative color midway in value between either one selected. Cover-black is naturally more satisfactory, as cover-white usually requires at least two impressions.

It must always be borne in mind that, unless cover-inks are used on cover-stock, the value of the color as shown on white stock is greatly altered by the hue and value of the colored stock. It also follows in using middle-value cover-stocks, two colors may be selected, the one as much above the value of the stock as the other is below.

In closing, let me say that the printer as well as the artist will find that experimenting with the gray scale, and particularly learning to recognize middle value, will be of immense help in judging the values of colors. I personally regret that every color shown is not the original sample tested by the photometer, instead of a reproduction by the three-color process. A reproduction never gives exact values.

all the time we have carried it I have never seen it used with a satisfactory color combination. About all we can recommend is black or a shade of the same hue." The reason for his remark was obvious. There was no printing-ink on the market of a suitable hue or chroma.

CHAPTER VI.

CHROMA AND THE UNION OF HUE, VALUE AND CHROMA
IN THE COLOR SOLID.

CHROMA, when used in reference to light, means the purity of one wave-length free from all others. In pigments chroma is the quality which distinguishes an intense color from one not so intense. The expression "give me a red that's red" means, as a rule, that the advertiser wishes a red of high chroma. Vermilion, flaming scarlet, Persian orange, emerald green and other lake colors are examples of high chromas. It often happens that it is possible to match the hue of the color on the engraver's proof with the inks you have on hand, but the mixed color lacks brilliancy. Disregarding the fact that you are using a much cheaper paper than the engraver, which, with normal or transparent inks, dulls the color, the difference is that the engraver always uses the most expensive colors in order to bring out the maximum quality of his plates. These expensive colors invariably are inks of high chromas, and, in order to approximate the engraver's proof, you must use inks ground from the same material although not necessarily as heavy in body. Mixing yellow and blue will give a great variety of greens, but none of them will have the high chroma of emerald or other lake greens. As explained in Chapter IV, the colors of pigments arise from the absorption of light, the distinctive hue being due to the wave-lengths of white light which they do not absorb. Disregarding a possible chemical reaction in the pigments themselves, which always dulls the chroma, the loss of chroma in mixing colors may be summed up as follows: No pigment reflects a single wave-length free from all others, but a number, some of which are quite dissimilar to the predominating color; the larger the number of pigments you use in a mixture the

more counteracting wave-lengths you have; the more counteracting wave-lengths present the less chance of obtaining a color of high chroma.

The experiment of mixing yellow and blue by rotation also illustrates that different colors have different limits as to possible chroma. In the rotation apparatus illustrated in Fig. 17, page 43, the complements yellow and purple-blue were so arranged that, by mixing, the resultant color was a neutral gray which exactly matched the gray obtained by rotating equal parts of white and black. But in order to balance the yellow and purple-blue it was necessary to use a larger proportion of the purple-blue than the yellow, as was shown in the illustration.

In the case of the exact colors used in my experiment it required fifty-eight per cent of purple-blue to balance forty-two per cent of yellow. This demonstrates at once that the yellow had a higher chroma than the purple-blue, and as I selected both colors in their common or high intensities it also suggests that blues do not possess the possibility of high chromas found in the yellows. The manner of calculating relative intensities is simple. If forty-two per cent of yellow balances fifty-eight per cent of blue, it is evident that it takes over one-third more of the purple-blue than the yellow to effect neutralization. If we let C equal the chroma of yellow and C' the chroma of purple-blue, we have

$$42 C = 58 C'$$

and if we arbitrarily make this yellow the standard of chroma or 100, it follows that the chroma of the purple-blue is 72.4.

$$\begin{aligned} 42 \times 100 &= 58 C' \\ C' &= \frac{4200}{58} \text{ or } 72.4 \end{aligned}$$

In Plate III are shown five of the ten fundamental colors in various degrees of chroma. The central point (N) is a neutral gray, and as the colors move outward they become higher in chroma; red having a possibility of 100 degrees of chroma, yellow 90, green 60, blue 50 and purple 60. It follows that the intermediates not shown in the plate, RP,

YR, GY, BG and PB, have possibilities of chroma determined by the chromas of their constituent colors. Thus yellow-red has a possibility of a chroma between 90 and 100. Green-yellow about half-way between 60 and 90, or 75, etc.

Plate III also illustrates an exact sequence of hue, based on equidistant hues in the spectrum with the addition of purple which unites the ends of the spectrum and produces a pigment color circuit. The colors in the plate show an increasing area of color, as the chroma increases, so that the difference in chroma may be noticed; but the position of the color in the circuit, its hue, is a single degree or division of the circuit of 100 hues. Thus red occurs at 20, yellow at 40, and yellow-red half-way between, or 30, etc. The exact numbering of the circuit is, of course, arbitrary. As purple does not occur in the spectrum, and as it fills the gap between the red and violet wave-lengths when we imitate the spectrum in pigments, it seems that the logical starting point in numbering should be where purple begins to take on a reddish hue. With this as a starting point, RP occurs at 10, R at 20, YR 30, Y 40, GY 50, G 60, BG 70, B 80, PB 90, P 100.

With five equidistant hues established as shown in Plate III, it is an easy matter to produce the intermediates making the ten fundamental colors of the circuit, and, in most cases, these ten colors serve for the necessary distinctions as to hue. But where a fine discrimination is desired the hue may be called simply by number. Thus hue 25 is a hue half-way between red and yellow-red; hue 21 is nine-tenths red and one-tenth yellow-red, etc. The numbering of the circuit also enables the exact complement of any color to be located by adding or subtracting 50 from the number of the color. For hues from 1 to 50 add; for hues from 51 to 100 subtract. Thus the complement of red (20) is blue-green (70); the complement of hue 21 is hue 71; the complement of hue 80 is hue 30, etc.

It would seem impossible to name and classify every kind and degree of color; but if all colors possess the same three qualities, hue, value and chroma, and if each quality is measured, it follows that any color may be described by these three dimensions. Plate III shows that hue is measured by

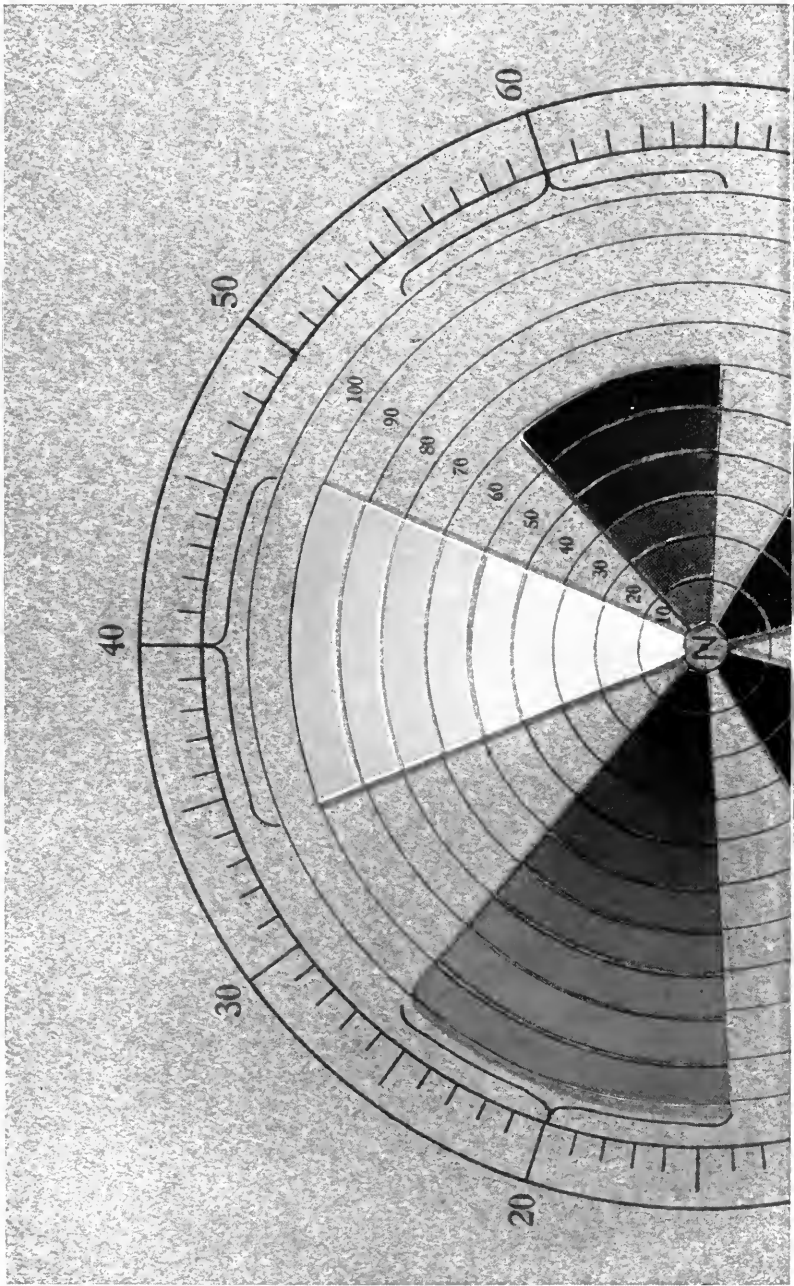

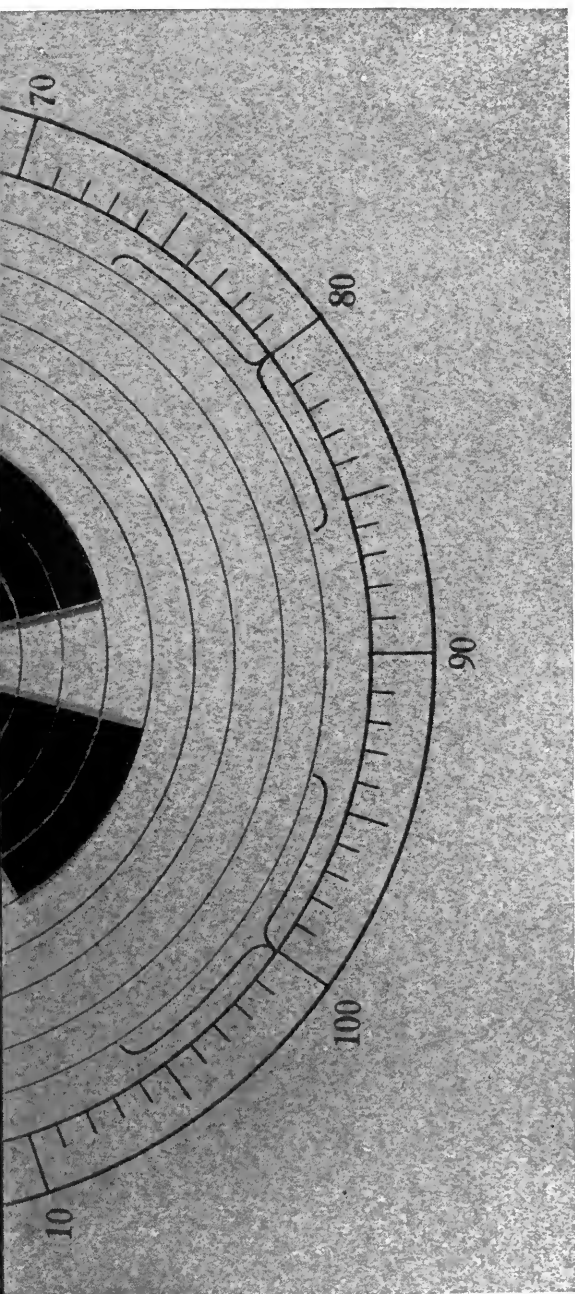

PLATE III.

This plate illustrates five of the fundamental colors of the decimal color circuit, equidistant in hue, each color is shown at the value in which it reaches its highest chroma. Red attains its greatest intensity, 100, at a value of 40, and the plate shows ten chromas all of this value. Yellow reaches a chroma of 80, green a chroma of 60 at a value of 50, and blue and purple, chromas of 50 and 60 respectively at a value of 30.

An increasing area of color toward the circumference of the circle is used so that the steps of chroma may be more readily noticed, but each series is really the chromas of a single degree of each color. According to the dial surrounding the circle, the red shown is at 20 in hue and yellow at 40. Yellow-red would occur at 30, and the steps between 20 and 30 would be a gradual approach to yellow-red in hue. Thus to indicate any possible color the hue or rotation around the circle must be given first, then the value and thirdly the chroma. For example, hue 20, value 40, chroma 100. With this arrangement complementary colors are opposite; the complement of red, hue 20, would be hue 70; blue-green, a mixture of 60 and 80.

The four-color process plates for the above reproduction were made by the Faithorn Company, Chicago, Illinois.

the distance around, the rotation from the starting point (0 or 100), and chroma is measured by the distance out from the center (N). But what of value? It is measured by the distance up and down, and N in Plate III is the end of the vertical axis of our color solid. In order to connect the three dimensions of color let us look again at the neutral axis shown in Plate III (N) from the front instead of the top. See Fig. 19, page 49.

Although colors may have any value above 0 and below 100, at a certain value each color has a possibility of its maximum intensity, its highest chroma. Red reaches its maximum chroma, 100, at a value of 40, yellow its maximum chroma, 90, at a value of 80, green its maximum, 60, at a value of 50, and blue and purple reach chromas of 50 and 60 respectively at a value of 30. Therefore, every degree of chroma of each color shown in Plate III should be connected with its own neutral gray. Red comes out of the neutral axis at 40 (Fig. 19), and begins with a chroma of 10, then 20, etc.; yellow leaves the neutral axis at 80, etc., and in the top view of our color solid, N stands for different values for the different colors.

Various solids have been used by psychologists and writers on color in endeavoring to classify colors with regard to hue, value and chroma. The sphere was used by Runge over a century ago and in many ways it is best adapted for this purpose. It has, however, two objections. First, it limits the chromas of the colors shown on its surface to the chroma of the weakest pigment. Mr. Munsell in teaching his color system to school children uses a sphere, but brings all the five fundamental colors to a chroma of 50, the chroma of his blue, and further equalizes the values of the five colors, making them all 50 in value. These five colors he places around the equator of the sphere, and above he shows a lighter value and below a darker value of each fundamental color. As these fundamental colors and their lighter and darker values are equidistant in hue, when the sphere is rotated they blend into three bands of neutral grays.

The middle value and middle chroma colors are, as Mr. Munsell so logically argues, the best colors for training the

color perceptions of a child, as they are constantly found in the masterpieces of painting, Oriental rugs and Japanese prints. The crude yellows, reds, and greens, etc., used in decorating a child's toys, could no more be combined into a scale of color than one note from a cornet, one from a trombone, one from a flute, would furnish a harmonious musical scale. These crude colors of higher chroma he is obliged to locate outside of the color sphere and indicate them as projections. Vermilion, for example, may be represented by sticking a pin in the section occupied by middle red, the length of the pin indicating that vermilion has a chroma of 90 — 40 degrees beyond the surface of the sphere.

The printer's color problems are not those of a teacher instructing a child, however. While the middle-value colors have their place in printing, and, if used more often, would result in better colorwork, the printer is also obliged to know how to handle the colors of higher chroma. Much of the colorwork of the average printer consists in adding a decorative or initial color to a page of black type-matter, and, if the customer specifies red, the printer at the present writing would be considered lacking in color sense if he showed a proof of middle-value red; he will do well if he is left to select the proper brilliant red and to keep the customer from using it on every other line.

The second objection to the sphere for the printer's use is that colors when they approach white in value do not necessarily lose in chroma as when they approach black; that is, a very light tint, near white in value, may be made from a powerful lake color, such as yellow lake, which would give the mixture a fairly high chroma. Taking this point into consideration in constructing a color solid leads us to some such form as is shown in Fig. 26. It starts from a point where neither light nor color exists, absolute black, and gradually increases in size until the diameter is more than great enough to accommodate the plotting of the colors of the highest chromas and then straight up to white. Obviously absolute white has neither hue nor chroma, and the extreme end of the neutral axis at white may be supposed to project slightly above the top of the solid. The

COLOR AND ITS APPLICATION TO PRINTING.

top view of Fig. 26 is shown in Plate III in color, except that the chromas of only five fundamentals were indicated, each at the value where the fundamental color reaches its highest chroma. These lines to the points of highest chroma are

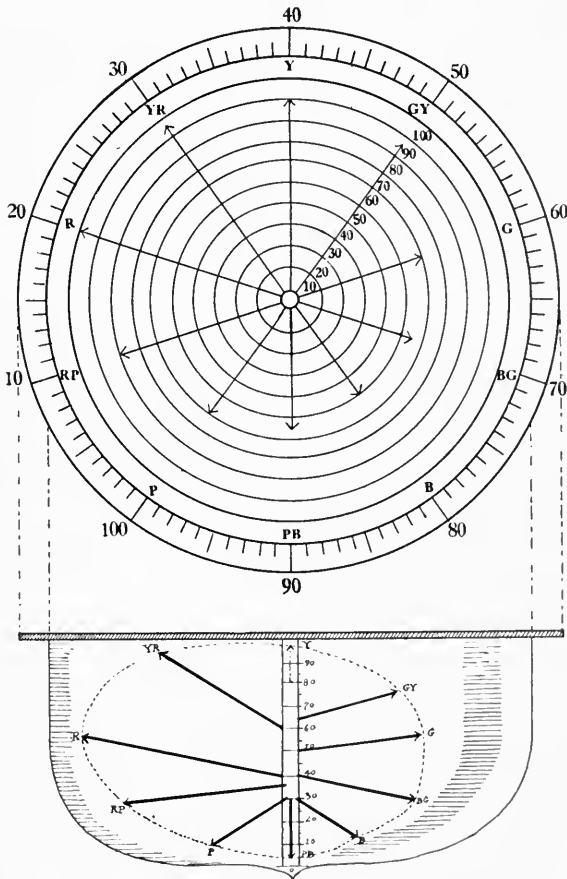

FIG. 26.

shown in the lower part of Fig. 26 and the dotted line connecting the extreme points forms an ellipse, tracing a path which varies in value and chroma as well as hue. It is on this elliptical circuit that practically all color systems have

been established. Apparently the sole object of standardization has been one of hue, with the red in highest chroma showing no trace of purple or yellow, the green also in its highest chroma exactly midway between yellow and blue, etc. An example of such a standardization will be found in the Milton Bradley school papers.

CHAPTER VII.

THE COLOR SOLID AS A BASIS FOR COLOR COMBINATIONS.

A COLOR solid such as shown in Fig. 26 standardizes hue not only in one value, but in all values and chromas, and leaves room for the location of new colors of high chroma, which may be discovered in the laboratory at some future time. This color solid also enables the classification of color harmony into three typical paths and their combinations. Suppose that we start with blue, at a value of 30 and a chroma of 50. *Moving around the color solid* in the same chroma (distance from the center), and at the same value (distance up and down), we find blue-green, value 30, chroma 50, on the right, and purple-blue at the same value and chroma on the left. These two are exact analogous colors to the blue and will harmonize with it. *The second path is vertical*, leading us through different values of blue. This is illustrated by using what is commonly called the shade and tint of a color, one of the safest methods of obtaining color harmony for the beginner. There are no complications of contrast of hue, the sole problem being one of balancing values. For example, the blue of 30 value mentioned above, when used for type-matter may be combined with a blue of 70 in value, used as a solid tint-block. In this case the type is as much above black as the tint is below white. In fact, any number of values of blue may be used, providing they are properly balanced. Where white stock serves as a background and the 30 value blue is used for type, a decorative blue of like area will balance if it is 65 in value, or, to be more definite, half-way between the type (30) and stock (100). By combining a vertical path with the lateral we have analogies where one end of the sequence has a higher value than the other end. Instead of using blue, value 30, chroma 50, with blue-green or purple-blue of the same value

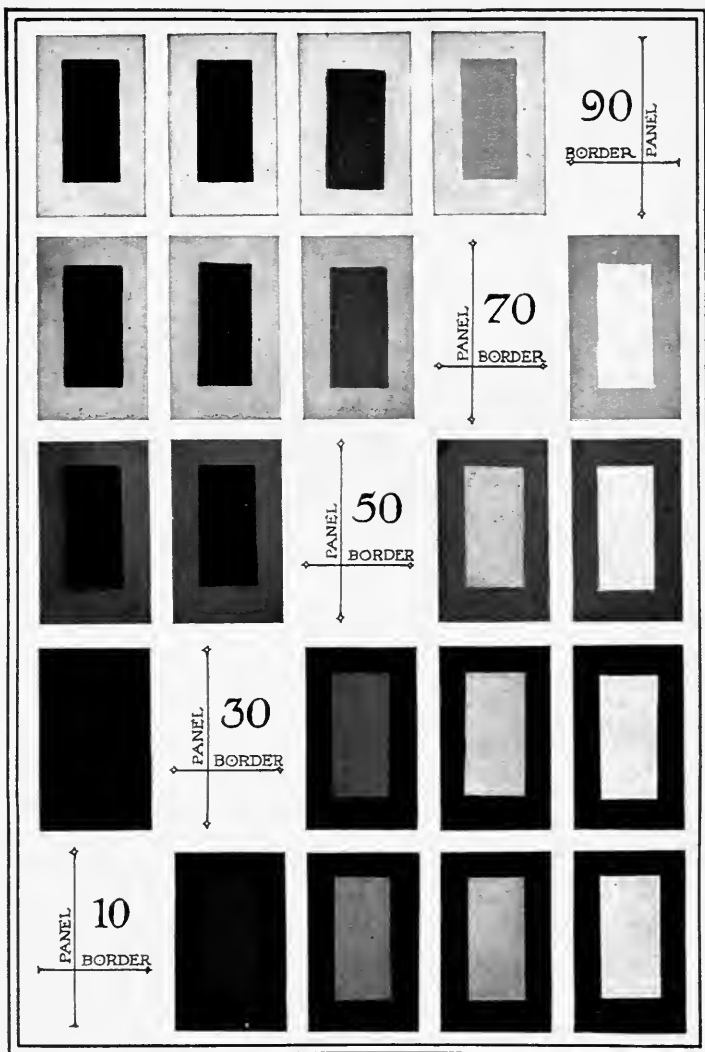

FIG. 27.

A plate showing contrasts of two values each, using values 10, 30, 50, 70 and 90 in the neutral-gray scale. Each gray of the original chart was standardized by means of the Munsell photometer, and the half-tone plate corrected to imitate more exactly the value relations. This plate illustrates Division I of typical color combinations.

and chroma, we may use that blue with the blue-green or purple-blue of higher or lower values. *The third path is toward the axis of the solid* through decreasing chromas until we reach neutral gray, and then out on the other side through the increasing chromas of the complementary hue. This third path may be varied by moving through the adjacent colors of the complement to the right or left after leaving neutral gray. The third path is the most difficult for the novice, as it combines constant change of chroma and a change of hue without a change of value. Adding the third path to the lateral and vertical enables us to obtain color harmony by analogy or contrast in various degrees of hue, value and chroma.

Good color-schemes are due to a balance which combines warmth and coolness (hue), light and shade (value), and intensity and grayness (chroma). The pleasing proportions of these qualities are worked out unconsciously by the great colorists, and often combinations are used which seem to break all laws formulated for the guidance of the beginner. This should not discourage us, as the master must understand the color laws better than any one else before he can successfully break them. Then, too, the laws of simultaneous contrast often make what appears to be a deviation necessary. Take the case of a decorative cover showing a large expanse of blue sky and a white cloud. The cloud should appear tinged with yellow-red, but if you print it with white, to which you have added even the smallest proportion of yellow-red or yellow-red-gray, it will appear altogether too strong. In fact a very light tint of green-yellow-gray will appear yellow-red under these conditions. Imagination also plays a part in the effect of a color-scheme, and often color is suggested throughout the design by a very limited use of it in certain portions. Before the artist can leave out color, however, he must know how to put it in. The simple in design comes from a thorough knowledge of the complex. An artist of national reputation aptly illustrated this point not long ago by dashing off the word "Chicago," of which no letter, except the capital "C," could have been recognized if it had stood alone. Yet the word, as

a whole, was grasped instantly. "It is like this," he said, "if you practice each letter by itself time and time again, and then practice writing them together, eventually you suggest the word by one or two typical characteristics. So, too, in painting, you must know all the details of the construction of a house and then suggest them without putting them in the picture." An appreciation of the value of suggestion will be readily obtained by observation.

But to return to the subject of the balance of hue, value, and chroma. Most successful color-schemes worked out consciously are the result of the careful analysis of the color-schemes of others. The color solid helps us to label the good color-scheme so that we not only recognize why it is good but are able to use it again in a somewhat altered form. Whatever attracts us in color, catalogue cover, Japanese print or magazine illustration, may be analyzed according to the relation of its hues, values and chromas. If one of the colors is red, is it the red which occurs at 20 in hue or is it a little yellower, perhaps hue 22? Does it have the value of the red shown in Plate III—a value of 40, or is it higher with a little white in it—perhaps 50? And the chroma. Is it 100? No, about 80. This red we have described surrounds a somewhat neutral tint-block, but on closer analysis we find it is blue-green with a value, say, of 80 and a chroma of 20 or 30. It may be necessary to cover up the red when analyzing the blue-green-gray because by simultaneous contrast the red of high chroma adds its complement, blue-green, to the gray. It will be a matter of surprise how much the plotting of the relations of a good color-scheme in the solid will help recall it when we wish to use it. Besides, there is pleasure in the analysis itself. Those who listen at a concert for the union of melody, harmony and counter-point, and are familiar with the different instruments, enjoy recalling the composition in much the same way. We are not all gifted in music, but education in color offers not only enjoyment but it also offers the printer a rich return on the right side of the ledger.

The balancing of two or more colors depends upon the area of each used, and as a general rule colors of high

chromas should be confined to small areas—the higher the chroma the smaller the area—and vice versa, a large area should be somewhat neutral.* Secondly, the values should be balanced with each other as explained in Chapter V. Thirdly, the hue should be selected with a knowledge of the result of simultaneous contrast, in order to avoid glaring effects. If all the hues in a combination are not analogous or contrasting, in the limited sense I use the words, there must be a compensating hue in the color-scheme in order to hold the hue not falling in the above classifications in its proper place. This last method of obtaining color harmony is sometimes called Harmony by Balanced Contrasts. It will be taken up in detail later.

In classifying color combinations there is one important distinction between art subjects and printed matter in the use of color. The artist never uses black, except to indicate absence of light. In printing, on the contrary, black is used more than colors, and in filing good color-schemes for reference the classification given on the next page will be found valuable.

* NOTE.—If two colors of the same chroma are used, like areas will balance, but if the chroma of one is *lower* than the chroma of the other it must be given a *proportionately greater* area. Say that the chroma of one color is 90 and the other 50; the area of the 90 color should be to the area covered by the other as 50 is to 90, inversely proportional to the chromas. In other words, balance 5 parts of the 90 chroma against 9 parts of the 50-chroma color.

- I — Black and white with scale between. }
 a. Intermediates produced by screens.
 b. Intermediate produced by mixing black and white pigments.
- II — Black on white or colored stock, with scale between and one decorative color. }
 a. Black for type and white stock. Decorative color in middle value.
 b. Black for type and colored stock. Decorative color of hue to harmonize with stock, and chroma to balance area it occupies; of a value midway between stock and black, if stock is high in value. If stock is low, decorative color will balance if the value is as much above value of stock as black is below.
 c. A neutral gray for type and white stock.
 d. A neutral gray for type and colored stock.
- III — Black on white or colored stock, with scale between and more than one color. }
 a. Black for type, one color for half-tones, one for decorations, etc.
 b. Neutral gray for type, one color for half-tones, one for decorations, etc.
 c. One color for type, black for half-tones and a second color for decorations, etc.
 a. Two or more tones of one color differing in value or chroma.
 b. Two or more analogous colors.
 c. Two contrasting colors.
 d. Two or more analogous colors with one or more contrasting colors.
 e. One color with the second not analogous or contrasting, but between the two, and a third color to hold the second in place and avoid the results of simultaneous contrast.
- IV — Colors alone on white or colored stock. }
 A balancing of values with decorative trasts of the neutrals in the axis of the color solid.
 A balancing of values with decorative color of suitable hue and a chroma in proportion to the ratio of its area to the area of the type-matter.
 A balancing of values, with decorative color selected according to II; the type color should always be low in value and chroma, a dark somewhat neutral color. The red, yellow and green-grays are, next to black, best adapted for this purpose.
 A balancing of values in colors alone, with the hues and chromas selected according to II and III. If stock is colored, its color should be considered the first color of the combination.

CHAPTER VIII.

THE LAW OF MODIFICATION OF COLORS DUE TO
OPPOSITION.

THE change in appearance when one color is surrounded by another or placed alongside of it, or when two colors are examined successively, is commonly called the effect of color contrast. We *contrast* one color with another in the sense of comparing them side by side; we place them in opposition, or show the difference in the two colors. But part of the change in appearance is due to error in judgment as well as to effects generated in the eye itself. Indeed, some of these illusions disappear as soon as we realize that our eyes are not mirroring exact facts.

We have defined *contrasting colors* as the complement of a given color and the color immediately to its right and left; therefore, we should *avoid using* the term *contrasting colors* in the sense of colors brought together so that we may compare their differences. Say that we examine a red and a yellow side by side; the red becomes bluer and the yellow greener. Their difference in hue is increased and also such opposition brings out the difference in the value and chroma of the two colors. But because we are comparing red and yellow, or in other words, contrasting them, they do not become contrasting colors. Some writers have fallen into this error, and in order to be still more specific in the meaning of the words analogous and contrasting as they refer to definite color relations, I have charted the analogous and contrasting colors of each of the ten fundamental colors in Figs. 28 to 32. It is obvious that the division I have made is arbitrary, but it is logical in construction, and if it will help to definitize these terms it will have accomplished much.

In Fig. 28, red at the highest chroma possible for the different values is connected with yellow-red on one side and red-purple on the other in their respective highest

chromas for the various values. This vertical surface forms the outer face of the space containing the analogous colors of red. The inner limit is neutrality, but as shown in the figure the surface extends in a line from yellow-red toward

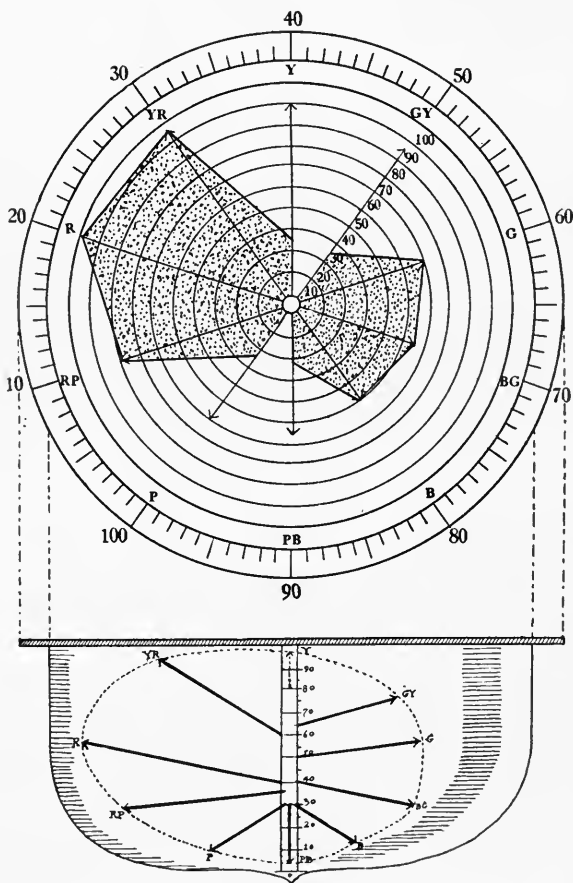

FIG. 28.

Red and its analogous colors in relation to its complement blue-green and its analogous colors.

blue-green (the complement of red), and on the other side from red-purple toward blue-green. In either case, however, the surface bends inward on the line of the second color to

the right and left of red, namely, yellow and purple, and from these points moves to neutrality. The object of this shape rather than a form where the sides would run directly from yellow-red to neutrality and from red-purple to neu-

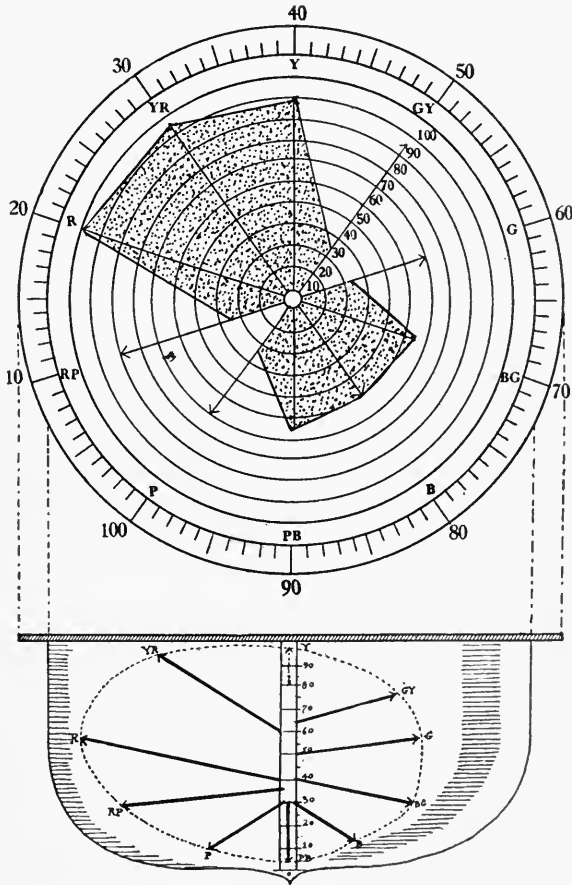

FIG. 29.

Yellow-red and its analogous colors in relation to its complement blue and its analogous colors.

trality, is to include in the red analogy the partially neutralized yellows and purples. Analogy means similarity, and if we raise colors almost to white, or lower them nearly to

COLOR AND ITS APPLICATION TO PRINTING.

black, they lose their distinctive hue besides having similar values. Also, if we reduce the chroma of the various colors so that they approach neutrality, they naturally become analogous. The form indicated takes these facts into con-

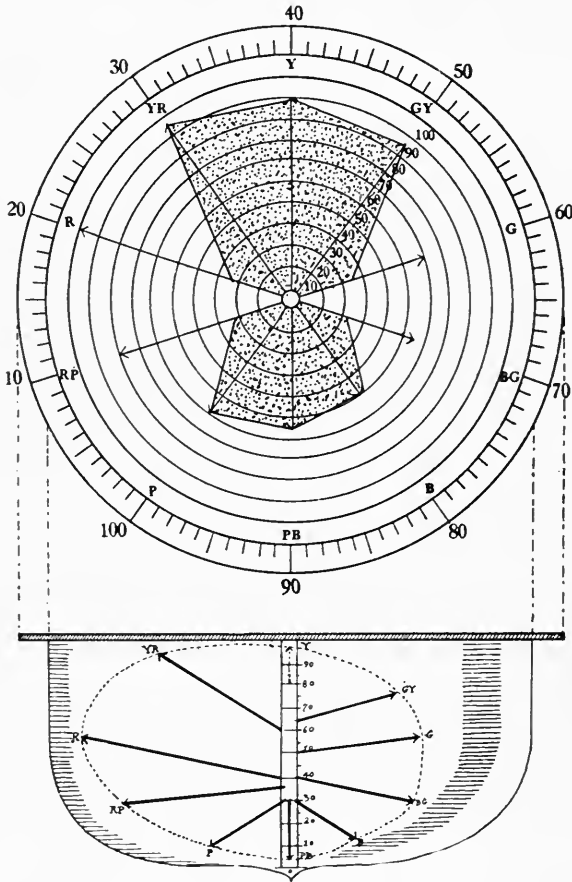

FIG. 30.

Yellow and its analogous colors in relation to its complement purple-blue and its analogous colors.

sideration, particularly the loss of chroma in colors near the neutral axis, and in practical use will serve as a guide in determining the various possibilities in a red analogy.

It is obvious that Fig. 28 not only shows red and its analogous colors in relation to its complement blue-green and its analogous colors, but also the reverse, namely, blue-green and its analogous colors with its complement red and its

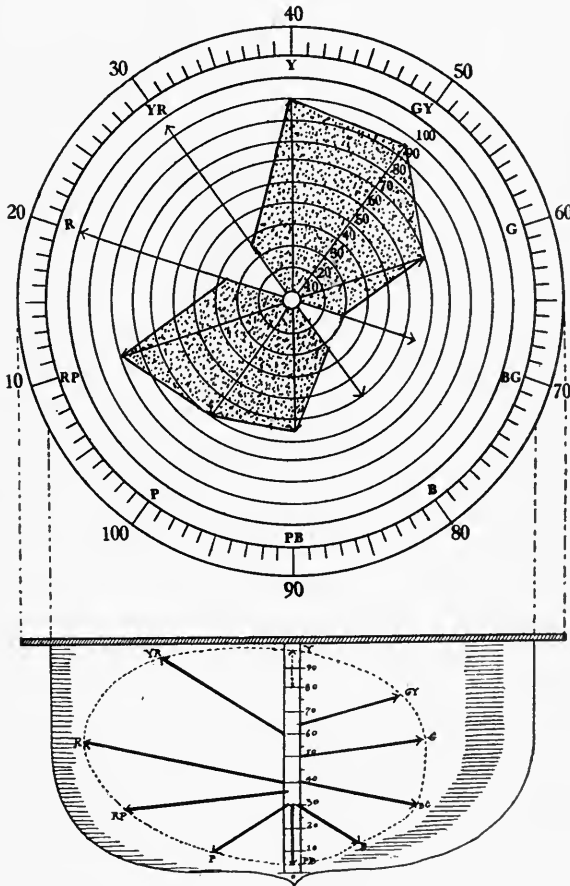

FIG. 31.

Green-yellow and its analogous colors in relation to its complement purple and its analogous colors.

analogous colors. Thus the five figures cover the range of analogous and contrasting colors common to the ten fundamental colors, and these same ten fundamental colors will

COLOR AND ITS APPLICATION TO PRINTING.

serve in almost all cases where the printer is asked to suggest a color-scheme. For those who care to make further subdivisions it is only necessary to locate accurately the hue of the first color by comparing it with the five fundamentals

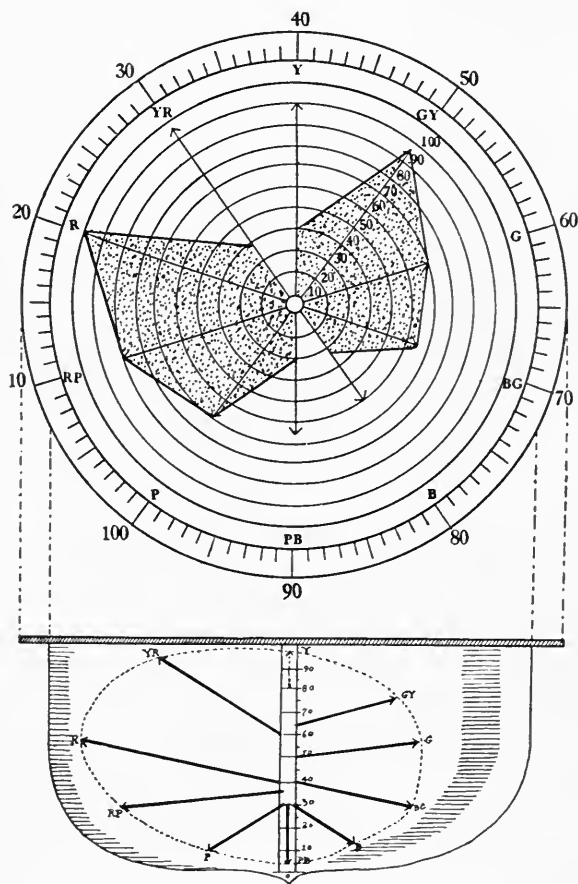

FIG. 32.

Green and its analogous colors in relation to its complement red-purple and its analogous colors.

shown in color in Plate III, and construct the analogous and contrasting colors as just described. The actual charting would be unnecessary, as one of the five figures, 28 to 32,

would be close enough to use to discover the limitations of the given analogous or contrasting colors. Say that the hue of the first color fell at 25, or half-way between red and yellow-red; the analogous colors would lie between 15 and 35, or ten divisions to its right and left. The contrasting colors would be the complement immediately across from 25, or 75, and the colors included in the ten divisions on either side of the complement, or between 65 and 85. The boundary surfaces would approach neutrality in the manner just described in the red analogy shown in Fig. 28.

Complementaries, or the greatest contrasts in hue, were discussed in Chapter IV, and it follows that, in order to obtain a maximum contrast, the two colors should be in the highest respective chromas. But colors to be complementary need not be of high chroma. They may be raised in value by the addition of white, or lowered with black, and as long as they produce white when mixed as colored lights or gray when mixed as pigments by rotation, they are complementary. The white which is added must be neutral, and the black free from toner, or the relation of the hues of the two colors will be altered.

In bringing out the effects of opposition some writers give long tables comparing a given color with all others, but the entire subject may be summed up in the simple statement that colors in opposition tend to make each other appear as dissimilar as possible, and when one color is of a high chroma and of large area and the other somewhat neutral the high-chroma color makes the neutral color appear to be toned with the complement of the high-chroma color. A large man appears larger when placed alongside of a small man, and the small man smaller than when the two men are judged separately. In colors we might call this opposition of values. Let us suppose that the large man is ruddy and the small man pale. In comparing them this difference also would be emphasized. This might correspond with the change of hues in colors. Thirdly, one man might be very strong and the other very weak; to continue the comparison they possess different chromas, and this difference apparently would be increased. Neutral grays have no hue nor

COLOR AND ITS APPLICATION TO PRINTING.

chroma but present effects of opposition in light and shade, or opposition of values only. Fig. 33, at the top, shows a neutral gray of 60-value on the left and a neutral gray of 40-value on the right with the same grays brought in contact in the middle of the cut. Along the line where the 60-value

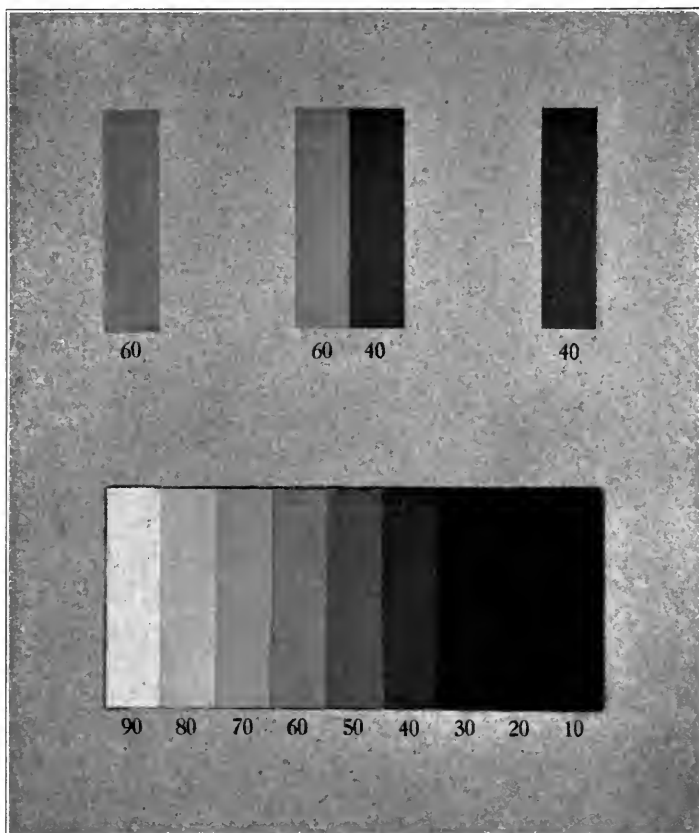

FIG. 33.

joins the darker gray, the 60-value gray appears lighter than when examined by itself, and further, it appears gradually to get darker as it approaches the outer vertical edge. The opposite effect is noticed in the 40-value gray. It appears darkest in the line of junction and grows slightly lighter

toward the opposite edge. If we look steadily at the diagram for some time the 60-value gray will appear darker by itself than when in contact with the 40-value gray, and the latter will appear darker in union with the 60-value gray than by itself. The lower part of Fig. 33 illustrates the opposition of values even better. Standardized by means of a photometer each of these grays presents an even surface ranging from the value of 90 on the left to a value of 10 on the right, but the effect is that of a fluted column, each division, with the exception of the end ones, appearing as if hollowed out. This illusion is caused by opposition of values, and is effected by the edge of the lighter value in contact with the darker value next to it.

This illusion also may be obtained by using any color in the values indicated, each value of the same chroma, but such a standardization is difficult to accomplish, as adding black lowers the chroma as well as the value, and each sample has to be tested a number of times. The effects of opposition in chroma alone are shown in Plate III. Much is lost in the reproduction in the four-color process, however. The red in the various chromas of forty value shows the effects of opposition better than the other colors, but the best way to try the experiment is to lay the various chromas side by side, beginning at the lowest chroma; each chroma added, instantly makes the lower chroma appear much more neutral.

Bearing in mind the results of opposing different values and chromas, let us look at the changes which occur in the hue of colors in opposition. The statement that colors in opposition tend to make each other appear as dissimilar as possible means what, as applied to hue? The most dissimilar color to a given color in hue is its complement, so that two colors side by side tend to look complementary. In the case of closely related colors this is obviously impossible, and the change is simply one of a wider separation of hue, each color appearing to move a little nearer the hue of the next color farther away. Red and yellow side by side make the red appear more purplish and the yellow greenish. Since complementary colors are as widely separated as possible they

COLOR AND ITS APPLICATION TO PRINTING.

simply intensify each other and appear more brilliant. Fig. 34 shows the effects of opposition of green on the other colors; red-purple in the sequence of the ten fundamental colors is duplicated for purposes of the diagram. Green and red-purple are complementary, so that there is no change in hue as indicated by the unbroken lines with the arrows pointing directly to the colors mentioned. With the other pairs of colors the brackets formed by the unbroken lines point to the colors in opposition and the dotted arrows indicate the resultant change in hue. The sequence of color in pigments

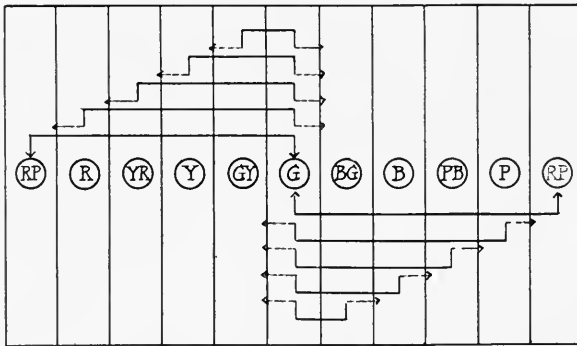

FIG. 34.

is unbroken, so that any color may be placed in the central position for purposes of comparison by transposing the colors from one end of the sequence to the other.

Probably the easiest manner of familiarizing oneself with the effects of opposition of hue is to make a few experiments similar to those suggested by Professor Rood in his "Text Book of Color." First, cut out some small strips of colored papers or inks and some larger squares as indicated in Fig. 35. The sizes I use, which give a desirable relative area, are 1 by 1½ inches for the small strips and 6 inches for the squares. First, lay out two squares, one red and the other green (A), selecting colors of high chroma. On these lay two strips of red (B). The strip of red on the red square will appear very dull, compared with the red on the green, as we naturally glance from the large green area to the red

in its center and back again, etc. In fact this red appears so much more brilliant than the other strip that one would be inclined to doubt that the two were cut from the same sample.

In a similar manner, by what is known as successive contrast—namely, looking in succession from one surface to another—it is possible to make a neutral gray appear to

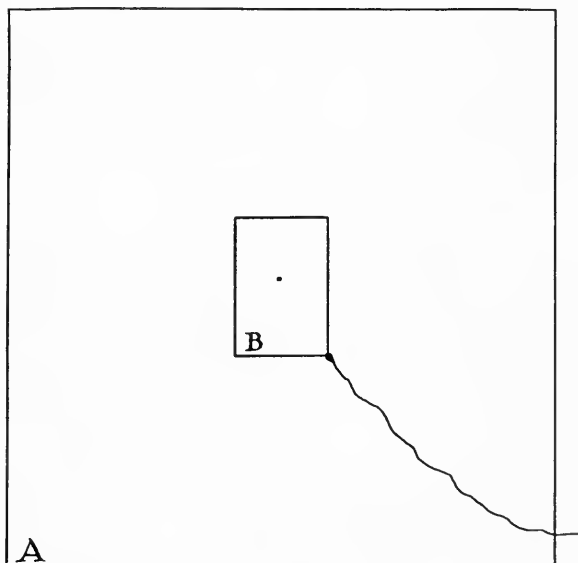

FIG. 35.

have color. Take a square of gray (A), somewhere near middle value, and place on it a small strip of a green of high chroma (B), make a small dot near the center of the green strip and attach a thread at the corner by means of a piece of shoemakers' wax. If we concentrate our attention on the dot for a few seconds and then suddenly jerk the strip away by means of the thread, there will appear a red-purplish tint of the exact size of the surface originally covered by the green strip. This image disappears in a few seconds, and the gray surface resumes a natural appearance. It will be noticed that the image brought about in this experiment has

a color complementary to the color which caused it to develop. The explanation according to Mrs. Franklin's theory of color perception is that the green strip arouses the green chemical process in the retina, but influences only slightly the other color processes. When the green paper is suddenly jerked away, gray light is presented to the eye, which for the purpose here may be said to consist of a mixture of red, green, and blue sensations. The red and blue processes of the eye not being fatigued respond strongly to the stimulus of gray, while the green process has not had time to recover from the excessive demands just made upon it. In consequence we have a mixture mainly of the sensations of red and blue, which gives us the red-purplish image. The green process is not so exhausted that it does not act at all, however, and its partial action combined with the red and blue process adds the sensation of white to the red-purplish image, making it appear a red-purplish tint. The exact value of the gray which I found gave the best results was sixty, and with strips of the maxima chroma of five of the fundamental colors the best after image was obtained with the green, and then yellow, red, blue, and purple.

Knowing the result of the experiment just given, if we substitute a large square of blue for the gray and repeat the experiment, we may imagine the result. The green forms the same negative image, but the complementary tint, instead of being judged on a white or gray surface, is affected by the color of the background, and we have a mixture of the blue with the weaker red-purplish tint forming a blue-purplish tint. A yellow background in a like manner will give a yellow-red tint. Any color may be substituted for the green strip with the background of a closely related color with similar results. Another experiment is to use black for the small strip (B) with any color for the background, when, after concentrating the attention on the edge of the black strip, it is suddenly withdrawn, one sees in its place a more luminous color than the background itself, although naturally of the same hue; in fact, the background outside of this spot will appear to possess a decidedly lower chroma. The explanation is that one or more of the chem-

ical processes of the eye has been taxed over the larger part of the retina, but has not been stimulated at the spot receiving the image of the black strip. When the strip is removed that portion receives a much greater stimulus, naturally, than the balance of the retina, and the outer portion of the square appears much grayer than the luminous spot. If instead of a black strip we use a colored strip complementary in hue to the background, we still further intensify the after image, as we not only protect the retina at that point from certain rays so that later it will be very sensitive to them, but further we fatigue the nerves capable of receiving the other colors. In short, by staring at a blue-green, we tire the nerves capable of receiving all colors except red, and when the red is uncovered we receive an exceptionally pure sensation of that color.

Successive contrast plays an important part in design, because the eye involuntarily wanders from one surface to another, and it even affects the intensity of black printing-ink. If black is printed on solid red it will appear greenish; on green it will tend to look as if a dirty red had been mixed with it, etc. To overcome this difficulty, mix a little of the background color into the black, if the inks used in making the background color will not injure the working qualities of the black. Use just enough to overcome the hue generated by opposition. The best colors to use in toning blacks under such circumstances are bronze-red on a red background, emerald or other lake greens on a green background, a high-grade bronze-blue on blue, indian-yellow on yellow and purple-lake for a purple tint-block. The effects of opposition act more decidedly on a given color, where the other color occupies a large area and surrounds it, as is the case with the tint-block and the black type-matter just mentioned.

In all experiments in successive contrast the illusion is obtained by retinal fatigue, either through voluntary or involuntary concentration, the latter due to the presence of a large area of a color of high chroma. The effects of *simultaneous* contrast, on the contrary, are not due to retinal fatigue, but to deception of judgment. The same strips and

squares of paper used before, with a sheet of tissue or other semi-transparent white paper, will enable us to prove this statement. If we take a large square of a high-chroma purple (A) and lay on it a small strip of gray (B) there is only a slight change in the appearance of the gray, and it requires close observation to detect it. Now comes the curious part of the experiment. The instant we cover both colors with the tissue-paper the gray slip becomes a decidedly yellow-gray. This proves that the effects of opposition are much greater between tints than between full-strength colors, as covering the combination with tissue-paper is equivalent to adding a large amount of white to both colors. Using the five colors, red, yellow, green, blue, and purple, in their highest chromas, with all the neutral values from 10 to 90 for the small slip, I arrived at the following results: With a number of people of trained color vision the greatest change was with yellow as a background and 60-value gray; with the tissue-paper 40 gray gave the greatest change. Green came next as a background, affording the greatest change in a 60-value gray; with tissue-paper, 20 gray. Then purple with 60 gray; with tissue, 40 gray. Then red with 30 gray, or 20 with tissue, and lastly the blue background, which gave its strongest contrast with a 40-value gray with or without tissue-paper. Analyzing these results demonstrates that yellow (value 80) and red (value 40) show greater contrasts with a gray of a lower value than they have, while with green (value 50), blue (value 30), and purple (value 30) the reverse is true. This fact is useful to the painter in giving a surface of neutral-gray color by opposition. If it joins red or yellow, he knows beforehand that the value of the gray must be lower than the value of the red or yellow which he has mixed on his palette, if he expects the maximum brilliancy in the gray itself. With green, blue, or purple he raises the gray above the value of these colors.

Another experiment naturally suggests itself, namely: that of using a large gray square and placing on it a small colored slip. Even with tissue-paper, however, it is difficult to notice any change in the appearance of the gray

square. This demonstrates that to notice effects of opposition the active color must have a surface considerably larger than the one acted upon and should surround the latter, as stated above.

To sum up the effects of simultaneous contrast, it may be said that when tints are contrasted with each other, as in printing flat surfaces, the change in appearance is greater than with full-strength colors. If one of the surfaces is somewhat neutral and of smaller area than the other color, the neutral color is the one that undergoes change, but if both are fairly strong colors of the same relative area, both will undergo change as indicated in Fig. 34.

CHAPTER IX.

HARMONY BY BALANCED CONTRASTS — SEQUENCES —
ANALOGIES OF HUE, VALUE AND CHROMA.

IN the table of typical color combinations, Chapter VII, under Section IV e, I speak of a three-color combination where the second color is neither analogous nor contrasting to the first color, and the third color holds the second color in place, obviating the results of simultaneous contrast. This is called Harmony by Balanced Contrasts, and I purposely left the discussion of this subject until after we had taken up the modification of colors due to opposition, so that the purpose of the third color would be self-evident. To illustrate: let us take yellow as the first color of the combination; with this we wish to use blue-green, a color which is neither analogous nor contrasting. We know from experiment that the yellow will tend to make the blue-green appear blue, and we know further, from experience, that yellow and blue-green do not make a pleasing combination unless they are brought into harmony by reducing their chromas or changing their values. The way out of the predicament is to add a third color to the combination, a color lying on the opposite side of blue-green, farther away from the yellow. The color immediately to the right of blue-green — namely, blue — is too close to serve the purpose, but any of the next three — purple-blue, purple or red-purple — may be selected. It is obvious that as the third color is closer to the complement of yellow, or in one case the complement, it would tend to make the blue-green dissimilar to itself — namely, more greenish, just opposite from the way it is affected by yellow. The blue-green between opposite influences retains its normal appearance and the third color also completes the triad, giving us a relation of the two intervals between the middle color and the extremes. If the second color is three steps

COLOR AND ITS APPLICATION TO PRINTING.

away from the first color selected, then the third color may be five, six, or seven steps away; if four steps, as in the case above, the third color may be the sixth, seventh or eighth color. *Always count the first color selected, the color you start from, as one.* In the example given, yellow would be one, green-yellow two, green three, blue-green four. The total number of these three-color combinations would be:

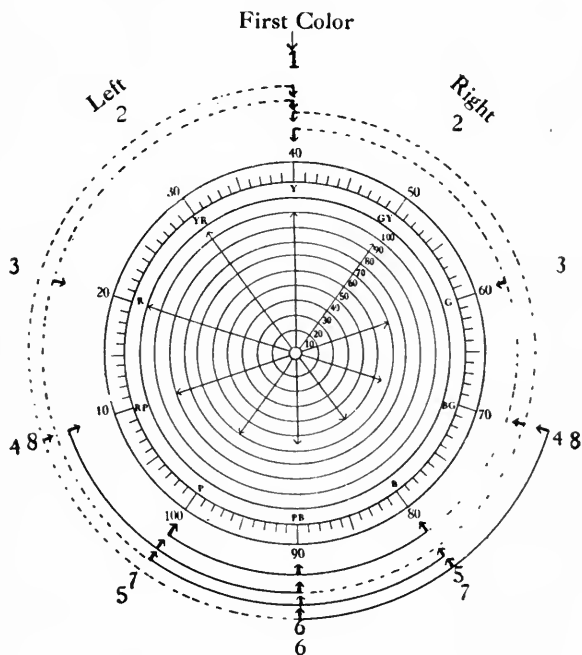

FIG. 36.

One (the first color selected) with 3 and 5, 6 or 7, counting to the right.

One (the first color selected) with 3 and 5, 6 or 7, counting to the left.

One (the first color selected) with 4 and 6, 7 or 8, counting to the right.

One (the first color selected) with 4 and 6, 7 or 8, counting to the left.

Fig. 36 illustrates the balanced contrasts of these classifications with yellow as the first color. It is understood, of course, that in selecting a color-scheme by any of the four methods the values of the colors must conform to the requirements of the design. A large tint-block should not be printed in a color of high chroma; use a color of low chroma, and alter the value by adding white until it balances with the darker type-matter and decorative color. If a strong color is used, confine it to a small area, as stated before in regard to other methods of obtaining color harmony; let it accentuate the design, and do not injure the effect by introducing another bright color. Constantly keep in mind that the farther you get from the high-chroma colors in selecting your color-scheme the more refined is the color harmony.

In Chapter V it was demonstrated that in the neutral value scale analogy is the surest road to harmony. This is true also of colors, and in obtaining harmony spots of color

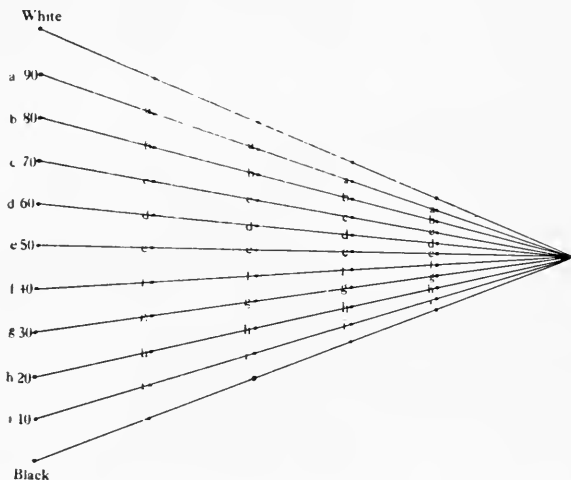

FIG. 37.

may be analogous in value, in hue, and, when they are of the same hue, they may be analogous in chroma. If two or more values of the same color are used, a light and dark green for example, the harmony of chroma is obtained by bringing both colors to approximately the same chroma.

COLOR AND ITS APPLICATION TO PRINTING.

Let us apply this principle of analogy to correcting an unsuccessful color-scheme. The first thought is to bring the colors into more analogous values — namely, to diminish the range of values toward one value. The value toward which we converge them may be any value between black and white; in printing-inks, however, the very dark colors are often mistaken for dirty blacks, and light tints soil too easily to be practical. In Fig. 37 the colors a to i have values from 90 down to 10, and are indicated in four places as approaching analogy in middle value. A, b, c, etc., may be any color at the value indicated, and in experimenting with color combinations three colors probably would answer; for example: tint-block at 80 (b), type color at 20 (h), and decorative color at 50 (e). They may be made more analogous, as indicated in the four positions, but absolute analogy in value is not desired and becomes monotonous.

The second thought in altering an unsuccessful color-scheme is to obtain a closer analogy of hue. This may be done by adding some color which we wish to predominate to each of the colors. If we view nature through a piece of blue-green glass, blue-green is added to every color we see and reds appear almost black; in pigments the same effects are obtained as indicated above and are extremely interesting. Often it is possible to save a color-design by mixing a given color — blue, for example — with each of the colors, using one-half as much blue as the color itself. Where the quantity of blue added equals the quantity of the other color, allowance being made for inequality of chromas, the complement of blue — yellow-red — becomes a neutral. The addition of blue is shown as follows, using five of the fundamental colors and yellow-red:

	R	YR	Y	G	B	P
Plus	B	B	B	B	B	B
	<hr style="width: 100%;"/>	<hr style="width: 100%;"/>	<hr style="width: 100%;"/>	<hr style="width: 100%;"/>	<hr style="width: 100%;"/>	<hr style="width: 100%;"/>
Equals	P	N	G	BG	B	PB

Therefore, in this analogy of hue, or, more properly speaking, this “blue accent,” purple would be used where we had used red before, neutral gray for yellow-red, green

for yellow, blue-green for green; blue remains the same, or we may alter it by adding white to raise the value, and purple-blue is used instead of purple. The analogy, as far as hue is concerned, is illustrated in Fig. 38; the purple and green obtained by mixing the red and blue and yellow and blue are not as high in chroma, however, as the original purple and green.

A third method of correcting an unsatisfactory color-scheme is to approach a harmony of neutrality; a glance at

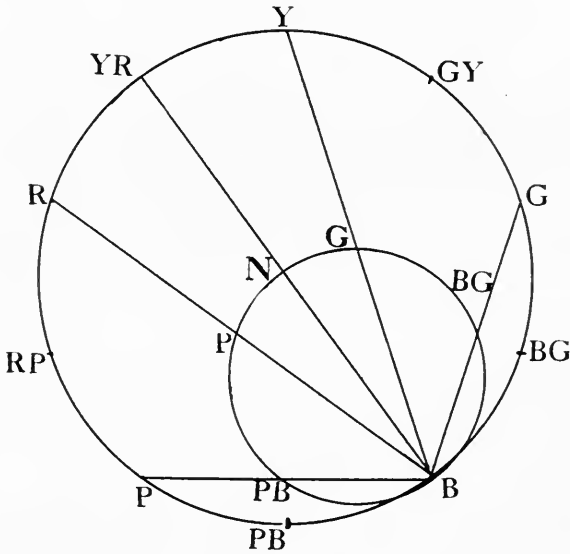

FIG. 38.

the color solid will show the method of procedure. To each color we must add the complement of that color or black, and if by so doing the value of color is lowered, it must be raised to its original value with white. It is also possible to combine analogy of value with analogy of neutralization by converging the values first and then graying them toward neutrality.

In Chapter VII I outlined the three paths through the color solids as bases for color-schemes and further suggested the combination of these paths one with another.

COLOR AND ITS APPLICATION TO PRINTING.

Combining the lateral with the vertical path—namely, sequence of hue—in all values gives us such a great variety of tones from which to choose color-schemes that, even neglecting the question of varying chroma, we are often at a loss as to where to begin. The diagonal path, in sequence of hue, confines our attention to certain possibilities; but even with this formula to guide us, we have a great variety of color-schemes from which to choose, as we may select colors at various intervals. Let us trace the diagonal paths in Table II, which is Table I doubled in size for the sake of convenience. Let us start from red (R), value 10, near the middle of the table. The sequence of the diagonal to the right is R (10) YR (20) Y (30) GY (40) G (50) BG (60) B (70) PB (80) P (90); to the left R (10) RP (20) P (30)

DIAGRAM OF POSSIBLE COLOR VALUES.

	100	(White)																				
	90	RP	R	YR	Y	GY	G	BG	B	PB	P	RP	R	YR	Y	GY	G	BG	B	PB	P	90
	80	RP	R	YR	Y	GY	G	BG	B	PB	P	RP	R	YR	Y	GY	G	BG	B	PB	P	80
	70	RP	R	YR	Y	GY	G	BG	B	PB	P	RP	R	YR	Y	GY	G	BG	B	PB	P	70
	60	RP	R	YR	Y	GY	G	BG	B	PB	P	RP	R	YR	Y	GY	G	BG	B	PB	P	60
	50	RP	R	YR	Y	GY	G	BG	B	PB	P	RP	R	YR	Y	GY	G	BG	B	PB	P	50
	40	RP	R	YR	Y	GY	G	BG	B	PB	P	RP	R	YR	Y	GY	G	BG	B	PB	P	40
	30	RP	R	YR	Y	GY	G	BG	B	PB	P	RP	R	YR	Y	GY	G	BG	B	PB	P	30
	20	RP	R	YR	Y	GY	G	BG	B	PB	P	RP	R	YR	Y	GY	G	BG	B	PB	P	20
	10	RP	R	YR	Y	GY	G	BG	B	PB	P	RP	R	YR	Y	GY	G	BG	B	PB	P	10
	0	(Black)																		(Black) 0		

TABLE II.

PB (40) B (50) BG (60) G (70) GY (80) Y (90). Since these sequences are composed of hues which lie adjacent to each other, such sequences would be called sequences of seconds. More interesting sequences are those of intervals of the third, fourth, fifth and sixth. Always count the color you start with as one, and after counting one interval count it again as one in the second interval. Using intervals of the sixth gives us a color and its complement repeated in different values. If we start with red, value 10, as before, and trace the diagonal to the right in sixths, we have: R (10) BG (20) R (30) BG (40), etc., which is a sequence without enough change in value in the successive reds and blue-greens to make it interesting. Dropping out the even values in Table II—namely, 20, 40, 60, and 80—will improve the sequence; it would then be: R (10) BG (30) R (50) BG (70) R (90), which is a good five-color scheme.

Sequences may also be obtained by the repetition of certain intervals, such as the fourth followed by the fifth, which would give R (10) GY (20) PB (30) R (40) G (50) PB (60) YR (70) G (80) and P (90), or, omitting the even values as before, R (10) PB (30) G (50) YR (70) and P (90).

For those who are anxious to go more deeply into the question of sequences, I would recommend again "A Theory of Pure Design," by Denman W. Ross. He treats the subject exhaustively. My personal regret is that his use of the twelve-step sequence of hue instead of the ten-step sequence may prove confusing to some.

CHAPTER X.

THE WEIGHING AND MIXING OF INKS.

IF a printer expects to derive full benefit from reading works on color, he must alternate his reading with practical experiments; the laboratory is as important in color as in chemistry. A good way to begin is to construct a neutral value-scale, using black and white, and the first surprise of the novice will be the tinctorial power of black. Half black and half white by weight will be so near black itself as to show very little difference in value. Next the beginner will find that the same bulk-quantity of different inks varies greatly in weight. Almost every color represents a different specific gravity. For example, mixing-white is over one and one-half times as heavy as half-tone black, and cover-white is still heavier. In order to obtain any degree of accuracy in compounding inks, they must be *weighed*, and *weighed carefully*. Naturally, the first thing to buy is a scale, and a satisfactory scale for just such work is sold by Fairbanks, Morse & Co. It is known as No. 932 Harvard Trip, and it comes fitted with two six-inch porcelain plates. In weighing ink, it should always be handled on glass, porcelain or marble. Brass and iron are affected by the chemical composition of the ink itself, besides tarnishing and rusting. If you weigh on paper, use a parafined or oil paper, as it is difficult to scrape ink from ordinary stock, to say nothing of the danger of getting paper-dust into it.

In arranging a color-mixing department for your own experiments, or for your pressroom, find a bench or table of suitable height; lay on it an old imposition-stone, or a piece of plate-glass, about 3 feet wide and 4 feet long; place your scales at the back, and fix a rack for a dozen ink-spatulas above. The lower part of the bench may be used for storing the inks used in mixing colors. For the neutral-gray value-

COLOR AND ITS APPLICATION TO PRINTING.

scale you need two inks only—a neutral white and an untoned engraver's hand-press black. Any untoned black, of course, will answer, but engraver's proofing-black is ground with more care and represents the maximum amount of density. The ink-spatulas are more pliable than ink-knives, and you will find it advisable to buy at least six of each size. For the convenience of those who may take up these experiments, I will group the materials I would advise buying, giving the size and cost:

One piece of marble or plate glass, 3 feet wide, 4 feet long. Buy it secondhand.....	\$3.00
One No. 932 Harvard Trip Scale, Fairbanks, Morse & Co.	7.50
One set brass-knob weights in open block, 500 grams to 1 gram, Fairbanks, Morse & Co.....	3.50
Six 5-inch spatulas.....	1.12
Six 2¼-inch palette knives.....	.90
Twelve 5-ounce Gill's plain seamless ointment boxes. Get these from your druggist, who can order them from his wholesaler, or buy direct from a can factory25
Five pounds Neutral White, 50 cents per pound.....	2.50
One pound Engravers' Hand Press Black No. 2.....	3.00
One formula book—make it yourself.....	2.00

Fig. 39 illustrates such an equipment, excepting the size of the table.

In adding the formula-book, I take it for granted that any printer making the investment just mentioned will want to use this equipment for his every-day color-matching, as well as weighing up a few experiments. The formula-book should be made in duplicate in some such form as indicated in Fig. 40. One copy of the formula, which is perforated, should be pinned to the job-ticket, after it has been carefully copied on the duplicate or permanent record. In our factory we have found it convenient to have the formula-book made up in duplicate, ten on a page, and numbered consecutively. If you depend on numbering when you tear out the formula-slip, it is a very easy matter to become confused and use the same formula-number for two different matches. We have also found that it pays to save a small

COLOR AND ITS APPLICATION TO PRINTING.

half-ounce sample in a flat ointment-box of each formula-number, no matter how many times it may be duplicated. The original sample is saved indefinitely and is filed away in a flat drawer, just large enough to hold one hundred samples, arranged ten by ten. The duplicates are saved for a year at least and then are thrown away.



FIG. 39.

Whether it pays a printer to do his own color-matching for jobs requiring over five pounds of ink, depends upon his location. If he is in a large city, the right inkman can do it better and more quickly, but the printer should select the inkman who uses the most care in weighing and preserving his formulas. On large runs, or jobs that are repeated in

COLOR AND ITS APPLICATION TO PRINTING.

the same color-scheme, it will always pay both the city and country printer to give the inkman the order and have the ink made up to exactly suit the stock used. For jobs requiring only a pound or so of ink, even the city printer will find it convenient to do the mixing himself, and the country printer is forced to match his own colors, on account of lack

PARTS	NAME OF INK		No. 1
			DATE
			JOB No.
			FIRM
			MIXED BY
POUNDS	PRICE PER LB.	AMOUNT	CHARGED BY

FIG. 40.

of time. The scale I specified has a capacity of only one pound, which is sufficient for matching colors, and the same formula may be weighed a number of times. For larger quantities Fairbanks, Morse & Co. make a No. 1216 scale, costing \$18, which has a capacity of three hundred pounds.

You will notice that I specified gram weights. In your work you consider grams as parts, and in Table III I have figured the equivalent in pounds and fractions of a pound, so that when you have completed your formula and find you have a certain number of parts, you can turn to this table and tell just how much to charge up to the job. For example, you have used 230 parts. This is between $\frac{2}{3}$ and $\frac{3}{4}$ of a pound, roughly $\frac{1}{2}$; at \$1.50 per pound, the charge would be 75 cents, plus your percentage for waste and handling.

COLOR AND ITS APPLICATION TO PRINTING.

TABLE OF COMPARISON, PARTS (METRIC SYSTEM) WITH
POUNDS AVOIRDUPOIS.

1 pound = 453.592 grams — roughly, 450.

Parts (grams).	Pounds.	Rough equivalents in pounds and fractions.
1.....	.00220.....	$\frac{1}{500}$
2.....	.00440.....	
3.....	.00661.....	
4.....	.00881.....	
5.....	.01102.....	
6.....	.01322.....	
7.....	.01543.....	
8.....	.01763.....	
9.....	.01984.....	
10.....	.02204.....	$\frac{1}{50}$
20.....	.04409.....	
30.....	.06613.....	
40.....	.08818.....	
50.....	.11023.....	
60.....	.13227.....	
70.....	.15432.....	
80.....	.17636.....	
90.....	.19841.....	
100.....	.22046.....	$\frac{1}{5}$
200.....	.44092.....	$\frac{2}{5}$
300.....	.66138.....	$\frac{2}{3}$
400.....	.88184.....	$\frac{9}{10}$
500.....	1.10231.....	$1\frac{1}{10}$
600.....	1.32277.....	$1\frac{1}{3}$
700.....	1.54323.....	$1\frac{1}{2}$
800.....	1.76369.....	$1\frac{3}{4}$
900.....	1.98415.....	2
1,000.....	2.20462.....	$2\frac{1}{5}$
2,000.....	4.40924.....	$4\frac{2}{5}$
3,000.....	6.61386.....	$6\frac{3}{5}$
4,000.....	8.81848.....	$8\frac{4}{5}$
5,000.....	11.02310.....	11
6,000.....	13.22772.....	$13\frac{1}{5}$
7,000.....	15.43234.....	$15\frac{2}{5}$
8,000.....	17.63696.....	$17\frac{3}{5}$
9,000.....	19.84158.....	$19\frac{4}{5}$
10,000.....	22.04621.....	22

TABLE III.

COLOR AND ITS APPLICATION TO PRINTING.

Pounds, ounces and fractions of an ounce are exceedingly unhandy in making trial formulas, and when you wish to increase the formula one is obliged to change pounds to ounces and ounces to the smallest fraction of an ounce used. Then you multiply by the right number, to get the desired increase, and begin again to divide up your sixty-fourth ounces, if such be the case, in ounces, and in turn into pounds. For example, take the following formula :

White	1 $\frac{25}{64}$ ounces.
Black	$\frac{1}{64}$ ounce.
Wanted 2 lbs.	

It will take you quite a little time to figure it out. Let me express the same ratio according to Table III :

White	89 parts.
Black	1 part.
<hr/>	
Total	90 parts.

Ninety parts is about $\frac{1}{2}$ of a pound (.19836 exactly), therefore, two pounds would be ten times as many parts ($\frac{1}{2}$ into 2 = 10), or

White	890 parts.
Black	10 parts.
<hr/>	
900 parts, or 2 lbs.	

About the only objection to the part system just described is that ink is not bought nor sold by the kilogram (one thousand parts or one thousand grams), but by the pound, requiring one extra multiplication in order to connect parts with the avoirdupois pound. The ideal system to use in handling inks is to divide the *pound* into one thousand parts, and then, no matter how complex your formula may be, you can increase or decrease it to any desired amount with one multiplication only. My first experience in the printing-ink business was in figuring out formulas based on pounds, ounces and fractions of an ounce. If a man had purchased seven pounds of a complex formula, and wanted exactly twenty pounds more, it would sometimes take a half an hour to figure the formula accurately and verify it.

Often the printer had used up all of the first lot before he had an opportunity to telephone the repeat order, and his cylinder press, as a consequence, was standing all the time we were figuring, weighing and delivering it.

My first thought was of the metric system, but if it were adopted it would necessitate every man about the office and factory becoming so familiar with it that he could take an order in pounds and write out the order in kilograms. So I decided to have special weights made up which would use the pound as a basis, but would divide the pound into tenths, hundredths and thousandths. I figured the equivalents of the different units required very accurately in the metric system, using the nearest weight in either system and filing it down until it was exactly the decimal part of a pound required. There was naturally some opposition to changing our system of weighing, but we are now using the decimal system in all of our branches, even with the large No. 1216 scales, and it saves us an immense amount of time. Such a set of weights costs a few dollars more than the set of gram weights specified, on account of the extra work in standardizing.

The same example expressed in the decimal system results in the following formula :

White089 pound.
Black001 pound.
	—
Total090 pound.

To increase the formula to any desired quantity it is necessary to make *one multiplication only*, and, as a rule, this multiplication can be accomplished by merely moving the point to the right and multiplying or dividing by simple numbers, such as two or three. If you care to have your formula come out *exact*, you divide the total of your trial formula, in this case .090 pounds, into the number of pounds desired, and the result will be the exact multiplier which is used with every item of your trial formula. For two pounds, .090 into two pounds results in 22.22 +, but 22 is near enough for practical purposes. Multiplying by this number gives us :

COLOR AND ITS APPLICATION TO PRINTING.

White	1.958 pounds.
Black022 pound.
	1.980 pounds.

For those who have trained themselves to think in ounces and are interested in adopting the decimal system, I add Table IV, which shows ounces and fractions as decimal parts of a pound.

CONVERSION OF OUNCES AND FRACTIONAL PARTS OF AN OUNCE INTO DECIMAL PARTS OF A POUND.

16 oz.....	1.000	5 oz.....	.313	$\frac{9}{16}$ oz.....	.035
15 oz.....	.938	4 oz.....	.250	$\frac{1}{2}$ oz.....	.031
14 oz.....	.875	3 oz.....	.188	$\frac{7}{16}$ oz.....	.027
13 oz.....	.812	2 oz.....	.125	$\frac{3}{8}$ oz.....	.023
12 oz.....	.750	1 oz.....	.063	$\frac{5}{16}$ oz.....	.020
11 oz.....	.688	$\frac{15}{16}$ oz.....	.059	$\frac{1}{4}$ oz.....	.016
10 oz.....	.625	$\frac{7}{8}$ oz.....	.055	$\frac{3}{16}$ oz.....	.012
9 oz.....	.563	$\frac{13}{16}$ oz.....	.051	$\frac{1}{8}$ oz.....	.008
8 oz.....	.500	$\frac{3}{4}$ oz.....	.047	$\frac{1}{16}$ oz.....	.004
7 oz.....	.438	$\frac{11}{16}$ oz.....	.043	$\frac{1}{32}$ oz.....	.002
6 oz.....	.375	$\frac{5}{8}$ oz.....	.039	$\frac{1}{64}$ oz.....	.001*

* Approximate.

TABLE IV.

In Fig. 41 I have indicated the relative proportion of white and black for each ten divisions of the decimal value-scale, and have indicated the older artist's classification of values. In constructing a decimal-value scale by weight, the first point to determine is the proportion of black and white, to give middle value. I have found that, in a number of experiments, 40 white to 1 of black was an average ratio, using the inks specified in the list. Of course, the value of the printed color depends so much on the amount carried on, that, with the same ink, it is possible to obtain a variance of ten points in value. My 40 to 1 mixture, with an average impression, showed a variance of about three points, when tested with a photometer. Of course, if you are not using the same inks, or if the density of either ink varies, you will have a different proportion for middle value. A good way to check your various attempts is to buy a sheet of Milton

COLOR AND ITS APPLICATION TO PRINTING.

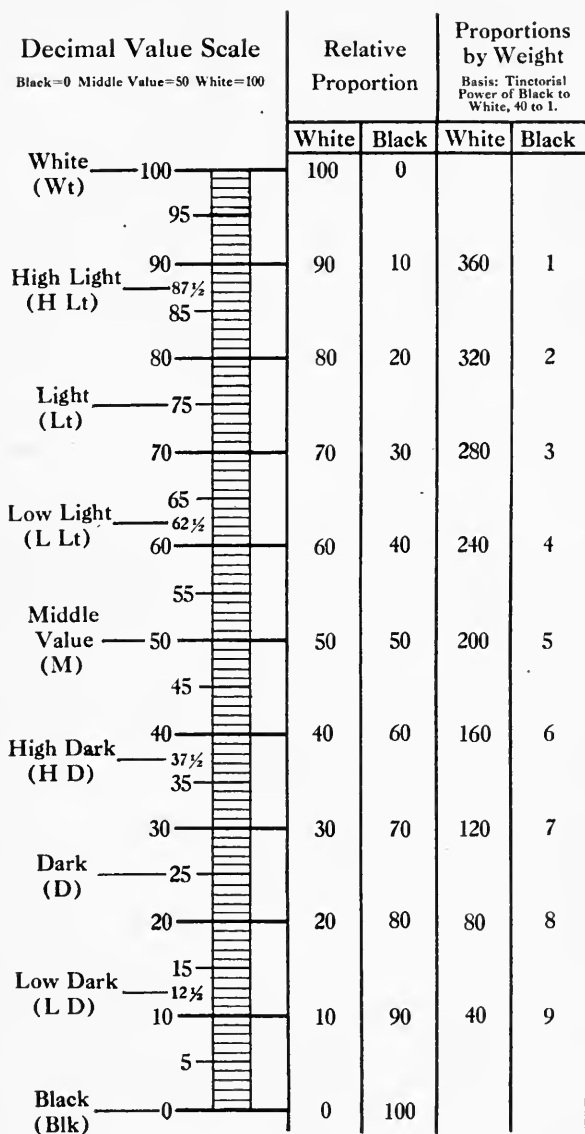

FIG. 41.

Bradley's white and black school-paper; then lay your printed sample of middle value between the white and the black paper and see whether the contrast is greater with either one. It is well not to tire the eyes, as a fresh eye can often detect differences in value when a fatigued eye can not. In scientific work with a photometer they make readings with each eye and take the mean, as the two eyes are seldom equally sensitive.

After you have determined the proportion for middle value, for example, 40 to 1, you substitute this ratio in the "Relative Proportion" column of the table. In the value of 90 the relative proportion is 90 to 10, or 9 to 1, and, since it takes 40 of white to equal 1 of black, multiply your 9 by 40, which gives you the proportion by weight of 360 to 1.

In weighing inks, always start by weighing out the lighter color, or the white, first. It is well also in weighing up the decimal-value scale to start at the bottom and weigh up the value of ten first, as the amounts involved are smaller than anywhere else in the scale, and if you make a few mistakes you will still have enough white left to complete it. In fact, weighing the scale in parts and using the proportions by weight indicated will require about four pounds, which does not allow for very much waste if you have purchased only five pounds.

After weighing the white, scrape it off the porcelain plate, one spatulaful at a time, and place it on the slab, not in a can. The best way to get every particle off the plate is to scrape the spatula on a second spatula, held in the left hand. Then weigh the black, get it on the slab the same way and mix a little of the white with the black, being sure that every trace of the black unites with the white, forming an even gray, which constant working does not show to contain specks or streaks. Then shove this gray mixture into the remaining white and mix again by pressing the spatula up and down rapidly, gathering the mass together occasionally by scraping it around its edge toward the center. It is well to use two spatulas in mixing also, holding one in the left hand two or three inches above the mixture, and scraping the ink on it with the other spatula. Do not be afraid to

mix long and carefully, as mixing by hand is a difficult matter, especially if one of the inks is very heavy-bodied.

Some inks unite with other materials only after the entire mass has been warmed by the heat generated in mixing vigorously or by grinding on a mill. In making my experiments with white and engraver's hand-press black, each mixture was ground three times, to insure obtaining the full tinctorial power of the black. A mill is not necessary, however, if you use care. In making up formulas *always mix the ingredients in the same order*, as often there is a slight chemical change, which causes a noticeable change of shade when compared with the same formula mixed in a different order. This is especially true of very delicate tints.

CHAPTER XI.

COLOR MATCHING.

IN Chapter X I describe the equipment necessary to do accurate color-mixing in the average pressroom, but I do not take up the question of how many colors it is advisable to carry in stock. Many printers buy a pound or so of every color shown by the inkman without regard as to how and when they may use them. The result is that the ink shelf shows more variety than usefulness. Each printer must lay in a supply according to his own needs, and it is impossible to outline one list to fit many cases. If your work is of high grade on enamel and bond paper, it follows that you must have a heavy, high-grade half-tone black for enamel paper and also a softer half-tone black to use in reducing, if the heavier one picks the stock. Then, too, a brilliant light red is necessary to use for decoration or initial letters on enamel papers. This red should be in middle value. Such a red is known on the market as flaming scarlet. For the bond paper you should have a heavy job or bond black and a light or yellow red of the same color as the enamel-red, but heavier body—a job flaming scarlet. The kind of half-tone work done by the printer, or, in other words, his ability to fit the ink to the stock after the job is properly made ready, and the proper use of the right red, often makes the reputation of the printer. In these two inks at least it is advisable to carry two bodies in stock. Other colors may be made heavier by adding a heavy varnish, and softened by reducing-varnish or compound, and the customer will not discriminate so carefully. A few pounds of the high-chroma lake inks should be kept in stock also, as well as bronze-red, bronze-blue, and vermilion, but in matching colors the most important ten pigments are the fundamentals at their highest chromas, shown in Plate III, and these same five colors—

red, yellow, green, blue, and purple—reduced in chroma until nearing neutralization, and lowered in value, colors similar to those shown in the bottom line of Fig. A, Plate II. With these ten colors, and white and black, a very large proportion of all colors may be obtained quickly and accurately. The exceptions are the high-chroma and lake colors, some of which are mentioned above, and the high-chroma colors lying between the five fundamentals in Plate III. Mixing two colors in order to produce a third always lowers the chroma of the mixed color below the average chroma of its components. This is due, as explained before, to the fact that no pigment reflects the rays of its own hue alone, but many others, and when these “stray” rays are mixed with the “stray” rays of the second color, some neutral gray is the result.

In locating the five fundamentals mentioned, among the unclassified and unstandardized colors on the market a com-

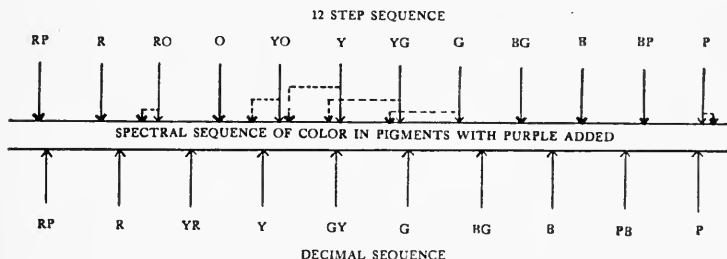

FIG. 42.

parison of the old twelve-step sequence with the decimal circuit will be instructive. If we start with red, yellow, and blue, and by subdividing get red, orange, yellow, green, blue, and purple, and then add the intermediates, the twelve steps will compare with the colors of the decimal circuit as indicated in Fig. 42. Only a glance is necessary to show that the twelve-step sequence not only gives the wrong complementaries, as explained previously, but that there are gaps and inequalities of spacing necessary in order to make a given color-name, such as yellow, occur over the color it represents, using the decimal circuit as a standard.

Those who doubt may verify the standard for themselves by placing the five hues indicated in Plate III around a sphere, and if each color be brought to the same value and chroma they produce a neutral gray when the sphere is rotated. If we select the five colors at a chroma of 50 and a value of 50, the neutral gray will have a value of 50; if the colors are selected at a value of 70, the neutral gray will have a value of 70, proving without a doubt that the hues of the five fundamentals are equidistant from each other, or a colored gray would be the result of rotation. Such spheres have been put on the market by Mr. A. H. Munsell for use in schools where, owing to lack of apparatus, it would be difficult for the teacher to standardize the colors for class demonstration.

The same experiment may be tried with the twelve-step sequence, and the result verifies the inequalities shown in Fig. 42; for, instead of a neutral gray, rotation shows an excess of yellow-red.

You will notice that the red in the twelve-step sequence is not so near yellow as in the decimal circuit, the yellow is a little nearer green. (The yellow of the twelve-step sequence actually occurs as indicated by the black arrow-head which is connected by dotted lines with the position where yellow should fall were the twelve-step circuit correct. This same method of indicating the actual position, as opposed to the theoretical position, is followed in the other colors); the green is yellower than in the decimal circuit, the blue more purplish and the purple a trifle nearer red. The most marked difference is in the blue, and those who have always thought of blue as having a hue approximating ultramarine experience a distinct shock when shown the blue of the decimal circuit. "It's blue-green and not blue," is a common remark; but if a true blue-green is placed on one side of it, and purple-blue on the other, the correctness of its hue is evident. Moreover, the decimal blue, besides fulfilling the requirements for a blue exactly midway between green and purple, has the greatest possibilities as an artistic color. It is found in Oriental rugs, Japanese prints, and other works of art. At a recent test

made by a large class of art students at the University of Chicago, a blue of this hue was almost unanimously selected as being the most satisfying of all blues.

With these ten pigments at our command, color-matching becomes a matter of judging the predominating hue of the color we wish to imitate, matching the hue and then adjusting the chroma and value of our mixture. To judge the predominating hue we must forget such terms as brown, russet, buff, citron, sage, slate, plum, etc., and substitute for brown, red-gray, yellow-red, gray or yellow-gray, as the case may be; buff becomes a yellow-red-gray, having a higher value than the red-gray we formerly called brown, while sage, slate, and plum become green, blue, and purple grays. It is obvious that the color to be matched may not fall exactly on one of the five colors we are using as a basis, nor yet exactly half-way between any two, but if the general hue, for example, is red inclining toward yellow rather than purple, by adding yellow to red in small proportions we may stop at any point we desire. Let us suppose the hue of the unknown to be a hue half-way between red and yellow-red, and the strong chroma colors we have used in mixing have produced the correct hue but have given it too high a chroma. What then? Either we must add a small proportion of the complement of this color, or mix together a little of the neutralized red and yellow (in the same proportion as we used of the high-chroma colors), and add this to our formula. The proper complement is shown by a glance at the color solid: the complement of red is blue-green, that of yellow-red, blue; so that if we are to add the complementary color to our formula it consists in a mixture of blue and blue-green. But to get just the right amount of each color! There lies the difficulty. A trifle too much blue, and we have changed the hue of the ink, when it was our intention to lower the chroma only. The usefulness of a neutralized color for each of the high-chroma fundamentals is evident, for no matter how much red-gray we add to red the hue is not altered, but proceeds in a straight line toward the neutral axis of the color solid. In matching full-strength colors the question of value may be left to the last, as the five fundamentals are natural

in their respective values and by mixture will produce natural values. By natural values I mean that the decimal red is what we describe as a full-strength red without any admixture of gray. It occurs (Plate III) at 40, yellow at 80, green at 50, and blue and purple at 30.

Where the unknown is a tint, value should be considered first, and the white should be weighed out first. Starting the other way often means that by the time you have added enough white to get the correct value, you have twice as much ink as is necessary for the job. A word about chroma, when it comes to mixing: Red and yellow in the five fundamentals have chromas of 100 and 90 respectively, so that in weighing equal parts you may be confident that the hue of the mixture will be about midway between the two colors. Green has a chroma of 60, blue 50, and purple 60; these also may be mixed with each other without allowance for inequality of chroma. But when yellow and green are used to produce green-yellow, a greater weight of green must be used than yellow, in order to offset the higher chroma of yellow. The same rule applies in mixing red, with a chroma of 100, with purple of 60 chroma; purple must be used in the larger quantity if we wish to produce a red-purple midway between the two colors in hue.

The color-matcher must learn to see the presence of a high-chroma color, or much time will be wasted before he finds that he is on the wrong track. Yellow-lake or Indian-yellow can not be imitated by the fundamental yellow, neither will the fundamental red and yellow produce Persian-orange. Emerald and velvet greens, royal and ultramarine blues, royal purples and magenta lakes are other examples of colors that can not be imitated by mixing. You must have each and every one of these colors in stock if you are to accurately match a color in which they have been used.

A word about accurate color-matching. This is always exceedingly difficult, owing to the difference between the stock used for the job and that submitted by the engraver. If you are dealing with the engraver direct, insist that he pull proofs on the identical stock you have bought for the job. Matching an artist's water-color proof is in many cases

absolutely impossible, owing to the fact that the artist may carry on his color much heavier than you can lay it on with a press. In the use of high-chroma colors, too, the artist and engraver seem to conspire against the printer, often to no purpose, as far as the beauty of the design is concerned. What the printer should educate his customer to look for in the finished work is not the arbitrary following of an unstandardized and sometimes undesirable color-scheme, but the beauty of balanced-color relations. When you proof the job, show it to the customer with an enthusiasm as to your interpretation of the right color-scheme, rather than with an apology for not quite matching the artist's or engraver's proof. Remember that the artist and engraver, if asked to duplicate the color-schemes without the proof to go by, would produce only an approximation of what they formerly considered desirable, if they did not substitute a new color-scheme altogether. The case is similar to colored etchings. After the plate is finished the artist pulls many proofs in different color-schemes, and it is hard for him or any one else to say which is better. The most he can say is that "Personally, I like this one best of all." Try then to educate your customer to the fact that it is possible for the printer to produce something better than the proof submitted. The only question you should permit him to discuss is whether or not your proofs please him, and in producing pleasing color-schemes standardized colors such as those I have indicated are greatly to be desired as opposed to the unstandardized relations of miscellaneous high-chroma pigments.

CHAPTER XII.

PRESSROOM DIFFICULTIES.

WITH the press and rollers in perfect condition the problem of good printing is to adapt the ink to the paper in body and drying qualities. On long runs and particular jobs it is always well to try out a few sheets of the stock, examining them carefully next day before beginning the regular run. Further, it is well to look through the

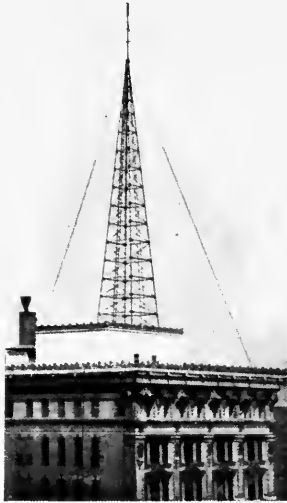

FIG. 43.

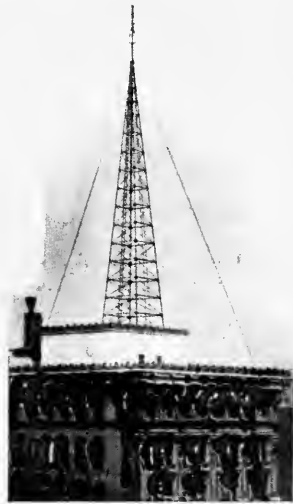

FIG. 44.

stock before it is cut, as often one side of the sheet may have a perfect printing surface, while the other is unevenly coated. Fig. 43 shows a cut taken from one side of an actual job and Fig. 44 the results of defective coating on the other side. Of course, the paperman would have been glad to have replaced the imperfect stock had he been notified before it

was cut, but with half the job run it was up to the printer to find some ink which would overcome the difficulty, which meant a considerable loss of time and probably the profit on the job. To get the best results the body of an ink should be as heavy as the stock will stand. This is particularly true in half-tone printing, and it is always advisable to carry two

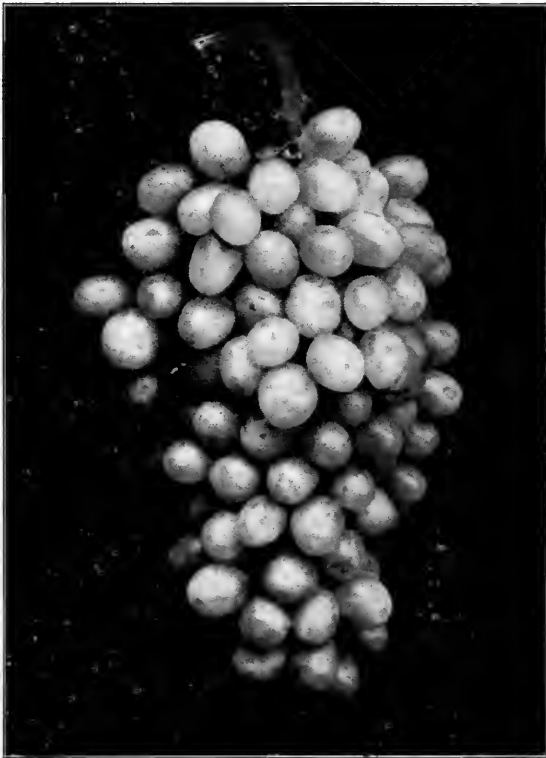

FIG. 45.

bodies in stock, in blacks at least—both of the same high quality, but ground in one case in a heavy varnish and in the other in a soft varnish. This point was mentioned in the last chapter, but its importance can not be overemphasized. If the pressroom is not at the correct temperature of 80°, or if the stock is not hard enough to stand the heavy ink, a

“picked” sheet, such as Fig. 45, will be the result. Instantly we should add a little of the soft half-tone and try another impression. If the ink still picks, add a little more, and in a short time we have solved the difficulty, as illustrated in Fig. 46. Compare this result with that gotten by adding reducing varnish to soften the ink, Fig. 47. Some printers



FIG. 46.

use a soft black instead of varnish, but buy the soft black for medium-grade work. The result of adding this black to the high-grade half-tone black, while not as bad as if varnish had been used, never produces the best job. The soft half-tone should be of such quality that if the coating of the stock is unusually weak, or the room cold, it may be run straight

with as good results as a heavy half-tone would give on harder stock on a warmer day. If you use a color on half-tones, be sure the inkman gives you a heavy-bodied ink. If it picks, you may reduce it with a little thin varnish or compound; or even better, a little tint base; it is harder to add body than to take it out.

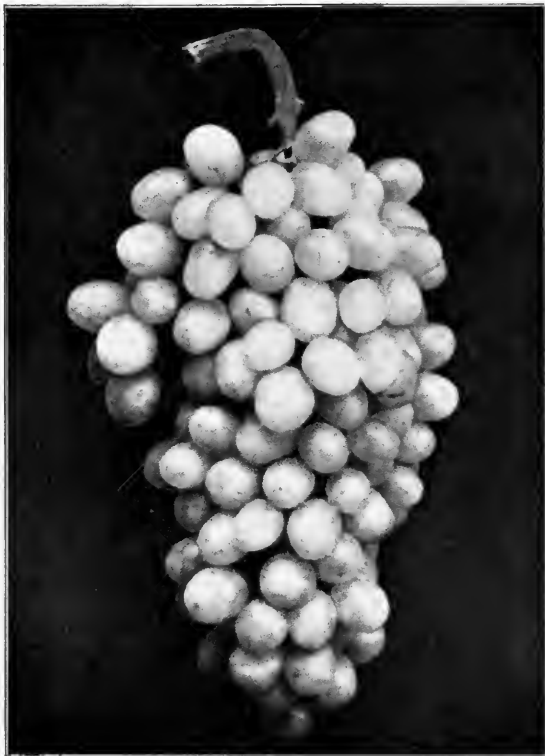

FIG. 47.

Just what you wish to accomplish with regard to the drying of an ink depends on whether the color is the only one to be run, or whether other colors are to be printed on top of it, and how soon. In the case of the one-color job, hard drying is of no consequence save for the ink drying on the rollers. Inks that tend to rub off wet, such as black,

bronze-blue, and dark colors, which, as a rule, lay smoothly, require a thin dryer, such as Japan, to help pull the color into the stock. Inks that do not lay so well, such as light greens, light blues and purples, have a tendency to powder; that is, the varnish goes into the stock and leaves the color on the surface. These colors need a heavy, or concentrated, dryer, which will bind the color to the varnish on the surface of the stock.

In running process or other color work where one color is printed on top of another, care should be taken that the first color does not dry in spots. This is often caused by the stock being unevenly coated, and is one of the most serious difficulties which the pressman can encounter. The term "crystallization," as applied to the yellow of a three-color job drying too hard, is often improperly used to convey the idea of this unequal drying, or "drying in spots." If a color dries too hard, but dries evenly, there are products on the market which if mixed with the second color will make it "take." Or if the first color is not dry enough it is possible to run the same plate again, adding more dryer, but in the case of the uneven drying, the only solution of the difficulty is to produce an even surface by running a solid tint-block the full size of the cuts, using magnesia or tint-base to which dryer has been added, and then start the job over again.

In colorwork one color should follow another about twenty-four hours apart. If this is not possible, owing to the lack of presses, a compound should be added to the first color in proportion to the length of time which will elapse before the second color will be printed. Compounds suitable for this work should contain nondrying substances. Generally one pound of compound to ten of color will present a good printing surface a week later, while one-half a pound of compound will allow a delay of twenty-four hours in following with the second color.

The stock has a great deal to do with the drying of any ink, and it is always better, as I said before, to try out a few sheets before starting the regular run. One of the best color houses in the country makes it a practice of trying

out a new ink on all the stocks it uses on colorwork, and, if the ink dries properly even on one stock, it is not considered at fault in drying quality, and is adapted to the other stocks by manipulation. In other words, the inkman is not expected to furnish an ink for colorwork that will dry on any stock at random. The proposition of fitting the ink to the paper is the printer's duty, unless he submits the stock in advance and has the ink made to order. With a little practice some idea of how an ink is going to dry on a given stock may be gained by wetting the stock with the tongue and watching the rapidity with which the moisture is absorbed. If the absorption does not take place at once, you may be sure that a little dryer in the ink will do no harm.

Estimating the amount of ink required is one of the difficulties in making a price in advance on a given job. When the form is similar to one with which the printer is familiar, the amount of black required may be estimated with some degree of certainty, but where the form is made up of tint-blocks in color, the area of the tint-blocks should be measured accurately and this area subtracted from the total area of the form before attempting to gage the percentage of the balance of the sheet which is covered by type-matter. To illustrate, suppose the form measures $26\frac{1}{2}$ by 38, or roughly, a thousand square inches. Figure the amount of ink for the tint-blocks, and then add to it your estimate of the amount of ink used for type-matter. With five hundred square inches of tint a thousand impressions would give an area of five hundred thousand square inches. Dividing into this area the number of square inches per pound, which the ink is supposed to cover, will give the number of pounds per thousand impressions. On enamel paper, inks will cover from one hundred thousand to two hundred and fifty thousand square inches per pound—the lighter and bulkier the ink, the greater the covering capacity. The writer has seen only one case where a covering capacity of two hundred and fifty thousand square inches was reached. In this case the tint was made almost entirely of tint-base with a powerful pigment used as coloring material. Pulp and lake colors always go further than inks made from earth colors. In the

case of heavy-bodied cover-inks on cover-stocks the covering capacity is less than one hundred thousand square inches, but on enamel paper the printer ought to be reasonably sure of his estimate in figuring this covering capacity per pound. Some printers who use large quantities of a given color have gone to the trouble of testing out the covering capacities of the various inks. They use a tint-block, 10 by 10, or one hundred square inches. The test is made by putting an accurately weighed amount of ink in the fountain, for example, two pounds, and running until the ink is exhausted. If the result is two thousand sheets, one side, the covering capacity of that ink is one hundred thousand square inches per pound.

The more the printer knows about his business, especially about the covering power of inks, the more willing he is to pay for good material. In the case of the exceptionally high covering capacity referred to the printer was getting only one hundred and twenty-five thousand square inches per pound, using a white base, and by spending 10 cents a pound more for his material he was able to double this covering capacity. Such great differences, of course, are the exception, but the intelligent use of the right materials very often will increase the covering capacity fifty per cent. The most remarkable example of increasing the price of an ink and lowering the cost was in the case of a carton manufacturer in Michigan. He was using eight pounds to the thousand of a color, evidently improperly made. He paid twenty-five per cent more and increased the covering capacity one hundred and twenty per cent.

In estimating type-matter, many printers figure fifteen per cent solid, but as this is a variable figure, the covering power of the ink in solids must be ascertained with some degree of accuracy. To do this it will pay any printer to make a few tests, and to know something about the relation of the body of an ink to its covering power, and the relation of the surface of the stock to ink consumption.

It is impossible to give a full list of all the difficulties which may arise in the pressroom, as the oldest in the business are constantly finding new problems to solve. In this

list, however, there may be some points which are not generally known :

Never compare a wet proof with the copy as to color ; wait until the proof dries.

Never compare an ink in the bulk with the color to be matched — the undertone may be entirely different.

For hard stocks with a soft filler use a long-bodied stiff ink, as it does not “squash” out on the edges of the type.

Do not use vermilion, which is made from mercuric sulphid, with electrotyped plates. Have the plates nickel-typed.*

In colorwork with black, where both forms are to be printed on the same press, run the black first, if possible, and use transparent colors. This saves registering the black for position and then taking the form off again.

Do not run transparent yellow over black, however. It is too near white in value and makes the black appear gray.

Do not expect to get a delicate tint from zinc plates if the tint is made from white, as the zinc plates discolor the white, especially when they are new. If you expect to use zinc plates on delicate tints, have them nickeltyped.

Do not run vignettes over tints. The roughness of the surface of the tint causes the vignette to wear.

Do not run any color you happen to have on hand for outdoor work or where the job is to be exposed to light. Most printing-inks are not permanent for more than thirty days' exposure. Ask the inkman for special colors for work of this kind.

Be careful in printing labels for a product which is strongly alkaline, as strong alkali will destroy most colors. Ask the inkman for alkali inks and test them yourself by dipping a printed sample into a three-per-cent solution of caustic potash. If the color runs, it is not alkali-proof. The paste used in sticking on the labels will also cause many

* NOTE.—The action of mercuric sulphid on copper is due to a chemical decomposition. The sulphur ion of mercuric sulphid has a greater affinity for copper than for mercury, and it, therefore, leaves the mercury and unites with the copper, forming copper sulphid, a black substance, which dulls the vermilion color as well as gradually destroying the face of the electrotype. It is best to avoid using vermilion at all, on account of its poor laying qualities ; instead use flaming scarlet.

colors to run, especially reds. An alkali-proof ink will not be affected by this paste, but more inks are paste-proof than alkali-proof, among them many possessing better laying qualities.

Inks for bread labels also should be specifically ordered, as baking destroys the color.

Alcohol-proof inks are sold for use on paper where it is covered with celluloid by dipping it in a celluloid solvent and then pressing the celluloid against it.

The waste in inks properly kept in cans is less than in tube inks. Do not order tubes, as the heavy-bodied inks can not be put up in this manner.

Never put water on top of an ink to keep it from skinning. It causes the ink to congeal and become lumpy, especially at the bottom of the container. Each time the pressman takes out some ink he forces some of the water down into the cavity made by the ink-knife, so that little bubbles of water become incorporated with the ink.

Each time an ink is taken from the can, see that the top is evened off and the oiled paper replaced. If the ink is not to be used again for some time it may be covered with linseed oil or petrolatum and the can banded as when delivered.

Use old and hard rollers for running copying-ink, and sponge them with warm water before putting them on the press. If the copying-ink is too heavy, use glycerin to reduce it. The suction of rollers may be killed by sprinkling them with powdered alum. Try and keep a set of rollers for each color, but if this is not possible, spirits of wine or denatured alcohol is a good cleanser. The printers who do the best work with copying-ink not only have separate rollers for each color, but even confine the work with copying-ink to one or two presses, selecting those which are easily washed up. The "flying" of copying-ink may be stopped by reducing the ink with alum water.

Imitation typewriter letters require special ink, special type and must be printed through silk. The old idea of using ordinary ink and giving a double-impression is easily detected. In fact, the production of the imitation typewriter letter is a specialty, and the ordinary printer will find it wise

COLOR AND ITS APPLICATION TO PRINTING.

as well as economical to send this work to the specialist. Even the best work of this kind is now detected in most cases — we are looking for it.

Kerosene is better to use on rollers than benzin or gasoline, as it does not crack them so much. Kerosene rubbed on the press keeps it from rusting.

When rollers are not in use, rub them with petrolatum.



NOTES

NOTES

NOTES

NOTES

NOTES

NOTES

NOTES

NOTES

NOTES

NOTES

NOTES

NOTES

NOTES

NOTES

NOTES

NOTES

NOTES

NOTES

NOTES

NOTES

NOTES

NOTES

NOTES

NOTES

NOTES

NOTES

NOTES

NOTES

NOTES

NOTES

NOTES

NOTES

NOTES

NOTES

NOTES

NOTES

NOTES

NOTES

NOTES

NOTES

NOTES

NOTES

NOTES

NOTES

NOTES

NOTES

NOTES

NOTES



University of California
SOUTHERN REGIONAL LIBRARY FACILITY
405 Hilgard Avenue, Los Angeles, CA 90024-1388
Return this material to the library
from which it was borrowed.

RECEIVED
JUN 1 1997

JUN 05 1997

SEL CHEMISTRY



A 000 701 332 9



Unive
So
L