

BOSTON PUBLIC LIBRARY



3 9999 03290 935 8







Digitized by the Internet Archive  
in 2010 with funding from  
Boston Public Library







The Commonwealth of Massachusetts  
SECRETARY OF STATE

**REGULATION FILING AND PUBLICATION**

The following  
development c

1. RECAPITULATION OF CHAPTER NUMBER AND HEADING:  
Advisory MASSACHUSETTS STATE BUILDING CODE INCLUDING APPENDICES AND INDEX  
Code 1
2. NAME OF AGENCY: STATE BUILDING CODE COMMISSION
3. THIS DOCUMENT IS REPRINTED FROM THE CODE OF MASSACHUSETTS REGULATIONS AND CONTAINS THE FOLLOWING:

THIS IS THE STATE BUILDING CODE AND ALL APPENDICES AS ADOPTED BY THE STATE BUILDING CODE COMMISSION AND ON FILE WITH THE OFFICE OF THE SECRETARY OF STATE.

UNDER THE PROVISIONS OF MASSACHUSETTS GENERAL LAWS, CHAPTER 30A, SECTION 6 AND CHAPTER 233, SECTION 75 THIS DOCUMENT MAY BE USED AS EVIDENCE OF THE ORIGINAL DOCUMENTS ON FILE WITH THE STATE SECRETARY.

*Current as of Mass. Register  
# 546 (26 Dec. 1986) ?*

COMPILED AS IN FULL FORCE AND EFFECT : SEPTEMBER 30, 1985  
REPRINTED; FEBRUARY 3, 1986.

\$24.00

A TRUE COPY, ATTEST  
*Michael Joseph Connolly*  
MICHAEL JOSEPH CONNOLLY,  
SECRETARY OF STATE

~~KF 02859~~  
~~ATA 32~~  
~~1984~~

NOTICE

THIS CODE, AS ALL CODES, IS SUBJECT TO AMENDMENT. AMENDMENTS ARE PUBLISHED BY THE SECRETARY OF STATE IN THE WEEKLY MASSACHUSETTS REGISTER AND ARE INCORPORATED INTO REPLACEMENT PAGES WHICH ARE PUBLISHED QUARTERLY. NOTICE OF THE AVAILABILITY OF THESE REPLACEMENT PAGES IS PUBLISHED IN THE WEEKLY CENTRAL REGISTER IN THE FINAL ISSUE OF THE MONTHS OF JANUARY, APRIL, JULY AND AUGUST.

THE CENTRAL REGISTER IS AVAILABLE IN YOUR PUBLIC LIBRARY.

Gov Doc  
JH 224  
.M43  
4th edition  
1985 Version



SPECIAL ACKNOWLEDGMENTS

The following committees and organizations contributed toward the development of specific sections of the Massachusetts State Building Code:

- \* The Advisory Committee on Historic Buildings for developing the Basic Code provisions for historic buildings, the first in the nation, and for the basic work they performed on the Code provisions for existing buildings.
- \* The Advisory Committee on Code Provisions for the Reuse of Existing Buildings (Appendix S) for committee members.
- \* The National Bureau of Standards, Office of Building Standards and Code Services, U.S. Department of Commerce, Washington, D.C.
- \* National Conference of States on Building Codes and Standards, 481 Carlisle Drive, Herndon, Virginia.
- \* International conference of Building Officials, 5360 South Workman Mill Road, Whittier, California.
- \* Southern Building Code Congress, International, 900 Montclair Road, Birmingham, Alabama.
- \* Association of Major Cities Building Officials, 1970 Chain Bridge Road, McLean, Virginia.
- \* National Association of Housing and Redevelopment Officials, 2600 Virginia Avenue, N.W., Washington, D.C.

A substantial portion of this Code has been copied from the BOCA Basic Building Code/1978, Seventh Edition, Copyright 1978, Building Officials and Code Administrators International, Inc. All rights reserved. For further information write BOCA International, Inc. 17926 South Halsted Street, Homewood, Illinois, 60430.



## TABLE OF CONTENTS

Article 1 ADMINISTRATION AND ENFORCEMENT

## Section

100. Scope
101. Applicability
102. Ordinary repairs
103. Installation of service equipment
104. Maintenance
105. Change in existing use
106. Alterations and repairs
107. Building department
108. Duties and powers of the building official and state inspector
109. Rules and regulations
110. Approval
111. Inspection
112. Right of entry
113. Application for permit
114. Permits
115. Conditions of permit
116. Demolition of structures
117. Moving structures
118. Fees
119. Certification of use and occupancy
120. Posting structures
121. Violations
122. Stop-work order
123. Unsafe structures
124. Emergency measures
125. Reserved
126. Controlled construction
128. Construction materials safety board
129. Activities requiring licenses
130. Fire prevention-Fire protection board
- 131.
139. Reserved
140. Validity

Article 2 DEFINITIONS AND CLASSIFICATIONS

200. General
201. General definitions
202. Use group classification
203. Use group A, assembly buildings
204. Use group B, business buildings
205. Use group F, factory and industrial buildings
206. Use group H, high hazard buildings
207. Use group I, institutional buildings
208. Use group M, mercantile buildings

## Article 2 - continued

## Section

- 209. Use group R, residential buildings
- 210. Use group S, storage buildings
- 211. Use group T, temporary and miscellaneous uses
- 212. Doubtful use classification
- 213. Mixed use and occupancy
- 214. Construction classification
- 215. Type 1, fireproof construction
- 216. Type 2, noncombustible construction
- 217. Type 3, exterior masonry wall construction
- 218. Type 4, frame construction

Article 3 GENERAL BUILDING LIMITATIONS

- 300. General
- 301. Fire limits
- 302. Restriction within the fire limits
- 303. Restrictions outside fire limits
- 304. Existing buildings
- 305. General area and height limitations
- 306. Area exceptions
- 307. Unlimited areas
- 308. Height exceptions
- 309. Street encroachments
- 310. Permissible street projections
- 311. Permissible yard and court encroachments
- 312. Special and temporary projections
- 313. Awnings and canopies
- 314. Temporary structures
- 315. Accessibility for the physically handicapped

Article 4 SPECIAL USE AND OCCUPANCY REQUIREMENTS

- 400. General
- 401. Explosion hazards
- 402. Volatile flammables
- 403. Fire prevention codes
- 404. Special permits and certificates of fitness
- 405. Existing buildings
- 406. Liquefied petroleum gases
- 407. Pyroxylin plastics
- 408. Use and storage of flammable film
- 409. Use and storage of combustible fibers
- 410. Combustible dusts, grain processing and storage
- 411. Paint spraying and spray booths
- 412. Dry cleaning establishments
- 413. Private garages
- 414. Public garages
- 415. Motor fuel service stations
- 416. Motor vehicle repair shops
- 417. Places of public assembly
- 418. Public assembly other than theaters

Article 4 - continued

Section

- 419. Amusement parks
- 420. Stadiums and grandstands
- 421. Drive in motion picture theatres
- 422. Tents, air-supported structures and other temporary structures
- 423. Parking lots
- 424. Group residence
- 425. Motels
- 426. Radio and television towers
- 427. Radio and television antennae
- 428. Swimming pools
- 429. Open parking structures
- 430. Fallout shelters
- 431. High rise buildings
- 432. Covered malls
- 433. Nursing homes, rest homes, charitable homes for the aged, convalescent homes and hospitals
- 434. Day care centers
- 435. Summer camps for children
- 436. Historic buildings
- 437. Open wells

Article 5 LIGHT, VENTILATION AND SOUND TRANSMISSION CONTROL

- 500. General
- 501. Plans and specifications
- 502. Standards of natural light
- 503. Standards of natural ventilation
- 504. Artificial light and ventilation
- 505. Existing buildings
- 506. Natural lighting and ventilation of rooms
- 507. Lighting and venting of special spaces
- 508. Basements and cellars
- 509. Business and work rooms
- 510. Assembly rooms
- 511. Rooms of institutional buildings
- 512. Bath and toilet rooms
- 513. Stairways and exitways
- 514. Required fresh air supply
- 515. Ventilation of shafts other than elevator and dumbwaiter hoistways
- 516. Courts
- 517. Rear yards
- 518. Obstruction of courts and yards
- 519. Fire emergency ventilating system
- 520. Reserved
- 521. Window cleaning safeguards
- 522. Sound transmission control in residential buildings

Article 6 MEANS OF EGRESS

- 600. General
- 601. Plans and specifications

## Article 6 - continued

## Section

- 602. Use and occupancy requirements
- 603. Air-conditioned buildings
- 604. Existing buildings
- 605. Maintenance of exitways
- 606. Occupancy load
- 607. Types and location of exitways
- 608. Capacity of exits
- 609. Number of exitways
- 610. Exitway access passageways and corridors
- 611. Grade passageways and lobbies used as an exitway element
- 612. Means of egress doorways
- 613. Revolving doors
- 614. Horizontal exits
- 615. Egress ramps
- 616. Interior exitway stairways
- 617. Access to roof
- 618. Smokeproof enclosures
- 619. Exterior exitway stairways
- 620. Moving exitway stairways
- 621. Fire escapes
- 622. Slidescapes
- 623. Exit signs and lights
- 624. Means of egress lighting
- 625. Hazards to means of egress

Article 7 STRUCTURAL AND FOUNDATION LOADS AND STRESSES

- 700. General
- 701. Design safe load
- 702. Test safe load
- 703. Design live load
- 704. Design dead load
- 705. Existing buildings
- 706. Uniformly distributed live load
- 707. Concentrated loads
- 708. Impact loads
- 709. Special loads
- 710. Roof loads
- 711. Snow load
- 712. Wind load
- 713. Wind load on structures as a whole, and on vertical surfaces of enclosed or partially enclosed structures
- 714. Wind load on roofs
- 715. Special configurations, shapes and considerations for wind forces
- 716. Earthquake load
- 717. Combination of loads
- 718. Live load reduction
- 719. Strength criteria
- 720. Bearing value of soils

## Article 7 - continued

## Section

- 721. Subsurface explorations
- 722. Bearing tests, pile loads tests and settlement analyses
- 723. Allowable foundation pressure
- 724. Depth of footings
- 725. Footing design
- 726. Timber footings, wood foundations
- 727. Steel grillages
- 728. Concrete footings
- 729. Masonry unit footings
- 730. Floating foundations
- 731. Foundation piers
- 732. Pile foundations
- 733. Corrosion protection
- 734. Allowable pile loads
- 735. Timber piles
- 736. Precast concrete piles
- 737. Cast-in-place concrete piles
- 738. Concrete-filled pile and tapered tubular piles
- 739. Concrete-filled pipe and steel core caissons
- 740. Structural steel piles
- 741. Composite piles
- 742. Special piles and caissons
- 743. Lateral support
- 744. Design requirements for floodplains and coastal high hazard areas

Article 8 Part A MATERIALS AND TESTS

- 800. General
- 801. Basic classification of construction materials
- 802. Tests
- 803. Conditions of acceptance
- 804. Approvals
- 805. Masonry construction units
- 806. Brick units
- 807. Structural clay tile units
- 808. Glazed clay masonry units
- 809. Concrete units
- 810. Gypsum units
- 811. Structural glass block units
- 812. Architectural terra cotta
- 813. Natural stone
- 814. Cast stone
- 815. Mortar for masonry
- 816. Concrete aggregates
- 817. Ready-mix concrete
- 818. Structural wood glues
- 819. Interior lathing and plastering
- 820. Exterior lathing and stucco
- 821. Plastering materials
- 822. Plaster bases
- 823. Fiber boards
- 824. Plywood
- 825. Wallboards and sheathing

Article 8 Part B STEEL MASONRY, CONCRETE, GYPSUM AND LUMBER CONSTRUCTION

Section

- 826. Structural steel construction
- 827. Formed steel construction
- 828. Steel joist construction
- 829. Reinforcing steel
- 830. Cast steel construction
- 831. Deleted
- 832. Special steels
- 833. Light weight metal alloys
- 834. Masonry wall construction
- 835. Bonding of walls
- 836. Lateral bracing of walls
- 837. Chases and recesses in bearing walls
- 838. Corbeled and projected masonry
- 839. Bearing on hollow unit walls
- 840. Plain concrete
- 841. Reinforced concrete
- 842. Deleted
- 843. Deleted
- 844. Deleted
- 845. Deleted
- 846. Concrete-filled pipe columns
- 847. Pneumatic concrete
- 848. Minimum concrete dimensions
- 849. Reinforced gypsum concrete
- 850. Engineered unreinforced masonry
- 851. Reinforced masonry
- 852. Lumber and timber construction
- 853. Heavy timber type construction
- 854. Wood frame construction
- 855. Stress skin panels
- 856. Structural glued laminated timber and built-up wood construction

Article 8 Part C BUILDING ENCLOSURES, WALLS AND WALL THICKNESS

- 857. Enclosure walls
- 858. Protection of wall openings
- 859. Fire access panels
- 860. Structural glass block walls
- 861. Wall facings and veneers
- 862. Structural glass veneers
- 863. Thin stone and tile veneers
- 864. Metal veneers
- 865. Plastic veneers
- 866. Thickness of solid masonry walls
- 867. Thickness of panel walls
- 868. Deleted
- 869. Foundation walls
- 870. Retaining walls
- 871. Deleted
- 872. Waterproofing and floodproofing



## Article 8 - continued

## Section

- 873. Deleted
- 874. Protection against decay and termites
- 875. Delete, add Reserved
- 876. Thermal insulating materials

Article 9 FIRERESISTIVE CONSTRUCTION REQUIREMENTS

- 900. General
- 901. Plans and specifications
- 902. Fire hazard classification
- 903. Fireresistance tests
- 904. Flameresistance tests
- 905. Special fireresistive requirements
- 906. Exterior walls
- 907. Fire walls and party walls
- 908. Fire wall openings
- 909. Fire separation walls
- 910. Vertical shafts
- 911. Fireresistance of structural members
- 912. Fireresistance rated floor/roof-ceiling assemblies
- 913. Roof construction
- 914. Exterior opening protectives
- 915. Fire doors
- 916. Fire windows and shutters
- 917. Wired glass
- 918. Fireresistive requirements for plaster
- 919. Firestopping and draftstopping
- 920. Interior wall and ceiling finish, floor coverings and trim
- 921. Application of interior finish
- 922. Combustible materials permitted in floor construction of Type 1 and Type 2 buildings
- 923. Decorative material restrictions
- 924. Exterior trim restrictions
- 925. Roof structures
- 926. Roof coverings

Article 10 CHIMNEYS, FLUES AND VENT PIPES

- 1000. General
- 1001. Plans and specifications
- 1002. Performance test and acceptance criteria
- 1003. Chimneys
- 1004. Appliances requiring chimneys
- 1005. Existing buildings
- 1006. Vent systems
- 1007. Fireplaces
- 1008. Incinerators
- 1009. Construction of metal ducts and vents
- 1010. Spark arrestors

Article 11 MECHANICAL EQUIPMENT AND SYSTEMS

## Section

- 1100. General
- 1101. Plans and specifications
- 1102. Inspections and tests
- 1103. Existing buildings
- 1104. Fees
- 1105. Boiler rooms
- 1106. Drying rooms
- 1107. Refuse chutes
- 1108. Refuse vaults
- 1109. Dust, stock and refuse conveyor systems
- 1110. Solid fuel burning heating appliances

Article 12 FIRE PROTECTION SYSTEMS

- 1200. General
- 1201. Plans and specifications
- 1202. Fire suppression systems
- 1203. Suppression system selection
- 1204. Water sprinkler systems
- 1205. Limited area sprinkler systems
- 1206. Water spray fixed systems
- 1207. Foam extinguishing systems
- 1208. Carbon dioxide extinguishing systems
- 1209. Halogenated fire extinguishing systems
- 1210. Dry chemical extinguishing systems
- 1211. Standpipe systems
- 1212. Standpipes for buildings under construction or demolition
- 1213. Fire department connections
- 1214. Water supply and other extinguishing supply media
- 1215. Yard hydrants
- 1216. Automatic fire systems
- 1217. Manual fire alarm systems (pull stations)
- 1218. Supervision

Article 13 PRECAUTIONS DURING BUILDING OPERATIONS

- 1300. General
- 1301. Plans, specifications and special permits
- 1302. Tests
- 1303. Inspection
- 1304. Maintenance
- 1305. Existing buildings
- 1306. Protection of public and workmen
- 1307. Excavations
- 1308. Regulations of lots
- 1309. Retaining walls and partition fences
- 1310. Storage of materials
- 1311. Removal of waste material
- 1312. Protection of adjoining property
- 1313. Protection of floor and wall openings
- 1314. Scaffolds
- 1315. Hoists

Article 13 - continued

Section

- 1316. Stairways and ladders
- 1317. Lighting
- 1318. Fire hazards
- 1319. Health hazards
- 1320. Welding safety precautions
- 1321. Deleted
- 1322. Disputes

Article 14 SIGNS

- 1400. General
- 1401. Plans, specifications and permits
- 1402. Exemptions
- 1403. Unsafe and unlawful signs
- 1404. Existing signs
- 1405. Maintenance and inspection
- 1406. Bonds and liability insurance
- 1407. General requirements for all signs
- 1408. Ground signs
- 1409. Roof signs
- 1410. Wall signs
- 1411. Projecting signs
- 1412. Marquee signs
- 1413. Miscellaneous and temporary signs
- 1414. Illuminated signs
- 1415. Portable signs

Article 15 ELECTRICAL WIRING AND EQUIPMENT

Article 16 ELEVATOR DUMBWAITER AND CONVEYOR EQUIPMENT INSTALLATION AND MAINTENANCE

Article 17 PLUMBING AND GAS FITTING

Article 18 MANUFACTURED BUILDINGS, BUILDING COMPONENTS AND MOBILE HOMES

- 1800. General
- 1801. Approval
- 1802. Certification
- 1803. Reciprocity
- 1804. Assurance inspection
- 1805. Responsibility of the building official
- 1806. Suspension and revocation of certification

Article 19 LIGHT-TRANSMITTING PLASTIC CONSTRUCTION

- 1900. General
- 1901. Design and installation
- 1902. Glazing of unprotected openings
- 1903. Exterior panel walls
- 1904. Roof panels

## Article 19 - continued

## Section

- 1905. Skylight assemblies
- 1906. Light-diffusing systems
- 1907. Partitions
- 1908. Bathroom accessories
- 1909. Awnings and similar structures
- 1910. Greenhouses

Article 20 ENERGY CONSERVATION

- 2000. General
- 2001. Administrative
- 2002. Existing buildings
- 2003. Plans and specifications
- 2004. Materials and equipment
- 2005. Design conditions
- 2006. Building insulation
- 2007. Vapor barriers
- 2008. Component design
- 2009. Exterior envelope requirements
- 2010. Mechanical systems
- 2011. Electrical power distribution
- 2012. Lighting power limits
- 2013. Building design by system analysis
- 2014. Buildings utilizing solar, geothermal, wind or other non-depletable energy sources as alternative design
- 2015. Lighting power limits for existing buildings

Article 21 ONE AND TWO FAMILY DWELLING

- 2107. Roof coverings
- 2108. Chimneys, fireplaces and connector pipes
- 2109. Solid fuel burning heating appliances
- 2110. Mechanical equipment general
- 2111. Combustion air
- 2112. Warm-air furnaces
- 2113. Vented decorative appliances, floor furnaces, vented wall furnaces and vented room heaters
- 2114. Venting of appliances
- 2115. Ducts
- 2116. Comfort cooling
- 2117. Absorption units and absorption systems for comfort cooling and comfort heating
- 2118. Fuel supply systems
- 2119. Energy conservation by component design
- 2120. Building insulation
- 2121. Ventilation
- 2122. Vapor barriers
- 2123. U-values of building components
- 2124. Air leakage for all buildings
- 2125. System design heating/cooling capacity
- 2126. Controls

Article 21 - continued

Section

- 2127. Balancing
- 2128. Duct insulation
- 2129. Pipe insulation
- Reference Standards
- Index to Tables and Figures
- General Index

Article 22 REPAIR, ALTERATION, ADDITION AND CHANGE OF USE OF EXISTING BUILDINGS

- 2200. Scope
- 2201. Definitions
- 2202. Implementation
- 2203. Requirements for continuation of the same use group or change to a use group of equal or lesser hazard index
- 2204. Requirements for change in use group to one hazard index greater
- 2205. Requirement for change in use group to two or more hazard indices greater
- 2206. Compliance alternatives
- 2207. Energy provisions for existing buildings
- 2208. Other Code Sections pertaining to repair alteration or change of use of existing buildings



Article 1

ADMINISTRATION AND ENFORCEMENT

SECTION 100.0 SCOPE

100.1 Title: These regulations shall be known as the Commonwealth of Massachusetts State Building Code hereinafter referred to as "this code."

100.2 Scope: These regulations, in accordance with Chapter 802 of the Acts of 1972 as amended, shall control: a) the construction, reconstruction, alteration, repair, demolition, removal, inspection, issuance and revocation of permits or licenses, installation of equipment, classification and definition of any building or structure and use or occupancy of all buildings and structures and parts thereof or classes of buildings and structures and parts thereof; b) the rehabilitation and maintenance of existing buildings; c) the standards or requirements for materials to be used in connection therewith, including but not limited to provisions for safety, ingress and egress, energy conservation and sanitary conditions; d) the establishment of reasonable fees for the issuance of licenses and permits in connection therewith; except as such matters are otherwise provided for in the Massachusetts General Laws Annotated, or in the rules and regulations authorized for promulgation under the provisions of this code.

100.3 Application of reference: Unless otherwise specifically provided in this code, all references to article or section numbers, or to provisions not specifically identified by number, shall be construed to refer to such article, section or provision of this code.

100.4 Code remedial: This code shall be construed to secure its expressed intent which is to insure public safety, health and welfare insofar as they are affected by building construction through structural strength, adequate egress facilities, sanitary conditions, equipment, light and ventilation and fire safety; and, in general, to secure safety to life and property.

100.5 Specialized codes: Specialized codes, rules or regulations pertaining to building construction, reconstruction, alteration, repair, or demolition promulgated, and as amended, from time to time, by the various authorized state agencies shall be incorporated in this code. The said specialized codes, rules or regulations include, but are not limited to, those listed in Appendix P.

100.5.1 Technical Code Council: The Technical Code Council is comprised of representatives from each of the state agencies

having jurisdiction over the specialized codes including those listed in Appendix P, and serves as an advisory board to the State Building Code Commission, herein referred to as the Commission, on matters related to uniformity of rules and regulations governing building construction and the establishment of uniform procedures relative to their administration and enforcement. Members of the Technical Code Council are listed in Appendix R.

## SECTION 101.0 APPLICABILITY

101.1 General: The provisions of this code shall apply to all matters affecting or relating to buildings and structures; and shall apply with equal force to municipal, county, state authorities of or established by the legislature and private buildings and structures, except where such buildings and structures are otherwise specifically provided for by statute.

Exceptions:

1. Unless specifically provided otherwise in this code, all existing buildings and structures shall meet and shall be presumed to meet, the provisions of the applicable laws, codes, rules or regulations, by-laws or ordinances in effect at the time such building or structure was erected or substantially altered.
2. In cases where applicable codes, rules or regulations, by-laws or ordinances were not in use at the time of such erection or substantial alteration, the provisions of Section 104.0 of this code shall apply.
3. In cases where the provisions of this code are less stringent than the applicable codes, rules or regulations, by-laws or ordinances in force at the time of such erection or substantial alteration, the applicable provisions of this code shall apply, providing such application of these provisions does not result in danger to the public as determined by the building official.

101.2 Zoning restrictions: When the provisions herein specified for structural strength, adequate egress facilities, sanitary conditions, equipment, light and ventilation, and fire safety conflict with the local zoning by-laws or ordinances, this code shall control the erection or alteration of buildings.

101.3 Matters not covered: Any requirements essential for structural, fire or sanitary safety of an existing or proposed building or structure, or essential for the safety of the occupants thereof, and which is not specifically covered by this code, shall be determined by the building official. The State



Building Code Commission and the Department of Public Safety shall be notified in writing within seven (7) working days of any action taken under this section.

#### SECTION 102.0 ORDINARY REPAIRS

102.1 General: Except as provided in Section 113.1, a permit shall not be required for ordinary repairs to buildings and structures.

#### SECTION 103.0 INSTALLATION OF SERVICE EQUIPMENT

103.1 General: When the installation, extension, alteration or repair of an elevator, moving stairway, mechanical equipment, refrigeration, air conditioning or ventilating apparatus, plumbing, gas piping, electric wiring, heating system or any other equipment is specifically controlled by the provisions of this code or the approved rules, it shall be unlawful to use such equipment until a certificate of approval has been issued therefor by the building official or other agency having jurisdiction.

#### SECTION 104.0 MAINTENANCE

104.1 General: All buildings and structures and all parts thereof, both existing and new, shall be maintained in a safe and sanitary condition. All service equipment, means of egress, devices and safeguards which are required by this code in a building or structure, or which were required by a previous statute in a building or structure, when erected, altered or repaired, shall be maintained in good working order.

104.2 Owner responsibility: The owner, as defined in Article 2, shall be responsible for the safe and sanitary maintenance of the building or structure and its exitway facilities at all times, unless otherwise specifically provided in this code.

#### SECTION 105.0 CHANGE IN EXISTING USE

105.1 Continuation of existing use: The legal use and occupancy of any existing structure for which it had been heretofore approved, may be continued without change, except as may be specifically covered in this code or as may be deemed necessary by the building official for the general safety and welfare of the occupants and the public.

105.2 Change of existing use: Any change in the use and occupancy of any existing building or structure shall comply with Article 22.

SECTION 106.0 ALTERATIONS AND REPAIRS

106.1 Application: Except as provided in this code, existing buildings or structures when altered or repaired shall be made to conform to Article 22.

SECTION 107.0 BUILDING DEPARTMENT

107.1 Appointment: The chief administrative officer of each city or town shall employ and designate an inspector of buildings or building commissioner, as well as such other local inspectors as are reasonably necessary. The inspector of buildings or building commissioner shall report directly and be solely responsible to the appointing authority.

107.2 Building commissioner or inspector of buildings: The building department shall have an administrative chief responsible for the administration and enforcement of this code who shall be known as the building commissioner or inspector of buildings.

107.2.1 Local Inspector: The local inspector shall assist the building commissioner or inspector of buildings in the performance of his duties and shall also be responsible for the enforcement of this code.

107.2.2 Alternate inspector: An alternate inspector of buildings may be appointed to act in the disability of the inspector of buildings in case of illness, absence, or conflict of interest. The alternate inspector shall meet the qualifications of Section 107.3.

107.3 Qualifications of the building commissioner or inspector of buildings: Each building commissioner or inspector of buildings shall have had at least five (5) years of experience in the supervision of building construction or design or in the alternative a four-year undergraduate degree in a field related to building construction or design. In addition, such persons shall have had general knowledge of the accepted requirements for building construction, fire prevention, light, ventilation and safe egress; as well as a general knowledge of other equipment and materials essential for safety, comfort, and convenience of the occupants of a building or structure; plus whatever other requirements of experience and knowledge that are deemed necessary by the municipality.

107.4 Qualifications of the local inspector: Each local inspector shall have had at least five (5) years of experience in the supervision of building construction or design or in the alternative a two-year associate degree in a field related to building construction or design. In addition, such persons shall have a

general knowledge of the accepted requirements for building construction, fire prevention, light, ventilation and safe egress; as well as a general knowledge of other equipment and materials essential for safety, comfort, and convenience of the occupants of a building or structure; plus whatever other requirements of experience and knowledge that are deemed necessary by the municipality.

107.5 Restriction on employees: No full-time building commissioner, inspector of buildings, or full-time local inspector as defined herein shall be engaged in, or directly or indirectly connected with, the furnishing of labor, materials or appliances for the construction, alteration or maintenance of a building or structure, or the preparation of plans or of specifications therefor within the city, town or region for which he is appointed, unless he is the owner of the building or structure; nor shall any officer or employee associated with the building department engage in any work which conflicts with his official duties or with the interests of the department.

107.6 Relief from personal liability: Insofar as the law allows, while acting for the municipality, the building official, charged with the enforcement of this code shall not be deemed personally liable in the discharge of his official duties.

#### SECTION 108.0 DUTIES AND POWERS OF THE BUILDING OFFICIAL AND STATE INSPECTOR

108.1 The local building official: The building commissioner or inspector of buildings and the local inspector shall enforce all the provisions of this code and any other applicable state statutes, rules and regulations, or ordinances and by-laws, and act on any question relative to the mode or manner of construction, and the materials to be used in the construction, reconstruction, alteration, repair, demolition, removal, installation of equipment, and the location, use, occupancy, and maintenance of all buildings and structures, including any building or structure owned by any authority established by the legislature but not owned by the Commonwealth.

108.2 Applications and permits: The building official shall receive applications and inspect the premises for which permits have been issued and enforce compliance with the provisions of this code.

108.3 Building notices and orders: The building official shall issue all necessary notices or orders to remove illegal or unsafe conditions, to require the necessary safeguards during construction, to require adequate egress facilities in new and existing buildings and structures, and to insure compliance with all the code requirements for the safety, health and general welfare of the public.

108.4 Credentials: The building official or his authorized representative shall carry proper credentials of his respective office for the purpose of inspecting any and all buildings, structures and premises in the performance of his duties under this code.

108.5 Inspections: The building official shall make all the required inspections or may accept reports of inspections from a qualified registered professional engineer or architect or others certified by the Commission, and all reports of such inspections shall be in writing; or the building official may engage such experts as he may deem necessary to report upon unusual technical issues that may arise.

108.5.1 Inspection and certification, specified use groups: The building official shall periodically inspect and certify buildings and structures or parts thereof in accordance with Table 108. A building or structure shall not be occupied or continue to be occupied without the posting of a valid certificate of inspection where required by Table 108. A certificate of inspection as herein specified shall not be issued until an inspection is made certifying that the building or structure or parts thereof complies with all the applicable requirements of this code, and until the fee is paid as specified in Table 108. Municipalities may waive only in their entirety the fees as specified in Table 108 for buildings and structures or parts thereof. Municipalities may increase the fees specified in Table 108 or may waive only in their entirety the fees as specified in said Table 108 for buildings and structures or parts thereof.

Exception: Municipalities may revise or modify, or waive in part those fees for buildings and structures or parts thereof owned by the municipality, county or political subdivision thereof and for buildings and structures or parts thereof used solely for religious purposes.

108.6 Administrative procedures: The building commissioner or inspector of buildings shall have the authority to formulate administrative procedures necessary to uniformly administer and enforce this code provided that such procedures do not conflict with the rules and regulations promulgated by the Commission.

TABLE 108  
 REQUIRED MINIMUM INSPECTIONS AND CERTIFICATIONS FOR SPECIFIED USE GROUPS  
 (See Article 2 for complete description of use groups.)

| USE group | With stage and scenery   | MINIMUM INSPECTIONS | MAXIMUM CERTIFICATION PERIOD | FEE PER MAXIMUM CERTIFICATION PERIOD |
|-----------|--|---------------------|------------------------------|--------------------------------------|
| A-1-A+    | Assembly theatres  | Semi-Annually       | One Year                     | \$75                                 |
| A-1-B+    | (accommodating over 400)   | "                   | "                            | "                                    |
| A-2+      | Assembly -- Night clubs and similar uses (accommodating over 400)                          | "                   | "                            | "                                    |
| A-3+      | Assembly -- Lecture halls, recreation centers, terminals, etc. (accommodating over 400)    | "                   | "                            | note a                               |
| A-1-A     | Assembly theatres  | Annually            | One Year                     | \$40                                 |
| A-1-B     | (accommodating 400)  | "                   | "                            | "                                    |
| A-2       | Assembly -- Night clubs and similar uses (accommodating 400 or less)                       | "                   | "                            | "                                    |
| A-3       | Assembly -- Lecture halls, recreation centers, terminals, etc. (accommodating 400 or less) | "                   | "                            | "                                    |
| A-4       | Assembly -- Churches, low density recreation and similar uses                              | Prior to the        | Five Years                   | \$40                                 |
| A-4       | Assembly -- Schools: 10 or more students   | issuance of each    | One Year                     | \$40                                 |
| A-5       | Assembly -- stadiums, bleachers, etc.  | new certificate     | One Year                     | note b                               |
| I-1       | Institutional -- Restrained--jails, prisons, etc.  | "                   | Two Years                    | note c                               |
| I-2       | Institutional -- Incapacitated--hospitals, etc.  | "                   | Two Years                    | note d                               |
| R-1       | Residential -- Hotels, lodging houses, etc.  | "                   | One Year                     | note e                               |
| R-1       | Detoxification Facilities  | "                   | Two Years                    | \$75                                 |
| R-2       | Residential -- Multi-Family  | "                   | Five Years                   | note f                               |
| R-2       | Summer camps for children  | Annually            | One Year                     | note h                               |
| --R-3     | Limited Group Residences   | Annually            | One Year                     | \$40                                 |

## Notes applicable to Table 108

## General:

The maximum certification period specified in Table 108 is intended to provide administrative flexibility. For those buildings and structures or parts thereof allowing more than a one (1) year maximum certification period, the building official may determine the length of validity of the certificate issued. For example, a building in the R-2 use group could be issued a certificate valid for 1, 2, 3, 4 or 5 years. The total amount of fees charged for a certificate or certificates issued during the maximum certification period can exceed the fee listed or referenced in column 4 of Table 108. For example, if the building official issues a certificate valid for two (2) years for a building in the R-2 use group, the fee charged would be two-fifths ( $2/5$ ) times the fee per maximum certification period as determined for the building in question using the formula in note f below.

Note a. For all buildings or structures, or parts thereof, in the A-3+ use group, the fee to be charged for the maximum certification period of one (1) year is \$75 for accommodations for up to five thousand (5,000) persons, plus \$15 for the accommodations for each additional one thousand (1,000) persons or fraction thereof.

Note b. For all buildings or structures, or parts thereof, in A-5 use group, the fee to be charged for the maximum certification period of one (1) year is \$40 for seating accommodations for up to five thousand (5,000) persons, plus \$8 for the accommodation for each additional one thousand (1,000) persons or fraction thereof.

Note c. For all buildings and structures, or parts thereof, in the I-1 use group, the fee to be charged for the maximum certification period of two (2) years is \$75 for each structure containing up to one hundred (100) beds, plus a \$2 charge for each additional ten (10) beds or fraction thereof over the initial one hundred (100) beds.

Note d. For hospitals, nursing homes, sanitariums, and orphanages in the I-2 use group, the fee to be charged for the maximum certification period of two (2) years is \$75 for each structure containing up to one hundred (100) beds, plus a \$2 charge for each additional ten (10) beds or fraction thereof over the initial one hundred (100) beds. All other buildings or structures or parts thereof in the I-2 use group classification shall be charged a fee of \$75 for a two (2) year maximum certification period.

Note e. For all buildings and structures or parts thereof in the R-1 use group, the fee to be charged for the maximum certification period of one (1) year shall be \$40 for up to five (5) units plus \$2 per unit for all over five (5) units. A unit shall be defined as follows:

- two (2) hotel guest rooms;
- two (2) lodging house guest rooms;
- two (2) boarding house guest rooms; or
- four (4) dormitory beds

Note f. For all buildings and structures or parts thereof in the R-2 use group, the fee to be charged for the maximum certification period of five (5) years shall be \$75, plus \$2 per dwelling unit, except three (3) family dwelling units shall be exempt from such fees.

Note g. For purposes of determining the required number of inspections, the maximum certification period, and the fees, as specified in Table 108, dormitories are included in the R-1 use group classification rather than the R-2.

Note h. Summer camps for children in use group R-2 shall be inspected and certified annually prior to the beginning of each season. The annual fee shall be \$15 for the first twenty-five (25) residential units; \$8 for each additional twenty-five (25) residential units; and \$15 for each assembly building or use. (A residential unit for this purpose shall be defined as four (4) beds.)

108.7 Department records: The building official shall keep in a public place and open to public inspection during normal working hours official records of applications received, permits and certificates issued, fees collected, reports of inspections, variances granted, and notices and orders issued. File copies of all papers in connection with building operations shall be retained in the official records so long as the building or structure to which they relate remains in existence.

108.8 Reports: The building official shall submit the following reports:

1. to the Department of Community Affairs on a form provided by said department a report of the building permit activity for the month;
2. to the chief administrative officer of the municipality a written statement of all permits and certificates issued, fees collected, inspections made, and notices and orders issued for the year;

3. to the Commission and Department of Public Safety reports on decisions regarding the matters not covered as specified in Section 101.3; and
4. to the assessors of the municipality reports on permits issued as specified in Section 114.2.

108.9 The state inspector: In every city and town this code shall be enforced by the state inspector as to any structures or buildings or parts thereof that are owned by the Commonwealth or any departments, commissions, agencies, or authorities of the Commonwealth. The state inspector shall have as to such buildings and structures all the powers of a building commissioner or inspector of buildings. All buildings and structures owned by any authority established by the legislature shall be regulated in accordance with Section 108.1 of this code.

108.9.1 Other responsibilities: The state inspector shall make periodic reviews of all local building inspection practices, provide technical assistance and advice to the local building officials in the implementation of this code, and report in writing his findings to the building officials.

108.9.2 Review by the commissioner: The Commissioner of the Commonwealth of Massachusetts, Department of Public Safety shall establish districts which shall be supervised by a state inspector of the Division of Inspection. The Commissioner may review, on his own initiative or on the application of any state inspector, any action or refusal or failure of action by any building official the result of which does not comply with the uniform implementation of this code; and may reverse, modify or annul, in whole or in part, such action except with respect to the specialized codes, provided that an order or action of the Commissioner shall not reverse, modify, annul, or contravene any order, action, determination, interpretation or any decision by the Commission or the State Building Code Appeals Board.

108.9.3 Reports: The state inspector shall file with the Commission reports of his periodic reviews and recommendations for improvements of building inspection practices. The format and due dates for these reports shall be determined by the Commission.

## SECTION 109.0 RULES AND REGULATIONS

109.1 Rule making authority: Under authority granted by Chapter 802, Acts of 1972, as amended, the Commission is empowered in the interest of public safety, health and general welfare, to adopt and promulgate rules and regulations, and to interpret and implement the provisions of this code to secure the intent thereof.



109.1.1 Licensing of Construction Supervisors:

Except for those structures governed by Construction Control in Section 127.0, effective September 1, 1982 no individual shall be engaged in directly supervising persons engaged in construction, reconstruction, alteration, repair, removal or demolition involving the structural elements of buildings and structures, unless he or she is licensed in accordance with the rules and regulations promulgated by the Commission as listed in Appendix Q, entitled Rules and Regulations for Licensing Construction Supervisors.

Exception: Any Home Owner performing work for which a building permit is required shall be exempt from the provisions of this section; provided that if a Home Owner engages a person(s) for hire to do such work, that such Home Owner shall act as supervisor.

For purposes of this section only, a "Home Owner" is defined as follows:

Person(s) who owns a parcel of land on which he/she resides or intends to reside, on which there is, or is intended to be, a dwelling of six or less units, attached or detached structures accessory to such use and/or farm structures. A person who constructs more than one home in a two-year period shall not be considered a home owner.

109.1.1.1 No municipality shall be prohibited from requiring a license for those individuals engaged in directly supervising persons engaged in construction, reconstruction, alteration, repair, removal or demolition in those categories of building and structures for which the commission is not requiring a license, provided that those municipalities which have established licensing requirements for construction supervisors prior to January 1, 1975, may maintain their existing licensing requirements.

109.1.2 Licensing of laboratories and test personnel: The Commission shall issue rules and regulations for the examination and licensing, and the revocation of licenses of individuals, laboratories and firms responsible for the inspection and/or testing of materials, devices and methods of construction, in accordance with the Rules and Regulations for Concrete Testing Personnel and the Rules and Regulations for Licensing of Concrete Testing Laboratories referenced in Appendix Q.

109.1.3 Manufactured buildings: The Commission shall issue rules and regulations pursuant to Article 18 governing manufactured buildings and building components referenced in Appendix Q.

109.1.4 Mobile homes: The Commission shall issue rules and regulations pursuant to Article 18 governing mobile homes referenced in Appendix Q.

109.2 Amendments and promulgation of rules: Any person may propose amendments to this code. Public hearings shall be held in the city of Boston in May and October of each year, and at such other times and places as the Commission may determine, to consider petitions for such amendments. Amendments adopted by the Commission shall be binding and have the full force and effect in all cities and towns.

#### SECTION 110.0 APPROVAL

110.1 Approved materials and equipment: All materials, equipment, devices, systems or methods of construction shall be subject to the following approvals required by this section.

110.2 Accepted engineering practice: If not otherwise specified in this code, the regulations, specifications and standards listed in the appropriate appendices shall be deemed to represent accepted engineering practice with respect to the material, equipment, device, system or method of construction therein specified.

110.3 New materials and methods of construction: The provisions of this code are not intended to prevent the use of any material, system or method of construction not specifically prescribed by this code. The building official shall accept approvals of the Commission on all new materials, systems or methods of construction proposed for use which are not specifically provided for in this code.

110.4 Used materials and equipment: Used materials, equipment and devices which meet the minimum requirements of this code for new materials, equipment and devices shall be permitted; however, the building official may require satisfactory proof that such materials, equipment and devices have been reconditioned, tested, and/or placed in good and proper working condition prior to approval.

110.5 Research and investigations: Wherever there is insufficient evidence that any material, system or method of construction conforms to the requirements of this code or there is insufficient evidence to substantiate claims for alternative materials, systems or methods of construction, the building official may require tests meeting the functional requirements of this code (see Sections 800.0, 802.0, and 803.0) and such test shall be conducted by a laboratory and/or personnel approved by the Commission. The costs of all such tests or other investigations required under these provisions shall be paid by the applicant.

110.5.1 Test results: Copies of the results of all such tests shall be forwarded to the Commission within ten (10) days and shall be kept on file in the permanent records of the building department.

110.5.2 Retesting: The Commission may require tests to be repeated, if at any time there is reason to believe that material or construction no longer conforms to the requirements on which its approval was based.

110.6 Variances/modifications: When there are practical difficulties involved in carrying out structural or mechanical provisions of this code, the Board of Appeals may allow a variance or a modification from such provisions as applied for by the owner as provided in Section 126.0, provided that the decision of the Board shall not conflict with the general objectives of this code and its enabling legislation and provided that no decision shall be considered by any person or agency as a precedent for future decisions.

#### SECTION 111.0 INSPECTION

111.1 Preliminary inspection: Before issuing a permit, the

NON-TEXT PAGE

building official may examine or cause to be examined all buildings, structures and sites for which an application has been filed for a permit to construct, reconstruct, alter, repair, remove, demolish or change the use thereof.

111.2 Inspection: The building official shall make all required inspections as specified in the provisions of this code and he shall conduct such inspections from time to time during and upon completion of the work for which he has issued a permit; and he shall maintain a record of all such examinations and inspections and of all violations of this code. In conjunction with specific construction projects, the building official may designate specific inspection points in the course of construction that require the contractor or builder to give the building official twenty-four (24) hours notice prior to the time when those inspections need to be performed. The building official shall make the inspection within forty-eight (48) hours after such notification.

111.2.1 Inspection services: The building official may accept the written report of inspections from a qualified registered professional engineer or architect or others certified by the Commission; and such inspection report shall specify but not be limited to any violation of the requirements of this code in respect to egress requirements, floor load, fire grading, occupancy load and use of the buildings or structures.

111.3 Final inspection: The owner or his authorized representative shall notify the building official upon completion of the building or structure or part thereof. Prior to the issuance of the certificate of use and occupancy required in Section 119.0, a final inspection shall be made and all violations of the approved plans and permit shall be noted and the holder of the permit shall be notified of any discrepancies.

#### 111.4 Manufactured Buildings

111.4.1 Plant inspection: Inspection of all manufactured buildings and building components at the plant shall be performed by a third party which shall be certified and approved by the Commission and monitored as specified in Article 18 and the rules and regulations pursuant thereto.

111.4.2 Site inspection: Inspection of all manufactured buildings, building components, and mobile homes at the installation site shall be made by the building official as specified in Article 18 and the rules and regulations pursuant thereto.

#### 111.5 Existing Buildings

111.5.1 Periodic Inspections: The building commissioner or inspector of buildings shall develop plans for the systematic periodic inspection of all existing buildings and structures and

shall cause such buildings and structures to be periodically or otherwise inspected as specified in Section 108.5.1 and Section 120.4, for compliance with this code.

#### SECTION 112.0 RIGHT OF ENTRY

112.1 General: In the discharge of his duties, the building official shall have the authority to enter at any reasonable hour any building, structure or premises in the municipality to enforce the provisions of this code.

If any owner, occupant, or other person refuses, impedes, inhibits, intereferes with, restricts, or obstructs entry and free access to every part of the structure, operation or premises where inspection authorized by this code is sought, the building official, or state inspector may:

1. seek in a court of competent jurisdiction a search warrant so as to apprise the owner, occupant or other person concerning the nature of the inspection and justification for it and may seek the assistance of police authorities in presenting said warrant; and/or
2. revoke or suspend any permit, license, certificate or other permission regulated under this code where inspection of the structures, operation or premises is sought to determine compliance with this code.

112.2 Office badge: The Commission may adopt a badge of office for building officials which shall be displayed for the purpose of identification.

112.3 Jurisdictional cooperation: The assistance and cooperation of police, fire, and health departments and all other officials shall be available to the building official as required in the performance of his duties.

#### SECTION 113.0 APPLICATION FOR PERMIT

113.1 When permit is required: It shall be unlawful to construct, reconstruct, alter, repair, remove or demolish a structure; or to change the use or occupancy of a building or structure; or to install or alter any equipment for which provision is made or the installation of which is regulated by this code without first filing a written application with the building official and obtaining the required permit therefor.

Exception: Ordinary repairs as defined in Section 201.0.

113.2 Form of application: The application for a permit shall be submitted in such form as the building official may prescribe

and shall be accompanied by the required fee as prescribed in Section 118.0.

113.3 By whom application is made: Application for a permit shall be made by the owner of the building or structure. The full names and addresses of the owner, applicant, and of the responsible officers, if the owner is a corporate body, shall be stated in the application.

113.4 Description of work: The application shall contain a general description of the proposed work, its location, the use and occupancy of all parts of the building or structure and of all portions of the site or lot not covered by the building; and shall state whether or not fire extinguishing equipment, plumbing, water piping, gasfitting, heating or electrical work is involved, the estimated cost of such work including the general work, and such additional information as may be required by the building commissioner or inspector of buildings. The building commissioner or inspector of buildings may require the facts contained in each application to be certified by the applicant under oath.

113.5 Plans and specifications: The application for the permit shall be accompanied by not less than three (3) copies of specifications and of plans drawn to scale, with sufficient clarity and detail dimensions to show the nature and character of the work to be performed. When quality of materials is essential for conformity to this code, specific information shall be given to establish such quality; and the code shall not be cited nor the term "legal" or its equivalent be used as a substitute for specific information. The building official may waive the requirement for filing plans when the work involved is of a minor nature.

When such application for a permit must comply with the provisions of Article 4 or Article 12 of this code, the building official shall cause one (1) such set of plans and specifications received by him to be forwarded simultaneously to the head of the fire department for his file and approval of the items specified in Section 1200.0 as they relate to the applicable sections of Article 4 and Article 12. The head of the fire department shall within ten (10) working days from the date of receipt by him approve or disapprove such plans and specifications. Upon request by the head of the fire department, the building official may grant one (1) or more extensions for such review, providing, however, that the total review by said head of the fire department shall not exceed thirty (30) calendar days. If such approval, disapproval or request for an extension of time shall not be received by the building official within said ten (10) working days, the building official may deem the plans and specifications to be in full compliance with the applicable sections of Article 4 and Article 12 and, therefore, approved by the head of the fire department.

All plans filed with the building official shall include but not be limited to:

1. the accurate locations and dimension of all means of egress from fire and an occupancy schedule of persons for all occupiable spaces;
2. the method and amount of ventilation and sanitation;
3. the methods of firestopping as required in this code; and
4. schedules and details indicating compliance of interior trim and finish with provisions of Article 9.

113.5.1 Structures subject to control: In those structures subject to control as required in Section 127.0, affidavits must be submitted with the permit application that the individuals and testing laboratories responsible for carrying out the duties specified in Section 127.0 have been licensed by the Commission.

113.5.2 Architects' and engineers' seals: Unless otherwise provided in this code, all plans and specifications for buildings and structures containing more than thirty-five thousand (35,000) cubic feet of enclosed space shall bear the Massachusetts seal of registration of a qualified registered professional engineer or architect.

Plans and specifications, plats and records whenever required to be stamped with the seal of a registered professional engineer or architect shall be signed by the registrant named thereon. The use of a facsimile signature stamp shall not be deemed to comply with this section.

113.6 Site plan: There shall also be filed prior to a permit being granted for the excavation or for the erection of any building or structure a site plan showing to scale the size and location of all new construction and all existing structures on the site, distances from lot lines, the established street grades if they exist (verified by the town or city) and proposed finished grades. In the case of demolition, the site plan shall show all construction to be demolished and the location and size of all existing structures and construction that are to remain on the site or plot. The site plan shall not be changed except as specified in Sections 113.8 and 115.3.

113.7 Engineering details: The building official may require adequate details of structural, mechanical and electrical work, including computations, stress diagrams and other essential technical data, prepared by a registered professional engineer qualified by experience in the specific field of construction, to be filed. All such plans and computations shall bear the Massachusetts seal of registration and signature of the qualified registered professional engineer or architect.



113.8 Amendments to application: Subject to the limitations of Section 113.9, amendments or revisions to a plan or other records accompanying the same may not be made until the proposed changes have been filed with and approved by the building official; and such approved amendments shall be deemed part of the original application and shall be filed therewith.

113.9 Time limitation of application: An application for a permit for any proposed work shall be deemed to have been abandoned six (6) months after date of filing, unless such application has been diligently prosecuted or a permit has been issued; except that for reasonable cause the building official may grant one or more extensions of time for additional periods not exceeding ninety (90) days each.

#### SECTION 114.0 PERMITS

114.1 Action on application: The building commissioner or inspector of buildings shall examine or cause to be examined all applications for permits and amendments thereto within thirty (30) days after filing. If the application or the plans do not conform to the requirements of Section 113.0 or other related sections of this code or of all pertinent laws, he shall reject such application in writing citing the specific sections of this code or pertinent law. If he is satisfied that the proposed work conforms to the requirements of this code and all pertinent law applicable thereto, he shall issue a permit.

114.2 Report to assessors: The building official shall give to the assessors of the municipality written notice of the granting by him of permits for the construction of any buildings or structures, or for the removal or demolition, or for any substantial alteration or addition thereto. Such notice shall be given within seven (7) days after the granting of each permit, and shall state the name of the person to whom the permit was granted and the location of the building or structure to be constructed, reconstructed, altered, demolished or removed.

114.3 Expiration of permit: Any permit issued shall be deemed abandoned and invalid unless the work authorized by it shall have been commenced within six (6) months after its issuance; however, for cause, one or more extensions of time, for periods not exceeding six (6) months each, may be granted in writing by the building commissioner or inspector of buildings. Work under such a permit in the opinion of the building commissioner or inspector of buildings, must proceed in good faith continuously to completion so far as is reasonably practicable under the circumstances.

For purposes of this section, any permit issued shall not be considered invalid if such abandonment or suspension of work is

due to a court order prohibiting such work as authorized by such permit; provided, however, in the opinion of the building commissioner or inspector of buildings, the person so prohibited by such court order, adequately defends such action before the court.

114.4 Previous approvals: Nothing in this code or the rules and regulations pursuant thereto shall affect any building permit lawfully issued, or any building or structure lawfully begun in conformance with such permit, before the effective date of this code or any amendments thereto.

114.5 Signature to permit: The building commissioner or inspector of buildings shall attach his signature to every permit, or he may authorize a subordinate to affix such signature thereto.

114.6 Approved plans: If approved by him, the building commissioner or inspector of buildings or his authorized subordinate shall stamp and endorse in writing the plans submitted in accordance with Section 113.5; one (1) set of such stamped and endorsed plans shall be retained; the other set of plans shall be kept at the building site, open to the inspection of the building commissioner, inspector of buildings, or his authorized subordinate, at all reasonable times.

114.7 Revocation of permits: The building commissioner or inspector of buildings may revoke a permit or approval issued under the provisions of this code in case of any false statement or misrepresentation of fact in the application or the plans on which the permit or approval was based.

114.8 Approval in part: When application for a permit to erect or add to a building or structure has been filed, as required in Section 113.5 and pending issuance of such permit, the building commissioner or inspector of buildings may, at his discretion, issue a special permit for the foundations or any other part of a building or structure. The holder of such a special permit may proceed at his own risk without assurance that a permit for the entire structure will be granted.

114.9 Posting of permit: A copy of the building permit provided by the building department shall be kept in view and protected from the weather on the site of operation during the entire time the work is under execution and until the certificate of use and occupancy shall have been issued. The building permit shall serve as an inspection record card to allow the building official conveniently to make entries thereon regarding inspection of the work.

114.10 Notice of start: At least twenty-four (24) hours' notice of start of work under a building permit shall be given to the building official.

SECTION 115.0 CONDITIONS OF PERMIT

115.1 Compliance with code: The permit shall be a license to proceed with the work and shall not be construed as authority to violate, cancel or set aside any of the provisions of this code, except as specifically stipulated by modification or legally granted variation in accordance with Section 126.0.

115.2 Compliance with permit: All work shall conform to the stamped or endorsed application and plans for which the permit has been issued and any approved amendments thereto.

115.3 Change in site plan: A lot or site shall not be changed, increased or diminished in area from that shown on the official site plan, as specified in Section 113.6, unless a revised plan showing such changes accompanied by the necessary affidavit of owner or applicant shall have been filed and approved.

Exception: A revised site plan will not be required if the change is caused by reason of an official street opening, street widening or other public improvement.

SECTION 116.0 DEMOLITION OF STRUCTURES

116.1 Service connections: Before a building or structure can be demolished or removed, the owner or agent shall notify all utilities having service connections within the building or structure, such as; water, electric, gas, sewer and other connections. A permit to demolish or remove a building or structure shall not be issued until a release is obtained from the utilities, stating that their respective service connections and appurtenant equipment, such as; meters and regulators have been removed or sealed and plugged in a safe manner.

116.2 Lot regulation: When a building or structure has been demolished or removed and a building operation has not been projected or approved, the vacant lot shall be filled with non-organic fill, graded and maintained in conformity with adjacent grades. The lot shall be maintained free from the accumulation of rubbish and all other unsafe or hazardous conditions which endanger the life or health of the public; provisions shall be made to prevent the accumulation of water or damage to any foundations on the premises or the adjoining property; and the necessary retaining walls and fences shall be erected in accordance with the provisions of Article 13.

SECTION 117.0 MOVED STRUCTURES

117.1 General: Buildings and structures moved into or within the jurisdiction shall comply with the provisions of this code.

SECTION 118.0 FEES

118.1 General: A permit shall not be issued to begin work for new construction, alteration, removal, demolition or other building operation until the fees prescribed by municipal ordinance or by-law shall have been paid to the city or town collector or other municipal agency authorized to collect such fees.

118.2 Special fees: The payment of the fee for the construction, alteration, removal or demolition and for all work done in connection with or concurrently with the work contemplated by a building permit shall not relieve the applicant or holder of the permit from the payment of other fees that may be prescribed by law or ordinance for water taps, sewer connections, electrical and plumbing permits, erection of signs and display structures, marquees or other appurtenant structures, or fees for inspections, certificates of use and occupancy or other privileges or requirements, both within and without the jurisdiction of the building department.

SECTION 119.0 CERTIFICATE OF USE AND OCCUPANCY

119.1 New buildings and structures: A building or structure hereafter shall not be used or occupied in whole or in part until the certificate of use and occupancy shall have been issued by the building commissioner or inspector of buildings or, when applicable, the state inspector. The certificate shall not be issued until all the work has been completed in accordance with the provisions of the approved permits and of the applicable codes for which a permit is required, except as provided in Section 119.4.

119.2 Buildings or structures hereafter altered: A building or structure, in whole or in part, altered to change from one use group to another; to a different use within the same use group; the fire-grading; the maximum live load capacity; the occupancy load capacity; or a building or structure hereafter altered for which a certificate of use and occupancy has not been heretofore issued, shall not be occupied or used until the certificate shall have been issued certifying that the work has been completed in accordance with the provisions of the approved permits and of the applicable codes for which a permit is required. Any use or occupancy, which was not discontinued during the work of alteration, shall be discontinued within thirty (30) days after the completion of the alteration unless the required certificate is issued.

119.3 Existing buildings or structures: If a certificate of use and occupancy has not been issued, upon written request from the owner of an existing building or structure, a certificate of use and occupancy shall be issued, provided there are no violations of law or orders of the building official pending, and

it is established after inspection and investigation that the alleged use of the building or structure has heretofore existed. Nothing in this code shall require the removal, alteration or abandonment of, or prevent the continuance of the use and occupancy of a lawfully existing building or structure, unless such use is deemed to endanger public safety and welfare.

119.4 Temporary occupancy: Upon the request of the holder of a permit, a temporary certificate of occupancy for a building or structure or part thereof may be issued before the entire work covered by the permit shall have been completed, provided such portion or portions may be occupied safely prior to full completion of the building or structure without endangering life or public welfare, and provided that the agencies having jurisdiction for permits issued under other applicable codes are notified of the decision to issue a temporary certificate.

119.5 Contents of certificate: The certificate shall certify compliance with the provisions of this code and the purpose for which the building or structure may be used in its several parts; and shall be issued within ten (10) days after final inspection, provided that the provisions of the approved permits and of the applicable codes for which permits are required have been met. The certificate of use and occupancy shall specify: the use group in accordance with the provisions of Article 2, the fire grading as defined in Article 2 and Table 902, the maximum live load on all floors as prescribed in Article 7, the occupancy load in the building and all parts thereof as defined in Article 2 and Article 6, and any special stipulations and conditions of the building permit.

## SECTION 120.0 POSTING STRUCTURES

120.1 Posted use and occupancy: A suitably designed placard approved by the building official shall be posted by the owner on all floors of every building and structure and part thereof designed for high hazard, storage, mercantile, factory and industrial or business use (use groups H, S, M, F and B) as defined in Article 2. Said placard shall be securely fastened to the building or structure in a readily visible place, stating: the use group, the fire grading, the live load and the occupancy load.

120.2 Posted occupancy load: A suitably designed placard approved by the building official shall be posted by the owner in every room where practicable of every building and structure and part thereof designed for use as a place of public assembly or as an institutional building for harboring people for penal, correctional, educational, medical or other care or treatment, or as residential buildings used for hotels, lodging houses, boarding houses, dormitory buildings, multiple-family dwellings (use

groups A, I, R-1 and R-2). Said placard shall designate the maximum occupancy load.

120.3 Replacement of posted signs: All posting signs shall be furnished by the owner and shall be of permanent design; they shall not be removed or defaced, and if lost, removed or defaced, shall be immediately replaced.

120.4 Periodic inspection for posting: The building official may periodically inspect all existing buildings and structures except one and two-family dwellings for compliance with this code in respect to posting; or he may accept the report of such inspections from a qualified registered engineer or architect or others certified by the Commission; and such inspections and reports shall specify any violation of the requirements of this code in respect to the posting of floor load, fire grading, occupancy load and use group of the building or structure.

#### SECTION 121.0 VIOLATIONS

121.1 Unlawful acts: It shall be unlawful for any person, firm or corporation to erect, construct, alter, reconstruct, repair, remove, demolish, use or occupy any building or structure or equipment regulated by this code, or cause same to be done, contrary to or in conflict with or in violation of any of the provisions of this code.

121.2 Notice of violation: The building official shall serve a notice of violation or order on the person responsible for the erection, construction, alteration, reconstruction, repair, removal, demolition, use or occupancy of a building or structure in violation of the provisions of this code, or in violation of a detail statement or a plan approved thereunder, or in violation of a permit or certificate issued under the provisions of this code; and such order shall direct the discontinuance of the illegal action or condition and the abatement of the violation.

121.2.1 Notice or orders, service and content: Every notice or order authorized by this code shall be in writing and shall be served on the person responsible:

1. personally, by any person authorized by the building official; or
2. by any person authorized to serve civil process by leaving a copy of the order or notice at his last and usual place of abode; or
3. by sending him a copy of the order by registered or certified mail return receipt requested, if he is within the Commonwealth; or

4. if his last and usual place of abode is unknown, by posting a copy of this order or notice in a conspicuous place on or about the premises in violation and by publishing it for at least three (3) out of five (5) consecutive days in one (1) or more newspapers of general circulation wherein the building or premises affected is situated.

121.3 Prosecution of violation: If the notice of violation is not complied with within the time period specified in the notice, unless otherwise provided in this code, the building official may institute the appropriate proceedings at law or in equity in a court of competent jurisdiction to restrain, correct or abate such violation or to require the removal or termination of the unlawful use of the building or structure in violation of the provisions of this code or of the order or direction made pursuant thereto.

121.4 Violation penalties: Anyone who shall violate a provision of this code shall be punishable by a fine of not more than one thousand dollars (\$1,000) or by imprisonment for not more than one year, or both, for each violation. Each day during which any portion of a violation continues shall constitute a separate offense.

121.5 Abatement of violation: The imposition of the penalties herein prescribed shall not preclude the building official from instituting appropriate action to prevent unlawful construction or to restrain, correct or abate a violation, or to prevent illegal occupancy of a building, structure or premises or to stop an illegal act, conduct, business or use of a building or structure in or about any premises.

## SECTION 122.0 STOP-WORK ORDER

122.1 Notice to owner: Upon notice from the building official that any work is being prosecuted contrary to the provisions of this code or in an unsafe or dangerous manner, such work shall be immediately stopped. The stop-work order shall be in writing and shall be served on the owner or on the person doing the work, and shall state the conditions under which work may be resumed; provided, however, that in instances where immediate action is deemed necessary for public safety or in the public interest, the building official may require that work be stopped upon verbal order, provided that said verbal order be confirmed in writing within forty-eight (48) hours.

122.1.1 Posting: A stop-work notice shall be posted in a conspicuous place on the job site and can only be removed by the building official.

122.2 Unlawful continuance: Anyone who shall continue any work in or about the job site after having been served with a

stop-work order, except such work as he is directed by the building official to perform to remove a violation of unsafe conditions, shall be liable to prosecution as provided in Section 121.0.

#### SECTION 123.0 UNSAFE STRUCTURES

123.1 Inspection: The building official immediately upon being informed by report or otherwise that a building or other structure or anything attached thereto or connected therewith is dangerous to life or limb or that any building in that city or town is unused, uninhabited or abandoned, and open to the weather, shall inspect the same; and he shall forthwith in writing notify the owner to remove it or make it safe if it appears to him to be dangerous, or to make it secure if it is unused, uninhabited or abandoned and open to the weather. If it appears that such structure would be especially unsafe in case of fire, it shall be deemed dangerous within the meaning hereof, and the building official may affix in a conspicuous place upon its exterior walls a notice of its dangerous condition, which shall not be removed or defaced without authority from him.

123.2 Removal or making structure safe: Any person so notified shall be allowed until twelve o'clock noon of the day following the service of the notice in which to begin to remove such building or structure or make it safe, or to make it secure, and he shall employ sufficient labor speedily to make it safe or remove it or to make it secure; but if the public safety so requires and if the mayor or selectmen so order, the building official may immediately enter upon the premises with the necessary workmen and assistants and cause such unsafe structure to be made safe or demolished without delay and a proper fence put up for the protection of Passersby, or to be made secure.

#### SECTION 124.0 EMERGENCY MEASURES

124.1 Failure to remove or make structure safe, survey board, survey report: If an owner of such unsafe structure refuses or neglects to comply with the requirements of such notice within the specified time limit, and such structure is not made safe or taken down as ordered therein, a careful survey of the premises shall be made by a board consisting; in a city, of a city engineer, the head of the fire department, as such term is defined in Section 1 of Chapter 148 of the Massachusetts General Laws Annotated, as amended, and one disinterested person to be appointed by the building official; and, in a town, of a surveyor, the head of the fire department and one disinterested person to be appointed by the building official. In the absence of any of the above officers or individuals, the mayor or selectmen shall designate one or more officers or other suitable



persons in place of the officers so named as members of said board. A written report of such survey shall be made, and a copy thereof served on such owner.

124.2 Removal of dangerous or abandoned structures: If such survey report as outlined in Section 124.1 declares such structure to be dangerous or to be unused, uninhabited or abandoned, and open to the weather, and if the owner continues such refusal or neglect, the building official shall cause it to be made safe or taken down or to be made secure; and, if the public safety so requires, said building official may at once enter the structure, the land on which it stands or the abutting land or buildings, with such assistance as he may require, and secure the same; and may remove and evict, under the pertinent provisions of Chapter 239 of the Massachusetts General Laws Annotated as amended, or otherwise, any tenant or occupant thereof; and may erect such protection for the public by proper fence or otherwise as may be necessary, and for this purpose may close a public highway. In the case of such demolition, the said building official shall cause such lot to be levelled to conform with adjacent grades by a non-organic fill. The costs and charges incurred shall constitute a lien upon the land upon which the structure is located, and shall be enforced in an action of contract; and such owner shall, for every day's continuance of such refusal or neglect after being so notified, be punished by a fine in accordance with Section 121.4. The provisions of the second paragraph of Section 3A of Chapter 139 of the Massachusetts General Laws Annotated as amended, relative to liens for such debt and the collection of claims for such debt shall apply to any debt referred to in this section, except that the said building official shall act hereunder in place of the mayor or board of selectmen. During the time such order is in effect, it shall be unlawful to use or occupy such structure or any portion thereof for any purpose.

124.3 Remedy of person ordered to remove a dangerous structure or make it safe: An owner, aggrieved by such order may have the remedy prescribed by Section 2 of Chapter 139 of the Massachusetts General Laws Annotated as amended; provided that any provision of said Section 2 shall not be construed so as to hinder, delay or prevent the building official from acting and proceeding under Section 124.2; and provided, further, that this section shall not prevent the city or town from recovering the forfeiture provided in said Section 124.2 from the date of the service of the original notice, unless the order is annulled by the jury.

125.0 RESERVED

SECTION 126.0 BOARD OF APPEALS

126.1 State Building Code Appeals Board: Whoever is aggrieved by an interpretation, order, requirement, direction or failure to act under this code by any agency or official of the city, town or region, or agency or official of the State charged with the administration or enforcement of this code or any of its rules or regulations, excepting any specialized codes, may appeal directly to the State Building Code Appeals Board as provided in Section 126.0.

Whoever is aggrieved by an interpretation, order, requirement, direction or failure to act under this code by any agency or official of a city, town or region charged with the administration or enforcement of this code or any of its rules and regulations, excepting any specialized codes, may appeal directly to the State Building Code Appeals Board or may appeal first to a local or regional appeals board and if aggrieved thereby he may then appeal to the State Building Code Appeals Board as provided in Section 126.0.

In the event an appeal is taken directly to the State Building Code Appeals Board from an interpretation, order, requirement or direction, said appeal shall be filed as specified in Section 126.3.1 with the State Building Code Appeals Board not later than forty-five (45) days after the service of notice thereof of the interpretation, order, requirement or direction.

In the event the appeal is taken directly to the State Building Code Appeals Board for the failure to act, the appeal shall be taken not later than forty-five (45) days after a request to act has been made by the aggrieved person in writing and served upon the appropriate building official or chief administrative officer of the state or local agency which fails to act.

If the aggrieved person elects to appeal before the local or regional board, he shall not be allowed to enter such appeal with the State Building Code Appeals Board until such time as the said local or regional board renders a decision, unless the reason for appeal to the State Building Code Appeals Board is the failure of the local or regional board to act.

126.2 Membership

126.2.1 Three member panel: The State Building Code Appeals Board (hereinafter referred to in Section 126.0 as the Board) shall consist of the membership of the State Building Code Commission. The chairman of the Commission shall be Chairman of the Board. The chairman of the Board may designate any three (3) members of the Board to act as a three (3) member panel to hold any public hearing under Section 126.0 and to hear testimony and take evidence. The chairman of the Board

shall select one (1) of the three (3) members to act as chairman of the said three (3) member panel. If a three (3) member panel is so designated, the three (3) member panel shall act as the Appeals Board and render a decision as provided in Section 126.0.

126.2.2 Clerk: The executive director of the Commission shall designate one (1) of the staff of the Commission to act as clerk to the Board. The clerk shall keep a detailed record of all decisions and appeals and a docket book on file showing the name of each appeal properly indexed and the disposition of the appeal. Said docket book shall be open to public inspection at all times during normal business hours.

126.2.3 Quorum: A majority of the Board shall constitute a quorum if the appeal is heard by the entire Board.

126.3 Appeals procedure for State Building Code Appeals Board

126.3.1 Entry: Appeals shall be entered on forms provided by the Commission and shall be accompanied by an entry fee of one hundred (\$100) dollars or such other amounts as may be determined by the Commission from time to time.

The appeal shall be signed by the appellant or his attorney or agent and shall note the name and address of the person or agency in whose behalf the appeal is taken and the name of the person and address wherein service of notice for the appellant is to be made. The appeal shall also state in detail the interpretation, order, requirement, direction or failure to act which are the grounds of the appeals as well as the particular section or sections of this code which are involved in the appeal and the reasons for the appellant advances supporting the appeal.

A copy of the appeal shall be served in accordance with Section 121.2.1 by the appellant on the person or state, regional or local agency from whose action or inaction the appeal is taken, on or before entry of the appeal. An affidavit, under oath, that such copy has been served shall be filed with the Board forthwith by the appellant.

126.3.2 Stay of Proceedings: Entry of an appeal shall stay all proceedings in furtherance of the action or failure to act appealed from, unless the state, regional or local agency or any person charged with the administration or enforcement of this code or any of its rules or regulations presents evidence and the Board or a three (3) member panel or a single member of the Board, appointed by the chairman for said purpose, finds that upon the evidence presented a stay would involve imminent peril to life or property. In such an event, stay of all proceedings shall be waived or the Board or three (3) member

panel or single member may order such other action necessary to preserve public safety.

Before waiving the stay or proceedings, the Board or three (3) member panel or single member of the Board, appointed by the chairman for said purpose, shall hold a hearing and give the appellant and state, regional or local agency or any person claiming that a stay would involve imminent peril to life or property, notice in writing of the hearing not less than twenty-four (24) hours before said hearing.

126.3.3 Documents: Upon entry, the clerk shall request in writing from the state, city, regional or town officer in charge of the matter on appeal, a copy of the record and all other papers and documents relative to the appeal to be transmitted forthwith to the Board. Said state, city, regional or town officer shall upon receipt of the request of the Board transmit forthwith all the papers and documents and a copy of the record relating to the matter on appeal.

126.3.4 Hearings: The chairman of the Board shall fix a convenient time and place for a public hearing. Said hearings shall be held not later than thirty (30) days after the entry of such appeal, unless such time is extended by agreement with the appellant. Any such party may appear in person or by agent or attorney at such hearing. The chairman or clerk shall give notice of the time and place of said hearing to all parties to the hearing and to anyone else requesting notice in writing at least ten (10) days prior thereto. Failure to hold a public hearing within thirty (30) days shall not affect the validity of the appeal or any decision rendered. The Board or three (3) member panel in its hearings conducted under this section shall not be bound by strict rules of evidence prevailing in courts of law or equity.

#### 126.4 Decisions

126.4.1 Votes required: If the appeal is conducted by a three (3) member panel, then the concurrence of two (2) of the three (3) members holding the public hearing shall be required. If the appeal is conducted by the entire Board, then a majority vote of those hearing the case shall be required.

126.4.2 Standard: The Board or a three (3) member panel may vary the application of any provision of this code to any particular case when in the opinion of the Board or a three (3) member panel, the enforcement of this code would do manifest injustice, provided that the Board or threemember panel finds that the decision to grant a variance shall not conflict with the general objectives set forth in Section 18 of Chapter 23B of the General Laws of the Commonwealth or with the general objectives of this code.

126.4.3 Time for decision: The Board shall within thirty (30) days after such hearing, unless such time is extended by agreement of the parties, issue a decision or order reversing, affirming or modifying in whole or in part the order, interpretation, requirement, direction or failure to act which is the subject matter of the appeal.

Failure to render a decision within thirty (30) days shall not affect the validity of any such decision or appeal.

Notice of and a copy of the decision shall be sent by the clerk to all parties to the appeal and anyone requesting in writing a copy of the decision.

126.4.4 Contents of decision: All decisions shall be in writing and state findings of fact, conclusions and reasons for decisions. Every decision shall indicate thereon the vote of each member and shall be signed by each member voting. A decision shall not be considered by any person or agency as a precedent for future decisions.

126.4.5 Additional powers: The Board or a three (3) member panel may impose in any decision, limitations both as to time and use, and a continuation of any use permitted may be conditioned upon compliance with future amendments to this code.

126.5 Enforcement: Upon receipt of the decision of the Board or a three (3) member panel, the parties to the appeal shall take action forthwith to comply with the decision unless a later time is specified in the decision.

126.6 Appeals from State Building Code Appeals Board: Any person aggrieved by a decision of the State Building Code Appeals Board may appeal to a court of law or equity in conformance with Chapter 30A, Section 14 of the General Laws.

126.7 Local and regional board of appeals

126.7.1 Local or regional board of appeals: Whoever is aggrieved by an interpretation, order, requirement, direction or failure to act under this code by any agency or official of a city, region or town charged with the administration or enforcement of this code or any of its rules and regulations may appeal first to the appeals board in that city, region or town and then to the State Building Code Appeals Board as provided in Section 126.0.

In the event an appeal is taken from an interpretation, order, requirement or direction, said appeal shall be filed with the local or regional appeals board not later than forty-five (45) days after the service of notice thereof of the interpretation, order, requirement or direction.

In the event the appeal is taken for the failure to act, the appeal shall be taken not later than forty-five (45) days after a request to act has been made by the aggrieved person in writing and served to the appropriate building official or chief administrative officer of the city, regional or town agency which fails to act.

126.7.2 Membership: Any building code board of appeals duly established by ordinance or by-law or otherwise in a city, region or town and in existence on January 1, 1975, shall qualify as a local board of appeals under Section 126.0 notwithstanding anything to the contrary contained herein. However, the procedure and rights for appeals for such board of appeals shall be governed by this code.

If a city, region or town had not duly established by ordinance or by-law or otherwise a local or regional building code appeals board prior to January 1, 1975, said city, region or town may establish a local or regional board of appeals, hereinafter referred to as the local board of appeals, consisting of five (5) members appointed by the chief administrative officer of the city, region or town: one (1) member appointed for five (5) years, one (1) for four (4) years, one for three (3) years, one for two (2) years and one to serve for one (1) year; and thereafter each new member to serve for five (5) years or until his successor has been appointed.

126.7.3 Qualifications of local board members: Each member of a local board of appeals established under Section 126.7.2 shall have had at least five (5) years experience in the construction, alteration, repair and maintenance of building and building codes. At least one (1) member shall be a registered structural or civil professional engineer and one (1) member a licensed professional architect.

126.7.4 Chairman of local or regional board: The board shall select one (1) of its members to serve as chairman and a detailed record of all proceedings shall be kept on file in the building department.

126.7.5 Absence of members: During the absence of a member of a local board of appeals for reason of disability or disqualification, the chief administrative officer of the city, region or town shall designate a substitute who shall meet the qualifications as outlined in Section 126.7.3.

126.7.6 Quorum: A quorum shall be three (3) members.

126.7.7 Procedures: Entry of appeals shall be governed by Section 126.3.1 excepting that a city, region or town may set its own entry fee.

Upon notice of entry of appeal the local building commissioner or inspector of buildings shall transmit a copy of the record and all the papers and documents to the local board of appeals.

Entry of an appeal shall stay all proceedings in furtherance of the action or failure to act appealed from, unless the building commissioner or inspector of buildings certifies in writing to the local board of appeals that a stay would involve imminent peril to life or property. Notice in writing of such certification by the building commissioner or inspector of buildings shall be given the appellant at least twenty-four (24) hours prior to the hearing. In such an event a hearing on such stay shall be given first priority and be the first matter heard by the local board of appeals at its next scheduled meeting. The hearing on the appeal shall be held as soon as possible thereafter in accordance with Section 126.7.8.

The local board of appeals may establish its own rules for procedure not established herein or not inconsistent with this code or the enabling legislation creating a statewide building code.

126.7.8 Hearings: All hearings shall be public and notice of said hearings shall be advertised in a newspaper of general circulation in the city, region or town in which the appeal is taken at least ten (10) days before said hearing. Notice of the hearing, setting forth the date and time of said hearing, shall be mailed by the local board of appeals to all parties and all those who requested notice in writing at least fourteen (14) days before said hearing. Said hearings shall be held not later than thirty (30) days after the entry of such appeal, unless such time is extended by agreement with the appellant. This section as it pertains to notice shall not apply to hearings on a stay as provided in Section 126.7.7.

126.7.9 Decisions of local boards: A concurring vote of a majority of all the members present shall be required for any decision. The local appeals board may vary the application of this code to any particular case when in its opinion the enforcement of this code would do manifest injustice; provided that the decision of the board shall not conflict with the general objectives of the state building code or any of its enabling legislation. The local board of appeals may impose in any decision, limitations both as to time and use, and a continuation of any use permitted may be conditioned upon compliance with future amendments to this code.

126.7.10 Time for decision: The board shall within thirty (30) days after such hearing, unless such time is extended by agreement of the parties, issue a decision or order reversing,

affirming or modifying in whole or in part the order, interpretation, requirement, direction or failure to act which is the subject matter of the appeal.

Failure to render a decision within thirty (30) days shall not affect the validity of any such decision or appeal.

Notice of and a copy of the decision shall be sent by the clerk to all parties to the appeal and to anyone requesting in writing a copy of the decision.

126.7.11 Contents of decision: All decisions shall be in writing and state findings of fact, conclusions and reasons for the decisions. Every decision shall indicate thereon the vote of each member and shall be signed by each member voting. Any decision shall not be considered by any person or agency as a precedent for future decisions.

126.7.12 Copy of decision: A copy of any decision by a local board of appeals shall be transmitted to the State Building Code Appeals Board within ten (10) days after the rendering of such decision. If the State Building Code Appeals Board disapproves of the said decision of the local board, it may on its own motion appeal from the local appeals board's decision according to Section 126.0 and call for a hearing de novo.

If the State Building Code Appeals Board does not notify the local board in writing within forty-five (45) days from the date of the local board's decision, the said decision shall be deemed approved; provided that the decision shall not conflict with the general objectives of the state building code and any of its enabling legislation.

126.7.13 Enforcement of decision: If said decision is approved by the State Building Code Appeals Board, all parties to the appeal shall take immediate action in accordance with the decision of the local board unless the person aggrieved by such decision appeals to the State Building Code Appeals Board as provided in Section 126.0.

126.7.14 Review: Any person, including the State Building Code Appeals Board, aggrieved by a decision of the local board of appeals, whether or not a previous party to the decision, or any municipal officer or official board of the municipality, may, not later than forty-five (45) days after the mailing of the decision of the local board, apply to the State Building Code Appeals Board for a hearing de novo before the State Board, in accordance with the regulations contained in Section 126.0.



SECTION 127.0 CONSTRUCTION CONTROL

127.1 Responsibilities: The provisions of this section define the construction controls required for all structures needing registered professional architectural or engineering services, and delineate the responsibilities of such professional services together with those services that are the responsibility of the contractor during construction.

Exceptions:

1. Any building containing less than thirty-five thousand (35,000) cubic feet of enclosed space;
2. Any single or two-family house or any accessory building thereto;
3. Any building used for farm purposes; and
4. Retaining walls less than ten (10) feet in height at all points along the wall as measured from the base of the footing to the top of the wall.

127.2 Professional architecture or engineering services.

127.2.1 Design: All plans, computations and specifications involving new construction, alterations, repairs, expansions or additions shall be prepared by or under the direct supervision of a registered professional architect or engineer and bear his signature and seal; said signature and seal shall signify that the plans, computations and specifications meet the applicable provisions of this code, all acceptable engineering practices and all applicable laws and ordinances.

127.2.2 Architect/engineer inspectional responsibility: The registered professional architect or engineer shall be responsible for the following:

1. Review of shop drawings, samples and other submittals of the contractor as required by the construction contract documents as submitted for building permit, and approval for conformance to the design concept.
2. Review and approval of the quality control procedures for all code-required controlled materials.
3. Special architectural or engineering professional inspection of critical construction components requiring controlled materials or construction specified in the accepted engineering practice standards listed in Appendix B.

The registered professional architect or engineer shall perform the necessary professional services and be present on the construction site on a regular and periodic basis to determine that, generally, the work is proceeding in accordance with the documents approved for the building permit.

127.2.3 Reporting: The registered professional architect or engineer shall submit periodically, in a form acceptable to the building official, a progress report together with pertinent comments. At the completion of the construction, the registered professional architect or engineer shall submit to the building official a report as to the satisfactory completion and the readiness of the project for occupancy (excepting any items not endangering such occupancy and listing pertinent deviations from the approved building permit documents).

127.3 Construction contractor services: The actual construction of the work shall be the responsibility of the general contractor as identified on the approved building permit and shall involve the following:

1. Execution of all work in accordance with the approved construction documents.
2. Execution and control of all methods of construction in a safe and satisfactory manner in accordance with all applicable local, state, and federal statutes and regulations.
3. Upon completion of the construction, he shall certify to the best of his knowledge and belief that such has been done in substantial accord with items 1 and 2 above and with all pertinent deviations specifically noted.

127.4 Special professional services: When applications for unusual designs or magnitude of construction are filed, or where code reference standards and/or Appendix B require special architectural or engineering inspections, the building official may require full-time project representation by the registered professional architect or engineer in addition to that provided in Section 127.2.2. The project representative shall keep daily records and submit reports as may be required by the building official. Upon completion of the work, the registered professional architect or engineer shall file a final report as required under Section 127.2.3.

127.4.1 Building permit requirement: This special professional service requirement shall be determined prior to the issuance of the building permit and shall be a requisite for the permit issuance. Refusal by the applicant to provide such service as required by the building official shall result in the denial of the permit. However, the applicant may file an appeal as provided in Section 126.0.

127.4.2 Fee and costs: All fees and costs related to the performance of special professional services shall be borne by the applicant.

127.5 Building official responsibility: Nothing contained in this section shall have the effect of waiving or limiting the building official's authority to enforce this code with respect to examination of the contract documents, including plans, computations and specifications, and field inspections (see Section 108.0).

## SECTION 128.0 CONSTRUCTION MATERIALS SAFETY BOARD

128.1 Membership: There shall be a board under the control of the Commission called the Construction Materials Safety Board, hereafter in Section 128.0 called the Board which shall consist of nine (9) members, one (1) of whom shall be a member of the Commission who shall be ex officio and a voting member of the Board and eight (8) members to be appointed by the chairman of the Commission: one of whom shall be a registered professional engineer who is a structural engineer; one of whom shall be a registered architect; one of whom shall be a representative of a commercial testing laboratory; one of whom shall be a representative of a public testing laboratory; two of whom shall be representatives from the construction industry; one of whom shall be a member of a university faculty engaged in research and teaching in structural materials; and one of whom shall be a member of a university faculty engaged in research and teaching in the area of theoretical and applied mechanics.

128.2 Duties: The Board will review applications for registration or licensing of individuals, laboratories or firms responsible for the inspection, control and testing of construction materials, and review applications and pertinent data relevant to all materials, devices, products and methods of construction not included in this code; and report to the Commission their recommendations. The Board will collect information and review cases where disciplinary action against an existing license, whether an individual, laboratory or firm, has been proposed; and make recommendations to the Commission. The Commission will issue applications, receive payment for the review of such applications and approvals, registration and licensing fees, and maintain records for the efficient dispatch of the duties of the Board.

128.3 Testing and evaluation groups: The Commission shall establish and maintain testing and evaluation groups who will have the responsibility of administering and directing, under the supervision of the Commission, the testing and controls for evaluating individual applicants, laboratories and firms wishing to become registered or licensed.

SECTION 129.0 ACTIVITIES REQUIRING LICENSES

129.1 Concrete

129.1.1 Field technicians: A person shall not engage in the activities of field testing of concrete for use in structures subject to construction control (Section 127.0) and/or controlled materials (Section 719.0) unless such person is licensed by the Commission in accordance with the Rules and Regulations for Concrete Testing Personnel as referenced in Appendix Q.

129.1.2 Testing laboratories: A testing laboratory, branch laboratory and/or project laboratory shall not test concrete and/or concrete materials for use in structures subject to construction control (Section 127.0) and/or controlled materials (Section 719.0) unless licensed by the Commission in accordance with this code and the Rules and Regulations for Licensing of Concrete Testing Laboratories as referenced in Appendix Q.

129.2 Native lumber: A person shall not engage in producing of native lumber for use in structures within the Commonwealth of Massachusetts unless registered by the Commission in accordance with this code and the Rules and Regulations Controlling the Use of Native Lumber as referenced in Appendix Q.

129.3 Enforcement: Any person or laboratory who violates the provisions of this section, or any rules and regulations promulgated hereunder, or who falsifies or counterfeits a license or registration issued by the Commission, or who fraudulently issues or accepts such a license shall be punished as provided in Section 121.0.

SECTION 130.0 FIRE PREVENTION - FIRE PROTECTION BOARD

130.1 Constitution of the Fire Prevention - Fire Protection Board: There shall be a Board under the control of the Commission called the Fire Prevention - Fire Protection Board, hereinafter in Section 130.0 called the Board which shall consist of thirteen (13) members, two (2) of whom shall be members of the Commission; one (1) of whom shall be the State Fire Marshal or his designee, all three (3) of whom shall be ex-officio and voting members of the Board, and ten (10) members to be appointed by the chairman of the Commission for a term of one (1) year; three (3) of whom shall be representatives of the Fire Chiefs Association; two (2) of whom shall be representatives of the Massachusetts Fire Prevention Association; one (1) of whom shall be a representative of the International Municipal Signalmen's Association; one (1) of whom shall be a member of the Board of Fire Prevention Regulations; one (1) of whom shall be a Fire Protection Engineer; one (1) of whom shall be a building official and one (1) of whom shall be a registered professional

engineer or architect. A chairman and a vice chairman shall be chosen by the members of the Board to serve for one (1) year. A member of an agency or board of the state shall not be eligible for the office of chairman or vice chairman.

130.2 Purpose: The Board will review and recommend to the Commission changes to this code relating to fire prevention and fire protection and more specifically those matters contained in Article 12 of this code.

131.0 - 139.0 RESERVED

#### SECTION 140.0 VALIDITY

140.1 General: The provisions of this code are severable, and if any of its provisions shall be held unconstitutional or otherwise invalid by any court of competent jurisdiction, the decision of such court shall not affect or impair any of the remaining provisions.

NON-TEXT PAGE

ARTICLE 2

DEFINITIONS AND CLASSIFICATIONS

SECTION 200.0 GENERAL

200.1 Scope: The provisions of this article shall control the classification of all buildings as to use group and type of construction; and the definition of all terms relating thereto in the Commonwealth of Massachusetts.

200.2 Application of terms: The terms herein defined shall be used to interpret all the applicable provisions of this code.

200.3 Application of other laws: Nothing herein contained shall be deemed to nullify any provisions of the zoning by-laws or ordinance of any municipality in the Commonwealth of Massachusetts insofar as those provisions deal exclusively with those powers of regulating zoning granted by the provisions of Chapters 40A and 41 of the Massachusetts General Laws Annotated, as amended.

SECTION 201.0 GENERAL DEFINITIONS

201.1 Meaning: Unless otherwise expressly stated, the following terms shall, for the purpose of this code, have the meaning indicated in this section.

201.2 Tense, gender and number: Words used in the present tense include the future; words used in the masculine gender include the feminine and neuter; the singular number includes the plural and the plural the singular.

201.3 Terms not defined: Where terms are not defined, they shall have their ordinarily accepted meanings or such as the context may imply. Any terms relating to elevators, dumbwaiters and escalators shall have their meaning as defined by 524 CMR 3.00-11.00 and 524 CMR 15.00-33.00. Any terms relating to plumbing, gasfitting and electrical wiring shall have their terms as defined by 248 CMR 2.00, 248 CMR 3.00-8.00 and 527 CMR 12.00 respectively as listed in Appendix B.

Accepted engineering practice: That which conforms to accepted principles, tests or standards of nationally recognized technical or scientific authorities.

Accessory structure: A building or structure, the use of which is incidental to that of the main building or structure and which is located on the same lot.

Accessory use: A use incidental to the principal use of a building as defined or limited by the provisions of the local zoning laws.

Accredited authoritative agencies: See Appendix O.

Addition: An extension or increase in floor area or height of a building or structure.

Air-conditioning: The treatment of air so as to control simultaneously its temperature, humidity, cleanness and distribution to meet the requirements of a conditioned space.

Air duct: A tube or conduit used for conveying air.

Airplane hangar, private: A hangar for the storage of four (4) or less single motor planes and in which volatile or flammable oil is not handled, stored or kept other than that contained in the fuel storage tank of the plane.

Airplane hangar, public: A building for the storage, care or repair of private or commercial airplanes not included in the term "private airplane hangar".

Air supported structure: A structural and mechanical system which is constructed of high strength fabric or film and achieves its shape, stability, and support by pretensioning with internal air pressure; air structures may be used for temporary applications.

Air transport factor: The ratio of the rate of useful sensible heat removal from the conditioned space to the energy input to the supply and return fan motor(s), expressed in consistent units and under the designated operating conditions.

Aisle: A clear and unobstructed passageway through a room.

Alley: A secondary thoroughfare less than thirty (30) feet in width dedicated for the public use of vehicles and pedestrians, affording access to abutting property.

Alteration: A change or modification of a building or structure, or the service equipment thereof, that affects safety or health and that is not classified as an ordinary repair.

Alternate inspector: A person appointed to act in the absence of the inspector of buildings in case of illness, disability, or conflict of interest.

Amusement device: A device or structure open to the public by which persons are conveyed or moved in unusual manner for diversion.

Anchor store: An anchor store is an exterior perimeter department store or major merchandising or magnet center having direct access to a mall and having its required exits independent of the mall.



**Annunciator:** A unit containing two (2) or more identified targets or indicator lamps in each target, or lamp, indicating the circuit, condition or location to be annunciated.

**Apartment:** A "Dwelling unit" as defined in this code.

**Approval:** When used in Article 18 for manufactured buildings or building components, approved by the State Building Code Commission.

**Approved:** Approved by the Commission, the building official or other authority having jurisdiction.

**Approved material, equipment and methods:** Approved by the Commission or by an agency approved by the Commission.

**Approved plastic:** See Section 1900.2.1.

**Approved rules:** Those rules approved by the State Building Code Commission unless otherwise specified.

**Appurtenant structure:** A device or structure attached to the exterior or erected on the roof of a building designed to support service equipment or used in connection therewith, or for advertising or display purposes, or other similar uses.

**Architectural terra cotta:** Plain or ornamental hard-burned plastic clay units, larger in size than brick, with glazed or unglazed ceramic finish.

**Area (building):** The area included within surrounding exterior walls (or exterior walls and fire walls) exclusive of vent shafts and courts. Areas of the building not provided with surrounding walls shall be included in the building area if included within the horizontal projection of the roof or floor above.

**Areaway (form of construction):** An uncovered subsurface space adjacent to a building.

**Ashlar facing:** Facing of solid rectangular units larger in size than brick of burned clay or shale, natural or cast stone, with sawed, dressed and squared beds and mortar joints.

**Ashlar masonry:** Masonry composed of bonded, rectangular units, larger in size than brick, with sawed, dressed or squared beds and mortar joints.

**Atrium:** See "Open well".

**Attic:** The space between the ceiling beams of the top habitable story and the roof rafters.

**Attic (habitable):** A habitable attic is an attic which has a stairway as a means of access and egress and in which the ceiling area at a height of seven and one-third (7 1/3) feet above the attic floor is not less than one-third (1/3) the area of the floor next below.

**Automatic:** As applied to energy conservation, is self-acting, operating by its own mechanism when actuated by some impersonal influence such as a change in electric current, pressure, temperature, or mechanical configuration. (See definition of "Manual.")

**Automatic:** As applied to fire protection devices, is a device or system providing an emergency function without the necessity of a human intervention and activated as a result of a predetermined temperature rise, rate of rise of temperature, or increase in the level of combustion products; such as incorporated in an automatic sprinkler system, automatic fire door, etc.

**Automatic collapsible revolving door:** A door which is designed, supported and constructed so that the wings will release and fold back in the direction of egress under pressure exerted by persons under panic conditions, providing a means of travel on both sides of the door pivot.

**Automatic detecting device:** A device which automatically detects heat, smoke or other products of combustion.

**Automatic fire alarm system:** A system which automatically detects a fire condition and actuates a fire alarm signal device.

**Automatic fire door:** A fire door or other opening protective constructed and arranged so that, if open, it shall close when subjected to:

1. a predetermined temperature;
2. a predetermined rate of temperature rise, or
3. smoke or other products of combustion.

**Automatic sprinkler:** A device, connected to a water supply system, that opens automatically at a predetermined fixed temperature and discharges a spray of water.

**Automatic sprinkler system:** A sprinkler system for fire protection purposes, is an integrated system of underground and/or overhead piping designed in accordance with fire protection engineering standards. The system includes a suitable water supply. The portion of the system above ground is a network of specially or hydraulically designed piping installed in a building, structure, or area, generally overhead, and to which automatic sprinklers are connected in a systematic pattern. The system is usually activated by heat from a fire and discharges water over the fire area.

**Automatic water supply:** Water supplied through a gravity or pressure tank or automatically operated fire pumps, or from a direct connection to an approved municipal water main.

**Auxilliary alarm system:** A connection to the municipal fire alarm system to transmit an alarm of fire to the fire department. Fire alarms from an auxilliary alarm system are received at municipal fire alarm headquarters on the same equipment and by the same alerting methods as alarms transmitted from municipal fire alarm boxes located on streets.

**Base:** The level at which earthquake motions are considered to be imparted to the structure or the level at which the structure as a dynamic vibrator is supported.

**Basement:** That portion of a building which is partly below and partly above grade, and having at least one-half (1/2) its height above grade (see "Grade," "Story" and "Cellar").

**Basic Code:** The State Building Code of the Commonwealth of Massachusetts, also referred to as this code.

**Bay (part of a structure):** The space between two (2) adjacent piers or mullions or between two (2) adjacent lines of columns.

**Bay window:** A window projecting beyond the wall line of the building and extending down to the foundation.

**Billboard (poster panel):** A board panel or tablet used for the display of printed or painted advertising matter.

**Boiler:** A closed heating appliance intended to supply hot water or steam for space heating, processing or power purposes.

**Low pressure and temperature**

**Steam:** Any boiler, generator, pressure vessel, system, piping or steam equipment used for the purpose of heating or distributing steam for heating, power or processing, operating at pressure of fifteen (15) pounds per square inch gauge (psig) or less, shall be classed as low pressure.

**Hot water:** Any boiler, generator, pressure vessel, system, piping or equipment used for the purpose of heating or distributing hot water for heating, supply or processing, operating at pressure not exceeding one hundred sixty (160) psig and temperatures not exceeding two hundred (250) degrees F., shall be classed as low pressure.

**Exception:** Hot water supply boilers equipped with safety devices as required by the mechanical code listed in Appendix B and direct fired are considered outside the scope of this definition when the heat input is less

than two hundred thousand (200,000) Btus per hour, the water temperature is less than two hundred (200) degrees F. and the capacity is less than one hundred twenty (120) gallons.

High pressure and temperature

Steam: Any boiler, generator, pressure vessel, system, piping or equipment used for the purpose of heating or distributing steam for heating, power and processing, operating at pressure in excess of fifteen (15) psig, shall be classed as high pressure.

Hot water: Any boiler, generator, pressure vessel, system, piping or equipment used for the purpose of heating or distributing hot water for heating or processing, operating at pressures in excess of one hundred sixty (160) psig or temperatures in excess of two hundred fifty (250) degrees F., shall be classed as high pressure.

Boiler capacity: The amount of heat output in Btu/h at the design temperature rise and rated input.

Box system: A structural system where the vertical load is carried by bearing walls and structural framing and where the lateral stability and lateral force resisting system consists of shear walls or braced frames.

Braced frame: A vertical truss or its equivalent which is provided to resist lateral forces in which the members are subjected primarily to axial stresses.

Brick (clay or shale): A solid masonry unit of clay or shale, usually formed into a rectangular prism while plastic and burned or fired in a kiln.

Calcium-silicate brick (sand lime brick): A building unit made of sand and lime.

Concrete brick: A solid masonry unit having a shape approximately a rectangular prism and composed of inert aggregate particles embedded in a hardened cementitious matrix.

Hollow brick: A masonry unit of clay or shale whose net cross-sectional area in any plane parallel to the bearing surface is not less than sixty (60) per cent or more than seventy-five (75) per cent of its gross cross-sectional area measured in the same plane.

Building (see also "Structure"): A structure enclosed within exterior walls or firewalls, built, erected and framed of a combination of any materials, whether portable or fixed, having a roof, to form a structure for the shelter of persons, animals or property. For the purpose of this definition, "roof" shall include an awning or any similar covering,

whether or not permanent in nature. The word "building" shall be construed where the context requires as though followed by the words "or part or parts thereof".

**Building commissioner:** The administrative chief of the building department in a municipality who is charged with the administration and enforcement of this code. (See also "Inspector of buildings" and Section 107.1.)

**Building component:** Any subsystem, subassembly, or other system designed for use in or as part of a structure having concealed elements such as electrical, mechanical, plumbing and fire protection systems and other systems affecting health and safety.

**Building department:** The person, body, agency, department or office of any municipality charged with the administration and enforcement of this code.

**Building envelope:** The elements of a building which enclose conditioned spaces through which thermal energy may be transferred to or from the exterior.

**Building, existing:** Any structure erected or one for which a legal building permit has been issued prior to the adoption of this code (and its amendments).

**Building line:** The line established by law, beyond which a building shall not extend, except as specifically provided by law.

**Building official:** The officer or other designated authority charged with the administration and enforcement of this code. Building official as used herein includes the building commissioner or the inspector of buildings and the local inspector.

**Building service equipment:** The mechanical, electrical and elevator equipment, including piping, wiring, fixtures and other accessories, which provide sanitation, lighting, heating, ventilation, firefighting and transportation facilities essential for the habitable occupancy of the building or structure for its designated use and occupancy.

**Building site:** The area occupied by a building or structure, including the yards and courts required for light and ventilation, and such areas that are prescribed for access to the street.

**Building system:** See Article 18.

**Buttress:** A projecting part of a masonry wall built integrally therewith to furnish lateral stability which is supported on proper foundations.

Carbon dioxide extinguishing system (CO<sub>2</sub>): A system to supply CO<sub>2</sub> from a pressurized vessel through fixed pipes and nozzles. The system includes an automatic detection and actuating mechanism.

Cellar: That portion of a building which is partly or completely below grade and having at least one-half (1/2) its height below grade (see "Grade," "Story" and "Basement").

Central station system: A system, or group of systems, the operations of which are signaled to, recorded in, maintained and supervised from an approved central station, in which there are competent and experienced observers and operators in attendance at all times whose duty it shall be, upon receipt of a signal, to take such an action as shall be required under the rules established for their guidance. Such systems shall be controlled and operated by a person, firm, or corporation whose principal business is the furnishing and maintaining of supervised protective signaling service and who does not have interest in the protected properties.

Ceramic surface unit: See "Tile."

Certificate of use and occupancy: The certificate issued by the building official which permits the use of a building in accordance with the approved plans and specifications and which certifies compliance with the provisions of law for the use and occupancy of the building in its several parts, together with any special stipulations or conditions of the building permit.

Certification: Any manufactured building or building component that meets the provisions of Article 18 and the rules and regulations pursuant thereto; and which has been labeled accordingly.

Change of use: An alteration by change of use in a building heretofore existing to a new use group or sub-use group which imposes other special provisions of law governing building construction, equipment or means of egress.

Chimney: A primarily vertical enclosure containing one (1) or more passageways.

Factory-built chimneys: A chimney that is factory-made, listed by a nationally recognized testing or inspection agency, for venting gas appliances, gas incinerators and solid or liquid fuel burning appliances.

Masonry chimney: A field constructed chimney of solid masonry units, bricks, stones, listed hollow masonry units or reinforced concrete built in accordance with nationally recognized standards.

Metal chimney (smokestack): A field constructed chimney made of metal and built in accordance with nationally recognized standards.

Chimney connector: A pipe which connects a fuel burning appliance to a chimney.

Class A soil: Includes all the classes of soil and rock enumerated in Section 720.4.

Class A soil site:

1. A site composed exclusively of Class A soil; or
2. A site where Class A soil overlies or includes Class B soil, provided that the depth below ground surface to the uppermost Class B soil and the cumulative thickness of Class B soil meet the criteria in Figure 716.1.

Class B soil: Includes all classes of soil not qualifying as Class A soil.

Class B soil site: Any site which does not meet the criteria for Class A soil site.

Classroom: A room with desks or equivalent used for group instruction purposes for ten (10) or more students. Libraries, study halls, science laboratories, shops, domestic science rooms and typing rooms shall be considered classrooms for the number of students indicated in the occupancy schedule.

Clay masonry unit: A building unit larger in size than a brick, composed of burned clay, shale, fireclay or mixtures thereof.

Coefficient of performance (COP): See Section 2010.0 for the definitions of COP as appropriate: electrically operated HVAC equipment--cooling; applied HVAC system components--cooling; heat operated HVAC system equipment--cooling; and heat pump--heating.

Cold-formed steel construction: That type of construction made up entirely or in part of steel structural members cold-formed to shape from sheet or strip steel, such as roof deck, floor and wall panels, studs, floor joists, roof joists and other structural elements.

Combination of municipalities: Any two (2) or more cities and/or towns who have agreed to combine in order to share costs necessary for the administration and enforcement of this code in the said cities and/or towns.

Combination system: A system of piping designed to provide both stand-pipe service and automatic sprinkler protection.

Combustible fire damper: A damper arranged to seal off air flow automatically through part of an air duct system, so as to restrict the passage of heat. The fire damper may also be used as a smoke damper if the location lends itself to the dual purpose.

**Combustible (material):** A combustible (material) is a material which cannot be classified as noncombustible in accordance with that definition.

**Comfort envelope:** The area on a psychometric chart enclosing all those conditions described in ASHRAE 55-74 as being comfortable.

**Commenced:** Any physical action begun on the job site for the purposes of construction for which a building permit is required.

**Commission:** See "State Building Code Commission."

**Common hallway:** A common corridor or space separately enclosed which provides any of the following in any story:

1. common access to the required exitways of the building, or
2. common access for more than one (1) tenant; or
3. common access for more than thirty (30) persons.

**Complete sprinkler system:** An automatic sprinkler system providing protection for the entire building or structure.

**Compliance assurance program:** The system, documentation and methods for assuring that manufactured buildings, building components, building systems and mobile homes, including their manufacture, storage, transportation and assembly and handling and installation, conform with Article 18 and the rules and regulations promulgated pursuant thereto.

**Component:** An integral part of a building or its mechanical systems; an element of a building envelope.

**Concrete:** A mixture of cement, aggregates and water, of such proportions and manipulation as to meet specific requirements.

**Concrete masonry unit:** A building unit or block larger in size than twelve (12) by four (4) by four (4) inches made of cement and suitable aggregates.

**Conditioned floor area:** All portions of interior gross floor area which are contained within exterior walls and which are conditioned directly or indirectly by an energy-using system (see "Gross floor area").

**Conflagration hazard:** The fire risk involved in the spread of fire by exterior exposure to and from adjoining buildings and structures.

**Connected lighting load:** Total possible simultaneous demand for lighting, including power used in the lamp itself and any losses in the fixture and ballast.



**Construction operation:** The erection, alteration, repair, renovation, demolition or removal of any building or structure; and the excavation, filling, grading and regulation of lots in connection therewith.

**Construction supervisor:** Any individual directly supervising persons engaged in construction, reconstruction, alterations, repairs or demolition involving the structural elements of buildings and structures.

**Controlled construction:** The construction of a building or structure or a specific part thereof which has been designated and erected under the supervision of a licensed professional engineer or architect using controlled materials as herein defined in compliance with accepted engineering practice under the procedure of Section 127.0.

**Controlled materials:** Materials which are certified by an accredited authoritative agency as meeting accepted engineering standards for quality and as provided in Sections 719.0 and 800.0.

**Controlled materials procedure:** See Section 127.0.

**Corridor:** A hallway, passageway or other compartmented space providing the occupants with access to the required exitways of the building or floor area.

**Court:** An open, uncovered, and unoccupied space on the same lot with a building.

**Inner:** Any court other than an outer court.

**Outer:** A court extending to and opening upon a street, public alley, or other approved open space, not less than fifteen (15) feet wide, or upon a required yard.

**Covered mall buildings:** A covered mall building is a single building enclosing a number of tenants, and occupancies such as retail stores, restaurants, places of assemblage, recreation facilities, motion picture theaters, offices, banks, specialty shops and anchor stores, but excluding high hazard (H) and institutional (I) occupancies, and may be either of two (2) types:

**Type A:** A covered mall building containing such occupancies in airport passenger terminals, hotel lobbies, department stores, discount stores, the lower stories of office buildings, etc. in which the allowable distance of travel from the most remote part of the buildings is measured to an exterior exit door, horizontal exit, exit passageway or an enclosed stairway.

**Type B:** A covered mall building wherein two (2) or more tenants have a main entrance into one (1) or more malls which are roofed interior areas providing common pedestrian facilities for the public wherein the distance

of travel of one (1) of the exits from any point within a tenant space is measured to the mall.

**Curb level:** The elevation of the street curb as established in accordance with law.

**Building or wall height:** The elevation of the street grade opposite the center of the wall nearest to and facing the street lot line.

**Excavations:** The elevation of the street grade nearest to the point of excavation.

**Day care center:** Any facility operated on a regular basis whether known as a day nursery, nursery school, kindergarten, child play school, progressive school, child development center, or preschool, or known under any other name, which receives children not of common parentage under seven (7) years of age or under sixteen (16) years of age if such children have special needs for non-residential custody and care during part or all of the day separated from their parents. Day care center shall not include: any part of a public school system; any part of a private, organized educational system unless the services of such system are primarily limited to kindergarten, nursery or related preschool services; a Sunday school conducted by a religious institution; a facility operated by a religious organization where children are cared for during short periods of time while persons responsible for such children are attending religious services; a family day care home, as defined by Chapter 28A, Section 9, of the MGLA as amended; an informal cooperative arrangement among neighbors or relatives; or the occasional care of children with or without compensation therefor.

**Degree day, heating:** A unit, based upon temperature difference and time, used in estimating fuel consumption and specifying nominal heating load of a building in winter. For any one day, when the mean temperature is less than 65°F there exists as many degree days as there are Fahrenheit degrees difference in temperature between the mean temperature for the day and 65°F.

**Deluge system:** An automatic sprinkler system consisting of open sprinklers with water supply valves activated by a separate automatic detection system.

**Department (DPS):** The Department of Public Safety, Division of Inspection. **Detoxification Facility:** See Section 439.0.

**Display sign:** Any fabricated sign, including its structure, consisting of any letter, figure, character, mark, point, plane, marquee sign, design, poster, pictorial, picture, stroke, stripe, line, trademark, reading matter, of illuminating device which is constructed, attached, erected, fastened, or manufactured in any manner whatsoever so that the same is used for the attraction of the public to any place, subject, person, firm, corpora-

tion, public performance, article, machine or merchandise whatsoever, and is displayed in any manner whatsoever out of doors for recognized advertising purposes.

**Display surface:** The surface which is made available by the structure either for the direct mounting of letters and decoration or for the mounting of the facing material that is intended to carry the entire advertising message.

**Doorway:** The clear width of the opening protected by a door, subject to the width reduction provisions of this code.

**Draft:** The pressure difference existing between the equipment or any component part and the atmosphere which causes a continuous flow of air and products of combustion through the gas passages of the appliance to the atmosphere.

**Forced draft:** The pressure difference created by the action of a fan, blower or ejector which supplies the primary combustion air above atmospheric pressure.

**Induced draft:** The pressure difference created by the action of a fan, blower or ejector which is located between the appliance and the chimney or vent termination.

**Natural draft:** The pressure difference created by a vent or chimney due to its height and the temperature difference between the flue gases and the atmosphere.

**Draft hood:** A device built into a gas appliance or made a part of a chimney connector or vent connector from a gas appliance which is designed to:

1. permit the ready escape of flue gases in the event of zero draft, a back-draft or stoppage in the vent beyond the draft hood;
2. permit the ready relief of the back pressure from a back-draft so it does not enter the gas appliance; and
3. neutralize the possible effect of excess draft (stack action) upon the operation of the appliance.

**Draft regulator:** A device which functions to maintain a desired draft in the appliance by automatically reducing the draft to the desired value.

**Dry chemical extinguishing system:** A system consisting of dry chemical and expellant gas storage tanks, fixed piping, and nozzles used to assure proper distribution of an approved extinguishing agent on a specific fire hazard or into a potential fire area. The system includes an automatic detection and actuating mechanism.

Dual bracing system: Consists of a moment resisting space frame and shear walls which meet the following design criteria:

1. The space frame and shear walls shall resist the total lateral force in accordance with their relative rigidities considering the interaction of the shear walls and space frame.
2. The shear walls acting independently of the resisting portions of the space frame shall resist the total lateral force.
3. The space frame shall have the capacity to resist not less than twenty-five (25) per cent of the total lateral force.

Duct: A tube or conduit used for conveying or encasing purposes as specifically defined below:

Air duct: A tube or conduit used for conveying air. The air passages of self-contained systems are not to be construed as air ducts.

Pipe duct: A tube or conduit used for encasing pipe.

Wire duct: A tube or conduit used for encasing either moving or stationary wire, rope, etc.

Dumbwaiter: A hoisting and lowering mechanism with a car of limited capacity and size which moves in guides in a substantially vertical direction and is used exclusively for carrying material.

#### Dwellings

Boarding house, tourist house: A building arranged or used for lodging, with or without meals, for compensation, by more than three (3) lodgers or boarders (use group R-1).

Dormitory: A space in a building where group sleeping accommodations are provided for persons not members of the same family group, in one (1) room, or in a series of closely associated rooms.

Hotel: Any building containing six (6) or more guest rooms intended or designed to be used, or which are used, rented or hired out to be occupied or which are occupied for sleeping purposes by guests.

Lodging house: Any building or portion thereof arranged or used for lodging by more than three (3) lodgers or boarders and where cooking or sanitary facilities may be provided (R-1 use group).

Multi-family apartment house: A building or portion thereof containing more than two (2) dwelling units and not classified as a one- or two-family dwelling.

One-family dwelling: A building containing one (1) dwelling unit with not more than three (3) lodgers or boarders.

Two-family dwelling: A building containing two (2) dwelling units with not more than three (3) lodgers or boarders per family.

Dwelling unit: A single unit providing complete, independent living facilities for one (1) or more persons including permanent provisions for living, sleeping, eating, cooking, and sanitation.

Efficiency, overall system: For a designated time period, the ratio of useful energy at the point of use to the thermal energy input expressed in per cent.

Egress: See "Means of egress."

Elevator: See Elevator and Escalator Regulations (524 CMR 3.00 through 11.00); Elevator, Dumbwaiter, Escalator and Moving Walk Regulations (524 CMR 15.00 through 33.00).

Elevator lobby: That portion of a floor, platform or alcove immediately adjacent to the elevator shaft opening, used to receive and discharge passengers or freight, or used as a waiting area.

Energy: The capacity for doing work. Energy takes a number of forms which may be transformed from one into another, such as thermal (heat), mechanical (motion), electrical, and chemical. In customary units, energy is measured in kilowatt-hours (kwh) or British thermal units (Btu).

Energy efficiency ratio (EER): The ratio of net cooling capacity in Btu/h to total rate of electric input in watts under designated operating conditions.

Erection: The construction of a building or structure or a specific part thereof.

Escalator: A moving stairway.

Existing building: See "Building, existing."

Existing equipment: Any equipment covered by this article which was installed prior to the effective date of this code or for which an application for permit to install was filed with the building official prior thereto.

Exitway: That portion of a means of egress which is separated from all other spaces of a building or structure by construction or equipment as required in this code to provide a protected way of travel to the exitway discharge.

**Exitway access:** Exitway access is that portion of a means of egress which leads to an entrance to an exitway.

**Exitway discharge:** That portion of a means of egress between the termination of an exitway and a public way.

**Exitway discharge court:** An exterior unoccupied space which is open to the sky for its entire area, located on the same lot with a theatre or other assembly building which it serves exclusively as an obstructed passageway to the street or other public space.

**Exterior envelope:** The elements of a building which enclose conditioned spaces through which thermal energy may be transferred to or from the exterior.

**Exterior masonry wall construction:** See Section 217.0.

**Fenestration:** Any light-transmitting devices in the building envelope admitting natural light.

**Fire area:** The floor area enclosed and bounded by fire walls or exterior walls of a building to restrict the spread of fire.

**Fire damper:** A damper arranged to seal off air flow automatically through part of an air duct system, so as to restrict the passage of heat. The fire damper may also be used as a smoke damper if location lends itself to the dual purpose.

**Fire department connection:** A connection for fire department use in supplementing or supplying water for standpipes or sprinkler systems.

**Fire department hose outlet:** A connection to standpipe or combination system piping to which the public fire department can connect its hose to provide an effective hose stream.

**Fire district:** See "Fire limits."

**Fire division:** The interior means of separation of one part of a floor area from another part together with fireresistive floor construction to form a complete barrier between adjoining or superimposed floor areas in the same building or structure.

**Fire door:** A door and its assembly, so constructed and assembled in place as to give protection against the passage of fire.

**Fire door assembly:** The assembly of a fire door and its accessories, including all hardware and closing devices and their anchors; and the door frame, when required, and its anchors.

**Fire drill:** The organized procedure conducted with or without a private fire brigade for vacating the occupants of a building and for operating the first-aid fire appliances and equipment for the extinguishing of fire and safeguarding of life.

**Fire grading:** The fire hazard classification of a building or structure in hours or fractions of an hour established for its use group and occupancy in Table 902.

**Fire hazard:** The potential degree of fire severity existing in the use occupancy of a building and classified as high, moderate or low.

**High:** All uses which involve the storage, sale, manufacture or processing of highly combustible, volatile flammable or explosive products which are likely to burn with extreme rapidity and produce large volumes of smoke, poisonous fumes, gases or explosions in the event of fire.

**Moderate:** All uses which involve the storage, sale, manufacture or processing of materials which are likely to burn with moderate rapidity and a considerable volume of smoke, but which do not produce either poisonous fumes or explosions in the event of fire.

**Low:** All uses which involve the storage, sale or manufacture of materials that do not ordinarily burn rapidly, nor produce excessive smoke, poisonous fumes, or explosions in the event of fire.

**Fire limits:** The territories defined and limited by the provisions of this code for the restriction of types of construction.

**Fire partition:** A partition which subdivides a story of a building to provide an area of refuge or to restrict the spread of fire.

**Fire prevention:** The preventive measures which provide for the safe conduct and operation of hazardous processes, storage of highly combustible and flammable materials, conduct of fire drills, and the maintenance of fire detecting and fire-extinguishing service equipment and good housekeeping conditions.

**Fireproof construction:** See Section 215.0.

**Fire protection:** The provision of safeguards in construction and of exit facilities, and the installation of fire alarm, fire detecting and fire-extinguishing service equipment, to reduce the fire risk and the conflagration hazard.

**Fire protection system:** A system including systems, devices, and equipment to detect a fire, actuate an alarm or suppress or control a fire or any combination thereof.

**Fireresistance:** That property of materials or their assemblies which prevents or retards the passage of excessive heat, hot gases or flames under conditions of use.

**Fireresistance rating:** The time in hours or fractions thereof that materials or their assemblies will resist fire exposure as determined by fire tests conducted in compliance with recognized standards.

**Fireresistive partition:** A partition other than a fire partition which is required to subdivide the floor area of a fireresistive building for the purpose of restricting the spread of fire.

**Fireretardant construction:** Fabricated units or assemblies of units or construction which have a fireresistance rating of not less than one-third (1/3) hour.

**Fireretardant lumber:** Wood so treated by a recognized impregnation process as to reduce its combustibility.

**Fire safety:** The measure of protection of a building or structure against interior and exposure fire hazards through fireresistive construction and the provision of safe exitways and fire-detecting and extinguishing equipment.

**Fire separation, exterior fire exposure:** The distance in feet measured from the building face to the closest interior lot line, to the center line of a street or public space or to an imaginary line between two buildings on the same property.

**Fire separation wall:** A fireresistance rated assembly of materials not having unprotected openings, designed to restrict the spread of fire.

**Fire suppression system:** A mechanical system designed and equipped to detect a fire, actuate an alarm and suppress or control a fire.

**Fire wall:** A fireresistance rated wall, having protected openings, which restricts the spread of fire and extends continuously from the foundation to or through the roof.

**Fire window:** A window constructed and glazed to give protection against the passage of fire.

**Flameresistance:** The property of materials or combinations of component materials which restricts the spread of flame as determined by the flame-resistance tests specified in this code (see Section 904.0).

**Flame spread:** The propagation of flame over a surface.

**Flame spread rating:** The measurement of flame spread on the surface of materials or their assemblies as determined by tests conducted in compliance with recognized standards.



**Flammable:** Subject to easy ignition and rapid flaming combustion.

**Floor area, gross:** Gross floor area shall be the floor area within the perimeter of the outside walls of the building under consideration, without deduction for hallways, stairs, closets, thickness of walls, columns, or other features.

**Floor area, net:** For the purpose of determining the number of persons for whom exitways are to be provided, net floor area shall be the actual occupied area, not including accessory unoccupied areas or thickness of walls.

**Floor fill:** The fill between the structural floor arch or slab and the finished flooring.

**Floor filling:** The type of short-span floor construction in fireproof and fireresistive buildings installed between structural steel framing to serve as a combination structural floor slab or arch and fireproof protection of the framing.

**Floor finish:** The finish placed on top of the floor arch, slab or other structural floor element.

**Foam extinguishing system:** A special system to discharge a foam made from concentrates, either mechanically or chemically, over the area to be protected.

**Formed steel construction:** That type of construction used in floor and roof systems consisting of integrated units of sheet or strip steel plates which are shaped into parallel steel ribs or beams with a continuous connecting flange deck; generally attached to and supported on the primary or secondary members of a structural steel or reinforced concrete frame.

**Foundation:** A base constructed to support any building or structure including but not limited to footings, floating foundation, piles, caissons.

**Foundation level:** The lowest of any of the following:

1. the bottom of any spread or combined footing or foundation mat;
2. the bottom of any pile cap; or
3. the top of any pier or caisson.

**Foundation wall:** A wall below the floor nearest grade serving as a support for a wall, pier, column or other structural part of a building.

**Foyer:** The enclosed space surrounding or in the rear of the auditorium of a theatre or other place of assembly which is completely shut off from

the auditorium and is used as an assembly or waiting space for the occupants.

Fuel: A solid, liquid, or gaseous substance with a high energy content that can be burned to release the energy.

Fuel oil: A liquid mixture or compound derived from petroleum which does not emit flammable vapor below a temperature of one hundred and twenty-five (125) degrees F. in a Tag closed-cup tester (ASTM D56).

Furnace

Floor furnace: A self-contained, connected or vented furnace designed to be suspended from the floor of the space being heated taking air for combustion outside this heated space and with means for observing the flame and lighting the appliance from the space being heated.

Forced warm air furnace: A furnace equipped with a blower to provide the primary means for circulating air.

Warm air furnace: A solid, liquid or gas-fired appliance for heating air to be distributed with or without duct systems to the space to be heated.

Furring: The application of thin wood, brick, or metal to a surface to level it, or to create an air space.

Garage, private: A garage for four (4) or less passenger motor vehicles without provision for repairing or servicing such vehicles for profit.

Garage, public: A building or structure for the storage or parking of more than four (4) passenger motor vehicles or motor powered boats, or more than one (1) commercial motor vehicle; and in which provision may be made for the dispensing of gasoline, oil or similar products for the servicing of such vehicles. Public garages shall be classified according to their specific use in one (1) of the following groups:

Group 1: A public garage in which provision is made for the care, storage, repair or painting of motor vehicles.

Group 2: A public garage used exclusively for passenger vehicles that will accommodate not more than nine (9) passengers.

Glass fiber reinforced plastic: See Section 1900.2.1.

Grade: A reference plane representing the average of finished ground level adjoining the building at all exterior walls.

Grade hallway, grade lobby, grade passageway: An enclosed hallway or corridor that is an element of an exitway, terminating at a street or an open space or court communicating with a street.

**Grandstand:** Any structure, except movable seating and sectional benches, intended primarily to support individuals for the purposes of assembly, but this definition shall not apply to the permanent seating in theatres, churches, auditoriums and similar buildings.

**Gross floor area:** The floor area within the perimeter of the outside walls of the building, without deduction for hallways, stairs, closets, thickness of walls, columns, or other features.

**Gross leasable area:** The gross leasable area is the total floor area designed for tenant occupancy and exclusive use. The area of tenant occupancy is measured from the center lines of joint partitions to the outside of the tenant walls.

**Gross wall area:** The exterior wall area bounding interior space which is conditioned by an energy-using system. It includes the opaque wall, and window and door areas.

**Ground sign:** A sign supported by uprights or braces in or upon the ground surface.

**Group residence:** See Section 424.0.

**Habitable space:** Space in a structure for living, sleeping, eating or cooking. Bathrooms, toilet compartments, closets, halls, storage or utility space, and similar areas are not considered habitable space.

**Hallway, common:** A common corridor or space separately enclosed which provides any of the following in any story:

1. common access to the required exitways of the building;
2. common access for more than one (1) tenant, or
3. common access for more than thirty (30) persons.

**Halogenated extinguishing system:** A system of pipes, nozzles and an actuating mechanism and a container of halogenated agent under pressure.

**Head of the fire department:** The chief executive officer of the fire department in a city, town or fire district having such an officer, otherwise the fire commissioner, board of fire commissioners or fire engineers, or commissioner of public safety; and in towns not having a fire department, the chief engineer, if any, otherwise the chairman of the board of selectmen.

**Heat:** The form of energy that is transferred by virtue of a temperature difference.

**Heated slab:** Containing heated pipes or ducts that constitute a radiant slab or portion thereof for complete or partial heating of the contained space.

**Heating appliance:** Any device designed or constructed for the generation of heat from solid, liquid or gaseous fuel or electricity.

**Recessed heater:** A completely self-contained heating unit usually recessed in a wall and located entirely above the floor of the space it is intended to heat.

**Unit heater:** A factory-assembled device designed to heat and circulate air. Essential components are a heat transfer element, housing and fan with driving motor. Normally designed for free delivery of recirculated air.

**Heated space:** A space within a building which is provided with a positive heat supply to maintain air temperature of fifty (50) degrees F. or higher.

**Height, building:** The vertical distance from the grade to the top of the highest roof beams of a flat roof, or to the mean level of the highest gable or slope of a hip roof. When a building faces on more than one (1) street, the height shall be measured from the average of the grades at the center of each street front.

**Court:** The vertical distance from the lowest level of the court to the mean height of the top of the enclosing walls.

**Story:** The vertical distance from top to top of two (2) successive tiers of beams or finished floor surfaces; and, for the topmost story, from the top of the floor finish to the top of the ceiling joists, or, where there is not a ceiling, to the top of the roof rafters.

**Wall:** The vertical distance from the foundation wall or other immediate support of such wall to the top of the wall.

**Hereafter:** After the time that this code becomes effective.

**Heretofore:** Before the time that this code became effective.

**High hazard use:** See Section 206.0.

**Historic buildings:** See Section 436.2.

**Hollow masonry unit:** A masonry unit whose net cross-sectional area in any plane parallel to the bearing surface is less than seventy-five (75) per cent of its gross cross-sectional area measured in the same plane.

**Horizontal exit:** A way of passage from one (1) building or fire area to an area of refuge in another building or fire area on approximately the same level, which affords safety from fire or smoke from the area of escape and areas communicating therewith.

**Horizontal fire line:** A fire line installed around the interior walls and columns of a building, pier or wharf, with hose outlets located so that every part of the floor area is within reach of at least one (1) fire stream.

**Humidistat:** An instrument which measures changes in humidity and controls a device(s) for maintaining a desired humidity.

**HVAC:** Heating, ventilating, and air conditioning.

**HVAC system:** A system that provides either collectively or individually the processes of comfort heating, ventilating, and/or air conditioning within or associated with a building.

**Industrial lift (material lift):** A non-portable power operated raising or lowering device for transporting freight vertically, operating entirely within one (1) story of the building or structure.

**Illumination:** The density of the luminous flux incident on a surface; it is the quotient of the luminous flux and the area of the surface when the latter is uniformly illuminated.

**Infiltration:** The uncontrolled inward air leakage through cracks and interstices in any building element and around windows and doors of a building, caused by the pressure effects of wind and/or the effect of differences in the indoor and the outdoor air density.

**Inspector of buildings:** The administrative chief of the building department in a municipality who is charged with the administration and enforcement of this code. See also "Building commissioner" and Section 107.1).

**Installation:** See Article 18.

**Interior lot line:** Any lot line other than one adjoining a street or public space.

**Kerosene:** An oil or liquid product of petroleum which does not emit a flammable vapor below a temperature of one hundred and fifteen (115) degrees F. when tested in a Tag closed-cup tester (ASTM D56).

**Kiosk:** A small structure used as a newstand, refreshment booth and/or pavillion for similar usage.

**Label:** See Article 18.

**Lateral force resisting system:** That part of the structural system to which the total lateral forces prescribed in Section 716.4 are assigned.

**Light-diffusing system:** A suspended construction consisting in whole or in part of lenses, panels, grids or baffles suspended below lighting fixtures.

**Light gage steel construction:** That type of construction in which the structural frame consists of studs, floor joists, arch ribs, rafters, steel decks and other structural elements which are composed and fabricated of cold-formed sheet or strip steel members less than three sixteenths (3/16) inch thick.

**Limited access:** Available only to authorized personnel.

**Limited area sprinkler system:** An automatic sprinkler system consisting of not more than twenty (20) sprinklers for use in a room or space enclosed by construction assemblies as required by this code.

**Lintel:** A beam placed over a opening or recess in a wall which supports the wall construction above.

**Liquefaction:** A term used to describe a group of phenomena occurring in saturated cohesionless sandy and silty soils consisting of a large decrease in effective stress (total stress minus pore pressure) accompanied by large deformations under either static or cyclic loading. The term cyclic mobility should also be included within the scope of the definition of liquefaction.

## Load

**Dead load:** The weight of all permanent construction including walls, floors, roofs, partitions and stairways, and of fixed service equipment.

**Duration of load:** The period of continuous application of a given load, or the aggregate of periods of intermittent applications of the same load.

**Earthquake load:** The assumed lateral load acting in any horizontal direction on the structural frame due to the kinetic action of earthquakes.

**Impact load:** The load resulting from moving machinery, elevators, cranes, vehicles, and other similar forces and kinetic loads.

**Lateral soil load:** The lateral pressure due to the weight of the adjacent soil, including due allowance for hydrostatic pressure and possible surcharge from fixed or moving loads.

**Live load:** The weight superimposed by the use and occupancy of the building, not including the wind load, earthquake load, snow load or dead load.

**Wind load:** The pressure (either positive pressure or suction), on, or in, a building or structure due to wind blowing in any direction.

**Loading ramp:** A hinged, non-portable device, either mechanical or hydraulic, hand or power operated, used for spanning gaps or adjusting heights between loading surface and carrier or between loading surface and loading surface.

**Lobby:** The enclosed vestibule between the principal entrance to the building and the doors to the main floor of the auditorium or assembly room of a theatre or place of assembly, or to the main floor corridor of a business building (see also "Elevator lobby").

**Local enforcement agency:** A department or agency in a municipality charged with the enforcement of this code and appropriate specialized codes which include, but are not limited to, The State Plumbing Gas Fitting Code, and the State Electrical Code.

**Local inspector:** A person in a municipality who assists the building commissioner or inspector of buildings in the performance of his duties and is charged with the enforcement of this code (see Section 107.11).

**Lot:** A portion or parcel of land considered as a unit.

**Corner lot:** A lot with two (2) adjacent sides abutting upon streets or other public spaces.

**Interior lot:** A lot which faces on one (1) street or with opposite sides on two (2) streets.

**Lot line:** A line dividing one lot from another, or from a street or any public place.

**Low hazard use:** See Section 210.3.

**Maintenance:** Restoring or replacing deteriorated elements.

**Mall:** A mall is a roofed-over common pedestrian area serving more than one (1) tenant located within a covered mall building.

**Manual:** Capable of being operated by personal intervention (see "Automatic").

**Manual fire alarm system:** An interior alarm system composed of sending stations and signaling devices in a building, operated on an electric circuit, so arranged that the operation of any one station will ring all signals throughout the building on at one or more approved locations. Signals may be either non-coded, or coded to indicate the floor area in which the signal originated and may be transmitted to an outside central station.

**Manufactured building:** Any building which has concealed elements, such as electrical, mechanical, plumbing, fire protection, insulation, and other systems affecting health and safety, and which is manufactured or assembled in manufacturing facilities, on or off the building site. Also, any building as defined above which does not have concealed elements, but which has been approved by the Commission at the request of the manufacturer.

**Marquee sign:** A sign attached to or hung from a marquee canopy or other covered structure projecting from and supported by the building and extending beyond the building wall, building line or street lot line.

**Masonry:** A built-up construction or combination of building units or materials of clay, shale, concrete, glass, gypsum, stone or other approved units bonded together with mortar or monolithic concrete. Reinforced concrete is not classed as masonry.

**Material platform hoist:** A power or manually operated suspended platform conveyance operating in guide rails for the exclusive raising or lowering of materials, which is operated and controlled from a point outside the conveyance.

**Means of egress:** A continuous and unobstructed path of travel from any point in a building or structure to a public way and consists of three (3) separate and distinct parts: (a) the exitway access; (b) the exitway; and (c) the exitway discharge. A means of egress comprises the vertical and horizontal means of travel and shall include intervening room spaces, doors, hallways, corridors, passageways, balconies, ramps, stairs, enclosures, lobbies, escalators, horizontal exits, courts, and yards.

**Mechanical ventilation:** The mechanical process of supplying air to, or removing air from, any space.

**Mezzanine:** An intermediate level between the floor and ceiling of any story, and covering not more than thirty-three (33) per cent of the floor area of the room in which it is located.

**Miscellaneous hoisting and elevating equipment:** See Elevator and Escalator Regulations (524 CMR 3.00 through 11.00); Elevator, Dumbwaiter, Escalator and Moving Walk Regulations (524 CMR 15.00 through 33.00).

**Mobile home:** A structure, transportable in one or more sections, which is eight (8) body feet or more in width and is thirty-two (32) body feet or more in length, and which is built on a permanent chassis, and designed to be used as a dwelling with permanent foundation, when connected to the required utilities, and includes the plumbing, heating, air-conditioning and electrical systems contained therein.

**Mobile unit:** A structure of vehicular, portable design built on a chassis and designed to be moved from one site to another and to be used, with or without a permanent foundation.



Moderate hazard use: See Section 210.2.

Moment-resisting space frame: A space frame designed to carry all vertical loads and in which the members and joints are capable of resisting design lateral forces by bending moments.

Mortar: A plastic mixture of approved cementitious materials, fine aggregates and water used to bond masonry or other structural units.

Motel: A hotel as defined in this code.

Motor fuel service station: A structure, building or premise or any portion thereof where a flammable fluid is stored, housed or sold for supply to motor vehicles.

Motor vehicle repair shop: A building, structure or enclosure in which the general business of repairing motor vehicles is conducted, including a public garage.

Moving stairway (escalator): See Elevator and Escalator Regulations (524 CMR 3.00 through 11.00); Elevator, Dumbwaiter, Escalator and Moving Walk Regulations (524 CMR 15.00 through 33.00).

Moving walk: See Elevator and Escalator Regulations (524 CMR 3.00 through 11.00); Elevator, Dumbwaiter, Escalator and Moving Walk Regulations (524 CMR 15.00 through 33.00).

Municipality: Any city or town in the Commonwealth of Massachusetts. The word "municipality" shall be construed, where the context requires, as though followed by the words "or combination of municipalities."

Native lumber: Native lumber is wood processed in the Commonwealth of Massachusetts by a mill registered in accordance with the regulations of the State Building Code Commission. Such wood is ungraded but is stamped or certified in accordance with the requirements of Section 852.1.1 of this code. For the purpose of this definition, native lumber shall be restricted to use in one- and two-story dwellings, barns, sheds, agricultural and accessory buildings and other structures when permitted by section 852.1.1.

Nominal dimension

Lumber: A dimension that may vary from actual dimensions as provided in American Lumber Standard listed in Appendix C.

Masonry: A dimension that may vary from actual masonry dimensions by the thickness of a mortar joint but not to exceed one-half (1/2) inch.

Non-automatic sprinkler system: A sprinkler system in which all pipes are maintained dry and which is equipped with a siamese fire department connection.

**Non-depletable energy sources:** Sources of energy (excluding minerals) derived from incoming solar radiation including photosynthetic processes; from phenomena resulting therefrom including wind, waves and tides, lake or pond thermal differences; and energy derived from the internal heat of the earth, including nocturnal thermal exchanges.

**Noncombustible:** This is a general, relative term. Its precise meaning is defined in this code for specific applications.

**Noncombustible building material (incombustible):** See Section 903.0

**Noncombustible construction:** See Section 216.0.

**Non-slip:** As used in this code, shall mean a surface that is tested and approved to be slip resistant by a nationally recognized testing laboratory, and have a minimum coefficient of anti-slip friction of forty one-hundredths (0.40) as defined by Research Paper No. RP-1879 of the National Bureau of Standards.

**Notice:** See Section 122.1.

**Occupancy:** The purpose for which a building, or part thereof, is used or intended to be used, within a use group.

**Occupancy load:** The number of individuals normally occupying the building, or part thereof, or for which the exitway facilities have been designed.

**Occupancy sprinkler system:** An automatic sprinkler system servicing a use group in a building enclosed by construction assemblies as required by this code.

**Occupant use hose station:** A valve, rack, one and one-half (1 1/2) inch hose, and nozzle assembly located and labeled for use by building occupants only. Such occupant use hose stations may be connected to stand-pipe, combination or sprinkler systems.

**Occupiable room, minimum height:** A clear height from finished floor to ceiling or lowest projection of not less than seven and one quarter (7 1/4) feet shall be provided in all exitway access and occupiable rooms of assembly, business or mercantile uses.

**Occupied:** As applied to a building, shall be construed as though followed by the words "or intended, arranged or designed to be occupied."

**One-source sprinkler system:** An automatic sprinkler system which is supplied from one of the approved automatic sources of water supply.

**Opaque areas:** All exposed areas of a building envelope which enclose conditioned space, except openings for windows, skylights, doors, and building service systems.

**Open Well:** A floor opening, series of floor openings or an atrium connecting two or more stories, which does not meet the requirements for a covered shaft with respect to enclosure.

**Ordinary materials:** Materials which do not conform to the requirements of this code for controlled materials.

**Oriel window:** A window projected beyond and suspended from the wall of the building or cantilevered therefrom.

**Outbuilding:** A building the use of which is incidental to that of the main building, and which is located on the same lot.

**Outside air:** Air taken from the outdoors and, therefore, not previously circulated through the system.

**Overall thermal transfer value (ottv):** Overall heat gain through the building wall.

**Owner:** Every person who alone or jointly or severally with others (a) has legal title to any building or structure; or (b) has care, charge, or control of any building or structure in any capacity including but not limited to agent, executor, executrix, administrator, administratrix, trustee or guardian of the estate of the holder of legal title; or (c) lessee under a written letting agreement; or (d) mortgagee in possession; or (e) agent, trustee or other person appointed by the courts. Each such person is bound to comply with the provisions of this code.

**Packaged terminal air-conditioner:** A factory-selected combination of heating and cooling components, assemblies, or sections, intended to serve a room or zone.

**Panel (part of a structure):** The section of a floor or wall comprised between the supporting frame of two (2) adjacent rows of columns and girders or column bands of floor construction.

**Panning:** The sealing off of a joist or stud space for use as a plenum. This is allowed in one and two-family dwellings only for use as a return air plenum.

**Parking structure, open:** A structure for the parking of passenger cars wherein two (2) or more sides of such structure are not less than fifty (50) per cent open on each floor or level for fifty (50) per cent of the distance from the floor to the ceiling and wherein provision for the re-pairing of such vehicles is not made. Such open parking structures are not classified as public garages, but shall comply with the requirements of Section 429.0 and FPR-4.

**Party wall:** A fire wall on an interior lot line used or adapted for joint service between two (2) buildings.

**Penthouse:** An enclosed structure above the roof of a building, other than a roof structure or bulkhead, occupying not more than thirty-three and one third (33 1/3) per cent of the roof area.

**Permit:** An official document or certificate issued by the authority having jurisdiction authorizing performance of a specified activity.

**Person:** Every individual, partnership, corporation, firm, association, trustee or group, including a city, town, county, authority or other governmental unit, owning property or conducting any activity regulated by this code.

**Place of Assembly:** A room or space accommodating fifty (50) or more individuals for religious, recreational, educational, political, social or amusement purposes, or for the consumption of food and drink, including all connected rooms or space with a common means of egress and entrance.

**Place of outdoor assembly:** Premises used or intended to be used for public gatherings of two hundred (200) or more individuals in other than buildings.

**Plastic, combustible:** A plastic material more than one twentieth (1/20) inches in thickness which burns at a rate of not more than two and one-half (2 1/2) inches per minute when subjected to ASTM D635, Standard Method of Test for Flammability of Self-Supporting Plastics, listed in Appendix C.

**Plastic glazing:** Material glazed, or set in frame or sash, and not held by mechanical fasteners which pass through the glazing material.

**Plastic roof panels:** Approved plastic materials which are mechanically fastened to structural members, or to structural panels or sheathing, and which are used as light-transmitting media in roofs.

**Plastic wall panel:** Approved plastic materials which are mechanically fastened to structural members, or to structural panels or sheathing, and which are used as light-transmitting media in exterior walls.

**Plenum:** An air compartment or chamber to which one (1) or more ducts are connected, and which forms part of an air distribution system.

**Portable sign:** A sign, usually of a temporary nature, not securely anchored to the ground or to a building or structure and which obtains some or all of its structural stability with respect to wind or other normally applied forces by means of its geometry or character.

**Positive heat supply:** Heat supplied to a space by design.

**Posted use and occupancy:** The posted classification of a building in respect to use, fire grading, floor load and occupancy load.

**Posted sign:** The tablet, card or plate which defines the use, occupancy, fire grading and floor loads of each story, floor or parts thereof for which the building or part thereof has been approved.

**Power:** In connection with machines, power is the time rate of doing work. In connection with the transmission of energy of all types, power refers to the rate at which energy is transmitted; in customary units, it is measured in watts (W) or British thermal units per hour (Btu/h).

**Prefabricated:** Construction materials or assembled units fabricated prior to erection or installation in a building or structure (See "Manufactured buildings" and "Building components").

**Prefabricated buildings:** The completely assembled and erected building or structure, including the service equipment, of which the structural parts consist of prefabricated individual units or subassemblies using ordinary or controlled materials; and in which the service equipment may be either prefabricated or at-site construction.

**Prefabricated subassembly:** A built-up combination of several structural elements designed and fabricated as an assembled section of wall, ceiling, floor or roof to be incorporated into the structure by field erection of two (2) or more such subassemblies.

**Prefabricated unit:** A built-up section forming an individual structural element of the building, such as a beam, girder, plank, strut, column or truss, the integrated parts of which are prefabricated prior to incorporation into the structure, including the necessary means for erection and connection at the site to complete the structural frame.

**Prefabricated unit service equipment:** A prefabricated assembly of mechanical units, fixtures and accessories comprising a complete service unit of mechanical equipment, including bathroom and kitchen plumbing assemblies, unit heating and air-conditioning systems and loop-wiring assemblies of electric circuits.

**Preservative treatment (treated material):** Unless otherwise noted, is impregnation under pressure with a wood preservative. Wood preservative is any suitable substance that is toxic to fungi, insects, borers, and other living wood-destroying organisms.

**Primary member:** Any member of the structural frame of a building or structure used as a column, grillage beam, or to support masonry walls and partitions; including trusses, isolated lintels spanning an opening of eight (8) feet or more, and any other member required to brace a column or a truss.

**Professional engineer or architect:** An individual technically and legally qualified to practice the profession of engineering or architecture.

**Projecting sign:** A display sign which is attached directly to the building wall, and which extends more than fifteen (15) inches from the face of the wall.

**Proprietary (local) system:** An electrical alarm system capable of automatically notifying building supervisory personnel of a water flow and/or an impairment of a sprinkler system.

**Protected construction:** That in which all structural members are constructed, chemically treated, covered or protected so that the individual unit or the combined assemblage of all such units has the required fire-resistance rating specified for its particular use or application in Table 214; including protected-frame, protected-ordinary and protected-non-combustible construction.

**Public way:** Any street, alley or other parcel of land open to the outside air leading to a public street, deeded, dedicated, or otherwise permanently appropriated to the public for public use and having a clear width of not less than ten (10) feet.

**Pyroxylin plastic:** Any nitro-cellulose product or compound soluble in a volatile, flammable liquid, including such substances as celluloid, pyroxylin, fiberloid and other cellulose nitrates (other than nitrocellulose film) which are susceptible to explosion from rapid ignition of the gases emitted therefrom.

**Raised platform:** A raised portion of floor to be used for simple stage purposes that involves a minimum of fire hazard, so located that it extends not more than eighteen (18) feet behind the probable curtain line of the proscenium opening and of an area limited to seventeen and one-half (17.5) per cent of the assembly room floor area or fifteen hundred and fifty (1,550) square feet, whichever is less.

**Raised platform, enclosed:** A raised portion of a floor, to be used for simple stage purposes that involve a minimum of fire hazard, having a ceiling which extends not more than five (5) feet above the top of the proscenium opening, containing a proscenium opening curtain, not containing a gridiron, fly gallery or other apparatus above or below the stage for the movement of scenery, not extending more than eight (8) feet beyond the curtain line and having two (2) separate and independent means of egress such that any point behind the curtain shall not be more than fifty (50) feet from an egress doorway.

**Readily accessible:** Capable of being reached quickly for operation, maintenance, or inspection, without requiring those to whom ready access is requisite to climb over or remove obstacles or to resort to portable ladders, chairs, etc.

**Recovered energy:** Energy utilized, which would otherwise be wasted, from a system that utilizes energy for any purpose.

**Refrigerant:** The medium used to produce cooling or refrigeration by the process of expansion or vaporization.

**Refrigeration:** The mechanical process of removing heat from the air in an enclosed space of a building or structure.

**Reheat:** The application of sensible heat to the supply air that has been previously cooled below the temperature of the conditioned space by either mechanical refrigeration or the introduction of outdoor air.

**Reinforced concrete:** Concrete in which reinforcement, other than that provided for shrinkage or temperature changes, is combined in such manner that the two (2) materials act together in resisting forces.

**Reinforced thermosetting plastic:** A thermosetting plastic reinforced with a glass fiber mat having not less than one and one-half (1 1/2) ounces of glass fiber per square foot.

**Remote station system:** An electrical alarm system capable of automatically notifying the public or private fire departments, or other approved constantly-attended location, when the system is activated.

**Repair:** Any maintenance which affects structure, egress, fire protection systems, fire ratings, energy conservative provisions (Article 20), use, occupancy or utilities. A building permit is required.

**Repairs, ordinary:** Any maintenance which does not affect structure, egress, fire protection systems, fire ratings, energy conservation provisions (Article 20), plumbing, sanitary, gas, electrical or other utilities. A building permit is not required for ordinary repairs.

**Required:** Shall be construed to be mandatory by provisions of this code.

**Reset:** Adjustment of the set point of a control instrument to a higher or a lower value, either automatically or manually in order to conserve energy.

**Residential unit:** a) in R-2 multi-family use group, a dwelling unit; b) in R-2 dormitory use group, a room or group of rooms occupied as a single unit; and c) in R-1 use group, a room or group of rooms occupied as a single unit.

**Resistance, thermal (R):** A measure of the ability to retard the flow of heat. The R value is the reciprocal of a heat transfer coefficient as expressed by U.  $R = 1/U$ .

**Riser:** The vertical supply pipes in a sprinkler system or standpipe system.

**Roof:** The roof slab or deck with its supporting members, not including vertical supports.

**Roof covering:** The covering applied to the roof for weather resistance, fireresistance or appearance.

**Roof sign:** A sign which is erected, constructed and maintained above the roof of the building.

**Roof structure:** An enclosed structure on or above the roof of any part of a building.

**Room air conditioner:** An encased assembly designated as a unit for mounting in a window or through a wall, or as a console. It is designed primarily to provide free delivery of conditioned air to an enclosed space, room or zone. It includes a prime source of refrigeration for cooling and dehumidification and means for circulating and cleaning air, and may also include means for ventilating and heating.

**Room dimensions:** See Section 506.5.

**Rubble**

**Coursed rubble:** Masonry composed of roughly shaped stones fitting approximately on level beds and well bonded.

**Random rubble:** Masonry composed of roughly-shaped stones laid without regularity of coursing but well bonded and fitted together to form well defined joints.

**Rough or ordinary rubble:** Masonry composed of unsquared field stones laid without regularity of coursing but well bonded.

**Rubble masonry:** Masonry composed of roughly shaped stones.

**Runway:** Any aisle or walkway constructed or maintained as a temporary passageway for pedestrians or vehicles.

**Rupture member:** A mechanical device that will rupture at a predetermined pressure to control automatically the compressor or maximum pressure of operation of the refrigerant.

**Salamander:** Portable stove or incinerator.

**Scaffold:** Any elevated platform which is used for supporting workmen, materials or both.



**Schoolhouse:** Any building or premise in which a regular course of public or private instruction is given to not less than ten (10) students at one time, except for rooms in buildings separate from or attached to churches used for the primary purpose of religious instruction.

**Secondary member:** Any member of the structural framework other than a primary member, including filling-in beams of floor systems.

**Self-closing:** As applied to a fire door or other opening protective, means normally closed and equipped with an approved device which will insure closing after having been opened for use.

**Sensible heat:** Heat added or removed which can be measured by a change in temperature of the substance.

**Separate sleeping area:** See Section 1216.3.2.2.

**Sequence:** A consecutive series of operations.

**Service systems:** All energy-using systems in a building that are operated to provide services for the occupants or processes housed therein, including HVAC, service water heating, illumination, transportation, cooking or food preparation, laundering or similar functions.

**Service water heating:** Supply of hot water for domestic or commercial purposes other than comfort heating.

**Service water heating demand:** The maximum design rate of heated water withdrawal from a service water heating system in a designated period of time (usually an hour or a day).

**Shading coefficient:** The ratio of the solar heat gain through a glazing system corrected for external and internal shading to the solar gain through an unshaded single light of double strength sheet glass under the same set of conditions.

**Shaft, covered:** An interior enclosed space extending through one (1) or more stories of a building, connecting openings in successive floors, or floors and roof, and covered at the top.

**Shaft, open:** An exterior, enclosed space extending through one (1) or more stories of a building, enclosed with walls of the required weather and fireresistance rating for exterior walls, and open to the sky at the top.

**Shall:** The term, when used in this code, shall be construed as mandatory.

Shear wall: A wall designed to resist lateral forces parallel to the wall.

Signs: Any fabricated sign or outdoor display structure, including its structure, consisting of any letter, figure, character, mark, point, plane, marquee sign, design, poster, pictorial picture stroke, stripe, line, trademark, reading matter, or illuminating device, constructed, attached, erected, fastened, or manufactured in any manner whatsoever so that the same shall be used for the attraction of the public to any place, subject, person, firm, corporation, public performance, article, machine, or merchandise whatsoever, and displayed in any manner out of doors for recognized advertising purposes.

Closed sign: A sign in which more than fifty (50) per cent of the entire area is solid or tightly enclosed or covered, preventing transmission of wind.

Open sign: A sign in which at least fifty (50) per cent of the enclosed area is uncovered, or open to the transmission of wind.

Slidescape: A straight or spiral chute erected on the interior or exterior of a building which is designed as a means of human egress direct to the street or other public space.

Smoke detector: An approved, listed detector sensing visible or invisible particles of combustion.

Smokeproof enclosure: An enclosed stairway, with access from the floor area of the building either through outside balconies or ventilated vestibules, opening on a street or yard or open court, and with a separately enclosed direct exitway to the street at the grade floor.

Solar energy source: Source of thermal, chemical or electrical energy derived directly from conversion of incident solar radiation.

Solid fuel burning appliance: Room heaters which are free standing fire chamber assemblies designed to burn wood or coal. They may be of the circulating or radiant type. These units are for attachment to a residential type chimney and may be thermostatically controlled.

Solid masonry: Masonry consisting of solid masonry units laid contiguously with the joints between the units filled with mortar, or consisting of plain concrete.

Solid masonry unit: A masonry unit whose net cross-sectional area in every plane parallel to the bearing surface is seventy-five (75) per cent or more of its gross cross-sectional area measured in the same plane.

Space frame: A three-dimensional structural system composed of interconnected members, other than bearing walls, designed to function as a complete self-contained laterally stable unit with or without the aid of horizontal diaphragms or floor bracing systems.

**Special hoisting and conveying equipment:** Manually or power-operated hoisting, lowering or conveying mechanisms, other than elevators, moving stairways or dumbwaiters for the transport of persons or freight in a vertical, inclined or horizontal direction on one (1) floor or in successive floors.

**Automotive lift:** A fixed mechanical device for raising an entire motor vehicle above the floor level, but not through successive floors of the building or structure.

**Conveyors:** A system of machinery and manual or mechanized devices other than elevator and dumbwaiter equipment, consisting of belts, chains, rollers, buckets, aprons, slides and chutes and other miscellaneous equipment for hoisting, lowering and transporting materials and merchandise in packages or in bulk in any direction in a building or structure.

**Manlifts:** A power-operated belt device with steps and handholds for transporting persons in a vertical position through successive floors or levels of the building or structure.

**Material lift:** A power-operated rising or lowering device for transporting freight vertically, operating entirely within one (1) story of the building or structure.

**Specialized Code:** All building codes, rules or regulations pertaining to building construction, reconstruction, alteration, repair or demolition promulgated by and under the authority of the various agencies which have been authorized from time to time by the General Court of the Commonwealth of Massachusetts.

**Sprinkler alarm system:** An alarm activated by waterflow from a sprinkler system.

**Sprinklered:** A building or structure equipped with a complete, approved automatic sprinkler system properly maintained.

**Sprinkler system, dry pipe:** A system in which all pipes and sprinkler heads are filled with air under pressure and the water supply is controlled by an approved automatic dry-pipe valve, in the event of fire actuated either by the release of air or by thermostatic electric control.

**Sprinkler system, thermostatic:** An open or closed head sprinkler system operated through an auxiliary thermostatic device which functions at a predetermined rate of temperature rise.

**Sprinkler system, wet pipe:** A system of automatic sprinklers in which all pipes are filled with water at all times.

**Stage:** A partially enclosed portion of a building which is designed or used for the presentation of plays, demonstrations, or other entertainment wherein scenery, drops or other effects may be installed or used.

**Stairway:** One (1) or more flights of stairs, and the necessary landings and platforms connecting them, to form a continuous and uninterrupted passage from one floor to another. A flight of stairs, for the purposes of this code, must have at least three (3) risers.

**Standard fire tests:** See Appendix G.

**Standpipe:** A system of piping and allied equipment installed to provide a means for manual application of water to fires in buildings. Standpipe systems are for fire department use to obtain effective hose streams in taller buildings or large low buildings.

**Standpipe, dry:** A standpipe system not having permanent water supply connection. Water is supplied by the fire department through the required fire department connection only.

**Standpipe, dry/wet:** A standpipe system which is normally dry but can be charged with water.

**Standpipe, wet:** A standpipe system which has the supply normally open and water pressure maintained in all portions of the standpipe system at all times.

**State Building Code:** The State Building Code and amendments and rules and regulations thereto as promulgated by the State Building Code Commission under Chapter 23B, Sections 16, 17 and 18, of the Massachusetts General Laws Annotated as amended.

**State Building Code Commission (SBCC):** The Massachusetts State rules and regulations thereto as promulgated by the State Building Code Commission established by Chapter 23B, Section 16, of the Massachusetts General Laws Annotated as amended.

**State inspector:** An employee of the Division of Inspection, State Department of Public Safety who is charged with administering and enforcing this code relative to any structure or building or parts thereof that are owned by the Commonwealth or any departments, commissions, agencies or authorities of the Commonwealth. The state inspector is also charged with supervising the enforcement of this code relative to all buildings and structures other than those owned by the Commonwealth (see Section 108.9).

**Steel joist:** Any secondary steel member of a building or structure made of hot or cold-formed solid or open-web sections, or riveted or welded bar, strip or sheet steel members or slotted and expanded or otherwise deformed rolled sections.

**Story:** That portion of a building included between the upper surface of a floor and upper surface of the floor or roof next above (see also "Mezzanine").

Story (first): The lowermost story entirely above the grade plane.

Street: A public thoroughfare (street, avenue, boulevard) which has been dedicated for public use.

Street lot line: The lot line dividing a lot from a street or other public space.

Structural clay tile: A hollow masonry unit composed of burned clay, shale, fireclay or mixtures thereof, and having parallel cells.

Structural steel member: Any primary or secondary member of a building or structure consisting of a rolled steel structural shape other than cold-formed steel, light gage steel or steel joist members.

Structure: A combination of materials assembled at a fixed location to give support or shelter, such as a building, framework, retaining wall, tent, reviewing stand, platform, bin, fence, sign, flagpole, recreational tramway, mast for radio antenna or the like. The word "structure" shall be construed, where the context requires, as though followed by the words, "or part or parts thereof."

Summer camps for children: premises, operated solely between April and October of each year for recreational or other purposes, and having residential facilities. The use of such accommodations for purposes of inspection, certification and inspection fees shall be considered as being similar to a dormitory in R-2 use group and subject to Article 4, Sections 435.2 through 435.6.

Supervised sprinkler system: A system in which all water supply, valves and accessory equipment are provided with electrical contact devices to transmit signals to an outside central supervisory station.

System: A combination of equipment and/or controls, accessories interconnecting means, and terminal elements by which energy is transformed and delivered to desired areas so as to perform a special function, such as HVAC, service water heating, or illumination.

Task lighting: Illumination applied to an individual location, with local control of switching. Examples include desk lights, examining lights, and machine lights.

Technical Code Council: See Section 100.5.1.

Temperature difference equivalent, TDeq: Total heat flow through the structure caused by solar radiation and outside temperature.

Temporary signs: A sign constructed of cloth, fabric or other light temporary material with or without a structural frame intended for a limited period of display; including decoration displays for holidays or public demonstrations.

**Terminal element:** The means by which the transformed energy from a system is finally delivered; i.e., registers, diffusers, lighting fixtures, faucets, etc.

**Theatre:** A building or part thereof in which it is intended to make a business of the presentation of performances for the entertainment of spectators, with a stage which can be used for scenery and other appliances (see Section 203.2).

**Thermal resistance, R:** A measure of the ability to retard the flow of heat. The R value is the reciprocal of the heat transfer coefficient.  $R = 1/U$ .

**Thermal transmittance overall,  $U_o$ , or overall  $U_o$ :** Overall (average) heat transmission of a gross area of the exterior building envelope, expressed in units of Btu per hour per square foot per degree F. The  $U_o$  value applies to the combined effect of the time rate of heat flows through the various parallel paths, such as windows, doors, and opaque construction areas, comprising the gross area of one or more exterior building components, such as walls, floors, or roof/ceiling.

**Thermal transmittance, U:** Coefficient of heat transmission (air to air) expressed in units of Btu per hour per square foot per degree F. It is the time rate of heat flow. The U value applies to combinations of different materials used in series along the heat flow path, single materials used in series along the heat flow path, single materials that comprise a building section, cavity air spaces, and surface air films on both sides of a building element.

**Thermoplastic material:** A solid plastic material which is capable of being repeatedly softened by increase of temperature and hardened by decrease of temperature.

**Thermosetting material:** A solid plastic material which is capable of being changed into a substantially non-reformable product when cured under the application of heat or pressure.

**Thermostat:** An instrument which measures changes in temperature, and controls devices for maintaining a desired temperature.

**Tile:** A ceramic surface unit, usually relatively thin in relation to facial area, made from clay or a mixture of clay and other ceramic materials, called the body of the tile, having either "glazed" or "unglazed" face and fired above red heat in the course of manufacture to a temperature sufficiently high to produce specific physical properties and characteristics.

**Travel trailer:** A vehicular, portable structure built on a chassis and designed to be used for temporary occupancy for travel, recreational or vacation use; with the manufacturer's permanent identification "Travel Trailer," thereon; and when factory equipped for the road, being of any

length provided its gross weight does not exceed forty-five hundred (4500) pounds, or being of any weight provided its overall length does not exceed twenty-eight (28) feet.

**Two-source system:** An automatic sprinkler system which is supplied from a combination of any two (2) of the approved automatic sources of water supply, or from two (2) pressure tanks, or by direct connections of the municipal water supply on two (2) streets in which the water mains are separately valved.

**Unitary cooling and heating equipment:** One or more factory-made assemblies which normally include an evaporator or cooling coil, a compressor and condenser combination, and may include a heating function as well. Where such equipment is provided in more than one assembly, the separate assemblies shall be designed to be used together.

**Unitary heat pump:** One or more factory-made assemblies which normally include an indoor conditioning coil, compressor(s) and outdoor coil or refrigerant-to-water heat exchanger, including means to provide both heating and cooling functions. It is designed to provide the functions of air-circulation, air cleaning, cooling, and heating with controlled temperature, and dehumidifying, and may optionally include the function of humidifying. When such equipment is provided in more than one assembly, the separate assemblies shall be designed to be used together.

**Use group:** The classification of a building or structure based on the purpose for which it is used as set forth in Sections 203.0 through 212.0.

**Use (used):** The purpose for which the building or structure is designed, used or intended to be used.

**Vent:** A conduit or passageway, vertical or nearly so, for conveying products of combustion to the outside atmosphere.

**Type B and Type B-W:** A gas venting system consisting of vent piping and fittings listed for use with a listed gas appliance.

**Type L:** A low temperature venting system, consisting of listing vent piping and fittings for use with oil-burning appliances listed for use with Type L vents, or with listed gas appliances.

**Vent connector:** The pipe used to connect an approved fuel-fired appliance to a chimney or vent.

**Vent system:** A continuous open passageway from the flue collar or draft hood of a fuel burning appliance to the outside atmosphere for the purpose of removing products of combustion.

**Ventilation:** The process of supplying air to, or removing air from, any space. Such air may or may not have been conditioned.

**Ventilation air:** That portion of supply air which comes from outdoors, plus any recirculated air that has been treated to maintain the desired quality of air within a designated space.

**Vertical opening:** An opening through a floor or roof.

**Volatile flammables:** A liquid that will emit a flammable vapor at a temperature of less than one-hundred (100) degrees Fahrenheit, to be ascertained by any standard closed-cup instrument.

## Wall

**Apron wall:** That portion of a skeleton wall below the sill of a window.

**Bearing wall:** A wall supporting any vertical load in addition to its own weight.

**Cavity wall:** A wall built of masonry units or of plain concrete, or a combination of these materials, arranged to provide an air space within the wall, and in which the inner and outer parts of the wall are tied together with metal ties.

**Composite wall:** A wall built of a combination of two (2) or more masonry units of different materials bonded together, one (1) forming the back-up and the other the facing elements.

**Curtain wall:** A non-bearing enclosure wall not supported at each story.

**Division wall:** A wall used to divide the floor area of a building or structure into separate parts for fire protection, for different uses, for restricted occupancy, or for other purposes specified in this code.

**Faced wall:** A wall in which the masonry facing and backing are so bonded as to exert common action under load.

**Hollow wall:** A wall built of masonry units so arranged as to provide an air space within the wall, and in which the facing and backing of the wall are bonded together with masonry units.

**Non-bearing wall:** A wall which does not support vertical load other than its own weight.

**Parapet wall:** That part of any wall entirely above the roof line.

**Retaining wall:** A wall designed to resist the lateral displacement of soil or other material.

**Skeleton or panel wall:** A nonbearing wall supported by each story on a skeleton frame.



780 CMR: STATE BUILDING CODE COMMISSION

**Spandrel wall:** That portion of a skeleton wall above the head of a window or door.

**Veneered wall:** A wall having a facing of masonry or other weather-resisting noncombustible materials securely attached to the backing but not so bonded as to exert common action under load.

**Wall sign:** A sign which is painted on or attached directly to a fence or on the surface of masonry, concrete, frame or other approved building walls, and which extends not more than fifteen (15) inches from the face of the fence or wall.

**Water spray fixed system:** A system using water in a form having a predetermined pattern, particle size, velocity, and density discharged from specially designed nozzles or devices.

**Width**

**Inner court:** As applied to an inner court, means its least horizontal dimension.

**Outer court:** As applied to an outer court, means the shortest horizontal dimension measured in a direction substantially parallel with the principal open end of such court.

**Winder:** A step in a winding stairway.

**Writing:** The term shall be construed to include handwriting, type-writing, printing, photo-offset or any other form of reproduction in legible symbols or characters.

**Written notice:** A notification in writing delivered in person to the individual or parties intended, or delivered at, or sent by certified or registered mail to the last residential or business address of legal record.

**Yard:** An unoccupied open space other than a court.

**Zone:** A space or group of spaces within a building with heating and/ or cooling requirements sufficiently similar so that comfort conditions can be maintained throughout by a single controlling device.

**Zoning:** The reservation of certain specified areas within a community or city for building and structures, or use of land, for certain purposes with other limitations such as height, lot coverage and other stipulated requirements.

SECTION 202.0 USE GROUP CLASSIFICATION

**202.1 General:** All buildings and structures shall be classified with respect to use in one (1) of the following use groups listed below:

1. Use group A assembly (see Section 203.0).
2. Use group B business (see Section 204.0).
3. Use group F factory and industrial (see Section 205.0).
4. Use group H high hazard (see Section 206.0).
5. Use group I institutional (see Section 207.0).
6. Use group M mercantile (see Section 208.0).
7. Use group R residential (see Section 209.0).
8. Use group S storage (see Section 210.0).
9. Use group T temporary and miscellaneous (see Section 211.0).

202.2 Fire grading of buildings: All buildings and structures shall be graded in accordance with the degree of fire hazard of their use in terms of hours and fractions of an hour and as regulated by Section 902.0.

202.3 New uses: The building official shall establish by approved rules the degree of hazard involved and the fire grading of any use not specifically provided for in this code.

#### SECTION 203.0 USE GROUP A, ASSEMBLY BUILDINGS

203.1 General: All buildings and structures, or parts thereof, shall be classified in the assembly (A) use group which are used or designed for places of assembly as defined in this code. Other buildings and structures, or parts thereof, which accommodate less than fifty (50) individuals but would otherwise qualify as places of assembly, shall be classified in the business (B) use group.

##### 203.2 Use group A-1, theatres

203.2.1 Use group A-1-A structures: This use group shall include all theatres and other buildings used primarily for theatrical or operatic performances and exhibitions, arranged with a raised stage proscenium curtain, fixed or portable scenery loft, lights, motion picture booth, mechanical appliances or other theatrical accessories and equipment, and provided with fixed seats.

203.2.2 Use group A-1-B structures: This use group shall include all theatres without a stage and equipped with fixed seats used for motion picture performances.

203.3 Use group A-2 structures: This use group shall include all buildings and places of public assembly, without theatrical stage accessories, designed for use as dance halls, night clubs and for similar purposes including all rooms, lobbies and other spaces connected thereto with a common means of egress and entrance.

203.4 Use group A-3 structures: This use group shall include all buildings with or without an auditorium in which persons assemble for amusement, entertainment or recreation, and incidental motion picture dramatic, theatrical or educational presentations, lectures, or other similar purposes without theatrical stage other than a raised platform; and principally used without permanent seating facilities, including art galleries, exhibition halls, museums, lecture halls, libraries, restaurants other than night clubs, and recreation centers; and buildings designed for other similar assembly purposes including passenger terminals.

203.5 Use group A-4 structures: This use group shall include all buildings used as churches, schools, colleges and for similar educational and religious purposes. (see Section 434.0, Day care centers.)

203.6 Use group A-5 structures: This use group shall include grandstands, bleachers, coliseums, stadiums, drive-in theatres, tents and similar structures for outdoor assembly use, and shall comply with the provisions of this code for special uses and occupancies (see Article 4).

203.7 Regulations guide: The following listing contained in Table 203.7 is a guide to the principal requirements of this code applicable to use group A, assembly buildings. They are not necessarily the only, nor all, of the provisions with which compliance is required. Omission of reference to any provision shall not nullify any requirement of this code, nor exempt any structure from such requirement.

Table 203.7

## ASSEMBLY BUILDINGS REGULATIONS GUIDE

|                           |   |
|---------------------------|---|
| Types of construction:    | Construction classification 214.0<br>Historic buildings 436.0<br>Places of public assembly 417.0<br>Public assembly other than theatres 418.0<br>Stadiums and grandstands 420.0<br>Drive-in motion picture theatres 421.0   |
| Allowable area:           | General area limitations 305.0<br>Area exceptions 306.0<br>Subdivision of attic spaces 875.9<br>Unlimited areas 307.0<br>Unlimited area, school bldgs. 307.1.1<br>Unlimited area, indoor recreation 307.1.2   |
| Allowable height:         | General height limitations 305.0<br>Height exceptions 308.0   |
| Fire separations:         | Fire walls and party walls 907.0<br>Fire separation walls 909.0<br>Elevator opening protectives Article 16<br>Automatic, fire doors and dampers 903.0<br>Mixed use and occupancy 213.0<br>Vertical shafts 910.0<br>Fireresistance rated floor/roof assemblies 912.0   |
| Exterior wall protection: | Exterior walls 906.0<br>Exterior opening protectives 914.0<br>Glazing of unprotected openings 1902.0  |
| Fire limit requirements:  | Restrictions within fire limits 302.0<br>Restrictions outside fire limits 303.0<br>Roof structures 925.0  |
| Fireresistance:           | Fire hazard classification 902.0<br>Fireresistance tests 903.0<br>Roof coverings 903.3<br>Opening protectives 903.4<br>Fire-retardant treated wood 903.6<br>Fireresistance of structural members 911.0<br>Fireresistance rated floor/roof assemblies 912.0<br>Roof construction 913.0<br>Fire windows and shutters 916.0<br>Fire stopping 919.0 and 875.9<br>Balconies 924.0<br>Roof structures 925.0<br>Roof coverings 926.0<br>Refuse vaults, enclosure requirements 1108.0<br>Basement assembly uses 905.7.3<br>Grade floor protection 905.7 |
| Interior finish:          | Interior finish and trim 920.0<br>Application of interior finish 921.0<br>Flame resistance tests 904.0<br>Decorative material restrictions 923.0  |
| Means of egress:          | Occupancy load 606.0<br>Location 607.0<br>Capacity 608.0<br>Number of exitways 609.0  |

## ASSEMBLY BUILDINGS REGULATIONS GUIDE

|  |   |
|--|---|
| Means of egress:<br>(continued)          | Exitway access corridors 610.0<br>Grade passageways 611.0<br>Means of egress doorways 612.0<br>Horizontal exits 614.0<br>Interior exitway stairways 616.0<br>Access to roof 617.0<br>Exit signs 623.0<br>Means of egress lighting 624.0<br>Elevator, exitway restrictions Article 16<br>Smokeproof enclosures 618.0<br>Exterior exitway stairways 619.0<br>Panic hardware 612.5.2 (also see Sections 417.0 and 418.0) |
| Fire protection systems:                 | Water sprinkler systems 1204.0<br>Fire suppression systems 1202.0<br>Standpipe systems 1211.0<br>Fire department connections 1213.0<br>Water supply 1214.0<br>Manual fire alarm systems 1217.0<br>Supervision 1218.0  |
| Vertical openings:                       | Shafts 515.0<br>Firestopping 919.0<br>Vertical shafts and hoistways 910.0<br>Hoistway enclosures and venting Article 16<br>Fire ventilation of open wells 520.0   |
| Hazardous area:                          | Boiler and equipment rooms 400.6<br>Segregation of storage space 400.8<br>Existing buildings 405.0<br>Pyroxylin plastics 407.0<br>Inspection of hazardous uses 403.1  |
| Light and ventilation:                   | Bath and toilet rooms 512.0<br>Required fresh air supply 514.0<br>Ventilation of shafts 515.0<br>Artificial light and ventilation 504.0<br>Natural light and ventilation 506.0<br>Air-conditioning, refrigeration and mechanical ventilation (see mechanical code listed in Appendix B)<br>Skylights 1905.0   |
| Sanitation:                              | Plumbing and drainage Article 17<br>Termite protection 874.0  |
| Electrical wiring:                       | Article 15  |
| Motion picture protection rooms:         | Use and storage of flammable films 408.0<br>Projection rooms, construction 408.3  |
| Stages and platforms:                    | Stage construction 417.7<br>Dressing rooms 417.8  |
| Provisions for the handicapped and aged: | Section 315.0   |
| Energy conservation:                     | Article 20  |

## SECTION 204.0 USE GROUP B, BUSINESS BUILDINGS

204.1 General: All buildings and structures, or parts thereof, shall be classified in the business ( B ) use group which are used for the trans- action of business for the rendering of professional services, or for other services that involve stocks of goods, wares or merchandise in limited quantities for use incidental to office uses or similar purposes; including among others offices, banks, civic administration activities, courthouses fire houses, police stations, professional services, clinics operated on an outpatient basis which do not harbor patients overnight, testing and research laboratories, radio stations, telephone exchanges, motor fuel service stations and similar establishments.

204.2 Regulations guide: The following listing contained in Table 204.2 is a guide to the principal requirements of this code applicable to use group B, business buildings. They are not necessarily the only, nor all of the provisions with which compliance is required. Omission of refer- ence to any provision shall not nullify any requirement of this code, nor exempt any structure from such requirement.

Table 204.2  
BUSINESS BUILDINGS REGULATIONS GUIDE

|                           |  |
|---------------------------|--|
| Types of construction:    | Construction classification 214.0<br>Mixed use and occupancy 213.0<br>Historic buildings 436.0<br>Motor fuel service stations 415.0<br>Open parking structures 429.0<br>High rise buildings 431.0  |
| Allowable area:           | General area limitations 305.0<br>Area exceptions 306.0<br>Subdivision of attic spaces 875.9<br>Unlimited area buildings 307.0   |
| Allowable height:         | General height limitations 305.0<br>Height exceptions 308.0  |
| Fire separations:         | Fire walls and party walls 907.0<br>Fire separation walls 909.0<br>Elevator opening protectives Article 16<br>Automatic fire doors and dampers 903.0<br>Mixed use and occupancy 213.0<br>Vertical shafts 910.0<br>Fireresistance rated floor/roof assemblies 912.0 |
| Exterior wall protection: | Exterior walls 906.0<br>Exterior opening protectives 914.0<br>Glazing of unprotected openings 1902.0   |
| Fire limit requirements:  | Restrictions within fire limits 302.0<br>Restrictions outside fire limits 303.0<br>Roof structures 925.0   |
| Fireresistance:           | Fire hazard classification 902.0<br>Fireresistance tests 903.0<br>Roof coverings 903.3<br>Opening protectives 903.4  |

Table 204.2

Table 204.2 (cont'd.)  
**BUSINESS BUILDINGS REGULATIONS GUIDE**

|   |   |
|---|---|
| Light and ventilation:<br>(continued)       | Air-conditioning, refrigeration and<br>mechanical ventilation (see mechanical code<br>listed in Appendix B)<br>Skylights 1905.0 |
| Sanitation:                                 | Plumbing and drainage Article 17<br>Termite protection 874.0  |
| Electrical wiring:                          | Article 15  |
| Provisions for the handicapped<br>and aged: | Section 315.0   |
| Energy conservation:                        | Article 20  |

Table 204.2 (cont'd.)  
**BUSINESS BUILDINGS REGULATIONS GUIDE**

|                                       |   |
|---------------------------------------|---|
| <b>Fireresistance:</b><br>(continued) | Fire-retardant treated wood 903.6<br>Fireresistance of structural members 911.0<br>Fireresistance rated floor/roof assemblies 912.0<br>Roof construction 913.0<br>Fire windows and shutters 916.0<br>Fire stopping 919.0<br>Balconies 924.0<br>Roof structures 925.0<br>Roof coverings 926.0<br>Refuse vaults, enclosure requirements 1108.0<br>Shipping areas 905.5<br>Grade floor protection 905.7  |
| <b>Interior finish:</b>               | Interior finish and trim 920.0<br>Application of interior finish 921.0<br>Flame resistance tests 904.0  |
| <b>Means of egress:</b>               | Occupancy load 606.0<br>Location 607.0<br>Capacity 608.0<br>Number of exitways 609.0<br>Exitway access corridors 610.0<br>Grade passageways 611.0<br>Means of egress doorways 612.0<br>Horizontal exits 614.0<br>Interior exitway stairways 616.0<br>Access to roof 617.0<br>Exit signs 623.0<br>Means of egress lighting 624.0<br>Elevator, exitway restrictions Article 16<br>Smokeproof enclosures 618.0<br>Exterior exitway stairways 619.0<br>Buildings with one exitway 609.3 |
| <b>Fire protection systems:</b>       | Water sprinkler systems 1204.0<br>Fire suppression systems 431.0 and Article 12<br>Standpipe systems 1211.0<br>Fire department connections 1213.0<br>Water supply 1214.0<br>Automatic fire alarm systems 1216.0<br>Manual fire alarm systems 1217.0<br>Supervision 1218.0   |
| <b>Vertical openings:</b>             | Shafts 515.0<br>Firestopping 919.0<br>Vertical shafts and hoistways 910.0<br>Hoistway enclosures and venting Article 16<br>Fire ventilation of open wells 520.0   |
| <b>Hazardous area:</b>                | Boiler and equipment rooms 400.6<br>Segregation of storage space 400.8<br>Existing buildings 405.0<br>Pyroxylin plastics 407.0  |
| <b>Light and ventilation:</b>         | Bath and toilet rooms 512.0<br>Required fresh air supply 514.0<br>Ventilation of shafts 515.0<br>Artificial light and ventilation 504.0<br>Natural light and ventilation 506.0  |



SECTION 205.0 USE GROUP F, FACTORY AND INDUSTRIAL BUILDINGS

205.1 General: All buildings and structures, or parts thereof, in which occupants are engaged in performing work or labor in fabricating, assembling or processing, of products or materials, shall be classified in the factory and industrial (F) use group; including, among others, factories, assembling plants, industrial laboratories and all other industrial and manufacturing uses, except those involving highly combustible, flammable or explosive products and materials of the high hazard use group (use group H).

205.2 List of factory and industrial uses: The processes and manufacturers listed in the following Table 205.2 shall be indicative of, and include, the uses permitted in use group F buildings.

Table 205.2

Table 205.2  
USE GROUP F, FACTORY AND INDUSTRIAL USES

|   |  |
|---|--|
| Bakeries  | Ice plants   |
| Boiler works  | Leather and tanneries, excluding enameling or japanning                          |
| Breweries   | Millwork and woodworking   |
| Canneries, including food products  | Sugar refineries   |
| Condensed and powered milk manufacture  | Tenant factories, excluding ladies' dresses and other high hazard uses.          |
| Dry cleaning using other than volatile flammable liquids in cleaning or dyeing operations or other than classified in Table 206.3 | Textile mills, including canvas, cotton cloth, bagging, burlap, carpets and rags |
| Electric light plants and power houses  | Upholstery and manufacturing shops   |
| Electrolytic reducing works   | Water-pumping plants   |
| Glass plants  |  |

205.3 Special industrial uses: All buildings and structures designed to house low hazard industrial processes, including, among others, the production and distribution of electric, gas or steam power and rolling mills and foundries, requiring large areas and unusual heights to accommodate craneways or special machinery and equipment, shall be exempt from the height and area limitations of Table 305.

205.3.1 Construction: Buildings and structures for such special industrial uses shall comply with the requirements of Section 307.0, except as to height, and when constructed of noncombustible (Type 2C) construction may have balconies and mezzanine floors which do not exceed two-thirds (2/3) the area of the main floor in any one (1) tier.

205.3.2 Exterior walls: The exterior walls of buildings of such low hazard industrial uses shall be constructed of approved noncombustible and weather resisting materials, and, when located with a fire separation of less than thirty (30) feet from interior lot lines of any other building shall be protected or constructed to provide a fireresistance rating of not less than two (2) hours.

205.3.3 Fire protection systems: Special use industrial buildings as herein defined shall comply with the requirements of Article 12 for fire protection systems; except that the provisions of Section 307.0 for automatic fire suppression systems in unlimited area buildings may be waived by the building official when such installations would be detrimental or dangerous to the specific use and occupancy.

205.4 Regulations guide: The following listing contained in Table 205.4 is a guide to the principal requirements of this code applicable to use group F, factory and industrial buildings. They are not necessarily the only, nor all, of the provisions with which compliance is required. Omission of reference to any provision shall not nullify any requirement of this code, nor exempt any structure from such requirement.

Table 205.4  
FACTORY AND INDUSTRIAL BUILDINGS REGULATIONS GUIDE

|                        |  |
|------------------------|--|
| Types of construction: | Construction classification 214.0<br>Mixed use and occupancy 213.0<br>Historic buildings 436.0   |
| Allowable area:        | General area limitations 305.0<br>Area exceptions 306.0<br>Subdivision of attic spaces 875.9<br>Unlimited area buildings 307.0   |
| Allowable height:      | General height limitations 305.0<br>Height exceptions 308.0  |
| Fire separations:      | Fire walls and party walls 907.0<br>Fire separation walls 909.0<br>Elevator opening protectives Article 16<br>Automatic fire doors and dampers 903.0<br>Mixed use and occupancy 213.0<br>Vertical Shafts 910.0<br>Fireresistance rated floor/roof assemblies 912.0 |

Table 205.4

|                           |  |
|---------------------------|--|
| Exterior wall protection: | Exterior walls 906.0<br>Exterior opening protectives 914.0<br>Glazing of unprotected openings 1902.0   |
| Fire limit requirements:  | Restrictions within fire limits 302.0<br>Restrictions outside fire limits 303.0<br>Roof structures 925.0   |
| Fire resistance:          | Fire hazard classification 902.0<br>Fire resistance tests 903.0<br>Roof coverings 903.3<br>Opening protectives 903.4<br>Fire-retardant treated wood 903.6<br>Fire resistance of structural members 911.0<br>Fire resistance rated floor/roof assemblies 912.0<br>Roof construction 913.0<br>Fire windows and shutters 916.0<br>Fire stopping 919.0 and 875.9<br>Balconies 924.0<br>Roof structures 925.0<br>Roof coverings 926.0<br>Refuse vaults, enclosure requirements 1108.0<br>Grade floor protection 905.7 |
| Interior finish:          | Interior finish and trim 920.0<br>Application of interior finish 921.0<br>Flame resistance tests 904.0   |
| Means of egress:          | Occupancy load 606.0<br>Location 607.0<br>Capacity 608.0<br>Number of exitways 609.0<br>Exitway access corridors 610.0<br>Grade passageways 611.0<br>Means of egress doorways 612.0<br>Horizontal exits 614.0<br>Interior exitway stairways 616.0<br>Access to roof 617.0<br>Exit signs 623.0<br>Means of egress lighting 624.0<br>Elevator, exitway restrictions Article 16<br>Smokeproof enclosures 618.0<br>Exterior exitway stairways 619.0  |
| Fire protection systems:  | Water sprinkler systems 1204.0<br>Fire suppression systems 1202.0<br>Standpipe systems 1211.0<br>Fire department connections 1213.0<br>Water supply 1214.0<br>Supervision 1218.0   |
| Vertical openings:        | Shafts 515.0<br>Firestopping 919.0<br>Vertical shafts and hoistways 910.0<br>Hoistway enclosures and venting Article 16  |

Table 205.4

|   |  |
|---|--|
| Hazardous area:                             | Boiler and equipment rooms 400.6<br>Segregation of storage space 400.8<br>Existing buildings 405.0<br>Pyroxylin plastics 407.0<br>Special permits 404.0<br>Paint spraying 411.0<br>Dry cleaning establishments 412.0   |
| Light and ventilation:                      | Bath and toilet rooms 512.0<br>Required fresh air supply 514.0<br>Ventilation of shafts 515.0<br>Artificial light and ventilation 504.0<br>Natural light and ventilation 506.0<br>Air-conditioning, refrigeration and<br>mechanical ventilation (see mechanical code<br>listed in Appendix B)<br>Skylights 1905.0<br>Drying rooms 1106.0 |
| Sanitation:                                 | Plumbing and drainage Article 17<br>Termite protection 874.0   |
| Electrical wiring:                          | Article 15   |
| Provisions for the handicapped<br>and aged: | Section 315.0  |
| Energy conservation:                        | Article 20   |

SECTION 206.0 USE GROUP H, HIGH HAZARD BUILDINGS

206.1 General: All buildings and structures, or parts thereof, shall be classified in the high hazard (H) use group which are used for the storage, manufacture or processing of highly combustible or explosive products or materials, which are likely to burn with extreme rapidity, or which may produce poisonous fumes or explosions; for storage or manufacturing which involves highly corrosive, toxic or noxious alkalies, acids or other liquids or chemicals producing flame, fume, poisonous, irritant or corrosive gases; and for the storage or processing of any materials producing explosive mixtures of dust, or which result in the division of matter into fine particles subject to spontaneous ignition.

206.2 List of high hazard uses: The processes, materials and manufactures listed in the following Table 206.2 are indicative of and shall be included among high hazard uses.

Table 206.2  
Use Group H, High Hazard Uses

|  |   |
|--|---|
| Acetylene gas and gases under pressure of fifteen (15) pounds or more and in quantities of greater than twenty-five hundred (2500) cubic feet; including hydrogen, illuminating, natural, ammonia, chlorine, phosgene, sulphur dioxide, carbon monoxide, methyl oxide and all gases subject to explosion, fume or toxic hazard                                 | Kerosene, fuel, lubricating, or any oil storage with a flash point under two hundred (200) degrees F. |
| Ammunition, explosives and fireworks manufacture   | Match manufacture or storage  |
| Artificial flowers and synthetic leather manufacture   | Metal enameling or japanning  |
| Celluloid and celluloid products   | Nitro-cellulose film exchanges and laboratories   |
| Cereal, feed, flour and grist mills  | Paint and varnish manufacture   |
| Cotton batting and cotton waste processes  | Paint spraying or dipping   |
| Cotton dressmaking   | Petroleum manufacture   |
| Dry cleaning establishments using or storing more than three (3) gallons of gasoline or other hazardous liquids with a flash point under one hundred (100) degrees F., or more than sixty (60) gallons of volatile flammable liquids with flash point between one hundred (100) and one hundred and forty (140) degrees F., in a closed-cup tester (ASTM D56). | Processing of paper or cardboard in loose form  |
| Feather renovating   | PYROXYLIN products manufacture and storage  |
| Fruit ripening processes   | Rag sorting and storage   |
| Grain elevators  | Refrigerating systems using high hazard refrigerants as defined in the mechanical code                |
| Hydrogenation processes  | Shoddy mills  |
| Industries employing solids or substances which ignite or produce flammable gases on contact with water  | Shoe polish manufacture   |
|  | Smoke houses (industrial)   |
|  | Straw goods manufacture or broom corn storage   |
|  | Sugar and starch pulverizing mills  |
|  | Tar, pitch or resin processing  |
|  | Tanneries with enameling or japanning   |
|  | Tire storage warehouse  |
|  | Waste paper sorting, shredding, storage or baling   |

206.3 Regulations guide: The following listing contained in Table 206.3 is a guide to the principal requirements of this code applicable to use group H, high hazard buildings. They are not necessarily the only, nor all, of the provisions with which compliance is required. Omission of reference to any provision shall not nullify any requirement of this code, nor exempt any structure from such requirement.

Table 206.3

## HIGH HAZARD BUILDINGS REGULATIONS GUIDE

|                           |  |
|---------------------------|--|
| Types of construction:    | Construction classification 214.0<br>Mixed use and occupancy 213.0<br>Historic buildings 436.0<br>Special high hazards 400.3   |
| Allowable area:           | General area limitations 305.0<br>Area exceptions 306.0<br>Subdivision of attic spaces 875.9   |
| Allowable height:         | General height limitations 305.0<br>Height exceptions 308.0  |
| Fire separations:         | Fire walls and party walls 907.0<br>Fire separation walls 909.0<br>Elevator opening protectives Article 16<br>Automatic fire doors and dampers 903.0<br>Mixed use and occupancy 213.0<br>Vertical shafts 910.0<br>Fireresistance rated floor/roof assemblies 912.0   |
| Exterior wall protection: | Exterior walls 906.0<br>Exterior opening protectives 914.0<br>Glazing of unprotected openings 1902.0   |
| Fire limit requirements:  | Restrictions within limits 302.0<br>Restrictions outside fire limits 303.0<br>Roof structures 925.0  |
| Fireresistance:           | Fire hazard classification 902.0<br>Fireresistance tests 903.0<br>Roof coverings 903.3<br>Opening protectives 903.4<br>Fire-retardant-treated wood 903.6<br>Fireresistance of structural members 911.0<br>Fireresistance rated floor/roof assemblies 912.0<br>Roof construction 913.0<br>Fire windows and shutters 916.0<br>Firestopping 919.0 and 875.9<br>Balconies 924.0<br>Roof structures 925.0<br>Roof coverings 926.0<br>Refuse vaults, enclosure requirements 1108.0<br>Grade floor protection 905.7 |
| Interior finish:          | Interior finish and trim 920.0<br>Application of interior finish 921.0<br>Flame resistance tests 904.0   |

Table 206.3 (cont'd.)

## HIGH HAZARD BUILDINGS REGULATIONS GUIDE

|   |  |
|---|--|
| Means of egress:                            | Occupancy load 606.0<br>Location 607.0<br>Capacity 608.0<br>Number of exitways 609.0<br>Exitway access corridors 610.0<br>Grade passageways 611.0<br>Means of egress doorways 612.0<br>Horizontal exits 614.0<br>Interior exitway stairways 616.0<br>Access to roof 617.0<br>Exit signs 623.0<br>Means of egress lighting 624.0<br>Elevator, exitway restrictions Article 16<br>Exterior exitway stairway 619.0<br>Slidescapes 622.0 |
| Fire protection systems:                    | Water sprinkler systems 1204.0<br>Fire suppression systems 1202.0<br>Standpipe systems 1211.0<br>Fire department connections 1213.0<br>Water supply 1214.0<br>Supervision 1218.0   |
| Vertical openings:                          | Shafts 515.0<br>Firestopping 919.0<br>Vertical shafts and hoistways 910.0<br>Hoistway enclosures and venting Article 16<br>Fire ventilation of open wells 520.0  |
| Hazardous area:                             | Boiler and equipment rooms 400.6<br>Segregation of storage space 400.8<br>Existing buildings 405.0<br>Pyroxylin plastics 407.0<br>Explosion hazards 401.0<br>Volatile flammables 402.0<br>Outside aboveground storage 402.2.2<br>Inspection of hazardous uses 403.1<br>Special permits 404.0   |
| Hazardous area:<br>(continued)              | Combustible dusts, grain processing and storage 410.0<br>Combustible fibers, construction requirements 409.2<br>Paint spraying 411.0<br>Dry cleaning establishments 412.0  |
| Light and ventilation:                      | Bath and toilet rooms 512.0<br>Required fresh air supply 514.0<br>Ventilation of shafts 515.0<br>Artificial light and ventilation 504.0<br>Natural light and ventilation 506.0<br>Air-conditioning, refrigeration and mechanical ventilation<br>(see mechanical code listed in Appendix B)<br>Skylights 1905.0   |
| Sanitation:                                 | Plumbing and drainage Article 17<br>Termite protection 874.0   |
| Electrical wiring:                          | Article 15   |
| Provisions for the handicapped<br>and aged: | Section 315.0  |
| Energy conservation:                        | Article 20   |

SECTION 207.0 USE GROUP I, INSTITUTIONAL BUILDINGS

207.1 General: All buildings and structures, or parts thereof, shall be classified in the institutional (I) use group in which people suffering from physical limitations because of health or age are harbored for medical or other care or treatment, or in which people are detained for penal or correctional purposes, or in which the liberty of the inmates is restricted.

207.2 Use group I-1: This use group shall include all buildings designed for the detention of people under restraint, including, among others, jails, prisons, reformatories, insane asylums and similar uses.

207.3 Use group I-2: This use group shall include all buildings used for housing people suffering from physical limitations because of health or age, including among others, day nurseries, hospitals, sanitariums, clinics, infirmaries, orphanages, and homes for aged and infirm. (see Section 434.0, Day care centers.)

207.4 Regulations guide: The following listing contained in Table 207.4 is a guide to the principal requirements of this code applicable to use group I, institutional buildings. They are not necessarily the only, nor all, of the provisions with which compliance is required. Omission of reference to any provisions shall not nullify any requirement of this code, nor exempt any structure from such requirement.



Table 207.4  
**INSTITUTIONAL BUILDINGS REGULATIONS GUIDE**

|                           |  |
|---------------------------|--|
| Types of construction:    | Construction classification 214.0<br>Mixed use and occupancy 213.0<br>Historic buildings 436.0   |
| Allowable area:           | General area limitations 305.0<br>Area exceptions 306.0<br>Subdivision of attic spaces 875.9<br>Unlimited area buildings 307.0   |
| Allowable height:         | General height limitations 305.0<br>Height exceptions 308.0  |
| Fire separations:         | Fire walls and party walls 907.0<br>Fire separation walls 909.0<br>Elevator opening protectives Article 16<br>Automatic fire doors and dampers 903.0<br>Mixed use and occupancy 213.0<br>Vertical shafts 910.0<br>Fireresistance rated floor/roof assemblies 912.0   |
| Exterior wall protection: | Exterior walls 906.0<br>Exterior opening protectives 914.0<br>Glazing of unprotected openings 1902.0   |
| Fire limit requirements:  | Restrictions within fire limits 302.0<br>Restrictions outside fire limits 303.0<br>Roof structures 925.0   |
| Fireresistance:           | Fire hazard classification 902.0<br>Fireresistance tests 903.0<br>Roof coverings 903.3<br>Opening protectives 903.4<br>Fire-retardant treated wood 903.6<br>Fireresistance of structural members 911.0<br>Fireresistance rated floor/roof assemblies 912.0<br>Roof construction 913.0<br>Fire windows and shutters 916.0<br>Firestopping 919.0<br>Balconies 924.0<br>Roof structures 925.0<br>Roof coverings 926.0<br>Refuse vaults, enclosure requirements 1108.0<br>Grade floor protection 905.7 |
| Interior finish:          | Interior finish and trim 920.0<br>Application of interior finish 921.0<br>Flame resistance tests 904.0   |
| Means of egress:          | Occupancy load 606.0<br>Location 607.0<br>Capacity 608.0<br>Number of exitways 609.0<br>Exitway access corridors 610.0<br>Grade passageways 611.0<br>Means of egress doorways 612.0<br>Horizontal exits 614.0<br>Interior exitway stairways 616.0<br>Access to roof 617.0<br>Exit signs 623.0  |

Table 207.4 (cont'd.)

INSTITUTIONAL BUILDINGS REGULATIONS GUIDE

|   |  |
|---|--|
| Means of egress:<br>(continued)             | Means of egress lighting 624.0<br>Elevator, exitway restrictions Article 16<br>Smokeproof enclosures 618.0<br>Slidescapes 622.0<br>Revolving doors 613.0   |
| Fire protection systems:                    | Water sprinkler systems 1204.0<br>Fire suppression systems 1202.0<br>Standpipe systems 1211.0<br>Fire department connections 1213.0<br>Water supply 1214.0<br>Fire emergency ventilating system 519.0<br>Automatic fire alarm systems 1216.0<br>Supervision 1218.0   |
| Vertical openings:                          | Shafts 515.0<br>Firestopping 919.0<br>Vertical shafts and hoistways 910.0<br>Hoistway enclosures and venting Article 16  |
| Hazardous area:                             | Boiler and equipment rooms 400.6<br>Segregation of storage space 400.8<br>Existing buildings 405.0<br>Pyroxylin plastics 407.0   |
| Light and ventilation:                      | Bath and toilet rooms 512.0<br>Required fresh air supply 514.0<br>Ventilation of shafts 515.0<br>Artificial light and ventilation 504.0<br>Natural light and ventilation 506.0<br>Air-conditioning, refrigeration and mechanical ventilation<br>(see mechanical code-listed in Appendix B)<br>Skylights 1905.0 |
| Sanitation:                                 | Plumbing and drainage Article 17<br>Termite protection 874.0   |
| Electrical wiring:                          | Article 15   |
| Provisions for the handicapped<br>and aged: | Section 315.0  |
| Energy conservation:                        | Article 20   |

## SECTION 208.0 USE GROUP M, MERCANTILE BUILDINGS

208.1 General: All buildings and structures, or parts thereof, shall be classified in the mercantile (M) use group which are used for display and sales purposes involving stocks of goods, wares or merchandise incidental to such purposes and accessible to the public; including, among others, retail stores, shops and salesrooms and markets. Highly combustible goods, such as merchandise made of pyroxylin products, shall be limited to small quantities that do not constitute a high hazard; and if not so limited, the construction shall comply with the requirements of the high hazard use group as required by the provisions of Article 4 and Tables 214 and 305.

208.2 Regulations guide: The following listing contained in Table 208.2 is a guide to the principal requirements of this code applicable to use group M, mercantile buildings. They are not necessarily the only, nor all, of the provisions with which compliance is required. Omission of reference to any provisions shall not nullify any requirement of this code, nor exempt any structure from such requirement.

Table 208.2

## MERCANTILE BUILDINGS REGULATIONS GUIDE

|                           |   |
|---------------------------|---|
| Types of construction:    | Construction classification 214.0<br>Mixed use and occupancy 213.0<br>Historic buildings 436.0<br>Tents and air supported structures 422.0<br>Radio and television towers 426.0<br>Radio and television antennae 427.0<br>Open parking structures 429.0<br>Covered malls 432.0                    |
| Allowable area:           | General area limitations 305.0<br>Area exceptions 306.0<br>Subdivision attic spaces 875.9<br>Unlimited area buildings 307.0   |
| Allowable height:         | General height limitations 305.0<br>Height exceptions 308.0   |
| Fire separations:         | Fire walls and party walls 907.0<br>Fire separation walls 909.0<br>Elevator opening protectives Article 16<br>Automatic fire doors and dampers 903.0<br>Retail business use 905.6.3<br>Mixed use and occupancy 213.0<br>Vertical shafts 910.0<br>Fireresistance rated floor/roof assemblies 912.0 |
| Exterior wall protection: | Exterior walls 906.0<br>Exterior opening protectives 914.0<br>Glazing of unprotected openings 1902.0  |

Table 208.2 (cont'd.)  
**MERCANTILE BUILDINGS REGULATIONS GUIDE**

|                          |   |
|--------------------------|---|
| Fire limit requirements: | Restrictions within fire limits 302.0<br>Restrictions outside fire limits 303.0<br>Roof structures 925.0  |
| Fire resistance:         | Fire hazard classification 902.0<br>Fire resistance tests 903.0<br>Roof coverings 903.3<br>Opening protectives 903.4<br>Fire-retardant treated wood 903.6<br>Fire resistance of structural members 911.0<br>Fire resistance rated floor/roof assemblies 912.0<br>Roof construction 913.0<br>Fire windows and shutters 916.0<br>Firestopping 919.0<br>Balconies 924.0<br>Roof structures 925.0<br>Roof coverings 926.0<br>Refuse vaults, enclosure requirements 1108.0<br>Packing and shipping rooms 905.4<br>Grade floor protection 905.7 |
| Interior finish:         | Interior finish and trim 920.0<br>Application of interior finish 921.0<br>Flame resistance tests 904.0  |
| Means of egress:         | (also see section 432.0)<br>Occupancy load 606.0<br>Location 607.0<br>Capacity 608.0<br>Number of exitways 609.0<br>Exitway access corridors 610.0<br>Grade passageways 611.0<br>Means of egress doorways 612.0<br>Horizontal exits 614.0<br>Interior exitway stairways 616.0<br>Access to roof 617.0<br>Exit signs 623.0<br>Means of egress lighting 624.0<br>Elevator, exitway restrictions Article 16<br>Smokeproof enclosures 618.0<br>Exterior exitway stairways 619.0   |
| Fire protection systems: | Water sprinkler systems 1204.0<br>Fire suppression systems 1202.0<br>Standpipe systems 1211.0<br>Fire department connections 1213.0<br>Water supply 1214.0<br>Supervision 1218.0  |
| Vertical openings:       | Shafts 515.0<br>Firestopping 919.0<br>Vertical shafts and hoistways 910.0<br>Hoistway enclosures and venting Article 16<br>Fire ventilation of open wells 520.0   |
| Hazardous area:          | Boiler and equipment rooms 400.6<br>Segregation of storage space 400.8<br>Existing buildings 405.0<br>Pyroxylin plastics 407.0  |

Table 208.2 (cont'd.)

## MERCANTILE BUILDINGS REGULATIONS GUIDE

|   |   |
|---|---|
| Light and ventilation:                      | Bath and toilet rooms 512.0<br>Required fresh air supply 514.0<br>Ventilation of shafts 515.0<br>Artificial light and ventilation 504.0<br>Natural light and ventilation 506.0<br>Air-conditioning, refrigeration and mechanical ventilation<br>(see mechanical code listed in Appendix B)<br>Skylights 1905.0<br>Business and work rooms 509.0 |
| Sanitation:                                 | Plumbing and drainage Article 17<br>Termite protection 874.0  |
| Electrical wiring:                          | Article 15  |
| Provisions for the handicapped<br>and aged: | Section 315.0   |
| Energy conservation:                        | Article 20  |

SECTION 209.0 USE GROUP R, RESIDENTIAL BUILDINGS

209.1 General: All buildings and structures, or parts thereof, shall be classified in the residential (R) use group in which families or households live or in which sleeping accommodations are provided for individuals with or without dining facilities, excluding those that are classified as institutional buildings.

209.2 Use group R-1 structures: This use group shall include all hotel and motel buildings, detoxification facilities, and dormitory buildings arranged for the shelter and sleeping accommodation of more than twenty (20) individuals.

209.3 Use group R-2 structures: This use group shall include all multiple-family dwellings having more than two (2) dwelling units; and shall also include all dormitories, boarding and lodging houses arranged for shelter and sleeping accommodation by more than three (3) and not more than twenty (20) individuals.

209.4 Use group R-3 structures: This use group shall include all buildings arranged for the use of one- or two-family dwelling units including not more than three (3) lodgers or boarders per family.

209.5 Use group R-4 structures: This use group shall include all detached one- or two-family dwellings not more than three (3) stories in height, and their accessory structures as indicated in Article 21, One- and Two-Family Dwelling Code. All such structures may be designed in accordance with the One- and Two-Family Dwelling Code or in accordance with the requirements of this code for a use group R-3 structure.

209.6 Use group R-5 structures: This use group shall include all buildings arranged for use as limited group residences in accordance with the requirements of this Code (see Section 438.0).

209.7 Regulations guide: The following listing contained in Table 209.6 is a guide to the principal requirements of this code applicable to use group R, residential buildings. They are not necessarily the only, nor all, of the provisions with which compliance is required. Omission of reference to any provision shall not nullify any requirement of this code, nor exempt any structure from such requirement.

Table 209.6

## RESIDENTIAL BUILDINGS REGULATIONS GUIDE

|                           |  |
|---------------------------|--|
| Types of construction:    | Construction classification 214.0<br>Mixed use and occupancy 213.0<br>Historic buildings 436.0<br>Motels 425.0<br>High rise buildings 431.0<br>Mobile units 424.0<br>Detoxification facilities 439.0   |
| Allowable area:           | General area limitations 305.0<br>Area exceptions 306.0<br>Subdivision of attic spaces 875.9   |
| Allowable height:         | General height limitations 305.0<br>Height exceptions 308.0  |
| Fire separations:         | Fire walls and party walls 907.0<br>Fire separation walls 909.0<br>Elevator opening protectives Article 16<br>Automatic fire doors and dampers 903.0<br>Private garages 413.0<br>Lot line separation 303.2<br>Mixed use and occupancy 213.0<br>Vertical shafts 910.0<br>Fireresistance rated floor/roof assemblies 912.0   |
| Exterior wall protection: | Exterior walls 906.0<br>Exterior opening protectives 914.0<br>Glazing of unprotected openings 1902.0   |
| Fire limit requirements:  | Restrictions with fire limits 302.0<br>Restrictions outside fire limits 303.0<br>Roof structures 925.0   |
| Fireresistance:           | Fire hazard classification 902.0<br>Fireresistance tests 903.0<br>Roof coverings 903.3<br>Opening protectives 903.4<br>Fire-retardant treated wood 903.6<br>Fireresistance of structural members 911.0<br>Fireresistance rated floor/roof assemblies 912.0<br>Roof construction 913.0<br>Fire windows and shutters 916.0<br>Firestopping 919.0<br>Balconies 924.0<br>Roof structures 925.0<br>Roof coverings 926.0<br>Refuse vaults, enclosure requirements 1108.0 |
| Interior finish:          | Interior finish and trim 920.0<br>Application of interior finish 921.0<br>Flame resistance tests 904.0   |
| Means of egress:          | Occupancy load 606.0<br>Location 607.0<br>Capacity 608.0<br>Number of exitways 609.0<br>Exitway access corridors 610.0<br>Grade passageways 611.0<br>Means of egress doorways 612.0<br>Horizontal exits 614.0  |

Table 209.6 (cont'd.)

## RESIDENTIAL BUILDINGS REGULATIONS GUIDE

|  |  |
|--|--|
| Means of egress:<br>(continued)            | Interior exitway stairways 616.0<br>Access to roof 617.0<br>Exit signs 623.0<br>Means of egress lighting 624.0<br>Elevator, exitway restrictions Article 16<br>Smokeproof enclosures 618.0<br>Exterior exitway stairways 619.0<br>Buildings with one exitway 609.3   |
| Fire protection systems:                   | Water sprinkler systems 1204.0<br>Fire suppression systems 431.0 and Article 12<br>Standpipe systems 1211.0<br>Fire department connections 1213.0<br>Water supply 1214.0<br>Fire emergency ventilating system 519.0<br>Automatic fire alarm systems 1216.0<br>Manual fire alarm systems 1217.0                 |
| Vertical openings:                         | Shafts 515.0<br>Firestopping 919.0<br>Vertical shafts and hoistways 910.0<br>Hoistway enclosures and venting Article 16<br>Fire ventilation of open wells 520.0  |
| Hazardous area:                            | Boiler and equipment rooms 400.6<br>Segregation of storage space 400.8<br>Existing buildings 405.0<br>Pyroxylin plastics 407.0<br>Incinerator 1008.0   |
| Light and ventilation:                     | Bath and toilet rooms 512.0<br>Required fresh air supply 514.0<br>Ventilation of shafts 515.0<br>Artificial light and ventilation 504.0<br>Natural light and ventilation 506.0<br>Air-conditioning, refrigeration and mechanical ventilation<br>(see mechanical code listed in Appendix B)<br>Skylights 1905.0 |
| Sanitation:                                | Plumbing and drainage Article 17<br>Termite protection 874.0   |
| Electrical wiring:                         | Article 15   |
| Provisions for the handicapped<br>and aged | Section 315.0  |
| Sound transmission control:                | Section 522.0  |
| Energy conservation:                       | Article 20   |



SECTION 210.0 USE GROUP S, STORAGE BUILDINGS

210.1 General: All buildings and structures or parts thereof shall be classified in the storage (S) use group which are used primarily for the storage of goods, wares or merchandise, except those that involve highly combustible or explosive products or materials; including, among others, warehouses, storehouses and freight depots.

210.2 List of moderate hazard uses: Buildings used for the storage of moderate hazard contents are likely to burn with moderate rapidity, but which do not produce either poisonous gases, fumes or explosives, including among others, the materials listed in the following Table 210.2, shall be classified in the S-1 storage use group.

Table 210.2

USE GROUP S-1 STORAGE USES, MODERATE HAZARD

|   |  |
|---|--|
| Bags, cloth, burlap and paper                   | Linoleum   |
| Bamboo and rattan                               | Livestock shelters   |
| Baskets   | Lumber yards   |
| Belting, canvas and leather                     | Motor vehicle repair shops   |
| Books and paper in rolls or packs               | Petroleum warehouses for storage of lubricating oils with a flash point of three hundred (300) degrees F. or higher (see Section 905.3.) |
| Boots and shoes                                 | Photo-engraving  |
| Buttons, including cloth-covered, pearl or bone | Public garages (Group 1) and stables   |
| Cardboard and cardboard boxes                   | Silk   |
| Clothing, woolen wearing apparel                | Soap   |
| Cordage   | Sugar  |
| Furniture                                       | Tobacco, cigars, cigarettes and snuff  |
| Furs  | Upholstering and mattress manufacturing  |
| Glue, mucilage, paste and size                  | Wax candles  |
| Horn and combs, other than celluloid            |  |
| Leather enameling or japanning                  |  |

210.3 List of low hazard uses: Buildings used for the storage of non-combustibility materials, and of low hazard wares that do not ordinarily burn rapidly, shall be classified in the S-2 storage use group unless herein otherwise classified, including, among others, the materials listed in the following Table 210.3.

Table 210.3

USE GROUP S-2 STORAGE USES, LOW HAZARD

|                   |                       |
|-------------------|-----------------------|
| Asbestos          | Ivory                 |
| Chalk and crayons | Metals                |
| Food products     | Porcelain and pottery |
| Glass             | Talc and soapstones   |

210.4 Regulations guide: The following listing contained in Table 210.4 is a guide to the principal requirements of this code applicable to use group S, storage buildings. They are not necessarily the only, nor all, of the provisions with which compliance is required. Omission of reference to any provision shall not nullify any requirement of this code, nor exempt any structure from such requirement.

Table 210.4

STORAGE BUILDINGS REGULATIONS GUIDE

|                           |  |
|---------------------------|--|
| Types of construction:    | Construction classification 214.0<br>Mixed use and occupancy 213.0<br>Historic buildings 436.0<br>Motor vehicle repair shops 416.0<br>Open parking structures 429.0  |
| Allowable area:           | General area limitations 305.0<br>Area exceptions 306.0<br>Subdivision of attic spaces 875.9<br>Unlimited area buildings 307.0   |
| Allowable height:         | General height limitations 305.0<br>Height exceptions 308.0  |
| Fire separations:         | Fire walls and party walls 907.0<br>Fire separation walls 909.0<br>Elevator opening protectives Article 16<br>Automatic fire doors and dampers 903.0<br>Public garages 414.0<br>Mixed use and occupancy 213.0<br>Vertical shafts 910.0<br>Fireristance rated floor/roof assemblies 912.0 |
| Exterior wall protection: | Exterior walls 906.0<br>Exterior opening protectives 914.0<br>Glazing of unprotected openings 1902.0   |
| Fire limit requirements:  | Restrictions within fire limits 302.0<br>Restrictions outside fire limits 303.0<br>Roof structures 925.0   |
| Fireristance:             | Fire hazard classification 902.0<br>Fireristance tests 903.0<br>Roof coverings 903.3<br>Opening protectives 903.4  |

**780 CMR: STATE BUILDING CODE COMMISSION**

Table 210.4 (cont'd.)

**STORAGE BUILDINGS REGULATIONS GUIDE**

Fire-resistance:  
(continued)

Fire-retardant treated wood 903.6  
 Fire-resistance of structural members 911.0  
 Fire-resistance rated floor/roof assemblies 912.0  
 Roof construction 913.0  
 Fire windows and shutters 916.0  
 Firestopping 919.0  
 Balconies 924.0  
 Roof structures 925.0  
 Roof coverings 926.0  
 Refuse vaults, enclosure requirements 1108.0  
 Grade floor protection 905.7

Interior finish:

Interior finish and trim 920.0  
 Application of interior finish 921.0  
 Flame resistance tests 904.0

Means of egress:

Occupancy load 606.0  
 Location 607.0  
 Capacity 608.0  
 Number of exitways 609.0  
 Exitway access corridors 610.0  
 Grade passageways 611.0  
 Means of egress doorways 612.0  
 Horizontal exits 614.0  
 Interior exitway stairways 616.0  
 Access to roof 617.0  
 Exit signs 623.0  
 Means of egress lighting 624.0  
 Elevator, exitway restrictions Article 16  
 Exterior exitway stairways 619.0

Fire protection systems:

Water sprinkler systems 1204.0  
 Fire suppression systems 1202.0  
 Standpipe systems 1211.0  
 Fire department connections 1213.0  
 Water supply 1214.0  
 Supervision 1218.0

Vertical openings:

Shafts 515.0  
 Firestopping 919.0  
 Vertical shafts and hoistways 910.0  
 Hoistway enclosures and venting Article 16  
 Fire ventilation of open wells 520.0

Hazardous area:

Boiler and equipment rooms 400.6  
 Segregation of storage space 400.8  
 Existing buildings 405.0  
 Pyroxylin plastics 407.0  
 Outside aboveground storage 402.2.2  
 Inspection of hazardous uses 403.1  
 Special permits 404.0

Light and ventilation:

Bath and toilet rooms 512.0  
 Required fresh air supply 514.0  
 Ventilation of shafts 515.0  
 Artificial light and ventilation 504.0  
 Natural light and ventilation 506.0  
 Air-conditioning, refrigeration and mechanical ventilation  
 (see mechanical code listed in Appendix B)  
 Skylights 1905.0  
 Drying rooms 1106.0

Sanitation:

Plumbing and drainage Article 17  
 Termite protection 874.0

Electrical wiring:

Article 15

Provisions for the physically  
handicapped and aged:

Section 315.0

Energy conservation:

Article 20

## SECTION 211.0 USE GROUP T, TEMPORARY AND MISCELLANEOUS USES

211.1 General: Structures and buildings of a temporary character and miscellaneous structures not classified in any specific use group shall be constructed, equipped and maintained to meet the requirements of this code commensurate with the fire and life hazard incidental to their use. Miscellaneous uses shall include all accessory buildings and structures used as private garages, sheds, fences and similar purposes.

211.2 Regulations guide: The following listing contained in Table 211.2 is a guide to the principal requirements of this code applicable to use group T, temporary and miscellaneous buildings. They are not necessarily the only, nor all, of the provisions with which compliance is required. Omission of reference to any provision shall not nullify any requirement of this code, nor exempt any structure from such requirement.

Table 211.2

## TEMPORARY AND MISCELLANEOUS BUILDINGS REGULATIONS GUIDE

|                           |   |
|---------------------------|---|
| Types of construction:    | Construction classification 214.0<br>Mixed use and occupancy 213.0<br>Temporary structures 314.0<br>Tents and air supported structures 422.0<br>Builders shanties and reviewing stands 302.4<br>Signs Article 14  |
| Allowable area:           | General area limitations 305.0<br>Area exceptions 306.0<br>Subdivision of attic spaces 875.9<br>Temporary projections 312.0   |
| Allowable height:         | General height limitations 305.0<br>Height exceptions 308.0<br>Bins, tanks and towers 302.5<br>Storm enclosures 302.3   |
| Fire separations:         | Fire walls and party walls 907.0<br>Fire separation walls 909.0<br>Elevator opening protectives Article 16<br>Automatic fire doors and dampers 903.0<br>Mixed use and occupancy 213.0<br>Vertical shafts 910.0<br>Fire-resistance rated floor/roof assemblies 912.0 |
| Exterior wall protection: | Exterior walls 906.0<br>Exterior opening protectives 914.0<br>Glazing of unprotected openings 1902.0  |
| Fire limit requirements:  | Restrictions within fire limits 302.0<br>Restrictions outside fire limits 303.0<br>Roof structures 925.0  |

Table 211.2 (cont'd.)

## TEMPORARY AND MISCELLANEOUS BUILDINGS REGULATIONS GUIDE

|                          |  |
|--------------------------|--|
| Fire-resistance:         | <p>Fire hazard classification 902.0<br/>         Fire-resistance tests 903.0<br/>         Roof coverings 903.3<br/>         Opening protectives 903.4<br/>         Fire-retardant treated wood 903.6<br/>         Fire-resistance of structural members 911.0<br/>         Fire-resistance rated floor/roof assemblies 912.0<br/>         Roof construction 913.0<br/>         Fire windows and shutters 916.0<br/>         Firestopping 919.0<br/>         Balconies 924.0<br/>         Roof structures 925.0<br/>         Roof coverings 926.0<br/>         Refuse vaults, enclosure requirements 1108.0</p> |
| Interior finish:         | <p>Interior finish and trim 920.0<br/>         Application of interior finish 921.0<br/>         Flame resistance tests 904.0</p>  |
| Means of egress:         | <p>Occupancy load 606.0<br/>         Location 607.0<br/>         Capacity 608.0<br/>         Number of exitways 609.0<br/>         Exitway access corridors 610.0<br/>         Grade passageways 611.0<br/>         Means of egress doorways 612.0<br/>         Horizontal exits 614.0<br/>         Interior exitway stairways 616.0<br/>         Access to roof 617.0<br/>         Exit signs 623.0<br/>         Means of egress lighting 624.0<br/>         Elevator, exitway restrictions Article 16<br/>         Exterior exitway stairways 619.0</p>  |
| Fire protection systems: | <p>Water sprinkler systems 1204.0<br/>         Fire suppression systems 1202.0<br/>         Standpipe systems 1211.0<br/>         Fire department connections 1213.0<br/>         Water supply 1214.0</p>  |
| Vertical openings:       | <p>Shafts 515.0<br/>         Firestopping 919.0<br/>         Vertical shafts and hoistways 910.0<br/>         Hoistway enclosures and venting Article 16<br/>         Fire ventilation of open wells 520.0</p>   |
| Hazardous area:          | <p>Boiler and equipment rooms 400.6<br/>         Refrigeration of storage space 400.8<br/>         Existing buildings 405.0</p>  |
| Light and ventilation:   | <p>Bath and toilet rooms 512.0<br/>         Required fresh air supply 514.0<br/>         Ventilation of shafts 515.0<br/>         Artificial light and ventilation 504.0<br/>         Natural light and ventilation 506.0<br/>         Air-conditioning, refrigeration and mechanical ventilation<br/>         (see mechanical code listed in Appendix B)<br/>         Skylights 1905.0</p>  |
| Sanitation:              | <p>Plumbing and drainage Article 17<br/>         Termite protection 874.0<br/>         Plumbing and water connections 1807.0</p>   |
| Electrical wiring:       | <p>Article 15</p>  |

SECTION 212.0 DOUBTFUL USE CLASSIFICATION

212.1 General: When a building or structure is proposed for a use not specifically provided for in this code or the classification of which is doubtful, such building or structure shall be included in the use group which it most nearly resembles in respect to the existing or proposed life and fire hazard, and it shall be so classified by the building official.

SECTION 213.0 MIXED USE AND OCCUPANCY

213.1 Two or more uses: When a building is occupied for two (2) or more uses, not included in the same use group, one (1) of the following shall apply:

1. The provisions of the code applying to each use shall apply to such parts of the building as come within that use group; and if there are conflicting provisions the requirements securing the greater public safety shall apply to the entire building; or,
2. the mixed uses shall be completely separated, both horizontally and vertically, by fire separation walls and floor-ceiling assemblies having a fireresistance rating corresponding to the highest fire grading prescribed in Table 902 for the separate uses. Each part of the building shall be separately classified to use. The most restrictive height and area limitations in this code for the mixed uses shall apply to the entire building, or except as otherwise provided for in this code; or,
3. the mixed uses shall be completely separated by fire walls having a fireresistance rating corresponding to the highest fire grading prescribed in Table 902 for the separate uses. Each use group shall then comply with the provisions of this code applicable to that group.

213.1.1 Detoxification facilities: In mixed occupancies, the separation required by Sections 439.7 may be applied in lieu of the provisions of this section.

213.2 Incidental uses: Where the higher hazard use is supplemental to the main use of the building and the area devoted to such use is constructed and segregated by fireresistance rated construction as required in Article 4, the building shall be classified according to the main use.

SECTION 214.0 CONSTRUCTION CLASSIFICATION

214.1 General: All buildings and structures erected or to be erected, altered or extended in height or area shall be classified in any one (1) or in a combination of the four (4) construction types herein defined:

1. Type 1, fireproof construction;
2. Type 2, noncombustible construction;

3. Type 3, exterior masonry wall construction; and
4. Type 4, frame construction.

214.2 False designation: A building shall not be designated a given type of construction unless it conforms to the minimum requirements for that type; and it shall be unlawful to post, or use, or designate, or advertise a building as of a given type of construction unless it complies with the minimum code requirements for that type.

214.3 Minimum requirements: When a superior type of construction is used in preference to the minimum herein required for any special use, nothing in this code shall be construed to require full compliance with the specifications for the higher type; but the designated construction classification of the building shall be that of the lesser requirement, unless all the requirements for the higher type are fulfilled.

Note: Table 214 appears at the end of this article.

#### SECTION 215.0 TYPE 1, FIREPROOF CONSTRUCTION

215.1 General: Buildings and structures of fireproof construction are those in which the walls, partitions, structural elements, floors, ceilings, and roofs, and the exitways are constructed and protected with approved noncombustible materials to afford the fireresistance rating specified in Table 214, except as otherwise specifically regulated by the provisions of Article 9. Fireproof buildings shall be further classified as Types 1A and 1B. Fire-retardant treated wood may be used as specified in Table 214 and Section 903.6.

#### SECTION 216.0 TYPE 2, NONCOMBUSTIBLE CONSTRUCTION

216.1 General: Buildings and structures of noncombustible construction are those in which the walls, partitions, structural elements, floors, ceilings, roofs, and the exitways are constructed of approved noncombustible materials meeting the fireresistance rating requirements specified in Table 214, except as modified by the fire limit restrictions of Article 3, and as further regulated in Article 9. Noncombustible buildings shall be further classified as Types 2A, 2B, and 2C. Fire-retardant treated wood may be used as specified in Table 214 and Section 903.6.

#### SECTION 217.0 TYPE 3, EXTERIOR MASONRY WALL CONSTRUCTION

217.1 General: Buildings and structures of exterior masonry wall construction are those in which the exterior, fire and party walls are constructed of masonry or other approved noncombustible materials, of the required fireresistance rating and structural properties; and the floors, roofs, and interior framing are wholly or partly of wood or of metal or other approved construction; the fire and party walls are ground supported; except that girders and their supports carrying walls of masonry

shall be protected to afford the same degree of fireresistance rating of the walls supported thereon; and all structural elements have the required fireresistance rating specified in Table 214.

217.2 Type 3A: Buildings and structures of heavy timber construction are those in which fireresistance rating is attained by placing limitations on the minimum sizes of wood structural members and on minimum thickness and composition of wood floors and roofs; by the avoidance, or by the proper protection by firestopping or other acceptable means, of concealed spaces under floors and roofs; by the use of approved fastenings, construction details, and adhesives for structural members; and by providing the required degree of fireresistance rating in exterior and interior walls (see Section 853.0 for construction details).

217.2.1 Columns: Wood columns may be sawn or glued laminated and shall be not less than eight (8) inches, nominal, in any dimension when supporting floor loads and not less than six (6) inches, nominal, in width and not less than eight (8) inches, nominal, in depth when supporting roof and ceiling loads only.

217.2.2 Floor framing: Beams and girders of wood may be sawn or glued laminated and shall be not less than six (6) inches, nominal, in width and not less than ten (10) inches, nominal, in depth. Framed or glued laminated arches which spring from the floor line and support floor loads shall be not less than eight (8) inches, nominal, in any dimension. Framed timber trusses supporting floor loads shall have members of not less than eight (8) inches, nominal, in any dimension.

217.2.3 Roof framing: Framed or glued laminated arches for roof construction which spring from the floor line or from grade and do not support floor loads shall have members not less than six (6) inches, nominal, in width and not less than eight (8) inches, nominal, in depth for the lower half of the height and not less than six (6) inches, nominal, in depth for the upper half. Framed or glued laminated arches for roof construction which spring from the top of walls or wall abutments, framed timber trusses, and other roof framing which do not support floor loads, shall have members not less than four (4) inches, nominal, in width and not less than six (6) inches, nominal, in depth. Spaced members may be composed of two (2) or more pieces not less than three (3) inches, nominal, in thickness when blocked solidly throughout their intervening spaces or when such spaces are tightly closed by a continuous wood cover plate of not less than two (2) inches, nominal in thickness, secured to the underside of the members. Splice plates shall be not less than three (3) inches, nominal, in thickness. When protected by approved automatic sprinklers under the roof deck, framing members shall be not less than three (3) inches, nominal, in width.

217.2.4 Flooring: Floors shall be without concealed spaces and shall be of sawn or glued laminated plank, splined, or tongue-and-groove, of not



less than three (3) inches, nominal, in thickness covered with one (1) inch, nominal, dimension tongue-and-groove flooring, laid crosswise or diagonally, or one-half (1/2) inch plywood, or one-half (1/2) inch particle board; or of planks not less than four (4) inches, nominal, in width, set on edge close together and well spiked, and covered with one (1) inch, nominal, dimension flooring, or one-half (1/2) inch plywood, or one-half (1/2) inch particle board.

217.2.5 Roof decking: Roofs shall be without concealed spaces and roof decks shall be sawn or glued laminated, splined or tongue-and-groove plank, not less than two (2) inches, nominal, in thickness, one and one-eighth (1 1/8) inches thick interior plywood (exterior glue), or of planks not less than three (3) inches, nominal, in width, set on edge close together and laid as required for floors. Other types of decking may be used if providing equivalent fireresistance rating and structural properties.

217.2.6 Bearing walls: Bearing portions of exterior and interior walls shall be of approved noncombustible material and shall have a fireresistance rating of not less than two (2) hours.

217.2.7 Nonbearing walls: Nonbearing portions of exterior walls shall be of approved noncombustible materials, except as otherwise noted and where a horizontal separation of less than twenty (20) feet is provided, nonbearing exterior walls shall have a fireresistance rating of not less than two (2) hours. Where a horizontal separation of twenty (20) feet to thirty (30) feet is provided, nonbearing exterior walls shall have a fire-resistance rating of not less than one (1) hour. Where a horizontal separation of thirty (30) feet or more is provided, fireresistance rating is not required. Where a horizontal separation of twenty (20) feet or more is provided, wood columns and arches conforming to heavy timber sizes may be used externally.

217.3 Type 3B: Structures of Type 3B (ordinary protected) shall include all exterior masonry wall buildings in which the interior structural elements are wholly or partly of fire-protected wood of not less than two (2) inch nominal thickness, or of other approved protected combustible materials, or of metal protected and insulated to afford the fireresistance rating specified in Table 214.

217.4 Type 3C: Structures of Type 3C (ordinary unprotected) construction shall include all exterior masonry wall buildings in which the interior structural members are of wood of not less than two (2) inch nominal thickness or consist of other combustible or noncombustible materials with protection of less than one (1) hour fireresistance rating.

#### SECTION 218.0 TYPE 4, FRAME CONSTRUCTION

218.1 General: Buildings and structures of frame construction are those in which the exterior walls, bearing walls, partitions, floor and roof

construction are constructed wholly or partly of wood stud and joist assemblies with a minimum nominal dimension of two (2) inches, or of other approved combustible materials; with firestopping at all vertical and horizontal draft openings as regulated in Section 875.0, and in which the structural elements have the required fireresistance ratings specified in Table 214. Frame buildings shall be further classified as Types 4A and 4B according to Table 214.

NON-TEXT PAGE

**Table 214  
FIRERESISTANCE RATINGS OF STRUCTURAL ELEMENTS (IN HOURS)**

| Structural element<br>Note a  | Type of construction                 |                       |                         |                      |                         |                  |             |               |             |                                  |
|---|--------------------------------------|-----------------------|-------------------------|----------------------|-------------------------|------------------|-------------|---------------|-------------|----------------------------------|
|   | Type 1<br>Section 215.0              |                       | Type 2<br>Section 216.0 |                      | Type 3<br>Section 217.0 |                  |             | Section 214.0 |             |                                  |
|   | Fireproof                            | Noncombustible        | Note c                  | Heavy timbers (mill) | Ordinary masonry walls  | Protected        | Unprotected | Protected     | Unprotected | Type 4<br>Section 218.0<br>Frame |
| Exterior walls<br>(Section 906.0 and Note b)  | 1A<br>1B                             | 2A<br>2B              | 2C                      | 3A                   | 3B                      | 3C               | 4A          | 4B            |             |                                  |
| Bearing   | 4<br>3                               | 2<br>1                | 0                       | 2                    | 2                       | 2                | 1           | 0             |             |                                  |
| Non-bearing   | 0<br>0                               | 0<br>0                | 0                       | 0                    | 0                       | 0                | 0           | 0             |             |                                  |
| Bearing   | 4<br>3                               | 2<br>1 <sup>1,2</sup> | 1                       | 2                    | 2                       | 2                | 1           | 1             | Note d      |                                  |
| Non-bearing   | 2<br>2                               | 1 <sup>1,2</sup><br>1 | 1                       | 2                    | 2                       | 2                | 1           | 1             | Note d      |                                  |
| Bearing   | 4<br>3                               | 2<br>1                | 0                       | 2                    | 2                       | 2                | 1           | 0             |             |                                  |
| Non-bearing   | 2<br>2                               | 1 <sup>1,2</sup><br>1 | 0                       | 2                    | 2                       | 2                | 1           | 0             |             |                                  |
| Bearing   | 4<br>3                               | 2<br>1                | 0                       | 2                    | 2                       | 2                | 1           | 1             | c           |                                  |
| Non-bearing   | 1 <sup>1,2</sup><br>1 <sup>1,2</sup> | 1<br>1                | 0                       | See Sec. 217.0       | 1 <sup>1,2</sup>        | 1 <sup>1,2</sup> | 1           | 0             |             |                                  |
| Fire walls and party walls (Section 907.0)  | 4<br>3                               | 2<br>2                | 2                       | 2                    | 2                       | 2                | 2           | 2             |             |                                  |
| ←←←←← Firerestistance rating, corresponding to fire grading of use group — (See Table 902.1) —→→→→→ |                                      |                       |                         |                      |                         |                  |             |               |             |                                  |
| Fire separation assemblies (Note e)   | 2                                    | 2                     | 2                       | 2                    | 2                       | 2                | 2           | 2             | 1           | 1                                |
| Fire enclosure of exitways, exitway hallways and stairways (Section 909.0 and Note f)               | 2                                    | 2                     | 2                       | 2                    | 2                       | 2                | 2           | 2             | 1           | 1                                |
| Shafts (other than exitways), elevator hoistways (Section 910.0)                                    | 1                                    | 1                     | 1                       | 1                    | 1                       | 1                | 1           | 1             | 1           | 1                                |
| Exitway access corridors (Note j)   | 1                                    | 1                     | 1                       | 1                    | 1                       | 1                | 1           | 1             | 1           | 0                                |
| Vertical separation of tenant spaces  | 1                                    | 1                     | 1                       | 1                    | 1                       | 1                | 1           | 1             | 1           | 0                                |

Table 214 (cont'd.)  
**FIRE RESISTANCE RATINGS OF STRUCTURAL ELEMENTS (IN HOURS)**

|   | 1      | 1 | 1     | 1 | 1 | 1 | 1 | 1 | 1 | 1 | 1 | 1 | 1 | 1 | 1 | 1 | 1 | 1 |
|---|--------|---|-------|---|---|---|---|---|---|---|---|---|---|---|---|---|---|---|
| 7 Dwelling unit separations (Note k)  | 0      | 0 | 0     | 0 | 0 | 0 | 0 | 0 | 0 | 0 | 0 | 0 | 0 | 0 | 0 | 0 | 0 | 0 |
| Other non-bearing partitions  | Note h |   |       |   |   |   |   |   |   |   |   |   |   |   |   |   |   |   |
| 8 Interior bearing walls, bearing partitions, floor joists, trusses (other than roof trusses), and framing (Section 911.0 and Note l) | 4      | 3 | 2     | 1 | 0 | 0 | 0 | 0 | 0 | 0 | 0 | 0 | 0 | 0 | 0 | 0 | 0 | 0 |
| Supporting more than one floor  | Note h |   |       |   |   |   |   |   |   |   |   |   |   |   |   |   |   |   |
| Supporting one floor only   | 3      | 2 | 1 1/2 | 1 | 0 | 0 | 0 | 0 | 0 | 0 | 0 | 0 | 0 | 0 | 0 | 0 | 0 | 0 |
| Supporting a roof only  | 3      | 2 | 1 1/2 | 1 | 0 | 0 | 0 | 0 | 0 | 0 | 0 | 0 | 0 | 0 | 0 | 0 | 0 | 0 |
| 9 Structural members supporting wall (Section 911.0)  | 3      | 2 | 1 1/2 | 1 | 0 | 0 | 0 | 0 | 0 | 0 | 0 | 0 | 0 | 0 | 0 | 0 | 0 | 0 |
| Not less than fire resistance rating of wall supported  | Note h |   |       |   |   |   |   |   |   |   |   |   |   |   |   |   |   |   |
| 10 Floor construction including beams (Section 912.0 and Note g)  | 3      | 2 | 1 1/2 | 1 | 0 | 0 | 0 | 0 | 0 | 0 | 0 | 0 | 0 | 0 | 0 | 0 | 0 | 0 |
| 15' or less in height to lowest member  | Note h |   |       |   |   |   |   |   |   |   |   |   |   |   |   |   |   |   |
| 2   | 1 1/2  | 1 | 0     | 0 | 0 | 0 | 0 | 0 | 0 | 0 | 0 | 0 | 0 | 0 | 0 | 0 | 0 | 0 |
| More than 15' but less than 20' in height to lowest member  | Note h |   |       |   |   |   |   |   |   |   |   |   |   |   |   |   |   |   |
| 1   | 1      | 1 | 0     | 0 | 0 | 0 | 0 | 0 | 0 | 0 | 0 | 0 | 0 | 0 | 0 | 0 | 0 | 0 |
| 20' or more in height to lowest member  | Note h |   |       |   |   |   |   |   |   |   |   |   |   |   |   |   |   |   |
| 0   | 0      | 0 | 0     | 0 | 0 | 0 | 0 | 0 | 0 | 0 | 0 | 0 | 0 | 0 | 0 | 0 | 0 | 0 |
| See Sec. 217.0  | Note m |   |       |   |   |   |   |   |   |   |   |   |   |   |   |   |   |   |

Notes applicable to Table 214

Note a. For special high hazard uses involving a higher degree of fire severity and higher concentration of combustible contents, the fireresistance rating requirements for structural elements shall be increased accordingly (see Section 400.3).

Note b. The fire separation or fire exposure in feet as herein limited applies to the distance measured from the building face to the closest interior lot line, the center line of a street or public space or an imaginary line between two (2) buildings on the same property.

Note c. Protected exteriors shall be required within the fire limits in Type 2 construction as follows: high hazard uses, two (2) hour fireresistance with fire separation up to eleven (11) feet.

Note d. See Section 303.2.

Note e. See Sections 213.0, 909.0 and 912.0.

Note f. In all buildings of Types 3 or 4 construction, the stairways and their enclosures may be constructed of wood or other approved materials of similar characteristics and of adequate strength. Exitways may be enclosed in one (1) hour fireresistance rated construction in buildings three (3) stories or less in height.

Note g. In Type 3A construction members which are of material other than heavy timber shall have a fireresistance rating of not less than one (1) hour (see Section 853.2).

Note h. Fire-Retardant Treated Wood, complying with Section 903.6.1 may be used as provided in Section 903.6.2.

Note i. Where the omission of fire protection from roof trusses, roof framing and decking is permitted, the horizontal or sloping roofs in Type 1 and Type 2 buildings, immediately above such members, shall be constructed of noncombustible materials of the required strength without a specified fireresistance rating, or of mill type construction in buildings not over five (5) stories or sixty-five (65) feet in height (see Section 913.3).

Note j. Exitway access corridors serving thirty (30) or less occupants may have a zero (0) fireresistance rating (see Section 610.4).

Note k. Separation of all dwelling units shall have a fireresistance rating of not less than one (1) hour.

Note l. Interior bearing walls shall meet the requirements of Section 909.0 if serving a fire separation function.

Note m. Buildings of H (high hazard), S-1 (moderate hazard storage) or M (mercantile) occupancies when of Type 1 or 2A construction shall have not less than one (1) hour fireresistance rated roof construction (see Section 913.2). One (1) story buildings are exempted.

ARTICLE 3

GENERAL BUILDING LIMITATIONS

SECTION 300.0 GENERAL

300.1 Scope: The provisions of this article shall control the division of the municipalities of the Commonwealth of Massachusetts into fire limits and the general limitations of height and area of all buildings hereafter erected, and additions to existing buildings hereafter enlarged as affected by the fire and life hazard incident to type of construction, use group, density of development, exterior exposure and accessibility of buildings and structures to fire-fighting facilities and equipment.

SECTION 301.0 FIRE LIMITS

301.1 Fire limits: For the purpose of control of use and construction of buildings, the building official may establish designated fire limits and outside fire limits under the legal procedure of the municipalities of the Commonwealth of Massachusetts for creating and establishing fire limits.

301.2 Outside fire limits: All other areas not included in the fire limits shall be designated as outside fire limits.

301.3 Changes in fire limits: Any changes in the boundaries of fire limits shall be established by the local municipality.

301.4 Buildings on fire limit boundary: If a building or structure is partially located in a fire limit, the provisions of the fire limit shall apply.

SECTION 302.0 RESTRICTIONS WITHIN THE FIRE LIMITS

302.1 General: All buildings and structures, and all additions to existing buildings and structures, hereafter erected within the boundaries of the fire limits shall be of fireproof (Type 1), protected noncombustible (Types 2A and 2B), heavy timber (Type 3A), or ordinary protected (Type 3B), construction as defined in Article 2 and regulated in Table 214; and shall be constructed within the height and area limitations of Table 305 except as herein provided. Open parking structures may be constructed as permitted under Section 429.0.

302.2 Type 2C, 3C and 4A construction permitted: Buildings and structures, and additions to existing buildings and structures, hereafter erected within the fire limits may be of unprotected noncombustible (Type 2C), ordinary unprotected (Type 3C) or protected frame (Type 4A) construction as defined in Article 2 and regulated in Tables 214 and 305 when constructed and located in accordance with the requirements of Table 302.

Table 302

## EXTERIOR WALL FIRERESISTANCE RATING REQUIREMENTS

| Width of fire separation adjacent to exterior wall             | Fireresistance rating of exterior wall <sup>1</sup> or barrier | Fireresistance rating of exterior opening protectives | Classification minimum of roof covering |
|--|--|---|---|
| On lot lines or less than 3 ft. therefrom or from any building | 4 hour   | Not permitted   | B                                       |
| More than 3 ft. but less than 6 ft.                            | 3 hour   | 3 hour  | B                                       |
| 6 ft. or more but less than 11 ft.                             | 2 hour   | 1½ hour   | B                                       |
| 11 ft. or more but less than 30 ft.                            | 1 hour   | ¾ hour  | B                                       |
| 30 ft. or more   | 0 hour   | 0 hour  | C                                       |

\*Not less than that required by Table 214.

**Note 1.** The exterior wall or barrier shall extend to the height of the building and be so constructed that it will remain structurally in place for the duration of time indicated by the required fire resistance rating. When the exterior wall or barrier is adjacent to a flat roof, it shall be constructed with a parapet.

**Note 2.** Fences of Type 4 construction up to six (6) feet in height are allowed without permit; however, fences of Type 4 construction over six (6) feet in height are not allowed in the fire limits.

**Note 3.** Roof decking and roof fencing within the fire limits shall be of noncombustible construction or of exterior fire-retardant lumber complying with Section 903.6.2. Roof fences shall not exceed six (6) feet in height.

**Note 4.** Fireresistance of exterior wall for 2C and 3C (Type 4) construction to comply with Table 214.



302.3 Storm enclosures: Storm enclosures may be erected of frame (Type 4) construction not more than ten (10) feet in height and not more than three (3) feet wider than the entrance doors which they serve, provided they do not project more than six (6) feet beyond the building line.

#### 302.4 Accessory buildings

302.4.1 Outbuildings and parking lot offices: Outbuildings and parking lot offices not more than ten (10) feet in height and one hundred (100) square feet in area may be erected of frame (Type 4) construction when accessory to one- or two-family dwellings on the same lot or accessory to a lot approved for motor vehicle parking, when located not less than six (6) feet from the lot line or any other building.

302.4.2 Greenhouses: Greenhouses and similar structures may be erected of frame (Type 4) construction when accessory to a one- or two-family dwelling on the same lot and when located not less than six (6) feet from interior lot lines or any building.

302.4.3 Sheds: Sheds open on the long side not more than fifteen (15) feet in height nor more than five hundred (500) square feet in area may be erected of frame (Type 4) construction when located not less than six (6) feet from the lot lines.

302.4.4 Builders' shanties and reviewing stands: Temporary builders' shanties erected in connection with approved building operations, platforms, reviewing stands, and other similar miscellaneous structures may be erected of frame (Type 4) construction for a limited period of time as approved by the building official.

302.4.5 Garages: Garages of Type 4 construction are not allowed within the fire limits.

#### 302.5 Bins, tanks, towers and roof structures

302.5.1 Timber construction: Coal and material bins, water towers, tank structures and trestles may be erected of mill type heavy timber construction with dimensions not less than required for Type 3A construction, not over thirty-five (35) feet in height, when located thirty (30) feet from the interior lot lines of any building, except when located on lot lines along a railroad right of way or waterfront.

302.5.2 Erection on buildings: Aerial supports not more than twelve (12) feet in height, water tanks and flag poles may be erected on wood on buildings not more than three (3) stories nor more than forty (40) feet in height, and drip bars in cooling towers may be constructed of wood.

302.6 Motor fuel service stations: Gasoline service stations, and structures of similar business uses, not including high hazard (H) uses, may be erected of unprotected noncombustible (Type 2C) construction within the height and area limits of use group B of Table 305, provided they are located not less than eleven (11) feet from the lot line or any building.

302.7 Bus and passenger terminals: Roofs over parking lots, bus and passenger terminals may be erected one (1) story and not over twenty (20) feet in height and not more than eleven thousand (11,000) square feet in area of noncombustible (Type 2C) construction or of heavy timber mill (Type 3A) construction.

302.8 Store fronts: Wood veneers of one (1) inch nominal thickness or exterior grade plywood not less than three-eighths (3/8) inch thick may be used on store fronts when facing public streets; provided the veneer does not exceed one (1) story in height and is applied to noncombustible backing or is furred not to exceed one and five-eighths (1 5/8) inch and firestopped in accordance with Sections 875.0 and 912.0. Where all wood veneers comply with Section 903.6.2 for exterior use, the height may be increased to two (2) stories.

#### SECTION 303.0 RESTRICTIONS OUTSIDE FIRE LIMITS

303.1 General: Outside the fire limits, all types of construction except as herein specifically prohibited, or for which special approval is required in connection with high hazard uses and occupancies in Article 4, shall be permitted within the height and area limitations of Table 305.

303.2 Lot line separation: In frame construction, an exterior wall erected less than six (6) feet from its adjacent lot line shall be of one (1) hour fire-resistance rated construction, including opening protectives, except store front and window and door openings in one- and two-family dwellings. Exterior walls of Type 4 frame construction shall not have openings of any type when located three (3) feet or less from interior lot lines.

303.3 Roof coverings: Roof coverings shall conform to the fire-resistive requirements for Class A, B, C or non-rated roofings complying with the provisions of Sections 903.0 and 926.0.

#### SECTION 304.0 EXISTING BUILDINGS

##### 304.1 Alterations

304.1.1 Limitations: These provisions shall not be deemed to prohibit alterations within the limitations of Section 106.0, provided an unlawful change of use is not involved.

304.1.2 Minor changes: Changes, alterations or repairs to the interior of a building and to the front facing a street or other public space may

be permitted, provided such changes, in the opinion of the building official, do not increase the size or the fire hazard of the building, or endanger the public safety, and are not specifically prohibited by this code.

304.1.3 Existing projections: A change or enlargement shall not be made to an existing part of a building now projecting beyond the street lot line or building line where such is established by law, except in conformity to the provisions of Section 310.0 governing new construction.

304.2 Increase in height and area: It shall be unlawful to increase the height or area of an existing building or structure, unless it is of a type of construction permitted for new buildings of the increased height and area, and of a use group within the fire limit in which it is located and as regulated by Table 305.

#### SECTION 305.0 GENERAL AREA AND HEIGHT LIMITATIONS

305.1 General: The areas and heights of all buildings and structures between exterior walls, or between exterior walls and fire walls, shall be governed by the type of construction and the use group classification as defined in Article 2 and shall not exceed the limits fixed in Table 305, except as these may be specifically modified by other provisions of this article and Article 4.

305.2 Area limit: The area limitations specified in Table 305 shall apply to all buildings fronting on a street, or public space not less than thirty (30) feet in width accessible to a public street.

305.3 Height limit: The height in feet and number of stories specified in Table 305 shall apply to all buildings and to all separate parts of a building enclosed within lawful fire walls complying with the provisions of Article 9.

305.4 Multi-story buildings: Building two (2) stories in height may be built to the same area limits provided in Table 305 for one (1) story buildings. In buildings over two (2) stories in height, the area limits of Table 305 for one (1) story buildings shall be reduced as specified in the following Table 305.4.



**Notes applicable to Table 305**

**Note a.** See the following sections for general exceptions to Table 305.

Section 305.4 Allowable area reduction for multi-story buildings.

Section 306.2 Allowable area increase due to street frontage.

Section 306.3 Allowable area increase due to automatic fire suppression system installation.

Section 307.0 Unlimited area one-story buildings.

Section 308.1 Allowable height increase due to automatic fire suppression system installation.

**Note b.** Type 1 buildings permitted unlimited tabular heights and areas are not subject to special requirements that allow increased heights and areas for other types of construction.

**Note c.** The tabular area of one-story school buildings of use group A-4 may be increased two hundred (200) per cent provided every classroom has at least one (1) door opening directly to the exterior of the building. Not less than one-half (1/2) of the required exitways from any assembly room included in such buildings shall also open directly to the exterior of the building.

**Note d.** Church auditoriums of Type 3A construction may be erected to sixty-five (65) feet in height, and of Type 4 construction to forty-five (45) feet in height.

**Note e.** For exceptions to height and area limitations of high hazard use buildings, see Article 4 governing the specific use. For other special fire-resistive requirements governing specific uses, see Section 905.0.

**Note f.** For exceptions to height of multi-family dwellings of Types 2B and 3B construction, see Section 905.6.

**Note g.** For height and area exceptions covering open parking structures, see Section 429.0.

**Note h.** Deleted.

**Note i.** The tabular area for use group A-4 schoolhouse, Type 4B construction, shall be limited to forty-eight hundred (4800) square feet, one (1) story and twenty (20) feet high (no increase allowed for sprinklers or accessibility).

**Note j.** See Section 434.4 for applicable height and area limitations.

**Note k.** For R-1 detoxification facilities see Table 439.6

Table 305.4

**PER CENT REDUCTION OF AREA LIMITS**

| No. of stories | Type of construction |      |                            |
|----------------|----------------------|------|----------------------------|
|                | 1A & 1B              | 2A   | 2B, 2C, 3A, 3B, 3C, 4A, 4B |
| 1              | None                 | None | None                       |
| 2              | None                 | None | None                       |
| 3              | None                 | 5%   | 20%                        |
| 4              | None                 | 10%  | 20%                        |
| 5              | None                 | 15%  | 30%                        |
| 6              | None                 | 20%  | 40%                        |
| 7              | None                 | 25%  | 50%                        |
| 8              | None                 | 30%  | 60%                        |
| 9              | None                 | 35%  | 70%                        |
| 10             | None                 | 40%  | 80%                        |

**SECTION 306.0 AREA EXCEPTIONS**

**306.1 General:** The provisions of this section shall modify the area limits of Table 305 as herein specified.

306.2 Street frontage increase: When a building or structure has more than twenty-five (25) per cent of the building perimeter fronting on a street or other unoccupied space not less than thirty (30) feet in width accessible from a street by a posted fire lane not less than eighteen (18) feet in width, the tabular areas may be increased two (2) per cent for each one (1) per cent of such excess frontage.

306.3 Automatic fire suppression system: When a building of other than high hazard (use group H) use is equipped with an approved automatic fire suppression system, the tabular areas may be increased by two hundred (200) per cent for one (1) story buildings and one hundred (100) per cent for buildings more than one (1) story in height.

306.4 School buildings: When every classroom of a one (1) story school building (use group A-4) has at least one (1) door opening directly to the exterior of the building, the tabular area of Table 305 may be increased two hundred (200) per cent. Not less than one-half (1/2) of the required exitways from any assembly room included in such buildings shall also open directly to the exterior of the building.

306.5 Maximum total area: The maximum total area under the combined provisions of Sections 306.2 and 306.3 shall not exceed three and one-half (3 1/2) times the tabular area in Table 305.

#### SECTION 307.0 UNLIMITED AREAS

307.1 One-story buildings: In other than frame (Type 4) construction, the area of all buildings of assembly (use group A-3), business (B), factory and industrial (F), mercantile (M) and storage (S) use groups not including high hazard uses, which do not exceed one (1) story or eighty-five (85) feet in height shall not be limited; provided the exitway facilities comply with the provisions of Article 6, an automatic fire suppression system is provided complying with the provisions of Section 1202.0, and the building is isolated as specified in Section 307.2, except that a fire suppression system shall not be required for buildings of Type 1, Type 2 or Type 3A construction used exclusively for storage of non-combustible material, not packed or crated in combustible materials, or as exempted by Section 205.3 for special industrial uses.

307.1.1 School buildings: One (1) story school buildings of Types 2, 3A and 3B construction may be unlimited in area when a direct exitway to the outside of the building is provided from each classroom and the building is equipped with an approved automatic fire suppression system throughout. A fire separation shall be provided on all sides of such buildings as specified in Section 307.2.

307.1.2 Indoor recreation buildings: Indoor participant sport areas such as tennis courts, skating rinks, swimming pools and equestrian clubs may be unlimited in area and exempt from the automatic fire suppression system requirements, providing:

1. direct exitways to the outside are provided for all the occupants of the recreation area;
2. the recreation area is conspicuously posted as to use and occupancy load;
3. the building is equipped with a manual fire alarm system; and
4. all other areas are equipped with an automatic fire suppression system.

307.2 Fire separation: The minimum fire separation on any side of one (1) story buildings of unlimited area shall be determined by the type of construction and fireresistance rating of the exterior wall adjacent thereto as specified in the following Table 307.

Table 307

Table 307  
**MINIMUM FIRE SEPARATION FOR TYPE OF CONSTRUCTION**

| Type of construction | Fire-resistance rating of exterior bearing walls | Minimum fire separation*** | Fireresistance rating of bearing & non-bearing portions of exterior walls | Minimum fire separation |
|----------------------|--|----------------------------|---|-------------------------|
| 2A                   | 2 hr.  | 30 ft.                     | -   | -                       |
| 2B                   | 1 hr.  | 40 ft.                     | 2 hr.*  | 30 ft.                  |
| 2C                   | 0 hr.  | 50 ft.                     | 3 hr.**   | 30 ft.                  |
| 3A                   | 2 hr.  | 40 ft.                     | 3 hr.**   | 30 ft.                  |
| 3B                   | 2 hr.  | 40 ft.                     | 3 hr.**   | 30 ft.                  |
| 3C                   | 2 hr.  | 50 ft.                     | 4 hr.**   | 30 ft.                  |

\*All exterior wall openings shall be protected with one and one-half hour fireresistance rated approved opening protectives.

\*\*All exterior wall openings shall be protected with three hour fireresistance rated approved opening protectives.

\*\*\*When the fire separation exceeds the herein specified minimum, the requirements of Table 214, Row 1 (Exterior walls with fire separation of 30 ft. or more: bearing) shall apply.

307.3 Roof vents: The roof system of one (1) story buildings of unlimited area when of Type 2 or Type 3 construction shall be provided with smoke and heat vents in accordance with Sections 230 and 240 of the Guide for Smoke and Heat Venting (NFPA 204) listed in Appendix B.

307.4 Fire access panels: Grade level doors or fire access panels, as specified in Sections 859.4 and 1200.1.1, shall be provided and spaced not more than one hundred fifty (150) feet apart in exterior walls adjacent to a required fire separation less than forty (40) feet.

#### SECTION 308.0 HEIGHT EXCEPTIONS

308.1 Automatic fire suppression systems: When a building of other than high hazard (use group H) use is equipped with an approved automatic fire suppression system, the building may be erected one (1) story or twenty (20) feet higher than specified in Table 305.

308.2 Auditoriums: Auditoriums (use group A-4) of protected or heavy timber (Type 3A) construction may be erected to sixty-five (65) feet in height and of unprotected construction to forty-five (45) feet.

308.3 Roof structures: In applying the provisions of this code governing height limits, the following appurtenant structures shall not be included in the height of the building: roof tanks and their supports; ventilating, air conditioning and similar building service equipment; roof structures other than penthouses; chimneys and parapet walls not exceeding four (4) feet in height; unless the aggregate area of such structures including penthouses exceeds one-third ( $1/3$ ) of the area of the roof of the building upon which they are erected.

#### SECTION 309.0 STREET ENCROACHMENTS

309.1 General: Except as herein provided, a part of any building erected and additions to an existing building heretofore erected shall not project beyond the lot lines or beyond the building line when such line is established by the zoning law or any other statute controlling building construction.

309.2 Below grade: A part of a building erected below grade that is necessary for structural support of the building shall not project beyond the lot lines, except that the footings of street walls or their supports located at least eight (8) feet below grade may project not more than twelve (12) inches beyond the street lot line.

309.3 Above grade: All projections permitted beyond the street lot line or the building line above grade shall be so constructed as to be readily removable without endangering the safety of the building.



309.4 Projections necessary for safety: In any specific application, the building official may designate by approved rules such architectural features and accessories which are deemed desirable or necessary for the health or safety of the public and the extent to which they may project beyond the street lot line or the building line where such is established by statute, subject to all provisions and restrictions that may be otherwise prescribed by law, ordinance or rule of the authorities having jurisdiction over streets or public spaces.

309.5 Permit revocable: Any permit granted or permission expressed or implied in the provisions of this code to construct a building so as to project beyond the street lot line or building line shall be revocable by the municipality at will.

309.6 Existing encroachments: Parts of existing buildings and structures which already project beyond the street lot line or building line may be maintained as constructed until their removal is directed by the proper municipal authorities.

#### SECTION 310.0 PERMISSIBLE STREET PROJECTIONS

310.1 General: Subject to such provisions as may be otherwise prescribed by law or ordinance, or by rule of the municipal authorities having jurisdiction over streets, highways, and public spaces, the following projections, as described in Sections 310.2 through 310.11.1, shall be permitted beyond the street lot line or the building line, as the case may be.

310.2 Cornices and eaves: Main cornices or roof eaves located at least twelve (12) feet above the curb level shall project not more than three (3) feet.

310.3 Architectural decorations: Belt courses, lintels, sills, architraves, pediments and similar architectural decorations shall project not more than four (4) inches when less than ten (10) feet above the curb level, and not more than ten (10) inches when ten (10) feet or more above the curb level.

310.4 Ornamental columns: Ornamental columns, or pilasters, including the bases and moldings which emphasize the main entrance of the building, shall project not more than twelve (12) inches.

310.5 Entrance steps: Entrance steps and doors shall project not more than twelve (12) inches and shall be guarded by check pieces not less than three (3) feet high, or shall be located between ornamental columns or pilasters.

310.6 Oriel windows: Oriel windows with the lowest portion at least ten (10) feet above the curb level shall project not more than two and one-half (2 1/2) feet.

310.7 Balconies: Balconies located at least ten (10) feet above the curb level shall project not more than three (3) feet, except than when the balcony is required in connection with a fire escape or exterior stairway as an element of a means of egress, the projection may be increased, but not to exceed four (4) feet.

310.8 Awnings: Retractable or fixed awnings shall have clearances above the grade, and shall be installed in accordance with the requirements of Section 313.0.

310.9 Awning covers or boxes: Awning covers or boxes located at least eight (8) feet above the curb level shall project not more than three (3) feet.

310.10 Marquees: For the purpose of this section, a marquee shall include any object or decoration attached to or a part of said marquee.

310.10.1 Projection and clearance: The horizontal clearance between a marquee and the curb line shall be not less than two (2) feet. A marquee projecting more than two-thirds (2/3) of the distance from the property line to the curb line shall be not less than ten (10) feet above the ground or pavement below.

310.10.2 Thickness: The maximum height or thickness of a marquee measured vertically from its lowest to its highest point shall not exceed three (3) feet when the marquee projects more than two-thirds (2/3) of the distance from the property line to the curb line, and shall not exceed nine (9) feet when the marquee is less than two-thirds (2/3) of the distance from the property line to the curb line.

310.10.3 Roof construction: The roof or any part thereof may be a skylight of approved plastics, or wired glass not less than one-fourth (1/4) inch thick with a single pane not more than eighteen (18) inches wide. Every roof and skylight of a marquee shall be sloped to downspouts which shall conduct any drainage from the marquee in a manner not to spill over the sidewalk.

310.10.4 Location prohibited: Every marquee shall be so located as not to interfere with the operation of any exterior standpipe, and not to obstruct the clear passage of stairways or exitway discharge from the building or the installation or maintenance of street lighting.

310.10.5 Construction: A marquee shall be supported entirely from the building and constructed of noncombustible material. Marquees shall be designed and constructed to withstand wind or other lateral loads and live loads as required in Article 7 of this code. Structural members shall be protected to prevent deterioration as required by Article 8.

310.11 Vaults: Vaults below the sidewalk level shall extend not closer than three (3) feet to the curb line; and the construction and use of

such vaults shall be subject to the terms and conditions of the authority or legislative body having jurisdiction.

310.11.1 Areaways: Areaways shall not project beyond the street lot line more than four (4) feet; provided that every such areaway shall be covered over at the street grade by an approved grating of metal or other noncombustible material.

#### SECTION 311.0 PERMISSIBLE YARD AND COURT ENCROACHMENTS

311.1 General: A part of any building or structure shall not extend into side courts, inner courts or yards required for light and ventilation of habitable and occupiable rooms by the provisions of Article 5, or of the zoning law or other statutes controlling building construction, except as hereinafter provided; but the encroachment shall not exceed twenty (20) per cent of the legal area of yard or court required for light and ventilation purposes.

311.2 Roof eaves: Roof eaves shall project not more than three (3) feet beyond the face of the wall.

311.3 Steps and architectural features: Steps, window sills, belt courses and similar architectural features, rain leaders and chimneys shall project not more than two (2) feet beyond the face of the wall.

311.4 Exterior stairways and fire escapes: Outside stairways, smoke-proof tower balconies, fire escapes or other required elements of a means of egress shall not project more than four (4) feet beyond the face of the wall.

#### SECTION 312.0 SPECIAL AND TEMPORARY PROJECTIONS

312.1 Alley projections: The permissible projection beyond street lot lines shall apply in general to building projections into alleyways, except as may be modified by the local administrative authority having jurisdiction or by special deed restriction.

312.2 Special permits: When authorized by special permit, vestibules and storm doors may be erected for periods of time not exceeding seven (7) months in any one (1) year, and shall project not more than three (3) feet nor more than one-fourth (1/4) the width of the sidewalk beyond the street lot line. Temporary entrance awnings may be erected with a minimum clearance of seven (7) feet to the lowest portion of the hood or awning when supported on removable steel or other approved noncombustible supports.

SECTION 313.0 AWNINGS AND CANOPIES

313.1 Permit: A permit shall be obtained from the building official for the erection, repair or replacement of any fixed awning, canopy or hood except as provided in Section 313.1.1, and for any retractable awning located at the first story level and extending over the public street or over any portion of a court or yard beside a building serving as a passage from a required exitway or exitway discharge to a public street.

313.1.1 Exemption from permit: a permit shall not be required for the erection, repair or replacement of fixed or retractable awnings installed on one- and two-family dwellings, unless they project over public property, or for retractable awnings installed above the first story or where the awning does not project over the public street or over any court or yard serving as a passage from a required exitway to a public street.

313.2 Installation of awnings

313.2.1 Retractable awnings: There shall be a minimum clearance of seven (7) feet from the sidewalk to the lowest part of the framework or any fixed portion of any retractable awning, except that the bottom of the valance of canvas awnings may extend to six (6) feet nine (9) inches above the sidewalk. Retractable awnings shall be securely fastened to the building and shall not extend closer than twelve (12) inches from the curb line. They shall be equipped with a mechanism or device for raising and holding the awning in a retracted or closed position against the face of the building.

313.2.2 Fixed or permanent awnings: The clearance from the sidewalk to the lowest part of any fixed or permanent awning shall be the same as required in Section 313.2.1 for retractable awnings. Fixed or permanent awnings installed above the first story shall not project more than four (4) feet.

313.3 Canopies: Canopies shall be constructed of a metal framework, with an approved covering, attached to the building at the inner end and supported at the outer end by not more than two (2) stanchions with braces anchored in an approved manner and placed not less than two (2) feet in from the curb line. The horizontal portion of the framework shall be not less than eight (8) feet nor more than twelve (12) feet above the sidewalk and the clearance between the covering or valance and the sidewalk shall be not less than seven (7) feet. The width of canopies shall not exceed eight (8) feet.

313.4 Special applications of awnings: Rigid awnings supported in whole or part by members resting on the ground and used for patio covers, car ports, summer houses or other similar uses shall comply with the requirements of Section 313.5 for design and structure. Such structures shall be braced as required to provide rigidity.

313.5 Design and construction: Fixed awnings, canopies and similar structures shall be designed and constructed to withstand wind or other lateral loads and live loads as required by Article 7 of this code with due allowance for shape, open construction and similar features that relieve the pressures or loads. Structural members shall be protected to prevent deterioration.

#### SECTION 314.0 TEMPORARY STRUCTURES

314.1 General: The building official may issue a permit for temporary construction. Such permits shall be limited as to time of service, but such temporary construction shall not be for more than a period of one (1) year. However, such temporary construction may be extended for an additional one (1) year period.

314.2 Special approval: All temporary construction shall conform to structural strength, fire safety, means of egress, light, ventilation and sanitary requirements of this code necessary to insure the public health, safety and general welfare.

314.3 Termination of approval: The building official is hereby authorized to terminate such special approval and to order the demolition of any such construction at his discretion.

#### SECTION 315.0 ACCESSIBILITY FOR THE PHYSICALLY HANDICAPPED

315.1 Building access for handicapped: All buildings and parts thereof classified in use groups M (Mercantile), F (Factory and Industrial), B (Business), A (Assembly), I (Institutional), R-1 and R-2, (Residential), shall have at least one (1) primary entrance accessible to and usable by the handicapped. Such entrance shall provide access to a level that makes elevators available in buildings where elevators are provided. Where ramps are used to comply with this requirement, they shall have a slope not greater than one (1) in twelve (12).

315.1.1 Handicapped access for limited group residences: All required means of access in buildings classified in use group R-5 (limited group residence) shall be made accessible to the handicapped in accordance with the provisions of Section 438.3. Where ramps are used to comply with this requirement, they shall have a slope not greater than one (1) in twelve (12). Such ramps shall be constructed in accordance with the provisions of Section 615.0.

## ARTICLE 4

## SPECIAL USE AND OCCUPANCY REQUIREMENTS

## SECTION 400.0 GENERAL

400.1 Scope: In addition to the general requirements of this code governing the location, construction and equipment of all buildings and structures and the fireresistance ratings, height and area limitations of Tables 214 and 305, the provisions of this article shall control all buildings and structures designed for high hazard uses and occupancies which involve extreme fire, smoke, explosion or toxic gas risks, and places of assembly in which people congregate in large numbers and which are susceptible to panic incidental to crowds. Except as herein specifically provided, the applicable standards listed in Appendix B shall be deemed to comply with the requirements of this article.

Chemical plants, packing plants, grain elevators, refineries, flour mills and other special structures may be constructed in accordance with the recognized practices and requirements of the specific industry. The building official may permit such variations from the requirements of this code which will secure reasonable and economical construction with the necessary fire, life and property safeguards. In granting such variations, due regard shall be given to the isolation of the structure and fire hazard from and to surrounding property.

400.1.1 Applicable Massachusetts General Laws: The applicable Massachusetts General Laws Annotated, as amended, and applicable rules and regulations, specifically the 522 and 527 CMR series as listed in Appendix P and elsewhere, shall be adhered to in the design and construction of structures covered under this article.

400.2 Uses involving explosion hazards: The provisions of this article shall apply to all uses involving the storage, manufacture, handling or filling of flammable and volatile solids, liquids or gases which generate combustible and explosive air-vapor mixtures and toxic gases including nitrocellulose film; pyroxylin plastics; grain and other combustible dusts and pulverized fuels; combustible fibers; pyroxylin lacquer-spraying operations; liquified petroleum gases; alcohol, ether and gasoline; flammable dusts and residues resulting from fabrication, grinding and buffing operations, and all other explosion hazard risks.

400.3 Special high hazards: When necessary to resist a higher degree of fire severity than specified herein, for high concentrations of combustible contents and for buildings of high hazard uses which exceed five (5) stories or sixty-five (65) feet in height, the building official may require higher fireresistance ratings than the requirements of Table 214 governing the fireresistance ratings of types of construction and protection of structural elements.

400.4 Means of egress: The means of egress for buildings of hazardous uses and occupancies shall conform to the requirements of Article 6, except as may be modified by more restrictive provisions of this article for specific uses.

400.5 Heating and venting: The requirements herein prescribed for the installation of heating and venting appliances and equipment for high hazard uses and occupancies shall be construed as supplemental to the provisions of Articles 5 and 10, and the mechanical code listed in Appendix B.

400.6 Equipment rooms: Heating and ventilating equipment in occupancies involving fire hazards from flammable vapors, dust, combustible fibers or other highly combustible substances shall be installed and protected against fire and explosion hazards in accordance with the mechanical code listed in Appendix B. Rooms containing such equipment shall be segregated by construction of not less than two (2) hour fire-resistance rating except as may be required for specific uses, without openings in the enclosure walls and with means of direct ingress and egress from the exterior, or such equipment shall be located in accessory structures segregated from the main building.

400.7 Fire-fighting and extinguishing equipment: All buildings designed for specific hazardous uses shall be protected with approved automatic fire suppression systems or such other fire-extinguishing and auxiliary equipment as herein provided and in accordance with the requirements of Article 12.

400.8 Segregation of storage spaces: All rooms and spaces used for the storage of volatile and flammable materials shall be separately enclosed and segregated with fire-resistance rated construction as herein required for specific uses and occupancies.

400.9 Restricted locations: Except as otherwise specifically approved, high hazard uses shall not be located in the fire limits nor in a building of unprotected frame (Type 4B) construction, nor in any case within two hundred (200) feet of the nearest wall of a building classified in a public assembly or institutional use group.

400.10 Light and electric wiring: In every structure involving flash fire and explosion hazards, all artificial lighting shall be restricted to incandescent electric lights or other approved lighting with keyless sockets and dust-tight, vapor-proof globes protected against mechanical injury. All wiring in vaults or compartments for the storage of highly flammable materials shall be in metal or other approved conduit complying with the provisions of the Massachusetts Electrical Code (527 CMR 12.00).

## SECTION 401.0 EXPLOSION HAZARDS

401.1 Explosion relief: Every structure, room or space occupied for uses involving explosion hazards shall be equipped and vented with explosion relief systems and devices arranged for automatic release under predetermined increase in pressure as herein provided for specific uses or in accordance with accepted engineering standards and practice.

401.2 Venting devices: Venting devices to relieve the pressure resulting from explosive air-vapor mixtures shall consist of windows, skylights, vent flues or releasing roof or wall panels which discharge directly to the open air or to a public place or other unoccupied space not less than twenty (20) feet in width on the same lot. Such releasing devices shall be so located that the discharge end shall be not less than (10) feet vertically and twenty (20) horizontally from window openings or means of egress facilities in the same or adjoining buildings or structures. The exhaust shall always be in the direction of least exposure and never into the interior of the building.

401.3 Area of vents: The aggregate clear vent relief area shall be regulated by the type of construction of the building and shall be not less than prescribed below:

1. heavy reinforced concrete frame, one (1) square foot for eighty (80) cubic feet of volume;
2. light structural steel frame and ordinary construction, one (1) square foot for sixty-five (65) cubic feet of volume.

The combined area of open windows pivoted sash or wall panels arranged to open under internal pressure shall not be less than ten (10) per cent of the area of the enclosure walls, with not less than fifty (50) per cent of the opening arranged for automatic release.

401.4 Construction of vents: All explosion relief devices shall be of an approved type constructed of light weight, noncombustible and corrosion-resistant materials, and the discharge end shall be protected with approved screens of not more than three-quarter (3/4) inch mesh, arranged to blow out under relatively low pressures.

## SECTION 402.0 VOLATILE FLAMMABLES

## 402.1 Process storage

402.1.1 Inside storage: Unless otherwise approved by the fire official, inside storage in process rooms shall be limited to one (1) day's supply in approved sealed containers of not more than five (5) gallon capacity or in approved steel barrels or drums of not more than fifty-five (55) gallon capacity.

402.1.2 Handling: Discharge or filling operations shall be by pump through an approved system of securely attached and continuous piping or hose lines. In processes requiring the use of open vats or mixing



tanks, an approved mechanical ventilating system shall be provided to remove the vapors or to produce a vapor mixture of not more than one (1) per cent concentration.

402.1.3 Construction of enclosures: Process rooms shall be separated from other uses and occupancies by walls, floors and ceilings of not less than two (2) hours fire-resistance rating with one and one-half (1 1/2) hour fire doors or the approved labeled equivalent complying with Article 9. The interior door openings shall be provided with non-combustible sills not less than six (6) inches high and the room shall be vented as required in Section 401.1. Floors shall be waterproofed and drained to comply with Section 872.0

402.1.4 Fire protection: First aid fire appliances and automatic fire suppression systems or other extinguishing equipment shall be provided in accordance with Article 12 and the standards listed in Appendix I. Provision shall be made to prevent leaking flammable vapors from being exposed to open flames, fire or sparks.

402.2 Main storage: No tank for the storage of volatile flammable liquids shall be erected, altered, or removed without first obtaining a permit from the building official. No permit shall be issued by the building official to erect, alter, or remove a flammable liquid storage tank without first obtaining the written approval of the head of the fire department. Flammable liquid storage tanks shall be constructed, located, and installed in conformance to the applicable provisions of this section, 527 CMR 9.00, 522 CMR 10.00, 522 CMR 11.00, 522 CMR 12.00 (see Appendix P) and the accepted engineering practice standards listed in Appendix B of this code.

402.2.1 Special restrictions: When necessary to ensure public safety, greater fire separations may be required or greater limitations may be placed on storage capacity for flammable liquid storage tanks.

#### SECTION 403.0 FIRE PREVENTION CODES

403.1 Inspections: All buildings and structures involving the use and handling of flammable or explosive materials, places of assembly and other hazardous uses and occupancies shall be inspected in accordance with the fire prevention codes listed in Appendix B. Such inspection shall be made to insure compliance with the provisions of the fire prevention codes in respect to protection against fire and panic; maintenance of exitways and operation of fire door assemblies; fire protection systems; standpipes; hydrant and fire suppression systems; fire-alarm, signaling and central station alarm systems; conduct of fire drills and fire brigades; and all special fire extinguishing equipment.

403.2 Housekeeping: Periodic inspections of existing uses and occupancies shall be made to insure maintenance of good housekeeping conditions

including the removal of waste and rubbish; safe arrangement and storage of merchandise and other contents; proper segregation of hazardous processes; handling of volatile flammables; avoidance of dangerous congestion and maintenance of all means of egress clear of obstructions; and the safe operation of all places of public assembly in which combustible scenery and hazardous equipment are in use while open to the public.

403.3 Coordination of inspections: The building, fire, and health officials and other administrative agencies of the jurisdiction to whom the authority is delegated to inspect buildings and structures in respect to the maintenance of safe conditions of use and occupancy shall immediately notify the respective official of any violation of the provisions of this code or the fire prevention and health rules and regulations.

#### SECTION 404.0 SPECIAL PERMITS AND CERTIFICATES OF FITNESS

404.1 Special permits: A hazardous or dangerous industry, trade, occupation or use which involves the transportation, storage or handling of explosive, flammable, combustible or other substance involving fire or life hazards shall not be conducted without a permit from the fire official prescribing the conditions and requirements necessary to secure the public safety.

404.2 Certificate of fitness: Before any equipment involving fire or life hazard is placed in operation, the supervisor or operator shall secure a certificate of fitness from the administrative official certifying to the qualifications of the person to whom such certificate is issued. Certificates of fitness shall be required for the operation of boilers and unfired pressure vessels as specified in the mechanical and boiler codes listed in Appendix B and for the conduct of all high hazard uses involving the storage, use or handling of flammable volatile liquids, materials and mixtures, liquified gases and compressed gases under a pressure of more than fifteen (15) pounds per square inch (psi), and all acid and liquid chemicals of a combustible and explosive character. All certificates of fitness may be terminated for cause at any time, and shall be renewed at intervals of not more than one (1) year.

#### SECTION 405.0 EXISTING BUILDINGS

405.1 Special permit for existing uses: Any existing hazardous use which was heretofore authorized by a permit issued under the provisions of law or the regulations of the fire official may be continued by special permit provided the continuance of such use or occupancy does not endanger the public safety.

405.2 Existing use prohibited: An existing building of frame (Type 4) construction which is more than two (2) stories in height or more than five thousand (5,000) square feet in area; or of nonfireproof (Type 3) construction which is more than four (4) stories in height shall not be

continued in use or hereafter occupied for the manufacture of pyroxylin plastics or similar materials of high fire hazard and explosive characteristics.

405.3 Places of assembly

405.3.1 Change of use: An existing building or structure or part thereof shall not be altered or converted into a place of assembly unless it complies with the provisions of this code applicable to places of public assembly (see Article 22).

405.3.2 Deleted

405.3.3 Deleted

405.4 Deleted

405.4.1 Deleted

405.4.2 Deleted

SECTION 406.0 LIQUIFIED PETROLEUM GASES

406.1 General: The provisions of this section shall apply to the design, construction, location, installation, and operation of propane, butane and other petroleum gas facilities, normally stored in the liquid state under pressure for use in all buildings and structures. No tanks for the storage of liquified petroleum gases shall be erected, altered or removed without first obtaining a permit from the building official. No permit shall be issued by the building official to erect, alter or remove a liquified petroleum gas storage tank without first obtaining the written approval of the head of the fire department. Liquified petroleum gas storage tanks and accompanying valves, accessories, piping, vaporizers and safety devices shall be constructed, located, and installed in conformance to the applicable provisions of this section, 527 CMR 9.00, 522 CMR 10.00, 522 CMR 11.00, 522 CMR 12.00 (see Appendix P), and the accepted engineering practice standards listed in Appendix B of this code.

406.2 Classification of systems: Systems for the storage and use of liquified petroleum gases shall be classified as: cylinder or bottled gas systems; aboveground tank systems other than bottled gas; and underground tank systems. This applies to containers of less than ten thousand (10,000) gallons.

406.3 Bottled gas: A container or cylinder of bottled gas for domestic or commercial use shall not exceed twelve hundred (1200) gallon equivalent water capacity; and such container shall be tested and approved by an accredited testing authority and shall be identified in accordance with the Department of Transportation (DOT) regulations. The cylinders shall be installed above ground, with valves, flexible connectors, piping and safety devices in accordance with the approved rules; except that such containers, when approved by the building official, may be installed for

use inside buildings for industrial purposes or in connection with construction, repair or alteration operations.

406.4 Above ground tank systems other than bottled gas: Above ground bulk storage of liquified petroleum gases shall not be permitted within the fire limits.

406.4.1 Special restrictions: When necessary to ensure public safety, greater fire separations may be required or greater limitations may be placed on storage capacity for liquified petroleum gas storage tanks.

406.5 Underground tank systems: When required, underground tanks for storage of liquified petroleum gases shall be anchored or weighted to prevent flotation.

406.6 Labeling: All inlet and outlet connections except safety relief valves, level and pressure gauges shall be labeled to designate whether they communicate with vapor or liquid space and the tanks shall be marked with a securely attached label and nameplate identifying the system working pressure, vapor pressure of the contents and permissible liquid level in accordance with accepted engineering practice.

406.7 Instructions: Complete installation, operation and maintenance instructions shall be supplied for the personnel responsible for the use of the system.

406.8 Grounding: All aboveground tanks exceeding twelve hundred (1200) gallons equivalent water capacity shall be permanently and effectively grounded.

#### SECTION 407.0 PYROXYLIN PLASTICS

407.1 General: The provisions of this section, including reference 527 CMR 7.00, shall regulate all buildings, structures and parts thereof used for the storage, handling or fabrication of pyroxylin plastics permitted by Massachusetts law whether as raw material, process, finished product or scrap.

407.2 Exceptions: The provisions of this section shall not apply to the manufacture, use or storage of nitro-cellulose film or the incidental storage of articles manufactured from pyroxylin plastics offered for sale in mercantile buildings (see Section 208.0).

407.3 Restrictions: A permit for the storage or manufacture of pyroxylin plastics, except as specified in Section 407.2, shall not be issued for a building or structure hereafter erected, altered or used which is occupied or located as described in the following Sections 407.3.1 through 407.3.5.

407.3.1 Place of assembly: Within fifty (50) feet of the nearest wall of a school, theatre or other place of public assembly.

407.3.2 Residential building: As a residential building, use group R-1, R-2 or R-3.

407.3.3 High hazard uses: In quantities, exceeding one thousand (1,000) pounds in buildings where paints, varnishes or lacquers are manufactured, stored or kept for sale; or where matches, resin, oils, hemp, cotton or any explosives are stored or kept for sale.

407.3.4 Other flammable materials: Where drygoods, garments or other materials of a highly flammable nature are manufactured in any portion of the building above that used for nitro-cellulose products.

407.3.5 Tenant factory building: In quantities exceeding one hundred (100) pounds in any tenant factory building (use group F) in which more than five (5) people are employed or likely to congregate on one (1) floor at any one (1) time.

407.4 Inside storage: All pyroxylin raw material and products intended for use in further manufacture shall be stored as herein provided on the following Sections 407.4.1 through 407.4.6

407.4.1 Cabinets: Quantities of more than twenty-five (25) pounds and not more than five hundred (500) pounds shall be stored in approved cabinets constructed of noncombustible materials but the total quantity of storage shall not be more than one thousand (1,000) pounds in any work room or space enclosed in floor, walls and ceilings of not less than two (2) hours fireresistance rating.

407.4.2 Vaults: Quantities of more than one hundred (100) pounds and not more than ten thousand (10,000) pounds shall be stored in vaults enclosed in floors, walls and ceilings of not less than four (4) hours fireresistance rating. The interior storage volume of the vault shall be not more than fifteen hundred (1500) cubic feet and the vault shall be constructed vapor and gastight in accordance with the approved rules, with one and one-half (1 1/2) hour vapor-tight fire doors or the approved labeled fire door assembly equivalent on each side of the door opening. The vault shall be drained and provided with scuppers.

407.4.3 Tote boxes and scrap containers: During manufacture, pyroxylin materials and products not stored in finished stock rooms, cabinets or vaults shall be kept in approved covered noncombustible tote boxes. Scrap and other refuse material shall be collected in approved noncombustible containers in quantities not greater than three hundred and fifty (350) pounds and removed at frequent intervals as directed by the fire official.

407.4.4 Ventilation: Each separate compartment in storage vaults shall be vented directly to the outer air through flues complying with the requirements of the mechanical code listed in Appendix B for low temperature chimneys, or exterior metal smokestacks, or as otherwise provided in the approved rules. The vent shall discharge not less than four (4) feet above the roof of the building or on a street, court or other open space not less than fifty (50) feet distance from any other opening in adjoining walls which are not in the same plane, nor nearer than twenty-five (25) feet vertically or horizontally to an exterior stairway, fire escape or exit-way discharge. The area of the vent shall be not less than one (1) square inch for each seven (7) pounds of pyroxylin stored.

407.4.5 Structural strength: The floors, walls, roof and doors of all vaults, structures or buildings used for the storage or manufacture of pyroxylin materials and products shall be designed to resist an inside pressure load of not less than three hundred (300) pounds per square foot (psf).

407.4.6 Fire protection: Vaults located within buildings for the storage of raw pyroxylin shall be protected with an approved automatic sprinkler system capable of discharging one and sixty-six one-hundredths (1.66) gallons per minute (gpm) per square foot over the area of the vault.

407.5 Isolated storage buildings: Pyroxylin products in quantities greater than permitted for interior storage shall be housed in isolated storage buildings. Such buildings shall not be used for any purpose other than packing, receiving, shipping and storage of pyroxylin plastics unless otherwise approved by the building official.

407.5.1 Capacity: The maximum storage in any fire area enclosed in construction of four (4) hours fire resistance rating shall be not greater than one hundred thousand (100,000) pounds. The storage capacity of the building and its separation from lot lines and other buildings on the same lot shall be limited as provided in Table 407.5. When equipped with an approved automatic sprinkler system complying with the provisions of Article 12 and as herein modified, the exposure distances may be decreased fifty (50 per cent). Such systems shall be designed in accordance with Section 2061 of NFPA 42, Pyroxylin Plastics, as listed in Appendix B.

EXPOSURE DISTANCE FOR PYROXYLIN STORAGE BUILDINGS

| Maximum quantity stored in pounds | Fire separation from lot line or other buildings in feet |
|-----------------------------------|--|
| 1,000                             | 40   |
| 2,000                             | 50   |
| 3,000                             | 60   |
| 4,000                             | 70   |
| 5,000                             | 80   |
| 10,000                            | 100  |
| 20,000                            | 125  |
| 30,000                            | 150  |
| 40,000                            | 160  |
| 50,000                            | 180  |
| 75,000                            | 200  |
| 100,000                           | 225  |
| 150,000                           | 250  |
| 300,000                           | 300  |

## 407.6 Fire protection

407.6.1 Heating equipment: All radiators, heating coils, piping and heating apparatus shall be protected with approved noncombustible mesh to maintain a clearance of six (6) inches of all pyroxylin products from such equipment. All piping and risers within six (6) feet of the floor shall be insulated with approved noncombustible covering unless protected with wire guards.

407.6.2 Lighting control: All lighting shall comply with the provisions of Section 400.10, shall be controlled from panel boards located outside of storage compartments and vaults, shall comply with Article 15 of NFPA 42, Proxylin Plastics, as listed in Appendix B.

407.6.3 Standpipes: First-aid standpipes shall be provided for each five thousand (5,000) square feet of floor area equipped with one and one-half (1 1/2) inch hose, complying with Article 12.

407.6.4 Automatic sprinklers: All manufacturing and storage spaces and vaults where required shall be protected with an approved automatic sprinkler system as herein specified and with fire pails and portable fire extinguishers complying with Article 12 and the approved rules.

407.6.5 Special protection: Special chemical extinguishers and other first-aid fire appliances shall be provided around motors and other electrical equipment in accordance with the approved rules.

## SECTION 408.0 USE AND STORAGE OF FLAMMABLE FILM

408.1 Permit required: A permit for handling, use, storage or recovery of flammable film shall not be issued for any building located as specified in Section 407.3; except that those restrictions shall not apply to the screening and projection rooms of theatres and other places of amusement or instruction. It shall be unlawful to store, stock or use any nitro-celulose or other flammable film in quantities of more than two thousand (2,000) feet in length or more than ten (10) pounds in weight unless approved by the fire official. All installations shall comply with the applicable standards listed in Appendix B.

408.2 Storage: Other than motion picture projection and rewind rooms, or as herein specifically exempted, all rooms in which flammable film is stored or handled shall be enclosed in not less than two (2) hour fire-resistant construction complying with the provisions of Article 9. All film, except when in process or use, shall be kept in approved closed containers.

408.2.1 Cabinets: Flammable film in amounts of twenty-five (25) to one thousand (1,000) pounds shall be stored in approved noncombustible cabinets constructed and vented in accordance with the approved rules. One

(1) cabinet shall not contain more than three hundred and seventy-five (375) pounds. All cabinets with a capacity of more than seventy-five (75) pounds shall be equipped with not less than one (1) automatic sprinkler head.

408.2.2 Vaults: Flammable film in amounts greater than one thousand (1,000) pounds shall be kept in vaults constructed as provided in Section 407.0; except that the interior storage volume shall not exceed seven hundred and fifty (750) cubic feet.

408.2.3 Rooms: Unexposed film may be stored in the original approved shipping cases complying with the rules of the Department of Transportation (DOT) in rooms equipped with an approved automatic sprinkler system complying with the provisions of Section 407.4.6.

408.2.4 Ventilation: Storage rooms shall be ventilated as specified in Section 407.4.4 with the vents arranged to open automatically in the event of fire, in accordance with the approved rules.

408.2.5 Heating: All heating equipment and installations shall conform to the requirements of Section 407.6.1. The duct systems of warm air heating and air conditioning systems shall comply with Article 5, and shall be protected with automatic fire dampers to cut off all rooms in which film is handled from all other rooms and spaces in the building. The heating of film vaults shall be automatically controlled to a maximum temperature of seventy (70) degrees F.

408.2.6 Fire protection: Approved automatic sprinkler systems shall be provided in all buildings and structures and parts thereof in which flammable film is stored or handled in amounts of more than fifty (50) pounds and as herein specifically required, except in projection rooms and rewind rooms conforming to the requirements of Section 408.3. First-aid fire-extinguishing and auxiliary fire-fighting equipment shall be provided in accordance with Article 12 and the approved rules adopted thereunder.

408.3 Projection room required (scope): The provisions of this section shall apply to rooms in which ribbon-type cellulose acetate or other safety film is used in conjunction with electric arc, xenon or other light source projection equipment which develops hazardous gases, dust or radiation. Where cellulose nitrate film is used, projection rooms shall comply with NFPA 40, listed in Appendix B.

Every motion picture machine projecting film as mentioned within the scope of this section shall be enclosed in a projection room. Appurtenant electrical equipment, such as rheostats, transformers and generators, may be within the projection room or in an adjacent room of equivalent construction. There shall be posted on the outside of each projection room door and within the projection room itself a conspicuous sign with one (1) inch block letters stating: Safety film only permitted in this room.



408.3.1 Construction of projection rooms: Every projection room shall be of permanent construction consistent with the construction requirements for the type of building in which the projection room is located. Openings need not be protected.

The room shall have a floor area of not less than eighty (80) square feet for a single machine. Each motion picture projector, flood light, spotlight or similar piece of equipment shall have a clear working space of not less than thirty (30) inches by thirty (30) inches on each side and at the rear thereof, but only one (1) such space shall be required between two (2) adjacent projectors. The projection room and the rooms appurtenant thereto shall have a ceiling height of not less than seven (7) feet, six (6) inches. The aggregate of openings for projection equipment shall not exceed twenty-five (25) per cent of the area of the wall between the projection room and the auditorium. All openings shall be provided with glass or other approved material, so as to completely close the opening.

408.3.2 Means of egress from projection rooms: Exiting shall be provided as required in Article 6.

408.3.3 Ventilation of projection rooms: Ventilation shall be provided in accordance with the provisions of this section.

408.3.3.1 Projection room

1. Supply air: Each projection room shall be provided with two (2) or more separate fresh air inlet ducts with screened openings terminating within twelve (12) inches of the floor, and located at opposite ends of the room. Such air inlets shall be of sufficient size to permit an air change every three (3) minutes. Fresh air may be supplied from the general building air conditioning system; but when this is done, it shall be so arranged that the projection room will continue to receive one (1) change of air every three (3) minutes, regardless of the status of the general air conditioning system.
2. Exhaust air: Each projection room shall be provided with one (1) or more exhaust air outlets which may be manifolded into a single duct outside the room. Such outlets shall be so located as to insure circulation throughout the room. Projection room exhaust air systems shall be independent of any other air systems in the building. Exhaust air ducts shall terminate at the exterior of the building in such a location that the exhaust air cannot be readily recirculated into the supply air system. The exhaust system shall be mechanically operated and of such a capacity as to provide a minimum of one (1) change of air every three (3) minutes. The blower motor shall be outside the duct system. The projection room ventilation system may also serve appurtenant rooms, such as the generator room and the rewind room.

408.3.3.2 Projection equipment ventilation: Each projection machine shall be provided with an exhaust duct which will draw air from each lamp and exhaust it directly to the outside of the building in such a fashion that it will not be picked up by supply inlets. Such a duct shall be of rigid materials, except for a continuous flexible connector for the purpose. The lamp exhaust system shall not be interconnected with any other system.

1. Electric arc projection equipment: The exhaust capacity shall be two hundred (200) cubic feet per minute (cfm) for each lamp connected to the lamp exhaust system, or as recommended by the equipment manufacturer. Auxiliary air may be introduced into the system through a screened opening to stabilize the arc.
2. Xenon projection equipment: The lamp exhaust system shall exhaust not less than three hundred (300) cubic feet per minute (cfm) per lamp, nor less than that exhaust volume required or recommended by the equipment manufacturer, whichever is the greater. The external temperature of the lamp housing shall not exceed one hundred thirty (130) degrees F., when operating.

408.3.4 Lighting control: Provision shall be made for control of the auditorium lighting and the emergency lighting systems of theatres from inside of the room and from at least one (1) other convenient point in the building as required in Section 417.9.

408.3.5 Miscellaneous equipment: Each projection room shall be provided with rewind and film storage facilities. A maximum of four (4) containers for flammable liquids not greater than sixteen (16) ounce capacity and of a nonbreakable type may be permitted in each projection room.

408.3.6 Sanitary facilities: Every projection room shall be provided with a lavatory. Every projection room serving an assembly occupancy shall be provided with a water closet.

408.4 Screening rooms: Screening rooms shall provide a seating capacity of not more than thirty (30) persons, with not less than two (2) approved means of egress complying with Article 6. Such rooms shall be enclosed in one (1) hour fire separation walls with self-closing fire doors in their approved labeled equivalent at the openings. All seats shall be permanently fixed in position and the arrangement shall comply with the requirements of Section 417.4.

408.5 Temporary motion picture installations: Permits for portable and temporary room construction for incidental amusement and educational purposes shall be secured from the fire official in accordance with the approved rules.

408.6 Motion picture studios

408.6.1 Construction: All buildings designed or used as motion picture studios shall be protected with an approved two (2) source automatic sprinkler system complying with the provisions of Article 12; except that the building official may exempt rooms designed for housing electrical equipment from this requirement when constructed of fireproof (Type 1) construction.

408.6.2 Special rooms: Rooms and spaces used as carpenter and repair shops, dressing rooms, costume and property stage rooms shall be enclosed in floors, walls and ceilings of not less than two (2) hour fire-resistance rated construction.

408.6.3 Trim, finish and decorative hangings: All permanently attached acoustic, insulating and light reflecting materials and temporary hangings on walls and ceilings shall comply with the requirements of Article 9.

408.6.4 Film storage: All film shall be stored as required in Section 408.2 and surplus film shall not be kept on the studio stage except loaded magazines in the cameras and sound recording apparatus. All extra loaded magazines shall be stored in a separate magazine room enclosed in two (2) hour fire-resistive construction.

408.7 Film laboratories: Film laboratories shall not be conducted in other than fireproof (Type 1A) buildings or structures, equipped throughout with an approved automatic sprinkler system.

408.8 Film exchanges: All film exchanges and depots shall be housed in buildings and structures of fireproof (Type 1A) construction equipped throughout with an approved automatic sprinkler system. All flammable film other than that in process of receipt, delivery or distribution shall be stored in vaults complying with the requirements of Section 407.4.2.

#### SECTION 409.0 USE AND STORAGE OF COMBUSTIBLE FIBERS

409.1 General: The provisions of this section shall apply to all buildings and structures involving the storage or use of finely divided combustible vegetable or animal fibers and thin sheets or flakes of such materials involving flash fire hazard, including among others cotton, excelsior (shredded paper), hemp, sisal, jute, kapok and paper and cloth in the form of scraps and clippings in excess of one thousand (1,000) pounds. The provisions of the applicable standards listed in Appendix B except as herein specifically provided shall be deemed to conform to the provisions of this code.

409.2 Construction requirements: All buildings designed for the storage of combustible fibers as herein described shall be constructed within the limits of height and area specified in Table 305 for high hazard use (use group H) except as described in the following Sections 409.2.1 through 409.2.6.

409.2.1 Special limits: A single storage room or space shall not be more than five thousand (5,000) square feet in area or more than fifty thousand (50,000) cubic feet in volume unless of protected noncombustible (Type 2B) or better construction.

409.2.2 Floor loads: The floors of all buildings designed for the storage of combustible fibers shall not be loaded in excess of one-half (1/2) the safe load capacity of the floor, nor shall materials be piled to more than two thirds (2/3) of the clear story height.

409.2.3 Salvage doors: Every exterior wall shall be provided with a door to each storage compartment arranged for quick removal of the contents.

409.2.4 Wall openings: All openings in outside walls shall be equipped with approved fire doors and fire windows complying with Article 9.

409.2.5 Roof openings: All skylights, monitors and other roof openings shall be protected with galvanized wire or other approved corrosion-resistant screens with not less than thirty-six (36) meshes to the square inch or with wire glass in stationary frames.

409.2.6 Boiler rooms: All power and heating boilers and furnaces shall be located in detached boiler houses or in a segregated boiler room enclosed in three (3) hour fireresistance rated construction with direct entrance from the outside, except that rooms containing gas-fired heating equipment may have openings into the warehouse protected with one and one-half (1 1/2) hour fire doors or their approved labeled equivalent.

409.3 Fire protection: Fire protection equipment shall be provided complying with Article 12 consisting of casks, pails and portable chemical extinguishers and standpipes. Where deemed necessary by the administrative authority, a system of outside hydrants and hose shall be provided.

409.4 Housekeeping: Ashes, waste, rubbish or sweepings shall not be kept in wood or other combustible receptacles and shall be removed from the premises daily. Grass or weeds shall not be allowed to accumulate at any point on the premises.

409.5 Open storage: Only temporary open storage of combustible fibers shall be permitted on the same premises with a fiber warehouse and shall be kept covered on top and sides with tarpaulins secured in place. Not more than seven thousand two hundred (7,200) cubic feet of fiber shall be stored in the open; and fire-extinguishing equipment shall be provided as directed by the fire official.

409.6 Special treatments: When combustible fibers are packed in special noncombustible containers or when packed in bales covered with wrappings to prevent ready ignition, or when treated by approved chemical dipping or spraying processes to eliminate the flash fire hazard, the restrictions governing combustible fibers shall not apply.

SECTION 410.0 COMBUSTIBLE DUSTS, GRAIN PROCESSING  
AND STORAGE

410.1 General: The provisions of this section shall apply to all buildings in which materials producing flammable dusts and particles which are readily ignitable and subject to explosion hazards are stored or handled, including, among others, grain bleachers and elevators, malt houses, flour, feed or starch mills, wood flour manufacturing and manufacture and storage of pulverized fuel and similar uses. The applicable standards listed in Appendix B, except as herein specifically required, shall be deemed to conform to the requirements of this code.

410.2 Construction requirements

410.2.1 Buildings: All such buildings and structures, unless herein otherwise specifically provided, shall be of fireproof (Type 1), noncombustible (Type 2), or of laminated planks or lumber sizes qualified for heavy timber mill (Type 3A) construction, within the height and area limits of high hazard uses (use group H) of Table 305; except that when erected of fireproof (Type 1A) construction, the height and area of grain elevators and similar structures shall be unlimited, and when of heavy timber (Type 3A) construction, the structure may be erected to a height of sixty-five (65) feet; and except further that, in isolated areas, the height of Type 3A structures may be increased to eighty-five (85) feet.

410.2.2 Grinding rooms: Every room or space for grinding or other operations producing flammable dust shall be enclosed with floors and walls of not less than two (2) hour fireresistance rating when the area is not more than three thousand (3,000) square feet and of not less than four (4) hour fireresistance rating when the area is greater than three thousand (3,000) square feet.

410.2.3 Conveyors: All conveyors, chutes, piping and similar equipment passing through the enclosures of such rooms or spaces shall be constructed dirt and vapor tight, of approved noncombustible materials complying with Article 16.

410.3 Explosion relief: Means for explosion relief shall be provided as specified in Section 401.0, or such spaces shall be equipped with the equivalent mechanical ventilation complying with the mechanical code listed in Appendix B.

410.4 Grain elevators: Grain elevators, malt houses and buildings for similar uses shall not be located within thirty (30) feet of interior lot lines or structures on the same lot, except when erected along a railroad right of way.

410.5 Coal pockets: Coal pockets located less than thirty (30) feet from interior lot lines or structures on the same lot shall be constructed of not

less than protected noncombustible (Type 2A) construction. When more than thirty (30) feet from interior lot lines, or erected along a railroad right of way, such structures may be built of lumber sizes qualifying for heavy timber or laminated construction, provided they are not more than sixty-five (65) feet in height.

## SECTION 411.0 PAINT SPRAYING AND SPRAY BOOTHS

411.1 General: The provisions of this section shall apply to the construction, installation and use of buildings and structures or parts thereof for the spraying of flammable paints, varnishes and lacquers or other flammable materials, mixtures or compounds used for painting, varnishing staining or similar purpose. All such construction and equipment shall comply with the approved rules and the applicable standards listed in Appendix B.

411.2 Location of spraying processes: Such processes shall be conducted in a spraying space, spray booth, spray room or shall be isolated in a detached building or as otherwise approved by the building official in accordance with accepted engineering practice.

### 411.3 Construction

411.3.1 Spray spaces: All spray spaces shall be ventilated with an approved exhaust system to prevent the accumulation of flammable mist or vapors. When such spaces are not separately enclosed, noncombustible spray curtains shall be provided to restrict the spread of fire.

411.3.2 Spray booths: All spray booths shall be constructed of approved noncombustible materials equipped with mechanical ventilating systems.

411.3.3 Spray rooms: All spray rooms shall be enclosed in partitions of not less than one (1) hour fire-resistance rating. Floors shall be water-proofed and drained in an approved manner. Floor drains to the building drainage system and the public sewer shall be prohibited.

411.3.4 Storage rooms: Spraying materials in quantities of not more than twenty (20) gallons may be stored in approved cabinets ventilated at top and bottom; when in quantities of more than twenty (20) gallons and not more than one hundred (100) gallons, they may be stored in approved double-walled noncombustible cabinets vented directly to the outer air; and all spraying materials in quantities of more than one hundred (100) gallons shall be stored in an enclosure of not less than two (2) hour fire-resistance rating or in a separate exterior storage building. Such storage shall not be in quantities of more than two hundred and fifty (250) gallons, except when stored in isolated storage buildings; and except further that not more than twenty-five (25) gallons of spraying material shall be stored in buildings in which pyroxylin products are manufactured or stored.

411.4 Ventilation of spraying processes: The ventilation system shall comply with the provisions of Section 401.0 and shall be adequate to exhaust all vapors, fumes and residues of spraying material directly to the outer air. Fresh air shall be admitted to the spraying spaces in an amount equal to the capacity of the fan in such manner as to avoid short circuiting the path of air in the working space and to provide air movement with a velocity of not less than one hundred (100) feet per minute at the face of the spray booth. All ducts and vents shall be constructed and installed to comply with the mechanical code listed in Appendix B. Unless equipped with approved explosion-proof motors with nonferrous fan blade fans, the mechanical exhaust equipment shall be located outside of spray spaces.

411.5 Fire protection: Sprinkler heads shall be provided in all spray, dip and immersing spaces and storage rooms and shall be installed in accordance with accepted engineering practice and the standards listed in Appendix B. Where buildings containing spray areas are not equipped with an approved automatic sprinkler system, the sprinkler heads in booths and other spray areas and storage rooms may be supplied from the building water supply when approved by the building official, to comply with the provisions of Section 1205.0.

411.6 Electrical equipment: Artificial lighting and electrical equipment shall comply with Section 400.10.

#### SECTION 412.0 DRY CLEANING ESTABLISHMENTS

412.1 General: Before any dry cleaning plant is constructed or an existing plant is remodeled or altered, complete drawings shall be filed showing to scale the relative location of the dry cleaning area, the boiler room, finishing department, solvent storage tanks, pumps, washers, drying tumblers, extractors, filter traps, stills, piping and all other equipment involving the use of flammable liquid solvents. All dry cleaning by immersion and agitation shall be carried on in closed machines, installed and operated in accordance with the approved rules and the applicable standards listed in Appendix B.

412.2 Classification: For the purpose of this code, all dry cleaning and dry dyeing establishments shall be classified as described in the following Sections 412.2.1 through 412.2.3.

412.2.1 High hazard: All such establishments shall be classified as high hazard which employ gasoline or other solvents having a flash point below one hundred (100) degrees F. (ASTM D56) in quantities of more than three (3) gallons, or more than sixty (60) gallons of flammable solvents with a flash point between one hundred (100) and one hundred and forty (140) degrees F. (ASTM D56).

412.2.2 Moderate hazard: All such establishments employing less than three (3) gallons of volatile flammables with a flash point of less than one hundred (100) degrees F. or less than sixty (60) gallons of solvent with a flash point between one hundred (100) and one hundred and forty (140) degrees F. (ASTM D56) shall be classified as moderate hazard.

412.2.3 Low hazard: All such establishments using solvents of other than volatile flammable liquids or solvents with a flash point more than one hundred and forty (140) degrees F. (ASTM D56) in cleaning and dyeing operations shall be classified as low hazard.

#### 412.3 Construction of dry cleaning plants

412.3.1 High hazard: High hazard dry cleaning plants as herein defined shall be located in buildings or structures of fireproof (Type 1A) construction, not more than one (1) story in height with solid floors and roofs and without openings other than required for egress and ventilation purposes. Such a building shall not be used for any other purpose.

412.3.2 Moderate hazard: Moderate hazard dry cleaning plants as herein defined may be located in buildings or structures of any type of construction other than frame (Type 4) buildings subject to the fire limit restrictions of Article 3 and the height and area limitations for high hazard buildings (use group H) of Table 305. The room or space in which such operations are conducted shall be enclosed in not less than two (2) hour fire-resistance rated construction with not less than two (2) means of egress from each dry cleaning or dry dyeing room or space.

412.3.3 Low hazard: Low hazard dry cleaning plants shall not be restricted as to type of building construction within the height and area limitations for use group B of Table 305; except that such uses shall not be located in basements nor in a building used for public assembly (use group A) or institutional (use group I) purposes.

412.3.4 Roof construction of dry cleaning plants: The roof over high hazard dry cleaning plants shall be flat without attic or concealed spaces and shall be provided with a pivot type skylight or other approved vent complying with Section 401.0, arranged to release outwardly under explosion pressures.

412.3.5 Floor construction of dry cleaning plants: The floor finish in high hazard dry cleaning plants shall be constructed of water-resistant noncombustible materials with nonsparking surface elevated above the adjoining grade and with door sills not less than ten (10) inches in height. There shall not be openings, vaults or pits below the floor.

412.3.6 Exterior walls of dry cleaning plants: Exterior walls of high hazard dry cleaning plants having a fire separation of less than thirty (30) feet shall be solid masonry without openings, but more than two (2) sides of the building shall not be enclosed in blank walls. Opening pro



tectives of exterior doors and windows shall have not less than three-quarter (3/4) hour fireresistance or the labeled equivalent construction, and the windows shall be pressure-releasing to comply with Section 401.0.

412.3.7 Basements of dry cleaning plants: The basements of all buildings in which high or moderate hazard dry cleaning establishments are conducted shall be completely separated from the superstructure with unpierced floor construction of not less than two (2) hours fireresistance rating. The access to such basements shall be from the exterior only.

412.4 Boiler room separation: Boiler rooms and heating equipment for high hazard dry cleaning plants shall be separated from drying rooms, dry cleaning and dry dyeing rooms with unpierced walls of not less than four (4) hours fireresistance rating and in moderate hazard establishments with solid walls of not less than two (2) hours fireresistance rating; or such boiler rooms shall be located in a separate building.

412.5 Ventilation: All rooms and spaces in high hazard dry cleaning plants shall be provided with a mechanical system of ventilation capable of twenty (20) complete and continuous changes of air per hour. Mechanical systems of ventilation in moderate hazard shall have sufficient capacity to insure ten (10) complete and continuous changes of air per hour. Satisfactory mechanical or natural ventilation shall be provided in low hazard plants by means of fans, pipes and ducts to ventilate drying tumblers, drying cabinets and similar equipment directly to the outer air.

412.6 Solvent storage: All volatile flammable solvents with a flash point under seventy-five (75) degrees F. (ASTM D56) shall be stored underground in accordance with the provisions of Section 402.0. Interior aboveground storage shall be permitted for solvents with a flash point above seventy-five (75) degrees F. (ASTM D56) provided the aggregate quantity of such solvent in use in the system and in storage is not more than five hundred and fifty (550) gallons and the capacity of any individual tank is not more than two hundred and seventy-five (275) gallons.

412.7 Fire protection: Every dry cleaning room and dry dyeing room employing high and moderate hazard solvents shall be protected with a fire protection system consisting of approved automatic sprinklers, manually controlled steam-blankets carbon dioxide flooding systems or other approved fire-extinguishing equipment.

## SECTION 413.0 PRIVATE GARAGES

### 413.1 Attached garages

413.1.1 One- and two-family dwellings: Private garages located beneath one- and two-family dwellings shall have walls, partitions, floors and ceilings separating the garage space from the dwelling constructed of not

less than one (1) hour fireresistance rating. Private garages attached to one and two-family dwellings shall be completely separated from the dwelling and its attic area by means of one-half (1/2) inch gypsum board or equivalent applied to the garage side. The sills of all door openings between the garage and dwelling shall be raised by step or sill not less than four (4) inches above the garage floor. The door opening protectives shall be one and three-quarter (1 3/4) inch solid wood core doors or approved equivalent.

413.1.2 Motels and multi-family dwellings: Private garages located beneath motels and multi-family dwellings and in which gasoline or oil is not stored or handled shall be of protected construction of not less than one and one-half (1 1/2) hour fireresistance rating.

413.1.3 Separation by breezeway: A garage separated from a residence outside the fire limits by a breezeway not less than ten (10) feet in length may be of unprotected frame (Type 4B) construction, but the junction of the garage and breezeway shall be firestopped to comply with Section 875.0.

413.1.4 Other conditions: All private garages not falling within the purview of Sections 413.1.1, 413.1.2, or 413.1.3, attached to or located beneath a building shall comply with the requirements of Section 414.2.3 for public garages.

413.1.5 Heating equipment: Boilers, furnaces, hot water heaters or any other appliances having an open flame or exposed heated surfaces shall not be located in a private garage unless precautions are taken to protect such equipment from impact by automobiles. This equipment shall have the combustion chamber, ash pit etc., raised a minimum of eighteen (18) inches above the floor to eliminate a possible source of ignition.

413.2 Means of egress: Where living quarters are located above a private garage, required means of egress facilities shall be protected from the garage area with one (1) hour fireresistance rated construction.

#### SECTION 414.0 PUBLIC GARAGES

414.1 General: Public garages shall comply with the applicable requirements of this section. The portions of such buildings and structures in which gasoline, oil and similar products are dispensed shall comply with the requirements of Section 415.0; the portions in which motor vehicles are repaired shall comply with Section 416.0; and the portions in which paint spraying is done shall comply with the requirements of Section 411.0 and 527 CMR 5.00.

414.2 Construction: All Group 1 public garages hereafter erected shall be classified as storage buildings, moderate hazard (use group S-1) and all Group 2 public garages shall be classified as storage buildings, low

hazard (use group S-2) and shall conform to the height and area limitations of Table 305 except as herein specifically provided. The areas used for dispensing gasoline in such buildings shall be located on the grade floor and shall comply with the requirements of Section 415.0.

414.2.1 Special height limitations: Public garage buildings shall comply with the height and area limitations of Table 305 for the classification of the use as specified in Section 414.2. Such heights may be increased one (1) additional story when the building is equipped with an approved automatic fire suppression system.

414.2.2 Basements: The first floor construction of public garages of all classifications and public hangars with basements shall be constructed of not less than two (2) hour fireresistance rating and shall be water and vapor proof. Where openings are provided in the floor they shall be protected by a curb or ramp not less than six (6) inches high above the floor to avoid the accumulation of explosive liquids or vapors and prevent them from spilling to the lower floor. There shall be not less than two (2) means of egress from such areas, one (1) of which shall be directly to the outside independent of the exitways serving other areas of the building.

414.2.3 Mixed occupancy: A public garage shall not be located within or attached to a building occupied for any other use, unless separated from such other use by walls or floors complying with Table 902 for fireresistance rating. Such fire separation walls shall be continuous and unpierced by openings; except that door openings equipped with self-closing fire doors complying with Article 9 shall be permitted. In buildings of single occupancy not excluding the area limitations of Table 305, doors without a fireresistance rating shall be permitted between the garage area and salesroom or offices that are operated in connection with the garage.

414.2.4 Roof storage of motor vehicles and airplanes: The roof of a public garage shall not be used for the parking or storage of motor vehicles unless the building is of fireproof construction (Type 1A or 1B). When the roof of a building is used for parking or storage of motor vehicles, it shall be provided with a parapet wall or guard rail not less than three (3) feet six (6) inches in height and a wheel guard not less than six (6) inches in height, located so as to prevent any vehicle from striking the parapet wall or guard rail. The use of roofs for airplanes storage and landing shall be subject to the approval of the Federal Aviation Administration, if required.

414.2.5 Floor construction and drainage: Floors of public garages and airplane hangars shall be graded to drain through oil separators or traps to avoid accumulation of explosive vapors in building drains or sewers as provided in the Massachusetts Plumbing Code (248 CMR 2.00). The floor finish shall be of concrete or other approved nonabsorbent, noncombustible material.

### 414.3 Ventilation

414.3.1 Below grade: Enclosed and below grade public garages shall be equipped with mechanical ventilation adequate to provide six (6) air changes per hour. The ventilation system shall be operated at all times the garage areas are occupied by human beings.

414.3.2 Repair shops or rooms: When motor vehicles are to be operated or engines are run for test purposes or minor adjustments, provisions shall be made to collect the exhaust fumes from each vehicle individually and to discharge such fumes to the outer air by means of a positive induced draft. The discharge from such system shall be located so as not to create a hazard to adjoining properties, but not less than eight (8) feet above the adjacent ground level on the exterior of the building and shall discharge into a yard or court. When necessary to discharge across a walkway or private thoroughfare, the discharge opening shall be carried to a height of not less than twenty-five (25) feet above the ground level or to a distance four (4) inches above the highest point of the wall of the building or structure on which it is located.

414.3.3 Pits: Pits shall not be installed in floors below the first; and pits in first and upper stories shall be provided with mechanical ventilation sufficient to prevent the accumulation of noxious or volatile fumes or vapors. The ventilation system shall be operated at all times the pits are occupied by human things.

414.4 Special hazards: Any process conducted in conjunction with public garages involving volatile flammable solvents shall be segregated or located in a detached building or structure, except as provided in Section 402.0 for the storage and handling of gasoline and other volatile flammables. The quantity of flammable liquids stored or handled in public garages other than in underground storage and in the tanks of motor vehicles shall be not more than five (5) gallons in approved safety cans, except as provided in Rule 40 of 527 CMR 5.00.

414.5 Heating and protection of equipment: Radiation and heating coils and pipes located within six (6) inches of the floor shall be protected with wire mesh or other approved noncombustible shields of adequate strength; and with asbestos or other insulation on top of the equipment when located in partitions or near combustible racks or woodwork.

414.6 Boiler rooms of public garages: All heat generating plants other than approved direct fired heaters shall be located in separate buildings or shall be separately enclosed within the structure with solid, water and vapor tight masonry. All rooms housing boilers, stoves or other heating apparatus shall be cut off from all other parts of the building with four (4) hour fire-resistance rated construction with entrance from outside only, and there shall not be openings through the fire separation wall other than those necessary for heating pipes or ducts.

SECTION 415.0 MOTOR FUEL SERVICE STATIONS

415.1 Construction: Buildings and structures used for the storage and sale of motor fuel oils may be of all types of construction within the height and area limitations of Table 305 for business (use group B) buildings and as modified by Section 302.0. The canopies and supports over pumps and service equipment when located less than twenty (20) feet from interior lot lines shall be constructed of approved noncombustible materials, Type 3A (heavy timber) construction, or one (1) hour fire-resistance rated construction.

415.1.1 Exceptions: Approved plastics conforming to the requirements of Article 19 may be used in canopies over pumps when conforming to the following requirements.

1. The canopies are located at least ten (10) feet from any building on the same property and face yards or streets not less than forty (40) feet wide on the other sides;
2. the aggregate area of plastic in each canopy shall not exceed two hundred (200) square feet in the fire limits or one thousand (1,000) square feet outside the fire limits; and
3. the maximum area of each panel shall not exceed one hundred (100) square feet.

415.1.2 Opening protectives: All permissible openings in walls with a fire separation of less than twenty (20) feet shall be protected with approved fire windows or fire doors complying with Article 9, except doors in such walls to rest rooms.

415.1.3 Basements: Motor fuel service stations shall not have cellars or basements; and when pits are provided, they shall be vented as required in Section 414.3.

415.2 Gasoline storage: All volatile flammable liquid storage tanks shall be installed below ground and vented as specified in Section 402. Such tanks shall be subject to the approval of the fire official and comply with the provisions of 527 CMR 5.00.

415.3 Location of pumps: Gasoline pumps or other mechanical equipment shall not be installed so as to permit servicing of motor vehicles standing on a public street or highway; except when necessitated by the widening of streets or highways, the use of the outer driveway of existing service stations may be continued for servicing of vehicles when approved by the authority having jurisdiction.

SECTION 416.0 MOTOR VEHICLE REPAIR SHOPS

416.1 General: All buildings and structures designed and used for repair and servicing motor vehicles, motor boats, airplanes or other motor driven means of transportation shall be subject to the limitations of Tables

214 and 305 for moderate hazard storage (use group S-1). Such buildings shall be used solely for that purpose.

416.2 Enclosure walls: Exterior walls, when located within six (6) feet of interior lot lines or other buildings, shall not have openings therein.

416.3 Handling of volatile flammables: All volatile flammables shall be stored and handled as provided in Section 415.2 and as provided in 527 CMR 5.00.

416.4 Ventilation: All rooms and spaces used for motor vehicle repair shop purposes shall be provided with an approved system of mechanical ventilation meeting the requirements of Section 414.3 and the mechanical code listed in Appendix B.

416.5 Fire prevention: Open gas flames except heating devices complying with Section 414.6, torches, welding apparatus, or other equipment likely to create an open flame or spark shall not be located in a room or space in which flammable liquids or highly combustible materials are used or stored.

#### SECTION 417.0 PLACES OF PUBLIC ASSEMBLY

417.1 Applicability: The provisions of this section shall apply to all places of public assembly and all parts of buildings and structures classified in the use group A-1, theatres and in other places of public assembly, use groups A-2, A-3, and A-4, except as specifically exempted in Section 418.0.

##### 417.2 Restrictions

417.2.1 High hazard uses: A place of public assembly shall not be permitted in a building classified in the high hazard group (use group H).

417.2.2 Superimposed theatres: An addition or extension shall not be erected over the stage section of a theatre, nor shall a second theatre be erected above another. The building official may waive the prohibition against superimposed theatres and construction above the stage when adequate access is provided for fire fighting with direct means of ventilation to the outer air from the stage portion.

417.2.3 Frame construction: A theatre with stage, fly gallery and rigging loft shall not be permitted in a building of unprotected frame (Type 4B) construction.

417.2.4 Location: All buildings used for assembly purposes shall front on at least one (1) street in which the main entrance and exitway discharge shall be located. The total capacity of such main exitway shall be not less than one-third (1/3) of the total required width of building exitways.

417.2.5 Trim, finish and decorative hangings: All permanent acoustic insulating and similar materials and temporary hangings shall comply with the flameresistance requirements of Article 9. Moldings and decorations around the proscenium openings shall be constructed entirely of noncombustible material.

417.2.6 Existing buildings: Nothing herein contained shall prohibit the alteration of a building heretofore occupied as a place of public assembly for such continued use provided seats, aisles, passageways, balconies, stages, appurtenant rooms and all special permanent equipment comply with the requirements of this article (see Article 22).

417.2.7 Deleted

### 417.3 Theatre means of egress requirements

417.3.1 Types of exitways: The required exitways from every tier or floor of a theatre shall consist of grade exitway discharge doors, interior or exterior stairways or horizontal exitways which provide direct access to a street, an exitway discharge court, or unobstructed passageway, hallway or lobby leading to a street or open public space. The number, location and construction of all means of egress facilities shall comply with the requirements of Article 6 and the applicable standards listed in Appendix B, except as herein specifically provided.

417.3.2 Number of stairways in auditorium: Each tier above the main floor of a theatre or other auditorium shall be provided with at least two (2) interior enclosed stairways which shall be located on opposite sides of the structure; except that enclosures shall not be required for stairs serving the first balcony only, or mezzanine thereunder. Such stairways shall discharge to a lobby on the main floor. Exitway stairways serving galleries above the balcony shall lead directly to the street or open public space as provided in Section 417.3.1.

417.3.3 Emergency means of egress from main floor of auditorium: In addition to the main floor entrance and exitway, emergency exitway discharge doors shall be provided on both sides of the auditorium which lead directly to a street, or through a passageway to the street independent of other exitways, or to an exitway discharge court as defined in this code.

417.3.4 Emergency means of egress from balconies and galleries: Emergency exitways shall be provided from both sides of each balcony and gallery with direct egress to the street, or to an independent passageway, or to an exitway discharge court. There shall not be communication from any portion of the building to the emergency exitway stairways except from the tier for which such exitway is exclusively intended.

417.3.5 Exitway discharge courts: All exitway discharge courts shall be not less than six (6) feet wide for the first six hundred (600) persons to be accommodated or fraction thereof, and shall be increased one (1) foot

in width for each additional two hundred and fifty (250) persons. Such courts shall extend sufficiently in length to include the side and rear emergency exitways from the auditorium.

417.3.6 Hardware: Latches or bolts on all means of egress doorways shall be of an approved self-releasing, panicproof type complying with Section 612.5.2.

417.3.7 Width of exitway doors: The maximum width of single exitway doors shall be forty-two (42) inches and the minimum width of double doorways shall be sixty (60) inches.

417.3.8 "Exit" lights: All exitway doors shall be marked with illuminated Exit signs complying with Section 623.0 which shall be kept lighted at all times during occupancy of the building.

#### 417.4 Theatre seatings

417.4.1 Fixed seats: In all theatres and similar places of assembly except churches, stadiums and reviewing stands, individual fixed seats shall be provided with an average width of not less than twenty (20) inches and seats shall not be less than nineteen (19) inches wide. All seats shall be provided with separating arms and arranged in rows not less than thirty-two (32) inches apart, back to back, measured horizontally.

417.4.2 Number of seats: Aisles shall be provided so that not more than seven (7) seats intervene between any seat and the aisle or aisles, except that the number of seats in a row shall not be limited when self-raising seats are provided which leave an unobstructed passage between rows of seats of not less than eighteen (18) inches in width leading to side aisles in which exitway doorways are located at not more than twenty-five (25) foot intervals to the exitway corridor or exitway discharge court.

417.4.3 Box seats: In boxes or loges with level floors, the seats need not be fastened when not more than fourteen (14) in number.

#### 417.5 Theatre aisles

417.5.1 Longitudinal aisles: The width of longitudinal aisles at right angles to rows of seats and with seats on both sides of the aisle shall be not less than forty-two (42) inches, increasing one-quarter (1/4) inch for every foot of length of aisle from its beginning to an exitway door, or to a cross aisle or between cross aisles. The width of the longitudinal aisles with banks of seats on one side only shall be not less than thirty (30) inches, increasing one-quarter (1/4) inch for each foot of length from its beginning to an exitway door, or to a cross aisle or between cross seats.

417.5.2 Cross aisles: When there are twenty-seven (27) or more rows of seats on the main floor of theatres, cross aisles shall be provided so that a block of seats shall not have more than twenty-two (22) rows. The



width of cross aisles shall be not less than the widest aisle with which they connect or the width of exitway which they serve; but a cross aisle shall not be less than forty-two (42) inches wide, or when bordering on means of entrance not less than forty-eight (48) inches wide. In balconies and galleries of theatres, one (1) or more cross aisles shall be provided when there are more than ten (10) rows of seats and in accordance with the provisions of the Life Safety Code NFIPA 101.

417.5.3 Gradient: Aisles shall not exceed a gradient of one and three-quarter (1 3/4) inches per foot.

417.5.4 Balcony steps: Steps may be provided in balconies and galleries only, and such steps shall extend the full width of the aisle with treads and risers complying with Article 6, which shall be illuminated by lights on both sides or by a step light or otherwise to insure an intensity of not less than one (1) foot candle.

417.5.5 Railings: Metal or other approved noncombustible railings shall be provided on balconies and galleries as prescribed below:

1. At the fascia of boxes, balconies and galleries not less than thirty (30) inches in height; and not less than thirty-six (36) inches in height at the foot of steps;
2. along cross aisles not less than twenty-six (26) inches in height except where the backs of the seats along the front of the aisle project twenty-four (24) inches or more above the floor of the aisle; and
3. where seatings are arranged in successive tiers, and the height of rise between platforms exceeds eighteen (18) inches, not less than twenty-six (26) inches in height along the entire row of seats at the edge of the platform.

#### 417.6 Theatre foyers

417.6.1 Capacity: In every theatre or similar place of public assembly, not including churches, for theatrical use with stage and scenery loft, a foyer or lobby shall be provided with a net floor area, exclusive of stairs or landings, of not less than one and one-half (1 1/2) square feet for each occupant having access thereto. The use of foyers and lobbies and other available spaces for harboring occupants until seats become available shall not encroach upon the clear floor area herein prescribed or upon the required clear width of front exitways.

417.6.2 Egress: When the foyer is not directly connected to the public street through the main lobby, an unobstructed corridor or passage shall be provided which leads to and equals the required minimum width of main entrances and exitways. A mirror shall not be placed so as to give an appearance as a doorway, exit or passageway.

417.6.3 Gradient: The rear foyer shall be at the same level as the back of the auditorium and the means of egress leading therefrom shall not have a steeper gradient than one (1) foot in eight (8) feet.

417.6.4 Construction: The partitions separating the foyer from the auditorium and other adjoining rooms and spaces of theatres shall be constructed of not less than two (2) hour fire-resistance rating; except that opening protectives may be constructed of noncombustible materials without fire-resistance rating.

417.6.5 Waiting spaces: Waiting spaces for harboring occupants shall be located only on the first or auditorium floor. Separate exitways in addition to the required theatre exitways shall be provided from the waiting space based on an occupancy of one (1) person for each three (3) square feet of waiting space area.

#### 417.7 Theatre stage construction

417.7.1 Stage enclosure walls: Every stage hereafter erected or altered for theatrical performances which is equipped with portable or fixed scenery, lights and mechanical appliances, shall be enclosed on all sides with solid walls of not less than four (4) hour fire-resistance rating, extending continuously from foundation to at least four (4) feet above the roof. There shall not be window openings in such walls within six (6) feet of an interior lot line; and all permissible window openings shall be protected with three-quarter (3/4) hour fire windows complying with Article 9.

417.7.2 Floor construction: The entire stage, except that portion used for the working of scenery, traps, and other mechanical apparatus for the presentation of a scene, and the roof over the stage shall be not less than three (3) hour fire-resistance rated construction. All openings through the stage floor shall be equipped with tight fitting, solid wood trap doors not less than three (3) inches in thickness or other materials of equal physical and fire-resistance rated properties.

417.7.3 Roof and rigging loft: The roof over the stage shall be of not less than three (3) hour fire-resistive construction. The rigging loft, fly galleries and pin rails shall be constructed of approved noncombustible materials.

417.7.4 Footlights and stage electrical equipment: Footlights and border lights shall be installed in troughs constructed of noncombustible materials. The switchboard shall be so located as to be readily accessible at all times and the storage of placing of stage equipment against it shall be prohibited. All electrical equipment shall conform to the requirements of the Massachusetts Electric Code 527 CMR 12.00.

417.7.5 Exterior doors: All required exitway discharge door openings to

the outer air shall be protected with approved self-closing fire doors, complying with Article 9. All exterior openings which are located on the stage for means of egress or loading and unloading purposes which are likely to be open during occupancy of the theatre, shall be constructed with vestibules to prevent air draughts into the auditorium.

417.7.6 Proscenium wall: There shall not be other openings in the wall separating the stage from the auditorium except the main proscenium opening; two (2) doorways at the stage level, one (1) on each side thereof; and, where necessary, not more than two (2) doorways to the musicians' pit from the space below the stage floor. Each such doorway shall not exceed twenty-one (21) square feet in area and shall be protected with approved automatic and self-closing fire door assemblies complying with Article 9 with a combined fireresistance rating of three (3) hours or the approved labeled equivalent. The distance between the top of the proscenium opening and the ceiling of the stage shall be not less than five (5) feet.

417.7.7 Proscenium curtain: The proscenium opening shall be protected with an automatic fireresistive and smoke-tight curtain designed to resist an air pressure of not less than ten (10) pounds per square foot (psf) normal to its surface, both inward and outward. The curtain shall withstand a one-half (1/2) hour fire test at a temperature of not less than seventeen hundred (1700) degrees F. without the passage of flame. The curtain shall be operated by an automatic heat activated device to descend instantly and safely and to completely close the proscenium opening at a rate of temperature rise of fifteen (15) to twenty (20) degrees F. per minute; and by an auxiliary operating device to permit prompt and immediate manual closing of the proscenium opening.

417.7.8 Scenery: All combustible materials used in sets and scenery shall be rendered flameresistant to comply with Article 9.

417.7.9 Stage ventilation: Metal or other approved noncombustible ventilators, equipped with movable shutters or sash, shall be provided over the stage, constructed to open automatically and instantly by approved heat activated devices, with an aggregate clear area of opening not less than one-eighth (1/8) the area of the stage, except as otherwise provided in Section 417.2.2. Supplemental means shall be provided for manual operation of the ventilator.

417.8 Dressing and appurtenant rooms

417.8.1 Construction: Dressing rooms, scene docks, property rooms, work shops and store rooms and all compartments appurtenant to the stage shall be of fireproof (Type 1) construction and shall be separated from the stage and all other parts of the building by walls of not less than three (3) hour fireresistance rating. Such rooms shall not be placed immediately over or under the operating stage area. All shelving and closets in dressing rooms, property rooms or storage rooms shall be constructed of flameresistant materials complying with Article 9.

417.8.2 Opening protectives: Openings other than to trunk rooms and the necessary doorways at stage level shall not connect such rooms with the stage, and such openings shall be protected with one and one-half (1 1/2) hour self-closing fire doors or the approved labeled equivalent complying with Article 9.

417.8.3 Dressing room and stage exitways: Each tier of dressing rooms shall be provided with at least two (2) means of egress, one (1) of which shall lead directly to an exitway corridor, exitway discharge court or street. Exitway stairways from dressing and storage rooms may be unenclosed in the stage area behind the proscenium wall. At least one (1) approved exitway shall be provided from each side of the stage and from each side of the space under the stage, and from each fly gallery, and from the gridiron to a street, exitway discharge court or passageway to a street. An iron ladder shall be provided from the gridiron to a scuttle in the stage roof.

#### 417.9 Lighting

417.9.1 Exitways: During occupancy all exitways in places of assembly shall be lighted to comply with the requirements of Section 624.0.

417.9.2 Auditoriums: Aisles in auditoriums shall be provided with general illumination of not less than one-tenth (1/10) foot candles at the front row of seats and not less than two tenths (2/10) foot candles at the last row of seats and the illumination shall be maintained throughout the showing of motion pictures or other projections.

417.9.3 Foyers and waiting spaces: Foyers and waiting spaces shall be artificially lighted by electrical means at all times during occupancy of a place of assembly so as to provide illumination of at least three (3) foot candles at the level of the floor and on the surface of all stairs, steps, ramps, and escalators within the foyers and waiting spaces.

417.9.4 Open exterior spaces: Yards or courts which serve as open exterior spaces shall be artificially lighted by electrical means at all times between sunset and sunrise during occupancy of a place of assembly so as to provide illumination of at least one (1) foot candle at the level of the floor over at least the required area.

417.9.5 Other places of public assembly: All areas and portions of buildings used as places of public assembly other than theatres shall be lighted by electric light to provide a general illumination of not less than one (1) foot candle.

417.9.6 Control: The lighting of exitways, aisles and auditoriums shall be controlled from a location inaccessible to unauthorized persons. Supplementary control shall be provided as specified in Section 408.3.4 in the motion picture projection room.

417.10 Fire protection and fire fighting equipment: Every theatre classified in the use group A-1 shall be equipped with a fire protection system complying with the requirements of Article 12 and as herein specified.

417.10.1 Fire suppression system: Approved automatic fire suppression systems complying with the provisions of Section 1202.0 shall be provided to protect all parts of the building except the auditorium or in the immediate vicinity of automatic equipment or over dynamos and electric equipment. Such protection shall be provided over the stage, under the gridiron, under all fly galleries, in dressing rooms, over the proscenium opening on the stage side, under the stage, in all basements, cellars, work rooms, store rooms, property rooms and in toilet, lounge and smoking rooms.

417.10.2 Standpipes: Standpipe fire lines complying with the provisions of Section 1211.0 shall be provided with outlets and hose attachments; one (1) on each side of the auditorium in each tier; one (1) in each mezzanine; one (1) in each tier of dressing rooms; and protecting each property, store and work room; and one (1) on each side of the stage. Such standpipes shall be not less than two and one-half (2 1/2) inches in diameter, equipped with one and one-half (1 1/2) inch hose connections.

417.10.3 First-aid hand equipment: Approved portable two and one-half (2 1/2) gallon fire extinguishers shall be provided and located as follows: two (2) on each tier or floor of the stage; one (1) immediately outside of the motion picture projection room; one (1) in each dressing room; and one (1) in each work, utility and storage room. Fire axes and fire hooks shall also be provided as directed by the fire official; and all fire extinguishers and fire tools shall be securely mounted on walls in plain view and readily accessible.

#### SECTION 418.0 ASSEMBLY OTHER THAN THEATRES

418.1 General: Other places of public assembly, including auditoriums, armories, bowling alleys, broadcasting studios, chapels, churches, community houses, dance halls, gymnasiums, lecture halls, museums, exhibition halls, night clubs, rinks, roof gardens and similar occupancies and uses shall comply with the general exitway requirements of Article 6 and the applicable requirements of Section 417.0, except the provisions of Sections 417.5.5 and 417.6.4 or as herein specifically exempted. Places of public assembly which are equipped with a stage, movable scenery, scenery loft and dressing rooms shall comply with all the requirements of Section 417.0, except use group A-1, theatres.

Table 418

| Occupancy Load Per Floor | Minimum Number<br>of Exitways |
|--------------------------|-------------------------------|
| Not more than 500 .....  | 2                             |
| 501 to 900 .....         | 3                             |
| 901 to 1800 .....        | 4                             |
| Over 1800 .....          | 5                             |

418.2 Number of exitways: Every tier, floor level and story of places of public assembly other than theatres, shall be provided with the number of required exitways as specified in Section 609.2, and of not less than the required width complying with Section 608.0, for the occupancy load. The required exitways shall be remote and independent of each other and located on opposite sides of the area served thereby.

418.3 Aisles with fixed seats: All rows of seats shall be individually fixed or fixed in rigid units between longitudinal aisles complying with Sections 417.4.2 and 417.5 except as provided for chapels and churches in Section 610.3. Where permitted, continuous fixed benches shall comply with the provisions of Section 420.0.

418.4 Aisles without fixed seats: Tables and chairs in all rooms and spaces for assembly use shall provide convenient access by unobstructed aisles not less than thirty-six (36) inches wide which lead to required exitways complying with Article 6. Tables and chairs shall be so arranged that the distance from any chair at any table by way of a path between tables and chairs is not greater than eighteen (18) feet to an aisle leading to an exitway. The width of the path shall be at least eighteen (18) inches; except that it may be reduced by one (1) inch for each one (1) foot that the distance to the aisle is less than eighteen (18) feet, but may not be reduced to less than twelve (12) inches. Chairs, when placed with the front edge of the seat on a line with the edge of the table, shall not protrude into this path. Booths containing up to eight (8) seats may be used, provided they open directly on an aisle.

418.5 Bowling alleys: The storage and use of all volatile flammable liquids shall comply with Section 402.0 and the finishing rooms shall be separately enclosed in two (2) hour fire-resistance rated construction with floor finish of concrete or other noncombustible, nonabsorbent material.

418.6 Skating rinks: Skating rinks shall not be located below the floor nearest grade.

SECTION 419.0 AMUSEMENT PARKS

419.1 General: All buildings and structures used as part of an amusement park shall be subject to this code. This section specifically includes any building or structure supporting a moving device. The jurisdiction of structures or buildings is limited to the points of interface of the moving device and rails, said device is to be controlled by Form B-11, (520 CMR 5.00) Rules and Regulations for the Safety, Construction and Operation of Ferris Wheels, Carousels, Inclined Railways or Similar Amusement Devices, filed with the Secretary of State on December 16, 1974.

SECTION 420.0 STADIUMS AND GRANDSTANDS

420.1 General: Stadiums and grandstands shall be constructed as required by this code and in accordance with the approved rules and the Standard for Tents, Grandstands and Air-Supported Structures Used for Places of Assembly (NFIPA 102) listed in Appendix B.

420.2 Handrails: Means of egress stairways shall be provided with a handrail on at least one (1) side. The handrail may be broken as necessary to provide for entrance to the seating platforms.

420.3 Spaces underneath seats: Spaces underneath grandstand seats shall be kept free of all combustible and flammable materials and shall not be occupied or used for other than exitways; except that when enclosed in not less than one (1) hour fire-resistance rated construction, the building official may approve the use of such spaces for other purposes that do not endanger the safety to public.

SECTION 421.0 DRIVE-IN MOTION PICTURE THEATRES

421.1 Location: The location of drive-in motion picture theatres shall be approved by the local or state authority having jurisdiction over highways and streets.

421.2 Arrangement of lanes: Separate entrance and exit lanes shall be provided not less than twelve (12) feet in width, with not less than forty (40) foot intervals between access lanes. The parking space for each car shall not be less than nine (9) feet by twenty (20) feet in area, and so arranged to provide continuous lanes of travel.

421.3 Projection booth: The projection booth shall comply with Section 408.3 and shall be supported on a structure of Type 2C or other approved noncombustible construction. A motor vehicle shall not be permitted to park within twenty (20) feet of the projection booth or room.

421.4 Fire protection: Sufficient approved portable fire extinguishers shall be provided in readily accessible locations, plainly and visibly identified by signs, at distances of not more than one hundred and fifty (150) feet so as to be available to every motor vehicle as directed by the fire official. The fire extinguishers shall be mounted on posts or plat-

forms protected from mechanical injury with substantial guards as approved by the building official.

SECTION 422.0 TENTS, AIR-SUPPORTED STRUCTURES AND OTHER  
TEMPORARY STRUCTURES

422.1 Tents and other temporary structures

422.1.1 General: Tents shall be constructed as required by this code and in conformance with accepted engineering practice and the Standard for Tents, Grandstands and Air-Supported Structures Used for Places of Assembly (NFIPA 102) as listed in Appendix B.

422.1.2 Conditions of permit: A special temporary permit for tents and other temporary structures shall be obtained from the building official for installation for a period of time as determined by the building official but not to exceed ninety (90) days.

422.1.3 Location: Tents shall be located outside the fire limits unless an accessible unoccupied open space is provided around the perimeter with a minimum width of ten (10) feet beyond stakes. Such structures may not be erected within the fire district for a period of more than twenty-four (24) hours unless such use is reviewed and approved by the fire official, and any such structure shall be subject to any condition of use, egress, and protection as may be determined by the building official.

422.1.4 Approved type: Tents, and other temporary structures shall be of an approved type and shall have evidence submitted that the structure satisfies all structural and fire safety requirements as indicated in NFIPA 102.

422.1.5 Flame resistant treatment: For every tent used as a place of assembly, composed of combustible fabric material, there shall be submitted to the building official:

1. a certificate or other evidence of approval by a recognized accredited laboratory; or,
2. a certificate signed and stamped by a registered professional engineer, showing that the material has been tested and approved for flame resistance in accordance with the recommendations of NFIPA 701 within a period of twelve (12) months of the date on which the use will terminate under any building permit issued. If certification is not provided for within the time period indicated above, then the building official and fire official shall require confirmatory field tests using test specimens from the original material affixed at the time of manufacture to the exterior of the tent.

422.1.6 Combustible materials: Combustible materials shall not be permitted under stands or seats at any time. Excessive vegetation shall not be allowed beneath the stands or seats.



## 422.2 Air support structures

422.2.1 General: Air-supported structures shall be constructed as required by this code and in conformance with accepted engineering practice and the Standard for Tents, Grandstands and Air-Supported Structures used for Places or Assembly (NFIPA 102) listed in Appendix B.

422.2.2 Conditions of permit: A temporary permit or a permanent permit, with the following provisions, shall be obtained from the building official for installation of a period of time as determined by the building official. A permanent permit shall be issued for a period not longer than two (2) years, with the added provision that the owner of an air structure shall submit a certified inspection record to the building official upon renewal of said permit. This certification shall verify that the structure has been inspected and serviced by a qualified service organization.

422.2.3 Location: Air-supported structures may not be erected within the fire district for a period of more than twenty-four (24) hours unless such use is reviewed and approved by the fire official, and they shall be subject to any condition of use and protection as may be determined by the building official.

422.2.4 Approved type: Air-supported structures shall be of an approved type and shall have evidence submitted that the structure satisfies all structural and fire safety requirements as indicated in NFIPA 102 listed in Appendix B.

## SECTION 423.0 PARKING LOTS

423.1 Parking lot offices: The construction of parking lot offices shall comply with the fire limit restrictions of Section 302.0 and Section 56, Chapter 148 of the General Laws.

423.2 Protection of adjoining property: A substantial bumper of masonry, steel or heavy timber shall be placed near all interior lot lines to protect structures and property abutting the parking lot.

## SECTION 424.0 GROUP RESIDENCE

424.1 Definition: A group residence is a premise licensed by or operated by an agency of the Commonwealth of Massachusetts or subdivision thereof, as a special residence for those who are capable of self-preservation in the following categories:

1. not more than twelve (12) unrelated persons between the ages of seven (7) and fifteen (15) years of age inclusive; or
2. not more than twenty-five (25) unrelated persons, sixteen (16) years of age or over; or

3. a combination of Category 1 and 2 above consisting of not more than eighteen (18) unrelated persons over seven (7) years of age calculated at the rate of two (2) such persons, or portion thereof, from Category 2 being equal to one (1) such person in Category 1 all in accordance with Table 424.

Note: In determining the classification for proposed use, group residence shall not be construed as being similar in any way to a multi-family dwelling, two-family dwelling, boarding house, lodging house, dormitory, hotel, school or institution of any kind. For building code purposes, it shall be treated as a single-family residential building.

Table 424

|                               |    |    |    |    |    |    |    |    |    |    |    |    |    |
|-------------------------------|----|----|----|----|----|----|----|----|----|----|----|----|----|
| Category 1                    | 12 | 11 | 10 | 9  | 8  | 7  | 6  | 5  | 4  | 3  | 2  | 1  | 0  |
| Category 2                    | 0  | 2  | 4  | 6  | 8  | 10 | 12 | 13 | 14 | 15 | 16 | 17 | 25 |
| Maximum<br>Total<br>Residents | 12 | 13 | 14 | 15 | 16 | 17 | 18 | 18 | 18 | 18 | 18 | 18 | 25 |

424.1.1 Special definitions: For the purpose of Section 424.0, the following terms shall be defined exclusively for use with group residences:

**Self preservation:** Having the capability, both mentally and physically, to take action to preserve one's own life. Specifically, to egress the building within two and one-half (2 1/2) minutes. (Reference inspection procedures in Sections 424.7 and 424.8.)

**Egress:** A continuous unobstructed path of travel from any space in a building to the open air outside at grade.

**Principal means of egress:** The primary choice of two (2) routes normally used by occupants to enter or leave a building.

**Escape route:** To reduce the possibility of entrapment in the event that the principal means of egress is blocked by fire or smoke, an escape route shall be available which performs in accordance with Section 424.8. In an existing building where a second means of egress is physically impractical from above grade floors, any proven, usable path to the open air outside at grade shall be deemed acceptable, including but not limited to connecting doors, porches, windows within six (6) feet of grade, ramps, fire escapes, balcony evacuation systems, etc.

**Authorized inspectors:** The state or local building official having jurisdiction and a representative of the licensing or operating agency having jurisdiction.

Room: See definition of "Habitable space" and "Occupiable room" in Section 201.0.

424.2 Existing buildings: These regulations shall apply to existing dwelling units which are to be converted to a group residence, notwithstanding Section 106.0

424.2.1 Height limitations: Existing buildings, of Type 4B construction, greater than two and one-half (2 1/2) stories, or thirty-five (35) feet in height may be allowed to be used (as an exception to Table 305) as a group residence.

424.3 Plans and specifications: Plans shall be filed with the building official having jurisdiction in accordance with Section 113.0 for any building to be constructed as, or altered for use as, a group residence under Section 424.0. The floor plans shall show all rooms, spaces, closets, doors, corridors, windows, stairs and stairways, hazardous vertical openings and the location of all required fire warning equipment and proposed fire suppression equipment.

424.4 Hazardous contents: Any contents which represent a fire hazard greater than that which could be expected of ordinary household furnishings, shall not be allowed. Storage shall not be allowed above the second floor.

424.4.1 Interior finish: Only Class I and Class II interior finish materials shall be allowed in the principal means of egress. In refinishing any other area, material having a Class III flame spread rating shall be allowed provided it does not decrease the existing rating. The smoke contribution rating of any material shall not exceed 450 (see Section 904.0).

424.4.2 Exception: In existing buildings, the required flame spread or smoke development classification of interior surfaces may be obtained by applying approved fire retardant paints or solutions to existing interior surfaces having a higher flame spread rating than permitted.

424.5 Egress: In existing buildings there shall be one (1) means of egress and one (1) escape route serving each floor, remote as possible from each other and leading to grade. The stairway between the first and second floors, if unenclosed, may remain unenclosed to preserve functional and aesthetic requirements. In new construction, two (2) means of egress are required in accordance with the One- and Two-Family Dwelling Code, and stairways above the grade floor shall be enclosed with one (1) hour fireresistive construction.

424.6 Fire protection systems

424.6.1 Hazardous vertical openings: Openings to such spaces as laundry chutes, dumbwaiters, heating plenums or combustible concealed spa-

ces shall be permanently blocked with one (1) hour construction, as regulated by the provisions of Article 9.

424.6.2 Automatic fire warning systems: An approved automatic fire warning system shall be provided in accordance with Article 12.

424.7 Inspections: There shall be three (3) mandatory types of inspections as described below. The results of such inspections shall be on file in the office of the building official with copies sent to the licensing or operating agency on a prepared checklist and signed by the authorized inspectors.

424.7.1 Temporary certificate: The building official shall perform plan review and post-construction inspection to ensure that the building conforms to this code. He shall issue a temporary certificate of occupancy effective for ninety (90) days only.

424.7.2 Final certificate: Before issuance of the final certificate of occupancy, the authorized inspectors shall mutually conduct a test (see Section 424.8.1) to ensure that the occupants are capable of self-preservation. Upon complete satisfaction of all requirements, the building official shall then issue a permanent certificate of occupancy. This test shall be conducted once a year in accordance with Section 108.5.1 for purposes of recertifying both the building and the occupants.

424.8 Inspection procedure: The building and the occupants' capability of self-preservation constitute a system of life safety which are unique for each building and for each occupant in a group residence. Therefore, a simple direct test is specified herein to determine the capability of the occupant and/or the suitability of the building as a life safety system.

424.8.1 Direct test/fire drill: A fire drill shall be conducted as the direct test required by Section 424.8. The building official may require that he be present for the fire drill, or may accept an affidavit signed by the residence manager citing the names of the authorized inspectors present, the names of the occupants who participated, the name(s) of any occupants who failed to egress the building within two and one-half (2 1/2) minutes, the date, time and place where said fire drill was held. During the conduct of the drill, all staff personnel of the group residence shall isolate themselves from the occupants. The authorized inspector(s), when present, shall then cause to be blocked any one point in the principal egress route to simulate a hazardous condition and the internal alarm system shall be activated for two and one-half minutes.

424.8.2 Evaluation: Any occupant who fails to escape from the building and achieve egress outside the building at ground level within the two and one-half (2 1/2) minute period shall not be permitted to remain living in the residence.

Note: The occupant or the building may be at fault; therefore, the system has failed to perform adequately to provide life safety and is, consequently, unacceptable for that occupant.

424.8.3 Other tests: Other tests are not necessary and shall not be required by the building official. It shall be the responsibility of the residence manager of the group residence to provide immediate suitable accommodations elsewhere for any occupant deemed unacceptable by the building official. Each occupant must be certified at regular intervals but not less than every quarter at the group residence by the licensing or operating agency. The building official may require an inspection at his discretion when he feels that either the building or the occupant may not conform.

424.9 Certificate of occupancy: Any certificate of occupancy issued for a building intended to be used as a group residence, as defined in Section 424.1, shall become invalid if the premises have not been licensed or authorized by an agency of the Commonwealth of Massachusetts within ninety (90) days of the date of issuance of the certificate of occupancy.

#### SECTION 425.0 MOTELS

425.1 General: All buildings and accessory structures used as motels shall comply with the requirements and limitations of this code for the occupancy and use for which they are designed and as herein specifically required.

425.2 Garages: Garages when attached to motel residential buildings shall have the interior faces of all walls, when not of approved masonry construction, and the ceilings protected to afford one (1) hour fireresistance rating and all connecting openings shall be protected with approved three-quarter (3/4) hour fire doors or their equivalent complying with Article 9, or with one and three-quarter (1 3/4) inch solid core wood doors. Roofed-over passageways may be used to connect garages to dwellings if protected with one (1) hour fireresistance rated construction.

425.3 Required exitways: All exitways in buildings more than one (1) story in height shall be constructed of one (1) hour fireresistance rating and all stories above the first shall have at least two (2) means of egress complying with Article 6. All exitways from residential quarters shall lead to open spaces not less than twenty (20) feet in width which provide direct access to public streets or highways.

425.4 Driveways and parking spaces: The arrangement of driveways and lanes shall provide adequate access for emergency vehicles.

#### SECTION 426.0 RADIO AND TELEVISION TOWERS

426.1 General: Subject to the structural provisions of Section 715.0 for wind loads and the requirements of Section 925.0 governing the fireresis-

tance ratings of buildings for the support of roof structures, all radio and television towers shall be designed and constructed as herein provided.

426.2 Location and access: The towers shall be so located and equipped with step bolts and ladders to be readily accessible for inspection purposes. Guy wires or other accessories shall not cross or encroach upon any street or other public space, or over any electric power lines, or encroach upon any other privately owned property without written consent of the owner.

426.3 Construction: All towers shall be constructed of approved corrosion-resistive, noncombustible materials. Within the limitations of Section 302.0 for fire limits, isolated radio towers may be constructed of lumber sizes qualifying for mill type construction when not more than one hundred (100) feet in height.

426.4 Loads: The structure shall be securely braced and anchored to resist a wind of not less than thirty (30) pounds per square foot (psf) on the net area of both sides of latticed construction and on the projected area of the antennae plus the wind on ice-covered sections in localities where subject to freezing temperatures. Where subject to winds of unusual velocity, the loads shall be increased accordingly. Due allowance shall be made for effect of shape of individual elements and contour of the tower as provided in Section 715.0 in computing wind loads.

426.4.1 Dead load: Antennae and towers shall be designed for the dead load plus ice load in regions where ice formation is likely to occur.

426.4.2 Uplift: Adequate foundations and anchorage shall be provided to resist two (2) times the calculated wind uplift.

426.5 Grounding: All towers shall be permanently and effectively grounded.

#### SECTION 427.0 RADIO AND TELEVISION ANTENNAE

427.1 Permits not required: Antennae structures for private radio or television reception not more than twelve (12) feet in height may be erected and maintained on the roof of any building without a building permit. Such a structure, however, shall not be erected so as to injure the roof covering and when removed from the roof, the roof covering shall be repaired to maintain weather and water tightness. The installation shall not be erected nearer to the lot line than the total height of the antennae structure, nor shall such structure be installed near electric power lines or encroach upon any street or other public space.

427.2 Permits required: The approval of the building official shall be secured for all antennae structures more than twelve (12) feet in height. The application shall be accompanied by detailed drawings of the struc-

ture and methods of anchorage. All connections to the roof structure must be properly flashed to maintain water tightness. The design and materials of construction shall comply with the requirements of Section 426.3 for character, quality, and minimum dimensions.

#### SECTION 428.0 SWIMMING POOLS

428.1 General: Pools used for swimming or bathing shall be in conformity with the requirements of this section, provided, however, these regulations shall not be applicable to any such pool less than twenty-four (24) inches deep or having a surface area less than two-hundred and fifty (250) square feet, except when such pools are permanently equipped with a water recirculating system or involve structural materials. For purposes of this code, pools are classified as private swimming pools or public and semi-public swimming pools, as defined in Section 428.2.

Materials and constructions used in swimming pools shall comply with the applicable requirements of this code. Pools used for swimming or bathing and their equipment or accessories which are constructed, installed and maintained in accordance with the applicable standards listed in Appendix B shall be deemed to conform to the requirements of this code, provided the requirements of Section 428.8 are included in the installation and the requirements of the Commonwealth of Massachusetts Environmental Code 310 CMR 16.00 are met.

428.2 Classification of pools: Any constructed pool which is used, or intended to be used, as a swimming pool in connection with a single family residence and available only to the family of the householder and his private guests shall be classified as a private swimming pool. Any swimming pool other than a private swimming pool shall be classified in the public or semi-public swimming pool categories.

#### 428.3 Plans and permits

428.3.1 Permits: A swimming pool or appurtenances thereto shall not be constructed, installed, enlarged or altered until a permit has been obtained from the building official. The approval of all city, county and state authorities having jurisdiction over swimming pools shall be obtained before applying to the building official for a permit. Certified copies of these approvals shall be filed as part of the supporting data for the application for the permit.

428.3.2 Plans: Plans shall accurately show dimensions and construction of pool and appurtenances and properly established distances to lot lines, buildings, walks and fences; details of water supply system, drainage and water disposal systems, and all appurtenances pertaining to the swimming pool. Detail plans of structures, vertical elevations, and sections through the pool showing depth shall be included.

428.4 Locations: Private swimming pools shall not encroach on any front or side yard required by this code, or the governing zoning law, except

by specific rules of the jurisdiction in which it may be located. A wall of a swimming pool shall not be located less than six (6) feet from any rear or side property line or ten (10) feet from any street property line, except by specific rules of the jurisdiction in which it may be located.

#### 428.5 Design and construction

428.5.1 Structural design: The pool structure shall be engineered and designed to withstand the expected forces to which it will be subjected.

428.5.2 Wall slopes: To a depth up to five (5) feet from the top, the wall slope shall not be more than two (2) feet horizontal in five (5) feet vertical.

428.5.3 Floor slopes: The slope of the floor on the shallow side of transition point shall not exceed one (1) foot vertical to seven (7) feet horizontal. The transition point between shallow and deep water shall not be more than five (5) feet deep.

428.5.4 Surface cleaning: All swimming pools shall be provided with a recirculating skimming device or overflow gutters to remove scum and foreign matter from the surface of the water. Where skimmers are used there shall be at least one (1) skimming device for each one thousand (1,000) square feet of surface area or fraction thereof. Where overflow gutters are used they shall be not less than three (3) inches deep, pitched one-quarter (1/4) inch per foot to drains, and constructed so they are safe, cleanable and that matter entering the gutters will not be washed out by a sudden surge of entering water.

428.5.5 Walkways: All public or semi-public swimming pools shall have walkways not less than four (4) feet in width extending entirely around the pool. Where curbs or sidewalks are used around any swimming pool they shall have a non-slip surface for a width of not less than one (1) foot at the edge of the pool and shall be so arranged to prevent return of surface water to the pool.

428.5.6 Steps and ladders: One (1) or more means of egress shall be provided from the pool. Treads of steps or ladders shall have non-slip surfaces and handrails on both sides, except that handrails may be omitted when there are not more than (4) steps or when they extend the full width of the slide or end of the pool. Access to public pools shall include a paraplegic lift.

#### 428.6 Water supply, treatment and drainage systems

428.6.1 Water supply: All swimming pools shall be provided with a potable water supply, free of cross-connections with the pool or its equipment.



428.6.2 Water treatment: Public and semi-public swimming pools shall be designed and installed so that there is a pool water turnover at least once every eight (8) hours. Filters shall not filter water at a rate in excess of three (3) gallons per minute per square foot of surface area. The treatment system shall be so designed and installed to provide in the water, at all times when the pool is in use, excess chlorine of not less than four-tenths (0.4) parts per million (ppm) or more than six-tenths (0.6) ppm, or excess chloramine between seven-tenths (0.7) and one (1.0) ppm, or disinfection may be provided by other approved means. Acidity-alkalinity of the pool water shall not be below seven (7.0) or more than seven and one-half (7.5). All recirculation systems shall be provided with an approved hair and lint strainer installed in the system ahead of the pump.

Private swimming pools shall be designed and installed so that there is a pool water turnover at least once every eighteen (18) hours. Filters shall not filter water at a rate in excess of five (5) gallons per minute per square foot of surface area. The pool owner shall be instructed in proper care and maintenance of the pool, by the supplier or builder, including the use of high test calcium hypochlorite (dry chlorine) or sodium hypochlorite (liquid chlorine) or equally effectively germicide and algaecide and the importance of proper pH (alkalinity and acidity) control.

428.6.3 Drainage systems: The swimming pool and equipment shall be equipped to be completely emptied of water and the discharged water shall be disposed of in an approved manner that will not create a nuisance to adjoining property.

#### 428.7 Appurtenant structures and accessories

428.7.1 Appurtenant structures: All appurtenant structures, installations, and equipment, such as showers, dressing rooms, equipment houses or other buildings and structures, including plumbing, heating, and air conditioning, amongst others appurtenant to a swimming pool, shall comply with all applicable requirements of this code, the zoning laws, the Commonwealth of Massachusetts Department of Public Health Sanitary Code 310 CMR 12.00, the Plumbing Code 248 CMR 2.00, as well as the Massachusetts Electrical Code 527 CMR 12.00.

428.7.2 Accessories: All swimming pool accessories shall be designed, constructed, and installed so as not to be a safety hazard. Installations or structures for diving purposes shall be properly anchored to insure stability, and properly designed and located for maximum safety.

#### 428.8 Safety precautions

428.8.1 Equipment installations: Pumps, filters, and other mechanical and electrical equipment for public and semi-public swimming pools shall be enclosed in such a manner as to be accessible only to authorized

persons and not to bathers. Construction and drainage shall be such as to avoid the entrance and accumulation of water in the vicinity of electrical equipment. The construction and installation of electrical wiring for equipment in or adjacent to swimming pools, to metallic appurtenances in or within five (5) feet of the pool, and to auxiliary equipment such as pumps, filters, and similar equipment shall conform to Article 680 of the Massachusetts Electrical Code 527 CMR 12.00.

428.8.2 Enclosures: Every public and semi-public outdoor in-ground swimming pool shall be enclosed by a fence five (5) feet in height and firmly secured at ground level. If over five (5) feet in height, the fence shall be chain link. Such enclosure, including gates therein, shall not be less than five (5) feet above the ground, and any gate shall be self-latching with latches placed four (4) feet above the ground or otherwise made inaccessible from the outside to children up to eight (8) years of age. Any such pool shall be equipped with at least one (1) life ring and a rescue hook.

428.8.3 Draining: Every outdoor in-ground swimming pool open to the public shall be drained or covered within seven (7) days of closing.

428.8.4 Inspection: Every public and semi-public outdoor in-ground swimming pool shall be inspected annually by the inspector of buildings of each city and town in which said pools are located (in accordance with Chapter 140, Section 206, of the Massachusetts General Laws as amended).

428.8.5 General safety requirements: Cities or towns may enact by-laws or ordinances for enclosing private swimming pools by requiring the installation of fences or equivalent enclosures or means of protection from access to the pool.

#### SECTION 429.0 OPEN PARKING STRUCTURES

429.1 General: Open passenger vehicle parking structures are those structures used for the parking or storage of passenger motor vehicles designed to carry not more than nine (9) persons, and include the following two (2) general types:

1. Ramp type parking structures are those employing a series of continuously rising floors or a series of interconnecting ramps between floors permitting the movement of passenger automobiles under their own power to and from the street level.
2. Mechanical type parking structures are those employing specially designed parking machines, elevators, lifts, conveyors, moving cranes, dollies or other devices for moving passenger automobiles to and from the street level.

For exitway requirements see Section 609.5.

429.2 General construction requirements: Passenger vehicle structures shall be constructed of noncombustible materials throughout, including structural framing, floors, roofs and walls. Any enclosed rooms or spaces on the premises shall comply with the applicable requirements of this code.

429.3 Separations: Parking structures may be erected without exterior walls except that an enclosure wall with not less than two (2) hours fire-resistance rating, without openings therein, shall be provided when located within six (6) feet of interior lot lines.

429.4 Basements: Basements, if used for parking of vehicles, shall be sprinklered in accordance with the provisions of Section 1202.0 and shall be ventilated in accordance with the provisions of Section 414.3.1.

429.5 Gasoline dispensing: Areas used for dispensing of gasoline in parking structures shall be located on the grade floor and shall comply with the requirements of Section 415.0.

429.6 Heights and areas: Heights and areas of open parking structures shall not exceed the limits specified in the following Table 429.

Table 429

## HEIGHT AND AREA LIMITATION FOR OPEN PARKING STRUCTURES

| Type of construction | Height                         | Area in square feet |
|----------------------|--------------------------------|---------------------|
| 1A & 1B              | Unlimited                      | Unlimited           |
| 2A                   | 12 Stories—120 feet            | Unlimited           |
| 2B                   | 10 Stories—100 feet            | 50,000              |
| 2C                   | 8 Stories—85 feet              | 30,000              |
| 2B & 2C              | 2 Stories—25 feet <sup>1</sup> | Unlimited           |

Note 1. Type 2B and 2C construction may be six (6) stories in height and unlimited in area when at least fifty (50) per cent open on all sides and when the horizontal distance from any point on any level to an exterior wall opening on a street, alley, courtyard or any other permanent open space does not exceed two hundred (200) feet.

The areas of structures wherein more than twenty-five (25) per cent of the perimeter has frontage on street or other open space leading to a street each of which is not less than thirty (30) feet wide may be in-

creased as provided in Section 306.2. When an automatic sprinkler system is installed in accordance with Section 1204.0 in Types 2B and 2C construction, the area may be unlimited. The above limits of height permit parking on the roof.

429.7 Protective guard rails: All wells, shafts and other open, exposed spaces throughout, except first floor, shall be enclosed and protected with continuous walls or protective guard rails at least three (3) feet six

(6) inches in height, except that in those structures wherein vehicles are hoisted to the desired level and placed in the parking space entirely by approved mechanical means, the three (3) foot six (6) inch high continuous wall or protective guard rail may be omitted on the side of the parking levels adjacent to the space occupied by the hoisting and placing equipment.

429.8 Curbs and bumpers: Curbs or bumpers of noncombustible materials shall be provided at the perimeter of each parking tier. Such curbs or bumpers shall be at least twelve (12) inches high, substantially anchored, and so located that any part of any motor vehicle will not contact a wall, partition or railing.

429.9 Special restrictions: Open parking structures shall be subject to the provisions of this section and the Massachusetts Fire Prevention Regulation 527 CMR 5.00 and NFIPA 88. Where 527 CMR 5.00 and NFIPA 88 may conflict with construction regulations contained in this code, this code shall govern.

#### SECTION 430.0 FALLOUT SHELTERS

430.1 General: This article shall establish the minimum criteria which must be met before a building or building space can be constructed, occupied, used, or designated as a fallout shelter, and such shelters must be constructed in accordance with the applicable standards as listed in Appendix B.

#### SECTION 431.0 HIGH-RISE BUILDINGS

431.1 Applicability: The provisions of this section shall apply to all buildings more than seventy (70) feet above mean grade.

431.2 Maintenance and inspection: All fire protection systems shall be maintained in an operative condition at all times and shall be periodically inspected and tested in accordance with the fire prevention code listed in Appendix B. Maintenance inspections shall be made quarterly and logged in a journal kept available for inspection.

431.3 General: All high-rise buildings complying with Section 431.1 shall be provided with an approved automatic fire suppression system.

431.3.1 Automatic fire suppression system: The automatic fire suppression system shall be installed throughout the building. The system shall be designed using the parameters set forth in the applicable standards listed in Appendix I, and shutoff valves and a water flow device shall be provided for each floor.

Exception: In use groups R-1 and R-2, sprinklers may be omitted in closets and similar spaces which are located within an individual dwelling unit when the least dimension of such spaces is not greater than thirty (30) inches and the floor areas within such spaces does not exceed twenty-four (24) square feet.

431.3.1.1 Automatic fire suppression system alternatives: When a fire suppression system is installed, modifications to this code are permitted as described below.

1. The type of construction required by this code may be modified as follows:

| Type of construction set forth in Table 214 | Modified type of construction permitted hereunder |
|---|---|
| 1A  | 1B  |
| 1B  | 2A  |
| 2A  | 2B  |

2. The fire-resistance rating of exitway access corridors and vertical separation of tenant spaces shall:
  - a. not be required in use group B (business) buildings;
  - b. be a minimum of one-half (1/2) hour in use group R-1 (residential, hotel) and R-2 (residential, multi-family) buildings; and the wall or partitions may be terminated at the lowest portion of the fire-resistance rated assembly above.
3. Vertical shafts other than stairway enclosures and elevator hoistway enclosures may be reduced to one (1) hour when sprinklers are installed within the shafts at alternate floors.
4. The exitway access and common corridor doors need not meet the requirements of Section 610.4 except they shall be self-closing and tight fitting.
5. The one and one-half (1 1/2) inch hose line, nozzle, rack and cabinet may be omitted as set forth in Section 1211.5.1.

6. The exitway access travel distance set forth in Table 607 may be increased to three hundred (300) feet.
7. Smokeproof enclosures as set forth in Section 618.0 may be omitted, but required stairways shall be pressurized to fifteen-hundredths (0.15) inches of water column in the manner described in Section 618.9.3.
8. Spandrel walls, eyebrows and compartmentation are not required; however, the fireresistance rating of the floors and junctures of exterior walls with each floor must be maintained.
9. Fire dampers, other than those needed to maintain the fireresistance rating of the floor-ceiling assembly, are not required. Where fire dampers will interfere with the operation of the smoke control system approved alternate protective devices shall be utilized.
10. Operable windows required by Section 609.4 for emergency egress or rescue may be omitted.

#### 431.4 Smoke detection systems in high-rise buildings.

431.4.1 Mechanical and equipment rooms: An approved smoke detector suitable for the intended use shall be installed in every mechanical equipment, electrical, transformer, telephone equipment, elevator machine or similar room unless such rooms are protected with an automatic fire suppression system.

The actuation of any detector required by this section shall operate the voice alarm system and shall place into operation all equipment necessary to prevent the recirculation of smoke.

431.4.2 Dwelling units: In use groups R-1 and R-2, single or multiple station smoke detectors shall be installed in accordance with Section 1216.3.2.1, Item 6.

431.5 Alarm and communication systems: Alarm and communication systems shall be provided. The alarm and communication systems shall be so designed and installed that damage to any terminal unit or speaker will not render more than one (1) zone of the system inoperative.

A single communication system may be designed to serve the voice alarm, public address and fire department communication system as follows:

1. Voice alarm system: The operation of any smoke detection, sprinkler waterflow device or manual fire alarm station shall automatically activate a voice alarm system. Activation of the system shall automatically sound an alert signal to the desired areas. The

voice alarm system shall provide a predetermined message on a selective basis to the area where the alarm originated and shall provide information and give direction to the occupants. The alarm shall be designed to be heard clearly by all occupants within the building or designated portions thereof as is required for the public address system.

The central control station shall contain controls for the voice alarm system so that a selective or general voice alarm may be manually initiated.

The system shall be continuously electrically supervised against component failure of the audiopath including amplifiers, speaker wiring, switches and electrical contacts and shall detect opens, shorts and grounds which might impair the function of the system.

2. Public address system: A public address communication system designed to be clearly heard by all occupants of the building shall operate from the central control station. It shall be established on a selective or general basis to the following terminal areas:
  - a. elevators,
  - b. elevator lobbies,
  - c. corridors,
  - d. exitway stairways,
  - e. rooms and tenant spaces exceeding one thousand (1,000) square feet in area,
  - f. dwelling units in apartment houses, and
  - g. hotel guest rooms or suites.
3. Fire department communication system: A two (2) way fire department communication system shall be provided for fire department use. It shall operate between the central control station and every elevator, elevator lobby and entry to every enclosed exitway stairway.

431.6 Central control station: A central control station for fire department operations shall be provided in a location approved by the fire department. It shall contain:

1. the voice alarm and public address system panels;
2. the fire department communications panel;
3. fire detection and alarm system annunciator panels;
4. status indicator for elevators;
5. status indicators and controls for air handling systems;
6. controls for unlocking all stairway doors simultaneously;
7. sprinkler valve and waterflow detector display panels;
8. emergency power, light and emergency system controls and status indicators; and
9. a telephone for fire department use with controlled access to the public telephone system.

431.7 Smoke control: Natural or mechanical ventilation for the removal of products of combustion shall be provided in every story and shall consist of one (1) of the following:

1. Panels or windows in the exterior walls which can be opened remotely from an approved location other than the fire floor. Such venting facilities shall be provided at the rate of twenty (20) square feet per fifty (50) lineal feet of exterior wall in each story and shall be distributed around the perimeter at not more than fifty (50) foot intervals. Such windows or panels and their controls shall be clearly identified.
2. When a complete and approved automatic fire suppression system is installed, the mechanical air handling equipment may be designed to accomplish smoke removal. Under fire conditions, the return and exhaust air shall be moved directly to the outside without recirculation to other sections of the building. The air handling system shall provide a minimum of one (1) exhaust air change each ten (10) minutes for the area involved.
3. A continuous shaft through which smoke and heat can be mechanically vented to the outdoors. The size of the shaft shall be uniform throughout and of such dimension as to produce one (1) air change per ten (10) minutes in the largest compartments served anywhere in the building. Openings into the shaft shall be protected with an automatic single-piece shutter located as high in the room as possible and designed to vent the entire compartment.
4. Any other approved design which will produce equivalent results.

431.8 Elevators: Elevator operation and installation shall be in accordance with Article 16 and the standards listed in Appendix B, and the elevator cab shall be of such size as to accommodate an ambulance cot in its horizontal open position, and in accordance with the provisions of 524 CMR 3.00-11.00.

431.9 Emergency power, light and emergency systems: Emergency power, light and emergency systems shall comply with the following:

1. Emergency power: A permanently installed on-site power generation system shall be provided. All power, lighting, signal and communication facilities provided under the requirements of this section, including an independent ventilation system for the emergency power generator room, shall be transferable to the emergency power source.

The electrical power requirements for sizing the emergency power generation systems shall include but not be limited to the following:

- a. fire protection equipment, including fire pumps;



- b. mechanical ventilation equipment required by this section including power operated windows;
  - c. elevator cars required by 524 CMR 15.00-33.00;
  - d. emergency lighting; and
  - e. the normal loads of all facilities classed as emergency. The regular light and power circuits supplying such facilities are classified as emergency systems and shall be automatically transferable to the emergency power generation system.
2. Emergency lighting: Emergency lighting shall include but not be limited to the following:
- a. separate lighting circuits and facilities sufficient to provide light with an intensity not less than one (1) foot candle measured at floor level in all exitway access corridors, stairways, smokeproof enclosures, elevators, elevator lobbies, and other areas which are clearly part of the means of egress; and
  - b. all circuits supplying lighting for the central control station, the emergency power generator rooms, and other rooms housing control equipment for mechanical systems required by this section shall be transferable to the emergency power system.
3. Emergency systems: All electrical systems and facilities required by this section and classified as emergency shall be installed in an approved manner. The following systems and lighting loads are classified as emergency facilities and shall operate within ten (10) seconds of primary power failure:
- a. required lighted exit signs and exit pathway illumination,
  - b. fire alarm and sprinkler alarm systems,
  - c. fire detection systems,
  - d. elevator car lighting,
  - e. stairway door control systems, and
  - f. voice communication systems.

431.10 Exits: Exits shall comply with other requirements of this code and the following:

- 1. All stairway doors which are to be locked from the stairway side shall have the capability of being unlocked simultaneously without unlatching upon a signal from the central control station.
- 2. A telephone or other two-way communications system connected to an approved emergency service which operates continuously shall be provided at not less than every fifth (5) floor in each required stairway where other provisions of this code permit the doors to be locked.

3. Smokeproof enclosures may be eliminated if all enclosed stairways are pressurized, as provided for mechanically operated smokeproof enclosures, to a minimum of fifteen-hundredths (0.15) and a maximum of thirty-five hundredths (0.35) inch of water column in fully sprinklered buildings.

#### SECTION 432.0 COVERED MALLS

432.1 Scope: Covered mall buildings are subject to the special requirements of this section and are of two (2) types:

1. Type A covered mall buildings are subject to the general provisions of this code.
2. Type B covered mall buildings may be designed and constructed in accordance with the special provisions as noted herein. All other applicable provisions not specified herein shall be complied with.

432.2 Requirements for Type B covered mall buildings

432.2.1 Lease plan: The permit holder shall provide both the building and fire departments with a lease plan showing the locations of each occupancy and its means of egress after the certificate of occupancy has been issued. Such plans shall be kept current. No modifications or changes in occupancy or use shall be made from that shown on the lease plan without prior approval of the building official.

432.2.2 Tenant separations: Each tenant shall be separated from adjoining tenants by a wall having a minimum one (1) hour fire-resistance rating which shall extend from the floor to the underside of the ceiling. No separation is required between a tenant space and a mall.

432.2.3 Exitways: Exitways shall be provided in accordance with the following:

1. The maximum length of exitway access travel from any point within the mall to an approved exitway along the natural and unobstructed path of travel shall not exceed two hundred (200) feet.
2. Each individual occupancy within the covered mall building shall be provided with a means of egress in accordance with other provisions of this code. Measurements may be made to the entrance to the mall.
3. When the length of travel from the most remote point within a tenant space exceeds one hundred (100) feet to the mall, a second means of egress shall be provided. When two (2) or more means of egress are required, the secondary exits may open into the mall, an exit corridor, an exit enclosure, or to the exterior. When a corridor provides the second means of egress, it shall be of one (1) hour fire-resistance rated construction and doors to the corridors

shall be one (1) hour opening protectives. Such doors shall be self closing, and be so maintained, or shall be automatic closing when actuated by smoke detectors.

4. Anchor stores shall provide the required number of exitways and units of exit width directly to the exterior. The occupant load of anchor stores opening into the mall shall not be included in determining exitway requirements for the mall.
5. The dead end of a mall shall not exceed twice its width.
6. In determining required exitway facilities of the mall, the number of occupants for whom exitway facilities are to be provided, shall be based on gross leasable area of the covered mall building (including anchor stores) and shall be based on the following table.

| Square feet per person | Gross leasable area (sq. ft.) |
|------------------------|-------------------------------|
| 30                     | under 300,000                 |
| 40                     | 300,000-700,000               |
| 50                     | over 700,000                  |

7. The minimum width of exitway access passageways and corridors from a mall shall be fifty-six (56) inches.
8. The required units of exit width and exitways shall be distributed equally throughout the mall.
9. Storage is prohibited in exitway corridors which are also used for service to the tenants. Such corridors shall be posted with conspicuous signs so stating.

432.2.4 Mall width: The minimum width of the mall shall be thirty (30) feet.

There shall be a minimum of ten (10) feet clear exitway width to a height of eight (8) feet between any projection of a tenant space bordering the mall and the nearest kiosk, vending machine, bench, display opening, or other obstruction to egress travel.

The mall width shall be sufficient to accommodate the occupancy load emptying into the immediately adjacent mall as determined by Section 432.2.3 for all occupancies except assembly which shall be determined by Section 606.0

## 432.2.5 Type of construction

1. The structural elements of the covered mall building shall be of noncombustible (Types 1 and 2) or heavy timber (Type 3A) construction.
2. Floor/ceiling assemblies and their supporting columns and beams within multi-level covered malls shall be of one (1) hour fire-resistance rated noncombustible construction.
3. Separation between tenant spaces and the mall is not required. When walls are provided, they shall comply with the provisions of Table 214 for other non-bearing partitions.

432.2.6 Roof coverings: Roof coverings for covered mall buildings shall be Class A, B, or C as required by Section 926.0.

432.2.7 Mixed occupancy: Use groups assembly (A), business (B), mercantile (M), and residential (R) may be accessory to the covered mall building. Accessory occupancies may be three (3) times the area permitted by Table 305 for the type of construction and the occupancy involved. Use groups assembly (A), business (B), mercantile (M) and residential (R) shall be separated from adjacent tenants by a minimum of one (1) hour fireresistance rated separation wall.

Exception: Assembly (A) occupancies shall be located in the covered mall building so that their main entrance is immediately adjacent to a principal entrance to the mall.

The sprinkler system required in covered mall buildings shall not be substituted for required one (1) hour fireresistance rated construction. Assembly (A) occupancies other than restaurants shall have not less than one-half (1/2) of their required exitways opening directly to the exterior of the covered mall building.

432.2.8 Fire protection: Every covered mall building shall be provided with fire protection equipment as follows:

1. The covered mall and all buildings connected thereto shall be provided throughout with an approved fire suppression system. The suppression system in the covered mall shall be independent of the suppression systems in the buildings connected to the covered mall.
2. All sprinkler control valves shall be electrically supervised and connected to either the fire department or to an approved supervisory service, except as otherwise approved by the local fire official.

Fire department standpipe outlets shall be provided within the mall at each entrance to an exit passageway, corridor or enclosed stairway and at exterior exits.

4. First aid fire extinguishers shall be provided as required by the fire prevention code listed in Appendix B, and as required by the local fire official.

432.2.9 Fire emergency ventilating system: The covered mall and exitway corridors serving the mall shall be equipped with an approved automatic exhaust system capable of producing six (6) air changes per hour computed on volume measured to a height of twelve (12) feet above each pedestrian area. Necessary outside air to accomplish the six (6) air changes per hour shall be provided.

The exhaust system shall be activated by smoke detectors complying with the applicable standards listed in Appendix B, by operation of the sprinkler system, and manually. The activation system shall be installed in an approved manner. Exhaust shall be taken uniformly from the entire mall area and exitways serving the mall through an approved duct system with vents spaced not more than fifty (50) feet or through a ceiling plenum with uniformly distributed openings. Where tenant spaces are open to the mall area exhaust may be taken through the tenant spaces.

The approved automatic exhaust system may be a separate system or may be integrated with an approved air-conditioning system. Where a separate system is provided, operation of the fire emergency ventilating system shall automatically shut down the air-conditioning system or any other devices which interfere with the effective operation of the fire emergency ventilating system. The fire emergency ventilating system shall be connected to an emergency power source in accordance with the requirements of the Massachusetts Electric Code 527 CMR 12.00.

432.2.10 Fire department access to equipment: Controls for air-conditioning systems, sprinkler risers and valves, or other fire detection, suppression or control elements shall be accessible to and properly identified for use by the fire department.

432.2.11 Plastic panels and plastic signs: Within every story or level and from side wall to side wall of each tenant, approved plastic panels and signs shall be limited as follows:

1. They shall not exceed twenty (20) per cent of the wall area facing the mall.
2. They shall not exceed a height of thirty-six (36) inches, except if the sign is vertical, the height shall not exceed ninety-six (96) inches and the width shall not exceed thirty-six (36) inches.
3. They shall be located a minimum distance of eighteen (18) inches from adjacent tenants.

4. All edges and the backs shall be fully encased in metal.

432.2.12 Kiosks: Kiosks and similar structures (temporary or permanent) shall meet the following requirements:

1. Combustible kiosks or other structures shall not be located within the covered mall unless constructed of fire retardant treated wood throughout, conforming to the standards listed in Appendices C and G.
2. Kiosks or similar structures located within the covered mall shall be provided with approved fire suppression and detection devices.
3. The minimum horizontal separation between kiosks and other structures within the covered mall shall be twenty (20) feet.
4. Kiosks or similar structures shall have a maximum area of three hundred (300) square feet.

SECTION 433.0 NURSING HOMES, REST HOMES, CHARITABLE HOMES  
FOR THE AGED, CONVALESCENT HOMES AND HOSPITALS

433.1 New facilities: Buildings to be constructed or proposed for a change of occupancy, to be used as nursing homes, rest homes, charitable homes for the aged, convalescent homes and hospitals (in use group I-2) shall meet the provisions of NFIPA 101 Life Safety Code, as referenced in Appendix B and the applicable provisions of this code.

433.2 Deleted

433.2.1 Deleted

433.2.2 Deleted

433.2.3 Deleted

433.2.4 Deleted

433.2.5 Deleted

433.2.6 Deleted

433.2.7 Deleted

433.3 Construction requirements: Hospitals, nursing homes, and convalescent homes shall be built only of Type 1 construction, in accordance with Chapter 111, Sections 51 and 71, of the Massachusetts General Laws, as amended.

SECTION 434.0 DAY CARE CENTERS

434.1 General: Day care centers shall be subject to the applicable provisions of this code and the special requirements of this section. Day care centers licensed by the Office for Children may be subject to compliance with the rules and regulations of that authority. These provisions shall apply to new and existing day care centers.

434.2 High hazard restriction: A day care center shall not occupy the same building with, or be located within two hundred (200) feet of a high hazard occupancy.

434.3 Day care center use groups

434.3.1 Less than two years and nine months in age: Buildings and portions thereof licensed by the Office for Children as day care centers for children two (2) years and nine (9) months in age or younger shall be classified as I-2 use group.

434.3.2 More than two years and nine months in age: Buildings and portions thereof licensed by the Office for Children as day care centers for children more than two (2) years and nine (9) months in age shall be classified as A-4 use group.

434.4 Height and area limitations

434.4.1 I-2 limitations: Existing buildings containing day care occupancies (use group I-2) not in conformance with the height and area limitations of Table 305 shall be limited to not more than three (3) stories and forty (40) feet in height. The day care center shall be restricted to the first floor and cellar or basement use and not more than two thousand four hundred (2,400) square feet per floor. All required egresses shall be directly to grade.

434.4.2 A-4 limitations: Existing buildings containing day care occupancies (use group A-4) not in conformance with the height and area limitations of Table 305 shall be limited to not more than three (3) stories and forty (40) feet in height. The day care center shall be restricted to the first two (2) stories and the basement or cellar use and not more than four thousand eight hundred (4,800) square feet per floor.

434.4.3 Increases: Increases in height or area shall not be allowed for A-4 or I-2 day care center use groups.

434.5 Day care centers classified as I-2 use group

434.5.1 Basement and cellar use in Types 3C and 4B construction

434.5.1.1 Basement use: A basement, as defined in this code, of a Type 3C or 4B construction may be used for a day care center in accord-

ance with the following requirements: there shall be two (2) separate and independent means of egress, remote from each other:

1. leading to grade; or
2. leading to a one (1) hour fire-rated enclosed stairway not more than four (4) feet in height vertically which leads directly to grade and is separated from any other use as an egress by one (1) hour fire-rated partitions and self-closing doors.

434.5.1.2 Cellar use: A cellar, as defined in this code, of a Type 3C or 4B construction may be used for a day care center in accordance with the following requirements:

1. There shall be at least two (2) separate and independent interior means of egress, remote as possible from each other and leading directly to grade or to a one (1) hour fire-rated enclosed stairway not more than four (4) feet in height, vertically. Any such stairway serving as a required means of egress from a day care center shall serve only the day care center.
2. Smoke detectors shall be located in the story of use and in the story below, if one exists, directly beneath the area being used for the day care center.
3. Interior stairways used as required means of egress shall contain smoke detectors connected to alarms audible throughout the day care center.

434.6 Egress requirements for I-2 and A-4 day care center use groups

434.6.1 Below grade: All day care centers or parts thereof located below grade, except for I-2 day care center use in Types 3C and 4B construction is provided in Sections 434.5.1.1 and 434.5.1.2, shall conform to the following requirements:

1. There shall be at least two (2) separate and independent means of egress, remote as possible from each other, at least one (1) of
2. Required interior stairways shall be of at least one (1) hour fire-rated construction enclosed with self-closing fire doors.
3. Required interior stairways shall contain smoke detectors connected to alarms audible throughout the day care center.

434.6.2 Egress on floors other than basement or cellar: Each story of the day care center shall be provided with not less than two (2) independent means of egress, remote as possible from each other, and such additional approved means of egress leading from the occupied spaces so that to reach an egress it will not be necessary to pass through a common corridor or space.



434.6.2.1 Buildings of Types 1, 2A and 2B construction: In buildings of Types 1, 2A or 2B construction, except for R-2 use group, equipped with a fire suppression system in compliance with Section 1202.0, a single common corridor shall be acceptable for providing access to two (2) means of egress as required in this section.

434.6.2.2 Common corridors used as exitways: Common corridors may be subdivided, for the purpose of Section 424.6.2 to provide separate and independent exitways by using smoke stop partitions complying with the provisions of this code. The doors in the smoke stop partitions may be equipped with an automatic hold open device connected to smoke or smoke and heat detectors and designed to close automatically by activation of the detector system.

434.6.2.3 Egress from each room: Two (2) approved means of egress located as remotely as possible from each other shall be required for each occupied room. One (1) such required egress may be made by communicating door.

434.6.3 Roof egress: Where the roof is used by a day care center, two (2) enclosed stairways shall be provided, one (1) leading directly to an enclosed exitway system and one (1) leading to a corridor on a floor below that leads to two (2) remote and independent exitways. The stairways shall comply with all the provisions of Section 434.0 and this code.

434.6.4 Egress lighting: Egress lighting shall be provided in conformance with Article 6, including requirements for emergency lighting.

434.6.5 Doorways: All required exitway doorways shall be at least thirty-six (36) inches in width. All other egress doorways shall be at least thirty-two (32) inches in width.

434.6.6 Handrails: All required egress stairways shall be provided with double handrails on both sides, and these shall be continuous including all runs and platforms and shall be built as follows.

1. The upper rail shall be not less than thirty (30) inches nor more than thirty-three (33) inches, measured vertically, above the nosing of the treads.
2. The lower rail shall be installed at approximately twenty (20) inches high measured vertically at the face of the riser.

434.7 Heating system: Any portable or permanent heater in spaces occupied by children shall be separated from the occupied space by partitions, guards, screens, or other means. Space and unit heaters using combustible fuels shall be prohibited.

434.8 Boiler rooms: Boilers, furnaces or other fire units shall be enclosed as required in Section 1105.0. Boiler room doors shall not open into occupied areas.

434.9 Roofs: Where a roof is used by a day care center, there shall be a solid, smooth non-climbable fence or barrier a minimum of seven (7) feet high on all sides and separating the day care center area from any other uses. Fences shall be set back at least three (3) feet from the outside edge of the exterior wall below. A weatherproof telephone or equivalent means of communication shall be provided for use in emergencies and shall be openable without keys, coins, etc.

434.10 Fire alarm systems: Fire alarm systems shall be provided in day care centers in accordance with the requirements of this section. The requirements of Sections 434.5.1.2 and 434.6.1 may be combined with the requirements of this section.

1. Facilities for up to twenty-four (24) children shall be provided with a manual alarm system which will sound an alarm audible throughout the day care center.
2. Facilities for twenty-five (25) or more children shall be provided with an automatic alarm system consisting of approved smoke detectors located as provided in Section 434.11 and audible throughout the day care center or throughout each floor of the center. In addition, there shall be at least one (1) manual alarm on each floor of the day care center which will sound on all floors when actuated.

434.11 Location of detectors: Smoke detectors shall be installed on the ceiling of each story occupied by the day care center above or in front of the doors to the stairways and at not greater than thirty (30) foot spacing in the corridor providing required means of egress on all floors of the day care center. Smoke detectors shall also be installed in all accessory spaces of the day care center not used for children, including storage over one hundred (100) square feet in area. All required detectors shall be located on the same circuit and interconnected so that when one (1) sounds, all will sound. Required detectors shall meet the requirements of UL 217 as listed in Appendix I and shall have an alarm decibel rating of at least 85.

434.12 Floor and ceiling protection: When the floor occupied by the day care center is above any usable space, the floor shall have a minimum of three quarter (3/4) hour fire rating. When the floor occupied by the day care center is below any usable space, the ceiling shall have at least a three quarter (3/4) hour fire rating or the floor above shall be equipped with smoke detectors.

#### SECTION 435.0 SUMMER CAMPS FOR CHILDREN

435.1 Definition: Summer camps for children include premises, operated solely between April and October of each year for recreational or other purposes, and having residential facilities. The use of such accommodations for purposes of inspection, certification and inspection fees shall be considered as being similar to a dormitory in R-2 use group and subject to the following provisions of this section.

435.2 New and existing occupancies: These regulations shall apply to existing and new summer camps for children as defined in Section 435.1 of this code.

435.3 Means of egress: All one-story, one-room buildings having one thousand (1,000) square feet or less and having twenty-five (25) occupants or less shall require only one (1) means of egress provided that:

1. the length of travel does not exceed fifty (50) feet from any point in the building to the outside at grade; and,
2. the minimum width for aisles and corridors shall be three (3) feet.

435.3.1 Emergency escape: Every sleeping room shall have at least one (1) exterior door or openable window to permit emergency exit or rescue; the windows shall conform to the following restrictions:

1. must be openable from the inside without the use of separate tools;
2. the sill height shall not be more than thirty-six (36) inches above the finish floor and with a maximum six (6) foot drop from the window sill to grade below the window; and
3. provide a minimum net clear opening area of three and three tenths (3.3) square feet with a rectangle having minimum net clear opening dimensions of twenty (20) inches by twenty-four (24) inches.

435.4 Fire protection: Smoke detectors shall be required for existing and new residential units in accordance with Section 1216.0 of this code and may be either A.C. wired or battery-operated.

Exception: Tents and other temporary shelters which are designed to sleep less than eight (8) persons and which have an open side consisting of greater than one sixth (1/6) of the perimeter of the shelter or which have built-in provisions for emergency escape.

435.5 Mechanical: If camps are heated, then the building must conform to all applicable code sections and specialized codes, notwithstanding any of the provisions in Section 435.0.

435.6 Enforcement and inspections: Enforcement shall be by the local building official who shall inspect and certify the summer camps yearly, prior to season opening. Fees charged shall be in accordance with Table 108 of this code.

## SECTION 436.0 HISTORIC BUILDINGS

436.1 Scope: The provisions of Section 436.0 shall govern all buildings and structures in the Commonwealth which are legally designated as historic buildings. This section shall preempt all other regulations of this code governing the reconstruction, alterations, change of use and occu-

pancy, repairs, maintenance and additions for the conformity of historic buildings and structures to this code, with the exception of Section 126.0 for appeals, or unless otherwise specified (see Appendix U).

#### 436.2 Definitions

**Historic buildings:** Any individual building or structure, but excluding districts, so designated by the National Register of Historic Places or certified by the Massachusetts Historic Commission and ratified by the Massachusetts Building Code Commission as listed in Appendix U. Historic buildings shall be further defined as totally or partially preserved buildings.

**Partially preserved buildings:** Any building or structure designated as a historic building by the State Building Code Commission or listed in the National Register of Historic Places and not designated as a totally preserved building in Appendix U.

**Restoration:** Restoration is the process of accurately reconstructing the form and details of a building or structure or portion thereof as it appeared at a particular period or periods of time by means of removal of later work and/or the replacement of missing original work.

**Totally preserved buildings:** A totally preserved building is a historic building or structure. The principal use of such a building or structure must be as an exhibit of the building or structure itself which is open to the public not less than twelve (12) days per year, although additional uses, original or ancillary to the principal use, shall be permitted within the same building up to maximum of twenty-five (25) per cent of the gross floor area. Totally preserved buildings shall be those listed in Appendix U.

#### 436.3 Totally preserved buildings

436.3.1 State Building Code exceptions: A totally preserved building shall be subject to the following exceptions:

1. Repairs, maintenance and restoration shall be allowed without conformity to this code if the provisions of Section 436.4 have been fully complied with.
2. In case of fire or other casualty to a totally preserved building, it may be rebuilt, in total or in part, using such techniques and materials as are necessary to restore it to its original condition and use group.
3. If a historic building or structure, as a result of proposed work, would become eligible for certification as a totally preserved building and the Massachusetts Historical Commission so certifies by affidavit and it is submitted to the building official with the permit

application, then the building official shall allow the work to proceed under the provisions of this section.

436.4 Mandatory safety requirements: All totally preserved buildings shall comply to the following requirements:

436.4.1 Fire protection equipment: Fire protection equipment shall be provided according to the following requirements.

1. Manual fire extinguishing equipment: all use groups, other than residential R-3, shall have approved manual fire extinguishing equipment, as determined by the fire official.
2. Automatic fire warning system: all residential buildings in use groups R-1, R-2, and R-3 shall conform to the requirements of Section 1216.3.2 of this code. All other use groups shall comply with Items a and b below:
  - a. Locations: provide one (1) smoke detector, but not less than one, for every twelve hundred (1200) square feet of floor area per level. In addition, all lobbies, common corridors, hallways and exitway access and discharge routes shall be provided with approved smoke detectors with not more than thirty (30) foot spacing between detectors. All required smoke detectors shall have an alarm audible throughout the structure or building.
  - b. Single station and multiple station smoke detection devices: smoke detectors of single station and multiple station types shall meet the requirements of U.L. 217 and be listed or approved by a nationally-recognized fire-testing laboratory.
3. Manual pull stations: a manual fire alarm pull station shall be provided in the natural path of egress in all use groups except R-3. Manual pull stations shall be connected to the building fire warning system in conformance with NFIPA 72A as listed in Appendix B.

436.4.2 Exit signs and emergency lights: Approved exit signs and emergency lighting, where designated by the local building official, shall be provided in compliance with Sections 623.0 and 624.0 of this code.

Exception: All totally preserved buildings need not comply with Sections 623.0 and 624.0 if not occupied after daylight hours, except that paths of egress shall have exit signs.

436.4.3 Maximum occupancy: Occupancy shall be limited by the actual structural floor load capacity as certified by a qualified Massachusetts registered professional engineer or architect or as per Section 606.0, whichever is less. Said floor load shall be posted as per the procedures set forth in Sections 119.0, 120.0 and 705.0. The owner shall submit

evidence of this certification and related computations to the building official upon request.

436.4.4 Limited egress: Where one or more floors of a totally preserved building are limited to one (1) means of egress, the occupancy load shall be computed as follows:

1. Floors below the first story: not more than one (1) occupant per one hundred (100) square feet of gross floor area with a maximum occupancy of forty-nine (49).
2. First story: not more than one (1) occupant per fifty (50) square feet of gross floor area.
3. Second story and above: not more than one (1) occupant per one hundred (100) square feet of gross floor area, or thirty (30) occupants per unit of egress width, whichever condition results in the lesser occupancy load.

436.4.5 Inspections: The building official and fire official shall inspect all totally preserved buildings not less frequently than once every year in order to determine that the building or structure continues to conform to Section 436.4. A qualified Massachusetts registered professional engineer or architect shall certify every five (5) years thereafter as to the exact floor load capacity of the building or structure. The building official shall certify all totally preserved buildings not less frequently than once every year. Fees shall be established at \$25 per building per inspection.

436.5 Historic buildings not qualified as totally preserved

436.5.1 Applicability: This section and Article 22 shall apply to all historic buildings which are not defined as totally preserved buildings.

436.5.2 Continuation of use and occupancy: The legal use and occupancy of any partially preserved building may be continued without change or further compliance to this code. The provisions of Section 436.4 shall be required for historic buildings accessible to the public on more than fifty (50) days per year.

436.5.3 Inspection, certification and fees: The building inspector shall inspect all partially preserved buildings not less frequently than once a year in order to determine that the building or structure continues to conform to Sections 436.5 and/or 436.4. If in conformance, then he shall issue a certification. Fees shall be in conformance with Table 108.

436.5.4 Fire damage: If a building or structure is damaged from fire or other casualty, it may be restored to its original condition using techniques and methods consistent with its original construction, or it shall meet the requirements of this code provided these requirements do not compromise the features for which the building was considered historic when listed in Appendix U of this code or the National Register of His-

toric Places.

436.5.5 Repairs and maintenance: See Article 22.

436.5.6 Change in occupancy: See Article 22.

436.5.7 New systems: See Article 22.

436.5.8 Lesser and equal hazard: See Article 22.

436.5.9 Greater hazard: See Article 22.

#### SECTION 437.0 OPEN WELLS

437.1 General: Open wells are to be classified as either atriums (Section 437.2) or floor openings (Section 437.3) and shall be permitted in all buildings in other than use group H (high hazard) when provided with the protection herein required.

437.1.1 Fire suppression: An approved automatic fire suppression system shall be installed throughout all floor areas connected by the open well in accordance with the provisions of Article 12, except those floor areas separated from the open well by fire separation assemblies conforming to Table 214.

437.1.2 Use: The floor of the open well shall not be used for other than low fire hazard uses and only approved materials and decorations may be used in the open well space.

The open well space may be used for any approved use when the individual space is provided with an approved fire suppression system.

437.1.3 Exitways: An open well connecting not more than three (3) floor levels may contain an exitway as permitted by Section 616.10.

437.1.4 Standby power: All equipment required to provide smoke control shall be connected to a standby power system meeting the requirements of Section 431.9.

437.1.5 Acceptance of the smoke control system: Before the certificate of occupancy is issued, the smoke control system shall be tested in an approved manner to show compliance with the requirements of this section.

437.1.6 Inspections of the smoke control system: All operating parts of the smoke control system (including dampers) shall be tested by the owner every three (3) months and a log of the tests shall be kept for examination by the fire department. At six (6) month intervals the system shall be inspected and operated in accordance with the Basic Fire Prevention Code listed in Appendix B.

437.2 Atriums: Atriums shall be constructed as herein required except atriums in buildings two (2) stories in height shall not be required to be equipped with a smoke control system as indicated in Section 437.2.2. For purposes of this section, the volume of the atrium shall include all spaces not separated from the atrium in accordance with Section 437.2.2.

437.2.1 Smoke control: A smoke control system shall be designed to control the migration of products of combustion in the atrium spaces. Upon detection of a fire or smoke, the system shall shut down the air supply to the fire floor and the return air from all non-fire floors.

437.2.1.1 Atriums fifty-five (55) feet or less in height: In atriums fifty-five (55) feet or less in height with a volume of six hundred thousand (600,000) cubic feet or less a smoke exhaust system shall be located at the ceiling of the atrium. Such system shall exhaust forty thousand (40,000) cfm or six (6) air changes per hour, whichever is greater. When the volume of the atrium exceeds six hundred thousand (600,000) cubic feet, the exhaust system shall be sized to provide a minimum of four (4) air changes per hour.

Supply air may be provided at the lowest level of the atrium. These inlets shall be sized for seventy-five (75) per cent of the exhaust.

437.2.1.2 Atriums in excess of fifty-five (55) feet in height: When the height of the atrium exceeds fifty-five (55) feet, an exhaust system shall be provided as required by Section 437.2.1.1; however, supply air shall be introduced mechanically from the floor of the atrium and shall be directed vertically at the exhaust outlet above. The capacity of the supply shall be seventy-five (75) per cent of the exhaust.

437.2.1.3 Smoke detectors: Smoke detectors shall be provided at the ceiling of the atrium and on the underside of each floor area projecting into the atrium space. Detectors shall be located in accordance with their listing.

437.2.1.4 Smoke control activation: The smoke control system required for the atrium spaces shall be activated by the fire suppression system, smoke detectors required by Section 437.2.1.3 and by manual controls provided for the fire department use. The system shall not be activated by a manual fire alarm system required by Section 1217.0. Manual controls shall be located in the central control station or other location approved by the fire department.

437.2.1.5 Other approved methods: Any other approved design which will achieve the same level of smoke control as described in this section may be used in lieu of these requirements.

437.2.2 Enclosure of atriums: Atrium spaces shall be separated from adjacent spaces by a one (1) hour fire separation wall. A glass wall forming a smoke partition may be used in lieu of the required fire separa-



tion wall where automatic sprinklers are spaced six (6) feet or less along both sides of the separation wall, or on the room side only if there is not a walkway on the atrium side, and not more than one (1) foot away from the glass and so designed that the entire surface of the glass will be wet upon activation of the sprinkler system.

Exception: The adjacent spaces of any three (3) floors of the atrium shall not be required to be separated from the atrium; however, these spaces shall be included in the atrium volume according to Section 437.2.

437.2.3 Voice alarm: In use groups R-1, R-2 and I, a voice alarm system complying with the requirements of Section 431.5, Item 1, shall be required on the floors communicating with the atrium. The alarm shall be initiated by either the fire suppression system or the activation of two (2) or more smoke detectors in the atrium.

437.2.4 Travel distance: In other than the lowest level of the atrium, when the required means of egress is through the atrium space, the exitway access travel distance shall not exceed one hundred and fifty (150) feet.

437.3 Floor openings: Floor openings for unenclosed supplemental stairways, except supplemental stairways conforming to Section 616.8, or escalators conforming to Article 16 shall be permitted when protected on every floor pierced by the opening with an approved automatic exhaust system or by other approved smoke control method as herein required to prevent the passage of products of combustion to the story above.

437.3.1 Smoke control: The approved automatic exhaust system may be a separate unit or integrated with an approved air handling system and shall be thermostatically controlled to operate simultaneously with the detection of fire.

437.3.1.1 Capacity of exhaust system: The exhaust system shall be of adequate capacity to create a controlled draft in the floor opening with sufficient velocity of flow over the entire area of the floor opening under normal conditions of window and door openings in the building.

437.3.1.2 Operation of mechanical system: The exhaust system herein required shall be so arranged as to automatically stop the operation of the normal mechanical air handling system and ventilating systems and close the dampers of the return air duct connection in the event of fire.

437.3.2 Draft stop: An approved draft stop shall be intalled herein at each story of the floor opening. The draft stop shall enclose the perimeter of the opening and shall extend from the ceiling downward at least eighteen (18) inches on all sides. Automatic sprinklers shall be provided around the perimeter of the opening and within two (2) feet of the draft stop. The distance between the sprinklers shall not exceed six (6) feet center to center.

SECTION 438.0 LIMITED GROUP RESIDENCE

438.1 General: A building licensed by or operated by the Department of Mental Health or the Office for Children, Commonwealth of Massachusetts as a limited group residence: this is a special residence to include residents not capable of self-preservation.

438.1.1 Scope: A limited group residence shall have a maximum of twelve (12) residents who are at least four (4) years of age. Not more than four (4) of the residents shall be impaired; provided, however, that more than four (4) such residents may be impaired if the structure complies with Section 438.2. A limited group residence shall be classified in the R-5 use category for code purposes.

438.1.2 Definitions: The following terms shall have the meaning indicated for the purpose of Section 438.0:

Existing building or structure: Any completed building or structure which has been legally occupied and/or legally used for a period of at least five (5) years. Structures which fail to qualify with this definition shall comply with Section 438.2.

Resident: A client in need of care who resides in the limited group residence of the licensing or operation agency. Staff are not considered as residents under the provisions of Section 438.0. The licensing agency shall classify all residents in one (1) of the following three (3) categories:

Impaired: All residents not capable of self-preservation through physical, mental and/or developmental disability and requiring physical assistance to exit the building. All residents under seven (7) years of age shall be classified as impaired.

Partially impaired: All residents physically, mentally and/or developmentally disabled but capable of exiting the limited group residence with either supervision and/or instruction without any physical assistance.

Unimpaired: All residents capable of exiting the building without physical assistance and/or supervision or instruction by staff personnel and capable of negotiating any exitway of the limited group residence.

438.1.3 Application of building code and reference: Except as may otherwise be specifically provided for in Section 438.0, the Massachusetts State Building Code shall apply in its entirety.

Exception: Article 22 shall not apply.

438.1.4 Mixed use occupancy: A limited group residence shall not be housed in a building used for any occupancy other than a limited group residence (R-5).

438.1.5 Plans and specifications: Plans shall be filed with the building official having jurisdiction in accordance with Section 113.0 for any building to be constructed as, or altered for use as, a limited group residence under Section 438.0.

438.1.6 Temporary certificate of occupancy: Upon satisfactory compliance with the code sections pertaining to building requirements, the building official shall issue a temporary certificate of occupancy in accordance with Section 119.4 for a period not to exceed ninety (90) days. This temporary certificate of occupancy specifically prohibits residents as defined in Section 438.1.2 from inhabiting the building overnight until the building official issues the certificate of occupancy under Section 438.1.8.

438.1.7 Rules and regulations of the licensing or operating agency pertaining to and including, but not limited to, smoking regulations, staffing ratios, and resident classifications shall be provided to the building official by the licensing or operating agency prior to the issuance of a certificate of occupancy.

438.1.8 Certificate of occupancy: Certificates of occupancy shall only be issued when a license, if appropriate, and an affidavit from the Department of Mental Health or the Office for Children, Commonwealth of Massachusetts have been accepted by the building official attesting to the satisfactory compliance with the applicable rules and regulations referenced in Section 438.1.7.

438.1.9 Certificate of inspection: Certificates of inspection shall be issued by the building official in accordance with Section 108.5.1 and Table 108.

438.1.10 Failure to comply: The building official immediately upon being informed by written report or otherwise that a building or structure or anything attached thereto or connected therewith is being occupied in violation of this code may revoke or suspend any permit, license, certificate or other permission regulated by this code and granted by him, and no such building or structure shall be continued to be operated after such revocation or suspension. Such revocation or suspension shall not preclude the building official from instituting appropriate action in accordance with Section 121.0.

438.2 New structures: All new structures shall be constructed, equipped, and maintained to the requirements of Article 21, Section 438.0 and this code, and shall be limited to one (1) story in height. Corridors shall be of one (1) hour fireresistive construction.

438.2.1 Other requirements: New structures shall also satisfy the general requirements contained in Sections 438.1 and 438.3.

438.3 Existing structures: Existing structures of any construction up to three (3) stories or forty (40) feet in height may be converted and used for limited group residence occupancies. All residents classified

as impaired as defined in Section 438.1.2 are restricted to those stories having direct access to grade without steps or changes in elevation other than ramps in accordance with Section 315.1.

438.3.1 Third-story utilization: The third (3rd) story of buildings permitted by Section 438.3 may be only occupied by staff. Other use of the third (3rd) story is restricted to heating, ventilation units and ordinary storage. All doors leading to non-resident areas shall be maintained locked.

438.3.2 Vertical openings: Openings to such spaces as laundry chutes, dumb-waiters, heating plenums or combustible concealed spaces shall be permanently blocked with one (1) hour construction, in accordance with the provisions of Article 9, unless such installation is in compliance with the pertinent provisions of other sections of this code.

438.3.2.1 Firestopping and draftstopping: Firestopping and draftstopping shall be provided in accordance with Sections 919.0 and 2103.2.7 or as approved by the building official.

#### 438.3.3 Exitway Details

438.3.3.1 Corridor width: The minimum clear width of an exitway access corridor shall be three (3) feet.

Exception: In new structures the minimum clear width shall be four (4) feet.

438.3.3.2 Dead ends: In no case shall dead end corridors exceed thirty (30) feet. Existing dead end corridors, wherever possible, shall be altered so that exitways shall be accessible in at least two (2) different directions from all points in corridors.

438.3.3.3 Corridor walls: Corridor walls that separate use areas from exitway access corridors shall be of construction that will resist the passage of smoke.

Exception: Existing openings to congregate living areas, other than kitchens, shall be allowed to remain open.

438.3.3.4 Sleeping room doors: All sleeping room doors shall be of construction that will resist the passage of smoke. All doors shall be equipped with approved positive latching hardware and approved self-closing devices.

Exceptions:

1. Sleeping room doors may be equipped with approved hold-open smoke activated devices in accordance with Section 612.5.4.
2. Hollow core doors shall not be permitted.

438.3.3.5 Means of Egress: All habitable floors shall be provided with at least two (2) means of egress, located as remote as practicable from one another. Exitways shall be located to provide a safe path of travel to a public way without traversing any corridor or space exposed to an unprotected open stairway.

Exceptions:

1. Open stairs may be used as one (1) of the required means of egress when permitted by Section 438.3.3.6, Exception 3. However, in no case may both required means of egress traverse the unprotected open space.
2. Access to one (1) of the required exitways on sleeping room floors may be through adjoining rooms.

438.3.3.6 Interior exitway stairs: Every story shall be provided with at least one (1) enclosed interior stairway which discharges directly to grade or through a grade passageway to a public way. The enclosed interior stairway(s) shall be of construction having a minimum fire-resistance rating of one (1) hour, properly firestopped. Spaces below the stairway(s) shall be enclosed to maintain the integrity of the one (1) hour fire-resistive construction of the stairway enclosure. Stairway(s) openings shall be protected by at least Class "B" label one (1) hour fire door assemblies.

New stair construction shall comply with Section 616.0. Existing stairs shall comply with Section 2101.10.8 or as approved by the building official.

Exceptions:

1. Secondary stairs not considered an exitway component may have door openings protected by a minimum one and three-eighths (1 3/8) inch solid bonded wood core doors or equivalent; however, such doors shall be equipped with approved automatic positive latching hardware and approved self-closing devices.
2. Basement/cellar: Stairway(s) shall be separated from the first floor by a twenty (20) minute fire rated, self-closing door or its equivalent.
3. One (1) stairway may be allowed to remain unenclosed to preserve functional and aesthetic requirements.

438.3.3.7 Door widths: No single egress door in a doorway shall be less than twenty-eight (28) inches wide.

Exceptions:

1. Exitway door leaves shall not be less than thirty-four (34) inches wide.

2. Door leaves to resident bedrooms occupied by residents who are classified as "Impaired" shall not be less than thirty-four (34) inches wide.

438.3.3.8 Basement/cellar: Basements/cellars shall be provided with at least two (2) acceptable exitways, one (1) of which shall discharge directly to the outside of the building.

Exception: Basement/cellar areas with only one (1) existing entrance from the outside only, and used solely as a mechanical space shall be permitted to maintain only one (1) doorway which shall be maintained locked as an entrance/exitway.

438.3.3.9 Emergency escape: All sleeping rooms shall have at least one (1) openable window or exterior door to permit smoke control, emergency escape, or rescue. A required door or window must be openable from the inside without the use of separate tools, and shall comply with Section 609.4.

438.3.3.10 Means of egress lighting: Means of egress lighting systems shall be provided in accordance with Section 624.0.

438.3.3.11 Locks: Locks installed in resident sleeping room doors shall be so arranged that they can be locked from the corridor side. All such locks shall be arranged to permit exit from the room by a simple operation without the use of a key. Double cylinder dead bolts requiring key operation on both sides are prohibited throughout this occupancy.

438.3.4 Interior finish: The flame spread of interior finish shall be limited to Class II in exitways or exit access corridors. Rooms shall be permitted to have interior finish of a Class III flame spread. Floor coverings shall conform to the requirements of Section 920.7 except that carpet type floor coverings shall possess a critical radiant flux of  $0.22 \text{ w/cm}^2$  or greater.

438.3.5 Fire suppression systems: Automatic fire suppression systems shall be provided and installed in accordance with NFIPA Standard No. 13D, 1980 edition.

Additions:

1. Exceptions listed in NFIPA Standard No. 13D applicable to dwellings shall not apply.
2. A water flow detector, connected to the fire alarm system, shall be provided.
3. NFIPA Standard No. 13D, Sections 4-6; Exception 1 shall not apply.

4. The control valve(s) shall be secured in the open position.

438.3.6 Fire alarm system: A manual fire alarm system shall be provided and installed in accordance with Section 1217.0 and specifically NFIPA Standard No. 72A as listed in Appendix I.

438.3.7 Automatic protection alarm system: Approved smoke detectors shall be installed in accordance with Section 1216.0 and specifically NFIPA Standard No. 72E as listed in Appendix I in the following locations:

1. exitway access corridors not more than thirty (30) feet on center;
2. congregate living areas other than kitchens;
3. at least one (1) detector in all basement/cellar areas; and
4. all sleeping rooms.

Exception: Smoke detectors used in combination with automatic closing devices may be substituted in each area aforementioned for the protection herein required.

438.3.8 Fire department connection: All automatic and manual fire alarm systems shall be electrically interconnected; this combined system shall automatically transmit an alarm to the municipal fire department or to such other outside assistance as may be available. Such connection shall be made in accordance with NFIPA Standard Nos. 71 or 72B or 72C as listed in Appendix I.

438.3.9 Heating devices: Portable comfort heating devices and solid fuel burning appliances are prohibited. Any heating device, other than a central heating plant, shall be so designed and installed that combustible material will not be ignited by it or its appurtenances. If fuel-fired, such heating devices shall be chimney or vent connected, shall take air for combustion directly from the outside, and shall be so designed and installed to provide for complete separation of the combustion system from the atmosphere of the occupied area. The heating system shall have safety devices to immediately stop the flow of fuel and shut down the equipment in case of either excessive temperature or ignition failure.

Exceptions:

1. Approved suspended unit heaters may be used in locations other than means of egress and sleeping areas, provided such heaters are located high enough to be out of the reach of persons using the area and provided they are equipped with the safety devices specified in Section 438.3.9.

2. Fireplaces which comply with Sections 1007.0 and 2108.0 may be used only in areas other than resident sleeping rooms. The fireplaces shall be equipped with a heat tempered glass fireplace enclosure guaranteed against breakage up to a temperature of 650 Farenheit. A lock on the enclosure shall be required.

438.3.10 Fire drills: The licensing or operating agency shall require that fire drills be held with sufficient frequency so as to familiarize all residents and staff personnel with emergency procedures. Drills shall be held at unexpected times under varying conditions to simulate the unpredictable conditions which may occur in case of fire, including blocking of any point of any means of egress.

438.3.10.1 Log: A log shall be kept of all fire drills and shall be available for inspection and duplication by the building official, fire official, and other parties having jurisdiction.

438.3.10.2 The resident manager shall record in said log the names of any authorized inspectors who may have been present and the names or identifying numbers of the residents who participated.



SECTION 439.0 DETOXIFICATION FACILITIES

439.1 General: A detoxification facility is a facility licensed or operated by the Department of Public Health, Division of Alcoholism in accordance with the Rules and Regulations for Detoxification Facilities issued by the Department of Public Health, Division of Alcoholism, Commonwealth of Massachusetts, and shall be used to treat individuals acceptable to the program in accordance with those Rules and Regulations.

439.2 Scope: Detoxification facilities shall be subject to the requirements of this section for new and existing buildings which are to be used or operated as licensed facilities. This section shall establish the requirements applicable to such facilities. Where specific reference is made to other sections of the Massachusetts State Building Code, to reference standards or other regulations, those requirements cited shall apply. Where no reference is specifically made, this code, including Article 22, shall apply.

439.3 Classification of Residents: All residents enrolled in the detoxification program shall be identified according to one of the following classifications when evaluated by the facility personnel in accordance with the Rules and Regulations for Detoxification Facilities of the Division of Alcoholism of the Department of Public Health:

1. Impaired
2. Partially Impaired
3. Unimpaired

439.4 Definitions: The following terms shall have the meaning indicated for the purpose of this section:

Impaired: Anyone who will require assistance to egress the building.

Partially Impaired: Anyone who may require assistance to egress the building.

Unimpaired: Anyone who appears able to egress the building without assistance.

439.5 Use group classification: Detoxification facilities licensed and approved in accordance with these provisions shall be classified in the R-1 use group.

439.6 Mixed use occupancy: A portion of a building may be used for a detoxification facility provided that it is completely separated from the rest of the building by both horizontal and vertical fire division assemblies of at least one (1) hour fire-resistance rating.

Exception: Detoxification facilities shall not be located in buildings in which any of the following use groups are located: A-2, F, H, or S-1.

439.7 Submission of plans: Plans shall be filed with the building official in accordance with Section 113.0 for any building to be constructed as, or altered

for use as, a detoxification facility under Section 439.0. The plans shall also identify those rooms which comply with these regulations for use by the impaired.

439.8 Inspection and certification: The building official shall inspect and certify detoxification facilities once every two years Fees shall be applied in accordance with Table 108 for the R-1 Use Group.

439.9 Resident location limitations: In buildings used as detoxification facilities, in accordance with these provisions, resident locations shall be limited according to the use and type of construction as provided in Table 439.9. All heights are in stories above grade. All buildings used as detoxification facilities in accordance with these provisions shall be accessible to the Fire Department wherever escape windows are required.

TABLE 439.9

## RESIDENT SLEEPING ROOM LOCATION LIMITATION FOR DIFFERENT TYPES OF CONSTRUCTION

|                    | 1A          | 1B          | 2A       | 2B       | 2C       | 3A        | 3B       | 3C       | 4A       | 4B        |
|--------------------|-------------|-------------|----------|----------|----------|-----------|----------|----------|----------|-----------|
| Impaired           | NO<br>LIMIT | 8<br>St.    | 4<br>St. | 2<br>St. | 1<br>St. | -2<br>St. | 2<br>St. | 1<br>St. | 1<br>St. | 1*<br>St. |
| Partially Impaired | NO<br>LIMIT | NO<br>LIMIT | 8<br>St. | 3<br>St. | 1<br>St. | 3<br>St.  | 3<br>St. | 2<br>St. | 2<br>St. | 1<br>St.  |
| Unimpaired         | NO<br>LIMIT | NO<br>LIMIT | 9<br>St. | 4<br>St. | 3<br>St. | 4<br>St.  | 4<br>St. | 3<br>St. | 3<br>St. | 2<br>St.  |

Note: \* Impaired sleeping rooms in 4B construction require either full building sprinklering or one (1) hour fire rated separation for floor and ceiling of sleeping room walls.

439.9.1 Sprinklered buildings: Buildings which are completely sprinklered may have resident locations one story higher than allowed in Table 439.9.

439.9.2 Sleeping room limitations: Sleeping facilities in building licensed for use as detoxification facilities shall not be located below the first story.

439.10 Egress: At least two (2) exitways located as remote as practicable from each other shall be provided from each floor of the building.

439.10.1 Every room used for sleeping for the impaired and partially impaired shall have an exitway access door leading directly to an exitway access corridor:

Exceptions:

1. Rooms having a means of egress doorway leading directly to the exterior of the building at grade.
2. Rooms having a means of egress doorway leading directly to the exterior of the building above grade and connected directly to grade by means of an exterior stairway in accordance with Section 619.

439.10.2 All other sleeping rooms: All other sleeping rooms shall comply with the requirements of Article 6 in accordance with the provisions for the R-1 use group.

439.10.3 Corridors shall provide at least thirty-six (36) inches minimum nominal width.

439.10.4 All means of egress doorways shall be thirty-two (32) inches minimum nominal width.

Exception: Egress doorways from impaired sleeping rooms shall be thirty-six (36) inches minimum nominal width.

439.10.5 Every required exitway access corridor shall have a one (1) hour fire-resistance rating and shall provide access to at least two (2) approved exitways without passing through any intervening rooms or spaces other than corridors and lobbies.

Exception: In buildings with a complete sprinkler system, exitway access corridors not required for the impaired or partially impaired may be separated from other use areas by non-fire rated partitions.

439.10.6 Stairways: Where not otherwise specified in this section, stairways required as a means of egress shall be subject to these requirements:

439.10.6.1 Stairways required to provide egress for the impaired shall be at least thirty-six (36) inches minimum nominal width. The total capacity of the stairways shall be adequate for the occupancy load served.

439.10.6.2 Stairway enclosures shall have a fireresistance rating of one (1) hour for buildings not exceeding three (3) stories in height, and two (2) hours for buildings exceeding three (3) stories in height.

439.10.6.3 Doors to the required exitway stairways shall comply with the provisions of Section 616.6.3.

439.11 Interior finish: Interior finish requirements shall comply with Table 439.11

## Exceptions:

1. In buildings which are completely sprinklered, the interior finish requirements may be reduced one (1) level except in sleeping rooms for the impaired.
2. The interior finish classifications in existing buildings may be improved one (1) level by the use of fire retardant coatings which have been approved when tested in accordance with ASTM E-84.

TABLE 439.11

## INTERIOR FINISH REQUIREMENTS

| LOCATION                           | WALLS | FLOOR           | CEILING |
|------------------------------------|-------|-----------------|---------|
| Sleeping rooms, Impaired           | II    | II <sup>2</sup> | II      |
| Corridors, Impaired                | I     | I <sup>1</sup>  | I       |
| Sleeping Rooms, Partially Impaired | I     | I <sup>1</sup>  | I       |
| Corridors, Partially Impaired      | I     | I <sup>1</sup>  | I       |
| All Other Exitway Access Corridors | II    | II <sup>2</sup> | II      |
| Stairways                          | I     | I <sup>1</sup>  | I       |

Note 1: Carpet type floor coverings shall withstand a test exposure of 0.45 watts per square centimeter when tested in accordance with Section 904.3.

Note 2: Carpet type floor coverings shall withstand a test exposure of 0.22 watts per square centimeter when tested in accordance with Section 904.3.

439.12 Fire alarm systems: Manual and automatic fire alarm systems shall be provided in accordance with Sections 1216.0 and 1217.0 as they apply to Use Group R-1.

Exceptions:

1. In rooms for the impaired and partially impaired the heat detectors required by Section 1216.3.2.1 (7) (b) shall be replaced with approved smoke detectors.
2. Buildings or portions thereof with twenty-five (25) beds or less shall have as a minimum a Type II system as described in Section 1216.3.2.3 (2): buildings with twenty-six (26) beds or more shall have as a minimum a Type I system as described in Section 1216.3.2.3 (1).
3. All buildings or portions thereof regardless of the number of beds shall incorporate manual pull stations in conformance with Section 1216.3.2.4.

439.12.1 All automatic and manual fire alarm systems shall be electrically interconnected; this combined system shall automatically transmit an alarm to the municipal fire department or to another approved source of assistance. Such communication shall be made in accordance with NFPA Standards Nos. 71 or 72B or 72C as listed in Appendix I.

439.13 Means of egress lighting: Means of egress lighting including an emergency lighting system shall be provided throughout the facility in accordance with Section 624.

439.14 Smoke enclosure doors: Smoke enclosure doors shall be tight-fitting with approved hardware.

439.15 Heating apparatus: The use of portable heaters, solid fuel burning room heaters and fireplaces shall be prohibited.

439.16 Sprinkler systems: Where a complete building sprinkler system is installed, it shall comply with the provisions of NFPA Standard No. 13, 1976 edition as referenced in Appendix I.

439.16.1 All rooms used for sleeping for the impaired shall be sprinklered.

Exception: A partial system required for impaired sleeping rooms may be provided with a sprinkler system serving no more than six (6) sprinklers, which may be connected directly to a domestic water supply system having a capacity sufficient to provide 0.15 gallons per minute per square foot of floor area throughout the entire area. An indicating shut-off valve shall be installed in an accessible location between the sprinklers and the connection to the domestic water supply.

ARTICLE 5

LIGHT, VENTILATION AND SOUND  
TRANSMISSION CONTROL

SECTION 500.0 GENERAL

500.1 Scope: The provision of this article shall govern the means of light and ventilation required in all habitable and occupiable spaces and rooms. Every building and structure hereafter erected and every building room or space which is changed in use shall be constructed, arranged and equipped to conform to the requirements of this article and the applicable standards listed in Appendix B.

500.2 Conflicting laws: The provisions in this article shall not be construed to nullify the provisions of any other law or ordinance regulating yards, courts, or other spaces required for light or ventilation; but the provisions specifying the greater requirements shall control the construction.

500.3 Buildings on same lot: If more than one (1) building is hereafter placed on a lot, or if a building is placed on the same lot with existing buildings, the several buildings may be treated as a single structure for the purpose of this article, provided equivalent uncovered lot area or other adequate sources of light and ventilation are furnished for all habitable and occupiable spaces and rooms.

500.4 Other standards: Compliance with the applicable provisions of the standards listed in Appendix B shall be deemed to meet the requirements of this article, unless otherwise specifically provided herein.

SECTION 501.0 PLANS AND SPECIFICATIONS

501.1 General: Plans for all buildings and structures other than one- and two-family and multi-family dwellings, which are designed for human occupancy, shall designate the number of occupants to be accommodated in the various rooms and spaces, and when means of artificial lighting and ventilation are required, the application shall include sufficient details and description of the mechanical system to be installed as herein required or as specified in the mechanical code listed in Appendix B.

SECTION 502.0 STANDARDS OF NATURAL LIGHT

502.1 General: In the application of the provisions of this article, the standard of natural light for all habitable and occupiable rooms, unless otherwise specifically required by the provisions of Article 4 for special uses and occupancies, shall be based on two hundred and fifty (250) foot candles of illumination on the vertical plane adjacent to the exterior of the light transmitting device in the enclosure wall and shall be adequate to provide an average illumination of six (6) foot candles over the area of the room at a height of thirty (30) inches above the floor level.

SECTION 503.0 STANDARDS OF NATURAL VENTILATION

503.1 General: In the application of the provisions of this article, the standard of natural ventilation for all habitable and occupiable rooms shall be based on a volume of four hundred (400) cubic feet of air per occupant with ventilating skylights, monitors, louvres, windows, transoms, doors or other alternate ventilating devices located in the exterior walls or on the roof of the building as provided in Sections 506.0 to 514.0 inclusive.

SECTION 504.0 ARTIFICIAL LIGHT AND VENTILATION

504.1 When required: When natural light and ventilation do not meet the minimum requirements of this code, or when rooms, which by use or occupancy, involve the presence of dust, fumes, gases, vapors or other noxious or deleterious impurities that create a fire or health hazard, or when required by the provisions of Article 4 for special uses, the building shall be equipped with artificial light and mechanical means of ventilation under the conditions and of the minimum capacity prescribed herein and in the mechanical code listed in Appendix B.

504.2 Operation of ventilating systems: Where mechanical ventilation is accepted as an alternate for natural means of ventilation, or is required under the conditions herein prescribed, the system, equipment and distributing ducts shall be installed in accordance with the provisions of Article 10 and the mechanical code listed in Appendix B. Ventilating systems shall be kept in operation at all times during normal occupancy of the building or space so used.

504.3 Habitable rooms: The glazed areas of windows and exterior doors in habitable rooms and spaces need not be openable where an approved mechanical ventilation system is provided capable of producing two (2) changes of air per hour. Recirculation of not more than seventy-five (75) per cent of the air supplied may be permitted in habitable rooms except kitchens, provided the air recirculated does not come from a plenum or system fed with air returned from habitable rooms occupied by other families, or from the stairways or common hallways; except that recirculation of one hundred (100) per cent of the air supplied may be permitted if the system supplies only a single dwelling unit.

SECTION 505.0 EXISTING BUILDINGS

505.1 Unsafe conditions: In all existing rooms or spaces in which the provisions for light and ventilation do not meet the requirements of this article and which, in the opinion of the building official, are dangerous to the health and safety of the occupants, he shall order the required repairs or installations to render the building or structure livable for the posted use and occupancy load.

505.2 Alterations: A building shall not hereafter be altered or re-arranged so as to reduce either the size of a room, or the fresh air supply, or the amount of available natural light to less than that required for buildings hereafter erected; or to create an additional room unless made to conform to the requirements of Section 506.0. The building official may permit new rooms to be of the same height as existing rooms in the same story unless in his opinion greater provision of artificial light and ventilation is deemed necessary to insure healthful living conditions.

505.3 Uncovered yard and court area: A building shall not be hereafter enlarged, nor shall the lot on which it is located be diminished so as to decrease the required courts or yards to less than that prescribed in this article for the lighting and ventilation of new buildings.

#### SECTION 506.0 NATURAL LIGHTING AND VENTILATION OF ROOMS

506.1 Window and skylights: All habitable and occupiable rooms or spaces shall contain windows, skylights, monitors, glazed doors, transoms, glass block panels or other light transmitting media opening to the sky or on a public street, yard or court complying with the provisions of this article. The light transmitting properties and the area of the devices used shall be adequate to meet the minimum daylighting and ventilating requirements specified herein and in the approved rules.

506.2 Window size: Windows and exterior doors may be used as a natural means of light and ventilation, and when so used their aggregate glass area shall amount to not less than eight (8) per cent of the floor area served, and with not less than one-half (1/2) of this required area available for unobstructed ventilation.

506.3 Openings on yards and courts: In order to be credited as a source of natural light or ventilation under the provisions of this article, a window or any other approved device shall open directly on a public street, alley or other open public space, or on a yard or court located on the same lot or plot complying with the requirements of Sections 516.0, 517.0 and 518.0.

506.4 Alternate devices: In place of the means for natural light and ventilation herein prescribed, alternate arrangement of windows, louvres, or other methods and devices that will provide the equivalent minimum performance requirements shall be permitted when complying with the code.

#### 506.5 Room dimensions

506.5.1 Ceiling heights: Habitable (space) rooms, other than kitchens, storage rooms and laundry rooms shall have a ceiling height of not less than seven (7) feet three (3) inches. Hallways, corridors, bathrooms, water closet rooms, and kitchens shall have a ceiling height of not less than seven (7) feet measured to the lowest projection from the ceiling.



If any room in a building has a sloping ceiling, the prescribed ceiling height for the room is required in only one-half (1/2) the area thereof. No portion of the room measuring less than five (5) feet from the finished floor to the finished ceiling shall be included in any computation of the minimum area thereof.

If any room has a furred ceiling, the prescribed ceiling height is required in two-thirds (2/3) of the area thereof, but in no case shall the height of the furred ceiling be less than seven (7) feet.

506.5.2 Floor area: Habitable rooms except kitchens shall have an area of not less than seventy (70) square feet between enclosing walls of partitions, exclusive of closet and storage spaces.

506.5.3 Width: No habitable room other than a kitchen shall be less than seven (7) feet in any dimension.

#### SECTION 507.0 LIGHTING AND VENTING OF SPECIAL SPACES

507.1 Alcove rooms: When alcove rooms open without obstruction into adjoining rooms, the required window openings to the outer air shall be based on the combined floor area of room and alcove. An alcove space shall not be more than sixty (60) square feet in area and the opening to the adjoining room shall be not less than eighty (80) per cent of the superficial area of the dividing wall, unless provided with separate means of light and ventilation.

507.2 Attic ventilation: Enclosed attics, and enclosed rafter spaces formed where ceilings are applied direct to the underside of the roof rafters, shall have cross ventilation for each separate space by ventilating openings protected against the entrance of rain and snow, sized by the following criteria:

1. With a ceiling vapor barrier installed: attics with a ceiling vapor barrier shall be ventilated with screened openings of at least one (1) square foot of free vent area for each three hundred (300) square feet of ceiling area.
2. Without a ceiling vapor barrier installed: attics without a ceiling vapor barrier installed shall be ventilated with screened openings of at least one (1) square foot of free vent area for each one hundred and fifty (150) square feet of ceiling area.
3. Flat roofs: blocking and bridging shall be arranged so as not to interfere with the movement of air. Such roofs shall be ventilated along the overhanging eaves with at least one (1) square foot of free vent area for each two hundred and fifty (250) square feet of ceiling area.

4. Eave vents: when eave vents are installed, adequate baffling shall be provided to deflect the incoming air above the surface of the insulation. Baffles shall be installed prior to insulation, and shall be installed over the exterior wall at an angle to provide a two (2) inch minimum clearance under the roof deck for upward flow of ventilation air to the fixed vents in the upper portion of the attic. The ridge or gable vent must be at least three (3) feet above the level of the eave vents.

507.3 Underfloor space ventilation: Enclosed underfloor spaces shall have cross ventilation for each separate space by ventilating openings protected against the entrance of rain and snow, sized by the following criteria.

1. With a ground vapor barrier: underfloor spaces with a vapor barrier installed on the ground surface shall be ventilated with screened openings of one (1) square foot of vent area for each fifteen hundred (1500) square feet of crawl space.
2. Without a ground vapor barrier: underfloor spaces without a vapor barrier installed on the ground surface shall be ventilated with screened openings of one (1) square foot of vent area for each fifty (50) square feet of crawl space.

#### SECTION 508.0 BASEMENTS AND CELLARS

508.1 General: Except as may be otherwise specified for habitable or occupiable rooms or specifically provided in Article 4 for special uses, the glass window area in basements and cellars, except crawl spaces as provided in Section 507.3, shall be not less than one-fiftieth (1/50) of the floor area served, and provisions shall be made for fresh air supply prescribed for specific uses in Section 514.0 and the mechanical code listed in Appendix B.

#### SECTION 509.0 BUSINESS AND WORK ROOMS

509.1 General: Offices, stores, mercantile and salesrooms, restaurants, markets, bakeries, hotel and restaurant kitchens, factories, workshops, machinery and boiler rooms shall be provided with the required windows specified in Section 506.0 for habitable and occupiable rooms, opening directly on a street or required yard or court; or such rooms shall be equipped with an approved system of mechanical ventilation complying with Section 504.0 and the mechanical code listed in Appendix B.

#### SECTION 510.0 ASSEMBLY ROOMS

510.1 General: In addition to the requirements of Article 4 for special uses, the required windows or other approved devices for natural ventilation shall be distributed as equally as practicable on at least two (2)

sides of the room; and artificial lighting shall comply with the requirements of this article and Article 15.

#### SECTION 511.0 ROOMS OF INSTITUTIONAL BUILDINGS

511.1 General: In buildings of the institutional use group, every habitable and occupiable room shall be provided with light and ventilation as herein provided, except that in buildings used for enforced detention of people (use group I-1) indirect openings to the street or court may be permitted through intermediate corridors or by other approved means of light and ventilation.

#### SECTION 512.0 BATH AND TOILET ROOMS

512.1 General: Every bath and toilet room shall be lighted and ventilated by one (1) of the methods prescribed in Sections 512.2 through 512.7.

512.2 Exterior windows: Windows opening to the outer air as provided in Section 506.0 but not less than three (3) square feet in area.

512.3 Vent shaft windows: Windows as provided in Section 506.0 but not less than three (3) square feet in area, opening on a vent shaft with a cross-sectional area of one (1) square foot for every foot in height, but not less than nine (9) square feet in area, open to the outer air at top or constructed with equivalent side louver openings.

512.4 Vents and ducts: Individual vents or ducts constructed of approved noncombustible materials complying with Section 1009.0 with a minimum cross-sectional area of one-half (1/2) square foot and one-third (1/3) additional square foot for each additional water closet or urinal above two (2) in number. Such ducts shall be of adequate height and so located as to insure a minimum supply of two (2) cubic feet of fresh air per square foot of room area.

512.5 Skylights: A skylight of approved noncombustible construction complying with Section 925.3, and not less than three (3) square feet in area with ventilating opening.

512.6 Mechanical ventilating systems: Any system of mechanical or gravity ventilation capable of producing a change of air every 12 minutes in private bathrooms. Public bathroom mechanical ventilation systems shall comply with the mechanical code listed in Appendix B.

512.6.1 Recirculation: Recirculation of air supplied to toilet rooms, bathrooms and rest rooms shall not be permitted.

512.7 Artificial lighting: Illumination shall be provided in all toilet rooms to afford an average intensity of three (3) foot candles measured at a level thirty (30) inches above the floor.

SECTION 513.0 STAIRWAYS AND EXITWAYS

513.1 Residential and institutional buildings

513.1.1 Windows: In all multi-family dwellings (use group R-2) and in institutional buildings for the care or treatment of people (use group I-2) required interior stairways shall be provided with windows to the outer air having a glass area of not less than ten (10) square feet which opens on a required street, alley, yard or court, or with the equivalent source of light for each story through which the stairway passes; and such additional artificial lighting to provide the equivalent illumination at all times that the building is occupied as specified in Section 624.0 and Article 15.

513.1.2 Skylights: When the building is not more than three (3) stories in height, a ventilating skylight of the required area may be used in lieu of windows.

513.1.3 Hallways: Hallways shall have at least one (1) window opening directly on a street or on a required yard or court in each story, located so that light penetrates the full length of the hallway, with additional windows for each change of direction of the hallway; or the equivalent artificial lighting shall be provided. Every recess or return with a depth or length which exceeds twice the width of the hall, and every corridor separately shut off by a door, shall be treated as a separate hall in applying the provisions of this section.

513.1.4 Mechanical ventilating systems: All exitways and common corridors in multi-family dwellings (use group R-2) and in institutional buildings (use group I) shall be provided with not less than one (1) cubic foot per minute of fresh air per square foot of floor area. Not more than seventy-five (75) per cent of the air supplied shall be recirculated. For institutional (Use Group I) buildings where controlled environmental conditions, such as air-conditioning, are provided, mechanical ventilating systems for corridors and exitways shall comply to the applicable reference standard as listed in Appendix B of this code.

513.2 Business and assembly buildings: All stairway enclosures shall conform to the requirements of Articles 6 and 9 for construction and shall have the means of artificial illumination to meet the requirements of this article and Article 15.

513.3 Intensity of illumination: In all required exitways, except in one-and two-family dwellings, and wherever natural lighting is not available, artificial lighting shall be provided to furnish not less than three (3) foot candles at the floor level of all required exitways.

SECTION 514.0 REQUIRED FRESH AIR SUPPLY

514.1 General: Mechanical or gravity systems of ventilation shall provide the minimum air changes per hour specified in this code and the mechanical code listed in Appendix B. Recirculation of air supplied to kitchens, lavatories, toilet rooms, bathrooms, rest rooms, laboratories and garages shall not be permitted.

SECTION 515.0 VENTILATION OF SHAFTS OTHER THAN ELEVATOR AND DUMBWAITER HOISTWAYS

515.1 General: All enclosed vertical shafts extending through more than two (2) stories of every building or structure, except elevator or dumb-waiter hoistways, shall be automatically vented to the outer air as herein required or as specified in Section 910.0.

515.2 Extending to roof: Shaft enclosures extending to the roof shall be provided with a metal skylight constructed to comply with Section 925.3 or with windows of equivalent area or with other approved automatic means of removing hot air and gases.

515.3 Thermostatic control: The automatic operation of fire shutters, skylights and other vent relief devices may be controlled by fusible links designed to operate at a fixed temperature of not more than one hundred and sixty (160) degrees F., or by electric or pneumatic operation under a rapid rise in temperature at a rate of fifteen (15) to twenty (20) degrees F. per minute or by other approved methods.

515.4 Not extending to roof: Shaft enclosures not extending to the roof shall be provided with gas and smoke relief vents or adequate mechanical means of ventilation in conformity to the provisions of Section 910.6 and the mechanical code listed in Appendix B.

SECTION 516.0 COURTS

516.1 General: All courts required to serve rooms for light and ventilation purposes shall comply with the requirements of this section.

516.2 Width of court

516.2.1 Minimum width: Every such court shall have a minimum width of three (3) inches for each foot of height or fraction thereof but not less than five (5) feet for outer courts and twice these values for inner courts.

516.2.2 Irregular court width: In the case of irregular or gore-shaped courts, the required minimum width of a court may be deemed to be the average width, provided that such a court shall not be less than five (5) feet at any point.

516.3 Area of court: The cross-sectional area of a required court shall

be not less than one and one-half (1 1/2) times the square of its width; nor shall the length of any court be more than twice its width.

516.4 Access to court: A door or other means of access shall be provided at the bottom of every court that is not otherwise conveniently accessible for purposes of cleaning.

516.5 Air intakes to court

516.5.1 Inner court: Every court serving one (1) or more habitable rooms that does not open for its full height on one (1) or more sides to a street or legal yard shall be connected at or near the bottom with a street or yard by a horizontal intake or passage of fireresistive construction. Such intake or passageway shall have a cross-sectional area of not less than twenty-one (21) square feet, and shall remain fully open at both ends and unobstructed for its full size and length, except that grilles of noncombustible construction complying with the approved rules may be permitted at the ends of the intake.

516.5.2 Fireresistance: The walls, floors and ceilings of such intakes or passages shall have a fireresistance rating of not less than two (2) hours in buildings of Types 1, 2 or 3 construction and not less than one (1) hour in Type 4 construction.

516.6 Court walls: When, in the opinion of the building official, windows facing on courts do not receive adequate direct light by reason of peculiar arrangement or orientation, he may require the walls to be constructed of light colored masonry, or to be painted and maintained a light color to furnish additional reflected light.

516.7 Court drainage: The bottom of every court shall be properly graded and drained to a public sewer or other approved disposal system complying with the plumbing code listed in Appendix P; and shall be paved with concrete or other non-absorbent material when required by the building official.

## SECTION 517.0 REAR YARDS

517.1 Residential and institutional buildings: At the rear of every building hereafter erected to be occupied as a one- and two-family or multi-family dwelling (use groups R-2 and R-3), or institutional building (use group I), there shall be maintained a yard of the minimum dimensions herein prescribed. When such yard serves as a required light and ventilation court, its minimum dimensions shall be those required for a court in this article.

517.1.1 Depth of yards: The depth of a required yard between the extreme rear of the building and the rear lot line shall be not less than fifteen (15) feet at any point for a height of thirty-five (35) feet, and

shall increase four (4) inches in depth for each additional foot of height above that limit; except that for a corner lot the minimum depth shall be not less than ten (10) feet. When the lot is less than sixty-five (65) feet in depth, the required yard may be diminished six (6) inches in depth for each foot less than sixty-five (65) feet.

517.2 Other use groups: In buildings of other use groups, rear yards shall be provided to serve all habitable and occupiable rooms requiring light and ventilation from such source. Except for basements, such yards shall have a depth of not less than ten (10) feet for a height of thirty-five (35) feet and shall increase three (3) inches for each additional foot of height above that level.

#### SECTION 518.0 OBSTRUCTION OF COURTS AND YARDS

518.1 Permissible projections: Every required court and yard shall remain unobstructed for its required area and full height, except for the projections permitted in Section 311.0. In residential and institutional buildings, clothes poles, arbors, garden trellises and other such accessories shall not be prohibited in the open spaces at ground level.

518.2 Motor vehicle parking: When approved by the building official, required court and yard areas may be used for automobile parking spaces or private garages not exceeding one (1) story in height when accessory to and only for the use of the occupants of a residential building, provided required windows for light and ventilation are not obstructed thereby.

#### SECTION 519.0 FIRE EMERGENCY VENTILATING SYSTEM

519.1 Common corridors: In all buildings and structures herein required to have fire emergency ventilating systems, the common corridors shall be constructed with:

1. vertical fire vent stacks and lateral fire vent ducts as herein provided, or
2. windows to the outer air, or
3. mechanical ventilating or exhaust systems or
4. other equivalent approved means for dissipating smoke, heated air and toxic gases directly to the outer air in the event of fire.

519.2 Where required: Fire emergency ventilating systems shall be provided as described below:

1. In buildings used for I-1 and I-2 (institutional) use groups which:
  - a. exceed three (3) stories or forty (40) feet in height; and

- b. exceed ten thousand (10,000) square feet in floor area; and
  - c. are occupied by more than fifty (50) persons above the first floor, or have more than twenty-five (25) sleeping rooms above the first floor.
2. In buildings used for R-1 and R-2 (hotel and apartment house) use groups which:
    - a. same as 1.a. above;
    - b. same as 1.b. above;
    - c. same as 1.c. above.
  3. In all fully enclosed industrial buildings without provision of exterior openings for ventilation purposes.

519.3 Fire vent ducts: When the common corridors and exitways are not ventilated by windows opening directly to the outer air as required in Section 513.0, a system of collecting fire ducts shall be provided in each story of aggregate size to remove the smoke, hot air and noxious fumes or gases in event of fire. Each duct shall be not less than one (1) square foot in area located in the common hallways, with screened openings complying with the approved rules, constructed as provided for hot air ducts in Section 1009.0.

519.4 Thermostatic operation: When not connected to a vent stack, the inlet openings on each story shall be controlled by automatic heat-operated devices as required in Section 515.3 and in accordance with the approved rules.

519.5 Fire vent stacks: When the fire ducts do not discharge directly to the outer air in each story, one (1) or more fire vent stacks of adequate capacity shall be installed to accommodate the discharge from the fire duct system in any one (1) floor or enclosed fire area, but an individual stack shall not be less than four (4) square feet in area, and all stacks shall terminate in an approved automatic cowl or ventilator outlet above the roof.

519.6 Location of stacks: The vent stack shall be located in as central a position as practicable with respect to the floor area vented thereby, preferably in the vicinity of vertical shafts, and shall extend continuously to the roof.

519.7 Vent control of stacks: The vent control of the vertical stacks shall consist of approved noncombustible dampers, shutters, or glazed metal sash designed to open outwardly, located not less than twenty (20) feet distant from window openings or exitway doors in adjoining walls,



and shall be equipped with a thermostatic unit arranged to open at a predetermined rate of temperature rise in accordance with the approved rules. Auxiliary mechanical means for manual operation of all vent controls shall be provided in an accessible location designated by the building official.

519.8 Stack construction: The stack enclosure shall be constructed to be vapor and smoke tight with walls of not less than two (2) hour fire-resistance rating, and without openings other than the fire duct inlets and the top automatic ventilator outlet.

519.9 Mechanical exhaust systems: When mechanical exhaust is required to operate the emergency ventilating system either in horizontal ducts or vertical vent stacks, the installation shall be thermostatically controlled and installed in accordance with the provisions of the mechanical code listed in Appendix B and the approved rules.

#### SECTION 520.0 FIRE VENTILATION OF OPEN WELLS

520.1 through 520.6 deleted.

#### SECTION 521.0 WINDOW CLEANING SAFEGUARDS

521.1 General: All buildings and structures shall be designed to comply with the Dept. of Labor and Industry's Rules and Regulations for the Prevention of Accidents in Window Cleaning, (Industrial Bulletin No. 21), 441 CMR 19.00.

#### SECTION 522.0 SOUND TRANSMISSION CONTROL IN RESIDENTIAL BUILDINGS

522.1 Scope: This section shall apply to all common interior walls, partitions and floor-ceiling constructions between adjacent tenant units or between a tenant unit and adjacent public areas such as halls, corridors, stairs or service areas in all residential occupancies.

522.2 Airborne noise: Walls, partitions and floor-ceiling constructions separating tenant units from each other or from public or service areas shall have a sound transmission class (STC) of not less than forty-five (45) for airborne noise. This requirement shall not apply to dwelling unit entrance doors. However, such doors shall be tight fitting to the frame and sill.

522.2.1 Tested assemblies: All walls, partitions and floor-ceiling constructions tested in accordance with the applicable standard ASTM E90 listed in Appendix C and which meet the requirements for a forty-five (45) STC rating shall be considered as meeting the requirements of this section.

522.3 Structureborne sound: Floor-ceiling constructions between tenant units and between a tenant and public or service areas within the structure shall have an impact insulation class (IIC) rating of not less than forty-five (45).

522.3.1 Tested assemblies: All floor-ceiling constructions tested in accordance with the applicable standard ASTM E492 listed in Appendix C and which meet the requirements for a forty-five (45) IIC rating shall be considered as meeting the requirements of this section.

## ARTICLE 6

## MEANS OF EGRESS

## SECTION 600.0 GENERAL

600.1 Scope: The provisions of this article shall control the design, construction and arrangement of building elements required to provide a reasonably safe means of egress from all buildings hereafter erected and from all buildings hereafter altered to a new occupancy load, or manner of use, or inherent fire hazard.

600.2 Modification of exitway requirements: When strict compliance with the provisions of this code is not practical, the building official may accept alternate means of egress which will accomplish the same purpose, by the procedure established in Article 1 for modification of this code, or by adoption of approved rules. Existing buildings shall not be occupied during repairs or alterations unless all existing exitways and any existing fire protection are continuously maintained, or in lieu thereof other measures are taken which provide equivalent safety.

600.3 Minimum requirements: It shall be unlawful to alter any building or structure in any manner that will reduce the number of exitways or the capacity of exitways below the requirements of this code for new buildings of the proposed use and occupancy.

600.4 Other standards: Compliance with the applicable provisions of the standards listed in Appendix B shall be deemed to meet the requirements of this article, unless otherwise specifically provided herein.

## SECTION 601.0 PLANS AND SPECIFICATIONS

601.1 Arrangement of exitways: The plans shall show in sufficient detail the location, construction, size and character of all exitways together with the arrangement of aisles, corridors, passageways and hallways leading thereto in compliance with the provisions of this code.

601.2 Number of occupants: In other than one- and two-family and multi-family dwellings, the plans and the application for permit shall designate the number of occupants to be accommodated on every floor, and in all rooms and spaces when required by the building official. When not otherwise specified, the minimum number of occupants to be accommodated by the exitways shall be determined by the occupancy load prescribed in Section 606.0. The posted occupancy load of the building shall be limited to that number.

## SECTION 602.0 USE AND OCCUPANCY REQUIREMENTS

602.1 New buildings: Every building and structure and part thereof hereafter erected shall have the prescribed number of exitways of one (1)

or more of the approved types defined in this article. Exitways, in combination with the exitway access and exitway discharge, shall provide safe and continuous means of egress to a street or to an open space with direct access to a street.

602.2 Mixed use groups: In buildings classified in more than one (1) use group, each fire area shall be considered separately in determining the required number, capacity, size and construction of all exitways.

602.3 Multiple tenants: When more than one (1) tenant occupies any one (1) floor of a building or structure, each tenant shall be provided with direct access to approved exitways.

### SECTION 603.0 AIR-CONDITIONED BUILDINGS

603.1 Location of stairways: In all buildings, without exterior window openings in all stories, that are artificially ventilated and air-conditioned as provided in Section 504.0, the stairway element of required exitways shall be located as to be accessible to the fire department either through the access openings specified in Section 859.0 or as otherwise approved in at least alternate stories of the building.

603.2 Exhaust ducts: Exhaust ducts or vents of air-conditioning systems shall not discharge into stairway or elevator enclosures, nor shall corridors serving as exitway access be used as the return exhaust from air-conditioned spaces through louvres or other devices in the doors or partitions enclosing such air-conditioned spaces; unless such passageways are equipped with approved smoke detectors to automatically stop the supply and exhaust fans and close the louvres, and unless such use is approved by the building official.

### SECTION 604.0 EXISTING BUILDINGS

604.1 Owner responsibility: The owner or lessee of every existing building and structure shall be responsible for the safety of all persons in, or occupying, such premises with respect to the adequacy of means of egress therefrom (see Section 104.0).

604.2 Unsafe means of egress

604.2.1 Inadequate exitways: See Article 22.

604.2.2 Appeal from exitway order: Within seven (7) days after the service of the exitway order of the building official, the owner may file a written appeal therefrom, and the building official shall appoint a board of survey as defined in Section 124.0 to make a final determination. Nothing herein is to supersede the provisions of Section 123.0, Unsafe structures.

SECTION 605.0 MAINTENANCE OF EXITWAYS

605.1 Obstructions: It shall be unlawful to obstruct, or reduce in any manner, the clear widths of any doorway, hallway, passageway or any other exitway required by the provisions of this code.

605.2 Maintenance: All required means of egress components shall at all times be maintained in a safe usable condition. All exterior stairways, fire escapes, egress balconies and bridges shall be kept free of snow and ice. All corrodible structural parts thereof shall be kept painted, or otherwise protected against rust and corrosion both before and after erection. All wood structural members shall be maintained to prevent rotting and decaying. Where these elements tie directly into the building structural system, all joints shall be sealed to prevent water from damaging or corroding the structural elements.

605.3 Testing and certification: All exterior bridges, steel or wooden stairways, fire escapes and egress balconies shall be examined and/or tested, and certified for structural adequacy and safety every five (5) years, by a Massachusetts Registered Professional Engineer, or others qualified and acceptable to the building official, who shall then submit an affidavit to the building official.

SECTION 606.0 OCCUPANCY LOAD

606.1 Design occupancy load: In determining required exitway facilities, the number of occupants for whom exitway facilities shall be provided shall be established by the largest number computed as follows:

1. the actual number of occupants for whom each occupied space, floor, or building, as the case may be, is designed for;
2. the number of occupants computed at the rate of one (1) occupant per unit of area as prescribed in Table 606; or
3. the number of occupants of any space as computed in 1 or 2 above, plus the number of occupants similarly computed for all spaces that discharge through the space in order to gain access to an exitway.

606.1.1 Assembly occupancy: The occupancy load for places of assembly may be determined as provided in Section 606.1 if the necessary aisles and means of egress are provided as approved by the building official. An aisle, egress and seating diagram may be required by the building official to substantiate the occupancy load.

606.2 Mezzanine levels: The occupancy load of a mezzanine level discharging through a floor below shall be added to that floor occupancy and the capacity of the exitways shall be designed for the total occupancy loads thus established.

606.3 Roofs: Roof areas occupied as roof gardens or for assembly, storage or other purposes shall be provided with exitway facilities to accommodate the required occupancy load, but there shall not be less than two (2) approved means of egress for assembly uses from such roof areas.

606.4 Special or unlisted occupancies: Where data regarding the square feet per person for an occupancy is not listed in Table 606, the occupant load shall be established by the architect or engineer, subject to the approval of the building official.

Table 606

## MAXIMUM FLOOR AREA ALLOWANCES PER OCCUPANT

| Use  | Floor area in square feet per occupant |
|--|--|
| Assembly without fixed seats   |  |
| Concentrated (chairs only—not fixed)   | 7 net                                  |
| Unconcentrated (tables and chairs)   | 15 net                                 |
| Standing space   | 3 net                                  |
| <b>Assembly with fixed seats</b>   | <b>Note 1</b>                          |
| Business areas   | 100 gross                              |
| Court rooms  | 40 net                                 |
| Educational  |  |
| Classroom area   | 20 net                                 |
| Shops and other vocational room areas  | 50 net                                 |
| Industrial areas   | 200 gross                              |
| Institutional areas  |  |
| Sleeping areas   | 80 gross                               |
| Inpatient treatment areas  | 240 gross                              |
| Outpatient areas   | 100 gross                              |
| Library  |  |
| Reading rooms  | 50 net                                 |
| Stack area   | 100 gross                              |
| Mercantile, basement and grade floor areas   | 30 gross                               |
| Areas on other floors  | 60 gross                               |
| Storage, shipping areas  | 100 gross                              |
| Residential  | 200 gross                              |
| Sleeping rooms   | 50 net                                 |
| Storage areas, mechanical equipment room   | 300 gross                              |
| Bowling alleys, allow 5 persons for each alley including 15 feet of runway, and for additional areas | 7 net                                  |

**Note 1.** The occupant load for an assembly area having fixed seats shall be determined by the number of fixed seats installed.

606.5 Conflicts: When there are special requirements for specific occupancies and users which differ from general requirements herein prescribed, such special provisions shall take precedence.

606.6 Non-simultaneous occupancy: The occupant load of toilets, locker rooms, meeting rooms, storage rooms, employee cafeterias, and similar rooms or spaces that are not occupied at the same time as other rooms or spaces on the same floor of a building, may be omitted from the occupant load calculation of the floor on which they are located, to the extent that such spaces only serve occupied rooms on the same floor.

606.7 Modifications: The following modifications may be used in determining the occupant load:

1. When the actual occupant load of any space will be significantly different than that determined by Table 606, the building official may establish an alternate basis for the determination of the occupant load. The space occupied by permanent fixtures or displays may serve to reduce the occupant load.
2. When a building is altered or changed in occupancy or use so as to require enlarged exitway facilities, the building official may authorize the alteration or change in occupancy or use without an enlargement of exitway facilities, provided the occupant load is limited to that accommodated by the existing exitway facilities as determined by the provisions of this code, and the building or space is posted as required by Section 120.0.

#### SECTION 607.0 TYPES AND LOCATION OF EXITWAYS

607.1 General: All approved exitways, including doorways, passageways, corridors, interior stairways, exterior stairways, moving stairways, smokeproof enclosures, ramps, horizontal exits, bridges, balconies, fire escapes and combinations thereof shall be arranged and constructed as provided in this code.

607.2 Arrangement: All required exitways shall be so located as to be discernible and accessible with unobstructed access thereto and so arranged as to lead directly to the street or to an area of refuge with supplemental means of egress that will not be obstructed or impaired by fire, smoke or other cause.

607.2.1 Exitway discharge: All exitways shall discharge directly at a public way or at a yard, court or open space of the required width and size to provide all occupants with a safe access to a public way.

607.3 Remote location: Whenever more than one (1) exitway is required from any room, space or floor of a building, they shall be placed as remote from each other as practicable, and shall be arranged to provide direct access in separate directions from any point in the area served.

607.4 Length of travel: Except as modified by provisions of Section 609.3 for buildings with one (1) exitway, all exitways shall be so located that the maximum length of exitway access travel, measured from the most remote point to an approved exitway along the natural and unobstructed line of travel shall not exceed the distances given in Table 607; except where the area is subdivided into rooms or compartments, and the egress travel in the room or compartment is not greater than fifty (50) feet [one hundred (100) ft. in use groups equipped with an automatic fire suppression system], the distance shall be measured from the exitway access entrance to the nearest exitway.

Table 607

LENGTH OF EXITWAY ACCESS TRAVEL (FT.)

| Use group                | Without fire suppression system | With fire suppression system |
|--------------------------|---------------------------------|------------------------------|
| Assembly                 | 150                             | 200                          |
| Business                 | 200                             | 300                          |
| Factory and industrial   | 200                             | 300                          |
| High hazard              | —                               | 75                           |
| Institutional            | 100                             | 200                          |
| Mercantile               | 100                             | 150                          |
| Residential              | 100                             | 150                          |
| Storage, low hazard      | 300                             | 400                          |
| Storage, moderate hazard | 200                             | 300                          |

Note. The maximum length of exitway access travel in unlimited area buildings shall be 400 feet.

## SECTION 608.0 CAPACITY OF EXITS

608.1 Unit of egress width: The unit of egress width for all approved types of means of egress parts and facilities shall be twenty-two (22) inches with a credit of one-half (1/2) unit for each twelve (12) inches width in addition to one (1) or more twenty-two (22) inch units. Fractions of a unit of width less than twelve (12) inches shall not be credited.

608.2 Design allowance for use groups: Except as may be specifically modified in Article 4, the design capacity per unit of egress width shall be computed in accordance with Table 608 for the specified use groups.



Table 608  
CAPACITY PER UNIT EGRESS WIDTH

| Use group                 | Without fire suppression system<br>Number of occupants |                               | With fire suppression system<br>Number of occupants |                               |
|---------------------------|--|-------------------------------|---|-------------------------------|
|                           | Stairways  | Doors, ramps and<br>corridors | Stairways   | Doors, ramps and<br>corridors |
| Assembly                  | 75   | 100                           | 113   | 150                           |
| Business                  | 60   | 100                           | 90  | 150                           |
| Factory and<br>industrial |  | 100                           | 90  | 150                           |
| High hazard               |  |                               | 60  | 100                           |
| Institutional             | 22   | 30                            | 33  | 45                            |
| Mercantile                | 60   | 100                           | 90  | 150                           |
| Residential               | 75   | 100                           | 113   | 150                           |
| Storage                   | 60   | 100                           | 90  | 150                           |

Note. The main exitway of a bowling alley shall be of sufficient capacity to accommodate 50 per cent of the total occupant load, without regard to the number of aisles which it serves.

#### SECTION 609.0 NUMBER OF EXITWAYS

609.1 General: The following general requirements apply to buildings of all use groups. More restrictive requirements that may be provided in Article 4 for special uses and occupancies shall take precedence over the general provisions of this section.

609.2 Minimum number: There shall be not less than two (2) approved independent exitways serving every building except as modified in Section 609.3. There shall be not less than two (2) approved independent exitways serving every story, except in one and two-family dwellings and as modified in Section 609.3.

609.3 Buildings with one exitway: Only one (1) exitway shall be required in buildings of the use group and characteristics specified in the following Table 609. In a building with the first story two thousand (2,000) square feet or less in area and with an occupancy load not exceeding fifty (50) persons, one (1) means of egress may be permitted from the first story. Egress from other stories, shall comply with other sections of this article.

Table 609

**BUILDINGS WITH ONE EXITWAY**

| Characteristics of the building |                         |                        |                                     |  |   |
|---------------------------------|-------------------------|------------------------|-------------------------------------|--|---|
| Use group                       | Max. height above grade | Size                   | Max. exitway access travel distance | Min. fire-resistance rating of exitway enclosure | Min. fire-resistance rating of opening protection |
| B<br>(Business)                 | 2 stories               | 3000 sq. ft. per floor | 75 ft.                              | 1 hour   | 1 hour  |

Note 1. Areas complying with definition for basements shall not be counted as a story.

609.4 Emergency escape: Every sleeping room below the fourth (4th) story shall have at least one (1) operable window or exterior door approved for emergency egress or rescue. The units must be operable from the inside opening without the use of separate tools. Where windows are provided as a means of egress or rescue they shall have a sill height not more than forty-four (44) inches above the floor. All egress or rescue windows from sleeping rooms must have a minimum net clear opening of three and three-tenths (3.3) square feet. The minimum net rectangular clear opening dimensions shall be twenty (20) inches by twenty-four (24) inches in either direction.

Bars, grills or screens placed over emergency escape windows shall be releasable or removable from the inside without the use of a key, tool or excessive force.

609.5 Open parking structures: Parking structures shall have not less than two (2) exitways from each parking tier, except that where vehicles are mechanically parked, only one (1) exitway need be provided. The maximum distance from any point on a parking tier to an exitway at that tier shall not exceed three hundred (300) feet. Unenclosed vehicle ramps may be considered as required exitways if pedestrian facilities are provided. Interior exitway stairways need not be enclosed.

**SECTION 610.0 EXITWAY ACCESS PASSAGEWAYS AND CORRIDORS**

610.1 Access passageways: Direct exitway access shall be provided to required exitways through continuous passageways, aisles or corridors, conveniently accessible to all occupants and maintained free of obstruction.

610.1.1 Turnstiles and gates: Access through turnstiles, gates, rails or similar devices shall not be permitted unless such a device is equipped to readily swing in the exiting direction of travel under a total pressure of not more than fifteen (15) pounds.

610.1.2 Restrictions: The required width of passageways, aisles or corridors shall be maintained free of projections and restrictions except doors opening into such spaces may reduce the clear width to not less than one-half (1/2) the required width. When fully open, the door may project not more than seven (7) inches into the required width.

610.2 Dead ends: Exitway access passageways and corridors in all stories which serve more than one (1) exitway shall provide direct connection to such exitways in opposite directions from any point in the passageway or corridor, insofar as practicable. The length of a dead end corridor shall not be more than twenty (20) feet.

610.3 Width: The unit of egress width and occupancy allowance of aisles and corridors, unless otherwise provided for special uses and occupancies in Article 4, shall comply with Table 608 with a minimum total width of forty-four (44) inches except in institutional (I) buildings used for the movement of beds which shall be ninety-six (96) inches; in schools with more than one hundred (100) occupants which shall be seventy-two (72) inches; in one- and two-family dwellings which shall be thirty-six (36) inches; and in churches and chapels, side aisles may be one-half (1/2) the width but not less than thirty-two (32) inches clear.

610.4 Enclosures: All corridors serving as exitway access shall be enclosed in fire separation walls having a fireresistance rating of at least one (1) hour when serving an occupancy load greater than thirty (30).

610.4.1 Opening protectives: All door assemblies from rooms opening onto a corridor required to be of one (1) hour fireresistance rated construction shall be self-closing or automatic closing by smoke detection, with a twenty (20) minute fire protection rating when tested in accordance with ASTM E152 without the hose stream and labeled and listed by an independent, approved agency; or be one and three-quarter (1 3/4) inch solid wood core door or equivalent.

All door assemblies from rooms opening onto a corridor, required by Table 214 to be of two (2) hour fireresistance rated construction, shall be one and one-half (1 1/2) hour fire doors.

#### SECTION 611.0 GRADE PASSAGEWAYS USED AS AN EXITWAY ELEMENT

611.1 Passageways: Every required interior and exterior exitway element which does not adjoin a public way shall be directly connected to the public way or to an open court leading to the public way by an enclosed grade passageway or other unobstructed exitway element constructed as provided in this section.

611.2 Vestibule: An exitway may discharge into an interior vestibule used for ingress and egress only and which complies with the following:

1. The vestibule depth from the exterior of the building is not greater than ten (10) feet and the width is not greater than twenty (20) feet; and
2. The vestibule is separated from the remainder of the level of discharge by self-closing doors and the equivalent of one-quarter (1/4) inch thick wired glass in steel frames.

611.3 Lobby: An exitway may discharge into an interior lobby which shall be provided with an automatic fire suppression system and any other portion of the floor with access to the lobby shall be provided with an automatic fire suppression system or shall be separated therefrom in accordance with the requirements for the enclosure of exitways.

611.4 Width and height: The effective width of the passageway shall be not less than three-quarters (3/4) of the aggregate width of all required exitway stairways leading thereto and all required exitway doorways opening into the passageway. Such passageway shall have a minimum width of forty-four (44) inches and a minimum clear ceiling height of eight (8) feet.

611.5 Maximum stairway limitations: Not more than fifty (50) per cent of the required stairways shall discharge through the same passageway.

#### SECTION 612.0 MEANS OF EGRESS DOORWAYS

612.1 General: The requirements of this section shall apply to all doorways serving as a component or element of a means of egress; except that this section shall not apply to doorways leading to or from required stairways (see Sections 616.6, 618.4 and 619.3).

612.2 Number of doorways: Every room or tenant space with an occupancy load of more than fifty (50) or which exceeds two thousand (2,000) square feet in area shall have at least two (2) egress doorways leading from the room or tenant space to an exitway or corridor. All doors shall swing in the direction of egress travel when serving an occupancy load of fifty (50) or more or a high hazard occupancy.

#### Exceptions

1. For all areas, spaces or rooms with an occupancy load of ten (10) or more persons used for instructional purposes (see "Classroom" definition, Section 201.0) there shall be at least two (2) independent means of egress, leading to separate exitways remote from each other, and so arranged that to reach one it will not be necessary to pass through a common corridor or space, unless effectively divided by a smoke screen barrier into independent areas. Communicating doors, which may swing in either direction, will be allowed as a second means of egress.

## 2. One- and two-family dwellings.

612.2.1 Entrance and egress doorways: Where separate doors are provided for entrance and egress use, the entrance door shall be clearly marked Entrance only in letters not less than six (6) inches in height and legible from both inside and outside.

612.3 Size of doors: The minimum width of single door openings shall provide a clear width of not less than thirty-two (32) inches except in one- and two-family dwellings (use groups R-3 and R-4) the clear width shall be not less than twenty-eight (28) inches. The maximum width shall be forty-eight (48) inches nominal. Means of egress doors in institutional buildings (use group I) used for the movement of beds shall be at least forty-four (44) inches wide. When the doorway is subdivided into two (2) or more separate openings, the minimum clear width of one (1) opening shall be not less than thirty-two (32) inches, and each opening shall be computed separately in determining the number of required units of egress width. A door forty (40) inches in width shall be deemed the equivalent of two (2) full units of egress width. The height of doors shall not be less than six and two-thirds (6 2/3) feet except in one- and two-family dwellings (use groups R-3 and R-4) the height of doors shall be not less than six and one-half (6 1/2) feet.

612.4 Location of doors: The required doorways opening from a room or space within a building and leading to an exitway access shall be located as remote as practicable from each other. The distance of exitway access travel from any point in a room or space to a required exitway door shall not exceed the limitations of Section 607.4.

### 612.5 Door hardware

612.5.1 Operation: All egress doors shall be readily opened from the side from which egress is to be made without the use of a key or special knowledge or effort except for special institutional uses as indicated in Section 612.5.3. Except for dwelling units, draw bolts, hooks and other similar devices shall be prohibited on all egress doors, unless there is a readily visible, durable sign on the door stating "This door to remain unlocked during occupancy." The sign shall be in letters not less than one (1) inch high on a contrasting background. The locking device must be of a type that will be readily distinguishable as locked. The use of manually operated flush bolts or surface bolts is prohibited.

Double cylinder dead bolts requiring a key operation on both sides are prohibited on required means of egress doors in residential occupancies (use group R), excepting where serving only one dwelling unit.

612.5.1.1 Locks in multi-family dwellings: Requirements for locks in multi-family dwellings are subject to the provisions of Section 3R of Chapter 143 of the Massachusetts General Laws Annotated, as amended.

612.5.2 Panic devices: All doors equipped with latching devices in buildings of use group A (assembly) with an occupant load greater than forty nine (49) shall be equipped with approved panic hardware. Acceptable panic hardware will be a device which causes the door latch to release when a force of fifteen (15) pounds is applied in the direction of egress to a bar or panel extending not less than one-half (1/2) of the width of the door and at a height greater than thirty (30) inches but less than forty-four (44) inches above the floor.

612.5.3 Remote control: In rooms of use group I-1 (institutional, restrained) occupied as places of detention, approved releasing devices with remote control shall be provided for emergency use unless otherwise specifically approved.

612.5.4 Mechanical operations: All doors which open into enclosed exitway stairs, exitway passageways or those which are installed to provide fire or smoke barriers across corridors shall be self-closing and be so maintained, or shall be automatic doors which will close upon activation of an approved smoke detector. Where egress doors are arranged to be opened by non-power operated mechanical devices of any kind, they shall be so constructed that the door may be opened manually and will release under a total pressure of not more than fifteen (15) pounds applied in the direction of egress travel. Power operated exitway doors shall be capable of being opened with not more than fifty (50) pounds pressure applied at the normal door knob location when power is lost.

612.6 Door construction: All required egress doors that serve as an element of an exitway shall be self-closing or automatic except for grade floor exitway discharge doors and revolving exitway doors.

612.6.1 Grade exitway discharge doors: Doors at grade may be glazed with plate glass not less than seven thirty-seconds (7/32) inch thick, or with any other approved glazing materials. Approved doors having one (1) or more unframed edges may be used, provided they are constructed of safety glazing not less than one-half (1/2) inch thick.

612.7 Deleted

612.8 Door arrangement: Doors in series shall have a space between them of not less than seven (7) feet when measured in their closed positions.

Exceptions: Power operated doors, one- and two-family dwellings (use groups R-3 and R-4) and use group T.

#### SECTION 613.0 REVOLVING DOORS

613.1 Limitations of use: Revolving doors shall not be used in calculating exitway door requirements.

613.2 Speed control: All approved automatic collapsible revolving doors shall be equipped with an approved speed control governor adjustable to safe traffic speed as required by the approved rules, but not more than fifteen (15) nor less than ten (10) revolutions per minute.

613.3 Construction: All approved automatic collapsible revolving doors shall be constructed as indicated in the following Sections 613.3.1 through 613.3.5.

613.3.1 Operating mechanism: The collapsing mechanism shall be constructed of stainless steel or other approved corrosion-resistive materials.

613.3.2 Use of wood: The doors may be constructed of wood or other approved materials of similar combustible characteristics with a minimum thickness of one and one-quarter (1 1/4) inches.

613.3.3 Floor covering: Approved mats or other floor coverings, not more than one-half (1/2) inch thick, may be installed within the enclosure when permanently secured to the structural flooring and finishing flush with the adjacent floor area.

613.3.4 Glazing: The doors shall be glazed with approved safety glazing.

613.3.5 Door size: The door shall be not less than six (6) feet, six (6) inches nor more than seven (7) feet, six (6) inches in diameter and not less than seven (7) feet nor more than nine (9) feet in height.

#### SECTION 614.0 HORIZONTAL EXITS

614.1 General: Horizontal exits as herein defined shall be accepted as an approved element of a required means of egress when complying with the requirements of this article. The connection between the areas of refuge as herein specified may be accomplished by protected openings in a fireresistance rated wall, by a vestibule, or by an open-air balcony or bridge.

614.2 Separation: The separation between fire areas shall be provided by at least a two (2) hour fireresistance rated fire wall or fire separation wall complying with Article 9 and Table 214.

614.2.1 Opening protectives: All fire doors in horizontal exits are to be self-closing or automatically closing when activated by an approved smoke detector. All doors shall swing in the direction of egress travel. When serving as a dual element of a means of egress, there shall be adjacent openings with swinging fire doors opening in opposite directions.

614.3 Size of doors: Size of openings in fire walls shall comply with the provisions of Section 908.0, but the width of one (1) opening used as a required exit shall not be greater than eighty-eight (88) inches nor shall the area exceed eighty (80) square feet.

614.4 Area of refuge: The discharge area of a horizontal exit shall be either public areas or spaces occupied by the same tenant and each such area of refuge shall be adequate to house the total occupancy load of both connected areas. The capacity of areas of refuge shall be computed on a net floor area allowance of three (3) square feet for each occupant to be accommodated therein except for non-ambulatory institutional areas which shall be thirty (30) square feet per occupant, not including areas of stairs, elevators and other shafts or courts.

614.5 Unlocked doors: Horizontal exit doors shall be kept unlocked and unobstructed whenever the area on either side of the horizontal exit is occupied.

614.6 Egress from area of refuge

614.6.1 Stairway exitway: In multi-story buildings, there shall be at least one (1) interior enclosed stairway or smokeproof enclosure on each side of the horizontal exit, and any fire area not having a stairway accessible thereto shall be considered as part of an adjoining section with such stairway; but the length of exitway access travel distance to the horizontal exit or the required exitway shall not exceed the requirements of Section 607.4

614.6.2 Auxiliary elevator: When horizontal exits are provided in floors located twelve (12) or more stories above grade, the required stairway shall be supplemented by at least one (1) passenger elevator maintained ready for use during normal occupancy of the building.

#### SECTION 615.0 EGRESS RAMPS

615.1 Capacity: The capacity of ramps used as an egress component shall be computed in accordance with Section 608.0.

615.2 Minimum dimensions

615.2.1 Width: The minimum width of an egress ramp shall be not less than that required for corridors by Section 610.3

615.2.2 Headroom: The minimum headroom in all parts of the egress ramp shall be not less than six and two-thirds (6 2/3) feet.

615.2.3 Restrictions: Egress ramps shall not reduce in width in the direction of egress travel. Projections into the required ramp and landing width are prohibited except for handrails and stringers. Doors opening onto a landing shall not reduce the clear width to less than forty-two (42) inches.

615.3 Landings: Landings shall be provided at all points of turning, entrance, exiting and doors. Ramp slopes greater than one (1) in fifteen (15) shall have landings at the top, bottom and each five (5) feet of



vertical rise. Each landing shall have a minimum length of five (5) feet except the bottom landing shall have a length of six (6) feet.

615.4 Maximum slope: A ramp used for egress for the physically handicapped shall have a maximum slope of one (1) in twelve (12). All other egress ramps shall have a maximum slope of one (1) in eight (8).

615.4.1 Surface: For all slopes exceeding one (1) in twelve (12), and wherever the use is such as to involve danger of slipping, the ramp shall be surfaced with approved non-slip materials.

615.5 Handrails: Handrails shall be provided on at least one (1) side of every ramp having a slope greater than one (1) in fifteen (15), and they shall be not less than thirty (30) inches nor more than thirty-four (34) inches in height, measured from the surface of the ramp. Handrails shall be smooth and shall extend one (1) foot beyond the top and bottom of the ramp and return to walls or posts at the ends.

615.6 Ramp construction: Ramps used as an exitway shall conform to the applicable requirements of Section 616.9 as to materials of construction and enclosure.

#### SECTION 616.0 INTERIOR EXITWAY STAIRWAYS

616.1 Capacity: The capacity of stairways and doors per unit of exit width shall be computed in accordance with Section 608.0.

##### 616.2 Minimum dimensions

616.2.1 Width: All interior exitway stairways shall be not less than forty-four (44) inches in width, except that such width may be reduced to thirty-six (36) inches when serving an occupancy load of fifty (50) or less.

616.2.2 Headroom: The minimum headroom in all parts of the stair enclosure shall be not less than six and two-thirds (6 2/3) feet measured vertically from the tread nosing or from the floor surface of the landing or platform.

616.2.3 Restrictions: Stairways shall not reduce in width in the direction of exit travel. Projections into a stairway are prohibited except for handrails as indicated in Section 616.5.1 and for stairway stringers which may project not more than one and one-half (1 1/2) inches.

##### 616.3 Landings and platforms

616.3.1 Width: The least dimension of landings and platforms shall be not less than the required width of stairway.

616.3.2 Vertical rise: In all buildings a stairway shall not have a height of vertical rise of more than twelve (12) feet between landings and intermediate platforms.

#### 616.4 Treads and risers

616.4.1 Minimum dimensions: The height of risers and width of treads in inches shall be as indicated in the following Table 616.

TREAD AND RISER SIZE<sup>1</sup>

| Use group                               | Maximum riser | Minimum tread |
|---|---------------|---------------|
| Assembly and institutional <sup>2</sup> | 7½"           | 10"           |
| One and two family dwellings            | 8¼"           | 9"            |
| All others <sup>2</sup>                 | 8"            | 9"            |

Note 1. Within any flight, a three-sixteenths (3/16) inch maximum variation in riser height or tread width is permitted.

Note 2. Except in one and two family dwellings, tread and riser shall be so proportioned that the sum of two (2) risers plus one (1) tread, exclusive of nosing, is not less than twenty-four (24) nor more than twenty-five (25) inches.

616.4.2 Winders: Winders shall not be permitted in required exitway stairways except in one- and two-family dwellings and stairways serving a single dwelling unit and in ornamental stairways not required as an element of an exitway. Such winders shall have a tread width of not less than nine (9) inches at a point not more than twelve (12) inches from the side where the tread is narrower and the minimum tread width is not less than six (6) inches.

616.5 Stairway guards and handrails: Stairways shall have continuous guards and handrails on both sides, and in addition thereto, stairways more than eighty-eight (88) inches in required width shall have intermediate handrails dividing the stairway into portions not more than eighty-eight (88) inches wide. Stairways in one- and two-family dwellings may have one (1) handrail.

616.5.1 Handrail details: Handrails shall be provided according to the following requirements:

1. Handrails may project not more than three and one-half (3 1/2) inches into the required stair width.
2. Handrails shall be not less than thirty (30) inches, nor more than thirty-four (34) inches, measured vertically, above the nosing of the treads.
3. Handrails shall extend eighteen (18) inches beyond the top and bottom step if a guard or wall exists and shall be returned to walls or posts at the ends of the stairways.
4. Handrails shall be designed to withstand an applied load of two hundred (200) pounds in any direction at any point.

616.5.2 Guard details: Guards shall be provided according to the following requirements:

1. Guards shall be not less than forty-two (42) inches in height measured vertically above the nosing of the tread.
 

Exception: Guards shall be not less than thirty (30) inches in height measured vertically above the nosing of the tread along stairs which:

  - a. do not exceed twenty (20) feet in height; or
  - b. reverse direction at intermediate landings with twelve (12) inches or less measured horizontally between successive flights.
2. Guards shall be constructed so that the area in the plane of the guard, from the top of the tread to the top of the guard, is subdivided or filled in one (1) of the following methods:
  - a. a sufficient number of intermediate longitudinal rails constructed so that the clear distance between rails (measured at right angles to the rail) does not exceed six (6) inches. The bottom rail shall not be more than six (6) inches (measured vertically) from the tread nosing; or
  - b. balusters spaced not more than six (6) inches apart; or
  - c. panels of wire mesh, or expanded metal, or ornamental grills which provide protection equivalent to that provided by the intermediate rails or balusters specified in the two (2) preceding paragraphs; or
  - d. walls; or
  - e. any combination of the foregoing.
3. Guards at least forty-two (42) inches in height shall be located along open-sided floor areas, mezzanines and landings.

Exception: In R-3 and R-4 occupancies, guards shall be at least thirty-six (36) inches in height.

## 616.6 Stair exitway doors

616.6.1 Width: The width of every exitway door to or from a stairway shall be not less than the number of units of exit width required for the capacity of the stairway which services the floor or area from which the exitway door leads; but such a door shall not be less than twenty-eight

(28) inches in clear width in use group R-3 and R-4 buildings (one- and two-family dwellings), nor less than thirty-two (32) inches in clear width in all other use groups.

616.6.2 Direction of swing: All doors shall swing on a landing in the direction of exit travel. When opening, stair exitway doors shall not reduce the width of landings to less than one-half (1/2) the minimum required for its capacity. When fully open, the exitway door may project seven (7) inches onto the landing.

616.6.3 Door construction: All doorway opening protectives, including the frames and hardware, shall be approved self-closing, swinging fire doors, except in one- and two-family dwellings where one and three-quarters (1 3/4) inch solid core wood doors are permitted. Labeled fire doors shall have a maximum transmitted temperature end point of not more than four hundred fifty (450) degrees F. above ambient at the end of thirty (30) minutes of standard fire test exposure.

616.7 Spiral stairways: Spiral stairways of noncombustible construction may be used as an element of a means of egress in one- and two-family dwellings and within a single dwelling unit and from a mezzanine area not more than two hundred fifty (250) square feet in area and serving not more than five (5) occupants. The minimum width shall be twenty-six (26) inches with each tread having a seven and one-half (7 1/2) inch minimum tread width at twelve (12) inches from the narrow edge. All treads shall be identical and the rise shall be not more than nine and one-half (9 1/2) inches. A minimum headroom of six and one-half (6 1/2) feet shall be provided.

616.7.1 Circular stairways: Circular stairways may be used as an element of egress when a minimum tread width of ten (10) inches is provided and the smaller radius is not less than twice the width of the stairway.

616.8 Supplemental stairways: Stairways which are not a required means of egress element, serving one (1) adjacent floor and not connected with a corridor or stairway serving other floors, may be used in all use groups except institutional (use group I). (See Sections 520.1, 1202.1 and 1202.17.)

616.9 Stairway construction: Unless herein otherwise provided, all required interior stairways shall be built entirely of noncombustible materials with solid risers, treads and landing platforms and all finish floor surfaces of non-slip noncombustible materials; except that wood handrails shall be permitted, complying with the requirements of Section 616.5.

616.9.1 Strength: All stairways, platforms, landings and exitways in other than one- and two-family dwellings, shall be adequate to support a live load of one hundred (100) pounds per square foot (psf) and a concentrated load of three hundred (300) pounds.

616.9.2 Enclosures: Required interior exitway stairways shall be enclosed in fire separation assemblies of the fire-resistance rating specified in Table 214. An exitway enclosure shall not be used for any purpose other than means of egress. A space below a stairway shall be enclosed as required or kept open. Doors shall not open into the stairway enclosure except exitway doors.

Exceptions:

1. Exitways in buildings of use groups R-3 and R-4 (residential, one- and two-family).
2. Exitways serving and contained within a single residential dwelling unit.
3. Exitways in communicating floor levels as provided in Section 616.10.
4. Supplemental stairways as provided in Section 616.8.

616.9.3 Combustible construction: In all buildings of Types 3 or 4 construction, the stairways and their enclosures may be constructed of wood or other approved materials of similar characteristics and of adequate strength.

616.10 Communicating floors: In other than use groups A-4 (assembly, schools) or I (institutional), any building with low hazard occupancy (use group S-2), or with ordinary hazard occupancy (use groups B, M, R-1 and R-2) with automatic sprinkler protection where necessary to the effective utilization of a building site with sloping grade or otherwise essential to the functional design of the building, not more than three (3) communicating floor levels may be permitted without enclosure or protection between such areas, only provided all the conditions described below are met:

1. the lowest, or next to the lowest, level is a street floor;
2. the entire area, including all communicating floor levels, is sufficiently open and unobstructed to be assumed that a fire or other dangerous condition in any part will be immediately obvious to the occupants of all communicating levels and areas;
3. egress capacity is simultaneously sufficient for all the occupants of all communicating levels and areas, all communicating levels in the same fire area being considered as a single floor area for purposes of determination of required egress capacity; and
4. each floor level, considered separately, has at least one-half (1/2) of its individual required egress capacity provided by an exitway or exitways leading directly out of that area without traversing another

other communicating floor level or being exposed to the spread of fire or smoke therefrom.

616.11 Discharge identification: Stairways which continue beyond the floor of discharge shall be interrupted at the floor of discharge by partitions, doors or other effective means of preventing persons from continuing past the floor of discharge while egressing. A sign shall be provided at each landing in all interior stairways more than three (3) stories in height designating the floor level above the floor of discharge.

#### SECTION 617.0 ACCESS TO ROOF

617.1 By stairway or ladder: In buildings more than three (3) stories in height except those with a roof slope greater than four (4) in twelve (12), access to the roof shall be provided by means of a stairway or a ladder and trap door; the ladder shall not be on the exterior of the building. Where the roof is used as a roof garden or for other habitable purposes, sufficient stairways shall extend to it to provide the necessary exitway facilities from the roof as required for such occupancy. Roof trap doors shall be constructed to comply with Section 925.2.

617.1.1 Optional stairway or ladder: Buildings not required to have a stairway or ladder to the roof as described above, may include such a stairway or ladder at the discretion of the designer of the building. The stairway or ladder shall conform to the provisions of this section, except that ladders may be placed on the exterior of the building. The siderails of exterior ladders shall be carried over the coping or parapet to afford hand hold; the ladder shall be metal, and if it exceeds twenty (20) feet in height, shall have a protective cage or other safety device; other design details of such exterior ladders are subject to the approval of the building official.

617.2 Roof enclosures: Stairways extending through roofs shall be enclosed in roof structures of fire-resistance rated construction meeting the requirements of Section 925.0.

#### SECTION 618.0 SMOKEPROOF ENCLOSURES

618.1 General: A smokeproof enclosure shall consist of a continuous stairway, enclosed from the highest point to the lowest point, meeting the requirements of this section.

618.2 Where required: At least one (1) of the required exitways shall be a smokeproof enclosure in buildings over six (6) stories or seventy-five (75) feet in height when of one (1) of the following use groups:

1. use groups A-2, A-3, A-4, A-5 (assembly other than theaters);
2. use group B (business);
3. use group F (factory and industrial);
4. use group I (institutional);

5. use group M (mercantile); and
6. use group R-1 (residential, hotel).

618.3 Access: Exitway access to the stairway at each story shall be through a vestibule or balcony with an unobstructed width not less than the required stairway width and a minimum dimension of seventy-two (72) inches in the direction of exit travel.

618.4 Doors: Door openings from interior spaces to the vestibule or balcony and from the vestibule or balcony to the stairway, shall be as required in Section 612.3. The doors from interior spaces to the vestibule shall have a fireresistance rating not less than one and one-half (1 1/2) hours and shall comply with the requirements of Section 616.6 for stair exitway doors. The door from the vestibule to the stairway shall be a tight-fitting door, equal to not less than an exterior type solid wood door without voids, assembled with exterior type glue, one and three-quarter (1 3/4) inch minimum thickness set in a steel frame. Wired glass, if provided, shall not exceed one hundred (100) square inches in area and shall be set in a steel frame. The door shall be provided with a drop sill and be weather stripped or otherwise provided to minimize air leakage.

618.5 Terminal passageway: The smokeproof enclosure shall terminate at grade level and shall provide egress to the street independently of all other exitways. When grade passageways are used, they shall comply with the requirements of Section 611.0, except that there shall not be openings therein other than the smokeproof enclosure and street exit doorways. The passageway walls shall be of four (4) hour fireresistance rated construction, and the floor and roof of three (3) hour fireresistance rated construction.

618.6 Construction: The construction of smokeproof enclosures shall be of walls with a four (4) hour fireresistance rating without openings other than the required doorways. The vestibule shall be considered to be an element of the exitway and shall be constructed in accordance with the fireresistance rating requirements of Table 214. The balcony shall be constructed in accordance with the fireresistance rating requirements in Table 214 for floor construction. The stairshaft vestibule or balcony shall be provided with emergency lighting from an approved independent power source to assure continued illumination in case of emergency.

618.7 Ventilation of smokeproof enclosures: Smokeproof enclosures shall be ventilated with natural ventilation or mechanical ventilation meeting the requirements of Section 618.8 or 618.9.

618.8 Smokeproof enclosure by natural ventilation: The balcony separating the smokeproof enclosure from the interior building spaces shall have at least one (1) open side adjacent to a street, alley, or yard with guard railings across the open side(s). One (1) open side of the balcony shall

have a minimum open area of sixteen (16) square feet with any dimension at least thirty (30) inches. The balcony floor shall be level with or installed below the building floor where climatic conditions involve the possibility of door obstruction by snow or ice. A step shall not be permitted between the balcony and the smokeproof enclosure. The street, alley, or yard adjacent to one (1) open side of the balcony shall have a minimum area of two hundred (200) square feet and a minimum dimension of ten (10) feet.

618.9 Smokeproof enclosure by mechanical ventilation: The stairshaft and vestibule shall be provided with a mechanical ventilation system as specified herein that will be automatically activated on three (3) or more floors in case of emergency.

618.9.1 Operation of ventilating equipment: Vestibule and stairshaft mechanical ventilation may be inactive or may operate at reduced levels for normal operations, but when the detectors referred to herein either fail or are activated, the vestibule and stairshaft mechanical ventilation systems shall operate at the levels specified in Section 618.9.2 and 618.9.3. The vestibule ventilation system shall be designed and activated in accordance with one (1) of the following methods.

1. Total system: simultaneous operation of all vestibules. If the vestibule mechanical ventilation system is designed to provide the ventilation in the vestibules on all floors simultaneously, a products-of-combustion detector shall be located outside each vestibule so designed that activation or failure of any one (1) of the detectors will simultaneously activate the vestibule ventilation system on all floors.
2. Zoned system: simultaneous operation of three (3) or more vestibules. If the vestibule ventilation system is designed as one (1) or more zones to provide the simultaneous ventilation in the vestibules for at least a three (3) floor zone, automatic supply and exhaust dampers shall be provided in all vestibules in order to obtain the zoned control of the ventilation as follows: a smoke detector shall be located outside each vestibule so designed to open the supply and exhaust duct dampers in the vestibules within the affected zone [three (3) or more floors] and to actuate the stairshaft ventilation system in case any detector in the affected zone either fails or is activated.

618.9.2 Vestibule ventilation: The vestibule shall have an emergency ventilating system providing a supply of not less than one (1) air change per minute. The exhaust shall be one hundred fifty (150) per cent of the supply. Supply air and exhaust air shall serve the vestibule through separate tightly constructed ducts used only for that purpose. Supply air shall enter the vestibule within six (6) inches of the floor level. The top of the exhaust register shall be located within six (6) inches of the



vestibule ceiling and shall be entirely within the smoke trap area. Doors, when in the open position, shall not obstruct the duct openings. Duct openings may be provided with controlling dampers if required by Section 618.9.1 (method 2) but these are not otherwise required. The vestibule ceiling shall be at least twenty (20) inches higher than the door opening into the vestibule, to serve as a smoke trap and to provide an upward moving air column. Special provision shall be made in the design to avoid creation of negative pressures which would retard the opening of the door to the stairshaft from the vestibule.

618.9.3 Stairshaft ventilation: The stairshaft shall be provided with emergency mechanical supply and exhaust air. There shall be a minimum of twenty-five hundred (2500) cubic feet per minute (cfm) discharge at the top of the shaft. The supply shall be sufficient to provide a minimum of five-hundredths (.05) inches of water column pressure above atmospheric pressure with all doors closed and a minimum of ten-hundredths (.10) inch water column difference between the stairshaft and the vestibule. Supply air shall be introduced at the level of the grade exitway discharge.

618.9.4 Standby power: Mechanical vestibule stairshaft ventilation systems and detector systems shall be powered by an approved self-contained generator designed to operate whenever there is a loss of power in the normal house current. The generator shall be located in a separate room of two (2) hour fire-resistance rated construction and shall have a minimum fuel supply to operate the equipment for two (2) hours.

618.9.5 Emergency lighting: The vestibules and stairshaft shall be provided with emergency lighting. The standby generator which is installed for the vestibule and stairshaft mechanical ventilation equipment may be used for the standby emergency lighting power supply.

618.9.6 Fire protection indicator panel: A fire protection indicator panel may be required by the building official and, if so, shall be located as near as practical inside the entrance to the smokeproof tower stairshaft at grade. Said panel shall indicate the floor or floors having caused the alarm. Said panel shall have an overriding manual switch capable of deactivating the ventilation equipment.

618.9.7 Fire department communications connection: The fire protection indicator panel shall have a direct connection to the fire department facilities if required by the building official.

618.9.8 Acceptance and testing: Before the foregoing equipment is accepted by the building official, it shall be tested in his presence to confirm that equipment is operating in compliance with these requirements.

618.9.9 Building owners' responsibility: The building engineer shall test all the equipment referred to in these requirements at least once every

thirty (30) days and maintain a log attesting to the results. The log shall be available for inspection by the building official and the fire official.

## SECTION 619.0 EXTERIOR EXITWAY STAIRWAYS

619.1 As required exitway: Exterior stairways conforming to the requirements for interior stairways in all respects, except as to enclosures and except as herein specifically modified, may be accepted as an element of a required means of egress in buildings not exceeding five (5) stories or sixty-five (65) feet in height for other than use group I (institutional) buildings, except as provided in Section 619.1.1 for residential buildings. Exterior stairways which are accepted as exitway elements shall be relieved from requirements for fire doors, but shall be provided with handrails and guards as required for interior exitway stairs. Exterior stairways in climates subject to snow or ice shall be protected to prevent accumulation of snow and ice.

619.1.1 Location and arrangement: Exterior stairways may be utilized where at least one (1) door from each tenant opens onto a roofed-over open porch or balcony served by at least two (2) stairways, except that one (1) stairway may be provided as permitted in Table 609, so located as to provide a choice of independent, unobstructed means of egress directly to the grade. Such porches and stairways shall comply with the requirements for interior exitway stairways as specified in Section 616.0. Porches and balconies shall be not less than four and one-half (4 1/2) feet in width. The stairways shall be located remotely from each other. The maximum travel distance from any tenant space to the nearest stairway shall be as specified in Table 607. Porches and stairways shall be located at least ten (10) feet from adjacent property lot lines and from other buildings on the same lot, unless openings in such buildings are protected by three-quarter (3/4) hour fire-resistance rated doors or windows.

619.2 Guards and handrails: Guards and handrails shall be as specified in Section 616.0.

619.3 Opening protectives: Openings below and within ten (10) feet horizontally of the stairway shall be protected with approved three-quarter (3/4) hour fire-resistance rated automatic opening protectives.

Exception: Buildings two (2) stories or less in height.

### 619.4 Location

619.4.1 Access to street: All required exterior stairways shall be located so as to lead directly to a street or open space with direct access to a street; or when located on the rear of the building may lead through a passageway at grade complying with Section 611.0.

619.4.2 Projection: Exterior stairways shall not project beyond the street lot line.

619.5 Construction: Exterior stairs, porches and balconies shall be constructed of materials consistent with the types of materials permitted in Table 214 for the type of construction of the building to which the stairway is attached.

#### SECTION 620.0 MOVING EXITWAY STAIRWAYS

620.1 When acceptable: Moving stairways of the horizontal non-slip tread type moving in the direction of egress may be accepted as an approved exitway element in buildings of all use groups except assembly (A) and institutional (I) uses, when constructed and approved in accordance with the requirements of this article and the provisions of 524 CMR 15.00 through 33.00. When accepted as an element of a required means of egress, they shall be enclosed with fireresistance rated partitions as specified in Section 616.0.

620.2 Width: The width shall be not less than forty (40) inches between guards and the moving tread shall be not less than thirty-six (36) inches in width, and fifteen three-quarter (15 3/4) inches in depth.

620.3 Capacity: The occupancy capacity shall be computed as provided in Section 608.0 for exitway stairways.

620.4 Landings and platforms: Landings and platforms shall be provided at the top and bottom of each unit as required for interior exitway stairways.

620.5 Railings: Guards shall be surmounted with moving handrails traveling at the same speed as the stairway.

620.6 Egress: Means of egress to the street shall be provided as specified herein for interior stairways.

#### 620.7 Construction

620.7.1 Noncombustible materials: Only noncombustible materials shall be used in the construction of moving stairways accepted as a required means of egress except for step wheels, handrails, electrical equipment, and wood veneers not more than one twenty-eighth (1/28) inch thick directly attached to metal or other noncombustible backing with a nonvolatile and nonflammable cement.

620.7.2 Fireresistance: The enclosure shall afford the fireresistance rating required for approved interior exitway stairways as specified in Section 616.9.

620.7.3 Height of travel per unit: A single moving stairway unit shall not have a vertical travel of more than (2) stories nor more than thirty-five (35) feet.

#### SECTION 621.0 FIRE ESCAPES

621.1 Where permitted: Fire escapes shall not be permitted as an element of a required means of egress except on existing buildings or structures when constructed in accordance with the approved rules and when more adequate exitway facilities cannot be provided. Fire escapes shall not provide more than fifty (50) per cent of the required exit capacity. Fire escapes shall conform to NFPA 101 and the specific requirements of Section 621.0.

621.2 Location: When located on the front of the building and projecting beyond the building line, the lowest landing shall be not less than seven (7) or more than twelve (12) feet above grade, equipped with a counter-balanced stairway to the street. In alleyways and thoroughfares less than thirty (30) feet wide, the clearance under the lowest landing shall be not less than twelve (12) feet.

621.3 Construction: The fire escape shall be designed to support a live load of one hundred (100) pounds per square foot (psf), and shall be constructed of steel or other approved noncombustible materials. Fire escapes may be constructed of wood not less than two (2) inches thick on buildings of Type 4 construction.

621.3.1 Dimensions: Stairs shall be at least twenty-two (22) inches wide with risers not more and treads not less than eight (8) inches and landings at foot of stairs not less than forty (40) inches wide by thirty-six (36) inches long, located not more than eight (8) inches below the access window or door.

621.3.2 Opening protectives: Doors and windows along the fire escape shall be protected with three-quarter (3/4) hour fireresistance rated opening protectives.

621.3.3 Connections: All structural connections to and through the face of the building shall be designed to be corrosion and deterioration resistant.

#### SECTION 622.0 SLIDESCAPES

622.1 Where permitted: Slidescapes and safety chutes shall be permitted in buildings of the high hazard use group, and in existing school and institutional buildings, when approved by the building official and constructed in accordance with the approved rules.

622.2 Location: The arrangement and location of slidescapes shall conform to this article for means of egress and shall be designated by exit signs and lights as provided in Section 623.0.

622.3 Construction: All chutes shall be constructed of approved non-combustible materials with a pitch in the line of travel of not less than twenty-four (24) nor more than forty-two (42) degrees measured on the developed circumference of spiral chutes. Straight chutes shall be not less than twenty-four (24) inches and spiral chutes not less than twenty-eight (28) inches wide in the clear; nor more than forty-four (44) inches wide in any case. When erected on the interior of a building, they shall be enclosed as required in Section 616.9 for interior stairways with direct means of egress to the street or other public space.

622.4 Capacity: Slidescapes, where permitted as an element of a required exitway, shall be rated at one (1) unit of egress width per slide, with rated capacity of sixty (60). Slidescapes, except as permitted for high hazard manufacturing buildings or structures, shall not constitute more than twenty-five (25) per cent of the required number of units of egress width from any building or structure or any individual story.

#### SECTION 623.0 EXIT SIGNS AND LIGHTS

623.1 Location: In all buildings having an occupancy load of fifty (50) or more, all required means of egress shall be indicated with approved illuminated signs reading Exit visible from the exitway access and, when necessary, supplemented by directional signs in the access corridors indicating the direction and way of egress. All Exit signs shall be located at exitway doors or exitway access areas, so as to be readily visible.

623.2 Size and color: Exit signs shall have red letters at least six (6) inches high and the minimum width of each stroke shall be three-quarters (3/4) inch on a white background or in other approved distinguishable colors. If an arrow is provided as part of an Exit sign, the construction shall be such that the arrow direction cannot be readily changed. The letters "Exit" shall be clearly discernible when the illuminated sign is not energized.

623.3 Illumination: Each sign shall be illuminated by a source providing not less than three (3) foot candles at the illuminated surface.

623.4 Power source: All Exit signs shall be illuminated at all times when the building is occupied and provided with an emergency power source as described in Section 624.4.

#### SECTION 624.0 MEANS OF EGRESS LIGHTING

624.1 Artificial lighting: All means of egress in other than one- and two-family dwellings shall be equipped with artificial lighting facilities to

provide the intensity of illumination herein prescribed continuously during the time that conditions of occupancy of the building require that the exitways be available. Lighting shall also be provided to illuminate the exitway discharge.

624.2 Intensity of illumination: The intensity of floor lighting shall be not less than one (1) foot candle.

624.3 Places of assembly: In places of assembly for the exhibition of motion pictures or other projections by means of directed light, the illumination of floors of exitway access areas may be reduced during such period of projection to not less than one-half (1/2) foot candle.

624.4 Emergency lighting system: Means of egress lighting shall be provided from an independent power source or other approved auxiliary source of power to assure continued illumination in case of emergency or primary power loss for a duration of one (1) hour in the following:

1. use group A (public assembly);
2. use group B (business);
3. use group I (institutional);
4. use group M (mercantile) when greater than three thousand (3,000) square feet in area on any floor or when having one (1) or more floors above or below grade floor;
5. use group R-1 (hotels and detoxification facilities);
6. use group R-2 (multi-family dwellings) containing four (4) or more dwelling units; and
7. in all windowless buildings or portions thereof regardless of use group, except R-3 and R-4

#### SECTION 625.0 HAZARDS TO MEANS OF EGRESS

625.1 Floor openings: Manholes or floor access panels shall not be located in the line of egress which reduce the clearance to less than thirty-two (32) inches.

625.2 Protrusions: There shall not be low-hanging door closers that remain within the opening of a doorway when the door is open or that protrude hazardously into corridors or line of egress when the door is closed. There shall not be low-hanging signs, ceiling lights or similar fixtures which protrude into corridors or lines of egress.

625.3 Identification of hazardous exits: Doors leading to dangerous areas such as fire escapes, loading platforms, switch rooms and mechanical rooms shall be equipped with knobs, handles or push bars that have been knurled.

625.4 Floor surfaces: All floors of corridors and lines of egress shall have a surface that is non-slip.

ARTICLE 7

STRUCTURAL AND FOUNDATION  
LOADS AND STRESSES

SECTION 700.0 GENERAL

700.1 Scope: The provisions of this article shall control the structural design of all structures, and their foundations, hereafter erected to insure adequate strength of all parts thereof for the safe support of all superimposed live and special loads in addition to their own dead load, without exceeding the design capabilities. The loads specified herein are the minimum suitable for use with stresses and load factors prescribed in this code or in accepted engineering practice.

SECTION 701.0 DESIGN SAFE LOAD

701.1 Structural analysis: The safe load for any structural member or system of construction shall be determined by accepted engineering analysis except as provided in Sections 702.0 and 803.0 for tests of assemblies not capable of analysis.

701.2 Check tests: When there is reasonable doubt as to the design capacity of any structural unit or assembly, the building official may require that tests be made of such unit or assembly under the supervision of a qualified registered professional engineer. Such tests shall be made by an approved testing facility and personnel, and the procedures and results of such tests shall be signed and stamped by the said designated qualified registered professional engineer.

SECTION 702.0 TEST SAFE LOAD

702.1 When required: When not capable of being accurately analyzed, any system of construction or structural unit and its connections shall be subjected to tests prescribed in Article 8 or in the test standards listed in Appendices D and E, or to such other tests which may be certified by a qualified registered professional engineer as being acceptable for providing the information required. Any tests performed shall be conducted as required by the provisions of Section 701.2 for testing.

702.2 Test load: The test load shall be subject to the provisions of Section 803.2 and, where applicable, deflections shall be limited as provided in Section 803.3.

SECTION 703.0 DESIGN LIVE LOAD

703.1 Required live load: The live loads to be assumed in the design of buildings and structures shall be the greatest load produced by the intended use and occupancy, but not less than the minimum uniformly distributed unit loads required in Section 706.0 for specific uses.

703.2 Loads not specified: The building official shall approve the live load for any use not specifically provided for in Table 706.

#### SECTION 704.0 DESIGN DEAD LOAD

704.1 Construction materials: In estimating dead load for the purposes of structural design, the weights of materials shall be used, but shall not be less than the unit dead loads prescribed in Appendix J and the Standard for Minimum Design Loads in Buildings and Other Structures listed in Appendix B.

704.2 Service equipment: In estimating dead loads for the purposes of structural design, the weight of service equipment and their distribution components for plumbing, electrical, heating, ventilating, air conditioning, sprinkler and similar systems shall be included.

704.3 Partition load: In structures where subdividing partitions may be subsequently erected, rearranged or relocated, provision shall be made to support the weight of such partitions where they occur, or for an equivalent uniform load, which shall be assumed not less than twenty (20) pounds per square foot (psf) of floor area, in addition to the specified uniformly distributed live load. Provision for partition weight shall be made whether or not partitions are shown on the plans, unless the specified live load exceeds eighty (80) psf.

#### SECTION 705.0 EXISTING BUILDINGS

705.1 General: In the reconstruction, repair, extension or alteration of existing buildings, the allowable working stresses used in design shall be as indicated in the following Sections 705.2 through 705.5 (see Article 22).

705.2 Building extended: When an existing building is altered by an extension in height or area, all existing structural parts affected by the addition shall be strengthened where necessary, and all new structural parts shall be designed to meet the requirements for buildings hereafter erected.

705.3 Building repaired: When repairs are made to the structural portion of an existing building, and the uncovered structural portions are found unsound, such parts shall be made to conform to the requirements for buildings hereafter erected.

705.4 Existing live load: When an existing building heretofore approved is altered or repaired within the limitations prescribed in Article 22, the structure may be designed for the loads and stresses applicable at the time of erection, provided the public safety is not endangered thereby.

705.5 Posted live load: Any existing building heretofore approved, in which there is not a change in use to a new use group requiring greater



floor loads, may be posted for the originally approved live loads, provided the building is structurally safe in all its parts, adequate for its existing use, and the public safety is not endangered thereby.

### SECTION 706.0 UNIFORMLY DISTRIBUTED LIVE LOADS

706.1 Uniform live load: The plans for all buildings and structures intended for other than R-3 and R-4 use groups shall specify the live and partition loads for which each floor or part thereof has been designed. The minimum uniformly distributed live load in pounds per square foot (psf) shall be as provided in Table 706, and for all concentrated loads wherever they occur as provided in Section 707.0.

Table 706

#### MINIMUM UNIFORMLY DISTRIBUTED LIVE LOADS

| Occupancy or use   | Live load (psf) |
|--|-----------------|
| Apartments (see Residential)                               |                 |
| Armories and drill rooms                                   | 150             |
| Assembly halls and other places of assembly:               |                 |
| Fixed seats  | 60              |
| Movable seats  | 100             |
| Platforms (assembly)                                       | 100             |
| Balcony (exterior)   | 100             |
| One- and two- family dwellings only                        | 60              |
| Bowling alleys, poolrooms, and similar recreational areas  | 75              |
| Cornices   | 75              |
| Court rooms  | 100             |
| Corridors:   |                 |
| First floor  | 100             |
| Other floors, same as occupancy served except as indicated |                 |
| Dance halls and ballrooms                                  | 100             |
| Dining rooms and restaurants                               | 100             |
| Dwellings (see Residential)                                |                 |

706.2 Partial loading: The full intensity of the appropriately reduced live load applied only to a portion of the length of a structure or member

## 780 CMR: STATE BUILDING CODE COMMISSION

Table 706 (cont'd.)  
 MINIMUM UNIFORMLY DISTRIBUTED LIVE LOADS

| Occupancy or use   | Live load (psf) |
|--|-----------------|
| Elevator Machine Room  | 150             |
| Fire escapes   | 100             |
| On multi- or single-family residential buildings only  | 40              |
| Garages (passenger cars only)  | 50              |
| For trucks and buses use AASTHO <sup>1</sup> lane loads<br>(see Table 707 for concentrated load requirements)<br>(see Section 710.1 for roofs) |                 |
| Grandstands (see Reviewing stands)   |                 |
| Gymnasiums, main floors and balconies  | 100             |
| Hospitals  |                 |
| Operating rooms, laboratories  | 60              |
| Private rooms  | 40              |
| Wards  | 40              |
| Corridors, above first floor   | 80              |
| Hotels (see Residential)   |                 |
| Libraries:   |                 |
| Reading rooms  | 60              |
| Stack rooms (books & shelving at 65 pcf)<br>but not less than  | 150             |
| Corridors, above first floor   | 80              |
| Manufacturing:   |                 |
| Light  | 125             |
| Heavy  | 250             |
| Marquees   | 75              |
| Office buildings:  |                 |
| Offices  | 50              |
| Lobbies  | 100             |
| Corridors, above first floor   | 80              |
| File and computer rooms require heavier<br>loads based upon anticipated occupancy  |                 |
| Open parking structures (passenger cars only)  | 50              |
| Penal institutions:  |                 |
| Cell blocks  | 40              |
| Corridors  | 100             |
| Residential:   |                 |
| Multifamily houses   |                 |
| Private apartments   | 40              |
| Public rooms   | 100             |
| Corridors  | 80              |
| Dwellings  |                 |
| First floor  | 40              |
| Second floor and habitable attics  | 30              |
| Uninhabitable attics <sup>2</sup>  | 20              |
| Hotels   |                 |
| Guest rooms  | 40              |
| Public rooms   | 100             |
| Corridors serving public rooms   | 100             |
| Corridors  | 80              |
| Reviewing stands and bleachers <sup>3</sup>  | 100             |
| Schools  |                 |
| Classrooms   | 50              |
| Corridors  | 100             |
| Flexible open plan areas   | 100             |
| Sidewalks, vehicular driveways, and yards, subject to trucking   | 250             |
| Skating rinks  | 100             |

**Table 706 (cont'd.)**  
**MINIMUM UNIFORMLY DISTRIBUTED LIVE LOADS**

| Occupancy or use                | Live load (psf) |
|---------------------------------|-----------------|
| Stairs and exitways             | 100             |
| Storage warehouse               |                 |
| Light                           | 125             |
| Heavy                           | 250             |
| Stores                          |                 |
| Retail                          |                 |
| First floor, rooms              | 100             |
| Upper floors                    | 75              |
| Wholesale                       | 125             |
| Theaters                        |                 |
| Aisles, corridors, and lobbies  | 100             |
| Orchestra floors                | 60              |
| Balconies                       | 60              |
| Stage floors                    | 150             |
| Yards and terraces, pedestrians | 100             |

**Note 1.** American Association of State Highway Transportation Officials.

**Note 2.** Live load need be applied to joists or to bottom chords of trusses or trussed rafters only in those portions of attic space having a clear height of forty-two (42) inches or more between joist and rafter in conventional rafter construction, and between bottom chord and any other member in trusses or trussed rafter construction. However, joists or the bottom chords of trusses or trussed rafters shall be designed to sustain the imposed dead load or ten (10) pounds per square foot (psf) whichever be greater, uniformly distributed over the entire span.

A further ceiling dead load reduction to a minimum of five (5) pounds per square foot (psf) or the actual dead load, whichever is greater, may be applied to joists in conventional rafter construction, or to the bottom chords of trusses or trussed rafters under either or both of the following conditions.

1. If the clear height is not over thirty (30) inches between joist and rafter in conventional construction and between the bottom chord and any other member for trusses or trussed rafter construction.
2. If a clear height of greater than thirty (30) inches, as defined in item a directly above, does not exist for a horizontal distance of more than twelve (12) inches along the member.

**Note 3.** For detailed recommendations, see the Standard for Tents, Grandstands, and Air-Supported Structures Used for Places of Assembly, NFPA 102, listed in Appendix B.

shall be considered if it produces a more unfavorable effect than the same intensity applied over the full length of the structure or member.

706.3 Posting of live loads: In every building or structure or part thereof used for mercantile, business, industrial or storage purposes, the design and partition loads shall be marked on plates of approved design which shall be supplied and securely affixed by the owner of the building in a conspicuous place in each space to which they relate. Any plates lost, removed or defaced shall be replaced by the owner.

## SECTION 707.0 CONCENTRATED LOADS

707.1 General: Floors of buildings in the locations specified in Table 707 shall be design to support the uniformly distributed live loads prescribed in Section 706.0 or the following concentrated loads, whichever produces the greater stresses. The indicated concentration shall be so located to produce the maximum stress conditions in the structural members.

Table 707 CONCENTRATED LOADS

| Location                                      | Concentration<br>(pounds) |            | Area<br>(Inches sq.) |
|---|---------------------------|------------|----------------------|
| Elevator machine room grating                 | 300                       |            | 2                    |
| Finish light floor plate construction         | 200                       |            | 1                    |
| Garages                                       |                           | See note 1 |                      |
| Greenhouse roof bars, purlins and rafters     | 100                       |            | 1                    |
| Manufacturing and storage buildings           |                           | See note 2 |                      |
| Office floors                                 | 2000                      |            | 30                   |
| Roofs   | 200                       |            | 6                    |
| Scuttle, skylight and accessible ceiling ribs | 200                       |            | 1                    |
| Sidewalks                                     | 8000                      |            | 15                   |
| Stair treads                                  | 300                       |            | 2                    |

Note 1. Garages or portions of buildings used for storage of motor vehicles (see Section 710.1 for roofs):

1. for passenger cars accommodating not more than nine (9) passengers, two thousand (2,000) pounds acting on an area of six (6) inches square;
2. for mechanical parking structures without slab or deck, passenger cars only, one thousand five hundred (1,500) pounds per wheel; and
3. for trucks or buses, maximum axle load on an area produced by a tire pressure of forty (40) pounds per square inch.

Note 2. For buildings in which mechanical material handling equipment, machines or apparatus will be utilized, the actual concentrated loads.

## SECTION 708.0 IMPACT LOADS

708.1 General: The live loads specified in Section 706.0 shall be assumed to include adequate allowance for ordinary impact conditions. Provision shall be made in the structural design for special uses and

loads which involve vibration and impact forces. Where dynamic effects such as resonance and fatigue are likely to be important as a result of vibration of equipment or machinery, a dynamic analysis shall be carried out.

708.2 Elevators: All moving elevator loads shall be increased one hundred (100) per cent for impact, and the structural supports shall be designed within the limits of deflection as specified in the Department of Public Safety Board of Elevator Regulations. (524 CMR 15.00 through 33.00)

708.3 Other vertical impact loads: The minimum design load due to equipment, machinery or other objects or persons that may produce impact, shall be the total of the weight of the equipment, machinery, or other objects plus its maximum lifting capacity; or the appropriate live load, multiplied by an appropriate factor listed below:

| Impact due to   | Factor |
|---|--------|
| 1. operation of motor-driven cranes . . . . .                           | 1.25   |
| 2. operation of hand-driven cranes . . . . .                            | 1.10   |
| 3. live loads on hanger supported floors and stairs . . . . .           | 1.33   |
| 4. elevator machinery . . . . .   | 2.0    |
| 5. supports for light machinery, shaft or motor driven . . . . .        | 1.20   |
| 6. supports for reciprocating machinery or power driven units . . . . . | 1.50   |

The factor for equipment and machinery shall be increased when so recommended by the manufacturer.

708.4 Horizontal crane loads: The minimum horizontal design loads on crane runway rails shall be:

1. the lateral force, which shall be
  - a. for power-operated crane trolleys, twenty (20) per cent, and for hand-operated trolleys, ten (10) per cent, of the sum of the weights of the lifted loads and of the crane trolley excluding other parts of the crane;
  - b. applied at the top of the rail, one-half (1/2) on each side of the runway; and
  - c. considered as acting in either direction normal to the runway rail; and
2. the longitudinal force, which shall be
  - a. ten (10) per cent of the maximum wheel loads of the crane; and
  - b. applied at the top of the rail.

3. Where there are positive and reliable means which limit the lateral or longitudinal impact loads due to power-operated cranes, the design lateral or longitudinal loads may be based upon the actual crane equipment, provided that design impact loads are not less than one-half (1/2) those specified in Section 708.4. Documentation and computations for such reduced forces shall be submitted to the building official.
4. For exterior craneways, the specified design impact loads need not be included in the loading combination of dead plus live plus wind load.

708.5 Assembly structures: Grandstands, stadiums and similar assembly structures shall be designed to resist a horizontal swaying load applied parallel to the rows of seats, in addition to any wind loads, of not less than twenty-four (24) pounds per lineal foot of seats per row; and of not less than ten (10) pounds per lineal foot of seats applied transversely.

708.6 Vehicular impact in driveway and parking areas

708.6.1 Railings, bumpers, or similar devices: Railings, bumpers or similar devices used in driveways and parking areas subject to possible impact of moving vehicles shall be designed to resist a uniformly distributed lateral load of not less than five hundred (500) pounds per foot and a concentrated lateral load of not less than four thousand (4,000) pounds, applied at least twenty-one (21) inches above the roadway. The distributed load and the concentrated load need not be assumed to act concurrently.

708.6.2 Columns: Unless specially protected by independent permanent protective devices, columns in driveway and parking areas subject to possible impact of moving vehicles shall be designed to resist a concentrated lateral load due to impact of not less than four thousand (4,000) pounds applied at least twenty-one (21) inches above the roadway. This load shall be considered to act simultaneously with other design loads.

#### SECTION 709.0 SPECIAL LOADS

709.1 General: Provisions shall be made for all special loads herein prescribed and all other special loads to which the building or structure may be subjected.

709.2 Below grade: All retaining walls and other walls below grade shall be designed to resist lateral soil pressures with due allowance for hydrostatic pressure and for all superimposed vertical loads.

709.3 Hydrostatic uplift: All foundation slabs and other footings subjected to water pressure shall be designed to resist a uniformly distributed uplift equal to the full hydrostatic pressure.

709.4 Railings: Railings around stairwalls, balconies and other floor openings, both exterior and interior, shall be designed to resist a concentrated load of at least two hundred (200) pounds applied in any direction at any point of the top rail and also a vertical and a horizontal thrust of fifty (50) pounds per lineal foot applied at the top railing. The concentrated load and distributed loads need not be assumed to act concurrently. Railings and guards of grandstands and similar assembly structures shall be capable of resisting a lateral force of fifty (50) pounds per lineal foot concurrently with a vertical load of one hundred (100) pounds per lineal foot.

709.5 Construction loads and erection loads: Provision shall be made for temporary construction loads and wind loads which may occur during the erection of a building or structure; and all structural members and connections shall be designed and erected so as to prevent overloading during construction.

709.6 Temperature loads: Forces and movements resulting from changes in temperature shall be considered in the design of all buildings and structures.

#### SECTION 710.0 ROOF LOADS

710.1 General: Roofs shall be designed to resist their dead load combined with the maximum effect of either snow load, wind load, earthquake load, or live load where appropriate for occupied roofs, whichever is more severe. Where roofs are used for parking, the appropriate live load shall be added to the snow load. Roofs shall also be designed to resist the applicable special loads required in Section 709.0.

710.2 Design roof loads: Maximum effects of the following roof loads are given in the referenced sections of this code.

710.2.1 Snow load: As provided in Section 711.0.

710.2.2 Wind load: As provided in Sections 712.0, 713.0, 714.0, and 715.0.

710.2.3 Earthquake load: As provided in Section 716.0.

710.2.4 Other live load: As provided in Sections 706.0 and 707.0.

710.3 Overhanging eaves: In other than one- and two-family dwellings, and except where framing of overhang is a continuation of the roof framing, overhanging eaves, cornices and other roof projections shall be designed for a minimum uniformly distributed live load of sixty (60) pounds per square foot.

710.4 Ponding: Roofs shall be designed for the maximum possible depth of water that may be ponded thereon as determined by the relative levels

of roof deck and overflow weirs, scuppers, edges of serviceable drains in combination with the deflected structural elements.

710.5 Special purpose roofs: When used for incidental promenade purposes, roofs shall be designed for a minimum live load of sixty (60) pounds per square foot and one hundred (100) pounds per square foot when designed for roof gardens or assembly uses; or for snow loads, as provided in Section 711.0; whichever is larger.

710.5.1 Landscaped roofs: Where roofs are to be landscaped, the design live load shall be the sum of the appropriate uniform live load and the landscaping load shall be considered as a dead load and shall be computed on the basis of saturation of the soil.

#### SECTION 711.0 SNOW LOAD

711.1 General: The map snow loads shown in Figure 711.1 shall be used as the basis for deriving design snow loads for all buildings and structures.

711.2 Roof snow loads: The minimum snow loads for the design of roofs shall be determined from Figures 711.1, 711.2, 711.3, 711.4, 711.5, 711.6, 711.7, and 711.8 as applicable.



Figure 711.1

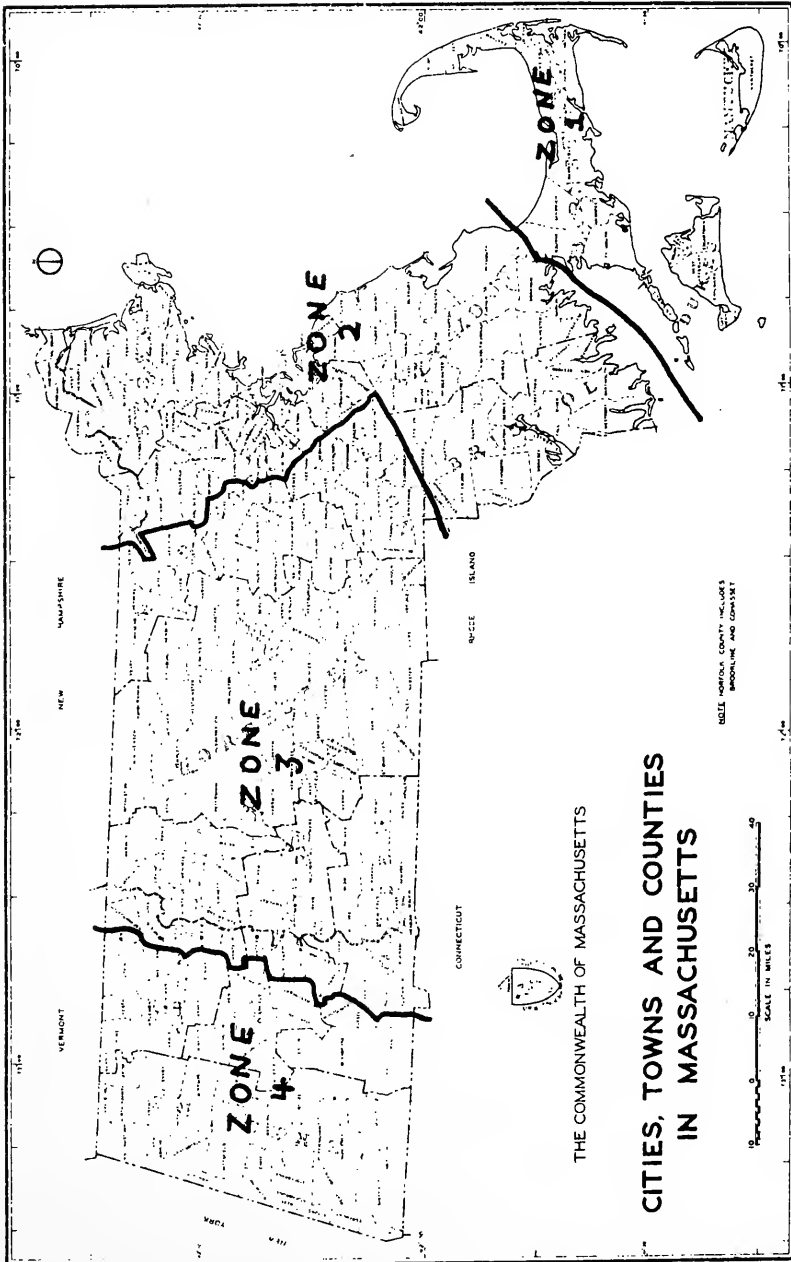

SNOW LOAD ZONES

Figure 711.2

DESIGN SNOW LOAD AND DISTRIBUTION, CONDITION ONE

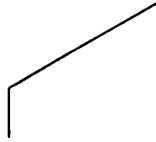
ROOF SHAPES

| DESIGN SNOW LOAD<br>(POUNDS PER SQUARE FT.) |      |    |    |    |
|---|------|----|----|----|
| PITCH                                       | ZONE |    |    |    |
|   | 1    | 2  | 3  | 4  |
| 0 - 7:12                                    | 25   | 30 | 35 | 40 |
| 7:12 - 10:12                                | 20   | 24 | 28 | 32 |
| 10:12 - 14:12                               | 15   | 18 | 21 | 24 |
| 14:12 - 21:12                               | 10   | 12 | 14 | 16 |
| > 21:12                                     | 0    | 0  | 0  | 0  |

$$\text{PITCH} = \frac{\text{RISE}}{\text{RUN}}$$

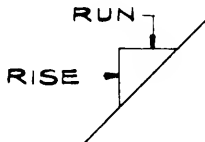
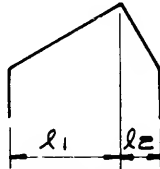

Figure 711.3

DESIGN SNOW LOAD AND DISTRIBUTION, CONDITION TWO

ROOF SHAPES



| DESIGN SNOW LOAD<br>(POUNDS PER SQUARE FT.) |      |    |    |    |
|---|------|----|----|----|
| PITCH                                       | ZONE |    |    |    |
|   | 1    | 2  | 3  | 4  |
| 0 - 7:12                                    | 25   | 30 | 35 | 40 |
| 7:12 - 10:12                                | 20   | 24 | 28 | 32 |
| 10:12 - 14:12                               | 15   | 18 | 21 | 24 |
| 14:12 - 21:12                               | 10   | 12 | 14 | 16 |
| > 21:12                                     | 0    | 0  | 0  | 0  |

FOR PITCH GREATER THAN 7:12 USE CASE I OR II WHICHEVER RESULTS IN THE GREATER STRESSES.

CASE I

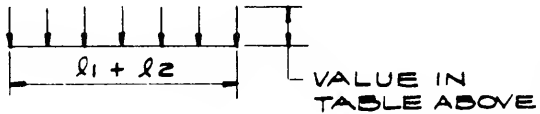

CASE II

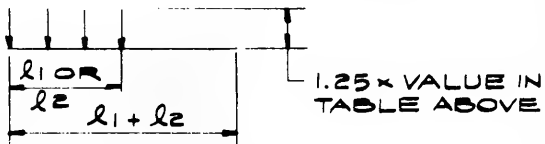
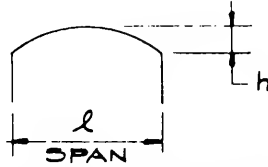

Figure 711.4  
 DESIGN SNOW LOAD AND DISTRIBUTION, CONDITION THREE

ROOF SHAPES



| DESIGN SNOW LOAD<br>(POUNDS PER SQUARE FT.) |      |    |    |    |
|---|------|----|----|----|
| h/l   | ZONE |    |    |    |
|   | 1    | 2  | 3  | 4  |
| 0 - 0.2                                     | 25   | 30 | 35 | 40 |
| 0.2 - 0.3                                   | 20   | 24 | 28 | 32 |
| 0.3 - 0.6                                   | 15   | 18 | 21 | 24 |
| > 0.6                                       | 10   | 12 | 14 | 16 |

FOR h/l RATIO GREATER THAN 0.2  
 USE CASE I OR II, WHICHEVER  
 RESULTS IN THE GREATER STRESSES.

CASE I

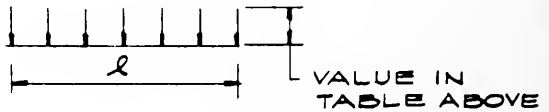

CASE II

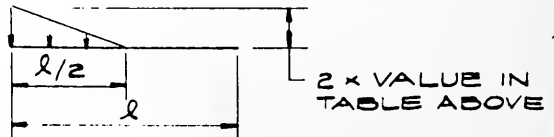
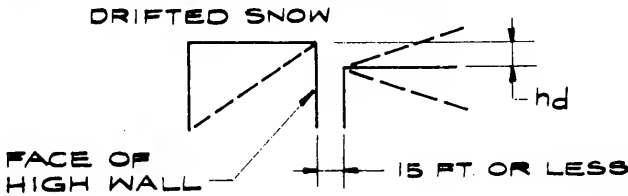

Figure 711.5

DESIGN SNOW LOAD AND DISTRIBUTION, CONDITION FOUR

**ROOF SHAPES**



LOWER LEVEL OF MULTI-LEVEL ROOFS  
(WHEN UPPER ROOF IS PART OF THE  
SAME BUILDING OR AN ADJACENT  
BUILDING NOT MORE THAN 15 FT. AWAY).

| DESIGN SNOW LOAD<br>(POUNDS PER SQUARE FT.) |      |    |     |     |
|---|------|----|-----|-----|
| HEIGHT $hd$<br>(FT)                         | ZONE |    |     |     |
|   | 1    | 2  | 3   | 4   |
| 0-2   | 25   | 30 | 35  | 40  |
| 3   | 45   | 45 | 45  | 45  |
| 4   | 60   | 60 | 60  | 60  |
| 5   | 75   | 75 | 75  | 75  |
| 6   | 75   | 90 | 90  | 90  |
| 7   | 75   | 90 | 105 | 105 |
| $\geq 8$                                    | 75   | 90 | 105 | 120 |

VALUE FROM  
TABLE ABOVE

VALUE FROM  
CONDITION 1

FACE OF  
HIGH WALL

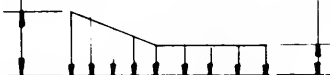

$2hd \leq 30 \text{ FT.}$

Figure 711.6  
 DESIGN SNOW LOAD AND DISTRIBUTION, CONDITION FIVE

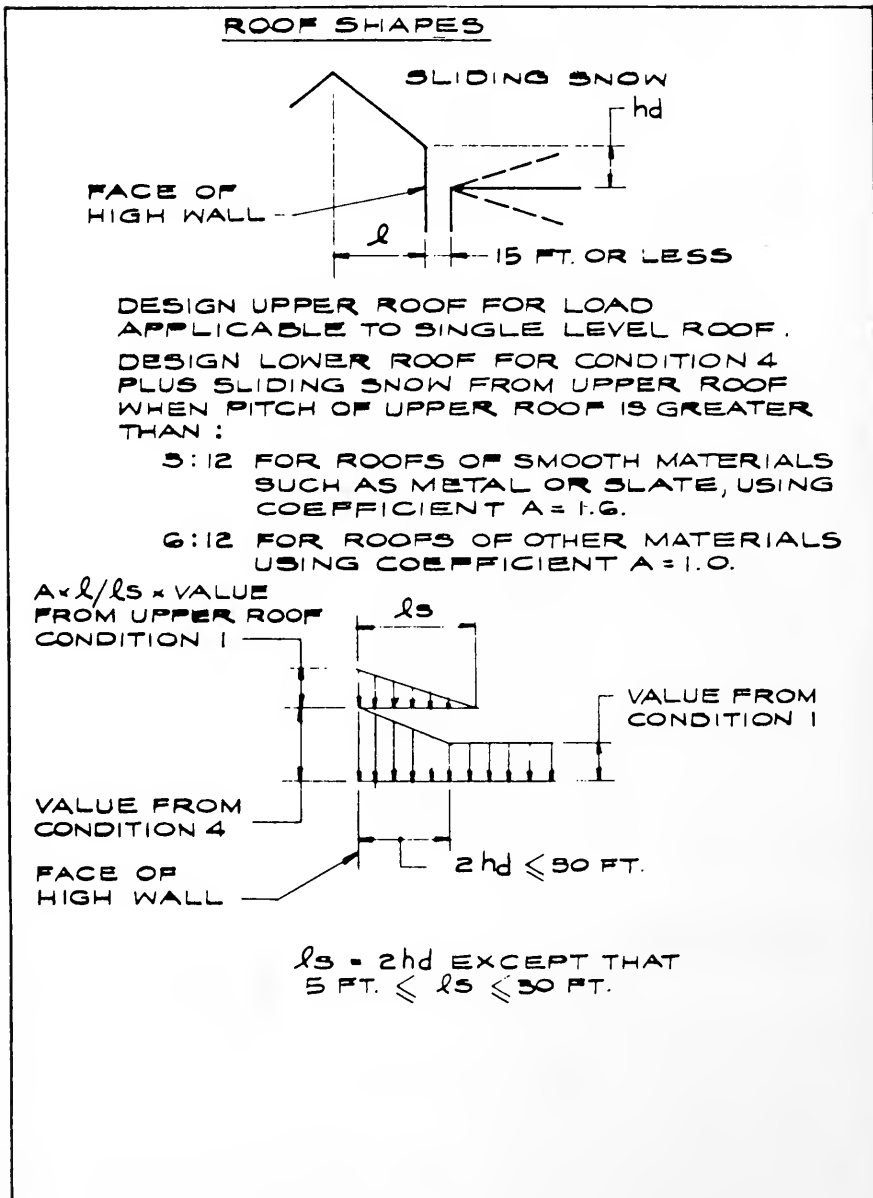
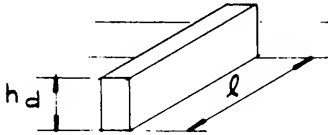

Figure 711.7

DESIGN SNOW LOAD AND DISTRIBUTION, CONDITION SIX

**ROOF SHAPES**



ROOF AREAS ADJACENT TO SMALL PARAPETS, SCREENS, FENCES, PROJECTIONS AND OBSTRUCTIONS ON ROOFS.

| DESIGN SNOW LOAD<br>(POUNDS PER SQUARE FT) |      |    |    |    |
|--|------|----|----|----|
| HEIGHT $h_d$<br>(FT.)*                     | ZONE |    |    |    |
|  | 1    | 2  | 3  | 4  |
| 0-2  | 25   | 30 | 55 | 40 |
| 3  | 30   | 30 | 35 | 40 |
| 4  | 40   | 40 | 40 | 40 |
| 5  | 50   | 50 | 50 | 50 |
| 6  | 50   | 60 | 60 | 60 |
| 7  | 50   | 60 | 70 | 70 |
| $\geq 8$                                   | 50   | 60 | 70 | 80 |

|   |   |   |   |   |
|---|---|---|---|---|
| *USE $h_d=0$ WHEN $l$ (FT) IS LESS THAN | 5 | 6 | 7 | 8 |
|---|---|---|---|---|

VALUE FROM TABLE ABOVE

VALUE FROM CONDITION 1

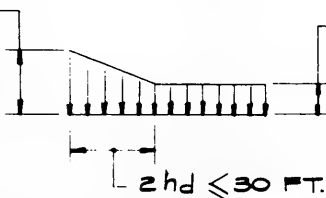
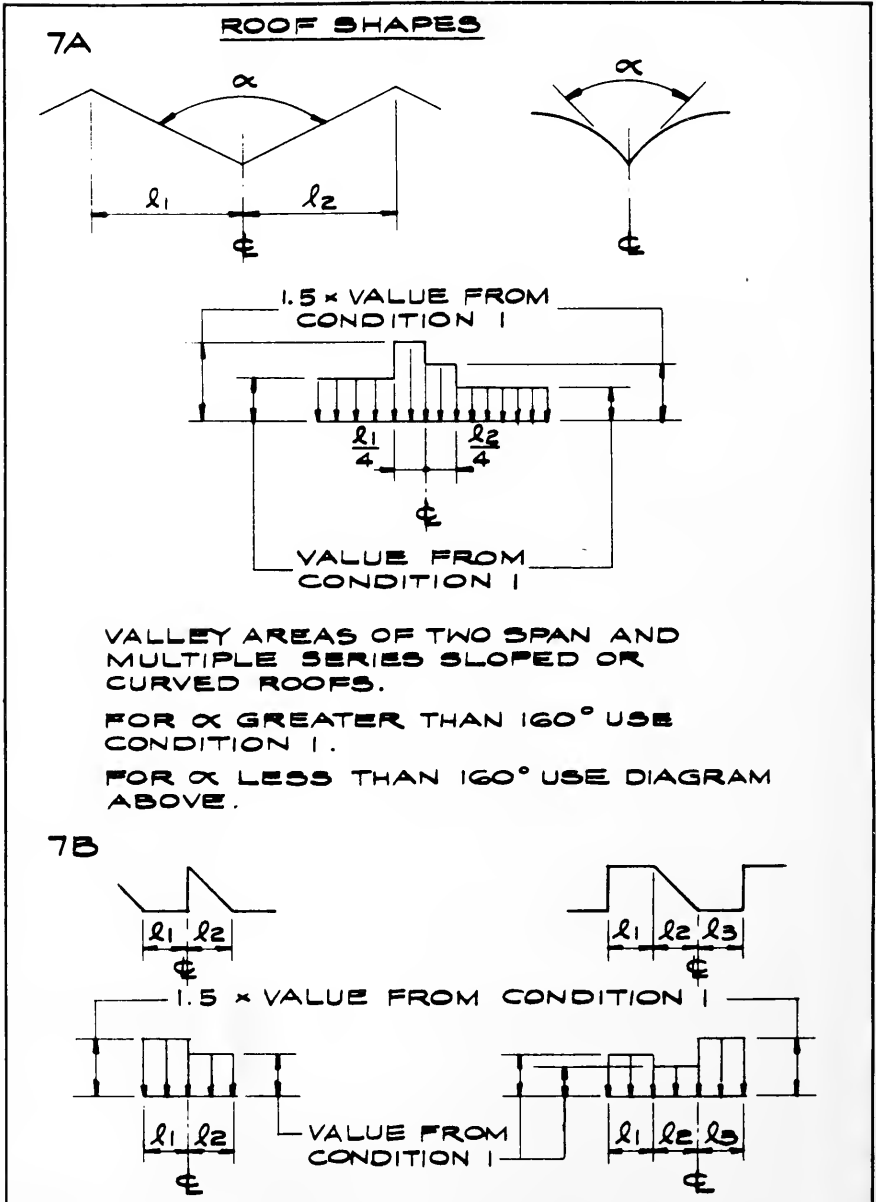

Figure 711.8

DESIGN SNOW LOAD AND DISTRIBUTION, CONDITION SEVEN





711.3 Unbalanced snow loading: Account shall be taken of unbalanced snow loads relative to the stability and strength of structures by applying pattern loadings of one hundred (100) per cent of design snow load alternating with fifty (50) per cent of design snow load, located to maximize the various structural effects, except as otherwise provided in Figures 711.2, 711.3, 711.4, 711.5, 711.6, 711.7, and 711.8.

711.4 Snow pockets or wells: Consideration of potentially excessive snow accumulation shall be given to any roof areas which have pockets or wells which could serve as snow collectors.

711.5 Snow storage and collection areas: Consideration of potentially excessive snow accumulation shall be given to portions of structures which may be designated or used as snow collection or storage areas during and after snow removal operations.

#### SECTION 712.0 WIND LOAD

712.1 Wind load zones: The locations of wind load zones are shown in the Figure 712.1 map. Zone 1 consists of the Counties of Berkshire, Franklin, Hampshire and Hampden; Zone 2 consists of the County of Worcester; and Zone 3 consists of the Counties of Essex, Middlesex, Suffolk, Norfolk, Plymouth, Bristol, Barnstable, Dukes and Nantucket.

712.2 Exposures: Exposure is defined as a measure of terrain roughness and is classified as follows:

Exposure A: centers of large cities and very rough, hilly terrain. Exposure A applies for downtown areas only when the terrain for at least one-half (1/2) mile upwind of the structure is heavily built up, with at least fifty (50) per cent of the buildings being in excess of four stories, and when Exposure B prevails beyond this boundary. Exercise caution in using these reduced wind pressures for buildings and structures on high ground in the midst of cities or rough terrain.

Exposure B: suburban areas, towns, city outskirts, wooded areas, and rolling terrain. Exposure B applies only when the terrain for at least one (1) mile upwind is a continuous urban development, forest, wooded area, or rolling terrain.

Exposure C: open level terrain with only scattered buildings, structures, trees or miscellaneous obstructions, open water, or shorelines.

712.2.1 Special exposures: Consideration shall be given to the application of a more severe exposure (e.g., Exposure C instead of Exposures B or A) when the ground slope near the site of a structure changes abruptly, to account for the resulting higher wind speeds near ground level.

712.3 Reference wind velocities: The reference wind velocity for each wind load zone is the "fastest-mile" wind velocity at thirty (30) feet above the ground ( $V_{30}$  for Exposure C, as follows:

| <u>Zone</u> | $V_{30}$ -MPH |
|-------------|---------------|
| 1           | 70            |
| 2           | 80            |
| 3           | 90            |

712.4 Reference wind pressures: Reference wind pressures for the various exposures and wind zones are given in the following Table 712. The tabulated pressures are combined windward and leeward pressures representing the overall effect of the wind on essentially rectangular structures, and accounts for typical gust effects as found in ordinary buildings. These pressures do not account for buffeting or channeling caused by positions of nearby structures, vortex shedding, or wind sensitive dynamic properties of a particular structure.

Table 712

REFERENCE PRESSURE (POUNDS PER SQUARE FOOT)

| H (feet)           | Zone 1   |    |    |          |    |    | Zone 2   |    |    |          |    |    | Zone 3   |    |    |          |    |    |
|--------------------|----------|----|----|----------|----|----|----------|----|----|----------|----|----|----------|----|----|----------|----|----|
|                    | Exposure |    |    | Exposure |    |    | Exposure |    |    | Exposure |    |    | Exposure |    |    | Exposure |    |    |
|                    | A        | B  | C  | A        | B  | C  | A        | B  | C  | A        | B  | C  | A        | B  | C  | A        | B  | C  |
| Height above grade | 11       | 12 | 12 | 11       | 17 | 17 | 17       | 17 | 17 | 17       | 17 | 17 | 14       | 21 | 21 | 14       | 21 | 21 |
| 0-50               | 11       | 12 | 12 | 11       | 17 | 17 | 17       | 17 | 17 | 17       | 17 | 17 | 14       | 21 | 21 | 14       | 21 | 21 |
| 50-100             | 11       | 12 | 18 | 11       | 17 | 24 | 11       | 17 | 24 | 11       | 17 | 24 | 14       | 21 | 26 | 14       | 21 | 31 |
| 100-150            | 11       | 16 | 22 | 14       | 21 | 29 | 14       | 21 | 29 | 14       | 21 | 29 | 18       | 26 | 30 | 18       | 26 | 37 |
| 150-200            | 13       | 18 | 25 | 17       | 24 | 33 | 17       | 24 | 33 | 17       | 24 | 33 | 22       | 30 | 34 | 22       | 30 | 41 |
| 200-250            | 15       | 20 | 27 | 20       | 27 | 36 | 20       | 27 | 36 | 20       | 27 | 36 | 25       | 34 | 37 | 25       | 34 | 45 |
| 250-300            | 17       | 22 | 29 | 22       | 30 | 39 | 22       | 30 | 39 | 22       | 30 | 39 | 28       | 37 | 41 | 28       | 37 | 48 |
| 300-400            | 19       | 25 | 31 | 25       | 33 | 42 | 25       | 33 | 42 | 25       | 33 | 42 | 32       | 41 | 46 | 32       | 41 | 52 |
| 400-500            | 22       | 28 | 34 | 29       | 37 | 46 | 29       | 37 | 46 | 29       | 37 | 46 | 36       | 46 | 51 | 36       | 46 | 57 |
| 500-600            | 24       | 30 | 37 | 33       | 41 | 49 | 33       | 41 | 49 | 33       | 41 | 49 | 41       | 51 | 55 | 41       | 51 | 61 |
| 600-700            | 27       | 33 | 39 | 36       | 44 | 52 | 36       | 44 | 52 | 36       | 44 | 52 | 45       | 55 | 60 | 45       | 55 | 65 |
| 700-800            | 29       | 35 | 41 | 39       | 47 | 55 | 39       | 47 | 55 | 39       | 47 | 55 | 48       | 58 | 62 | 48       | 58 | 68 |
| 800-900            | 31       | 37 | 43 | 41       | 49 | 57 | 41       | 49 | 57 | 41       | 49 | 57 | 52       | 62 | 65 | 52       | 62 | 72 |
| 900-1000           | 33       | 39 | 45 | 44       | 52 | 59 | 44       | 52 | 59 | 44       | 52 | 59 | 55       | 65 | 68 | 55       | 65 | 74 |

Empirical wind pressure formulas

$$p = 30 \left( \frac{H}{800} \right)^{.55} \quad p = 36 \left( \frac{H}{800} \right)^{.45} \quad p = 42 \left( \frac{H}{800} \right)^{.35} \quad p = 40 \left( \frac{H}{800} \right)^{.55} \quad p = 48 \left( \frac{H}{800} \right)^{.45} \quad p = 56 \left( \frac{H}{800} \right)^{.35} \quad p = 50 \left( \frac{H}{800} \right)^{.55} \quad p = 60 \left( \frac{H}{800} \right)^{.45} \quad p = 70 \left( \frac{H}{800} \right)^{.35}$$

The empirical wind pressure formulas may be used in lieu of the reference pressures tabulated above, but not below (100) feet.

Figure 712.1

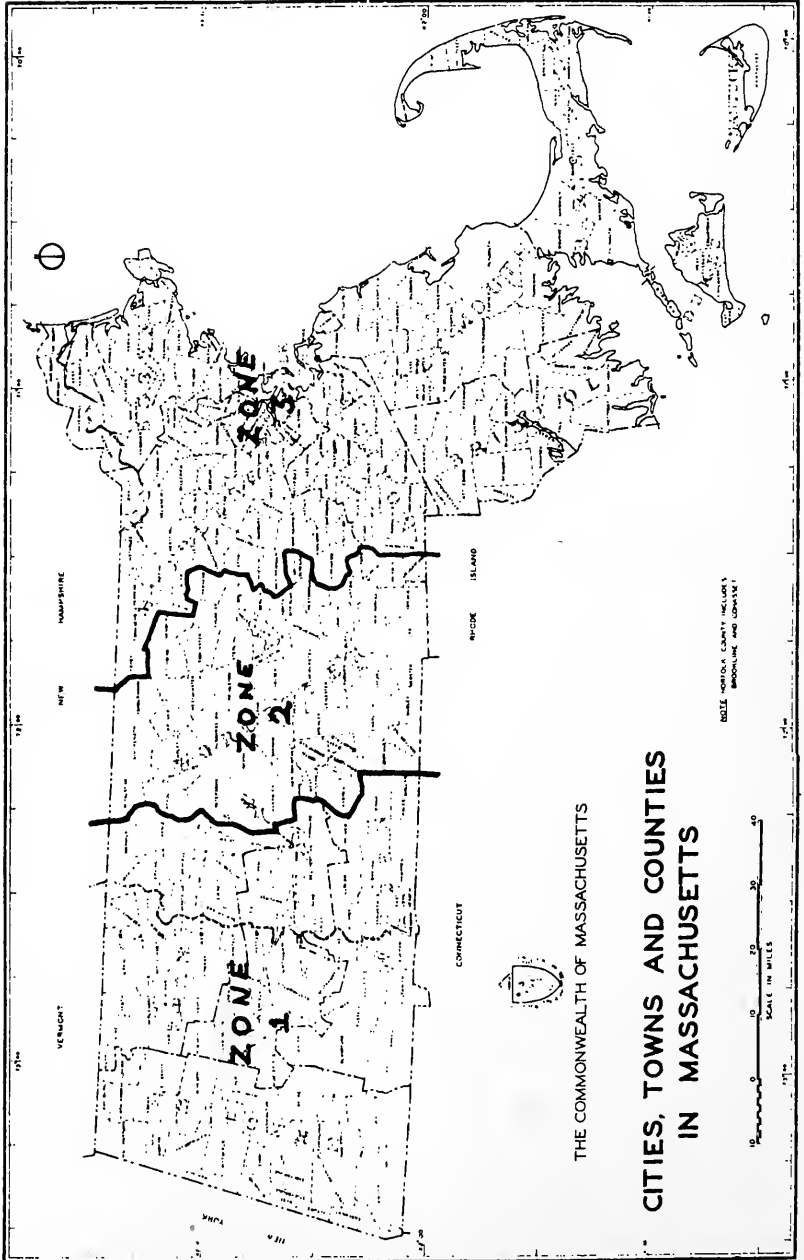

SECTION 713.0 WIND LOAD ON STRUCTURES AS A WHOLE  
AND ON VERTICAL SURFACES OF ENCLOSED  
OR PARTIALLY ENCLOSED STRUCTURES

713.1 Structures as a whole: All buildings and enclosed or partially enclosed structures shall be designed to withstand a total wind load acting on the structure as a whole determined by applying the appropriate reference wind pressures given in Table 712 to the vertical projected area, normal to the wind direction of the vertical surfaces of the structure, plus the appropriate wind forces on the roof as specified in Section 714.0. Consideration shall be given to wind acting in all directions.

713.1.1 Simultaneous wind forces on orthogonal sides: For structures which are essentially rectangular in plan, or whose plan shape is made up of rectangular parts, only wind directions normal to the sides of the structure need be considered, provided that zero point seven (0.7) times the effects of the wind acting simultaneously normal to adjacent orthogonal sides shall also be considered when it produces more severe effects in the structural support system. Factors other than zero point seven (0.7) may be used if substantiated by appropriate wind tunnel tests.

713.1.2 Wind force distribution: The total wind force on the vertical surfaces of a structure prescribed in Section 713.1 shall be distributed six-tenths (6/10) to the windward surfaces (as a positive pressure) and four-tenths (4/10) to the leeward surfaces (as a suction). Other distributions may be used if substantiated by appropriate wind tunnel tests.

713.2 Vertical parts of structures: Vertical parts of structures that are subjected directly to the wind, and their local supporting elements, shall be designed to resist the pressures listed in the following Table 713, normal to the surface, inward or outward. The pressures listed in the table represent the combined internal and external pressures. A local supporting element of a vertical part subjected directly to the wind shall be defined as a compound of a wall assembly, a stud, a mullion, a girt, or a similar item which distributes the wind load from the vertical part to the principal structural system of the structure.

Table 713

## WIND PRESSURES ON PARTS OF STRUCTURES AND LOCAL SUPPORTING ELEMENTS

| Location of applied wind pressure       | Tributary wind load area of part or local supporting element | Required design pressures                      |                   |                              |
|---|--|--|-------------------|------------------------------|
|   |  | Ref. pressure of Sec. 712.4 times <sup>1</sup> | But not less than | But need not be greater than |
| Within salient corner area <sup>2</sup> | Any  | 1.7  | 20 psf            | 70 psf                       |
| Beyond salient corner area              | Less than or equal to 200 sq. ft.                            | 1.2  | 20 psf            | 50 psf                       |
| Beyond salient corner area              | Greater than 200 sq. ft.                                     | 0.8  | 15 psf            | 50 psf                       |

**Note 1.** For partially enclosed structures, where any side is more than thirty-five (35) per cent open, add a factor of zero point three (0.3) to the coefficients of this column of the table.

**Note 2.** The salient corner area shall be defined as the vertical surface located within a distance equal to one-tenth (1/10) the least width of the structure, but not more than ten (10) feet, from a prominent (salient) corner.

## SECTION 714.0 WIND LOAD ON ROOFS

**714.1 General:** Roofs and their supporting structure shall be designed to resist the combined effects of the external and internal wind pressures specified in Sections 714.2 through 714.5. All pressures specified shall be considered to act normal to the roof surface. When applying the reference wind pressures of Section 712.4 to the provisions of Sections 714.2 through 714.5, the reference wind pressures shall be for a height equal to the average height of the roof eave above grade.

**714.2 External wind pressures on roofs of enclosed structures:** Except as specified otherwise in Section 714.5, external wind pressures shall be as specified in the following Table 714, or in Section 714.2.1. Where both positive pressure and suction are specified, the effects of each shall be evaluated.

**714.2.1 Roof shapes not specified:** For roof shapes not specified herein, external wind pressures shall be determined as specified in Section 715.2 but the minimum suction effect shall be equal to zero point six (0.6) times the reference wind pressure of Section 712.4.

**714.3 Internal wind pressures on roofs of enclosed structures:** Except as specified otherwise in Section 714.4, internal wind pressures shall be zero point two (0.2) times the reference wind pressure given in Section

712.4. The internal pressure shall be applied as a positive pressure or a suction, whichever gives the greater structural effect when added to the external pressure, for the design of each structural component.

714.4 Wind pressures on roofs over nonenclosed or partially enclosed structures: Except as specified otherwise in Section 714.5, wind pressures for roofs of partially enclosed or nonenclosed structures shall be as follows:

1. When a structure is partially enclosed, with each side not more than thirty-five (35) per cent open, the wind pressures shall be the same as for an enclosed structure.
2. When a structure is partially enclosed, with openings essentially all on one (1) side, and when that side is more than thirty-five (35) per cent open, external wind pressure shall be as specified in Table 712 and internal wind pressures shall be as specified in Section 714.3 except that the value of internal wind pressure shall be equal to zero point five (0.5) times the reference wind pressure given in Table 714.
3. For all other cases of partially enclosed structures, or for non-enclosed structures, the combined effect of the wind pressures above and below roofs shall be equal to one point twenty-five (1.25) times the values specified in Table 714 for the corresponding roof shapes and wind directions.

**WIND PRESSURES ON ROOFS**

| External wind pressures—flat, gable, shed roofs (wind perpendicular to ridge) |                   |  |         |               |
|---|-------------------|--|---------|---------------|
| Roof pitch  |                   | Multiples of ref. pressure of Sec. 712.4 |         |               |
| Degrees   | Rise/run          | Windward slope                           |         | Leeward slope |
|   |                   | Positive pressure                        | Suction | Suction       |
| 0-20  | Flat to 4/12      | —  | 0.6     | 0.5           |
| 20-30   | 4/12 to 7/12      | 0.2                                      | 0.5     | 0.5           |
| 30-40   | 7/12 to 10/12     | 0.3                                      | 0.4     | 0.5           |
| 40-50   | 10/12 to 14/12    | 0.4                                      | 0.3     | 0.5           |
| 50-90   | 14/12 to Vertical | 0.6                                      | 0.0     | 0.5           |

| External wind pressures—arch shaped roofs (wind perpendicular to ridge) |  |         |             |                 |
|---|--|---------|-------------|-----------------|
| Rise to span ratio  | Multiples of ref. pressure of Sec. 712.4 |         |             |                 |
|   | Windward quarter                         |         | Center half | Leeward quarter |
|   | Positive pressure                        | Suction | Suction     | Suction         |
| Less than 2/10  | 0.2                                      | 0.7     | 0.7         | 0.4             |
| 2/10 to 3/10  | 0.3                                      | —       | 0.8         | 0.4             |
| 3/10 to 6/10  | 0.6                                      | —       | 1.0         | 0.4             |

External wind pressures—flat, gabled, shed or arch shaped roofs (wind parallel to ridge)  
 Suction of 0.6 times the reference pressure of Section 712.4

714.5 Wind pressures for parts of roofs: Parts of roofs that are subjected directly to the wind, and their local supporting elements, shall be designed to resist the following pressures in an outward direction:

1. Where parts subjected directly to the wind are located within a distance of one-tenth (1/10) the least width of a structure, but not more than ten (10) feet, from a ridge, eave, or cornice, they shall resist a pressure one point seven (1.7) times the reference wind pressure given in Table 712 (representing the combined internal and external pressures).
2. Where parts subjected directly to the wind are located outside the zones specified in Item 1 above, they shall resist pressures as specified in Sections 714.2 through 714.4 and Table 714.

A local supporting element of a part of a roof shall be defined as a roof deck element, purlin, rafter, or similar item which distributes the wind load from the roof part to the principal structural system of the structure.

#### SECTION 715.0 SPECIAL CONFIGURATIONS, SHAPES AND CONSIDERATIONS FOR WIND FORCES

715.1 Wind load on signs, towers, exposed framing, tanks, stacks and chimneys: Signs, towers, exposed framing, tanks, stacks, chimneys, and similar structures, or parts thereof, shall be designed for wind forces determined by applying coefficients given in Sections 6.7, 6.8, 6.9 of ANSI A58.1 as listed in Appendix B for the applicable structure using zero point seventy-five (0.75) times the applicable reference wind pressures given in Table 712.

715.1.1 Shielding: Shielding effect of one element by another shall not be considered when the distance between them exceeds four (4) times the projected smallest dimension of the windward element.

715.1.2 Signs: For open or solid outdoor signs with ratios of dimensions with the limits stated below, a wind load applied uniformly over the area of the sign and determined by the lesser of one point two P (1.2P) on the gross area within the outside dimensions of the sign, or one point six P (1.6P) on the net projected area of the sign; whichever is less, may be used in lieu of the loads given in reference standard ANSI A58.1, where "P" is the reference wind pressure given in Table 712 for a height equal to the average height of the sign above the ground.

1. Ground supported signs (whose bottom is .25 times the vertical height from the ground to the top of the sign): height to width ratio less than ten (10).
2. Above ground signs: largest to smallest dimension ratio less than twenty (20).



## 715.2 Special considerations for wind forces

715.2.1 Design wind forces and pressures using wind tunnel tests: Design wind forces and pressures may be determined by appropriate wind tunnel tests on specific structures as stipulated by the responsible design engineer and approved by the building official. The wind tunnel test program shall adequately represent the relevant properties of the structure and its surroundings and the oncoming wind flow. The wind tunnel tests may be combined with a detailed statistical study of meteorological records, including high level wind velocity and direction, from stations near the proposed structure. The wind effects used for design of the structure shall be not less than those corresponding to an event having an annual probability of occurrence of one one-hundredth (.01). In lieu of a detailed statistical study of meteorological records, the appropriate reference wind velocity stipulated in Section 712.3 may be used.

The wind forces and pressures so determined, plus an appropriate allowance for stack effects and internal pressures, may be used for the design of the structure as a whole, and its individual parts. However, these values of forces and pressures shall not be less than eight-tenths (.8) of the values required by Sections 713.0, 714.0, and 715.0, as applicable, for reference wind pressures for Exposure A and the appropriate wind zone specified in Table 712.

## 715.3 Uplift, overturning and sliding

715.3.1 Anchorage, roofs and walls: All parts of a structure subjected directly to the wind shall be anchored to the supporting structure, to resist specified wind loads inwardly or outwardly.

715.3.2 Anchorage, structural system: The design of the structural system and its elements for uplift, overturning moment, or horizontal shear, or their combination, shall not depend on more than sixty-seven (67) per cent of the available resistance due to dead load effects. When, at joints between parts of the structure or at the foundation bearing level, the uplift, overturning moment, or horizontal shear, or their combination, is in excess of sixty-seven (67) per cent of the available resistance due to dead load effects, the additional required capacity shall be provided by suitable connections and anchorage.

715.4 Eccentricity of wind forces: Consideration shall be given to the effects of specified wind forces being applied eccentric to the center of rigidity of a structure.

## SECTION 716.0 EARTHQUAKE LOAD

716.1 General: Provisions of this section reflect informed judgments regarding the probable intensities of future earthquake ground motions in this region, and their associated probabilities of occurrence. The objective of these provisions is to protect life safety by limiting structural failure.

1. Every structure and every portion thereof shall be designed and constructed to resist stresses produced by lateral forces as provided in this section, except detached one- and two-family dwellings and minor accessory buildings. Stresses shall be calculated as the effect of a force applied horizontally at each floor or roof level or to building parts above the foundation. The force shall be assumed to come from any horizontal direction.
2. Every structure and every portion designed and constructed to resist stresses produced by lateral forces as provided in this section shall be constructed and inspected in accordance with the applicable provisions of this code.

716.2 Definitions: (See Section 201.0)

716.3 Symbols and notations: The following symbols and notations apply only to the provisions of Section 716.0:

Ac, Ach, Ag, Ash See Section 716.5.1.3.c.2.

- C = Numerical coefficient for base shear as specified in Section 716.4.1, Item a.
- Cp = Numerical coefficient as specified in Section 716.4.5 and as set forth in Table 716.2.
- D = The dimension of the building in feet in a direction parallel to the applied forces.
- D = Dead load or related internal moments and forces, when used in Section 716.5.4.
- Ds = The plan dimension of the vertical lateral force resisting system in feet.
- E = Load effects of earthquake, or related internal moments and forces.
- FiFn
- Fx = Lateral force applied to level i, n, or x, respectively.
- Fp = Lateral force on the part of the structure and in the direction under consideration.
- Ft = That portion of V considered concentrated at the top of the structure at the level. The remaining portion of the total base shear V shall be distributed over the height of the structure including level according to Section 716.4.2.

- $F_{yh}$  See Section 716.5.1.3.c.2.
- $h_c$  See Section 716.5.1.3.c.2.
- $h_i, h_m$
- $h_x$  = Height in feet above the base to level  $i$ ,  $n$ , or  $x$ , respectively.
- $K$  = Numerical coefficient as set forth in Table 716.1.
- $L$  = Live loads or related internal moments and forces (see Section 716.5.1.4).
- Level  $i$  = Level of the structure referred to by the subscript "i."
- Level  $n$  = That level which is uppermost in the main portion of the structure
- Level  $x$  = That level which is under design consideration.
- $M$  = Overturning moment at the base of the building or structure.
- $M_x$  = The overturning moment at level "x."
- $N$  = The total number of stories above the base to level "n."
- $S$  = Numerical coefficient as specified in Section 716.5.1.
- $Sh$  = See Section 716.5.1.3.c.2.
- $T$  = Fundamental period of vibration of the building or structure in seconds in the direction under consideration.
- $U$  = Required strength to resist factored loads or related internal moments and forces (see Section 716.5.1.4).
- $V$  = Total lateral load or shear at the base.

$$V = F_t + \sum_{i=1}^n F_i$$

where  $i = 1$  designates first level above the base.

- $W$  = Total dead load including the partition loading where applicable plus fifty (50) per cent of the snow load.

Exception:  $W$  shall be equal to the total dead load plus twenty-five (25) per cent of the floor live load in storage and warehouse occupancies.

$w_i$  = That portion of W which is located or is assigned to level "i" or

wx "x," respectively.

Wp = The weight of a part or portion of a structure.

Yt = Total unit weight.

716.4 Minimum earthquake forces for structures: The provisions of Section 716.4 are applicable only to structures meeting the requirements of Section 716.5. All other structures shall be designed in accordance with Section 716.7.

716.4.1 Total lateral force: Every structure shall be designed and constructed to withstand minimum total lateral seismic forces assumed to act noncurrently in the direction of each of the main axes of the structure in accordance with the following formula:

$$V = 1/3 \cdot KCSW$$

1. C factor: the value of C shall be determined in accordance with the following formula:

$$C = \frac{0.05}{\sqrt[3]{T}}$$

For all one- and two-story buildings or structures the value of C shall be zero point one (0.1). The maximum value of C need not exceed zero point one (0.1).

T is the fundamental period of vibration of the structure in seconds in the direction under consideration. Properly substantiated technical data for establishing the period T may be submitted. In the absence of such data, the value for T for buildings shall be determined by the following formula:

$$T = \frac{0.05h_n}{\sqrt{D}}$$

Exception: In all buildings in which the lateral force resisting system consists of a moment-resisting space frame which resists one hundred (100) per cent of the required lateral forces and which frame is not enclosed by or adjoined by more rigid elements would tend to prevent the frame from resisting lateral forces.

$$T = 0.10 N$$

2. K factor: The horizontal force factors K for structures meeting the requirements of Section 716.5 are set forth in Table 716.1.
3. S factor: For a Class A soil site,  $S = 1$ . For a Class B soil site,  $S = 1.5$ . Intermediate values of S may be used as justified on the basis of Figure 716.1 or by the results of adequate studies by a registered professional engineer. The value of CS need not exceed zero point twelve (0.12). (See Section 720.5 for definition of Class A soil.)

Table 716.1

**HORIZONTAL FORCE FACTOR "K" FOR STRUCTURES<sup>1</sup>**

| Type of arrangement of resisting elements   | Value of K        |
|---|-------------------|
| Buildings with a box system as defined in Section 201.0   | 1.33              |
| Buildings with a dual bracing system as defined in Section 201.0  | 0.80              |
| Buildings with a moment-resisting space frame designed to resist the total required lateral force                     | 0.67              |
| Other buildings   | 1.00              |
| Elevated tanks plus full contents, on four (4) or more cross-braced legs and not supported by a building <sup>2</sup> | 3.00 <sup>3</sup> |
| Structures other than buildings and other than those set forth in Table 716.1   | 2.00              |

**Note 1.** Where wind load would produce higher stresses, this load shall be use in lieu of the loads resulting from earthquake forces.

**Note 2.** The minimum value of KC shall be zero point twelve (0.12) and the maximum value of KC need not exceed zero point twenty-five (0.25).

**Note 3.** The tower shall be designed for an accidental torsion of five (5) per cent as specified in Section 716.4.3. Elevated tanks which are supported by buildings or do not conform to type or arrangement of supporting elements as described above shall be designed in accordance with Section 716.4.5 using  $C_p = 0.2$ .

Figure 716.1

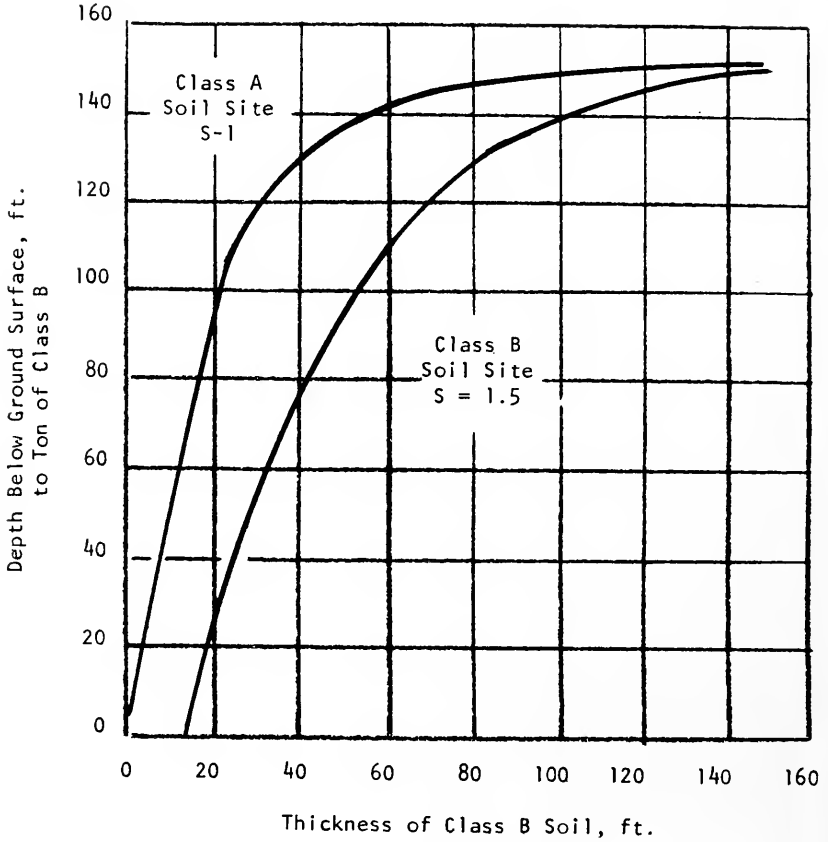

716.4.2 Distribution of lateral force

1. With vertical distribution for structures having regular shapes or framing systems, the total lateral force V shall be distributed in the height of the structure in the following manner:

$$F_t = .004V \left( \frac{h_n}{D_s} \right)^2$$

Ft need not exceed zero point fifteen (0.15) V and may be considered as zero (0) values  $\frac{hn}{Ds}$  of three (3) or less, and

$$F_x = \frac{(V - F_t) W_x h_x}{\sum_{i=1}^n W_i h_i} \quad Ds$$

Exception: One- and two-story buildings shall have uniform distribution.

At each level designated as "x," the force  $F_x$  shall be applied over the building in accordance with the mass distribution on that level.

2. Horizontal distribution: total shear in any horizontal plane shall be distributed to the various elements of the lateral force resisting system in proportion to their rigidities considering the rigidity of the horizontal bracing system or diaphragm.
3. Setbacks: buildings having setbacks wherein the plan dimension of the tower in each direction is at least seventy-five (75) per cent of the corresponding plan dimension of the lower part may be considered as a uniform building without setbacks for the purpose of determining seismic forces.

For other conditions of setbacks the tower shall be designed as a separate building using the larger of the seismic coefficients at the base of the tower determined by considering the tower as either a separate building for its own height or as part of the overall structure. The resulting total shear from the tower shall be applied at the top of the lower part of the building which shall be otherwise considered separately for its own height.

Exception: Nothing in Section 716.4.2, Item 3 shall be deemed to prohibit the submission of properly substantiated technical data for establishing the lateral design forces by a dynamic analysis in accordance with Section 716.4.2, Item 4.

4. Distribution of lateral forces for structures having irregular shapes or framing systems: the distribution of the lateral forces in buildings or structures which have highly irregular shapes, large Differences in lateral resistance or stiffness between adjacent stories, or other unusual structural features affecting seismic response shall be determined considering the dynamic characteristics of the structure. The total base shear shall not be less than required by Section 716.4.1. The analysis should be based either upon the model analysis procedure using the appropriate response spectrum in Figure 716.2 with

reduced ordinates or upon time histories of base motion with a frequency content similar to that implied by the appropriate response spectrum in Figure 716.2.

716.4.3 Horizontal torsional moments: Provisions shall be made for the increase in shear resulting from the horizontal torsion due to an eccentricity between the center of mass and the center of rigidity. Negative torsional shears shall be neglected. Where the vertical resisting elements depend on diaphragm action for shear distribution at any level, the shear-resisting elements shall be capable of resisting a torsional moment assumed to be equivalent to the story shear acting with an eccentricity of not less than five (5) per cent of the maximum building dimension at that level.

716.4.4 Overturning: Every structure shall be designed to resist the overturning effects caused by the wind forces and related requirements specified in Section 715.3 or the earthquake forces specified in this section, whichever governs.

At any level, the incremental changes of the design overturning moment in the story under consideration shall be distributed to the various resisting elements in the same proportions as the distribution of the shears in the resisting system. Where other vertical members are provided which are capable of partially resisting the overturning moments, a redistribution may be made to these members if framing members of sufficient strength and stiffness to transmit the required loads are provided. Where a vertical resisting element is discontinuous, the overturning moment carried by the lowest story of that element shall be carried down as loads to the foundation.

716.4.5 Lateral force on parts or portions of buildings or structures: Parts or portions of structures and their anchorage shall be designed for lateral forces in accordance with the following formula:

$$F_p = 1/3C_pW_p$$



Table 716.2

HORIZONTAL FORCE FACTOR "C<sub>p</sub>" FOR PARTS OF PORTIONS OR STRUCTURES

| Part or portion of structures  | Direction of force       | Value of C <sub>p</sub> |
|--|--------------------------|-------------------------|
| Exterior bearing and nonbearing walls, interior bearing walls and partitions, interior nonbearing walls and partitions over ten (10) feet in height masonry or concrete fences over six (6) feet in height                 | Normal to flat surface   | 0.20                    |
| Cantilever parapet and other cantilever walls, except retaining walls  | Normal to flat surface   | 1.00                    |
| Exterior and interior ornamentations and appendages  | Any direction            | 1.00                    |
| When connected to, part of, or housed within a building: towers, tanks towers and tanks plus contents, storage racks over six (6) feet in height plus contents, chimneys, smokestacks, penthouses, equipment and machinery | Any direction            | 0.20 <sup>1, 2</sup>    |
| When resting on the ground, tank plus effective mass of its contents   | Any direction            | 0.12 <sup>6</sup>       |
| Floors and roofs acting as diaphragms <sup>4</sup>   | Any direction            | 0.10                    |
| Connections for exterior panels or for elements complying with Section 716.6.6   | Any direction            | 2.00                    |
| Connections for prefabricated structural elements other than walls, with force applied at center of gravity of assembly  | Any horizontal direction | 0.30 <sup>6</sup>       |

Note 1. When located in the upper portion of any building where the "h<sub>n</sub>/D" ratio is five-to-one (5:1) or greater the value shall be increased by fifty (50) per cent.

Note 2. "W<sub>r</sub>" for storage racks shall be the weight of the racks plus contents. The value of "C<sub>p</sub>" for racks over two (2) storage support levels in height shall be zero point sixteen (0.16) for the levels below the top two (2) levels.

Note 3. For purposes of determining the lateral force, a minimum ceiling weight of five (5) pounds per square foot shall be used.

Note 4. Floors and roofs acting as diaphragms shall be designed for a minimum value of "C<sub>p</sub>" of ten (10) per cent applied to loads tributary from that story unless a greater value of "C<sub>p</sub>" is required by the basic seismic formula  $V = \frac{1}{3} KCSW$ .

Note 5. The "W<sub>f</sub>" shall be equal to the total load plus twenty-five (25) per cent of the floor live load in storage and warehouse occupancies.

Note 6. When the soil factor S is less than or equal to one point two (1.2) "C<sub>p</sub>" may be taken as zero point one (0.1) S.

The values of C<sub>p</sub> are set forth in Table 716.2. The distribution of these forces shall be according to the gravity loads pertaining thereto.

716.4.6 Lateral force on foundations: Provision shall be made for transmission of the base shear, acting in any direction, between structure and soil or rock, by means of one of the following:

1. lateral soil pressure against foundation walls, footings, grade beams and pipe caps;
2. lateral soil pressure against piles, piers, or caissons;
3. batter piles;
4. side or bottom friction on walls or footings; or
5. combinations of the foregoing.

Lateral pressure may not be more than one-third (1/3) the passive pressure. Bottom friction may not be relied upon where a building overlies Class B soil and is supported upon piles, piers or caissons. Even if not relied upon to transmit the base shear, foundation walls shall comply with the provisions of Section 716.6.10.

#### 716.5 Design requirements

716.5.1 Concrete: Design and construction of earthquake resisting reinforced concrete structures shall conform to the provisions of Section 841.0 and of reference standard ACI 318 (except Appendix A) as listed in Appendix B, and to the requirements of this section.

1. Physical requirements for reinforced concrete materials

Concrete shall have an ultimate compressive strength at twenty-eight (28) days  $f'_c$ , of not less than three thousand (3,000) pounds per square inch. The maximum specified ultimate compressive strength at twenty-eight (28) days,  $f'_c$ , for lightweight concrete shall be limited to four thousand (4,000) pounds per square inch. Reinforcing steel shall comply with ASTM A615, Grade 40 or 60, as listed in Appendix C.

2. Flexural members of moment-resisting space frames
  - a. Throughout the length of flexural members, both top and bottom reinforcement shall consist of not less than two (2) bars and ratio provided shall not be less than 200/fy.
  - b. Positive moment strength of flexural members at column connections shall not be less than twenty-five (25) per cent of the required negative moment strength.
  - c. All reinforcement shall be extended beyond the section at which it is required and developed by bond, hook, or mechanic device to develop the yield strength of the bar. In confined regions, length of anchorage shall be not less than sixty (60) per cent of the development length but not less than twenty-four (24) inches.

- d. Web reinforcement perpendicular to the longitudinal reinforcement shall be required throughout the length of each flexural member. The minimum area of such web reinforcement shall be zero point fifteen (0.15) per cent of the product of the width of the web and the spacing of the web reinforcement along the longitudinal axis of the member. The maximum spacing shall be three-quarter (3/4) d unless a smaller spacing is required by reference standard ACI 318.

Stirrup-ties shall be provided for a distance not less than one and one half (1 1/2) d from the face of the support. The first stirrup-tie shall be not more than (3) inches from the face of the support and the remainder at a spacing not greater than d/4. A stirrup-tie is a closed stirrup which conforms to requirements set forth for hoops in tied columns in a following paragraph.

Lapped splices located in a region of tension or reversing stress shall be confined by at least two (2) stirrup-ties at each splice.

### 3. Columns of moment-resisting space frames

- a. Special transverse reinforcement shall be provided in those portions of tied columns within a distance from the face of the joint equal to the maximum column dimension, one-sixth (1/6) of the clear height of the column, or eighteen (18) inches, whichever is the greatest. The first hoop shall be located two (2) inches from the face of the joint.
- b. At exterior and corner columns, the open sides of the joint shall be confined by special transverse reinforcement throughout the height of the joint.
- c. Where special transverse reinforcement is required, by the provisions of this section, it shall mean spirals, single hoops or overlapping hoops with supplementary cross ties, where required, in accordance with the following requirements:

1. For spiral columns,  $p_s$ , the ratio of the volume of spiral reinforcement to the volume of the core, measured out-to-out of spiral, shall be not less than

$$0.45 \left( \frac{A_g}{A_c} - 1 \right) \frac{f'_c}{f_{yh}} \quad \text{or} \quad 0.12 \frac{f'_c}{f_{yh}}$$

2. For tied columns, transverse ties in the form of rectangular hoops and supplementary cross ties shall be provided in sets spaced vertically not more than four (4) inches apart. The total cross-sectional area,  $A_{sh}$ , of hoop reinforcement, included supplementary cross-ties, shall be not less than

$$0.30 \left( \frac{A_g}{A_{ch}} - \rho \right) s_h h_c \frac{f'_c}{f_{yh}} \quad \text{or} \quad 0.12 s_h h_c \frac{f'_c}{f_{yh}}$$

where

$A_c$  = Area of circular core, measured out-to-out of spiral, in square inches.

$A_{ch}$  = Area of rectangular core of column measured out-to-out of hoops, in square inches.

$A_g$  = Gross area of column, in square inches.

$A_{sh}$  = Total cross-sectional area of hoop reinforcement, including supplementary cross ties having a spacing of  $s_h$  and crossing a section with a core dimension of  $h_c$ , square inches.

$F_{yh}$  = Specified yield strength of spiral or hoops psi.

$h_c$  = Core dimension of tied column in inches.

$s_h$  = Vertical spacing of hoops.

A hoop shall be a one-piece closed tie, #3 or larger, enclosing longitudinal bars, with a one hundred thirty-five (135) degree bend plus ten (10) tie-diameter extension at its ends, the bends being hooked around a single longitudinal bar.

Supplementary cross ties of the same size and longitudinal spacing as hoops, using one hundred eighty (180) degree standard hooks engaging the peripheral hoop and secured to a longitudinal bar, may be used. Supplementary cross-ties or legs of overlapping hoops shall be spaced not more than fourteen (14) inches on center transversely.

4. Earthquake resisting shear walls and braced frames: Shear walls and braced frames shall be designed by the strength design and Method except that the alternate design method of reference standard ACI 318 may be used, provided that the factor of safety in shear is equivalent to that achieved with the

strength design method. The formulas for required strength  $U$ , as provided in reference standard ACI 318 shall be modified to:

$$U = 1.4 (D + L) + 1.4 E$$

$$U = 0.9D + 1.4 E$$

except that  $2E$  shall be used in the calculation of shear stresses in shear walls of buildings without a moment-resisting space frame capable of carrying all vertical loads and lateral forces. Force  $B$  shall be determined from  $V$  in accordance with Section 716.4.1.

a. Shear walls

1. Special vertical boundary elements shall be provided at the edges of concrete shear walls in buildings with a dual bracing system as defined in Section 201.0. These elements shall be composed of concrete encased structural steel elements of A36, A440, A441, A572 (except Grades 60 and 65) or A588 steel, or shall be concrete reinforced as required for columns with special transverse reinforcement, as described above for the full length of the element. The boundary vertical elements and such other similar vertical elements as may be required shall be designed to carry all the vertical stresses resulting from the wall loads in addition to tributary dead and live loads and from the design lateral forces. Horizontal reinforcing in the walls shall be fully anchored to the vertical elements.
2. Similar confinement of horizontal and vertical boundaries at wall openings also shall be provided unless it can be demonstrated that the unit compressive stresses at the opening have a load factor two (2) times that given by the formulae of Section 716.5, Item 4, for required strength  $U$ .
3. Wall reinforcement required to resist wall shear shall be terminated with not less than a ninety (90) degree bend plus a twelve (12) bar diameter extension beyond the boundary reinforcing at vertical and horizontal end faces of wall sections. Wall reinforcement terminating in boundary column shall be fully anchored into the boundary of elements.

5. Braced frames

- a. Reinforced concrete members of braced frames subject primarily to axial stresses shall have special transverse reinforcement as specified above, through the full length of

the member. Tension members shall additionally meet the requirements for compressive members.

- b. In buildings without a moment-resisting space frame capable of carrying all vertical loads and the total required lateral force, all members in braced frames shall be designed for one point twenty-five (1.25) times the force determined in accordance with Section 716.4.1. Connections for these members are not permitted the thirty-three (33) per cent stress increase for earthquake.

716.5.2 Steel: Design and construction of earthquake resisting structural steel framing members and their connections shall conform to the requirements of Section 826.0 and of the Specification for the Design, Fabrication and Erection of Structural Steel for Buildings of the American Institute of Steel Construction and to the requirements of this section.

1. Moment-resisting space frames

- a. General: design and construction of steel framing in moment-resisting space frames shall conform to the provisions of Section 826.0 and the requirements of this section.

- b. Definitions

1. Joints: the joint is the entire assemblage at the intersections of the members.
2. Connections: the connection consists of only those elements that connect the member to the joint.

- c. Connections:

Each beam or girder moment connection to a column shall be capable of developing in the beam the full plastic capacity of the beam or girder.

Exception: The connection need not develop the full plastic capacity of the beam or girder if it can be shown that adequately ductile joint displacement is provided with a lesser connection.

- d. Local buckling: members in which hinges will form during inelastic displacement of the frames shall comply with the requirement for plastic design sections.
- e. Slenderness ratios: the effective length  $k_l$  used in determining the slenderness ratio of an axially loaded compression member in the moment-resisting space frame depends

on its own bending stiffness for the lateral stability of the building, even if bracing or shear walls are provided.

- f. Nondestructive welding testing: welded connections between primary members of the moment-resisting space frame shall be tested by nondestructive methods for compliance with the code and job specifications. A program for this testing shall be established by the person responsible for structural design. As a minimum, this program shall include the following:

1. All complete penetration groove welds contained in joints and splices shall be tested one hundred (100) per cent either by ultrasonic testing or by radiography.

Exception: The nondestructive testing rate for an individual welder may be reduced to twenty-five (25) per cent subject to the concurrence of the design engineer of record, provided the reject rate is demonstrated to be five (5) per cent or less of the welds tested for the welder. A sampling of at least forty (40) completed welds shall be made for such reduction evaluation. Reject rate is defined as the number of welds containing rejectable defects divided by the number of welds completed. For evaluating the reject rate of continuous welds over three (3) feet in length, each twelve (12) inch increment shall be considered as one weld. For evaluating the reject rate for continuous welds greater than one (1) inch thick, each six (6) inches of length shall be considered one (1) weld.

2. Partial penetration groove welds when used in column splices shall be tested either by ultrasonic testing or radiography as required by the design engineer of record.

## 2. Braced frames

- a. All members in braced frames of  $K = 1.0$  and  $K = 1.33$  buildings shall be designed for one point twenty-five (1.25) times the force determined in accordance with Section 716.4 .1. Connections for these members are not permitted the thirty-three (33) per cent stress increase for earthquake, unless designed for the full capacity of the members.

### 716.5.3 Masonry

1. Walls: all bearing walls, shear walls, exterior walls, chimneys and parapets, which are constructed of masonry shall be reinforced in two (2) directions so as to qualify as reinforced

masonry according to the provisions of the BIA or NCMA Standards listed in Appendix B.

In masonry bearing or shear walls, principal reinforcement shall be spaced a maximum of four (4) feet on center in either the horizontal or vertical direction. In the other direction, spacing or reinforcement may be increased to six (6) feet.

Nonstructural masonry walls which enclose stairwells or elevator shafts, other than exterior walls, shall be designed as partially reinforced masonry in accordance with the standards listed in Appendix B. The spacing of reinforcement is not to exceed six (6) feet.

2. Columns: the size and spacing of ties at the ends of tied columns shall not be less than that required for concrete columns (See Section 716.5.1, Item 3).
3. Anchorage: masonry walls shall be anchored to all floors and roofs which provide lateral support for the wall. Such anchorage shall provide a positive direct connection capable of resisting the horizontal design forces or a minimum force of two hundred (200) pounds per lineal foot of wall, whichever is greater. Required anchors in masonry walls of hollow units or cavity walls shall be embedded in a reinforced grouted structural element of the wall.

#### 716.5.4 Timber

1. General: design and construction of earthquake resisting timber structures shall conform to the requirements of Section 852.0 and of the Timber Construction Manual of the American Institute of Timber Construction listed in Appendix B, and to the requirements of this section.
2. Diaphragms: lumber and plywood diaphragms may be used to resist wind or horizontal earthquake forces. The design of diaphragms shall conform to the accepted engineering practice as presented in the Timber Construction Manual.
3. Connections: axial and shear forces produced in wood members by wind or earthquake shall be transferred by positive connections and adequate anchorage. Uplift or horizontal displacement of seated connections shall be prevented by positive anchors. Toenailing or nails subject to withdrawal are not acceptable for connections resisting such forces or displacements.



4. Sheathing: sheathing materials may be used as tension ties provided the tension force does not produce cross-grain bending or cross-grain tension in the peripheral members or other framing members to which the sheathing connects.

716.5.5 Prefabricated construction: All structural elements within the structure which are considered to resist seismic forces or movement and/or are connected so as to participate with the structural system shall be designed in accordance with the provisions of this code in accordance with accepted engineering practice standards (ACI 318 for precast concrete) as listed in Appendix B. Connections shall accommodate all design forces and movement without loss of load carrying capacity of the interconnected members and shall conform to Section 716.5.7.

716.5.6 Other materials or methods of construction: Materials other than concrete, structural steel, clay masonry, concrete block masonry and wood and structural systems other than structural steel, reinforced concrete, reinforced masonry, wood frame or heavy timber shall not be relied on to resist lateral forces and deformations in building structures unless it can be demonstrated to the building official that the structure can safely withstand lateral distortion eight (8) times that computed for the lateral forces specified in Section 716.4.1. The building official shall require drawings and calculations submitted by a registered professional engineer to verify the requirements of this provision.

#### 716.5.7 Connections

1. Connections which transfer forces between members resisting seismic forces in flexure shall be designed for the required forces and also shall either:
  - a. develop the full plastic moment of the member; or
  - b. be capable of deforming to form a reversible plastic hinge.
2. Members which are part of the lateral force resisting system and resist seismic motion by direct axial force shall have connections designed to develop the axial capacities of the members.
3. Connections of structural members which are not part of the lateral force resisting system to supporting members shall be designed to resist the required seismic forces without reliance on frictional forces.
4. Column splices, base plate anchors and other types of connections that act primarily in bearing shall be designed to resist the required forces, and also shall be capable of resisting the forces resulting from the full seismic loading combined with two-thirds (2/3) of the dead load forces acting concurrently.

5. Connections between diaphragms and resisting shear walls and bracing shall be designed for twice the computed force.

#### 716.6 Other design requirements

716.6.1 Lateral force resisting system: Rigid elements that are assumed not to be part of the lateral force resisting system may be incorporated into buildings provided that their effect on the action of the system is considered and provided for in the design.

716.6.2 Moment resisting space frames: Moment resisting space frames may be enclosed by or adjoined by more rigid elements which would tend to prevent the space frame from resisting lateral forces where it can be shown that the action or failure of the more rigid elements will not impair the vertical and lateral load resisting ability of the space frame.

716.6.3 Building separations: All portions of structures shall be designed and constructed to act as an integral unit in resisting horizontal forces unless separated structurally by a distance sufficient to avoid contact under deflection from seismic action or wind forces.

#### 716.6.4 Deleted

716.6.5 Combined vertical and horizontal forces: In computing the effect of seismic force in combination with vertical loads, gravity load stresses induced in members by dead load plus design live load, except roof live load, shall be considered.

716.6.6 Exterior elements: Precast, nonbearing, nonshear wall panels, parapets, or other elements which are attached to, or enclose the exterior shall accommodate movements of the structure resulting from lateral forces or temperature changes. The concrete panels or other elements shall be supported by means of poured-in-place concrete or by mechanical fasteners in accordance with the following provisions:

1. Connections and panel joints shall allow for a relative movement between stories of not less than two (2) times story drift caused by wind or seismic forces; or one quarter (1/4) inch, whichever is greater.
2. Connections shall have sufficient ductility and rotation capacity so as to preclude fracture of the concrete or brittle failures at or near welds. Inserts in concrete shall be attached to, or hooked around reinforcing steel, or otherwise terminated so as to effectively transfer forces to the reinforcing steel.
3. Connections to permit movement in the plane of the panel for story drift may be properly designed sliding connections using slotted or oversize holes, or may be connections which permit movement by bending of steel.

716.6.7 Minor alterations: Minor structural alterations may be made in existing buildings and structures, but the resistance to lateral forces shall be not less than that before such alterations were made, unless the building as altered meets the requirements of this section of the code.

716.6.8 Drift: Lateral deflections or drift of a story relative of its adjacent stories shall be considered in accordance with accepted practice. Lateral deflection of diaphragms shall be considered in addition to the deflection of vertical bracing elements.

Rigid elements that are assumed not to be part of the lateral force resisting system may be incorporated into buildings provided that the effect of the action of the system is considered and provided for in the design. In addition, the effects of the drift on such rigid elements themselves and on their attachment to the building structure shall be considered.

716.6.9 Interconnections of foundations: Pile, pier and caisson caps shall be interconnected by ties when the caps overlie Class B soil. Each tie shall carry by tension or compression a horizontal force equal to ten (10) per cent of the larger pile, pier or caisson cap loading, unless it can be demonstrated that equivalent restraint can be provided by other means. At sites where footings are underlain at shallow depths by cohesionless granular soils, the blow counts of which only slightly exceed the criteria given in Figure 720.1, adequate consideration shall be given to the lateral and vertical movements of footings that may occur during the design earthquake specified in Section 716.7.

716.6.10 Retaining walls: Retaining walls shall be designed to resist at least the superimposed effects of the total static lateral soil pressure, excluding the pressure caused by any temporary surcharge, plus an earthquake force of  $0.045Y_H^2$  (horizontal backfill surface). Surcharges which are applied over extended periods of time shall be included in the total static lateral soil pressure and their earthquake lateral force shall be computed and added to the force of  $0.045yH^2$ . The earthquake force from the backfill shall be distributed as an inverse triangle over the height of the wall. The point of application of the earthquake force from an extended duration surcharge shall be determined on an individual case basis. If the backfill consists of loose saturated granular soil, consideration shall be given to the potential liquefaction of the backfill during the seismic loading.

716.7 Dynamic analysis: Any building or structure is deemed to have complied with the provisions of Section 716.0 if a qualified registered engineer determines that there is negligible risk to life safety if the building or structure experiences an earthquake with a peak acceleration of 0.12g and a frequency content similar to that implied by the appropriate response spectrum in Figure 716.2. A copy of the studies upon which the determination may be based upon shall be filed with the building official: Such a determination may be based upon:

Figure 716.2

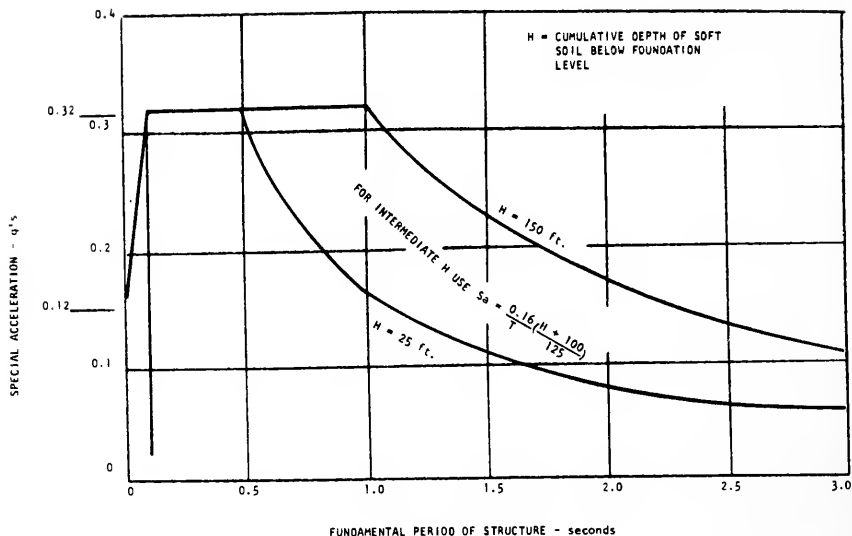

1. a dynamic analysis, based upon generally acceptable procedures, together with evidence that the building or structure can safely withstand the computed displacements and distortions;
2. a comparison of the building or structure with similar buildings or structures having similar foundations and subsoil conditions, that have withstood a similar actual earthquake; or
3. other accepted procedures.

#### SECTION 717.0 COMBINATION OF LOADS

717.1 General: All structures shall be investigated for the following combinations of loads.

1. dead plus live plus snow; and
2. dead plus live plus snow plus (wind or earthquake or thermal).

The most unfavorable effect may occur when one (1) or more of the contributing loads are not acting.

717.2 Counteracting loads: When the stresses in any member or joint due to a loading counteract those due to dead load, combinations omitting that loading shall also be considered. In addition, the effect of a thirty-three (33) per cent decrease in the computed dead load shall be considered.

717.3 Other loads: If the structure may be subjected to other loads not included in Section 717.1, such loads shall be added to the combinations given in that section.

#### SECTION 718.0 LIVE LOAD REDUCTION

718.1 General: In all buildings and structures, the design live loads may be reduced on columns, piers, walls, trusses, girders, and foundations as herein specified, except a reduction shall not be applied to the roof live load.

718.2 Live loads of 100 pounds or less: For live loads of one hundred (100) pounds or less per square foot, the design live load on any member supporting one hundred fifty (150) square feet or more may be reduced at the rate of eight-hundredths (0.08) per square foot of area supported by the members in excess of one hundred fifty (150) square feet except that a reduction shall not be made for areas to be occupied as places of assembly. The reduction shall exceed neither R as determined by the following formula, nor sixty (60) per cent:

$$R = 23 (1 + D/L)$$

where

R = reduction in per cent;

D = dead load per square foot of an area supported by the member; and

L = design live load per square foot of an area supported by the member.

718.3 Live loads of more than 100 pounds: For live loads exceeding one hundred (100) pounds per square foot, a reduction shall not be made, except that the design live loads on columns may be reduced twenty (20) per cent.

#### SECTION 719.0 STRENGTH CRITERIA

719.1 Controlled materials: Strength criteria for structural systems with controlled materials as defined in Section 201.0 shall conform to the specifications and methods of design of accepted engineering practice as given in reference standards contained in Appendix B, or to the approved

criteria in the absence of applicable standards. All structures shall be constructed with controlled materials, except as provided in Section 719.2, or as approved by the building official (see Section 128.0).

719.2 Ordinary materials: Strength criteria for structural systems with ordinary materials as defined in Section 201.0 shall be based on the working stress method of design with maximum stresses limited as provided in Appendix K. For materials not covered in Appendix K, allowable stresses shall be a maximum of three-fourths ( $3/4$ ) times allowable stresses given in applicable reference standards (listed in Appendix B). Only one- and two-family residential structures and one-story structures up to thirty-five thousand (35,000) cubic feet in size may be constructed with ordinary materials.

719.3 New materials: Strength criteria for materials which are not specifically covered by the reference standards listed in Appendix B or by other provisions of this code shall be established by tests as provided in Sections 702.0 and 803.0.

719.4 Light weight metals: Aluminum and other light weight metals and their alloys may be used in the design and construction of structures only after special approval of the building official, subject to the determination of the physical properties by tests as prescribed in Article 8 and in accordance with the provisions of Section 833.0 and provided that plans and calculations are submitted by a registered professional engineer or architect.

#### SECTION 720.1 BEARING VALUE OF SOILS

720.1 General: All applications for permits for the construction of new structures, and for the alteration of permanent structures which require changes in foundation loads and distribution, shall be accompanied by a statement describing soil in all bearing strata, including sufficient records and data to establish character, nature and load bearing capacity. Such records shall be certified by a qualified registered professional engineer or architect, except as otherwise specified in this article.

720.2 Satisfactory foundation materials: Satisfactory bearing strata to provide structural support shall be considered to include the following, provided they are of a standard consistent with engineering specifications: natural strata of rock, gravel, sand, inorganic silt, inorganic clay, or combination of these materials. Compacted fills, when designed and placed under the supervision of a registered professional engineer and certified by him as meeting the design requirements, may be accepted by the building official. Other conditions of unsatisfactory bearing materials which are altered under the supervision of a registered professional engineer and certified by him as meeting the design requirements may be accepted by the building official. Sites involving medium and fine sands, inorganic silt and compacted fills are subject to the additional special requirements of Section 720.4.

720.2.1 Loading interaction: Wherever bearing strata are subject to interaction from other loadings or strata reactions, such conditions shall be incorporated in the evaluation of the design bearing capacity of the support strata.

720.2.2 Bearing capacity for light weight structures: Light weight structures and accessory structures, such as garages and sheds may be founded on normally unacceptable bearing strata, providing such material is certified by a qualified registered professional engineer or architect as being satisfactory for the intended use.

720.2.3 Protection of bearing strata: Bearing strata which may be adversely affected by conditions within the structure, such as evaporation and shrinkages due to excess heat, shall be adequately protected.

720.3 Bearing values: The maximum pressure on soils under foundations shall not exceed values specified in Table 720 except when determined in accordance with the provisions of Section 722.0 or when modified by specific sections of this article.

TABLE 720 PRESUMPTIVE BEARING VALUE OF FOUNDATION MATERIALS

| Class of material**   | Tons per square foot* |
|---|-----------------------|
| 1. Massive crystalline bedrock including granite, diorite, gneiss, trap rock, and dolomite (hard limestone)                       | 60                    |
| 2. Foliated rock including limestone, schist and slate in sound condition   | 40                    |
| 3. Sedimentary rock including hard shales, sandstones, and thoroughly cemented conglomerates                                      | 20                    |
| 4. Soft or broken bedrock (excluding shale) and soft limestone  | 20                    |
| 5. Compacted, partially cemented gravels, and sand and hardpan overlying rock   | 10                    |
| 6. Gravel, well-graded sand and gravel mixtures   | 6                     |
| 7. Loose gravel, compact coarse sand, loose sand  | 4                     |
| 8. Loose coarse sand, loose sand-gravel mixtures, and compact fine sand (confined)  | 2                     |
| 9. Loose medium sand (confined)   | 1                     |
| 10. Loose fine sand   | (+)                   |
| 11. Hard clay   | 4                     |
| 12. Medium stiff clay, stiff varved silt  | 2 (t)                 |
| 13. Soft clay, soft broken shale  | 1 (t)                 |
| 14. Soft inorganic silt, preloaded material, shattered shale, or any natural deposit of unusual character not provided for herein | (+)                   |
| 15. Disturbed varved silt   | 0                     |
| 16. Compacted granular fill   | (2-5+)                |
|   | +                     |

\* The allowable bearing pressure given in this section, or when determined in accordance with the provisions of Section 722.0, will assure that the soils will be stressed within limits that lie safely below their strength. However, such allowable bearing pressure for Classes 9 to 12, inclusive, do not assure that the settlements will be within the tolerable limits for a given structure.

t Alternatively, the allowable bearing pressure shall be computed from the unconfined compressive strength of undisturbed samples, and shall be taken as one point five (1.5) times that strength for round and square footings, and one point twenty-five (1.25) times that strength for footings with length-width ratios of greater than four (4); for intermediate ratios, interpolation may be used.

+ Value to be fixed by the building official in accordance with Sections 722.0 and 723.0.

\*\* The allowable bearing pressure may be increased by one-third (1/3) for combined live loadings such as earthquake and wind.

720.3.1 Classification of bearing materials: The terms used in this section shall be interpreted in accordance with generally accepted engineering nomenclature. In addition, the following more specific definitions are used for bearing materials in the area:

#### Rocks

Shale: A soft, fine-grained sedimentary rock.

Slate: A hard, fine-grained metamorphic rock of sedimentary origin.

Conglomerate: A hard, well-cemented metamorphic rock consisting of fragments ranging from sand to gravel and cobbles set in a fine-grained matrix (locally known as Puddingstone).

#### Granular materials

Gravel: A mixture of mineral grains at least seventy (70) per cent (by weight) of which is retained on a No. 4 mesh sieve and not possessing dry strength.

Sand: A mixture of mineral grains at least seventy (70) per cent (by weight) of which passes a No. 4 mesh sieve which contains not more than fifteen (15) per cent (by weight) passing a No. 200 mesh sieve.

Coarse sand: A sand at least fifty (50) per cent (by weight) of which is retained on a No. 20 mesh sieve.

Medium sand: A sand at least fifty (50) per cent (by weight) of which passes a No. 20 mesh sieve and at least fifty (50) per cent (by weight) is retained on a No. 60 mesh sieve.

Fine sand: A sand at least fifty (50) per cent (by weight) of which passes a No. 60 mesh sieve and not more than fifteen (15) per cent (by weight) passing a No. 200 mesh sieve.

Well-graded sand-gravel mixtures: A mixture of mineral grains which contains between twenty-five (25) per cent and seventy (70) per cent (by weight) passing a No. 4 mesh sieve, between ten (10) and forty (40) per cent (by weight) passing a No. 20 mesh sieve, and containing not more than eight (8) per cent (by weight) passing a No. 200 mesh sieve.

#### Cohesive materials

Glacial till: A very dense, heterogeneous mixture ranging from very fine material to coarse gravel and boulders and generally lying over bedrock. It can be identified from geological evidence and from the very high penetration resistance encountered in soil boring and sampling operations.



Clay (inorganic): A fine-grained, inorganic soil possessing sufficient dry strength to form hard lumps which cannot readily be pulverized by the fingers.

Hard clay (inorganic): An inorganic clay requiring picking for removal, a fresh sample of which cannot be molded by pressure of the fingers.

Medium clay (inorganic): An inorganic clay which can be removed by spading, a fresh sample of which can be molded by a substantial pressure of the fingers.

Soft clay (inorganic): An inorganic clay, a fresh sample of which can be molded with slight pressure of the fingers.

Inorganic silt: A fine-grained inorganic soil consisting chiefly of grains which will pass a No. 200 mesh sieve and possessing sufficient dry strength to form lumps which can easily be pulverized with the fingers.

Note: Dry strength is determined by drying a wet pat of soil and breaking it with the fingers.

Compacted granular fill: A fill consisting of gravel, sand-gravel mixtures, coarse or medium sand, crushed stone, or slag containing not more than eight (8) per cent by weight passing a No. 200 mesh sieve and not having plasticity, shall be considered satisfactory bearing material when compacted in nine (9) inch thick layers, measured before compaction, with adjustment of water content as necessary to achieve required compaction by applying to each layer a minimum of four (4) coverages of one (1) of the following:

1. a vibratory roller with a steel drum with minimum weight of two (2) tons with a speed not exceeding one and one-half (1 1/2) miles per hour;
2. a rubber-tired roller having four (4) wheel abreast and weighted to a total load of not less than thirty-five (35) tons;
3. with the treads of a crawler type tractor with total load of not less than thirty-five (35) tons; or
4. other types of materials, compaction equipment, and procedures as may be approved by the building official on the basis of sufficient evidence that they will achieve compacted fills having satisfactory properties.

The building official will require a competent inspector, qualified by experience and training and satisfactory to him, to be on the project at all times while fill is being placed and compacted. The inspector

shall make an accurate record of the type of material used, including grain-size curves, thickness of lifts, densities, type of compacting equipment and number of coverages, the use of water and other pertinent data.

Whenever the building official or the inspector questions the suitability of a compacted granular fill (Section 722.0), bearing tests shall be performed. A copy of all these records and test data shall be filed with the building official.

#### Preloaded materials

1. The building official may allow the use of certain otherwise unsatisfactory natural soils and uncompacted fills for the support of one (1) story structures, after these materials have been pre-loaded to effective stresses not less than one hundred and fifty (150) per cent of the effective stresses which will be induced by the structure.
2. The building official may require the loading and unloading of a sufficiently large area, conducted under the direction of a registered professional engineer, approved by the building official, who shall submit a report containing a program which will allow sufficient time for adequate consolidation of the material, and an analysis of the preloaded material and of the probable settlements of the structure.

720.4 Liquefaction: The earthquake liquefaction potential of saturated clean medium to fine sands shall be evaluated on the basis of Figure 720 for cases where lateral sliding cannot occur. If the standard penetration resistances,  $N$ , in all strata of medium and fine sand lie above the applicable curve in Figure 720, the sands at the site shall not be considered subject to liquefaction. Liquefaction below a depth of sixty (60) feet from final grade need not be considered for level ground. For pressure-injected footings, the ten (10) foot thickness of soil immediately below the bottom of the driven shaft shall not be considered subject to liquefaction.

Figure 720

Standard Penetration Resistance  
blows/ft.

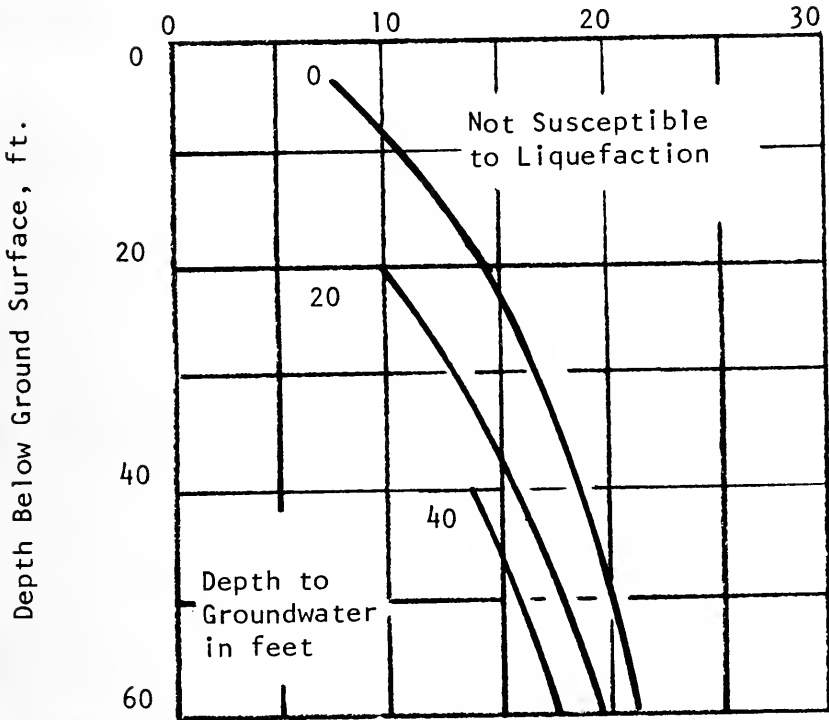

Compacted granular fills shall not be considered subject to liquefaction provided they are systematically compacted to at least ninety-three (93) per cent of maximum dry density as determined in accordance with laboratory test designation ASTM D1557, or a relative density of at least sixty (60) per cent in the case of granular soil having less than ten (10) per cent of weight passing the No. 200 sieve.

For sites not meeting the above criteria, studies by a registered professional engineer shall be made to determine that the structure loads can be safely supported. Such studies might include the following:

1. Investigations to establish that the soils at the site are not subject to liquefaction during the design earthquake as specified in Section 716.7.

2. Design of foundations that will not fail either by loss of bearing capacity or excessive settlements if liquefaction occurs.
3. Replacement or densification of liquefaction-susceptible soils such that liquefaction will not occur.

For sites underlain by saturated sands where lateral sliding (slope instability) may occur, studies by a registered professional engineer shall be made to establish the safety against sliding during earthquakes (see Section 716.0).

For sites underlain by saturated silty sands and inorganic nonplastic silts, studies shall be made by a registered professional engineer to determine the susceptibility to liquefaction of these soils.

720.5 Class A soils: For purposes of determining the S factor for earthquake design forces as specified in Sections 716.4 and 716.7, Class A soil includes the following classes from Table 720: massive igneous rocks and conglomerate; slate, shale in sound conditions, glacial till; gravel or well-graded sand and gravel, if dense to very dense; coarse sand, if dense to very dense; medium sand, if dense to very dense; fine sand, if dense to very dense; clay having an undrained shear strength of at least one thousand (1,000) psf; and compacted granular fill provided that fill soils are compacted throughout as required in Section 720.4 under continuous observations by a registered professional engineer or his authorized representative. (See Figure 716.1)

720.6 Class B soils: All other soils shall be considered Class B.

#### SECTION 721.0 SUBSURFACE EXPLORATIONS

721.1 Where required: Boring, tests, drill holes, core borings or any combination shall be required for all structures except the following, unless specifically required by the building official:

1. one- and two-family dwellings and their accessory buildings;
2. structures less than 35,000 cubic feet in gross volume; and
3. structures used for agricultural purposes.

The borings or tests shall be adequate in number and depth and so located to accurately define the nature of any subsurface material necessary for the support of the structure. When it is proposed to support the structure directly on bedrock, the building official shall require rock cores or core borings to be made into the rock, or shall require other satisfactory evidence to prove that the structure shall be adequately founded on bedrock.

721.2 Soil samples and boring reports: Samples of the strata penetrated in test borings or test pits, representing the natural disposition and conditions at the site, shall be available for examination by the building official. Wash or bucket samples shall not be accepted. Duplicate copies of the results obtained from all completed and uncompleted borings plotted to a true relative elevation and to scale, and of all test results or other pertinent soil data, shall be filed with the building official.

SECTION 722.0 BEARING TESTS, PILE LOAD TESTS  
AND SETTLEMENT ANALYSIS

722.1 General: Whenever the allowable bearing pressure on bearing materials, or the load bearing capacity of single piles or groups of piles is in doubt, the building official may require load tests and/or settlement analyses and the results analyzed. The work shall be performed under the direction of a registered professional engineer.

722.2 Approval of test method: The apparatus and procedure used shall be approved by the building official before they are used. A complete record of the test results together with a soil profile shall be filed by the registered professional engineer who shall have a representative on the site during all test operations.

722.3 Loading equipment: The load shall be applied by direct weight or by means of a recently-calibrated jack. Each load shall be maintained constant for the required period with an accuracy of plus or minus three (3) per cent.

722.3.1 Area: Except for pile load tests, the load area shall be not less than one (1) square foot for bearing materials of Classes 1 to 5 inclusive and not less than four (4) square feet for other classes.

722.4 Loading procedure: The application of the test load shall be in steps equal to not more than one-half (1/2) the contemplated design load, to at least twice the contemplated design load, except as provided in Section 722.8 for pile load tests. The unloading shall be at least two (2) steps, to the design load and then to zero (0) load. During the application of the test load, the contemplated design load and twice the contemplated design load shall be maintained constant for at least twenty-four (24) hours and until the movement does not exceed two hundredths (.02) of an inch during a twenty-four hour period. The load for all other load and unload steps including the zero (0) load at the end of the test shall be maintained constant for a period of not less than four (4) hours. Sufficient readings for each load step shall be made to define properly the time-deflection curve.

722.5 Measurements: Observation of vertical movement shall be made so that the data will accurately define the progress of vertical displacement during the test.

722.6 Additional requirements for soil bearing tests: Bearing tests shall be applied at the elevations of the proposed bearing surfaces of the structure; except that the load may be applied directly on the surface of compacted granular material (Class 16). The excavation immediately surrounding an area to be tested shall be made not deeper than one (1) foot above the plane of application of the test. The test plate shall be placed with uniform bearing. For the duration of the test, the material surrounding the test area shall be protected effectively against evaporation and frost action.

722.7 Determination of design load from soil bearing test: The proposed design load shall be allowed provided that the requirements of Section 722.0 are fulfilled and the settlements under the design load and twice the design load do not exceed three-eighths (3/8) of an inch and one (1) inch, respectively.

722.8 Additional requirements for pile load tests: A single pile shall be load-tested to not less than twice the design load. When two (2) or more piles are to be tested as a group, the total load shall be not less than one and one-half (1 1/2) times the design load for the group.

Provided that the load settlement curve does not show sign of failure and provided that the permanent settlement of the top of the pile after removal of all load at the completion of the test does not exceed one-half (1/2) inch, the maximum design load shall be the load allowed in this part for the type of pile or one-half (1/2) of the maximum applied load, whichever is less.

Whenever the soil conditions are such that substantial driving resistance and/or significant support of the pile test load is derived from soil strata overlying the intended bearing stratum this support shall be removed or the results of the pile test shall be analyzed so as to evaluate the actual support furnished by the bearing stratum.

722.9 Application of pile load test results: The results of the load test can be applied to other piles within the area of substantially similar subsoil conditions as that for the test pile; and providing the performance of the test pile has been satisfactory and the remaining piles are of the same type, shape and size as the test pile; and are installed using the same methods and equipment and are driven into the same bearing strata as the load-tested pile to an equal or greater penetration resistance.

722.10 Settlement analysis: Whenever a structure is to be supported by medium or soft clay (materials of Classes 12 and 13) or other materials which may be subject to settlement or consolidation, the settlements of the structure and of neighboring structures due to consolidation shall be given careful consideration, particularly if the subsurface material or the loading is subject to extensive variation. The building official may require a settlement analysis to be made by a registered professional engineer in case the live and dead loads of the structure, as specified in this

article, minus the weight of the excavated material, induce a maximum stress greater than three hundred (300) pounds per square foot at mid-depth of the underlying soft clay layer.

722.11 Settlement analysis computations: Settlement analyses will be based on a computation of the new increase in stress that will be induced by the structure and realistically appraised live loads, after deducting the weight of excavated material under which the soil was fully consolidated. The effects of fill loads within the building area or fill and other loads adjacent to the building shall be included in the settlement analysis. The appraisal of the live loads may be based on surveys of actual live loads of existing buildings with similar occupancy. The soil compressibility shall be determined by a registered professional engineer and approved by the building official.

### SECTION 723.0 ALLOWABLE FOUNDATION PRESSURE

723.1 General: The maximum allowable pressures on foundation materials shall be in accordance with Section 720.0 and as modified herein.

723.2 Rock foundations: Where subsurface explorations at the project site indicate variations or doubtful characteristics in the structure of the rock upon which it is proposed to construct foundations, a sufficient number of borings shall be made to a depth of not less than ten (10) feet below the level of the footings to provide assurance of the soundness of the foundation bed and its bearing capacity.

723.3 Bearing pressure on rock: The tabulated bearing pressures for rocks of Classes 1 and 3, inclusive, shall apply where the loaded area is on the surface of sound rock. Where the loaded area is below such surface these values may be increased ten (10) per cent for each foot of additional depth, but shall not exceed three (3) times the tabulated values.

723.4 Bearing pressures for Classes 4 to 9, inclusive: The allowable bearing pressures for materials of Classes 4 to 9, inclusive, may exceed the tabulated values by five (5) per cent for each foot of depth of the loaded area below the minimum required in Section 724.0, but shall not exceed twice the tabulated values. For areas of foundations smaller than three (3) feet in least lateral dimension, the allowable design bearing pressures shall be one-third (1/3) of the allowable bearing pressures multiplied by the least lateral dimension in feet.

723.5 Bearing pressures on clay: The tabulated bearing pressures for Classes 10 to 12, inclusive, shall apply only to pressures directly under individual footings, walls, and piers. If structures are founded on or are underlain by deposits of these classes, the total load over the area of any one bay or other major portion of the structure, minus the weight of all materials removed, divided by the area, shall not exceed one-half (1/2) the tabulated bearing pressures.

723.6 Vertical pressures: The computed vertical pressure at any level beneath a foundation shall not exceed the allowable bearing pressures for the material at that level. Computation of the vertical pressure in the bearing materials at any depth below a foundation shall be made on the assumption that the load is spread uniformly at an angle of sixty (60) degrees with the horizontal; but the area considered as supporting the load shall not extend beyond the intersection of sixty (60) degree planes of adjacent foundations.

723.7 Disturbance of bearing materials: Whenever the bearing materials are disturbed from any cause, for example, by the inward or upward flow of water and/or by construction activities, the extent of the disturbance shall be evaluated by a registered professional engineer and appropriate remedial measures taken satisfactory to the building official.

#### SECTION 724.0 DEPTH OF FOOTINGS

724.1 Frost protection: All permanent supports of buildings and structures shall extend a minimum of four (4) feet below finished grade except when erected upon sound bedrock or when protected from frost, or when the foundation grade is established by a registered professional engineer and as approved by the building official. The engineer shall support the design grade with data including the type and extent of free-draining foundation material, ground water levels, and climatic records.

724.2 Depth of spread foundations: The bottom surface of any footing resting on material of Classes 4 to 15, inclusive, shall be at least eighteen (18) inches below the lowest ground surface or the surface of a floor slab bearing directly on the soil immediately adjacent to the footing.

#### SECTION 725.0 FOOTING DESIGN

725.1 Design loads: The loads to be used in computing the pressure upon bearing materials directly underlying foundations shall be the live and dead loads of the structure, as specified in Section 718.0 including the weight of the foundations and of any immediately overlying material, but deducting from the resulting pressure per square foot the total weight of a one (1) square foot column of soil, including the water in its voids, which extends from the lowest immediately adjacent surface of the soil to the bottom of the footing, pier or mat. Foundations shall be constructed so as to resist the maximum probable hydrostatic pressures.

725.2 Pressure due to lateral loads: Where the pressure on the bearing material due to wind or other lateral loads is less than one-third ( $1/3$ ) of that due to dead and live loads, it may be neglected in the foundation design. Where this ratio exceeds one-third ( $1/3$ ), foundations shall be so proportioned that the pressure due to combined dead, live, wind loads, and other lateral loads shall not exceed the allowable bearing pressures by more than one-third ( $1/3$ ).



725.3 Earthquake loads: Special provision shall be made in the foundation design to comply with the provisions of Section 716.0.

725.4 Vibratory loads: Where machinery or other vibrations may be transmitted through the foundations, consideration shall be given in the design of the footings to prevent detrimental disturbances of the soil.

725.5 Eccentric loads: Eccentricity of loadings in foundations shall be fully investigated, and the maximum pressure on the basis of straight-line distribution shall not exceed the allowable bearing pressures.

725.6 Isolated footings: Footings on granular soil of Classes 5 to 10 and Class 16 of Table 720 shall be so located that the line drawn between the lower edges of adjoining footings shall not have a steeper slope than thirty (30) degrees with the vertical, unless the material supporting the higher footing is braced or retained or otherwise laterally supported in an approved manner.

725.7 Light structures: One-story structures without masonry walls and not exceeding eight hundred (800) square feet in area may be founded on a layer of satisfactory bearing material not less than three (3) feet thick, which is underlain by highly compressible material, provided that the stresses induced in the unsatisfactory material by the live and dead loads of the structure and the weight of any new fill, within or adjacent to the building area, will not exceed two hundred and fifty (250) pounds per square foot (psf).

#### SECTION 726.0 TIMBER FOOTINGS, WOOD FOUNDATIONS

726.1 Timber footings: Timber footings may be used for wood frame structures and as otherwise approved by the building official. Such footings shall be treated in accordance with the applicable standards in Appendix C or shall be placed entirely below permanent water level, except that untreated timbers may be used as capping of wood piles which project above the water level over submerged or marsh lands. The compressive stresses perpendicular to grain in untreated timber footings supported upon piles shall not exceed seventy (70) per cent of the allowable stresses for the species and grade of timber as specified in the National Design Specification for Stress Grade Lumber listed in Appendix B.

726.2 Pole buildings: Pole type buildings shall be designed and erected in accordance with the applicable standards listed in Appendix B. The poles shall be treated in accordance with the applicable standards in Appendix C.

#### SECTION 727.0 STEEL GRILLAGES

727.1 General: Structural steel grillage foundations shall have at least six (6) inches of concrete cover below the bottom of the steel and shall have at least four (4) inches of concrete cover above the steel and between the sides of the steel and the adjacent soil.

SECTION 728.0 CONCRETE FOOTINGS

728.1 Concrete strength: Concrete in footings shall have an ultimate compressive strength of not less than twenty-five hundred (2500) pounds per square inch (psi) at twenty-eight (28) days.

728.2 Design: Concrete footings shall comply with Sections 840.0 and 841.0 and the applicable reference standards therein listed for design.

728.3 Dimensions

728.3.1 Plain concrete: In plain concrete footings, the edge thickness shall be not less than twelve (12) inches for footings on soil or rock; except for wood frame buildings up to two (2) stories in height, these thicknesses may be reduced to eight (8) inches.

728.3.2 Reinforced concrete: In reinforced concrete footings the thickness at the edge above the bottom reinforcement shall be not less than six (6) inches for footings on soil, nor less than twelve (12) inches for footings on piles. The clear cover on reinforcement where the concrete is cast against the earth shall not be less than three (3) inches. Where concrete is exposed to soil after it has been cast, the clear cover shall be not less than one and one-half (1 1/2) inches for reinforcement smaller than No. 5 bars of five-eighths (5/8) inch diameter wire, nor two (2) inches for larger reinforcement.

728.4 Footings on piles and pile caps: Footings on piles and pile caps shall be of reinforced concrete. The minimum distance from the edge of the cap to the nearest pile surface shall be six (6) inches and there shall be at least two (2) inches of concrete between the top of the pile and the steel reinforcement of the cap. The pile caps shall extend not less than three (3) inches below the pile cutoff.

728.5 Deposition: Concrete for foundations shall not be poured through water. When placed under or in the presence of water, the concrete shall be deposited by approved and properly operated equipment which insures minimum segregation of the mix and negligible turbulence of the water.

728.6 Protection of concrete: Concrete footings shall be protected from freezing during deposition and for a period of not less than five (5) days thereafter and water shall not be allowed to flow through the deposited concrete.

SECTION 729.0 MASONRY UNIT FOOTINGS

729.1 Dimensions: Masonry unit footings shall be laid in type M or S mortar complying with Section 815.0 and the depth shall be not less than twice the projection beyond the wall, pier or column; and the width shall be not less than eight (8) inches wider than the wall supported thereon.

729.2 Offsets: The maximum offset of each course in brick foundation walls stepped up from the footings shall be one and one-half (1 1/2) inches if laid in single courses, and three (3) inches if laid in double courses.

#### SECTION 730.0 FLOATING FOUNDATIONS

730.1 General: The design of floating foundations shall include a settlement analysis in accordance with the provisions of Section 722.10.

#### SECTION 731.0 FOUNDATION PIERS

731.1 General: A foundation pier is here defined as a structural member which extends to a satisfactory bearing material, and which may be constructed in an excavation that afterwards is backfilled by an approved method, or by filling the excavation with concrete, or which may be built by sinking an open or pneumatic caisson.

731.2 Manner of construction: The manner of construction shall be by non-displacement methods and shall permit inspection of the bearing material in place.

731.3 Base enlargement: The bases of foundation piers may be enlarged by spread footings, pedestals or belled bottoms.

731.3.1 Belled bases: Bell-shaped bases shall have a minimum edge thickness of four (4) inches. The bell roof shall slope not less than sixty (60) degrees with the horizontal unless the base is designed in accordance with Sections 840.0 or 841.0.

731.4 Design of piers: Foundation piers may be designed as concrete columns with continuous lateral support. The unit compressive stress in the concrete at the least cross section shall not exceed twenty-five (25) per cent of the twenty-eight (28) day strength of the concrete nor eleven hundred (1100) pounds per square inch.

731.4.1 Reinforcement: When the center of the cross section of a foundation pier at any level deviates from the resultant of all forces more than one-sixtieth (1/60) of its height, or more than one-tenth (1/10) of its diameter, it shall be reinforced as provided in Section 841.0. The restraining effect of the surrounding soil may be taken into account.

731.5 Placement: With approval of the building official, concrete may be placed through still water by means of a properly operated tremie or pumped concrete.

731.6 Inspection: The owner shall engage a competent inspector, qualified by experience and training and satisfactory to the building official, to be present at all times while foundation piers are being installed, to inspect and approve the bearing soil and the placing of the concrete.

The inspector shall make a record of the type of bearing soil upon which the pier rests, of the dimensions of the pier, and of the class strength of concrete used in its construction. A copy of these records shall be filed in the office of the building official.

### SECTION 732.0 PILE FOUNDATIONS

732.1 Site investigation: In addition to the provisions for subsurface explorations, Section 721.0, the building site shall be investigated for all conditions which might promote deterioration of pile foundations, and approved protective measures meeting the requirements of Section 733.0 shall be taken to prevent corrosion or other destructive action from deleterious conditions.

When it is intended that a structure be supported on end-bearing piles, a sufficient number of borings shall be cored into bedrock, or shall extend into the bearing stratum to such depths that satisfactory evidence is provided to demonstrate that there are not compressible soil deposits below the bearing stratum which would adversely affect the structure.

732.2 Spacing: The minimum center-to-center spacing of piles shall be not less than twice the average diameter of a round pile, nor less than one and three-quarter ( $1\frac{3}{4}$ ) times the diagonal dimension of a rectangular pile. When driven to or penetrating into rock, the spacing shall be not less than twenty-four (24) inches. When receiving principal support from end-bearing on materials other than rock or through frictional resistance, the spacing shall be not less than thirty (30) inches.

732.3 Walls: All piles in wall foundations shall be staggered about the center line of the wall at a minimum distance of one-half ( $1/2$ ) the top diameter therefrom. A foundation wall restrained laterally so as to ensure stability both during and after construction may be supported by a single row of piles.

732.4 Isolated columns: An isolated column, when supported by piles, shall rest upon not less than three (3) piles, at least one (1) of which is offset; except that for other than precast concrete or wood-composite piles, such columns may be supported by two (2) piles or one (1) pile, provided the axis of the column is not more than one and one-half ( $1\frac{1}{2}$ ) inches away from the centroid of the pile or piles, and that the top of the pile group has adequate lateral support and the piles can withstand all moments induced by the eccentricity. Lateral support shall be provided as necessary during construction.

732.5 Minimum dimensions: Piles of uniform cross section or tapered piles shall have a minimum nominal diameter of eight (8) inches except as provided in Section 735.0 for timber piles or Section 736.0 for precast concrete piles. Tapered shoes or points of lesser dimensions may be attached to the pile unit.

732.6 Splices: Splices shall be avoided insofar as practicable. Where used, splices shall be sufficiently strong to withstand stresses induced during handling and driving without failure. Splices shall be so constructed as to provide and maintain true alignment and position of the component parts of the pile during installation and subsequent thereto. Splices shall be capable of transmitting all stresses at the location of the splice under design load without exceeding the allowable stresses for specific pile types in this code. Splices shall develop not less than fifty (50) per cent of the value of the pile in bending.

732.7 Pre-excavation: Jetting, augering and other methods of pre-excavation must be approved by the building official and carried out in a manner which will not impair the carrying capacity of the piles already in place or the safety of existing adjacent structures. Immediately after completion of jetting or augering, the pile shall be advanced to the maximum depth of pre-excavation and driven below this depth to the required load resistance.

732.8 Precautions: When piles have been damaged in driving, or driven in locations and alignment other than those indicated on the plans, or that have capacities less than required by the design, the affected pile groups and pile caps shall be investigated and if necessary, the pile groups or pile caps shall be redesigned or additional piles shall be driven to replace the defective piles. Piles shall be driven to embedment in the supporting stratum, as determined by borings.

732.9 Pile heave: Adequate provision shall be made to observe pile heave. Accurate reference points shall be established on each pile immediately after installation; for cast-in-place piles with corrugated shells, the reference point shall be at the bottom of the pile. If, following the installation of other piles in the vicinity, heaving of one-half (1/2) inch or more occurs, corrective measures shall be taken to ensure that the pile has adequate capacity.

732.10 Records: The owner shall engage a registered professional engineer who shall submit his qualifications in writing to the building official. This engineer, or his representative who must be qualified by experience and training shall be present at all times while piles are being driven and to observe all work in connection with the piles. The engineer or his representative shall make an accurate record of the material and the principal dimensions of each pile, of the weight and fall of the ram, the type, size and make of hammer, cushion blocks, the number of blows per minute, the energy per blow, the number of blows per inch for the last six (6) inches of driving, together with the grades at point and cutoff and any other pertinent details. A copy of these records shall be signed by the registered professional engineer, and filed in the office of the building official.

SECTION 733.0 CORROSION PROTECTION

733.1 General: Where boring records, previous experience, or site investigations indicate any condition which might promote deterioration or possible deleterious action on pile materials due to soil constituents, changing water levels or other causes, such pile materials shall be adequately protected as stated herein.

733.2 Preservative treatments: The preservative treatment of timber piles shall comply with the provisions of Section 735.0 and the reference standards as listed in Appendix C.

733.3 Steel and steel-concrete piles: At locations where steel and steel-concrete piles will be in contact with any material which is corrosive to the steel, one (1) of the following procedures shall be used for protection, or any other method which will satisfy the requirements of the building official:

1. Remove all objectionable material.
2. Effectively protect the steel surface from pile cutoff grade to a grade fifteen (15) feet below the bottom of the objectionable material by means of:
  - a. cathodic protection as approved by the building official; or
  - b. an approved encasement of not less than three (3) inches of dense concrete; or
  - c. an effective protective coating subject to the approval of the building official; or
  - d. providing an excess thickness of one-eighth (1/8) inch beyond design requirements on all exposed surfaces.

SECTION 734.0 ALLOWABLE PILE LOADS

734.1 General: The allowable load on piles shall be determined by the applicable formulas complying with accepted engineering practice and as stated herein. The maximum load capacity shall be limited by the supporting capacity as obtained from bearing upon or embedment in bearing materials as defined in Sections 720.0 and 723.0, but the load shall not exceed the capacity of the pile designed in accordance with the provisions of Section 734.1 and the requirements of Article 8 for the construction materials involved.

734.2 Lateral support of axially-loaded piles: The length of a pile below the ground surface shall be considered as a plain column with continuous lateral support. The length above the ground surface shall be designed as an unsupported column in accordance with the provisions of Section 743.0.

734.3 Determination of allowable load: In the absence of pile load tests, the load on a single pile, except for the pile types covered in Section 737.2 (pressure injected footings) and Section 739.0 (drilled-in caissons), shall not exceed the higher of the two (2) values determined in accordance with Section 734.3.1 (driving formula) or Section 734.3.2 (friction formula in clay), nor the maximum loads in Section 734.3.3 (jacked piles).

Where the proposed design load for any pile exceeds fifty (50) tons including pressure injected footings, or exceeds the value determined in accordance with Section 734.3.2 (friction formula in clay), or where the design load for any pile is in doubt, one or more pile load tests shall be performed in accordance with Section 722.0, (Bearing Tests, Pile Load Tests and Settlement Analysis), on representative piles. The stresses on pile materials shall not exceed those limits established herein for various pile types.

For design loads between fifty (50) and one hundred-twenty (120) tons, pile load tests may be waived by the building official, where justified, upon submittal of substantiating data prepared by a registered professional engineer which includes experience and/or performance records for the proposed pile installation under similar soil and loading conditions.

Higher stresses than those permitted in this code for various pile materials above may be approved by the State Building Code Commission based upon the submission of substantiating data and analyses which justify such higher stresses. The data shall be presented in a report, prepared by a registered professional engineer and shall include, as applicable: the results of soil investigations, dynamic analyses of pile behavior, pile load tests, analyses of load transfer during testing and prediction of pile performance during long term service.

#### 734.3.1 Driving formula:

1. Where the design load capacity of the pile does not exceed fifty (50) tons, the allowable load may be computed by means of the following driving formula:

$$R = 2E/(S + C)$$

where

R = allowable pile load in pounds;

E = energy per blow in foot pounds;

S = penetration of last blow or average penetration of last few blows experienced in inches; and

C = constant equal to 1.0 for drop hammer and 0.1 for steam or air hammer.

2. When the design load capacity of a pile exceeds fifty (50) tons the required driving resistance shall be increased above that required by the driving formula in Item 1 above based on load tests or past experience under similar conditions.
3. The value of S must be determined with the hammer operating at one hundred (100) per cent of the rated number of blows per minute for which the hammer is designed.
4. Any driving resistance developed in strata overlying the bearing material shall be discounted.
5. If the driving of the pile has been interrupted for more than one (1) hour, the value of S shall not be determined until the pile is driven at least an additional twelve (12) inches, except when it encounters refusal on or in a material of Classes 1 to 5 inclusive.
6. When the constant tapered portion of a pile, including a timber pile, is driven through a layer of gravel, sand or hard clay (Classes 6 to 10 inclusive, and Class 14) exceeding five (5) feet in thickness, and through an underlying soft stratum, the bearing capacity shall not be determined in accordance with the driving formula, unless jetting is used during the entire driving of the tapered portion of the pile through the layer of gravel, sand, hard clay or Class 14 material, or unless a hole is pre-excavated through said layer for each pile.

734.3.2 Friction formula in clay: The allowable load on a pile stopped in inorganic clay may be based on a friction value of five hundred (500) pounds per square foot of embedded pile surface for a design load not to exceed twenty-two (22) tons, or on a friction value determined from pile load tests. The embedded length shall be the length of the pile below the surface of the inorganic clay, or below the surface of immediately overlying satisfactory bearing material. The area of embedded pile surface shall be computed by multiplying the embedded length by the perimeter of the smallest circle or polygon that can be circumscribed around the average section of the embedded length of the pile. The method of determining the allowable load described in this paragraph shall not be used for a pile in which the drive pipe is withdrawn or for piles which are driven through the clay to or into firmer bearing materials.

In case these piles are in clusters, the allowable load shall be computed for the smaller of the following two (2) areas: the sum of the embedded pile surfaces of individual piles; or the area obtained by multiplying the perimeter of the polygon circumscribing the cluster at the surface of the satisfactory bearing material by the average embedded length of pile.

734.3.3 Jacked piles:



1. Not less than ten (10) per cent of jacked piles shall be load-tested to twice the design load (load test piles). All other jacked piles shall be founded in the same bearing stratum as the load test pile and shall be proof-loaded to one hundred and twenty-five (125) per cent of design load (production piles).
2. For production piles, the one hundred and twenty-five (125) per cent of design load shall be maintained for at least thirty (30) minutes. Acceptability criteria: during final fifteen (15) minutes of load, the rate is not progressive (plot is linear or decreasing when settlement is plotted against logarithm of time); and the rate of settlement is equal to or less than that observed for load test piles during the corresponding time period under one hundred and twenty-five (125) per cent of design load.
3. Settlement readings shall be plotted after 1, 2, 4, 8, and 15 minutes, and at 15 minute intervals thereafter. Load shall be maintained on production piles until acceptability criteria are met.
4. For load test piles, the load shall be applied directly to one hundred and twenty-five (125) per cent of design load and maintained for not less than thirty (30) minutes, but until the settlement rate is not progressive (as defined above). Load shall then be increased to twice the design load and maintained constant for not less than four (4) hours. Settlement during the four (4) hour period shall not exceed point zero fifty (.050) inches.

In the event that settlement exceeds point zero fifty (.050) inches in four (4) hours, the pile shall be deemed unacceptable for one half (1/2) of the final load. The allowable load on the rejected pile may be established by performing an additional load test at the lesser design load. The design load shall not exceed one half (1/2) the load maintained for a four (4) hour period during which time settlement did not exceed point zero fifty (.050) inches.

734.4 Negative friction: Where a pile or a group of piles is placed in subsiding fill or soil, the effect of the downward frictional forces shall be given consideration in the design.

734.5 Limiting load: Where weaker materials underlie the bearing material into which the piles are driven, time allowable pile load shall be limited by the provision that the vertical pressures in such underlying materials produced by the loads on all piles in a foundation shall not exceed the allowable bearing pressures of such materials as established by analysis, applying accepted principles of soil mechanics. Piles or pile groups shall be assumed to transfer their loads to the underlying materials by spreading the load uniformly at an angle of sixty (60) degrees with the horizontal, starting at a polygon circumscribing the piles at the top of the satisfactory bearing material in which they are embedded; but the area considered as supporting the load shall not extend beyond the intersection of the sixty (60) degree planes of adjacent piles or pile groups.

734.5.1 Pile load limitation: The allowable load on a pile shall not be limited to the load obtained by multiplying its point area by the allowable bearing pressure given in Section 720.0.

734.5.2 Liquefaction during earthquake: The requirements of Section 720.3 shall be considered in the design of pile foundations. If pile tips lie above soil which does not meet the criteria in Figure 720, special studies shall be made by a registered professional engineer to ensure safety during the design earthquake specified in Section 716.7.

#### SECTION 735.0 TIMBER PILES

735.1 Species: Piles shall be of Type I species, Type II species or other species approved for such use by the building official.

1. Type I species shall include southern yellow pine, oak, Douglas fir and other woods of similar strength and physical characteristics.
2. Type II species shall include Norway pine, spruce and other woods of similar strength and physical characteristics.

735.2 Quality: Timber piles shall conform to the application provisions of the Standard for Round Timber Piles, ASTM D25.

735.3 Minimum dimensions:

1. Piles shall be of adequate size to resist the applied loads without having to endure compressive stress parallel with the grain in excess of the following:
  - a. Eight hundred (800) pounds per square inch (psi) for Type I species of wood or five hundred (500) pounds per square inch for Type II species of wood on the pile cross section located at the surface of the bearing stratum for piles driven into materials of Classes 6 through 10.
  - b. Five hundred (500) pounds per square inch (psi) for Type I species of wood or three hundred (300) pounds per square inch for Type II species of wood on the pile cross section at the tips of piles driven to bearing on materials of Classes 1 through 5.
2. The piles shall measure at least six (6) inches in diameter at the tip and at least ten (10) inches in diameter at the cutoff, with these measurements being taken under the bark.
3. All piles shall be driven in one (1) piece except as provided in Section 741.0 for composite piles.

735.4 Cutoff: The tops of all timber piles shall be cut off in a horizontal plane; and if not treated by an approved preservative process, the

cutoff shall be below mean low water level or lowest ground water level, and shall be subject to the building official's approval. He may require the owner to install and maintain in good condition at least one (1) ground water observation well within the building, which shall be accessible to the building official.

735.5 Treated piles: Timber piles pressure-treated with creosote or creosote-coal-tar solution, and conforming to the requirements of this section, may be cut off above permanent ground water level when used for the support of buildings not exceeding two (2) stories in height.

735.5.1 Treatment: Preservative and final retention shall be in accordance with AWPA Standard C-3. When exposed to salt water, the treatment shall conform to the AWPB Standard MP-1, MP-2 or MP-4. Pile cutoffs shall be treated in accordance with AWPI Standard M-4.

735.5.2 Certification: Before any treated piles are driven, the building official shall be furnished with certification by a licensed testing laboratory, certifying that piles were free of decay, were properly peeled and otherwise prepared before treatment; and that the method of treatment, the chemical composition and the amount of retention of the preservative conform to the requirements of this Section 735.0.

735.6 Maximum load on wood piles: Except as provided in the fourth paragraph of Section 734.3, the load on a wood pile shall not exceed the allowable load specified in Section 734.0, nor thirty-five (35) tons. For timber piles driven into material of Classes 6 through 10, the area at the surface of the bearing stratum shall be used to compute the allowable load.

735.7 Precautions in driving: To avoid damage to the pile, the size of the hammer shall be such that the driving energy in foot-pounds per blow shall not exceed numerically the point diameter of the pile in inches multiplied by fifteen hundred (1500). The total driving energy in foot-pounds for six (6) inches of penetration shall for all types of hammers be numerically not greater than the point diameter in inches times thirty-two thousand (32,000) for Type I species of wood or times twenty-two thousand (22,000) for Type II species of wood. For the last inch of penetration, the energy in foot-pounds shall not exceed numerically the point diameter in inches multiplied by six thousand (6,000). In any case, driving shall be stopped immediately when abrupt high resistance to penetration is encountered. Any sudden decrease in driving resistance shall be investigated with regard to the possibility of breakage of the pile; and if such sudden decrease in driving resistance cannot be correlated to boring data, and if the pile cannot be removed for inspection, it shall be considered adequate reason for rejection of the pile.

## SECTION 736.0 PRECAST CONCRETE PILES

736.1 Concrete strength: A precast concrete pile shall not be driven before the concrete has attained a compressive strength of not less than four thousand (4,000) pounds per square inch (psi) based on tests of cylinders cast from the same batches and cured under the same conditions as the pile concrete. These piles shall be so proportioned, cast, cured, handled and driven as to resist without significant cracking stresses induced by handling and driving as well as by loads.

736.2 Design: The piles shall be designed and reinforced in accordance with the applicable reinforced concrete regulations cited in Section 841.0. If for any reason the pile is injured, or the reinforcement is exposed, its use shall be condemned. The lateral reinforcement at both ends of the pile shall be spaced sufficiently close to resist impact stresses due to driving and more than three (3) inches on center. When driven to or into bearing materials of Classes 1 to 5 inclusive, or through materials containing boulders, they shall have metal tips of approved design. The minimum lateral dimension of a precast concrete pile shall be ten (10) inches.

736.3 Limitation of load: Except as provided in the fourth paragraph of Section 734.3, the load on precast concrete piles shall not exceed the allowable load specified in Section 734.0, thirty-three (33) per cent of the twenty-eight (28) day strength of the concrete, nor sixteen hundred (1600) psi. For prestressed concrete piles, thirty-three (33) per cent of the effective prestress load in the concrete after losses shall be deducted from thirty-three (33) per cent of the twenty-eight (28) day strength of the concrete or sixteen hundred (1600) psi, whichever is less, in computing the maximum allowable load.

736.4 Protection: A minimum covering of two (2) inches of concrete shall be provided over all reinforcements, except that for piles to be exposed to sea water and other severe environments, a three (3) inch protective covering shall be furnished in the zone of such exposure.

736.5 Minimum spacing: The minimum spacing center-to-center of precast concrete piles shall be two and one-half (2 1/2) times the square root of the cross-sectional area at the butt.

736.6 Splices: One splice shall be permitted in precast concrete piles.

## SECTION 737.0 CAST-IN-PLACE CONCRETE PILES

737.1 General: In this section a distinction is made between poured-concrete piles and pressure injected footings (compacted concrete piles). A poured-concrete pile is formed by pouring concrete into a driven casing that is permanently installed in the ground. A pressure injected footing is formed by placing concrete having a zero (0) slump in small batches, and compacting each batch. All cast-in-place concrete piles shall be made

and placed as to ensure the exclusion of all foreign matter and to secure a well-formed unit of full cross-section. The minimum strength of concrete for cast-in-place piles shall be three thousand (3,000) pounds per square inch (psi). While placing the concrete, the casing or drive-pipe shall contain not more than three (3) inches of water.

The maximum size of coarse aggregate for all concrete shall be three-quarter (3/4) inch and the concrete shall have a slump of four (4) to seven (7) inches. If placed from the top of pile, all concrete shall be poured in rapid, continuous operation through a funnel hopper centered at the top of the pile and having a discharge diameter less than the smallest diameter of the pile. After filling with concrete, the top ten (10) feet shall be thoroughly rodded.

### 737.2 Poured concrete piles

737.2.1 Design: The shape of the pile may be cylindrical, or conical, or a combination thereof, or it may be a succession of cylinders of equal length, with the change in diameter of adjoining cylinders not exceeding one (1) inch.

737.2.2 Loading: Except as provided in the fourth paragraph of Section 734.3, the load on poured concrete piles shall not exceed the allowable load specified in Section 734.0, thirty-three (33) per cent of the twenty-eight (28) day strength of the concrete, nor sixteen hundred (1600) psi, when applied to the cross-sectional area computed on the following basis:

1. For metal-cased piles driven to and into materials of Classes 1 to 4 inclusive, using the diameter measured one (1) foot above the point, except that when the rock is immediately overlain by a bearing stratum consisting of one (1) or a combination of bearing materials of Classes 5, 6 and 7, using the diameter at the surface of the bearing stratum.
2. For metal-cased piles, driven through compressible materials including Classes 11, 12, 13 and 15 and into a bearing stratum consisting of one (1) or a combination of bearing materials of Classes 5 to 10 inclusive, using the diameter at the surface of the bearing stratum.

737.2.3 Installation: Immediately before filling with concrete, the inside of the casing shall be thoroughly cleaned to the bottom and subjected to a visual examination. The casing shall be subject to the following limitations:

1. The diameter shall not vary more than twenty (20) per cent from the specified value.
2. The point of the casing shall not deviate more than ten (10) per cent of the length of the pile from the design alignment.

3. The casing shall not deviate by more than four (4) per cent of the length of the casing from the straight line connecting the midpoints to the ends of the casing. Any other condition which may affect the design performance shall be duly noted and evaluated subject to the requirements of the building official. A casing or drive-pipe shall not be filled with concrete until all casings or drive-pipes shall be filled with concrete until all casings or drive-pipes within a radius of seven (7) feet, or within the heave range, whichever is greater, have been driven to the required resistance.

### 737.3 Pressure injected footings

737.3.1 Loading: Except as provided in the fourth paragraph of Section 734.3, the load on pressure-injected footings shall be limited by the provisions of Sections 734.4 except that the circumscribing polygon shall start at the junction of the shaft and the enlarged base, and the bearing area shall be taken at planes six (6) feet or more below the junction.

737.3.2 Installation: The installation of pressure-injected footings shall fulfill the following requirements:

1. The drive pipe used for installing the pipes shall not be less than twenty (20) inches outside diameter for piles which have an allowable of one hundred (100) tons or greater, and not less than sixteen (16) inches outside diameter for piles which have an allowable load between fifty (50) and one hundred (100) tons. For loads less than fifty (50) tons, smaller drive casing may be used subject to the approval of the building official.
2. The enlarged base of the pressure-injected footings shall be formed on or in bearing materials of Classes 1 to 9 inclusive. The Class 9 material (fine sand) shall have a maximum of fifteen (15) per cent by weight finer than the No. 200 mesh sieve and shall be non-plastic, unless satisfactory load test results or other substantiating data are submitted to, and approved by, the building official.
3. The concrete in the base shall have a minimum compressive strength at twenty-eight (28) days of four thousand (4,000) psi; shall be of zero (0) slump, and shall be placed in batches not to exceed five (5) cubic feet in volume.
4. The last batch of concrete shall be driven into the enlarged base with not less than twenty-five (25) blows, each of not less than one hundred and forty thousand (140,000) foot pounds. For lower allowable loads, the required number of blows on the last batch shall vary in proportion to the allowable load. On the basis of test data, and subject to approval by the building official, the hammer blow energy may be reduced, in which case the number of blows on the last batch shall vary inversely with the energy delivered per blow.

5. During injection of the last five (5) cubic feet, the level of concrete in the drive casing shall not be more than six (6) inches above the bottom of the casing.
6. As the drive pipe is being withdrawn, not less than two (2) blows of at least twenty-five thousand (25,000) foot-pounds each shall be applied to compact each batch of concrete in an uncased shaft.
7. An uncased shaft shall not be formed through inorganic clay or inorganic silt unless a hole is made through such soil by a nondisplacement method, at least equal to the inside diameter of the drive pipe unless the individual piles are located more than nine (9) feet part and outside the heave range. Pressure-injected footings shall have cased shafts when spaced closer than nine (9) feet apart and when installed through inorganic clay or inorganic silt.
8. An uncased shaft shall not be formed through peat or other organic soils.
9. The permanent metal casing shall be fastened to the enlarged base in such a manner that the two will not separate. The concrete may be placed in the metal casing in the same manner as for poured-concrete piles. A metal casing shall not be filled with concrete until after all pressure injected footings within a radius of at least nine (9) feet have been driven. In metal-cased shafts the stresses in the concrete shall be thirty-three (33) per cent of the twenty-eight (28) day strength, but not exceeding sixteen hundred (1600) psi if non-corrugated steel casing is at least two-tenths (0.2) inch thick, the stress in the steel shall be thirty-five (35) per cent of the minimum specified yield strength, but not exceeding twelve thousand six hundred (12,600) psi. When required by soil conditions, allowance shall be made for corrosion as specified in Section 733.0.

737.4 Spacing: The center-to-center spacing of piles shall be not less than three (3) times the shaft diameter and not less than three and one-half (3 1/2) feet.

#### SECTION 738.0 CONCRETE-FILLED PIPE AND TAPERED TUBULAR PILES

738.1 Installation: Immediately before filling with concrete, the inside of the casing shall be thoroughly cleaned to the bottom and subjected to a visual inspection. The casing shall be subject to the following limitations:

1. The diameter shall not vary more than twenty (20) per cent from the specified value.
2. The point of the casing shall not deviate more than ten (10) per cent of the length of the pile from the design alignment.

3. The casing shall not deviate by more than six (6) per cent of the length of the casing from the straight line connecting the mid-points of the ends of the casing. Any other condition which may affect the design performance shall be duly noted and evaluated subject to the requirements of the building official. Concrete shall not be placed through water; except that the building official may approve the use of a properly-operated tremie or pumped concrete in still water, provided the pipe is proven to be free of other material.

738.2 Steel pipe: All steel pipe shall conform to the applicable standards listed in the reference standards in the appendices for welded and seamless steel pipe and tubes, and for hot-rolled carbon steel sheets. The yield point used in the design of steel casings shall be that of the fabricated element as determined by test.

738.3 Design: Except as provided in the fourth paragraph of Section 734.3, the load on concrete-filled pipe piles shall not exceed the allowable load determined in accordance with Section 734.0, a load computed on the basis of stress in concrete at twenty-five (25) per cent of the twenty-eight (28) day strength, or eleven hundred (1100) pounds per square inch (psi) and stress in the steel at nine thousand (9000) pounds per square inch; nor shall the load carried by the steel on this basis exceed one-half (1/2) the total load on the pile.

738.4 Minimum thickness: The minimum wall thickness of all load-bearing pipe, tubes and shells shall be one-tenth (1/10) inches. When required by soil conditions, allowance shall be made for corrosion as specified in Section 733.0.

738.5 Splices: All splices of the steel section shall comply with Section 732.6.

#### SECTION 739.0 CONCRETE-FILLED PIPE WITH STEEL CORE CAISSONS

739.1 Construction: These units shall consist of a shaft section of concrete-filled pipe extended to and firmly seated in bedrock of Classes 1 or 2 with an uncased socket drilled into the bedrock which is filled with cement grout. The steel core shall be centered in the shaft and shall extend through the cement grout to the bottom of the socket.

739.2 Steel shell: The steel shell shall be seamless or welded steel pipe with a minimum yield point of thirty-three thousand (33,000) pounds per square inch (psi), fitted with an approved cutting shoe and structural cap, or with other approved means of transmitting the super-structure load. The minimum diameter for drilled caissons shall be twenty-four (24) inches and minimum shell thickness five-sixteenths (5/16) inches. Steel shall be protected under the conditions specified in Section 733.0. Splices shall be welded to develop one hundred (100) per cent of the strength of the pipe.



739.3 Concrete fill: The concrete fill of caissons shall be controlled concrete with a minimum compressive strength of four thousand (4,000) psi after twenty-eight (28) days. It shall be so placed that it shall fill completely the space between the steel core and the pipe. In case the socket cannot be kept free from inflow of water, the pipe shall be filled to its top with clean water before placing the cement grout. The details of the design and installation, including the cleaning and inspection of the socket, the placement of concrete under water or in the dry, the method of centering the steel core, and all other phases of the work shall be submitted to the building official for approval.

739.4 Rock socket: A socket, approximately the inside diameter of the pipe shall be made in bedrock of Classes 1 or 2 to a depth that will assure load transfer when computed for a bearing on the bottom surface of the socket in accordance with Sections 722.0 and 725.0 acting together with a bond stress on the perimeter surface of the socket of two hundred (200) psi. The minimum socket depth shall be at least equal to the diameter of the pipe. Before placement of concrete, the socket and pipe shall be thoroughly cleaned and the rock inspected by a registered professional engineer.

739.5 Steel core: The steel core shall consist of a structural steel member. The mating ends of the sections shall be spliced so as to safely withstand the stresses to which they may be subjected. The minimum clearance between structural core and shell shall be two (2) inches. When such cores are installed in more than one (1) length, they shall be assembled to develop the full compressive strength of the section.

739.6 Driving precautions: Drilled caissons shall not be driven out of plumb by more than two (2) per cent of the length of the caissons.

739.7 Spacing: The minimum center-to-center spacing shall be not less than two and one-half (2 1/2) times the outside diameter of the steel shell.

739.8 Allowable load: Except as provided in the fourth paragraph of Section 734.3, the load on concrete-filled pipe piles with steel core shall not exceed the allowable load determined in accordance with the provisions of Section 739.4; nor that computed on the basis of stress in concrete at thirty-three (33) per cent of the twenty-eight (28) day strength, but not exceeding sixteen hundred (1600) psi; plus stress in the steel at thirty-five (35) per cent of the minimum specified yield strength but not exceeding twelve thousand six hundred (12,600) psi of the net area of the steel pipe plus fifty (50) per cent of the minimum specified yield strength but not exceeding eighteen thousand (18,000) psi of the area of the core steel.

SECTION 740.0 STRUCTURAL STEEL PILES

740.1 Steel: Steel sections may be of any type of steel permitted by the provisions of the reference standards of this article.

1. Rolled structural steel piles shall be of H form, with flange projection not exceeding fourteen (14) times the minimum thickness of metal in either flange or web and with total flange width at least eighty-five (85) per cent of the depth of the section. A section shall not have a nominal thickness of metal less than four-tenths (4/10) inch, nor a nominal depth in the direction of the web of less than eight (8) inches.
2. The use of built-up sections or sections of other than H form will be permitted if the several components of the section are adequately connected to develop the strength of the adjacent components and if the ratio of width to thickness of the component parts does not exceed the values for conventional H sections.
3. The tips of all steel H piles having a thickness of metal less than five-tenths (5/10) inches which are driven to end bearing on rock of Classes 1 through 3 by an impact hammer, shall be reinforced. The installation of all steel H piles by impact hammer to end bearing on rock of Classes 1 through 3 shall be conducted so as to terminate driving directly when the pile reaches refusal on the rock surface.
4. Structural caps shall be rigidly attached to the pile section and shall be designed to transfer the full load into the piles; except that when the pile extends into the footing sufficiently to develop the full load by bond, or to permit the use of mechanical devices to develop the full load by shear, structural caps shall not be required.

740.2 Splices: If piles are spliced, the splice shall develop one hundred (100) per cent of the strength of the section.

740.3 Protection: Structural steel piles shall be protected under the conditions specified in Section 733.0 or due allowance shall be made for corrosion as therein specified.

740.4 Allowable load: Except as provided in the fourth paragraph of Section 734.3, the load on such piles shall not exceed the allowable load determined in accordance with Section 734.0, nor shall a load based on stress exceed thirty-five (35) per cent of the minimum specified yield strength or twelve thousand six hundred (12,600) pounds per square inch (psi) on the cross section.

SECTION 741.0 COMPOSITE PILES

741.1 Design: A composite pile shall consist of a combination of not more than two (2) of any of the different types of piles provided for in this article. The pile shall fulfill the requirements for each type, and in addition the provisions of Section 741.0. The requirements of Section 737.2.3 shall apply to the entire length of a pipe shell composite pile.

741.2 Limitation of load: The allowable load on composite piles shall be that allowed for the weaker of the two sections. Except as provided in the fourth paragraph of Section 734.3, the allowable load on wood composite piles shall not exceed eighty (80) per cent of that allowed for the wood section alone. Wood shell composite piles shall not be used for support of buildings exceeding two (2) stories in height.

741.3 Splices: Splices between concrete sections and steel or wood sections shall be designed to prevent separation of the sections both before and after the concrete portion has set, and to insure the alignment and transmission of the total pile load. Splices shall be designed to resist uplift due to heave during driving of adjacent piles and shall develop the full compressive strength and not less than fifty (50) per cent of the strength in tension and bending of the weaker sections.

741.4 Spacings: The center-to-center spacing shall be governed by the larger of the spacings required in this article for the types composing the pile.

SECTION 742.0 SPECIAL PILES AND CAISSONS

742.1 General: Types of piles or caissons not specifically covered by the provisions of this code may be permitted subject to the approval of the building official, provided sufficient test data, design and construction information are filed by a registered professional engineer certifying that the pile or caisson installation is adequate to fulfill the design requirements.

SECTION 743.0 LATERAL SUPPORT

743.1 Surrounding materials: Any soil other than water or fluid soil including strata of soil not meeting the criterion in Figure 720 shall be deemed to afford sufficient lateral support to permit the design of any type of pile as a short column. When piles are driven through soil which will be removed subsequent at the completion of the foundation, the resistance offered by such material shall not be considered to contribute to the lateral supporting capacity.

743.2 Column action: The portion of a pile or pier that is not laterally supported shall be designed as a column in accordance with Section 844.0 and taking into consideration the conditions of end fixity.

SECTION 744.0 DESIGN REQUIREMENTS FOR FLOODPLAINS  
AND COASTAL HIGH HAZARD AREAS

744.1 Designated areas and projects: Plans for all structures and gas storage tanks, including new construction and substantial improvements to existing structures, and the placement of manufactured buildings and mobile homes, shall be subject to review by the building official to determine if the location is within any area of special flood hazards as designated by the Federal Insurance Administration (FIA), through issuance of a Flood Hazard Boundary Map or through a scientific and engineering report entitled "Flood Insurance Study" with accompanying Flood Insurance Rate Maps and Flood Boundary and Floodway Maps.

For the purposes of this section only, substantial improvements shall be defined as any repairs, reconstruction, or improvements, the cost of which exceeds fifty (50) per cent of the market value of the structure before repairs or damages.

744.2 Structural requirements in floodplains: If a structure is to be constructed, or substantially improved within the one hundred (100) year floodplain (land subject to a one [1] per cent or greater chance of flooding in any given year), as determined by the building official, it shall be designed and constructed to minimize flood damage. Plans for such building shall be submitted and certified by a registered professional engineer or architect to insure that the following requirements are met:

1. The building is designed (or modified) and adequately anchored to prevent flotation, collapse or lateral movement.
2. The building is constructed with materials and utility equipment resistant to flood damage.
3. Residential structures shall have the lowest floor, including basement or cellar, elevated to or above the one hundred (100) year elevation; or in the case of nonresidential structures, be floodproofed watertight to the one hundred (100) year level.
4. Where floodproofing is allowed for a particular building, it shall be designed to be watertight below the one hundred (100) year flood level and the floodproofing methods shall be adequate to withstand the flood depths, pressures, velocities, impact and uplift forces and other factors associated with the one hundred (100) year flood.
5. All mobile homes be anchored to resist flotation collapse, or lateral movement by providing over-the-top and frame ties to ground anchors in the following manner:
  - a. over-the-top ties be provided at each of the four corners of the mobile home; with two (2) additional ties per side at intermediate locations for mobile homes greater or equal to fifty (50)

feet long, and one (1) additional tie per side for mobile homes less than fifty (50) feet long;

- b. frame ties be provided at each corner of the mobile home; with five (5) additional ties per side at immediate points for mobile homes greater or equal to fifty (50) feet long, and four (4) additional ties per side for mobile homes less than fifty (50) feet long;
- c. all components of the anchoring system be capable of carrying a force of four thousand eight hundred (4,800) pounds; and
- d. any additions to the mobile home be similarly anchored.

744.3 Structural requirements in coastal high hazard areas: If a structure is to be constructed or substantially improved within a coastal high hazard area (land subject to high velocity waters, including hurricane wave wash), as determined by the building official, plans for such building shall be submitted and certified by a registered professional engineer or architect to insure that the following requirements are met:

1. the structure is elevated on adequately anchored pilings or columns, and securely anchored to such piles or columns so that the lowest portion of the structural members of the lowest floor (excluding the pilings or columns) is elevated to or above the one hundred (100) year level;
2. the structure is securely anchored, as provided above, in order to withstand velocity waters and hurricane wave wash;
3. fill is not used for structural support; and
4. the space below the lowest floor free is of obstructions or constructed with breakaway walls intended to collapse under stress, such temporarily enclosed space not to be used for human habitation.

744.4 Records: The building official shall obtain (or have the applicant provide) and maintain for public inspection a record of:

1. the elevations, in relation to mean sea level, of the lowest floor, including basement or cellar, and whether or not the building has a basement or cellar;
2. the elevation, in relation to mean sea level, to which a building has been floodproofed; and
3. the date when such construction commenced.

ARTICLE 8-Part A

MATERIALS AND TESTS

SECTION 800.0 GENERAL

800.1 Scope: The provisions of this article shall govern the quality, workmanship and requirements for all materials and methods and the minimum specifications for enclosure walls and wall thickness hereafter used in the construction of buildings and structures. All materials and methods of construction shall conform to the approved rules and the standards for materials and tests and the requirements of accepted engineering practice as herein listed (see Section 110.0).

|                      |   |
|----------------------|---|
| Appendix B . . . . . | Accepted Engineering Practice           |
| Appendix C . . . . . | Material Standards                      |
| Appendix D . . . . . | Structural Unit Test Standards          |
| Appendix E . . . . . | Structural Assembly Test Standards      |
| Appendix F . . . . . | Durability Test Standards               |
| Appendix G . . . . . | Fire Test Standards                     |
| Appendix H . . . . . | Standard Time-Temperature Test Controls |
| Appendix I . . . . . | Fire Protection Standards               |

800.2 Accepted engineering practice: The quality, use and installation of all materials, equipment, devices, systems or methods of construction shall be controlled by the standards of accepted engineering practice as listed in Appendix B except where otherwise specifically provided in this code.

800.3 Material standards: All building units used in wall, partition and floor construction and for fireproofing or other insulation purposes shall comply with the applicable standards listed in Appendix C.

800.4 Material not conforming to standards: All building materials, equipment, devices systems or methods of construction not provided for in this code (including Sections 800.3 and 110.0), and any material of questioned suitability proposed for use in the construction of a building or structure, shall be subjected to the tests prescribed in Sections 802.0 and 803.0 and in the approved rules to determine its character, quality, and limitations of use.

800.5 New materials and methods of construction: The provisions of this code are not intended to prevent the use of any material, system or method of construction not specifically prescribed by this code, provided any such alternate has been approved (see "Definitions," Section 201.0). The building official shall accept duly authenticated reports from the Commission on all new materials and methods of construction proposed for use which are not specifically provided for in this code.

800.6 Used materials and equipment: Used materials, equipment and devices which meet the minimum requirements of this code for new materials materials, equipment and devices shall be permitted; the building official may require satisfactory proof that such materials, equipment and devices have been reconditioned, tested, and/or placed in good and proper working condition prior to approval.

800.7 Equivalent materials or systems: Materials or systems which are subjected to tests determined by the Commission to be equivalent to those tests required by this code shall be accepted as meeting the requirements of this code.

#### SECTION 801.0 BASIC CLASSIFICATION OF CONSTRUCTION MATERIALS

801.1 General: All materials and methods used in the design and construction of buildings and structures shall be classified as controlled materials and ordinary materials as defined in Sections 201.0 and 719.0. The design and construction shall be based on the assumptions, limitations, and methods of stress determination of recognized design procedures.

#### SECTION 802.0 TESTS

802.1 Test standards: All structural units and assemblies shall be tested in accordance with the standards listed in Appendices D, E and F. In the absence of test procedures governing any specific material or method of construction, the building official shall accept authenticated reports from recognized authoritative sources which meet the requirements of this code.

802.2 Strength tests: To determine the safe uniformly distributed working load, when not capable of design by accepted engineering analysis, or to check the adequacy of the structural design of an assembly when there is reasonable doubt as to its strength or stability, every system of construction, sub-assembly or assembled unit and its connections shall be subjected to strength tests prescribed in this code, or to such other tests acceptable to the building official that simulate the loads and conditions of application that the completed structure will be subjected to in normal use. Structural load determinations shall include transverse floor and roof, wall compression and racking, concentrated load, plaster bond, puncture penetration and soil tests.

802.2.1 Strength tests for glass: The working strength of glass for any location in which it is required to withstand wind or impact loads shall be determined according to the following design procedure and criteria:

1. Design for wind loads by Section 857.5.4.
2. Design for impact loads of fully tempered, laminated and wired glass

shall comply with the requirements of the standard listed in Appendix B.

802.3 Deleted

802.4 Deleted

802.5 Performance test: Whenever there is sufficient evidence that the stability or structural safety of a completed building or structure or part thereof is inadequate for the intended use, the building official may require a load test of the building unit or portion of the structure in question. Such existing structure shall be subjected to a superimposed load equal to two (2) times the design live load. The test load shall be left in place for a period of twenty-four (24) hours. If during the test, or upon removal of the test load, the structure shows evidence of failure, the building official shall order such reinforcement or modifications deemed necessary to insure adequacy of the structure for the rated capacity; or in lieu thereof, he may specify a reduced working load to which the structure shall be limited. The structure shall be considered to have successfully met the test requirements if the total deflection does not exceed the theoretical deflection computed by accepted engineering formulae. When the total deflection is greater than such theoretical value, the structure shall be considered safe for the design load, if it recovers seventy-five (75) per cent of the maximum deflection within twenty-four (24) hours after removal of the test load.

802.6 Tests of service equipment and devices: Tests of service equipment and accessories shall include proscenium curtain and stage ventilation, Section 417.7; structural load tests, Section 702.0; flues and chimneys, Section 1002.0; boilers, the mechanical code listed in Appendix B; electric installations, Article 15; moving stairways, elevator interlocks and safety devices, Article 16; refrigerating equipment, and other mechanical and plumbing systems and devices as required by the mechanical code and the plumbing code listed in Appendix B and all other service tests required by the approved rules.

802.7 Fire tests: In the determination of flash points, combustibility, flameresistance and fireresistance rating of construction materials and methods, all tests shall be conducted in conformity to Sections 902.0, 903.0 and 904.0 and the applicable standards listed in Appendices G and I.

802.8 Prefabricated construction tests: Prefabricated assemblies or sub-assemblies not capable of design by accepted engineering analysis shall meet all the requirements and tests for at-site construction. The floor panels and other prefabricated units shall be assembled to form an integrated test specimen constructed as in practice, of not less than three (3) units in width with two (2) longitudinal joints; and when designed on the assumption of a simple span, such units shall be tested with flat end supports.



802.9 Test specimens: The selection and construction of all test specimens and the details of test procedure herein required shall conform to the recognized test procedures listed in the appendices. All test specimens and constructions shall be truly representative of the materials, workmanship and details to be normally applied in practice.

Note: Test procedures. Test requirements constitute fundamental performance standards and therefore come within the scope of this code. The detail test specifications and procedures are formulated and defined in the approved rules or by reference to accepted test standards of authoritative test agencies and organizations. Details of test procedures have been omitted from this code, except for essential basic requirements when deemed necessary.

### SECTION 803.0 CONDITIONS OF ACCEPTANCE

803.1 General: In evaluating the physical properties of materials and methods of construction when not subject to design by accepted engineering analysis, the structural requirements shall be based on the criteria established by the provisions of the following Sections 803.2 through 803.7.

#### 803.2 Test load factor

803.2.1 Loading: The test specimen shall sustain for a period of twenty-four (24) hours, without visible damage other than hairline cracks, its own weight, plus a superimposed test load equal to the dead load to be added at the site plus one hundred fifty (150) per cent of the design live load.

803.2.2 Allowed deflection: After completion of the test required by Section 803.2.1 and removal of all superimposed loads, the recovery of deflection within twenty-four (24) hours shall be at least seventy-five (75) per cent of the deflection due to the superimposed loads.

803.2.3 Failure loading: The test specimen shall sustain without collapse its own weight, plus a superimposed test load equal to fifty (50) per cent of its weight plus one hundred fifty (150) per cent of the dead load to be added at the site, plus two hundred fifty (250) per cent of the design live load.

803.3 Working load deflection: Under the approved working load, the deflection of floor and roof assemblies shall not be greater than one three-hundred-sixtieth ( $1/360$ ) of the span for plastered construction; one two-hundred-fortieth ( $1/240$ ) of the span for unplastered floor construction; and one one-hundred-eightieth ( $1/180$ ) of the span for unplastered roof construction.

803.4 Wall and partition assemblies: Bearing wall and partition assemblies shall sustain the load test both with and without window framing.

803.5 Comparative tests: When not available from existing authoritative test data, the building official may require comparative tests of assemblies of standard traditional forms of construction used for similar purposes to assist in determining the adequacy of the new construction.

803.6 Concentrated load tests: When not capable of design, all floor constructions in the use classification groups specified in Table 707 shall be subjected to the concentrated loads therein prescribed when such loading exceeds in stress effect the uniformly distributed load specified for such uses in Table 706.

803.7 Puncture penetration tests: All finish floor constructions in which light gage metal or other thin materials are used as the structural floor shall withstand the application of a two hundred (200) pound concentrated load applied to the top surface on an area of one (1) square inch at any point or points of the construction designated by the building official.

#### SECTION 804.0 APPROVALS

804.1 Written approval: Any material, equipment, device, system or method of construction meeting the requirements of this code shall be approved by the building official in writing within a reasonable time after satisfactory completion of all required tests and submission of required test reports.

804.2 Approved record: Whenever any material, equipment, device, system or method of construction shall have been approved by the building official, a record of such approval, including all the conditions and limitations of its permitted use, shall be kept on file in his office and shall be open to public inspection during business hours.

804.3 Identification of product: When identification of a material is necessary for structural safety, the approved material shall be identified by the approved label and the grade mark, trademark or other manufacturer's identification for which official recognition is desired. A drawing of the identification marks shall be filed with the building official and kept in the official records.

804.4 Heretofore approved materials: The use of any material already fabricated or of any construction already erected, which conformed to requirements or approvals heretofore in effect, shall be permitted to continue, if not detrimental to life, health or safety of the public.

#### SECTION 805.0 MASONRY CONSTRUCTION UNITS

805.1 Nominal dimensions: Dimensions and thicknesses specified in this code are nominal dimensions; actual dimensions may vary from the prescribed minimum in accordance with accepted tolerances in the building industry.

805.2 Second-hand units: Brick and other second-hand masonry units may be reused subject to the approval of the building official as to quality, condition and compliance with the requirements for new masonry units. The unit shall be of whole, sound material, free from cracks and other defects that would interfere with its proper laying or use; and shall be cleaned free from old mortar before reuse.

#### SECTION 806.0 BRICK UNITS

806.1 General: Brick of clay, shale and calcium silicate (sand-lime) shall be of a quality equal to that required by ASTM Standards for brick units; C216 for solid units of face brick; C62 for solid units of building brick; C652 for hollow brick; and C73 for calcium silicate brick. Grade requirements for clay and shale brick units in contact with the ground and/or subject to water, frost and freezing action shall be governed by the standards listed in Appendix C.

#### SECTION 807.0 STRUCTURAL CLAY TILE UNITS

807.1 General: Structural clay wall tile shall be of a quality equal to that required by ASTM Standards for structural clay tile units: C34 for loadbearing wall tile; C212 for structural clay facing tile; C56 for structural clay non-loadbearing wall tile. Grade requirements for units subjected to the weather and/or contact with the ground shall be governed by the standards listed in Appendix C.

807.2 Deleted

807.3 Deleted

#### SECTION 808.0 GLAZED CLAY MASONRY UNITS

808.1 General: Glazed masonry building units shall be of quality equal to that required by ASTM Standard C216 for ceramic glazed structural clay facing tile, face brick and solid masonry units.

#### SECTION 809.0 CONCRETE UNITS

809.1 Quality: Cast concrete units shall be of sound, compact structure, uniform in shape and free from cracks, warpage or other defects that would impair their serviceability or strength when laid in the wall.

809.2 Hollow load-bearing units: Approved hollow load-bearing concrete units for use below grade or unprotected against the weather by stucco, brick or other approved facings or veneers shall have a minimum compressive strength on the gross area of one thousand (1,000) psi; and for protected exterior use and general interior construction not less than seven hundred (700) psi.

809.3 Hollow nonload-bearing units: Approved hollow nonload-bearing concrete units shall have a minimum compressive strength on the average gross area of three hundred and fifty (350) psi.

809.4 Solid load-bearing units: Approved solid load-bearing concrete masonry units when unprotected against the weather or subject to frost and water action shall have a minimum compressive strength of eighteen hundred (1800) psi, and for protected exterior use or general interior use not less than twelve hundred (1200) psi.

809.5 Concrete brick: Approved concrete brick for use when exposed to freezing in the presence of moisture, shall have a minimum compressive strength of twenty-five hundred (2500) psi; and when used as a back-up in exterior walls or for general interior construction, a compressive strength of not less than twelve hundred and fifty (1250) psi.

809.6 Concrete fireproofing and furring units: Approved concrete block or tile used in fireproofing or furring, when not exposed to the weather, shall have a minimum compressive strength of three hundred (300) psi on net area tested as laid in practice. When exposed to the weather, the compressive strength shall be not less than seven hundred (700) psi on gross area. All nonbearing units shall be clearly marked to distinguish them from load-bearing units.

809.7 Concrete floor tile

809.7.1 Structural fillers: Structural concrete filler-block or tile when included in strength calculations in ribbed floor construction shall have webs and shells not less than one (1) inch thick and shall develop an average compressive strength on the net area not less than that of the rib concrete.

809.7.2 Other fillers: Removable tile and permanent fillers which are not included in strength calculations shall be of adequate strength to insure integrity of the unit and safety in handling as approved by the building official.

#### SECTION 810.0 GYPSUM UNITS

810.1 General: Gypsum tile or block shall not be used in bearing wall or in any location exposed to frequent or continuous wetting or in exterior walls unless protected from the weather. Approved gypsum unit shall develop a compressive strength of not less than seventy-five (75) psi on the gross area.

#### SECTION 811.0 STRUCTURAL GLASS BLOCK UNITS

811.1 General: Solid or hollow approved structural glass blocks shall not be used in fire walls, party walls or fire separation walls, or for

load-bearing construction. All mortar-bearing surfaces of the block shall be precoated or prepared to insure adhesion between mortar and glass.

#### SECTION 812.0 ARCHITECTURAL TERRA COTTA

812.1 General: All approved architectural terra cotta units shall be formed with a strong, homogeneous body of hard-burned, weather-resisting clay which gives off a sharp, metallic ring when struck and shall meet the strength and durability requirements of accepted engineering practice. All units shall be formed to engage securely with and anchor to the structural frame or masonry wall.

#### SECTION 813.0 NATURAL STONE

813.1 General: Natural stone for masonry shall be sound and free from loose or friable inclusions; and shall meet the strength, fireresistance, durability and impact resistance for the intended use in accordance with accepted engineering practice.

#### SECTION 814.0 CAST STONE

814.1 All approved cast stone shall be fabricated of concrete or other approved materials of required strength, durability and fireresistance for the intended use and shall be reinforced where necessary to conform to Section 841.0 and standards listed in Appendix B.

#### SECTION 815.0 MORTAR FOR MASONRY

815.1 Materials: All portland, natural and masonry cements, quick-lime and hydrated lime for use in masonry mortar shall meet the minimum strength and durability requirements of the standards listed in Appendices B and C.

815.2 Mortar types and proportions: Mortar for masonry construction shall conform to one (1) of the following types shown in Table 815.2 and shall be mixed to a consistent workability in the specified proportions measured by volume with clean fresh water free from harmful amounts of acids, alkalis, oils or organic materials; and with approved aggregates composed of hard, strong, durable mineral particles well-graded from fine to coarse, free from injurious amounts of acid, alkalis, oils, saline, organic and other deleterious substances in accordance with accepted engineering practice. Masonry mortars shall have a flow after suction of not less than seventy (70) per cent.

Table 815.2

## MORTAR PROPORTIONS (PARTS BY VOLUME)

| Mortar type | Portland cement | Masonry cement | Hydrated lime or lime putty |      | Damp loose aggregate  |
|-------------|-----------------|----------------|-----------------------------|------|---|
|             |                 |                | Min.                        | Max. |   |
| M           | 1               | —              | —                           | ¼    | Not less than 2¼ and not more than 3 times the sum of the volumes of the cements and lime used. |
| S           | 1               | 1              | —                           | —    |   |
|             | 1               | —              | ¼                           | ½    |   |
| N           | ½               | 1              | —                           | —    |   |
|             | 1               | —              | ½                           | 1¼   |   |
| O           | —               | 1              | —                           | —    |   |
|             | 1               | —              | 1¼                          | 2½   |   |

815.3 Types of mortar permitted: Unit masonry shall be laid in mortar of the following types listed in Table 815.3.

Table 815.3  
MASONRY AND MORTAR TYPES

| Type of masonry                                   | Types of mortar permitted     |
|---|-------------------------------|
| Masonry in contact with earth                     | M or S                        |
| Grouted and filled cell masonry                   | M or S                        |
| Masonry above grade or interior masonry           |                               |
| Piers of solid units                              | M, S, or N                    |
| Piers of hollow units                             | M or S                        |
| Walls of solid units                              | M, S, N or O                  |
| Walls of hollow units                             | M, S or N                     |
| Cavity walls and masonry bonded hollow walls      |                               |
| Design wind pressure exceeds 20 psf               | M or S                        |
| Design wind pressure 20 psf or less               | M, S or N                     |
| Glass block masonry                               | S or N                        |
| Nonloadbearing partitions and fireproofing        | M, S, N, O or Gypsum          |
| Gypsum partition tile or block                    | Gypsum                        |
| Fire brick  | Refractory air-setting mortar |
| Linings of existing masonry, above or below grade | M or S                        |
| Masonry other than above                          | M, S or N                     |

815.4 Alternate methods: Alternative methods of constructing masonry walls may be used, providing that the structural requirements of Article are fully satisfied by the assembly.

815.5 Dry stacking and bonding: Masonry walls that are laid dry and are bonded on each side with a formulation of portland cement and alkali-resistant glass fibers with or without sand and mixed with water shall be permitted, providing the following allowable working stresses, based on gross area, are not exceeded.

|   |         |
|---|---------|
| 1. Compression                                |         |
| Standard hollow block . . . . .               | 45 psi  |
| Ground hollow block. . . . .                  | 85 psi  |
| Solid block                                   |         |
| 1800 + psi . . . . .                          | 110 psi |
| 1200 - 1800 psi . . . . .                     | 80 psi  |
| 2. Shear . . . . .                            | 10 psi  |
| 3. Flexural tension-vertical span . . . . .   | 18 psi  |
| 4. Flexural tension-horizontal span . . . . . | 30 psi  |

Bearing walls so constructed shall have a minimum wall thickness of six (6) inches.

815.6 Deleted

815.7 Deleted

815.8 Deleted

SECTION 816.0 CONCRETE AGGREGATES

816.1 Aggregate quality: All concrete aggregates shall conform to the requirements of ACI 318, ASTM C33 and ASTM C330 as listed in Appendices B and C.

816.2 Deleted

816.3 Deleted

816.4 Deleted

SECTION 817.0 READY-MIX CONCRETE

817.1 Control: Ready-mixed concrete shall conform to the requirements of ACI 318 and ASTM C94 as listed in Appendices B and C.

817.2 Deleted

817.3 Deleted

SECTION 818.0 STRUCTURAL WOOD GLUES

818.1 Quality of glue: Glues used in structural assemblies of built-up or laminated lumber sections shall develop the full strength of the wood, shall not produce decomposition or deleterious chemical reaction in the wood structure and shall not be attractive to vermin.

818.2 Manufacturers' requirements: Approved structural glues shall be handled, mixed and applied as prescribed by the manufacturer and the

gluing shall be done only in accordance with the timber construction standards listed in Appendix B.

818.3 Deleted

#### SECTION 819.0 INTERIOR LATHING AND PLASTERING

819.1 General: All interior lathing and plastering shall conform to the standards of accepted engineering practice for lathing, furring and accessories and gypsum and portland cement plastering listed in Appendices B and C; except as may be otherwise provided by statute or in this code for specific materials.

819.2 Deleted

#### SECTION 820.0 EXTERIOR LATHING AND STUCCO

820.1 General: All exterior lathing, plastering and stucco work shall be installed of portland cement or other approved mortar as provided in the standards listed in Appendices B and C, in accordance with accepted engineering practice or as provided in this code for specific materials.

820.2 Reinforcement: All stucco work shall be reinforced with approved metal lath or wire fabric except when applied directly to a masonry or concrete base, or when installed on a masonry base which is protected with bituminous surfacing.

820.3 Minimum weight: Metal lath, expanded metal and wire reinforcing fabric shall weigh not less than that indicated in the following Table 820.

Table 820  
MINIMUM REINFORCEMENT WEIGHT

| Type of reinforcement | Minimum steel wire gage | Maximum mesh (inches) | Minimum weight (pounds per square yard) |
|-----------------------|-------------------------|-----------------------|---|
| Metal lath .....      | —                       | —                     | 3.4                                     |
| Expanded metal .....  | —                       | —                     | 1.8                                     |
| Woven wire .....      | 18 (0.048 in.)          | 1                     | 1.74                                    |
| Woven wire .....      | 17 (0.054 in.)          | 1½                    | 1.41                                    |
| Woven wire .....      | 16 (0.063 in.)          | 2                     | 1.47                                    |
| Welded wire .....     | 18 (0.048 in.)          | 4 sq. in.             | 0.67                                    |
| Welded wire .....     | 17 (0.054 in.)          | 4 sq. in.             | 0.82                                    |
| Welded wire .....     | 16 (0.063 in.)          | 4 sq. in.             | 1.10                                    |

820.4 Corrosion resistance: All metal lath and stucco reinforcing fabric shall be protected with a zinc, or other approved rust-resistive coating or rust-inhibitive paint, or shall be manufactured from approved corrosion-resistive alloys.



820.5 Sheathing: Except in back-plastered construction, the studs shall be covered with approved sheathing complying with Section 854.0; or not less than No. 18 Steel Wire Gauge (0.048 inch) galvanized wire shall be stretched horizontally at six (6) inch centers and shall be covered with not less than fourteen (14) pound waterproof felt or paper before applying the reinforced stucco; or an approved paper-backed wire fabric may be used of not less than No. 16 Steel Wire Gauge (0.063 inch) galvanized wire with stiffening ribs not more than five (5) inches on centers to which is attached a double layer of fibrous waterproof backing. The mesh opening shall not exceed two by two (2x2) inches.

820.6 Back-plastered construction: In back-plastered construction, when spacing of studs exceeds sixteen (16) inches, approved horizontal non-combustible cross-furring at not more than sixteen (16) inch centers shall be first applied; unless approved stiffened lath is used and the frame is adequately stiffened as provided in Section 854.0.

820.7 Application on masonry base: When applied directly to masonry or monolithic concrete, the surfaces shall be roughened, hacked or bush-hammered to provide bond, or a preparatory dash coat of portland cement grout shall be applied. The dash coat shall be kept damp for at least two (2) days after application and before applying succeeding stucco coats.

#### 820.8 Protection

820.8.1 From freezing: At all times during application and for a period of not less than forty-eight (48) hours after application of each coat, provision shall be made to keep stucco work above fifty (50) degrees F.

820.8.2 From moisture: Stucco shall be kept a sufficient height above ground surfaces as provided in Section 854.0 and all sills, coping and projecting courses shall be flashed and provided with drips as therein specified.

### SECTION 821.0 PLASTERING MATERIALS

821.1 General: All sand, quick-lime, hydrated lime, hair binder, gypsum, keene and portland cements, pozzuolanic cements and aggregates and other materials used in plastering shall be stored, protected and applied in accordance with the standards of accepted engineering practice listed in Appendices B and C and the approved rules.

821.2 Special cements and plasters: Approved cements used in plastering may have admixtures of approved plasticity agents added in the manufacturing process or when mixing the plaster at the site in the approved proportions. All premixed special plasters, cements and aggregates shall be packaged and identified with the approved label.

821.3 Lime plaster: Lime and hydrated lime plasters for use in base and finish coats shall be applied in accordance with the approved rules and the manufacturers' specifications.

821.4 Gypsum plaster: All gypsum plaster shall comply with the standard specifications listed in Appendix C.

821.5 Gypsum plasters with special aggregates: When gypsum is used with manufactured aggregates in place of natural sand for plaster, the mixture shall be proportioned and applied in accordance with the manufacturer's recommendations and the applicable standard in Appendix B.

#### SECTION 822.0 PLASTER BASES

822.1 Fiber boards: Approved fiber boards used as plaster bases shall comply with Section 823.0. The surface of such boards shall be of a rough, fibrous texture to insure mechanical and suction bond; and the boards shall meet the bond and strength tests specified by the standards listed in Appendix C and the approved rules.

822.2 Gypsum lath: Except when greater thickness is required for fire-resistance rating under the provisions of Article 9, or as herein specified, gypsum lath used for plastering shall be not less than three-eighths (3/8) inch thick and shall comply with the standards listed in Appendix C.

822.3 Perforated gypsum lath: Where required to provide specified time-temperature performance, perforated gypsum lath shall be not less than three-eighths (3/8) inch thick. The openings shall be equivalent to three-quarter (3/4) inch diameter holes for each sixteen (16) square inches of lath surface; or the lath shall be perforated as determined by full size tests for load, strength and fireresistance ratings.

822.4 Metal lath: The dimensions and sizes of expanded, ribbed and sheet metal lath shall comply with accepted engineering practice and the standards listed in Appendix B; and shall be fabricated from not less than No. 30 Manufacturer's Standard Gauge (0.012 inch) steel sheets. It shall be manufactured from copper-bearing steel, coated with rust-inhibitive paint after cutting, or cut from zinc-coated steel sheets.

822.5 Wire lath: All types of wire lath shall comply with accepted engineering practice and the standards listed in Appendix B; and shall be fabricated from woven or welded wire of not less than No. 19 Steel Wire Gauge (0.041 inch) with not more than two and one-half (2 1/2) meshes to the inch. Woven or welded wire reinforcement shall be coated with zinc or rust-inhibitive paint.

822.6 Paper-backed lath: Expanded metal or wire lath backed with integral approved paper shall be fabricated from the minimum gages and weights specified in Sections 822.4 and 822.5.

822.7 Combustible lath: Wood lath shall be erected horizontally on walls and partitions and ceiling lath shall run in one (1) direction only; but in either case it shall not extend through cross-partitions from room to room. Wood lath shall be not less than one (1) inch wide nor less than five-sixteenth (5/16) inches thick and shall comply with all the requirements of accepted engineering practice. The lath joints shall be staggered so that not more than seven (7) laths occur in any one (1) continuous break.

#### SECTION 823.0 FIBER BOARDS

823.1 General: Insulating boards manufactured with wood or other vegetable fibers used as building boards for sheathing, roof decks, plaster bases, interior wall and ceiling finish, roof insulation or sound deadening, shall be vermin proof, resistant to rot-producing fungi, water-repellent and shall meet the strength and durability tests specified in the standards listed in Appendix C. When required under the provisions of Article 9, the boards shall be protected or treated to develop the required fireresistance rating or flameresistance as determined by test.

823.2 Jointing: To insure tight-fitting assemblies, edges shall be manufactured square or shiplapped, beveled, tongue-and-grooved or U-jointed; and shall be installed in accordance with accepted engineering practice.

823.3 Plaster base: When used as a plaster base, fiber boards shall be permitted in fireresistive construction complying with the test provisions of Article 9, except where specifically prohibited in fireproof (Type 1) and noncombustible (Type 2) construction.

823.4 Roof insulation: When used as roof insulation in all types of construction, fiber boards shall be protected with an approved type of roof covering.

823.5 Wall insulation: When installed and firestopped to comply with Article 9, fiberboards may be used for wall insulation in all types of construction. In fire wall and fire separation wall construction, unless treated to be fireretardant as provided in Sec. 904.0 for Class I materials, the boards shall be cemented directly to the masonry or other noncombustible base and shall be protected with an approved noncombustible veneer anchored to the base without intervening air spaces.

823.6 Dry wall construction: Where fireresistance ratings are required, provision shall be made for interlocking, lapping or otherwise protecting the joints between adjacent boards to insure smoke and flame tightness.

823.7 Insulating roof deck: When used as roof decking in open beam construction fiber board insulating roof deck shall have a minimum nominal thickness not less than one (1) inch.

## SECTION 824.0 PLYWOOD

824.1 Quality: All plywood when used structurally shall meet the performance standards and all other requirements of U.S. Product Standard PS 1 listed in Appendix C for the type, grade and identification index or species group of plywood involved and shall be so identified by an approved agency. Working stresses shall conform to the standards of accepted engineering practice as listed in Appendices B and C.

824.2 Types: Plywood for interior use may be either of the moisture resistant or exterior type; plywood for exterior use shall be of the exterior waterproof type. Exterior plywood may be applied directly to the framing as a siding, provided it has a nominal thickness of three-eighths (3/8) inch. Joints shall occur over framing members, unless wood or plywood sheathing is used or joints are lapped horizontally a minimum of one and one-half (1 1/2) inches or otherwise made waterproof to the satisfaction of the building official. If plywood is used as lapped siding without sheathing, the wall framing to which it is attached shall be diagonally braced.

824.3 Spans: The maximum spans for plywood roof sheathing and sub-flooring shall be limited by the allowable stresses and deflections for the design live load but shall have not less than the following identification index specified in Table 824.3.1, provided it is continuous over two (2) or more spans and laid with face grain perpendicular to the supports.

824.3.1 Floor and roof sheathing: Allowable spans for floor and roof sheathing shall be as specified in the following Table 824.3.2

Table 824.3.1

**ALLOWABLE SPANS FOR PLYWOOD FLOOR AND ROOF SHEATHING CONTINUOUS OVER TWO OR MORE SPANS AND FACE GRAIN PERPENDICULAR TO SUPPORTS<sup>1</sup> (SPAN IN INCHES)**

| Panel Identification Index <sup>2</sup><br>Roof span,<br>roof/floor span | Roof                  |                            |                 | Floor           |                 |                                    |
|--|-----------------------|----------------------------|-----------------|-----------------|-----------------|------------------------------------|
|  | Maximum Span (inches) |                            |                 | Load (psf)      |                 | Maximum span <sup>5</sup> (inches) |
|  | Thickness (inches)    | Edges blocked <sup>3</sup> | Edges unblocked | Total Load      | Live Load       |                                    |
| 12/0   | 5/16                  | 12                         | 12              | 155             | 150             | 0                                  |
| 16/0   | 5/16, 3/8             | 16                         | 16              | 95              | 75              | 0                                  |
| 20/0   | 5/16, 3/8             | 19.2                       | 19.2            | 75              | 65              | 0                                  |
| 24/0   | 3/8                   | 24                         | 20              | 65              | 50              | 0                                  |
| 24/0   | 1/2                   | 24                         | 24              | 65              | 50              | 0                                  |
| 30/12  | 3/8                   | 30                         | 26              | 70              | 50              | 12 <sup>7</sup>                    |
| 32/16  | 1/2, 5/8              | 32                         | 28              | 55              | 40              | 16 <sup>8</sup>                    |
| 36/16  | 3/4                   | 36                         | 30              | 55              | 50              | 16 <sup>8</sup>                    |
| 42/20  | 3/8, 3/4, 7/8         | 42 <sup>9</sup>            | 32              | 40 <sup>4</sup> | 35 <sup>4</sup> | 20 <sup>8</sup>                    |
| 48/24  | 3/4, 7/8              | 48                         | 36              | 40 <sup>4</sup> | 35 <sup>4</sup> | 24                                 |

Note 1: These values apply for Structural I and II, C-D and C-C grades only. Spans shall be limited to values shown because of possible effect of concentrated loads.

Note 2: Identification index appears on all panels in the construction grades listed in footnote (1).

Note 3: Edges may be blocked with lumber or other approved type of edge support.

Note 4: For roof live load of forty (40) psf or total load of fifty-five (55) psf, decrease spans by thirteen (13) per cent or use panel with next greater identification index.

Note 5: Plywood edges shall have approved tongue-and-groove joints or shall be supported with blocking, unless one-fourth (1/4) inch minimum thickness underlayment is installed, or finish floor is twenty-five thirty-seconds (25/32) inch wood strip. Allowable uniform load based on deflection of one three-sixtieth (1/300) of space is one hundred sixty-five (165) psf.

780 CMR: STATE BUILDING CODE COMMISSION

**Note 6.** Plywood roof sheathing continuous over two or more spans may be placed with face grain parallel to supports spaced not over twenty-four (24) inches on center if all panel edges are blocked or other approved type edge support is provided, and if live loads do not exceed twenty-five (25) psf for one-half (1/2) inch Structural I (4-ply) and one-half (1/2) inch 5-ply in other grades, or forty (40) psf for one-half (1/2) inch Structural I (5-ply) and five-eighths (5/8) inch 5-ply in other grades.

**Note 7.** May be sixteen (16) inches, if twenty-five thirty-seconds (25/32) inch wood strip flooring is installed at right angles to joists.

**Note 8.** May be twenty-four (24) inches if twenty-five thirty-seconds (25/32) inch wood strip flooring is installed at right angles to joists.

**Note 9.** For joists spaced twenty-four (24) inches on center plywood sheathing with Identification Index Numbers 42/20 or greater can be used for subfloors when supporting one and one-half (1 1/2) inches of lightweight concrete.

**Table 824.3.1.A**

**ALLOWABLE LOADS FOR PLYWOOD ROOF SHEATHING CONTINUOUS OVER TWO OR MORE SPANS AND FACE GRAIN PARALLEL TO SUPPORTS\***

|                              | Thickness | No. of plies | Span | Total load | Live load |
|------------------------------|-----------|--------------|------|------------|-----------|
| Structural I                 | 1/2       | 4            | 24   | 35         | 25        |
|                              | 1/2       | 5            | 24   | 55         | 40        |
| Other grades covered in PS 1 | 1/2       | 5            | 24   | 30         | 25        |
|                              | 5/8       | 4            | 24   | 40         | 30        |
|                              | 5/8       | 5            | 24   | 55         | 45        |

\*Uniform load deflection limitations: 1/180 of span under live load plus dead load, 1/240 under live load only. Edges shall be blocked with lumber or other approved type of edge supports.

**824.3.2 Plywood combination subfloor underlayment:** Allowable spans for combination subfloor underlayment shall be as specified in the following Table 824.3.2.

**Table 824.3.2**

**ALLOWABLE SPANS FOR PLYWOOD COMBINATION SUBFLOOR-UNDERLAYMENT, PLYWOOD CONTINUOUS OVER TWO (2) OR MORE SPANS AND FACE GRAIN PERPENDICULAR TO SUPPORTS (THICKNESS IN INCHES)**

| Species groups | Maximum spacing of joists (inches) |     |     |
|----------------|------------------------------------|-----|-----|
|                | 16                                 | 20  | 24  |
| 1              | 1/2                                | 5/8 | 3/4 |
| 2, 3           | 5/8                                | 3/4 | 7/8 |
| 4              | 3/4                                | 7/8 | 1   |

**Note 1.** Applicable to underlayment grade, C-C (plugged) and all grades of sanded exterior type plywood. Spans limited to values shown because of possible effect of concentrated loads. Allowable uniform load based on deflection of one three hundred sixtieth (1/360) of span is one hundred twenty-five (125) psf. Plywood edges shall have approved tongue-and-groove joints or shall be supported with blocking, unless one-fourth (1/4) inch minimum thickness underlayment is installed, or finish floor is twenty-five thirty-seconds (25/32) inch wood strip. If wood strips are perpendicular to supports, thicknesses shown for sixteen (16) inch and twenty (20) inch spans may be used on twenty-four (24) inch span. Except for one-half (1/2) inch, underlayment grade and C-C (plugged) panels may be of nominal thickness one thirty-second (1/32) inch less than the nominal thickness shown when marked with the reduced thickness.

**824.3.3 Vertical maximum stud spacing:** Stud spacing for vertical sheathing and for use in stress-skin panel or other prefabricated constructions shall be determined by accepted engineering analysis or by the tests prescribed for prefabricated assemblies in Section 802.0.

**SECTION 825.0 WALLBOARDS AND SHEATHING**

**825.1 Sheathing:** Sheathing of particleboard, gypsum, processed fiber or other approved materials shall conform to accepted engineering practice. All sheathing shall be identified as to compliance with appropriate standards. When used in frame construction, they shall meet requirements of Sections 854.2 and 854.3. When required to meet fire-resistance ratings, the assembled construction shall comply with Table 214 for structural elements and Article 9 for trim and finishes.

825.2 Wallboards: Wallboard of particleboard, gypsum, processed fiber or other approved materials shall conform to accepted engineering practice. All wallboards shall be identified as to compliance with appropriate standards. Wallboard shall conform to the standards of accepted engineering practice for gypsum or processed fiber wallboard interior finishes, listed in Appendices B and C. When required to meet fireresistance ratings, the assembled construction shall comply with Table 214 for structural elements and Article 9 for trim and finishes.

825.2.1 Water resistant gypsum backer board: In all areas subjected to repeated damp conditions and moisture accumulation such as bathtub and shower compartments, water resistant gypsum backer board (ASTM C630) shall be used as a substratum unless protected with a moisture proof and vapor proof covering.

ARTICLE 8-Part B

STEEL, MASONRY, CONCRETE, GYPSUM  
AND LUMBER CONSTRUCTION

SECTION 826.0 STRUCTURAL STEEL CONSTRUCTION

826.1 General: The quality, fabrication and erection of structural steel for buildings shall conform to the requirements of the Specifications for the Design, Fabrication and Erection of Structural Steel for Buildings of American Institute for Steel Construction as listed in Appendix B.

826.2 Deleted

826.3 Deleted

826.4 Deleted

826.5 Deleted

826.6 Deleted

SECTION 827.0 FORMED STEEL CONSTRUCTION

827.1 Formed steel construction: The design, fabrication and erection of cold-formed steel construction shall conform to the Specification for the Design of Cold-Formed Steel Structural Members of American Iron and Steel Institute as listed in Appendix B. All individual structural members and assembled panels of cold-formed steel construction, except where fabricated of approved corrosion-resistive steel or of steel having corrosion-resistive metallic or other approved coating, shall be protected against corrosion with an acceptable shop coat of paint, enamel, or other approved protection.

827.2 Cold-formed stainless steel construction: The design, fabrication and erection of cold-formed stainless steel construction shall conform to the Specification for the Design of Cold-Formed Stainless Steel Structural Members of American Iron Steel Institute as listed in Appendix B.

827.3 Deleted

827.4 Deleted

#### SECTION 828.0 STEEL JOIST CONSTRUCTION

828.1 General: The design, fabrication erection of open web steel joist construction shall conform to the requirements of the Standard Specifications for Open Web Steel Joists J- and H- Series of American Institute of Steel Construction and Steel Joist Institute as listed in Appendix B.

828.2 Deleted

828.3 Deleted

828.4 Deleted

#### SECTION 829.0 REINFORCING STEEL

829.1 General: Metal reinforcement for reinforced concrete, reinforced gypsum concrete, reinforced brickwork and reinforced hollow block construction shall conform to the requirements of Building Code Requirements for Reinforced Concrete, ACI 318; Building Code Requirements for Engineered Brick Masonry of the Brick Institute of America; Specification for the Design and Construction of Load-Bearing Concrete Masonry, NCMA 70, as listed in Appendix B, and applicable ASTM Standards listed in Appendix C.

829.2 Deleted

829.3 Deleted

829.4 Deleted

829.5 Deleted

#### SECTION 830.0 CAST STEEL CONSTRUCTION

830.1 Materials: Carbon steel casting for building construction shall be cast from steel conforming to the requirements of accepted engineering practice listed in Appendix B and the applicable standards listed in Appendix C. All castings shall be free from injurious blow holes or other defects which would impair the structural strength.

830.2 Higher strength cast steel: Higher strength cast steel may be used when approved under controlled material procedure.

830.3 Welding cast steel: Cast steel designed for use in welding shall be of weldable grade complying with the approved rules.

SECTION 831.0 DELETED

SECTION 832.0 SPECIAL STEELS

832.1 General: Alloy, high carbon or other special high strength steels not listed in Appendix C, may be used in the design and construction of buildings and structures as controlled materials as prescribed in Section 721.0.

SECTION 833.0 LIGHT WEIGHT METAL ALLOYS

833.1 General: Aluminum and other approved light weight metals and alloys shall be used for structural purposes in buildings and structures in accordance with the applicable standards listed in Appendix B.

SECTION 834.0 MASONRY WALL CONSTRUCTION

834.1 Design: All masonry construction shall comply with the provisions of this article governing quality of materials and manner of construction; and shall be of adequate strength and proportions to support all superimposed loads within working stresses prescribed in this code and the standards of accepted engineering practices listed in Appendix B.

834.2 Wetting of brick: Brick (clay or shale) at the time of laying shall require wetting if the units' initial rate of water absorption exceeds thirty (30) grams per thirty (30) square inches per minute or point zero thirty-five (0.035) ounces per square inch, as determined by ASTM C67, Standard Specifications for Sampling and Testing Brick and Structural Clay Tile as listed in Appendix B.

834.3 Cold weather construction: Masonry laid in temperatures of the outside air below forty (40) degrees F shall be protected in accordance with the provisions provided in Recommended Practices and Guide Specifications for Cold Weather Masonry of the International Masonry Industry All-Weather Council as listed in Appendix B.

SECTION 835.0 BONDING OF WALLS

835.1 General: Walls of solid, composite and hollow masonry and cavity and other hollow walls shall be bonded in accordance with accepted engineering practice.



835.2 Rubble stone walls: All stones in rubble masonry shall be laid on their natural bed and the walls shall be bonded with not less than one (1) through bond stone for each nine (9) superficial square feet of area.

835.3 Buttresses and piers: All buttresses shall be bonded into the wall by a masonry bond. The piers and buttresses shall have sufficient strength and stability with sufficient bonding or anchorage between the walls and the supports to resist wind pressure and suction.

835.4 Intersecting walls and partitions: Masonry walls and partitions shall be securely anchored or bonded at points where they intersect by one (1) of the following methods:

1. Walls may be bonded by laying at least fifty (50) per cent of the units at the intersection in true masonry bond with alternate units having a bearing of not less than three (3) inches upon the unit below, or they may be anchored with not less than three-sixteenths (3/16) inch corrosion-resistant metal wire ties or joint reinforcement at vertical intervals not to exceed two (2) feet, or by other equivalent approved anchorage.
2. Where walls are carried up separately, the intersection shall be toothed or blocked with eight (8) inch maximum offsets and shall be provided with approved metal anchors at vertical intervals of not more than four (4) feet or, when approved, blocking may be eliminated and rigid steel anchors shall be provided, spaced not more than two (2) feet apart vertically.
3. Interior non-loadbearing walls may be bonded or anchored as required by 1 or 2 above or they may be anchored at their intersection, at vertical intervals of not more than two (2) feet, with at least No. 22 Galvanized Sheet Gauge (0.034 in.) corrosion-resistant corrugated metal ties seven-eighths (7/8) inch in width, or other equivalent approved method of anchorage.

835.5 Erecting precautions: Where hollow walls decrease in thickness, a course of solid masonry or of concrete-filled units, or a continuous bearing plate shall be interposed between the thicker and thinner sections. A wall shall not be built up more than twenty-five (25) feet in advance of other walls of the same building or structure unless supported independently at each floor; and all walls shall be temporarily braced during erection.

#### SECTION 836.0 LATERAL BRACING OF WALLS

836.1 General: All masonry walls shall be laterally supported by horizontal bracing of floor and roof framing or vertical bracing of columns, buttresses or cross-walls at vertical or horizontal intervals as specified in the accepted engineering practice standards for masonry listed in Appen-

dix B; and provision shall be made in the structure to transfer wind pressures and other lateral forces to the foundations.

SECTION 837.0 CHASES AND RECESSES IN BEARING WALLS

837.1 General: Chases and recesses shall conform to the accepted engineering practice standards for masonry listed in Appendix B.

837.2 Deleted

837.3 Deleted

837.4 Deleted

837.5 Deleted

SECTION 838.0 CORBELED AND PROJECTED MASONRY

838.1 Limitations: The maximum total horizontal projection of corbels from the plane of the wall shall be not more than one-half (1/2) the thickness of the wall. The maximum projection of one (1) unit shall neither exceed one-half (1/2) the height of the unit nor one-third (1/3) of the bed depth.

838.2 Hollow masonry or cavity walls: Hollow masonry or masonry built of hollow units shall be supported on solid masonry conforming to corbeling limitations of Section 838.1.

838.3 Molded cornices: Unless structural support and anchorage is provided to resist the overturning moment, the center of gravity of all projecting masonry or molded cornices shall lie within the middle third of the supporting wall. Terra cotta and metal cornices shall be provided with a structural frame of approved noncombustible material anchored in an approved manner.

SECTION 839.0 BEARING ON HOLLOW UNIT WALLS

839.1 Bearing area: Beam, girder and other concentrated loads shall be provided with a bearing of solid masonry or filled cores of hollow unit masonry in accordance with acceptable engineering practice.

839.2 Closure tiles: All open cells in tile or blocks at wall ends and at openings shall be filled solidly with grout for a length of not less than twelve (12) inches.

SECTION 840.0 PLAIN CONCRETE

840.1 General: Structural members of plain concrete shall be designed and constructed to conform to the requirements of ACI 322 listed in Appendix B.

840.2 Deleted

SECTION 841.0 REINFORCED CONCRETE

841.1 General: All structures of reinforced concrete, including pre-stressed concrete, shall be designed and constructed to conform to the requirements of ACI 318 listed in Appendix B.

841.2 Deleted

841.3 Deleted

841.4 Deleted

841.5 Deleted

SECTION 842.0 DELETED

SECTION 843.0 DELETED

SECTION 844.0 DELETED

SECTION 845.0 DELETED

SECTION 846.0 CONCRETE-FILLED PIPE COLUMNS

846.1 General: Concrete-filled pipe columns shall be manufactured from standard, extra strong, or double extra strong steel pipe and tubing, filled with concrete so placed and manipulated as to secure maximum density and to insure complete filling of the pipe without voids.

846.2 Design: The safe supporting capacity of concrete-filled pipe columns shall be computed in accordance with the approved rules or as determined by test.

846.3 Connections: All caps, base-plates and connections shall be of approved types and shall be positively attached to the shell and anchored to the concrete core. Welding of brackets without mechanical anchorage shall be prohibited. When the pipe is slotted to accommodate webs of brackets or other connections, the integrity of the shell shall be restored by welding to insure hooping action of the composite section.

846.4 Reinforcement: To increase the safe load supporting capacity of concrete-filled pipe columns, the steel reinforcement shall be in the form of rods, structural shapes or pipe embedded in the concrete core with

sufficient clearance to insure the composite action of the section, but not nearer than one (1) inch to the exterior steel shell. All structural shapes used as reinforcement shall be milled to insure bearing on cap and base plates.

846.5 Fireresistance rating protection: Pipe columns shall be of such size or so protected as to develop the required fireresistance ratings specified in Table 214. When an outer steel shell is used to enclose the fireproof covering, it shall not be included in the calculations for strength of the column section. The minimum diameter of pipe columns shall be four (4) inches except that in frame structures not exceeding three (3) stories or forty (40) feet in height, three (3) inch columns may be used in the basement and as secondary steel members.

846.6 Approvals: All details of column connections and their splices shall be shop-fabricated by approved methods and shall be approved only after tests in accordance with the approved rules. Shop-fabricated concrete-filled pipe columns shall be inspected by the building official or by an approved representative of the manufacturer at the plant.

#### SECTION 847.0 PNEUMATIC CONCRETE

847.1 General: Pneumatic applied concrete or mortar shall conform to requirements of ACI 506 listed in Appendix B.

847.2 Deleted

847.3 Deleted

847.4 Deleted

847.5 Deleted

847.6 Deleted

#### SECTION 848.0 MINIMUM CONCRETE DIMENSIONS

848.1 General: The protection of reinforced concrete structural elements in buildings and structures of fireproof (Type 1) construction shall be adequate to meet the fire and strength tests of this code; but not less than the minimum dimensions established by the standards of accepted engineering practice. Any floor finish not placed monolithically with floor slabs, shall not be included in the calculations for structural strength.

#### SECTION 849.0 REINFORCED GYPSUM CONCRETE

849.1 General: Reinforced gypsum concrete for use in buildings and structures shall consist of a mixture of calcined gypsum and water, with or without the addition of wood chips, shavings, fiber or other approved

aggregates. The wood aggregates and gypsum shall be pre-mixed at the mill, requiring only the addition of water at the job or site. The manufacture, design and construction shall comply with the requirements of the standards of accepted engineering practice listed in Appendix B.

849.2 Limitations of use: Gypsum concrete shall not be used where exposed directly to the weather or where subject to frequent or continuous wetting. To prevent saturation or freezing, protection from the weather and from contact with moisture shall be furnished during shipment and storage of prefabricated units, and after erection or pouring at the site.

#### SECTION 850.0 ENGINEERED UNREINFORCED MASONRY

850.1 General: The wall thicknesses and lateral support requirements for unreinforced masonry shall be determined by a structural analysis based upon accepted engineering practices.

850.2 Brick masonry: Walls designed and constructed of brick masonry using solid clay shale units shall conform to the provisions of Building Code Requirements for Engineered Brick Masonry of the Brick Institute of America as listed in Appendix B.

850.3 Concrete block masonry: Walls designed and constructed of concrete block masonry units shall conform to the provisions of Specification for the Design and Construction of Load Bearing Concrete Masonry of the National Concrete Masonry Association as listed in Appendix B.

#### SECTION 851.0 REINFORCED MASONRY

851.1 General: All systems of reinforced masonry, except for engineered reinforced masonry, shall conform to the provisions of Building Code Requirements for Reinforced Masonry ANSI A41.2 as listed in Appendix B. Engineered reinforced brick masonry, requiring a structural analysis, shall conform to the Building Code Requirements for Engineered Brick Masonry of the Brick Institute of America as listed in Appendix B. Engineered reinforced concrete block, requiring a structural analysis, shall conform to the provisions of Specification for the Design and Construction of Load Bearing Concrete Masonry of the National Concrete Masonry Association as listed in Appendix B.

#### SECTION 852.0 LUMBER AND TIMBER CONSTRUCTION

852.1 Design: Structural lumber and timber and its fastenings shall be adequately designed and assembled to safely sustain all imposed loads. When stress-grade lumber is used and properly identified and controlled, working stresses may be in accordance with the accepted engineering practice standards listed in Appendix B. All lumber used for load supporting purposes shall be identified by the grade mark of a lumber grading inspection agency approved by the building official. Grading practi-

ces and identification shall be in accordance with rules published by an agency recognized as being competent. In lieu of a grade mark on the material, a certificate of inspection as to species and grade issued by a lumber grading or inspection agency approved by the building official may be accepted for precut, remanufactured, or rough sawn lumber; also for sizes larger than three (3) inches nominal thickness.

852.1.1 Native lumber: Native lumber, as defined in this code, shall be acceptable for use in one- and two- story dwellings, barns, sheds, agricultural and accessory structures. Native lumber shall also be acceptable for use in other structures of less than three (3) stories as columns when the design loads are twenty-five (25) per cent greater than required elsewhere by this code; as joists, principal beams, and girders in floor constructions when the design loads are fifteen (15) per cent greater than required elsewhere by this code; and as other elements when the design loads are as required elsewhere by this code.

Each piece of native lumber produced shall be stamped with the name and registration number of the producer in accordance with the rules and regulations of the State Building Code Commission. In addition, all native lumber shall bear an approved mark identifying the species of wood. In lieu of the stamp bearing the name and registration number and species identification, a certification bearing the same information may be provided by the producer for precut or remanufactured lumber in accordance with the rules and regulations of the Commission. When native lumber is used, it shall be subject to the following requirements:

1. Sizing criteria: For lumber, sized in accordance with the American Softwood Lumber Standard PS-20-70, figures for maximum fiber stress and modulus of elasticity for framing grade No. 2 will be used in establishing span and spacing characteristics for all structural members.
2. Stress increase: Lumber which is sized in excess of the dimensions established by the American Softwood Lumber Standard PS-20-70 for the given nominal size referenced shall be allowed to have a maximum fiber stress increase above that provided in Item 1 above in proportion to the increased bearing capacity of the cross section as provided in Table 2103-1 or as calculated.

## 852.2 Minimum dimensions

852.2.1 Sizes of structural members: All lumber sizes specified in this code are nominal sizes. Nominal sizes may be shown on the plans. Computations to determine the required size of members shall be based on the net dimensions (actual sizes).

852.2.2 Structural posts: All isolated structural posts shall have a minimum dimension of four (4) inches.

### 852.3 Fabrication

852.3.1 Connections: All connections shall be fabricated with approved timber connectors, bolts, lag screws, spikes, nails or gluing or other approved connecting devices in accordance with accepted engineering practice. Bolted connections shall be snugged up tightly without crushing wood fibers under the washers. All nailed connections shall meet the minimum requirements of Appendix M.

852.3.2 Cambering: Trusses and long span girders shall be designed with sufficient camber or other provision shall be made to counteract any possible deflection.

852.3.3 Cutting and notching: It shall be unlawful to notch, cut or pierce wood beams, joists, rafters or studs in excess of the limitations herein specified unless proven safe by structural analysis, or suitably reinforced to transmit all calculated loads. Notches in the top or bottom of joists shall not exceed one-sixth ( $1/6$ ) the depth of the member and shall not be located in the middle one-third ( $1/3$ ) of the span. Notches located closer to the supports than three (3) times the depth of the member shall not exceed one-fifth ( $1/5$ ) the depth. Holes bored or cut into joists for piping or electrical cables shall not be closer than two (2) inches to the top or bottom of the joist and the diameter of the hole shall not exceed one-third ( $1/3$ ) the depth of the joist. In studs of bearing walls or partitions, notches or bored holes made to receive piping, electrical conduit, air-conditioning or heating duct work or for other fabricating purposes shall not be cut or bored more than one-third ( $1/3$ ) the depth of the stud. When the stud is cut or bored in excess of one-third ( $1/3$ ) its depth, it shall be reinforced to be equal in load carrying capacity to a stud notched not more than one-third ( $1/3$ ) its depth.

852.4 Trimmer and header beams: When determined necessary by stress analysis, trimmer and header beams shall be hung in approved metal or other approved noncombustible stirrups or hangers, unless supported on a masonry wall or girder. All such beams shall be spiked together.

852.5 Bearing and anchorage on girders: All members framing into girders shall be anchored or tied to secure continuity. The ends of all wood beams or joists resting on girders shall bear not less than four (4) inches or shall be supported in approved metal stirrups, hangers or on wood clips or ribbon strips. Beams framing from opposite sides shall lap at least six (6) inches and be bolted or spiked together; and when framing end to end, they shall be secured together by metal ties, straps or dogs.

852.6 Maintenance: All connections in the joints of timber trusses and structural frames shall be inspected periodically and bolts and other connectors shall be maintained tight.

SECTION 853.0 HEAVY TIMBER TYPE CONSTRUCTION

853.1 Wood: All structural wood members, sawn or glued laminated, used in heavy timber type construction shall be stress-grade timbers identified as to grade and strength by authoritative manufacturing, testing or inspection agencies or bureaus. All structural timber members shall have the minimum dimensions specified in Section 217.0 for Type 3A construction.

853.2 Other structural materials: Structural steel or reinforced concrete members may be substituted for timber in any part of the structural frame, protected to develop the required fireresistance rating specified in Table 214, but not less than one (1) hour fireresistance rating. Structural members supporting walls shall be protected to afford the same fireresistance rating as the wall supported.

853.3 Columns: Columns shall be continuous or superimposed throughout all stories by means of reinforced concrete or metal caps with brackets, or shall be connected by properly designed steel or iron caps, with pintles and base plates, or by timber splice plates affixed to the columns by means of metal connectors housed within the contact faces, or by other approved methods. Girders or trusses supporting columns shall have at least one (1) hour fireresistance rating.

853.4 Floors: The planks shall be laid so that a continuous line of joints will not occur except at points of support and so that they are not spiked to supporting girders. Flooring shall not extend closer than one-half (1/2) inch to walls to provide an expansion joint, but the joint shall be covered at top or bottom to avoid flue action.

853.5 Beams and girders

853.5.1 Wall and girder supports: Wall plate boxes of self-releasing type or approved hangers shall be provided where beams and girders enter masonry. An air space of one-half (1/2) inch shall be provided at the top, end and sides of the member unless approved durable or treated wood is used. Where intermediate beams are used to support a floor, they shall rest on top of the girders, or shall be supported by ledgers or blocks securely fastened to the sides of the girders, or they may be supported by approved metal hangers into which the ends of the beams shall be closely fitted. Wood beams and girders supported by walls required to have a fireresistance rating of two (2) hours or more shall have not less than four (4) inches of solid masonry between their ends and the outside face of the wall and between adjacent beams. Adequate roof anchorage shall be provided.

853.5.2 Column connections: Where intermediate beams are used to support a floor, they shall rest on top of the girders, or shall be supported by ledgers or blocks securely fastened to the sides of the girders,



or they may be supported by approved metal hangers into which the ends of the beams shall be closely fitted.

## SECTION 854.0 WOOD FRAME CONSTRUCTION

854.1 General: The exterior walls, interior partitions, floors and roofs of wood frame construction shall be designed and constructed to develop adequate strength to resist all vertical and lateral forces due to both dead and live loads. Standard balloon, braced, platform, and post and beam types of construction shall be acceptable framing methods.

### 854.2 Wood stud frame

854.2.1 Bearing walls: Posts and studs in bearing walls and partitions shall be designed as columns, with due allowance for lateral support furnished by sheathing, intermediate bracing, horizontal bridging, wall coverings and the floor and roof assemblies. The walls shall be fabricated in such a manner as to provide adequate support for the material used to enclose the building and to provide for transfer of all lateral loads to the foundation, in accordance with Section 803.4.

854.2.2 Non-bearing walls: Studs in non-bearing walls and partitions shall not be spaced more than forty-eight (48) inches on centers, and may be erected with the long dimension parallel to the wall, unless otherwise approved after test as an integrated assembly.

854.2.3 Bracing: In buildings more than one (1) story in height and where necessary for strength in one (1) story buildings, the corner posts shall be the equivalent of not less than three (3) pieces of two (2) by four (4) inch studs, braced by not less than one (1) piece of one (1) by four (4) inch continuous diagonal brace let into the studs. Bracing may be omitted when diagonal wood sheathing or plywood panels are used, or other sheathing specified in Section 854.3 is applied vertically in panels of not less than four (4) feet by eight (8) feet in area with approved nailing complying with Appendix M. Ledger or ribbon boards used to support joists shall be not less than one (1) by four (4) inches in size, cut into and securely nailed to each stud.

854.2.4 Mortise and tenon framing: Where mortise and tenon framing is used, the vertical members of the frame shall be not less than four (4) by six (6) inches in size and shall be designed as a column.

854.2.5 Multiple stories: When the frame is more than one (1) story in height and studs and posts are not continuous from sill to roof, the members shall be secured together with approved clips, splices or other connections to insure a continuous, well-integrated structure. Sheet metal clamps, ties or clips shall be formed of galvanized steel or other approved corrosion-resistive materials equivalent to No. 20 Galvanized Sheet Gauge (0.040 in.) steel sheets for two (2) inch framing members

and not less than No. 18 Galvanized Sheet Gauge (0.052 in.) for three (3) inch structural members. For four (4) inch and larger members, column splices and beam and girder supports shall comply with Section 853.0.

854.2.6 Framing over openings: Headers, double joists, trusses or other approved assemblies of adequate size to transfer all superimposed loads to the vertical member shall be provided over all window and door openings in bearing walls and partitions.

854.2.7 Framing around flues and chimneys: Combustible framing shall be trimmed away from all flues and chimneys, and combustible material shall not be placed within two (2) inches of any chimney, nor within six (6) inches of any inlet opening to such chimney. Finished flooring shall have not less than one-half (1/2) inch clearance from the chimney walls.

854.3 Wall sheathing: Except as provided in Section 854.4 for weather boarding or when stucco construction complying with Section 820.6 is used, all enclosed buildings shall be sheathed with one (1) of the materials of the following nominal thickness or any other material of equal strength and durability approved by the building official:

|                                    |           |
|------------------------------------|-----------|
| Reinforced cement mortar . . . . . | .1 inch   |
| Wood sheathing . . . . .           | 5/8 inch  |
| Plywood . . . . .                  | 5/16 inch |
| Gypsum sheathing . . . . .         | 1/2 inch  |
| Fiber boards . . . . .             | 1/2 inch  |
| Particle boards . . . . .          | 3/8 inch  |

854.3.1 Paper-backed lath sheathing: In one- and two-family dwellings and one (1) story commercial buildings with brick or similar veneers, the sheathing may consist of a layer of paper-backed lath complying with Section 820.5 with a one (1) inch intermediate space which shall be mortar-filled as each course of veneering is applied.

854.3.2 Insulation sheathing: Insulation boards are approved for sheathing when recognized for this use by one (1) or more accredited authoritative agencies listed in the Appendix O. Each board shall be clearly marked with the authoritative agency's report number.

854.3.2.1 Bracing: Buildings, including one-story buildings, shall be braced as specified in Section 854.2.3.

854.3.2.2 Fastening: Insulation sheathing boards are to be fastened at each stud. When square-edged boards are used, vertical joints must be over framing members. When tongue-and-groove-edged boards are used, vertical joints may fall between studs when the boards above and below the joint are continuous across that wall area.

854.3.2.3 Fasteners: Fasteners may be seven-sixteenths (7/16) inch head roofing nails or three-quarter (3/4) inch crown staples on eight (8) inch centers, one (1) inch head nails or one (1) inch crown staples on twelve (12) inch centers, or any other fastener approved by the building official. All fasteners shall be long enough to penetrate the studs a minimum of one-half (1/2) inch.

854.3.2.4 Underlying membrane: A membrane under the siding is not required when insulation sheathing boards are used.

854.3.2.5 Exterior finish: Exterior finish siding fasteners must go through the sheathing and into the studs a minimum of three-quarter (3/4) inch. Exterior weather-boarding shall comply with Section 854.4. Nails shall conform to Section 854.4.4.

854.4 Exterior weather-boarding, veneers and condensation: To secure weather-tightness in framed walls and other unoccupied spaces, the exterior walls shall be faced with an approved weather-resisting covering properly attached to resist wind and rain. The cellular spaces shall be so ventilated as not to vitiate the firestopping at floor, attic and roof levels or shall be provided with interior noncorrodible vapor-type barriers complying with the approved rules; or other means shall be used to avoid condensation and leakage of moisture. The following materials shall be acceptable as approved weather coverings of the nominal thickness specified:

|  |                |
|--|----------------|
| Brick masonry veneers . . . . .          | 2 inches       |
| Stone veneers . . . . .                  | 2 inches       |
| Clay tile veneers . . . . .              | 1/ 4 to 1 inch |
| Stucco or exterior plaster. . . . .      | 3/4 inch       |
| Precast stone facing . . . . .           | 5/8 inch       |
| Wood siding (without sheathing). . . . . | 1/2 inch       |

Note: Wood siding of lesser thickness may be used providing such wall covering is placed over sheathing which conforms to Section 854.3.

|   |                      |
|---|----------------------|
| Protected fiberboard siding . . . . .         | 1/2 inch             |
| Wood shingles . . . . .                       | 3/8 inch             |
| Exterior plywood (without sheathing). . . . . | see Sec. 824.2       |
| Exterior plywood (with sheathing) . . . . .   | 5/16 inch            |
| Asbestos shingles . . . . .                   | 5/32 inch            |
| Asbestos cement boards . . . . .              | 1/8 inch             |
| Aluminum clapboard siding. . . . .            | 0.024 inch           |
| Formed steel siding. . . . .                  | 29 gauge (0.017 in.) |
| Hardboard siding . . . . .                    | 1/4 inch             |
| Particleboard (with sheathing) . . . . .      | 3/8 inch             |
| Particleboard (without sheathing). . . . .    | 5/8 inch             |

854.4.1 Masonry veneers: Veneers of unit masonry shall be attached to the wood frame with at least No. 22 Galvanized Sheet Gauge (0.034 in.) corrosion-resistive, corrugated metal ties not less than seven-eighths (7/8) inch in width at vertical intervals of not more than sixteen (16) inches and horizontal intervals of not more than thirty-two (32) inches.

854.4.2 Metal veneers: Veneers of metal shall be fabricated from approved corrosion-resistive materials or shall be protected front and back with porcelain enamel or shall be otherwise treated to render the metal resistant to corrosion. Such veneers shall be not less than No. 29 (0.017 in.) Galvanized Sheet Gauge in thickness mounted on wood or metal furring strips or approved sheathing on the frame construction.

854.4.3 Height of veneers: The average height of four (4) inch brick veneer shall be not more than twenty-five (25) feet above its supports on foundation wall or on corbels of masonry or steel; and not more than eighteen (18) feet in height for two (2) inch veneers.

854.4.4 Nailing: All weatherboarding and wall and roof coverings shall be securely nailed with aluminum, copper, zinc, zinc-coated or other approved corrosion-resistive nails in accordance with the recommended nailing schedule or the approved manufacturer's standards. Shingles and other weather coverings shall be attached with appropriate standard shingle nails to furring strips securely nailed to studs, or with approved mechanically-bonding nails, except when sheathing is wood not less than one (1) inch nominal thickness or plywood not less than five-sixteenths (5/16) inch thick. Wood shingles or shakes attached with approved corrosion-resistive annular grooved nails may be applied over fiberboard shingle backer and fiberboard sheathing when the installation is in accordance with the approved manufacturer's standards listed in Appendix C. Wood shingles or shakes and asbestos shingles or siding may be nailed directly to nail base fiberboard sheathing not less than one-half (1/2) inch nominal thickness with approved corrosion-resistive annular grooved nails when the installation is in accordance with the approved manufacturer's standards listed in Appendix C.

854.5 Foundation anchorage: Wall sill plates, a minimum of a two-by-four inch (2" x 4") member, shall be sized and anchored to foundation walls or piers and at intermediate intervals as required to resist wind uplift. Anchor bolts shall be a minimum of one-half (1/2) inch diameter. The bolts shall be embedded in foundations to a depth of not less than eight (8) inches poured in place concrete, and not less than fifteen (15) inches in grouted unit masonry. There shall be a minimum of two (2) anchor bolts per section of plate and anchor bolts shall be placed twelve (12) inches from the end of each section of plate with intermediate bolts spaced a maximum of eight (8) feet on center.

854.6 At-grade protection

854.6.1 Wood framing: All exterior wood framework of buildings, whether structural or non-loadbearing, shall be supported on approved foundation walls at least eight (8) inches above the finished grade, and higher when necessitated by greater average snow fall. Where climatic conditions or the geographical location require additional control measures to protect buildings and structures against decay and termite attack, the provisions of Section 874.0 shall be complied with.

854.6.2 Metal siding: Exposed metal siding or sheathing shall be protected from corrosion at the ground level by supporting the foundation channel at sufficient height above grade on the concrete apron or other approved water-resisting foundation.

### 854.7 Floors

854.7.1 Bridging: Except as hereinafter noted, in all floor, attic and roof framing, there shall be not less than one (1) line of bridging for each eight (8) feet of span. The bridging shall consist of not less than one one-by-three (1x3) inch lumber, double-nailed at each end, or of equivalent metal bracing of equal rigidity. A line of bridging shall also be required at supports where adequate lateral support is not otherwise provided. Mid-span bridging is not required for floor, attic or roof framing in one- and two-family dwellings (use groups R-3 and R-4) and multi-family dwellings (use group R-2) except when the joist depth exceeds twelve (12) inches nominal and/or when the minimum uniformly distributed live load exceeds forty (40) psf.

854.7.2 Flooring: The flooring of wood frame construction shall be of adequate strength and stiffness to support required loads and, where necessary for strength and for lateral support of the building, subflooring shall be provided.

### 854.8 Roofs

854.8.1 Types of decking and sheathing: Roof deck sheathing shall consist of not less than five-eighths (5/8) inch boards or plywood of the thickness specified in Section 824.3, or other approved materials of equivalent strength and rigidity. When open-deck sheathing is used on pitched roofs, it shall consist of not less than one-by-four (1x4) inch roofers spaced not more than six (6) inches on centers or material of equivalent strength and rigidity.

854.8.2 Wood shingles: Wood shingles and handsplit shakes complying with the standards listed in Appendix C may be used for roof covering where permitted in Section 926.0, and may be installed on tight decking or on spaced roof boards.

### 854.8.3 Deleted

854.9 Deleted

854.9.1 Deleted

854.10 Deleted

#### SECTION 855.0 STRESS SKIN PANELS

855.1 Integrated assemblies: Approved panels or other integrated assemblies fabricated of dimension lumber with wood stress-coverings glued thereto, or consisting of structural units of metal-covered or molded plywood or other approved plastics, formed and molded into prefabricated load-bearing members shall be permitted for use in floors, roofs, walls, partitions and ceilings when designed in accordance with accepted engineering practice or meeting the test requirements of Sections 802.0, 803.0 and 804.0.

855.2 Splices: Splices and connections between panels shall be weather-tight and of sufficient strength to resist two and one-half (2 1/2) times the design live load to which they will be subjected in normal use. The fastenings of covering assemblies to structural studs, ribs or joists shall provide rigidity equivalent to approved gluing. Nailing shall not be acceptable for that purpose.

855.3 Molded plywood units: Structural units of plywood or other approved plastics of similar combustible characteristics formed and molded into prefabricated load-bearing members shall conform to the approved rules and shall be identified by the approved label. The design shall be based on accepted engineering analysis confirmed by the tests prescribed in Sections 802.0 and 803.0.

#### SECTION 856.0 STRUCTURAL GLUED LAMINATED TIMBER AND BUILT-UP WOOD CONSTRUCTION

856.1 General: Buildings and structures may be designed and erected of glued laminated structural members or of composite members of plywood and dimension lumber.

856.2 Structural glued laminated timber members: Stress rated fabricated units of suitably selected and prepared wood laminations not exceeding two (2) inches in net thickness, which may be comprised of pieces joined end to end or of pieces placed or glued edge to edge, securely bonded together with adhesives so that the grain of all laminations is approximately parallel longitudinally shall be designed and manufactured under controlled material procedure to meet the requirements of timber construction standards listed in Appendices B and C.

856.3 Glued laminated members and plywood components: Built-up beam and column sections consisting of one (1) or more webs with glued lumber

flanges and stiffeners shall be designed in accordance with accepted engineering analysis. Plywood components consisting of plywood alone or plywood in combination with sawn or glued laminated lumber and bonded together with adhesives shall be designed, fabricated and identified in accordance with the applicable standards listed in Appendices B and C.

856.3.1 Gluing surfaces: In glued lumber constructions, the surfaces to be glued shall be worked to a smooth, flat surface without sanding and free from wax grease or oil to insure a complete glue bond over the entire contact. Factory sanded plywood shall not be prohibited.

## ARTICLE 8-Part C

### BUILDING ENCLOSURES, WALLS AND WALL THICKNESS

#### SECTION 857.0 ENCLOSURE WALLS

857.1 General: All buildings, except as may be provided for miscellaneous structures designed for special uses, shall be enclosed on all sides with independent or party walls of frame, masonry or other approved construction. Such walls shall be constructed to afford the fireresistance rating specified in Table 214 and as required in this code and the laws of Massachusetts for location, use and type of construction.

857.2 Deleted

857.3 Exterior wall pockets: In exterior walls of all buildings and structures, wall pockets or crevices in which moisture may accumulate shall be avoided or protected with adequate caps or drips, or other approved means shall be provided to prevent water damage.

857.4 Exceptions: The provisions of this article shall not be deemed to prohibit the omission of exterior walls for all or part of a story of a building in accordance with the provisions of Section 906.2.

857.5 Glass in walls

857.5.1 Labeling: Each light of glass shall be labeled with a removable paper label showing type, thickness and manufacturer. To qualify as glass with special performance characteristics, each unit of laminated, heat strengthened, fully tempered, and insulating glass shall be permanently identified by the manufacturer. The identification shall be etched or ceramic-fired on the glass and be visible with the unit is glazed. Heat strengthened and tempered spandrel glasses are exempted from permanent labeling. This type of glass shall be labeled with a removable paper label by the manufacturer.

Safety glazing materials shall conform to the requirements of the Annotated Laws of Massachusetts Chapter 143, Sections 3T, 3U, and 3V, as amended.

857.5.2 Glass supports: Where one (1) or more sides of any light of glass is not firmly supported, or is subjected to unusual load conditions, detailed shop drawings, specifications and analysis or test data assuring safe performance for the specific installation shall be prepared by engineers experienced in this work and approved by the building official. Analysis shall be based on the wind loads specified in Section 713.2 for secondary framing members. The elevation of the glazed opening shall be computed by adding the distances from grade to the head and sill, respectively, and dividing the sum by two (2).

857.5.3 Glass dimensional tolerance: Glass thickness tolerance shall comply with those established in Table 857. Where thickness is to be controlled, nominal values are stated subject to the tolerances shown in the following Table 857.

Table 857  
MINIMUM GLASS THICKNESS

| Nominal thickness | Plate glass min. thickness (inches) | Sheet glass min. thickness (inches) |
|-------------------|-------------------------------------|-------------------------------------|
| SS                | ....                                | 0.085                               |
| DS                | ....                                | 0.115                               |
| 1/8               | 0.094                               | ....                                |
| 3/16              | 0.156                               | 0.182                               |
| 13/64             | 0.172                               | ....                                |
| 7/32              | ....                                | 0.205                               |
| 1/4               | 0.218                               | 0.236                               |
| 5/16              | 0.281                               | ....                                |
| 3/8               | 0.343                               | 0.357                               |
| 1/2               | 0.468                               | 0.478                               |
| 5/8               | 0.562                               | ....                                |
| 3/4               | 0.689                               | ....                                |
| 7/8               | 0.750                               | ....                                |
| 1                 | 0.875                               | ....                                |
| 1 1/4             | 1.125                               | ....                                |

857.5.4 Wind loads: Glass exposed to wind pressure shall be capable of withstanding the design criteria of Section 713.2 for secondary framing members but shall not be less than the thickness prescribed in Table 857.5.4.2. The wind load used to enter Table 857.5.4.2 shall be modified by dividing the load prescribed in Section 713.2 by the value shown in Table 857.5.4.1 for the type of glass involved.



Table 857.5.4.1

**RELATIVE RESISTANCE TO WIND LOAD**  
(Assuming equal thickness)

| Glass type                             | Approximate relationship* |
|--|---------------------------|
| Laminated                              | 0.6                       |
| Wired glass                            | 0.5                       |
| Heat strengthened                      | 2.0                       |
| Fully-tempered                         | 4.0                       |
| Factory fabricated<br>double glazing** | 1.5                       |
| Rough-rolled plate                     | 1.0                       |
| Sandblasted                            | 0.4                       |
| Regular plate or sheet                 | 1.0                       |

\*Before using Table 857.5.4.2 divide the design wind load from Section 713.0 by the value shown here for the glass type involved.

\*\*Use thickness of the thinner of the two lights, not thickness of unit.

Table 857.5.4.2

**REQUIRED NOMINAL THICKNESS OF REGULAR PLATE OR SHEET GLASS**  
 (Based on minimum thicknesses allowed in Federal Specifications DD-G-451b)  
 Design Factor = 2.5

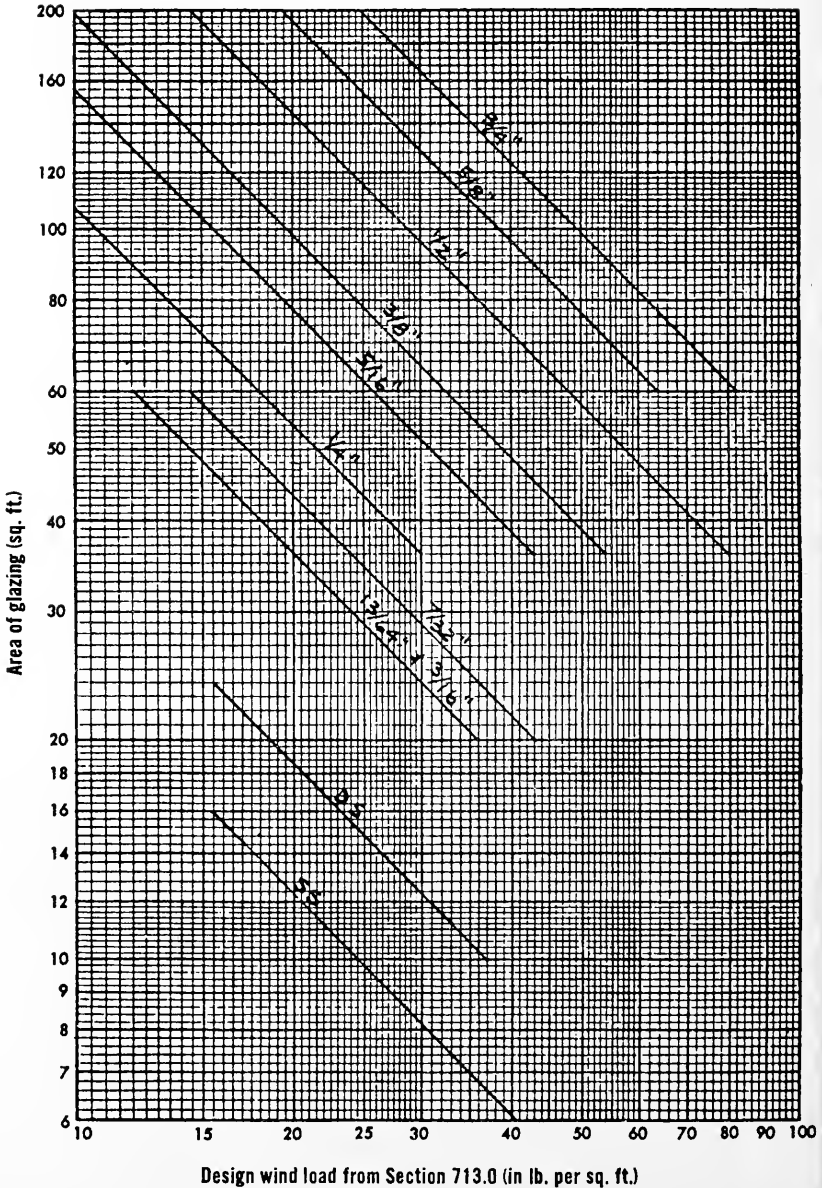

857.5.5 Jalousies: In jalousie windows and doors regular plate, float sheet or rolled glass thickness shall be not less than three-sixteenths (3/16) inch; glass length shall be not more than forty-eight (48) inches; glass edges shall be smooth. Other types of glass may be used if detailed shop drawings, specifications and analysis by methods described in Section 857.5.2 or test data assuring safe performance for the specific installation are prepared by engineers experienced in this work and approved by the building official.

857.5.6 Human impact loads: Individual glazed areas in hazardous locations such as those indicated in Section 857.5.6.1 shall comply with the ANSI Z97.1 Standard listed in Appendix B, or by comparative test shall be proven to produce at least equivalent performance. Annealed glass shall not be used.

857.5.6.1 Specific hazardous locations: The following shall be considered specific hazardous locations for purposes of glazing:

1. glazing in ingress and egress doors except wired glass in required fire doors and jalousies (see Section 857.5.5);
2. glazing in fixed and sliding panels of sliding type doors (patio and mall type);
3. glazing in storm doors;
4. glazing in all unframed swinging doors;
5. glazing in ingress and egress doors except wired glass in required fire doors and jalousies (see Section 857.5.5);
6. glazing, operable or nonoperable, whose nearest vertical edge is within forty-eight (48) inches of a door in nonresidential occupancies or within twelve (12) inches of a door in residential occupancies and whose bottom edge is below the top of the door unless an intervening interior permanent wall is between the door and the glazing; and
7. glazing in fixed panels having a glazed area in excess of nine (9) square feet with the lowest edge less than eighteen (18) inches above the finish floor level or walking surface and having a walking surface on both sides, both of which are within thirty-six (36) inches of such glazing and the horizontal planes of such surfaces are within twelve (12) inches of each other. In lieu of safety glazing, such glazed panels may be protected with a horizontal member not less than one and one-half (1 1/2) inches in width when located between twenty-four (24) and thirty-six (36) inches above the walking surface.

## SECTION 858.0 PROTECTION OF WALL OPENINGS

858.1 Fire-protected openings: Openings in exterior walls when required to be fire-protected shall comply with the provisions of Article 9.

858.2 Area of openings: All openings facing on a street, yard, court, or public space are required for light and ventilation shall comply with the provisions of Article 5.

858.3 Structural strength

858.3.1 Against wind forces: In all buildings required to resist wind pressure under the provisions of Article 7, exterior window openings shall be designed to resist the specified wind load when such protectives are more than one hundred (100) square feet in area in the first story or more than fifty (50) square feet in area in the upper stories.

858.3.2 Sash or frames: The glass, or other approved glazing material shall be of adequate thickness or shall be provided with steel frames or otherwise reinforced to resist the wind loads specified in Article 7 blowing both inwardly and outwardly.

#### SECTION 859.0 FIRE ACCESS PANELS

859.1 Required: Completely enclosed buildings, without exterior openings in the enclosure walls, or without ready access for the purpose of fighting fire, shall be provided with access panels and shall be approved by the local fire official (see Section 1200.1.1).

859.2 Multi-story buildings: In all exterior walls of buildings required to have thirty (30) foot wide open space adjacent thereto (see

Sections 305.2 and 306.2), each floor below the thirteenth (13th) floor shall be provided with access panels as follows:

1. if such access panels are not less than thirty-two (32) inches by forty-eight (48) inches in size, they shall be spaced not more than one hundred (100) feet apart in each story; or
2. if such access panels are not less than twenty-two (22) inches by forty-two (42) inches in size, they shall be spaced not more than thirty (30) feet apart in each story.

859.3 Single-story buildings: In one (1) story buildings, not more than eighty-five (85) feet in height:

1. roof vents shall be provided, spaced not more than one hundred twenty-five (125) feet apart; and
2. grade level doors, or fire access panels shall be provided spaced not more than one hundred twenty-five (125) feet apart in all exterior

walls of buildings required to have thirty (30) foot wide open space adjacent thereto (see Sections 305.2 and 306.2).

859.4 Construction of access panels: Access panels shall have a sill height of not more than thirty-six (36) inches; shall be readily identifiable from the outside; and shall be readily openable from the outside, or shall be glazed with plain flat glass. When required to be fire-resistance rated, access panels shall be equipped with approved opening protectives, complying with Article 9, which are readily openable from both the outside and inside. Access panels shall be not less than thirty-two (32) inches by forty-eight (48) inches in size, except in buildings of moderate fire hazard such as schools and offices, wherein the sizes may be reduced to a minimum of twenty-two (22) inches by forty-two (42) inches.

### SECTION 860.0 STRUCTURAL GLASS BLOCK WALLS

860.1 Exterior wall panels: The maximum dimensions of glass block wall panels in exterior walls, when used singly or in multiples forming continuous bands of structural glass blocks between structural supports, shall be twenty-five (25) feet in length and twenty (20) feet in height between structural supports and expansion joints; and the area of each individual panel shall be not more than two hundred and fifty (250) square feet. Intermediate structural supports shall be provided to support the dead load of the wall and all other superimposed loads. When individual panels are more than one hundred forty-four (144) square feet in area, a supplementary stiffener shall be provided behind the panels, anchored thereto and to the structural supports.

860.2 Joint materials: Glass blocks shall be laid up in Type S or N mortar with approved galvanized or other noncorrosive metal wall ties in the horizontal mortar joints of exterior panels. The sills of glass block panels shall be coated with approved asphaltic emulsion, or other elastic waterproofing material, previous to laying the first mortar course, and the perimeter of the panels shall be caulked to a depth of not less than one-half (1/2) inch with non-hardening caulking compound on both faces; or other approved expansion joints shall be provided. When laid up in joint materials other than mortars herein defined, a single panel shall not be more than one hundred (100) square feet in area nor more than ten (10) feet in either length or height.

860.3 Wind and earthquake loads: Exterior wall panels shall be held in place in the wall opening to resist both the internal and external pressures due to wind and earthquake loads specified in Sections 712.0, 713.0 and 716.0.

860.4 Interior wall panels: Structural glass blocks shall not be used in fire walls or party walls or for load-bearing construction. Such blocks shall be erected with mortar in metal frames or reinforcement as provided in this section for exterior walls or other approved joint materials, except

that wood strip framing may be used in partitions not required to be fire-resistance rated.

860.5 Fire-resistance rating: Nothing herein contained shall be construed to prohibit the use of glass blocks in an opening protective assembly or non-bearing partition or wall when required to afford a specific fire-resistance rating, provided approval of the building official is secured after satisfactory time-temperature performance under the prescribed test procedure of Article 9.

860.6 Access panels: Access panels shall be provided in exterior glass block walls for fire department use to comply with Section 859.0

### SECTION 861.0 WALL FACINGS AND VENEERS

861.1 Backing surfaces for veneers: Veneers for other than frame buildings, shall be attached only to substantial, rigid, noncombustible surfaces which are plumb, straight and of true plane; and wood backing surfaces shall not be used, except in frame construction. The backing shall provide sufficient rigidity, stability and weather resistance; and the veneer shall be installed and anchored as required in this code for the specific material.

861.2 Veneer thickness: Materials used for non-bearing veneers on masonry walls shall not have less than the thickness indicated in Table 861.

Table 861

#### MINIMUM THICKNESS OF NONBEARING VENEERS ON MASONRY WALLS

|   |   |
|---|---|
| Ceramic veneer (architectural terra cotta, anchored type) | 1 inch                                  |
| Brick   | 2 inches                                |
| Stone (natural)   | 2 inches                                |
| Stone (cast artificial)                                   | 1½ inches                               |
| Clay tile (structural)                                    | 1¾ inches                               |
| Clay tile (flat slab)                                     | ¾ to 1 inch                             |
| Marble slabs  | 1 inch                                  |
| Precast stone facing                                      | ⅝ inch                                  |
| Structural glass  | ⅜ inch                                  |
| Aluminum clapboard siding                                 | .024 inch                               |
| Metal (approved corrosion-resistive)                      | No. 28 Galvanized Sheet Gage (0.019 in) |

5861.2.1 Nonstructural: Masonry or other approved noncombustible materials used as facing on bearing walls or partitions shall not be considered to have structural value and shall be excluded in the determination of required wall thickness.

### SECTION 862.0 STRUCTURAL GLASS VENEERS

862.1 Dimensions: The minimum thickness of glass veneer shall be eleven thirty-seconds ( $11/32$ ) inch and the area of individual panels shall not exceed ten (10) square feet, with a maximum length of four (4) feet. The edge of each unit shall be ground square with a slight arris; and all exposed, external corners and angles shall be rounded to a radius of not more than three-sixteenths ( $3/16$ ) inch.

### 862.2 Construction

862.2.1 Backing surface: The glass veneer shall be set in mastic cement on a float coat of one (1) inch thick cement mortar reinforced with wire lath attached to noncombustible furring spaced not more than twelve (12) inches on centers.

862.2.2 Support of veneer: The base course of glass units shall be supported on a corrosion-resistive metal frame anchored to the backing and caulked with a waterproof compound at grade.

862.3 Reinforcement: Metal reinforcing of cold formed corrosion-resistive angles of not less than No. 16 Galvanized Sheet Gauge (0.064 in.), or other approved reinforcement shall be provided in all horizontal joints anchored into the masonry wall with expansion or toggle bolts.

862.4 Expansion joints: Expansion joints shall be provided at ends and intermediate sections caulked with an approved waterproofing compound as required by the approved rules. Where necessary for water-tightness, exposed edges shall be protected with corrosion-resistive metal or other approved noncombustible flashing.

862.5 Other loads: Signs, awning brackets or other loads shall not be hung directly from glass veneers, but shall be supported on framing anchored to or otherwise supported by the masonry wall, free from contact with the glass.

## SECTION 863.0 THIN STONE AND TILE VENEERS

863.1 Size of units: In localities subject to frost and freezing temperatures, tile and terra cotta units shall be frost-proof and shall not be more than two hundred eighty-eight (288) square inches in area; and where not subject to frost action, the size of the tile may be increased not more than fifty (50) per cent in area.

863.2 Construction: One (1) inch thick marble, granite, terra cotta, and similar materials; or ceramic tile facing one-quarter ( $1/4$ ) to one (1) inch in thickness shall be set in accordance with the applicable standards listed in Appendix B.

## SECTION 864.0 METAL VENEERS

864.1 Materials: Veneers of metal shall be fabricated from approved corrosion-resistive alloys, or shall be covered front and back with approved porcelain enamel, or otherwise treated to render the metal resistant to corrosion.

864.2 Construction: The metal veneer shall be securely attached to the masonry or supported on approved metal framing protected by painting, galvanizing or other approved protection, or on wood studs and furring strips, treated with an approved preservative process.

864.3 Waterproofing: All joints and edges exposed to the weather shall be caulked with approved durable waterproofing material or by other approved means to prevent penetration of moisture.

864.4 Grounding metal veneers: Grounding of metal veneers on all buildings shall comply with the requirements of Article 15 and the Massachusetts Electrical Code (527 CMR 12.00).

Metal enclosures shall be placed around equipment carrying voltages in excess of sixty (60) volts between conductors, unless in substations or vaults under the sole control of the supply company. Where extensive metal in or on buildings may become energized and is subject to personal contact, adequate bonding and grounding shall be provided for additional safety.

#### SECTION 865.0 PLASTIC VENEERS

865.1 General: Veneers of weather-resisting plastics shall comply with the definition of approved plastics in Section 1900.2.1 and shall be erected and anchored on a foundation coat, waterproofed or otherwise protected from moisture absorption and sealed with a coat of mastic or other approved waterproof coating in accordance with the approved rules.

865.2 Height limitation: Plastic veneer shall not be attached to any exterior wall to a height greater than thirty-five (35) feet above grade. Within the fire limits as provided in Section 301.0, exterior veneer shall be limited to the first story.

865.3 Area limitation: Sections of plastic veneer shall not exceed two hundred (200) square feet in area. Outside the fire limits, the area may be increased by fifty (50) per cent.

865.4 Separation: Sections of plastic veneer shall be separated by a minimum of four (4) feet vertically.

#### SECTION 866.0 THICKNESS OF SOLID MASONRY WALLS

866.1 General: All masonry walls shall be of the minimum thickness specified in the Building Code Requirements for Masonry listed in Appen-



dix B. The combined stress due to all loads shall not exceed the allowable working stresses specified in this code for the materials of construction.

#### SECTION 867.0 THICKNESS OF PANEL WALLS

867.1 Solid panel walls: Panel, apron or spandrel walls as defined in this code supported at vertical intervals not exceeding thirteen (13) feet in height, shall not be limited in thickness, provided they meet the fireresistance rating requirements of Article 9 and Table 214, and are constructed of approved noncombustible weather-resisting materials of adequate strength to resist the wind loads specified in Sections 712.0 and 713.0.

867.2 Hollow panel walls: Unless constructed of the materials and thickness specified by the accepted engineering standards for masonry, hollow panel walls shall be tested and approved in the assembled unit as constructed in normal practice to develop the required fireresistance ratings specified in Table 214 for exposure on both faces.

867.3 Weather resistance: When the construction is tested and approved for a fireresistance rating does not possess the required weather resistance, it shall be covered on the exterior with approved corrosion-resistant metal facings or other approved noncombustible weather-resisting veneers.

867.4 Anchorage: All panel walls shall be anchored to the structural frame to insure adequate lateral support and resistance to wind and to earthquake forces where subject to seismic disturbances.

#### SECTION 868.0 DELETED

#### SECTION 869.0 FOUNDATION WALLS

869.1 Design: Foundation walls shall be designed to resist frost action and to support safely all vertical and lateral loads as provided in Article 7. The maximum stresses due to combined load shall be within the values specified for the materials used in the construction. Unless properly reinforced, tensile stresses shall not exceed those permitted in plain masonry.

869.2 Minimum thickness: The minimum thickness of concrete or masonry foundation walls, with up to seven (7) feet of unbalanced fill (height of finish grade above basement floor or inside grade), shall be eight (8) inches or shall be designed according to acceptable engineering practice as listed in the standards in Appendix B and as required in Section 870.2. Where the unbalanced fill exceeds seven (7) feet, foundation wall thickness shall be determined by structural analysis as required in Section 807.2.

869.2.1 Deleted

869.2.2 Deleted

869.2.3 Deleted

Table 869 Deleted

869.2.4 Rubble stone: Foundation walls of rough or random rubble stone shall be not less than sixteen (16) inches thick.

869.2.5 Bonding: All foundation walls shall be bonded as required for superstructure walls in Section 835.0.

869.3 Deleted

869.4 Corbels on eight inch walls: Where an eight (8) inch wall is corbeled, the top corbel course shall be a full header course of headers at least six (6) inches in length, extending not higher than the bottom of the floor framing. The maximum projection of one (1) unit shall neither exceed one-half (1/2) the depth of the unit nor one-third (1/3) its width at right angles to the face which is offset.

869.5 Lateral stability: Foundation walls of buildings and structures which serve as retaining walls shall conform to the applicable requirements of Section 870.0 or shall be strengthened with buttresses or additional wall thickness to resist lateral soil and hydrostatic pressure when subjected thereto.

SECTION 870.0 RETAINING WALLS

870.1 General: Walls built to retain or support the lateral pressure of earth or water or other superimposed loads shall be designed and constructed of approved masonry, reinforced concrete, steel sheet piling or other approved materials within the allowable stresses of accepted engineering practice (see Section 874.5).

870.2 Design: Retaining walls shall be designed to resist the pressure of the retained material, including both dead and live load surcharges to which they may be subjected, and to insure stability against overturning, sliding, excessive foundation pressure and water uplift.

870.3 Hydrostatic pressure: Unless drainage is provided, the hydrostatic head of water pressure shall be assumed equal to the height of the wall.

870.4 Deleted

870.5 Guard rails: Retaining walls with a difference in grade level or

each side of the wall in excess of four (4) feet shall be provided with a forty-two (42) inch high guard rail or other approved protective measure.

SECTION 871.0 DELETED

SECTION 872.0 WATERPROOFING AND FLOODPROOFING

872.1 General: The exterior structural elements of all buildings herein specified shall be waterproofed in accordance with the approved rules.

872.2 Steel frame: Exterior steel columns and girders, before embedment in masonry of the required fire-resistance rating specified in Table 214, shall be protected from moisture by approved waterproofing material, a parging coat of cement mortar or by a minimum of eight (8) inches of weather-tight masonry.

872.3 Chases: The backs and sides of all chases in exterior walls with less than eight (8) inches of approved masonry to the exterior surface shall be insulated and waterproofed.

872.4 Foundations: Exterior walls below grade and the cellar floors of all buildings for institutional and residential uses (use groups I and R) enclosing habitable or occupiable rooms or spaces below grade shall be made watertight, and when necessary shall be reinforced to withstand water pressure as prescribed in Sections 709.0 and 870.0. The basement walls of buildings in the residential use groups and the walls of all habitable and occupiable rooms and spaces below grade shall be protected with not less than a one (1) coat application of approved waterproofing paint, or a one-half (1/2) inch parging coat of portland cement mortar or other approved dampproof covering.

872.4.1 Subsoil drains: Subsoil drains shall be provided around foundations enclosing habitable or usable spaces located below grade and which are subjected to ground water conditions. Drains shall be installed at or below the area to be protected and shall discharge by gravity or by mechanical means into an approved drainage system complying with the plumbing code listed in Appendix P.

872.5 Types of waterproofing: The processes and methods used to render buildings, structures or parts thereof watertight as herein required shall comply with accepted engineering practice covering types of waterproofing.

872.6 Floodproofing: Where a structure is located within a flood plain or coastal high hazard area as determined by the building official or the governmental body having jurisdiction, such a structure must be designed to resist or overcome the anticipated flood conditions in accordance with the provisions of Section 744.0.

SECTION 873.0 DELETED

SECTION 874.0 PROTECTION AGAINST DECAY AND TERMITES

874.1 Approval: The term "approval" as used in the following statements means approval in accordance with the procedure established by this code.

874.2 Where conditions are favorable to decay

874.2.1 Wood in contact with the ground: All wood in contact with the ground and supporting permanent structures shall be approved treated wood.

874.2.2 Untreated wood: Untreated wood may be used where entirely below ground water level or continuously submerged in fresh water; and may be used in contact with the ground for detached accessory buildings not intended for human occupancy, for temporary structures and for fences.

874.3 Wood joists or the bottom of wood structural floors: When wood joists or the bottom of wood structural floors without joists are closer than eighteen (18) inches, or wood girders are closer than twelve (12) inches, to exposed ground located within the periphery of the building over crawl spaces or unexcavated areas, they shall be approved durable or treated wood. Ventilation shall be provided as required in Section 507.0.

874.4 Sills: All sills which rest on concrete or masonry exterior walls and are less than eight (8) inches from exposed earth shall be of approved durable or treated wood.

874.4.1 Sleepers and sills: Sleepers and sills on a concrete or masonry slab which is in direct contact with earth shall be of approved durable or treated wood.

874.4.2 Posts or columns: Posts or columns in cellars shall be supported by piers projecting at least two (2) inches above the finish floor and separated therefrom by an approved impervious barrier except when approved durable or treated wood is used. Posts or columns used in damp locations below grade shall be of approved durable or treated wood.

874.4.3 Wall pockets: Ends of wood girders entering masonry or concrete walls shall be provided with a one-half (1/2) inch air space on top, sides and end, unless approved durable or treated wood is used.

874.4.4 Clearance between wood siding: Clearance between wood siding and earth on the exterior of a building shall be not less than six (6) inches.

874.5 Wood used in a retaining wall: Wood used in a retaining wall shall be approved durable or treated wood, except as follows:

1. when the wall is not more than two (2) feet in height and is located on the property line; or
2. when the wall is not more than four (4) feet in height and is separated from the property line by a minimum distance equal to the height of the wall.

A retaining wall of durable wood shall not exceed six (6) feet in height. A wood retaining wall shall be separated from any permanent building by a minimum distance equal to the height of the wall.

874.6 Where approved durable or treated woods are required: Where approved durable or treated woods are required in this code, the building official may require identification by an approved mark or certificate of inspection. All lumber and plywood required to be preservatively treated shall bear an approved quality mark of an inspection agency that maintains continuing control, testing and inspection over the quality of the product as described in the quality control standards listed in Appendix C.

874.7 Pressure treatment: Where pressure treatment of wood members is required by this code, preservatives and methods of treatment shall conform to the standards for pressure treatment and preserving of lumber listed in Appendix C.

874.7.1 Deleted

#### SECTION 875.0 DELETED

#### SECTION 876.0 THERMAL INSULATING MATERIALS

876.1 General: Insulating batts, blankets, fills or similar types of materials, including vapor barriers and breather papers or other coverings which are a part of the insulation, incorporated in construction elements shall be installed and used in a manner that will not increase the fire hazard characteristics of the building or any part thereof.

876.2 Installation in Type 1 and Type 2 construction: Such materials when exposed as installed in buildings of fireproof or noncombustible (Types 1 or 2) construction shall comply with the requirements of Section 904.2 for Class I materials.

876.3 Installation in Type 3 and Type 4 construction: Such materials when exposed as installed in attic spaces in buildings of ordinary or frame (Types 3 and 4) construction shall comply with the requirements of Section 904.2 for Class III materials.

876.4 Facings and coverings: Vapor barriers, breather papers or other coverings of insulating materials, when installed adjacent to or not more than one and one-half (1 1/2) inches from the unexposed surface of ceiling or side wall interior finish, or when installed in completely enclosed wall, ceiling joist or rafter spaces and firestopped as required in Section 875.0, are not required to have a flameresistance rating.

876.5 Foam plastic insulation: The provisions of this section shall govern the requirements and uses of foam plastic insulation in buildings and structures. For interior finish and trim, see Section 920.0.

Except where otherwise noted in this section, all foam plastics used in building construction shall have a flame spread rating of not more than seventy-five (75) and shall have a smoke developed rating of not more than four hundred and fifty (450) when tested in the maximum thickness intended for use in accordance with ASTM E84 listed in Appendix G. The interior of the building shall be separated from the foam plastic by an approved thermal barrier having an index of fifteen (15). The thermal barrier shall be installed in such a manner that it will remain in place for the time of its index classification based upon approved diversified tests.

876.5.1 Other specific applications: Foam plastics may be installed in accordance with Sections 876.5 and 876.5.2 or as listed in this section, and as allowed by other provisions of this code.

1. Masonry or concrete construction: foam plastics may be used without the thermal barrier described above, regardless of the type of construction, when the foam plastic is covered by a minimum of one (1) inch thickness of masonry or concrete in a wall, floor or roof system.
2. Attics and crawl spaces: within an attic or crawl space where entry is made only for service of utilities, foam plastics shall be protected against ignition by one and one half (1 1/2) inch thick mineral fiber insulation, one half (1/2) inch thick gypsum wallboard, No. 26 gauge sheet metal, or other approved material installed in such a manner that the foam plastic is not exposed.
3. Cold storage construction: foam plastic installed and meeting the requirements of Section 876.5 above when tested in a thickness of four (4) inches may be used in a thickness up to ten (10) inches in cold storage buildings, ice plants, food processing rooms, and similar areas. For rooms within a building, the foam plastic shall be protected by a thermal barrier on both sides. Foam plastic insulation may be used in free-standing coolers and freezers without the thermal barrier when the foam plastic has a flame spread rating for use, is covered by not less than point zero thirty-two (0.032) inches of aluminum or No. 26 gauge corrosion-resistant steel and is protected by an automatic sprinkler system. When such a room is within a

building, both the room and that part of the building in which the room is located shall be sprinklered.

Exception: Freestanding walk-in coolers and freezer units less than four hundred (400) square feet in floor area need meet only the flame spread and smoke requirements of Section 876.5 above.

4. Metal-clad building units: foam plastic insulation having a flame spread of twenty-five (25) or less may be used without the thermal barrier in or on walls in a thickness of not more than four (4) inches when the foam plastic is covered by a thickness of not less than point zero thirty-two (0.032) inch aluminum or No. 26 gauge corrosion-resistant steel and the area is protected with automatic sprinklers.
5. Roofing: foam plastics installed and meeting the requirements of Section 876.5, above, may be used as insulation beneath a roof covering when the roof covering has a Class A, B or C classification.
  - a. All roof coverings as allowed in Section 913.0 may be applied over foam plastic when the foam is separated from the interior of the building by plywood sheathing not less than one-half (1/2) inch in thickness bonded with exterior glue, with edges supported by blocking, tongue-and-groove joints or other approved type of edge support, or an equivalent material. The thermal barrier requirement is waived.
  - b. Foam plastic which is a component of factory-made insulation board or a factory-made assembly which also complies with either Fire Test Standard for Insulated Roof Deck Construction UL 1256 or Test Method for Fire Performance of Roof Deck Construction Factory Mutual, FM 4450, as listed in Appendix B. need not meet the requirements of Section 876.5.
  - c. The thermal barrier is waived in field-assembled roof coverings incorporating a foam plastic having a flame spread of seventy-five (75) or less and also meeting the requirements of either of the above roof deck construction tests.
  - d. For all roof applications the smoke development rating shall not be limited.
6. Doors: where doors are permitted without a fireresistive rating foam plastic having a flame spread of seventy-five (75) or less may be used as a core material when the door facing is wood or when the facing is metal having a minimum thickness of point zero thirty-two (0.032) inch aluminum or No. 26 gauge sheet steel. The thermal barrier is waived.

7. Siding backer board: foam plastic of not more than two thousand (2,000) Btu's per square foot as determined by NFPA 259-76, listed in Appendix B, may be used as siding backer board with a maximum thickness of one-half (1/2) inch, provided it is separated from the interior of the building by an interior thermal barrier, or not less than two (2) inches of mineral fiber insulation, or equivalent, in lieu of the thermal barrier.

876.5.2 Specific approval: Plastic foam or assemblies using foam plastics may be specifically approved based on approved diversified tests such as, but not limited to, tunnel tests conducted in accordance with ASTM E84 listed in Appendix G, fire tests related to actual end use such as a corner test and an ignition temperature test. The specific approval may be based on the end use, quantity, location and similar considerations where such tests would not be applicable or practical.

876.6 Cellulosic insulation: Cellulosic insulation shall be certified that it complies with Federal Specification HH-1-515C.

876.7 Urea based, foamed in place insulation: Urea based foamed in place thermal insulation shall be certified that it has been manufactured and installed in accordance with U.S. Department of Housing and Urban Development Use of Materials Bulletin No. 74.



ARTICLE 9

FIRERESISTIVE CONSTRUCTION REQUIREMENTS

SECTION 900.0 GENERAL

900.1 Scope: The provisions of this article shall govern the use and design of all materials and methods of construction in respect to required fireresistance rating and flameresistance as determined by the potential fire hazard of the use and occupancy of the building or structure and the location and function of all integral structural and other fire-protective elements of the building; and the installation of safeguards against the spread of fire to and from adjoining structures.

900.2 Performance standards: The requirements of this article shall constitute the minimum functional performance standards for fire-protection purposes; and shall not be deemed to decrease or waive any strength provisions or in any other manner decrease the requirements of this code in respect to structural safety.

900.3 Use of combustibles: All materials and forms of construction that develop the fireresistance rating required by this code shall be acceptable for fireproofing and structural purposes; except that the use of combustible component materials in structural units or structural assemblies shall be limited in types of construction specified in Sections 215.0 and 216.0 and in the following Section 900.3.1.

900.3.1 Combustible components: Combustible aggregates may be incorporated in concrete mixtures approved for fireresistance rated construction as provided in Sections 810.0 and 849.0 for gypsum concrete, and any other approved component material or admixture may be used in assemblies that meet the fireresistive test requirements of this code; and wood nailing strips or any other material of similar combustible characteristics may be embedded in concrete and masonry construction for securing trim and finish.

SECTION 901.0 PLANS AND SPECIFICATIONS

901.1 General: Plans for all buildings shall designate the type of construction and the fireresistance rating of all structural elements as required by this code. The plans or specifications shall include documentation or supporting data substantiating all required fireresistance ratings.

SECTION 902.0 FIRE HAZARD CLASSIFICATION

902.1 General: The degree of fire hazard of buildings and structures for each specific use group as defined by the fire grading in Table 902 shall determine the requirements for fire walls, fire separation walls and the segregation of mixed uses as prescribed in Section 213.0 and all

structural members supporting such elements unless otherwise provided for in this code.

Table 902

## FIRE GRADING OF USE GROUPS

| Class | Use group  | Fire grading<br>in hours |
|-------|--|--------------------------|
| A-1   | Assembly, theatres .....   | 3                        |
| A-2   | Assembly, night clubs .....  | 3                        |
| A-3   | Assembly, recreation centers, lecture halls, terminals, restaurants .... | 2                        |
| A-4   | Assembly, churches, schools .....  | 1½                       |
| B     | Business .....   | 2                        |
| F     | Factory and industrial .....   | 3                        |
| H     | High hazard .....  | 4                        |
| I-1   | Institutional, restrained occupants .....                                | 3                        |
| I-2   | Institutional, incapacitated occupants .....                             | 2                        |
| M     | Mercantile .....   | 3                        |
| R-1   | Residential, hotels .....  | 2                        |
| R-2   | Residential, multifamily dwellings .....                                 | 1½                       |
| R-3   | Residential, 1 and 2 family dwellings .....                              | 1                        |
| S-1   | Storage, moderate hazard .....   | 3                        |
| S-2   | Storage, low hazard .....  | 2                        |

902.2 Unclassified uses: The building official shall determine the fire hazard classification of a building or structure design for a use not specifically provided in Table 902 in accordance with the fire characteristics and potential fire hazard of the use group which it most nearly resembles.

## SECTION 903.0 FIRERESISTANCE TESTS

903.1 Structural building assemblies: Built-up masonry units and composite assemblies of structural materials including walls, partitions, columns, girders, beams and slabs and assemblies of slabs and beams or other combinations of structural units for use in floor and roof construction shall be regulated by the fireresistance ratings of Table 214. The fireresistance rating of the floor and ceiling assemblies shall extend to and be tight against the exterior wall.

## 903.2 Column, beam and girder protection

903.2.1 Tests without load: To evaluate column, beam and girder protection for structural units when the fireproofing is not a structural part of the element, in lieu of full size tests of loaded specimens, the struc-

tural sections encased in the material proposed for use as insulation and fire protection may be subjected to the standard test procedure without load.

903.2.2 Alternate protection: When it can be shown to the building official that the structural integrity of structural framing elements will not be reduced below a safe level by a fire, within the building or in an adjacent building, having a severity corresponding to the fireresistance rating required for the elements, through the use of heat shields, separations or other approved means of protection, fire protective coverings or insulating enclosing materials need not be provided for such elements.

### 903.3 Roof coverings

903.3.1 Test procedure and classification: Roof covering materials shall be classified in accordance with the severity of exposure to exterior fire and ability to resist the spread of fire from surrounding buildings and structures when tested in accordance with the roof covering standards (ASTM E108 or Modified Factory Mutual E108) listed in Appendix G.

903.3.2 Class A roofings: Are those which are effective against severe fire exposure. In addition to roof coverings which have been classified, asbestos cement, metal, portland cement concrete, slate, concrete masonry and tile are acceptable where Class A roof coverings are required.

903.3.3 Class B roofings: Are those which are effective against moderate fire exposure.

903.3.4 Class C roofings: Are those which are effective against light fire exposure.

903.3.5 Non-classified roofings: Are those not tested.

### 903.4 Opening protectives

903.4.1 Fire assembly: Shall include the fire doors, fire window, or fire damper and all required hardware, anchorage, frames and sills necessary for the assembly.

903.4.2 Labeled fire doors: Opening protective assemblies including the frames, hardware and operation which comply with the standards listed in Appendix G and accepted practice, including shop inspection, of an accredited authoritative testing or inspection agency shall be deemed to meet the requirements of this code for their recommended and approved locations and use as listed in Section 915.0.

903.4.3 Door openings more than 120 square feet: Labeled fire doors for openings which are more than one hundred and twenty (120) square feet in area may be approved as conforming to all the standard construction

requirements of tested and approved fire door assemblies except as to size.

903.4.4 Labeled fire windows and shutters: Fire window assemblies and shutters which comply with Section 916.0, and the standards listed in Appendix G and accepted practice of an accredited authoritative testing or inspection agency shall be deemed to meet the requirements of their recommended and required locations under this code.

903.4.5 Labeled fire dampers: Only fire dampers which have been tested in accordance with the standards listed in Appendix G and listed by an accredited authoritative testing or inspection agency shall be deemed to meet the requirements of this code.

903.5 Combustibility tests: Where the behavior of materials under exposure to fire is specified in this code, the characteristics of materials shall be determined by the following tests and criteria.

903.5.1 Tests: The following tests shall serve as criteria for acceptance of building materials (when tested in the form and thickness in which they are used) as set forth in Sections 215.0, 216.0 and 217.0 governing the combustibility of building materials for use in Types 1, 2 and 3 construction.

1. Materials which pass the test procedure for defining noncombustibility of elementary materials set forth in ASTM E 136 listed in Appendix G when exposed to a furnace temperature of thirteen hundred eighty-two (1382) degrees F. for a period of five (5) minutes, and do not cause a fifty-four (54) degrees F. rise above the furnace air temperature at the beginning of the test and which do not flame after an exposure of thirty (30) seconds.
2. Materials having a structural base of noncombustible material as defined in paragraph 1 above, with a surfacing not more than one-eighth (1/8) inch thick which has a flamespread rating not greater than fifty (50) when tested in accordance with the method of test for surface burning characteristics of building materials as set forth in ASTM E 84 listed in Appendix G.

The term noncombustible does not apply to the flame spread characteristics of interior finish or trim materials. A material shall not be classed as noncombustible building construction material which is subject to increase in combustible or flame spread rating beyond the limits herein established through the effects of age, moisture or other atmospheric conditions.

903.6 Fireretardant treated wood

903.6.1 Tests: Where permitted for use as a structural element, firere-

tardant treated wood shall be tested in accordance with the standard method of test for surface burning characteristics of building materials (ASTM E84) listed in Appendix G and shall show a flame spread rating not greater than twenty-five (25) when exposed for a period of not less than thirty (30) minutes without evidence of significant progressive combustion. The material shall bear the identification of an accredited authoritative testing or inspection agency showing the performance rating thereof.

903.6.2 Use limitations: Wood that has been pressure-treated with fireretardant chemicals in accordance with the standards for pressure treatment of lumber or plywood in buildings listed in Appendix G or treated by other approved means during manufacture may be used in Types 1 and 2 construction for partitions, structural elements and roof framing and sheathing as indicated by Note h in Table 214, provided that the assembly in which such material is used shall produce the required fireresistance rating when tested in accordance with the standard method of fire test for building construction and materials listed in Appendix G. Where the material is to be subjected to sustained high humidity or exposed to the weather, it shall be further identified to indicate that there is not an increase in listed fire hazard classification after being subjected to the Underwriters' Laboratories (UL) Standard Rain Test. Where used as a structural element, such material shall meet the requirements of Section 903.6.1. Where used as interior finish, such material shall meet the requirements of Section 904.0.

#### SECTION 904.0 FLAMERESISTANCE TESTS

904.1 General: All materials which are required to restrict the spread of fire or to be flame-resistant under the provisions of this code, including, but not limited to, interior wall and ceiling finish materials (ASTM E84), floor coverings (NFIPA 253), fire-retardant treated wood (ASTM E119 or ASTM E84, depending on usage), tents and tarpaulins (NFIPA 102, NFIPA 701 and 527 CMR 19.00), and interior hangings and decorations (527 CMR 21.00, NFIPA 102, NFIPA 701, or ASTM E84 depending on material), shall meet the requirements for their respective uses and classifications.

904.2 Interior wall and ceiling finish materials: All materials used for interior wall and ceiling finish shall be classified within the classification listed in Table 904 in accordance with the Method of Test for Surface Burning Characteristics of Building Materials (ASTM E84).

Table 904

#### INTERIOR FINISH CLASSIFICATION

| Class of material | Surface burning characteristics test (tunnel test) |
|-------------------|--|
| I                 | 0 to 25  |
| II                | 26 to 75   |
| III               | 76 to 200  |

Note: Refer to Table 920 for interior finish requirements by use group.

904.3 Floor coverings: Finish materials for floors in corridors and exitways shall be tested in accordance with Flooring Radiant Panel Test (NFIPA 253).

904.3.1 Test application: Floor coverings shall be tested in assemblies in the manner in which they are intended for use in accordance with NFIPA 253. Where a separate underlayment is used, the floor covering shall be tested as proposed for use over either the actual cushion pad to be used in the installation or a standard cushion pad consisting of Type 11 rubber-coated jute and animal hair or fiber, not less than three-eighths (3/8) inch thick and fifty (50) oz. per square yard, conforming to Federal Specification DDD-C-001023 (GSA-FSS) and subsequent amendments.

904.4 Tents and tarpaulins: All material used for tents and tarpaulins shall be classified in accordance with the test methods and requirements of Tents, Grandstands and Air-Supported Structures Used for Places of Assembly (NFIPA 102), Fire Tests for Flame-Resistant Textiles and Films (NFIPA 701) and Flame-Retardant Tentage and Flammable Tentage (527 CMR 19.00). (See Section 422.0.)

904.5 Interior hangings and decorations

904.5.1 Acceptance criteria: Where required to be flameresistant under the provisions of this code, all materials specified or required for artistic enhancement or use for decorations, draperies, curtains, scenery and hangings shall comply with the requirements for Flammable Decorations in 527 CMR 21.00.

## SECTION 905.0 SPECIAL FIRERESISTIVE REQUIREMENTS

905.1 General: In buildings or parts thereof of the uses and types of construction herein specified, the general fireresistive requirements of Table 214 and the height and area limitations of Table 305 shall be subject to the exceptions and modifications described in Sections 905.2 through 905.5 and to the requirements for Garages, Service Stations and Gasoline Stations and Gasoline in 527 CMR 5.00.

905.2 Public garages: All existing buildings and structures altered or converted for use to a garage, motor vehicle repair shop or gasoline service station, more than one (1) story in height, unless of fireproof (Type 1) construction, or heavy timber (Type 3A) construction, shall have the partitions, columns and girders and all floor and roof construction protected and insulated with noncombustible materials or assemblies of component materials having a fireresistance rating of not less than one (1) hour; except that existing roof trusses shall be exempt from all fireproofing requirements.

905.3 Deleted

905.4 Packing and shipping rooms: Every packing or shipping room located on or below a floor occupied for use group M (mercantile) use shall be separated therefrom by fire separation walls or floor-ceiling assemblies of not less than the fireresistance rating of the type of construction as set forth in Table 214 but not less than one (1) hour fire-resistance rating.

905.5 Truck loading and shipping areas: Truck loading and shipping areas shall be permitted within any use group B (Business) building, provided such areas are enclosed in construction of not less than the fireresistance rating of the type of construction as set forth in Table 214 but not less than one (1) hour, and direct access is provided therefrom to the street.

#### 905.6 Use group R (residential) buildings

905.6.1 Protected ordinary construction: Multi-family dwellings (use group R-2) of protected ordinary (Type 3B) construction may be increased to six (6) stories or seventy-five (75) feet in height when the first floor construction above the basement or cellar has a fireresistance rating of not less than three (3) hours and the floor area is subdivided by two (2) hour fire walls into fire areas of not more than three thousand (3,000) square feet.

905.6.2 Protected noncombustible construction: When of protected non-combustible (Type 2B) construction, multi-family dwellings (use group R-2) may be increased to nine (9) stories or one hundred (100) feet in height when separated by not less than fifty (50) feet from any other building on the lot and from interior lot lines, the exitways are segregated in a fire area enclosed in a fire wall of two (2) hour fireresistance rating and the first floor construction has a fireresistance rating of not less than one and one-half (1 1/2) hours.

905.6.3 Retail business use: The first floor of buildings of unprotected noncombustible (Type 2C), masonry wall (Type 3C) or frame (Type 4B) construction may be occupied for retail store use, provided the floor-ceiling assembly and enclosure wall are protected to afford one (1) hour fireresistance rating and the exitways from the residential floors are separately enclosed in accordance with the requirements of Article 6.

#### 905.7 Grade floor protection

905.7.1 Non-fireproof construction: In all buildings other than one- and two-family dwellings (use groups R-3 and R-4) and other than fireproof (Type 1) construction with habitable or occupiable stories or basements below grade the floor-ceiling assemblies and supports below the grade floor shall be protected by one (1) of the following methods:

1. fireresistance rating of not less than one (1) hour, or

2. heavy mill (Type 3A) construction, or
3. automatic fire suppression system.

The firerestance rating provided shall not be less than the rating required by Table 214 for type of construction.

905.7.2 Protected noncombustible construction: In all buildings of protected noncombustible (Type 2A) construction, more than four (4) stories or fifty (50) feet in height, in other than residential (R) use groups, the floor-ceiling assembly above the basement or cellar shall be constructed with a firerestance rating of not less than two (2) hours.

905.7.3 Basement assembly uses: Places of public assembly for amusement, entertainment, instruction, or service of food or refreshment shall not be located in stories or rooms below grade unless the floor-ceiling assembly above and below is of not less than one and one-half (1 1/2) hour firerestance rating.

905.8 Noncombustible construction exemptions: One (1) story buildings of Type 2C construction which do not exceed three thousand (3,000) square feet in area in all use groups except high hazard (H), assembly (A) and institutional (I) shall be exempt from all protected exterior wall requirements.

905.9 Interior partitions: In buildings and structures of other than institutional (I) and residential (R) use groups of fireproof (Type 1) and protected noncombustible (Types 2A and 2B) constructions, partitions of a single thickness of wood or approved composite panels, and glass or other approved materials of similar combustible characteristics, may be used to subdivide rooms or spaces into offices, entries, or other similar compartments, provided they do not establish a corridor serving an occupant load of thirty (30) or more in areas occupied by a single tenant and not exceeding five thousand (5,000) square feet between fire separation assemblies or fire walls. An area not exceeding seventy-five hundred (7500) square feet may be subdivided with fireretardant treated wood when complying with Section 903.6.

905.10 Plenums: The use of uninhabited basements, cellars, crawl spaces, cavity walls, areas above ceilings or attic spaces as supply, make up, exhaust air or return air plenums or ducts is prohibited.

Exception: Air-ceiling plenums may be installed as supply or return air plenums in all occupancies except one- and two-family dwellings, provided such air plenums meet the requirements of other applicable articles of this code and of the mechanical code listed in Appendix B and provided fuel-fired equipment or exposed combustible materials are not located therein. The use of air-ceiling plenums shall be confined to one (1) fire area. The floor or roof assembly above an unlisted air-ceiling plenum shall not depend upon the air ceiling for a portion of its fire-



resistive rating. Insulated cold water, hot water, steam, fire protection and electric lines are allowed in air-ceiling plenums. The use of air-ceiling plenums in evaporative cooling systems is prohibited. Panning of the joist or stud space for return air is permitted in one- and two-family dwellings only. Crawl spaces not used as storage areas in one- and two-family dwellings may be used for air distribution systems.

905.11 Fire dampers: Except when proper fire tests have shown that fire dampers are not necessary to maintain the integrity of the fireresistance rated assembly, fire dampers complying with the SMACNA Fire Damper Guide, listed in Appendix B or UL 555 listed in Appendix G, shall be installed in the following locations:

1. Ducts penetrating a fire wall. (When a fire wall is of three (3) hour or greater fire endurance, a fire door is required.)
2. Ducts passing through a fire separation wall.
3. Ducts penetrating a fireresistance rated shaft wall. Sub-ducts extending twenty-two (22) inches vertically upward may be used in lieu of fire dampers for exhaust ducts.
4. Ducts penetrating the ceiling of a fireresistance rated floor/roof-ceiling assembly.
5. Ducts penetrating fireresistance rated corridor walls, unless the building is completely sprinklered or unless the ducts are part of an engineered smoke removal system.

#### SECTION 906.0 EXTERIOR WALLS

906.1 General: All exterior walls shall comply with the structural provisions of Articles 7 and 8 and with the fireresistance rating requirements of Table 214.

906.2 Exceptions: The provisions of this code shall not be deemed to prohibit the omission of exterior walls for all or part of a story when required for special uses and occupancies; except that when so omitted, the open areas shall be separated from the rest of the area and from the upper and lower stories of the building by wall and floor construction of the fireresistance rating required in Table 214; and except as otherwise specifically permitted in this code, the piers, columns and other structural supports within the open portion shall be constructed with the fireresistance rating required for exterior bearing walls in Table 214.

906.3 Vertical separation of windows

906.3.1 Where required: In all buildings and structures designed for business (B), factory and industrial (F), high hazard (H), mercantile (M) or storage (S) uses, exceeding three (3) stories or forty (40) feet in height, openings located vertically above one another in exterior walls which are required to have a fireresistance rating of more than one (1) hour shall be separated by apron or spandrel walls not less than three

(3) feet in height extending between the top of any opening and the bottom of the opening next above.

906.3.2 Fireresistance rating: The apron or spandrel walls shall be constructed with the same fireresistance rating required for the exterior wall in which it is located as specified in Table 214; except when such required rating exceeds one (1) hour, approved wire glass construction in fixed noncombustible sash and frames not exceeding one-third (1/3) of the area of such apron or spandrel may be located therein, and except further that in exterior non-bearing enclosure walls which are not required to be of more than one (1) hour fireresistance rating the provisions of this section in respect to apron or spandrel walls shall not apply.

#### SECTION 907.0 FIRE WALLS AND PARTY WALLS

907.1 General: Walls shall have sufficient structural stability under fire conditions to allow collapse of construction on either side without collapse of the wall and shall be constructed of any approved noncombustible materials providing the required strength and fireresistance rating specified in Table 214 for the type of construction, but not less than the fire grading of the use group specified in Table 902. The construction shall comply with all the structural provisions for bearing or non-bearing walls of this code.

907.2 Solid masonry: When constructed of solid masonry, the wall thickness shall be not less than the requirements of Section 866.0.

907.3 Reinforced concrete: When constructed of reinforced concrete, the wall thickness shall be not less than nine (9) inches for the uppermost thirty-five (35) feet or portion thereof measured down from the top of the wall.

907.4 Cutting walls: A wall, eight (8) inches or less in thickness, shall not be cut for chases or socketed for insertion of structural members subsequent to erection (see Section 837.0).

907.5 Hollow masonry and cavity walls: When combustible members frame into hollow walls or walls of hollow units, all hollow spaces shall be solidly filled for the full thickness of the wall and for a distance not less than four (4) inches above, below and between the structural members, with noncombustible materials approved for firestopping in Section 919.0. The wall shall be not less than the minimum thickness specified in the Building Code Requirements for Masonry listed in Appendix B.

907.6 Combustible insulation: The building official may permit the application of cork, fiberboard or other combustible insulation if laid up without intervening air spaces and attached directly to the face of the wall, and protected on the exposed surface as provided in Sections 823.0 and 876.0.

907.7 Continuity of walls: In all buildings and structures, walls shall be continuous from foundation to two (2) feet eight (8) inches above the roof surface, except for the following:

1. The wall may terminate at the underside of the roof deck where the roof is of noncombustible construction and is properly firestopped at the wall.
2. The wall may terminate at the underside of the roof deck in Types 3 and 4 construction if properly firestopped, and the roof sheathing or deck is constructed of approved noncombustible materials for a distance of four (4) feet on either side of the wall and combustible material does not extend through or over the wall.

907.8 Offset fire walls: If fire walls are offset at intermediate floor levels in fire-protected skeleton frame construction, the offset floor construction and the intermediate wall supports shall be constructed of noncombustible materials with a fireresistance rating not less than that required for the fire wall.

#### SECTION 908.0 FIRE WALL OPENINGS

908.1 General: Openings in fire walls shall not exceed the limits in size and area herein prescribed and the opening protectives shall conform to the provisions of Sections 903.0 and 914.0.

908.2 Size of opening: Except in sprinklered buildings, an opening through a fire wall shall not exceed one hundred twenty (120) square feet in area, and aggregate width of all openings at any floor level shall not exceed twenty-five (25) per cent of the length of the wall.

908.2.1 First story exception: When the entire areas on both sides of a fire wall are protected with an approved automatic fire suppression system complying with the requirements of Article 12, openings designed for the passage of trucks may be constructed not more than two hundred forty (240) square feet in area with a minimum distance of three (3) feet between adjoining openings. Such openings shall be protected with approved automatic opening protectives of three (3) hour fireresistance rating and provided with an approved water curtain for such openings in addition to all other requirements.

908.3 Opening protectives: Every opening in a fire wall shall be protected on both sides with an approved automatic protective assembly as herein required, or the approved labeled equivalent, except horizontal exit openings.

908.3.1 Hold-open devices: Heat-actuated hold-open devices used on an automatic fire assembly providing three (3) hour fireresistance rating shall be installed, one (1) on each side of the wall at ceiling height where

the ceiling is more than three (3) feet above the opening. Fire assemblies protecting openings required to have one and one-half (1 1/2), one (1) or three-fourths (3/4) hour fire-resistance rating, and which are not exitway doors, may be activated in a similar manner, or by a single fusible link incorporated in the closing device. Doors opening in a means of egress shall be closed by actuation of a smoke detector conforming to the standards listed in Appendix I.

## SECTION 909.0 FIRE SEPARATION WALLS

### 909.1 Uses

909.1.1 Mixed uses: When a building contains more than one (1) occupancy, and each part of the building is separately classified as to use, the mixed uses shall be completely separated with fire separation walls as specified in Section 213.0.

909.1.2 One- and two-family dwellings: The requirements for the construction of fire separation walls in buildings containing single-family dwellings or two-family dwellings (use group R-3 or R-4) are as follows:

Two-family dwelling, superimposed dwelling units: When one (1) dwelling unit of a two-family dwelling is located wholly or partly above the other dwelling unit, the two (2) dwelling units shall be completely separated by fire separation walls and floor-ceiling assemblies of not less than one (1) hour fire-resistance rated construction.

Two-family dwelling, side-by-side dwelling units: When adjacent dwelling units of a two-family dwelling are attached by a common wall, said wall shall be a fire separation wall, having a minimum one (1) hour fire-resistance rating that shall serve to completely separate the dwelling units.

Multiple, single-family dwellings; side-by-side: When multiple, single-family dwellings (use group R-3) are attached by a common wall, said wall shall be a fire separation wall, having a minimum one (1) hour fire-resistance rating. Said wall shall extend from the foundation to the underside of the roof sheathing, and to the inside of the exterior wall sheathing.

Multiple, two-family dwellings; side-by-side: When multiple, two-family dwellings (use group R-3) are attached by a common wall, said wall shall be a fire separation wall, having a minimum one (1) hour fire-resistance rating. Said wall shall extend from the foundation to the underside of the roof sheathing and to the inside of the exterior wall sheathing.

909.1.3 Exitways: Fire separation walls required for the enclosure of exitways and areas of refuge shall be constructed of masonry, reinforced concrete or any other approved noncombustible materials having the minimum fire-resistance rating prescribed by Table 214; except that such walls may be constructed of combustible materials as regulated by Sections 616.9 and 909.3.

909.1.4 Other uses: Fire separation walls used for subdividing purposes other than exitways and areas of refuge shall be constructed of the types of materials and have the minimum fireresistance rating as prescribed by Table 214 for the type of construction.

## 909.2 Openings

909.2.1 Size: Exitway doors located in fire separation walls shall be limited to a maximum aggregate width of twenty-five (25) per cent of the length of the wall and the maximum area of any single opening shall not exceed forty-eight (48) square feet.

909.2.2 Protectives: All opening protectives in fire separation walls shall comply with the provisions of Section 903.0 and shall have the minimum fireresistance rating as set forth in Section 915.0.

## 909.3 Combustible stair enclosures

909.3.1 Construction: Stair enclosures constructed of approved combustible assemblies protected with component materials to afford the required fireresistance ratings shall be continuous through combustible floor construction and shall provide an unbroken fire barrier in combination with protected floors, ceilings and fire doors, separating the exitways from the unprotected areas of the building. Such enclosures shall be firestopped to comply with Sections 875.9 and 919.0.

909.3.2 Openings for lighting: Openings for the purpose of providing light in such enclosures may be protected with wired glass with single panes not more than three hundred sixty (360) square inches in area and a total area in one (1) story of not more than seven hundred twenty (720) square inches. Such light panels shall comply with the provisions of Section 917.0, and shall be contained in stationary sash and frames of steel or other approved noncombustible materials.

909.4 Continuity: All fire separation walls shall extend from the top of the fireresistance rated floor below to the ceiling above, unless otherwise provided for in this code, and shall be securely attached thereto. Where these walls enclose required exitways, areas of refuge and shafts, or where these walls separate mixed uses, they must be continuous through all concealed spaces such as the space above a suspended ceiling, and they must be constructed tight to the underside of the floor slab or roof deck above. The supporting construction shall be protected to afford the required fireresistance rating of the wall supported. All hollow vertical spaces shall be firestopped at every floor level as required in Sections 875.0 and 919.0.

## SECTION 910.0 VERTICAL SHAFTS

910.1 General: The provisions of this section shall apply to all vertical

shaft enclosures, except as provided for stairway enclosures in Sections 616.9 and 909.0, refuse chutes in Section 1107.0, and elevator and dumb-waiter hoistways in Article 16.

910.2 Open shaft enclosures: The enclosing wall of shafts that are open to the outer air at the top shall be constructed of materials specified in Article 8 for exterior walls of buildings and structures of the required fireresistance rating specified in Table 214.

910.3 Covered shaft enclosures: The enclosing walls and the top of interior covered shafts shall be constructed of approved masonry, reinforced concrete or other approved construction with a fireresistance rating of not less than two (2) hours, except as provided in Section 910.4.

910.4 Shafts in residential buildings: In one- and two-family dwellings of other than fireproof or noncombustible construction, shafts may be supported on and constructed of combustible materials or assemblies having a fireresistance rating of not less than one (1) hour and shall extend not less than three (3) feet above the roof with a ventilating skylight of noncombustible construction as specified in Section 925.0.

910.5 Duct and pipe shafts: In all buildings other than one- and two-family dwellings, vertical pipes arranged in groups of two (2) or more which penetrate two (2) or more floors and occupy an area of more than one (1) square foot, and vertical ducts which penetrate two (2) or more floors, shall be enclosed by construction of not less than one (1) hour fireresistance rating to comply with this section. All combustible pipes and ducts connecting two (2) or more stories shall be enclosed as indicated herein.

#### 910.6 Top enclosure

910.6.1 Not extending to roof: A shaft that does not extend into the top story of the building shall be enclosed with top construction of the same strength and fireresistance rating as the floors of the building or structure in which it occurs, but not less than that of the fireresistance rating of the shaft enclosure. Such shafts shall be provided with noncombustible vents for the relief of smoke and gases in the event of fire, with an area not less than ten (10) per cent of the shaft area.

910.6.2 Extending to roof: All shafts that extend to the roofs of buildings shall be covered at the top with a thermostatically controlled skylight of not less than ten (10) per cent of the area of the shaftway, constructed in accordance with the requirements of Section 925.0. The automatic operation of the skylight may be controlled by fusible links designed to operate at a fixed temperature of not more than one hundred sixty (160) degrees F. or by electric or pneumatic operation under a rapid rise in temperature at a rate of fifteen (15) to twenty (20) degrees F. per minute or by other approved methods.

910.6.3 Alternate shaft ventilation: The skylight herein required may be replaced by a window of equivalent area in the side of the shaft, provided the sill of such window is not less than two (2) feet above the adjoining roof, is equipped with an automatic vent opening, does not face on an interior lot line or within ten (10) feet thereof, and is not located within twenty (20) feet of an opening in adjacent walls.

910.7 Bottom enclosure: All shafts that do not extend to the bottom of building or structure shall be enclosed at the lowest level with construction of the same strength and fireresistance rating as the lowest floor through which they pass, but not with a fireresistance rating less than that of the shaft enclosure.

910.8 Existing shaftways: In all existing shaftways of buildings of assembly (use group A) and institutional classifications (use group I), which are not already enclosed as herein required, the building official shall direct such construction as he may deem necessary to insure the safety of the occupants, subject to review as provided in Section 126.0.

910.9 Shaft openings: Openings other than necessary for the purpose of the shaftway shall not be constructed in shaft enclosures; and all openings shall be protected with approved fire doors, fire windows or fire shutters complying with the provisions of Sections 914.0, 915.0 and 916.0.

#### SECTION 911.0 FIRERESISTANCE OF STRUCTURAL MEMBERS

911.1 Requirements: The fireresistance rating of construction assemblies and structural members shall comply with the requirements of Table 214 and Section 903.0.

911.2 Protection of structural members: Columns, girders, trusses, beams, lintels, or other structural members that are required to have a fireresistance rating and that support more than two (2) floors or one (1) floor and roof, or support a bearing wall, or a non-bearing wall more than two (2) stories high, shall be individually protected on all sides for their length or height with materials having the required fireresistance rating. All other structural members required to have a fireresistance rating may be protected by individual encasement, by a membrane or ceiling protection as specified in Section 912.0, or by a combination of both.

911.3 Embedments and enclosures: Pipes, wires, conduits, ducts or other service facilities shall not be embedded in the required fire protective covering of a structural member that is required to be individually encased.

911.4 Impact protection: Where the fire protective covering of a structural member is subject to impact damage from moving vehicles, the han-

dling of merchandise, or other activity, the fire protective covering shall be protected by corner guards or by a substantial jacket of metal or other noncombustible material, to a height adequate to provide full protection, but not less than five (5) feet from the finished floor.

#### 911.5 Deleted

911.6 Wall beams: Beams and girders which support walls required to have a fireresistance rating shall be protected to afford not less than the fireresistance rating of the wall supported, but the fireresistance rating shall not be less than one (1) hour for members supporting masonry walls.

911.7 Wall lintels: Unless supported or suspended from structural wall girders protected with insulating materials of the required fireresistance rating or when the opening is spanned by a masonry arch of the required strength, all lintels over openings in masonry walls more than eight (8) feet in length shall be protected as required for structural members supporting walls for the type of construction.

911.7.1 Stone lintels: The use of stone lintels on spans exceeding four (4) feet shall not be permitted unless supplemented by fireresistance rated structural members or masonry arches of the required strength to support the superimposed loads.

911.8 First story columns: In buildings of exterior masonry wall (Type 3) construction, required fire protection may be omitted from first story columns supporting enclosure walls located on the street lot line (see Section 217.0).

### SECTION 912.0 FIRERESISTANCE RATED FLOOR/ROOF-CEILING ASSEMBLIES

912.1 Installation of ceiling fixtures: Fireresistive ceilings which constitute an integral part of a floor or roof assembly to meet a required fire-resistance rating may have openings to accommodate noncombustible piping, ducts or electric outlets. The aggregate area of such openings in the ceiling shall be not greater than one hundred (100) square inches in any one hundred (100) square feet of ceiling area. The fixtures and attachments shall be installed so as not to decrease the fireresistance rating of the assembly. All duct openings shall be protected with approved noncombustible fire dampers.

912.2 Ceiling panels: Where the weight of lay-in ceiling panels, used as a part of fireresistive floor-ceiling or roof-ceiling assemblies, is not adequate to resist an upward force of one (1) pound per square foot (psf), wire or other approved devices shall be installed above the panels to prevent vertical displacement under such upward force.



912.3 Deleted

912.4 Deleted

912.5 Deleted

912.6 Unusable space: In an assembly required to be of one (1) hour fireresistance rating, the ceiling membrane may be omitted over unusable space or the floor may be omitted where unusable space occurs above.

912.7 Openings in fireresistance rated floors: The required fire resistance rating of floor or floor/ceiling assemblies shall be maintained where a penetration is made for electrical, mechanical, plumbing and communication conduits, pipes and systems.

#### SECTION 913.0 ROOF CONSTRUCTION

913.1 General: Roof construction shall be protected with noncombustible material or assemblies of noncombustible materials to afford the fireresistance rating required by Table 214 as herein modified.

913.2 Roofs 20 feet or higher: When every part of the structural framework of roofs in Type 1 or Type 2 buildings is twenty (20) feet or more above the floor immediately below, all fire protection of the structural members may be omitted, including the protection of trusses, roof framing and decking. Heavy timber members, in accordance with Section 217.1, may be used for such unprotected members in one (1) story buildings.

Exception: Buildings of H (High Hazard), S-1 (Moderate Hazard Storage) or M (Mercantile) occupancies when of Types 1 or 2A construction shall not have less than one (1) hour fireresistance rated roof construction.

913.3 Roof slabs, arches and decking: Where the omission of fire protection from roof trusses, roof framing and decking is permitted, the horizontal or sloping roofs in Type 1 and Type 2 buildings, immediately above such members, shall be constructed of noncombustible materials of the required strength without a specified fireresistance rating, or of mill type construction in buildings not over five (5) stories or sixty-five (65) feet in height.

913.4 Firestopping: Firestopping of ceiling and attic spaces shall be provided as required by Sections 875.0, 912.0 and 919.0.

#### SECTION 914.0 EXTERIOR OPENING PROTECTIVES

914.1 Where required: Where specified herein, the exterior openings of all buildings and structures other than churches (use group A-4), residential buildings (use groups R-2, R-3 and R-4), buildings of unprotected noncombustible (Type 2C) construction, and buildings of frame (Type

4) construction shall have approved opening protectives meeting the requirements of this code and the provisions of Article 4 for special uses and occupancies.

914.2 Horizontal exposure: Approved protectives shall be provided in every opening where the perpendicular fire separation is less than fifteen (15) feet.

914.3 Vertical exposure: Approved protectives shall be provided in every opening which is less than fifty (50) feet vertically above the roof of an adjoining or adjacent structure that is within a horizontal distance of thirty (30) feet perpendicular to the wall in which the opening is located, unless such roof construction affords a fireresistance rating of not less than one and one-half ( 1 1/2) hours.

914.4 First story openings: The required fireresistance rated opening protectives may be omitted in first story openings facing on a street or other public space not less than thirty (30) feet wide, when not extending more than twenty-five (25) feet above grade.

914.5 Protected openings: Required protective assemblies in exterior openings shall be fixed, or they may be self-closing, or provided with approved automatic self-closing devices.

914.6 Unprotected openings: Where a fireresistance rating is not required by this section for openings in exterior walls, window assemblies and doors may be of unprotected wood. Glazing shall conform to the requirements of Article 8 and Article 19.

SECTION 915.0 FIRE DOORS

915.1 Fire door assemblies: Approved fire door assemblies as defined in this code shall be constructed of any material or an assembly of component materials which meets the test requirements of Section 903.0 and the fireresistance ratings herein required, unless otherwise specifically provided for in this code.

Table 915

FIRE DOOR FIRERESISTANCE RATINGS

| Location  | Fireresistance rating in hours |
|---|--------------------------------|
| Fire walls and fire separation walls of three (3) or more hour construction . . . . .     | 3                              |
| Fire walls, fire separation walls and exitway enclosures of two (2) hour construction . . | 1½                             |
| Shaft enclosures and elevator hoistways of two (2) hour construction . . . . .            | 1½                             |
| Shaft enclosures of one (1) hour construction . . . . .                                   | 1                              |
| Fire separation walls of one (1) hour construction . . . . .                              | ¾ (note a)                     |

Note a: One and three-quarter (1¾) inch solid wood core or pressed wood particle board flush doors are acceptable (see Section 610.4.1).

915.2 Labeled protective assemblies: Labeled protective assemblies meeting the requirements of Sections 903.4.2 and 903.4.4 and the applicable fire protective standards listed in Appendix I, including shop inspection, shall be approved for use as provided for in this code.

### 915.3 Multiple doors

915.3.1 Fire walls: Two (2) doors, each with a fireresistance rating of one and one-half (1½) hours, installed on opposite sides of the same opening, shall be deemed equivalent in fireresistance rating to one (1) three (3) hour fire door.

915.3.2 Fire separation walls: Two (2) doors of three-quarter (¾) hour fireresistance rating each, installed on opposite sides of the same opening shall be deemed equivalent in fireresistance rating to a one and one-half (1½) hour fire door; except when used in a required exitway.

915.4 Glass panels: wired glass panels shall be permitted in fire doors within the limitations of Section 917.0 and as herein specifically prescribed.

915.5 Closing devices: Except as may be otherwise provided for openings in fire walls and fire separation walls, all fire doors shall be self-closing and shall be closed during occupancy of the building or part thereof. The building official may accept the use of rate of rise heat actuated devices meeting the requirements of the approved rules on doors that are normally required to be open for ventilation or other specified purposes when the safety of the occupants is not endangered thereby.

## SECTION 916.0 FIRE WINDOWS AND SHUTTERS

916.1 Fireresistance rating: Approved assemblies of fire windows and fire shutters shall meet the test requirements of Section 903.0, or shall be approved labeled assemblies meeting the requirements of Section 903.4.4.

916.1.1 Exception: Steel window frame assemblies of one-eighth (1/8) inch minimum solid section or of not less than No. 18 Manufacturer's Standard Gauge (0.048 in.) formed sheet steel members fabricated by pressing, mitering, riveting, interlocking or welding and having provision for glazing with one-quarter (1/4) inch wired glass as required in Section 917.0 when securely installed in the building construction and glazed with one-quarter (1/4) inch labeled wired glass, shall be deemed to meet the requirements for a three-quarter (¾) hour fire window assembly.

916.2 Window mullions: All metal mullions which exceed a nominal height of twelve (12) feet shall be protected with insulating materials to afford the same fireresistance rating as required for the wall construction in which the protective is located.

916.3 Swinging fire shutters: When fire shutters of the swinging type are used in exterior openings, not less than one (1) row in every three (3) vertical rows shall be arranged to be readily opened from the outside and shall be identified by distinguishing marks or letters not less than six (6) inches high.

916.4 Rolling fire shutters: When fire shutters of the rolling type are used, they shall be of approved counterbalance construction that can be readily opened from the outside.

#### SECTION 917.0 WIRED GLASS

917.1 Maximum size: One-quarter (1/4) inch wired glass, which has been listed and labeled for use in approved labeled opening protectives, may be used with the size limitations described in Table 917.

Table 917

**LIMITING SIZE OF WIRED GLASS PANELS**

| Rating, opening            | Max. area<br>sq. in. | Max. height<br>inches | Max. width<br>inches |
|----------------------------|----------------------|-----------------------|----------------------|
| 3 hour, Class A door       | 0                    | 0                     | 0                    |
| 1 & 1½ hour, Class B doors | 100                  | 33                    | 10                   |
| ¾ hour, Class C door       | 1296                 | 54                    | 54                   |
| 1½ hour, Class D door      | 0                    | 0                     | 0                    |
| ¾ hour, Class E door       | 1296                 | 54                    | 54                   |
| Fire windows               | 1296                 | 54                    | 54                   |

917.1.1 Fire walls: Wired glass in fire doors located in fire walls shall be prohibited, except when serving as horizontal exits. In such instances, the self-closing swinging door may be provided with a vision panel of not more than one hundred (100) square inches without a dimension exceeding twelve (12) inches.

917.1.2 Fire separation walls: Wired glass vision panels may be used in fire doors of one and one-half (1 1/2) hour fireresistance rating intended for use in fire separation walls; but the glass panels shall not be more than one hundred (100) square inches.

917.2 Exitway protectives: Unless specifically required in Article 4 to be solid in such locations where unusually hazardous conditions prevail, fire doors in elevator and stairway shaft enclosures may be equipped with approved wired glass vision panels which shall be so located as to furnish clear vision of the passageway or approach to the elevator or stairway. Such vision panels shall not exceed the size limitations specified for Class B doors.

917.3 Fire separation walls: One-quarter (1/4) inch wired glass panels may be used in fire separation walls used for subdividing purposes as set forth in Section 909.1.3, provided the required fireresistance rating of the wall does not exceed one (1) hour. The maximum size of such panels shall not exceed the limitations for a three-quarter (3/4) hour Class C door.

## SECTION 918.0 FIRERESISTIVE REQUIREMENTS FOR PLASTER

918.1 Thickness of plaster: The required thickness of fireresistance rated plaster protection shall be determined by the prescribed fire tests for specified use and type of construction and in accordance with the provisions of Section 819.0 for interior plastering and Section 820.0 for exterior plaster (stucco). The thickness in all cases shall be measured from the face of the lath when applied to fiber board, wood, or gypsum lath and from the back of metal lath.

918.2 Plaster equivalents: For fireresistive purposes, one-half (1/2) inch of unsanded gypsum plaster shall be deemed equivalent to three-quarter (3/4) inches of one (1) to three (3) sanded gypsum or one (1) inch portland cement sand plaster.

918.3 Noncombustible furring: In fireproof (Type 1) and noncombustible (Type 2) construction, plaster shall be applied directly on masonry or on approved noncombustible plastering base and furring.

918.4 Double reinforcement: Except in solid plaster partitions, or when otherwise determined by the prescribed fire tests, plaster protections more than one (1) inch in thickness shall be reinforced with an additional layer of approved lath imbedded at least three-quarter (3/4) inch from the outer surface and fixed securely in place.

918.5 Plaster alternate for concrete: In reinforced concrete construction, gypsum or portland cement plaster may be substituted for one-half (1/2) inch of the required concrete protection, except that a minimum thickness of three-eighths (3/8) inch of concrete shall be provided around the reinforcement in all reinforced concrete floors and one (1) inch in reinforced concrete columns in addition to the plaster finish, and the concrete base shall be prepared in accordance with Section 820.7.

#### SECTION 919.0 FIRESTOPPING AND DRAFTSTOPPING

919.1 General: To prevent the free passage of flame and products of combustion through concealed spaces or openings in the event of fire, provisions shall be made to provide effective firestops or draftstops as herein specified.

919.2 Firestopping materials: All firestopping shall consist of approved noncombustible materials securely fastened in place. Firestops of two (2) thicknesses of one (1) inch lumber with broken lap joint or one thickness of three-quarter (3/4) inch plywood with joints backed by three-quarter (3/4) inch plywood or of two (2) inch lumber installed with tight joints shall be permitted in open spaces of wood framing.

919.3 Draftstopping materials: Draftstopping materials shall be not less than one-half (1/2) inch gypsum board, three-eighths (3/8) inch plywood or other approved materials adequately supported.

919.4 Integrity: The integrity of all firestopping and draftstopping shall be continuously maintained.

919.5 Required inspection: Firestopping and draftstopping shall not be concealed from view until inspected and approved by the building official.

919.6 Firestopping required: Firestopping shall be provided in the following locations:

1. In concealed spaces of stud walls and partitions, including furred or studded-off spaces of masonry or concrete walls, at the ceiling and floor or roof levels.
2. At all interconnections between vertical and horizontal spaces such as occur at soffits over cabinets, drop ceilings, cove ceilings, etc.
3. In concealed spaces between stair stringers at the top and bottom of the run.
4. At openings around vents, pipes, ducts, chimneys and fireplaces at ceiling and floor levels, with noncombustible materials.
5. In exterior cornices and other exterior architectural elements where

permitted of combustible construction in 924.0, or when erected with combustible frames, at maximum intervals of twenty (20) feet. If non-continuous, they shall have closed ends, with at least four (4) inches separation between sections.

6. In the space behind combustible trim and finish where permitted under this code and all other hollow spaces where permitted in fireresistance rated construction at ten (10) foot intervals or the space shall be solidly filled with noncombustible materials.
7. In concealed spaces formed by floor sleepers in areas of not more than one hundred (100) square feet, or the space shall be solidly filled with noncombustible materials.

919.7 Draftstopping required: Draftstopping shall be provided in Types 3B, 3C and 4 construction in the following locations:

1. Where ceilings are suspended below solid wood joists or suspended or attached directly to the bottom of open web wood floor trusses, the space between the ceiling and the floor above shall be divided by providing draftstopping as follows:
  - a. In use groups R-1 and R-2 draftstopping shall be in line with the tenant separation walls when the walls do not extend to the floor sheathing above.
  - b. In use groups R-3 and R-4 the space shall be divided into approximately equal areas with no area greater than five hundred (500) square feet. The draftstopping shall be provided parallel to the main framing members.
  - c. In all other use groups draftstopping shall be provided so that horizontal areas do not exceed one thousand (1,000) square feet.

Exception: Where the space above a ceiling is of combustible construction and the building is sprinklered with sprinklers above and below the ceiling, the draftstopping may be omitted.

2. Attics and concealed spaces:

- a. Use groups R-1 and R-2: In the attic, mansard, overhang or other concealed roof space, above and in line with the tenant separation when the separation walls do not extend to the roof sheathing above.

Exceptions:

1. Where corridor walls provide a tenant separation, draftstopping shall only be required above one of the corri-

dor walls.

2. Where flat roofs with solid joist construction are used, draftstopping over tenant separation walls is not required.
  3. Where the space above a ceiling is of combustible construction and the building is sprinklered with sprinklers above and below the ceiling, the draftstopping may be omitted.
- b. Use groups R-3 and R-4: Draftstopping is not required in the attic space.
- c. In all other use groups: In attics and concealed roof spaces so that no horizontal area exceeds three thousand (3,000) square feet.

Exceptions:

1. Where flat roofs with solid joist construction are used, draftstopping over tenant separation walls is not required.
2. Where the space above a ceiling is of combustible construction and the building is sprinklered with sprinklers above and below the ceiling, the draftstopping may be omitted.

919.8 Ventilation: Ventilation of concealed roof spaces shall be maintained in accordance with Section 507.0.

919.9 Access to attics: In use groups R-1, R-2, R-3 and R-4, a readily accessible attic access opening not less than twenty-two (22) inches by thirty (30) inches shall be provided from every living unit to any attic area having a clear height of over thirty (30) inches. When doors or other openings are provided in the draftstopping, they shall be of approved materials specified in this section, and the construction shall be tightly fitted around all pipes, ducts or other assemblies piercing the draftstopping.

SECTION 920.0 INTERIOR WALL AND CEILING FINISH, FLOOR COVERINGS AND TRIM

920.1 General: Interior finish and interior trim of buildings shall conform to the requirements of this section. Interior finish shall include all wainscoting and paneling or other finish applied structurally or for acoustical treatment, insulation, decoration or similar purposes. The use of a surface finish of paper or of material of not greater fire hazard than



paper shall not be prohibited provided such finish does not exceed one twenty-eighth (1/28) of an inch in thickness, and is applied directly to a noncombustible base or substrate meeting the requirements of Section 903.6.2. Show windows in the first story of buildings may be of wood or of unprotected metal framing.

920.2 Exposed construction: These requirements shall not be considered as requiring the installation of interior finish, but where construction or fire protection materials are exposed in rooms or spaces used for the occupancies specified, the hazard from rate of flame spread of such exposed materials shall be not greater than that of the interior finish permitted for such occupancy or use. Exposed portions of structural members complying with the requirements for heavy timber type construction in Sections 217.0 and 853.0 shall not be subject to interior finish regulations.

920.3 Smoke or gases: Interior finish materials shall not be permitted that have a smoke developed factor greater than four hundred fifty (450) when tested in accordance with the Method of Test For Surface Burning Characteristics of Building Materials (ASTM E84) listed in Appendix G. When restrictions are not otherwise established in this code, interior finish is not controlled, except that pyroxlin or similar finishes shall not be applied which, as dry films, produce excessive smoke or toxic fumes when exposed to fire.

920.4 Materials: Material may be used for interior finish and trim only as specifically provided in this code for the occupancy or use of the space in which it is installed. Use of any material for floor finish, interior finish, and trim in a building of Type 1 or Type 2 construction within the scope permitted in this section or Section 922.0 shall not declassify the building with respect to its type of construction.

920.4.1 Foam plastics: Foam plastics shall not be used as interior finish.

920.5 Interior finish: Interior finish of walls and ceilings shall have a flame spread rating not greater than that designated by the class prescribed for the various occupancy groups listed in Table 920 when tested in accordance with the requirements of Section 904.0.

**Table 920**  
**INTERIOR FINISH REQUIREMENTS<sup>f</sup>**

| Use groups                                  | Required vertical exitways and passageways (d) | Corridors providing exitway access | Rooms or enclosed spaces (a) |
|---|--|------------------------------------|------------------------------|
| A-1 Assembly, theatres                      | I  | I                                  | II (b)                       |
| A-2 Assembly, night clubs                   | I  | I                                  | II (b)                       |
| A-3 Assembly, halls, terminals, restaurants | I  | I                                  | II (b)                       |
| A-4 Assembly, churches, schools             | I  | I                                  | III                          |
| B Business                                  | I  | II                                 | III                          |
| F Factory and industrial                    | I  | II                                 | III                          |
| H High hazard                               | I  | II                                 | III                          |
| I-1 Institutional, restrained               | I  | I                                  | I (c)                        |
| I-2 Institutional, incapacitated            | I  | II                                 | I (c)                        |
| M Mercantile walls, ceilings                | I  | II                                 | III                          |
| R-1 Residential, hotels (g)                 | I  | II                                 | III                          |
| R-2 Residential, multi-family dwellings     | I  | II                                 | III                          |
| R-3 Residential, 1 and 2 family dwellings   | III  | III                                | III                          |
| S-1 Storage, moderate hazard                | I  | II                                 | III                          |
| S-2 Storage, low hazard                     | I  | II                                 | III                          |

**Note a.** Requirements for rooms or enclosed spaces are based upon spaces enclosed in partitions of the building or structure, and where fire-resistance rating is required for the structural elements the enclosing partitions shall extend from the floor to the ceiling. Partitions which do not comply with this shall be considered as enclosing spaces and the rooms or spaces on both sides thereof shall be counted as one. In determining the applicable requirements for rooms or enclosed spaces, the specific use or occupancy thereof shall be the governing factor, regardless of the occupancy group classification of the building or structure. When an approved automatic fire suppression system is provided, the interior finish of Class II or III materials may be used in place of Class I or II materials respectively, where required in the table.

**Note b.** Class III interior finish materials may be used in place of assembly with a capacity of three hundred (300) persons or less.

**Note c.** Class III interior finish materials may be used in administrative areas. Class II interior finish materials may be used in individual rooms of not over four (4) persons capacity. Provisions in Note a allowing a change in interior finish classes when fire suppression protection is provided shall not apply.

**Note d.** Class III interior finish materials may be used for wainscoting or paneling for not more than one thousand (1,000) square feet of applied surface area in the grade lobby when applied directly to a non-combustible base or over furring strips applied to a noncombustible base and fire-stopped as required by Section 921.0.

**Note e.** Class III interior finish materials may be used in mercantile occupancies of three thousand (3,000) square feet or less gross area. Used for sales purposes on the street floor only. (Balcony permitted).

**Note f.** Carpeting and similar materials having napped, looped or similar surface may be used as interior finish on walls and ceilings only when they are Class I.

**Note g.** Interior finish in detoxification facilities shall comply with Table 430.11.

**920.5.1 Basements:** In buildings other than 1- and 2-family residences, Class I or II interior finish shall be used in all basements or other underground spaces from which there is not direct exit to the outside of the building if subject to occupancy for any purpose other than storage or service facilities.

**920.5.2 Maximum flame spread:** Interior finish materials with flame spread classifications in excess of two hundred (200) shall not be used in any room or space subject to human occupancy, except to such extent as may be specifically permitted by the building official on the basis of a finding that such use does not significantly increase the life hazard.

**920.6 Interior trim:** Baseboards, chair-rails, mouldings, trim around openings and other interior trim, not in excess of ten (10) per cent of the aggregate wall and ceiling areas of any room or space, may be of Class I, II or III materials, except that trim around fire windows and fire doors shall comply with the requirements of Section 915.0 and Section 916.0.

## 920.7 Floor covering

920.7.1 Acceptance without tests: All wood, ceramic, concrete flooring and one-quarter (1/4) inch maximum thickness of resilient composition flooring shall be exempt from the requirements of this section unless the building official determines the floor surface is hazardous.

920.7.2 Test acceptance criteria: Carpet type floor coverings, used in corridors and exitways in use groups A-1, A-2, I-1 and I-2 shall withstand a test exposure of zero point forty-five (0.45) watts per square centimeter when tested in accordance with Section 904.3. Carpet type floor coverings, used in corridors and exitways in all other than the above use groups, and excepting R-3 and R-4 use groups, shall satisfactorily withstand a test exposure of zero point twenty-two (0.22) watts per square centimeter when tested in accordance with Section 904.3. Where a complete standard system of automatic sprinklers is installed, carpet type floor coverings used in corridors and exitways of use groups A-1, A-2, I-1 and I-2 shall satisfactorily withstand a test exposure of zero point twenty-two (0.22) watts per square centimeter.

Exception: Carpeting in R-1 detoxification facilities shall comply with Table

Whenever the building official determines that the use of a particular floor finish in a particular use group constitutes a fire hazard, the building official shall request other fire test data which is applicable to floor coverings.

## SECTION 921.0 APPLICATION OF INTERIOR FINISH

921.1 Attachment: Where interior finish is regulated by the requirements of this code, interior finish materials shall be applied or otherwise fastened in such a manner that they will not readily become detached when subjected to room temperatures of two hundred (200) degrees F. or less for thirty (30) minutes, or otherwise become loose through changes in the setting medium from the effects of time or conditions of occupancy.

921.2 Application to structural elements: Interior finish materials applied to walls, ceilings, or structural elements of a building or structure which are required to be fireresistance rated or to be constructed of noncombustible component materials, shall be applied directly against the exposed surface of such structural elements, or to furring strips attached to such surfaces with all concealed spaces created thereby firestopped where in excess of ten (10) square feet in area or eight (8) feet in any dimension.

921.3 Furred construction: Where walls, ceilings or other structural elements are required to be fireresistance rated or to be constructed of noncombustible component materials and interior finish is set out or dropped distances greater than one and three-quarter (1 3/4) inches from the surface of such elements, only material of which both faces qualify as Class I shall be used, unless the finish material is protected on both sides by an automatic fire suppression system (see Note a to Table 920)

or is attached to a noncombustible backing complying with Section 921.6 or to furring strips applied directly to such backing as provided in Section 921.2.

921.4 Heavy timber construction: Interior finish materials may be applied directly to the wood members and decking of heavy timber (Type 3A) construction, where permitted, or to furring strips applied to such members or wood decking as provided in Section 921.2.

921.5 Class II and III material: Interior finish materials, other than Class I material, which are less than one-fourth (1/4) inch in thickness shall be applied directly against a noncombustible backing or a backing complying with the requirements of Section 903.6.2 unless the tests under which such material has been classed were made with the materials suspended from the noncombustible backing.

921.6 Backing material: Backing for interior finish materials shall be a continuous surface with permanently tight joints, equal in area to the area of the finish, and extending completely behind such finish in all directions; and may be of any materials meeting the requirements of this code for noncombustible classification of material under Section 903.5.1 or of fire-retardant treated wood. When the backing does not constitute an integral part of the structural elements or system, it shall be attached directly to the structural elements or to furring strips as required for the application of finish according to Section 921.2, or may be suspended from the structural members at any distance provided concealed spaces created thereby shall be firestopped in accordance with the applicable requirements of this code.

#### SECTION 922.0 COMBUSTIBLE MATERIALS PERMITTED IN FLOOR CONSTRUCTION OF TYPE 1 AND 2 BUILDINGS

922.1 General: Except as provided in Section 616.0 for stairs and Section 417.0 for theatres and similar places of public assembly (use groups A-1 and A-2), the use of combustible materials in or on floors of Types 1 and 2 buildings shall be herein specified.

922.2 Sleepers, bucks, and grounds: Floor sleepers, bucks, nailing blocks and grounds may be constructed of combustible materials, provided the space between the fireresistance rated floor construction and the flooring is either solidly filled with noncombustible materials or firestopped in areas of not more than one hundred (100) square feet, provided such open spaces shall not extend under or through permanent partitions or walls.

922.3 Flooring: Wood finish floorings may be attached directly to the embedded or firestopped wood sleepers and wood finish flooring shall be permitted when cemented directly to the top surface of approved fireresistance rated construction or cemented directly to a wood subfloor attached

to sleepers as provided in Section 922.2. Combustible insulating boards not more than one-half (1/2) inch thick and covered with approved finished flooring may be used for sound deadening or heat insulating when attached directly to a noncombustible floor assembly or to wood subflooring attached to sleepers as provided in Section 922.2.

#### SECTION 923.0 DECORATIVE MATERIAL RESTRICTIONS

923.1 General: In places of public assembly, all draperies, hangings, and other decorative materials suspended from walls or ceilings shall be noncombustible or flameresistant meeting the requirements of Section 904.0 as herein specified. Compliance to 527 CMR 21.00 is also required for use groups therein specified (A, I, M, and R-1 use groups).

923.2 Noncombustible: The permissible amount of noncombustible decorative hangings shall not be limited.

923.3 Flameresistant: The permissible amount of flameresistant decorative hangings shall not exceed ten (10) per cent of the total wall and ceiling area.

#### SECTION 924.0 EXTERIOR TRIM RESTRICTIONS

924.1 Gutters: All gutters hereafter placed on buildings and structures other than frame (Type 4) buildings, one- and two-family dwellings and private garages and similar accessory buildings shall be constructed of noncombustible materials.

##### 924.2 Architectural trim

924.2.1 Construction requirements: All architectural trim, such as cornices and other exterior architectural elements attached to the exterior walls of buildings of Types 1 and 2 construction shall be constructed of approved noncombustible materials and shall be secured to the wall with metal or other approved noncombustible brackets; except that outside the fire limits, such trim may be of combustible material when the building does not exceed three (3) stories or forty (40) feet in height. Combustible trim may be used on all buildings of Types 3 and 4 construction.

924.2.2 Location: When combustible architectural trim is located along the top of exterior walls it must be completely backed up by the exterior wall and shall not extend over or above the top of exterior walls.

924.2.3 Firestopping: Continuous exterior architectural trim constructed of combustible materials shall be firestopped as required in Section 919.0.

924.3 Combustible half-timbering: In buildings of masonry (Type 3) construction that do not exceed three (3) stories or forty (40) feet in height, exterior half-timbering and similar architectural decorations may

be constructed of wood or other equivalent combustible materials, provided such trim is backed up solidly with approved noncombustible materials.

924.4 Balconies: All balconies attached to or supported by buildings of Types 1 and 2 construction shall be constructed of noncombustible materials. Balconies attached to or supported by buildings of Types 3 and 4 construction may be of unprotected noncombustible materials or frame construction. Balconies of frame construction shall afford the fire-resistance rating required by Table 214 for floor construction and the aggregate length shall not exceed fifty (50) per cent of the building perimeter on each floor.

924.5 Bay and oriel windows: All bay and oriel windows attached to or supported by walls other than frame construction shall be of noncombustible construction, framed with brackets of steel, concrete or other approved noncombustible materials, unless specifically exempted by Section 302.0.

924.6 Existing combustible construction: Any existing cornice or other exterior architectural element constructed of wood or similar combustible materials may be repaired with the same material to the extent of fifty (50) per cent of its area in any one (1) year if the public safety is not thereby endangered.

924.7 Wood veneers: Inside the fire limits, wood veneers are permitted in accordance with Section 302.0.

## SECTION 925.0 ROOF STRUCTURES

925.1 General: All construction, other than aerial supports, clothes dryers and similar structures less than twelve (12) feet high, water tanks and cooling towers as hereinafter provided and flag poles, erected above the roof of any part of any building or structure located within the fire limits or of any building or structure more than forty (40) feet in height outside the fire limits shall be constructed of noncombustible materials.

925.2 Scuttles: Trap doors and scuttles as required by Section 617.0 shall be not less than two (2) feet by three (3) feet in size and shall be of fire-resistance rated construction in fireproof (Types 1A and 1B), and noncombustible (Type 2) buildings and of approved noncombustible materials, or of wood covered on top and edges with sheet metal in exterior masonry (Type 3) and protected frame (Type 4A) buildings.

### 925.3 Skylight

925.3.1 Sash and frames: Sashes and frames of all skylights on buildings of Types 1 and 2 construction shall be constructed of steel or other approved noncombustible materials. In foundries or buildings where acid

fumes deleterious to metal are incidental to the use of the building, treated wood or other approved noncorrosive materials shall be permitted.

925.3.2 Structural requirements: When part of the roof system, skylights shall be designed to meet all structural requirements for roofs, specified in Article 7. Design of glazing shall be in accordance with glazing industry design methods.

925.3.3 Mounting: All skylights having their glazing set at an angle of less than forty-five (45) degrees measured from the horizontal, shall be mounted at least four (4) inches above the plane of the roof on a curb constructed as required for the frame.

925.3.4 Glazing materials: Skylights may be glazed with any of the following glazed materials, subject to the noted limitations: laminated glass, wired glass, annealed glass, heat strengthened glass, tempered glass, glass block and light transmitting plastic. Annealed, heat strengthened and tempered glass shall be protected by screens as specified in Section 925.3.5. Light transmitting plastic skylights shall meet the requirements of Section 1905.0. Glass construction shall conform to the requirements of Sections 811.0 and 860.0.

925.3.5 Screens: Annealed glass skylights shall be protected from falling objects by screens above the skylight. Annealed, heat strengthened and tempered glass skylights shall be equipped with screens below the skylight to protect building occupants from falling glazing should breakage occur. Screens shall be of noncombustible materials and shall have a mesh not larger than one-by-one (1x1) inches. They shall be constructed of not lighter than 12B and S Gage (0.0808 inches). Where utilized in a corrosive atmosphere, structurally equivalent noncorrosive materials shall be used. Screens above the skylight shall be at least four (4) inches above the skylight and shall project on all sides for a distance of not less than the height of the screen above the glass. When multiple layer glazing systems are used, a protective screen is not required when laminated glass is glazed on the interior surface.

925.3.6 Venting skylights: Where required over shafts and stairs by Sections 515.2 and 910.6.2, venting skylights shall be glazed with a readily breakable glazing material.

925.4 Penthouses: Penthouses shall be considered a part of the next lower story and the enclosure shall conform to the requirements for exterior walls of the building type as regulated by Table 214 and Article 8 except as modified herein.

925.4.1 Recessed walls: When the exterior wall of a penthouse is recessed five (5) feet or more from the exterior wall of the next lower story and the exterior wall of the next lower story is required to have a fire-resistance rating of greater than one and one-half (1 1/2) hours, the penthouse exterior wall may be constructed with a fire-resistance rating of

not less than one and one-half (1 1/2) hours, covered on the outside with noncombustible, weatherproof material and supported on protected steel or reinforced concrete construction.

925.4.2 Doors, frames, and sash: Doors, frames, and window sash, except where otherwise specifically required to be fireproof or fireresistance rated under this code, shall be constructed the same as other similar elements in the building or structure.

925.5 Other enclosed roof structures: Enclosed roof structures, other than the penthouses as defined in Article 2, shall be considered a story of the building and the enclosure shall conform to the requirements for exterior walls of the building type as regulated by Table 214 and Article 8 and the provisions described in the following Sections 925.5.1 and 925.5.2.

925.5.1 Noncombustible materials: Unless constructed of masonry or reinforced concrete in accordance with Article 8, roof structures erected on buildings and structures of fireproof or noncombustible (Types 1 or 2) constructions shall be enclosed in walls of noncombustible materials having a fireresistance rating of not less than one (1) hour, protected with weather-resistive roof coverings complying with Section 926.0.

925.5.2 Combustible materials: Roof structures erected on the roof of exterior masonry buildings (Type 3) and protected frame buildings (Type 4A) may be constructed of combustible materials protected to afford a one (1) hour fireresistance rating covered on the outside with approved roofing materials.

925.6 Mansard roofs and other sloping roofs

925.6.1 High slope roofs: Every mansard roof or other sloping roof having a pitch of more than sixty (60) degrees to the horizontal hereafter erected on any building or structure of other than Type 4 frame construction more than three (3) stories or forty (40) feet in height shall be constructed of noncombustible materials with a fireresistance rating of not less than one (1) hour; except that when the building is more than seven (7) stories or eighty-five (85) feet in height, such roofs shall afford the same fireresistance rating required for the exterior walls of the building but need not exceed one and one-half ( 1 1/2) hour fireresistance rating.

925.6.2 Low slope roofs: When the pitch is less than sixty (60) degrees to the horizontal, the mansard roof or other sloping roof located on any building may be constructed of the same materials as required for the roof of the building.

925.7 Dormers: The sides and roofs of dormers shall be of the same type of construction as the main roof construction; except that where a side of the dormer is merely a vertical extension of an exterior wall it



shall be subject to the same fireresistance rating requirements as apply to the wall of the building. The roofs of dormers shall be protected with approved roof coverings complying with Section 926.0. The side of dormers shall be protected with approved roof coverings or with material which would be permitted for covering the exterior walls of the building.

#### 925.8 Water tanks

925.8.1 Supports: Water tanks having a capacity of more than five hundred (500) gallons placed in or on a building shall be supported on masonry, reinforced concrete, steel or other approved noncombustible framing or on timber conforming to heavy timber mill construction (Type 3A); provided that, when such supports are located in the building above the lowest floor, they shall be fireresistance rated as required for fire-proof (Type 1A) construction.

925.8.2 Emergency discharge: A pipe or outlet shall be located in the bottom or in the side close to the bottom, or the tank shall be fitted with a quick-opening valve to enable the contents to be discharged in an emergency to a suitable drain complying with the plumbing code listed in Appendix P.

925.8.3 Location: A tank shall not be located over or near a stairway or elevator shaft unless a solid roof or floor deck is constructed underneath the tank.

825.8.4 Tank cover: All unenclosed roof tanks exposed to the weather shall have approved covers sloping towards the outer edges.

925.8.5 Hoop and strap protection: When metal hoops are used in the construction of wood tanks, they shall be protected with acceptable corrosion-resistive coatings or shall be manufactured from approved corrosion-resistive alloys.

#### 925.9 Cooling towers

925.9.1 Located in fire limits: Within the fire limits, cooling towers erected on the roofs of buildings shall be constructed of noncombustible materials, except that drip bars may be of wood. Cooling towers may be constructed entirely of fire-retardant treated wood, including drip bars.

925.9.2 Located outside fire limits: Outside the fire limits, cooling towers may be constructed of wood or other approved materials of similar combustible characteristics; except that when the base of the tower is more than fifty-five (55) feet above grade and the tower is located on a building, the drip bars only may be fabricated of combustible materials as herein provided.

925.10 Miscellaneous roof structures: Except as herein specifically

provided, all towers, spires, dormers or cupolas shall be erected of the type of construction and fireresistance rating required for the building to which they are accessory as regulated by Tables 214 and 305; except that when the height of such appurtenant structures exceeds eighty-five (85) feet above grade or when the area at any horizontal section of the tower, spire, dormer or cupola exceeds two hundred (200) square feet or when it is used for any purpose other than as a belfry or architectural embellishment, the structure and its supports shall be of fireproof (Type 1) construction, noncombustible (Type 2) construction or fire-retardant treated wood complying with Sections 903.6.1 and 903.6.2. Radio and television towers and antennae shall be constructed to comply with Sections 426.0 and 427.0.

### SECTION 926.0 ROOF COVERINGS

926.1 Classification: All approved roof coverings shall meet the test requirements and be classified in accordance with Section 903.3 of this code.

926.2 Existing roofs: The repair of existing roofs shall comply with provisions of Section 106.0 but more than twenty-five (25) per cent of the roof covering of any building shall not be replaced in a period of twelve (12) months unless the entire roof covering is made to conform to the requirements for new roofing.

926.3 Classification of use

926.3.1 Class A roof coverings: Class A roof coverings shall be permitted for use in buildings and structures of all types of construction.

926.3.2 Class B roof coverings: Class B roof coverings shall be permitted as the minimum for use in buildings and structures of Type 1 construction.

926.3.3 Class C roof coverings: Class C roof coverings shall be permitted as the minimum for use in buildings and structures of Types 2, 3 and 4A construction.

926.3.4 Non-classified roof coverings: Non-classified roof coverings shall be permitted on the buildings and structures listed below:

1. Buildings and structures of unprotected frame (Type 4B) construction when the distance from any other building is not less than twelve (12) feet.
2. Private garages, airplane hangars and similar accessory structures, not exceeding one (1) story or twenty (20) feet in height and twenty-five hundred (2500) square feet in area, when outside the fire limits, located in the same lot with a dwelling and with a fire separation of not less than twelve (12) feet.

3. Moderate and low hazard storage buildings (use groups S-1 and S-2) not exceeding one (1) story or twenty (20) feet in height and six thousand (6,000) square feet in area with a fire separation of not less than twelve (12) feet.

Fire walls may be used to obtain the required fire separation.

926.4 Roof insulation: The use of cork, fiber board and other combustible roof insulation shall be permitted provided it is covered with approved roof coverings directly applied thereto.

926.5 Grounding of metal roofs: Whenever, because of hazard resulting from electrical equipment or apparatus located thereon, or because of proximity to power lines, or for any other reason, it is deemed necessary by the building official, metal roofs shall be grounded by bonding together each course or strip and the bonding conductor or conductors shall be extended to and attached in an approved manner to the grounding electrode used to ground the electrical system within the building on which such metal roofing is applied. The conductors used to bond courses or strips of metal roofing together, or any conductor extended for grounding to the grounding electrode, shall not have greater resistance than the conductor used to ground the electrical system within the building.

926.5.1 Alternate methods of grounding metal roofing: Alternate methods of grounding metal roofing may be used, provided they are at least equal in performance to the methods described herein, and further provided that such desired method is first submitted to and approved by the building official.

ARTICLE 10

CHIMNEYS, FLUES AND VENT PIPES

SECTION 1000.0 GENERAL

1000.1 Scope: The provisions of this article shall control the design, installation, maintenance, repair and approval of all chimneys, vents and connectors hereafter erected or altered in all buildings and structures.

1000.2 Other standards: Unless otherwise specifically provided herein, conformity to the applicable requirements for chimney construction and vents contained in the mechanical code listed in Appendix B shall be deemed to meet the requirements of this code.

1000.2.1 Commonwealth of Massachusetts requirements: Gas vents required for appliances or equipment using fuel gases of any kind, such as natural gas, manufactured gas, undiluted liquified petroleum gases, liquified petroleum gas-air mixtures, or mixtures of any of these gases shall comply with the requirements of the Massachusetts Fuel Gas Code, 248 CMR 3.00 - 8.00, listed in Appendix B.

1000.3 Minor repairs: Minor repairs for the purpose of maintenance and upkeep which do not increase the capacity of the heating apparatus or appliances, or which do not involve structural changes in the permanent chimney and vents of a building, may be made without a permit.

1000.3.1 Multiple flue connections: A solid fuel burning heating appliance may be vented into a common flue of a masonry chimney with a liquid fuel burning device provided that:

1. The flue does not also vent a working fireplace.
2. The solid fuel burning appliance's connector, if separate, shall enter at a minimum of six (6) inches below the liquid fueled appliance's connector pipe.
3. All appliances shall be approved by the appropriate state agencies.
4. The flue shall be of sufficient size to serve all the units connected to it if operated simultaneously (see Table 1000).

Table 1000

## CAPACITY OF A MASONRY CHIMNEY SERVING TWO APPLIANCES

| Total Vent Height<br>(feet) of Not Less<br>Than | Combined Appliance Input Rating of Not Greater Than<br>(Thousands of Btu's per Hour) |       |              |        |        |
|---|--|-------|--------------|--------|--------|
| 8   | 81   | 118   | 162          | 277    | 405    |
| 10  | 89   | 129   | 175          | 300    | 450    |
| 15  | 105  | 150   | 210          | 360    | 540    |
| 20  | 120  | 170   | 240          | 415    | 640    |
| 30  | 135  | 195   | 275          | 490    | 740    |
| 50  | -  | -     | 325          | 600    | 910    |
| Liner Dimensions with Equivalents               |  |       |              |        |        |
| nominal liner<br>size (in.)<br>(sq./rect.)      | 4x8  | 4x8   | 8x8          | 8x12   | 12x16  |
| inside dimension<br>of liner (in.)              | 2½x6½  | 2½x6½ | 6 ¾ x<br>6 ¾ | 6½x10½ | 9½x13½ |
| inside diameter<br>(in.) (circular)             | 6  | 7     | 8            | 10     | 12     |
| equivalent area<br>(square in.)                 | 28.3   | 38.5  | 50.3         | 78.5   | 113.0  |

10004.4 Cleanouts: A cleanout or other approved device shall be provided at the base of every flue.

## SECTION 1001.0 PLANS AND SPECIFICATIONS

1001.1 General: The structural plans and specifications shall describe in sufficient detail the location, size and construction of all chimneys, vents and ducts and their connections to boilers, furnaces, appliances and fireplaces. The thickness and character of all insulation materials, clearances from walls, partitions and ceilings and proximity of heating devices and equipment to wall openings and exitways shall be clearly shown and described.

1001.2 Appliances: All appliances required to be vented shall be connected to a vent or chimney, except as provided in Section 1006.3 and as provided in the standards listed in Appendix B for special venting arrangements.

#### SECTION 1002.0 PERFORMANCE TEST AND ACCEPTANCE CRITERIA

1002.1 Tests: The building official may require a test or tests of any chimney or vent to insure fire safety and the removal of smoke and products of combustion.

1002.2 Acceptance criteria: The system shall be accepted if the following conditions are fulfilled.

1. There shall not be spillage at the draft hood when any one (1) or combination of appliances connected to the system is in operation.
2. Temperature on adjacent combustible surfaces shall not be raised more than limits acceptable to nationally recognized testing or inspection agencies.
3. Condensation shall not be developed in a way that would cause deterioration of the vent or chimney drip from joints or bottom end of the vent or chimney.
4. The draft reading taken at the place recommended in the installation instructions shall be within the range specified by the appliance manufacturer.

1002.2.1 Approved installations: Factory-built chimneys and gas vents which have been tested and listed by a nationally recognized testing or inspection agency shall be accepted as complying with the requirements of Item 2 of Section 1002.2 when installed in accordance with the clearances specified in their listing.

#### SECTION 1003.0 CHIMNEYS

1003.1 Classification: Chimneys as used in this article shall be classified as:

1. factory-built chimneys,
2. masonry chimneys, and
3. metal chimneys (smokestacks).

#### SECTION 1004.0 APPLIANCES REQUIRING CHIMNEYS

1004.1 General: All heating appliances, except those appliances specifically exempted by the provisions of Section 1006.3 shall be

connected to chimneys as specified in the chimney selection chart contained in the mechanical code listed in Appendix B.

#### SECTION 1005.0 EXISTING BUILDINGS

1005.1 Raising existing chimneys: Whenever a building is hereafter erected, enlarged or increased in height so that a wall along an interior lot line, or within three (3) feet thereof, extends above the top of an existing chimney or vent of an adjoining existing building, the owner of the building so erected, enlarged or increased in height shall carry up at his own expense, with the consent of the adjoining property owner, either independently, or in his own building, all chimneys connected to fuel burning appliances. Vents within six (6) feet of any portion of the wall of such adjoining building shall be extended two (2) feet above the roof or parapet of the adjoining building.

1005.2 Size of extended chimneys: The construction of an extended chimney shall conform to the requirements of this article for new chimneys, but the internal area of such extension shall not be less than that of the existing chimney.

1005.3 Notice to adjoining owner: It shall be the duty of the owner of the building which is erected, enlarged or increased in height to notify in writing, and to secure the consent of the owner of existing chimneys affected, at least ten (10) days before starting such work.

1005.4 Existing chimneys: An existing chimney, except one which does not endanger the fire safety of a building or structure and is acceptable to the building official, shall not be continued in use unless it conforms to all requirements of this article for new chimneys.

1005.5 Cleanouts and maintenance: Whenever a new chimney is completed or an existing chimney is altered, it shall be cleaned and left smooth on the inside. If the chimney is constructed of masonry or tile, the interior mortar joints must be left smooth and flush. Cleanouts or other approved devices shall be provided at the base of all flues to enable the passage-ways to be maintained and cleaned.

#### SECTION 1006.0 VENT SYSTEMS

1006.1 Listed appliances: For the purpose of determining vent requirements, gas-fired and oil-fired appliances shall be classified as "listed" or "unlisted." A listed appliance is one that is shown in a list published by an accredited authoritative testing agency, qualified and equipped for testing of such appliances, and maintaining an adequate periodic inspection of current production of listed models and whose listing states either that the appliance or accessory complies with nationally recognized safety requirements or has been tested and found

safe for use in a specific manner. Compliance may be determined by the presence on the appliance or accessory of a label of the testing agency stating that the appliance or accessory complies with nationally recognized safety requirements. An unlisted appliance or accessory is one that is not shown on such a list or does not bear such a label. In cases where an applicable standard has not been developed for a given class of appliance or accessory, approval of the authority having jurisdiction should be obtained before the appliance or accessory is installed.

1006.2 Appliances required to be vented: Appliances shall be connected to a listed venting system or provided with other means for exhausting the flue gases to the outside atmosphere in accordance with the venting system selection chart contained in the mechanical code listed in Appendix B.

1006.3 Exemption: Connections to vent systems shall not be required for appliances of such size or character that the absence of such connection does not constitute a hazard to the fire safety of the building or its occupants. The following appliances are not required to be vented unless so required by their listing:

1. listed gas ranges;
2. built-in domestic cooking units listed and marked as unvented units;
3. listed hot plates and listed laundry stoves;
4. listed domestic clothes dryers;
5. listed gas refrigerators;
6. counter appliances;
7. space (room) heaters listed for unvented use, only upon prior approval by the building official;
8. specialized equipment of limited input such as laboratory burners or gas lights; and
9. electric appliances.

When any or all of the appliances listed in Items 5, 6 and 7 above are installed so that the aggregate input rating exceeds thirty (30) British thermal units (Btu's) per hour per cubic foot of room or space in which they are installed, one (1) or more of them shall be vent connected or provided with approved means for exhausting the vent gases to the outside atmosphere so that the aggregate input rating of the remaining unvented appliances does not exceed thirty (30) Btu's per hour per cubic foot of room or space in which they are installed. Where the room or space in which they are installed is directly connected to another room or space by a doorway, arch, or other opening of comparable size, which cannot be closed, the volume of such adjacent room or space may be included in the calculations.

#### SECTION 1007.0 FIREPLACES

1007.1 General: Fireplaces, barbecues, smoke chambers and fireplace chimneys shall be of solid masonry or reinforced concrete or other approved materials, and shall conform to requirements of this section.



1007.2 Construction: Structural walls of fireplaces shall be at least eight (8) inches thick. Where a lining of low duty refractory brick (ASTM C64) or the equivalent, at least two (2) inches thick laid in fire clay mortar (ASTM C105, medium duty), or the equivalent, or other approved lining is provided, the total thickness of back and sides, including the lining, shall be not less than eight (8) inches. Where such lining is not provided, the thickness of back and sides shall be not less than twelve (12) inches. The firebox shall be twenty (20) inches in depth and will be permitted to be open on all sides, provided all fireplace openings are located entirely within one (1) room.

1007.3 Lining: The lining shall extend from the throat of the fireplace to a point at least four (4) inches above the top of the enclosing masonry walls.

#### 1007.4 Clearance

1007.4.1 Distance: The distance between fireplace and combustibles shall be at least four (4) inches; and such combustibles shall not be placed within six (6) inches of the fireplace opening. Wood facings or trim normally placed around the fireplace opening may be permitted when conforming to the requirements of this section; however, such facing or trim shall be furred out from the fireplace wall at least four (4) inches and attached to noncombustible furring strips. The edges of such facings or trim shall be covered with a noncombustible material. Where the walls of the fireplace are twelve (12) inches thick, the facings or trim may be directly attached to the fireplace.

1007.4.2 Metal hoods: Metal hoods used as part of a fireplace or barbecue shall be at least eighteen (18) inches from combustible material unless approved for reduced clearances.

1007.5 Metal: Metal hoods used as a part of a fireplace or barbecue shall be at least No. 18 B&S (0.0403 inch) Gauge sheet copper, No. 18 Galvanized Steel Gauge (0.052 in.) galvanized steel or other equivalent corrosion-resistant ferrous metal with all seams and connections of smoke-proof unsoldered construction. The hoods shall be sloped at an angle of forty-five (45) degrees or less from the vertical and shall extend horizontally at least six (6) inches beyond the limits of the firebox.

1007.6 Metal heat circulators: Approved metal heat circulators may be installed in fireplaces, provided the thickness of the fireplace walls is not reduced.

1007.7 Smoke chamber: All walls, including back walls, shall be at least eight (8) inches in thickness.

1007.8 Areas of flues, throats and dampers: The net cross-sectional area of the flue and of the throat between the firebox and the smoke chamber of a fireplace shall be at least that required in the mechanical code listed in Appendix B. When dampers are used, damper openings shall be at least, when fully opened, equal to the required flue area and shall be of No. 12 Galvanized Steel Gauge (0.018 in.) metal.

1007.9 Lintel: Masonry over the fireplace opening shall be supported by a noncombustible lintel.

1007.10 Hearth: Every fireplace shall be constructed with a hearth of brick, stone, tile or other noncombustible material. For fireplaces with an opening of less than six (6) square feet, the hearth shall extend not less than sixteen (16) inches in front and not less than eight (8) inches on each side of the fireplace opening. For fireplaces with an opening of six (6) square feet or more, the hearth shall extend not less than twenty (20) inches in front and not less than twelve (12) inches on each side of the fireplace opening. Such hearths shall be supported on trimmer arches of brick, stone, tile or concrete not less than four (4) inches thick or other equally strong and fireresistance rated materials. All combustible forms or centering shall be removed after completion of the supporting construction.

1007.11 Firestopping: Firestopping between chimneys and wooden construction shall meet the requirements specified in Section 919.0 and the mechanical code listed in Appendix B.

1007.12 Support: Fireplaces shall be supported on foundations designed in conformity with Section 725.0.

1007.13 Screens: Screens or other acceptable protection devices shall be provided for all fireplace openings.

1007.14 Other type fireplaces: Other fireplaces not conforming to the requirements of this section shall be subject to approval by the building official prior to installation. Imitation fireplaces shall not be used for the burning of gas, solid or liquid fuel. Approved factory-built fireplaces may be installed and shall conform to the applicable portions of this code. Factory-built fireplaces shall bear the seal of a nationally recognized testing or inspection agency.

1007.15 Solid wastes; Solid waste shall not be burned in a fireplace.

#### SECTION 1008.0 INCINERATORS

1008.1 Mechanical code: Incinerators of all types shall be installed in accordance with the applicable provisions of the mechanical code listed in Appendix B.

SECTION 1009.0 CONSTRUCTION OF METAL DUCTS AND VENTS

1009.1 Mechanical code: All metal vents, ducts and duct systems required under the provisions of this article for heating systems and equipment, and under the provisions of Article 5 for ventilating and air-conditioning systems shall be constructed and installed in accordance with the requirements of the mechanical code listed in Appendix B.

1009.2 Construction of ducts: Ducts and plenums may be constructed of approved material constructed in accordance with the requirements of the mechanical code listed in Appendix B. Non-metallic ducts shall be constructed and installed in accordance with their approval and the applicable standards listed in Appendix B. Aluminum ducts shall not be used in equipment rooms with fuel-fired equipment, encased in or under concrete slabs on grade, for kitchen or fume exhausts or in systems where air entering the duct is over two hundred fifty (250) degrees F.

1009.3 Ducts for solid or solid/liquid fueled central hearing appliances.

1009.3.1 Supply ducts: Supply ducts conveying heated conditioned air shall be fabricated of noncombustible material.

1009.3.2 Hot air ducts: Hot air ducts shall have a clearance of not less than twelve (12) inches from combustibles for the first ten (10) feet of distance from the appliance plenum/bonnet.

1009.3.3 Ducts: All ducts shall be otherwise constructed, installed, supported and insulated as required by this code.

SECTION 1010.0 SPARK ARRESTORS

1010.1 Mechanical code: All chimneys, stacks and flues, including incinerator stacks, which emit sparks shall be provided with a spark arrester conforming to the requirements of the mechanical code listed in Appendix B.

ARTICLE 11

MECHANICAL EQUIPMENT AND SYSTEMS

SECTION 1100.0 GENERAL

1100.1 Scope: The provisions of this article shall control the construction, inspection and maintenance of all mechanical equipment and systems in respect to structural strength, fire safety and operation. For the purposes of this article, mechanical equipment shall include solid fuel burning heating appliances.

1100.2 Mechanical code: All mechanical equipment and systems shall be constructed, installed and maintained in accordance with this code and the mechanical code listed in Appendix B.

1100.3 Commonwealth of Massachusetts requirements: All installations of gas appliances shall comply with the Massachusetts Fuel Gas Code, 248 CMR 3.00-8.00, as listed in Appendix B. The construction, installation and operation of oil burning equipment is subject to the provisions of 527 CMR 4.00. The construction, installation, testing and inspection of boilers, unfired pressure vessels, air tanks, ammonia compressor valves and refrigeration and air-conditioning systems of twenty (20) tons or more capacity are subject to the provisions of 522 CMR 2.00-12.00, and chapter 146 of the Massachusetts General Laws Annotated, as amended.

SECTION 1101.0 PLANS AND SPECIFICATIONS

1101.1 General: Plans and specifications for the installation, repair, extension or removal of any mechanical equipment or system shall be submitted in accordance with the mechanical code listed in Appendix B and a permit shall be secured prior to the commencement of any work.

1101.2 Matter covered: The plans and specifications shall show in sufficient detail all pertinent features and clearances of the appliances and systems, including: size and type of apparatus; construction of flue, stack or chimney; stack connections; type of fuel; method of operation; and the method of compliance with all regulations for the class and type of equipment installed.

1101.3 Details: An application for permit shall be accompanied by specifications and diagrammatic mechanical drawings in sufficient detail, complying with the provisions of the mechanical code listed in Appendix B, before a permit shall be issued for the mechanical equipment and system. The plans shall be drawn to a scale of not less than one-eighth (1/8) inch to the foot and shall show the location and arrangement of all equipment and distribution elements including safeties and pressure controlling devices.

SECTION 1102.0 INSPECTIONS AND TESTS

1102.1 Inspection: All mechanical equipment and systems requiring a permit shall be inspected in accordance with the mechanical code listed in Appendix B and shall not be placed in operation until they have been tested and approved. All solid fuel burning heating appliances shall be tested and approved according to the applicable test standards listed in Appendix B and contained in the applicable Rules and Regulations listed in Appendix Q.

Exception: Used solid fuel burning room heaters which are not labeled must be inspected and approved prior to installation by the local building official or fire official and installed in accordance to the provisions of this code.

1102.2 Concealment: It shall be unlawful for owners, contractors or workmen to lath over or in any way to conceal, any piping outlet boxes or other parts of the mechanical equipment or system requiring a permit until an inspection has been made thereof and due notice given that the work has been approved.

1102.3 Defects and repairs: Upon inspection or reinspection of a mechanical system, any defects or deficiencies which require repair to insure safe operation shall be rectified before the system is placed in use.

1102.4 Power of condemnation: When a system or any part thereof is found unsafe to life or property, it shall be condemned and such system shall not be restored to use until it has been made safe and approved.

SECTION 1103.0 EXISTING BUILDINGS

1103.1 Unsafe orders: All existing mechanical equipment and systems shall be maintained and operated in accordance with the requirements of this code and the mechanical code listed in Appendix B. Any such equipment which does not comply with the requirements, and the operation of which is deemed unsafe to the building occupants, shall be altered as ordered by the building official to secure adequate safety.

SECTION 1104.0 FEES

1104.1 General: A permit to begin work for new construction or alteration shall not be issued until the application fee and permit fee prescribed have been paid, nor shall an amendment to a permit necessitating an additional fee because of the additional work involved be issued until the additional fee shall have been paid.

SECTION 1105.0 BOILER ROOMS

1105.1 Boiler room: Every boiler or combination boiler and cooling unit shall be installed in a space which allows a minimum clearance of twenty-four (24) inches on all service sides. Such room shall be constructed of at least one (1) hour fireresistance rated construction, and the door shall be a Class C fire door or a one and three-quarter (1 3/4) inch solid wood core door. Such door shall be equipped with an automatic self-closer. Combustion air shall be provided to such room in conformance with the mechanical code listed in Appendix B. Storage or living quarters shall not be permitted in any boiler or similar heating equipment room.

Exception: One- and two-family dwellings, except for combustion air requirements as set forth in the mechanical code listed in Appendix B.

1105.2 Boiler room location: Boiler rooms shall not be located immediately below exitways; nor shall any space heater, floor furnace or other similar equipment be located in any aisle or passageway used as an element of a required means of egress from the building or structure.

SECTION 1106.0 DRYING ROOMS

1106.1 General: A drying room or dry kiln installed within a building shall be constructed entirely of approved noncombustible materials or assemblies or such materials with the required fireresistance rating based on the fire hazard of the contents and the process as regulated by the approved rules or as required in Article 4 for special uses.

1106.2 Piping clearance: All overhead heating pipes shall have a clearance of not less than two (2) inches from combustible contents of the dryer.

1106.3 Insulation: When the operating temperature of the dryer is one hundred seventy-five (175) degrees F. or more, metal enclosures shall be insulated from adjacent combustible materials by not less than twelve (12) inches of air space, or the metal walls shall be lined with one-quarter (1/4) inch asbestos mill board or other approved equal insulation.

1106.4 Fire protection: Drying rooms designed for high hazard materials and processes, including dry cleaning and other special uses provided for in Article 4, shall be protected by approved automatic sprinkler or fog systems, manually controlled steam smothering systems, or other approved fire-extinguishing equipment conforming to the provisions of Article 12 and the mechanical code listed in Appendix B.

SECTION 1107.0 REFUSE CHUTES

1107.1 Chute discharge: A refuse chute shall not feed directly to the combustion chamber of an incinerator, but shall discharge into an enclosed

room or bin separated from the incinerator room by ceiling and walls of not less than two (2) hour fireresistance rating, unless otherwise approved by the building official.

1107.2 Chute enclosures: Refuse chutes shall be enclosed with walls of masonry of not less than two (2) hour fireresistance rating for interior chutes and of noncombustible (Type 2) construction for exterior chutes. All chutes shall be supported on substantial foundations complying with Article 7.

1107.3 Chute height: An interior refuse chute shall extend not less than four (4) feet above the roof and shall be covered with an approved ventilating skylight complying with Section 925.0.

1107.4 Service compartments: Service openings for chutes shall be located in separate rooms or compartments enclosed in walls, partitions, floors and ceilings which have a fireresistance rating of not less than one (1) hour and in which the openings are equipped with fire doors or other approved protectives of not less than three-quarter (3/4) hour fireresistance rating or their approved labeled equivalent.

1107.5 Opening protectives: All openings between refuse rooms, chutes and incinerator rooms shall be protected with one and one-half (1 1/2) hour fire doors or their approved labeled equivalent complying with Article 9.

#### SECTION 1108.0 REFUSE VAULTS

1108.1 Refuse vault enclosures: A vault for receiving combustible refuse from an exhaust system shall be constructed of not less than three (3) hour fireresistance rated assemblies.

1108.2 Openings to boiler rooms: The opening between a vault and a boiler room shall not exceed nine (9) square feet in area and shall be located at least eight (8) feet from the firing door of the boiler, and the bottom of the opening shall be not less than six (6) inches above the boiler room floor. All openings shall be equipped with approved automatic fire doors of not less than one and one-half (1 1/2) hour fireresistance rating or the approved labeled equivalent complying with Article 9.

1108.3 Location: When located within a building, a refuse vaults shall extend above the roof or shall be directly vented to the outer air with ducts complying with Section 1009.0.

1108.4 Fire protection: A vault for combustible refuse which exceeds three hundred sixty (360) cubic feet in volume shall be protected by an automatic fire suppression system conforming to Article 12 and the mechanical code listed in Appendix B.

SECTION 1109.0 DUST, STOCK AND REFUSE CONVEYOR SYSTEMS

1109.1 Power transmission: Power for fans located in rooms from which flammable dust is being removed shall be transmitted by means of a shaft passing through a bushed hole, or by a belt, chain or similar driving mechanism which is encased in a metal or other noncombustible dust-tight enclosure, both within and without the room.

1109.2 Collectors and separators: Cyclone collectors and separators and their supports shall be constructed of noncombustible materials and shall be located whenever possible on the exterior of the building or structure. A collector or separator shall not be located nearer than ten (10) feet to combustible construction or to an unprotected wall or floor opening, unless the collector is provided with a metal vent pipe which extends above the highest part of any roof within a distance of thirty (30) feet.

1109.3 Discharge pipes: Discharge pipes shall conform to all the requirements for ducts, including clearances required for high heat appliances, as contained in the mechanical code listed in Appendix B. A delivery pipe from a cyclone collector shall not convey refuse directly into the firebox of a boiler, furnace, dutch oven, refuse burner, incinerator or other appliance.

1109.4 Vents for exhaust conveyor systems: An exhaust system shall be vented to the outside of the building either directly by flue, or indirectly through the separator, bin, or vault into which it discharges.

1109.5 Spark protection: The outlet of an open air vent shall be protected with an approved metal or other noncombustible screen or by other equally efficient means to prevent the entry of sparks.

1109.6 Explosion relief vents: A safety or explosion relief vent shall be provided on all systems which convey combustible refuse or stock of an explosive nature, in accordance with the requirements of Article 4.

1109.6.1 Screens: When a screen is used in a safety relief vent, it shall be so attached as to permit ready release under emergency pressure.

1109.6.2 Hoods: The relief vent shall be provided with an approved noncombustible cowl or hood, or with a counterbalanced relief valve or cover arranged to prevent the escape of hazardous materials, gases or liquids.

1110.0 SOLID FUEL BURNING HEATING APPLIANCES

1110.1 Installation: The installation of solid fuel burning heating appliances in new or existing buildings shall conform to the provisions of the code or the manufacturers' recommended installation procedures.

1110.1.1 Installation clearances: Clearance shall be provided from com-



combustible construction in accordance with manufacturers' recommendations following testing under the applicable standards listed in Appendix B and contained in the applicable Rules and Regulations listed in Appendix Q, or in accordance with Table 1110.1.1 (for solid fuel burning room heaters only).

#### INSTALLATION CLEARANCES, SOLID FUEL BURNING HEATING APPLIANCES

| Type of unit                              | Above top of casing or appliance (inches) | From front (inches) | From back (inches) | From sides (inches) | Chimney connector (inches) |
|---|---|---------------------|--------------------|---------------------|----------------------------|
| Circulating type, vented or unvented      | 36  | 24                  | 12                 | 12                  | 18                         |
| Radiant or other type, vented or unvented | 36  | 36                  | 36                 | 36                  | 18                         |

**Note 1.** The floor shall be of masonry or other noncombustible construction with not less than a one (1) hour fire resistance rating and shall extend twelve (12) inches beyond the appliance on all sides and at least eighteen (18) inches on the fuel and ash access side. Solid fuel heaters may be installed on a combustible floor if the appliance is listed for such installation or if the floor is protected in an approved manner.

1110.1.2 Reduced clearances: Installation clearances may be decreased according to Table 1110.1.2 when exposed construction is protected with noncombustible materials.

1110.2 Solid fuel burning room heaters installed in fireplaces: When a solid fuel burning room heater is set in front of a fireplace to use the existing chimney, the stove pipe must be connected either into the open damper through a snug fitting, noncombustible seal or through a noncombustible fireplace opening closure which seals off the fireplace. Both methods of installation must have access for cleanout.

1110.3 Solid fuel burning room heater labeling: Every solid fuel burning room heater shall bear a permanent and legible factory-applied label supplied to the manufacturer and controlled by an approved testing laboratory containing the following:

1. Manufacturer's name or trademark
2. Model and/or identification number of the appliance
3. Type of fuel(s) approved
4. Testing laboratory's name or trademark and location
5. Data tested
6. Clearance to combustibles

- a. Side
  - b. Rear
7. Test standard
  8. Label serial number

Table 1110.1.2

**REDUCED INSTALLATION CLEARANCES WITH SPECIFIED FORMS OF PROTECTION**

| Type of protection applied to the combustible material unless otherwise specified and covering all surfaces within the distance specified as the required clearance without protection (thicknesses are minimum) | Where the required clearance without protection is: |                |                           |           |                |                           |           |                |                           |                |
|--|---|----------------|---------------------------|-----------|----------------|---------------------------|-----------|----------------|---------------------------|----------------|
|  | 36 inches   |                |                           | 18 inches |                |                           | 12 inches |                |                           |                |
|  | Above   | Sides and rear | Chimney or vent connector | Above     | Sides and rear | Chimney or vent connector | Above     | Sides and rear | Chimney or vent connector | Sides and rear |
| 1. 1/4" asbestos millboard spaced out 1"   | 30  | 18             | 30                        | 15        | 9              | 12                        | 9         | 9              | 12                        | 6              |
| 2. No. 28 Manufacturers' Standard Gage steel sheet on 1/4" asbestos millboard  | 24  | 18             | 24                        | 12        | 9              | 12                        | 9         | 9              | 12                        | 6              |
| 3. No. 28 Manufacturers' Standard Gage steel sheet spaced out 1"   | 18  | 12             | 18                        | 9         | 6              | 9                         | 6         | 6              | 9                         | 4              |
| 4. No. 28 Manufacturers' Standard Gage steel on 1/8" asbestos millboard spaced out 1"  | 18  | 12             | 18                        | 9         | 6              | 9                         | 6         | 6              | 9                         | 4              |
| 5. 1/4" asbestos millboard on 1" mineral fiber batts reinforced with wire mesh or equivalent   | 18  | 12             | 18                        | 6         | 6              | 6                         | 4         | 4              | 6                         | 4              |
| 6. No. 22 Manufacturers' Standard Gage steel sheet on 1" mineral fiber batts reinforced with wire or equivalent  | 18  | 12             | 12                        | 4         | 3              | 3                         | 2         | 2              | 3                         | 2              |
| 7. 1/4" asbestos cement board or 1/4" asbestos millboard   | 36  | 36             | 36                        | 18        | 18             | 18                        | 12        | 12             | 18                        | 12             |
| 8. 1/4" cellular asbestos  | 36  | 36             | 36                        | 18        | 18             | 18                        | 18        | 18             | 18                        | 12             |

Note 1. Except for the protection described in item 5, all clearances shall be measured from the outer surface of the appliance to the combustible material disregarding any intervening protection applied to the combustible material.  
 Note 2. Spacers shall be of noncombustible material.

1110.4 Central heating appliance installation: Solid or solid/liquid fueled heating (central heating) appliances installed into an existing liquid or gas-fueled central heating system shall be positioned downstream of the existing appliance. Clearances to combustible materials shall be provided in accordance with the requirements specified on the label affixed to the central heating appliance (see Section 2108.3.2.7).

1110.5 Central heating appliance labeling: Every solid or solid/liquid fueled boiler or warm air furnace shall bear a permanent and legible factory applied label, supplied to the manufacturer and controlled by an approved testing laboratory, containing the following information:

1. Manufacturer's name or trademark.
2. Model/identification name or number of the appliance.
3. Types of fuel(s) approved.
4. Testing laboratory's name or trademark and location.
5. Date tested.
6. Clearance to combustibles:
  - a. side
  - b. rear
  - c. top
  - d. front
7. Test standard(s).
8. Label serial number.
9. Type of appliance (boiler or warm air furnace).
10. Every boiler, pressure vessel, or pressure relief device must be stamped in accordance with the requirements of the ASME Boiler and Pressure Vessel Code. ASME stamping shall also be required for boilers, pressure vessels and pressure relief devices produced outside the United States of America. Where required by the ASME Boiler and Pressure Vessel Code, ASME stamping may be affixed directly to the appliance in lieu of on the data plate.

Note: Additional information as required by the applicable test standard(s) may be affixed separately.

1110.5.1 Exceptions: Prior to January 1, 1981, the following exceptions shall apply:

1. ASME stamping shall not be required.

2. Solid or solid/liquid fueled central heating appliances shall be considered acceptable only if they have been tested and labeled by a laboratory accredited by the Commission to test other comfort heating appliances; or any nationally recognized laboratory.

ARTICLE 12

FIRE PROTECTION SYSTEMS

SECTION 1200.0 GENERAL

1200.1 Scope: The provisions of this article shall control when and where fire protection systems are required in all buildings and structures or parts thereof. All electrical equipment and the details of wiring for fire protection systems installations shall comply with the provisions of the Massachusetts Electrical Code (527 CMR 12.00) and the applicable standards listed in the appendices.

1200.1.1 Authority: Plans submitted under Section 113.5 and Article 4 of this code relative to this article shall be reviewed by the local fire official for approval of the following items:

1. source and capacity of water supply, including size of water main;
2. location of hydrants and siamese connections;
3. access for fire fighting apparatus and rescue vehicles;
4. provisions for a fire pump, if necessary, including electrical supervisory control;
5. design and location of standpipes and/or sprinkler systems and related equipment;
6. design and locations of required fire alarm systems, including detection, supervision, and all related equipment;
7. smoke control;
8. firefighter elevator key location and associated equipment;
9. solid fuel-burning heating appliances; and
10. fire access panels (see Section 859.0)

1200.2 Installation requirements: The installation methods, repair, operation or maintenance of fire protection systems shall be in accordance with this code and the mechanical code listed in Appendix B.

1200.3 Maintenance: The owner, tenant or lessee of every building or structure shall be responsible for the care and maintenance of all fire protection systems, including equipment and devices, to insure the safety and welfare of the occupants. Fire protection systems shall not be disconnected or otherwise rendered unserviceable without first notifying the fire department. When installations of required fire protection systems are interrupted for repairs or other necessary reasons, the owner, tenant or lessee shall immediately advise the fire department and shall diligently prosecute the restoration of the protection.

1200.4 Threads: All threads provided for fire department connections to sprinkler systems, standpipe systems, yard hydrants or any other fire hose connections shall be uniform to those used by the local fire department.

1200.5 Signs: If fire suppression control valves are located in a separate room, or building, a sign shall be provided on the entrance door. The lettering for such sign shall be of a conspicuous color and shall be at least four (4) inches in height and shall read Sprinkler control valves and/or Standpipe control valves or indicate other types of systems (see Section 1213.8 for additional signs).

1200.6 Material and equipment: All materials and equipment used in a fire protection system shall be approved, consistent with the requirements of this code (see Section 110.0) and the standards as listed in Appendices B, C or I.

1200.7 Acceptance tests: Before final approval and acceptance by the building official and fire official of all fire extinguishing equipment in any building or structure, the installation shall be subjected to the tests prescribed herein or in the approved rules. It shall be unlawful to cover up or permanently conceal piping, wiring and accessory devices in any portion of a newly-constructed system until it has been tested and approved.

1200.7.1 Standpipe tests: Upon completion of a standpipe installation, every standpipe fire line shall be tested for static pressure and flow, including the top and bottom outlets in the presence of the fire official authorized to witness such test.

1200.7.2 Pressure test: The test shall demonstrate that the system will sustain a hydrostatic pressure of not less than one hundred (100) pounds per square inch (psi) at the topmost hose outlet, and not less than three hundred (300) psi at the fire department connection to the risers. In buildings not exceeding three (3) stories nor more than forty (40) feet in height, the test pressures may be reduced to not more than twenty-five (25) per cent in excess of the normal operating pressure.

1200.7.3 Temporary construction standpipes: The feed mains, risers, interconnections and branch lines of temporary standpipes in structures under erection shall be maintained watertight when work is not being done on the system.

1200.7.4 Sprinkler tests

1200.7.4.1 Wet pipe systems: Automatic wet pipe systems shall be subjected to a hydrostatic pressure test for two (2) hours duration of not less than two hundred (200) psi in every part of the installation exclusive of water supply tanks; except that in buildings of not more than three (3) stories or not more than forty (40) feet in height, the test pressure need not be more than fifty (50) pounds per square inch in excess of the normal pressure carried in the system or in excess of the pressure necessary to operate the highest sprinklers in nonautomatic systems.

1200.7.4.2 Pressure tanks: Pressure tanks shall be tested to a pressure of one and one-half ( $1\frac{1}{2}$ ) times the working pressure.

#### 1200.8 Periodic inspections and tests

1200.8.1 Inspections: Inspections and field tests of fire extinguishing equipment shall be made by the owner, his authorized representative, or insurance organization and may be witnessed by the fire official of the municipality as the fire official may direct, as herein required to enforce the maintenance of all service equipment in operating conditions and to familiarize the fire fighting force with existing condition and to familiarize the fire fighting force with existing conditions in all buildings and structures.

1200.8.2 Maintenance and test records: All fire fighting and fire extinguishing service equipment and appliances, including valves, hose, tools, accessories and fire alarm systems shall be maintained readily available and in good working order at all times for immediate use of the occupants of the building and the fire department. Records of required inspections and tests shall be available for examination by or filed with the fire official as he may direct.

1200.8.3 Test expense: All tests shall be conducted at the owner's risk and expense and not less than forty-eight (48) hours' notice shall be given to the building and fire official having jurisdiction before any test is made.

### SECTION 1201.0 PLANS AND SPECIFICATIONS

1201.1 Required: Before any standpipe or sprinkler equipment is installed, or existing equipment which involves ten (10) or more sprinkler heads in any one (1) fire area or on any one (1) floor is remodeled, or before the installation or extension of any interior fire alarm signal system, a preliminary set of plans, drawn to suitable scale, shall be submitted by a qualified registered professional engineer to the building official and the local fire official with specifications in sufficient detail showing essential features of the construction, heights or stories, location, size and arrangement of all required piping and accessories for each proposed standpipe fire line and sprinkler installation, and layout and wiring of the fire alarm system. Plans and specifications for fire suppression systems as required in this article for high-rise structures with a height of seventy (70) feet or more above mean grade must be submitted by a registered professional engineer qualified by experience to design and specify the appropriate elements of the fire suppression system.

1201.2 Approval by other agencies: Approval by other agencies having jurisdiction is required for any change in fire protection and fire extinguishing equipment.



1201.3 Standpipe fire lines: Plans for the standpipe installation shall show the size and location of siamese connections, tanks, pumps, hose stations, length of hose, stairways, stair sections and all subdividing partitions and walls.

1201.4 Sprinkler systems: Plans for the sprinkler installation shall show the location, capacity of water supply, connecting piping, feed lines and risers, all gate, check, alarm and dry pipe valves, location and number of all heads, locations and number of all actuating devices, and standpipe fire lines, if any.

1201.5 Interior fire alarms: Plans for the interior fire alarm signal system shall show location and number of all sending stations and signals with specifications of the type, construction, and operation of the system.

1201.6 Approved plans: After acceptance of the preliminary plans, three (3) final sets of plans shall be filed for final approval of every installation of standpipe fire line, sprinkler and fire alarm signal system.

#### SECTION 1202.0 FIRE SUPPRESSION SYSTEMS

1202.1 Where required: Fire suppression systems shall be installed and maintained in full operating condition, as specified in this code, in the following locations, except one- and two-family dwellings, indicated in Sections 1202.2 through 1202.18.

Exception: Requirements for R-1 detoxification facilities are contained in Section 439.0.

1202.2 Assembly (A-1) use: In all buildings or portions thereof of A-1 (assembly, theatres) use group.

Exception: Auditoriums, foyers, lobbies and toilet rooms.

1202.3 Assembly (A-2) use: In all buildings or structures or portions thereof of use group A-2 (assembly, night clubs):

1. when more than five thousand (5,000) square feet in area; or
2. when more than one (1) story in height.

1202.4 Assembly (A-3) use: In all buildings or structures or portions thereof of use group A-3 (assembly) when more than twelve thousand (12,000) square feet in area.

1202.5 Stages in assembly (A) use: Stages of any size, in assembly occupancies (A) in the following locations:

1. over the stage;
2. stage gridirons when side wall sprinklers with one hundred thirty-five (135) degrees F. rated heads with heat-baffle plates are installed around the entire perimeter of the stage at points not more than thirty (30) inches below the gridiron, nor more than six (6) inches below the baffle plate;
3. under all fly galleries;

4. over the proscenium opening on the stage side;
5. under the stage;
6. in all basements, cellars, work rooms, dressing rooms, store rooms, and property rooms; and
7. in toilet, lounge and smoking rooms.

1202.6 High hazard (H) use: In all buildings or structures or portions thereof of use group H (high hazard).

1202.7 Institutional (I) use: In all buildings or structures or portions thereof of use group I (institutional).

Exceptions:

1. One-story hospitals with patient rooms having direct egress to grade level at the exterior of the building.
2. In hospitals of Type I construction, the automatic fire suppression system may be omitted from operating rooms, X-ray rooms, delivery rooms, cardiac and intensive care rooms and patient sleeping rooms not exceeding six hundred (600) square feet in area when such room is protected by an automatic fire alarm system connected to a central annunciator panel.
3. One-story day nurseries housing one hundred (100) children or less with each room having an exit directly to the outside.
4. I-1 (institutional-restrained) occupancies having an occupancy load of less than six (6).
5. In I-1 (institutional-restrained) occupancies the fire suppression system shall be a sprinkler system which may be manual or automatic in operation.

1202.8 Mercantile (M), moderate hazard storage (S-1), or factory and industrial (F) uses: In all buildings or structures of use groups M, S-1, and F (mercantile, moderate hazard storage or factory and industrial):

1. when more than twelve thousand (12,000) square feet in area; or
2. when more than twenty-four thousand (24,000) square feet in total area on all floors; or
3. when more than three (3) stories in height).

1202.9 Public garages: In all public garages:

1. when more than ten thousand (10,000) square feet in area; or
2. when more than seven thousand five hundred (7,500) square feet in area and more than one (1) story in height; or
3. when more than five thousand (5,000) square feet in area, and more than two (2) stories in height; or
4. when more than three (3) stories in height; or
5. when located in buildings where the upper stories are designed for other uses; or
6. When located in any story that is more than fifty (50) per cent below grade.

Exception: Open parking structures (see 527 CMR 5.00 in Appendix B).

1202.10 Bus garages: In all bus garages:

1. when required by Section 1202.9; or
2. when used as passenger terminals for four (4) or more buses; or
3. when used for storage or loading of four (4) or more buses.

1202.11 Unlimited area buildings: In "unlimited area buildings" as required by Section 307.0.

Exception: Special industrial uses as indicated in Section 205.3.

1202.11.1 High-rise buildings: In all high-rise buildings exceeding seventy (70) feet in height as required by Chapter 148, Section 26A of the Massachusetts General Laws, as amended.

1202.12 Storage and workshop areas: In all portions of use groups A (assembly), B (business), I (institutional) or R-1 and R-2 (residential, hotels and multi-family) occupied for storage, workshop or similar purposes.

Exception: Individual storage or workshop areas located entirely within a dwelling unit.

1202.13 Story, cellar or basement: In every story, cellar or basement of all buildings where there is not provided at least twenty (20) square feet of opening entirely above the adjoining grade level in each fifty (50) lineal feet of exterior wall in the story, cellar or basement, on at least two (2) sides of the building. Openings shall have a minimum dimension of not less than twenty-two (22) inches. Such openings shall be unobstructed to allow fire-fighting and rescue operations from the exterior.

Exception: If the area of a cellar exceeds two thousand five hundred (2,500) square feet, an automatic fire suppression system is required.

For purposes of this section, an opening in an exterior wall qualifies as follows:

1. doors or access panels may be included in the determination of openings;
2. windows may be included in the determination of openings if they provide a breakable glazed area of not less than twenty-two inches in its least clear dimension.

1202.14 Painting rooms: In spray painting rooms or shops where painting, brushing, dipping or mixing is regularly conducted using flammable materials.

1202.15 Trash rooms and chutes: In rooms or areas used for incineration, trash, laundry collection, or similar uses. At alternate floor levels

and at the top of all chutes used in conjunction with these rooms or areas.

1202.16 Furnace rooms: In furnace rooms, boiler rooms and rooms for similar uses.

Exception: Such room located entirely within and serving a single dwelling unit.

1202.17 Unenclosed vertical openings: In unenclosed vertical openings between floors as required by Sections 520.0 and 616.8.

1202.18 Range hoods: In range hoods, in accordance with the requirements listed below.

1. Where natural or liquefied petroleum gas is used as a fuel, a manual reset safety valve shall be installed on the gas service line to prevent fuel from flowing into the burner or pilot in the event of activation of any suppression (extinguishing) system.
2. Hood and duct suppression (extinguishing) systems shall provide for both automatic and manual actuation of the system.
3. A manual station for activation of the suppression (extinguishing) system shall be located at or near one (1) of the means of egress from the area, but not nearer than ten (10) feet to the range hood, unless otherwise specifically approved.
4. The manual station shall be securely mounted not less than four and one-half (4½) feet nor more than five (5) feet above the floor.
5. The system shall be maintained at full operating capacity by the owner or tenant and shall be serviced every six (6) months. A metallic sign with contrasting letters and background shall indicate the manual station of the system and the proper operating (actuation) procedure.
6. All nozzles shall be accessible for cleaning and replacement.
7. CO<sub>2</sub> (carbon dioxide) suppression (extinguishing) systems shall be installed in accordance with the above and Section 1208.6.
8. Dry chemical (approved dry chemical extinguishing media) suppression systems shall be installed in accordance with the above and Section 1210.6.

1202.19 Alternate protection: In special use areas of buildings or structures, an automatic fire alarm system may be installed in lieu of a fire suppression system when approved by the building official and fire department and when such fire suppression system installation would be detrimental or dangerous to the specific use or occupancy.

1202.19.1 Telephone central office equipment buildings: Within telephone central office equipment buildings, automatic fire sprinklers may be omitted in the following rooms or areas when such rooms or areas are protected with an approved automatic fire alarm system:

1. Generator and transformer rooms.
2. Communication equipment areas when such areas are separated from

the remainder of the building by one (1) hour fireresistance rated wall and two (2) hour fireresistance rated floor-ceiling assemblies, and are used exclusively for such equipment.

### SECTION 1203.0 SUPPRESSION SYSTEM SELECTION

1203.1 General: To guide the administrative authority with the selection of the proper type of fixed fire suppression system, and the extinguishing agent for each type of hazard, fire may be classified as follows:

Class A Fires involving ordinary combustible materials (such as wood, cloth, paper, rubber and many plastics) requiring the heat-absorbing (cooling) effects of water, water solutions, or the coating effects of certain dry chemicals which retard combustion.

Class B Fires involving flammable or combustible liquids, flammable gases, greases and similar materials where extinguishment is most readily secured by excluding air (oxygen), inhibiting the release of combustible vapors, or interrupting the combustion chain reaction.

Class C Fires involving energized electrical equipment where safety to the operator requires the use of electrically nonconductive extinguishing agents.

Note: Electrical fires should not be fought with portable Class A or B extinguishers, or with hand-held solid stream nozzle. However, fixed water spray systems may be used to fight fires in energized electrical systems.

1203.2 Special hazards: In rooms or buildings containing combustibles, such as aluminum powder, calcium carbide, calcium phosphide, metallic sodium and potassium, quick-lime, magnesium powder or sodium peroxide, which are incompatible with the use of water as an extinguishing agent, other extinguishing agents shall be used.

1203.3 Types: Where a fire suppression system is required in this code, Table 1203 may be used by the administrative authority to determine the type of suppression system suitable for the hazard involved, if not otherwise specified in this code.

1203.4 Installation: Fixed fire suppression systems shall be of an approved type designed and installed in accordance with the requirements of this code.

1203.5 Tests: All tests required by this code and the standards listed in Appendix B shall be conducted at the expense of the owner or his representative.

Table 1203  
GUIDE FOR SUPPRESSION SYSTEM SELECTION

| Hazard                                    | Water<br>sprinklers<br>or spray<br>1204.0<br>to<br>1206.0 | Foam<br>1207.0 | Carbon<br>dioxide or<br>halogenated<br>1208.0<br>to<br>1209.0 | Dry<br>chemical<br>1210.0 |
|---|---|----------------|---|---------------------------|
| Class A fire potential                    | X   | X              | X   | X                         |
| Class B fire potential                    | X   | X              | X   | X                         |
| Class C fire potential                    | X   |                | X   |                           |
| <b>SPECIAL FIRE HAZARD AREAS*</b>         |   |                |   |                           |
| Aircraft hangars                          | X   | X              | X   | X                         |
| Alcohol storage                           | X   | X              | X   | X                         |
| Ammunition loading                        | X   |                |   |                           |
| Ammunition magazines                      | X   |                |   |                           |
| Asphalt impregnating                      | X   | X              |   |                           |
| Battery rooms                             |   |                | X   |                           |
| Carburetor overhaul shops                 | X   | X              | X   | X                         |
| Cleaning plant equipment                  | X   | X              | X   | X                         |
| Computer rooms                            | X   |                | X   |                           |
| Dowtherm                                  | X   |                |   |                           |
| Drying ovens                              | X   |                | X   | X                         |
| Engine test cells                         | X   | X              | X   |                           |
| Escalator, stair wells                    | X   |                |   |                           |
| Explosives: manufacturing, storage        | X   |                |   |                           |
| Flammable liquids storage                 | X   | X              | X   |                           |
| Flammable solids storage                  | X   |                |   |                           |
| Fuel oil storage                          | X   | X              |   |                           |
| Hangar decks                              | X   | X              |   |                           |
| Hydraulic oil, lubricating oil            | X   |                | X   |                           |
| Hydro-turbine generators                  | X   |                | X   |                           |
| Jet engine test cells                     | X   | X              | X   |                           |
| Library stacks                            | X   |                | X   |                           |
| Lignite storage and handling              | X   |                |   |                           |
| Liquefied petroleum gas storage           | X   |                |   |                           |
| Oil quenching bath                        | X   | X              | X   | X                         |
| Paints: manufacturing, storage            | X   | X              | X   | X                         |
| Paint spray booths                        | X   |                | X   | X                         |
| Petrochemical storage                     | X   | X              | X   |                           |
| Petroleum testing laboratories            | X   | X              | X   |                           |
| Printing presses                          | X   |                | X   |                           |
| Range hoods                               | X   |                | X   | X                         |
| Reactor and fractionating towers          | X   |                |   |                           |
| Record vaults                             |   |                | X   |                           |
| Rubber mixing and heat treating           | X   |                |   |                           |
| Service stations (inside buildings)       | X   |                | X   |                           |
| Shipboard storage                         | X   |                | X   |                           |
| Solvent cleaning tanks                    |   | X              | X   | X                         |
| Solvent thinned coatings                  |   | X              | X   | X                         |
| Switchgear rooms                          |   |                | X   |                           |
| Transformers, circuit breakers (outdoors) | X   |                |   |                           |
| Transformers, circuit breakers (indoors)  | X   |                | X   |                           |
| Turbine lubricating oil                   | X   | X              | X   | X                         |
| Vegetable oil, solvent extraction         | X   | X              |   |                           |

\*Within buildings or areas, so classified, as to require a suppression system.

SECTION 1204.0 WATER SPRINKLER SYSTEMS

1204.1 General: Water sprinkler extinguishing systems shall be of an approved type and installed in accordance with the provisions of this code and the standards listed in Appendices B or I.

1204.2 Occupancy sprinkler system: Within a building of mixed occupancies and where an occupancy is required by this code to be sprinklered with more than twenty (20) sprinklers, the area shall be enclosed by construction assemblies as required by this code and equipped with a complete sprinkler system.

1204.3 Design: The details on the system supplied with the plans and specifications shall include information and the calculations on the sprinkler spacing and arrangement with water supply and discharge requirements, size and equivalent lengths of pipe and fittings and water supply source. Sufficient information shall be included to identify the apparatus and devices used.

1204.4 Actuation: Water sprinkler extinguishing systems shall be automatically actuated unless otherwise specifically provided in this code.

1204.5 Sprinkler alarms: Approved audible or visual alarm devices shall be connected to every water sprinkler system and such alarm device shall be located in an approved location.

Exception: Alarms and alarm attachments shall not be required for limited area sprinkler systems (see Section 1205.5).

1204.5.1 Additional alarms: At least one (1) additional audible or visual alarm device shall be installed within the building.

1204.6 Water control valve tags: Identification tags shall be provided in accordance with the standards listed in Appendix I.

1204.7 Sprinkler riser: The sprinkler system riser(s) may also serve as the wet standpipe riser(s) in buildings required to have both systems or in buildings having both systems (see Section 1211.4.3).

1204.8 Tests: A completed system shall be tested hydrostatically for two (2) hours without visible leakage at not less than two hundred (200) pounds per square inch (psi), or at fifty (50) psi in excess of the maximum static pressure when the maximum static pressure is in excess of one hundred fifty (150) psi.

SECTION 1205.0 LIMITED AREA SPRINKLER SYSTEMS

1205.1 General: A limited area sprinkler system shall be of an approved type and installed in accordance with the provisions of this code

and the standards listed in Appendices B or I.

1205.2 Installation: Where the provisions of this code require a limited number of sprinklers, a limited area sprinkler system may be installed to comply with these requirements.

1205.3 Design: The detail on the system supplied with the plans and specifications shall include information and the calculations on the sprinkler spacing and arrangement with water supply and discharge requirements, size and equivalent lengths of pipe and fittings and water supply source. Sufficient information shall be included to identify the apparatus and devices used.

1205.4 Actuation: A limited area sprinkler extinguishing system shall be automatically activated.

1205.5 Sprinkler alarms: Alarms and alarm attachments shall not be required.

1205.6 Water supply: Limited area sprinklers may be supplied from the domestic water system provided the domestic water system is designed to adequately support the design flow of the largest number of sprinklers in any one (1) of the enclosed areas. When supplied by the domestic water system, the maximum number of sprinklers in any one (1) enclosed room or area shall not exceed twenty (20) sprinklers which must totally protect the room or area.

Exception: See Section 439.16 for requirements for limited area sprinkler systems in R-1 detoxification facilities use group.

1205.6.1 Fire department connections: A fire department connection is not required for limited area sprinkler systems supplied from the domestic water system.

1205.6.2 Standpipe connection: the water supply for the limited area sprinkler system shall be from the building standpipe system when available (see Section 1211.4.3).

1205.6.3 Cross connection: A limited area sprinkler system may be supplied individually from the domestic water system or from the standpipe system. There shall not be a cross-connection between the domestic and standpipe system.

1205.7 Use: Limited area sprinklers shall be used only in rooms or areas enclosed with construction assemblies as required by this code.

#### SECTION 1206.0 WATER SPRAY FIXED SYSTEMS

1206.1 General: Water spray extinguishing systems shall be of an approved type and installed in accordance with the provisions of this code and NFPA 15 listed in Appendix I.



1206.2 Design: The detail on the system supplied with the plans and specifications shall include information and the calculations on the sprinkler spacing and arrangement with water supply and discharge requirements, size and equivalent lengths of pipe and fittings and water supply source. Sufficient information shall be included to identify the apparatus and devices used.

1206.3 Actuation: Waterspray extinguishing systems shall be the automatically actuated type with supplementary auxiliary manual tripping capability.

1206.4 Tests: All new system piping shall be hydrostatically tested in accordance with the provisions of the standard referenced above.

#### SECTION 1207.0 FOAM EXTINGUISHING SYSTEMS

1207.1 General: Foam extinguishing systems shall be of an approved type and installed in accordance with the provisions of this code and NFPA 11, 11A and 16 listed in Appendix I.

1207.2 Design: The detail on the system supplied with the plans and specifications shall include complete computations showing pressure drop in all system piping, friction loss calculations on liquid lines and a detailed layout of the entire hazard to be protected. Hydraulic characteristics of foam proportioners and foam makers as determined by tests shall be supplied by the manufacturer to the building official (including the range of operating conditions required for the proposed installation), to permit determination of the adequacy of the hydraulics of the proposed protection.

1207.3 Actuation: A foam extinguishing system shall be automatically actuated with supplementary auxiliary manual tripping capability.

1207.4 Tests: All piping except that piping which handles expanded foam shall be subjected to a two (2) hour hydrostatic pressure test at two hundred (200) psi or fifty (50) pounds in excess of the maximum pressure anticipated, whichever is greater without leakage. The system shall be subjected to a flow test to insure that the hazard is fully protected in conformance with the design specification, and to determine the flow pressures, actual discharge capacity, foam quality, consumption rate of foam-producing materials, manpower requirements and other operating characteristics.

#### SECTION 1208.0 CARBON DIOXIDE EXTINGUISHING SYSTEMS

1208.1 General: Carbon dioxide extinguishing systems shall be of an approved type and installed in accordance with the provisions of this code and NFPA 12 listed in Appendix I.

1208.2 Design: The detail on the system supplied with the plans and specifications shall include information and calculations on the amount of carbon dioxide; the location and flow rate of each nozzle including equivalent orifice area; the location, size and the carbon dioxide storage facility. Information shall be submitted pertaining to the location and function of the detection devices, operating devices, auxiliary equipment, and electrical circuitry, if used. Sufficient information shall be indicated to identify properly the apparatus and devices used. Any special features should be adequately explained.

1208.3 Actuation: Carbon dioxide extinguishing systems shall be automatically actuated with supplementary auxiliary manual tripping capability.

1208.4 Safety requirements: In any proposed use of carbon dioxide where there is a possibility that persons may be trapped in, or enter into atmospheres made hazardous by a carbon dioxide discharge, warning signs, discharge alarms and breathing apparatus shall be provided to insure prompt evacuation of and to prevent entry into such atmospheres and also to provide means for prompt rescue of any trapped persons.

1208.5 Tests: A completed system shall be tested for tightness up to the selector valve, and for continuity of piping with free unobstructed flow beyond the selector valve. The labeling of devices with proper designations and instructions shall be checked. Operational tests should be conducted on all devices except cylinder valves in multi-cylinder high pressure systems. Where conditions prevail that make it difficult to determine adequately the system requirements or design, a suitable discharge and analysis test should be made. All tests are to be conducted as indicated in the above standard.

1208.6 Range hoods: In addition to the above requirements and the requirements of Section 1202.18, range hood CO<sub>2</sub> systems shall conform to the requirements listed below:

1. Where multiple hoods are served, each hood shall be provided with a separate manual station (actuator) and a separate CO<sub>2</sub> supply.
2. Total CO<sub>2</sub> requirements shall be calculated on the following accumulative basis:
  - a. open area of hood (sq. ft.) @ 0.6 = lbs of CO<sub>2</sub>;
  - b. volume of hood (cu. ft.) (minimum depth of 2 ft.) @ 8.0 = lbs of CO<sub>2</sub>;
  - c. hoods located over liquid surface operations; liquid surface area (sq. ft.) @ 0.4 = lbs. CO<sub>2</sub> (10 lbs. minimum);
  - d. volume of plenum (cu. ft.) @ 8.0 = lbs. of CO<sub>2</sub>;
  - e. volume of duct of fire damper (cu. ft.) @ 8.0 = lbs. of CO<sub>2</sub>;
  - f. duct above fire damper, minimum 10 lbs. CO<sub>2</sub>; and
  - g. in addition to the calculations, an additional 10 lbs. of CO<sub>2</sub> shall be provided as a safety factor.
3. Upon activation of the CO<sub>2</sub> system, the fan(s) shall cease to operate

- and the supply valve shall shut the pilot and burner(s) off.
4. Duct systems from range hoods shall not be equipped with fire dampers unless specifically approved for such use, or are required as part of an approved extinguishing system, or an approved fan bypass system.
  5. CO<sub>2</sub> bottles shall be located at least fifteen (15) feet from the range or range hood. The temperature in the storage area shall not exceed one hundred twenty (120) degrees F. or be less than thirty-two (32) degrees F.
  6. An electric warning light of ten (10) watts or more shall be provided on the CO<sub>2</sub> bottle or system which will automatically illuminate when the bottle or system is depleted. The light shall be of a distinctive red color and shall be located in a conspicuous location.

#### SECTION 1209.0 HALOGENATED FIRE EXTINGUISHING SYSTEMS

1209.1 General: Halogenated fire extinguishing systems shall be of an approved type and installed in accordance with the provisions of this code and NFPA 12 and 12B listed in Appendix I.

1209.2 Design: The detail on the system supplied with the plan and specifications shall include information and calculations of the amount of extinguishing agent; container storage pressure; the location and flow rate of each nozzle including equivalent orifice area; the location, size and equivalent lengths of pipe, fittings and hose; and the location and size of the storage facility. Information shall be submitted pertaining to the location and size of the storage facility. Information shall be submitted pertaining to the location and function of the detection devices, auxiliary equipment, and electrical circuitry, if used. Sufficient information shall be indicated to identify properly the apparatus and devices used. Any special features should be adequately explained.

1209.3 Actuation: Halogenated fire extinguishing systems shall be automatically actuated with supplementary auxiliary manual tripping capability.

1209.4 Safety requirements: In any proposed use of a halogenated fire extinguishing system where there is a possibility that persons may be trapped in or enter into atmospheres made hazardous by a discharge, warning signs, discharge alarms and breathing apparatus shall be provided to insure prompt evacuation of and to prevent entry into such atmospheres and also to provide means for prompt rescue of any trapped persons.

1209.5 Tests: A completed system shall be tested for tightness up to the selector valve, and for continuity of piping with free unobstructed flow beyond the selector valve. The labeling of devices with proper designations and instructions shall be checked. Operational tests should be conducted on all devices except cylinder valves in multi-cylinder sys-

tems. Where conditions prevail that make it difficult to determine adequately the system requirements or design, a suitable discharge test or concentration analysis should be made. All tests are to be conducted as indicated in the above standard.

## SECTION 1210.0 DRY CHEMICAL EXTINGUISHING SYSTEMS

1210.1 General: Dry chemical extinguishing systems shall be of an approved type and installed in accordance with the provisions of this code and NFPA 17 listed in Appendix I.

1210.2 Design: The details on the system supplied with the plans and specifications shall include sufficient information and calculations on the amount of dry chemical; the size, length, and arrangement of connected piping, or piping and hose; description and location of nozzles so that the adequacy of the system can be determined. Information shall be submitted pertaining to the location and function of detection devices, operating devices, auxiliary equipment and electrical circuitry, if used. Sufficient information shall be indicated to identify properly the apparatus and devices used. Any special features should be adequately explained.

1210.3 Actuation: A dry chemical extinguishing system shall be automatically actuated with supplementary auxiliary manual tripping capability.

1210.4 Safety requirements: Where there is a possibility that persons may be exposed to a dry chemical discharge, warning signs, discharge alarms and breathing apparatus shall be provided to ensure prompt evacuation of such locations, and also to provide means for prompt rescue of any trapped persons.

1210.5 Tests: A completed system shall be tested by a discharge of expellant gas through the piping and nozzles. Observations for serious gas leakage and for continuity of piping with free unobstructed flow shall be made. Observations shall be made of the flow of expellant gas through all nozzles. The labeling of devices with proper designations and instructions should be checked. After testing, all piping and nozzles are to be blown clean, using compressed air or nitrogen and the system properly charged and placed in the normal "set" condition. All tests are to be conducted as indicated in the above standard.

1210.6 Range hoods: In addition to the above requirements and the requirements of Section 1202.18, range hood dry chemical systems shall conform to the requirements listed below:

1. Dry chemical systems shall bear the label of a nationally recognized testing or inspection agency and shall be installed in accordance with their recommendations and shall be approved by the building official and fire official.
2. The size of hood and duct covered by a single system shall not ex-

ceed the agency's recommendations.

3. Dry chemical agent used shall be non-toxic.
4. Multiple hoods may be protected by a common system if in conformance with a report of a nationally recognized testing or inspection agency.
5. Each duct system shall constitute an individual system serving only exhaust hoods on one (1) floor.
6. Dry chemical bottles shall be located at least fifteen (15) feet from the range or range hood, or as approved by the building official and fire official.
7. An approved portable fire extinguisher having at least a twenty (20) B.C. rating shall be provided and located not more than fifteen (15) feet and not less than ten (10) feet from the hazard.

#### SECTION 1211.0 STANDPIPE SYSTEMS

1211.1 General: All buildings and structures shall be equipped with two and one-half (2½) inch or larger standpipes, and shall be made to comply with the requirements of this section.

1211.2 Where required: Standpipes shall be installed and maintained in full operating condition, as specified in this article and the standards listed in Appendix I, in the locations described in Sections 1211.2.1 through 1211.2.3. Such standpipe systems must be protected against freezing.

1211.2.1 Assembly (A-1, A-2 or A-3): In buildings two (2) or more stories in height of use groups A-1, A-2, or A-3 (assembly) with an occupancy load of more than three hundred (300).

1211.2.2 Three stories: In buildings three (3) stories in height when:

1. of use groups B (business), F (factory and industrial), M (mercantile) or S-1 (moderate hazard storage) more than three thousand (3,000) square feet in area per floor; or
2. of use groups A (assembly), I (institutional), or R-1 (residential, hotels); or
3. of any use group more than ten thousand (10,000) square feet in area per floor.

1211.2.3 Four stories: In buildings four (4) stories or more in height regardless of the area per floor.

1211.2.4 Public garages: In all public garages:

1. when more than ten thousand (10,000) square feet in area; or
2. when more than seven thousand five hundred (7,500) square feet in area and more than one (1) story in height; or
3. when more than five thousand (5,000) square feet in area, and more

- than two (2) stories in height; or
4. when more than three (3) stories in height; or
  5. when located in buildings where the upper stories are designed for other uses; or
  6. when located in any story that is more than fifty (50) per cent below grade.

1211.3 Sizes: Standpipes shall extend from the lowest portion of the building to a height five (5) feet above the finished floor of the topmost story and shall have a minimum diameter as described in the following Table 1211.

Table 1211

## BUILDING HEIGHT AND STANDPIPE SIZE

| Maximum building height | Minimum standpipe size** |
|-------------------------|--------------------------|
| 3 stories or 40 feet    | 2½ inches                |
| 4 stories or 50 feet    | 2½ inches                |
| 5 stories or 65 feet    | 4 inches                 |
| 6 stories or 75 feet    | 4 inches                 |
| 7* stories or 85 feet   | 6 inches                 |
| 8* stories or 95 feet   | 6 inches                 |
| 95* feet to 250 feet    | 6 inches                 |
| over 250* feet          | 8 inches                 |

\*At least one (1) standpipe shall extend through the roof and terminate in a two-way, two and one-half (2½) inch hose connection.

\*\*In sprinklered buildings, the minimum standpipe diameter may be based on hydraulic calculations.

## 1211.4 Number of risers

1211.4.1 Based on floor area: The number of standpipe risers shall be such that all parts of every floor area can be reached by a thirty (30) foot hose stream from a nozzle attached to not more than one hundred (100) feet of hose connected to a riser outlet. In those buildings equipped with an interior smokeproof enclosure vestibule, at least one (1) standpipe hose connection shall be located in the vestibule.

1211.4.2 Based on street fronts: There shall be at least one (1) riser for each front on which the building or structure faces; except that a corner building need not be considered as facing on more than one (1) street.

1211.4.3 Buildings seventy (70) feet in height or over: All buildings seventy (70) feet in height or over must have each floor supplied by a minimum of two (2) combination risers.

1211.4.4 Combination: The standpipe system riser(s) may also serve as the water sprinkler system riser(s) in buildings required to have both systems or in buildings having both systems. A control valve shall be installed in each sprinkler system or standpipe to allow the system to remain operational.

#### 1211.5 Outlets

1211.5.1 Hose connections: At each floor level, and not more than five (5) feet above the floor, there shall be connected to each standpipe a two and one-half (2½) inch hose connection and a one and one-half (1½) inch hose connection with valves and threads conforming to the local fire department's standard. Each one and one-half (1½) inch hose connection shall not be equipped with an approved hose unless required by the local fire department.

1211.5.2 Roof hydrant: Where standpipes extend through the roof, an approved hydrant or manifold shall be provided. The main control valve on a roof hydrant or manifold shall be located in an area not subject to freezing, as close to the roof access as practical and plainly marked (see Section 1213.0).

1211.6 Material: All standpipes shall be constructed of approved materials. All pipe, fittings and valves shall be of extra heavy pattern when the working pressure will exceed one hundred seventy-five (175) psi.

1211.7 Capacity: Where only one (1) standpipe is required, its supply piping shall be sized for a minimum flow of five hundred (500) gallons per minute. Where more than one (1) standpipe is required, all common supply piping shall be sized for a minimum flow of five hundred (500) gallons per minute for the first standpipe plus two hundred fifty (250) gallons per minute for each additional standpipe, the total not to exceed twenty-five hundred (2,500) gallons per minute. The supply shall be sufficient to maintain a residual pressure of sixty-five (65) pounds per square inch at the topmost outlet of each standpipe with five hundred (500) gallons per minute flowing.

### SECTION 1212.0 STANDPIPES FOR BUILDINGS UNDER CONSTRUCTION OR DEMOLITION

1212.1 General: Standpipes required by this section may be temporary or permanent in nature, with or without a water supply, provided, however, that such standpipes shall remain in service until completion of the work.

1212.2 Number required: Every building or structure under construction five (5) or more stories in height above grade, shall be equipped with one (1) or more standpipes at least four (4) inches in diameter. A sufficient number of standpipes with hose shall be provided so that every

portion of the building can be reached with one hundred (100) feet of hose and a thirty (30) foot hose stream.

1212.3 Construction: All standpipes shall be constructed of approved materials. All pipe, fittings and valves shall be extra heavy pattern when the working pressure exceeds one hundred seventy-five (175) pounds per square inch (psi).

1212.4 Height: The standpipe systems shall be carried up with each floor and shall be installed and ready for use as each floor progresses. Standpipes shall not be more than one (1) floor below the highest forms or staging. Each standpipe system shall be in operating condition at all times and protected from freezing.

1212.5 Fire department connections: At the street level there shall be provided for each temporary or permanent standpipe installation one (1) or more two-way fire department inlet connections. Fire department inlet connections shall be prominently marked and readily and easily accessible at all times (see Section 1213.8).

1212.6 Outlets: At each floor level and on each standpipe, there shall be provided one (1) two and one-half ( $2\frac{1}{2}$ ) inch hose outlet and one (1) two and one-half ( $2\frac{1}{2}$ ) inch hose valve with cap and chain. At each floor level and on each standpipe, there shall be provided a one and one-half ( $1\frac{1}{2}$ ) inch hose outlet with one hundred (100) feet of approved hose. Outlets shall be located not more than five (5) feet above floor level.

Exception: In sprinklered buildings, the one and one-half ( $1\frac{1}{2}$ ) inch outlet is not required; however, the one and one-half ( $1\frac{1}{2}$ ) hose line shall be provided with a one and one-half ( $1\frac{1}{2}$ ) to two and one-half ( $2\frac{1}{2}$ ) reducer (see Section 1211.5.1).

1212.7 Buildings under demolition: Where a building is being demolished and a standpipe is existing within such a building, such standpipe shall be maintained in an operable condition so as to be available for use by the fire department. Such standpipe shall be demolished with the building, but the standpipe shall not be more than one (1) floor below the floor above being demolished.

#### SECTION 1213.0 FIRE DEPARTMENT CONNECTIONS (See Section 1212.5 for temporary standpipes)

1213.1 Required: All water sprinkler and standpipe systems shall be provided with at least one (1) two-way fire department connection. Each inlet of the fire department connection shall be at least two and one-half ( $2\frac{1}{2}$ ) inches in diameter. The pipe from the standpipe system to the fire department connection shall not be smaller than four (4) inches. The pipe from the water sprinkler system to the fire department connection shall not be smaller than four (4) inches. Single fire department connections may be installed when approved by the building official and the fire official.



Exception: A fire department connection shall not be required for limited area sprinkler systems (see Section 1205.6.1).

1213.2 Connections: Fire department connections shall be arranged in such a manner that the use of any one (1) water sprinkler connection will serve all the sprinklers, and the use of any one (1) standpipe connection will serve all the standpipes within the building.

1213.3 Location: Fire department connections shall be located and be visible on a street front or in a location approved by the building official and the fire official. Such connections shall be located so that immediate access can be made by the fire department. Obstructions such as fences, bushes, trees, walls or any other similar object shall not be permitted for new or existing installations.

1213.4 Height: Fire department connections shall not be less than one (1) foot six (6) inches and not more than three (3) feet six (6) inches in elevation, measured from the ground level to the center line of the inlets.

1213.5 Projection: Where the fire department connection would project beyond the property line or into the public way, a flush-type fire department connection shall be provided.

1213.6 Hose threads: Hose threads in the fire department connection shall be uniform with that used by the local fire department.

1213.7 Fittings: Fire department inlet connections shall be fitted with check valves, ball-drip valves, and caps and chains.

1213.8 Signs: A metal sign with raised letters at least one (1) inch in height shall be mounted on all fire department connections serving sprinklers and/or standpipes. Such signs shall read "Automatic Sprinklers and/or Standpipe."

#### SECTION 1214.0 WATER SUPPLY AND OTHER EXTINGUISHING SUPPLY MEDIA

1214.1 Required: Automatic sprinkler systems shall have at least one (1) approved automatic source of water supply meeting the requirements of this section.

1214.2 Public water sprinkler supply: Direct connections to public water supplies shall be capable of supplying water at not less than fifteen (15) pounds per square inch (psi) pressure for the maximum number of sprinkler heads in the designated fire area. When supplied by a street main, the accessible flow shall not be less than five hundred (500) gallons per minute from a hydrant within two hundred (200) feet of the building under the minimum pressure herein specified.

1214.2.1 Sprinkler gravity tank: Gravity tanks shall be capable of supplying twenty-five (25) per cent of the number of sprinkler heads in the maximum protected fire area for a period of twenty (20) minutes but capacity of any one (1) tank shall not be less than five thousand (5,000) gallons.

1214.2.2 Sprinkler pressure tank: Pressure tanks shall be capable of supplying twelve and one-half (12½) per cent of the number of sprinkler heads in the maximum protected fire area; but the capacity shall not be less than three thousand (3,000) gallons of water for a wet pipe system, nor less than five thousand (5,000) gallons for a dry pipe system; nor shall any single tank have a capacity of more than six thousand (6,000) gallons. The tank shall be maintained two-thirds (2/3) full of water under a pressure of seventy-five (75) psi at all times.

1214.3 Sprinkler fire pump: Automatic fire pumps shall be of an approved type with a supply capacity of at least five hundred (500) gallons per minute. The pumps shall be adequate to supply fifty (50) per cent of the sprinkler heads in the maximum protected fire area and shall be located in a room enclosed with not less than two (2) hours fire-resistive construction, and shall be protected against freezing. Such sprinkler fire pump room shall have either direct access to the room from grade or access by a two (2) hour fire-rated passageway and shall be properly secured from unauthorized entry.

1214.4 Combined water supply: When the sprinklers and standpipes are supplied from one (1) tank, the standpipe supply shall be drawn from the top portion of the tank and be so located that the bottom of the tank shall be not less than twenty-five (25) feet above the topmost outlet. The tank shall have a capacity greater than five thousand (5000) gallons and be so arranged as to provide a reserve supply of not less than five thousand (5000) gallons at all times for the standpipe fire line.

#### 1214.5 Standpipes

1214.5.1 Water service: Standpipes shall be connected to a street water main with a fire water service at least equal to the size of the largest standpipe within the building, or shall be hydraulically calculated to satisfy total demand. The size of the water service at the base of the standpipe risers shall be at least the size of the largest standpipe.

1214.5.2 Interconnection: The required water supply shall be connected to the base of each standpipe. Where more than one (1) standpipe is required, all standpipes shall be interconnected at their base and an approved indicating valve shall be installed at the base of each standpipe so as to permit individual risers to be taken out of service if damaged or broken without interrupting the water supply to other risers.

1214.6 Main control valve: Every sprinkler system shall be provided with a readily accessible outside screw and yoke valve or an indicator gate valve to control all sources of water supply except that from the

fire department connection. Such valves shall be kept in a locked open position or shall be provided with an anti-tampering device which shall sound a local alarm and may transmit a signal to the local fire department if such an installation is provided.

1214.7 Water curtains for wall openings: In all buildings and structures designed for high hazard (use group H), storage (use group S), mercantile (use group M), and industrial (use group F) uses involving the storage, sale or processing of flammable materials or products, the exterior wall openings located on or within six (6) feet of interior lot lines shall be protected with an approved water curtain (see Section 914.0).

1214.8 Manual fire extinguishing equipment: All hand-operated auxiliary fire extinguishing equipment shall be of an approved type suitable to the occupational use of the building and shall be installed in corridors and other locations, visible and readily accessible to the occupants of the building in accordance with the requirements of the fire official and as herein specified.

1214.8.1 Cabinets: When auxiliary emergency equipment is enclosed in cabinets, they shall be of an approved type of noncombustible construction equipped with readily openable keyless doors or with readily broken glass access panels.

1214.9 Drainage of discharge: Provisions shall be made for discharge of the overflow of water on every floor of sprinklered buildings designated for industrial and storage uses to comply with the Massachusetts State Plumbing Code (248 CMR 2.00).

#### SECTION 1215.0 YARD HYDRANTS

1215.1 Fire hydrants: Fire hydrants installed on private property shall be located and installed as directed by the fire department. Hydrants shall conform to the standards of the administrative authority of this jurisdiction and the fire department. Hydrants shall not be installed on a water main of less than six (6) inches in diameter.

#### SECTION 1216.0 AUTOMATIC FIRE ALARM SYSTEMS

1216.1 Plans and specifications: Where required by this code, the

Table 1216

## RESIDENTIAL FIRE PROTECTION REQUIREMENTS

| Use group   | Number of units | Unit occupant protection | Other occupant protection | Standby power     | Manual stations   | Zoned             | Provision for fire dept. notification |
|-------------|-----------------|--------------------------|---------------------------|-------------------|-------------------|-------------------|---------------------------------------|
| R-3         | 1-2             | Yes<br>1216.3.2.2        | —                         | —                 | —                 | —                 | —                                     |
| R-1,<br>R-2 | 6 or less       | Yes<br>1216.3.2.1        | Yes<br>1216.3.2.1         | —                 | *                 | —                 | —                                     |
| R-1,<br>R-2 | 7-12            | Yes<br>1216.3.2.1        | Yes<br>1216.3.2.1         | Yes<br>1216.3.2.3 | *                 | —                 | —                                     |
| R-1,<br>R-2 | 13-24           | Yes<br>1216.3.2.1        | Yes<br>1216.3.2.1         | Yes<br>1216.3.2.3 | Yes<br>1216.3.2.4 | Yes<br>1216.3.2.5 | —                                     |
| R-1,<br>R-2 | 25 or more      | Yes<br>1216.3.2.1        | Yes<br>1216.3.2.1         | Yes<br>1216.3.2.3 | Yes<br>1216.3.2.4 | Yes<br>1216.3.2.5 | Yes<br>1216.3.2.6                     |

\* Manual pull stations required for R-1 and R-2 use groups three (3) stories or more in height.

plans and specifications for the automatic fire alarm system shall show location and number of all sending station and signals with specifications of the type, construction, and operation of the system including all automatic detection devices. Installation of all equipment shall conform to the requirements of this code and the applicable standards listed in Appendix I.

1216.2 Approval: The automatic fire alarm system shall be approved for the particular application.

1216.3 Where required: An automatic fire alarm system shall be installed and maintained in full operating condition in the locations described in the following Sections 1216.3.1 through 1216.3.4.

1216.3.1 Institutional (I) use: In all buildings of use group I (institutional) in accordance with NFPA Standard No. 101 as listed in Appendix B.

1216.3.2 Automatic fire warning systems in residential use groups R-1, R-2, R-3 and R-4: Every building, structure or portion thereof for which a permit was issued on or after January 1, 1975, and not exceeding seventy (70) feet in height above mean grade, in use groups R-1, R-2, R-3 or R-4 shall be subject to the provisions of this section. Such buildings in use groups R-1 or R-2 which exceed seventy (70) feet in height shall be subject to the provisions of Section 1216.3.2.1, Item 6 (see also Section 431.4). Buildings or structures which are altered or repaired shall be subject to the provisions of Section 106.0. A summary of the requirements is given in Table 1216.

1216.3.2.1 R-1 and R-2 use groups: All buildings or portions thereof of R-1 and R-2 use groups shall incorporate automatic fire detectors located as required in the following items 1 through 9 (see Section 1216.3.2.3 for type of system):

1. All buildings of R-1 and R-2 use groups which contain six (6) or less separate residential units shall use a Type III or Type II system with multiple station smoke detectors on each level of the common space as defined in Section 1216.3.2.1, item 7a [see Item 4 if three (3) or more stories].
2. All buildings of R-1 and R-2 use groups which contain seven (7) to twelve (12) separate residential units shall be provided with a Type II system (see Item 4 if three (3) or more stories.)
3. All buildings of R-1 and R-2 use groups which contain thirteen (13) or more separate residential units shall be provided with a Type I system and zoned in conformance with Section 1216.3.2.5.
4. All buildings of R-1 and R-2 use groups which contain thirteen (13) or more separate residential units, or are three (3) or more stories in height, shall incorporate manual pull stations located in conformance with Section 1216.3.2.4.

5. All buildings of R-1 and R-2 use groups which contain twenty-five (25) or more separate residential units shall incorporate provisions for automatic fire department notification in conformance with Section 1216.3.2.6.
6. Approved single or multiple station smoke detectors shall be located within each residential unit to comply with the following minimum requirements:
  - a. Minimum number of detectors
    - i. One (1) approved smoke detector shall be located outside of each separate sleeping area, in accordance with the definition for "separate sleeping area" as defined in Section 1216.3.2.2, item 2.b.i and NFIPA 74 as listed in Appendix I.
    - ii. In residential units twelve hundred (1200) square feet or more in area, at least one (1) permanently wired multiple station smoke detector shall be provided for each twelve hundred (1,200) square feet of area or part thereof.
  - b. Location of detectors
    - i. One (1) approved smoke detector shall be located outside of each separate sleeping area, as defined in Section 1216.3.2.2, item 2.b.i, and NFIPA 74 as listed in Appendix I.
    - ii. One (1) approved smoke detector shall be located on the ceiling near the base of, but not within, each stairway.
    - iii. A smoke detector shall not be required to be located in or within six (6) feet of a kitchen or cooking area. (This provision does not preclude installation in these areas.)
7. Approved fire detectors also shall be located within the structure to comply with the following minimum requirements:
  - a. Corridors, lobbies and exitway discharge: all lobbies, common corridors, hallways and exitway access and discharge routes shall be provided with approved smoke detectors with not more than a thirty (30) foot spacing between detectors.
  - b. Inside residential unit entrance doorways: all residential unit doorways to corridors or hallways shall be provided with an approved heat detector located not more than six (6) feet inside the doorway and in conformance with the requirements of NFIPA 72E as listed in Appendix I.
  - c. Other rooms: all rooms one hundred (100) square feet in area or more, not in residential units, shall be equipped with approved heat detectors or smoke detectors located in accordance with the requirements of their listing and in conformance with NFIPA 72E as listed in Appendix I.
8. All detectors in Section 1216.3.2.1, Item 7, shall be arranged to activate the building fire alarm in accordance with Section 1216.3.2.3.
9. Any building of R-1 and R-2 use groups that is completely protected

by an approved automatic sprinkler system may omit the detectors required in Section 1216.3.2.1, Item 7, provided that waterflow will sound the building fire alarms in accordance with Section 1216.3.2.3. When a building in use group R-1 and R-2 is completely sprinklered, sprinklers may be omitted in closets and similar spaces which are located within an individual dwelling unit when the least dimension of such spaces is not greater than thirty (30) inches and the floor area within such spaces does not exceed twenty-four (24) square feet.

Exceptions:

1. See Section 439.16 for types of systems required in R-1 detoxification facilities.
2. Required smoke detectors shall not be deleted when an approved automatic sprinkler system is installed.

1216.3.2.2 R-3 and R-4 use groups, including manufactured homes

1. All buildings which are defined by this code as one or two-family dwellings shall contain a Type III system in conformance with Section 1216.3.2.3 with smoke detectors located as required in Section 1216.3.2.2, Item 2, of this section and in accordance with NFPA 72E as listed in Appendix I.
2. Smoke detectors shall be located to comply with the following minimum requirements:
  - a. Minimum number of detectors
    - i. Not less than one (1) approved smoke detector shall be provided on the highest habitable level and on each floor, story or level below, including basements or cellars.
    - ii. For any floor, level or story exceeding twelve hundred (1200) square feet in area, one (1) approved smoke detector shall be provided for each twelve hundred (1,200) square feet or part thereof.
  - b. Location of detectors
    - i. One (1) approved smoke detector shall be located outside of each separate sleeping area. By sleeping area is meant the area or areas of the family living unit in which the bedrooms (or sleeping rooms) are located. Bedrooms (or sleeping rooms) separated by other use areas, such as kitchens or living rooms (but not bathrooms), shall be considered as separate sleeping areas for the purposes of this regulation.
    - ii. One (1) approved smoke detector shall be located on the ceiling near the base of, but not within, each stairway.
    - iii. A smoke detector shall not be required to be located in or within six (6) feet of a kitchen, cooking area or garage. (This provision does not preclude installation in these areas).

- c. Combined coverage: smoke detectors required by Section 1216.3.2.2, Item 2.a, may be used to fulfill the requirements of Section 1216.3.2.2, Item 2.b.

1216.3.2.3 Type of systems: Systems shall be one (1) of the following types as required by this section:

1. Type I: A Type I system shall be installed in conformance with the Massachusetts Electrical Code (527 CMR 12.00) and NFIPA 72A as listed in Appendix I. A Type I system shall include an approved secondary source of power and incorporate an annunciator at the grade level located as directed by the local fire department.
2. Type II: A Type II system shall be installed in conformance with the Massachusetts Electrical Code (527 CMR 12.00) and NFIPA 72A as listed in Appendix I and include an approved secondary source of power.
3. Type III: A Type III system shall be installed in accordance with NFIPA 74 as listed in Appendix I. Power shall be supplied from a permanently-wired connection directly to an A.C. primary source of power or monitored batteries. All power for A.C. powered detectors shall be taken from a single branch circuit which also provides other detectors shall be on the supply side, ahead of any switches. All required smoke detectors shall be provided with a visible power-on indication. All required smoke detectors shall be interconnected so that when one actuates all will sound to meet the requirements of NFIPA 74, Section 2-2.4, as listed in Appendix I. All required smoke detectors shall conform with Section 1216.3.2.7, Items 1, 2 and 5.

1216.3.2.4 Manual pull stations: Where required, manual pull stations shall be located on the corridor side of, and within six (6) feet of each entrance to an exitway. Manual pull stations shall be connected to the building fire alarm system in conformance with NFIPA 72A as listed in Appendix I.

1216.3.2.5 Zones: Where required, each floor, level or story shall be separately zoned. The length of any zone on any floor, level or story shall not exceed two hundred (200) feet in any direction.

1216.3.2.6 Automatic fire department notification: Where required to provide automatic fire department notification, the system shall be connected to the fire department alarm headquarters if so directed by the head of the local fire department, in conformance with NFIPA 72B, NFIPA 72C, or NFIPA 71 as listed in Appendix I.

1216.3.2.7 Approved devices

1. Single station and multiple station smoke detection devices: smoke detectors of single station and multiple station types shall meet the requirements of U.L. 217 as listed in Appendix I and be listed or approved by a nationally recognized fire testing laboratory.
2. Smoke detectors, other than single station and multiple station devices, shall meet the room fire test provisions of U.L. 167 in addition to carrying a listing or approval as meeting U.L. 167 or U.L.



168.

3. All heat detectors shall be listed or approved for a spacing not less than thirty (30) feet.
4. All other alarm equipment used in this section shall be listed or approved by a nationally recognized fire testing laboratory.
5. The State Building Code Commission shall withdraw the approval from any device or equipment which repeatedly fails to perform under this section.

1216.3.2.8 Maintenance and testing

1. It shall be the responsibility of the owner to properly maintain the system.
2. All Type I and Type II systems shall be tested at least annually in conformance with the NFPA 72A as listed in Appendix I with the performance of each initiating device and indicating device recorded with the head of the fire department.
3. In addition to the above, all Type I systems connected to the fire department shall be tested with advance notice as required by the head of the fire department.

1216.3.3 Assembly (A-4) use: In all buildings of use group A-4 (churches, schools, colleges, universities).

1216.3.4 Low density recreation: In all buildings used for low density recreation such as swimming, tennis and skating where there are accommodations for less than one hundred (100) spectators.

1216.4 Alarms for fully-sprinklered buildings: Buildings which are comcompletely equipped with an automatic fire suppression system are not required to be equipped with an automatic fire alarm system but are required to be equipped with a manual fire alarm system conforming to Section 1217.0.

Exceptions:

1. R-1 and R-2 use groups: In use groups R-1 and R-2, single or multiple station smoke detectors shall be provided in each dwelling unit in conformance with Section 1216.3.2.1, Item 6.
2. Partially sprinklered buildings: When portions of buildings are completely protected by an approved automatic fire suppression system and are separated by two (2) hour fire rated construction from unprotected portions, the protected portions need not be equipped with automatic fire alarm systems, but shall be equipped with a manual fire alarm system conforming to Section 1217.0.

1216.5 Manual pull stations: A manual fire alarm system conforming to the requirements of Section 1217.0 shall be installed in conjunction with an automatic fire alarm system.

Exception: Automatic fire alarm system for use groups R-2, R-3 and R-4 as required by Section 1216.3.2.

1216.6 Distances: Approved fire detecting devices shall be installed not to exceed the lineal or square footage allowances specified, based on the generally accepted test standards under which they were tested and approved.

1216.7 Not mandatory: In special use buildings and structures or parts thereof, an automatic fire alarm system may be installed in lieu of an automatic fire suppression system when approved by the building official and the fire official when such installation would be detrimental or dangerous to the specific use and occupancy (see Section 1202.19).

1216.8 Power supply: The power for the automatic fire alarm system shall be provided from an emergency electrical system.

Exception: Automatic fire alarm systems for use groups R-2, R-3 and R-4 as required by Section 1216.3.2

1216.9 Requirements: All automatic fire alarm systems shall be of the closed circuit type and shall be electrically or mechanically supervised. In addition, such systems shall comply with the following Section 1216.9.1 through 1216.9.3:

1216.9.1 Wiring: All wiring shall conform to the requirements of NFIPA 72 as listed in Appendix I and Massachusetts Electrical Code (527 CMR 12.00).

1216.9.2 Audible alarms: Audible alarms, of approved type, shall be provided. The operation of any detection device shall cause all audible or visual alarms to operate. Visual and audible alarms shall be provided in occupancies housing the hard-of-hearing. Alarm-sounding devices shall be of an approved type, shall provide a distinctive tone and shall not be used for any other purpose than that of a fire alarm. They shall be located so as to be effectively heard above all other sounds, by all the occupants, in every occupied space within the building.

1216.9.3 Zones: Each floor shall be zoned separately. If the floor area exceeds twenty thousand (20,000) square feet, additional zoning shall be provided. The length of any zone shall not exceed two hundred (200) feet in any direction. Zoning indicator panels and controls shall be located as approved by the building official and the fire official. Annunciators shall lock in until the system is reset.

1216.10 Fire alarm acceptance tests: Upon completion of a fire alarm system, the installation shall be subjected to a performance test to demonstrate its efficiency of operation. Also, all connections and wiring, with signal devices disconnected shall develop an insulation resistance of no less than one (1) megohm.

SECTION 1217.0 MANUAL FIRE ALARM SYSTEMS (PULL STATIONS)

1217.1 Plans and specifications: Where required by this code, the plans and specifications for the manual fire alarm system shall show the location and number of all sending stations and signals with specifications of the type, construction and operation of the system. Installation of all equipment shall conform to the requirements of this code and the applicable standards listed in Appendix I.

1217.2 Approval: The manual fire alarm system shall be approved for the particular application and shall be used for fire protection signaling purposes only. Alarm boxes shall be painted a distinctive red color.

1217.3 Where required: A manual fire alarm system shall be installed and maintained in full operating condition in the locations described in the following Sections 1217.3.1 through 1217.3.5:

1217.3.1 Automatic alarm system: In all buildings required to be equipped with an automatic fire alarm system (see Section 1216.5).

Exception: Automatic fire alarm system as required by Section 1216.3.2 for dwelling units in use groups R- 2, R-3 and R-4.

1217.3.2 Mercantile (M) use: In all buildings of use group M (mercantile) which have one (1) or more levels above the grade level to which the public is admitted.

1217.3.3 Assembly (A-4) use: In all new and existing buildings of use group A-4 (assembly, educational).

Exception: Sanctuary and nave areas of churches and similar religious buildings.

1217.3.4 Business (B) use: In all buildings of use group B (business) when three (3) or more stories in height.

Exception: Buildings equipped with an automatic fire suppression system and less than seventy feet in height.

1217.3.5 Factory and industrial (F) use: In all buildings of use group F (factory) and twenty-five (25) or more individuals are employed above the first or ground floor.

1217.4 Location: Manual pull stations shall be located in each common corridor of each story including basements or cellars, so that from each common corridor door, not more than two hundred (200) feet will be traversed in order to reach a manual station. Stations shall be located as near as possible and not more than five (5) feet from each exitway. Where corridors are not provided, manual stations shall be located so that any point in the building is not more than two hundred (200) feet from a

station. Where a stage is provided, a manual pull station shall be located adjacent to the lighting control panel.

1217.5 Coding: Coded stations shall be coded in conformance with the standards as listed in Appendix I.

1217.6 Power supply: The power for the fire alarm system shall be provided from an emergency electrical system.

1217.7 Requirements: Fire alarm systems shall be of the closed circuit type and shall be electrically or mechanically supervised. In addition, such systems shall comply with the following Sections 1217.7.1 through 1217.7.5:

1217.7.1 Wiring: All wiring shall conform to the requirements of NFPA 72 as listed in Appendix I.

1217.7.2 Alarms: Audible alarms, of the approved type, shall be provided. In institutional occupancies, audible and visual alarms shall be provided. The operation of any fire alarm device shall cause all audible or visual alarms to operate. Visual and audible alarms shall be provided in occupancies housing the hard-of-hearing. Alarm-sounding devices shall be of approved type, shall provide a distinctive tone and shall not be used for any other purpose than that of an alarm of fire. They shall be of such character and so located as to be effectively heard above all other sounds (or seen), by all the occupants, in every occupied space within the building.

1217.7.3 Pre-signal system: A pre-signal system may be installed in institutional occupancies. Pre-signal systems shall not be installed in other occupancies, unless approved by the building official, and by the fire official. Where a pre-signal system is installed, twenty-four (24) hour personnel supervision shall be provided at a location approved by the building official and fire official, in order that the alarm signal can be actuated in the event of fire or other emergency.

1217.7.4 Box height: The height of the manual pull station boxes shall be not more than four (4) feet, measured vertically from the floor level.

1217.7.5 Zones: Each floor shall be zoned separately. If the floor area exceeds twenty thousand (20,000) square feet, additional zoning shall be provided. The length of any zone shall not exceed two hundred (200) feet in any direction. Zoning indicator panels and controls shall be located as approved by the department. Annunciators shall lock in until the system is reset.

1217.8 Acceptance tests: Upon completion of a fire alarm system, the installation shall be subjected to a performance test to demonstrate its efficiency of operation. Also, all connections and wiring, with signa

devices disconnected shall develop an insulation resistance of not less than one (1) megohm.

#### SECTION 1218.0 SUPERVISION

1218.1 Fire suppression systems: Valves controlling required fire suppression systems shall be supervised open by one (1) of the following methods:

1. approved central station system, proprietary system or remote station system of the jurisdiction;
2. local alarm service which will cause the sounding of an audible signal at a constantly attended location;
3. locking valves open; or
4. sealing of valves and approved weekly recorded inspection when valves are located within fenced enclosures under the control of the owner.

##### Exceptions

1. Underground gate valves with roadway boxes.
2. Halogenated extinguishing systems.
3. Carbon dioxide extinguishing systems.
4. Dry chemical extinguishing systems.

1218.2 Fire protection systems: All required fire protection systems shall be connected to an approved central station system, proprietary system, or remote station system of the jurisdiction, when approved by the fire department.

##### Exceptions

1. Fire suppression systems shall conform to Section 1218.1.
2. Standpipe systems.
3. Fire alarm systems in residential occupancies (use group R), except for detoxification facilities, when less than five (5) stories high.
4. Automatic fire alarm devices protecting individual dwelling units as required by Section 1216.3.2.

## ARTICLE 13

### PRECAUTIONS DURING BUILDING OPERATIONS

#### SECTION 1300.0 GENERAL

1300.1 Scope: The provisions of this article shall apply to all construction operations in connection with the erection, alteration, repair, removal or demolition of buildings and structures. The execution of the detail requirements shall be regulated by the approved rules and the safety codes for building construction listed in Appendix B.

1300.2 Other laws: Nothing herein contained shall be construed to nullify any rules, regulations or statutes of state agencies governing the protection of the public or workmen from health or other hazards involved in manufacturing, mining and other processes and operations which generate toxic gases, dust or other elements dangerous to the respiratory system, eyesight or health.

1300.2.1 Other regulations: In addition, the following regulations also shall apply when not covered by this code: Rules and Regulations for the Prevention of Accidents in Construction Operations (441 CMR 10.00); and Keeping, Storage, Use, Manufacture, Sale, Handling, Transportation or other Disposition of Explosives (527 CMR 13.00).

1300.3 Combustible and explosive hazards: The provisions of this code which apply to the storage, use or transportation of explosives, highly flammable and combustible substances, gases and chemicals shall be construed as supplemental to the requirements of the federal laws, the regulations of the Department of Transportation (DOT) and the rules and regulations of the jurisdiction.

#### SECTION 1301.0 PLANS, SPECIFICATIONS AND SPECIAL PERMITS

1301.1 Temporary construction: Before any construction operation is started, plans and specifications shall be filed with the building official showing the design and construction of all sidewalk sheds, truck runways, trestles, foot bridges, guard fences and other similar devices required in the operation; and the approval of the building official shall be secured before the commencement of any work.

1301.2 Special permits: All special licenses and permits for the storage of materials on sidewalks and highways, for the use of water or other public facilities and for the storage and handling of explosives shall be secured from the administrative authorities having jurisdiction.

1301.3 Temporary encroachments: Subject to the approval of the building official, sidewalk sheds, underpinning and other temporary protective guards and devices may project beyond the interior and street lot lines as may be required to insure the safety of the adjoining property

and the public. When necessary, the consent of the adjoining property owner shall be obtained.

#### SECTION 1302.0 TESTS

1302.1 Loading: It shall be unlawful to load any structure, temporary support, scaffolding, sidewalk bridge or sidewalk shed or any other device or construction equipment during the construction or demolition of any building or structure in excess of its safe working capacity as provided in Article 7 for allowable loads and working stresses.

1302.2 Unsafe equipment: Whenever any doubt arises as to the structural quality or strength of scaffolding plank or other construction equipment, such material shall be replaced; provided, however, the building official may accept a strength test to four (4) times the superimposed live load to which the material or structural member is to be subjected. The member shall sustain the test load without failure.

#### SECTION 1303.0 INSPECTION

1303.1 Unsafe conditions: When inspection of any construction operation reveals that any unsafe or illegal conditions exist, the building official shall notify the owner and direct him to take the necessary remedial measures to remove the hazard or violation.

1303.2 Failure to comply with orders: Unless the owner so notified proceeds to comply with the orders of the building official within twenty-four (24) hours, the building official shall have full power to correct the unsafe conditions as provided in Sections 124.0 and 125.0. All expenses incurred in the correction of such unsafe conditions shall become a lien on the property.

1303.3 Unsafe construction equipment: When the strength and adequacy of any scaffold or other device or construction equipment is in doubt, or when any complaint is made, the building official may inspect such equipment and shall prohibit its use until tested as required in Section 1302.2 or until all danger is removed.

#### SECTION 1304.0 MAINTENANCE

1304.1 General: All construction equipment and safeguards shall be constructed, installed and maintained in a substantial manner and shall be so operated as to insure protection to the workmen engaged thereon and to the general public. It shall be unlawful to remove or render inoperative any structural, fire protective or sanitary safeguard or device herein required except when necessary for the actual installation and prosecution of the work.

SECTION 1305.0 EXISTING BUILDINGS

1305.1 Protection: All existing and adjoining public and private property shall be protected from damage incidental to construction operations.

1305.2 Chimney, soil and vent stacks: Whenever a new building or structure is erected to greater or lesser heights than an adjoining building, the construction and extension of new or existing chimneys shall conform to the provisions of Section 1005.0 and to soil and vent stacks, and the location of window openings shall conform to the provisions of Article 17 and Sections 1305.2.1 through 1305.2.3.

1305.2.1 Extension above new building: When a new building is erected higher than an existing building, windows or other wall openings shall not be located nearer than six (6) feet to an existing soil or vent stack on the lower building unless the owner of the new building makes the necessary provision to extend such soil or vent stacks to a height of not less than three (3) feet above the topmost opening at his own expense and with the approval of the adjoining owner.

1305.2.2 Extension above existing building: When the existing adjoining building is of greater height than the new building, the owner of the structure of greater height may, with the consent of the new owner of the new structure, extend all new soil, waste or vent stacks which are located within twenty (20) feet of the common lot line to a level above the higher existing roof.

1305.2.3 Exemption: Approved fixed window assemblies of the required fire-resistance rated construction which comply with the provisions of Article 9, when permitted in lot line walls, shall not be deemed wall openings within the meaning of this section.

1305.3 Adjoining walls: The owner of the new or altered structure shall preserve all adjoining independent and party walls from damage as provided herein. He shall underpin where necessary and support the adjoining building or structure by proper foundations to comply with Section 1307.0.

1305.3.1 Maintenance: In case an existing party wall is intended to be used by the person who causes an excavation to be made, and such party wall is in good condition and sufficient for the use of both the existing and proposed building, such person shall preserve the party wall from injury and support it by proper foundations at his own expense, so that it shall remain as safe and useful as it was before the excavation was commenced. During the demolition, the party wall shall be maintained weather-proof and structurally safe by adequate bracing until such time as the permanent structural supports shall have been provided.

1305.3.2 Beam holes: When a structure involving a party wall is being



demolished, the owner of the demolished structure shall, at his own expense, bend over all wall anchors at the beam ends of the standing wall and shall brick-up all open beam holes and otherwise maintain the safety and usefulness of the wall.

1305.3.3 Party wall exitways: A party wall balcony or horizontal exit shall not be destroyed unless and until a substitute means of egress has been provided and approved by the building official.

1305.4 Adjoining roofs: When a new building or demolition of an existing building is being prosecuted at a greater height, the roof, roof outlets and roof structures of adjoining buildings shall be protected against damage with adequate safeguards by the person doing the work.

#### SECTION 1306.0 PROTECTION OF PUBLIC AND WORKMEN

1306.1 General: Whenever a building or structure is erected, altered, repaired, removed or demolished, the operation shall be conducted in a safe manner and suitable protection for the general public and workmen employed thereon shall be provided.

1306.2 Fences: An adequate fence or other barrier shall be erected when required by the building official during construction operations.

1306.3 Sidewalk bridge: Whenever the ground is excavated under the sidewalk, a sidewalk bridge shall be constructed at least four (4) feet wide, or a protected walkway of equal width shall be erected in the street, provided the required permit for such walkway is obtained from the administrative authority.

1306.4 Sidewalk shed

1306.4.1 Within ten feet of street lot line: When any building or part thereof which is located within ten (10) feet of the street lot line is to be erected or raised to exceed forty (40) feet in height, or whenever a building more than forty (40) feet in height within ten (10) feet of the street lot line is to be demolished, a sidewalk shed shall be erected and maintained for the full length of the building on all street fronts for the entire time that work is performed on the exterior of the building.

1306.4.2 Within 20 feet of street lot line: When the building being demolished or erected is located within twenty (20) feet of the street lot line and is more than forty (40) feet in height, exterior flare fans or catch platforms shall be erected at vertical intervals of not more than two (2) stories.

1306.4.3 Buildings higher than six stories: When the building being demolished or erected is more than six (6) stories or seventy-five (75) feet in height, unless set back from the street lot line a distance more than one-half ( $\frac{1}{2}$ ) its height, a sidewalk shed shall be provided.

1306.4.4 Walkway: An adequately lighted walkway at least four (4) feet wide and eight (8) feet high in the clear shall be maintained under all sidewalk sheds for pedestrians. Where ramps are required, they shall conform to the provisions of this article and Section 615.0.

1306.5 Thrust-out platforms: The building official may approve thrust-out platforms or other substitute protections in lieu of sidewalk sheds when deemed adequate to insure the public safety. Thrust-out platforms shall not be used for the storage of materials.

1306.6 Watchman: Whenever a building is being demolished, erected or altered, a watchman shall be employed to warn the general public when intermittent hazardous operations are conducted across the sidewalk or walkway.

### SECTION 1307.0 EXCAVATIONS

1307.1 Temporary support: Until permanent support has been provided, all excavations shall be safeguarded and protected by the person causing the excavations to be made, to avoid all danger to life or limb. Where necessary, such excavations shall be retained by temporary retaining walls, sheet-piling and bracing or other approved method to support the adjoining earth. (See 441 CMR 10.00).

1307.1.1 Examination of adjoining property: Before any excavation or demolition is undertaken, license to enter upon adjoining property for the purpose of physical examination shall be afforded by the owner and tenants of such adjoining property to the person undertaking such excavation or demolition, prior to the commencement and at reasonable periods during the progress of the work.

1307.1.2 Notice to the building official: If the person who causes an excavation to be made or an existing structure to be demolished has reason to believe that an adjoining structure is unsafe, he shall forthwith report in writing to the building official. The building official shall inspect such premises, and if the structure is found unsafe, he shall order it repaired as provided in Section 123.0.

1307.1.3 Responsibility of adjoining owner: The person making or causing an excavation to be made shall, before starting the work, give at least one (1) week's notice in writing to the owner of each neighboring building or structure, the safety of which may be affected. Having received consent to enter a building, structure or premises, he shall make the necessary provisions to protect it structurally and to insure it against damage by the elements which may ensue from such excavation. If license to enter is not afforded, then the adjoining owner shall have the entire responsibility of providing both temporary and permanent support of his premises at his own expense; and for that purpose, he shall be

afforded the license when necessary to enter the property where the excavation is to be made.

1307.1.4 Excavations for other than construction purposes: Excavations made for the purpose of removing soil, earth, sand, gravel, rock or other materials shall be performed in such a manner as will prevent injury to neighboring properties or to the street which adjoins the lot where such materials are excavated, and to safeguard the general public health and welfare.

#### 1307.2 Permanent Support

1307.2.1 Excavations: Whenever an excavation is made below the established grade, the person who causes such excavation to be made, if afforded the necessary license to enter the adjoining premises, shall preserve and protect from injury at all times and at his own expense such adjoining structure or premises which may be affected by the excavation. If the necessary license is not afforded, it shall then be the duty of the owner of the adjoining premises to make his building or structure safe by installing proper underpinning or foundations or otherwise; and such owner, if it be necessary for the prosecution of his work, shall be granted the necessary license to enter the premises where the excavation or demolition is contemplated (see Section 1307.1.3).

#### 1307.2.2 Deleted

### SECTION 1308.0 REGULATION OF LOTS

1308.1 Grading of lot: When a building or structure has been demolished or removed and a building operation has not been projected or approved, the vacant lot shall be filled with non-organic fill, graded and maintained in conformity with adjacent grades. The lot shall be maintained free from the accumulation of rubbish and all other unsafe or hazardous conditions which endanger the life or health of the public; and provisions shall be made to prevent the accumulation of water or damage to any foundations on the premises or the adjoining property.

1308.2 Utility connections: All service utility connections shall be discontinued and capped in accordance with Section 116.1.

### SECTION 1309.0 RETAINING WALLS AND PARTITION FENCES

1309.1 General: When the adjoining grade is not higher than the legal level, the person causing an excavation to be made shall erect, when necessary, a retaining wall at his own expense and on his own land. Such wall shall be built to a height sufficient to retain the adjoining earth, shall be properly coped as required in Section 870.0 and shall be provided with a guard rail or fence not less than forty-two (42) inches in height.

SECTION 1310.0 STORAGE OF MATERIALS

1310.1 General: All materials and equipment required in construction operations shall be stored and placed so as not to endanger the public, the workmen or adjoining property.

1310.2 Design capacity: Materials or equipment stored within the building, or on sidewalks, sheds or scaffolds shall be placed so as not to overload any part of the construction beyond its design capacity, nor interfere with the safe prosecution of the work.

1310.3 Special loading: Unless the construction is designed for special loading, materials stored on sidewalk sheds and scaffolds shall not exceed one (1) day's supply. All materials shall be piled in an orderly manner and height, to permit removal of individual pieces without endangering the stability of the pile.

1310.4 Pedestrian walkways: Materials or equipment shall not be stored on the street without a permit issued by the administrative official having jurisdiction. When so stored they shall not unduly interfere with vehicular traffic, or the orderly travel of pedestrians on the highways and streets. The piles shall be arranged to maintain a safe walkway not less than four (4) feet wide, unobstructed for its full length, and adequately lighted at night and at all necessary times for the use of the public.

1310.5 Obstructions: Material and equipment shall not be placed or stored so as to obstruct access to fire hydrants, standpipes, fire or police alarm boxes, utility boxes, catch basins, or manholes, nor shall they be located within twenty (20) feet of a street intersection, or so placed as to obstruct normal observations of traffic signals or to hinder the use of street car loading platforms.

SECTION 1311.0 REMOVAL OF WASTE MATERIAL

1311.1 Removal of waste material: Material shall not be dropped by gravity or thrown outside the exterior walls of a building during demolition or erection. Enclosed chutes shall be provided for this purpose and any material which in its removal will cause an excessive amount of dust shall be wetted down to prevent the creation of a nuisance.

SECTION 1312.0 PROTECTION OF ADJOINING PROPERTY

1312.1 General: Adjoining property shall be completely protected from any damage incidental to the building operation when the owner of the property permits free access to the building at all reasonable times to provide the necessary safeguards in accordance with Section 1307.0.

SECTION 1313.0 PROTECTION OF FLOOR AND WALL OPENINGS

1313.1 Noncombustible floor construction: The arches, slabs or structural floor fillings of buildings or fireproof construction (Type 1) and noncombustible construction (Type 2) shall be installed as the building progresses.

1313.2 Combustible floor construction: In wood joist floor construction (Types 3 and 4) when double flooring is used, the underfloor shall be laid on each story as the building progresses; and when double floors are not used, the floors shall be planked over two (2) stories below the level where work is being performed.

1313.3 Steel structural frames: In steel construction, the entire tier of iron or steel beams upon which the structural work is in progress shall be planked over within two (2) floors but not more than twenty-five (25) feet, with the exception of necessary hoistways and permanent openings; and the steel work shall not advance more than four (4) floors or forty-eight (48) feet ahead of unfinished bolting or welding above the foundation or highest permanently secured floor, nor more than six (6) floors ahead of the permanent floor construction.

1313.4 Guardrails: All floor and wall openings shall be protected with substantial guard rails and toe boards in accordance with accepted engineering practice.

#### SECTION 1314.0 SCAFFOLDS

1314.1 Load capacity: Scaffolds and their components shall be capable of supporting without failure at least four (4) times the maximum intended load. All platforms and supporting elements of scaffolds shall be designed and constructed to support uniform minimum live loads in pounds per square foot (psf) of the platform area in accordance with the classifications described in the following Table 1314.

1314.2 Erection: Built-up, swinging, and suspended scaffolds shall be erected by competent workmen only.

1314.3 Fire-retardant construction

1314.3.1 All buildings: All scaffolding exceeding sixty (60) feet or seven (7) stories in height used in construction operations involving the erection, alteration or maintenance of buildings, shall be constructed of noncombustible or fire-retardant materials except for the platform planking which may be of wood, complying with the provisions of Section 903.0.

Table 1314

## SCAFFOLD LOAD CAPACITY

| Classification | Service type                               | Load<br>(pounds per<br>square foot) |
|----------------|--|-------------------------------------|
| Light duty     | Carpenters                                 | 25                                  |
|                | Stone setters<br>(No stone on scaffold)    | 25                                  |
|                | Miscellaneous<br>(No material on scaffold) | 25                                  |
| Medium duty    | Bricklayers                                | 50                                  |
|                | Stucco                                     | 50                                  |
|                | Lathers & plasterers                       | 50                                  |
| Heavy duty     | Stone masons                               | 75                                  |

1314.3.2 Institutional buildings: All scaffolding used in construction operations involving the repair or partial demolition of institutional buildings (use groups I-1 and I-2), during occupancy of the building shall be constructed of noncombustible or fire-retardant materials complying with the provisions of Section 903.0.

## SECTION 1315.0 HOISTS

1315.1 Equipment for handling and hoisting materials: Equipment for handling and hoisting materials shall be in accordance with Article 17 of the Rules and Regulations for the Prevention of Accidents in Construction Operations (441 CMR 10.00).

1315.2 Deleted

1315.3 Deleted

1315.4 Deleted

## SECTION 1316.0 STAIRWAYS AND LADDERS

1316.1 Temporary stairways: When a building has been constructed to a greater height than fifty (50) feet or four (4) stories, or when an existing building which exceeds fifty (50) feet in height is altered, at least one (1) temporary lighted stairways are shall be provided unless one (1) or more of the permanent stairways is erected as the construction progresses.

1316.2 Ladders: Temporary ladders, when permitted for access to floors before stairways are installed, or which are designed for other working purposes, shall extend at least forty-two (42) inches above the floor level which they serve.

SECTION 1317.0 LIGHTING

1317.1 General: All stairways and parts of buildings under demolition, erection or repair shall be adequately lighted while persons are engaged at work, to comply with the provisions of Section 624.0 and Article 15.

SECTION 1318.0 FIRE HAZARDS

1318.1 General: The provisions of this code and of the fire prevention regulations shall be strictly observed to safeguard against all fire hazards attendant upon construction operations.

1318.2 Temporary heating: Whenever salamanders or other heating devices are used for temporary heating, all regulations as to maximum temperature, distance from combustible materials, spark arrestors, removal of noxious gases, and other requirements prescribed by the building official shall be fully observed. When the source of temporary heat consists of salamanders or other open-flame devices, temporary canvas enclosures shall comply with Section 904.0.

1318.3 Steam boilers: All temporary or permanent high pressure steam boilers shall be operated, or be in charge of engineers or firemen licensed in accordance with the provisions of Inspection of Boilers, Air Tanks, etc.; Licenses of Hoisting Machinery, Chapter 146 of the Massachusetts General Laws Annotated, as amended, and as listed under Boiler Regulations in Appendix B. When such boilers are located within a building or within ten (10) feet thereof, all such boilers shall be enclosed with approved noncombustible construction.

1318.4 Storage of flammables: Storage of gasoline for hoists, oils, paints and other highly flammable materials shall be permitted only as specified in Article 4 and when stored in approved safety containers. The storage of larger quantities may be approved by the administrative official when stored in separate compartments or enclosures of approved noncombustible construction.

1318.5 Flame cutting and welding: The use of oxyacetylene torches for cutting or welding shall be permitted only in accordance with the applicable standards for air and gas welding in building construction.

1318.6 Concrete forms: Combustible materials shall not be stored on any floor of a building under construction until all combustible concrete forms are removed from the tier immediately above.

1318.7 Fire-extinguishing equipment: Required fire extinguishers, water buckets, auxiliary fire-fighting tools or other portable extinguishing equipment shall be installed and maintained on all floors of a construction operation in accessible locations as required in Article 12 and the fire prevention regulation.

1318.8 Standpipes and fire lines: Where standpipes are provided as a permanent part of the building, they shall be installed and made ready for instant use of the fire department as the structure progresses in accordance with the provisions of Section 1212.0. Free access from the street to such standpipes shall be maintained at all times; and materials shall not be stored within five (5) feet of any fire hydrant or in the roadway between such hydrant and the center line of the street.

1318.9 Housekeeping: Rubbish and trash shall not be allowed to accumulate on the site and shall be removed as fast as conditions warrant; combustible rubbish shall be removed daily, and shall not be disposed of by burning on the premises or in the immediate vicinity, and the entire premises and area adjoining and around the operation shall be kept in a safe and sanitary condition and free of accumulations of trash, rubbish, nuts, bolts, small tools and other equipment.

#### SECTION 1319.0 HEALTH HAZARDS

1319.1 General: Every construction or maintenance operation which results in the diffusion of dust, stone and other small particles, toxic gases or other harmful substances in quantities hazardous to health shall be safeguarded by means of local ventilation or other protective devices to insure the safety of the public as required by the regulations of the administrative official.

1319.2 Removal of dust: Dust, sand blasts or other harmful agents, when employed or occurring in construction operations, shall be disposed of at or near the point of origin to prevent their diffusion over adjoining premises or streets.

1319.3 Protective equipment: Facilities shall be provided for housing the necessary vision, respiratory and protective equipment required in welding operations in approved closed containers and in accordance with the regulations of the administrative official (see Section 1319.1).

#### SECTION 1320.0 WELDING SAFETY PRECAUTIONS

1320.1 Welding enclosures: All welding and flame-cutting operations shall be performed in protected areas with full consideration to safety and fire hazards. Such closed spaces shall be properly ventilated while welding or cutting is being done. Suitable protection against the rays of the electric arc shall be maintained by the contractor where arc-welding operations might be viewed within harmful range by persons other than the welding operators and inspectors.

1320.2 Flammable materials: Proper precautions shall be taken to avoid all risk of fire or explosion, and flammable or explosive materials shall not be stored in the vicinity of welding or cutting operations.



SECTION 1321.0 DELETED

SECTION 1322.0 DISPUTES

1322.1 General: The building official, when requested by any person, aggrieved or otherwise, shall serve a written notice on any owner, tenant and their agents who fail to conform to the requirements of this article directing him to take the necessary remedial action. If the person whose duty it is to protect his own or adjoining property under those provisions fails to proceed to fully comply with such notice within three (3) days of the receipt thereof, or within a reasonable time thereafter as determined by the building official, he may cause the necessary work to be done when the health, safety and general welfare of the public are involved. The cost of such work shall become a lien against the property of the offending owner and the legal authority of the jurisdiction shall institute appropriate action for its recovery.

## ARTICLE 14

### SIGNS

#### SECTION 1400.0 GENERAL

1400.1 Scope: The provisions of this article shall govern the construction, alteration, repair and maintenance of all signs, together with their appurtenant and auxiliary devices in respect to structural and fire safety.

1400.2 Zoning law: Where more restrictive in respect to location, use, size or height of signs, the limitations of the zoning laws affecting required light and ventilation requirements and use of land shall take precedence over the regulations of this code.

1400.3 Approved rules: In the absence of approved rules governing details of construction, the provisions of the applicable standards listed in Appendix B shall be deemed to confirm to the requirements of this code unless otherwise specified in this article.

1400.3.1 Commonwealth of Massachusetts regulations: Outdoor advertising subject to the Rules and Regulations of the Outdoor Advertising Board, Massachusetts General Laws Annotated, as amended, and as listed in Appendix B and 311 CMR 1.00-3.00, requires the approval of the said Board prior to permit issuance.

#### SECTION 1401.0 PLANS, SPECIFICATIONS AND PERMITS

1401.1 Owner's consent: Before any permit is granted for the erection of a sign, plans and specifications shall be filed with the building official showing the dimensions, materials and required details of construction, including loads, stresses and anchorage. The applications shall be accompanied by the written consent of the owner or lessee of the premises upon which the sign is to be erected.

1401.2 New signs: A new sign shall not hereafter be erected, constructed, altered or maintained except as herein provided and until after a permit has been issued by the building official and the bond, if required, shall have been filed in accordance with Section 1406.0.

1401.3 Deleted

1401.4 Alterations: A sign shall not be enlarged or relocated except in conformity to the provisions of this article for new signs, nor until a proper permit has been secured. The changing of movable parts of an approved sign that is designed for such changes, or the repainting or reposting of display matter, shall not be deemed an alteration; provided the conditions of the original approval and the requirements of this article are not violated.

1401.5 Plans and specifications: Any sign twelve (12) feet or over in height above average adjoining grade, or any free-standing sign with an area of over sixty (60) square feet, or any roof sign, projecting sign, or marquee sign, shall have structural drawings and specifications, including foundations, submitted by a registered professional engineer.

#### SECTION 1402.0 EXEMPTIONS

1402.1 General: A permit shall not be required for the signs covered by the provisions of this section. Such exceptions, however, shall not be construed to relieve the owner of the sign from responsibility for its erection and maintenance in a safe manner.

1402.2 Wall signs: A sign painted on the surface of a fence or approved building wall; or any non-illuminated wall sign on a building or structure which is not more than ten (10) square feet in area.

1402.3 Ground signs: The ground signs listed in the following Sections 1402.3.1 through 1402.3.3 shall not require a permit.

1402.3.1 Sale or rent: Signs erected to announce the sale or rent of the property so designated, provided such signs are not more than twenty-five (25) square feet in area.

1402.3.2 Transit directions: The erection or maintenance of a sign designating the location of a transit line, a railroad station or other public carrier when not more than three (3) square feet in area.

1402.3.3 Street signs: A sign erected by a jurisdiction for street direction.

1402.4 Projecting signs: A projecting sign not exceeding two and one-half (2½) square feet of display surface.

1402.4.1 Government building signs: Signs erected on a municipal, state or federal building which announce the name, nature of the occupancy and information as to use of, or admission to, the premises.

#### SECTION 1403.0 UNSAFE AND UNLAWFUL SIGNS

1403.1 Notice of unsafe signs: When any sign becomes insecure, in danger of falling, or otherwise unsafe, or if any sign shall be unlawfully installed, erected or maintained in violation of any of the provisions of this code, the owner thereof or the person or firm maintaining same, shall upon written notice of the building official, forthwith in the case of immediate danger and in any case within not more than ten (10) days, make such sign conform to the provisions of this article or shall remove it. If within ten (10) days the order is not complied with, the building official may remove such sign at the expense of the owner or lessee thereof as provided in Section 124.0.

1403.2 Unlawful signs: The location or positioning of signs listed in the following Sections 1403.2.1 through 1403.2.4 shall be considered unlawful.

1403.2.1 Egress obstructions: A sign shall not be erected, constructed, or maintained so as to obstruct any fire escape, required exitway, window or door opening used as an element of a means of egress or to prevent free passage from one part of a roof to another part thereof or access thereto as required by the provisions of Article 6 or for the fire-fighting forces having jurisdiction.

1403.2.2 Obstruction to ventilation: A sign shall not be attached in any form, shape or manner which will interfere with any opening required for ventilation by Article 5, except than such signs may be erected in front of and may cover transom windows when not in violation of the provisions of this code.

1403.2.3 Projecting signs: A projecting sign erected at other than right angles to the wall of the building or structure outside of the building line which extends above the roof cornice or parapet wall, or above the roof level when there is not a cornice or parapet wall and which obstructs access to the roof is hereby deemed unlawful. Such signs shall be reconstructed or removed as herein required.

1403.2.4 Alley signs: Signs shall not be permitted to project beyond alley lot lines.

#### SECTION 1404.0 EXISTING SIGNS

1404.1 Removing or reconstructing signs: A sign heretofore approved and erected shall not be repaired, altered or moved, nor shall any sign, or any substantial part thereof, which is blown down, destroyed or removed be re-erected, reconstructed, rebuilt or relocated unless it is made to comply with all applicable requirements of this article.

1404.2 Repair of unsafe signs: This section shall not be construed to prevent the repair or restoration to a safe condition as directed by the building official of any part of an existing sign when damaged by storm or other accidental emergency.

1404.3 Relocating signs: Any sign that is moved to another location either on the same or to other premises shall be considered a new sign and a permit shall be secured for any work performed in connection therewith when required by this article.

1404.4 Projecting signs: See Section 1403.2.3.

#### SECTION 1405.0 MAINTENANCE AND INSPECTION

1405.1 Removal: The building official may order the removal of any sign that is not maintained in accordance with the provisions of this article.

1405.2 Maintenance: All signs for which a permit is required, together with all their supports, braces, guys, and anchors shall be kept in repair in accordance with the provisions of this article and Article I; and when not galvanized or constructed of approved corrosion-resistant, non-combustible materials shall be painted when necessary to prevent corrosion.

1405.3 Housekeeping: It shall be the duty and responsibility of the owner or lessee of every sign to maintain the immediate premises occupied by the sign in a clean, sanitary and healthful condition.

1405.4 Inspection: Every sign shall be subject to the inspection and approval of the building official.

#### SECTION 1406.0 BONDS AND LIABILITY INSURANCE

1406.1 Filing: A person shall not erect, install, remove, rehang or maintain over public property any sign for which a permit is required under the provisions of this code until approved bond or liability insurance shall have been filed in accordance with the requirements of the municipality, if any.

1406.2 Conditions: Such bond or insurance policy may provide that the municipality shall be protected and held harmless from any and all claims or demands for damages by reason of any negligence of the sign hanger, contractor or his agents, or by any reason of defects in the construction or damages resulting from the collapse, failure or combustion of the sign or parts thereof.

1406.3 Notice of cancellation: Any such obligation shall remain in force and effect during the lifetime of every such sign and shall not be cancelled by the principal or surety until after thirty (30) days' notice to the building official.

#### SECTION 1407.0 GENERAL REQUIREMENTS FOR ALL SIGNS

1407.1 Construction: All signs shall be designed and constructed in conformity to the provisions for materials, loads and stresses of Articles 7 and 8 and the requirements of this article.

1407.2 Design loads: Loads listed in the following Sections 1407.2.1 through 1407.2.2 shall be as the minimum for the design of signs.

1407.2.1 Wind: All signs shall be designed and constructed to withstand wind pressure as provided in Section 715.0.

1407.2.2 Earthquake: Signs adequately designed to withstand wind pressures shall generally be considered capable of withstanding earthquake shocks, except as provided in Section 716.0 and for combined loading in Section 717.0.

1407.3 Illumination: A sign shall not be illuminated by other than electrical means and electrical devices, and wiring shall be installed in accordance with the requirements of the Massachusetts State Electrical Code (527 CMR 12.00) listed in Appendix B. Any open spark or flame shall not be used for display purposes unless specifically approved by the building official.

1407.4 Use of combustibles: The following Sections 1407.4.1 through 1407.4.2 shall apply to combustible material for signs.

1407.4.1 Ornamental features: In all signs required to be constructed of noncombustible materials under the provisions of this code, wood or other materials of combustible characteristics similar to wood may be used for moldings, cappings, trim, nailing blocks, letters, latticing, and other purely ornamental features.

1407.4.2 Sign facings: Sign facings may be made of approved combustible plastic providing the total area of such facing is not more than one hundred twenty (120) square feet, or provided that sections of facings be separated from each other by a distance not less than six (6) feet, and the wiring for electric lighting is entirely enclosed in the sign cabinet with a clearance of not less than two (2) inches from the facing material. Such facings, in the plane of the wall, shall not be permitted above seventy-five (75) feet.

1407.5 Servicing devices: Ladders, platforms, hooks, rings and all other devices for the use of servicing personnel shall have safety devices and design loading in accordance with the safety requirements in Appendix B.

1407.6 Animated devices: Signs which contain moving sections or ornaments shall have fail-safe provisions to prevent the section or ornament from releasing and falling or shifting its center of gravity more than fifteen (15) inches. The fail-safe device shall be in addition to the mechanism and its housing which operate the movable section or ornament. The fail-safe device shall be capable of supporting the full dead weight of the section or ornament when the moving mechanism releases.

#### SECTION 1408.0 GROUND SIGNS

1408.1 Bottom clearance: The bottom capping of all ground signs shall be at least thirty (30) inches above the ground but the intervening space may be filled with open lattice work or platform decorative trim.

1408.1.1 Deleted

1408.1.2 Deleted

1408.2 Maximum size: In all locations, when constructed entirely of noncombustible material, ground signs may be erected to a height of one hundred (100) feet above the ground; and to greater heights when approved by the building official and located so as not to create hazard or danger to the public.

#### SECTION 1409.0 ROOF SIGNS

1409.1 Materials: All roof signs shall be constructed entirely of metal or other approved noncombustible materials except as provided in Section 1407.4. Provisions shall be made for electric ground of all metallic parts; and where combustible materials are permitted in letters or other ornamental features, all wiring and tubing shall be kept free and insulated therefrom.

1409.2 Bottom clearance: There shall be a clear space of not less than six (6) feet between the lowest part of the sign and the roof level, except for necessary structural supports.

1409.3 Closed signs: A closed roof sign shall not be erected to a height greater than fifty (50) feet above the roof of Types 1 and 2 constructed buildings nor more than thirty-five (35) feet above the roof of Types 3 and 4 constructed buildings.

1409.4 Open signs: An open roof sign shall not exceed a height of one hundred (100) feet above the roof of buildings of Types 1 and 2 construction; and not more than sixty (60) feet above the roof of buildings of Types 3 and 4 construction.

1409.5 Combustible supports: A roof sign which exceeds forty (40) feet in height shall not be supported on or braced to wooden beams or other combustible construction of a building or structure unless otherwise approved by the building official.

#### SECTION 1410.0 WALL SIGNS

1410.1 Materials: Wall signs which have an area exceeding forty (40) square feet shall be constructed of metal or other approved noncombustible materials, except for nailing rails and as provided in Section 1407.4.

1410.2 Extension: Wall signs shall not be erected to extend above the top of the wall, nor extend beyond the ends of the wall to which they are attached, unless meeting all the requirements for roof signs, projecting signs or ground signs as the case may be.

SECTION 1411.0 PROJECTING SIGNS

1411.1 Materials: Projecting signs shall be constructed entirely of metal or other approved noncombustible materials except as provided in Section 1407.4.

1411.2 Maximum projection: A projecting sign shall not extend beyond a vertical plane two (2) feet inside the curb line.

1411.3 Clearances: A clear space of not less than ten (10) feet shall be provided below all parts of such signs.

1411.4 Additional loads: Projecting sign structures which could be used to support an individual on a ladder or other servicing device whether or not specifically designed for the servicing device shall be capable of supporting the anticipated additional load but in no case less than one hundred (100) pounds concentrated horizontal load and three hundred (300) pounds vertical concentrated load applied at the point of assumed loading or point of most eccentric loading. The building component to which the projecting sign is attached shall also be designated to support the additional loads.

SECTION 1412.0 MARQUEE SIGNS

1412.1 Materials: Marquee signs shall be constructed entirely of metal or other approved noncombustible materials except as provided in Section 1407.4.

1412.2 Marquee: Marquee signs shall be attached to approved marquees constructed in accordance with Section 310.10.

1412.3 Dimensions: Marquee signs may extend the full length, but they shall not project beyond the perimeter of the marquee.

SECTION 1413.0 MISCELLANEOUS AND TEMPORARY SIGNS

1413.1 Banner and cloth signs: Temporary signs and banners attached to or suspended from a building, constructed of cloth or other combustible material shall be strongly constructed and shall be securely attached to their supports. They shall be removed as soon as torn or damaged, and not later than sixty (60) days after erection; except that permits for temporary signs suspended from or attached to a canopy or marquee shall be limited to a period of ten (10) days.

1413.2 Maximum size: Temporary signs of combustible construction shall be not more than ten (10) feet in one (1) dimension nor more than five hundred (500) square feet in area.

1413.3 Supports: When more than one hundred (100) square feet in area, temporary signs and banners shall be constructed and fastened to



supports capable of withstanding the design loads listed in Section 715.0.

1413.4 Special permits: Temporary signs used for holiday, public demonstrations or promotion of civic welfare or charitable purposes which extend across streets or other public spaces, shall be subject to special approval of the authority having jurisdiction.

#### SECTION 1414.0 ILLUMINATED SIGNS

1414.1 Certificates: All electrically-illuminated signs shall conform to the requirements of the Massachusetts State Electrical Code (527 CMR 12.00). Permits shall be issued for the erection of illuminated signs within the limitations set forth in this article for the location, size and type of sign or outdoor display.

1414.2 Additional approval: Approval shall be obtained for the erection or maintenance of illuminated signs in accordance with the Massachusetts Electrical Code (527 CMR 12.00).

1414.3 Relettering signs: The requirements of this section shall not apply to the relettering of illuminated signs, except where such relettering requires a change of wiring or piping of the sign.

#### SECTION 1415.0 PORTABLE SIGNS

1415.1 Conformance: Portable signs shall conform to all requirements for ground, roof, projecting, flat and temporary signs when they are used in a similar capacity. The stipulations in this section shall not be construed as to require portable signs to have connections to surfaces, tie-down or foundations when provisions are made by temporary means or configuration of the structure to provide stability for the expected duration of the installation.

1415.2 Electrical: Portable signs which require electrical service shall conform to the Massachusetts State Electrical Code (527 CMR 12.00).

ARTICLE 15

ELECTRICAL WIRING AND EQUIPMENT

Chapter 143, Section 3L of the Massachusetts General Laws Annotated, as amended, provides that all installation, repair and maintenance of electrical wiring and electrical fixtures used for light, heat and power purposes in buildings and structures shall be in conformance with the Massachusetts Electrical Code (527 CMR 12.00) promulgated by the Board of Fire Prevention Regulations of the Commonwealth of Massachusetts, Department of Public Safety.

ARTICLE 16

ELEVATOR, DUMBWAITER AND CONVEYOR  
EQUIPMENT, INSTALLATION AND MAINTENANCE

Chapter 143, Section 69 of the Massachusetts General Laws Annotated, as amended, provides that elevators, dumbwaiters, moving stairways (escalators), and moving walks shall be installed, relocated, or materially changed in conformance with Elevator and Escalator Regulations (524 CMR 3.00), and Elevator, Dumbwaiter, Escalator, and Moving Walk Regulations (524 CMR 15.00 through 33.00) promulgated by the Board of Elevator Regulations of the Commonwealth of Massachusetts, Department of Public Safety.

ARTICLE 17

PLUMBING AND GASFITTING

Chapter 142, Section 13 of the Massachusetts General Laws Annotated, as amended, provides that all construction, alteration, repair and inspection of plumbing and gasfitting shall be in conformance with the Massachusetts State Plumbing Code (248 CMR 2.00) and the Massachusetts Fuel Gas Code (248 CMR 3.00 through 8.00) promulgated by the Commonwealth of Massachusetts Board of State Examiners of Plumbers and Gas Fitters.

ARTICLE 18

MANUFACTURED BUILDINGS, BUILDING  
COMPONENTS AND MOBILE HOMES

SECTION 1800.0 GENERAL

1800.1 Installation in the State: The provisions of this article shall govern the materials, design, manufacture, handling, storage, transportation, assembly, construction and/or installation of manufactured buildings and building components intended for installation in the Commonwealth of Massachusetts. Manufactured buildings or building components shall not be installed in any jurisdiction of this State unless such manufactured buildings or building components have been approved and certified, in accordance with the applicable codes as provided in this article, applicable provisions of the code, and the Rules and Regulations for Manufactured Buildings, Building Components and Mobile Homes of the State Building Code Commission, listed in Appendix Q, and hereinafter referred to in this article as the "rules and regulations."

Exception: All manufactured buildings and building components manufactured prior to January 1, 1975, with the approval of the building official and which met all the requirements of state laws, rules and regulations, or local by-laws or ordinances in force at that time shall be deemed approved in accordance with the provisions of Section 114.4 of this code; provided that such manufactured buildings or building components are used for the purpose and within the limitations for which they were approved and provided such uses are not detrimental to the health and safety of the occupants and the public.

1800.2 Manufactured in the State: The provisions of this article shall also govern manufactured buildings and building components manufactured in the State for shipment to any other State or government jurisdiction where such manufactured buildings and building components and the label thereon are accepted.

1800.3 Mobile homes: The article shall also govern the installation within the State of all mobile homes. The evaluation and approval of all mobile homes for installation in the State shall be in accordance with the Mobile Home Construction and Safety Standards of the U.S. Department of Housing and Urban Development (hereinafter referred to as "HUD") as listed in Appendix B.

Exception: All mobile homes manufactured between January 1, 1975 and July 17, 1976 and sold, delivered to or installed on building sites in any jurisdiction of this State shall comply with the provisions of ANSI A119.1 (1974 edition) as amended by the State Building Code Commission and with this article and the rules and regulations pursuant thereto.

SECTION 1801.0 APPROVAL

1801.1 General: The Commonwealth of Massachusetts, Department of Public Safety, Division of Inspection (hereinafter referred to as the "Division of Inspection" in this article) shall evaluate manufactured buildings and building components and recommend approval to the State Building Code Commission of those which it determines to be in compliance with applicable sections of this article, other applicable sections of this code, and the rules and regulations.

However, all approvals of plumbing, electrical or gas systems shall be made by the appropriate state agencies having jurisdiction, as specified in the rules and regulations.

1801.2 Approved tests: The Division of Inspection may utilize the results of approved tests to determine whether a manufactured building or building component meets the requirements of this article and the rules and regulations, if that determination cannot be made from evaluation of plans, specifications and documentation alone.

1801.3 Approval of compliance assurance programs: The Division of Inspection shall evaluate manufacturers' compliance assurance programs and make recommendations for approval to the Commission of those which it determines to be in compliance with this article and the rules and regulations.

1801.4 Authorization to vary: A manufactured building, building component or a compliance assurance program which has approval shall not be varied in any way without prior authorization by the Division of Inspection in accordance with the rules and regulations.

SECTION 1802.0 CERTIFICATION

1802.1 Labeling: Any manufactured building or building component which has approval, in accordance with Section 1801.0, shall have an approved device or seal affixed as certification of such approval.

SECTION 1803.0 RECIPROCIY

1803.1 General: If the Commission finds that the standards for manufacture and inspection of manufactured buildings or building components prescribed by the statutes or rules and regulations of another state or other governmental agency meet the objectives of this article and the rules and regulations, and such standards are enforced satisfactorily by such other state or governmental agency or by its agents, the Commission shall grant approval and the Division of Inspection shall accept all manufactured buildings or building components which have been approved by such other state or governmental agency and shall insure that the product is properly labeled.

1803.1.1 Condition of reciprocity: The standards of another state shall not be deemed to be satisfactorily enforced unless such other state provides for notification to the Division of Inspection of suspensions or revocations of approvals issued by that other state, in a manner satisfactory to the Commission.

1803.2 Suspension of reciprocal approval: The Division of Inspection shall suspend or cause to be suspended reciprocal approval for the following reasons:

1. if it determines that the standards for the manufacture and inspection of such manufactured buildings or building components of another state or other governmental agency do not meet the objectives of this article and the rules and regulations or that the standards are not being enforced to the satisfaction of the Division of Inspection; and
2. if another state or governmental agency, or its agent, suspends or revokes its approval, the approval granted under this section shall be suspended or revoked accordingly.

#### SECTION 1804.0 ASSURANCE INSPECTION

1804.1 General: Any person or firm manufacturing buildings or building components desiring certification shall agree in writing that the Division of Inspection has the right to conduct unannounced inspections at any reasonable time.

1804.2 Responsibilities of Division of Inspection: The Division of Inspection shall carry out the following responsibilities:

1. Periodically make, or cause to be made, inspections of the entire process of manufacture of buildings or building components in order to verify the reliability of the compliance assurance program and of the approved inspection agency.
2. In addition to other on-site inspection provided for in this section, the Division of Inspection shall inspect, or cause to be inspected, certified manufactured buildings or building components which it determines to have been sufficiently damaged after certification to warrant such action with regard to such buildings or building components as is authorized hereof, or as is otherwise necessary to eliminate dangerous conditions.

Note: An inspection entailing disassembly, damage to or destruction of certified manufactured buildings or building components shall not be conducted except to implement the provisions of this article.

SECTION 1805.0 RESPONSIBILITY OF THE  
LOCAL ENFORCEMENT AGENCIES

1805.1 Issuance of building permits: Upon application and in conformity with the provisions of this code, the building official shall issue building permits for installation of certified manufactured buildings or building components or mobile homes.

1805.2 Inspection: The local enforcement agency shall make the following inspections:

1. The site preparation work, including foundations, installation of any certified manufactured buildings or building components or approved homes; and for all utility service connections, including plumbing, electrical, gas, water and sewer; for compliance with the applicable codes.
2. Inspect all certified manufactured buildings or building components or approved mobile homes upon, or promptly after, installation at the building sites to determine whether all applicable instructions or conditions have been followed. This may include tests for tightness of plumbing and mechanical systems, for malfunctions in the electrical system, and a visual inspection for obvious violations of the rules and regulations. Destructive disassembly of certified buildings or building components or approved mobile homes shall not be performed in order to conduct such inspections. Nondestructive disassembly may be performed only in accordance with the rules and regulations.

1805.3 Issuance of certificates of occupancy: The building official shall issue a certificate of occupancy for all certified manufactured buildings or approved mobile homes that have been installed and inspected and that meet the requirements of this code.

SECTION 1806.0 SUSPENSION AND REVOCATION  
OF CERTIFICATION

1806.1 General: The Commission shall suspend or revoke the approval of any manufactured building or building component which does not comply with the provisions of this code or with the rules and regulations.

1806.2 Labels of certification: The Division of Inspection shall remove or cause to be removed the label of certification from any such manufactured building or building component not in compliance until such time as it is brought into compliance with this article and the rules and regulations.

1806.3 Notice of suspension or revocation: Notice shall be submitted in writing to the affected parties stating the reason for the suspension or revocation.



780 CMR: STATE BUILDING CODE COMMISSION

1806.4 Appeals Procedure: All appeals from suspension or revocation shall be heard by the State Building Code Appeals Board as specified in the pertinent provisions of Section 126.0 of this code.

## ARTICLE 19

## LIGHT-TRANSMITTING PLASTIC CONSTRUCTION

## SECTION 1900.0 GENERAL

1900.1 Scope: The provisions of this article shall govern the quality and methods of application of plastics for use as light-transmitting materials in buildings and structures. When used as interior finish, plastic materials shall meet the requirements of Section 920.0.

1900.2 Approved materials: The use of plastics which meet the strength, durability, sanitary and fireresistive requirements of this code, ASTM D635 Standard Method of Test for Flammability of Self-Supporting Plastic, ASTM D374 Method of Test for Thickness of Solid Electrical Insulation, ASTM D1929 Method of Test for the Ignition Properties of Plastics, and ASTM D2843 Method of Test for Measuring the Density of Smoke from the Burning or Decomposition of Plastics as listed in Appendix C, and ASTM E84 Method of Test for Surface Burning Characteristics of Building Materials as listed in Appendix G, shall be permitted subject to the limitations of this article.

## 1900.2.1 Definitions

Approved plastic: An approved plastic shall be any thermoplastic, thermosetting, or reinforced thermosetting plastic material which has a self-ignition temperature of six hundred fifty (650) degrees F. or greater when tested in accordance with ASTM D1929 Method of Test for Ignition Properties of Plastics listed in Appendix C, a smoke density rating not greater than four hundred fifty (450) when tested in the way intended for use by ASTM E84 listed in Appendix G or a smoke density rating not greater than seventy-five (75) when tested in the thickness intended for use according to ASTM D2843 Standard Method of Test for Measuring the Density of Smoke from the Burning or Decomposition of Plastics listed in Appendix C, and which meet one (1) of the following combustibility classifications:

Class C-1: Plastic materials which have a burning extent of one (1) inch or less when tested in nominal point zero sixty (.060) inch thickness, or in the thickness intended for use, by ASTM D635 listed in Appendix C.

Class C-2: Plastic materials which have a burning rate of two and one-half (2½) inches per minute or less when tested in nominal point zero sixty (.060) inch thickness, or in the thickness intended for use, by ASTM D635.

Light-diffusing system: A suspended construction consisting in whole or in part of lenses, panels, grids, or baffles suspended below independently mounted electrical lighting sources.

Plastic glazing: Plastic materials which are glazed or set in frame or sash and not held by mechanical fasteners which pass through the glazing material.

Plastic roof panels: Plastic materials which are fastened to structural members or to structural panels or sheathing and which are used as light-transmitting media in roofs.

Plastic wall panels: Plastic materials which are fastened to structural members or to structural panels or sheathing and which are used as light-transmitting media in exterior walls.

Glass fiber reinforced plastic: Plastic reinforced with glass fiber having not less than twenty (20) per cent of glass fibers by weight.

Thermosetting materials: A plastic material which is capable of being changed into a substantially non-reformable product when cured.

Thermoplastic material: A plastic material which is capable of being repeatedly softened by increase of temperature and hardened by decrease of temperature.

900.2.2 Application for approval: Applicants for approval of a plastic material shall furnish, in accordance with Section 804.0, all technical data in accordance with the applicable reference standards of this code. The data may include the chemical composition; pertinent physical, mechanical and thermal properties such as fireresistance, flammability, and flame-spread; weather-resistance, electrical properties; products of combustion and coefficients of expansion.

900.3 Identification: All plastic materials approved for use under this code shall be identified by the trade formula number or name or other acceptable identification. Each unit or package shall bear the approval number or other identification mark of the approving authority.

## SECTION 1901.0 DESIGN AND INSTALLATION

901.1 Structural requirements: All plastic materials and their assemblies shall be of adequate strength and durability to withstand the loads and forces specified in Article 7 for their approved use.

901.2 Connections and supports: All fastenings, connections and supports shall be proportioned to safely transmit two and one-half (2½) times the design live load. Adequate allowance shall be made in the fastenings and supports for differential expansion and contraction of the connected materials.

SECTION 1902.0 GLAZING OF UNPROTECTED OPENINGS

1902.1 Use in Type 4B construction: Doors, sash and framed openings which are not required to be fire-resistance rated may be glazed with approved plastic materials in buildings of Type 4B (unprotected, frame) construction.

1902.2 Use group F: In all types of construction of use group F (factory and industrial), doors, sash and framed openings which are not required to be fire-resistance rated may be glazed with approved plastic materials.

1902.3 Other classes of construction and use group: In other classes of construction and use, such openings not required to be fire-resistance rated by Section 914.0 may be glazed or equipped with approved plastic materials subject to the requirements listed below:

1. The area of such glazing shall not exceed twenty-five (25) per cent of the wall face of the story in which it is installed (see Section 1902.4).
2. The area of a unit or pane of glazing installed above the first story shall not exceed sixteen (16) square feet and the vertical dimension of a unit or pane shall not exceed four (4) feet. There shall be a minimum three (3) feet vertical spandrel wall between stories.
3. Approved plastics shall not be installed more than seventy-five (75) feet above grade level.
4. Approved thermoplastic materials may be installed in areas up to fifty (50) per cent of the wall area of each story in structures less than one hundred fifty (150) feet in height which are provided on each floor above the first floor with continuous architectural projections constituting an effective fire canopy extending at least three (3) feet from the surface of the wall in which the glazing is installed. The size and the dimensions of individual units shall not be limited in such installations except as required to meet structural loading requirements.

1902.4 Automatic fire suppression: When a complete approved automatic fire suppression system is provided in the building, the permissible area of glazing permitted by Section 1902.3, Item 1, may be increased one hundred (100) per cent.

SECTION 1903.0 EXTERIOR PANEL WALLS

1903.1 General: Approved plastic materials may be used as wall panels, in exterior walls not required to have a fire-resistance rating (except in use groups A-1, A-2, H and I) subject to the requirement listed in the following Sections 1903.1.1 through 1903.3.

1903.1.1 Installation: Exterior wall panels installed as provided herein shall not alter the type-of-construction classification of the building.

1903.1.2 Height limitation: Approved plastics shall not be installed more than seventy-five (75) feet above grade level, except as allowed by Section 1903.2.

1903.1.3 Area limitation and separation: Area limitation and separation requirements of exterior wall panels shall be as provided in Table 1903.

Table 1903  
AREA LIMITATION AND SEPARATION REQUIREMENTS FOR PLASTIC WALL PANELS<sup>1</sup>

| Fire separation (ft.)               | Class of plastic | Max. % area of ext. wall in plastic panels | Max. sq. ft. single area | Minimum separation of panels (ft.) |            |
|-------------------------------------|------------------|--|--------------------------|------------------------------------|------------|
|                                     |                  |  |                          | Vertical                           | Horizontal |
| 6 ft. or less                       | —                | NP <sup>2</sup>                            | NP                       | —                                  | —          |
| 6 ft. or more but less than 11 ft.  | C1               | 10   | 50                       | 8                                  | 4          |
|                                     | C2               | NP   | NP                       | —                                  | —          |
| 11 ft. or more but less than 30 ft. | C1               | 25   | 90                       | 6                                  | 4          |
|                                     | C2               | 15   | 70                       | 8                                  | 4          |
| Over 30                             | C1               | 50   | Not limited<br>100       | 3 <sup>2</sup>                     | 0          |
|                                     | C2               | 50   |                          | 6 <sup>2</sup>                     | 3          |

Note 1. See Section 1903.3 for combination of glazing and wall panel areas permitted.

Note 2. See Section 1903.1.5.

1903.1.4 Spandrel separation: Vertical spandrel wall separation between stories shall be as follows:

1. three (3) feet for Class C-1 plastic wall panels, and
2. four (4) feet for Class C-2 plastic wall panels.

1903.1.5 Fire canopies: In structures which are provided, on any floor above the first, with continuous architectural projections constituting an effective fire canopy extending at least thirty-six (36) inches from the surface of the wall in which plastic wall panels are installed, there need not be vertical separation at that floor except that provided by the vertical thickness of the projection.

1903.2 Automatic fire suppression: When a complete approved automatic fire suppression system is provided in the building, the maximum per cent area of exterior wall in plastic panels and the maximum square feet of single area given in Table 1903 may be increased one hundred (100) per cent but the area of plastic wall panels shall not exceed fifty (50) per cent of the wall area.

1903.3 Combinations of glazing and wall panels: Combinations of plastic glazing and plastic wall panels shall be subject to the area, height and percentage limitations, and separation requirements applicable to the class of plastics as prescribed for wall panel installations and shall be subject to the provisions of Articles 3 and 9 controlling exterior wall openings.

## SECTION 1904.0 ROOF PANELS

1904.1 General: Approved plastic roof panels may be installed (except in use groups A-1, A-2, A-3, H and I) as follows:

1. in roofs of buildings protected by a complete approved automatic fire suppression system;
2. where the roof is not required to have a fireresistance rating by Table 214; or
3. where the roof panels meet the requirements for roof coverings of the particular occupancy group.

1904.2 Separations: Individual roof panels shall be separated from each other by a distance of not less than four (4) feet measured in a horizontal plane.

1904.3 Location: Where exterior wall openings are required to be fireresistance rated by Section 914.0, a roof panel or unit shall not be installed within six (6) feet of such exterior wall.

1904.4 Area limitations: Roof panels or units shall be limited in area, and the aggregate area of panels shall be limited by a percentage of the floor area of the room or space sheltered in accordance with Table 1904.

Table 1904

## AREA LIMITATIONS FOR ROOF PANELS

| Class of plastic | Maximum area individual unit of panel (sq. ft.) | Maximum aggregate area (% of floor area) |
|------------------|---|--|
| C1               | 300   | 30                                       |
| C2               | 100   | 25                                       |

1904.5 Exceptions: The uses listed below shall be exempt from the requirements of Section 1904.4.

1. One (1) story buildings not more than sixteen (16) feet in height and not exceeding twelve hundred (1200) square feet in area and not closer than eleven (11) feet to another building are exempt from the limitations of Section 1904.4.
2. Low hazard use buildings such as swimming pool shelters, greenhouses, etc., are exempt from the area limitations of Section 1904.4 provided the buildings do not exceed five thousand (5,000) square

feet in area and are not closer than eleven (11) feet to the property line or adjacent buildings.

3. Roof coverings over terraces and patios of one- and two-family dwellings shall be permitted with approved plastics.

#### SECTION 1905.0 SKYLIGHT ASSEMBLIES

1905.1 Skylight assemblies: Skylight assemblies may be glazed with approved plastic materials (except in use group H) in accordance with the following provisions.

1905.1.1 Mounting: The plastic shall be mounted above the plane of the roof on a curb constructed consistent with the requirements for the type of construction classification, but at least four (4) inches above the plane of the roof. Edges of plastic skylights or domes shall be protected by metal or noncombustible material.

1905.1.1.1 Dome-shape: Dome-shape skylights shall rise above the mounting flange a minimum distance equal to ten (10) per cent of the maximum span of the dome, but not less than five (5) inches.

1905.1.2 Maximum area of skylight units: Each skylight unit shall have a maximum area within the curb of one hundred (100) square feet.

1905.1.3 Aggregate area of skylights: The aggregate area of skylights shall not exceed thirty-three (33) per cent when Class C-1 materials are used, and twenty-five (25) per cent when Class C-2 materials are used, of the floor area of the room or space sheltered by the roof in which they are installed.

1905.1.4 Separation: Skylights shall be separated from each other by a distance of not less than four (4) feet measured in a horizontal plane.

1905.1.5 Location: Where exterior wall openings are required to be fireresistance rated by Section 914.0, a skylight shall not be installed within six (6) feet of such exterior wall.

1905.1.6 Exception: The provisions of 1905.0 need not be applied if:  
a) the building on which the skylights are located is not more than one (1) story in height, the building has an exterior separation from other buildings of at least thirty (30) feet, and the room or space sheltered by the roof is not classified as a high hazard or institutional use group or as a means of egress; or  
b) the plastic material meets the fireresistive requirements of the roof.

1905.1.7 Combinations of roof panels and skylights: Combinations of plastic roof panels and skylights shall be subject to the area and percentage limitations and separation requirements applicable to roof panel installations.

SECTION 1906.0 LIGHT-DIFFUSING SYSTEMS

1906.1 General: Light-diffusing systems shall not be installed in use groups H and I, nor in exitways, unless protected with a fire suppression system. Plastic diffusers shall be supported directly or indirectly from ceiling or roof construction by use of noncombustible hangers. Hangers shall be at least No. 12 Steel Wire Gauge (0.106 inch) galvanized wire or equivalent.

1906.2 Installation: Approved plastic diffusers shall comply with Section 920.0 (interior finish) unless the plastic panels will fall from their mountings before igniting and at an ambient temperature of at least two hundred (200) degrees F. below their ignition temperature. The panels must, however, remain in place at an ambient room temperature of one hundred seventy-five (175) degrees F. for a period of not less than fifteen (15) minutes.

1906.3 Size limitations: Individual panels or units shall not exceed ten (10) feet in length nor thirty (30) square feet in area.

1906.4 Fire suppression system: In buildings having a complete approved automatic fire suppression system, the sprinklers shall be installed below the plastic light-diffusing systems. Areas of light-diffusing systems shall not be limited if properly protected by an approved fire suppression system.

1906.5 Electrical lighting fixtures: Plastic light-transmitting panels and light-diffuser panels installed in approved electrical lighting fixtures shall comply with Section 920.0 unless the plastic panels meet the requirements of Section 1906.2. The area of approved plastic materials when used in required fire exits or corridors shall not exceed thirty (30) per cent of the aggregate area of the ceiling in which they are installed, unless the occupancy is protected by an approved fire suppression system.

SECTION 1907.0 PARTITIONS

1907.1 General: Approved light-transmitting plastics may be used in or as partitions provided the requirements of the occupancy class as given in Section 920.0 are met. Such partitions may be installed as provided in Section 909.3.

SECTION 1908.0 BATHROOM ACCESSORIES

1908.1 Use of plastics: Approved plastics shall be permitted as glazing in shower stalls, shower doors, bathtub enclosures, and similar accessory units (see Section 857.5.6).

SECTION 1909.0 AWNINGS AND SIMILAR STRUCTURES



1909.1 General: Approved light-transmitting plastics may be used on awnings and similar structures in conformity with general performance provisions of other sections of this code.

SECTION 1910.0 GREENHOUSES

1910.1 General: Approved light-transmitting plastics may be used in lieu of plain glass in greenhouses.

ARTICLE 20

ENERGY CONSERVATION

SECTION 2000.0 GENERAL

2000.1 Scope: This article sets forth requirements for the effective use of energy in structures.

SECTION 2001.0 ADMINISTRATIVE

2001.1 Compliance: Buildings shall be in compliance with this article when they are built according to the provisions of the following:

1. component design (Section 2008.0); or
2. building design by systems analysis (Section 2013.0); or
3. buildings utilizing nondepletable energy sources (Section 2014.0).

2001.2 Other regulations: This article is not intended to abridge any safety or health provisions required under any other applicable codes or ordinances.

2001.3 Existing buildings: Nothing in this article shall require the removal, alteration, or abandonment, or prevent the continuance of the use and occupancy of, a lawfully existing building, unless provided otherwise specifically by this article.

2001.4 Exempt buildings: The following buildings are exempt from the provisions of this article, with the exception of Section 2015.0 dealing with lighting requirements:

1. Buildings and structures or portions thereof whose peak design rate of energy usage is less than one (1) watt per square foot or three and four tenths (3.4) Btu/h per square foot of floor area for all purposes.
2. Buildings which are neither heated nor cooled.
3. Greenhouses that are free-standing, or attached to a building and separated by a wall having the same thermal value as an exterior wall, and provided with a separate temperature control system.
4. Buildings with less than one hundred (100) square feet of gross floor area.

SECTION 2002.0 EXISTING BUILDINGS

2002.1 Additions to existing buildings: Additions to existing buildings or structures shall be made without making the entire building or structure comply. The new construction shall conform to the provisions of this article as they relate to the addition only.

2002.2 Alterations to existing buildings: See Article 22.

SECTION 2003.0 PLANS AND SPECIFICATIONS

2003.1 General: Plans, specifications and necessary computations shall be submitted to indicate conformance with this section and other applicable sections of the code.

2003.2 Details: The data submitted shall show all pertinent information and features to be incorporated into the building, including but not limited to: the exterior envelope component materials; the R values of the respective elements; the U values of the overall assembly; calculations of the OTTV and overall U of the walls, roof/ceiling, and floors; the size and type of apparatus and equipment; controls; and other pertinent data to indicate conformance to this article.

2003.3 Calculation procedures: Calculation procedures shall be in accordance with data in the latest ASHRAE publications.

SECTION 2004.0 MATERIALS AND EQUIPMENT

2004.1 Identification: Where practicable, all materials and equipment referenced in Section 2003.2 shall be marked in order to show compliance with the approved plans and specifications.

2004.2 Maintenance information: Service systems which require preventive maintenance to maintain efficient operation shall be furnished with complete necessary maintenance information. Required routine maintenance actions, as specified by the manufacturer, shall be stated clearly and incorporated on a readily accessible label on the equipment. Such label may be limited to identifying, by title or publication number, the operation and maintenance manual for that particular model and type of product.

SECTION 2005.0 DESIGN CONDITIONS

2005.1 General: The criteria of this section establish the minimum requirements for the thermal design of the exterior envelope of buildings and for HVAC systems and their parts.

2005.2 Thermal performance: A building that is designed to be both heated and cooled shall meet the more stringent of the heating or cooling requirements as provided in this article when requirements differ.

2005.3 Design parameters: The design parameters listed in Table 2005 shall be used for calculations required under this article.

Table 2005

## DESIGN TEMPERATURES

| Location    | Outside ambient             |                                      |                             | Heating degree days |
|-------------|-----------------------------|--------------------------------------|-----------------------------|---------------------|
|             | Heating degrees F. (winter) | Cooling degrees F. dry bulb (summer) | Cooling degrees F. wet bulb |                     |
| Boston      | 9                           | 88                                   | 74                          | 5634                |
| Clinton     | 2                           | 87                                   | 73                          | 6517                |
| Fall River  | 9                           | 84                                   | 73                          | 5774                |
| Framingham  | 6                           | 86                                   | 73                          | 6144                |
| Gloucester  | 5                           | 86                                   | 74                          | —                   |
| Greenfield  | -2                          | 85                                   | 73                          | —                   |
| Lawrence    | 0                           | 87                                   | 74                          | 6195                |
| Lowell      | 1                           | 88                                   | 74                          | 6056                |
| New Bedford | 9                           | 82                                   | 73                          | 5395                |
| Pittsfield  | -3                          | 84                                   | 72                          | 7578                |
| Springfield | 0                           | 87                                   | 73                          | 5844                |
| Taunton     | 9                           | 86                                   | 74                          | 6184                |
| Worcester   | 4                           | 84                                   | 72                          | 6969                |

2005.3.1 Indoor design temperature: Indoor design temperature shall be seventy-two (72) degrees F for heating and seventy-eight (78) degrees F for cooling.

2005.3.2 Design humidity: Indoor design relative humidity for heating shall not exceed thirty (30) per cent. For cooling, the actual design relative humidity within the comfort envelope as defined in ASHRAE Standard 55-74 listed in Appendix B shall be selected for minimum total HVAC system energy use in accordance with accepted practice.

2005.4 Ventilation: Ventilation air shall conform to the requirements specified in mechanical code listed in Appendix B.

2005.5 Swimming pools: All pool enclosures shall be designed in accordance with ASHRAE 1978 Applications Handbook Chapter 4.7/4.8.

Such pool enclosures shall have a maximum overall (roof/gables/sidewalls) U value of .25.

## SECTION 2006.0 BUILDING INSULATION

2006.1 General: Insulating materials must conform to the Federal Specifications (F.S.) and the American Society for Testing and Materials (ASTM) Test Standards as listed in Table 2006.

Table 2006

## INSULATION MATERIALS STANDARDS

| Material  | Federal Specification               | ASTM test                     |
|---|-------------------------------------|-------------------------------|
| Mineral fiber<br>Blanket/batt<br>Loose-fill                                     | HH-1-521E<br>HH-1-1030A             | C665-70<br>C-764-73           |
| Mineral cellular<br>Perlite<br>Vermiculite                                      | HH-1-574A<br>HH-1-585B              | C549-73<br>C516-67            |
| Organic fiber<br>Cellulose  | HH-1-515C                           | E84-77<br>C739-77             |
| Organic cellular<br>Polystyrene board<br>Urethane board<br>Flexible unicellular | HH-1-524B<br>HH-1-530A<br>HH-1-573B | C578-69<br>C591-69<br>C534-70 |

2006.2 Moisture control: The design of buildings for energy conservation shall not create conditions of accelerated deterioration from moisture condensation. See Article 5 for attic and underfloor-space ventilation.

### 2006.3 Installation

2006.3.1 Recessed light fixtures: Insulation shall be installed with a clearance of three (3) inches around each side of the fixture to preclude excessive heat buildup. Insulation shall not be installed over a recessed light fixture.

2006.3.2 High heat sources: A clearance of three (3) inches from any high heat source, including but not limited to chimneys, flues and vents, shall be maintained for combustible insulating materials.

2006.3.3 Urea formaldehyde foams: Urea formaldehyde foams shall be installed according to minimum standards set forth in HUD Use of Materials Bulletin No. 74.

2006.3.4 Walls: Batt/blanket insulation with a vapor barrier attached shall be stapled to the sides or faces of wall studs at intervals of eight (8) inches on center vertically.

2006.3.5 Cavities: Small cavities between rough framing and door and window heads, jambs, and sills shall be filled with insulation and covered with a vapor barrier.

2006.3.6 Perimeter insulation: Perimeter insulation for slab on grade construction shall be installed so that the concrete to concrete contact between the foundation wall and the floor slab is broken and extends downward the thickness of the slab and then extends an additional two (2) feet below exterior grade vertically or two (2) feet horizontally beneath the floor slab; or it shall be installed in a manner to thermally isolate the floor from the exterior.

2006.4 Fire safety: See Section 876.0.

2006.5 Labeling

2006.5.1 Batt and blanket and rigid board: Insulation of this type shall be labeled according to type, manufacturer or distributor, R value of the insulation at the labeled thickness and material specification as listed in Table 2006.

2006.5.2 Blown, poured, or sprayed on types: Insulation of these types shall be labeled according to type, manufacturer, recommended insulation density, R value, fire safety requirements and material specifications as listed in Table 2006.

2006.5.3 Urea formaldehyde foams: Urea formaldehyde foams shall meet labeling standards set forth in HUD Use of Materials Bulletin No. 74.

#### SECTION 2007.0 VAPOR BARRIERS

2007.1 Vapor barriers: A vapor barrier of one point zero (1.0) perm or less shall be installed on the winter warm side of walls, ceilings and floors enclosing a conditioned space.

Exception: Vapor barriers may be eliminated with adequate ventilation as defined in Article 5.

2007.2 Taping: All tears in the vapor barrier shall be taped or sealed.

#### SECTION 2008.0 COMPONENT DESIGN

2008.1 Scope: All buildings that are heated or mechanically cooled shall be constructed so as to provide the required thermal performance of the various components listed in Sections 2008.0 through 2012.0.

2008.2 Gross wall area: For the purposes of this article, the gross area of exterior walls consists of all opaque wall areas, including foundation walls, areas between floor spandrels, peripheral edges of floors, window areas including sash, and door areas, where such surfaces enclose a heated or mechanically cooled space including interstitial areas between two (2) such spaces.

2008.3 Roof assembly: For the purpose of this article, a roof assembly shall be considered as all components of the roof/ceiling envelope through which heat flows, thereby creating a building transmission heat loss or gain, where such assembly is exposed to outdoor air and encloses a heated or mechanically cooled space.

2008.3.1 Gross roof area: The gross area of a roof assembly consists of the total interior surface of such assembly, including skylights, exposed to the heated or mechanically cooled space.

2008.3.2 Ceiling plenums: Where air ceiling plenums are employed, the roof/ceiling assembly shall:

1. for thermal transmittance purposes not include the ceiling proper nor the plenum space as part of the assembly; and
2. for gross area purposes be based upon the interior face of the upper plenum surface.

#### SECTION 2009.0 EXTERIOR ENVELOPE REQUIREMENTS

2009.1 Criteria for residential buildings: The following requirements shall apply to all buildings and structures or portions thereof in use groups R-1, R-2, R-3 and R-4 (hotels, multi-family, and one- and two-family) that are heated or mechanically cooled when not more than three (3) stories or forty (40) feet in height.

1. All buildings in these use groups shall conform to the thermal transmittance values in Table 2009.1.
2. An overall  $U_o$  value of zero point twenty (0.20) for the combination of walls, doors and windows containing heated space may be used in lieu of the separate  $U$  values listed for "walls," "foundation walls," and "doors and windows". The overall  $U_o$  of zero point twenty (0.20) shall be used when the doors or windows exceed twenty (20) per cent of the gross exterior wall area. See Section 2009.3 for the calculations of the overall  $U_o$ . The  $U_o$  of zero point twenty (0.20) applies only to gross walls enclosing a space provided with a positive heat supply and not the entire envelope.
3. Framing members shall not be included in the calculations of R and U values.

2009.2 Criteria for all buildings other than those covered by Section 2009.1: R-1, R-2, R-3 and R-4 residential buildings over three (3) stories or over forty (40) feet high, and all nonresidential buildings shall have an overall thermal transmittance value ( $U_o$ ) not exceeding the values shown in Table 2009.2. See Section 2009.3 for the calculations of the overall  $U_o$ .

Table 2009.1

**MAXIMUM U VALUES OF WALLS, ROOF/CEILING, AND FLOORS  
FOR RESIDENTIAL BUILDINGS OF SECTION 2009.1**

| Element                               | Description   | U value | Total R value | Notes |
|---------------------------------------|---|---------|---------------|-------|
| Walls                                 | All wall construction containing heated or mechanically cooled space                  | 0.08    | 12.5          | 1     |
| Foundation walls including band joist | Containing heated or mechanically cooled space  | 0.08    | 12.5          |       |
|                                       | Containing unheated space   | 0.17    | 5.9           | 5     |
| Roof/ceiling assembly                 | Plank and beam construction containing heated or mechanically cooled space            | 0.08    | 12.5          | 2     |
| Roof/ceiling assembly                 | Construction other than plank and beam containing heated or mechanically cooled space | 0.05    | 20.0          |       |
| Doors and windows                     | All construction enclosing heated or mechanically cooled space                        | 0.65    | 1.54          | 3     |
| Floors                                | Floor sections over areas exposed to outside air or unheated areas                    | 0.08    | 12.5          | 4     |
|                                       | Unheated slab on grade  | —       | 5.50          | 6     |
|                                       | Heated slab on grade  | —       | 7.75          | 6     |

**Note 1.** This value may be used when the doors and windows do not exceed twenty (20) per cent of the gross exterior wall area. When doors and windows exceed twenty (20) per cent of the gross wall area, see Section 2009.1, item 2.

**Note 2.** Plank and beam assemblies are construction in which the finished interior surface is the underside of the roof deck.

**Note 3.** Double glazing or storm windows will satisfy the required U value of zero point sixty-five (0.65).

**Note 4.** Insulation may be omitted from floors over unheated areas when foundation walls are provided with a U value of zero point seventeen (0.17).

**Note 5.** The U value requirement of zero point seventeen (0.17) for foundation walls may be omitted when floors over unheated spaces are provided with a U value of point zero eight (0.08).

**Note 6.** R value for perimeter insulation (see Section 2006.3.6).

Table 2009.2

**MAXIMUM OVERALL U<sub>o</sub> VALUES OF WALLS, ROOF AND FLOORS  
FOR BUILDINGS OF SECTION 2009.2**

| Element               | Description            | Overall U <sub>o</sub> value |
|-----------------------|------------------------|------------------------------|
| Walls                 | 3 stories and under    | 0.25 Note 1                  |
|                       | Over 3 stories         | 0.30 Note 1                  |
| Roof/ceiling assembly | All construction       | 0.07                         |
| Floors                | Over unheated spaces   | 0.08                         |
|                       | Unheated slab on grade | 5.50 Note 2                  |
|                       | Heated slab on grade   | 7.75 Note 2                  |

**Note 1.** For cooling see Section 2009.2.1.

**Note 2.** R value for perimeter insulation.



2009.2.1 OTTV for air conditioned buildings: Air conditioned buildings covered by Section 2009.2 shall have an overall thermal transfer value (OTTV) not greater than thirty-four point two (34.2) Btu/hr/sq. ft. of gross area of exterior walls for the portion of the building being cooled. The required OTTV shall be provided in addition to the overall  $U_o$  for walls provided in Table 2009.2. The following formula shall be used to calculate OTTV:

$$\text{OTTV} = \frac{(U_w A_w \text{TD}_{\text{eq}}) + (A_f \text{SFSC}) + (U_f A_f \Delta T)}{A}$$

Where

OTTV = overall thermal transfer value for exterior walls.

A = gross exterior wall area.

$U_w$  = U value of opaque wall (all elements).

$A_w$  = opaque wall area.

$U_f$  = U value of fenestration area.

$A_f$  = fenestration area.

$\text{TD}_{\text{EQ}}$  = temperature difference value (from Table 2009.2.1).

SC = shading coefficient of the fenestration (see definition, Section 201.0).

T = temperature difference between exterior and interior design conditions, degrees Fahrenheit.

SF = solar factor value (130 Btu/h/sq. ft.)

Note: Where more than one (1) type of wall and/or fenestration is used, the respective terms for those elements shall be expanded into sub-elements.

Table 2009.2.1

| EQUIVALENT TEMPERATURE DIFFERENCES FOR WALLS |                        |
|--|------------------------|
| Weight of wall construction                  | T <sub>EQ</sub> factor |
| 0-25   | 44                     |
| 26-40  | 37                     |
| 41-70  | 30                     |
| 71 and above                                 | 23                     |

2009.3 Calculation of  $U_o$ : Separate overall thermal transmittance values shall be calculated for wall, roof/ceiling assemblies and floors. Equation 1 is provided as an example of the  $U_o$  calculation for walls.

$$\text{Overall wall } U_o = \frac{U_w A_w + U_g A_g + U_d A_d}{A} \quad (\text{equation 1})$$

Where

- $U_o$  = the average or combined transmittance of the gross exterior wall.
- $A$  = the gross exterior wall area.
- $U_w$  = the thermal transmittance of the components of the opaque wall.
- $A_w$  = opaque wall area.
- $U_w$  = the thermal transmittance of the windows.
- $A_g$  = window area.
- $U_d$  = the thermal transmittance of the door or similar opening.
- $A_d$  = the door area.

Note: Where more than one (1) type of wall, window, and door is used, the U and A terms for those items shall be expanded into sub-elements as  $U_{w1}$ ,  $A_{w1}$ , and  $U_{w2}$ ,  $A_{w2}$ , etc.

2009.4 Alternates: The stated  $U_o$  (or U) value of any one (1) assembly, such as roof/ceiling, wall or floor, may be increased and the  $U_o$  (or U) value for other components decreased provided that the overall heat gain or loss for the entire building envelope does not exceed the total resulting from conformance to the stated  $U_o$  (or U) values.

#### 2009.5 Air leakage for all buildings

1. The requirements of this section shall apply to all buildings and structures and apply to those locations separating outdoor ambient conditions from interior spaces that are heated or mechanically cooled and are not applicable to the separation of interior conditioned spaces from each other.
2. Exterior joints around windows and door frames; openings between walls and foundations, between walls and roof and between wall panels; openings at penetrations of utility services through walls, floors, and roofs; and all other such openings in the building envelope shall be caulked, gasketed, weatherstripped, or otherwise sealed.
3. All exterior doors and windows shall be designed to limit air leakage into or from the building envelope, and shall have air infiltration rates not greater than those shown in Table 2009.5.

Table 2009.5  
ALLOWABLE AIR INFILTRATION RATES

| Windows<br>(Cfm per linear<br>foot of operable<br>sash crack) | Residential doors<br>(Cfm per square<br>foot of door area) |          | Commercial doors<br>(Cfm per linear<br>foot of crack) |
|---|--|----------|---|
|   | Sliding<br>glass   | Entrance | Swinging, sliding,<br>revolving                       |
| 0.5   | 0.5  | 1.25     | 11.0  |

Note 1. When tested at a pressure differential of one point five six seven (1.567) lb./sq. ft. which is equivalent to the impact pressure of a twenty-five (25) mph wind.

Note 2. Compliance with the criteria for air leakage of all types of windows and doors shall be determined by ASTM E283, ANSI A134.1 and A134.2 as referenced in Appendix B.

Note 3. Fixed glazing is exempt from infiltration testing requirements.

Note 4. Storm windows and doors installed over exterior windows and doors shall be accepted when windows and doors have not been tested for infiltration according to Table 2009.4.

## SECTION 2010.0 MECHANICAL SYSTEMS

2010.1 Scope: This section covers the determination of heating and cooling loads, equipment and component performance, and control requirements. Criteria are established for insulating HVAC systems and for duct construction.

Exception: Special applications, including but not limited to hospitals, museums, laboratories, rooms containing thermally sensitive equipment such as computers, open refrigerated display cases, may be exempted from the requirements of this section, when calculations and requirements are submitted establishing the unique environmental criteria that exists.

## 2010.2 Calculation of heating and cooling loads

2010.2.1 Calculation procedures: For the purpose of sizing HVAC systems, heating and cooling design loads shall be determined in accordance with techniques recommended in the appropriate ASHRAE publications. The design parameters specified in Section 2005.0 shall apply for all computations.

2010.3 System heating/cooling capacity: The rated output capacity of the heating/cooling system at design conditions shall not be greater than one hundred twenty-five (125) per cent of the design load calculated in accordance with this article. Equipment designed for standby purposes is not included in the capacity limitation requirement. The cooling cycles of heat pumps are exempt from this requirement.

2010.4 Simultaneous heating and cooling: Simultaneous heating and cooling by reheating or recooling supply air or by concurrent operation of independent heating and cooling systems serving a common zone shall be restricted as delineated below:

1. Recovered energy: Recovered energy, provided the new energy expended in the recovery process is less than the amount recovered, may be used for control of temperature and humidity. (New energy is defined as energy, other than recovered, utilized for the purpose of heating or cooling).
2. New energy for humidity control: New energy may be used, when necessary, to prevent relative humidity from rising above sixty (60) per cent for comfort control or to prevent condensation on terminal units or outlets.
3. New energy for temperature control: New energy may be used for control of temperature if minimized as delineated in paragraphs 4 through 8 following.
4. Reheat systems: Systems employing reheat and serving more than one (1) zone, other than those employing variable air volume for temperature control, shall be provided with controls that will automatically reset the cold air supply. The temperature shall be controlled to sequence reheat and cooling.
5. Dual duct and multi zone systems: These systems shall be provided with controls that will automatically reset the cold deck air supply to the highest temperature that will satisfy the zone requiring the coolest air, and the hot deck air supply to the lowest temperature that will satisfy the zone requiring the warmest air.

6. Recooling systems: Systems in which heated air is recooling, directly or indirectly, to maintain space temperature shall be provided with controls that will automatically reset the temperature to which the supply air is heated. The temperature shall be the lowest level that will satisfy the zone requiring the warmest air.
7. Multiple zones: For systems with multiple zones, one (1) or more zones may be chosen to represent a number of zones with similar heating/cooling characteristics. A multiple zone HVAC system that employs reheating or recooling for control of not more than five thousand (5,000) cubic feet per minute (cfm) or twenty (20) per cent of the total supply air of the system, whichever is less, shall be exempt from the supply air temperature reset requirement of paragraphs 4 through 6.
8. Concurrent operation: Concurrent operation of independent heating and cooling systems serving common spaces and requiring the use of new energy for heating or cooling shall be minimized by one (1) or both of the following:
  - a. by providing sequential temperature control of both heating and cooling capacity in each zone; and/or
  - b. by limiting the heating energy input through automatic reset control of the temperature of the heating medium to only that necessary to offset heat loss due to transmission and infiltration and, where applicable, to heat the ventilation air supply to the space.

2010.5 Mechanical ventilation: Each mechanical ventilation system (supply and/or exhaust) shall be equipped with a readily accessible means for either shut-off or volume reduction, and shut-off when ventilation is not required.

2010.6 HVAC equipment performance requirements: The requirements of this section apply to equipment and component performance for heating, ventilating, and air conditioning systems. Where equipment efficiency levels are specified, data furnished by the equipment supplier, or certified under a nationally-recognized certification program or rating procedure, shall be used to satisfy these requirements.

2010.6.1 HVAC system combustion heating equipment: All gas and oil fired comfort heating equipment shall show a minimum combustion efficiency of seventy-five (75) per cent at maximum rated output. Combustion efficiency is defined as one hundred (100) percent minus stack losses in per cent of heat input. Stack losses are:

1. loss due to sensible heat in dry flue gas;
2. loss due to incomplete combustion; and
3. loss due to sensible and latent heat in moisture formed by combustion of hydrogen in the flue.

2010.6.2 HVAC system heating equipment, heat pumps heating mode: Heat pumps whose energy input is entirely electric shall show a coefficient of performance (COP heating, as defined herein) not less than the values shown in Table 2010.6.2a.

1. These requirements apply to, but are not limited to, unitary heat pumps (air source and water source) in the heating mode, and to heat pumps in the packaged terminal air conditioner and room air conditioner forms in the heating mode. Field assembled unitary heat pumps, consisting of one (1) or more components, shall show compliance with this section.
2. Coefficient of performance heating: the ratio of the rate of net heat output to the rate of total energy input, expressed in consistent units and under designated rating conditions.

The rate of net heat output shall be defined as the change in the total heat content of the air between entering and leaving the equipment (not including supplementary heat).

Total energy input shall be determined by combining the energy inputs to all elements of the heat pump except supplementary heaters. This includes, but is not limited to, compressor(s), pump(s), supply-air fan(s), return-air fan(s), outdoor air fan(s), cooling tower fan(s), and the HVAC system equipment control circuit.

3. Supplementary heater: The heat pump shall be installed with a control to prevent supplementary heater operation when the heating load can be met by the heat pump alone.

Supplementary heater operation is permitted during transient periods, such as start-ups, following room thermostat set-point advance and during defrost.

A two (2) stage thermostat, which controls the supplementary heat on its second stage, shall be accepted as meeting this requirement. The cut-on temperature for the compression heating shall be higher than the cut-on temperature for the supplementary heat, and the cut-off temperature for the compression heating shall be higher than the cut-off temperature for the supplementary heat. Supplementary heat may be derived from any source of electric resistance heating or combustion heating.

Table 2010.6.2a

MINIMUM COP FOR HEAT PUMPS, HEATING MODE<sup>1</sup>

| Source and outdoor temperature (F) | Minimum COP |
|------------------------------------|-------------|
| Air source-47 dB/43WB              | 2.2         |
| Air source-17 dB/15WB              | 1.2         |
| Water source-60 entering           | 2.2         |

Note 1. When tested at the standard rating specified in Table 2010.6.2(b).

Table 2010.6.2b

**HVAC SYSTEM HEATING EQUIPMENT (HEAT PUMPS)  
STANDARD RATING CONDITIONS**

| Conditions                 |    | Type: | Air source  |             | Water source            |
|----------------------------|----|-------|-------------|-------------|-------------------------|
| Air entering equipment     | °F |       | 70 db       | 70 db       | 70 db                   |
| Outdoor unit ambient       | °F |       | 47 db/43 wb | 17 db/15 wb | —                       |
| Entering water temperature | °F |       | —           | —           | 60                      |
| Water flow rate            |    |       | —           | —           | as used in cooling mode |

2010.6.3 HVAC system equipment, electrically operated cooling mode: HVAC system equipment as listed below whose energy input in the cooling mode is entirely electric shall show a coefficient of performance (COP) cooling as defined herein not less than the values shown in Table 2010.6.3a:

1. These requirements apply to, but are not limited to, unitary cooling equipment (air-cooled, water-cooled and evaporatively-cooled); the cooling mode of unitary heat pumps (air source and water source); packaged terminal airconditioners; and room airconditioners.
2. Coefficient of performance cooling: the ratio of the rate of net heat removal to the rate of total energy input, expressed in consistent units and under designated rating conditions.

The rate of new heat removal shall be defined as the change in the total heat content of the air between entering and leaving the equipment (without reheat).

Total energy input shall be determined by combining the energy inputs to all elements of the equipment, including, but not limited to, compressor(s), pump(s), supply air fan(s), return air fan(s), condenser air fan(s), cooling tower fan(s), and pump(s), and the HVAC system equipment control circuit.

2010.6.4 Applied HVAC system components, electrically operated, cooling mode: HVAC system components as listed in Table 2010.6.4a whose energy input is entirely electric shall show a coefficient of performance (COP) cooling, as defined herein, not less than the values shown in Table 2010.6.4a.

Coefficient of performance (COP) cooling is the ratio of the rate of net heat removal to the rate of total energy input, expressed in consistent units and under designated rating conditions. The rate of net heat removal is defined as the difference in total heat content of the water or refrigerant entering and leaving the component.

**780 CMR: STATE BUILDING CODE COMMISSION**

Total energy input shall be determined by combining the energy inputs to all elements and accessories of the component, including but not limited to compressor(s), internal circulating pumps(s), purge, and the HVAC system component control circuit.

**Table 2010.6.3a  
MINIMUM EER AND COP  
FOR ELECTRICALLY DRIVEN AIR CONDITIONING SYSTEM EQUIPMENT<sup>1</sup>**

| Standard rating capacity | EER | COP |
|--------------------------|-----|-----|
| Under 65,000 Btu/h       | 6.1 | 1.8 |
| 65,000 Btu/h and over    | 6.8 | 2.0 |

**Note 1.** When tested at the standard rating conditions specified in Table 2010.6.3(b).

**Table 2010.6.3b  
HVAC SYSTEM EQUIPMENT  
STANDARD RATING CONDITIONS, COOLING<sup>1</sup>**

| Conditions                     |    | Temperatures |    |       |        |
|--------------------------------|----|--------------|----|-------|--------|
|                                |    | DB           | WB | Inlet | Outlet |
| Air entering equipment         | °F | 80           | 67 | —     | —      |
| Condenser ambient (air cooled) | °F | 95           | 75 | —     | —      |
| Condenser water (water cooled) | °F | —            | —  | 85    | 95     |

**Note 1.** Standard ratings are at sea level.

**Table 2010.6.4a  
MINIMUM EER AND COP  
FOR ELECTRICALLY DRIVEN AIR CONDITIONING SYSTEM COMPONENTS<sup>1</sup>**

| Component   | Condensing means      | Air |     | Water |     | Evaporator |      |
|---|-----------------------|-----|-----|-------|-----|------------|------|
|   |                       | EER | COP | EER   | COP | EER        | COP  |
| Self-contained water chillers                                     | Centrifugal           | 7.5 | 2.2 | 12.9  | 3.8 |            |      |
| Self-contained water chillers                                     | Positive displacement | 7.2 | 2.1 | 10.9  | 3.2 |            |      |
| Condenserless water chillers                                      | Positive displacement | 8.9 | 2.6 | 10.9  | 3.2 |            |      |
| Compressor and condenser units 65,000 Btu/h and over <sup>2</sup> | Positive displacement | 7.8 | 2.3 | 11.3  | 3.3 | 11.3       | 11.3 |

**Note 1.** When tested at the standard rating conditions specified in Table 2010.6.4(b).

**Note 2.** Ratings in accordance with ARI Standard 524-74 (Appendix B) as applicable. COP based on condensing unit standard rating capacity and energy input to the unit, all at sea level.



Table 2010.6.4b  
 APPLIED HVAC SYSTEM COMPONENTS  
 STANDARD RATING CONDITIONS, COOLING<sup>1</sup>

| Item                                    |                                | Centrifugal or self-contained reciprocating water-chiller | Condenserless reciprocating water-chiller |
|---|--------------------------------|---|---|
| Leaving chilled water temp.             | °F                             | 44  | 44  |
| Entering chilled water temp.            | °F                             | 54  | 54  |
| Leaving condenser water temp.           | °F                             | 95  | —   |
| Entering water temp.                    | °F                             | 85  | —   |
| non-ferrous tubes                       | *                              | 0.0005  | 0.0005                                    |
| Fouling factor, water                   | *                              |   |   |
| steel tubes                             | *                              | 0.0010  | 0.0010                                    |
| Fouling factor, refrigerant             | *                              | 0.0000  | 0.0000                                    |
| Condenser ambient (air or evap. cooled) | °F                             | 95 db/75 wb   | —   |
| Compressor saturated                    | Water cooled (or evap. cooled) | °F  | 105                                       |
|   | Air cooled                     | °F  | 120                                       |
| Discharge temp.                         |                                |   |   |

\*h ft<sup>2</sup> F/Btu

Note 1. Standard ratings are at sea level.

2010.6.5 HVAC system equipment, heat operated cooling mode: Heat operated cooling equipment shall show a coefficient performance (COP) cooling not less than the values shown in Table 2010.6.5. These requirements apply to, but are not limited to, absorption equipment, engine driven equipment, and turbine drive equipment.

Where the refrigeration components are supplied by different manufacturers, it shall be the responsibility of the system designer to determine compliance with these requirements, using data provided by the suppliers of the elements.

Table 2010.6.5  
 MINIMUM COP FOR HEAT OPERATED AIR CONDITIONING SYSTEM EQUIPMENT

| Heat source                       | Minimum COP |
|-----------------------------------|-------------|
| Direct fired (gas, oil)           | 0.40        |
| Indirect fired (steam, hot water) | 0.65        |

2010.7 Energy for air delivery, air transport factor: The air transport factor for each all-air HVAC system shall not be less than four point zero (4.0). The factor shall be based on design system air flow for con-

stant volume systems. The factor for variable air volume systems may be based on average conditions of operation. Energy for transfer of air through heat recovery devices shall not be included in the evaluation of the effectiveness of the heat recovery system.

$$\text{Air transport factor} = \frac{\text{Space sensible heat removal}^*}{(\text{Supply} + \text{return fan[s] power input})^*}$$

## 2010.8 Controls:

2010.8.1 Temperature control: Each HVAC system shall be provided with at least one (1) thermostat for the regulation of temperature. Each thermostat shall be capable of being set as follows:

1. where used to control heating only, 55-75 degrees F;
2. where used to control cooling only, 70-85 degrees F; and
3. where used to control both heating and cooling it shall be capable of being set from 55-85 degrees F, and shall be capable of operating the system heating and cooling in sequence. It shall be adjustable to provide a temperature range of up to ten (10) degrees F between full heating and full cooling, except as allowed in Section 2010.4, item 8.

2010.8.2 Humidity control: If an HVAC system is equipped with a means for adding moisture to maintain specific selected relative humidities in spaces or zones, a humidistat shall be provided. This device shall be capable of being set to prevent new energy from being used to produce space relative humidity above thirty (30) per cent relative humidity. Where a humidistat is used in an HVAC system for controlling moisture removal to maintain specific selected relative humidities in spaces or zones, it shall be capable of being set to prevent new energy from being used to produce a space relative humidity.

## 2010.8.3 Zoning for temperature control

1. One- and two-family dwellings: At least one (1) thermostat for regulation of space temperature shall be provided for each separate HVAC system. In addition, a readily accessible manual or automatic means shall be provided to partially restrict or shut off the heating and/or cooling input to each zone or floor.
2. Multi-family dwellings: For multi-family dwellings, each individual dwelling unit shall be considered separately and shall meet the above requirements. Spaces other than living units shall meet the requirements of item 3 following.
3. In all other types of buildings or occupancies, at least one (1) thermostat for regulation of space temperature shall be provided for:

\* Expressed in BTU/hr.

- a. each separate HVAC system; and
- b. each separate zone as defined in Section 201.0. As a minimum, each floor of a building shall be considered as a separate zone. In a multi-story building where the perimeter system offsets only the transmission losses of the exterior wall, an entire side of uniform exposure may be zoned separately. A readily accessible manual or automatic means shall be provided to partially restrict or shut off the heating and/or cooling input (for the exposure) to each floor.

2010.8.4 Control setback and shut-off: Lowering thermostat set points to reduce energy consumption of heating systems shall not cause energy to be expended to reach the reduced setting.

1. Residential occupancy (use groups R-2, R-3 and R-4): The thermostat required in paragraphs 1 and 2 of Section 2010.8.3, or an alternate means such as a switch or clock, shall provide a readily accessible, manual or automatic means for reducing the energy required for heating and cooling during periods of nonuse or reduced need, such as, but not limited to, unoccupied periods and sleeping hours.
2. Other buildings and occupancies: Each HVAC system shall be equipped with a readily accessible means of shutting off or reducing the energy used for HVAC during periods of nonuse or alternate uses of the building spaces or zones served by the system. The following are examples that meet this requirement:
  - a. manually adjustable automatic timing devices;
  - b. manual devices for use by operating personnel; and
  - c. automatic control systems.
3. Swimming pools
  - a. Heated swimming pools shall be equipped with controls to limit heating water temperatures to not more than eighty (80) degrees F.

Exception: Pools used for therapeutic purposes are exempt from this requirement when approved by the building official.

- b. Uncovered (unenclosed) heating pools shall be controlled so that the electric or fossil fuel pool water heating systems are inoperative whenever the outdoor air temperature is below sixty (60) degrees F.

2010.9 Duct construction: All duct work shall be constructed and erected in accordance with this code and the mechanical code listed in Appendix B.

1. High pressure and medium pressure ducts shall be leak tested in accordance with applicable Sheet Metal and Air Conditioning Contractors National Association Duct Construction Standards listed in Appendix B.

2. When low pressure supply air ducts are located outside of the conditioned space (except return air plenums), all transverse joints shall be sealed using mastic or mastic plus tape. For fibrous glass duct work, pressure sensitive tape may be used.
3. Automatic or manual dampers installed for the purpose of shutting off outside air intakes for ventilation air shall be designed with tight shut-off characteristics to minimize air leakage.

2010.10 Air handling duct system insulation: All ducts, plenums and enclosures installed in or on buildings shall be thermally insulated as follows:

1. All duct systems, or portions thereof, shall be insulated to provide a thermal resistance, excluding film resistance, of

$$R = \frac{\Delta t}{15 \text{ (hr) (F) (ft}^2\text{) / Btu}}$$

where  $\Delta t$  = the design temperature differential between the air in the duct and the surrounding air in degrees F.

Exception: Duct insulation is not required in any of the following cases:

- a. Where  $\Delta t$  is twenty-five (25) degrees F or less.
  - b. Supply or return air ducts installed in unventilated crawl spaces with insulated walls, and basements or cellars with insulated walls in one- and two-family dwellings.
  - c. When the heat gain or loss of the ducts, without insulation, will not increase the energy requirements of the building.
  - d. Within HVAC equipment.
  - e. Exhaust air ducts.
2. Vapor barriers shall be provided, where required, to prevent condensation.

2010.11 Cooling with outdoor air (economizer cycle): Each fan system shall be designed to use up to and including one hundred (100) per cent of the fan system capacity for cooling with outdoor air automatically whenever its use will result in lower usage of new energy. Activation of economizer cycle shall be controlled by sensing outdoor air enthalpy and dry bulb temperature jointly or outdoor air dry bulb temperature alone to accomplish the above.

Exception: Cooling with outdoor air is not required under any one (1) or more of the following conditions.

1. Fan system capacity less than five thousand (5,000) cubic feet per minute (cfm) or one hundred thirty-four thousand (134,000) Btu/h total cooling capacity.
2. The quality of the outdoor air is so poor as to require extensive treatment of the air.

3. The need for humidification or dehumidification requires the use of more energy than is conserved by the outdoor air cooling.
4. The use of outdoor air cooling may affect the operation of other systems so as to increase the overall energy consumption of the building.
5. Internal/external zone heat recovery or other energy recovery is used.
6. When all space cooling is accomplished by a circulating liquid which transfers space heat directly or indirectly to a heat rejection device such as a cooling tower without the use of a refrigeration system.

2010.12 Balancing: The HVAC system design shall provide means for balancing the air and water systems such as but not limited to dampers, temperature and pressure test connections, flow measuring stations or meters, and balancing valves. The HVAC systems shall be field balanced to achieve conditions stated in the plans and specifications.

2010.13 Piping insulation: All piping installed to serve buildings and within buildings shall be thermally insulated in accordance with Table 2010.13.

Exception: Piping insulation is not required in any of the following cases:

1. Piping installed with HVAC equipment.
2. Piping for fluids at temperatures between fifty-five (55) degrees F and one hundred twenty (120) degrees F.
3. When the heat loss and/or heat gain of the piping, without insulation, does not increase the heating and/or cooling energy requirements of the building.
4. Piping, installed in unventilated crawl spaces with insulated walls, and basements or cellars with insulated walls in one- and two-family dwellings.

2010.13.1 Other insulation thickness: Insulation thickness in Table 2010.13 are based on insulation having thermal resistance in the range of four point zero (4.0) to four point six (4.6) per inch of thickness on a flat surface at a mean temperature of seventy-five (75) degrees F. 2SPS. Minimum insulation thickness shall be increased for materials having R values less than four point zero (4.0), or may be reduced for materials having R values greater than four point six (4.6).

1. For materials with thermal resistance greater than R = four point six (4.6), the minimum insulation thickness may be reduced as follows:

$$\frac{4.6 \times \text{Table 2010.13 thickness}}{\text{Actual R}} = \text{New minimum thickness}$$

2. For materials with thermal resistance less than  $R = \text{four point zero (4.0)}$ , the minimum insulation thickness shall be increased as follows:

$$\frac{4.0 \times \text{Table 2010.13 thickness}}{\text{Actual R}} = \text{New minimum thickness}$$

2010.13.2 Vapor barriers: Vapor barriers shall be provided to prevent condensation where required.

Table 2010.13

MINIMUM PIPE INSULATION

| Piping system types               | Fluid temperature range, F. | Insulation thickness in inches for pipe sizes |             |           |           |          |               |
|-----------------------------------|-----------------------------|---|-------------|-----------|-----------|----------|---------------|
|                                   |                             | Runouts up to 2"                              | 1" and less | 1¼" to 2" | 2½" to 4" | 5" to 6" | 8" and Larger |
| Heating systems                   |                             |   |             |           |           |          |               |
| Steam and hot water               |                             |   |             |           |           |          |               |
| High pressure/ temp.              | 306-450                     | 1½  | 1½          | 2         | 2½        | 3½       | 3½            |
| Med. pressure/ temp.              | 251-305                     | 1½  | 1½          | 2         | 2½        | 3        | 3             |
| Low pressure/ temp.               | 201-250                     | 1   | 1           | 1½        | 1½        | 2        | 2             |
| Low temperature                   | 120-200                     | ½   | ¾           | 1         | 1         | 1        | 1½            |
| Steam condensate (for feed water) | Any                         | 1   | 1           | 1         | 1½        | 1½       | 2             |
| Cooling systems                   |                             |   |             |           |           |          |               |
| Chilled water                     | 40-55                       | ½   | ½           | ¾         | 1         | 1        | 1             |
| Refrigerant or brine              | Below 40                    | 1   | 1           | 1½        | 1½        | 1½       | 1½            |

Note 1. Runouts not exceeding twelve (12) inches in length to individual terminal units.

SECTION 2011.0 ELECTRICAL POWER DISTRIBUTION

2011.1 Scope: Electrical distribution systems shall be designed for the efficient distribution of electrical energy from the service entrance to the points of use.

2011.1.1 Exempt buildings: Buildings in use groups R-3 and R-4 (one- and two-family dwellings) shall be exempt from the requirements of this section.

2011.2 Power factor: Utilization equipment greater than one thousand (1,000) watts and lighting equipment greater than fifteen (15) watts with an inductive reactance load component shall have a power factor of not less than eighty-five (85) per cent under rated load conditions. Power factor of less than eighty-five (85) per cent shall be corrected to at least ninety (90) per cent under rated load conditions. Power factor corrective devices, installed to comply with this code, shall be switched with the utilization equipment, except where this results in an unsafe condition or interferes with the intended operation of the equipment.

2011.3 Service voltage: Where a choice of service voltage is available, a computation shall be made to determine which service voltage would produce the least energy loss, and that voltage shall be selected.

#### 2011.4 Lighting switching

1. Each area enclosed by ceiling height partitions shall have independent control of the lighting within that area.
2. All switching devices used to control lighting within an area shall be readily accessible to personnel occupying that area.
3. The maximum area to be switch controlled shall be one thousand (1,000) square feet. For all areas larger than five hundred (500) square feet, the connected lighting load shall be so controlled that the overall illumination may be reduced by at least one-half ( $\frac{1}{2}$ ).
4. In all interior areas where effective use may be made of natural light, lighting circuiting shall be arranged so that units, in portions of the area where natural light is available, are switched independently of the remainder of the area.
5. In all exterior areas, lighting fixtures shall be switched automatically for nonoperation when natural light is available.

2011.5 Electric energy determination: In all multi-family dwellings, each dwelling unit shall be separately metered.

#### Exceptions:

1. Publicly financed housing for the elderly with fuel fired heating systems, with centrally operated airconditioning systems, or without airconditioning systems are exempt from this requirement.
2. Publicly financed housing for the elderly with electric resistance or storage heating systems are exempt from this requirement provided there is informational metering of the individual dwelling units.

SECTION 2012.0 LIGHTING POWER LIMITS

2012.1 Scope: This section establishes the maximum power limits for interior and exterior illumination systems for new building design and for alterations to and additions to existing buildings.

2012.2 Exempt buildings: The following buildings are exempt from the provisions of this section:

1. buildings in use groups R-3 and R-4 (one- and two-family dwellings);
2. the dwelling unit portions of use group R-2 (multi-family); and
3. the manufacturing portion of industrial plants.

2012.3 Lighting power limit: A lighting power limit is the upper limit of the power to be available to provide the lighting needs of a building. Separate lighting power limits shall be calculated for the building interior and for the building exterior.

2012.4 Calculation procedure: To establish a lighting power limit, the following procedure set forth in Sections 2012.4.1 through 2012.4.3 shall be used:

2012.4.1 Interiors

1. Determine the use categories for the various parts of the building from Table 2012.
2. Multiply the maximum power limit for each category by the gross floor area included in that category.
3. Add the total number of watts for each area to arrive at the total lighting power limit for the building.
4. In open concept office spaces in excess of two thousand (2,000) square feet, without defined egress or circulation pattern, twenty-five (25) per cent of the area shall be designated as Category B.
5. In rooms with ceiling height in excess of twenty (20) feet, a power allowance, in watts per square foot, of an additional two (2) per cent per foot of height is permitted, up to a maximum of twice the limit in Table 2012.
6. In retail stores and in museums, an allowance of fifty thousand (50,000) watts may be added to the calculated lighting power limit for the building interior. However, the data which must be provided according to the provisions of Section 2012.7 shall indicate that the average watts per square foot of merchandising areas of Category A shall not exceed six and one-half (6.5).
7. In all cases of alterations or additions to existing buildings, the lighting power limit shall be calculated by combining the square footage of each category represented in such alterations or additions with the total square footage of the respective categories of the building within which such alterations or additions are planned.



## 2012.4.2 Exteriors:

1. Facade lighting: Multiply the limit given in Table 2012 by the number of linear feet in the building perimeter.
2. Parking: Multiply the value in Category F in Table 2012 by the area to be illuminated.

Table 2012

## LIGHTING LIMIT (CONNECTED LOAD) FOR LISTED OCCUPANCIES

Type of Use

Max. watts/sq. ft

## Interior

Category A: classrooms, office areas, mechanical areas, museums, conference rooms, drafting rooms, clerical areas, laboratories merchandising areas, kitchens, examining rooms, book stacks, athletic facilities, boiler rooms, outside sales areas, combined kitchen and dining facilities, day care centers, libraries, banks, valance and display case lighting  
2.50

Category B: auditoriums, waiting areas, spectator areas, restrooms, dining areas, transportation terminals, working corridors in prisons and hospitals, book storage areas, active inventory storage, hospital bedrooms, enclosed shopping mall concourse areas, stairways, locker rooms, churches, assembly areas, filing areas of offices, shipping and receiving areas, laundry areas, hotel and motel guest rooms.  
1.00

Category C: corridors, lobbies, elevators, inactive storage areas and foyers.  
1.00

Category D: indoor parking.  
0.25

## Exterior

Category E: building perimeter: wall-wash, facade, canopy.  
5.00  
(per linear foot)

Category F: outdoor parking  
0.10

## 2012.4.3 Exceptions:

1. Task lighting shall not be included in lighting power limit calculation.
2. Lighting for, but not limited to, clean rooms, sanctuaries in religious buildings, theatrical, television, spectator sports and like performances shall not be included in the total building limit. There shall be limited access to the controls for such lighting.
3. Heat lamps in bathrooms of hotel and motel guest rooms shall not be included in the total building limit. Such lamps shall be equipped with an automatic timer.

4. Lighting for the examination of patients by health care professionals shall not be included in the total building limit.
5. Sleeping areas of dormitories and patient rooms in nursing homes shall not be included in the total building limit.

2012.5 Alternatives: The installed lighting power for any interior area may be increased or decreased from the values of Table 2012 provided that the total interior lighting power limit calculated in Table 2012 is not exceeded.

2012.6 Special requirements: Bathrooms in hotels and motels shall have a switchable, permanently installed night light with a maximum wattage of five (5) watts.

2012.7 Documentation: Lighting power loads shall be included with the plans and specifications submitted to the building official. This data shall provide, for each category of Table 2012, the total area, the total connected lighting power load in watts, and the average watts per square foot. This data shall be provided on forms available from the State Building Code Commission.

#### SECTION 2013.0 BUILDING DESIGN BY SYSTEMS ANALYSIS

2013.1 Scope: This section establishes design criteria in terms of total energy use by a building including all of its systems.

2013.2 Compliance: Compliance with this section is optional and will require an analysis of the annual energy consumption. Section 2008.0 through 2012.0 establishes criteria for different energy consuming and enclosure elements of the building which, if followed, will eliminate the requirement for an annual energy analysis while meeting the intent of this article.

A building designed in accordance with this section will be deemed as complying with this article if the annual energy consumption is not greater than if the building were designed with enclosure elements and energy consuming systems in compliance with Sections 2008.0 through 2012.0.

2013.3 Standard design: The standard design, conforming to the criteria of Section 2008.0, and the proposed alternative design, shall be designed on a common basis as specified herein. The comparison shall be expressed as Btu input per square foot of gross floor area per year.

Identical energy sources must serve the same purpose in both the standard and the proposed alternative design. If the proposed alternative design results in an increase in consumption of one (1) energy source and a decrease in another energy source, each energy source shall be converted to equivalent Btu units for purposes of comparing the total energy used.

2013.4 Analysis procedure: The analysis of the annual energy usage of the standard and the proposed alternative building and system design shall meet the following criteria:

1. The building heating/cooling load calculation procedure used for annual energy consumption analysis shall be of sufficient detail to permit the evaluation of the effect of the factors specified in Section 2013.4.1
2. The calculation procedure used to simulate the operation of the building and its service systems through a full year operating period shall be of sufficient detail to permit the evaluation of the effect of system design, climatic factors, operational characteristics, and mechanical equipment on annual energy usage. Manufacturer's data or comparable field test data shall be used when available in the simulation of all systems and equipment. The calculation procedure shall be based upon eighty-seven hundred and sixty (8760) hours of operation of the building and its service systems and shall utilize techniques recommended in the appropriate ASHRAE publications.

2013.4.1 Calculation procedure: The calculation procedure shall cover the following items.

1. Environmental requirements as indicated in Section 2005.0.
2. Climatic data: coincident hourly data for temperatures, solar radiation, wind and humidity of typical days in the year representing seasonal variation.
3. Building data: orientation, size, shape, transfer characteristics of mass, air, moisture and heat.
4. Operational characteristics: temperature, humidity, ventilation, illumination, control sequence for occupied and unoccupied hours.
5. Mechanical equipment: design capacity, part load profile.
6. Internal heat generation from lighting, equipment, number of people during occupied and unoccupied periods.
7. Electrical equipment: lighting, power consumption.

2013.4.2 Documentation: Proposed alternative designs, submitted as requests for exception to the standard design criteria, shall be accompanied by an energy analysis comparison report prepared by a professional registered engineer or registered architect. The report shall provide sufficient technical detail on the two (2) buildings and systems designs, and on the data used in and resulting from the comparative analysis, to verify that both the analysis and the designs meet the criteria of this article. The documentation shall demonstrate that the analysis used is consistent with ASHRAE calculation procedures and accepted engineering practice.

Exception: Proposed alternative designs for buildings having an area of five thousand (5,000) square feet or less and having the indoor temperature controlled from a single point are exempted from the full

year energy analysis as described above. A comparison of energy consumption between the alternative design and the standard design shall be provided in a report prepared by a registered professional engineer or architect. Such analysis shall follow the bin or degree day methods or other simplified analysis procedures consistent with accepted engineering practice.

SECTION 2014.0 BUILDINGS UTILIZING SOLAR, GEOTHERMAL, WIND, OR OTHER NONDEPLETABLE ENERGY SOURCES AS ALTERNATIVE DESIGNS

2014.1 General: When a proposed alternative building, submitted in accordance with Section 2013.0, utilizes solar, geothermal, wind, wood or other nondepletable energy, that portion supplied to the building shall be excluded from the total energy chargeable to the proposed alternative design.

2014.2 Passive solar energy: The solar energy passing through windows shall be considered if there is a net Btu/year saving over fossil fuel or electric energy systems.

2014.2.1 Nocturnal cooling: This provision shall also apply to nocturnal cooling processes in lieu of energy consuming processes.

2014.2.2 Other criteria: All other criteria covered in Section 2013.0 shall apply to the proposed alternative designs utilizing nondepletable sources of energy.

2014.3 Documentation: Proposed alternative designs, submitted as requests for exception to the standard design criteria shall be accompanied by an energy analysis, as specified in Section 2013.0. The report shall provide sufficient technical detail on the alternative building and system designs and on the data employed in and resulting from the comparative analysis to verify that both the analysis and the designs meet the criteria of this article. The documentation shall demonstrate that the analysis used is consistent with ASHRAE calculation procedures.

Exception: Proposed alternative designs that derive over fifty (50) per cent of their annual thermal requirements (heating, cooling, service water heating) or over thirty (30) per cent of their annual total energy requirements from nondepletable sources shall be exempted from the necessity of comparing the proposed design to a standard design. Documentation, verifying the percentage of annual energy use derived from such nondepletable sources shall be required as provided in Section 2014.3 and shall be prepared by a registered professional engineer or architect.

2014.3.1 Performance data: The energy derived from nondepletable sources and the reduction in conventional energy requirements derived shall be separately identified from the overall building energy use. Sup-

porting documentation, on the basis of the performance estimates for the aforementioned nondepletable energy sources or nocturnal cooling means, must be submitted.

#### SECTION 2015.0 LIGHTING POWER LIMITS FOR EXISTING BUILDINGS

2015.1 Scope: This section establishes the maximum power limits for interior and exterior illumination systems for existing buildings.

2015.2 Regulated buildings: The provisions in Section 2015.0 shall apply to all existing buildings and structures with a gross floor area in excess of ten thousand (10,000) square feet.

2015.3 Existing buildings: For the purpose of Section 2015.0, existing buildings shall be defined as all buildings and structures in existence on July 1, 1978, and buildings and structures for which a building permit has been issued prior to July 1, 1978.

2015.4 Exempt buildings: The following buildings are exempt from the provisions of this section:

1. buildings in use groups R-3 and R-4 (one- and two-family);
2. the dwelling unit portion of use group R-2 (multi-family); and
3. the manufacturing portion of industrial plants.

2015.5 Lighting power limit: The lighting power limit is the upper limit of the power to be available to provide the lighting needs of a building. Separate lighting power limits shall be calculated for the building interior and for the building exterior. The building owner shall maintain the building lighting within the lighting power limit.

2015.6 Lighting switching: In all areas exterior to the building, lighting fixtures shall be capable of being switched automatically for nonoperation when natural light is available.

2015.7 Calculation procedure: To establish the lighting power limit, the following procedure set forth in Sections 2015.7.1 through 2015.7.3 shall be used:

##### 2015.7.1 Interiors:

1. Determine the use categories for the various parts of the building from Table 2015.
2. Multiply the maximum power limit for each category by the area included in that category.
3. Add the total number of watts for each area to arrive at the total lighting power limit for the buildings.
4. In open concept office spaces in excess of two thousand (2,000) square feet, without defined egress or circulation pattern, twenty-five (25) per cent of the area shall be designated as Category B.

5. In rooms with ceiling height in excess of twenty (20) feet, a power allowance, in watts per square foot, of an additional two (2) per cent per foot of height is permitted, up to a maximum of twice the limit in Table 2015.
6. In retail stores and in museums, an allowance of fifty thousand (50,000) watts may be added to the calculated lighting power limit for the building interior. However, the data which must be provided according to the provisions of Section 2015.9 shall indicate that the average watts per square foot of merchandising areas of Category A shall not exceed six and one-half (6.5).

2015.7.2 Exteriors

1. Facade lightings: Multiply the limit given in Table 2015 by the number of linear feet in the building perimeter.
2. Parking: Multiply the value in Category F in Table 2015 by the area to be illuminated.

2015.7.3 Exceptions:

1. Task lighting shall not be included in the lighting power limit calculation.
2. Lighting for, but not limited to, clean rooms, sanctuaries in religious buildings, and theatrical, television, spectator sports and like performances shall not be included in the total building limit. There shall be limited access to the controls for such lighting.
3. Heat lamps in bathrooms of hotel and motel guest rooms shall not be included in the total building limit. Such lamps shall be equipped with an automatic timer.
4. Lighting for the examination of patients by health care professionals shall not be included in the total building limit.
5. Sleeping areas of dormitories and patient rooms in nursing homes shall not be included in the total building limit.

Table 2015

LIGHTING LIMIT (CONNECTED LOAD)

FOR LISTED OCCUPANCIES: EXISTING BUILDINGS

see opposite page

780 CMR: STATE BUILDING CODE COMMISSION

| Type of Use   | Max. watts/sq. ft.       |
|---|--------------------------|
| terior  |                          |
| Category A: classrooms, office areas, mechanical areas, museums, conference rooms, drafting rooms, clerical areas, laboratories, merchandising areas, kitchens, examining rooms, book stacks, athletic facilities, boiler rooms, outside sales areas, combined kitchen and dining facilities, day care centers, libraries, banks, valance and display case lighting, hotel and motel guest rooms. | 3.00                     |
| Category B: auditoriums, waiting areas, spectator areas, restrooms, dining areas, transportation terminals, working corridors in prisons and hospitals, book storage areas, active inventory storage, hospital bedrooms, enclosed shopping mall concourse areas, stairways, locker rooms, churches, assembly areas, filing areas of offices, shipping and receiving areas, laundry areas.         | 1.00                     |
| Category C: corridors, lobbies, elevators, inactive storage areas and foyers.   | 0.50                     |
| Category D: indoor parking.   | 0.25                     |
| terior  |                          |
| Category E: building perimeter: wall-wash, facade, canopy.  | 5.00<br>(per linear foot |
| Category F: outdoor parking.  | 0.10                     |

2015.8 Alternatives: The lighting power for any interior area may be increased or decreased from the values of Table 2015 provided that the total interior lighting power limit calculated in Table 2015 is not exceeded.

2015.9 Documentation

2015.9.1 Lighting power audit form: Prior to November 1, 1978 a report of the lighting power load for every building subject to the provisions of Section 2015.0 shall have been submitted to the local building official and to the State Building Code Commission by the building owner. The report shall indicate for each building area corresponding to one (1) of the categories of Table 2015 the existing connected lighting power load in watts, the total area, and the average watts per square foot. The report shall be made on lighting power audit forms available at local building departments or at the office of the State Building Code Commission.

2015.9.2 Compliance plan: When lighting power loads exceed the limits of Section 2015.0, the building owner shall include with his lighting power audit an implementation plan indicating how and when the building will be brought into compliance with Section 2015.0. Implementation shall have been completed by February 1, 1979.

2015.9.3 Lighting power load certification: Certification of the building lighting power load by a registered engineer or architect may be required by the building official.

## SECTION 2016.0 BUILDING TEMPERATURE RESTRICTIONS

016.1 Scope: This section establishes requirements governing the maximum and minimum operating temperatures for heating and cooling respectively and limits the supply temperature for domestic hot water in buildings.

016.2 Regulated buildings: The requirements of this section shall apply to all buildings except as exempted in Section 2016.3.

016.3 Exempt buildings: The following buildings are exempt from the provisions of this Section:

1. Residential buildings in use groups R-3, R-4.
2. The dwelling units of use group R-2.
3. Health care facilities in use group I-2.
4. Lodging areas of hotels, motels, boarding houses, lodging houses and dormitories in use groups R-1, R-2.
5. Elementary schools, nursery schools and day care centers.

016.4 Compliance: Buildings shall be in compliance with this section when they meet one (1) of the following requirements:

1. Building Temperatures Restrictions (Section 2016.5); or
2. Alternative Compliance (Section 2016.6).

016.5 Building temperature restrictions: Buildings shall be operated at temperatures consistent with regulations published in the Federal Register 4 FR 39354 of July 5, 1979 and as amended from time to time in the Federal Register, as outlined in Appendix V.

016.6 Alternative compliance: Operation of a building at temperatures other than those required in this section may be permitted by utilizing one of the following methods of alternative compliance.

1. Percentage reduction:
  - a. Submission and implementation of a plan to reduce the annual energy consumption in a building by ten (10) per cent through means of a permanent alteration to the building envelope or energy utilizing system; or
  - b. Submission of documentation of a permanent alteration to the building envelope or energy utilizing system, completed since July 1, 1977, which resulted in a ten (10) per cent reduction in annual energy consumption.
  - c. Documentation shall be expressed in Btu/sf/yr of gross floor area.
2. Comparative analysis: An analysis comparing the building's annual energy consumption utilizing the current or proposed operating temperature with the building's annual energy consumption utilizing the required operating temperatures, as published in the Federal



Register 44 FR 39354 of July 5, 1979 and as amended from time to time in the Federal Register shall be submitted and shall meet the following criteria:

- a. For the purpose of this analysis, the base year for computing the building's annual energy consumption at the required temperature setting shall be any one (1) of the five (5) years immediately preceding July 1, 1977.
- b. When an analysis shows that the operation of the building at the required temperature settings results in a reduced level of energy consumption, an accompanying plan of permanent alteration to the exterior envelope or to an energy utilizing system which achieves this reduced level of consumption, shall be submitted and implemented.
- c. The building heating/cooling load calculations used for annual energy consumption analysis shall be of sufficient detail to permit the evaluation of the effect of the following:
  1. Environmental requirements as indicated in Section 2005.0
  2. Climatic data: coincident hourly data for temperatures, solar radiation, wind and humidity of typical days in the year representing seasonal variation.
  3. Building data: orientation, size, shape, transfer characteristics of mass, air, moisture and heat.
  4. Operational characteristics: temperature, humidity, ventilation, illumination, control sequence for occupied and unoccupied hours.
  5. Mechanical equipment: design capacity; part load profile
  6. Internal heat generation from lighting, equipment, number of people during occupied and unoccupied periods.
  7. Electrical equipment: lighting, power consumption.
- d. The comparison shall be expressed in Btu/sf/yr of gross floor area.

Exception: Comparative analysis for buildings having an area of fifteen thousand (15,000) square feet or less is exempt from the full year analysis. Analysis for buildings which qualify for this exemption shall follow the bin or degree day methods or other simplified analysis procedures, consistent with accepted engineering practice.

### 3. Design Analysis:

- a. An analysis of the building's energy consumption shall be performed comparing the building, as designed or built, with the standard design building as defined in Section 2013.0.
- b. The analysis shall be performed in accordance with Section 2013.0 utilizing the required operating temperatures, as published in the Federal Register 44 FR 39354 of July 5, 1979 and as amended from time to time in the Federal Register for the standard design building.

- c. A building, as designed or built, shall be deemed in compliance with this section if the annual energy consumption is less than the standard design building.

2016.6.1 Exception: Process energy is exempt from the provisions of alternative compliance.

2016.7 Documentation: Certification of a building's operation at the required temperature settings shall be in accordance with Part 490.43 of the Federal Register 44 FR 39354 of July 5, 1979, or an alternative compliance plan and, when necessary, an accompanying plan of permanent alteration showing compliance with Section 2016.0 shall be submitted by the building owner to the building official and to the State Building Code Commission. Alternative compliance plans shall be prepared by a registered professional engineer.

ARTICLE 21

BUILDING CODE PROVISIONS FOR ONE AND  
TWO-FAMILY DWELLINGS

SECTION 2100.0 GENERAL

2100.1 Scope: Contained within Article 21 of the State Building Code are provisions which shall regulate one- and two-family dwellings. These provisions are supplied to provide a single comprehensive reference for one and two-family dwellings. These provisions shall be considered as being applicable as stated.

2100.1.1 Basic code provisions: The requirements for one and two-family dwellings are stated in other articles of the basic code on a performance-oriented basis and may be used at the option of the designer. In addition, any requirements for which provisions are not made within this article shall be subject to the provisions of the other articles of the basic code.

2100.1.2 Reference standards: \* Standards referenced in the text of Article 21 represent recognized practices and specifications to be applied specifically using Article 21. If your copy of Article 21 has been printed separately, these reference standards are located immediately after the text of Article 21. Where Article 21 has been included as a portion of the Basic Code, these specific reference standards are included in Appendix W. Other reference standards contained in the Basic Code may be used at the option of the designer, in accordance with the provisions of Section 2100.1.1.

2100.2 Energy conservation

2100.2.1 Building design: Building design shall be based on compliance with the energy conservation performance standards of the basic code. If systems analysis or non-depletable energy sources are used, refer to Article 20.

2100.2.2 Exempt buildings: The following buildings are exempt from the energy conservation provisions of this article:

1. Buildings and structures or portions thereof whose peak design rate of energy usage is less than one (1) watt per square foot or three and four tenths (3.4) Btu/h per square foot of floor area for all purposes.
2. Buildings which are neither heated nor cooled.

2100.2.3 Additions to existing buildings: Additions to existing buildings or structures may be made without making the entire

\* Editorial addition

building or structure comply with the requirements of this code. The new construction shall conform to the requirements of this article as they relate to the addition only.

2100.2.4 Alterations to existing buildings: Alterations to existing buildings shall comply with this article on a component basis. When there are alterations to or replacement of the building enclosure elements (walls, roof or floors) or mechanical systems, those components only shall comply.

### 2100.3 Definitions

2100.3.1 Meaning: Unless otherwise expressly stated, the following terms shall, for the purpose of this code, have the meaning indicated in this section.

2100.3.2 Tense, gender and number: Words used in the present tense include the future; words used in the masculine gender include the feminine and neuter; the singular number includes the plural and the plural the singular.

2100.3.3 Terms not defined: Where terms are not defined, they shall have their ordinarily accepted meanings or such as the context may imply. Any terms relating to plumbing and electrical wiring shall have their terms as defined by the Regulations of the Commonwealth of Massachusetts pertaining to plumbing and electrical wiring.

Accepted engineering practice: That which conforms to accepted principles, tests or standards of nationally recognized technical or scientific authorities.

Accessory structure: A building or structure, the use of which is incidental to that of the main building or structure and which is located on the same lot.

Accessory use: A use incidental to the principal use of a building as defined or limited by the provisions of the local zoning laws.

Addition: An extension or increase in floor area or height of a building or structure.

Air-conditioning: The treatment of air so as to control simultaneously its temperature, humidity, cleanness and distribution to meet the requirements of a conditioned space.

Air duct: A tube or conduit used for conveying air.

Alteration: A change or modification of a building or structure, or the service equipment thereof, that affects safety or health and that is not classified as ordinary repairs.

- Alternate inspector:** A person appointed to act in the absence of the inspector of buildings in case of illness, disability, or conflict of interest.
- Approved:** Approved by the commission, the building official or accepted engineering practice. (See Section 110.0.)
- Approved material, equipment and methods:** Approved by the Commission or by an agency approved by the Commission.
- Approved rules:** Those rules approved by the State Building Code Commission unless otherwise specified.
- Area (building):** The area included within surrounding exterior walls (or exterior walls and fire walls) exclusive of vent shafts and courts. Areas of the building not provided with surrounding walls shall be included in the building area if included within the horizontal projection of the roof or floor above.
- Areaway (form of construction):** An uncovered subsurface space adjacent to a building.
- Attic:** The space between the ceiling beams of the top habitable story and the roof rafters.
- Attic (habitable):** A habitable attic is an attic which has a stairway as a means of access and egress and in which the ceiling area at a height of seven and one-third (7-1/3) feet above the attic floor is not less than one-third (1/3) the area of the floor next below.
- Automatic detecting device:** A device which automatically detects heat, smoke or other products of combustion.
- Automatic fire alarm system:** A system which automatically detects a fire condition and actuates a fire alarm signal device.
- Basement:** That portion of a building which is partly below and partly above grade, and having at least one-half (1/2) its height above grade (see "Grade", "Story" and "Cellar").
- Basic code:** The State Building Code of the Commonwealth of Massachusetts, also referred to as "this Code".
- Bay (part of a structure):** The space between two (2) adjacent piers or mullions or between two (2) adjacent lines of columns.
- Bay window:** A window projecting beyond the wall line of a building.

**Boiler:** A closed heating appliance intended to supply hot water or steam for space heating, processing or power purposes.

**Boiler capacity:** The amount of heat output in Btu/h at the design temperature rise and rated input.

**Brick (clay or shale):** A solid masonry unit of clay or shale, usually formed into a rectangular prism while plastic and burned or fired in a kiln.

**Calcium-silicate brick (sand lime brick):** A building unit made of sand and lime.

**Concrete brick:** A solid masonry unit having a shape approximately a rectangular prism and composed of inert aggregate particles embedded in a hardened cementitious matrix.

**Hollow brick:** A masonry unit of clay or shale whose net cross-sectional area in any plane parallel to the bearing surface is not less than sixty (60) per cent or more than seventy-five (75) per cent of its gross cross-sectional area measured in the same plane.

**Building:** Any structure used or intended for supporting or sheltering any use or occupancy.

**Building commissioner:** The administrative chief of the building department in a municipality who is charged with the administration and enforcement of this code. See also Inspector of Buildings and Section 107.1.

**Building component:** Any subsystem, subassembly or other system designed for use in or as part of a structure.

**Building department:** The person, body, agency, department or office of any municipality charged with the administration and enforcement of this code.

**Building envelope:** The elements of a building which enclose conditioned spaces through which thermal energy may be transferred to or from the exterior.

**Building, existing:** Any structure erected or one for which a legal building permit has been issued prior to the adoption of this code (and its amendments).

**Building line:** The line established by law, beyond which a building shall not extend, except as specifically provided by law.

**Building official:** The officer or other designated authority charged with the administration and enforcement of this code. Building official as used herein includes the building commissioner or the inspector of buildings and the local inspector.

**Building service equipment:** The mechanical, electrical and elevator equipment, including piping, wiring, fixtures and other accessories, which provide sanitation, lighting, heating, ventilation, fire-fighting and transportation facilities essential for the habitable occupancy of the building or structure for its designated use and occupancy.

**Building site:** The area occupied by a building or structure, including the yards and courts required for light and ventilation, and such areas that are prescribed for access to the street.

**Buttress:** A projecting part of a masonry wall built integrally therewith to furnish lateral stability which is supported on proper foundations.

**Cellar:** That portion of a building which is partly or completely below grade and having at least one-half (1/2) its height below grade (see "Grade", "Story" and "Basement").

**Certificate of use and occupancy:** The certificate issued by the building official which permits the use of a building in accordance with the approved plans and specifications and which certifies compliance with the provisions of law for the use and occupancy of the building in its several parts together with any special stipulations or conditions of the building permit.

**Change of use:** An alteration by change of use in a building heretofore existing to a new use group or sub-use group which imposes other special provisions of law governing building construction, equipment or means of egress.

**Chimney:** A primarily vertical enclosure containing one (1) or more passageways.

**Factory-built chimney:** A chimney that is factory-made, listed by a nationally recognized testing or inspection agency, for venting gas appliances, gas incinerators and solid or liquid fuel burning appliances.

**Masonry chimney:** A field constructed chimney of solid masonry units, bricks, stones, listed hollow masonry units or reinforced concrete built in accordance with nationally recognized standards.

- Metal chimney (smokestack):** A field constructed chimney made of metal and built in accordance with nationally recognized standards.
- Chimney connector:** A pipe which connects a fuel burning appliance to a chimney.
- Clay masonry unit:** A building unit larger in size than a brick, composed of burned clay, shale, fireclay or mixtures thereof.
- Combination of municipalities:** Any two or more cities and/or towns who have agreed to combine in order to share costs necessary for the administration and enforcement of this code in the said cities and/or towns.
- Combustible (material):** A combustible (material) is a material which cannot be classified as noncombustible in accordance with that definition.
- Commenced:** Any physical action begun on the job site for the purposes of construction for which a building permit is required.
- Commission:** See State Building Code Commission.
- Component:** An integral part of a building or its mechanical systems; an element of a building envelope.
- Concrete:** A mixture of cement, aggregates and water, of such proportions and manipulation as to meet specific requirements.
- Concrete masonry unit:** A building unit or block larger in size than twelve (12) by four (4) by four (4) inches made of cement and suitable aggregates.
- Conditioned floor area:** All portions of interior gross floor area which are contained within exterior walls and which are conditioned directly or indirectly by an energy-using system. (See gross floor area).
- Conflagration hazard:** The fire risk involved in the spread of fire by exterior exposure to and from adjoining buildings and structures.
- Construction operation:** The erection, alteration, repair, renovation, demolition or removal of any building or structure; and the excavation, filling, grading and regulation of lots in connection therewith.



**Construction supervisor:** Any individual directly supervising persons engaged in construction, reconstruction, alterations or repairs involving the structural elements of buildings and structures.

**Controlled construction:** The construction of a building or structure or a specific part thereof which has been designated and erected under the supervision of a licensed professional engineer or architect using controlled materials as herein defined in compliance with accepted engineering practice under the procedure of Section 127.0.

**Corridor:** A hallway, passageway or other compartmented space providing the occupants with access to the required exitways of the building or floor area.

**Court:** An open, uncovered, and unoccupied space on the same lot with a building.

**Inner court:** Any court other than an outer court.

**Outer court:** A court extending to and opening upon a street, public alley, or other approved open space, not less than fifteen (15) feet wide, or upon a required yard.

**Degree day, heating:** A unit, based upon temperature difference and time, used in estimating fuel consumption and specifying nominal heating load of a building in winter. For any one day, when the mean temperature is less than 65° F there exist as many degree days as there are Fahrenheit degrees difference in temperature between the mean temperature for the day and 65° F.

**Department/DPS:** The Department of Public Safety, Division of Inspections.

**Draft:** The pressure difference existing between the equipment or any component part of the atmosphere which causes a continuous flow of air and products of combustion through the gas passages of the appliance to the atmosphere.

**Forced draft:** The pressure difference created by the action of a fan, blower or ejector which supplies the primary combustion air above atmospheric pressure.

**Induced draft:** The pressure difference created by the action of a fan, blower or ejector which is located between the appliance and the chimney or vent termination.

**Natural draft:** The pressure difference created by a vent or chimney due to its height and the temperature difference between the flue gases and the atmosphere.

**Draft regulator:** A device which functions to maintain a desired draft in the appliance by automatically reducing the draft to the desired value.

**Duct:** A tube or conduit used for conveying or encasing purposes as specifically defined below:

**Air duct:** A tube or conduit used for conveying air. The air passages of self-contained systems are not to be construed as air ducts.

**Pipe duct:** A tube or conduit used for encasing pipe.

**Wire duct:** A tube or conduit used for encasing either moving or stationary wire, pipe, etc.

**Dwellings:**

**One-family dwelling:** A building containing one (1) dwelling unit with not more than three (3) lodgers or boarders.

**Two-family dwelling:** A building containing two (2) dwelling units with not more than three (3) lodgers or boarders per family but not more than twenty (20) individuals.

**Dwelling unit:** A single unit providing complete, independent living facilities for one (1) or more persons including permanent provisions for living, sleeping, eating, cooking, and sanitation.

**Energy:** The capacity for doing work. Energy takes a number of forms which may be transformed from one into another, such as thermal (heat), mechanical (motion), electrical, and chemical. In customary units, energy is measured in kilowatt-hours (kwh) or British thermal units (Btu).

**Energy efficiency ratio (EER):** The ratio of net cooling capacity in Btu/h to total rate of electric input in watts under designated operating conditions.

**Existing building:** See "Building, existing".

**Existing equipment:** Any equipment covered by this article which was installed prior to the effective date of this code or for which an application for permit to install was filed with the building official prior thereto.

**Exitway:** That portion of a means of egress which is separated from all other spaces of a building or structure by construction or equipment as required in this code to provide a protected way of travel to the exitway discharge.

**Exterior envelope:** The elements of a building which enclose conditioned spaces through which thermal energy may be transferred to or from the exterior.

**Fenestration:** Any light-transmitting device in the building envelope admitting natural light.

**Fire door:** A door and its assembly, so constructed and assembled in place as to give protection against the passage of fire.

**Fire door assembly:** The assembly of a fire door and its accessories, including all hardware and closing devices and their anchors; and the door frame, when required, and its anchors.

**Fireresistance:** That property of materials or their assemblies which prevents or retards the passage of excessive heat, hot gases or flames under conditions of use.

**Fireresistance rating:** The time in hours or fractions thereof that materials or their assemblies will resist fire exposure as determined by fire tests conducted in compliance with recognized standards.

**Fire separation wall:** A fireresistance rated assembly of materials not having unprotected openings, designed to restrict the spread of fire.

**Fire wall:** A fireresistance rated wall, having protected openings, which restricts the spread of fire and extends continuously from the foundation to or through the roof.

**Fire window:** A window constructed and glazed to give protection against the passage of fire.

**Flameresistance:** The property of materials or combinations of component materials which restricts the spread of flame as determined by the flameresistance tests specified in this code.

**Flame spread:** The propagation of flame over a surface.

**Flame spread rating:** The measurement of flame spread on the surface of materials or their assemblies and determined by tests conducted in compliance with recognized standards.

**Flammable:** Subject to easy ignition and rapid flaming combustion.

**Floor area, gross:** Gross floor area shall be the floor area within the perimeter of the outside walls of the building under consideration, without deduction for hallways, stairs, closets, thickness of walls, columns, or other features.

**Floor area, net:** For the purpose of determining the number of persons for whom exitways are to be provided, net floor area shall be the actual occupied area, not including accessory unoccupied areas or thickness of walls.

**Foundation:** A base constructed to support any building or structure including but not limited to footings, floating foundation, piles, caissons.

**Foundation wall:** A wall below the floor nearest grade serving as a support for a wall, pier, column or other structural part of a building.

**Fuel:** A solid, liquid, or gaseous substance with a high energy content that can be burned to release the energy.

**Fuel oil:** A liquid mixture or compound derived from petroleum which does not emit flammable vapor below a temperature of one hundred and twenty-five (125) degrees F. in a Tag closed-cup tester (ASTM D56).

#### **Furnace**

**Floor furnace:** A self-contained, connected or vented furnace designed to be suspended from the floor of the space being heated taking air for combustion outside this heated space and with means for observing the flame and lighting the appliance from the space being heated.

**Forced warm air furnace:** A furnace equipped with a blower to provide the primary means for circulating air.

**Warm air furnace:** A solid, liquid or gas-fired appliance for heating air to be distributed with or without duct systems to the space to be heated.

**Garage, private:** A garage for four (4) or less passenger motor vehicles without provision for repairing or servicing such vehicles for profit.

- Grade:** A reference plane representing the average of finished ground level adjoining the building at all exterior walls.
- Grade hallway, grade lobby, grade passageway:** An enclosed hallway or corridor that is an element of an exitway, terminating at a street or an open space or court communicating with a street.
- Heat:** The form of energy that is transferred by virtue of a temperature difference.
- Habitable space:** Space in a structure for living, sleeping, eating, or cooking. Bathrooms, toilet compartments, closets, halls, storage or utility space, and similar areas are not considered habitable space.
- Heated slab:** Containing heating pipes or ducts that constitute a radiant slab or portion thereof for complete or partial heating of the house.
- Heating appliance:** Any device designed or constructed for the generation of heat from solid, liquid or gaseous fuel or electricity.
- Recessed heater:** A completely self-contained heating unit usually recessed in a wall and located entirely above the floor of the space it is intended to heat.
- Unit heater:** A factory-assembled device designed to heat and circulate air. Essential components are a heat transfer element, housing and fan with driving motor. Normally designed for free delivery of recirculated air.
- Heated space:** A space within a building which is provided with a positive heat supply to maintain air temperature of fifty (50) degrees F. or higher.
- Height, building:** The vertical distance from the grade to the top of the highest roof beams of a flat roof, or to the mean level of the highest gable or slope of a hip roof. When a building faces on more than one (1) street, the height shall be measured from the average of the grades at the center of each street front.
- Height, court:** The vertical distance from the lowest level of the court to the mean height of the top of the enclosing walls.

**Height, story:** The vertical distance from top to top of two (2) successive tiers of beams or finished floor surfaces; and, for the topmost story, from the top of the floor finish to the top of the ceiling joists, or, where there is not a ceiling, to the top of the roof rafters.

**Height, wall:** The vertical distance from the foundation wall or other immediate support of such wall to the top of the wall.

**Hereafter:** After the time that this code becomes effective.

**Heretofore:** Before the time that this code becomes effective.

**Hollow masonry unit:** A masonry unit whose net cross-sectional area in any plane parallel to the bearing surface is less than seventy-five (75) per cent of its gross cross-sectional area measured in the same plane.

**Humidistat:** An instrument which measures changes in humidity and controls a device(s) for maintaining a desired humidity.

**HVAC:** Heating, ventilating, and air conditioning.

**HVAC system:** A system that provides either collectively or individually the processes of comfort heating, ventilating, and/or air-conditioning within or associated with a building.

**Infiltration:** The uncontrolled inward air leakage through cracks and interstices in any building element and around windows and doors of a building, caused by the pressure effects of wind and/or the effect of differences in the indoor and the outdoor air density.

**Inspector of buildings:** The administrative chief of the building department in a municipality who is charged with the administration and enforcement of this code. See also building commissioner. (See Section 107.1).

**Interior lot line:** Any lot line other than one adjoining a street or public space.

**Lintel:** A beam placed over an opening or recess in a wall which supports the wall construction above.

**Local enforcement agency:** A department or agency in a municipality charged with the enforcement of this code and appropriate specialized codes which include, but are not limited to, the Massachusetts Plumbing Code, Massachusetts Fuel Gas Code, and the Massachusetts Electrical Code.

**Local inspector:** A person in a municipality who assists the building commissioner or inspector of buildings in the performance of his duties and is charged with the enforcement of this code. (See Section 107.11).

**Lot:** A portion or parcel of land considered as a unit.

**Corner lot:** A lot with two (2) adjacent sides abutting upon streets or other public spaces.

**Interior lot:** A lot which faces on one (1) street or with opposite sides on two (2) streets.

**Lot line:** A line dividing one lot from another, or from a street or any public place.

**Maintenance:** Restoring or replacing deteriorated elements.

**Manual:** Capable of being operated by personal intervention. (See automatic).

**Masonry:** A built-up construction or combination of building units or materials of clay, shale, concrete, glass, gypsum, stone or other approved units bonded together with mortar or monolithic concrete. Reinforced concrete is not classed as masonry.

**Means of egress:** A continuous and unobstructed path of travel from any point in a building or structure to a public way.

**Mechanical ventilation:** The mechanical process of supplying air to, or removing air from, any space.

**Mortar:** A plastic mixture of approved cementitious materials, fine aggregates and water used to bond masonry or other structural units.

**Municipality:** Any city or town in the Commonwealth of Massachusetts. The word "municipality" shall be construed, where the context requires, as though followed by the words "or combination of municipalities".

**Native lumber:** Native lumber is wood processed in the Commonwealth of Massachusetts by a mill registered in accordance with the regulations of the State Building Code Commission. Such wood is ungraded but is stamped or certified in accordance with the requirements of Section 852.1.1 of the code. For the purpose of this definition, native lumber shall be restricted to use in one and two-story dwellings, barns, sheds, agricultural and accessory buildings and structures, and other uses when permitted by section 852.1.1.

**Nominal dimension:**

**Lumber:** A dimension that may vary from actual dimensions as provided in American Lumber Standard listed in Appendix C.

**Masonry:** A dimension that may vary from actual masonry dimensions by the thickness of a mortar joint but not to exceed one-half (1/2) inch.

**Non-depletable energy sources:** Sources of energy (excluding minerals) derived from incoming solar radiation including photosynthetic processes; from phenomena resulting therefrom including wind, waves and tides, lake or pond thermal differences; and energy derived from the internal heat of the earth, including nocturnal thermal exchanges.

**Noncombustible:** This is a general, relative term. Its precise meaning is defined in this code for specific applications.

**Occupancy:** The purpose for which a building, or part thereof, is used or intended to be used.

**Occupancy load:** The number of individuals normally occupying the building, or part thereof, or for which the exitway facilities have been designed.

**Occupied:** As applied to a building, shall be construed as though followed by the words "or intended, arranged or designed to be occupied".

**Opaque areas:** All exposed areas of a building envelope which enclose conditioned space, except opening for windows, skylights, doors, and building service systems.

**Ordinary materials:** Materials which do not conform to the requirements of this code for controlled materials.

**Outside air:** Air taken from the outdoors and, therefore, not previously circulated through the system.

**Overall thermal transfer value, (ottv):** Overall heat gain through the building wall.

**Owner:** Every person who alone or jointly or severally with others (a) has legal title to any building or structure; or (b) has care, charge, control of any building or structure in any capacity including but not limited to agent, executor, executrix, administrator, administratrix, trustee or guardian of the estate of the holder of legal title; or (c) lessee under a written letting agreement; or (d) mortgagee in possession; or (e) agent, trustee or other person appointed



by the courts. Each such person is bound to comply with the provisions of the Basic Code.

**Packaged terminal air-conditioner:** A factory-selected combination of heating and cooling components, assemblies, or sections, intended to serve a room or zone.

**Panel (Part of a structure):** The section of a floor or wall comprised between the supporting frame of two (2) adjacent rows of columns and girders or column bands of floor construction.

**Party wall:** A fire wall on an interior lot line used or adapted for joint service between two (2) buildings.

**Penthouse:** An enclosed structure above the roof of a building, other than a roof structure or bulkhead, occupying not more than thirty-three and one-third (33-1/3) per cent of the roof area.

**Permit:** An official document or certificate issued by the authority having jurisdiction authorizing performance of a specified activity.

**Person:** Every individual, partnership, corporation, firm, association, trustee or group, including a city, town, county, authority or other governmental unit, owning property or conducting any activity regulated by this Basic Code.

**Plenum:** An air compartment or chamber to which one (1) or more ducts are connected, and which forms part of an air distribution system.

**Positive heat supply:** Heat supplied to a space by design.

**Power:** In connection with machines, power is the time rate of doing work. In connection with the transmission of energy of all types, power refers to the rate at which energy is transmitted; in customary units, it is measured in watts (W) or British thermal units per hour (Btu/h).

**Prefabricated:** Construction materials or assembled units fabricated prior to erection or installation in a building or structure.

**Prefabricated building:** The completely assembled and erected building or structure, including the service equipment, of which the structural parts consist of prefabricated individual units or subassemblies using ordinary or controlled materials; and in which the service equipment may be either prefabricated or at-site construction.

- Prefabricated subassembly: A built-up combination of several structural elements designed and fabricated as an assembled section of wall, ceiling, floor or roof to be incorporated into the structure by field erection of two (2) or more such sub-assemblies.
- Prefabricated unit: A built-up section forming an individual structural element of the building, such as a beam, girder, plank, strut, column or truss, the integrated parts of which are prefabricated prior to incorporation into the structure, including the necessary means for erection and connection at the site to complete the structural frame.
- Prefabricated unit service equipment: A prefabricated assembly of mechanical units, fixtures and accessories comprising a complete service unit of mechanical equipment, including bathroom and kitchen plumbing assemblies, unit heating and air-conditioning systems and loopwiring assemblies of electric circuits.
- Preservative treatment (treated material): Unless otherwise noted, is impregnation under pressure with a wood preservative. Wood preservative is any suitable substance that is toxic to fungi, insects, borers, and other living wood-destroying organisms.
- Primary member: Any member of the structural frame of a building or structure used as a column; grillage beam; or to support masonry walls and partitions; including trusses, isolated lintels spanning an opening of eight (8) feet or more; and any other member required to brace a column or a truss.
- Professional engineer or architect: An individual technically and legally qualified to practice the profession of engineering or architecture.
- Public way: Any street, alley or other parcel of land open to the outside air leading to a public street, deeded, dedicated, or otherwise permanently appropriated to the public for public use and having a clear width of not less than ten (10) feet.
- Reinforced concrete: Concrete in which reinforcement, other than that provided for shrinkage or temperature changes, is combined in such manner that the two (2) materials act together in resisting forces.

**Repair:** Any maintenance which affects structure, egress, fire protection systems, fire ratings, energy conservation provisions (Article 20), or utilities. A building permit is required.

**Repairs, ordinary:** Any maintenance which does not affect structure, egress, fire protection systems, fire ratings, energy conservation provisions (Article 20), plumbing, sanitary, gas, electrical or other utilities. A building permit is not required for ordinary repairs.

**Reset:** Adjustment of the set point of a control instrument to a higher or a lower value, either automatically or manually in order to conserve energy.

**Residential unit:** In R-3 use group, a room or group of rooms occupied as a single unit.

**Resistance, thermal R:** A measure of the ability to retard the flow of heat. The R value is the reciprocal of a heat transfer coefficient as expressed by U.  $R = 1/U$ .

**Required:** Shall be construed to be mandatory by provisions of this code.

**Roof:** The roof slab or deck with its supporting members, not including vertical supports.

**Roof covering:** The covering applied to the roof for weather resistance, fireresistance or appearance.

**Roof structure:** An enclosed structure on or above the roof of any part of a building.

**Room air conditioner:** An encased assembly designed as a unit for mounting in a window or through a wall, or as a console. It is designed primarily to provide free delivery of conditioned air to an enclosed space, room or zone. It includes a prime source of refrigeration for cooling and dehumidification and means for circulating and cleaning air, and may also include means for ventilating and heating.

**Rubble masonry:** Masonry composed of roughly shaped stones.

**Secondary member:** Any member of the structural framework other than a primary member, including filling-in beams of floor systems.

**Sensible heat:** Heat added or removed which can be measured by a change in temperature of the substance.

**Separate sleeping area:** Area or areas of the family living unit in which the bedrooms (or sleeping rooms) are located. Bedrooms (or sleeping rooms) separated by other use areas, such as kitchens or living rooms (but not bathrooms), shall be considered as separate sleeping areas.

**Service systems:** All energy-using systems in a building that are operated to provide services for the occupants or processes housed therein, including HVAC, service water heating, illumination, transportation, cooking or food preparation, laundering or similar functions.

**Service water heating:** Supply of hot water for domestic or commercial purposes other than comfort heating.

**Service water heating demand:** The maximum design rate of heated water withdrawal from a service water heating system in a designated period of time (usually an hour or a day).

**Shall:** The term, when used in this code, shall be construed as mandatory.

**Smoke detector:** An approved, listed detector sensing visible or invisible particles of combustion.

**Solar energy source:** Source of thermal, chemical or electrical energy derived directly from conversion of incident solar radiation.

**Solid masonry:** Masonry consisting of solid masonry units laid contiguously with the joints between the units filled with mortar, or consisting of plain concrete.

**Stairway:** One (1) or more flights of stairs, and the necessary landings and platforms connecting them, to form a continuous and uninterrupted passage from one floor to another. A flight of stairs, for the purposes of this article, must have at least three (3) risers.

**State building code:** The State Building Code and amendments and rules and regulations thereto as promulgated by the State Building Code Commission under Sections sixteen (16), seventeen (17), and eighteen (18) of Chapter twenty-three (23)B of the Massachusetts General Laws Annotated as amended.

State building code commission (SBCC): The Massachusetts State Building Code Commission established by Section sixteen (16) of Chapter twenty-three (23)B of the Massachusetts General Laws Annotated as amended.

State inspector: An employee of the Division of Inspection, State Department of Public Safety, who is charged with administering and enforcing the Basic Code relative to any structure or building or parts thereof that are owned by the Commonwealth or any departments, commissions, agencies or authorities of the Commonwealth. The state inspector is also charged with supervising the enforcement of the Basic Code relative to all buildings and structures other than those owned by the Commonwealth. (See Section 108.9).

Story: That portion of a building included between the upper surface of a floor and upper surface of the floor or roof next above.

Story (first): The lower-most story entirely above the grade plane.

Street: A public thoroughfare (street, avenue, boulevard) which has been dedicated for public use.

Street lot line: The lot line dividing a lot from a street or other public space.

Structural clay tile: A hollow masonry unit composed of burned clay, shale, fireclay or mixtures thereof, and having parallel cells.

Structural steel member: Any primary or secondary member of a building or structure consisting of a rolled steel structural shape, cold-formed steel, light gage steel or steel joist members.

Structure: A combination of materials assembled at a fixed location to give support or shelter, such as a building, framework, retaining wall, tent, reviewing stand, platform, bin, fence, sign, flagpole, recreational tramway, mast for radio antenna or the like. The word "structure" shall be construed, where the context requires, as though followed by the words, "or part or parts thereof".

System: A combination of equipment and/or controls, accessories, interconnecting means, and terminal elements by which energy is transformed and delivered to desired areas so as

to perform a special function, such as HVAC, service water heating, or illumination.

**Thermal resistance R:** A measure of the ability to retard the flow of heat. The R value is the reciprocal of the heat transfer coefficient.  $R = 1/U$ .

**Thermal transmittance, U:** Coefficient of heat transmission (air to air) expressed in units of Btu per hour per square foot per degree F. It is the time rate of heat flow. The U value applies to combinations of different materials used in series along the heat flow path, single materials used in series along the heat flow path, single materials that comprise a building section, cavity air spaces, and surface air films on both sides of a building element.

**Thermal transmittance overall,  $U_o$  or overall  $U_o$ :** Overall (average) heat transmission of a gross area of the exterior building envelope, expressed in units of Btu per hour per square foot per degree F. The  $U_o$  value applies to the combined effect of the time rate of heat flows through the various parallel paths, such as windows, doors, and opaque construction areas, comprising the gross area of one or more exterior building components, such as walls, floors, or roof/ceiling.

**Thermostat:** An instrument which measures changes in temperature, and controls device(s) for maintaining a desired temperature.

**Tile:** A ceramic surface unit, usually relatively thin in relation to facial area, made from clay or a mixture of clay and other ceramic materials, called the body of the tile, having either "glazed" or "unglazed" face and fired above red heat in the course of manufacture to a temperature sufficiently high to produce specific physical properties and characteristics.

**Unitary cooling and heating equipment:** One or more factory-made assemblies which normally include an evaporator or cooling coil, a compressor and condenser combination, and may include a heating function as well. Where such equipment is provided in more than one assembly, the separate assemblies shall be designed to be used together.

**Unitary heat pump:** One or more factory-made assemblies which normally include an indoor conditioning coil, compressor(s) and outdoor coil or refrigerant-to-water heat exchanger, including means to provide both heating and cooling functions. It is designed to provide the functions of air-circulation, air cleaning, cooling, and heating with controlled temperature, and dehumidifying, and may optionally include

the function of humidifying. When such equipment is provided in more than one assembly, the separate assemblies shall be designed to be used together.

**Vent:** A conduit or passageway, vertical or nearly so, for conveying products of combustion to the outside atmosphere.  
**Type B and B-W:** A gas venting system consisting of vent piping and fittings listed for use with a listed gas appliance.

**Type L:** A low temperature venting system, consisting of listing vent piping and fittings for use with oil-burning appliances listed for use with Type L vents, or with listed gas appliances.

**Vent connector:** The pipe used to connect an approved fuel-fired appliance to a chimney or vent.

**Vent system:** A continuous open passageway from the flue collar or draft hood of a fuel burning appliance to the outside atmosphere for the purpose of removing products of combustion.

**Ventilation:** The process of supplying air to, or removing air from, any space. Such air may or may not have been conditioned.

**Ventilation air:** That portion of supply air which comes from outdoors, plus any recirculated air that has been treated to maintain the desired quality of air within a designated space.

**Vertical opening:** An opening through a floor or roof.

**Wall:**

**Bearing wall:** A wall supporting any vertical load in addition to its own weight.

**Cavity wall:** A wall built of masonry units or of plain concrete, or a combination of these materials, arranged to provide an air space within the wall, and in which the inner and outer parts of the wall are tied together with metal ties.

**Composite wall:** A wall built of a combination of two (2) or more masonry units of different materials bonded together, one (1) forming the back-up and the other the facing elements.

**Non-bearing wall:** A wall which does not support vertical load other than its own weight.

**Parapet wall:** That part of a wall entirely above the roof line.

Retaining wall: A wall designed to resist the lateral displacement of soil or other material.

Veneered wall: A wall having a facing of masonry or other weather-resisting noncombustible materials securely attached to the backing, but not so bonded as to exert common action under load.

Winder: A step in a winding stairway.

Writing: The term shall be construed to include handwriting, typewriting, printing, photo-offset or any other form of reproduction in legible symbols or characters.

Written notice: A notification in writing delivered in person to the individual or parties intended, or delivered at, or sent by certified or registered mail to the last residential or business address of legal record.

Yard: An unoccupied open space.

Zone: A space or group of spaces within a building with heating and/or cooling requirements sufficiently similar so that comfort conditions can be maintained throughout by a single controlling device.

Zoning: The reservation of certain specified areas within a community or city for buildings and structures, or use of land, for certain purposes with other limitations such as height, lot coverage and other stipulated requirements.

## SECTION 2101.0 BUILDING PLANNING

2101.1 General: Conformity with the applicable material, test, construction and design standards specified in the reference standards of this article shall be acceptable as providing compliance with the requirements of this article.

2101.1.1 Material and equipment identification: Where practicable, all materials and equipment requiring conformance to this code shall be marked in order to show compliance with the approved plans and specifications.

2101.1.2 Alternate materials, methods of construction, design or insulating systems: The provisions of this article are not intended to prevent the use of any material, method of construction, design or insulating system not specifically prescribed herein, provided that such construction, design or insulating system has been approved as specified in Section 110.0.



## 2101.2 Design criteria

2101.2.1 General: One and two-family dwelling structures shall be designed based upon the wind, snow, and live load criteria of Article 7 of the basic code. (30 psf-bedrooms, 40 psf-living areas and 30 psf-roof).

2101.3 Design conditions for energy conservation: The criteria of this section establish the minimum requirements for the thermal design of the exterior envelope of buildings and for HVAC systems and their parts.

2101.3.1 Thermal performance: A building that is designed to be both heated and cooled shall meet the more stringent of the heating or cooling requirements as provided in this article.

2101.3.2 Design parameters: The following design parameters shall be used for calculations required. (See Table 2101-1).

Table 2101-1  
DESIGN TEMPERATURES AND DEGREE DAYS

|             | Heating<br>Degree<br>Days | Heating<br>Degrees F. | Cooling<br>Degrees F.<br>Dry Bulb | Cooling<br>Degrees F.<br>Wet Bulb |
|-------------|---------------------------|-----------------------|-----------------------------------|-----------------------------------|
| Boston      | 5634                      | +10                   | 88                                | 74                                |
| Clinton     | 6517                      | + 2                   | 85                                | 74                                |
| Fall River  | 5774                      | + 9                   | 86                                | 74                                |
| Framingham  | 6144                      | + 3                   | 89                                | 74                                |
| Lawrence    | 6195                      | + 1                   | 88                                | 74                                |
| Lowell      | 6056                      | + 3                   | 89                                | 74                                |
| New Bedford | 5395                      | +13                   | 84                                | 73                                |
| Pittsfield  | 7578                      | + 1                   | 84                                | 74                                |
| Springfield | 5844                      | + 1                   | 88                                | 74                                |
| Taunton     | 6184                      | + 5                   | 86                                | 75                                |
| Worcester   | 6969                      | + 1                   | 87                                | 73                                |

2101.4 Location on lot: Exterior walls of dwellings located less than three (3) feet from property lines shall have not less than one (1) hour fireresistive rating.

2101.4.1 Opening protectives: Openings shall not be permitted in exterior walls of dwellings located less than three (3) feet from the property line.

2101.5 Light and ventilation: All habitable rooms shall be provided with aggregate glazing area of not less than eight (8) per cent of the floor area of such rooms. One-half (1/2) of the required area of glazing shall be openable.

Exception: A combination of natural and mechanical ventilation shall be allowed when evidence is submitted that the combination meets the minimum requirements established in this article.

2101.5.1 Alcove rooms: When alcove rooms open without obstruction into adjoining rooms, the required window openings to the outer air shall be based on the combined floor area of room and alcove. An alcove space shall be not more than sixty (60) square feet in area and the opening to the adjoining room shall not be less than fifty (50) per cent of the superficial area of the dividing wall, unless provided with separate means of light and ventilation.

2101.5.2 Mechanical ventilation: Ventilation air shall conform to Std. RS-21-12. The minimum value for each type of room use is given in Table 2101-2. The ventilation quantities specified are for one hundred (100) per cent outdoor air ventilating systems. A reduction to thirty-three (33) per cent of the specified outdoor values for recirculating HVAC systems is permitted. In no case shall the outdoor air quantity be less than five (5) cfm per person.

Exception: If outdoor air quantities other than those specified are used or required because of special occupancy requirements or other standards, the required outdoor air quantities shall be used as the basis for calculating the heating and cooling design loads.

Table 2101-2  
VENTILATION REQUIREMENTS FOR ONE- AND  
TWO-FAMILY DWELLINGS

| Type of Room                   | Required ventilation air<br>in cubic feet per minute<br>per human occupant |
|--------------------------------|--|
| General living areas, bedrooms | 5  |
| Kitchens                       | 20   |
| Baths, toilet rooms            | 20   |
| Basements, utility rooms       | 5  |

Note: If design occupancy is not known, ventilation is to be based upon an estimate of five (5) persons per one thousand (1,000) square feet of floor area.

2101.5.2.1 Natural ventilation: In a bathroom, if a window is available which is unrestricted and opens directly to the outer air, no mechanical ventilation shall be necessary.

#### 2101.6 Room dimensions

2101.6.1 Ceiling heights: Habitable (space) rooms, other than kitchens, storage rooms and laundry rooms shall have a ceiling height of not less than seven (7) feet three (3) inches. Hallways, corridors, bathrooms, water closet rooms, and kitchens shall have a ceiling height of not less than seven (7) feet measured to the lowest projection from the ceiling.

If any room in a building has a sloping ceiling, the prescribed ceiling height for the room is required in only one-half (1/2) the area thereof. No portion of the room measuring less than five (5) feet from the finished floor to the finished ceiling shall be included in any computation of the minimum area thereof.

If any room has a furred ceiling, the prescribed ceiling height is required in two-thirds (2/3) of the area thereof, but in no case shall the height of the furred ceiling be less than seven (7) feet.

2101.6.2 Floor area: Habitable rooms except kitchens shall have an area of not less than seventy (70) square feet between enclosing walls or partitions, exclusive of closet and storage spaces.

2101.6.3 Width: No habitable room other than a kitchen shall be less than seven (7) feet in any dimension.

Exception: Beams and girders spaced not less than six (6) feet on center may project not more than seven (7) inches below the required average ceiling height.

#### 2101.7 Glazing

2101.7.1 Human impact loads: Individual glazed areas in hazardous locations such as those indicated in Section 2101.7.2 shall comply with the requirements of the ANSI Z97.1 standard listed in RS-21-2, or by comparative test shall be proven to produce at least equivalent performance. Annealed glass shall not be used.

2101.7.2 Specific hazardous locations: The following shall be considered specific hazardous locations for purposes of glazing:

1. glazing in ingress and egress doors;
2. glazing in fixed and sliding panels of sliding type doors (patio and mall type);
3. glazing in storm doors;
4. glazing in all unframed swinging doors;
5. glazing in shower doors and tub enclosures;
6. glazing in fixed panels within sixty (60) inches horizontally of the nearest vertical edge of the ingress and egress door;
7. glazing in fixed panels with a bulkhead less than thirty-six (36) inches above the finish floor level which because of their size or design may be mistaken as a means of ingress or egress; and
8. glazing closer to the floor than eighteen (18) inches and exceeding six (6) square feet in area.

2101.8 Sanitation: Every dwelling unit shall meet the requirements of the Department of Public Health and the Massachusetts State Plumbing Code (248 CMR 2.00) relative to sanitation.

#### 2101.9 Private garages

2101.9.1 Openings: There shall be no openings from a private garage directly into a room used for sleeping purposes. Other openings between the garage and residence shall be equipped with doors providing a fire rating equivalent to twenty (20) minutes.

2101.9.2 Fire protection: The garage shall have five-eighths (5/8) inch gypsum board on the garage side of wall or floor adjacent to the house, and wherever the attic area is continuous between the garage and the house a firestop of one-half (1/2) inch gypsum board shall be used to form a barrier to separate the garage and house.

2101.9.3 Flooring: Garage and carport floor surfaces shall be approved nonabsorbent, noncombustible material.

2101.9.4 Floor level: The floor level of all door openings between the garage and the dwelling shall have either a minimum four (4) inch raised sill or the floor shall have a ramp or floor pitched a minimum of five (5) per cent in the direction of the overhead garage doors.

#### 2101.10 Egress

2101.10.1 Means of egress: In one- and two-family dwellings, each dwelling unit shall have two (2) independent means of egress, remote as possible from each other and leading to grade; in addition, every floor within a dwelling unit shall have at least one (1) means of egress which shall provide a continuous and unobstructed path leading to grade.

2101.10.2 Egress doors: Access to grade at termination of the required means of egress may be provided by the use of both side-hinged swinging doors or sliding glass doors. Swinging doors provided to meet this requirement may swing inward.

2101.10.3 Emergency egress: Sleeping rooms shall have at least one (1) openable window or exterior door to permit emergency egress or rescue. A required window must be openable from the inside without the use of separate tools, and shall conform to the following:

1. the sill height shall be not more than forty-four (44) inches above the finish floor;
2. shall provide a minimum net clear opening area of 3.3 square feet with a rectangle having minimum net clear opening dimensions of twenty (20) inches by twenty-four (24) inches, in either direction. If a double hung unit is used, then such dimensions shall apply to the bottom half.

2101.10.4 Doorways and hallways

2101.10.4.1 Interior doorways: The minimum nominal width of any interior doorway, except in closets, storage areas and bathrooms, shall be two (2) feet six (6) inches. There shall be no minimum requirement for doorway width in closets, storage areas and bathrooms.

2101.10.4.2 Exitway doorways: The minimum nominal width of every required exitway doorway to or from a stairway shall be thirty-six (36) inches.

Exception: Second means of egress doorways may be thirty-two (32) inches.

2101.10.4.3 Nominal height: The minimum nominal height of required egress doorways shall be six (6) feet six (6) inches.

2101.10.4.4 Exitway access: The minimum clear width of a hallway or exitway access shall be three (3) feet.

2101.10.4.5 Door hardware: Double cylinder dead bolts requiring a key operation on both sides are prohibited on required means of egress doors serving more than one dwelling unit.

2101.10.5 Landings: A landing shall be provided on each side of an egress door. The interior floor or landing shall not be more than two (2) inches lower than the threshold of the doorway. Where doors open over landings, the landings shall have a minimum width and depth of three (3) feet.

Exception: A landing is not required where the exit door does not swing over the stair.

2101.10.6 Door swing: A door may open at the top of a flight of stairs provided the door does not swing over the top step and the top step is not more than seven and one-half (7-1/2) inches below the threshold level.

2101.10.7 Accessory doors: Storm, screen or other doors accessory to exit doors which swing over stairs shall require a landing where they swing in the direction of the stairs. The landing shall be not more than seven and one-half (7-1/2) inches below the threshold level.

2101.10.8 Stairways: Required egress stairways shall be not less than three (3) feet in clear width. Headroom, rise and run shall conform to Figure 2101-1. Minimum headroom for basement cellar and service stairs shall be six (6) feet six (6) inches. Handrails may project from each side of a stairway a distance of three and one-half (3-1/2) inches into the required width.

2101.10.8.1 Loading: Stairways and landings shall provide for safe ascent and descent under normal and emergency conditions and for the transport of furniture and equipment.

2101.10.8.2 Spiral stairways: Spiral stairways may be used as an element of a means of egress within a single dwelling unit. The minimum width of tread shall be twenty-six (26) inches with each tread having a seven and one-half (7-1/2) inch minimum tread width at twelve (12) inches from the narrow edge. All treads shall be identical and the rise shall be not more than nine and one-half (9-1/2) inches. A minimum headroom of six and one-half (6-1/2) feet shall be provided.

2101.10.8.3 Winders: Winders may be used as an element of a means of egress, provided the width of the tread, at a point not more than eighteen (18) inches from the side where the treads are narrower, is not less than nine (9) inches.

Figure 2101-1

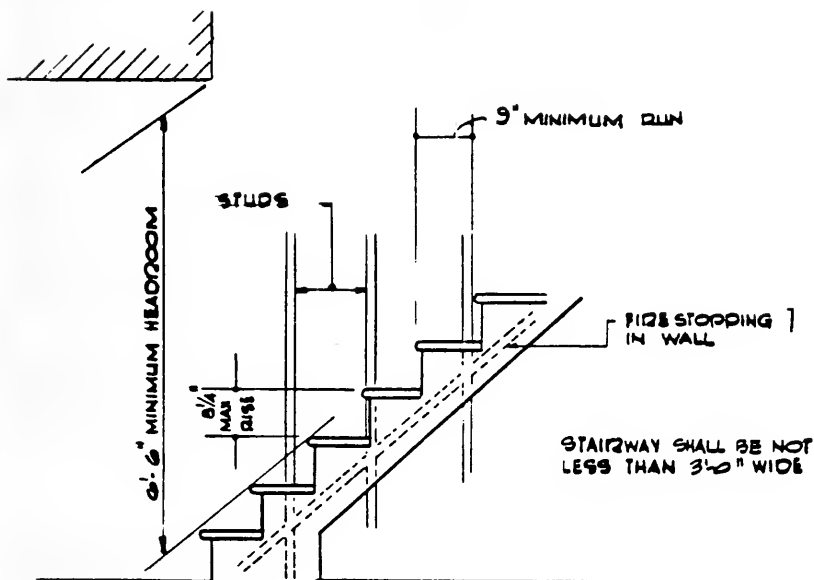

STAIR DETAIL

- 1 Indicate Firestopping as the dotted lines parallel to the stair stringers
- 2 Nosing not to exceed one and one-quarter (1¼) inches

2101.11 Handrails and guardrails: Handrails having minimum and maximum height of thirty (30) inches and thirty-four (34) inches, respectively, measured vertically from the nosing of the treads shall be provided on at least one (1) side of stairways of three (3) or more risers. Open sides of all stairs shall be similarly protected by guards. However, handrails shall not be required on stairways with three (3) or more risers where the raised platform to which they lead is thirty (30) inches or less above the floor or grade.

2101.11.1 Other guardrails: Porches, balconies or raised floor surfaces located more than thirty (30) inches above the floor or grade below shall have guardrails not less than thirty-six (36) inches in height.

2101.11.2 Details: Guards shall be constructed so that the area in the plane of the guard, from the top of the tread to the top of the guard, is subdivided or filled in one (1) of the following methods:

1. a sufficient number of intermediate longitudinal rails constructed so that the clear distance between rails (measured at right angles to the rail) does not exceed nine (9) inches. The bottom rail shall not be more than nine (9) inches (measured vertically) from the tread nosing; or
2. balusters spaced not more than nine (9) inches apart; or
3. panels of wire mesh, or expanded metal, or ornamental grills which provide protection equivalent to that provided by the intermediate rails or balusters specified in the two (2) preceding paragraphs; or
4. walls; or
5. any combination of the foregoing.

2101.12 Gutters and downspouts: When a city or town requires by ordinance or by-law, run-off control, then the provisions of Sections 2101.12.1 and 2101.12.2 shall apply.

2101.12.1 Minimum size of gutters: Gutters shall have the same area as downspouts for spacings up to forty (40) feet between downspouts. The width of the gutter shall be increased by one (1) inch for each additional twenty (20) feet of gutter.

2101.12.2 Downspouts: Downspouts shall be sized on the basis of approximately one hundred (100) square feet of roof surface to one (1) square inch leader.

2101.13 Flame spread for walls and ceilings

2101.13.1 Flame spread: All room, wall and ceiling finishes shall have a flamespread classification of not greater than two hundred 200 as tested in accordance with ASTM E84.

Exception: Flamespread requirements are not applicable to bathrooms.

2101.14 Fire protection

2101.14.1 Smoke detectors: All buildings which are defined by this code as one or two-family dwellings, including manufactured homes, shall contain a Type III system in conformance



with 2101.14.1.1 of this section with smoke detectors located as herein required and installed in conformance with NFIPA 74.

2101.14.1.1 Type III system: A Type III system shall be installed in accordance with NFIPA 74. Power shall be supplied from a permanently wired connection directly to an A.C. primary source of power or monitored batteries. All power for A.C. powered detectors shall be taken from a single branch circuit which also provides other electrical service to a habitable area; and the power source for the detectors shall be on the supply side, ahead of any switches. All required smoke detectors shall be provided with a visible power-on indication. All required smoke detectors shall be inter-connected so that when one actuates, all will sound to meet the requirements of NFIPA 74, Section 2-2.4. All required smoke detectors shall conform to Section 2101.14.3.

2101.14.2 Location: Smoke detectors shall be located to comply with the following minimum requirements:

1. Minimum number of detectors:
  - a. No less than one (1) approved smoke detector shall be provided on the highest habitable level and on each floor, story or level below, including basements or cellars.
  - b. For any floor, level or story exceeding twelve hundred (1200) square feet in area, one (1) approved smoke detector shall be provided for each twelve hundred (1200) square feet or part thereof.
2. Location of detectors:
  - a. One (1) approved smoke detector shall be located outside of each separate sleeping area, in accordance with the definition of "Separate Sleeping Area".
  - b. One (1) approved smoke detector shall be located on the ceiling near the base of, but not within, each stairway.
3. Combined coverage: Smoke detectors required by item 2-a of this section may be used to fulfill the requirements of item 2-b of this section.

2101.14.3 Approved devices: Single station and multiple station smoke detection devices: Smoke detectors of single station and multiple station types shall meet the requirements of U.L. 217 and be listed or approved by a nationally-recognized fire testing laboratory.

2101.14.4 Maintenance and testing:

1. It shall be the responsibility of the owner to properly maintain the system.

2101.15 Building in a flood plain: Where a structure is located in a flood plain or coastal high hazard area as determined by the building official or the governmental body having jurisdiction, such a structure must be designed to resist or overcome the anticipated flood conditions in accordance with the provisions of Section 744.0.

2101.16 Fire separation: The requirements for the construction of fire separation walls in buildings containing single-family dwellings or two-family dwellings (use group R-3 or R-4) are as follows:

1. Two-family dwelling, superimposed dwelling units: When one(1) dwelling unit of a two-family dwelling is located wholly or partly above the other dwelling unit, the two (2) dwelling units shall be completely separated by fire separation walls and floor-ceiling assemblies of not less than one (1) hour fire-resistance rated construction.
2. Two-family dwelling, side-by-side dwelling units: When adjacent dwelling units of a two-family dwelling are attached by a common wall, said wall shall be a fire separation wall, having a minimum one (1) hour fire-resistance rating that shall serve to completely separate the dwelling units.
3. Multiple single-family dwellings, side-by-side: When multiple single-family dwellings (use group R-3) are attached by a common wall, said wall shall be a fire separation wall, having a minimum one (1) hour fire-resistance rating. Said wall shall extend from the foundation to the underside of the roof sheathing, and to the inside of the exterior wall sheathing.
4. Multiple two-family dwellings; side-by-side: When a multiple two-family dwellings (use group R-3) are attached by a common wall, said wall shall be a fire separation wall, having a minimum one (1) hour fire-resistance rating. Said wall shall extend from the foundation to the underside of the roof sheathing and to the inside of the exterior wall sheathing.

#### SECTION 2102.0 FOUNDATIONS

2102.1 General: Foundations, footings and basement walls shall be constructed in accordance with the requirements of this section.

2102.2 Materials: Conformity with the applicable standards specified in the reference standards of this Article shall be acceptable as providing compliance with the requirements of this Article.

2102.2.1 Compressive strength: The ultimate compressive strength of concrete foundations at twenty-eight (28) days shall be not less than two thousand (2,000) pounds per square inch except where weather exposure requires a greater strength or cement content.

2102.3 Footings: All exterior walls, bearing walls, columns and piers shall be supported on solid masonry, or concrete footings, or other approved structural systems which shall be of sufficient design to support safely the loads imposed as determined from the character of the soil.

2102.3.1 Grade clearance: Foundation walls shall extend at least eight (8) inches above the finished grade adjacent to the foundation at all points, except where otherwise approved by the building official.

2102.3.2 Foundations on sloping grade: Foundations for all buildings where the surface of the ground slopes more than one (1) foot in ten (10) feet shall be level or shall be stepped so that both top and bottom of such foundations are level.

2102.3.3 Unformed foundation walls: Unformed foundation walls may be used when soil conditions warrant, subject to the approval of the building official.

2102.3.4 General: Footings of adequate size shall be provided when necessary to properly distribute the load within the allowable bearing pressure of the soil. All permanent supports of buildings and structures shall extend a minimum of four (4) feet below finished grade except when erected upon sound bedrock or when protected from frost, or when the foundation grade is established by a registered professional engineer and is approved by the building official. The engineer shall support the design grade with data including the type and extent of free-draining foundation material, ground water levels, and climatic records.

2102.4 Basement walls: Basement walls shall be constructed in accordance with the provisions of this section and in accordance with accepted practice.

2102.4.1 Masonry and concrete walls: Where unstable soil or ground water conditions do not exist, walls may be constructed of unreinforced masonry or concrete with the thickness shown in Table 2102-1.

2102.4.1.1 Reinforced masonry or concrete: Where unstable soil conditions exist or in seismic zones specified by the State Building Code Commission, basement walls may be constructed of reinforced masonry or concrete as set forth in Table 2102-1

provided the walls are not subjected to equivalent fluid pressures of more than thirty (30) pounds per square foot.

Exception: Basement walls retaining less than four (4) feet of unbalanced fill need not be reinforced.

2102.4.2 Design and installation:

1. Basement walls subjected to more than thirty (30) pounds per square foot equivalent fluid pressure shall be designed in accordance with accepted engineering practices.
2. Backfill adjacent to the wall shall not be placed until the wall has sufficient strength or has been sufficiently braced to prevent damage by the backfill.
3. Basement walls shall be drained and dampproofed in accordance with Section 2102.5 and Section 2102.6 respectively.

2102.5 Waterproofing: Drains shall be provided around concrete and masonry foundations enclosing habitable or usable spaces located below grade and which are subjected to ground water conditions. Drains shall be installed at or below the area to be protected and shall discharge by gravity or by mechanical means into an approved drainage system.

2102.5.1 Drainage tile protections: The top joints and perforations of drain tiles shall be protected with strips of building paper and the tiles shall be placed on two (2) inches of crushed rock and covered with not less than six (6) inches of the same material.

2102.6 Dampproofing: Exterior foundation walls of masonry construction enclosing basements shall be dampproofed by applying not less than three-eighths (3/8) inch of portland cement parging to the wall from footing to finish grade. The parging shall be covered with a coat of approved bituminous material applied at the recommended rate. Exterior foundation walls of concrete construction enclosing basements shall be dampproofed by applying a coat of approved bituminous material to the wall from the footing to the finish grade at the recommended rate.

2102.6.1 Concrete and masonry: Foundation walls of habitable rooms located below grade shall be waterproofed with membranes extending from the edge of the footing to the finish grade line. The membrane shall consist of either two (2) ply hot-mopped felts, six (6) mil polyvinyl chloride, fifty-five (55) pound roll roofing or equivalent material. The laps in the waterproofing membrane shall be sealed and firmly affixed to the wall.

2102.6.2 Other methods: Basement walls may be dampproofed or waterproofed using materials or methods of construction

other than covered in the section when approved by the building official.

2102.7 Foundation kneewalls: Studs shall have a minimum length of fourteen (14) inches and shall be not less in size and spacing than the studding required for exterior walls, and when exceeding four (4) feet in height shall be of the size required for an additional story.

2102.7.1 Kneewall bracing: Foundation kneewall studs of exterior walls and bearing partitions shall be thoroughly and effectively cross-braced (see Table 2103.3).

2102.8 Protection against decay and termites

2102.8.1 Wood in contact with the ground: All wood in contact with the ground and supporting permanent structures shall be approved treated wood. All wood below two (2) inches above surrounding grade, or in locations subject to ponding of water and/or dampers shall be of approved wood type or treated (pressure).

2102.8.2 Untreated wood: Untreated wood may be used where entirely below ground water level or continuously submerged in fresh water; and may be used in contact with the ground for detached accessory buildings not intended for human occupancy, for temporary structures, and for fences.

2102.8.3 Wood joists or the bottom of wood structural floors: When wood joists or the bottom of wood structural floors without joists are closer than eighteen (18) inches, or wood girders are closer than twelve (12) inches, to exposed ground located within the periphery of the building over crawl spaces or unexcavated areas, they shall be approved durable or treated wood. Ventilation shall be provided as required in Section 2102.9.

2102.8.4 Sills: All sills which rest on concrete or masonry exterior walls and are less than eight (8) inches from exposed earth shall be approved durable or treated wood.

2102.8.5 Wood posts or columns: Posts or columns in cellars shall be supported by piers projecting at least two (2) inches above the finish floor and separated therefrom by an approved impervious barrier except when approved durable or treated wood is used. Posts or columns used in damp locations below grade shall be of approved durable or treated wood.

2102.8.6 Wall pockets: Ends of wood girders entering masonry or concrete walls shall be provided with a one-half (1/2) inch

TABLE 2102-1  
 MINIMUM THICKNESS AND ALLOWABLE DEPTH OF  
 UNBALANCED FILL FOR UNREINFORCED MASONRY  
 AND CONCRETE WALLS<sup>1</sup> WHERE UNSTABLE  
 SOIL OR GROUND WATER CONDITIONS DO NOT EXIST

| Foundation Wall Construction | Nominal Thickness (inches)   | Maximum depth of unbalanced fill in feet <sup>1</sup> |                |         |
|------------------------------|--|---|----------------|---------|
|                              |  | Type of Super-Structure                               |                |         |
|                              |  | Wood Frame  | Masonry Veneer | Masonry |
| Masonry of Hollow Units      | 8  | 4 (6)   | 4.5 (6)        | 5 (7)   |
|                              | 10   | 5 (7)   | 5.5 (7)        | 6 (7)   |
|                              | 12   | 7   | 7              | 7       |
| Masonry of Solid Units       | 6  | 3   | 4              | 4       |
|                              | 8  | 5 (7)   | 5.5 (7)        | 6 (7)   |
|                              | 10   | 6 (7)   | 6 (7)          | 6.5 (7) |
|                              | 12   | 7   | 7              | 7       |
| Plain Concrete               | 6 <sup>2</sup>   | 4   | 4              | 4       |
|                              | 8  | 7   | 7              | 7       |
|                              | 10   | 7   | 7              | 7       |
|                              | 12   | 7   | 7              | 7       |
| Rubble Stone                 | Foundation walls of rubble stone shall be at least sixteen (16) inches thick. Rough or random rubble shall not be used as foundations for walls exceeding 35 feet in height. |   |                |         |

Note 1: The depth of unbalanced fill may be increased up to the values shown in parentheses where it is warranted by soil conditions. Unbalanced fill is the height of outside finish grade above the basement floor or inside grade.

Note 2: Six (6) inch plain concrete walls shall be formed both sides.

TABLE 2102-2  
 REINFORCEMENT REQUIRED FOR BASEMENT WALLS SUBJECTED TO NOT  
 MORE THAN 30 POUNDS PER SQUARE FOOT EQUIVALENT FLUID PRESSURE

| Material Type                          | Height of Unbalanced Fill in Feet | Length of Wall Between Supporting Masonry or Concrete Walls in Feet | Minimum <sup>1</sup> Wall Thickness in Inches | Required Reinforcing                      |                                   |
|--|-----------------------------------|---|---|---|-----------------------------------|
|  |                                   |   |   | Horizontal Bar in Upper 12 Inches of Wall | Size and Spacing of Vertical Bars |
| Hollow Masonry                         | 4 or less                         | unlimited   | 8   | not required                              | not required                      |
|  | more than 4                       | design required   | design req.                                   | design required                           | design required                   |
| Concrete or Solid <sup>2</sup> Masonry | 4 or less                         | unlimited   | 8   | not required                              | not required                      |
|  | more than 4                       | less than 8   | 8   | 2 - No. 3                                 | No. 3 @ 18" O.C.                  |
|  | 8 or less                         | 8 to 10   | 8   | 2 - No. 4                                 | No. 3 @ 18" O.C.                  |
|  | 8 or less                         | 10 to 12  | 8   | 2 - No. 5                                 | No. 3 @ 18" O.C.                  |
|  | more than 8                       | design required   | design req.                                   | design required                           | design required                   |

Note 1: Thickness of concrete walls may be six (6) inches provided reinforcing is placed not less than one (1) inch nor more than two (2) inches from the face of the wall not against the earth.

Note 2: Solid masonry shall include solid brick or concrete units and hollow concrete units with all cells grouted.

Note 3: Backfilling shall not be commenced until after the wall is anchored to the floor.

air space on top, sides and end, unless approved durable or treated wood is used.

2102.8.7 Clearance between wood siding: Clearance between wood siding and earth on the exterior of a building shall be not less than six (6) inches.

2102.8.8 Wood used in a retaining wall: Wood used in a retaining wall shall be approved durable or treated wood, except as follows:

1. when the wall is not more than two (2) feet in height and is located on the property line; or
2. when the wall is not more than four (4) feet in height and is separated from the property line by a minimum distance equal to the height of the wall.

2102.8.9 Where approved durable or treated woods are required: Where approved durable or treated woods are required in this code, the building official shall require identification by an approved mark or certificate of inspection. All lumber and plywood required to be preservatively treated shall bear an approved quality mark of an inspection agency that maintains continuing control, testing and inspection over the quality of the product.

2102.8.10 Pressure treatment: Where pressure treatment of wood members is required by this code, preservations and methods of treatment shall conform to the standards for pressure treatment and preserving of lumber listed in Reference Standard RS-21-4.

## 2102.9 Underfloor space ventilation

2102.9.1 General: The space between the bottom of the floor joists and the earth under any building (except such space as is occupied by a basement or cellar) shall be provided with a sufficient number of ventilating openings through foundation walls or exterior walls to insure ample ventilation, and such openings shall be covered with a corrosion-resistant wire mesh not greater than one-half (1/2) inch nor less than one-quarter (1/4) inch in any dimension. The minimum total area of ventilating openings shall be proportioned according to Section 2121.2. Vents shall be located to provide cross-ventilation.

Exception: Ventilation openings may be omitted when crawl space is used as a plenum.

2102.9.2 Access: An access crawl hole eighteen (18) inches by twenty-four (24) inches shall be provided to the underfloor space.



2102.9.3 Vegetation and organics: The underfloor grade shall be cleaned of all vegetation and organic material.

2102.9.4 Thermal performance: Floor sections over areas exposed to outside air shall meet the criteria for thermal transmittance specified in Table 2123-1.

## SECTION 2103.0 WALL CONSTRUCTION

2103.1 General: Wall and partition construction shall conform to the requirements of this section.

2103.1.1 Specifications: Conformity with the applicable grading, material, test, construction and design standards specified in the reference standards of this article shall be acceptable as providing compliance with the requirements of this section.

2103.1.2 Energy conservation requirements: Exterior walls shall meet the thermal transmittance requirements as specified in Table 2123-1.

### 2103.2 Wood

2103.2.1 Identification: All load-bearing lumber, plywood and particleboard shall conform to applicable standards or grading rules and shall be so identified by the grade mark, or certificate of inspection issued by an approved grading or inspection bureau or agency.

2103.2.2 Grade: All headers and studs shall be at least of No. 2, Standard or Stud Grade Lumber or equivalent.

#### Exceptions:

1. Bearing studs not supporting floors may be No. 3 or Utility Grade or equivalent provided the studs are spaced not more than sixteen (16) inches on center.
2. Nonbearing studs may be of No. 3 or Utility Grade or equivalent lumber.

2103.2.3 Construction: Exterior walls of wood frame residential buildings shall be constructed in accordance with Figures 2103-1 and 2103-2, and Tables 2103-2 and 2103-3.

2103.2.4 Engineering design: Exterior walls subject to wind pressure greater than thirty (30) pounds per square foot, as established in this code shall be designed in accordance with accepted engineering practice.

2103.2.5 Cutting and notching: It shall be unlawful to notch, cut or pierce wood beams, joists, rafters or studs in excess of the limitations herein specified unless proven safe by structural analysis, or suitably reinforced to transmit all calculated loads. Notches in the top or bottom of joists shall not exceed one-sixth ( $1/6$ ) the depth of the member and shall not be located in the middle of one-third ( $1/3$ ) of the span. Notches located closer to the supports than three (3) times the depth of the member shall not exceed one-fifth ( $1/5$ ) the depth. Holes bored or cut into joists for piping or electrical cables shall not be closer than two (2) inches to the top or bottom of the joist and the diameter of the hole shall not exceed one-third ( $1/3$ ) the depth of the joist. In studs of bearing walls or partitions, notches or bored holes made to receive piping, electrical conduit, air-conditioning or heating duct work or for other fabricating purposes shall not be cut or bored more than one-third ( $1/3$ ) the depth of the stud. When the stud is cut or bored in excess of one-third ( $1/3$ ) its depth, it shall be reinforced to be equal in load-carrying capacity to a stud notched not more than one-third ( $1/3$ ) its depth.

2103.2.6 Headers: The allowable span for headers in bearing walls shall not exceed the values set forth in Table 2103-4.

2103.2.7 Firestopping: Firestopping shall be provided to cut off all concealed draft openings (both vertical and horizontal) and form an effective fire barrier between stories, and between a top story and the roof space. It shall also be used in:

1. stud walls at ceilings and floor levels; and
2. in walls parallel to stair stringers; and
3. any other locations not specifically mentioned above, such as holes for pipes, shafting, behind furring strips, and similar places which could afford a passage for flames.

2103.2.7.1 Dimensions: Firestopping shall consist of approved noncombustible materials or of wood two (2) inches nominal thickness or three-quarter  $3/4$ " plywood. If width of opening is such that more than one (1) piece of lumber is necessary, there shall be two (2) thicknesses of one (1) inch nominal material with staggered joints.

2103.3 Native lumber: Native lumber, as defined in this code, shall be acceptable for use in one and two-story dwellings, barns, sheds, agricultural and accessory structures. Native lumber shall also be acceptable for use in other structures of less than three (3) stories as columns when the design loads are twenty-five (25) per cent greater than required elsewhere by this code; as joists, principal beams, and girders in floor constructions when the design loads are fifteen (15) per cent greater than required elsewhere by this code; and as other

elements when the design loads are as required elsewhere by this code.

Each piece of native lumber produced shall be stamped with the name and registration number of the producer in accordance with the rules and regulations of the State Building Code Commission. In addition, all native lumber shall bear an approved mark identifying the species of wood. In lieu of the stamp bearing the name and registration number and species identification, a certification bearing the same information may be provided by the producer for pre-cut or remanufactured lumber in accordance with the rules and regulations of the Commission. When native lumber is used, it shall be subject to the following requirements:

1. Sizing criteria: For lumber sized in accordance with the American Softwood Lumber Standard PS-20-70, figures for maximum fiber stress and modulus of elasticity for framing grade No. 2 will be used in establishing span and spacing characteristics for all structural members.
2. Stress increases: Lumber which is sized in excess of the dimensions established by the American Softwood Lumber Standard PS-20-70 for the given nominal size referenced shall be allowed to have a maximum fiber stress increase above that provided in Item 1 above in proportion to the increased bearing capacity of the cross-section as provided in Table 2103-1 or as calculated.

2103.4 Metal: Steel structural elements in walls and partitions may be either hot rolled structural steel shapes or bar sections or members cold formed to shape from steel sheet, strap or plate, or a fabricated combination thereof. Members shall be straight and free of any defects which would significantly affect their structural performance. The allowable span for steel headers in bearing walls shall not exceed the values set forth in Table 2103-4.

2103.4.1 Aluminum materials: Aluminum structural elements in walls and partitions shall be constructed of materials and designed in accordance with accepted engineering practice.

2103.5 Masonry construction: For additional information on masonry construction, see Article 8 of the basic code.

2103.5.1 Corbelling: Corbels may be built only into solid masonry walls twelve (12) inches or more in thickness. The projection for each course in such corbel shall not exceed one-third (1/3) of total thickness of the wall when used to support structural members, and not more than six (6) inches when used to

support a chimney built into the wall. The top course of all corbels shall be a header course.

2103.5.2 Combined units: In walls or other structural members composed of different kinds or grades of units, materials, or mortars, the maximum stress shall not exceed the allowable stress for the weakest of the combination units, materials, and mortars of which the member is composed. The net thickness of any facing unit which is used to resist stress shall be not less than one and one-half (1-1/2) inches.

2103.5.3 Stack bond: In unreinforced masonry where masonry units are laid in stack bond, longitudinal reinforcements consisting of not less than two (2) continuous wires each with a minimum aggregate cross-sectional area of .017 square inch shall be provided in horizontal bed joints spaced not more than sixteen (16) inches on center vertically.

2103.5.4 Unsupported height: The unsupported height of masonry walls shall not exceed the values set forth in Table 2103-6. The unsupported height shall be measured between points of anchorage. Footings may be considered as points of lateral support.

Where wall stability is provided by intersecting walls or vertical stiffening elements such as pilasters, the unsupported length may be measured between these elements providing the stiffening elements are anchored to the roof and floor with connectors capable of transmitting all tributary wind and seismic forces.

2103.5.5 Lintels: Masonry walls shall be reinforced over openings in accordance with Table 2103-7. Exceptions are allowed when an engineering analysis using standard accepted practice is provided to justify variations from the table below.

2103.5.5.1 Reinforcement: The reinforcement shall be located in spaces fully grouted to a depth of not less than eight (8) inches and shall extend not less than twelve (12) inches beyond the sides of the opening.

2103.5.6 Beam supports: Beams, girders or other concentrated loads supported by a wall or column shall have bearing of at least three (3) inches in depth measured parallel to the beam and three (3) inches in length upon solid masonry or upon a metal bearing plate of adequate design and dimensions to distribute the load safely, or upon a continuous reinforced masonry member projecting not less than four (4) inches from the face of the wall.

2103.5.6.1 Joists shall be supported in accordance with accepted engineering practice.

#### 2103.6 Hollow unit masonry

2103.6.1 General: Hollow unit masonry shall be laid with full face shell mortar beds and head and end joints shall be solidly filled with mortar for a distance in from the face of the wall or unit not less than the thickness of the longitudinal face shells. For details, see Article 8 of the basic code.

#### 2103.7 Solid masonry

2103.7.1 General: In each wythe of plain solid masonry, not less than seventy-five (75) percent of the units in any vertical plane perpendicular to the wall plane shall lap the ends of the units above and below a distance not less than one and one-half (1-1/2) inches or one-half (1/2) the height of the units, whichever is greater, or the masonry shall be reinforced longitudinally. For details, see the applicable reference standards and Article 8 of the basic code.

#### 2103.8 Cavity wall masonry

2103.8.1 General: Cavity wall masonry is that type of construction made with brick, structural clay tile or concrete masonry units or any combination of such units in which facing and backing are completely separated except for the metal ties which serve as bonding. For details, see the applicable reference standards and Article 8 of the basic code.

2103.8.2 Reinforcing: The facing and backing of cavity walls shall be bonded with three-sixteenths (3/16) inch diameter steel rods or metal ties of equivalent strength and stiffness embedded in the horizontal joints. There shall be one (1) metal tie for not more than each four and one-half (4-1/2) square feet of wall area for cavity widths up to three and one-half (3-1/2) inches net in width. Where the cavity exceeds three and one-half (3-1/2) inches net in width, there shall be one (1) metal tie for not more than three (3) square feet of wall area. Ties in alternate courses shall be staggered and the maximum vertical distance between ties shall not exceed twenty-four (24) inches and the maximum horizontal distance shall not exceed thirty-six (36) inches. Rods bent to rectangular shape shall be used with hollow masonry units laid with the cells vertical; in other walls the ends of ties shall be bent to ninety (90) degree angles to provide hooks not less than two (2) inches long. Additional bonding ties shall be provided at all openings, spaced not more than three (3) feet apart around the perimeter and within twelve (12) inches of the opening. Ties shall be of

corrosion-resistant metal, or shall be coated with a corrosion-resistant metal or other approved protective coating.

2103.9 Grouted masonry

2103.9.1 General: At the time of laying, all masonry units shall be free of excessive dust and dirt. Only Type M and Type S mortar consisting of a mixture of portland cement, hydrated lime and aggregate shall be used. For details, refer to the applicable reference standards and Article 8 of the basic code.



FIGURE 2103-2

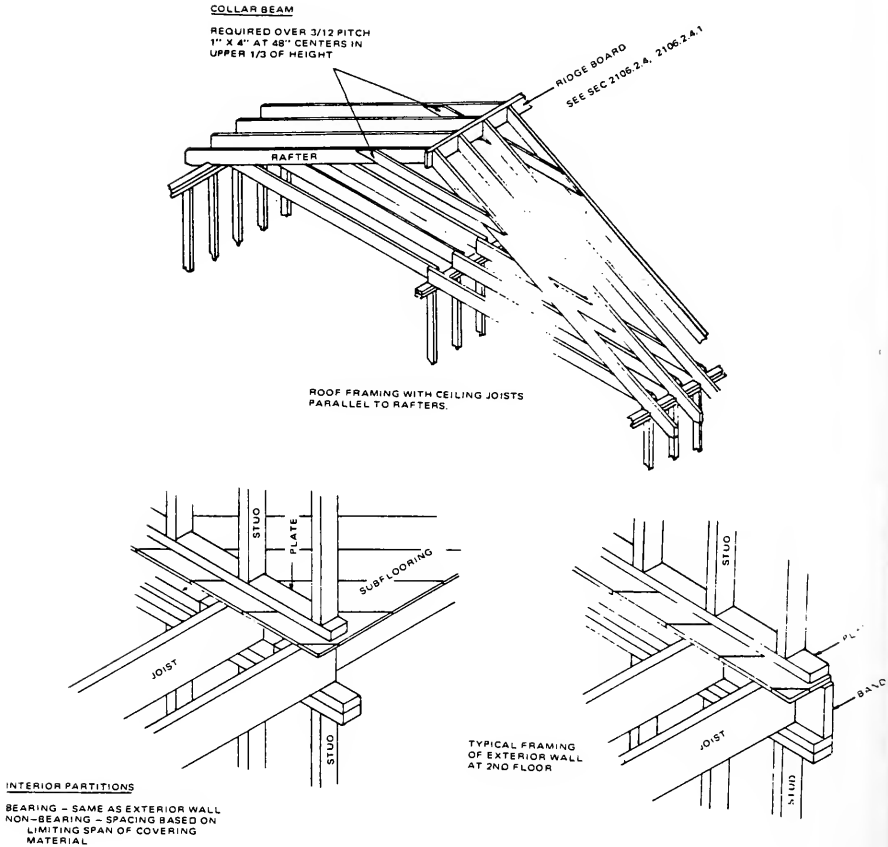
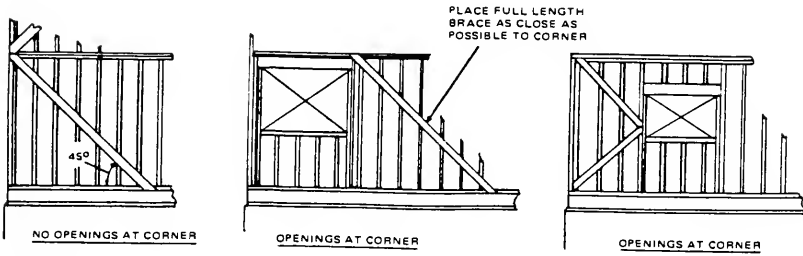



FIGURE 2103-3



**CORNER BRACING REQUIRED**

MIN. 1" X 4" AT 45° ANGLE OR METAL "T" STRIPS

NOT REQUIRED - WITH 4' X 8' PLYWOOD OR COMPOSITION SHEATHING APPLIED HORIZONTALLY OR VERTICALLY

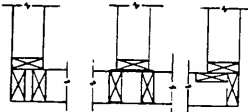
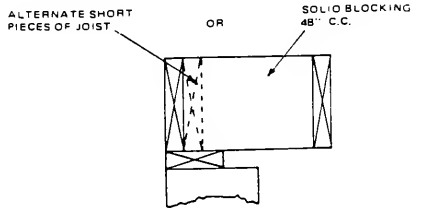
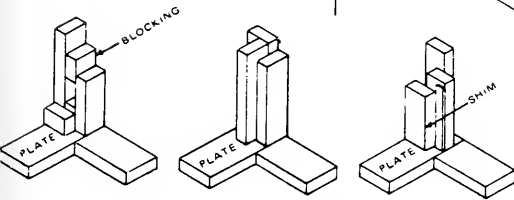
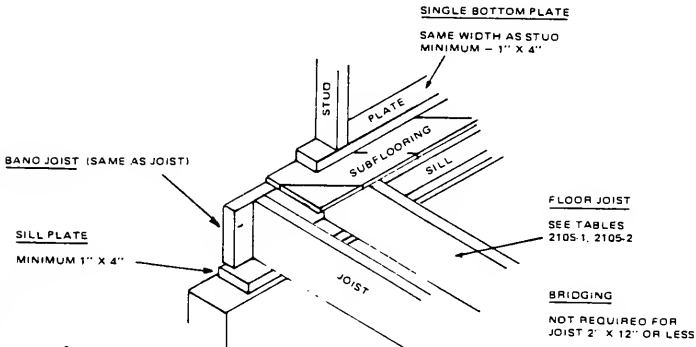

**CORNER STUDS**

**TYPICAL**

## 780 CMR: STATE BUILDING CODE COMMISSION

Table 2103-1  
NATIVE LUMBER ALLOWABLE STRESS

| Nominal Size | Actual Lumber Size. Closest Size which does not exceed the Dimension Shown |                        | Multiplier Factor Lumber Based on Width | Factor to be Added to Column 3 Factor for Lumber Oversized in Thickness |   |
|--------------|--|------------------------|---|---|---|
|              | Actual Size Thickness  | Width                  |   | Thick-ness In-crease of 1/4" to 1/2"                                    | Thick-ness In-crease of over 1/2" to 1" |
| 3 x 8        | 2-1/2 x<br>x<br>x  | 7-1/2<br>7-3/4<br>8    | 1.0 x Fs<br>1.07<br>1.14                | +0.10   | +0.20                                   |
| 3 x 10       | 2-1/2 x<br>x<br>x  | 9-1/2<br>9-3/4<br>10   | 1.0<br>1.05<br>1.11                     |   |   |
| 3 x 12       | 2-1/2 x<br>x<br>x  | 11-1/2<br>11-3/4<br>12 | 1.0<br>1.04<br>1.09                     |   |   |
| 3 x 14       | 2-1/2 x<br>x<br>x  | 13-1/2<br>13-3/4<br>14 | 1.0<br>1.04<br>1.07                     |   |   |
| 4 x 10       | 3-1/2 x<br>x<br>x  | 9-1/2<br>9-3/4<br>10   | 1.0<br>1.05<br>1.11                     | +0.07   | +0.14                                   |
| 4 x 12       | 3-1/2 x<br>x<br>x  | 11-1/2<br>11-3/4<br>12 | 1.0<br>1.04<br>1.09                     |   |   |
| 4 x 14       | 3-1/2 x<br>x<br>x  | 13-1/2<br>13-3/4<br>14 | 1.0<br>1.04<br>1.08                     |   |   |

## Notes to Table 2103-1

Note 1. Notation:  $F_s$  is the allowable maximum fiber stress for the assumed grade as established by this code in Sections 2105.2.2 and 2106.2.1.  $F's$  ("operating" stress) is the modified allowable maximum fiber stress which may be used in the span tables and for calculating required lumber sizes.  $F's$  is found by multiplying  $F_s$  by the factors given in the table.

## Note 2. Table Columns:

Column 1: is the nominal commonly used lumber size.

Column 2: is a list of actual sizes of the supplied lumber. Column 2 lists the sizes on the basis of a constant thickness and a width increasing by one-quarter (1/4) inch and one-half (1/2) inch.

Column 3: gives the multiplier for increasing the assumed allowable stress ( $F_s$ ) based on the increase in width as listed in Column 2.

Column 4: gives the multiplier for increasing the assumed allowable stress ( $F_s$ ) based on increases in thickness.

Note 3. Example: Fiber stress for assumed grade = one thousand (1,000) psi - Actual size 3-1/8 x 9-3/4

|                         |                                       |              |
|-------------------------|---------------------------------------|--------------|
| Nominal size            | 1. Multiplier factor for Width = 1.05 |              |
| <u>3 x 10</u>           |                                       |              |
| <u>3-1/8 = increase</u> | 2. Multiplier factor for Thick        | +            |
| of 1/8" total           | ness                                  | <u>= .20</u> |
|                         | Sum                                   | 1.25         |

3. Operating stress  $F's = 1.25 \times F_s$   
 $F's = 1.25 \times 1,000 = 1,250$

Therefore,  $F's = 1,250$  psi is used for calculations and in the span tables.

## 780 CMR: STATE BUILDING CODE COMMISSION

Table 2103-2 FASTENER SCHEDULE FOR STRUCTURAL MEMBERS 5

| DESCRIPTION OF BUILDING MATERIALS                            | NUMBER & TYPE <sup>1</sup><br>OF<br>FASTENER <sup>2,3,5</sup> | SPACING<br>OF<br>FASTENERS  |
|--|---|---|
| Joist to sill or girder, toe nail                            | 3-8d  | -   |
| 1" x 6" subfloor to each joist,<br>face nail                 | 2-8d<br>2-staples, 1 3/4"                                     | -<br>-  |
| Wider than 1" x 6" subfloor to<br>each joist, face nail      | 3-8d<br>4-staples, 1 3/4"                                     | -<br>-  |
| 2" subfloor to joist or girder,<br>blind and face nail       | 2-16d   | -   |
| Sole plate to joist or blocking,<br>face nail                | 16d   | 16" o.c.  |
| Top or sole plate to stud, end nail                          | 2-16d   | -   |
| Stud to sole plate, toe nail                                 | 4-8d or 3-16d   | -   |
| Doubled studs, face nail                                     | 16d   | 24" o.c.  |
| Doubled top plates, face nail                                | 16d   | 16" o.c.  |
| Top plates, taps and intersections,<br>face nail             | 2-16d   | -   |
| Continued header, two pieces                                 | 16d   | 16" o.c.<br>along each edge   |
| Ceiling joists to plate, toe nail                            | 2-16d   | -   |
| Continuous header to stud, toe nail                          | 4-8d  | -   |
| Ceiling joist, taps over partitions,<br>face nail            | 3-16d   | -   |
| Ceiling joist to parallel rafters,<br>face nail              | 3-16d   | -   |
| Rafter to plate, toe nail                                    | 3-8d  | -   |
| 1" brace to each stud and plate,<br>face nail                | 2-8d<br>2-staples, 1 3/4"                                     | -<br>-  |
| 1" x 6" sheathing to each bearing,<br>face nail              | 2-8d<br>2-staples, 1 3/4"                                     | -   |
| 1" x 8" sheathing to each bearing,<br>face nail              | 2-8d<br>3-staples, 1 3/4"                                     | -<br>-  |
| Wider than 1" x 8" sheathing to each<br>bearing, face nail   | 3-8d<br>4-staples, 1 3/4"                                     | -<br>-  |
| Built-up corner studs  | 16d   | 30" o.c.  |
| Built-up girder and beams                                    | 20d   | 32" o.c. at top<br>& bottom &<br>staggered 2-20d<br>at ends & at ea.<br>splice. |
| 2-inch planks  | 2-16d   | at each bearing   |
| Roof rafters to ridge, valley<br>or hip rafters,<br>toe nail | 2-16d   | -   |
| face nail  | 3-16d   | -   |
| Collar ties to rafters, face nail                            | 3-8d  | -   |

## 780 CMR: STATE BUILDING CODE COMMISSION

Table 2103-2 (continued)

| DESCRIPTION OF BUILDING MATERIALS                  | DESCRIPTION <sup>1</sup> OF FASTENERS <sup>2,3,5</sup>                  | SPACING OF FASTENERS |                          |
|--|---|----------------------|--------------------------|
|  |   | edges.               | inter. sup. <sup>4</sup> |
| Plywood subfloor, roof and wall sheathing to frame |   |                      |                          |
| 1/2 inch - 5/16 inch                               | 6d staple 16 ga.  | 6"<br>4"             | 10"<br>7"                |
| 5/8 inch - 3/4 inch                                | 8d smooth or 6d deformed  | 6"                   | 10"                      |
| 7/8 inch   | 8d  | 6"                   | 10"                      |
| 1 inch - 1 1/8 inch                                | 10d smooth or 8d deformed   | 6"                   | 6"                       |
| Other wall sheathing <sup>7</sup> / <sub>16</sub>  |   |                      |                          |
| 1/2" Fiberboard sheathing                          | 1-1/2" galvanized roofing nail 6d common nail staple 16 ga. 1-1/8" long | 3"                   | 6"                       |
| 25/32" Fiberboard Sheathing                        | 1-3/4" galvanized roofing nail 8d common nail staple 16 ga. 1-1/2" long | 3"                   | 6"                       |
| 1/2" Gypsum Sheathing                              | 1-1/2 galvanized roofing nail 6d common nail staple 16 ga. 1-1/2" long  | 4"                   | 8"                       |
| Particleboard wall Sheathing (Exterior-Type 2-B-1) |   |                      |                          |
| 3/8" - 1/2"  | 6d common nail  | 6"                   | 12"                      |
| 5/8" - 3/4"  | 8d common nail staple 16 ga. 1-1/2" long                                | 6"                   | 12"                      |
| Combination subfloor-underlayment to framing       |   |                      |                          |
| 3/4 inch and less                                  | 6d deformed   | 6"                   | 10"                      |
| 7/8 inch - 1 inch                                  | 8d deformed   | 6"                   | 10"                      |
| 1-1/8 inches - 1-1/4 inches                        | 10d smooth or 8d deformed   | 6"                   | 6"                       |

Note 1. All nails are smooth-common, box or deformed shanks except where otherwise stated.

Note 2. Nail is a general description and may be T-head, modified round head or round head.

Note 3. Staples are sixteen (16) gauge wire and have a minimum seven-sixteenths (7/16) inch O.D. crown width.

Note 4. Nails shall be spaced at not more than six (6) inches o.c. at all supports where spans are forty-eight (48) inches or greater. Nails shall be spaced at not more than ten (10) inches o.c. at intermediate supports for floors.

Note 5. The number of fasteners required for connections not included in this table shall be based on the values set forth in Reference Standard RS-21-6.

Note 6. 4' x 8' or 4' x 9' panels shall be applied vertically.

Table 2103-3  
FRAMING SIZES

| Stud Size | Wall Bearing | Maxim Spacing | Min. # & Plate Size  | Min. Sole | Max. Stud Height | Comments & Notes                                       |
|-----------|--------------|---------------|----------------------|-----------|------------------|--|
| 2"x6"     | yes f        | 24"           | single 2"x6"<br>a, d | 2"x6"     | 20' b,c,e        | 2 post corner - see Figure 2103-3                      |
| 2"x6"     | no           | 48"           | single 2"x6"<br>a, d | 2"x6"     | note i           |  |
| 3"x4"     | yes f        | 24"           | single 2"x4"         | 2"x4"     | 14' b            |  |
| 2"x4"     | yes f        | 16"           | double 2"x4"<br>g    | 2"x4"     | 14' b,e,h        |  |
| 2"x3"     | no           | 48"           | single 2"x3"<br>g    | 2"x3"     | 10' e,f,i        | Exterior wall & Interior partition - see Figure 2103-3 |
| 2"x4"     | no           | 24"           | double 2"x4"<br>g    | 2"x4"     | 14' b,e          |  |

Notes to Table 2103-3

Note a. Allowed if plate spliced directly over studs.

Note b. Maximum eight (8) foot height for utility studs.

Note c. Allowed in up to three (3) story buildings only.

Note d. Allowed if 1/8" x 1 1/2" x 6" inches metal tie plates used and if ceiling joists and/or roof trusses directly over studs

Note e. Maximum allowable height unless braced laterally.

Note f. Allowed if supporting not more than a ceiling and roof load when using utility studs.

Note g. If all elements line up, then twenty-four (24) inch spacing allowed with single plate.

Note h. Allowed only up to two (2) stories in height unless first floor is framed with 2" x 6" studs, then three (3) stories.

Note i. Ten (10) foot maximum for utility studs.

Note j. One (1) inch sole plate attached to studs by end nailing is acceptable.

Note k. Exceptions are allowed when an engineering analysis using standard accepted practice is provided to justify variations from the above Table 2103-3.

Table 2103-4  
 MAXIMUM ALLOWABLE SPANS FOR HEADERS  
 SUPPORTING WOOD FRAME WALLS

| Size of Steel Header                    | Size of Wood Header <sup>3</sup> | Allowable Span of Headers in Feet for Bearing Walls <sup>1,2</sup> |                 |                   |   |
|---|----------------------------------|--|-----------------|-------------------|---|
|   |                                  | Sptg. Roof   | One Story Above | Two Stories Above | Allowable Span of Headers in Garages or in Walls not Supporting Floors or Roofs |
| 2- $\frac{1}{2}$ x2- $\frac{1}{2}$ x1/4 | 2-2"x4"                          | 4'   | -               | -                 | 6'  |
| 3- $\frac{1}{2}$ x3- $\frac{1}{2}$ x1/4 | 2-2"x6"                          | 4' to 6'   | 4'              | -                 | 6' to 8'  |
| 6x1-7/8 jr                              | 2-2"x8"                          | 6' to 8'   | 4' to 6'        | -                 | 8' to 10'   |
| 4x2-5/8                                 | 2-2"x10"                         | 8' to 10'  | 6' to 8'        | 4' to 6'          | 10' to 12'  |
| 7x2-1/8 jr                              | 2-2"x12"                         | 10' to 12'   | 8' to 10'       | 6' to 8'          | 12' to 16'  |

Notes to Table 2103-4

Note 1. Based on header providing support for wall height equal to width of opening.

Note 2. Nominal four (4) inch wide single headers may be substituted for the double members.

Note 3. Spans are based on number two (2) or Standard Grade lumber. Number three (3) Grade lumber may be used with appropriate design.

Table 2103-5  
 PLYWOOD WALL SHEATHING  
 Face Grain Parallel or  
 Perpendicular to Studs

| Minimum Thickness | Panel Identification Index | Stud Spacing (inches)  |                             |  |
|-------------------|----------------------------|------------------------|-----------------------------|--|
|                   |                            | Siding Nailed to Studs | Sheathing Parallel to Studs | Siding Nailed to Sheathing to Sheathing Perpendicular to Studs |
| 5/16              | 12/0, 16/0<br>20/0         | 16                     | —                           | 16   |
| 3/8               | 16/0, 20/0<br>24/0         | 24                     | 16                          | 24   |
| 1/2               | 24/0, 32/16                | 24                     | 24                          | 24   |

Table 2103-6  
ALLOWABLE SPAN FOR MASONRY WALLS  
BETWEEN LATERAL SUPPORTS

| TYPE OF MASONRY WALL                 | ALLOWABLE <sup>4</sup><br>H or L<br>(between supports) <sup>1</sup> |
|--------------------------------------|---|
| Stone                                | 14 × t <sup>2</sup>   |
| Cavity and <sup>3</sup> Hollow Units | 18 × t <sup>2</sup>   |
| Solid and Grouted (plain)            | 20 × t <sup>2</sup>   |
| Reinforced Grouted                   | 25 × t <sup>2</sup>   |

Notes to Table 2103-6

Note 1. Support may be provided by roofs, floors, foundations, beams, etc., in vertical direction or by pilasters, columns, piers, cross walls, etc., in horizontal direction, either but not both are required.

Note 2. "t" is taken as the nominal thickness of the wall in inches.

Note 3. "t" for cavity walls, is the sum of the nominal thickness of the wythes without the cavity.

Note 4. An additional unsupported height of six (6) feet is permitted for gable end walls.

Table 2103-7  
ALLOWABLE SPAN FOR MASONRY AND STEEL  
LINTELS SUPPORTING MASONRY WALLS

| Number of 1/2" <sup>1</sup><br>Diameter, or<br>Equivalent Area,<br>Reinforcing Bars | Allowable Span in <sup>2</sup> Feet and Inches |                    |                     | Structural <sup>3</sup> Steel           |
|---|--|--------------------|---------------------|---|
|   | No Floor<br>Above                              | One Floor<br>Above | Two Floors<br>Above |   |
| 1   | 4' - 6"  | 3' - 0"            | 2' - 6"             | ∠ 2-1/2 × 2-1/2 × 5/16<br>∠ 3 × 3 × 1/4 |
| 2   | 6' - 0"  | 4' - 0"            | 3' - 6"             | ∠ 3-1/2 × 3-1/2 × 5/16<br>ST 5 I        |
| 3   | 8' - 6"  | 5' - 0"            | 4' - 0"             | ST 5<br>ST 6 I                          |
| 4   | 10' - 0"                                       | 6' - 0"            | 5' - 0"             | ST 6<br>ST 8 B                          |



## Notes to Table 2103-7

Note 1. Depth of reinforced lintels shall be not less than eight (8) inches and all cells of hollow masonry lintels shall be grouted solid. Reinforcing bars shall extend not less than eight (8) inches into the support.

Note 2. Based on ten (10) foot tributary floor and roof loads; in other words, headers located in exterior walls and supporting twenty (20) foot span joists or headers located in interior bearing walls and supporting joists spanning ten (10) foot wide rooms on each side.

Note 3. Extend steel lintels six (6) inches into the support.

TABLE 2103-7A  
ALLOWABLE SPANS FOR LINTELS  
SUPPORTING MASONRY VENEER

| Size of Steel Angle <sup>1</sup> | No Story Above | One Story Above | Two Stories Above | No. of 1/2" or Equivalent Reinforcing Bars <sup>2</sup> |
|----------------------------------|----------------|-----------------|-------------------|---|
| ∠ 3 X 3 X 1/4                    | 6' - 0"        | 3' - 6"         | 3' - 0"           | 1   |
| ∠ 4 X 3 X 1/4                    | 8' - 0"        | 5' - 0"         | 3' - 0"           | 1   |
| ∠ 6 X 3 1/2 X 1/4                | 14' - 0"       | 8' - 0"         | 3' - 6"           | 2   |
| ∠ 2 - 6 X 3 1/2 X 1/4            | 20' - 0"       | 11' - 0"        | 5' - 0"           | 4   |

## Notes to Table 2103-7A

Note 1. Long leg of the angle shall be placed in a vertical position.

Note 2. Depth of reinforced lintels shall be not less than eight (8) inches and all cells of hollow masonry lintels shall be grouted solid. Reinforcing bars shall extend not less than eight (8) inches into the support.

780 CMR: STATE BUILDING CODE COMMISSION

Table 2108-A

DESIGN VALUES FOR JOISTS AND RAFTERS-VISUAL GRADING

These "F<sub>b</sub>" values are for use where repetitive members are spaced not more than 24 inches. For wider spacing the "F<sub>b</sub>" values should be reduced 13 percent.

Values for surfaced dry or surfaced green lumber apply at 19 percent maximum moisture content in use.

| Species and Grade  | Size                | Design Value<br>in Bending "F <sub>b</sub> " |                 |                  | Modulus of<br>Elasticity<br>"E" |
|--|---------------------|--|-----------------|------------------|---------------------------------|
|  |                     | Normal<br>Duration                           | Snow<br>Loading | 7 Day<br>Loading |                                 |
| <b>ASPEN (Surfaced dry or surfaced green)</b>              |                     |  |                 |                  |                                 |
| Select Structural  | 2x5<br>and<br>wider | 1300   | 1500            | 1620             | 1,100,000                       |
| No. 1 & Appearance   |                     | 1100   | 1260            | 1380             | 1,100,000                       |
| No. 2  |                     | 900  | 1040            | 1120             | 1,000,000                       |
| No. 3  |                     | 525  | 600             | 660              | 900,000                         |
| Stud   |                     | 525  | 600             | 660              | 900,000                         |
| <b>BALSAM FIR (Surfaced dry or surfaced green)</b>         |                     |  |                 |                  |                                 |
| Select Structural  | 2x5<br>and<br>wider | 1350   | 1550            | 1690             | 1,200,000                       |
| No. 1 & Appearance   |                     | 1150   | 1320            | 1440             | 1,200,000                       |
| No. 2  |                     | 950  | 1090            | 1190             | 1,100,000                       |
| No. 3  |                     | 550  | 630             | 690              | 900,000                         |
| Stud   |                     | 550  | 630             | 690              | 900,000                         |
| <b>BLACK COTTONWOOD (Surfaced dry or surfaced green)</b>   |                     |  |                 |                  |                                 |
| Select Structural  | 2x5<br>and<br>wider | 1000   | 1150            | 1250             | 1,200,000                       |
| No. 1 & Appearance   |                     | 875  | 1010            | 1090             | 1,200,000                       |
| No. 2  |                     | 700  | 800             | 880              | 1,100,000                       |
| No. 3  |                     | 425  | 490             | 530              | 900,000                         |
| Stud   |                     | 425  | 490             | 530              | 900,000                         |
| <b>CALIFORNIA REDWOOD (Surfaced dry or surfaced green)</b> |                     |  |                 |                  |                                 |
| Select Structural  | 2x5<br>and<br>wider | 2000   | 2300            | 2500             | 1,400,000                       |
| Select Structural, Open grain                              |                     | 1600   | 1840            | 2000             | 1,100,000                       |
| No. 1  |                     | 1700   | 1960            | 2120             | 1,400,000                       |
| No. 1, Open grain  |                     | 1350   | 1550            | 1690             | 1,100,000                       |
| No. 2  |                     | 1400   | 1610            | 1750             | 1,250,000                       |
| No. 2, Open grain  |                     | 1100   | 1260            | 1380             | 1,000,000                       |
| No. 3  |                     | 800  | 920             | 1000             | 1,100,000                       |
| No. 3, Open grain  |                     | 650  | 750             | 810              | 900,000                         |
| Stud   |                     | 650  | 750             | 810              | 900,000                         |
| <b>COAST SITKA SPRUCE (Surfaced dry or surfaced green)</b> |                     |  |                 |                  |                                 |
| Select Structural  | 2x5<br>and<br>wider | 1500   | 1720            | 1880             | 1,700,000                       |
| No. 1 & Appearance   |                     | 1250   | 1440            | 1560             | 1,700,000                       |
| No. 2  |                     | 1050   | 1210            | 1310             | 1,500,000                       |
| No. 3  |                     | 600  | 690             | 750              | 1,300,000                       |
| Stud   |                     | 600  | 690             | 750              | 1,300,000                       |
| <b>COAST SPECIES (Surfaced dry or surfaced green)</b>      |                     |  |                 |                  |                                 |
| Select Structural  | 2x5<br>and<br>wider | 1500   | 1720            | 1880             | 1,500,000                       |
| No. 1 & Appearance   |                     | 1250   | 1440            | 1560             | 1,500,000                       |
| No. 2  |                     | 1050   | 1210            | 1310             | 1,400,000                       |
| No. 3  |                     | 600  | 690             | 750              | 1,200,000                       |
| Stud   |                     | 600  | 690             | 750              | 1,200,000                       |
| <b>DOUGLAS FIR-LARCH (Surfaced dry or surfaced green)</b>  |                     |  |                 |                  |                                 |
| Dense Select Structural                                    | 2x5<br>and<br>wider | 2400   | 2760            | 3000             | 1,900,000                       |
| Select Structural  |                     | 2050   | 2360            | 2560             | 1,800,000                       |
| Dense No. 1  |                     | 2050   | 2360            | 2560             | 1,900,000                       |
| No. 1 & Appearance   |                     | 1750   | 2010            | 2190             | 1,800,000                       |
| Dense No. 2  |                     | 1700   | 1960            | 2120             | 1,700,000                       |
| No. 2  |                     | 1450   | 1670            | 1810             | 1,700,000                       |
| No. 3  |                     | 850  | 980             | 1060             | 1,500,000                       |
| Stud   |                     | 850  | 980             | 1060             | 1,500,000                       |
| <b>DOUGLAS FIR SOUTH (Surfaced dry or surfaced green)</b>  |                     |  |                 |                  |                                 |
| Select Structural  | 2x5<br>and<br>wider | 1950   | 2240            | 2440             | 1,400,000                       |
| No. 1 & Appearance   |                     | 1650   | 1900            | 2060             | 1,400,000                       |
| No. 2  |                     | 1350   | 1550            | 1690             | 1,300,000                       |
| No. 3  |                     | 800  | 920             | 1000             | 1,100,000                       |
| Stud   |                     | 800  | 920             | 1000             | 1,100,000                       |

780 CMR: STATE BUILDING CODE COMMISSION

Table 2103-88

DESIGN VALUES FOR JOISTS AND RAFTERS--VISUAL GRADING

These "F<sub>b</sub>" values are for use where repetitive members are spaced not more than 24 inches. For wider spacing, the "F<sub>b</sub>" values should be reduced 13 percent.  
 Values for surfaced dry or surfaced green lumber apply at 19 percent maximum moisture content in use.

| Species and Grade  | Size  | Design Value<br>in Bending "F <sub>b</sub> " |                 |                  | Modulus of<br>Elasticity<br>"E" |
|--|-------|--|-----------------|------------------|---------------------------------|
|  |       | Normal<br>Duration                           | Snow<br>Loading | 7 Day<br>Loading |                                 |
| <b>EASTERN HEMLOCK TAMARACK (Surfaced dry or surfaced green)</b>     |       |  |                 |                  |                                 |
| Select Structural  |       | 1750   | 2010            | 2190             | 1,300,000                       |
| No. 1 & Appearance   | 2x5   | 1500   | 1720            | 1880             | 1,300,000                       |
| No. 2  | and   | 1200   | 1380            | 1500             | 1,100,000                       |
| No. 3  | wider | 725  | 830             | 910              | 1,000,000                       |
| Stud   |       | 725  | 830             | 910              | 1,000,000                       |
| <b>EASTERN SPRUCE (Surfaced dry or surfaced green)</b>               |       |  |                 |                  |                                 |
| Select Structural  |       | 1500   | 1720            | 1880             | 1,400,000                       |
| No. 1 & Appearance   | 2x5   | 1250   | 1440            | 1560             | 1,400,000                       |
| No. 2  | and   | 1000   | 1150            | 1250             | 1,200,000                       |
| No. 3  | wider | 600  | 690             | 750              | 1,100,000                       |
| Stud   |       | 600  | 690             | 750              | 1,100,000                       |
| <b>EASTERN WHITE PINE (Surfaced dry or surfaced green)</b>           |       |  |                 |                  |                                 |
| Select Structural  |       | 1350   | 1550            | 1690             | 1,200,000                       |
| No. 1 & Appearance   | 2x5   | 1150   | 1320            | 1440             | 1,200,000                       |
| No. 2  | and   | 950  | 1090            | 1190             | 1,100,000                       |
| No. 3  | wider | 550  | 630             | 690              | 1,000,000                       |
| Stud   |       | 550  | 630             | 690              | 1,000,000                       |
| <b>EASTERN WOODS (Surfaced dry or surfaced green)</b>                |       |  |                 |                  |                                 |
| Select Structural  |       | 1300   | 1500            | 1620             | 1,100,000                       |
| No. 1 & Appearance   | 2x5   | 1100   | 1260            | 1380             | 1,100,000                       |
| No. 2  | and   | 900  | 1040            | 1120             | 1,000,000                       |
| No. 3  | wider | 525  | 600             | 660              | 900,000                         |
| Stud   |       | 525  | 600             | 660              | 900,000                         |
| <b>ENGELMANN SPRUCE--ALPINE FIR (ENGELMANN SPRUCE--LOGPOLE PINE)</b> |       |  |                 |                  |                                 |
| Select Structural  |       | 1350   | 1550            | 1690             | 1,300,000                       |
| No. 1 & Appearance   | 2x5   | 1150   | 1320            | 1440             | 1,300,000                       |
| No. 2  | and   | 950  | 1090            | 1190             | 1,100,000                       |
| No. 3  | wider | 550  | 630             | 690              | 1,000,000                       |
| Stud   |       | 550  | 630             | 690              | 1,000,000                       |
| <b>HEM--FIR (Surfaced dry or surfaced green)</b>                     |       |  |                 |                  |                                 |
| Select Structural  |       | 1650   | 1900            | 2060             | 1,500,000                       |
| No. 1 & Appearance   | 2x5   | 1400   | 1610            | 1750             | 1,500,000                       |
| No. 2  | and   | 1150   | 1320            | 1440             | 1,400,000                       |
| No. 3  | wider | 675  | 780             | 840              | 1,200,000                       |
| Stud   |       | 675  | 780             | 840              | 1,200,000                       |
| <b>IDAHO WHITE PINE (Surfaced dry or surfaced green)</b>             |       |  |                 |                  |                                 |
| Select Structural  |       | 1300   | 1500            | 1620             | 1,400,000                       |
| No. 1 & Appearance   | 2x5   | 1100   | 1260            | 1380             | 1,400,000                       |
| No. 2  | and   | 925  | 1060            | 1160             | 1,300,000                       |
| No. 3  | wider | 550  | 630             | 690              | 1,200,000                       |
| Stud   |       | 550  | 630             | 690              | 1,200,000                       |
| <b>LOGPOLE PINE (Surfaced dry or surfaced green)</b>                 |       |  |                 |                  |                                 |
| Select Structural  |       | 1500   | 1720            | 1880             | 1,300,000                       |
| No. 1 & Appearance   | 2x5   | 1300   | 1500            | 1620             | 1,300,000                       |
| No. 2  | and   | 1050   | 1210            | 1310             | 1,200,000                       |
| No. 3  | wider | 625  | 720             | 780              | 1,000,000                       |
| Stud   |       | 625  | 720             | 780              | 1,000,000                       |

780 CMR: STATE BUILDING CODE COMMISSION

Table 2108-C

DESIGN VALUES FOR JOISTS AND RAFTERS-VISUAL GRADING

These "F<sub>b</sub>" values are for use where repetitive members are spaced not more than 24 inches. For wider spacing the "F<sub>b</sub>" values should be reduced 13 percent. Values for surfaced dry or surfaced green lumber apply at 19 percent maximum moisture content in use.

| Species and Grade  | Size                | Design Value<br>in Bending "F <sub>b</sub> " |                 |                  | Modulus of<br>Elasticity<br>"E" |
|--|---------------------|--|-----------------|------------------|---------------------------------|
|  |                     | Normal<br>Duration                           | Snow<br>Loading | 7 Day<br>Loading |                                 |
| <b>MOUNTAIN HEMLOCK (Surfaced dry or surfaced green)</b>   |                     |  |                 |                  |                                 |
| Select Structural  | 2x5<br>and<br>wider | 1700   | 1960            | 2120             | 1,300,000                       |
| No. 1 & Appearance   |                     | 1450   | 1670            | 1810             | 1,300,000                       |
| No. 2  |                     | 1200   | 1380            | 1500             | 1,100,000                       |
| No. 3  |                     | 700  | 800             | 890              | 1,000,000                       |
| Stud   |                     | 700  | 800             | 880              | 1,000,000                       |
| <b>MOUNTAIN HEMLOCK - HEM-FIR (Surfaced dry or surfaced green)</b>                                       |                     |  |                 |                  |                                 |
| Select Structural  | 2x5<br>and<br>wider | 1650   | 1900            | 2060             | 1,300,000                       |
| No. 1 & Appearance   |                     | 1400   | 1610            | 1750             | 1,300,000                       |
| No. 2  |                     | 1150   | 1320            | 1440             | 1,100,000                       |
| No. 3  |                     | 675  | 780             | 840              | 1,000,000                       |
| Stud   |                     | 675  | 780             | 840              | 1,000,000                       |
| <b>NORTHERN PINE (Surfaced dry or surfaced green)</b>  |                     |  |                 |                  |                                 |
| Select Structural  | 2x5<br>and<br>wider | 1600   | 1840            | 2000             | 1,400,000                       |
| No. 1 & Appearance   |                     | 1400   | 1610            | 1750             | 1,400,000                       |
| No. 2  |                     | 1100   | 1260            | 1380             | 1,300,000                       |
| No. 3  |                     | 650  | 750             | 810              | 1,100,000                       |
| Stud   |                     | 650  | 750             | 810              | 1,100,000                       |
| <b>NORTHERN SPECIES (Surfaced dry or surfaced green)</b>   |                     |  |                 |                  |                                 |
| Select Structural  | 2x5<br>and<br>wider | 1300   | 1500            | 1620             | 1,100,000                       |
| No. 1 & Appearance   |                     | 1150   | 1320            | 1440             | 1,100,000                       |
| No. 2  |                     | 925  | 1060            | 1160             | 1,000,000                       |
| No. 3  |                     | 550  | 630             | 690              | 900,000                         |
| Stud   |                     | 550  | 630             | 690              | 900,000                         |
| <b>NORTHERN WHITE CEDAR (Surfaced dry or surfaced green)</b>   |                     |  |                 |                  |                                 |
| Select Structural  | 2x5<br>and<br>wider | 1150   | 1320            | 1440             | 800,000                         |
| No. 1 & Appearance   |                     | 1000   | 1150            | 1250             | 800,000                         |
| No. 2  |                     | 825  | 950             | 1030             | 700,000                         |
| No. 3  |                     | 475  | 550             | 590              | 600,000                         |
| Stud   |                     | 475  | 550             | 590              | 600,000                         |
| <b>PONDEROSA PINE (Surfaced dry or surfaced green)</b>   |                     |  |                 |                  |                                 |
| Select Structural  | 2x5<br>and<br>wider | 1400   | 1610            | 1750             | 1,200,000                       |
| No. 1 & Appearance   |                     | 1200   | 1380            | 1500             | 1,200,000                       |
| No. 2  |                     | 975  | 1120            | 1220             | 1,100,000                       |
| No. 3  |                     | 575  | 660             | 720              | 1,000,000                       |
| Stud   |                     | 575  | 660             | 720              | 1,000,000                       |
| <b>PONDEROSA PINE - SUGAR PINE (PONDEROSA PINE - LODGEPOLE PINE)</b><br>(Surfaced dry or surfaced green) |                     |  |                 |                  |                                 |
| Select Structural  | 2x5<br>and<br>wider | 1400   | 1610            | 1750             | 1,200,000                       |
| No. 1 & Appearance   |                     | 1200   | 1380            | 1500             | 1,200,000                       |
| No. 2  |                     | 975  | 1120            | 1220             | 1,100,000                       |
| No. 3  |                     | 575  | 660             | 720              | 1,000,000                       |
| Stud   |                     | 575  | 660             | 720              | 1,000,000                       |
| <b>RED PINE (Surfaced dry or surfaced green)</b>   |                     |  |                 |                  |                                 |
| Select Structural  | 2x5<br>and<br>wider | 1350   | 1550            | 1690             | 1,300,000                       |
| No. 1 & Appearance   |                     | 1150   | 1320            | 1440             | 1,300,000                       |
| No. 2  |                     | 950  | 1090            | 1190             | 1,200,000                       |
| No. 3  |                     | 550  | 630             | 690              | 1,000,000                       |
| Stud   |                     | 550  | 630             | 690              | 1,000,000                       |

780 CMR: STATE BUILDING CODE COMMISSION

Table 2108-D

DESIGN VALUES FOR JOISTS AND RAFTERS-VISUAL GRADING

These "F<sub>b</sub>" values are for use where repetitive members are spaced not more than 24 inches. For wider spacing the "F<sub>b</sub>" values should be reduced 13 percent. Values for surfaced dry or surfaced green lumber apply at 19 percent maximum moisture content in use.

| Species and Grade   | Size                | Design Value<br>In Bending "F <sub>b</sub> " |                 |                  | Modulus of<br>Elasticity<br>"E" |
|---|---------------------|--|-----------------|------------------|---------------------------------|
|   |                     | Normal<br>Duration                           | Snow<br>Loading | 7 Day<br>Loading |                                 |
| <b>SITKA SPRUCE (Surfaced dry or surfaced green)</b>              |                     |  |                 |                  |                                 |
| Select Structural   | 2x5<br>and<br>wider | 1550   | 1780            | 1940             | 1,500,000                       |
| No. 1 & Appearance  |                     | 1300   | 1500            | 1620             | 1,500,000                       |
| No. 2   |                     | 1050   | 1210            | 1310             | 1,300,000                       |
| No. 3   |                     | 600  | 690             | 759              | 1,200,000                       |
| Stud  |                     | 600  | 690             | 750              | 1,200,000                       |
| <b>SOUTHERN PINE (Surfaced dry)</b>                               |                     |  |                 |                  |                                 |
| Select Structural   | 2x5<br>and<br>wider | 2000   | 2300            | 2500             | 1,700,000                       |
| Dense Select Structural   |                     | 2350   | 2700            | 2940             | 1,800,000                       |
| No. 1   |                     | 1700   | 1960            | 2120             | 1,700,000                       |
| No. 1 Dense   |                     | 2000   | 2300            | 2500             | 1,800,000                       |
| No. 2   |                     | 1400   | 1610            | 1750             | 1,600,000                       |
| No. 2 Dense   |                     | 1650   | 1900            | 2060             | 1,600,000                       |
| No. 3   |                     | 800  | 920             | 1000             | 1,400,000                       |
| No. 3 Dense   |                     | 925  | 1060            | 1160             | 1,500,000                       |
| Stud  |                     | 850  | 980             | 1060             | 1,400,000                       |
| <b>SOUTHERN PINE (Surfaced at 19 percent moisture content KD)</b> |                     |  |                 |                  |                                 |
| Select Structural   | 2x5<br>and<br>wider | 2150   | 2470            | 2690             | 1,800,000                       |
| Dense Select Structural   |                     | 2500   | 2880            | 3120             | 1,900,000                       |
| No. 1   |                     | 1850   | 2130            | 2310             | 1,800,000                       |
| No. 1 Dense   |                     | 2150   | 2470            | 2690             | 1,900,000                       |
| No. 2   |                     | 1500   | 1720            | 1880             | 1,600,000                       |
| No. 2 Dense   |                     | 1750   | 2010            | 2190             | 1,700,000                       |
| No. 3   |                     | 875  | 1010            | 1090             | 1,500,000                       |
| No. 3 Dense   |                     | 1000   | 1150            | 1250             | 1,500,000                       |
| Stud  |                     | 900  | 1040            | 1120             | 1,500,000                       |
| <b>SPRUCE-PINE-FIR (Surfaced dry or surfaced green)</b>           |                     |  |                 |                  |                                 |
| Select Structural   | 2x5<br>and<br>wider | 1450   | 1670            | 1810             | 1,500,000                       |
| No. 1 & Appearance  |                     | 1200   | 1380            | 1500             | 1,500,000                       |
| No. 2   |                     | 1000   | 1150            | 1250             | 1,300,000                       |
| No. 3   |                     | 575  | 660             | 720              | 1,200,000                       |
| Stud  |                     | 575  | 660             | 720              | 1,200,000                       |
| <b>WESTERN CEDARS (Surfaced dry or surfaced green)</b>            |                     |  |                 |                  |                                 |
| Select Structural   | 2x5<br>and<br>wider | 1500   | 1720            | 1880             | 1,100,000                       |
| No. 1 & Appearance  |                     | 1300   | 1500            | 1620             | 1,100,000                       |
| No. 2   |                     | 1050   | 1210            | 1310             | 1,000,000                       |
| No. 3   |                     | 625  | 720             | 780              | 900,000                         |
| Stud  |                     | 625  | 720             | 780              | 900,000                         |
| <b>WESTERN CEDARS (NORTH) (Surfaced dry or surfaced green)</b>    |                     |  |                 |                  |                                 |
| Select Structural   | 2x5<br>and<br>wider | 1450   | 1670            | 1810             | 1,100,000                       |
| No. 1 & Appearance  |                     | 1250   | 1440            | 1560             | 1,100,000                       |
| No. 2   |                     | 1000   | 1150            | 1250             | 1,000,000                       |
| No. 3   |                     | 600  | 690             | 750              | 900,000                         |
| Stud  |                     | 600  | 690             | 750              | 900,000                         |

780 CMR: STATE BUILDING CODE COMMISSION

Table 2108-E

DESIGN VALUES FOR JOISTS AND RAFTERS-VISUAL GRADING

These "F<sub>b</sub>" values are for use where repetitive members are spaced not more than 24 inches. For wider spacing the "F<sub>b</sub>" values should be reduced 13 percent. Values for surfaced dry or surfaced green lumber apply at 19 percent maximum moisture content in use.

| Species and Grade                                       | Size                | Design Value<br>In Bending "F <sub>b</sub> " |                 |                  | Modulus of<br>Elasticity<br>"E" |
|---|---------------------|--|-----------------|------------------|---------------------------------|
|   |                     | Normal<br>Duration                           | Snow<br>Loading | 7 Day<br>Loading |                                 |
| SPRUCE - PINE - FIR (Surfaced dry or surfaced green)    |                     |  |                 |                  |                                 |
| Select Structural                                       | 2x5<br>and<br>wider | 1450   | 1670            | 1810             | 1,500,000                       |
| No. 1 & Appearance                                      |                     | 1200   | 1380            | 1500             | 1,500,000                       |
| No. 2   |                     | 1000   | 1150            | 1250             | 1,300,000                       |
| No. 3   |                     | 575  | 660             | 720              | 1,200,000                       |
| Stud  |                     | 575  | 660             | 720              | 1,200,000                       |
| WESTERN CEDARS (Surfaced dry or surfaced green)         |                     |  |                 |                  |                                 |
| Select Structural                                       | 2x5<br>and<br>wider | 1500   | 1720            | 1880             | 1,100,000                       |
| No. 1 & Appearance                                      |                     | 1300   | 1500            | 1620             | 1,100,000                       |
| No. 2   |                     | 1050   | 1210            | 1310             | 1,000,000                       |
| No. 3   |                     | 625  | 720             | 780              | 900,000                         |
| Stud  |                     | 625  | 720             | 780              | 900,000                         |
| WESTERN CEDARS (NORTH) (Surfaced dry or surfaced green) |                     |  |                 |                  |                                 |
| Select Structural                                       | 2x5<br>and<br>wider | 1450   | 1670            | 1810             | 1,100,000                       |
| No. 1 & Appearance                                      |                     | 1250   | 1440            | 1560             | 1,100,000                       |
| No. 2   |                     | 1000   | 1150            | 1250             | 1,000,000                       |
| No. 3   |                     | 600  | 690             | 750              | 900,000                         |
| Stud  |                     | 600  | 690             | 750              | 900,000                         |
| EASTERN HEMLOCK (Surfaced dry or surfaced green)        |                     |  |                 |                  |                                 |
| Select Structural                                       | 2x5<br>and<br>wider | 1750   | 2010            | 2190             | 1,200,000                       |
| No. 1 & Appearance                                      |                     | 1500   | 1720            | 1880             | 1,200,000                       |
| No. 2   |                     | 1250   | 1440            | 1560             | 1,100,000                       |
| No. 3   |                     | 725  | 830             | 910              | 1,000,000                       |
| Stud  |                     | 725  | 830             | 910              | 1,000,000                       |

# 780 CMR: STATE BUILDING CODE COMMISSION

Table 2103-9

## DESIGN VALUES FOR JOISTS AND RAFTERS— MACHINE STRESS RATED LUMBER

These "F<sub>b</sub>" values are for use where repetitive members are spaced not more than 24 inches. For wider spacing, the "F<sub>b</sub>" values should be reduced 13 percent.

Values apply at 19 percent maximum moisture content in use.

| Grade Designation | Grading Rules Agency (see footnotes 1,2,3,4) | Size Classification                 | Design Value in Bending "F <sub>b</sub> " |              |               | Modulus of Elasticity "E" |           |
|-------------------|--|-------------------------------------|---|--------------|---------------|---------------------------|-----------|
|                   |  |                                     | Normal Duration                           | Snow Loading | 7-Day Loading |                           |           |
| 900f-1.0E         | 3  | Machine rated lumber, 2x4 and wider | 1050                                      | 1210         | 1310          | 1,000,000                 |           |
| 1200f-1.2E        | 1,2,3,4                                      |                                     | 1400                                      | 1610         | 1750          | 1,200,000                 |           |
| 1350f-1.3E        | 2,4  |                                     | 1550                                      | 1780         | 1940          | 1,300,000                 |           |
| 1450f-1.3E        | 1,3,4  |                                     | 1650                                      | 1900         | 2060          | 1,300,000                 |           |
| 1500f-1.4E        | 1,2,3,4                                      |                                     | 1750                                      | 2010         | 2190          | 1,400,000                 |           |
| 1650f-1.5E        | 1,2,3,4                                      |                                     | 1900                                      | 2180         | 2380          | 1,500,000                 |           |
| 1800f-1.6E        | 1,2,3,4                                      |                                     | 2050                                      | 2360         | 2560          | 1,600,000                 |           |
| 1950f-1.7E        | 1,2,4  |                                     | 2250                                      | 2590         | 2810          | 1,700,000                 |           |
| 2100f-1.8E        | 1,2,3,4                                      |                                     | 2400                                      | 2760         | 3000          | 1,800,000                 |           |
| 2250f-1.9E        | 1,2,4  |                                     | 2600                                      | 2990         | 3250          | 1,900,000                 |           |
| 2400f-2.0E        | 1,2,3,4                                      |                                     | 2750                                      | 3160         | 3440          | 2,000,000                 |           |
| 2550f-2.1f        | 1,2,4  |                                     | 2950                                      | 3390         | 3690          | 2,100,000                 |           |
| 2700f-2.2E        | 1,2,3,4                                      |                                     | 3100                                      | 3570         | 3880          | 2,200,000                 |           |
| 2850f-2.3E        | 2,4  |                                     | 3300                                      | 3800         | 4130          | 2,300,000                 |           |
| 3000f-2.4E        | 1,2,4  |                                     | 3450                                      | 3970         | 4310          | 2,400,000                 |           |
| 3150f-2.5E        | 2,4  |                                     | 3600                                      | 4140         | 4500          | 2,500,000                 |           |
| 3300f-2.6E        | 2,4  |                                     | 3800                                      | 4370         | 4750          | 2,600,000                 |           |
| 900f-1.0E         | 1,2,3,4                                      |                                     | See footnotes                             | 1050         | 1210          | 1310                      | 1,000,000 |
| 900f-1.2E         | 1,2,3,4                                      |                                     |   | 1050         | 1210          | 1310                      | 1,200,000 |
| 1200f-1.5E        | 1,2,3,4                                      |                                     |   | 1400         | 1610          | 1750                      | 1,500,000 |
| 1350f-1.8E        | 1,2,4  | 1550                                |   | 1780         | 1940          | 1,800,000                 |           |
| 1500f-1.8E        | 3  | 1750                                |   | 2010         | 2190          | 1,800,000                 |           |
| 1800f-2.1E        | 1,2,3,4                                      | 2050                                |   | 2360         | 2560          | 2,100,000                 |           |

1. National Lumber Grades Authority (see Footnote 2, Table W-1) Machine Rated Lumber, 2x4 and wider.

2. Southern Pine Inspection Bureau; Machine Rated Lumber, 2x4 and wider.

3. West Coast Lumber Inspection Bureau; Machine Rated Lumber, 2x4 and wider; Machine Rated Joists, 2x6 and wider.

4. Western Wood Products Association; Machine Rated Lumber, 2x4 and wider.

SECTION 2104.0 WALL COVERING

2104.1 General: Interior and exterior wall covering shall conform to the requirements of this section.

2104.1.1 Compliance: Conformity with the applicable material, test, construction and design standards specified in the reference standards of this article shall be acceptable as providing compliance with the requirements of this article.

2104.2 Interior coverings

2104.2.1 General: Interior coverings shall be installed in accordance with this section and Table 2104-6.

2104.2.2 Vertical assemblies: Vertical support for lath or gypsum wallboard shall be not less than two (2) inches nominal in least dimension. Wood stripping for furring shall be not less than two (2) inches nominal thickness in the least dimension except that furring strips not less than one (1) inch by two (2) inch dimension may be used over solid backing.

2104.2.3 Moisture protection: Where wood frame walls and partitions are covered on the interior with plaster or tile or similar material and subject to water splash, the framing shall be protected with an approved moisture barrier.

2104.2.3.1 Lath application: Gypsum lath shall be applied with the long dimension perpendicular to supports, and with end joints staggered in successive courses. End joints may occur on one support where lath is applied the full length of the joint.

2104.2.3.2 Attachment: The type and weight of metal lath, the gauge and spacing of nails and staples, the spacing of supports, and the methods of attachment to wood supports shall be as set forth in the reference standards, except that gypsum veneer plaster may be applied in one (1) coat.

2104.2.4 Interior plaster: Plastering with gypsum plaster or portland cement plaster shall be not less than three (3) coats when applied over metal lath or wire lath and shall be not less than two (2) coats when applied over other bases permitted by this section except that veneer plaster may be applied in one (1) coat, not to exceed three-sixteenths (3/16) inch thickness.

2104.2.5 Gypsum wallboard: All gypsum wallboard shall be installed in accordance with the provisions of this section.

2104.2.5.1 Installation protection: Gypsum wallboard shall not be installed until weather protection is provided.



2104.2.5.2 Supports: Supports shall be spaced not to exceed the spacing as set forth in Table 2104-6 for single-ply application.

2104.2.5.3 Spacing: All edges and ends of gypsum wallboard shall occur on the framing members, except those edges and ends which are perpendicular to the framing members.

2104.2.5.4 Fastening: The size and spacing of fasteners shall comply with Table 2104-6.

2104.2.6 Shower and bath compartments: Shower and bath stalls and compartments shall be finished in accordance with the requirements of 105 CMR 410.000 (Article II State Sanitary Code, Minimum Standards of Fitness for Human Habitation).

2104.2.7 Other interior finishes: All approved interior finishes shall conform to the applicable reference standards of this article.

### 2104.3 Exterior coverings

2104.3.1 General: Exterior coverings shall be installed in accordance with this section, Table 2104-7 and manufacturer's recommendations.

2104.3.2 Exterior lath: All lath and lath attachments shall be of corrosion-resistant materials.

2104.3.2.1 Backing: Backing for vertical surfaces shall consist of sheathing or of not less than No. 18 U.S. gauge steel wire stretched taut horizontally and spaced not more than six (6) inches apart vertically.

2104.3.2.2 Backing support: Where lath on vertical surfaces extends between rafters, or other similar projecting members, solid backing shall be installed to provide support for lath and attachments.

2104.3.2.3 Gypsum lath: Gypsum lath shall not be used, except that on horizontal supports of ceilings or roof soffits, it may be used as backing for metal lath or wire lath and portland cement plaster.

2104.3.2.4 Required backing: Backing is not required under metal lath or paperbacked wire lath.

2104.3.3 Exterior plaster: Plastering with portland cement plaster shall be not less than three (3) coats when applied over metal lath or wire lath and shall be not less than two (2) coats

when applied over masonry, concrete, or gypsum backing. If plaster surface is completely covered by veneer or other facing material, or is completely concealed, plaster application need only be two (2) coats provided the total thickness is as set forth by manufacturer's recommendations.

#### 2104.3.4 Masonry veneer

2104.3.4.1 General: All masonry veneer shall be installed in accordance with this section and manufacturer's recommendations.

2104.3.4.2 Veneer support: Masonry veneer shall not support any vertical load other than the dead load of the veneer above. Veneer above openings shall be supported upon lintels of non-combustible material and the allowable span shall not exceed the values set forth in Table 2103-7. The lintels shall have a bearing of not less than four (4) inches.

2104.3.4.3 Metal ties: Masonry veneer shall be attached to the supporting wall with corrosion-resistant metal ties. Veneer ties, if strand wire, shall be not less in thickness than No. 6 U.S. gauge wire and shall have a hook embedded in the mortar joint, or if sheet metal, not less than No. 22 U.S. gauge corrugated. Each tie shall be spaced not more than twenty-four (24) inches on center horizontally and shall support not more than three and one-quarter (3-1/4) square feet of wall area.

Exception: In wind areas of more than thirty (30) pounds per square foot, each tie shall support not more than two (2) square feet of wall area.

2104.3.4.4 Other method: In lieu of such wire ties, an approved method of grouting the veneer to a paperbacked reinforcement attached directly to the studs may be used.

#### 2104.3.5 Weather protection

2104.3.5.1 Wall protection: Exterior walls shall be covered with a weather-resistant siding and/or membrane.

2104.3.5.2 Weather-resistant membrane: Asphalt-saturated felt free from holes and breaks and weighing not less than fourteen (14) pounds per one hundred (100) square feet or other approved weather-resistant membrane shall be applied over studs or sheathing of all exterior walls as required by Table 2104-7. Such felt or membrane shall be applied weatherboard fashion, lapped not less than two (2) inches at horizontal joints and not less than six (6) inches at vertical joints.

Exception: Such felt or membrane may be omitted in the following cases:

1. Under weather-resistant siding as per Table 2104-7.
2. In accessory buildings.
3. Under approved paperbacked metal or wire fabric lath.
4. Under metal lath, wire lath or wire fabric lath on non-combustible construction.
5. Under insulated sheathing boards.

2104.3.5.3 Flashing: Approved corrosion-resistive flashing shall be provided at top and sides of all exterior window and door openings in such manner as to be leakproof. Similar flashings shall be installed at the intersection of chimneys or other masonry construction with frame or stucco walls, with projecting lips on both sides under stucco copings; under and at the ends of masonry, wood or metal copings and sills; continuously above all projecting wood trim; at wall and roof intersections; under built-in gutters; at junction of chimneys and roofs; in all roof valleys and around all roof openings.

#### 2104.3.6 Sheathing

2104.3.6.1 Plywood application: Exterior plywood joints shall occur over framing members, unless wood or plywood sheathing is used underneath, or joints are lapped horizontally a minimum of one and one-half (1-1/2) inches, or battens are applied, or tongue and groove or ship lap sheets are used, or otherwise made waterproof to the satisfaction of the building official.

2104.3.6.2 Sheathing insulation board: Insulation boards are approved for sheathing when recognized for this use by an accredited authoritative agency listed in Appendix A of the basic code.

1. Each board shall be clearly marked with a model code approval, recognized testing laboratory label, or as approved by the Massachusetts State Building Code Commission.
2. Insulation-sheathing boards are to be fastened at each stud. When square edged boards are used, vertical joints must be over framing members. When tongue and groove edged boards are used, vertical joints may fall between studs when the boards above and below the joint are continuous across that wall area.

Fasteners may be seven-sixteenths (7/16) inch head roofing nails or three-quarters (3/4) inch crown staples on eight (8) inch centers, one (1) inch head nails or one (1) inch crown staples on twelve (12) inch centers, or any other fastener approved by the building official.

All fasteners shall be long enough to penetrate the studs a minimum of one-half (1/2) inch.

Exterior finish-siding fasteners must go through the sheathing and into the studs a minimum of three-quarters (3/4) inch.

3. A membrane under the siding is not required when insulation-sheathing boards are used.

Table 2104-6  
APPLICATION OF GYPSUM WALLBOARD

| THICKNESS OF GYPSUM WALLBOARD (Inch)         | PLANE OF FRAMING SURFACE | LONG DIMENSION OF GYPSUM WALLBOARD SHEETS IN RELATION TO DIRECTION OF FRAMING MEMBERS | MAXIMUM SPACING OF FRAMING MEMBERS (center-to-center) (In Inches) | MAXIMUM SPACING OF FASTENERS (center-to-center) (In Inches) |                     | NAILS' — TO WOOD  |
|--|--------------------------|---|---|---|---------------------|---|
|  |                          |   |   | NAILS <sup>1,2</sup>  | SCREWS <sup>3</sup> |   |
| 1/2  | Horizontal               | Either Direction  | 16  |   | 12                  | No. 13 gauge, 1-3/8" long, 18/64" head<br>No. .098 gauge, 1-1/4" long, Annular ringed 5d, cooler nail |
|  | Horizontal               | Perpendicular   | 24  | 7   | 12                  |   |
|  | Vertical                 |   | 24  | 8   | 12                  |   |
| 5/8  | Horizontal               | Either Direction  | 16  | 7   | 12                  | No. 13 gauge, 1-5/8" long, 18/64" head<br>No. .098 gauge, 1-3/8" long, Annular ringed 6d, cooler nail |
|  | Horizontal               | Perpendicular   | 24  | 7   | 12                  |   |
|  | Vertical                 | Either Direction  | 24  |   | 12                  |   |
| Fastening Required with Adhesive Application |                          |   |   |   |                     |   |
| 1/2<br>or<br>5/8                             | Horizontal               | Either Direction  | 16  | 16  | 16                  | As required for 1/2" and 5/8" gypsum wallboard, see above   |
|  | Horizontal               | Perpendicular   | 24  | 12  | 16                  |   |
| 2-3/8<br>(3/4 total)                         | Horizontal               | Perpendicular   | 24  | 16  | 16                  | Base ply nailed as required for 1/2" gypsum wallboard and face ply placed with adhesive               |
|  | Vertical                 | Either Direction  | 24  | 24  | 24                  |   |

Notes to Table 2104-6

Note 1. Where the metal framing has a clinching design formed to receive the nails by two (2) edges of metal, the nails shall be not less than five-eighths (5/8) inch longer than the wallboard thickness, and shall have ringed shanks. Where the metal framing has a nailing groove formed to receive the nails, the nails shall have barbed shanks or be 5d, No. 13 1/2 gauge, one and five-eighths (1 5/8) inches long, fifteen-sixty-fourths (15/64) inch head for one-half (1/2) inch gypsum wallboard; 6d, No. 13 gauge, one and seven-eighths (1 7/8) inches long, fifteen-sixty-fourths (15/64) inch head for five-eighths (5/8) inch gypsum wallboard.

Note 2. Two (2) nails spaced not less than two (2) inches apart, nor more than two and one-half (2 1/2) inches apart and pairs of nails spaced not more than twelve (12) inches center-to-center may be used.

Note 3. Screws shall be No. 6 with tapered head and long enough to penetrate into wood framing not less than five-eighths (5/8) inch and metal framing not less than one-quarter (1/4) inch.

Table 2104-7  
WEATHER-RESISTANT SIDING ATTACHMENT

| Siding Material   |                    | Nominal <sup>1</sup> Thickness (Inches) | Joint Treatment | Weather Resistance Membrane Required | TYPE OF SUPPORTS FOR THE SIDING MATERIAL AND FASTENERS <sup>9</sup> |                                |                                |                                |   |
|---|--------------------|---|-----------------|--------------------------------------|---|--------------------------------|--------------------------------|--------------------------------|---|
|   |                    |   |                 |                                      | Wood or Plywood Sheathing   | Fiberboard Sheathing into Stud | Gypsum Sheathing into Stud     | Direct to Studs                | Number of Spacing of Fasteners  |
| Horiz Alum. <sup>8</sup>                                | Without Insulation | .015 <sup>10</sup>                      | Lap             | No                                   | .120-Nail-14"   | .120-Nail-2"                   | .120-Nail-2"                   | Not Allowed                    | Same as Stud Spacing  |
|   |                    | .024                                    | Lap             | No                                   | .120-Nail 14" long  | .120-Nail 2" long              | .120-Nail 2" long              | Not Allowed                    |   |
|   | With Insul.        | .019                                    | Lap             | No                                   | .120-Nail-14"   | .120-Nail-24"                  | .120-Nail-24"                  | .120-Nail-14"                  |   |
| Horizontal Asbestos Cement Boards Shingles <sup>7</sup> |                    | 5/32<br>1/8                             | (2)<br>Lap      | (2)<br>Yes                           | .113-Nail-14"   | .113-Nail-2"                   | .113-Nail-1 3/4"               | .113-Nail-1 3/8"               | 2 Nails per Shingle   |
| Brick Veneer<br>Clay Tile Veneer<br>Concrete Veneer     |                    | 2<br>1/4 to 1<br>2                      | Sec. 2103.3     | Yes                                  | -See Sec. 2103.3 and Figure 2103-1                                  |                                |                                |                                |   |
| Horizontal Fiberboard <sup>3</sup>                      |                    | 1/2                                     | Sec. 2103.3     | No                                   | .099-Nail-2" Staple 1 3/4"  | .113-Nail-2 3/4" Staple 2 1/2" | .113-Nail-2 1/2" Staple 2 1/2" | .099-Nail-2" Staple 1 3/4"     | Same as Stud Spacing  |
| Hardboard <sup>3</sup> Board and Batten Vertical        |                    | 1/4                                     | (2)             | (2)                                  | .099-Nail-2" Staple 1 1/2"  | .099-Nail-2 1/2" Staple 2"     | .099-Nail-2" Staple 1 3/4"     | .099-Nail-1 3/4" Staple 1 1/2" | 6" Panel Edges<br>8" Inter. Sup.  |
| Hardboard <sup>3</sup> Lap Siding Horizontal            |                    | 7/16                                    | (2)             | (2)                                  | .099-Nail-2" Staple 1 7/8"  | .099-Nail-2 1/2" Staple 2 1/2" | .099-Nail-2 1/2" Staple 2 1/2" | .099-Nail-2" Staple 1 7/8"     | Same as Stud Spacing<br>2 per Bearing   |
| Vertical Panel Siding                                   |                    | 7/16                                    | (2)             | (2)                                  | .099-Nail-2" Staple 1 1/2"  | .099-Nail-2 1/2" Staple 2 1/2" | .099-Nail-2" Staple 2"         | .080-Nail-1 3/4" Staple 1 1/2" | 6" Panel Edges<br>12" Inter. Sup.   |
| Steel <sup>3</sup>                                      |                    | 29 ga.                                  | Lap             | No                                   | .113-Nail-1 3/4" Staple 1 3/4"                                      | .113-Nail-2 3/4" Staple 2 1/2" | .113-Nail-2 1/2" Staple 2 1/2" | Not Allowed                    | Same as Stud Spacing  |
| Stone Veneer  |                    | 2                                       | Sec. 2103.3     | Yes                                  | -See Sec. 2103.3 and Figure 2103-3-                                 |                                |                                |                                |   |
| Particle-board Panels                                   |                    | 3/8                                     | (2)             | (2)                                  | .113-NG 1-2" Staple 1 3/8"  | .113-Nail-2 1/2" Staple 2 1/2" | .113-Nail 1-2" Staple 2"       | Not Allowed                    | 6" on Edges<br>8" Inter. Sup.   |
|   |                    | 5/8                                     | (2)             | (2)                                  | .113-Nail-2" Staple 1 7/8"  | .113-Nail-2 1/2" Staple 2 1/2" | .113-Nail-2 1/2" Staple 2 1/2" | .113-Nail-2" Staple 1 5/8"     | 6" on Edges<br>8" Inter. Sup.   |
| Plywood Panels <sup>11</sup> (Exterior Grade)           |                    | 3/8                                     | (2)             | (2)                                  | .099-Nail-2" Staple 1 3/8"  | .113-Nail-2 1/2" Staple 2 1/2" | .099-Nail-2" Staple 2"         | .099-Nail-2" Staple 1 3/8"     | 6" on Edges<br>12" Inter. Sup.  |
| Wood Rustic, Drop Siplap                                |                    | 3/8<br>19/32 Av.                        | Lap             | No                                   | Fastener Penetration Into Stud-1"                                   |                                |                                | .113-Nail 2 1/2" Staple 2"     | Face Nailing up to 6" Widths, 1 Nail per bearing, 8" Widths and over, 2 Nails per Bearing |
| Bevel Butt Tipp   |                    | 7/16<br>3/16                            | Lap<br>Lap      | No<br>No                             |   |                                |                                |                                |   |
| Shakes <sup>7</sup>                                     |                    | 3/8                                     | Lap             | Yes                                  | .0915-Nail-2" Staple 2"   |                                |                                |                                |   |
| Shingles <sup>7</sup>                                   |                    | 3/8                                     | Lap             | Yes                                  | 16" and 18" Shingles  |                                | .076-Nail-14"                  |                                | 2 Fasteners per Shingle or Shake  |
|   |                    |   |                 |                                      |   |                                | Staple - 14"                   |                                |   |
|   |                    |   |                 |                                      | 24" Shingles  |                                | .080-Nail-14"                  |                                |   |
|   |                    |   |                 |                                      |   |                                | Staple - 14"                   |                                |   |

Notes to Table 2104-7

Note 1. Based on stud spacing of sixteen (16) inches o.c. Where studs are spaced twenty-four (24) inches siding may be applied to sheathing approved for that spacing.

Note 2. If boards are applied over sheathing or weather-resistant membrane joints need not be treated. Otherwise, vertical joints must occur at studs and covered with batts.

Note 3. Shall be of approved type.

Note 4. Nail is a general description and may be T-head, modified round head, or round head with smooth or deformed shanks.

Note 5. Staples shall have a minimum crown width of seven-sixteenths (7/16) inch o.d. and be manufactured of minimum sixteen (16) gauge wire.

Note 6. All attachments shall be coated with a corrosion-resistive coating.

Note 7. Shingles and shakes applied over regular density fiberboard or gypsum sheathing shall be fastened to horizontal wood nailers or fiberboard shingle backer.

Note 8. Aluminum nails shall be used to attach aluminum siding.

Note 9. Nails or staples must be aluminum, galvanized, or rust-preventative coated and shall be driven into the studs for fiberboard or gypsum backing.

Note 10. Aluminum (0.19-inch) may be unbacked only when the flat areas are five (5) inches or less in the narrow dimension.

Note 11. Three-eighths (3/8) inch plywood may be applied direct to studs spaced sixteen (16) inches on center. One-half (1/2) inch plywood may be applied direct to studs spaced twenty-four (24) inches on center.

Figure 2104-7  
MASONRY VENEERED WALL

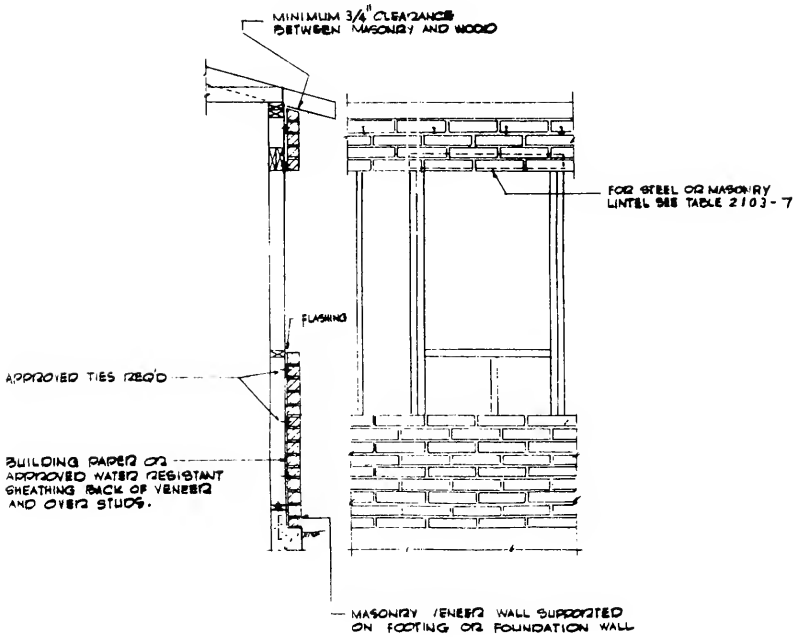

SECTION 2105.0 FLOORS

2105.1 General: Design of floors shall be based on a first floor live load of forty (40) pounds per square foot and a second floor live load of thirty (30) pounds per square foot, with twenty (20) pounds per square foot for nonusable attics. Floors shall be constructed in accordance with the requirements of this article and Figures 2103-1 and 2103-2, Tables 2105-1 through 2105-6, and nailed in accordance with Table 2103-2, or shall comply with the reference standards of this article.

2105.1.1 Compliance: Conformity with the applicable material, test, construction and design standards specified in the reference standards of this article shall be accepted as providing compliance with the requirements of this article.

2105.2 Wood

2105.2.1 Identification: All load-bearing lumber, plywood and particle-board shall conform to applicable standards or grading rules and shall be so identified by a grade mark, or certificate of inspection issued by an approved lumber grading or inspection bureau or agency.

2105.2.2 Grade: All joists and beams shall be of at least No. 3 or Standard Grade lumber or equivalent. Blocking and sheathing may be of Utility or No. 4 Grade lumber or equivalent.

Exception: Native lumber - Items 2105.2.1 Identification and 2105.2.2 Grade of this section shall be subject to the provisions of Section 2103.3 for native lumber.

2105.2.3 Allowable spans: The unsupported spans or floor joists shall not exceed the values set forth in Tables 2105-1 and 2105-2. The modulus of elasticity, "E", and the actual stress in bending, " $F_b$ ", shown in the Tables shall not exceed the values given.

2105.2.3.1 Girder spans: The allowable spans of girders shall be designed in accordance with Table 2105-6 and accepted engineering practice.

2105.2.3.2 Floor sheathing span: The allowable spans and minimum grades for plywood floor sheathing shall conform to the requirements set forth in Tables 2105-3 and 2105-4. The allowable spans for floor sheathing shall conform to the requirements set forth in Table 2105-5.

2105.2.4 Bearing: The ends of each joist shall have not less than one and one-half (1-1/2) inches of bearing on wood or



metal and not less than three (3) inches on masonry except where supported on a one (1) inch by four (4) inch ribbon strip and nailed to the adjacent stud.

2105.2.5 Lateral support: Joists shall be supported laterally at the ends.

2105.3 Concrete floors (on ground)

2105.3.1 General: Concrete slab-on-ground floors shall be constructed according to accepted engineering practice. The concrete shall conform to the requirements of Section 2102.2 and only approved air-entraining agents shall be used where required. When part of heated space, perimeter insulation is required according to Section 2120.5.

2105.3.1.1 Contraction joints: Slabs shall be constructed with contraction joints, having a depth of at least one-fourth (1/4) the slab thickness, and joints shall be spaced at intervals not more than thirty (30) feet in each direction and slabs not rectangular in shape shall have contraction joints across the slab at points of offset, if offset exceeds ten (10) feet.

Exception: Contraction joints are not required where 6 x 6--6/6 welded wire fabric or equivalent is placed at mid-depth of the slab.

2105.3.2 Site preparation: The area within the foundation walls shall have all vegetation, top soil and foreign material removed and the fill material shall be free of vegetation and foreign material.

2105.3.2.1 Soil compaction: The fill shall be compacted to assure uniform support of the slab and except where otherwise approved the fill depths shall not exceed twenty-four (24) inches for clean sand or gravel and eight (8) inches for earth.

2105.3.2.2 Base course: A four (4) inch thick base course shall be placed on the prepared subgrade, consisting of clean graded sand, gravel, crushed stone or crushed blast-furnace slag passing a two (2) inch sieve and retained on a one-quarter (1/4) inch sieve. An approved vapor barrier with joints lapped six (6) inches shall be placed between the base course and the concrete floor slab.

Exception: The vapor barrier may be omitted where approved by the building official, based upon local site condition.

2105.4 Metal: Steel structural elements in floors may be either hot-rolled structural steel shapes or members cold formed

to shape from steel sheet strip or plate, or a fabricated combination thereof. Members shall be straight and free of any defects which would significantly affect their structural performance.

2105.4.1 Span: The allowable span for steel girders or beams and the tributary area for steel columns in floors shall not exceed the values set forth in Tables 2105-6.

2105.4.2 Structural elements: Aluminum structural elements in floors shall be constructed of materials and designed in accordance with Reference Standard RS-21-5.

2105.5 Particleboard: Particleboard floor underlayment shall conform to Type 1-B-1 of the standards set forth in Standard RS-21-5. Underlayment shall be not less than one-quarter (1/4) inch in thickness and shall be identified by the grade mark of an approved inspection agency. Underlayment shall be installed in accordance with this code and as recommended by the manufacturer.

NON-TEXT PAGE

Table 2105-1  
ALLOWABLE SPANS FOR FLOOR JOISTS

| JOIST<br>SIZE SPACING<br>(IN) | Modulus of Elasticity, "E", in 1,000,000 psi |              |              |              |              |              |               |               |               |               |               |
|-------------------------------|--|--------------|--------------|--------------|--------------|--------------|---------------|---------------|---------------|---------------|---------------|
|                               | 0.4  | 0.5          | 0.6          | 0.7          | 0.8          | 0.9          | 1.0           | 1.1           | 1.2           | 1.3           |               |
| 2x8                           | 12.0   | 7-5<br>440   | 8-0<br>510   | 8-6<br>570   | 8-11<br>640  | 9-4<br>700   | 9-9<br>750    | 10-1<br>810   | 10-5<br>860   | 10-9<br>910   | 11-0<br>960   |
|                               | 13.7   | 7-1<br>460   | 7-8<br>530   | 8-2<br>600   | 8-7<br>670   | 8-11<br>730  | 9-4<br>790    | 9-8<br>840    | 10-0<br>900   | 10-3<br>950   | 10-6<br>1010  |
|                               | 16.0   | 6-9<br>480   | 7-3<br>560   | 7-9<br>630   | 8-2<br>700   | 8-6<br>770   | 8-10<br>830   | 9-2<br>890    | 9-6<br>950    | 9-9<br>1000   | 10-0<br>1060  |
|                               | 19.2   | 6-4<br>510   | 6-10<br>600  | 7-3<br>670   | 7-8<br>740   | 8-0<br>810   | 8-4<br>880    | 8-8<br>940    | 8-11<br>1010  | 9-2<br>1070   | 9-5<br>1130   |
|                               | 24.0   | 6-11<br>550  | 6-4<br>640   | 6-9<br>720   | 7-1<br>800   | 7-6<br>880   | 7-9<br>950    | 8-0<br>1020   | 8-3<br>1080   | 8-6<br>1150   | 8-9<br>1210   |
|                               | 32.0   |              |              |              |              | 6-9<br>960   | 7-0<br>1040   | 7-3<br>1110   | 7-6<br>1180   | 7-9<br>1270   | 7-11<br>1330  |
| 2x8                           | 12.0   | 9-10<br>440  | 10-7<br>510  | 11-3<br>570  | 11-10<br>640 | 12-4<br>700  | 12-10<br>750  | 13-4<br>810   | 13-9<br>860   | 14-2<br>910   | 14-6<br>960   |
|                               | 13.7   | 9-4<br>460   | 10-1<br>530  | 10-9<br>600  | 11-4<br>670  | 11-10<br>730 | 12-3<br>790   | 12-9<br>840   | 13-2<br>900   | 13-6<br>950   | 13-11<br>1010 |
|                               | 16.0   | 8-11<br>480  | 9-7<br>560   | 10-2<br>630  | 10-9<br>700  | 11-3<br>770  | 11-8<br>830   | 12-1<br>890   | 12-6<br>950   | 12-10<br>1000 | 13-2<br>1060  |
|                               | 19.2   | 8-6<br>510   | 9-0<br>600   | 9-7<br>670   | 10-1<br>740  | 10-7<br>810  | 11-0<br>880   | 11-4<br>940   | 11-9<br>1010  | 12-1<br>1070  | 12-5<br>1130  |
|                               | 24.0   | 7-9<br>550   | 8-5<br>640   | 8-11<br>720  | 9-4<br>800   | 9-10<br>880  | 10-2<br>950   | 10-7<br>1020  | 10-11<br>1080 | 11-3<br>1150  | 11-6<br>1210  |
|                               | 32.0   |              |              |              |              | 8-11<br>970  | 9-3<br>1040   | 9-7<br>1120   | 9-11<br>1200  | 10-2<br>1260  | 10-6<br>1340  |
| 2x10                          | 12.0   | 12-6<br>440  | 13-6<br>510  | 14-4<br>570  | 15-1<br>640  | 15-9<br>700  | 16-5<br>750   | 17-0<br>810   | 17-6<br>860   | 18-0<br>910   | 18-6<br>960   |
|                               | 13.7   | 11-11<br>460 | 12-11<br>530 | 13-8<br>600  | 14-5<br>670  | 15-1<br>730  | 15-8<br>790   | 16-3<br>840   | 16-9<br>900   | 17-3<br>950   | 17-9<br>1010  |
|                               | 16.0   | 11-4<br>480  | 12-3<br>560  | 13-0<br>630  | 13-8<br>700  | 14-4<br>770  | 14-11<br>830  | 15-5<br>890   | 15-11<br>950  | 16-5<br>1000  | 16-10<br>1060 |
|                               | 19.2   | 10-8<br>510  | 11-6<br>600  | 12-3<br>670  | 12-11<br>740 | 13-6<br>810  | 14-0<br>880   | 14-6<br>940   | 15-0<br>1010  | 15-5<br>1070  | 15-10<br>1130 |
|                               | 24.0   | 9-11<br>550  | 10-8<br>640  | 11-4<br>720  | 11-11<br>800 | 12-6<br>880  | 13-0<br>950   | 13-6<br>1020  | 13-11<br>1080 | 14-4<br>1150  | 14-8<br>1210  |
|                               | 32.0   |              |              |              |              | 11-4<br>960  | 11-10<br>1050 | 12-3<br>1120  | 12-8<br>1200  | 13-0<br>1260  | 13-4<br>1330  |
| 2x12                          | 12.0   | 15-2<br>440  | 16-5<br>510  | 17-5<br>570  | 18-4<br>640  | 19-2<br>700  | 19-11<br>750  | 20-8<br>810   | 21-4<br>860   | 21-11<br>910  | 22-6<br>960   |
|                               | 13.7   | 14-7<br>460  | 15-8<br>530  | 16-8<br>600  | 17-6<br>670  | 18-4<br>730  | 19-1<br>790   | 19-9<br>840   | 20-5<br>900   | 21-0<br>950   | 21-7<br>1010  |
|                               | 16.0   | 13-10<br>480 | 14-11<br>560 | 15-10<br>630 | 16-8<br>700  | 17-5<br>770  | 18-1<br>830   | 18-9<br>890   | 19-4<br>950   | 19-11<br>1000 | 20-6<br>1060  |
|                               | 19.2   | 13-0<br>510  | 14-0<br>600  | 14-11<br>670 | 15-8<br>740  | 16-6<br>810  | 17-0<br>880   | 17-8<br>940   | 18-3<br>1010  | 18-9<br>1070  | 19-3<br>1130  |
|                               | 24.0   | 12-1<br>550  | 13-0<br>640  | 13-10<br>720 | 14-7<br>800  | 15-2<br>880  | 15-10<br>950  | 16-5<br>1020  | 16-11<br>1080 | 17-5<br>1150  | 17-11<br>1210 |
|                               | 32.0   |              |              |              |              | 13-10<br>970 | 14-4<br>1040  | 14-11<br>1130 | 15-4<br>1190  | 15-10<br>1270 | 16-3<br>1340  |

Note: The extreme fiber stress in bending, "F<sub>b</sub>", in pounds per square inch is shown below each span.

(All rooms used for sleeping areas and attic floors)

Strength - Live load of 30 lbs. per sq. ft. plus dead load of 10 lbs. per sq. ft. determines the fiber stress value shown

DESIGN CRITERIA: Deflection - For 30 lbs. per sq. ft. live load. Limited to span in inches divided by 360.

Table 2105-1 (cont.)

| JOIST<br>SIZE SPACING<br>(IN) | Modulus of Elasticity, "E", in 1,000,000 psi |               |               |               |               |               |               |               |               |               |
|-------------------------------|--|---------------|---------------|---------------|---------------|---------------|---------------|---------------|---------------|---------------|
|                               | 1.4  | 1.5           | 1.6           | 1.7           | 1.8           | 1.9           | 2.0           | 2.2           | 2.4           |               |
| 2x6                           | 12.0   | 11-3<br>1010  | 11-7<br>1060  | 11-10<br>1100 | 12-0<br>1150  | 12-3<br>1200  | 12-6<br>1240  | 12-9<br>1280  | 13-1<br>1370  | 13-6<br>1450  |
|                               | 13.7   | 10-10<br>1060 | 11-1<br>1110  | 11-3<br>1160  | 11-6<br>1200  | 11-9<br>1250  | 11-11<br>1300 | 12-2<br>1340  | 12-7<br>1430  | 12-11<br>1510 |
|                               | 16.0   | 10-3<br>1110  | 10-6<br>1160  | 10-9<br>1220  | 10-11<br>1270 | 11-2<br>1320  | 11-4<br>1360  | 11-7<br>1410  | 11-11<br>1500 | 12-3<br>1590  |
|                               | 19.2   | 9-8<br>1180   | 9-10<br>1240  | 10-1<br>1290  | 10-4<br>1350  | 10-6<br>1400  | 10-8<br>1450  | 10-10<br>1500 | 11-3<br>1600  | 11-7<br>1690  |
|                               | 24.0   | 8-11<br>1270  | 9-2<br>1330   | 9-4<br>1390   | 9-7<br>1450   | 9-9<br>1510   | 9-11<br>1560  | 10-1<br>1620  | 10-5<br>1720  | 10-9<br>1820  |
|                               | 32.0   | 8-2<br>1410   | 8-4<br>1470   | 8-6<br>1530   | 8-8<br>1590   | 8-10<br>1650  | 9-0<br>1710   | 9-2<br>1780   | 9-6<br>1910   | 9-9<br>2010   |
| 2x8                           | 12.0   | 14-11<br>1010 | 15-3<br>1060  | 15-7<br>1100  | 15-10<br>1150 | 16-2<br>1200  | 16-6<br>1240  | 16-9<br>1280  | 17-4<br>1370  | 17-10<br>1450 |
|                               | 13.7   | 14-3<br>1060  | 14-7<br>1110  | 14-11<br>1160 | 15-2<br>1200  | 15-6<br>1250  | 15-9<br>1300  | 16-0<br>1340  | 16-7<br>1430  | 17-0<br>1510  |
|                               | 16.0   | 13-6<br>1110  | 13-10<br>1160 | 14-2<br>1220  | 14-5<br>1270  | 14-8<br>1320  | 15-0<br>1360  | 15-3<br>1410  | 15-9<br>1500  | 16-2<br>1590  |
|                               | 19.2   | 12-9<br>1180  | 13-0<br>1240  | 13-4<br>1290  | 13-7<br>1350  | 13-10<br>1400 | 14-1<br>1450  | 14-4<br>1500  | 14-9<br>1600  | 15-3<br>1690  |
|                               | 24.0   | 11-10<br>1270 | 12-1<br>1330  | 12-4<br>1390  | 12-7<br>1450  | 12-10<br>1510 | 13-1<br>1560  | 13-4<br>1620  | 13-9<br>1720  | 14-2<br>1820  |
|                               | 32.0   | 10-9<br>1410  | 11-0<br>1470  | 11-3<br>1540  | 11-5<br>1590  | 11-8<br>1660  | 11-11<br>1730 | 12-1<br>1780  | 12-6<br>1900  | 12-10<br>2010 |
| 2x10                          | 12.0   | 19-0<br>1010  | 19-5<br>1060  | 19-10<br>1100 | 20-3<br>1150  | 20-8<br>1200  | 21-0<br>1240  | 21-5<br>1280  | 22-1<br>1370  | 22-9<br>1450  |
|                               | 13.7   | 18-2<br>1060  | 18-7<br>1110  | 19-0<br>1160  | 19-4<br>1200  | 19-9<br>1250  | 20-1<br>1300  | 20-5<br>1340  | 21-1<br>1430  | 21-9<br>1510  |
|                               | 16.0   | 17-3<br>1110  | 17-8<br>1160  | 18-0<br>1220  | 18-5<br>1270  | 18-9<br>1320  | 19-1<br>1360  | 19-5<br>1410  | 20-1<br>1500  | 20-8<br>1590  |
|                               | 19.2   | 16-3<br>1180  | 16-7<br>1240  | 17-0<br>1290  | 17-4<br>1350  | 17-8<br>1400  | 18-0<br>1450  | 18-3<br>1500  | 18-10<br>1600 | 19-5<br>1690  |
|                               | 24.0   | 15-1<br>1270  | 15-5<br>1330  | 15-9<br>1390  | 16-1<br>1450  | 16-5<br>1510  | 16-8<br>1560  | 17-0<br>1620  | 17-6<br>1720  | 18-0<br>1820  |
|                               | 32.0   | 13-8<br>1400  | 14-0<br>1470  | 14-4<br>1540  | 14-7<br>1590  | 14-11<br>1660 | 15-2<br>1720  | 15-5<br>1780  | 15-11<br>1890 | 16-5<br>2020  |
| 2x12                          | 12.0   | 23-1<br>1010  | 23-7<br>1060  | 24-2<br>1100  | 24-8<br>1150  | 25-1<br>1200  | 25-7<br>1240  | 26-0<br>1280  | 26-10<br>1370 | 27-8<br>1450  |
|                               | 13.7   | 22-1<br>1060  | 22-7<br>1110  | 23-1<br>1160  | 23-7<br>1200  | 24-0<br>1250  | 24-5<br>1300  | 24-10<br>1340 | 25-8<br>1430  | 26-5<br>1510  |
|                               | 16.0   | 21-0<br>1110  | 21-6<br>1160  | 21-11<br>1220 | 22-5<br>1270  | 22-10<br>1320 | 23-3<br>1360  | 23-7<br>1410  | 24-5<br>1500  | 25-1<br>1590  |
|                               | 19.2   | 19-9<br>1180  | 20-2<br>1240  | 20-8<br>1290  | 21-1<br>1350  | 21-6<br>1400  | 21-10<br>1450 | 22-3<br>1500  | 22-11<br>1600 | 23-7<br>1690  |
|                               | 24.0   | 18-4<br>1270  | 18-9<br>1330  | 19-2<br>1390  | 19-7<br>1450  | 19-11<br>1510 | 20-3<br>1560  | 20-8<br>1620  | 21-4<br>1720  | 21-11<br>1820 |
|                               | 32.0   | 16-8<br>1400  | 17-0<br>1460  | 17-5<br>1530  | 17-9<br>1590  | 18-1<br>1650  | 18-5<br>1720  | 18-9<br>1780  | 19-4<br>1890  | 19-11<br>2010 |

HOW TO USE TABLES: Enter Table with span of joists (upper figure in each square). Determine size and spacing (first column) based on stress grade (lower figure in each square) and modulus of elasticity (top row) of lumber to be used.

Table 2105-2  
ALLOWABLE SPANS FOR FLOOR JOISTS  
40 Lbs. Per Sq. Ft. Live Load

| JOIST<br>SIZE SPACING<br>(IN) |      | Modulus of Elasticity, "E", in 1,000,000 psi |              |              |              |              |              |               |               |               |              |
|-------------------------------|------|--|--------------|--------------|--------------|--------------|--------------|---------------|---------------|---------------|--------------|
|                               |      | 0.4  | 0.5          | 0.6          | 0.7          | 0.8          | 0.9          | 1.0           | 1.1           | 1.2           | 1.3          |
| 2x6                           | 12.0 | 6-9<br>450                                   | 7-3<br>520   | 7-9<br>590   | 8-2<br>660   | 8-6<br>720   | 8-10<br>780  | 9-2<br>830    | 9-6<br>890    | 9-9<br>940    | 10-0<br>990  |
|                               |      | 6-6<br>470                                   | 7-0<br>550   | 7-5<br>620   | 7-9<br>690   | 8-2<br>750   | 8-6<br>810   | 8-9<br>870    | 9-1<br>930    | 9-4<br>980    | 9-7<br>1040  |
|                               | 13.7 | 6-2<br>500                                   | 6-7<br>580   | 7-0<br>650   | 7-5<br>720   | 7-9<br>790   | 8-0<br>860   | 8-4<br>920    | 8-7<br>980    | 8-10<br>1040  | 9-1<br>1090  |
|                               |      | 5-9<br>530                                   | 6-3<br>610   | 6-7<br>690   | 7-0<br>770   | 7-3<br>840   | 7-7<br>910   | 7-10<br>970   | 8-1<br>1040   | 8-4<br>1100   | 8-7<br>1160  |
|                               | 16.0 | 5-4<br>570                                   | 5-9<br>660   | 6-2<br>750   | 6-6<br>830   | 6-9<br>900   | 7-0<br>980   | 7-3<br>1050   | 7-6<br>1120   | 7-9<br>1190   | 7-11<br>1250 |
|                               |      | 32.0   |              |              |              | 6-2<br>1010  | 6-5<br>1090  | 6-7<br>1150   | 6-10<br>1230  | 7-0<br>1300   | 7-3<br>1390  |
| 2x8                           | 12.0 | 8-11<br>450                                  | 9-7<br>520   | 10-2<br>590  | 10-9<br>660  | 11-3<br>720  | 11-8<br>780  | 12-1<br>830   | 12-6<br>890   | 12-10<br>940  | 13-<br>990   |
|                               |      | 8-6<br>470                                   | 9-2<br>550   | 9-9<br>620   | 10-3<br>690  | 10-9<br>750  | 11-2<br>810  | 11-7<br>870   | 11-11<br>930  | 12-3<br>980   | 12-7<br>1040 |
|                               | 13.7 | 8-1<br>500                                   | 8-9<br>580   | 9-3<br>650   | 9-9<br>720   | 10-2<br>790  | 10-7<br>850  | 11-0<br>920   | 11-4<br>980   | 11-8<br>1040  | 12-0<br>1090 |
|                               |      | 7-7<br>530                                   | 8-2<br>610   | 8-9<br>690   | 9-2<br>770   | 9-7<br>840   | 10-0<br>910  | 10-4<br>970   | 10-8<br>1040  | 11-0<br>1100  | 11-3<br>1160 |
|                               | 16.0 | 7-1<br>570                                   | 7-7<br>660   | 8-1<br>750   | 8-6<br>830   | 8-11<br>900  | 9-3<br>980   | 9-7<br>1050   | 9-11<br>1120  | 10-2<br>1190  | 10-6<br>1250 |
|                               |      | 32.0   |              |              |              | 8-1<br>990   | 8-5<br>1080  | 8-9<br>1170   | 9-0<br>1230   | 9-3<br>1300   | 9-6<br>1370  |
| 2x10                          | 12.0 | 11-4<br>450                                  | 12-3<br>520  | 13-0<br>590  | 13-8<br>660  | 14-4<br>720  | 14-11<br>780 | 15-5<br>830   | 15-11<br>890  | 16-5<br>940   | 16-10<br>990 |
|                               |      | 10-10<br>470                                 | 11-8<br>550  | 12-5<br>620  | 13-1<br>690  | 13-8<br>750  | 14-3<br>810  | 14-9<br>870   | 15-3<br>930   | 15-8<br>980   | 16-1<br>1040 |
|                               | 13.7 | 10-4<br>500                                  | 11-1<br>580  | 11-10<br>650 | 12-5<br>720  | 13-0<br>790  | 13-6<br>850  | 14-0<br>920   | 14-6<br>980   | 14-11<br>1040 | 15-3<br>1090 |
|                               |      | 9-9<br>530                                   | 10-6<br>610  | 11-1<br>690  | 11-8<br>770  | 12-3<br>840  | 12-9<br>910  | 13-2<br>970   | 13-7<br>1040  | 14-0<br>1100  | 14-5<br>1160 |
|                               | 16.0 | 9-0<br>570                                   | 9-9<br>660   | 10-4<br>750  | 10-10<br>830 | 11-4<br>900  | 11-10<br>980 | 12-3<br>1050  | 12-8<br>1120  | 13-0<br>1190  | 13-4<br>1250 |
|                               |      | 32.0   |              |              |              | 10-4<br>1000 | 10-9<br>1080 | 11-1<br>1150  | 11-6<br>1240  | 11-10<br>1310 | 12-2<br>1380 |
| 2x12                          | 12.0 | 13-10<br>450                                 | 14-11<br>520 | 15-10<br>590 | 16-8<br>660  | 17-5<br>720  | 18-1<br>780  | 18-9<br>830   | 19-4<br>890   | 19-11<br>940  | 20-6<br>990  |
|                               |      | 13-3<br>470                                  | 14-3<br>550  | 15-2<br>620  | 15-11<br>690 | 16-8<br>750  | 17-4<br>810  | 17-11<br>870  | 18-6<br>930   | 19-1<br>980   | 19-7<br>1040 |
|                               | 13.7 | 12-7<br>500                                  | 13-6<br>580  | 14-4<br>650  | 15-2<br>720  | 15-10<br>790 | 16-5<br>860  | 17-0<br>920   | 17-7<br>980   | 18-1<br>1040  | 18-7<br>1090 |
|                               |      | 11-10<br>530                                 | 12-9<br>610  | 13-6<br>690  | 14-3<br>770  | 14-11<br>840 | 15-6<br>910  | 16-0<br>970   | 16-7<br>1040  | 17-0<br>1100  | 17-6<br>1160 |
|                               | 16.0 | 11-0<br>570                                  | 11-10<br>660 | 12-7<br>750  | 13-3<br>830  | 13-10<br>900 | 14-4<br>980  | 14-11<br>1050 | 15-4<br>1120  | 15-10<br>1190 | 16-3<br>1250 |
|                               |      | 32.0   |              |              |              | 12-7<br>1000 | 13-1<br>1080 | 13-6<br>1150  | 13-11<br>1220 | 14-4<br>1300  | 14-9<br>1380 |

Note: The extreme fiber stress in bending, " $F_b$ ", in pounds per square inch is shown below each span.

(All rooms except those used for sleeping areas and attic floors)  
Strength - Live load of 40 lbs. per sq. ft. plus dead load of 10 lbs. per sq. ft. determines the fiber stress value shown.

DESIGN CRITERIA: Deflection - For 40 lbs. per sq. ft. live load. Limited to span in inches divided by 360.

Table 2105-2 (cont.)

| JOIST<br>SIZE SPACING<br>(IN)<br>(IN) |      | Modulus of Elasticity, "E", in 1,000,000 psi |       |       |       |       |       |       |       |       |
|---------------------------------------|------|--|-------|-------|-------|-------|-------|-------|-------|-------|
|                                       |      | 1.4  | 1.5   | 1.6   | 1.7   | 1.8   | 1.9   | 2.0   | 2.2   | 2.4   |
| 2x8                                   | 12.0 | 10-3   | 10-8  | 10-9  | 10-11 | 11-2  | 11-4  | 11-7  | 11-11 | 12-3  |
|                                       |      | 1040   | 1090  | 1140  | 1190  | 1230  | 1280  | 1320  | 1410  | 1490  |
|                                       | 13.7 | 9-10   | 10-0  | 10-3  | 10-6  | 10-8  | 10-10 | 11-1  | 11-5  | 11-9  |
|                                       |      | 1090   | 1140  | 1190  | 1240  | 1290  | 1340  | 1380  | 1470  | 1560  |
|                                       | 16.0 | 9-4  | 9-6   | 9-9   | 9-11  | 10-2  | 10-4  | 10-6  | 10-10 | 11-2  |
|                                       |      | 1150   | 1200  | 1250  | 1310  | 1360  | 1410  | 1460  | 1550  | 1640  |
|                                       | 19.2 | 8-9  | 9-0   | 9-2   | 9-4   | 9-6   | 9-8   | 9-10  | 10-2  | 10-6  |
| 1220                                  |      | 1280   | 1330  | 1390  | 1440  | 1500  | 1550  | 1650  | 1750  |       |
| 24.0                                  | 8-2  | 8-4  | 8-6   | 8-8   | 8-10  | 9-0   | 9-2   | 9-6   | 9-9   |       |
|                                       | 1310 | 1380   | 1440  | 1500  | 1550  | 1610  | 1670  | 1780  | 1880  |       |
| 32.0                                  | 7-5  | 7-7  | 7-9   | 7-11  | 8-0   | 8-2   | 8-4   | 8-7   | 8-10  |       |
|                                       | 1450 | 1520   | 1590  | 1660  | 1690  | 1760  | 1840  | 1950  | 2060  |       |
| 2x8                                   | 12.0 | 13-6   | 13-10 | 14-2  | 14-5  | 14-8  | 15-0  | 15-3  | 15-9  | 16-2  |
|                                       |      | 1040   | 1090  | 1140  | 1190  | 1230  | 1280  | 1320  | 1410  | 1490  |
|                                       | 13.7 | 12-11  | 13-3  | 13-6  | 13-10 | 14-1  | 14-4  | 14-7  | 15-0  | 15-6  |
|                                       |      | 1090   | 1140  | 1190  | 1240  | 1290  | 1340  | 1380  | 1470  | 1560  |
|                                       | 16.0 | 12-3   | 12-7  | 12-10 | 13-1  | 13-4  | 13-7  | 13-10 | 14-3  | 14-8  |
|                                       |      | 1150   | 1200  | 1250  | 1310  | 1360  | 1410  | 1460  | 1550  | 1640  |
|                                       | 19.2 | 11-7   | 11-10 | 12-1  | 12-4  | 12-7  | 12-10 | 13-0  | 13-5  | 13-10 |
| 1220                                  |      | 1280   | 1330  | 1390  | 1440  | 1500  | 1550  | 1650  | 1750  |       |
| 24.0                                  | 10-9 | 11-0   | 11-3  | 11-5  | 11-8  | 12-11 | 12-1  | 12-6  | 12-10 |       |
|                                       | 1310 | 1380   | 1440  | 1500  | 1550  | 1610  | 1670  | 1780  | 1880  |       |
| 32.0                                  | 9-9  | 10-0   | 10-2  | 10-5  | 10-7  | 10-10 | 11-0  | 11-4  | 11-8  |       |
|                                       | 1450 | 1520   | 1570  | 1650  | 1700  | 1790  | 1840  | 1950  | 2070  |       |
| 2x10                                  | 12.0 | 17-3   | 17-8  | 18-0  | 18-5  | 18-9  | 19-1  | 19-5  | 20-1  | 20-8  |
|                                       |      | 1040   | 1090  | 1140  | 1190  | 1230  | 1280  | 1320  | 1410  | 1490  |
|                                       | 13.7 | 16-6   | 16-11 | 17-3  | 17-7  | 17-11 | 18-3  | 18-7  | 19-2  | 19-9  |
|                                       |      | 1090   | 1140  | 1190  | 1240  | 1290  | 1340  | 1380  | 1470  | 1560  |
|                                       | 16.0 | 15-8   | 16-0  | 16-5  | 16-9  | 17-0  | 17-4  | 17-8  | 18-3  | 18-9  |
|                                       |      | 1150   | 1200  | 1250  | 1310  | 1360  | 1410  | 1460  | 1550  | 1640  |
|                                       | 19.2 | 14-9   | 15-1  | 15-5  | 15-9  | 16-0  | 16-4  | 16-7  | 17-2  | 17-8  |
| 1220                                  |      | 1280   | 1330  | 1390  | 1440  | 1500  | 1550  | 1650  | 1750  |       |
| 24.0                                  | 13-8 | 14-0   | 14-4  | 14-7  | 14-11 | 15-2  | 15-5  | 15-11 | 16-5  |       |
|                                       | 1310 | 1380   | 1440  | 1500  | 1550  | 1610  | 1670  | 1780  | 1880  |       |
| 32.0                                  | 12-5 | 12-9   | 13-0  | 13-3  | 13-6  | 13-9  | 14-0  | 14-6  | 14-11 |       |
|                                       | 1440 | 1520   | 1580  | 1640  | 1700  | 1770  | 1830  | 1970  | 2080  |       |
| 2x12                                  | 12.0 | 21-0   | 21-6  | 21-11 | 22-5  | 22-10 | 23-3  | 23-7  | 24-5  | 25-1  |
|                                       |      | 1040   | 1090  | 1140  | 1190  | 1230  | 1280  | 1320  | 1410  | 1490  |
|                                       | 13.7 | 20-1   | 20-6  | 21-0  | 21-5  | 21-10 | 22-3  | 22-7  | 23-4  | 24-0  |
|                                       |      | 1090   | 1140  | 1190  | 1240  | 1290  | 1340  | 1380  | 1470  | 1560  |
|                                       | 16.0 | 19-1   | 19-6  | 19-11 | 20-4  | 20-9  | 21-1  | 21-6  | 22-2  | 22-10 |
|                                       |      | 1150   | 1200  | 1250  | 1310  | 1360  | 1410  | 1460  | 1550  | 1640  |
|                                       | 19.2 | 17-11  | 18-4  | 18-9  | 19-2  | 19-6  | 19-10 | 20-2  | 20-10 | 21-6  |
| 1220                                  |      | 1280   | 1330  | 1390  | 1440  | 1500  | 1550  | 1650  | 1750  |       |
| 24.0                                  | 16-8 | 17-0   | 17-5  | 17-9  | 18-1  | 18-5  | 18-9  | 19-4  | 19-11 |       |
|                                       | 1310 | 1380   | 1440  | 1500  | 1550  | 1610  | 1670  | 1780  | 1880  |       |
| 32.0                                  | 15-2 | 15-6   | 15-10 | 16-2  | 16-5  | 16-9  | 17-0  | 17-7  | 18-1  |       |
|                                       | 1450 | 1520   | 1580  | 1650  | 1700  | 1770  | 1830  | 1950  | 2070  |       |

HOW TO USE TABLES: Enter Table with span of joists (upper figure in each square). Determine size and spacing (first column) based on stress grade (lower figure in each square) and modulus of elasticity (top row) of lumber to be used.

780 CMR: STATE BUILDING CODE COMMISSION

Table 2105-3  
 ALLOWABLE SPANS FOR PLYWOOD FLOOR AND ROOF SHEATHING  
 CONTINUOUS OVER TWO OR MORE SPANS AND FACE GRAIN  
 PERPENDICULAR TO SUPPORTS (1) (SPAN IN INCHES)

| Panel Identification Index <sup>(2)</sup><br>Roof Span,<br>Roof/Floor Span | Thickness (inches) | Roof                         |                 |                   |                   | Floor                                |
|--|--------------------|------------------------------|-----------------|-------------------|-------------------|--------------------------------------|
|  |                    | Maximum Span (inches)        |                 | Load (psf)        |                   | Maximum Span <sup>(5)</sup> (Inches) |
|  |                    | Edges Blocked <sup>(3)</sup> | Edges Unblocked | Total Load        | Live Load         |                                      |
| 12/0   | 5/16               | 12                           | 12              | 155               | 150               | 0                                    |
| 16/0   | 5/16, 3/8          | 16                           | 16              | 95                | 75                | 0                                    |
| 20/0   | 5/16, 3/8          | 20                           | 20              | 75                | 65                | 0                                    |
| 24/0   | 3/8                | 24                           | 20              | 65                | 50                | 0                                    |
| 24/0   | 1/2                | 24                           | 24              | 65                | 50                | 0                                    |
| 30/12  | 5/8                | 30                           | 26              | 70                | 50                | 12 <sup>(6)</sup>                    |
| 32/16  | 1/2, 5/8           | 32                           | 28              | 55                | 40                | 16 <sup>(7)</sup>                    |
| 36/16  | 3/4                | 36                           | 30              | 55                | 50                | 16 <sup>(7)</sup>                    |
| 42/20  | 5/8, 3/4,<br>7/8   | 42                           | 32              | 40 <sup>(4)</sup> | 35 <sup>(4)</sup> | 20 <sup>(7)</sup>                    |
| 48/24  | 3/4, 7/8           | 48                           | 36              | 40 <sup>(4)</sup> | 35 <sup>(4)</sup> | 24                                   |

Notes to Table 2105-3

Note 1. These values apply for C-D and C-C, Structural I and II grades only. Spans shall be limited to values shown because of possible effect of concentrated loads.

Note 2. Identification Index appears on all panels in the construction grades listed in footnote (1). Allowable uniform roof load deflection limitation: 1/180th of the span under live load plus dead load, 1/240th under live load only.

Note 3. Edges may be blocked with lumber or other approved type of edge support.

Note 4. For roof live load of forty (40) psf or total load of fifty-five (55) psf, decrease spans by thirteen (13) percent or use panel with next greater Identification Index.

Note 5. Plywood edges shall have approved tongue-and-groove joints or shall be supported with blocking, unless one-fourth (1/4) inch minimum thickness underlayment is installed, or finish floor is 25/32 inch wood strip. Allowable uniform load based on deflection of 1/360 of span is one hundred sixty-five (165) psf.

Note 6. May be sixteen (16) inches, if 25/32 inch wood strip flooring is installed at right angles to joists.

Note 7. May be twenty-four (24) inches if 25/32 inch wood strip flooring is installed at right angles to joists.



Table 2105-4  
PLYWOOD COMBINATION SUBFLOOR-UNDERLAYMENT

ALLOWABLE SPAN FOR PLYWOOD COMBINATION  
SUBFLOOR-UNDERLAYMENT (1)

PLYWOOD CONTINUOUS OVER TWO (2) OR MORE  
SPANS AND FACE GRAIN PERPENDICULAR  
TO SUPPORTS (THICKNESS IN INCHES)

| Species Groups | Maximum Spacing of Joists<br>(Inches) |     |     |
|----------------|---------------------------------------|-----|-----|
|                | 16                                    | 20  | 24  |
| 1              | 1/2                                   | 5/8 | 3/4 |
| 2,3            | 5/8                                   | 3/4 | 7/8 |
| 4              | 3/4                                   | 7/8 | 1   |

Notes to Table 2105-4

Note 1. Applicable to Underlayment Grade, C-C (Plugged) and all grades of sanded exterior type plywood. Spans limited to values shown because of possible effect of concentrated loads. Allowable uniform load based on deflection of 1/360 of span is one hundred twenty-five (125) psf. Plywood edges shall have approved tongue-and-groove joint\* or shall be supported with blocking, unless one-fourth (1/4) inch minimum thickness underlayment is installed, or finish floor is 25/32 inch wood strip. If wood strips are perpendicular to supports, thicknesses shown for sixteen (16) inch and twenty (20) inch spans may be used on twenty-four (24) inch span. Except for one-half (1/2) inch, underlayment grade and C-C (Plugged) panels may be of nominal thickness 1/32 inch less than the nominal thicknesses shown when marked with the reduced thickness.

Table 2105-5  
MINIMUM THICKNESS OF FLOOR SHEATHING

| Joist Spacing<br>(Inches) | Minimum Net Thickness (Inches) |                   |
|---------------------------|--------------------------------|-------------------|
|                           | Perpendicular to Joist         | Diagonal to Joist |
| 24                        | 11/16                          | 3/4               |
| 16                        | 5/8                            | 5/8               |

780 CMR: STATE BUILDING CODE COMMISSION

TABLE 2105-6

COLUMN SPACINGS UNDER GIRDERS

COLUMN SIZES - 4 X 4 or 31/2" O STL.

FOOTING SIZE - 2'-6" X 2' - 6" X 10" d

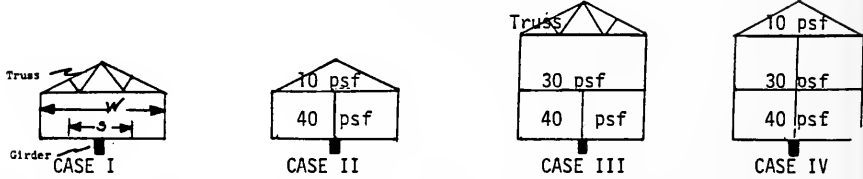

| GIRDER SIZE                                    | S = 13 |      |      |       | S = 14 |      |      |      | CASE I |      |      |      | S = 15 |      |      |      | S = 16 |  |  |  |
|--|--------|------|------|-------|--------|------|------|------|--------|------|------|------|--------|------|------|------|--------|--|--|--|
|  | fb =   |      |      |       |        |      |      |      |        |      |      |      |        |      |      |      |        |  |  |  |
| 4 x 10, 3-2 x 8                                | 6-4    | 7-0  | 7-6  | 8-0   | 6-1    | 6-8  | 7-3  | 7-8  | 5-10   | 6-5  | 7-0  | 7-5  | 5-8    | 6-3  | 6-9  | 7-3  |        |  |  |  |
| 4 x 12, 3-2 x 10                               | 8-1    | 8-9  | 9-6  | 10-3  | 7-9    | 8-6  | 9-3  | 9-10 | 7-6    | 8-3  | 8-10 | 9-6  | 7-3    | 8-0  | 8-8  | 9-3  |        |  |  |  |
| 6 x 12, 3-2 x 12                               | 9-9    | 10-9 | 11-7 | 12-5  | 9-6    | 10-4 | 11-4 | 12-0 | 9-1    | 10-0 | 10-9 | 11-7 | 8-9    | 9-8  | 10-6 | 11-3 |        |  |  |  |
| CASE II  |        |      |      |       |        |      |      |      |        |      |      |      |        |      |      |      |        |  |  |  |
| 4 x 10, 3-2 x 8                                | 5-6    | 6-0  | 6-6  | 7-0   | 5-4    | 5-9  | 6-4  | 6-8  | 5-1    | 5-7  | 6-1  | 6-6  | 5-0    | 5-6  | 5-10 | 6-4  |        |  |  |  |
| 4 x 12, 3-2 x 10                               | 7-0    | 7-9  | 8-5  | 9-0   | 6-9    | 7-6  | 8-1  | 8-8  | 6-7    | 7-3  | 7-9  | 8-3  | 6-4    | 7-0  | 7-6  | 8-1  |        |  |  |  |
| 6 x 12, 3-2 x 12                               | 8-8    | 9-5  | 10-3 | 10-10 | 8-4    | 9-1  | 9-9  | 10-6 | 8-0    | 8-9  | 9-6  | 10-1 | 7-9    | 8-6  | 9-2  | 9-9  |        |  |  |  |
| CASE III                                       |        |      |      |       |        |      |      |      |        |      |      |      |        |      |      |      |        |  |  |  |
| 4 x 10, 3-2 x 8                                | 4-8    | 5-1  | 5-7  | 6-0   | 4-6    | 5-0  | 5-3  | 5-8  | 4-3    | 4-9  | 5-2  | 5-6  | 4-3    | 4-8  | 5-0  | 5-3  |        |  |  |  |
| 4 x 12, 3-2 x 10                               | 6-0    | 6-7  | 7-1  | 7-7   | 5-9    | 6-4  | 6-9  | 7-4  | 5-7    | 6-1  | 6-8  | 7-1  | 5-5    | 5-10 | 6-5  | 6-9  |        |  |  |  |
| 6 x 12, 3-2 x 12                               | 7-4    | 8-0  | 8-8  | 9-3   | 7-0    | 7-8  | 8-4  | 8-10 | 6-9    | 7-6  | 8-0  | 8-8  | 6-7    | 7-3  | 7-9  | 8-4  |        |  |  |  |
| CASE IV  |        |      |      |       |        |      |      |      |        |      |      |      |        |      |      |      |        |  |  |  |
| 4 x 10, 3-2 x 8                                | 4-4    | 4-9  | 5-1  | 5-6   | 4-2    | 4-7  | 5-0  | 5-4  | 4-0    | 4-4  | 4-9  | 5-1  | 3-10   | 4-4  | 4-8  | 5-0  |        |  |  |  |
| 4 x 12, 3-2 x 10                               | 5-6    | 6-1  | 6-8  | 7-0   | 5-3    | 5-10 | 6-4  | 6-9  | 5-2    | 5-8  | 6-1  | 6-6  | 5-0    | 5-6  | 5-10 | 6-4  |        |  |  |  |
| 6 x 12, 3-2 x 12                               | 6-9    | 7-5  | 8-0  | 8-7   | 6-6    | 7-1  | 7-8  | 8-3  | 6-4    | 6-10 | 7-6  | 8-0  | 6-1    | 6-8  | 7-3  | 7-9  |        |  |  |  |
| STEEL GIRDER SPAN BETWEEN SUPPORTS (A-36 STL.) |        |      |      |       |        |      |      |      |        |      |      |      |        |      |      |      |        |  |  |  |
| 8'-0"  | 6W8.5  |      |      |       | 6W8.5  |      |      |      | 6W8.5  |      |      |      | 6W8.5  |      |      |      |        |  |  |  |
| 10'-0"   | 8W10   |      |      |       | 8W10   |      |      |      | 8W10   |      |      |      | 8W15   |      |      |      |        |  |  |  |
| 12'-0"   | 8W15   |      |      |       | 8W15   |      |      |      | 10W15  |      |      |      | 10W15  |      |      |      |        |  |  |  |
| 14'-0"   | 10W15  |      |      |       | 10W15  |      |      |      | 10W17  |      |      |      | 10W17  |      |      |      |        |  |  |  |

SECTION 2106.0 ROOF-CEILING CONSTRUCTION

2106.1 General: Roofs shall be constructed in accordance with Tables 2106-1 through 2106-6, the energy requirements in Table 2123-1, and nailed in accordance with Table 2103-2.

2106.1.1 Specifications: Conformity with the applicable material, test, construction and design standards specified in the reference standards of this article shall be acceptable as providing compliance with the requirements of this article.

2106.2 Wood

2106.2.1 Identification: All load-bearing lumber, plywood and particleboard shall conform to applicable standards or grading rules and be identified by a grade mark, or certificate or inspection issued by an approved lumber grading or inspection bureau or agency.

Exception: Native lumber - Items 2106.2.1 Identification and 2106.2.2 Grade of this section shall be subject to the provisions of Section 2103.3 for native lumber.

2106.2.2 Grade: All rafters and ceiling joists shall be of No. 3 or Standard Grade lumber or equivalent. Blocking and sheathing may be of No. 4 or Utility Grade lumber or equivalent.

2106.2.3 Allowable spans: The unsupported spans of rafters and ceiling joists shall not exceed the values set forth in Tables 2106-1, 2106-2, 2106-3, 2106-4, 2106-5 and 2106-6. The modulus of elasticity, "E", and the actual stress in bearing, " $F_b$ ", shall not exceed the values given in the tables.

2106.2.3.1 Other criteria: The allowable spans and minimum grades for plywood roof sheathing shall not exceed the values set forth in Table 2105-5. The allowable span for board type roof sheathing shall not exceed twenty-four (24) inches and shall be five-eighths ( $5/8$ ) inch minimum net thickness for solid sheathing and three-quarter ( $3/4$ ) inch minimum net thickness for spaced sheathing.

2106.2.4 Framing: Rafters shall be framed directly opposite each other at the ridge or there shall be a ridge board at least one (1) inch nominal thickness at all ridges and not less in depth than the size of the rafter. At all valleys and hips there shall be a single valley or hip rafter not less than two (2) inches nominal thickness and not less in depth than the size of the rafter.

2106.3 Metal: Steel structural elements in roof-ceiling construction may be either hot-rolled structural steel shapes or

members cold formed to shape from steel strip or plate or a fabricated combination thereof. Members shall be straight and free of any defects which would significantly affect their structural performance. Steel girders, trusses or beams in roof-ceiling construction shall be designed in accordance with the applicable standards in this article.

2106.3.1 Aluminum elements: Aluminum structural elements in roof-ceiling systems shall be constructed of materials and designed in accordance with the applicable reference standards of this article.

2106.4 Ceiling finishes: Ceilings shall be installed in accordance with recommended engineering practice and applicable reference standards.

2106.5 Attic access: An accessible attic opening not less than twenty-two (22) inches by thirty (30) inches shall be provided to any attic area with clear headroom of three (3) feet or more.

ON-TEXT PAGE

780 CMR: STATE BUILDING CODE COMMISSION

Table 2106-1  
ALLOWABLE SPANS FOR CEILING JOISTS

20 lbs. per sq. ft. Live Load  
(Limited attic storage where development of future rooms is not possible)  
(Drywall Ceiling)

DESIGN CRITERIA:

Deflection - for 20 lbs. per sq. ft. live load. Limited to span in inches divided by 240.  
Strength - Live load of 20 lbs. per sq. ft. plus dead load of 10 lbs. per sq. ft. determines required fiber stress value.

HOW TO USE TABLES: Enter Table with span of joists (upper figure in each square). Determine size and spacing (first column) based on stress grade (lower figure in each square) and modulus of elasticity (top row) of lumber to be used.

| JOIST SIZE SPACING (IN) |      | Modulus of Elasticity, "E", in 1,000,000 psi |               |               |               |               |               |               |               |               |               |               |               |               |               |
|-------------------------|------|--|---------------|---------------|---------------|---------------|---------------|---------------|---------------|---------------|---------------|---------------|---------------|---------------|---------------|
|                         |      | 0.8  | 0.9           | 1.0           | 1.1           | 1.2           | 1.3           | 1.4           | 1.5           | 1.6           | 1.7           | 1.8           | 1.9           | 2.0           | 2.2           |
| 2x4                     | 12.0 | 7-10<br>900                                  | 8-1<br>970    | 8-5<br>1040   | 8-8<br>1110   | 8-11<br>1170  | 9-2<br>1240   | 9-5<br>1300   | 9-8<br>1360   | 9-10<br>1420  | 10-0<br>1460  | 10-3<br>1540  | 10-5<br>1600  | 10-7<br>1650  | 10-11<br>1760 |
|                         | 13.7 | 7-6<br>940                                   | 7-9<br>1010   | 8-1<br>1090   | 8-4<br>1160   | 8-7<br>1230   | 8-9<br>1300   | 9-0<br>1360   | 9-3<br>1420   | 9-5<br>1490   | 9-7<br>1550   | 9-9<br>1610   | 10-0<br>1670  | 10-2<br>1730  | 10-6<br>1840  |
|                         | 18.0 | 7-1<br>990                                   | 7-5<br>1070   | 7-8<br>1140   | 7-11<br>1220  | 8-1<br>1290   | 8-4<br>1360   | 8-7<br>1430   | 8-9<br>1500   | 8-11<br>1570  | 9-1<br>1630   | 9-4<br>1690   | 9-6<br>1760   | 9-8<br>1820   | 9-11<br>1940  |
|                         | 19.2 | 6-8<br>1050                                  | 6-11<br>1130  | 7-2<br>1220   | 7-5<br>1310   | 7-8<br>1370   | 7-10<br>1450  | 8-1<br>1520   | 8-3<br>1590   | 8-5<br>1660   | 8-7<br>1730   | 8-9<br>1800   | 8-11<br>1870  | 9-1<br>1930   | 9-4<br>2060   |
|                         | 24.0 | 6-2<br>1130                                  | 6-5<br>1220   | 6-8<br>1310   | 6-11<br>1400  | 7-1<br>1480   | 7-3<br>1560   | 7-6<br>1640   | 7-8<br>1720   | 7-10<br>1790  | 8-0<br>1870   | 8-1<br>1940   | 8-3<br>2010   | 8-5<br>2080   | 8-8<br>2220   |
| 2x6                     | 12.0 | 12-3<br>900                                  | 12-9<br>970   | 13-3<br>1040  | 13-8<br>1110  | 14-1<br>1170  | 14-5<br>1240  | 14-9<br>1300  | 15-2<br>1360  | 15-6<br>1420  | 15-9<br>1480  | 16-1<br>1540  | 16-4<br>1600  | 16-8<br>1650  | 17-2<br>1760  |
|                         | 13.7 | 11-9<br>940                                  | 12-3<br>1010  | 12-8<br>1090  | 13-1<br>1160  | 13-5<br>1230  | 13-10<br>1300 | 14-2<br>1360  | 14-6<br>1420  | 14-9<br>1490  | 15-1<br>1550  | 15-5<br>1610  | 15-8<br>1670  | 15-11<br>1730 | 16-5<br>1840  |
|                         | 16.0 | 11-2<br>990                                  | 11-7<br>1070  | 12-0<br>1140  | 12-5<br>1220  | 12-9<br>1290  | 13-1<br>1350  | 13-5<br>1430  | 13-9<br>1500  | 14-1<br>1570  | 14-4<br>1630  | 14-7<br>1690  | 14-11<br>1760 | 15-2<br>1820  | 15-7<br>1940  |
|                         | 19.2 | 10-6<br>1050                                 | 10-11<br>1130 | 11-4<br>1220  | 11-8<br>1300  | 12-0<br>1370  | 12-4<br>1450  | 12-8<br>1520  | 12-11<br>1590 | 13-3<br>1660  | 13-6<br>1730  | 13-9<br>1800  | 14-0<br>1870  | 14-3<br>1930  | 14-8<br>2060  |
|                         | 24.0 | 9-9<br>1130                                  | 10-2<br>1220  | 10-6<br>1310  | 10-10<br>1400 | 11-2<br>1480  | 11-5<br>1560  | 11-9<br>1640  | 12-0<br>1720  | 12-3<br>1790  | 12-6<br>1870  | 12-9<br>1940  | 13-0<br>2010  | 13-3<br>2080  | 13-8<br>2220  |
| 2x8                     | 12.0 | 16-2<br>920                                  | 16-10<br>970  | 17-5<br>1040  | 18-0<br>1110  | 18-6<br>1170  | 19-0<br>1240  | 19-6<br>1300  | 19-11<br>1360 | 20-5<br>1420  | 20-10<br>1480 | 21-2<br>1540  | 21-7<br>1600  | 21-11<br>1650 | 22-8<br>1760  |
|                         | 13.7 | 15-6<br>940                                  | 16-1<br>1010  | 16-8<br>1090  | 17-2<br>1160  | 17-9<br>1230  | 18-2<br>1300  | 18-8<br>1360  | 19-1<br>1420  | 19-6<br>1490  | 19-11<br>1550 | 20-3<br>1610  | 20-8<br>1670  | 21-0<br>1730  | 21-8<br>1840  |
|                         | 16.0 | 14-8<br>990                                  | 15-3<br>1070  | 15-10<br>1140 | 16-4<br>1220  | 16-10<br>1290 | 17-3<br>1360  | 17-9<br>1430  | 18-2<br>1500  | 18-6<br>1570  | 18-11<br>1630 | 19-3<br>1690  | 19-7<br>1760  | 19-11<br>1820 | 20-7<br>1940  |
|                         | 19.2 | 13-10<br>1050                                | 14-5<br>1130  | 14-11<br>1220 | 15-5<br>1300  | 15-10<br>1370 | 16-3<br>1450  | 16-8<br>1520  | 17-1<br>1590  | 17-5<br>1660  | 17-9<br>1730  | 18-2<br>1800  | 18-5<br>1870  | 18-9<br>1930  | 19-5<br>2060  |
|                         | 24.0 | 12-10<br>1130                                | 13-4<br>1220  | 13-10<br>1310 | 14-3<br>1400  | 14-8<br>1480  | 15-1<br>1560  | 15-6<br>1640  | 15-10<br>1720 | 16-2<br>1790  | 16-6<br>1870  | 16-10<br>1940 | 17-2<br>2010  | 17-5<br>2080  | 18-0<br>2220  |
| 2x10                    | 12.0 | 20-8<br>900                                  | 21-6<br>970   | 22-3<br>1040  | 22-11<br>1110 | 23-8<br>1170  | 24-3<br>1240  | 24-10<br>1300 | 25-5<br>1360  | 26-0<br>1420  | 26-6<br>1480  | 27-1<br>1540  | 27-6<br>1600  | 28-0<br>1650  | 28-11<br>1760 |
|                         | 13.7 | 19-9<br>940                                  | 20-6<br>1010  | 21-3<br>1090  | 21-11<br>1160 | 22-7<br>1230  | 23-3<br>1300  | 23-9<br>1360  | 24-4<br>1420  | 24-10<br>1490 | 25-5<br>1550  | 26-0<br>1610  | 26-4<br>1670  | 26-10<br>1730 | 27-8<br>1840  |
|                         | 16.0 | 18-9<br>990                                  | 19-6<br>1070  | 20-2<br>1140  | 20-10<br>1220 | 21-6<br>1290  | 22-1<br>1360  | 22-7<br>1430  | 23-2<br>1500  | 23-8<br>1570  | 24-1<br>1630  | 24-7<br>1690  | 25-0<br>1760  | 25-5<br>1820  | 26-3<br>1940  |
|                         | 19.2 | 17-8<br>1050                                 | 18-4<br>1130  | 19-0<br>1220  | 19-7<br>1300  | 20-2<br>1370  | 20-9<br>1450  | 21-3<br>1520  | 21-9<br>1590  | 22-3<br>1660  | 22-8<br>1730  | 23-2<br>1800  | 23-7<br>1870  | 23-11<br>1930 | 24-9<br>2060  |
|                         | 24.0 | 16-5<br>1130                                 | 17-0<br>1220  | 17-8<br>1310  | 18-3<br>1400  | 18-9<br>1480  | 19-3<br>1560  | 19-9<br>1640  | 20-2<br>1720  | 20-8<br>1790  | 21-1<br>1870  | 21-6<br>1940  | 21-10<br>2010 | 22-3<br>2080  | 22-11<br>2220 |

Note: The required extreme fiber stress in bending, "F<sub>b</sub>", in pounds per square inch is shown below each span.

780 CMR: STATE BUILDING CODE COMMISSION

Table 2106-2  
ALLOWABLE SPANS FOR CEILING JOISTS

10 lbs. per sq. ft. Live Load  
(No attic storage and roof slope not steeper than 3 in 12)  
(Drywall Ceiling)

**DESIGN CRITERIA:**  
Deflection - for 10 lbs. per sq. ft. live load. Limited to span in inches divided by 240.  
Strength - Live load of 10 lbs. per sq. ft. plus dead load of 5 lbs. per sq. ft. determines required fiber stress value.

**HOW TO USE TABLES:** Enter Table with span of joists (upper figure in each square). Determine size and spacing (first column) based on stress grade (lower figure in each square) and modulus of elasticity (top row) of lumber to be used.

| JOIST SIZE SPACING (IN) | Modulus of Elasticity, "E", in 1,000,000 psi |              |              |              |               |               |               |               |               |               |               |               |               |               |               |
|-------------------------|--|--------------|--------------|--------------|---------------|---------------|---------------|---------------|---------------|---------------|---------------|---------------|---------------|---------------|---------------|
|                         | 0.8  | 0.9          | 1.0          | 1.1          | 1.2           | 1.3           | 1.4           | 1.5           | 1.6           | 1.7           | 1.8           | 1.9           | 2.0           | 2.2           |               |
| 2x4                     | 12.0   | 9-10<br>710  | 10-3<br>770  | 10-7<br>830  | 10-11<br>880  | 11-3<br>930   | 11-7<br>980   | 11-10<br>1030 | 12-2<br>1080  | 12-5<br>1130  | 12-8<br>1180  | 12-11<br>1220 | 13-2<br>1270  | 13-4<br>1310  | 13-9<br>1400  |
|                         | 13.7   | 9-5<br>740   | 9-9<br>800   | 10-2<br>860  | 10-6<br>920   | 10-9<br>970   | 11-1<br>1030  | 11-4<br>1080  | 11-7<br>1130  | 11-10<br>1180 | 12-1<br>1230  | 12-4<br>1280  | 12-7<br>1320  | 12-9<br>1370  | 13-2<br>1460  |
|                         | 16.0   | 8-11<br>780  | 9-4<br>850   | 9-8<br>910   | 9-11<br>970   | 10-3<br>1030  | 10-6<br>1080  | 10-9<br>1140  | 11-0<br>1190  | 11-3<br>1240  | 11-6<br>1290  | 11-9<br>1340  | 11-11<br>1390 | 12-2<br>1440  | 12-6<br>1540  |
|                         | 19.2   | 8-5<br>830   | 8-9<br>900   | 9-1<br>970   | 9-4<br>1030   | 9-8<br>1090   | 9-11<br>1150  | 10-2<br>1210  | 10-4<br>1270  | 10-7<br>1320  | 10-10<br>1380 | 11-0<br>1430  | 11-3<br>1480  | 11-5<br>1530  | 11-9<br>1630  |
|                         | 24.0   | 7-10<br>900  | 8-1<br>970   | 8-5<br>1040  | 8-8<br>1110   | 8-11<br>1170  | 9-2<br>1240   | 9-5<br>1300   | 9-8<br>1360   | 9-10<br>1420  | 10-0<br>1480  | 10-3<br>1540  | 10-5<br>1600  | 10-7<br>1650  | 10-11<br>1760 |
| 2x6                     | 12.0   | 15-6<br>710  | 16-1<br>770  | 16-8<br>830  | 17-2<br>880   | 17-8<br>930   | 18-2<br>980   | 18-8<br>1030  | 19-1<br>1080  | 19-6<br>1130  | 19-11<br>1180 | 20-3<br>1220  | 20-8<br>1270  | 21-0<br>1310  | 21-8<br>1400  |
|                         | 13.7   | 14-9<br>740  | 15-5<br>800  | 15-11<br>860 | 16-5<br>920   | 16-11<br>970  | 17-5<br>1030  | 18-3<br>1080  | 18-8<br>1130  | 19-0<br>1180  | 19-5<br>1230  | 19-9<br>1280  | 19-9<br>1320  | 20-1<br>1370  | 20-9<br>1460  |
|                         | 16.0   | 14-1<br>780  | 14-7<br>850  | 15-2<br>910  | 15-7<br>970   | 16-1<br>1030  | 16-6<br>1080  | 16-11<br>1140 | 17-4<br>1190  | 17-8<br>1240  | 18-1<br>1290  | 18-5<br>1340  | 18-9<br>1390  | 19-1<br>1440  | 19-8<br>1540  |
|                         | 19.2   | 13-3<br>830  | 13-9<br>900  | 14-3<br>970  | 14-8<br>1030  | 15-2<br>1090  | 15-7<br>1150  | 15-11<br>1210 | 16-4<br>1270  | 16-8<br>1320  | 17-0<br>1380  | 17-4<br>1430  | 17-8<br>1480  | 17-11<br>1530 | 18-6<br>1630  |
|                         | 24.0   | 12-3<br>900  | 12-9<br>970  | 13-3<br>1040 | 13-8<br>1110  | 14-1<br>1170  | 14-5<br>1240  | 14-9<br>1300  | 15-2<br>1360  | 15-6<br>1420  | 15-9<br>1480  | 16-1<br>1540  | 16-4<br>1600  | 16-8<br>1650  | 17-2<br>1760  |
| 2x8                     | 12.0   | 20-5<br>710  | 21-2<br>770  | 21-11<br>830 | 22-8<br>880   | 23-4<br>930   | 24-0<br>980   | 24-7<br>1030  | 25-2<br>1080  | 25-8<br>1130  | 26-2<br>1180  | 26-9<br>1220  | 27-2<br>1270  | 27-8<br>1310  | 28-7<br>1400  |
|                         | 13.7   | 19-6<br>740  | 20-3<br>800  | 21-0<br>860  | 21-8<br>920   | 22-4<br>970   | 22-11<br>1030 | 23-6<br>1080  | 24-0<br>1130  | 24-7<br>1180  | 25-1<br>1230  | 25-7<br>1280  | 26-0<br>1320  | 26-6<br>1370  | 27-4<br>1460  |
|                         | 16.0   | 18-6<br>780  | 19-3<br>850  | 19-11<br>910 | 20-7<br>970   | 21-2<br>1030  | 21-9<br>1080  | 22-4<br>1140  | 22-10<br>1190 | 23-4<br>1240  | 23-10<br>1290 | 24-3<br>1340  | 24-8<br>1390  | 25-2<br>1440  | 25-11<br>1540 |
|                         | 19.2   | 17-5<br>830  | 18-2<br>900  | 18-9<br>970  | 19-5<br>1030  | 19-11<br>1090 | 20-6<br>1150  | 21-0<br>1210  | 21-6<br>1270  | 21-11<br>1320 | 22-5<br>1380  | 22-10<br>1430 | 23-3<br>1480  | 23-8<br>1530  | 24-5<br>1630  |
|                         | 24.0   | 16-2<br>900  | 16-10<br>970 | 17-5<br>1040 | 18-0<br>1110  | 18-6<br>1170  | 19-0<br>1240  | 19-6<br>1300  | 19-11<br>1360 | 20-5<br>1420  | 20-10<br>1480 | 21-2<br>1540  | 21-7<br>1600  | 21-11<br>1650 | 22-8<br>1760  |
| 2x10                    | 12.0   | 26-0<br>710  | 27-1<br>770  | 28-0<br>830  | 28-11<br>880  | 29-9<br>930   | 30-7<br>980   | 31-4<br>1030  | 32-1<br>1080  | 32-9<br>1130  | 33-5<br>1180  | 34-1<br>1220  | 34-8<br>1270  | 35-4<br>1310  | 36-5<br>1400  |
|                         | 13.7   | 24-10<br>740 | 25-10<br>800 | 25-10<br>860 | 27-8<br>920   | 28-6<br>970   | 29-3<br>1030  | 30-0<br>1080  | 30-8<br>1130  | 31-4<br>1180  | 32-0<br>1230  | 32-7<br>1280  | 33-2<br>1320  | 33-9<br>1370  | 34-10<br>1460 |
|                         | 16.0   | 23-8<br>780  | 24-7<br>850  | 25-5<br>910  | 26-3<br>970   | 27-1<br>1030  | 27-9<br>1080  | 28-6<br>1140  | 29-2<br>1190  | 29-9<br>1240  | 30-5<br>1290  | 31-0<br>1340  | 31-6<br>1390  | 32-1<br>1440  | 33-1<br>1540  |
|                         | 19.2   | 22-3<br>830  | 23-2<br>900  | 23-11<br>970 | 24-9<br>1030  | 25-5<br>1090  | 26-2<br>1150  | 26-10<br>1210 | 27-5<br>1270  | 28-0<br>1320  | 28-7<br>1380  | 29-2<br>1430  | 29-8<br>1480  | 30-2<br>1530  | 31-2<br>1630  |
|                         | 24.0   | 20-8<br>900  | 21-6<br>970  | 22-3<br>1040 | 22-11<br>1110 | 23-8<br>1170  | 24-3<br>1240  | 24-10<br>1300 | 25-5<br>1360  | 26-0<br>1420  | 26-6<br>1480  | 27-1<br>1540  | 27-6<br>1600  | 28-0<br>1650  | 28-11<br>1760 |

Note: The required extreme fiber stress in bending "F<sub>b</sub>", in pounds per square inch is shown below each span.

## DESIGN CRITERIA:

Strength - 15 lbs. per sq. ft. dead load  
plus 30 lbs. per sq. ft. live load  
determines required fiber stress.

Deflection - For 30 lbs. per sq. ft. live  
load. Limited to span in inches divided  
by 240.

| RAFTER<br>SIZE SPACING<br>(IN) (IN) |      | Allowable Extreme Fiber Stress in Bending, "F <sub>b</sub> " (psi). |               |               |               |               |               |               |               |               |
|-------------------------------------|------|---|---------------|---------------|---------------|---------------|---------------|---------------|---------------|---------------|
|                                     |      | 500   | 600           | 700           | 800           | 900           | 1000          | 1100          | 1200          | 1300          |
| 2x6                                 | 12.0 | 7-6<br>0.27   | 8-2<br>0.36   | 8-10<br>0.45  | 9-6<br>0.55   | 10-0<br>0.66  | 10-7<br>0.77  | 11-1<br>0.89  | 11-7<br>1.01  | 12-1<br>1.14  |
|                                     | 13.7 | 7-0<br>0.25   | 7-8<br>0.33   | 8-3<br>0.42   | 8-10<br>0.52  | 9-5<br>0.61   | 9-11<br>0.72  | 10-5<br>0.83  | 10-10<br>0.95 | 11-3<br>1.07  |
|                                     | 16.0 | 6-6<br>0.24   | 7-1<br>0.31   | 7-8<br>0.39   | 8-2<br>0.48   | 8-8<br>0.57   | 9-2<br>0.67   | 9-7<br>0.77   | 10-0<br>0.88  | 10-5<br>0.99  |
|                                     | 19.2 | 5-11<br>0.22  | 6-6<br>0.28   | 7-0<br>0.36   | 7-6<br>0.44   | 7-11<br>0.52  | 8-4<br>0.61   | 8-9<br>0.70   | 9-2<br>0.80   | 9-6<br>0.90   |
|                                     | 24.0 | 5-4<br>0.19   | 5-10<br>0.25  | 6-3<br>0.32   | 6-8<br>0.39   | 7-1<br>0.46   | 7-6<br>0.54   | 7-10<br>0.63  | 8-2<br>0.72   | 8-6<br>0.81   |
| 2x8                                 | 12.0 | 9-10<br>0.27  | 10-10<br>0.36 | 11-8<br>0.45  | 12-6<br>0.55  | 13-3<br>0.66  | 13-11<br>0.77 | 14-8<br>0.89  | 15-3<br>1.01  | 15-11<br>1.14 |
|                                     | 13.7 | 9-3<br>0.25   | 10-1<br>0.33  | 10-11<br>0.42 | 11-8<br>0.52  | 12-5<br>0.61  | 13-1<br>0.72  | 13-8<br>0.83  | 14-4<br>0.95  | 14-11<br>1.07 |
|                                     | 16.0 | 8-7<br>0.24   | 9-4<br>0.31   | 10-1<br>0.39  | 10-10<br>0.48 | 11-6<br>0.57  | 12-1<br>0.67  | 12-8<br>0.77  | 13-3<br>0.88  | 13-9<br>0.99  |
|                                     | 19.2 | 7-10<br>0.22  | 8-7<br>0.28   | 9-3<br>0.35   | 9-10<br>0.44  | 10-6<br>0.52  | 11-0<br>0.61  | 11-7<br>0.70  | 12-1<br>0.80  | 12-7<br>0.90  |
|                                     | 24.0 | 7-0<br>0.19   | 7-8<br>0.25   | 8-3<br>0.32   | 8-10<br>0.39  | 9-4<br>0.46   | 9-10<br>0.54  | 10-4<br>0.63  | 10-10<br>0.72 | 11-3<br>0.81  |
| 2x10                                | 12.0 | 12-7<br>0.27  | 13-9<br>0.36  | 14-11<br>0.45 | 15-11<br>0.55 | 16-11<br>0.66 | 17-10<br>0.77 | 18-8<br>0.89  | 19-6<br>1.01  | 20-4<br>1.14  |
|                                     | 13.7 | 11-9<br>0.25  | 12-11<br>0.33 | 13-11<br>0.42 | 14-11<br>0.52 | 15-10<br>0.61 | 16-8<br>0.72  | 17-6<br>0.83  | 18-3<br>0.95  | 19-0<br>1.07  |
|                                     | 16.0 | 10-11<br>0.24   | 11-11<br>0.31 | 12-11<br>0.39 | 13-9<br>0.48  | 14-8<br>0.57  | 15-5<br>0.67  | 16-2<br>0.77  | 16-11<br>0.88 | 17-7<br>0.99  |
|                                     | 19.2 | 9-11<br>0.22  | 10-11<br>0.28 | 11-9<br>0.36  | 12-7<br>0.44  | 13-4<br>0.52  | 14-1<br>0.61  | 14-9<br>0.70  | 15-5<br>0.80  | 16-1<br>0.90  |
|                                     | 24.0 | 8-11<br>0.19  | 9-9<br>0.25   | 10-6<br>0.32  | 11-3<br>0.39  | 11-11<br>0.46 | 12-7<br>0.54  | 13-2<br>0.63  | 13-9<br>0.72  | 14-4<br>0.81  |
| 2x12                                | 12.0 | 15-4<br>0.27  | 16-9<br>0.36  | 18-1<br>0.45  | 19-4<br>0.55  | 20-6<br>0.66  | 21-8<br>0.77  | 22-8<br>0.89  | 23-9<br>1.01  | 24-8<br>1.14  |
|                                     | 13.7 | 14-4<br>0.25  | 15-8<br>0.33  | 16-11<br>0.42 | 18-1<br>0.52  | 19-3<br>0.61  | 20-3<br>0.72  | 21-3<br>0.83  | 22-2<br>0.95  | 23-1<br>1.07  |
|                                     | 16.0 | 13-3<br>0.24  | 14-6<br>0.31  | 15-8<br>0.39  | 16-9<br>0.48  | 17-9<br>0.57  | 18-9<br>0.67  | 19-8<br>0.77  | 20-6<br>0.88  | 21-5<br>0.99  |
|                                     | 19.2 | 12-1<br>0.22  | 13-3<br>0.28  | 14-4<br>0.36  | 15-4<br>0.44  | 16-3<br>0.52  | 17-1<br>0.61  | 17-11<br>0.70 | 18-9<br>0.80  | 19-6<br>0.90  |
|                                     | 24.0 | 10-10<br>0.19   | 11-10<br>0.25 | 12-10<br>0.32 | 13-8<br>0.39  | 14-6<br>0.46  | 15-4<br>0.54  | 16-1<br>0.63  | 16-9<br>0.72  | 17-5<br>0.81  |

Note: The required modulus of elasticity, "E", in 1,000,000  
pounds per square inch is shown below each span.



780 CMR: STATE BUILDING CODE COMMISSION

RAFTERS: Spans are measured along the horizontal projection and loads are considered as applied on the horizontal projection.

of rafters (upper figure in each square). Determine size and spacing (first column) based on stress grade (top row) and modulus of elasticity (lower figure in each square) of lumber to be used.

HOW TO USE TABLES:  
Enter table with span

| RAFTER<br>SIZE SPACING<br>(IN) (IN) |       | Allowable Extreme Fiber Stress in Bending, "F <sub>b</sub> " (psi). |       |       |       |       |       |
|-------------------------------------|-------|---|-------|-------|-------|-------|-------|
|                                     |       | 1400  | 1500  | 1600  | 1700  | 1800  | 1900  |
| 2x6                                 | 12.0  | 12-6  | 13-0  | 13-5  | 13-10 | 14-2  | 14-7  |
|                                     |       | 1.28  | 1.41  | 1.56  | 1.71  | 1.86  | 2.02  |
|                                     | 13.7  | 11-9  | 12-2  | 12-6  | 12-11 | 13-3  | 13-8  |
|                                     |       | 1.19  | 1.32  | 1.46  | 1.60  | 1.74  | 1.89  |
|                                     | 16.0  | 10-10   | 11-3  | 11-7  | 11-11 | 12-4  | 12-8  |
| 1.10                                |       | 1.22  | 1.35  | 1.48  | 1.61  | 1.75  |       |
| 19.2                                | 9-11  | 10-3  | 10-7  | 10-11 | 11-3  | 11-6  |       |
|                                     | 1.01  | 1.12  | 1.23  | 1.35  | 1.47  | 1.59  |       |
| 24.0                                | 8-10  | 9-2   | 9-6   | 9-9   | 10-0  | 10-4  |       |
|                                     | 0.90  | 1.00  | 1.10  | 1.21  | 1.31  | 1.43  |       |
| 2x8                                 | 12.0  | 16-6  | 17-1  | 17-8  | 18-2  | 18-9  | 19-3  |
|                                     |       | 1.28  | 1.41  | 1.56  | 1.71  | 1.86  | 2.02  |
|                                     | 13.7  | 15-5  | 16-0  | 16-6  | 17-0  | 17-6  | 18-0  |
|                                     |       | 1.19  | 1.32  | 1.46  | 1.60  | 1.74  | 1.89  |
|                                     | 16.0  | 14-4  | 14-10 | 15-3  | 15-9  | 16-3  | 16-8  |
| 1.10                                |       | 1.22  | 1.35  | 1.48  | 1.61  | 1.75  |       |
| 19.2                                | 13-1  | 13-6  | 13-11 | 14-5  | 14-10 | 15-2  |       |
|                                     | 1.01  | 1.12  | 1.23  | 1.35  | 1.47  | 1.59  |       |
| 24.0                                | 11-8  | 12-1  | 12-6  | 12-10 | 13-3  | 13-7  |       |
|                                     | 0.90  | 1.00  | 1.10  | 1.21  | 1.31  | 1.43  |       |
| 2x10                                | 12.0  | 21-1  | 21-10 | 22-6  | 23-3  | 23-11 | 24-6  |
|                                     |       | 1.28  | 1.41  | 1.56  | 1.71  | 1.86  | 2.02  |
|                                     | 13.7  | 19-8  | 20-5  | 21-1  | 21-9  | 22-4  | 22-11 |
|                                     |       | 1.19  | 1.32  | 1.46  | 1.60  | 1.74  | 1.89  |
|                                     | 16.0  | 18-3  | 18-11 | 19-6  | 20-1  | 20-8  | 21-3  |
| 1.10                                |       | 1.22  | 1.35  | 1.48  | 1.61  | 1.75  |       |
| 19.2                                | 16-8  | 17-3  | 17-10 | 18-4  | 18-11 | 19-5  |       |
|                                     | 1.01  | 1.12  | 1.23  | 1.35  | 1.47  | 1.59  |       |
| 24.0                                | 14-11 | 15-5  | 15-11 | 16-5  | 16-11 | 17-4  |       |
|                                     | 0.90  | 1.00  | 1.10  | 1.21  | 1.31  | 1.43  |       |
| 2x12                                | 12.0  | 25-7  | 26-6  | 27-5  | 28-3  | 29-1  | 29-10 |
|                                     |       | 1.28  | 1.41  | 1.55  | 1.71  | 1.86  | 2.02  |
|                                     | 13.7  | 24-0  | 24-10 | 25-7  | 26-5  | 27-2  | 27-11 |
|                                     |       | 1.19  | 1.32  | 1.46  | 1.60  | 1.74  | 1.89  |
|                                     | 16.0  | 22-2  | 23-0  | 23-9  | 24-5  | 25-2  | 25-10 |
| 1.10                                |       | 1.22  | 1.35  | 1.48  | 1.61  | 1.75  |       |
| 19.2                                | 20-3  | 21-0  | 21-8  | 22-4  | 23-0  | 23-7  |       |
|                                     | 1.01  | 1.12  | 1.23  | 1.35  | 1.47  | 1.59  |       |
| 24.0                                | 18-1  | 18-9  | 19-4  | 20-0  | 20-6  | 21-1  |       |
|                                     | 0.90  | 1.00  | 1.10  | 1.21  | 1.31  | 1.43  |       |

## 780 CMR: STATE BUILDING CODE COMMISSION

Table 2106-4  
ALLOWABLE SPANS FOR "CATHEDRAL" ROOF RAFTERS  
No Attic Space

## DESIGN CRITERIA:

Strength - 10 lbs. per sq. ft. dead load plus  
30 lbs. per sq. ft. live load determines  
required fiber stress.

Deflection - For 30 lbs. per sq. ft. live load,  
Limited to span in inches divided by 240.

| RAFTER<br>SIZE<br>SPACING<br>(IN) | RAFTER<br>SIZE<br>(IN) | Allowable Extreme Fiber Stress In Bending, "F <sub>b</sub> " (psi). |              |               |               |               |               |               |               |               |
|-----------------------------------|------------------------|---|--------------|---------------|---------------|---------------|---------------|---------------|---------------|---------------|
|                                   |                        | 500   | 600          | 700           | 800           | 900           | 1000          | 1100          | 1200          | 1300          |
| 2x6                               | 12.0                   | 7-11<br>0.32  | 8-8<br>0.43  | 9-5<br>0.54   | 10-0<br>0.66  | 10-8<br>0.78  | 11-3<br>0.92  | 11-9<br>1.06  | 12-4<br>1.21  | 12-10<br>1.36 |
|                                   | 13.7                   | 7-5<br>0.30   | 8-2<br>0.40  | 8-9<br>0.50   | 9-5<br>0.61   | 10-0<br>0.73  | 10-6<br>0.86  | 11-0<br>0.99  | 11-6<br>1.13  | 12-0<br>1.27  |
|                                   | 16.0                   | 6-11<br>0.28  | 7-6<br>0.37  | 8-2<br>0.47   | 8-8<br>0.57   | 9-3<br>0.68   | 9-9<br>0.80   | 10-2<br>0.92  | 10-8<br>1.05  | 11-1<br>1.18  |
|                                   | 19.2                   | 6-3<br>0.26   | 6-11<br>0.34 | 7-5<br>0.43   | 7-11<br>0.52  | 8-5<br>0.62   | 8-11<br>0.73  | 9-4<br>0.84   | 9-9<br>0.95   | 10-1<br>1.08  |
|                                   | 24.0                   | 5-7<br>0.23   | 6-2<br>0.30  | 6-8<br>0.38   | 7-1<br>0.46   | 7-6<br>0.55   | 7-11<br>0.65  | 8-4<br>0.75   | 8-8<br>0.85   | 9-1<br>0.96   |
| 2x8                               | 12.0                   | 10-6<br>0.32  | 11-6<br>0.43 | 12-5<br>0.54  | 13-3<br>0.66  | 14-0<br>0.78  | 14-10<br>0.92 | 15-6<br>1.06  | 16-3<br>1.21  | 16-10<br>1.36 |
|                                   | 13.7                   | 9-9<br>0.30   | 10-9<br>0.40 | 11-7<br>0.50  | 12-5<br>0.61  | 13-2<br>0.73  | 13-10<br>0.86 | 14-6<br>0.99  | 15-2<br>1.13  | 15-9<br>1.27  |
|                                   | 16.0                   | 9-1<br>0.28   | 9-11<br>0.37 | 10-9<br>0.47  | 11-6<br>0.57  | 12-2<br>0.68  | 12-10<br>0.80 | 13-5<br>0.92  | 14-0<br>1.05  | 14-7<br>1.18  |
|                                   | 19.2                   | 8-3<br>0.26   | 9-1<br>0.34  | 9-9<br>0.43   | 10-6<br>0.52  | 11-1<br>0.62  | 11-8<br>0.73  | 12-3<br>0.84  | 12-10<br>0.95 | 13-4<br>1.08  |
|                                   | 24.0                   | 7-5<br>0.23   | 8-1<br>0.30  | 8-9<br>0.38   | 9-4<br>0.46   | 9-11<br>0.55  | 10-6<br>0.65  | 11-0<br>0.75  | 11-6<br>0.85  | 11-11<br>0.96 |
| 2x10                              | 12.0                   | 13-4<br>0.32  | 14-8<br>0.43 | 15-10<br>0.54 | 16-11<br>0.66 | 17-11<br>0.78 | 18-11<br>0.92 | 19-10<br>1.06 | 20-8<br>1.21  | 21-6<br>1.36  |
|                                   | 13.7                   | 12-6<br>0.30  | 13-8<br>0.40 | 14-9<br>0.50  | 15-10<br>0.61 | 16-9<br>0.73  | 17-8<br>0.86  | 18-6<br>0.99  | 19-4<br>1.13  | 20-2<br>1.27  |
|                                   | 16.0                   | 11-7<br>0.28  | 12-8<br>0.37 | 13-8<br>0.47  | 14-8<br>0.57  | 15-6<br>0.68  | 16-4<br>0.80  | 17-2<br>0.92  | 17-11<br>1.05 | 18-8<br>1.18  |
|                                   | 19.2                   | 10-7<br>0.26  | 11-7<br>0.34 | 12-6<br>0.43  | 13-4<br>0.52  | 14-2<br>0.62  | 14-11<br>0.73 | 15-8<br>0.84  | 16-4<br>0.95  | 17-0<br>1.08  |
|                                   | 24.0                   | 9-5<br>0.23   | 10-4<br>0.30 | 11-2<br>0.38  | 11-11<br>0.46 | 12-8<br>0.55  | 13-4<br>0.65  | 14-0<br>0.75  | 14-8<br>0.85  | 15-3<br>0.96  |
| 2x12                              | 12.0                   | 16-3<br>0.32  | 17-9<br>0.43 | 19-3<br>0.54  | 20-6<br>0.66  | 21-9<br>0.78  | 23-0<br>0.92  | 24-1<br>1.06  | 25-2<br>1.21  | 26-2<br>1.36  |
|                                   | 13.7                   | 15-2<br>0.30  | 16-8<br>0.40 | 18-0<br>0.50  | 19-3<br>0.61  | 20-5<br>0.73  | 21-6<br>0.86  | 22-6<br>0.99  | 23-6<br>1.13  | 24-6<br>1.27  |
|                                   | 16.0                   | 14-1<br>0.28  | 15-5<br>0.37 | 16-8<br>0.47  | 17-9<br>0.57  | 18-10<br>0.68 | 19-11<br>0.80 | 20-10<br>0.92 | 21-9<br>1.05  | 22-8<br>1.18  |
|                                   | 19.2                   | 12-10<br>0.26   | 14-1<br>0.34 | 15-2<br>0.43  | 16-3<br>0.52  | 17-3<br>0.62  | 18-2<br>0.73  | 19-0<br>0.84  | 19-11<br>0.95 | 20-8<br>1.08  |
|                                   | 24.0                   | 11-6<br>0.23  | 12-7<br>0.30 | 13-7<br>0.38  | 14-6<br>0.46  | 15-5<br>0.55  | 16-3<br>0.65  | 17-0<br>0.75  | 17-9<br>0.85  | 18-6<br>0.96  |

Note: The required modulus of elasticity, "E", in 1,000,000 pounds per square inch is shown below each span.

780 CMR: STATE BUILDING CODE COMMISSION

30 lbs. Per Sq. Ft. Live Load  
(No Finished Ceiling)

RAFTERS: Spans are measured along the horizontal projection and loads are considered as applied on the horizontal projection.

HOW TO USE TABLES: Enter table with span of rafters (upper figure in each square). Determine size and spacing (first column) based on stress grade (top row) and modulus of elasticity (lower figure in each square) of lumber to be used.

| RAFTER<br>SIZE SPACING<br>(IN) (IN) |      | Allowable Extreme Fiber Stress in Bending, "F <sub>b</sub> " (psi). |               |               |               |               |                           |
|-------------------------------------|------|---|---------------|---------------|---------------|---------------|---------------------------|
|                                     |      | 1400  | 1500          | 1600          | 1700          | 1800          | 1900                      |
| 2x6                                 | 12.0 | 13-3<br>1.52  | 13-9<br>1.69  | 14-2<br>1.86  | 14-8<br>2.04  | 15-1<br>2.22  | 15-6<br>2.41              |
|                                     | 13.7 | 12-5<br>1.42  | 12-10<br>1.58 | 13-3<br>1.74  | 13-8<br>1.90  | 14-1<br>2.08  | 14-6<br>2.25              |
|                                     | 16.0 | 11-6<br>1.32  | 11-11<br>1.46 | 12-4<br>1.61  | 12-8<br>1.76  | 13-1<br>1.92  | 13-5<br>2.08              |
|                                     | 19.2 | 10-6<br>1.20  | 10-10<br>1.33 | 11-3<br>1.47  | 11-7<br>1.61  | 11-11<br>1.75 | 12-3<br>1.90              |
|                                     | 24.0 | 9-5<br>1.08   | 9-9<br>1.19   | 10-0<br>1.31  | 10-4<br>1.44  | 10-8<br>1.57  | 10-11<br>1.70             |
| 2x8                                 | 12.0 | 17-6<br>1.52  | 18-2<br>1.69  | 18-9<br>1.86  | 19-4<br>2.04  | 19-10<br>2.22 | 20-5<br>2.41              |
|                                     | 13.7 | 16-5<br>1.42  | 16-11<br>1.58 | 17-6<br>1.74  | 18-1<br>1.90  | 18-7<br>2.08  | 19-1<br>2.25              |
|                                     | 16.0 | 15-2<br>1.32  | 15-8<br>1.46  | 16-3<br>1.61  | 16-9<br>1.76  | 17-2<br>1.92  | 17-8<br>2.08              |
|                                     | 19.2 | 13-10<br>1.20   | 14-4<br>1.33  | 14-10<br>1.47 | 15-3<br>1.61  | 15-8<br>1.75  | 16-2<br>1.90              |
|                                     | 24.0 | 12-5<br>1.08  | 12-10<br>1.19 | 13-3<br>1.31  | 13-8<br>1.44  | 14-0<br>1.57  | 14-5<br>1.70              |
| 2x10                                | 12.0 | 22-4<br>1.52  | 23-2<br>1.69  | 23-11<br>1.86 | 24-7<br>2.04  | 25-4<br>2.22  | 26-0<br>2.41              |
|                                     | 13.7 | 20-11<br>1.42   | 21-8<br>1.58  | 22-4<br>1.74  | 23-0<br>1.90  | 23-8<br>2.08  | 24-4<br>2.25              |
|                                     | 16.0 | 19-4<br>1.32  | 20-0<br>1.46  | 20-8<br>1.61  | 21-4<br>1.76  | 21-11<br>1.92 | 22-6<br>2.08              |
|                                     | 19.2 | 17-8<br>1.20  | 18-3<br>1.33  | 18-11<br>1.47 | 19-6<br>1.61  | 20-0<br>1.75  | 20-7<br>1.90              |
|                                     | 24.0 | 15-10<br>1.08   | 16-4<br>1.19  | 16-11<br>1.31 | 17-5<br>1.44  | 17-11<br>1.57 | 18-5<br>1.70              |
| 2x12                                | 12.0 | 27-2<br>1.52  | 28-2<br>1.69  | 29-1<br>1.86  | 29-11<br>2.04 | 30-10<br>2.22 | 31-8 <sup>A</sup><br>2.41 |
|                                     | 13.7 | 25-5<br>1.42  | 26-4<br>1.58  | 27-2<br>1.74  | 28-0<br>1.90  | 28-10<br>2.08 | 29-7<br>2.25              |
|                                     | 16.0 | 23-6<br>1.32  | 24-4<br>1.46  | 25-2<br>1.61  | 25-11<br>1.76 | 26-8<br>1.92  | 27-5<br>2.08              |
|                                     | 19.2 | 21-6<br>1.20  | 22-3<br>1.33  | 23-0<br>1.47  | 23-8<br>1.61  | 24-4<br>1.75  | 25-0<br>1.90              |
|                                     | 24.0 | 19-3<br>1.08  | 19-11<br>1.19 | 20-6<br>1.31  | 21-2<br>1.44  | 21-9<br>1.57  | 22-5<br>1.70              |

780 CMR: STATE BUILDING CODE COMMISSION

Table 2106-5  
 ALLOWABLE SPANS FOR ROOF RAFTERS  
 Over Attic Space  
 30 lbs. Per Sq. Ft. Live Load  
 (Tile, Slate, Conc. Roof Covering)

DESIGN CRITERIA:

Strength - 15 lbs. per sq. ft. dead load plus  
 30 lbs. per sq. ft. live load determines  
 required fiber stress.

Deflection - For 30 lbs. per sq. ft. live load.  
 Limited to span in inches divided by 180.

| RAFTER<br>SIZE SPACING<br>(IN) (IN) |      | Allowable Extreme Fiber Stress in Bending, "F <sub>b</sub> " (psi). |               |               |               |               |               |              |               |               |
|-------------------------------------|------|---|---------------|---------------|---------------|---------------|---------------|--------------|---------------|---------------|
|                                     |      | 500   | 600           | 700           | 800           | 900           | 1000          | 1100         | 1200          | 1300          |
| 2x4                                 | 12.0 | 4-9<br>0.20   | 5-3<br>0.27   | 5-8<br>0.34   | 6-0<br>0.41   | 6-5<br>0.49   | 6-9<br>0.58   | 7-1<br>0.67  | 7-5<br>0.76   | 7-8<br>0.86   |
|                                     | 13.7 | 4-5<br>0.19   | 4-11<br>0.25  | 5-3<br>0.32   | 5-8<br>0.39   | 6-0<br>0.46   | 6-4<br>0.54   | 6-7<br>0.62  | 6-11<br>0.71  | 7-2<br>0.80   |
|                                     | 16.0 | 4-1<br>0.18   | 4-6<br>0.23   | 4-11<br>0.29  | 5-3<br>0.36   | 5-6<br>0.43   | 5-10<br>0.50  | 6-1<br>0.58  | 6-5<br>0.66   | 6-8<br>0.74   |
|                                     | 19.2 | 3-9<br>0.16   | 4-1<br>0.21   | 4-5<br>0.27   | 4-9<br>0.33   | 5-1<br>0.39   | 5-4<br>0.46   | 5-7<br>0.53  | 5-10<br>0.60  | 6-1<br>0.68   |
|                                     | 24.0 | 3-4<br>0.14   | 3-8<br>0.19   | 4-0<br>0.24   | 4-3<br>0.29   | 4-6<br>0.35   | 4-9<br>0.41   | 5-0<br>0.47  | 5-3<br>0.54   | 5-5<br>0.61   |
| 2x6                                 | 12.0 | 7-6<br>0.20   | 8-2<br>0.27   | 8-10<br>0.34  | 9-6<br>0.41   | 10-0<br>0.49  | 10-7<br>0.58  | 11-1<br>0.67 | 11-7<br>0.76  | 12-1<br>0.86  |
|                                     | 13.7 | 7-0<br>0.19   | 7-8<br>0.25   | 8-3<br>0.32   | 8-10<br>0.39  | 9-5<br>0.46   | 9-11<br>0.54  | 10-5<br>0.62 | 10-10<br>0.71 | 11-3<br>0.80  |
|                                     | 16.0 | 6-6<br>0.18   | 7-1<br>0.23   | 7-8<br>0.29   | 8-2<br>0.36   | 8-8<br>0.43   | 9-2<br>0.50   | 9-7<br>0.58  | 10-0<br>0.66  | 10-5<br>0.74  |
|                                     | 19.2 | 5-11<br>0.16  | 6-6<br>0.21   | 7-0<br>0.27   | 7-6<br>0.33   | 7-11<br>0.39  | 8-4<br>0.46   | 8-9<br>0.53  | 9-2<br>0.60   | 9-6<br>0.68   |
|                                     | 24.0 | 5-4<br>0.14   | 5-10<br>0.19  | 6-3<br>0.24   | 6-8<br>0.29   | 7-1<br>0.35   | 7-6<br>0.41   | 7-10<br>0.47 | 8-2<br>0.54   | 8-6<br>0.61   |
| 2x8                                 | 12.0 | 9-10<br>0.20  | 10-10<br>0.27 | 11-8<br>0.34  | 12-6<br>0.41  | 13-3<br>0.49  | 13-11<br>0.58 | 14-8<br>0.67 | 15-3<br>0.76  | 15-11<br>0.86 |
|                                     | 13.7 | 9-3<br>0.19   | 10-1<br>0.25  | 10-11<br>0.32 | 11-8<br>0.39  | 12-5<br>0.46  | 13-1<br>0.54  | 13-8<br>0.62 | 14-4<br>0.71  | 14-11<br>0.80 |
|                                     | 16.0 | 8-7<br>0.18   | 9-4<br>0.23   | 10-1<br>0.29  | 10-10<br>0.36 | 11-6<br>0.43  | 12-1<br>0.50  | 12-8<br>0.58 | 13-3<br>0.66  | 13-9<br>0.74  |
|                                     | 19.2 | 7-10<br>0.16  | 8-7<br>0.21   | 9-3<br>0.27   | 9-10<br>0.33  | 10-6<br>0.39  | 11-0<br>0.46  | 11-7<br>0.53 | 12-1<br>0.60  | 12-7<br>0.68  |
|                                     | 24.0 | 7-0<br>0.14   | 7-8<br>0.19   | 8-3<br>0.24   | 8-10<br>0.29  | 9-4<br>0.35   | 9-10<br>0.41  | 10-4<br>0.47 | 10-10<br>0.54 | 11-3<br>0.61  |
| 2x10                                | 12.0 | 12-7<br>0.20  | 13-9<br>0.27  | 14-11<br>0.34 | 15-11<br>0.41 | 16-11<br>0.49 | 17-10<br>0.58 | 18-8<br>0.67 | 19-6<br>0.76  | 20-4<br>0.86  |
|                                     | 13.7 | 11-9<br>0.19  | 12-11<br>0.25 | 13-11<br>0.32 | 14-11<br>0.39 | 15-10<br>0.46 | 16-8<br>0.54  | 17-6<br>0.62 | 18-3<br>0.71  | 19-0<br>0.80  |
|                                     | 16.0 | 10-11<br>0.18   | 11-11<br>0.23 | 12-11<br>0.29 | 13-9<br>0.36  | 14-8<br>0.43  | 15-5<br>0.50  | 16-2<br>0.58 | 16-11<br>0.66 | 17-7<br>0.74  |
|                                     | 19.2 | 9-11<br>0.16  | 10-11<br>0.21 | 11-9<br>0.27  | 12-7<br>0.33  | 13-4<br>0.39  | 14-1<br>0.46  | 14-9<br>0.53 | 15-5<br>0.60  | 16-1<br>0.68  |
|                                     | 24.0 | 8-11<br>0.14  | 9-9<br>0.19   | 10-6<br>0.24  | 11-3<br>0.29  | 11-11<br>0.35 | 12-7<br>0.41  | 13-2<br>0.47 | 13-9<br>0.54  | 14-4<br>0.61  |

Note: The required modulus of elasticity, "E", in 1,000,000 pounds per square inch is shown below each span.

HOW TO USE TABLES:  
 Enter table with span of rafters (upper figure in each square). Determine size and spacing (first column) based on stress grade (top row) and modulus of elasticity (lower figure in each square) of lumber to be used

RAFTERS: Spans are measured along the horizontal projection and loads are considered as applied on the horizontal projection.

| RAFTER SIZE SPACING (IN) |      | Allowable Extreme Fiber Stress in Bending, "F <sub>b</sub> " (psi). |               |               |               |               |               |
|--------------------------|------|---|---------------|---------------|---------------|---------------|---------------|
|                          |      | 1400  | 1500          | 1600          | 1700          | 1800          | 1900          |
| 2x4                      | 12.0 | 8-0<br>0.96   | 8-3<br>1.06   | 8-6<br>1.17   | 8-9<br>1.28   | 9-0<br>1.39   | 9-3<br>1.51   |
|                          | 13.7 | 7-5<br>0.89   | 7-9<br>0.99   | 8-0<br>1.09   | 8-3<br>1.20   | 8-5<br>1.30   | 8-8<br>1.41   |
|                          | 16.0 | 6-11<br>0.83  | 7-2<br>0.92   | 7-5<br>1.01   | 7-7<br>1.11   | 7-10<br>1.21  | 8-0<br>1.31   |
|                          | 19.2 | 6-4<br>0.76   | 6-6<br>0.84   | 6-9<br>0.92   | 6-11<br>1.01  | 7-2<br>1.10   | 7-4<br>1.20   |
|                          | 24.0 | 5-8<br>0.68   | 5-10<br>0.75  | 6-0<br>0.83   | 6-3<br>0.90   | 6-5<br>0.99   | 6-7<br>1.07   |
| 2x6                      | 12.0 | 12-6<br>0.96  | 13-0<br>1.06  | 13-5<br>1.17  | 13-10<br>1.28 | 14-2<br>1.39  | 14-7<br>1.51  |
|                          | 13.7 | 11-9<br>0.89  | 12-2<br>0.99  | 12-6<br>1.09  | 12-11<br>1.20 | 13-3<br>1.30  | 13-8<br>1.41  |
|                          | 16.0 | 10-10<br>0.83   | 11-3<br>0.92  | 11-7<br>1.01  | 11-11<br>1.11 | 12-4<br>1.21  | 12-8<br>1.31  |
|                          | 19.2 | 9-11<br>0.76  | 10-3<br>0.84  | 10-7<br>0.92  | 10-11<br>1.01 | 11-3<br>1.10  | 11-6<br>1.20  |
|                          | 24.0 | 8-10<br>0.68  | 9-2<br>0.75   | 9-6<br>0.83   | 9-9<br>0.90   | 10-0<br>0.99  | 10-4<br>1.07  |
| 2x8                      | 12.0 | 16-6<br>0.96  | 17-1<br>1.06  | 17-8<br>1.17  | 18-2<br>1.28  | 18-9<br>1.39  | 19-3<br>1.51  |
|                          | 13.7 | 15-5<br>0.89  | 16-0<br>0.99  | 16-6<br>1.09  | 17-0<br>1.20  | 17-6<br>1.30  | 18-0<br>1.41  |
|                          | 16.0 | 14-4<br>0.83  | 14-10<br>0.92 | 15-3<br>1.01  | 15-9<br>1.11  | 16-3<br>1.21  | 16-8<br>1.31  |
|                          | 19.2 | 13-1<br>0.76  | 13-6<br>0.84  | 13-11<br>0.92 | 14-5<br>1.01  | 14-10<br>1.10 | 15-2<br>1.20  |
|                          | 24.0 | 11-8<br>0.68  | 12-1<br>0.75  | 12-6<br>0.83  | 12-10<br>0.90 | 13-3<br>0.99  | 13-7<br>1.07  |
| 2x10                     | 12.0 | 21-1<br>0.96  | 21-10<br>1.06 | 22-6<br>1.17  | 23-3<br>1.28  | 23-11<br>1.39 | 24-6<br>1.51  |
|                          | 13.7 | 19-8<br>0.89  | 20-5<br>0.99  | 21-1<br>1.09  | 21-9<br>1.20  | 22-4<br>1.30  | 22-11<br>1.41 |
|                          | 16.0 | 18-3<br>0.83  | 18-11<br>0.92 | 19-6<br>1.01  | 20-1<br>1.11  | 20-8<br>1.21  | 21-3<br>1.31  |
|                          | 19.2 | 16-8<br>0.76  | 17-3<br>0.84  | 17-10<br>0.92 | 18-4<br>1.01  | 18-11<br>1.10 | 19-5<br>1.20  |
|                          | 24.0 | 14-11<br>0.68   | 15-5<br>0.75  | 15-11<br>0.83 | 16-5<br>0.90  | 16-11<br>0.99 | 17-4<br>1.07  |

780 CMR: STATE BUILDING CODE COMMISSION

Table 2106-6  
 ALLOWABLE SPANS FOR ROOF RAFTERS  
 Over Attic Space  
 30 lbs. Per Sq. Ft. Live Load  
 (Light Roof Coverings)  
 (Wood, Asphalt, etc..)

DESIGN CRITERIA:

Strength - 7 lbs per sq. ft. dead load plus  
 30 lbs. per sq. ft. live load determines  
 required fiber stress.

Deflection - For 30 lbs per sq. ft. live load.  
 Limited to span in inches divided by 180.

| RAFTER<br>SIZE SPACING<br>(IN) |      | Allowable Extreme Fiber Stress in Bending, "F <sub>b</sub> " (psi). |               |               |               |              |               |               |               |               |
|--------------------------------|------|---|---------------|---------------|---------------|--------------|---------------|---------------|---------------|---------------|
|                                |      | 500   | 600           | 700           | 800           | 900          | 1000          | 1100          | 1200          | 1300          |
| 2x4                            | 12.0 | 5-3<br>0.27   | 5-9<br>0.36   | 6-3<br>0.45   | 6-8<br>0.55   | 7-1<br>0.66  | 7-5<br>0.77   | 7-9<br>0.89   | 8-2<br>1.02   | 8-6<br>1.15   |
|                                | 13.7 | 4-11<br>0.26  | 5-5<br>0.34   | 5-10<br>0.42  | 6-3<br>0.52   | 6-7<br>0.62  | 6-11<br>0.72  | 7-3<br>0.84   | 7-7<br>0.95   | 7-11<br>1.07  |
|                                | 16.0 | 4-7<br>0.24   | 5-0<br>0.31   | 5-5<br>0.39   | 5-9<br>0.48   | 6-1<br>0.57  | 6-5<br>0.67   | 6-9<br>0.77   | 7-1<br>0.88   | 7-4<br>0.99   |
|                                | 19.2 | 4-2<br>0.22   | 4-7<br>0.28   | 4-11<br>0.36  | 5-3<br>0.44   | 5-7<br>0.52  | 5-10<br>0.61  | 6-2<br>0.71   | 6-5<br>0.80   | 6-8<br>0.91   |
|                                | 24.0 | 3-9<br>0.19   | 4-1<br>0.25   | 4-5<br>0.32   | 4-8<br>0.39   | 5-0<br>0.47  | 5-3<br>0.55   | 5-6<br>0.63   | 5-9<br>0.72   | 6-0<br>0.81   |
| 2x6                            | 12.0 | 8-3<br>0.27   | 9-1<br>0.36   | 9-9<br>0.45   | 10-5<br>0.55  | 11-1<br>0.66 | 11-8<br>0.77  | 12-3<br>0.89  | 12-9<br>1.02  | 13-4<br>1.15  |
|                                | 13.7 | 7-9<br>0.26   | 8-5<br>0.34   | 9-2<br>0.42   | 9-9<br>0.52   | 10-4<br>0.62 | 10-11<br>0.72 | 11-5<br>0.84  | 12-0<br>0.95  | 12-5<br>1.07  |
|                                | 16.0 | 7-2<br>0.24   | 7-10<br>0.31  | 8-5<br>0.39   | 9-1<br>0.48   | 9-7<br>0.57  | 10-1<br>0.67  | 10-7<br>0.77  | 11-1<br>0.88  | 11-6<br>0.99  |
|                                | 19.2 | 6-6<br>0.22   | 7-2<br>0.28   | 7-9<br>0.36   | 8-3<br>0.44   | 8-9<br>0.52  | 9-3<br>0.61   | 9-8<br>0.71   | 10-1<br>0.80  | 10-6<br>0.91  |
|                                | 24.0 | 5-10<br>0.19  | 6-5<br>0.25   | 6-11<br>0.32  | 7-5<br>0.39   | 7-10<br>0.47 | 8-3<br>0.55   | 8-8<br>0.63   | 9-1<br>0.72   | 9-5<br>0.81   |
| 2x8                            | 12.0 | 10-11<br>0.27   | 11-11<br>0.36 | 12-10<br>0.45 | 13-9<br>0.55  | 14-7<br>0.66 | 15-5<br>0.77  | 16-2<br>0.89  | 16-10<br>1.02 | 17-7<br>1.15  |
|                                | 13.7 | 10-2<br>0.26  | 11-2<br>0.34  | 12-1<br>0.42  | 12-10<br>0.52 | 13-8<br>0.62 | 14-5<br>0.72  | 15-1<br>0.84  | 15-9<br>0.95  | 16-5<br>1.07  |
|                                | 16.0 | 9-5<br>0.24   | 10-4<br>0.31  | 11-2<br>0.39  | 11-11<br>0.48 | 12-8<br>0.57 | 13-4<br>0.67  | 14-0<br>0.77  | 14-7<br>0.88  | 15-2<br>0.99  |
|                                | 19.2 | 8-7<br>0.22   | 9-5<br>0.28   | 10-2<br>0.36  | 10-11<br>0.44 | 11-6<br>0.52 | 12-2<br>0.61  | 12-9<br>0.71  | 13-4<br>0.80  | 13-10<br>0.91 |
|                                | 24.0 | 7-8<br>0.19   | 8-5<br>0.25   | 9-1<br>0.32   | 9-9<br>0.39   | 10-4<br>0.47 | 10-11<br>0.55 | 11-5<br>0.63  | 11-11<br>0.72 | 12-5<br>0.81  |
| 2x10                           | 12.0 | 13-11<br>0.27   | 15-2<br>0.36  | 16-5<br>0.45  | 17-7<br>0.55  | 18-7<br>0.66 | 19-8<br>0.77  | 20-7<br>0.89  | 21-6<br>1.02  | 22-5<br>1.15  |
|                                | 13.7 | 13-0<br>0.26  | 14-3<br>0.34  | 15-4<br>0.42  | 16-5<br>0.52  | 17-5<br>0.62 | 18-4<br>0.72  | 19-3<br>0.84  | 20-1<br>0.95  | 20-11<br>1.07 |
|                                | 16.0 | 12-0<br>0.26  | 13-2<br>0.34  | 14-3<br>0.43  | 15-2<br>0.53  | 16-2<br>0.63 | 17-0<br>0.74  | 17-10<br>0.85 | 18-7<br>0.97  | 19-5<br>1.09  |
|                                | 19.2 | 11-0<br>0.22  | 12-0<br>0.28  | 13-0<br>0.36  | 13-11<br>0.44 | 14-9<br>0.52 | 15-6<br>0.61  | 16-3<br>0.71  | 17-0<br>0.80  | 17-8<br>0.91  |
|                                | 24.0 | 9-10<br>0.19  | 10-9<br>0.25  | 11-7<br>0.32  | 12-5<br>0.39  | 13-2<br>0.47 | 13-11<br>0.55 | 14-7<br>0.63  | 15-2<br>0.72  | 15-10<br>0.81 |

Note: The required modulus of elasticity, "E", in 1,000,000 pounds per square inch is shown below each span.

**HOW TO USE TABLES:**  
 Enter table with span of rafters (upper figure in each square). Determine size and spacing (first column) based on stress grade (top row) and modulus of elasticity (lower figure in each square) of lumber to be used.

**RAFTERS:** Spans are measured along the horizontal projection and loads are considered as applied on the horizontal projection.

| RAFTER<br>SIZE SPACING<br>(IN) (IN) |       | Allowable Extreme Fiber Stress<br>in Bending, "F <sub>b</sub> " (psi). |       |       |       |       |       |
|-------------------------------------|-------|--|-------|-------|-------|-------|-------|
|                                     |       | 1400   | 1500  | 1600  | 1700  | 1800  | 1900  |
| 2x4                                 | 12.0  | 8-9  | 9-1   | 9-5   | 9-8   | 10-0  | 10-3  |
|                                     |       | 1.28   | 1.42  | 1.57  | 1.72  | 1.87  | 2.03  |
|                                     | 13.7  | 8-3  | 8-6   | 8-9   | 9-1   | 9-4   | 9-7   |
|                                     |       | 1.20   | 1.33  | 1.47  | 1.61  | 1.75  | 1.90  |
|                                     | 16.0  | 7-7  | 7-11  | 8-2   | 8-5   | 8-8   | 8-10  |
|                                     |       | 1.11   | 1.23  | 1.36  | 1.49  | 1.62  | 1.76  |
| 19.2                                | 6-11  | 7-2  | 7-5   | 7-8   | 7-11  | 8-1   |       |
|                                     | 1.01  | 1.12   | 1.24  | 1.36  | 1.48  | 1.60  |       |
| 24.0                                | 6-3   | 6-5  | 6-8   | 6-10  | 7-1   | 7-3   |       |
|                                     | 0.91  | 1.01   | 1.11  | 1.21  | 1.32  | 1.43  |       |
| 2x6                                 | 12.0  | 13-10  | 14-4  | 14-9  | 15-3  | 15-8  | 16-1  |
|                                     |       | 1.28   | 1.42  | 1.57  | 1.72  | 1.87  | 2.03  |
|                                     | 13.7  | 12-11  | 13-4  | 13-10 | 14-3  | 14-8  | 15-1  |
|                                     |       | 1.20   | 1.33  | 1.47  | 1.61  | 1.75  | 1.90  |
|                                     | 16.0  | 12-0   | 12-5  | 12-9  | 13-2  | 13-7  | 13-11 |
|                                     |       | 1.11   | 1.23  | 1.36  | 1.49  | 1.62  | 1.76  |
| 19.2                                | 10-11 | 11-4   | 11-8  | 12-0  | 12-5  | 12-9  |       |
|                                     | 1.01  | 1.12   | 1.24  | 1.36  | 1.48  | 1.60  |       |
| 24.0                                | 9-9   | 10-1   | 10-5  | 10-9  | 11-1  | 11-5  |       |
|                                     | 0.91  | 1.01   | 1.11  | 1.21  | 1.32  | 1.43  |       |
| 2x8                                 | 12.0  | 18-2   | 18-10 | 19-6  | 20-1  | 20-8  | 21-3  |
|                                     |       | 1.28   | 1.42  | 1.57  | 1.72  | 1.87  | 2.03  |
|                                     | 13.7  | 17-0   | 17-8  | 18-2  | 18-9  | 19-4  | 19-10 |
|                                     |       | 1.20   | 1.33  | 1.47  | 1.61  | 1.75  | 1.90  |
|                                     | 16.0  | 15-9   | 16-4  | 16-10 | 17-4  | 17-11 | 18-4  |
|                                     |       | 1.11   | 1.23  | 1.36  | 1.49  | 1.62  | 1.76  |
| 19.2                                | 14-5  | 14-11  | 15-5  | 15-10 | 16-4  | 16-9  |       |
|                                     | 1.01  | 1.12   | 1.24  | 1.36  | 1.48  | 1.60  |       |
| 24.0                                | 12-10 | 13-4   | 13-9  | 14-2  | 14-7  | 15-0  |       |
|                                     | 0.91  | 1.01   | 1.11  | 1.21  | 1.32  | 1.43  |       |
| 2x10                                | 12.0  | 23-3   | 24-1  | 24-10 | 25-7  | 26-4  | 27-1  |
|                                     |       | 1.28   | 1.42  | 1.57  | 1.72  | 1.87  | 2.03  |
|                                     | 13.7  | 21-9   | 22-6  | 23-3  | 23-11 | 24-8  | 25-4  |
|                                     |       | 1.20   | 1.33  | 1.47  | 1.61  | 1.75  | 1.90  |
|                                     | 16.0  | 20-1   | 20-10 | 21-6  | 22-2  | 22-10 | 23-5  |
|                                     |       | 1.22   | 1.35  | 1.49  | 1.63  | 1.78  | 1.93  |
| 19.2                                | 18-4  | 19-0   | 19-8  | 20-3  | 20-10 | 21-5  |       |
|                                     | 1.01  | 1.12   | 1.24  | 1.36  | 1.48  | 1.60  |       |
| 24.0                                | 16-5  | 17-0   | 17-7  | 18-1  | 18-7  | 19-2  |       |
|                                     | 0.91  | 1.01   | 1.11  | 1.21  | 1.32  | 1.43  |       |

SECTION 2107.0 ROOF COVERINGS

2107.1 General: Conformity with applicable material, test, construction and design standards specified in the reference standards of this article shall be acceptable as providing compliance with the requirements of this article.

2107.1.1 Coverings: Roofs shall be covered with Class A, B, or C roof covering.

Exception: The roof coverings set forth in Sections 2107.3, 2107.8, 2107.9 and 2107.10 may be used provided the building is located in areas designated by law as permitting their use and not less than ten (10) feet are provided between buildings.

2107.1.2 Class A materials: The roofing materials set forth in Sections 2107.4, 2107.5, 2107.6 and 2107.7 and concrete slabs may be accepted as Class A roof covering.

2107.1.3 Other roof systems: Material used as part of an integral roof solar collector system shall be acceptable so long as it is properly flashed and caulked with silicone or similar sealant to be waterproofed and provided it is used in combination with a metal absorber plate beneath the surface. (See 2107.11.)

2107.2 Base sheet application: Base sheets shall be applied only to solid surface roofs and shall be cemented to a suitable deck using not less than twenty-five (25) pounds of hot asphalt or not less than two (2) gallons of cold bituminous compound in accordance with the manufacturer's published specifications or thirty (30) pounds of hot coal tar pitch per roofing square, or nailed to a roof sheathing using not less than one (1) nail to each one and one-third (1-1/3) square feet, or may be spot-cemented to a non-nailable deck using not less than ten (10) pounds of hot asphalt per roofing square.

2107.2.1 Cementing: Successive layers shall be cemented to the base sheets using no less cementing material than that specified for solidly cemented base sheets.

2107.3 Composition asphalt organic felt shingles

2107.3.1 General: Composition shingles shall be applied only to solidly sheathed roofs.

2107.3.2 Slope criteria: Composition shingles shall not be installed on a roof having a slope of less than four (4) in twelve (12) unless approved by the building official.



2107.3.3 Other requirements: Composition shingles shall be fastened according to manufacturer's printed instructions.

2107.3.4 Flashing: Roof valley flashing shall be provided of not less than No. 28 galvanized sheet gauge corrosion-resistant metal and shall extend at least eight (8) inches from the center line each way, and shall have a splash diverter rib not less than three-quarter (3/4) inch high at the flow line formed as part of the flashing. Sections of flashing shall have an end lap of not less than four (4) inches.

2107.3.5 Other material: Roof valley flashing may be of laced composition shingles, applied in an approved manner, with an underlay of not less than thirty (30) pound felt extending ten (10) inches from the center line each way, or shall be of two (2) layers of ninety (90) pound mineral surfaced cap sheet cemented together with the bottom layer not less than twelve (12) inches wide laid face down, and the top layer not less than twenty-four (24) inches wide laid face up.

#### 2107.4 Slate shingles

2107.4.1 General: Slate shingles shall be applied in an approved manner and securely fastened with corrosion-resistant nails or corrosion-resistant nails and wire.

2107.4.2 Underlay: Slate shingle roofs shall have an underlay of not less than two (2) layers of fifteen (15) pound felt or one (1) layer of thirty (30) pound felt, applied as required for a base sheet.

2107.4.3 Installation: Roof valley flashing shall be provided of not less than No. 28 gauge galvanized sheet corrosion-resistant metal and shall extend at least eleven (11) inches from the center line each way and shall have a splash diverter rib not less than one (1) inch high at the flow line formed as part of the flashing. Sections of flashing shall have an end lap of not less than four (4) inches.

#### 2107.5 Asbestos cement shingles

2107.5.1 General: Asbestos-cement roofing shall be applied in an approved manner. Asbestos-cement roofing shall have an underlay of not less than fifteen (15) pound felt, applied as required for a base sheet. The underlay may be omitted where the asbestos-cement shingles or sheets are applied over an existing roof covering.

2107.5.2 Slope criteria: Asbestos-cement roofing shall not be installed on a roof having a slope of less than three (3) in twelve (12) unless approved by the building official.

2107.5.3 Thickness: Corrugated asbestos-cement roofing not less than five-sixteenths (5/16) inch thick may be used wherever No. 24 galvanized sheet gauge corrugated steel is permitted.

2107.5.4 Installation: Roof valley flashing shall be the same as required for slate shingles. See Section 2107.3.3.

## 2107.6 Metal

2107.6.1 General: Flat sheets or shingles shall be applied only to solidly sheathed roofs.

2107.6.2 Metal roofing shall be applied in an approved manner, consistent with manufacturer's recommendations.

2107.6.3 Sloping criteria: Metal shingles shall not be installed on a roof having a slope of less than three (3) in twelve (12) unless approved by the building official.

2107.6.4 Installation: Metal shingles shall be applied over an underlay of not less than thirty (30) pound felt, applied as required for a base sheet.

## 2107.7 Tile, clay or concrete shingles

2107.7.1 General: All roof tile shall be securely fastened with corrosion-resistant nails or nails and wire, or other approved means.

2107.7.2 Slope criteria: Tile shall be installed on a roof having a slope of less than three (3) in twelve (12) unless approved by the building official.

2107.7.3 Anchor lugs: Tile with projection anchor lugs at the bottom of the tile shall be held in position by means of one (1) inch by two (2) inch wood stripping, treated to resist moisture deterioration, nailed to the roof sheathing over the underlay, or other approved means.

2107.7.4 Underlay: Tile roofs shall have an underlay of not less than two (2) layers of fifteen (15) pound felt or one (1) layer of thirty (30) pound felt, applied as required for a base sheet.

2107.7.5 Valley flashing: Valley flashing shall be the same as required for slate shingles.

## 2107.8 Built-up roofing

2107.8.1 General: Mineral aggregate surfaced built-up roofing shall consist of three (3) layers of fifteen (15) pound fiber felt installed in accordance with this section on roofs having slopes not greater than three (3) in twelve (12).

2107.8.2 Roof surface: Built-up roofing shall be applied only to solid surface roofs.

2107.8.3 Base sheets: Base sheets shall be cemented to a suitable deck using not less than twenty-five (25) pounds of hot asphalt or not less than two (2) gallons of cold bituminous compound in accordance with manufacturer's published specifications or thirty (30) pounds of hot coal tar pitch per roofing square, or nailed to roof sheathing using not less than one (1) nail to each one and one-third (1-1/3) square feet, or may be spot-cemented to a non-nailable deck using not less than ten (10) pounds of hot asphalt per roofing square.

2107.8.4 Successive layering: Successive layers shall be cemented to the base sheets using no less cementing material than that specified for solidly cemented base sheets.

2107.8.5 Aggregate surfaced roofs: Mineral aggregate surfaced roofs shall be surfaced with not less than fifty (50) pounds of hot asphalt or other cementing material in which is embedded not less than three hundred (300) pounds of gravel or other approved surfacing materials or two hundred fifty (250) pounds of crushed slag per roofing square.

2107.8.6 Cap sheets: Cap sheets shall be cemented to the base sheets using no less cementing material than that specified for solidly cemented base sheets.

2107.8.7 Application temperatures: Hot asphalt shall be applied at a temperature of not less than 375° F. nor more than 450° F. for high melt types. Low melt types shall not be applied at a temperature of less than 350° F. nor more than 400° F. Coal tar pitch shall not be heated to a temperature above 375° F.

#### 2107.9 Wood shingles

2107.9.1 General: Wood shingles may be applied to roofs with solid or spaced sheathing. The spaced sheathing shall be spaced not to exceed four (4) inches clear nor more than the width of the sheathing board. Spaced sheathing shall be not less than one (1) inch by three (3) inches nominal dimensions.

2107.9.2 Application: Shingles shall be laid with a side lap of not less than one and one-half (1-1/2) inches between joints in adjacent courses, and one-half (1/2) inch in alternate courses. Spaces between shingles shall be not less than one-quarter (1/4) inch nor more than three-eighths (3/8) inch. Each wood shingle shall be fastened to the sheathing with two (2) nails only.

2107.9.3 Slope criteria: Shingles shall not be installed on a roof having a slope less than four (4) in twelve (12) unless they are installed over an underlay of not less than fifteen (15) pound felt, applied as required for a base sheet.

2107.9.4 Valley flashing: Roof valley flashing shall be provided of not less than No. 28 gauge galvanized sheet corrosion-resistant metal and shall extend eight (8) inches from the center line each way. Sections of flashing shall have an end lap of not less than four (4) inches.

2107.9.5 Weathering: Weather exposures shall not exceed those set forth in Reference Standard RS-21-9. Hip and ridge weather exposures shall not exceed those permitted for the field of the roof.

#### 2107.10 Wood shakes

2107.10.1 General: Wood shakes may be applied to roofs with solid or spaced sheathing. The spaced sheathing shall be spaced not to exceed four (4) inches clear nor more than the width of the sheathing board. Spaced sheathing shall be not less than one (1) inch by four (4) inches nominal size. In snow areas, sheathing shall be solid and the shakes shall be applied over an underlay of not less than fifteen (15) pound felt, applied as required for a base sheet.

2107.10.2 Spacing: Shakes may be laid in straight or staggered courses with a side lap of not less than one and one-half (1-1/2) inches between joints in adjacent courses. Spacing between shakes shall be not more than one-half (1/2) inch.

2107.10.3 Fastening: Each wood shake shall be fastened to the sheathing with two (2) nails. The starter course at the eaves shall be doubled and the bottom layer shall be either fifteen (15) or eighteen (18) inch wood shakes or wood shingles. Fifteen (15) inch or eighteen (18) inch shakes may be used for the final course at the ridge.

2107.10.4 Underlay: Shakes shall be laid with not less than eighteen (18) inch wide strips of not less than fifteen (15) pound felt shingled between each course in such manner that no felt is exposed to the weather below the shake butts.

2107.10.5 Slope criteria: Shakes shall not be installed on a roof having a slope less than four (4) in twelve (12) unless they are installed over an underlay of not less than thirty (30) pound felt, applied as required for a base sheet.

2107.10.6 Valley flashing: Roof valley flashing shall be provided of not less than No. 28 gauge galvanized sheet corrosion-resistant metal and shall extend at least eleven (11) inches from the center line each way and shall have a splash diverter rib not less than one (1) inch high at the flow line formed as part of the flashing. Sections of flashing shall have an end lap of not less than four (4) inches.

2107.10.7 Weathering: Weather exposures shall not exceed those set forth in Reference Standard RS-21-9. Hip and ridge weather exposures shall not exceed those permitted for the field of the roof.

2107.11 Solar collectors: All solar collectors attached to but mounted above a finished roof shall be firmly anchored to the roof structure or solid blocking connecting structural elements and all the roof penetrations sealed to prevent water leakage. All solar collectors integral with the roof shall be designed for roof loads specified in Section 710.0, sealed to prevent water leakage and have an approved cover plate. Refer to allowable spans for roof rafters supporting solar collectors as contained in table 2107-11.

780 CMR: STATE BUILDING CODE COMMISSION

Table 2107-11

ALLOWABLE SPANS FOR ROOF RAFTERS SUPPORTING SOLAR COLLECTORS

HOW TO USE TABLES

1. Check to determine that none of the maximum conditions listed below are exceeded.
  - a. maximum pitch of collector--20:12 (60°) (See Notes)
  - b. maximum collector weight--7 lbs. per sq. ft.
  - c. maximum length of collector--9 ft.
2. Determine whether Condition A or Condition B applies.
3. Inspect roof rafters and determine their size, spacing and type of wood. (Most are hemfir or better.)
4. Determine whether light roof construction (LRC--asphalt, wood shingles, etc.) or heavy roof construction (HRC--slate, tile shingles, etc.) applies.
5. Read allowable span from tables. Rafter spans are measured along the horizontal projection and loads are considered as applied on the horizontal projection.

| MEMBER  | CONDITION A              |       |                           |        | CONDITION B              |       |                           |       |  |
|---------|--------------------------|-------|---------------------------|--------|--------------------------|-------|---------------------------|-------|--|
|         | 800psi(spruce or better) |       | 1200psi(hemfir or better) |        | 800psi(spruce or better) |       | 1200psi(hemfir or better) |       |  |
|         | LRC max. span            | HRC   | LRC max. span             | HRC    | LRC max. span            | HRC   | LRC max. span             | HRC   |  |
| 2 x 6   |                          |       |                           |        |                          |       |                           |       |  |
| 12"o.c. | 9- 1                     | 8- 8  | 11- 3                     | 10- 8  | 7- 0                     | 6- 9  | 8-10                      | 8- 6  |  |
| 16"o.c. | 7-11                     | 7- 5  | 9- 9                      | 9- 3   | 6- 0                     | 5-10  | 7- 6                      | 7- 3  |  |
| 24"o.c. | 6- 4                     | 6- 0  | 7-11                      | 7- 5   | 4-10                     | 4- 9  | 6- 0                      | 5-10  |  |
| 2 x 8   |                          |       |                           |        |                          |       |                           |       |  |
| 12"o.c. | 12- 2                    | 11- 7 | 15- 1                     | 14- 4  | 9- 7                     | 9- 3  | 12- 0                     | 11- 7 |  |
| 16"o.c. | 10- 6                    | 10- 0 | 13- 0                     | 12- 4  | 8- 2                     | 7-11  | 10- 3                     | 9-11  |  |
| 24"o.c. | 8- 6                     | 8- 1  | 10- 6                     | 10- 0  | 6- 5                     | 6- 3  | 8- 2                      | 7-11  |  |
| 2 x 10  |                          |       |                           |        |                          |       |                           |       |  |
| 12"o.c. | 15- 9                    | 14-11 | 19- 6                     | 18- 5  | 12- 7                    | 12- 1 | 15- 9                     | 15- 2 |  |
| 16"o.c. | 13- 6                    | 12-10 | 16- 9                     | 15- 10 | 10- 9                    | 10- 4 | 13- 5                     | 12-11 |  |
| 24"o.c. | 10-11                    | 10- 5 | 13- 6                     | 12-10  | 8- 6                     | 8- 3  | 10- 8                     | 10- 4 |  |
| 2 x 12  |                          |       |                           |        |                          |       |                           |       |  |
| 12"o.c. | 19- 4                    | 18- 4 | 23-11                     | 22- 7  | 15- 8                    | 15- 0 | 19- 7                     | 18-10 |  |
| 16"o.c. | 16- 8                    | 15- 9 | 20- 6                     | 19- 5  | 13- 4                    | 12-10 | 16- 9                     | 16- 1 |  |
| 24"o.c. | 13- 5                    | 12- 9 | 16- 7                     | 15- 9  | 10- 8                    | 10- 3 | 13- 4                     | 12-10 |  |

NOTES: Provide solid blocking between each panel connection to roof. Lag bolt or through bolt panel connection to rafters or blocking.

For situations exceeding any maximum condition listed above or not shown in Condition A or B, the structure shall be approved by a licensed professional engineer or registered architect.

DESIGN CRITERIA Strength: 10 lbs. per sq. ft. (light roof construction-LRC) or 15 lbs. per sq. ft. (heavy roof construction-HRC) as noted plus 30 lbs. per sq. ft. live load plus load of drifting snow plus loads of solar collectors determine fiber stress. Deflection: For 30 lbs. per sq. ft. live load, limited to span in inches divided by 180.

SECTION 2108.0 CHIMNEYS, FIREPLACES  
AND CONNECTOR PIPES

2108.1 Types of chimneys

2108.1.1 Factory-built chimneys: Factory-built chimneys are factory-made chimneys tested to U.L. 103 and shall be installed in strict accordance with the terms of their approval and listing and the manufacturer's instructions.

2108.1.2 Masonry chimneys: Masonry chimneys shall be field constructed to meet the requirements of Sections 2108.2 and 2108.3.

2108.2 Masonry chimneys, general requirements

2108.2.1 Foundations: Masonry chimneys shall be supported on properly designed foundations of masonry or reinforced concrete or on noncombustible material having a fireresistance rating of not less than three (3) hours, provided such supports are independent of the building construction, and the load is transferred to the ground.

2108.2.2 Structural design: Chimneys shall be designed, anchored, supported and reinforced as required in this article. Chimneys shall not support any structural load other than their own weight unless designed to act as supporting members. Chimneys in wood-frame buildings shall be anchored laterally at the ceiling lines and at each floor line which is more than six (6) feet above grade, except when entirely within the framework of the building.

2108.2.3 Area: Chimney passageways shall not be smaller in area than the vent connection on the appliance attached thereto, nor less than as set forth in Table 2108-2 unless alternate approved engineering methods have been used to design the system.

Table 2108-2  
 MINIMUM PASSAGE AREAS FOR MASONRY CHIMNEYS

| Type of<br>Masonry<br>Chimney <sup>1</sup> | Minimum cross-sectional area                    |   |
|--|---|---|
|  | Round   | Square or<br>rectangle                          |
| Residential<br>appliances                  | 50 sq. in.                                      | 50 sq. in.                                      |
| Fireplace <sup>2</sup>                     | 1/12 of<br>opening<br><br>Minimum<br>50 sq. in. | 1/10 of<br>opening<br><br>Minimum<br>64 sq. in. |
| Solid fuel burn-<br>ing appliances         | 50 sq. in.                                      | 57 sq. in.                                      |

Note 1. Areas for chimneys shall be determined using accepted engineering methods and as approved by the department.

Note 2. Where fireplaces open on more than one side, the fireplace opening shall be measured along the greatest dimension.

2108.2.4 Corbeling: Masonry chimneys shall not be corbeled from a wall more than six (6) inches nor shall a masonry chimney be corbeled from a wall which is less than twelve (12) inches in thickness, unless it projects equally on each side of the wall. In the second story of a two-story building corbeling of masonry chimneys on the exterior of the enclosing walls may equal the exterior wall thickness. In any case, the corbeling shall not exceed one (1) inch projection for each course of brick.

2108.2.5 Change in size or shape: Changes in the size or shape of a masonry chimney, where the chimney passes through the roof, shall not be permitted within a distance of six (6) inches above or below the roof joists or rafters.

2108.2.6 Inlets: Every connector inlet to any masonry chimney shall enter the side thereof and shall be of metal not less than No. 24 Manufacturer's Standard Gauge (0.024 inch) or five-eighths (5/8) inch thick refractory material (see Section 2108.6



for chimney connectors).

2108.2.7 Cleanouts: Every chimney flue shall be provided with an approved cleanout having a tight-fitting cover. Such cleanouts shall be installed at least twelve (12) inches below the lowest chimney inlet opening.

2108.2.8 Firestopping: All spaces between chimneys and floors and ceilings through which chimneys may pass shall be firestopped with noncombustible material. The firestopping of spaces between chimneys and wood joists, beams or headers shall be to a depth of one (1) inch only placed on strips of metal or metal lath laid across the spaces between combustible material and the chimney.

2108.2.9 Smoke test: Masonry chimneys shall be proved tight by a smoke test after erection and before being put into use.

### 2108.3 Masonry chimneys

2108.3.1 Construction: Masonry chimneys shall be constructed of solid masonry units or reinforced concrete with walls not less than four (4) inches thick or rubble stone masonry not less than twelve (12) inches thick. Masonry shall be constructed with full bed and head mortar joints (see Figure 2108.3).

2108.3.2 Lining: Masonry chimneys shall be lined with fire-clay flue lining (ASTM C315), or the equivalent, not less than five-eighths (5/8) of an inch thick, or with liner of other approved material that will resist corrosion, softening or cracking from flue gases at temperatures up to seventeen hundred (1700) degrees F.

2108.3.2.1 Liner installation: Fire-clay flue liner shall be installed ahead of the construction of the chimney as it is carried up and carefully bedded one on the other in refractory mortar (ASTM C105, medium duty), or the equivalent, with close fitting joints left smooth on the inside.

2108.3.2.2 Clearances: Liners shall be separate from the chimney wall by one inch clearance and the space between the liner and masonry shall not be filled; only enough mortar shall be used to make a good joint and hold the liners in position.

2108.3.2.3 Starting point: Flue liners shall start from a point not less than eight (8) inches below the lowest vent connector entrance. The lining shall extend, as nearly vertical as possible, for the entire height of the chimney.

2108.3.2.4 Adjoining flues: Where two (2) adjoining flues in the same chimney are separated only by flue liners, the joints of the adjacent flue liners shall be staggered at least seven (7) inches.

2108.3.2.5 Flue partitions: Where more than two (2) flues are located in the same chimney, masonry wythes (partitions) at least four (4) inches wide and bonded into the masonry walls of the chimney shall be built at such points between adjacent flue linings that there are not more than two (2) flues in any group of adjoining flues without such wythe separation.

2108.3.2.6 Termination (height): Masonry chimneys shall extend at least three (3) feet above the highest point where they pass through the roof of a building and at least two (2) feet higher than any portion of a building within ten (10) feet.

2108.3.2.7 Multiple flue connections: A solid fuel burning heating appliance may be vented into a common flue of a masonry chimney with a liquid fuel burning device provided that:

1. the flue does not also vent a working fireplace;
2. the solid fuel burning appliance's connector, if separate, shall enter at a minimum of six (6) inches below the liquid fueled appliance's connector pipe;
3. all appliances shall be approved by the appropriate state agencies; and
4. the flue shall be of sufficient size to serve all the units connected to it if operated simultaneously (see Table 2108.3.2.7).

### 2108.3.3 Clearance from combustible material

2108.3.3.1 General: All wood beams, joists and studs shall be trimmed away from chimneys. Headers, beams, joists and studs shall not be less than two (2) inches from the outside face of a chimney or from masonry enclosing a flue. Ends of wood girders may be supported on a corbeled shelf of a masonry chimney, provided there is not less than eight (8) inches of solid masonry between the ends and the flue liner.

2108.3.3.2 Other material: Combustible lathing, furring or plaster grounds shall not be placed against a chimney at any point more than one and one-half (1-1/2) inches from the corner of the chimney, but this shall not prevent plastering directly on the masonry or on metal lath and metal furring, nor shall it

prevent placing chimneys for low-heat appliances entirely on the exterior of a building against the sheathing.

Table 2108.3.2.7  
CAPACITY OF A MASONRY CHIMNEY SERVING TWO APPLIANCES

| Total Vent Height<br>(feet) of Not Less<br>Than | Combined Appliance Input Rating of Not Greater Than<br>(Thousands of Btu's per Hour) |       |              |        |        |
|---|--|-------|--------------|--------|--------|
| 8   | 81   | 118   | 162          | 277    | 405    |
| 10  | 89   | 129   | 175          | 300    | 450    |
| 15  | 105  | 150   | 210          | 360    | 540    |
| 20  | 120  | 170   | 240          | 415    | 640    |
| 30  | 135  | 195   | 275          | 490    | 740    |
| 50  | -  | -     | 325          | 600    | 910    |
| Liner Dimensions with Equivalents               |  |       |              |        |        |
| nominal liner<br>size (in.)<br>(sq./rect.)      | 4x8  | 4x8   | 8x8          | 8x12   | 12x16  |
| inside dimension<br>of liner (in.)              | 2½x6½  | 2½x6½ | 6 ¾ x<br>6 ¾ | 6½x10½ | 9½x13½ |
| inside diameter<br>(in.) (circular)             | 6  | 7     | 8            | 10     | 12     |
| equivalent area<br>(square in.)                 | 28.3   | 38.5  | 50.3         | 78.5   | 113.0  |

Figure 2108-3  
FIREPLACE CONSTRUCTION DETAILS

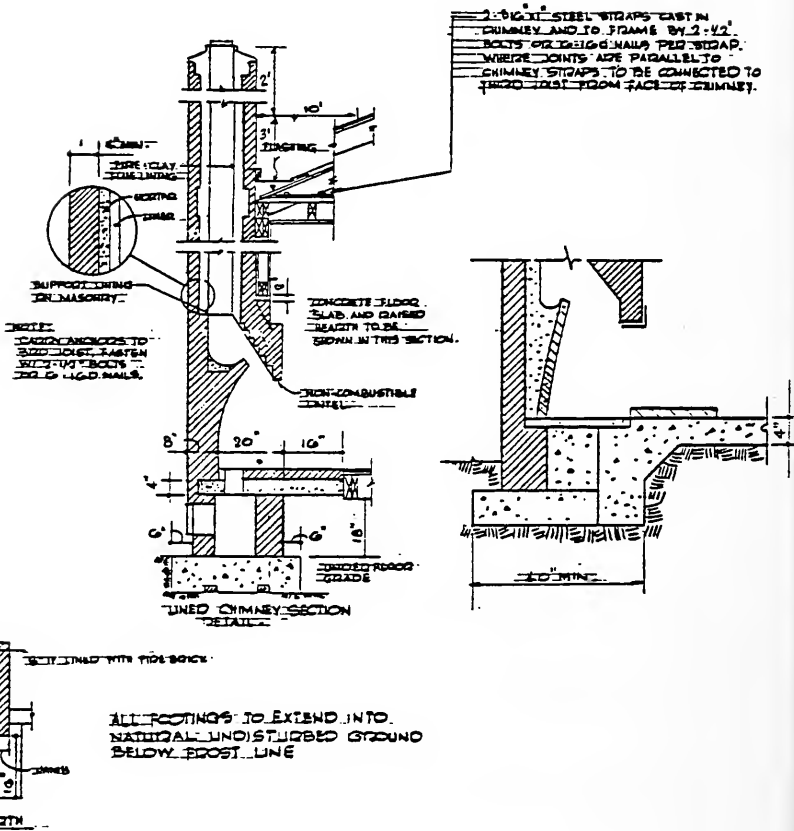

NOTES:

1. WHERE PLATES ARE CUT ANCHOR TO CHIMNEY BY 2" X 1" STEEL STRAPS HOOKED INTO CHIMNEY AND ATTACHED TO PLATES BY 2 3/8" X 3" LAG SCREWS, 2 1/2" BOLTS OR G-16d NAILS.

2. WHERE DAMPERS ARE USED THEY SHALL NOT BE LESS THAN NO. 12 GA. METAL AND WHEN FULLY OPEN THE DAMPER OPENING SHALL BE NOT LESS THAN 90% OF THE REQUIRED FLUE AREA

NOTE: THE FIREPLACE ASHPIT AND CLEANOUT SHOWN IS OPTIONAL.

2108.4 Factory-built chimneys, general requirements

2108.4.1 Prohibited installation

2108.4.1.1 Single wall: Single wall metal chimneys shall not be used in one- and two-family dwellings; connector pipe may be single wall (refer to 2108.5).

2108.4.2 Clearances: Factory-built exterior and interior chimneys shall have a clearance of not less than two (2") inches from combustible construction, or shall be installed to manufacturers' recommended clearances, whichever are more stringent. Factory-built chimneys shall be tested to U.L. Std. 103.

2108.4.3 Support: Metal chimneys shall be supported on properly designed supports of noncombustible material.

2108.4.4 Cleanouts: Cleanout openings shall be provided at the base of every metal chimney.

2108.5 Termination (height)

2108.5.1 General: All chimneys shall extend at least three (3) feet above the highest point where they pass through the roof of a building and at least two (2) feet higher than any portion of a building within ten (10) feet.

2108.5.2 Outlet: The outlet of a metal chimney equipped with an exhauster may terminate at a location not less than three (3) feet from an adjacent building or building opening and at least ten (10) feet above grade or walkways. In any case, the outlet shall be so arranged that the flue gases are not directed so as to jeopardize people, overheat combustible structures or enter building openings in the vicinity of the outlet.

2108.5.3 Ventilation thimble: Where a non-insulated metal chimney connector passes through a roof constructed of combustible material, it shall be guarded by a ventilating thimble of galvanized iron or approved corrosion-resistant metal, extending not less than nine (9) inches below and nine (9) inches above the roof construction, and of a size to provide not less than six (6) inches clearance on all sides of the chimney, or the combustible material in the roof construction shall be cut away so as to provide not less than eighteen (18) inches clearance on all sides of the chimney with the opening closed up with non-combustible material.

## 2108.6 Chimney connector pipe

2108.6.1 Materials: Single wall chimney connector pipe shall be constructed of not less than the following gauge galvanized metal specified in Table 2108-6.

Table 2108-6  
MINIMUM CHIMNEY CONNECTOR GAUGES

| Diameter of connector | Inch thickness | Birmingham or<br>Stubs Gauge |
|-----------------------|----------------|------------------------------|
| Less than 6"          | 0.022 in.      | 24                           |
| 6" to less than 10"   | 0.028 in.      | 22                           |
| 10" to 12"            | 0.034 in.      | 20                           |
| 13" to 16"            | 0.040 in.      | 18                           |
| greater than 16"      | 0.064 in.      | 16                           |

Note: The corrosive resistance shall be equivalent to or better than galvanized metal.

## 2108.6.2 Single wall metal pipe:

- shall be used only for runs directly from the space in which the appliance is located through the roof or exterior wall to the outer air. A pipe passing through a roof shall extend without interruption through roof flashing, roof jack or roof thimble.
- shall not originate in any unoccupied attic or concealed space, and shall not pass through any attic, inside wall, concealed space, or through any floor.

2108.6.3 Size: The size of the chimney connector shall be not less than the size of the smoke outlet from the appliance.

2108.6.4 Fastening: Connector sections shall be securely fastened together and into the chimney but in a way that they can be readily disassembled for cleaning.

2108.6.5 Clearances: Single wall chimney connectors shall be installed with the clearances to combustible materials specified in Table 2108.6.2. Reduced clearances shall be used with double wall or insulated connector pipe.

2108.6.6 Slope: Horizontal runs of chimney connectors shall have a continuous rise toward the chimney of not less than one quarter (1/4) inch per foot.

2108.6.7 Offsets: Chimney connectors shall have not more than two (2) offsets.

2108.6.8 Combustible walls: Chimney connectors may pass through combustible walls and partitions when protected by approved thimbles or by providing the required clearances.

2108.7 Fireplaces

2108.7.1 General: Fireplaces, barbecues, smoke chambers and fireplace chimneys shall be of solid masonry or reinforced concrete or other approved materials, and shall conform to requirements of this section.

2108.7.2 Construction: Structural walls of fireplaces shall be at least eight (8) inches thick. Where a lining of low duty refractory brick (ASTM C64) or the equivalent, at least two (2) inches thick laid in fire clay mortar (ASTM C105, medium duty), or the equivalent, or other approved lining is provided, the total thickness of back and sides, including the lining, shall be not less than eight (8) inches. Where such lining is not provided, the thickness of back and sides shall be not less than twelve (12) inches. The firebox shall be twenty (20) inches in depth and will be permitted to be open on all sides, provided all fireplace openings are located entirely within one (1) room.

Table 2108.6.2  
CHIMNEY CONNECTOR PIPE CLEARANCES

| DIAMETER<br>Inches | CLEARANCE<br>Inches | REDUCED<br>Clearance |
|--------------------|---------------------|----------------------|
| 0-12               | 18                  | 9                    |
| 12-36              | 20                  | 10                   |
| 36+                | 36                  | 18                   |

2108.7.3 Lining: The lining shall extend from the throat of the fireplace to a point at least four (4) inches above the top of the enclosing masonry walls.

## 2108.7.4 Clearance

2108.7.4.1 Distance: The distance between fireplace and combustibles shall be at least four (4) inches, and such combustibles shall not be placed within six (6) inches of the fireplace opening. Wood facings or trim normally placed around the fireplace opening may be permitted when conforming to the requirements of this section; however, such facing or trim shall be furred out from the fireplace wall at least four (4) inches and attached to noncombustible furring strips. The edges of such facings or trim shall be covered with a noncombustible material. Where the walls of the fireplace are twelve (12) inches thick, the facings or trim may be directly attached to the fireplace.

2108.7.4.2 Metal hoods: Metal hoods used as part of a fireplace or barbecue shall be at least eighteen (18) inches from combustible material unless approved for reduced clearances.

2108.7.4.3 Metal: Metal hoods used as a part of a fireplace or barbecue shall be at least No. 18 B&S (0.0403 inch) Gauge sheet copper, No. 18 Galvanized Steel Gauge (0.052 in.) galvanized steel or other equivalent corrosion-resistant ferrous metal with all seams and connections of smokeproof unsoldered construction. The hoods shall be sloped at an angle of forty-five (45) degrees or less from the vertical and shall extend horizontally at least six (6) inches beyond the limits of the firebox.

2108.7.4.4 Metal heat circulators: Approved metal heat circulators may be installed in fireplaces, provided the thickness of the fireplace walls is not reduced.

2108.7.4.5 Smoke chamber: All walls, including back walls, shall be at least eight (8) inches in thickness.

2108.7.5 Areas of flues, throats and dampers: The net cross-sectional area of the flue and of the throat between the firebox and the smoke chamber of a fireplace shall be at least that required in Table 2108.2. When dampers are used, damper openings shall be at least, when fully opened, equal to the required flue area and shall be of No. 12 Galvanized Steel Gauge (0.018 in.) metal.

2108.7.6 Lintel: Masonry over the fireplace opening shall be supported by a noncombustible lintel.

2108.7.7 Hearth: Every fireplace shall be constructed with a hearth of brick, stone, tile or other noncombustible material. For fireplaces with an opening of less than six (6) square feet, the hearth shall extend not less than sixteen (16) inches in



front and not less than eight (8) inches on each side of the fireplace opening. For fireplaces with an opening of six (6) square feet or more, the hearth shall extend not less than twenty (20) inches in front and not less than twelve (12) inches on each side of the fireplace opening. Such hearths shall be properly supported or reinforced to carry their own weight and all imposed loads. Combustible forms and centers used during the construction of hearth and hearth extension shall be removed after the construction is complete.

2108.7.8 Firestopping: Firestopping between chimneys and wooden construction shall meet the requirements specified in Section 2108.2.8.

2108.7.9 Support: Fireplaces shall be supported on foundations designed in conformity with Section 2108.2.1.

2108.7.10 Screens: Screens or other acceptable protection devices shall be provided for all fireplace openings.

2108.7.11 Imitation fireplaces: Imitation fireplaces shall not be used for the burning of gas, solid or liquid fuel.

2108.7.12 Factory-built fireplaces: A product which is defined as a fire chamber, its chimney, and related parts consisting entirely of factory-made parts designed for unit assembly without requiring field construction and enclosed in a wall, shall be tested by an approved testing agency to Underwriters Laboratories (U.L.) Standard U.L. 127 and installed in accordance with manufacturer's recommendations not in conflict with the basic code.

2108.7.12.1 Hearth extensions: Hearth extensions shall comply with the dimensions of Section 2108.7.7 but may be placed on combustible subflooring or finish flooring and shall be readily distinguished from the surrounding floor.

2108.7.12.2 Air duct construction: An air duct system portion of a circulating warm air type fireplace, is intended for installation in accordance with the National Fire Protection Association Standard (NFPA No. 90B).

2108.7.12.3 Fixed blowers: Fixed blowers and other electrical accessories for factory-built fireplaces shall conform to the Massachusetts State Electrical Code, 527 CMR 12.00.

2108.7.13 Steel fireplace liners: Steel fireplace units incorporating a firebox liner of not less than one-quarter (1/4) inch steel in thickness and an air chamber may be installed with masonry to provide a total thickness at the back and sides of

not less than eight (8) inches, of which not less than four (4) inches shall be of solid masonry. Warm air ducts employed with steel fireplace units of the circulating air type shall be constructed of metal or masonry. A noncombustible, fire chamber bottom, should be provided if not included with the liner.

## SECTION 2109.0 SOLID FUEL BURNING HEATING APPLIANCES

2109.1 General: Solid fuel burning heating appliances shall be tested and labeled in accordance with this code, the applicable standards listed in RS-21-14 and the applicable Rules and Regulations listed in Appendix Q. These units are for attachment to a residential type chimney (see Section 2108.0).

### 2109.2 Definitions:

1. Central heating appliance: A solid or solid/liquid fueled boiler or warm air furnace tested to the applicable standards listed in Appendix B and contained in the applicable Rules and Regulations listed in Appendix Q.
2. Circulating: A solid fuel burning heating appliance in which the fire chamber is surrounded by a jacket so that air flows past the fire chamber by convection or by forced circulation, or a radiant stove with a heat shield.
3. Fireplace insert: A piece of heating equipment inserted entirely and sealed into a completed masonry fire place fire chamber to adapt the fireplace for circulating warm air use and designed solely for that purpose.

#### Notes:

- a. Door assemblies, grills, duct work or mechanical blowers need not be entirely confined to the fire chamber so long as they do not serve as direct sources of radiant heat.
  - b. There are no test standards or labeling requirements for this type of fireplace insert.
  - c. A building permit is required for the installation of this type of fireplace insert.
4. Radiant: A solid fuel burning heating appliance in which the exterior wall of the fire chamber directly radiates the heat to the room.
  5. Room heater: A freestanding fire chamber assembly of the circulating or direct radiation type tested to UL 1482 and/or ANSI/UL 737 as applicable. A room heater shall not be connected to duct work or other heat distribution equipment which would make it function as a central heating appliance.

2109.3 Hearth: For a solid fuel low heat appliance the floor shall be of masonry or other noncombustible construction with not less than one (1) hour fireresistance and shall extend twelve (12) inches beyond the appliance on all sides and at least eighteen (18) inches on the fuel and ash access side.

2109.4 Appliance clearance: Clearance shall be provided from combustible construction adjacent to heating appliances and equipment not less than thirty-six (36) inches at the top, twelve (12) to thirty-six (36) inches at the sides and rear, and twenty-four (24) to thirty-six (36) inches at the front (clearance dependent on whether appliance is circulating or radiant type). The clearance from material may be decreased when exposed construction is protected with noncombustible materials to afford the fire protection resistance (see Tables 2109-4 and 2110-2) or may be reduced to manufacturer's tested clearances.

2109.5 Combustion air source: Combustion air may be obtained from interior spaces when volume in cubic feet is equal to one-twentieth (1/20) of the output Btu rating of all solid fuel burning heating appliances in the space.

2109.6 Solid fuel burning room heater installed in fireplaces: If a solid fuel burning room heater is set in front of a fireplace to use the existing chimney, the stove pipe must be connected either into the open damper through a snug fitting noncombustible seal or through a noncombustible fireplace opening closure which seals off the fireplace. Both methods of installation must have access for cleanout.

2109.7 Used solid fuel burning room heaters: Used solid fuel burning room heaters which are not labeled after July 1, 1979 must be inspected and approved prior to installation by the local building official or fire official and installed in accordance with the provisions of this code.

2109.8 Solid fuelburning room heater labeling: Every solid fuelburning room heater shall bear a permanent and legible factory-applied label supplied to the manufacturer and controlled by an approved testing laboratory containing the following:

1. Manufacturer's name and trademark
2. Model and/or identification number of the appliance
3. Type of fuel(s) approved
4. Testing laboratory's name or trademark and location
5. Date tested
6. Clearance to combustibles
  - a. Side
  - b. Rear
7. Test standard
8. Label serial number

Figure 2109-4  
CLEARANCES FOR SOLID FUEL BURNING APPLIANCES

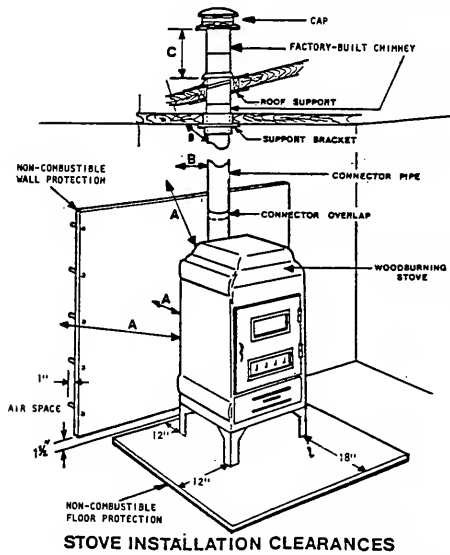

| Stove Components                        | Combustible Material  | 1/2" Asbestos Millboard Spaced Out 1" | Concrete/Masonry Foundation Wall | 4" Brick Veneer Spaced Out 1" |
|---|---|---------------------------------------|----------------------------------|-------------------------------|
| Radiant Stove<br>—Front                 | 1. 36"  | —                                     | —                                | —                             |
| Circulating Stove<br>—Front             | 1. 24"  | —                                     | —                                | —                             |
| A. Radiant Stove<br>—Side/Back          | 4. 36"  | 18"                                   | 6"                               | 18"                           |
| A. Circulating Stove<br>—Side/Back      | 12"   | 6"                                    | 6"                               | 6"                            |
| B. Single Wall<br>Connector Pipe        | 2. 18"  | 12"                                   | 6"                               | 8"                            |
| B. Insulated<br>Connector Pipe          | 2 1/2"  | 2 1/2"                                | 2 1/2"                           | 2 1/2"                        |
| C. Chimney Height<br>(Metal or Masonry) | Three (3) feet above adjacent roof and<br>two (2) feet above any roof ridge within 10 feet            |                                       |                                  |                               |
| D. Damper                               | If a damper is not included in the stove construction,<br>it must be installed in the connector pipe. |                                       |                                  |                               |

1. Front: Fuel or ash access side.
2. Thimble required for passage through combustible construction.
3. Non-combustible spacers required.
4. Clearances on each side of a radiant stove with a heat shield shall be measured as if a circulating type.

2109.9 Central heating appliance installation: Solid or solid/liquid fueled heating (central heating) appliances installed into an existing liquid or gas-fueled central heating system shall be positioned downstream of the existing appliance. Clearances to combustible materials shall be provided in accordance with the requirements specified on the label affixed to the central heating appliance (see Section 2109.3.2.7).

2109.10 Ducts for solid or solid/liquid fueled central heating appliances.

2109.10.1 Supply ducts: Supply ducts conveying heated conditioned air shall be fabricated of noncombustible material.

2109.10.2 Hot air ducts: Hot air ducts shall have a clearance of not less than twelve (12) inches from combustibles for the first ten (10) feet of distance from the appliance plenum/bonnet.

21.09.10.3 Ducts: All ducts shall be otherwise constructed, installed, supported and insulated as required by this code.

2109.11 Central heating appliance labeling: Every solid or solid/liquid fueled boiler or warm air furnace shall bear a permanent and legible factory applied label, supplied to the manufacturer and controlled by an approved testing laboratory, containing the following information:

1. Manufacturer's name or trademark
2. Model/identification name or number of the appliance
3. Types of fuel(s) approved
4. Testing laboratory's name or trademark and location
5. Date tested
6. Clearance to combustibles:
  - a. side
  - b. rear
  - c. top
  - d. front
7. Test standard(s)
8. Label serial number
9. Type of appliance (boiler or warm air furnace)

10. Every boiler, pressure vessel, or pressure relief device must be stamped in accordance with the requirements of the ASME Boiler and Pressure Vessel Code. ASME stamping shall also be required for boilers, pressure vessels and pressure relief devices produced outside the United States of America. Where required by the ASME Boiler and Pressure Vessel Code, ASME stamping may be affixed directly to the appliance in lieu of on the data plate.

Note: Additional information as required by the applicable test standard(s) may be affixed separately.

2109.11.1 Exceptions: Prior to January 1, 1981, the following exceptions shall apply:

1. ASME stamping shall not be required.
2. Solid or solid/liquid fueled central heating appliances shall be considered acceptable only if they have been tested and labeled by a laboratory accredited by the Commission to test other comfort heating appliances; or any nationally recognized laboratory.

SECTION 2110.0 MECHANICAL EQUIPMENT GENERAL

2110.1 General: Conformity with the applicable material, test, construction and design standards specified in the reference standards of this article shall be acceptable as providing compliance with the requirements of this article.

2110.2 Commonwealth of Massachusetts regulations: All installation of gas appliances must comply with 248 CMR 3.00 - 8.00 (Massachusetts Fuel Gas Code). The construction, installation and operation of oil burning equipment is subject to the provisions of 527 CMR 4.00 established in accordance with Chapter 148, Section 10 of the MGLA, as amended. The construction, installation, testing and inspection of boilers, air tanks, ammonia compressor valves, and refrigeration and air-conditioning systems of twenty (20) tons or more capacity are subject to the Rules and Regulations issued by the Board of Boiler Rules under authority of Chapter 146 of the MGLA, as amended.

2110.3 Cooperating agencies: Nothing herein contained shall be deemed to nullify the provisions of other legal statutes or regulations of the Commonwealth of Massachusetts governing the operation and maintenance of boilers and other heating appliances and equipment.

2110.4 Labeled heating and cooking appliances: Approved oil-fired warm air furnaces, floor furnaces, unit heaters, domestic incinerators, cooking and heating stoves and ranges and other heating equipment, inspected and approved by approved agencies shall be accepted by the building official when installed with the clearances provided in Table 2110-1 and in accordance with their listings.

2110.5 Type of fuel: Each comfort heating appliance shall be designed for use with the type of fuel to which it will be connected. Appliances shall not be converted from the fuel specified on the rating plate for use with a different fuel without securing reapproval from the building official and as recommended by the manufacturer of either the original equipment or the conversion equipment.

2110.6 Shutoff valve: A readily accessible approved shutoff valve shall be installed ahead of the union or other connection in the fuel piping outside and within three (3) feet of the appliance.

Exception: Shutoff valves may be accessibly located inside or under an appliance provided the appliance can be removed without removal of the shutoff valve.

2110.7 Appliance installation: Except as otherwise provided in this article or the basic code, the installation of comfort heating appliances shall conform to the conditions of their listing. The manufacturer's installation and operating instructions shall remain attached to the appliance.

2110.8 Appliance access: Comfort heating appliances shall be accessible for inspection, service, repair and replacement without removing permanent construction. Not less than thirty (30) inches working space and platform shall be provided in front of the appliance firebox opening of fuel burning appliances except unit and room heaters which must have a minimum of eighteen (18) inches.

2110.9 Control devices: Automatic gas-burning comfort heating appliances shall be equipped with listed devices which will shut off the gas to the main burner or burners in the event of pilot failure.

Exception: The listed shutoff devices shall not be required on range or cooking tops, log lighters, or other open burner manually operated appliances, or listed appliances not requiring such devices.

2110.9.1 Safety controls: Liquid fuelburning appliances shall be equipped with primary safety controls which will shut off flow of fuel to the burners in the event of ignition failure.

2110.9.2 Remote controls: Comfort heating fuelburning appliances whose manual fuel controls are not readily accessible from the main portion of the building being heated shall be equipped with remote controls.

2110.9.3 Temperature limit control: Forced-air and gravity-type warm-air furnaces shall be equipped with a listed air outlet temperature limit control which cannot be set for temperatures higher than 250° F. The controls shall be located in the bonnet or plenum, within two (2) feet of the discharge side of the heating element of gravity furnaces or in accordance with the conditions of listing.

2110.10 Ranges--vertical clearance above cooking top: Domestic freestanding or built-in ranges shall have a vertical clearance above the cooking top of not less than thirty (30) inches to unprotected combustible material. When the underside of such combustible material is protected with asbestos millboard at least one-quarter (1/4) inch thick covered with sheet metal of not less than No. 28 U.S. gauge or a metal ventilating hood, the distance shall be not less than twenty-four (24) inches.



2110.11 Ranges--horizontal clearance to built-in top cooking units: The minimum horizontal distance from the center of the burner head(s) of a top (or surface) cooking unit to surrounding top or surface shall be not less than that distance specified by the permanent marking on the unit.

2110.12 Open top broiler units: Listed open top broiler units and hoods shall be installed in accordance with their listing and the manufacturer's instructions.

2110.13 Domestic clothes dryers

2110.13.1 General: Where a clothes dryer is connected to a moisture exhaust duct, it shall be installed in accordance with manufacturer's instructions and recommendations.

1. A clothes dryer moisture exhaust duct shall not be connected into any vent connector, gas vent or chimney.
2. Ducts for exhausting moisture from clothes dryers shall not be constructed with sheet metal screws or other fastening means which extend into the duct.
3. In no case shall the moisture exhaust terminate beneath the building or in the attic.
4. Domestic clothes dryers shall be moisture exhausted to the outside when located in a habitable room or room containing other fuelburning appliances.

2110.14 Fuel-burning appliance labeling: Every fuelburning comfort heating appliance shall bear a permanent and legible factory applied nameplate on which shall appear:

1. the manufacturer's name or trademark;
2. the model and serial number;
3. instructions for the lighting, operation and shut-down of the appliance;
4. the type of fuel approved for use with the appliance; and
5. a seal indicating approval of the appliance by an approved testing agency, if acceptance is based on such approval.

2110.15 Electrical appliance labeling: Every electric appliance listed in Table 2110-1 shall bear a permanent and legible factory applied nameplate on which shall appear:

1. name or trademark of the manufacturer;
2. the catalog (model) number or equivalent;
3. the electrical rating in volts, amperes and phase;
4. individual marking for each electrical component in amperes or watts, volts and phase shall appear on the nameplate of that component.

2110.16 Appliance protection: Boilers, furnaces, hot water heaters or any other appliances having an open flame or exposed heated surfaces shall not be located in a private garage unless precautions are taken to protect such equipment from

impact by automobiles. This equipment shall have the combustion chamber, ash pit, etc., raised a minimum of eighteen (18) inches above the floor to eliminate a possible source of ignition.

Exception: Sealed combustion system appliances may be installed at floor level.

Table 2110-1

STANDARD INSTALLATION CLEARANCES FOR HEAT-PRODUCING APPLIANCES

These clearances apply unless otherwise shown on listed appliances. Appliances shall not be installed in alcoves or closets unless so listed. For installation on combustible floors see footnote 2.

| RESIDENTIAL TYPE APPLIANCES<br>For Installation in Rooms Which Are Large:                                 |  | APPLIANCE   |  |                            |                          |                           | CHIMNEY<br>CONNECTOR<br>(Inches) | VENT<br>CON-<br>NECTOR*<br>(Inches) |
|---|--|---|--|----------------------------|--------------------------|---------------------------|----------------------------------|-------------------------------------|
|   |  | Above<br>Top of<br>Casing or<br>Appliance<br>(Inches) | From<br>Top and<br>Sides of<br>Warm-Air<br>Bonnet or<br>Plenum<br>(Inches) | From<br>Front*<br>(Inches) | From<br>Back<br>(Inches) | From<br>Sides<br>(Inches) |                                  |                                     |
| <b>BOILERS AND WATER HEATERS* FUEL</b>  |  |   |  |                            |                          |                           |                                  |                                     |
| Steam Boilers—15 p.s.i.<br>Water Boilers—2500 F.<br>Water Heaters—2000 F.<br>All Water Walled or Jacketed | Automatic Oil or<br>Combination Gas<br>and Oil | 6   | —  | 24                         | 6                        | 6                         | 18                               | —                                   |
|   | Automatic Gas                                  | 6   | —  | 18                         | 6                        | 6                         | —                                | 9                                   |
|   | Solid  | 6   | —  | 48                         | 6                        | 6                         | 18                               | —                                   |
| <b>FURNACES—CENTRAL</b>   |  |   |  |                            |                          |                           |                                  |                                     |
| Gravity, Upflow, Downflow,<br>Horizontal and duct<br>Warm Air—2500 F. maximum<br>Limit Control            | Automatic Oil or<br>Combination Gas<br>and Oil | 6 <sup>7</sup>  | 6 <sup>7</sup>   | 24                         | 6                        | 6                         | 18                               | —                                   |
|   | Automatic Gas                                  | 6 <sup>7</sup>  | 6 <sup>7</sup>   | 18                         | 6                        | 6                         | —                                | 9                                   |
|   | Solid  | 18 <sup>8</sup>                                       | 18 <sup>8</sup>  | 48                         | 18                       | 18                        | 18                               | —                                   |
|   | Electric                                       | 6 <sup>7</sup>  | 6 <sup>7</sup>   | 18                         | 6                        | 6                         | —                                | —                                   |
| <b>FURNACES—FLOOR</b>   |  |   |  |                            |                          |                           |                                  |                                     |
| For Mounting in Combustible<br>Floors   | Automatic Oil or<br>Combination Gas<br>and Oil | 36  | —  | 12                         | 12                       | 12                        | 18                               | —                                   |
|   | Automatic Gas                                  | 36  | —  | 12                         | 12                       | 12                        | —                                | 9                                   |
| <b>HEAT EXCHANGER, SUPPLIED FROM A REMOTE SOURCE</b>  |  |   |  |                            |                          |                           |                                  |                                     |
| Steam—15 p.s.i. maximum<br>Hot water—2500 F. maximum  |  | 1   | 1  | 1                          | 1                        | 1                         | —                                | —                                   |
| <b>ROOM HEATERS AND ROOM HEATING STOVES BURNING SOLID FUEL</b>  |  |   |  |                            |                          |                           |                                  |                                     |
| Circulating Type Vented or<br>Unvented  | Oil or Solid                                   | 36  | —  | 24                         | 12                       | 12                        | 18                               | —                                   |
|   | Gas  | 36  | —  | 24                         | 12                       | 12                        | —                                | 9                                   |
| Radiant or Other Type<br>Vented or Unvented   | Oil or Solid                                   | 36  | —  | 36                         | 36                       | 36                        | 18                               | —                                   |
|   | Gas  | 36  | —  | 36                         | 18                       | 18                        | —                                | 9                                   |
|   | Gas with Double<br>Metal or Ceramic<br>Back    | 36  | —  | 36                         | 12                       | 18                        | —                                | 9                                   |
| <b>RADIATORS, SELF-CONTAINED*</b>   |  |   |  |                            |                          |                           |                                  |                                     |
| Steam or Hot Water  | Gas  | 36  | —  | 6                          | 6                        | 6                         | —                                | 9                                   |
| <b>RANGES—COOKING STOVES</b>  |  |   |  |                            |                          |                           |                                  |                                     |
| Vented or Unvented  | Oil  | 30  | —  | —                          | 6                        | 24                        | 18                               | 18                                  |
|   | Gas  | 30  | —  | —                          | 6                        | 6                         | 6                                | 6                                   |
|   | Solid—Clay lined<br>Firepot                    | 30  | —  | —                          | 24                       | 24                        | 18                               | 18                                  |
|   | Solid unlined<br>Firepot                       | 30  | —  | —                          | 36                       | 36                        | 18                               | 18                                  |
|   | Electric                                       | 30  | —  | —                          | 6                        | 6                         | —                                | —                                   |
| <b>CLOTHES DRYERS</b>   |  |   |  |                            |                          |                           |                                  |                                     |
| Listed Types  | Gas  | 6   | —  | 24                         | 6                        | 6                         | —                                | 1                                   |
|   | Electric                                       | 6   | —  | 24                         | 0                        | 0 one side                | —                                | —                                   |

780 CMR: STATE BUILDING CODE COMMISSION

Notes to Table 2110-1

Note 1. Standard clearances may be reduced in existing construction only by affording protection to combustible material in accordance with Table 2110-2.

Note 2. An appliance may be mounted on a combustible floor if the appliance is listed for such installation or if the floor is protected in an approved manner.

Note 3. Rooms which are large in comparison to the size of the appliance are those having a volume equal to at least twelve (12) times the total volume of a furnace and at least sixteen (16) times the total volume of a boiler. If the actual ceiling height of a room is greater than eight (8) feet, the volume of a room shall be figured on the basis of a ceiling height of eight (8) feet.

Note 4. The minimum dimension shall be that necessary for servicing the appliance including access for cleaning and normal care, tube removal, etc.

Note 5. The minimum dimension shall be eighteen (18) inches for gas appliances not equipped with draft hoods, except clothes dryers. The dimension may be six (6) inches for listed gas appliances equipped with draft hoods and for boilers and furnaces equipped with listed conversion burners and with draft hoods. A vent connector of listed Type B or L venting material may be used with listed gas appliances with draft hoods and may be installed at clearances marked on the material.

Note 6. Steampipes and hot-water heating pipes shall be installed with a clearance of at least one (1) inch to all combustible construction or material, except that at the points where pipes carrying steam or hot water at not over fifteen (15) pounds gauge pressure emerge from a floor, wall, or ceiling, the clearance at the opening through the finish floor boards or wall ceiling boards may be reduced to not less than one-half (1/2) inch. Each such opening shall be covered with a plate of noncombustible material.

Such pipes passing through stock shelving shall be covered with not less than one (1) inch of approved insulation.

Wood boxes or casings enclosing uninsulated steam or hot water heating pipes, or wooden covers to recesses in walls in which such uninsulated pipes are placed, shall be lined with metal or asbestos millboard.

Where the temperature of the boiler piping does not exceed one hundred sixty (160°) degrees F., the provisions of this table shall not apply.

780 CMR: STATE BUILDING CODE COMMISSION

Coverings or insulation used on steam or hot water pipes shall be of noncombustible material.

Note 7. For a listed oil, combination gas-oil, gas or electric furnace, this dimension may be two (2) inches if the furnace limit control cannot be set higher than two hundred fifty (250°) degrees F., or this dimension may be one (1) inch if the limit control cannot be set higher than two hundred (200°) degrees F.

Note 8. The dimension may be six (6) inches for an automatically stoker-fired forced warm-air furnace equipped with two hundred fifty (250°) degrees F. limit control operated by draft intensity of .13-inch water gauge.

Note 9. To combustible material or metal cabinets. If the underside of such combustible material or metal cabinet is protected with asbestos millboard at least one-quarter (1/4) inch thick covered with sheet metal of not less than No. 28 gauge, the distance may be not less than twenty-four (24) inches.

Table 2110-2  
 MAXIMUM REDUCED CLEARANCES (INCHES) WITH SPECIFIED FORMS OF PROTECTION<sup>1</sup>

| TYPE OF PROTECTION  | WHERE THE REQUIRED CLEARANCE WITH NO PROTECTION IS: |                |                           |       |                |                           |       |                |           |  |
|---|---|----------------|---------------------------|-------|----------------|---------------------------|-------|----------------|-----------|--|
|   | 36 inches   |                |                           |       | 18 inches      |                           |       |                | 12 inches |  |
|   | Above   | Sides and Rear | Chimney or vent Connector | Above | Sides and Rear | Chimney or vent Connector | Above | Sides and Rear |           |  |
| (a) ¼" asbestos millboard spaced out 1".....  | 30  | 18             | 30                        | 15    | 9              | 12                        | 9     | 6              |           |  |
| (b) No. 28 Manufacturers' Standard gage steel sheet on ¼" asbestos millboard.....                                     | 24  | 18             | 24                        | 12    | 9              | 12                        | 9     | 6              |           |  |
| (c) No. 28 Manufacturers' Standard gage steel sheet spaced out 1".....  | 18  | 12             | 18                        | 9     | 6              | 9                         | 6     | 4              |           |  |
| (d) No. 28 Manufacturers' Standard gage steel on 1/8" asbestos millboard spaced out 1"....                            | 18  | 12             | 18                        | 9     | 6              | 9                         | 6     | 4              |           |  |
| (e) ¼" asbestos millboard on 1" mineral fiber batts reinforced with wire mesh or equivalent.....                      | 18  | 12             | 18                        | 6     | 6              | 6                         | 4     | 4              |           |  |
| (f) No. 22 Manufacturers' Standard gage steel sheet on 1" mineral fiber batts reinforced with wire or equivalent..... | 18  | 12             | 12                        | 4     | 3              | 3                         | 2     | 2              |           |  |
| (g) ¼" asbestos cement board or ¼" asbestos millboard.....  | 36  | 36             | 36                        | 18    | 18             | 18                        | 12    | 12             |           |  |
| (h) ¼" cellular asbestos.....   | 36  | 36             | 36                        | 18    | 18             | 18                        | 12    | 12             |           |  |

Note 1: Except for the protection described in (e), all clearances shall be measured from the outer surface of the appliance to the combustible material disregarding any intervening protection applied to the combustible material.

Note 2: Spacers shall be of non-combustible material.

SECTION 2111.0 COMBUSTION AIR

2111.1 General: All fuelburning equipment shall have a sufficient supply of air for fuel combustion, ventilation draft hood dilution.

2111.2 Volume required: Additional combustion air shall be provided for fuelburning appliances if the volume of an appliance room in cubic feet is less than one-twentieth (1/20) of the maximum input Btu rating of all appliances therein.

Exception: Sealed combustion system appliances, cooking appliances, refrigerators and clothes dryers.

2111.3 Air supply: Rooms containing fuel-burning appliances and not having the volume required in Section 2111.2 shall be provided with two (2) square inches of combustion air opening for each input of one thousand (1000) Btu rating with a total of not less than two hundred (200) square inches.

Exception: One (1) square inch for each input rating of one thousand (1000) Btu's may be permitted provided the compartment floor area is more than twice the floor area of the appliance and the total area is not less than one hundred (100) square inches.

2111.3.1 Air supply ratio: One-half (1/2) of the required combustion air opening shall extend within the upper twelve (12) inches of the room and the other one-half (1/2) shall extend within the lower twelve (12) inches.

Exception: In any room containing gas or liquid burning appliances which has more than twice the floor area of all such appliances, the required combustion air supply may be reduced fifty (50) per cent, but not less than one hundred (100) square inches and in all rooms larger than fifty (50) square feet the required combustion air opening may be located within the upper twelve (12) inches of the room.

2111.4 Outside combustion air: If required, outside combustion air shall be supplied through openings or ducts of the required cross-sectional area extending to the appliance room. The same duct shall not serve both the upper and lower combustion air supply openings. The duct serving the upper air opening must be level or extended upward from appliance room.

2111.5 Attic combustion air: Combustion air supply may be obtained from an attic area provided:

1. The attic ventilation is sufficient to provide the required volume of combustion air.

2. Circulating air supplies for blower-type furnaces shall not be obtained from the area.

2111.6 Under floor combustion air: The lower combustion air supply required by Section 2111.3 may be obtained from under floor areas having unobstructed openings to the outside equivalent to not less than twice the required combustion air opening between the under floor space and the appliance room.

2111.7 Opening requirements: Outside combustion air openings shall be covered with corrosion-resistant screen of one-quarter (1/4) inch mesh.

2111.8 Combustion air ducts: Combustion air supply ducts shall be of corrosion-resistant material having a cross-sectional dimension of not less than three (3) inches and terminating in a space not less than six (6) inches in depth in front of, or open to, the front or firebox side of the appliance. The space shall extend from the floor to the ceiling of the appliance room.

2111.9 Gravity-type warm-air furnaces: Gravity-type warm-air furnaces shall be provided with combustion air supply specified in section 2111.0.

2111.10 Exhaust and ventilation systems: Air requirements for the operation of exhaust fans, kitchen ventilation systems, clothes dryers and fireplaces shall be considered in determining the adequacy of a space to provide combustion air requirements.

2111.11 Cold climate: Appliance rooms of unusually tight construction located in areas where temperatures prevail at lower than 20° F., may be provided with combustion air as set forth in Table 2111-1. Openings shall conform to Section 2111.3.

Exception: Sealed combustion systems.



Table 2111-1  
 APPLIANCE ROOM COMBUSTION AIR REQUIREMENTS  
 IN COLD CLIMATES (TIGHT CONSTRUCTION)

| Type of Openings                            | Minimum total free area of ducts or openings, where volume of compartment is less than 16 times of the appliance therein | Minimum total free area of ducts or openings, where volume of compartment is more than 16 times of the appliance therein |
|---|--|--|
| Direct Opening or Vertical Ducts to Outside | 1 square inch for each 4000 Btu's  | 1 square inch for each 5000 Btu's  |
| Horizontal Ducts to Outside                 | 1 square inch for each 2000 Btu's  | 1 square inch for each 2500 Btu's  |
| To Inside* of Building                      | 1 square inch for each 1000 Btu's  | 1 square inch for each 2000 Btu's  |

\*Combustion air shall be taken from other interior areas complying with Section 2110.2.

#### SECTION 2112.0 WARM-AIR FURNACE

2112.1 Installation: A direct-fired furnace shall not be located downstream from a refrigerant evaporator or other air cooling coil unless the heating equipment is listed for such use.

2112.1.1 A refrigerant evaporator or cooling coil shall not be located in the air discharge of a warm-air furnace except where the furnace is listed for operation at not less than 0.5-inch water column static pressure or for use with a cooling coil.

2112.1.2 Furnace conversion: Conversion of existing furnaces for use with cooling coils shall be permitted only if approved by the building official.

2112.2 Combustion air: Fuelburning warm-air furnaces shall be supplied with adequate combustion air as required by Section 2111.0 of this article.

2112.2.1 Separation: The combustion chamber opening shall be separated from the fan plenum of a forced air furnace by an airtight separation.

2112.3 Working space: A working space not less than thirty (30) inches deep and thirty (30) inches high shall be provided to the front or firebox side of all furnaces.

2112.3.1 Access space: A space not less than twenty-four (24) inches wide and thirty (30) inches high shall be provided to the access panel to the temperature limit control, air filter and where applicable, fuel control valve. A space not less than twenty-four (24) inches wide and eighteen (18) inches high shall be provided to the vent collar of fuelburning furnaces.

2112.4 Prohibited location: Warm-air furnaces shall not be located in a bedroom, bathroom, closet or confined space with access only to such room or space.

Exceptions:

1. Access to attic or underfloor furnaces may be through a closet.
2. Sealed combustion systems.
3. Enclosed furnaces.
4. Electric furnaces.

2112.5 Room access: Any room containing a warm-air furnace shall have access thereto by a door and passageway of not less than two (2) feet by six (6) inches and large enough to permit removal of equipment.

Exception: Underfloor and attic installations.

2112.6 Clearance of warm-air furnaces: Clearances shall be provided for warm-air furnaces in accordance with the requirements of Table 2110-1 or their listing. The clearance of the combustion chamber opening side shall be not less than six (6) inches for fuelburning appliances.

2112.7 Attic furnaces: A warm-air furnace installed in an attic less than five (5) feet in height shall be listed for that location.

2112.7.1 Equipment access: A passageway thirty (30) inches by thirty (30) inches minimum shall be provided from the attic opening to the furnace and its controls. The opening and

passageway shall be large enough to allow replacement of any part and the attic opening shall not be located more than twenty (20) feet from the furnace measured along the center line of the passageway. The passageway shall be unobstructed and have solid flooring not less than twenty-four (24) inches wide.

2112.8 Underfloor furnaces: Warm-air furnaces installed in the underfloor area shall comply with the following requirements:

1. An access opening and passageway shall be provided of sufficient height and width to permit removal of the furnace but not less than thirty (30) inches by thirty (30) inches and which extends to the working space in front of the furnace. The distance from the passageway opening to the heating equipment shall not exceed twenty (20) feet.
2. Furnaces supported on the ground shall rest on concrete or masonry bases extending not less than three (3) inches above the adjoining ground level.
3. Furnaces suspended from the building shall have a clearance of at least six (6) inches from the ground. Furnace excavations shall extend to a depth of not less than six (6) inches below and twelve (12) inches beyond the sides of the furnace, except that the control side shall have a clearance of not less than thirty (30) inches. Walls of excavations exceeding twelve (12) inches in depth shall be lined with concrete masonry extending not less than four (4) inches above the adjoining ground level. In flood plane areas not less than a twelve (12) inch clearance shall be provided between the furnace and finish grade.

2112.9 Exterior furnaces: Warm-air furnaces installed on the exterior of buildings shall be listed accordingly and comply with the following requirements:

1. Unless listed for outside installation, an appliance located on the exterior of a building shall be enclosed in a weather-resistant housing. A weatherproof housing may be constructed of No. 24 gauge galvanized steel or No. 22 gauge aluminum. The enclosure shall have not less than a six (6) inch clearance from the furnace.
2. The appliance shall be installed on a level platform.
3. For ground installations the appliance shall be supported on a concrete or masonry base extending not less than three (3) inches above the adjoining ground level.

2112.10 Circulating air supply--general: The circulating air supply shall be taken from outside the building or from the conditioned area inside the building or from both sources.

2112.10.1 Ducts: The circulating air supply for a forced air comfort heating system shall be conducted through ducts complying with Section 2115.0 or through concealed spaces provided vent or vent connectors do not extend into or through these spaces.

2112.10.2 Volume damper: A volume damper shall not be placed in the circulating air supply inlet so as to reduce the supply to the furnace.

2112.10.3 Screen covering: The outside circulating air supply inlet shall be covered with screen having one-quarter (1/4) inch openings.

2112.11 Circulating air supply--requirement: The unobstructed area of circulating air supply openings to a gravity-type warm-air furnace shall be not less than seven (7) inches for each input of one thousand (1000) Btu rating or as required by the conditions of listing.

2112.11.1 Area: The unobstructed area of circulating air supply opening or ducts to a forced air warm-air furnace shall be not less than two (2) square inches for each input of one thousand (1000) Btu rating or as required by the conditions of listing.

2112.12 Circulating air supply--source: The circulating air supply for a comfort heating system shall not be taken from the following locations:

1. Within ten (10) feet of an appliance or plumbing vent outlet which is located less than three (3) feet above the circulating air supply inlet.
2. Areas having objectionable odors, fumes or flammable vapors.
3. Areas whose volume is less than twenty-five (25) per cent of the volume served by the system and where permanent openings to supplemental areas are not provided in accordance with this section.

Exception: Openings for a warm-air furnace may be reduced to not less than fifty (50) per cent of the required circulating air supply area provided the balance is taken from a room or hall having at least three (3) doors leading to other rooms served by the furnace.

4. Areas having a direct-fired fuelburning appliance.  
Exceptions:
  1. A gravity-type comfort heating system.

2. A blower-type comfort heating system where the circulating air supply is taken from an area having a volume exceeding one (1) cubic foot for each ten (10) Btu's of fuel input rating of all fuelburning appliances therein and at least seventy-five (75) per cent of the conditioned air is discharged back into the area provided the circulating air supply inlet is not located within ten (10) feet of an appliance firebox or draft diverter.

2112.13 Conditioned air supply: The minimum unobstructed total area of the conditioned air ducts from a blower-type warm-air furnace shall be not less than two (2) square inches for each one thousand (1000) Btu approved hourly input rating of the furnace and the minimum unobstructed total area of the conditioned air ducts from a gravity-type warm-air furnace shall be not less than seven (7) square inches for each one thousand (1000) Btu approved hourly input rating or as specified by the conditions of listing of the furnace.

2112.13.1 Duct sizing: In no case need the total area of the conditioned air ducts be larger than the outlet plenum collar opening on the furnace.

2112.13.2 Control: For the purpose of this section a volume damper, grill, or register installed for the purpose of controlling the conditioned air flow shall not be considered an obstruction.

#### SECTION 2113.0 VENTED DECORATIVE APPLIANCES, FLOOR FURNACES, VENTED WALL FURNACES AND VENTED ROOM HEATERS

2113.1 General: A vented decorative appliance, floor furnace, vented wall furnace, or vented room heater shall not be located under a stairway.

2113.2 Vented decorative appliances: Vented decorative appliances shall comply with the requirements for comfort heating appliances.

2113.3 Prohibited use: Unvented room heaters are prohibited in accordance with M.G.L.A. Chapter 148, Sections 25A and 25B, as amended.

2113.4 Floor furnaces location: Flat floor furnaces shall be installed not less than six (6) inches from walls.

2113.4.1 Wall location: Wall register floor furnaces shall be installed not less than six (6) inches from inside room corners.

Exception: Replacement floor furnaces of the same or lesser input rating may be installed in the original location when approved by the building official.

2113.4.2 Other combustible: Floor furnaces shall not be located where draperies or a door can swing within twelve (12) inches of the warm air outlet.

2113.4.3 Outlet clearances: Floor furnaces warm air outlets shall not be installed less than sixty (60) inches below overhead projections.

2113.4.4 Floor space: A clear floor space of fifteen (15) inches shall be provided along two (2) adjoining sides of flat floor furnaces.

2113.4.5 Furnace projection: The floor furnace burner assembly shall not project into an occupied underfloor area.

2113.5 Floor furnace access: An opening and passageway not less than twenty-four (24) by eighteen (18) inches shall be provided to every floor furnace. The passageway shall be not more than twenty (20) feet in length from the access opening or from an underfloor area thirty (30) inches or more in height.

2113.6 Floor furnace installation: Floor furnaces shall be supported independently of the grill and shall have not less than six (6) inches clearance from grade.

Exception: Sealed furnaces may have a grade clearance of two (2) inches minimum.

2113.6.1 Furnace excavations: Furnace excavations shall extend not less than eighteen (18) inches beyond the control side and twelve (12) inches beyond the sides and back of the furnace. The excavation shall slope outward from the bottom to the natural grade at an angle not greater than forty-five (45) degrees from the horizontal.

2113.6.2 Slab on grade: Floor furnaces shall not be installed on concrete slabs on grade.

2113.7 Wall furnace location: Vented wall furnaces designed to be installed in a nominal four (4) inch wall shall be not less than six (6) inches from inside room corners except where listed for reduced clearances.

Exception: Vented wall furnaces replacements approved by the building official.

2113.7.1 Combustible clearances: Vented wall furnaces shall not be located where a door can swing within twelve (12) inches of the furnace air inlet or outlet and shall not be installed less than eighteen (18) inches below overhead projections.

2113.8 Wall furnace combustion air: Vented wall furnaces shall be provided with combustion air in accordance with Section 2110.0.

Exception: Combustion air openings may be omitted to the area in which a vented wall furnace is installed provided a cased opening or archway leads from that area into other rooms having a minimum combined volume in cubic feet equivalent to one-twentieth (1/20) of the input Btu rating of the furnace.

2113.9 Wall furnace installation: Ducts shall not be attached to a wall furnace. Casing extensions or boots may be installed if listed as part of the appliance.

2113.10 Vented room heaters: Floor mounted type unit heaters shall be installed in accordance with Table 2110-1.

2113.11 Room heaters: Vented room heaters shall be installed in accordance with Table 2110-1 or as listed.

2113.12 Unvented room heaters: No unvented fuelburning room heaters shall be installed.

#### SECTION 2114.0 VENTING OF APPLIANCES

2114.1 General: All fuelburning comfort heating and comfort cooling appliances shall be vented to the outside. Venting systems shall consist of approved chimneys, approved vents or a venting assembly which is an integral part of a listed appliance or may be designed in accordance with accepted engineering practices.

2114.1.1 Vent systems: Venting systems which are integral parts of vented appliances shall be installed in accordance with the terms of their listing, manufacturer's installation requirements and applicable requirements of this article.

2114.2 Commonwealth of Massachusetts requirements: Gas vents required for appliances or equipment using fuel gases of any kind such as natural gas, manufactured gas, undiluted liquified

petroleum gases, liquified petroleum gas-air mixtures, or mixtures of any of these gases shall comply with the requirements of the Massachusetts Fuel Gas Code, 248 CMR 3.00 - 8.00.

2114.3 Type of venting systems required: Gas appliances shall be vented in conformance with the regulations provided in Section 2114.2. Oil burning appliances may be used with type L vents where so listed.

2114.4 Installation and construction: Manually operated dampers shall not be placed in chimneys, vents or vent connectors of liquid or gasburning appliances. Fixed baffles on the appliance side of draft hoods and draft regulators shall not be classified as dampers.

2114.4.1 Automatically operated dampers: Automatically operated dampers shall be of approved type designed to maintain a safe damper opening and arranged to prevent firing of the burner unless the damper is opened to a safe position.

2114.5 Location: Vents shall not extend into or through an air supply duct or plenum.

Exception: Venting systems may pass through a combustion air duct.

2114.5.1 Multiple connections: Appliances shall not be vented into a fireplace or into a chimney serving a fireplace.

2114.6 Length pitch--clearance: Gravity vents shall not have more than two (2) offsets of more than forty-five (45) degrees from the vertical.

2114.6.1 Horizontal run: The horizontal run of a gravity vent and its connectors shall not be greater than seventy-five (75) per cent of the vertical height of the venting system measured from the appliance outlet.

2114.6.2 Vent connectors: Vent connectors in gravity-type venting systems shall have continuous rises of not less than one-quarter (1/4) inch per foot of length measured from the appliance vent collar to the vent.

2114.6.3 Single wall connectors: Single wall metal vent connectors for an appliance shall be located entirely within the room or area where the appliance is located.

2114.7 Vent termination--general: Vents shall extend above the roof surface, through a flashing and terminate in a listed vent cap.



2114.8 Gravity vent termination: Gravity-type venting systems, other than Type BW or venting systems which are integral with listed appliance, shall terminate not less than five (5) feet above the highest vent collar which they serve.

2114.9 B or BW vent termination: Type B or BW gas vents shall terminate not less than one (1) foot above the roof nor less than four (4) feet from a portion of the building which extends at an angle of more than forty-five (45) degrees upward from the horizontal.

2114.10 L vent termination: Type L venting systems shall terminate not less than two (2) feet above the roof nor less than four (4) feet from a portion of the building which extends at an angle of more than forty-five (45) degrees upward from the horizontal.

2114.11 Special vent requirements: Venting systems shall terminate not less than four (4) feet below, four (4) feet horizontally from or one (1) foot above a door, window or gravity air inlet into a building.

Exception: Venting systems which are integral parts of listed equipment may be located closer provided the door, window or gravity air inlet is serving the same room in which the appliance is located; the venting system does not terminate less than nine (9) inches from the door, window or gravity air inlet; and the appliance does not exceed an input rating of fifty thousand (50,000) Btu's.

2114.11.1 Inlet and property clearance: Venting systems shall terminate not less than three (3) feet above forced air inlets located within ten (10) feet (horizontally); nor less than four (4) feet from private property lines.

2114.12 Vent size: Vent systems shall have internal cross-sectional areas of not less than the area of the vent collars but not less than seven (7) square inches except where the vents are integral parts of listed appliances.

2114.13 Multiple appliance venting systems: Two (2) or more listed appliances may be connected to common gravity-type venting systems provided the appliances are equipped with listed primary safety controls and listed safety shutoff devices for oil and gas fuel respectively and comply with the following requirements:

1. Appliances which are connected to common venting systems shall be located in the same story of the building, except engineered systems as set forth in Section 2114.1.

2. Two (2) or more connectors shall not enter common venting systems unless the inlets are offset so that no portion of an inlet is opposite the other inlets.
3. The venting system shall be not less than the area of the largest vent connector plus fifty (50) per cent of the areas of the additional vent connectors. An oval vent may be used provided its capacity is not less than the capacity of the round vent for which it is substituted.

2114.14 Existing venting systems: Existing venting systems may be connected to replaced appliances in accordance with the following requirements:

1. The venting system shall have been installed in accordance with the code in effect at that time and have no apparent defects.
2. The internal area of the venting systems shall be in accordance with Section 2114.11.

2114.15 Draft hoods: Draft hoods shall be located in the same room or space as the combustion air openings of the appliances and shall be located so that the relief opening is not less than six (6) inches from any surface other than the appliance it serves, measured in a direction ninety (90) degrees to the plane of the relief opening.

## SECTION 2115.0 DUCTS

2115.1 Material: Ducts conveying air from outside the building or air from evaporative coolers shall be constructed of galvanized steel or corrosion-resistant metal.

2115.1.1 Other material: Ducts or concealed spaces used for inside circulating air may be of combustible material. Where space between studs in walls or partitions is used as a duct the portions of such space so used shall be cut off from all remaining unused portions by tight-fitting stops of sheet metal or of wood not less than two (2) inches nominal thickness. Not more than one (1) firestop may be crossed.

2115.1.2 Hot air ducts: Ducts conveying heated conditioned air shall be of noncombustible material.

2115.1.3 Other approved ducts: Approved ducts, plenums and fittings constructed of asbestos-cement, concrete or ceramic may be installed in the ground or in a concrete slab.

2115.1.4 Other criteria: Metal ducts shall conform to Table 2115-1.

2115.1.5 Temperature: Ducts constructed of gypsum products shall not be subject to air temperatures of more than 125° F.

2115.2 Construction: Duct work shall be constructed in accordance with the criteria contained in Appendix B of the code.

2115.3 Installation: Metal ducts shall be securely fastened in accordance with Table 2115.3.

2115.3.1 Metal ducts shall not be installed within four (4) inches of the ground except when encased in not less than two (2) inches of concrete.

2115.3.2 Duct Supports: Rectangular metal duct supports set forth in Table 2115.3 shall be riveted, bolted or screwed to each side of the duct.

2115.3.3 Other supports: Horizontal round duct supports set forth in Table 2115-3 shall consist of one (1) hanger installed in accordance with the following requirements:

1. The hanger shall be attached to one (1) inch wide circular bands of same gauge as duct extending around and supporting ducts exceeding ten (10) inches in diameter.
2. The ducts shall be braced to prevent lateral displacement.

2115.4 Insulation: Ducts shall be insulated, when required, according to Section 2128.1.

Exception: Ducts need not be insulated in an unheated basement or cellar when foundation walls are insulated.

Table 2115-1

**GAGES OR METAL DUCTS AND PLENUMS USED FOR COMFORT HEATING OR COOLING FOR A DWELLING UNIT**

|   | COMFORT HEATING OR COOLING    |   |                                 |
|---|-------------------------------|---|---------------------------------|
|   | GALVANIZED STEEL              |   | Approximate Aluminum B & S Gage |
|   | Nominal Thickness (In Inches) | Equivalent Galvanized Sheet Gage Number |                                 |
| Round Ducts and Enclosed Rectangular Ducts<br>14" or less<br>Over 14" | 0.016                         | 30                                      | 26                              |
|   | 0.019                         | 28                                      | 24                              |
| Exposed Rectangular Ducts<br>14" or less<br>Over 14"                  | 0.019                         | 28                                      | 24                              |
|   | 0.022                         | 26                                      | 23                              |

Table 2115-3

**METAL DUCT SUPPORTS**

| DUCT TYPE   | MAX. SIDE OR DIA. | DUCT POSITION | HANGER OR STRAP SIZE AND SPACING                                  |
|-------------|-------------------|---------------|---|
| CIRCULAR    | 10'               | Vertical      | No. 18 gage galvanized steel x 2" @ 12' o.c.                      |
|             |                   | Horizontal    | No. 30 gage galvanized steel x 1" or No. 18 steel wire @ 10' o.c. |
|             | 20                | Vertical      | No. 16 gage galvanized steel x 2" @ 12' o.c.                      |
|             |                   | Horizontal    | No. 28 gage galvanized steel x 1" or No. 18 steel wire @ 10' o.c. |
| RECTANGULAR | 24                | Vertical      | 1" x 1/8" steel galvanized strap @ 12' o.c.                       |
|             |                   | Horizontal    | No. 18 gage galvanized steel x 1" @ 10' o.c.                      |
|             | 36                | Vertical      | 1" x 1-1/8" steel galvanized angle @ 12' o.c.                     |
|             |                   | Horizontal    | 1" x 1/8" steel strap galvanized @ 10' o.c.                       |

SECTION 2116.0 COMFORT COOLING

2116.1 Commonwealth of Massachusetts Rules and Regulations: All installations of gas appliances shall be subject to and must comply with the Massachusetts Fuel Gas Code, 248 CMR 4.00 - 8.00. All oilburning appliances shall be subject to the provisions of 527 CMR 4.00 established in accordance with Chapter 148, Section 10 of the MGLA, as amended, which govern the construction, installation and operation of oilburning equipment. Also, compliance shall be required with the provisions of the rules and regulations issued by the Board of Boiler Rules under the authority of Chapter 146 of the MGLA, as amended, governing the construction, installation, testing and inspection of boilers, air tanks, ammonia compressor safety valves, and refrigeration and air-conditioning systems of twenty (20) tons or more capacity.

2116.2 Cooperating agencies: Nothing herein contained shall be deemed to nullify the federal, state or municipal rules and regulations governing the storage and use of flammable and explosive gases and chemicals, or the requirements of the Interstate Commerce Commission or other federal statutes governing the transportation and use of hazardous gases, explosives and other flammable substances.

2116.3 Permits: One- and two-family dwellings shall not be required to have permits unless the refrigeration systems contain more than ten (10) pounds of refrigerants or are actuated by motors or engines of one and one-half (1-1/2) horsepower or larger.

2116.4 Installation: Group 2 refrigerants shall not be used in direct refrigerating systems.

2116.4.1 Condensate: An approved means shall be provided for the collection and disposal of condensate from the air cooling coil to outside the building or other approved locations.

2116.4.2 Location: Comfort cooling equipment, other than ducts and piping, shall be located not less than three (3) inches above the ground.

2116.4.3 Lighting: Electric lighting shall be provided for equipment located inside a building.

2116.5 Access: Equipment requiring servicing shall be accessible by means of passageway two (2) feet by six (6) feet six (6) inches minimum.

Exception: An access opening to the attic or underfloor area may be reduced to a thirty (30) inch dimension provided the equipment can be replaced.

2116.5.1 Work space: Equipment shall be provided with an unobstructed space thirty (30) inches by six (6) feet six (6) inches minimum on the service side.

Exception: The height of the working space may be reduced to thirty (30) inches for an air handling unit, air filter or refrigerant and brine control valves. Fan coils in drop ceilings may be serviced through combination return air grills.

2116.6 Circulating air supply source: A positive separation shall be provided between the combustion air and the circulating air supply (see Section 2112.10).

2116.7 Return air limitation: Comfort cooling systems shall be arranged so that the circulating air from one (1) dwelling unit does not discharge into another dwelling unit.

2116.8 Screen: Exterior circulating air supply inlets shall be covered with screen having one-quarter (1/4) inch openings.

2116.9 Refrigerant piping: All refrigerant pipe and fittings installed within a building or structure and which may reach surface temperatures that will result in condensation forming on the piping shall be insulated.

#### SECTION 2117.0 ABSORPTION UNITS AND ABSORPTION SYSTEMS FOR COMFORT COOLING AND COMFORT HEATING

2117.1 General: Absorption units used for comfort heating or comfort cooling systems shall conform to the requirements of Sections 2110.0, 2111.0 and 2115.0.

2117.2 Identification: Fuelburning absorption units shall bear a label containing the following information:

1. Manufacturer's name
2. Model number
3. Amount and type of refrigerant
4. Factory test pressures or pressures applied
5. Normal Btu input rating
6. Cooling capacity in Btu's
7. Type of fuel
8. Symbol of the organization certifying the approval of the equipment

9. Instructions for the lighting, operation and shutdown of the system

#### SECTION 2118.0 FUEL SUPPLY SYSTEMS

2118.1 General: New fuel supply systems, except parts thereof controlled and maintained by a public utility, shall conform to the requirements of this section and shall not be made operative until first approved by the building official. Fuel supply system design, construction and workmanship shall be consistent with generally accepted good practice and in conformity with nationally recognized applicable standards acceptable to the State Building Code Commission.

2118.2 Location: Location of fuel supply tanks, meters, main shutoff valves, relief valves, and regulators other than integral appliance regulators shall be approved by the building official and shall conform to state and local regulations.

2118.3 Authority to disconnect: The building official is hereby authorized to order disconnected any fuel supply or appliance which does not conform to this code or which is found to be defective and may endanger life or property.

2118.3.1 Notice: A notice shall be attached to the piping or appliances stating the reasons for disconnection. Such notice shall not be removed nor shall the system or appliance be re-connected until authorized by the building official.

2118.4 Piping support: Gas piping shall be supported by metal straps or hooks at not more than six (6) feet on center for piping one (1) inch or less in size and not more than ten (10) feet on center for piping larger than one and one-quarter (1-1/4) inches. Piping shall be protected against physical damage. Buried piping shall be laid in a solid bed. Gas piping shall not be strained or bent and appliances shall not be supported by supply piping.

2118.5 Liquid fuel supply: Supply piping and all related equipment serving oilburning appliances shall be subject to the provisions of 527 CMR 4.00 (FPR-3).

#### SECTION 2119.0 ENERGY CONSERVATION BY COMPONENT DESIGN

2119.1 General: All buildings that are heated or mechanically cooled shall be constructed to provide the required thermal performance of the various components.

2119.2 Building enclosure elements

2119.2.1 Gross wall area: For the purposes of this article, the gross area of exterior walls consists of all opaque wall areas, including foundation walls, walls between floor spandrels, peripheral edges of floors, window areas including sash, and door areas, where such surfaces enclose a heated or mechanically cooled space including interstitial areas between two such spaces.

2119.2.2 Roof assembly: For the purposes of this article, a roof assembly shall be considered as all components of the roof/ceiling envelope through which heat flows, thereby creating a building transmission heat loss or gain, where such assembly is exposed to outdoor air and encloses a heated or mechanically cooled space.

2119.2.3 Gross roof area: The gross area of a roof assembly consists of the total interior surface of such assembly, including skylights exposed to the heated or mechanically cooled space.

2119.2.4 Ceiling plenums: Where air ceiling plenums are employed, the roof/ceiling assembly shall:

1. for thermal transmittance purposes, not include the ceiling proper nor the plenum space as part of the assembly; and,
2. for gross area purposes, be based upon the interior face of the upper plenum surface.

SECTION 2120.0 BUILDING INSULATION

2120.1 Standards: Insulating materials must conform to the Federal Specifications (F.S.) and the American Society for Testing and Materials (ASTM) Test Standards as listed in Table 2120-1 for thermal resistance and fire safety.

2120.2 Installation

2120.2.1 Recessed light fixtures: Install insulation with a clearance of three (3) inches around each side of fixture to preclude excessive heat build-up. Insulation shall not be installed over a recessed light fixture.

2120.2.2 High heat sources: A clearance of three (3) inches from any high heat source is required for combustible insulating materials, including but not limited to, chimneys, flues and vents.



2120.2.3 Liquid foams: Liquid foams must meet minimum standards set forth in HUD "Use of Materials" Bulletin No. 74.

Table 2120-1  
INSULATION MATERIAL STANDARDS

| Material or product                   | Material specifications               |
|---------------------------------------|---------------------------------------|
| Mineral fiber<br>Blanket/Batt         | F.S. HH-1-521E<br>ASTM C665-70        |
| Loose fill                            | F.S. HH-1-1030A<br>ASTM C764-73       |
| Mineral cellular<br>Perlite           | F.S. HH-1-574A<br>ASTM C549-73        |
| Vermiculite                           | F.S. HH-1-585B<br>ASTM C516-67        |
| Organic fiber<br>Cellulose            | F.S. HH-1-515C<br>ASTM C739-77 E84-77 |
| Reflective                            | F.S. HH-1-1252A                       |
| Organic Cellular<br>Polystyrene Board | F.S. HH-1-524B<br>ASTM C578-69        |
| Urethane Board                        | F.S. HH-1-530A<br>ASTM C591-69        |
| Flexible Unicellular                  | F.S. HH-1-573B<br>ASTM C534-70        |
| Vapor Barriers                        | ASTM C755-73                          |

### 2120.3 Foam plastics

2120.3.1 General: Except where specifically exempted by subsection 2 below, foam plastics shall have a flame spread rating

of not more than 75 and shall have a smoke developed rating of not more than 450 when tested in accordance with approved standards in the thickness intended for use.

2120.3.2 Specific requirements: The following requirements shall apply to all uses of foam plastics in or on the walls, ceilings, or in attics, roof or floors, crawl spaces or similar areas, and may be used in the following locations:

1. Within the cavity of a masonry or concrete wall.
2. On the room side surface of walls or ceilings or other surfaces provided the foam plastic is fully protected from the interior of the building by a thermal barrier of one-half (1/2) inch gypsum wallboard having a finish rating of not less than 15 minutes or other approved material having an equivalent finish rating. Thermal barriers shall be installed in a manner that they will remain in place for a minimum of 15 minutes under the same test conditions.
3. Foam plastic trim covering not more than ten (10) per cent of the wall or ceiling area may be used provided such trim: (1) has a density of not less than twenty (20) pounds per cubic foot; (2) has a maximum thickness of one-half (1/2) inch and a maximum width of four (4) inches; and (3) has a flame spread rating no greater than seventy-five (75).

2120.3.3 Roof coverings: Foam plastics may be used as a roof covering if the foam plastic is a part of a Class A, B or C roofing assembly. That plastic foam which is nearest the interior of the building shall be protected by an approved barrier which need not have a fifteen (15) minute finish rating.

2120.3.4 Coverings over foam plastics: Ordinary roof coverings, other than Class A, B, or C, may be applied over foam plastic when the foam is separated from the interior of the building by plywood sheathing not less than one-half (1/2) inch in thickness with exterior glue, with edges supported by blocking, tongue and groove joints, or other approved type of edge support, or an equivalent material.

2120.3.5 Non-structural foam sheathing: Refer to Section 2104.3.10.

#### 2120.4 Blanket/batt insulation

2120.4.1 Labeling: All insulation shall be labeled as required in Article 20.

2120.4.2 Cavities: Fill small cavities between rough framing and door and window heads, jambs, and sills with insulation.

2120.5 Perimeter insulation: Perimeter insulation for slab on grade construction must be installed so that the concrete to concrete contact between the foundation wall and the floor slab is broken and extends downward the thickness of the slab and then extends an additional two (2) feet below exterior grade vertically, or two (2) feet horizontally, beneath the floor slab.

#### SECTION 2121.0 VENTILATION

2121.1 Attic ventilation: Enclosed attics, and enclosed rafter spaces formed where ceilings are applied direct to the underside of roof rafters, shall have cross-ventilation for each separate space by ventilating openings protected against the entrance of rain and snow, sized by the criteria in Sections 2121.1.1 and 2121.1.2.

2121.1.1 With a ceiling vapor barrier installed: Attics with a ceiling vapor barrier must be ventilated with screened openings of at least one (1) square foot of free vent area for each three hundred (300) square feet of ceiling area.

2121.1.2 Without a ceiling vapor barrier installed: Attics without a ceiling vapor barrier installed shall be ventilated with screened openings of at least one (1) square foot of free vent area for each one hundred fifty (150) square feet of ceiling area.

2121.1.3 Eave vents: When eave vents are installed, adequate baffling shall be provided to deflect the incoming air above the surface of the insulation. Baffles shall be installed prior to insulation, and shall be installed over the exterior wall at an angle to provide a two (2) inch minimum clearance under the roof deck for upward flow of ventilation air to the fixed vents in the upper portion of the attic.

2121.1.4 Ridge or gable vent: When eave vents are installed, the ridge or gable vent must be at least three (3) feet above the level of the eave vents.

#### 2121.2 Underfloor space ventilation

2121.2.1 With a ground vapor barrier: Underfloor spaces with an approved vapor barrier installed on the ground surface shall be ventilated with screened openings of one (1) square foot of vent area for each fifteen hundred (1,500) square feet of crawl space. Vents shall be positioned to provide cross ventilation. See Section 2102.9.

SECTION 2122.0 VAPOR BARRIERS

2122.1 Vapor barriers: A vapor barrier of 1.0 perm or less shall be installed on the winter warm side of walls, ceilings and floors enclosing a conditioned space.

2122.2 Seams: When using blanket insulation, all seams and joints shall be butted tight and tears taped or sealed.

Exception: Vapor barriers may be eliminated with adequate ventilation as defined in Section 2121.0.

SECTION 2123.0 U-VALUES OF BUILDING COMPONENTS

2123.1 General: All new construction and additions to existing buildings covered by this section shall conform to the maximum U and R values listed in Table 2123-1 and as specified in this section.

2123.2 Alternates: The stated  $U_o$  (or U) value of any one assembly, such as roof/ceiling, wall<sup>o</sup> or floor, may be increased and the  $U_o$  (or U) value for other components decreased provided that the overall heat gain or loss for the entire building envelope does not exceed the total resulting from conformance to the stated  $U_o$  (or U) values.

Table 2123-1  
 MAXIMUM U-VALUES OF WALLS, ROOF/CEILINGS,  
 AND FLOORS FOR RESIDENTIAL BUILDINGS

| Element                               | Description   | Total U-Value | R-Value | Notes |
|---------------------------------------|---|---------------|---------|-------|
| Walls                                 | All wall construction containing heated or mechanically cooled space                  | 0.08          | 12.5    | 1     |
| Foundation Walls Including Band Joist | Containing heated or mechanically cooled space  | 0.08          | 12.5    |       |
|                                       | Containing unheated space   | 0.17          | 5.9     | 5     |
| Roof Assembly                         | Plank and beam containing heated or mechanically cooled space                         | 0.08          | 12.5    | 2     |
| Roof Assembly                         | Construction other than plank and beam containing heated or mechanically cooled space | 0.05          | 20.0    |       |
| Doors and Windows                     | All construction enclosing heated or mechanically cooled space                        | 0.65          | 1.54    | 3     |
| Floors                                | Floor sections over areas exposed to outside air or unheated areas                    | 0.08          | 12.5    | 4     |
|                                       | Unheated slab on grade  | -             | 5.50    | 6     |
|                                       | Heated slab on grade  | -             | 7.75    | 6     |

Notes to Table 2123-1

Note 1: This value may be used when the doors and windows do not exceed twenty (20) per cent of the gross exterior wall area. When doors and windows exceed twenty (20) per cent of the gross wall area, see Article 20.

Note 2: Plank and beam assemblies are construction in which the finished interior surface is the underside of the roof deck.

Note 3: Double glazing or storm windows will satisfy the required U-value of 0.65.

Note 4: Insulation may be omitted from floors over unheated areas when foundation walls are provided with a U-value of 0.17.

Note 5: The U-value requirement of 0.17 for foundation walls may be omitted when floors over unheated spaces are provided with a U-value of 0.08.

Note 6: R-value for perimeter insulation (see Section 2120.5).

SECTION 2124.0 AIR LEAKAGE  
FOR ALL BUILDINGS

2124.1 General: The requirements of this section shall apply to all buildings and structures and apply to those locations separating outdoor ambient conditions from interior spaces that are heated or mechanically cooled and are not applicable to the separation of interior conditioned spaces from each other.

2124.2 Exterior envelope sealing: Exterior joints around windows and door frames; openings between walls and foundations, between walls and roof and between wall panels; openings at penetrations of utility services through walls, floors and roofs; and all other such openings in the building envelope shall be caulked, gasketed, weatherstripped, or otherwise sealed.

2124.3 Infiltration: All exterior doors and windows shall be designed to limit air leakage into or from the building envelope, and shall have air infiltration rates no greater than 0.5 cfm per linear foot of operable sash crack for windows, 0.5 cfm per square foot of door area for sliding glass doors and 1.25 for entrance doors, according to the testing procedure of ASTM E283.

## Exceptions:

1. Permanently installed storm windows and doors installed over exterior windows and doors shall be accepted when windows and doors have not been tested for infiltration according to Section 2124.3.
2. Fixed glazing is exempt from infiltration testing requirements.
3. Fire doors with a fireresistive rating over one (1) hour, and fire windows are exempt from this section.

SECTION 2125.0 SYSTEM DESIGN  
HEATING/COOLING CAPACITY

2125.1 General: The rated capacity of the heating/cooling system at design conditions shall not be greater than one hundred twenty-five (125) per cent of the design output load calculated in accordance with this Article. Equipment designed for standby purposes is not included in the capacity limitation requirement. The cooling cycles of heat pumps are exempt from this requirement.

2125.2 HVAC equipment performance requirements: HVAC equipment shall meet the requirements stated here and in Article 20.

2125.2.1 Data: The requirements for energy conservation apply to equipment and component performance for heating, ventilating, and air conditioning systems. Where equipment efficiency levels are specified, data furnished by the equipment supplier, or certified under a nationally-recognized certification program or rating procedure, shall be used to satisfy these requirements.

2125.2.2 HVAC-system heating equipment, heat pumps-heating mode: Heat pumps whose energy input is entirely electric shall show a coefficient of performance (COP heating, as defined herein) not less than 2.2 for air source of 47 dB/43WB, 1.2 (17 dB/15WB and 2.2 water source (60 entering)).

2125.2.3 Mechanical ventilation: Each mechanical ventilation system (supply and/or exhaust) shall be equipped with a readily accessible means for either shut-off or volume reduction, and shut-off when ventilation is not required.

2125.2.4 HVAC-system equipment, electrically operated cooling mode: HVAC-system equipment as listed below whose energy input in the cooling mode is entirely electric, shall show a Coefficient of Performance (COP) cooling as defined herein not less than 1.8 for under 65,000 Btu/hr., 2.0 for over 65,000 Btu/hr.

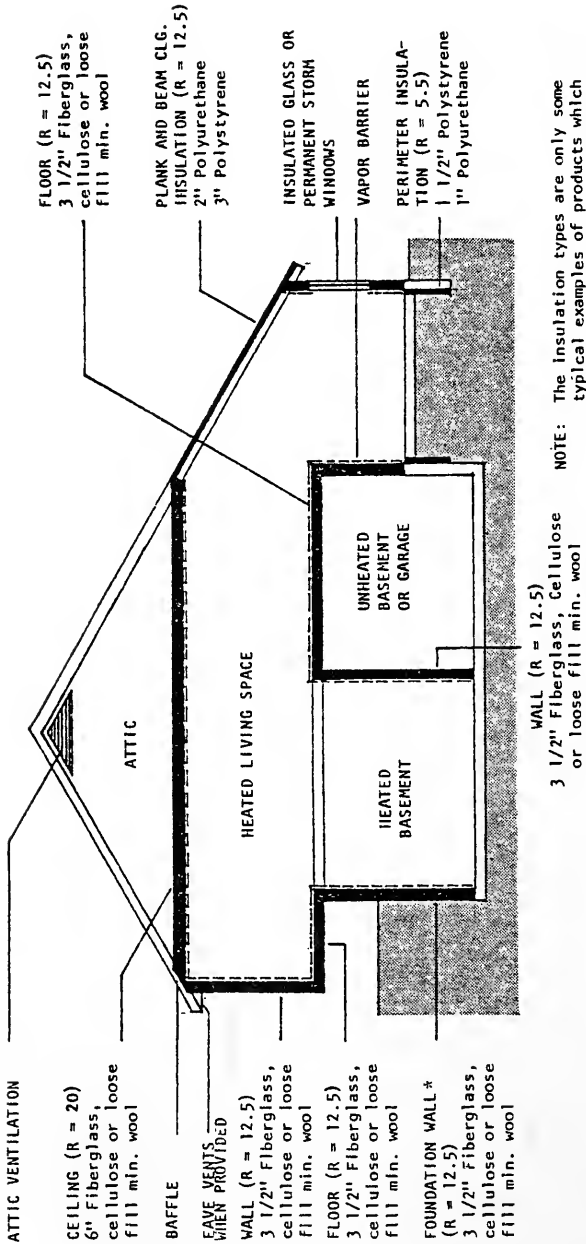

NOTE: The insulation types are only some typical examples of products which may be used and are not limited to those listed.

Figure 2123.1 TYPICAL INSULATING REQUIREMENTS FOR RESIDENTIAL APPLICATIONS

\*Required insulation may be reduced depending upon the extent of exposed foundation taking into account the insulating value of the earth using the ASHRAE procedure.



SECTION 2126.0 CONTROLS

2126.1 Temperature control: Each HVAC system shall be provided with at least one (1) thermostat for the regulation of temperature. Each thermostat shall be capable of being set as follows:

1. Where used to control heating only, 55-75° F.
2. Where used to control cooling only, 70-85° F.
3. Where used to control both heating and cooling it shall be capable of being set from 55-85° F. and shall be capable of operating the system heating and cooling in sequence. It shall be adjustable to provide a temperature range of up to 10° F. between full heating and full cooling.

2126.2 Humidity control: If an HVAC system is equipped with a means for adding moisture to maintain specific selected relative humidities in spaces or zones, a humidistat shall be provided. This device shall be capable of being set to prevent new energy from being used to produce space relative humidity above thirty (30) per cent relative humidity when moisture is added, or below sixty (60) per cent relative humidity when moisture is removed.

2126.3 Zoning for temperature control: At least one (1) thermostat for regulation of space temperature shall be provided for each separate HVAC system. In addition, a readily accessible manual or automatic means shall be provided to partially restrict or shut off the heating and/or cooling input to each zone or floor. Register dampers and hot water radiator hand dampers will suffice.

2126.4 Control setback and shut-off

2126.4.1 General: The thermostat required in Section 2126.3 or an alternate means such as a switch or clock, shall provide a readily accessible, manual or automatic means for reducing the energy required for heating and cooling during periods of nonuse or reduced need, such as, but not limited to, unoccupied periods and sleeping hours.

2126.4.2 Energy expended: Lowering thermostat set points to reduce energy consumption of heating systems shall not cause energy to be expended to reach the reduced setting.

SECTION 2127.0 BALANCING

2127.1 General: The HVAC system design shall provide means for balancing the air and water systems such as but not limited to dampers, temperature and pressure test connections,

flow measuring stations or meters, and balancing valves. The HVAC systems shall be field balanced to achieve conditions stated in the plans and specifications.

#### SECTION 2128.0 DUCT INSULATION

2128.1 General: When low pressure supply air ducts are located outside of the conditioned space (except return air plenums), all transverse joints shall be sealed using mastic or mastic plus tape. For fibrous glass duct work, pressure sensitive tape may be used. For duct construction refer to Section 2115.0, Ducts.

2128.2 Insulation: All duct systems, or portions thereof, exposed to nonconditioned spaces shall be insulated to provide a thermal resistance, excluding film resistances, of

$$R = \frac{t_i - t_o}{15} \text{ (hr) (sq. ft.) (F)/Btu, where } t_i - t_o \text{ is the}$$

temperature differential (absolute value) between the air in the duct and the surrounding air.

Exceptions: Duct insulation, except when needed to prevent condensation, is not required in any of the following cases:

1. In basements and cellars with insulated walls.
2. When the heat gain or loss of the ducts, without insulation, will not increase the energy requirements of the building.
3. Exhaust air ducts.

Where required to prevent condensation, insulation with vapor barriers shall be installed in addition to insulation required above.

#### SECTION 2129.0 PIPE INSULATION

2129.1 General: All hot water piping, or portions thereof, exposed to nonconditioned space shall be insulated to provide a thermal resistance in the range of R equals 4.0 to 4.6. This is typically one (1) inch of pipe insulation.

Reference Standards - Article 21

RS-21-1      Shower Compartment Finish

Glazed Ceramic Wall Tile Installed with Portland Cement Mortar ANSI A108.1,1967 - American National Standards Institute (ANSI) A108.1 - 1967

Ceramic Tile Installed with Chemical Resistant, Water Cleanable Tile-Setting and Grouting Epoxy-ANSI A108.6, 1969

Dry-Set Portland Cement Mortar (for installation of ceramic tile) - ANSI A118.1,1967

Organic Adhesives for Installation of Ceramic Tile-ANSI A136.1,1967 (Type I only in Shower Compartments) Standard Specification for Ceramic Tile-ANSI A137.1,1967

Ceramic Tile Installed with Dry-Set Portland Cement Mortar - ANSI A108.5,1967

Ceramic Mosaic Tile Installed with Portland Cement Mortar - ANSI A108.2,1967

Ceramic Tile Installed with Water-Resistant Organic Adhesives - ANSI A108.4,1968

RS-21-2      Glazing Materials

Glass. Federal Specification DD-G 451c

Safety Glazing Materials - ANSI Z97.1,1972

RS-21-3      Foundations

Building Brick and Facing Brick. (Made from Clay or Shale). Standard Specifications C62-58 and C216 of the American Society for Testing and Materials (ASTM).

Sand-Lime Building Brick. Standard Specification C73-51 of ASTM.

Concrete Building Brick. Standard Specification C55-55 of ASTM.

Hollow Load-Bearing Concrete Masonry Units. Standard Specification C90-59 of ASTM.

Solid Load-Bearing Concrete Masonry Units. Standard Specification C145-59 of ASTM.

- Method of Test for Concrete Masonry Units. Standard Specification C140-63T of ASTM.
- Structural Clay Load-Bearing Wall Tile. Standard Specifications C34-62 and C112-60 of ASTM.
- Cast Stone. Specification ACI 704-44 of the American Concrete Institute.
- Cold-Drawn Steel Wire for Concrete Reinforcement. Standard Specification A82 of ASTM.
- Cement, Masonry. Standard Specification C91-67 of ASTM.
- Quicklime for Structural Purposes. Standard Specification C5-59 of ASTM.
- Hydrated Lime for Masonry Purposes. Standard Specification C207-49 of ASTM.
- Processed Pulverized Quicklime. Standard Specification C51-47 of ASTM.
- Mortar for Masonry Other than Gypsum. Specifications C161-44T and C270-59T of ASTM.
- Aggregate for Masonry Mortar. Specification C144-52T of ASTM.
- Aggregates for Grout. Standard Specification C404 of ASTM.
- Sampling and Testing Brick. Standard Specification C67-60 of ASTM.
- Portland Cement. Standard Specifications C150-62 and C175-66 of ASTM.
- Portland Blast Furnace Slag Cement. Specification C205-62T of ASTM.
- Portland Pozzolan Cement. Specification C340-62T of ASTM.
- Concrete Aggregates. Specification C33-61T of ASTM.
- Concrete Proportions. ACI 613-54 and 613-59 of the American Concrete Institute.
- Concrete Reinforcement. Specifications A615-68, A616-68, A617-68 and A82-66 of ASTM.

Steel Bar Mats. Standard Specifications A184-65,  
A615-68, A616-68 and A617-68 of ASTM.

Welded Steel Wire Fabric. Specification A185-61T of  
ASTM.

Admixtures for Concrete. Standard Specification  
C494-62T of ASTM.

Concrete Tests. Standard Specifications C31-62,  
C39-61, C42-61 and C192-62 of ASTM.

Splitting Tensile Strength. Specification C496-62T  
of ASTM.

Ready-Mixed Concrete. Standard Specification C94-62  
of ASTM.

Welding Reinforcing Steel, Metal Inserts and  
Connections in Reinforced Concrete Construction.  
AWS D12. 1-61 of the American Welding Society.

Hollow Brick. (Hollow Masonry Units Made from Clay  
or Shale) Standard Specification C652-70 of ASTM.

Building Brick and Facing Brick. (made from Clay or  
Shale) Standard Specifications C62-69 and C216 of  
ASTM.

Mortar for Masonry Other than Gypsum. Standard  
Specification C270-68 of ASTM.

Aggregate for Masonry Mortar. Standard Specification  
C144-70 of ASTM.

Aggregate for Masonry Grout. Standard Specification  
C404-70 of ASTM.

Methods of Sampling and Testing Brick. Standard  
Specification C67-66 of ASTM.

Applicable Standards or Publications in Referenced  
Standard RS-21-5.

RS-21-4      Preservatives

American Wood Preserves Bureau (AWPB) Standards  
CP-22, CP-33, CP-44, CP-55, and CP-77 for  
pressure treated poles.

AWPB Standards LP-2, LP-3, LP-4, LP-5 and LP-7 for pressure treated softwood lumber used above ground.

AWPB Standards LP-22, LP-33, LP-44, LP-55 and LP-77 for pressure treated softwood lumber used in contact with the ground.

RS-21-5      Wall Construction

Applicable Standards or Publications in Reference Standard RS-21-3.

Classification, Definition and Methods of Grading for all Species of Lumber. Standard D245-70 of ASTM; American Softwood Lumber Standards PS 20-70 of the U. S. Department of Commerce.

Design for Permanence, Wood Construction DATA #6 National Forest Products Association (NF.PA).

Eastern Pine, Jack Pine, Eastern Spruce, Balsam Fire, Eastern Hemlock and Tamarack. Grading Rules, Northern Hardwood and Pine Manufacturers Association (September 1, 1970).

House Framing. Manual for National Forest Products Association Wood Construction DATA #1.

National Design Specification for Stress-Grade Lumber and Its Fastenings. National Forest Products Association 1977 with Supplement.

Northeastern Lumber. Standard Grading Rules, Northeastern Lumber Manufacturers Association (April, 1977).

Pine, Southern. Grading Rules, Southern Pine Inspection Bureau (1977).

Redwood. Specifications for Grades of California Redwood Lumber of the Redwood Inspection Service (December, 1976).

Softwood Plywood. Construction and Industrial Product Standard PS 1-74 (August, 1974) of the U. S. Department of Commerce, Bureau of Standards.

Design Specifications for Light Metal Plate Connected Wood Trusses. Truss Plate Institute (TPI) 197.

West Coast Lumber. Standard Grading Rules, West Coast Lumber Inspection Bureau.

Western Lumber. Standard Grading Rules, Western Wood Products Association (1977).

Poles Building Design. American Wood Preservers Institute (November, 1972).

Plank-and-Beam Framing. Wood Construction Data No. 4, National Forest Products Association.

Fiberboard Nail-Base Sheathing and Structural Insulating Board. Standard Specifications D2277-66 and C208-66 of ASTM.

Particleboard. U. S. Department of Commerce-Commercial Standard CS 236-66.

Material Specifications for Structural Steel. Standard Specifications A27, A36, A53, A148, A167, A235, A237, A242, A245, A252, A303, A307, A325, A354, A374, A375, A412, A440, A441, A446, A449, A490, A500, A501, A502, A514, A529, A570, A572 and A588 of ASTM.

Standard Specification for Structural Glued Laminated Timber Using "E" Rated and Visually Graded Lumber of Douglas Fir, Southern Pine, Hem-Fir and Lodepole Pine, American Institute of Timber Construction.

Canadian Lumber. Standard Grading Rules for Canadian Lumber, U. S. Edition (July 1, 1973). Approved by the American Lumber Standards Board of Review.

Specifications for Aluminum Structures of the Aluminum Association.

Connectors other than those specified in Section 2102.0 of this Code may be used in accordance with Table RS-21-6.

Specification for the Design, Fabrication and Erection of Structural Steel for Buildings, American Institute of Steel Construction, 1969 Edition and Supplements Nos. 1 and 2.

RS-21-6 Wall Covering

Applicable Standards and Publications in Reference Standards RS-21-2 and RS-21-5.

Aluminum Structures. Specifications for, by the Aluminum Association (November, 1967).

Plaster Liquid Bonding Agents. U. S. Government Military Specification MIL-B-19235 (Docks) (1965), and Standards Specifications of the California Lathing and Plastering Contractors Association (1965), and Recommendations of the Gypsum Association.

Adhesives for Fastening Gypsum Wallboard to Wood Framing. Specification C557-67 of ASTM.

Perlite, Vermiculite and Sand Aggregates for Gypsum and Portland Cement Plaster. Standards Specification C35-70 of ASTM.

Metal Lath, Wire Lath, Wire Fabric Lath and Metal Accessories. Approval Standard A42.4-1967 of ANSI.

Gypsum Wallboard Tape and Joint Compound. Standard Specifications C475-70 and C474-67 of ASTM.

Gypsum Backing Board. Standard Specification C442-67 of ASTM.

Gypsum Lath. Standard Specification C37-69 of ASTM.

Lime. Standard Specifications C206-68 and C6-49 of ASTM.

Gypsum Plasters. Standard Specification C28-68 of ASTM.

Gypsum Sheathing Board. Standards Specification C79-67 of ASTM.

Gypsum Veneer Plaster. Standards Specification C587-68 of ASTM.

Gypsum Veneer Base. Standard Specification C588-68 of ASTM.

Gypsum Wallboard. Standard Specification C36-70 of ASTM.

Keene's Cement. Standard Specification C61-64 of ASTM.

Gypsum Molding Plaster. Standard Specification C59-50 of ASTM.

Gypsum Plastering. Standard Specification A42.1-1964 of ANSI.



Interior Lathing and Furring. Standard Specifications  
2.4-1967 of ASTM.

Application and Finishing of Gypsum Wallboard.  
Standard Specifications A97.1-65 of ANSI.

Surface Burning Characteristics of Building Materials.  
Standard Method of Test E84-70 of ASTM.

RS-21-7 Floors

Applicable Standards or Publications in Reference  
Standards RS-21-3 and RS-21-5.

Maximum Spans for Joists and Rafters. Technical  
Bulletin 2, of NFoPA.

Canadian Dimension Lumber, Revised edition 1972,  
Canadian Wood Council.

RS-21-8 Roof-Ceiling

Applicable Standards or Publications in Reference  
Standards RS-21-3 and RS-21-6.

Maximum Spans for Joists and Rafters. Technical  
Bulletin 2, of NFoPA.

Canadian Dimension Lumber. 1971, Canadian Wood  
Council.

RS-21-9 Roof Coverings

Aluminum Sheet Metal Work in Building Construction  
by the Aluminum Association (October, 1967).

Composition Roofing. Standard Specification 55-A  
(May, 1967) Underwriters' Laboratories, Inc.

Roofing Asphalt. Standard Specification D312-44 of  
ASTM.

Composition Roofing. Standard Specification 55-B.  
(April, 1962), Underwriters' Laboratories, Inc.

Sheet Metals. Standard Specifications A245-62aT,  
A361-63T and B209-70 of ASTM.

Corrosion-Resistant Metals. Standard Specifications  
A219-58, A239-41 and B209-70 of ASTM.

Composition Roofing Testing. Standard Specification  
790 (September, 1958), Underwriters' Laboratories,  
Inc.

Hand-Split Shakes. Grading and Packing Rules, Hand-Split Red Cedar Shakes 1971, Red Cedar Shingle and Hand-Split Shake Bureau.

Asbestos-Cement Shingles. Standard Specification C222-60 of ASTM.

Slate Shingles. Standard Specification C406-57T of ASTM.

Wood Shingles. Commercial Standard CS31-52, U. S. Department of Commerce, National Bureau of Standards. Grading and Packing Rules for Red Cedar Shingles (1971) Red Cedar Shingles and Handsplit Shake Bureau.

Wire. Standard Specifications B134-62, B211-63, and B250-62 of ASTM.

RS-21-10 Chimney and Fireplace

Applicable Standards or Publications in Reference Standards RS-21-3 and RS-21-5.

RS-21-11 Mechanical Materials

Galvanized Sheet Metals. Standard Specification A525-64T of ASTM.

Tank Piping and Valves for Oil Burning Appliances. Pamphlet No. 31, June, 1965, of the NFPA.

Nonmetallic Ducts. Standard No. 181 of the UL.

Refrigeration. Standard No. B9.1-1964 of the ANSI.

Wrought Steel and Wrought Iron Pipe. Standard B36.10-1959 of the ANSI.

Seamless Copper Tube, Copper Pipe and Red Brass Pipe. Standard Specifications B42-62, B43-62, B68-60, B88-66, B251-66 and B280-66 of ASTM.

Compression (neoprene) Gaskets (including hubless piping system) for Cast Iron Piping and Fittings in Condensate Drain Lines. Standard Specification C564-70 of ASTM, or CISPI Standards HSN-72 and 301-72.

Stainless Steel Coupling (hubless piping system) for Cast Iron Piping and Fittings in Condensate Drain Lines. CISPI Standard 301-72.

Load Calculation for Residential Winter and Summer Air-Conditioning. Manual J., Third Edition, of NISC.

Installation of Gas Appliances and Gas Piping. Standard No. 54, 1969 of the NFIPA.

Installation of Gas Piping and Gas Equipment on Industrial Premises and Certain Other Premises. Standard No. 54-A, 1969 of the NFIPA.

Chimneys, Fireplaces and Venting Systems. Standard No. 211, 1970 of the NFIPA.

Installation of Residence-Type Warm Air Heating and Air Conditioning Systems. Standard No. 90-B, 1971 of the NFIPA.

RS-21-12      Mechanical Equipment

Applicable Standards or Publications in Reference Standard RS-21-11.

Mechanical Ventilation. Testing and Rating Procedures of Home Ventilating Institute.

RS-21-13      Smoke/Heat Detectors

NFiPA Standard No. 101 of 1971-1972

NFiPA Standards No. 74 of 1971-1972

RS-21-14      Solid-Fuel Appliances

Factory-Built Chimneys. Standard No. 103, 1978 of the UL.

Factory-Built Fireplaces. Standard No. 127, 1972 of the UL.

Free-Standing Fireplaces. Standard No. 737, 1978 of the ANSI/UL.

Free-Standing Room Heaters. Standard No. 1482, 1979 of the UL.

Solid and Solid/Liquid Fuel Burning Central Heating Boilers and Warm Air Furnaces. Standard No. B366-M, 1979 of the Canadian Standards Association (CSA).

NON-TEXT PAGE

## ARTICLE 22

REPAIR, ALTERATION, ADDITION, AND  
CHANGE OF USE OF EXISTING BUILDINGS

## SECTION 2200.0 SCOPE

2200.1 General: The provisions of this article are intended to maintain or increase public safety, health, and general welfare in existing buildings by permitting repair, alteration, addition, and/or change of use without requiring full compliance with the code for new construction except where otherwise specified in this article.

2200.2 Compliance: Repairs, alterations, additions, and changes of use shall conform to the requirements of this article. Where compliance with the provisions of this code for new construction, required by this article, is impractical because of structural or construction difficulties or regulatory conflicts, compliance alternatives as described in Section 2206.0 may be accepted by the building official.

Note: Specialized codes, rules, regulations, and laws pertaining to repair, alteration, addition, or change of use of existing buildings promulgated by various authorized agencies may impact upon the provisions of this article. Specialized state codes, rules, regulations, and laws include, but are not limited to those listed in Appendix P.

2200.3 Applicability: The provisions of this article apply to repair, alteration and/or addition to existing buildings which qualify to use this article (see Section 2200.3.1), based on the proposed continuation of or change in use group, as follows:

1. Continuation of the same use group, or a change in use group to a use group of an equal or lesser hazard index number (as listed in Table 2204) shall comply with Section 2203.0.
2. Change in use group to a use group of one (1) or greater hazard index number (as listed in Table 2204) shall comply with Section 2204.0.
3. Change in use group to a use group of two (2) or greater hazard index numbers (as listed in Table 2204) shall comply with the requirements of Section 2205.0 and the code for new construction.
4. Part change in use: If a portion of the building is changed to a new use group, and that portion is separated from the remainder of the building with vertical and horizontal fire separation assemblies complying with the fire grading required in Table 902, or with approved compliance alternatives, then the portion changed shall be made to conform to the provisions of this article.

If a portion of the building is changed to a new use group, and that portion is not separated from the remainder of the building with vertical and horizontal fire separation assemblies complying with the fire grading required in Table 902, or with approved compliance alternatives, then the provisions of this article applying

to each use shall apply to the entire building. If there are conflicting provisions, then those requirements which secure the greater public safety shall apply.

5. Additions: Additions to existing buildings shall comply with all code requirements for new construction. The combined height and area of the existing building and new addition shall not exceed that allowed by Table 305 and Sections 305.0 and 306.0. Where a fire wall complying with Section 907.0 is provided, the addition may be considered as a separate building.

Exception: One story vertical additions to a dwelling unit shall be permitted providing that the floor area of the addition does not exceed that of the floor area immediately below. Such additions shall be of the same or better type of construction as the existing building.

No addition shall impose loads which would cause the existing building to be subject to stresses exceeding those permitted by the code for new construction.

6. Ordinary repairs: Ordinary repairs conforming to Section 102.0 may be performed without a building permit.
7. Institutional use groups: When there is no change in occupancy within the institutional use group (I), the provisions of Section 2203.0 shall apply.

Any change to an institutional use group (I) or any change in occupancy within an institutional use group shall comply with the requirements of the code for new construction.

8. Places of assembly: Nothing contained herein shall prohibit the alteration of a building heretofore occupied as a place of assembly for such continued use, provided that the seats, aisles, passageways, balconies, stages, appurtenant rooms, and all special permanent equipment comply with the provisions of Sections 417.0 and 418.0.

All buildings changed to an assembly use group (A) or changed within the assembly use groups shall comply with the requirements of Section 417.0 and 418.0 and the applicable provisions of this article.

9. Historic buildings: Buildings which qualify as historic under Section 436.0 need only meet the provisions set forth in that section. The provisions of this article shall apply to historic buildings only when specifically cited in Section 436.0.

2200.3.1 Buildings which qualify: The provisions of this article shall apply to existing buildings which have been legally occupied and/or used for a period of at least five (5) years. No building for which there exists an outstanding notice of violation or other order of the building official shall qualify to use this article unless such proposed work includes correction of all outstanding violations and compliance with all outstanding orders of the building official. Structures which fail to qualify for use of the provisions of this article shall comply fully with the code for new construction.

2200.4 Hazardous exitways: The following exitway conditions shall be deemed to be hazardous when so cited by the building official. The owner of any building where such conditions are cited shall be required to correct such condition immediately:

1. Less than two (2) acceptable exitways serving every story.

Exceptions: One- or two-family dwellings and buildings subject to Sections 417.0, 418.0, or 609.3.

2. Any required door, aisle, passageway, stairway, or other required means of egress which is not of sufficient width to comply with Section 608.0 or is not so arranged as to provide safe and adequate means of egress.

#### SECTION 2201.0 DEFINITIONS

2201.1 General: Definitions shall be construed as being the same as defined in Article 2, except as follows:

Building system: Any mechanical, structural, egress, electrical, plumbing, building enclosure and/or fire protection system, or fire resistive construction system, or portion thereof.

Existing building or structure: Any completed building or structure.

Hazard index: The rating of a use group for relative hazard as listed in Table 2204.

#### SECTION 2202.0 IMPLEMENTATION

2202.1 Investigation and evaluation: For any proposed work covered by this article, the building owner shall cause the existing building to be investigated and evaluated in accordance with the provisions of this Article (see Appendix T).

2202.2 Submittal: The results of the investigation and evaluation, along with any proposed compliance alternatives, shall be submitted to the building official.

2202.3 Determination of compliance: The building official shall determine whether the existing building, with the proposed work incorporated, complies with the provisions of this article.

2202.4 Permit application: In addition to the requirements specified in Article 1, the application for a building permit shall include items of non or partial compliance with the requirements of this article, and compliance alternatives, if any are proposed, for approval by the building official. The building official shall respond to the acceptability of any proposed compliance alternatives within thirty (30) days of the filing of the building permit application.

2202.5 Documentation of compliance alternatives: Whenever action is taken on any building permit application to repair, make alterations or additions or change the use or occupancy of an existing building, and when said application proposes the use of compliance alternatives, the building official shall ensure that one (1) copy of the proposed compliance alternatives, including applicable plans, test data, or other data for evaluation, be submitted to the Commission, along with a copy of the building permit application and the building official's decision regarding the proposed compliance alternatives.

SECTION 2203.0 REQUIREMENTS FOR CONTINUATION OF THE  
SAME USE GROUP OR CHANGE TO A USE GROUP  
OF EQUAL OR LESSER HAZARD INDEX

2203.1 General: The requirements of this section shall apply to all repairs and alterations to existing buildings having a continuation of the same use group or to existing buildings changed in use group to an equal or lesser hazard index number (Table 2204).

2203.2 Requirements exceeding those required for new construction: Existing buildings which, in part or as a whole, exceed the requirements of this code may, in the course of compliance with this article, reduce or remove, in part or completely, features not required by this code for new construction.

2203.3 New systems: Any new building system or portion thereof shall conform to this code for new construction to the fullest extent practical. However, individual components of an existing building system may be repaired or replaced without requiring that system to comply fully with the code for new construction.

2203.4 Alterations and repairs: Alterations or repairs to existing buildings which maintain or improve the performance of the building may be made with the same or like materials. Full compliance to the provisions of Section 2203.0 is not required unless there is a change in use.

2203.5 Floor loads: All floors shall be specifically investigated to determine the adequacy of the existing floor system to support the proposed specific floor loads, which shall not be less than those provided in Article 7 for the proposed use group. However, the loads specified in Article 7 may be reduced by a registered professional engineer based on the specific occupancy loads to be encountered, provided such reduction is approved by the building official.

2203.6 Structural loads: Any portion of the existing building which will not safely support the loads of the proposed use group as specified in Article 7 or Section 2203.5 shall be replaced or strengthened to provide such support.

2203.7 Number of exits: Any existing building shall provide at least two (2) means of egress serving every story which are acceptable to the building official.



Exception: One- and two-family dwellings and buildings as modified in Sections 417.0, 418.0 (places of assembly), or 609.3 (two-story business buildings).

2203.8 Capacity of exits: All required means of egress shall comply with Section 608.0. Existing means of egress may be used to contribute to the total egress capacity requirement based on the unit egress widths of Section 608.0.

2203.9 Exit signs and lights: Exit signs and lighting shall be provided in accordance with Section 623.0.

2203.10 Means of egress lighting: Means of egress lighting shall be provided in accordance with Section 624.0.

2203.11 Fire alarm systems: Fire alarm systems shall be provided in accordance with Sections 1216.0 and 1217.0.

2203.12 Enclosure of stairways: Open stairways are prohibited except in one- and two-family dwellings or unless otherwise permitted by Article 6. There shall be no minimum fire resistance rating required for an existing enclosure of a stairway. Partitions or other new construction which is added in order to fully and solidly enclose a stairway shall provide a minimum fire resistance rating of one (1) hour. All doors in the enclosure shall be self-closing and tight-fitting with approved hardware. All doors in those portions of the stairway which are fire resistance rated shall comply to the applicable portions of Article 9.

2203.13 Places of assembly: Nothing herein contained shall prohibit the alteration of a building heretofore occupied as a place of public assembly for such continued use provided the seats, aisles, passageways, balconies, stages, appurtenant rooms, and all special permanent equipment comply with the requirements of Sections 417.0 and 418.0.

All buildings changed to an assembly use group (A) or changed within the assembly use groups shall comply with the requirements of Sections 417.0 and 418.0 and the applicable provisions of this article.

2203.14 Fire hazard to adjacent buildings: Any proposed change to the occupancy of an existing building shall not increase the fire hazard to adjacent buildings. If the fire hazard to adjacent buildings is substantially increased, then the requirements of Table 214 for exterior walls shall apply.

2203.15 Increase in the number of dwelling units: In buildings classified in residential use groups (R), the number of dwelling units may be increased up to fifteen (15) per cent without full compliance to the provisions of Section 2203.9 through 2203.11 inclusive. If an increase of greater than fifteen (15) per cent in the number of dwelling units is involved, the building shall comply with the requirements of Section

2203.0. For the purposes of this section only, the base number of dwelling units, which shall be used to calculate percentages of all increases in numbers of dwelling units, shall be that number of dwelling units legally occupied on June 1, 1979.

Exception: Buildings classified in residential use groups (R) containing less than seven (7) dwelling units may be altered to add one (1) dwelling unit without requiring full compliance with the provisions of Section 2203.0.

2203.16 Institutional uses: When there is no change in use or occupancy within the institutional use group (I), the provisions of Section 2203.0 shall apply.

Any change to an institutional use group (I) or any change within an institutional use group shall comply with the requirements of the code for new construction.

SECTION 2204.0 REQUIREMENTS FOR CHANGE IN USE GROUP  
TO ONE HAZARD INDEX GREATER

2204.1 General: When the existing use group is changed to a new use group of one (1) hazard index higher (as provided in Table 2204), the existing building shall conform to the requirements of the code for new construction, except as further provided in this section.

2204.2 Mixed use: Compliance is required with Section 213.0 and Table 902 except that floors and walls providing horizontal and vertical separation in buildings of Types 3 and 4 construction shall have a fire-resistance rating of not less than one (1) hour and shall be equipped with a fire suppression system.

2204.3 Restrictions within fire limits: No further compliance is required with Section 302.0. However, if the fire hazard to adjacent buildings is substantially increased due to an increased fire loading, then the requirements of Section 302.0 shall apply.

2204.4 Area and height limitations: No further compliance is required with Sections 305.2 and 305.3 (e.g., a change in use is allowed in an existing building even if it exceeds the area and height limits of Table 305).

2004.5 Accessibility for physically handicapped: No further compliance is required with Section 315.1.

2204.6 Exitway stairs: Compliance is required with Section 616.0, except that existing exitway stairways may be used as part of the required egress for the new use, provided that the width is of sufficient capacity for the occupancy load, they are structurally sound, and that the enclosures in buildings of Types 3 and 4 construction shall have a fireresis-

tance rating of not less than one (1) hour. Stairway enclosures in buildings of Type 1 and 2 construction shall have a fire resistance rating of not less than two (2) hours. Where stair exitway doors are doors to an apartment or office they need not swing onto the landing. Such doors shall be self-closing and tight-fitting with approved hardware.

2204.7 Earthquake resistance and liquefaction: No further compliance to Sections 716.0 and 720.0 is required. Structural alterations may be made to existing buildings, but the resistance to lateral forces shall not be less than before such alterations were made, unless the building as altered meets the requirements of this code for earthquake loads.

2204.8 Mortar: No further compliance is required with Section 815.0.

2204.9 Fire and party walls: No further compliance is required with Section 907.0. The height above the roof of existing fire, party and exterior walls need not comply with this section.

Table 2204  
HAZARD INDEX

Scale: 1-8 (1 is lowest, 8 is highest hazard)

| Use Group* | Description   | Index No.** |
|------------|---|-------------|
| A-1-A      | Theatre with stage  | 6           |
| A-1-B      | Theatre without stage   | 5           |
| A-2        | Night club  | 7           |
| A-3        | Restaurant  | 5           |
|            | Lecture halls, recreation centers,<br>museums, libraries, similar as-<br>sembly buildings | 4           |
| A-4        | Churches and schools  | 4           |
| B          | Business  | 2           |
| F          | Factory and Industrial  | 3           |
| H          | High hazard   | 8           |
| I-1        | Institutional restrained  | 5           |
| I-2        | Institutional incapacitated   | 4           |
| M          | Mercantile  | 3           |
| R-1        | Hotels, motels  | 2           |
| R-2        | Multi-family  | 2           |
| R-3        | One and two family  | 2           |
| S-1        | Storage, moderate hazard  | 3           |
| S-2        | Storage, low hazard   | 1           |

Notes to Table 2204:

\*See Section 203.0 thru 212.0 and Appendix T.

\*\*Hazard Index Modifier for selected construction types.

When a building is classified in Construction Type 1A, 1B, 2A, or 2B, subtract one (1) from the Hazard Index number shown in Table 2204 for the applicable proposed new use group only.

When a building is classified in construction Type 3C or 4B, add one (1) to the Hazard Index number shown in Table 2204 for the applicable proposed new use group only.

SECTION 2205.0 REQUIREMENT FOR CHANGE IN USE GROUP  
TO TWO OR MORE HAZARD INDICES GREATER

2205.1 General: When the existing use group is changed to a new use group of two (2) or more hazard indices higher (as provided in Table 2204), the existing building shall conform to the requirements of the code for new construction.

SECTION 2206.0 COMPLIANCE ALTERNATIVES

2206.1 General: Where compliance with the provisions of the code for new construction, required by this article, is impractical because of structural or construction difficulties or regulatory conflicts, compliance alternatives may be accepted by the building official.

Some compliance alternatives which have been used are provided in Appendix T. The building official may accept these compliance alternatives or others proposed.

2206.2 Documentation: In accordance with Section 2202.5, the building official shall ensure that the Commission is provided with information regarding compliance alternatives accepted or rejected by him.

#### SECTION 2207.0 ENERGY PROVISIONS FOR EXISTING BUILDINGS

2207.1 General: This section establishes the energy provisions for existing buildings governed by Section 2203.0. Existing buildings governed by Sections 2204.0, 2205.0, or by the code for new construction shall comply with the requirements of Article 20 for new construction.

2207.2 Compliance alternatives: Alterations to any of the building elements of an existing building must comply with Table 2207 on either a component basis; or an equivalent energy usage analysis basis; or a system analysis basis.

2207.2.1 Component basis: Alterations to any of the building elements (walls, windows, doors, roofs or mechanical systems) shall comply with Table 2207 and the applicable subsections of Article 20 for the altered elements only.

2207.2.2 Equivalent energy usage analysis: Alterations to any of the building envelope elements (walls, windows, doors, or roof) may be adjusted so that the energy losses of any element may be increased or decreased as long as the total does not exceed that which would have been calculated for the individual components.

2207.2.3 Systems analysis: Refer to Section 2013.0 of this code for design criteria for systems analysis.

2207.3 Exempt buildings: Refer to Section 2001.4 for thermally exempt buildings and Section 2015.0 for lighting exemptions.

#### 2207.4 Compliance exceptions

2207.4.1 Fenestration: When alterations to a wall assembly include only altering the fenestration component, the areas of fenestration may be decreased or replaced with an opaque wall element made to comply with the thermal transmittance value of the existing wall.

2207.4.2 Ordinary repairs: Ordinary repairs need not comply with the energy provisions.

2207.4.3 Roofs: Compliance of the roof/ceiling assembly is not required unless the existing roofing material is stripped off the roof deck. However, if a structural analysis by a registered professional engineer shows that the roof will not support the additional live loads imposed by compliance of the roof/ceiling assembly, or, if such analysis shows that addition of the required amount of insulation will cause ponding of water, then compliance of the roof/ceiling assembly is not required.

TABLE 2207  
COMPONENT VALUES FOR ALTERED ELEMENTS

|   |  |                                  |        |
|---|--|----------------------------------|--------|
| Walls                                     | All wall construction containing heated or mechanically cooled space                       | 0.08                             | 6, 8   |
| Foundation Walls Including Band           | Containing heated or mechanically cooled space   | 0.08                             | 4      |
|   | Containing unheated space  | 0.17                             |        |
| Roof/Ceiling Assembly                     | Wood plank and beam construction containing heated or mechanically cooled space            | 0.08                             | 1      |
| Roof/Ceiling Assembly                     | Construction other than wood plank and beam containing heated or mechanically cooled space | 0.05                             |        |
| Doors, Skylights and Windows              | All construction enclosing heated or mechanically cooled space                             | 0.65                             | 2, 7   |
|   |  | 0.65                             | 5<br>6 |
| Floors                                    | Floor sections over areas exposed to outside air or unheated areas                         | 0.08                             | 3      |
|   | Unheated slab on grade   | 5.50 (R)                         |        |
|   | Heated slab on grade   | 7.75 (R)                         |        |
| Mechanical Equipment                      | Heating, cooling, sizing and efficiency  | Sect. 2010.1 thru 2010.7         | 9      |
| Equipment Controls                        | Humidstats, thermostats and zoning   | Sect. 2010.8                     | 9      |
| Duct and Pipe Insulation and Construction | Located in unconditioned areas   | Sect. 2010.9<br>2010.10, 2010.13 |        |

|                      |                  |                           |
|----------------------|------------------|---------------------------|
| Electrical Equipment | Various sections | Section 2011.0 and 2012.0 |
| Lighting             | Lighting         | Sectin 2012.0             |

NOTES TO TABLE 2207

Note 1. Wood plank and beam assemblies are constructions in which the finished interior surface is the underside of the roof deck.

Note 2. Double glazing or storm windows will satisfy the required U Value of 0.65.

Note 3. Insulation may be omitted from floors over unheated areas when foundation walls are provided with a U value of 0.17.

Note 4. The U value requirement of 0.17 for foundation walls may be omitted when floors over unheated spaces are provided with a U value of 0.08.

Note 5. Allowable air infiltration values for windows - .50 cfm/lin. ft. of operable sash crack; residential doors - (sliding) .50 cfm/sf., (entrance) 1.25 cfm/sf.; commercial doors 11 cfm/lin.ft.

Note 6. The first floor exterior envelope of business and mercantile use groups shall have an overall thermal transmittance value not greater than .65 in lieu of individual component values for walls and fenestration.

Note 7. When the glass area is increased, the glass and wall components which are altered shall comply with the component values in Table 2207. The extent of wall made to comply shall be equivalent to the decreased opaque wall area.

Note 8. When any alterations to the exterior wall component exposes the wall cavity or, when a finished system is added to a wall having no cavity, the wall must comply with the values in Table 2207.

Note 9. When mechanical system compliance is required on an existing system, only the portions of the system altered and any other portions which can reasonably be incorporated need comply.

SECTION 2208.0 OTHER CODE SECTIONS PERTAINING TO REPAIR, ALTERATION, OR CHANGE OF USE OF EXISTING BUILDINGS

2208.1 General: The following is a list of some additional code sections which may pertain to repair, alteration, or change of use of existing

## buildings:

- 101.0 Applicability
- 102.0 Ordinary Repairs
- 103.0 Installation of Service Equipment
- 104.0 Maintenance
- 105.0 Change in Existing Use
- 106.0 Alterations and Repairs
- 108.5.1 Duties and Powers of the Building Official and State Inspector
  - Inspection and Certification - Specified Use Groups
- 111.1 Preliminary Inspection
- 116.0 Demolition of Structures
- 117.0 Moved Structures
- 119.2 Certificate of Use and Occupancy - Buildings or Structures Hereafter Altered
- 120.0 Posting Structures
- 121.0 Violations
- 123.0 Unsafe Structures
- 124.0 Emergency Measures
- 302.0 Restrictions Within the Fire Limits
- 309.0 Street Encroachments
- 403.0 Fire Prevention Code
- 405.0 Existing Buildings
- 414.0 Public Garages
- 417.2.2 Places of Public Assembly - Superimposed Theatres
- 417.2.3 Places of Public Assembly - Frame Construction
- 418.0 Places of Public Assembly other than Theatres
- 424.0 Group Residence
- 429.0 Open Parking Structures
- 434.0 Day Care Centers
- 435.2 Summer Camps for Children - New and Existing Occupancies
- 436.0 Historic Buildings
- 439.0 Detoxification Facilities
- 505.0 Existing Buildings (Light, Ventilation and Sound Transmission Control)
- 600.1 Means of Egress - Scope
- 600.2 Modification of Exitway Requirements
- 605.0 Maintenance of Exitways
- 621.0 Fire Escapes
- 705.0 Structural and Foundation Loads and Stresses - Existing Buildings
- 716.6.7 Earthquake Loads - Minor Alterations
- 744.0 Design Requirements for Floodplains and Coastal High Hazard Areas
- 804.4 Heretofore Approved Materials
- 924.6 Exterior Trim Restrictions - Existing Combustible Construction
- 926.2 Roof Covering - Existing Roofs
- 1005.0 Chimneys, Flues, and Vent Pipes - Existing Buildings
- 1103.0 Mechanical Equipment and Systems - Existing Buildings
- 1200.3 Fire Protection Systems - Maintenance



- 1200.8 Fire Protection Systems - Periodic Inspections and Tests
- 1201.1 Fire Protection Systems - Plans and Specifications - Required
- 1201.2 Fire Protection Systems - Plans and Specifications - Approved  
by other Agencies
- 1212.7 Standpipes for Buildings Under Demolition
- Article 13 Precautions During Building Operations
- 1403.0 Unsafe and Unlawful Signs - Notices
- 1404.0 Existing Signs
- 1405.0 Signs - Maintenance and Inspection
- 2001.3 Energy Conservation - Existing Buildings
- 2001.4 Energy Conservation - Exempt Buildings
- 2100.2.4 Building Code Provisions for One- and Two-Family Dwellings  
- Alterations to Existing Buildings

## APPENDIX A

## REFERENCE STANDARDS AGENCIES

The following agencies promulgate standards referenced in this code and the following appendices. The abbreviations in front of the agency are used to identify the standards that the agency promulgates.

- |  |   |
|--|---|
| <p>AA<br/>Aluminum Association<br/>818 Connecticut Avenue, N.W.<br/>Washington, D.C. 20006</p>   | <p>AITC<br/>American Institute of Timber<br/>Construction<br/>333 W. Hampden Avenue<br/>Englewood, Colorado 80110</p>   |
| <p>AAMA<br/>Architectural Aluminum<br/>Manufacturers Association<br/>35 East Wacker Drive<br/>Room 3200<br/>Chicago, Illinois 60601</p>        | <p>AInsa<br/>American Insurance Association<br/>85 John Street<br/>New York, New York 10038</p>   |
| <p>ABPA<br/>American Board Products Association<br/>205 West Touhy Avenue<br/>Park Ridge, Illinois 60068</p>                                   | <p>ANSI<br/>American National Standards<br/>1430 Broadway<br/>New York, New York 10018</p>  |
| <p>ACI<br/>American Concrete Institute<br/>P.O. Box 19150<br/>Redford Station<br/>Detroit, Michigan 48219</p>                                  | <p>APA<br/>American Plywood Association<br/>1119 A Street<br/>Tacoma, Washington 98401</p>  |
| <p>AISC<br/>American Institute of Steel<br/>Construction, Inc.<br/>1212 Avenue of the Americas<br/>Suite 1580<br/>New York, New York 10020</p> | <p>ASHRAE<br/>American Society of Heating<br/>Refrigerating and Air-<br/>Conditioning Engineers<br/>United Engineering Center<br/>345 East 47th Street<br/>New York, New York 10017</p> |
| <p>AISI<br/>American Iron and Steel Institute<br/>1000 Sixteenth Street, N.W.<br/>Washington, D.C. 20036</p>                                   | <p>ASME<br/>American Society of Mechanic<br/>Engineers<br/>United Engineering Center<br/>345 East 47th Street<br/>New York, New York 10017</p>  |

STM

American Society for Testing and  
Materials  
1916 Race Street  
Philadelphia, Pennsylvania 19103

WS

American Welding Society  
2501 N.W. Seventh Street  
Miami, Florida 33125

WPA

American Wood Preservers'  
Association  
1625 Eye Street, N.W.  
Washington, D.C. 20006

WPB

American Wood Preservers Bureau  
P.O. Box 6085  
Arlington, Virginia 22206

WPI

American Wood Preservers Institute  
1651 Old Meadow Road  
McLean, Virginia 22101

IA

Brick Institute of America  
1750 Old Meadow Road  
McLean, Virginia 22101

OCA

Building Officials and Code  
Administrators International  
17926 South Halsted Street  
Homewood, Illinois 60430

PSC

Consumer Product Safety  
Commission  
Washington, D.C. 20207

SA

Canadian Standards Association  
178 Rexdale Boulevard  
Rexdale, Ontario MGW IR3  
Canada

DOC

United States Department of  
Commerce  
National Bureaus of Standards  
Washington, D.C. 20234

DOD-OCD

Department of Defense  
Office of Civil Defense  
Office of the Secretary of the Army  
Washington, D.C. 20390

FM

Factory Mutual Engineering  
Corporation  
Standards-Laboratories Department  
1151 Boston-Providence Turnpike  
Norwood, Massachusetts 02062

FS

Federal Specifications  
Superintendent of Documents  
Government Printing Office  
Washington, D.C. 20402

GA

Gypsum Association  
1603 Orrington Avenue  
Suite 1210  
Evanston, Illinois 60201

HPMA

Hardwood Plywood Manufacturers  
Association  
P.O. Box 6246  
Arlington, Virginia 22206

HUD

United States Department of  
Housing and Urban Development  
Division of Mobile Home Standards  
451 Seventh Street, S.W.  
Washington, D.C. 20410

IES

Illuminating Engineers Society  
345 East 47th Street  
New York, New York 10017

ICBO

International Conference of  
Building Officials  
5360 South Workman Mill Road  
Whittier, California 90601

MBMA

Metal Buildings Manufacturers  
Association  
2130 Keith Building  
Cleveland, Ohio 44115

MCMA

National Concrete Masonry  
Association  
6845 Elm Street  
McLean, Virginia 22101

NFIPA

National Fire Protection Association  
470 Atlantic Avenue  
Boston, Massachusetts 02210

NFoPA

National Forest Products Association  
1619 Massachusetts Avenue, N.W.  
Washington, D.C. 20036

RCSHSB

Red Cedar Shingle and Handsplit  
Shake Bureau  
5510 White Building  
Seattle, Washington 98101

SJI

Steel Joist Institute  
2001 Jefferson Davis Highway  
Arlington, Virginia 22202

SMACNA

Sheet Metal and Air-Conditioning  
Contractors National Association,  
Inc.  
8224 Old Courthouse Road  
Vienna, Virginia 22180

SPIB

Southern Pine Inspection Bureau  
P.O. Box 846  
Pensacola, Florida 32594

SSSI

Steel Scaffolding & Shoring Insti  
2130 Keith Building  
Cleveland, Ohio 41115

TCA

Tile Council of America  
4801 Montgomery Lane  
Washington, D.C. 20014

TPI

Truss Plate Institute, Inc.  
7411 Riggs Road  
Hyattsville, Maryland 20783

UL

Underwriters Laboratories, Inc.  
207 East Chicago Street  
Chicago, Illinois 60611

U.S. Army

Office of the Chief of Engineers  
U.S. Army  
Publications Depot  
890 Pickett Street  
Alexandria, Virginia 22304

## APPENDIX B

### ACCEPTED ENGINEERING PRACTICE STANDARDS

See also Appendices C, D, E, F and G for standards on specific materials for test of units or assemblies; some of which include engineering practice standards for specific applications.

#### Concrete

- Concrete Formwork-Recommended Practice for .....ACI 347-68
- Inspection and Testing Agencies for  
Concrete, Steel and Bituminous  
Materials as Used in Construction .....ASTM E329-72
- Manufacturing Reinforced Concrete Floor and Roof Units-  
Recommended Practice for .....ACI 512-67
- Reinforced Concrete-Building Code Requirements for .....ACI 318-77
- Reinforced Concrete Structures-Manual of Standard  
Practice for Detailing .....ACI 315-74
- Reinforced Steel Welding Code .....AWS D12.1-75

#### Electrical Illumination

- Daylighting-Recommended Practices of .....IES RP5-62
- Design Criteria for Lighting Interior Living Spaces .....IES RP11-69
- Electrical Code-National .....NFIPA 70-78
- IEEE Standard Dictionary of Electrical and  
Electronic terms .....ANSI C42.100-72
- Industrial Lighting .....ANSI A 11.1-73
- Lighting Handbook .....IES-72
- Massachusetts Electrical Code .....527-CMR-12.00
- Office Lighting-Recommended Practice .....IES RP1-73
- School Lighting-Recommended Practice .....IES RP3-70

#### Energy Conservation

- ASHRAE 1977 Handbook of Fundamentals .....ASHRAE-77
- ASHRAE 1976 Systems Volume .....ASHRAE-76
- Energy Conservation in New Building Design .....ASHRAE 90-75
- Rate of Air Leakage through Exterior Windows, Curtain  
Walls, and Doors-Standard Method of Test for .....ASTM E283-73  
ANSI A134.1. 134.2  
NWMA IS-2 & IS-3

Energy Conservation-continued

- Thermal Environmental Conditions for Human Occupancy .....ASHRAE Standard 55-74
- Sheet Metal and Air Conditioning Contractors National Association
  - Fibrous Glass Duct Construction Standards .....3rd ed., 1972  
SMACNA
  - High Velocity Duct Construction Standards .....2nd ed., 1969  
SMACNA
  - Low Velocity Duct Construction Standards .....4th ed., 1969  
SMACNA
  - American Refrigeration Institute Standard .....520-74
  - Gas Water Heaters Vol. III, Circulatory Tank .....ANSI Z21.10.3-74
  - Household Automatic Electric Storage Type Heaters .....ANSI C72.11-72
  - Evaluation of Various Heating A/C Equipment and Devices-Standards for .....ASHRAE 90-75

Equipment

- Conveyors, Elevators, Hoists and Lifts
  - Construction, Care and Use of Automotive Lifts
    - Safety Requirements for .....ANSI B153.1-77
  - Conveyors and Related Equipment-Safety Standards for ....ANSI B20.1-77
    - Safety Code for .....ANSI A17.1-77
    - 1972 Supplement .....ANSI A17.1a-77
    - 1973 Supplement .....ANSI A17.1b-77
    - 1974 Supplement .....ANSI A17.1c-77
    - 1975 Supplement .....ANSI A17.1d,e,f-77
  - Elevators, Escalators and Moving Walks-Practice for the Inspection of .....ANSI A17.2-77
  - Elevator and Escalator Regulations .....524 CMR 3.00-11.0
  - Elevator, Dumbwaiter, Escalator, and Moving Walk Regulations .....524 CMR-15.00-33.0
  - Manlifts-Safety Standard for .....ANSI A90.1-77
    - 1972 Supplement .....ANSI A90.1a-77
  - Massachusetts Electrical Code .....524 CMR 12.00-1.0
  - Material Hoists, Safety Requirements for .....ANSI A 10.5-77
  - Personnel Hoists, Safety Requirements for .....ANSI A 10.4-77
- Heating
  - Boiler Code and Unfired Pressure Vessel Code .....ASME-1969
  - Inspection of Boilers, Air Tanks, etc. ....MGL Chapter 149A:01
  - Massachusetts Fuel Gas Code .....248 CMR 3.00-8.0
- Mechanical Equipment and Piping
  - Basic Mechanical Code .....BOCA-1969
  - Massachusetts Plumbing Code .....248 CMR 2.00-1.0
  - Material Hoists, Safety Requirements for .....ANSI A 10.5-77
  - Personnel Hoists, Safety Requirements for .....ANSI A 10.4-77
- Heating
  - Boiler Code and Unfired Pressure Vessel Code .....ASME-1969

## ACCEPTED ENGINEERING PRACTICE STANDARDS

equipment-continued

## Mechanical Equipment and Piping

|                             |         |
|-----------------------------|---------|
| Basic Mechanical Code ..... | BOCA-78 |
| Basic Plumbing Code .....   | BOCA-78 |

## Fire and Sound Testing Assemblies

|   |            |
|---|------------|
| Approved Guide, Equipment, Materials        |            |
| Services for Conservation of Property ..... | FM-FMED-77 |
| Fire Resistance Design Manual .....         | GA-600-78  |
| Fire Resistance Directory .....             | UL-77      |
| Fire Resistance Ratings .....               | AInsA-64   |
| -1968 Supplement .....                      | AInsA-68   |
| -1970 Supplement .....                      | AInsA-70   |
| -1972 Supplement .....                      | AInsA-72   |

## Fire Protection and Safety Practices

|   |              |
|---|--------------|
| Life Safety Code .....  | NFiPA 101-76 |
| NOTE: NFiPA 101-1976 is acceptable for matters of design of exits not provided for by the BOCA Codes. Finish and construction requirements incorporated therein are not applicable. |              |
| Aircraft Hangars-Standard on .....  | NFiPA 409-75 |
| Basic Fire Prevention Code .....  | BOCA-78      |
| Cellulose Nitrate Motion Picture Film   |              |
| -Standard for the Storage and Handling of .....   | NFiPA 40-74  |
| Dry Cleaning Plants-Standard for .....  | NFiPA 32-74  |
| Dust Explosions and Ignition,   |              |
| Standard for the Prevention of  |              |
| -in Flour and Feed Mills and Allied   |              |
| Grain Storage Elevators .....   | NFiPA 61C-73 |
| -in Grain Elevators, Bulk Handling Facilities .....   | NFiPA 61B-73 |
| -in Industrial Plants-Fundamental Principles for .....  | NFiPA 63-75  |
| -in Starch Factories .....  | NFiPA 61A-73 |
| Factory Built Chimneys (Low Heat). .....  | UL 103-78    |
| Factory Built Fireplaces .....  | UL 127-72    |
| Fire Damper Guide for Air Handling Systems .....  | SMACNA-70    |
| Fire Tests for Flame Resistant  |              |
| Textiles and Films-Standard Methods of .....  | NFiPA 701-76 |
| Garages   |              |
| -Parking Structures-Standard for .....  | NFiPA 88A-73 |
| -Repair Garages-Standard for .....  | NFiPA 88B-73 |
| Gas Shielded Arch Welding-Recommended   |              |
| Safe Practice for .....   | AWS A6.1-66  |
| Household Fire Warning Equipment-Standard for .....   | NFiPA 74-75  |
| Incinerators and Rubbish Handling-Standard on .....   | NFiPA 82-72  |
| Insulated Roof Deck Construction-Fire Standard for .....  | UL 1256      |

Fire Protection and Safety Practices-continued

Liquefied Petroleum Gases-Standard for the Storage and Handling of .....NFIPA 58-76

Liquefied Petroleum Gases at Utility Gas Plants-Standard for the Storage and Handling of .....NFIPA 59-76

Liquids, Flammable and Combustible-Code for .....NFIPA 30-76

Massachusetts Board of Fire Prevention Regulations .....See Appendix P

Oxygen-Fuel Gas Systems for Welding and Cutting -Standard for the Installation and Operation of .....NFIPA 51-74

Piers and Wharves-Standard for the Construction and Protection of .....NFIPA 87-75

Potential Heat of Building Materials-Standard Test Method for .....NFIPA 259-76

Pulverized Fuel Systems-Standard for the Installation and Operation of .....NFIPA 60-73

Pyroxylin Plastics-Code for Storage of .....NFIPA 40E-75

Room Heaters, Solid Fuel Type .....UL 1482-79

Roof Deck Construction, Fire Performance of - Test Method for .....FM 445

Safe Practices for Welding and Cutting Containers That Have Held Combustibles .....AWS A6.0-65

Safety in Welding and Cutting .....ANSI Z49.1-73

Smoke and Heat Venting-Guide for .....NFIPA 204-68

Solid Fuel Type Room Heater-Standard for .....UL 1482

Solid and Solid-Liquid Fuel Burning Central Heating Boilers and Warm Air Furnaces .....CSA B366-M-79

Spray Finishing Using Flammable and Combustible Materials-Standard for .....NFIPA 33-73

Standard for Fireplace Stoves .....ANSI/UL 737-78

Tents, Grandstands and Air-Supported Structures Used for Places of Assembly-Standard for .....NFIPA 102-72

lass

Safety Glazing Material Used in Buildings-Performance Specifications and Methods of Test for .....ANSI Z97.1-72/75

Massachusetts General Laws .....Chapter 143

terior Finishes

Application and Finishing of Gypsum Board-Specifications for (See Appendix M) .....GA 216-75

Gypsum Base for Veneer Plasters-Standard Specification for .....ASTM C588-76

Gypsum Board Products, Gypsum Lath, Gypsum Partition Tile or Block, and Precast Reinforced Gypsum Slabs-Method of Physical Testing of .....ASTM C473-76

Gypsum Lath-Standard Specification for .....ASTM C37-76

Gypsum Plasters-Specification for .....ASTM C28-76

Gypsum Plasters and Gypsum Concrete-Standard Methods for Physical Testing of .....ASTM C472-73



ACCEPTED ENGINEERING PRACTICE STANDARDS

Interior Finishes-continued

- Gypsum Veneer Plaster-Specifications for .....ASTM C587-73
- Gypsum Veneer Plaster-Specifications for Application .....GA 150-70
- Gypsum Wallboard-Specification for .....ASTM C36-76
- Interior Lathing and Furring-Specifications for .....ANSI A42.4-67
- Interior Marble-Specifications for .....ANSI A94.1-61
- Metal Ceiling Suspension Systems for Acoustical Tile and Lay-in Panels  
 -Standard Recommended Practice for Installation of .....ASTM C636-76
- Metal Suspension Systems for Acoustical Tile and Lay-in Panel  
 Ceilings-Standard Specifications for .....ASTM C635-76
- Portland Cement and Portland Cement-Lime Plastering,  
 Exterior (Stucco) and Interior, Lathing and Furring-  
 Specifications for .....ANSI A42.3-71
- Portland Cement and Portland Cement-Lime Plastering,  
 Exterior (Stucco) and Interior-Specifications for .....ANSI A42.2-71
- Steel Framing Members to Receive Screw-Attached Gypsum  
 Wallboard Backing Board, or Water-Resistant  
 Backing Board-Specifications for .....ASTM C754-74
- Tile, Ceramic, Installed with  
 -Chemical Resistant, Water Cleanable Tile-Setting and  
 Grouting Epoxy .....ANSI A108.6-76
- Dry-Set Portland Cement Mortar .....ANSI A108.5-76
- Water-Resistant Organic Adhesives .....ANSI A108.4-76
- Tile, Electrically Conductive Ceramic,  
 Installed with Conductive Dry Set  
 Portland Cement Mortar .....ANSI A108.7-76
- Tile, Installation of Glazed Wall Tile, Ceramic Mosaic Tile,  
 Quarry and Paver Tile with Portland Cement Mortar ....ANSI A108.1-76

Masonry

- Cold Weather Masonry Construction .....BIA-68
- Design and Construction of Loadbearing  
 Concrete Masonry-Specifications for .....NCMA-70
- Engineered Brick Masonry-Requirements for .....BIA-69
- NOTE: This standard (BIA-69) is only applicable  
 to brick masonry of solid masonry units  
 made from clay or shale.
- Masonry-Building Code Requirements for .....ANSI A41.1-70
- Materials, Proportioning, and Application  
 of Shotcrete, Specification for .....ACI 506.2-77
- Reinforced Masonry-Building Code Requirements for .....ANSI A41.2-70
- Structural Plain Concrete-Building Code Requirements for .....ACI322-72

Metal

Aluminum

- Aluminum Construction Manual, Aluminum Formed  
 Sheet Building Sheathing Design Guide .....AA-ABS32-69

## Metal-continued

|   |             |
|---|-------------|
| Aluminum Construction Manual,<br>Specifications for Aluminum Structures .....             | AA-SAS30-76 |
| Aluminum Construction Manual, Aluminum Sheet<br>Metal Work in Building Construction ..... | AA-ASM35-71 |

## Steel

|   |  |
|---|--|
| Architecturally Exposed Structural Steel<br>-Specification for .....  | AISC-S307-60                                 |
| Design of Cold-Formed Steel Structural Members<br>-Specification for .....  | AISI-68                                      |
| Addendum No. 1 .....  | AISI-78                                      |
| Design, Fabrication and Erection of Structural Steel for<br>Buildings-Specification for .....   | AISC-S326-78                                 |
| Design of Cold-Formed Stainless Steel Structural Members<br>-Specification for .....  | AISI-74                                      |
| Gas Systems for Welding and Cutting .....   | (See Fire Protection<br>and Safety Practice) |
| Longspan Steel Joist LH series, and Deepspan<br>Steel Joists DLH series-Standard Specifications for .....   | SJI/AISC-78                                  |
| Metal Building Systems Manual .....   | MBMA-74                                      |
| Non-Load (Axial) Bearing Steel Studs, Runners (Track), and<br>Rigid Furring Channels for Screw Application of Gypsum<br>Board-Specification for ..... | ASTM C645-76                                 |
| Open Web Steel Joists, H Series<br>-Standard Specification for .....  | SJI/AISC-78                                  |
| Joist Girders-Specification for .....   | SJI-78                                       |
| Steel Drill Screw Application of Gypsum Sheet<br>Material to Light Gauge Steel Studs-Specification for ...  | ASTM C646-76a                                |
| Structural Applications of Steel Cables for<br>Buildings-Criteria for .....   | AISI-73                                      |
| Structural Joints Using ASTM A325 or A490 Bolts<br>-Specification for .....   | AISC-S314-78                                 |
| Welding Code, Structural .....  | AWS D1.1-79                                  |
| Welding Sheet Steel in Structures-Specification for .....   | AWS D1.3-78                                  |

## Wood and Wood Products

|  |              |
|--|--------------|
| Adhesives for Field Glueing Plywood to Wood Framing-<br>Performance Specifications for ..... | APA-AFG01-74 |
| All-Weather Wood Foundation System-<br>Basic Requirements .....                              | NFoPA-TR7-76 |
| -1977 Supplement .....   | NFoPA-TR7-77 |
| APA Glued Floor System .....   | APA-U405-70  |
| Code of Suggested Practices-Timber Construction<br>Standard .....                            | AITC 106-77  |
| Construction Details-Typical Timber Construction Standard ...                                | AITC 104-70  |
| Heavy Timber Construction-Standard for .....   | AITC 108-68  |

## ACCEPTED ENGINEERING PRACTICE STANDARDS

## Wood and Wood Products-continued

|   |                         |
|---|-------------------------|
| Joists and Rafters  |                         |
| Span Tables for .....   | NFoPA-77                |
| Design Values .....   | NFoPA-77                |
| National Design Specifications for Wood Construction .....  | NFoPA-77                |
| -1977 Supplement (Design Values) .....  | NFoPA-77                |
| Pile Foundations Know How .....   | AWPI-70                 |
| Pole Building Design .....  | AWPI-72                 |
| Plywood Commerical/Industrial Construction Guide .....  | APA-Y300-76             |
| Plywood Design Specifications .....   | APA-Y510-76             |
| Plywood-Lumber Components-Design Specifications for (includes<br>curved panels, beams, stressed-skin panels, sandwich panels,<br>diaphragm construction and folded plates ..... | APA-V825-77             |
| Plywood-Lumber Components-Fabrication Specifications (includes<br>curved panels, beams, stressed-skin panels, sandwich panels,<br>and folded plates .....                       | APA-V820-77             |
| Plywood Residential Construction Guide .....  | APA-Y405-76             |
| Protection of Structural, Glued Laminated Timber During Transit,<br>Storage and Erection-Recommended Practice for .....   | AITC 111-65             |
| Structural Design Data-Wood .....   | NFoPA-70                |
| Structural Design Guide for Hardwood Plywood .....  | HPMA-HP-SG-72           |
| Structural Glued Laminated Timber-<br>Inspection Manual for .....   | AITC 200-73             |
| Structural Timber Framing-Standard for the Design of .....  | AITC 102-76             |
| Timber Construction Manual .....  | AITC-74                 |
| Trusses-Design Specifications for Light Metal Plate<br>Connected Wood .....   | TPI-74                  |
| Wood Handbook .....   | USDA Handbook No. 72-74 |

## Unclassified Miscellaneous

|   |                   |
|---|-------------------|
| Automatic Locks; Common Doors of Certain<br>Apartment Houses to be Equipped with .....  | MGL C 143-3R      |
| Basic Property Maintenance Code .....   | BOCA-78           |
| Building Materials and Equipment-<br>Coordination of Dimensions of .....  | ANSI A62.1-57     |
| Construction and Maintenance of Buildings or<br>Other Structures Used as Garages, and the<br>Related Storage, Keeping and Use of Gasoline<br>-Rules and Regulations Governing ..... | 527 CMR 5.00      |
| Control and Restriction of Billboards, Signs<br>and Other Advertising Devices, October 1, 1973<br>-Rules and Regulations for .....  | 311 CMR 1.00-3.00 |
| Demolition-Safety Requirements for .....  | ANSI A10.6-69     |
| Fallout Shelters-Suggested Building<br>Code Provisions for .....  | DOD-OCD-TR-36-66  |
| Flood Proofing Regulations .....  | U.S. Army-72      |

Unclassified Miscellaneous-continued

- Floor and Wall Openings, Railings, and  
Toe Boards-Safety Requirements for .....ANSI A12.1-73
- Hospital and Medical Facilities-General Standards  
of Construction and Equipment for .....USHEW HRA-79-14500
- Installing Vitrified Clay Sewer Pipe-Recommended  
Practice for .....ASTM C12-74
- Keeping, Storage, Use, Manufacture, Sale,  
Handling, Transportation or other  
Disposition of Explosives .....527 CMR 13.00

Unclassified Miscellaneous, continued

- Loads, Minimum Design in Buildings and Other Structures-  
Building Code Requirements for .....ANSI A58.1-72
- Mobile Home Construction and Safety Standards .....HUD-75
- One- and Two-Family Dwelling Code .....BOCA, AInA, SSBC, ICBO-75  
1976 Supplement .....BOCA, AInA, SSBC, ICBO-76
- Prevention of Accidents in Construction  
Operations-Rules and Regulations for .....441 CMR 10.00
- Pevention of Accidents in Window Cleaning,  
(Industrial Bulletin No. 21), Department of  
Labor & Industries-Rules and Regulations for .....441 CMR 19.00
- Rules and Regulations for Manufactured Bldgs.,  
Bldg. Components and Mobile Homes .....SBCC
- Shoring Concrete Formwork-Recommended Safety  
Requirements for .....SSSI-73
- Signs and Outdoor Display Structures-  
Building Code Requirements for .....ANSI A60.1-49
- Waterproofing and Drainage of Floors-Manual on .....NFIPA 92M-72

## APPENDIX C

## MATERIAL STANDARDS

See also Appendix D for standards for tests of specific materials.

## Concrete

|  |                |
|--|----------------|
| Aggregates, Concrete-Specifications for .....  | ASTM C33-77    |
| Aggregates, Lightweight, for Structural<br>Concrete-Specifications for .....             | ASTM C330-77   |
| Aggregates, Lightweight, for Concrete Masonry Units.....                                 | (See Masonry)  |
| Aggregates, Lightweight, for Insulating Concrete-<br>Specifications for .....            | ASTM C332-77   |
| Forms for One-way Concrete Joist Construction-<br>Types and Sizes of .....               | DOC PS 16-69   |
| Gypsum Concrete-Specifications for .....   | ASTM C317-75   |
| Manufacturing Reinforced Concrete Floor and<br>Roof Units-Recommended Practice for ..... | ACI 512-67     |
| Masonry Units-Concrete .....   | (See Masonry)  |
| Natural Cement-Specifications for .....  | ASTM C10-76    |
| Portland Cement-Specifications for .....   | ASTM C150-77   |
| Ready Mix Concrete-Specifications for .....  | ASTM C94-74a   |
| Reinforcing .....  | (See Metals)   |
| Sheet Materials for Curing Concrete-<br>Specifications for .....                         | ASTM C171-75   |
| Vermiculite Concrete Roofs and Slabs on<br>Grade-Specifications for .....                | ANSI A122.1-65 |

## Interior Finishes

|   |                |
|---|----------------|
| Adhesives, Organic, for Installation of<br>Ceramic Tile Types I and II-<br>Standard for .....             | ANSI A136.1-72 |
| Aggregates, Inorganic for use in<br>Gypsum Plaster-Specifications for .....                               | ASTM C35-76    |
| Conductive Dry-Set Portland Cement Mortar, Standard<br>Specification-(for Ceramic Tile) .....             | ANSI A118.2-76 |
| Dry-Set Portland Cement Mortar-(for Ceramic Tile) .....   | ANSI A118.1-76 |
| Epoxy, Chemical Resistant, Water Cleanable Tile-Setting<br>and Grouting-Standard Specifications for ..... | ANSI A118.3-76 |
| Gypsum and Gypsum Products, Chemical Analysis of-<br>Standard Methods for .....                           | ASTM C471-75   |
| Gypsum Base for Veneer Plaster-Specifications for .....   | ASTM C588-76   |

## Interior Finishes-continued

|   |                |
|---|----------------|
| Gypsum Board Products, Gypsum Lath, Gypsum Partition Tile or Block, and Precast Reinforced Gypsum Slabs-Method of Physical Testing of ..... | ASTM C473-76   |
| Gypsum Lath-Specifications for .....  | ASTM C37-76    |
| Gypsum Plasters-Specifications for .....  | ASTM C28-76    |
| Gypsum Plasters and Gypsum Concrete, Physical Testing of-Standard Methods for .....   | ASTM C472-73   |
| Gypsum Veneer Plaster-Specifications for .....  | ASTM C587-73   |
| Gypsum Wallboard-Specifications for .....   | ASTM C36-76    |
| Latex-Portland Cement Mortar, Standard Specification for (for Ceramic Tile) .....   | ANSI A118.4-76 |
| Lime, Hydrated, Normal Finishing-Specifications for .....   | ASTM C6-74     |
| Lime, Hydrated, Special Finishing-Specifications for .....  | ASTM C206-76   |
| Quicklime and Hydrated Lime-Methods of Physical Testing of .....  | ASTM C110-76a  |
| Quicklime for Structural Purposes-Specifications for .....  | ASTM C5-74     |
| Tile, Ceramic-Standard Specifications for .....   | TCA 137.1-76   |

## Masonry

|  |                         |
|--|-------------------------|
| Aggregate, Fine-Effect of Organic Impurities in, on Strength of Mortar .....           | ASTM C87-75             |
| Aggregates, Lightweight, for Concrete Masonry Units-Specifications for .....           | ASTM C331-77            |
| Aggregate for Masonry Grout-Specifications for .....                                   | ASTM C404-76            |
| Aggregate for Masonry Mortar-Specifications for .....                                  | ASTM C144-76            |
| Brick, Building (Solid Masonry Units Made from Clay or Shale)-Specifications for ..... | ASTM C62-75a            |
| Brick, Concrete Building-Specifications for .....                                      | ASTM C55-75             |
| Brick, Face, Calcium Silicate (Sand Lime Brick)-Specification for .....                | ASTM C73-75             |
| Brick, Facing (Solid Masonry Units Made from Clay or Shale)-Specifications for .....   | ASTM C216-77            |
| Brick, Hollow (Hollow Masonry Units Made from Clay or Shale) .....                     | ASTM C652-77            |
| Cement, Masonry-Specifications for .....   | ASTM C91-77             |
| Ceramic Tile (Veneers) .....   | (See Interior Finishes) |
| Clay Facing Tile, Structural-Specification for .....                                   | ASTM C212-77            |
| Clay Load-Bearing Wall Tile, Structural-Specifications for .....                       | ASTM C34-77             |
| Clay Non-Load Bearing Screen Tile, Structural-Specifications for .....                 | ASTM C530-77            |
| Clay Non-Load Bearing Wall Tile, Structural-Specification for ..                       | ASTM C56-77             |
| Concrete Masonry Units, Hollow Load Bearing-Specifications for .....                   | ASTM C90-77             |
| Concrete Masonry Units, Hollow Non-Load Bearing-Specifications for .....               | ASTM C129-77            |
| Concrete Masonry Units, Solid Load Bearing-Specifications for .....                    | ASTM C145-77            |

## masonry-continued

## MATERIAL STANDARDS

|  |                         |
|--|-------------------------|
| Glazed Units: Ceramic Glazed Structural Clay Facing Tile, Facing Brick, and Solid Masonry Units-Specifications for ..... | ASTM C126-76            |
| Gypsum Partition Tile and Block-Specifications for .....   | ASTM C52-77             |
| Lime, Hydrated for Masonry Purposes-Specifications for .....   | ASTM C207-76            |
| Limes .....  | (See Interior Finishes) |
| Mortar and Grout for Reinforced Masonry-Specification for .....  | ASTM C476-76            |
| Mortar for Unit Masonry-Specification for .....  | ASTM C270-73            |
| Portland Cement-Lime Mortar for Brick Masonry-Standard Specification for .....   | BIA MI-72               |
| Portland Cement-Specifications for .....   | (See Concrete)          |
| Chemical-Resistant Masonry Units-Specification for .....   | ASTM C279-54            |
| Structural Clay Products-Standard Definition of Terms Relating to .....  | ASTM C43-70             |

## etal

|   |               |
|---|---------------|
| Alloy Steel Bolts, Quenched and Tempered, for Structural Steel Joints-Standard Specifications for ..... | ASTM A490-76a |
| Alloy Steel Sheets and Strip, Regular Quality Hot-Rolled and Cold-Rolled-Specification for .....        | ASTM A506-73  |
| Aluminum-Alloy Bars, Rods and Wire-Standard Specifications for .....                                    | ASTM B211-75  |
| Aluminum-Alloy Extruded Bars, Rods, Shapes and Tubes-Standard Specifications for .....                  | ASTM B221-76a |
| Aluminum-Alloy Die and Hand Forgings-Standard Specifications for .....                                  | ASTM B247-76  |
| Aluminum Alloy Seamless Pipe and Seamless Extruded Tubing-Standard Specifications for .....             | ASTM B241-76  |
| Aluminum Alloy Sheet and Plate-Standard Specifications for .....  | ASTM B209-77  |
| Aluminum-Alloy Standard Structural Shapes, Rolled or Extruded-Standard Specifications for .....         | ASTM B308-73  |
| Aluminum-Alloy Drawn Seamless Tubes-Standard Specifications for .....                                   | ASTM B210-76  |
| Aluminum Alloy Extruded Structural Pipe and Tube-Standard Specifications for .....                      | ASTM B249-75  |
| Aluminum-Alloy Round Welded Tubes-Standard Specifications for .....                                     | ASTM B313-73  |
| Aluminum-Alloy Rivet and Cold Heading Wire and Rods-Standard Specifications for .....                   | ASTM B316-75  |
| Aluminum Alloy Dye Castings-Standard Specifications for .....   | ASTM B85-76   |
| Aluminum Alloy Permanent Mold Castings-Standard Specification for .....                                 | ASTM B108-76  |

tal-continued

|   |               |
|---|---------------|
| Aluminum Alloy Sand Castings-Standard Specifications for .....  | ASTM B26-76a  |
| Aluminum Sliding Glass Doors-Specifications for .....   | AAMA 402.9-77 |
| Aluminum Windows-Specifications for .....   | AAMA 302.9-77 |
| Bare Mild Steel Electrodes and Fluxes for Submerged Arc Welding-Specifications for .....                                      | AWS A5.17-76  |
| Bolts, High Strength, for Structured Steel Joints Including Suitable Nuts and Plain Hardened Washers-Specifications for ..... | ASTM A325-76c |
| Bolts and Studs, Quenched and Tempered Steel-Specifications for .....   | ASTM A449-76c |
| Carbon and Alloy Steel Nuts for Bolts for High-Pressure and High Temperature Service-Specifications for .....                 | ASTM A194-77  |
| Carbon-Steel Castings Suitable for Fusion Welding for High Temperature Service-Specifications for .....                       | ASTM A216-75  |
| Carbon Steel Nuts-Specifications for .....  | ASTM A563-76a |
| Carbon Steel Plates of Structural Quality, Low and Intermediate Tensile Strength-Specifications for .....                     | ASTM A283-75  |
| Carbon Steel Strip, Cold-Rolled-Specifications for .....  | ASTM A109-72  |
| Castings, Mild-to-Medium Strength Carbon Steel for General Application-Specifications for .....                               | ASTM A27-77   |
| Castings, Gray Iron-Specifications for .....  | ASTM A48-76   |
| Cold-Formed Welded and Seamless Carbon Steel Structural Tubing in Rounds and Squares-Specifications for .....                 | ASTM A500-77  |
| Steel Castings for Structural Purposes, High Strength-Specifications for .....  | ASTM A148-73  |
| Electrodes, Low Alloy Steel Covered Arc Welding-Specifications for .....  | AWS A5.5-69   |
| Electrodes, Mild Steel Arc Welding-Specifications for .....   | AWS A5.1-69   |
| High Strength, Low Alloy Structural Steel with 50,000 psi Minimum Yield Point to 4 inches Thick-Specifications for .....      | ASTM A588-77  |
| Hot-Formed Welded and Seamless Carbon Steel Structural Tubing-Specifications for .....  | ASTM A501-76  |
| Hot-Formed Welded and Seamless High-Strength Low-Allow Structural Tubing-Specifications for .....                             | ASTM A618-74  |
| Hot Rolled Carbon Steel Sheets and Strip, Structural Quality-Specifications for .....   | ASTM A570-75  |
| Steel Sheet, Zinc Coated (Galvanized) by the Hot-Dip Process for Roofing-Specifications for .....                             | ASTM A361-76  |
| Steel, Sheet, Cold-Rolled, Long-Terne Coated-Specification for .....  | ASTM A308-76  |
| Low Carbon Steel, External and Internal Threaded, Standard Fasteners-Specifications for .....                                 | ASTM A307-76b |



## Metal-continued

## MATERIAL STANDARDS

|   |                              |
|---|------------------------------|
| Mild Steel Electrodes for Flux-Cored Arc<br>Welding-Specifications for .....  | AWS A5.20-69                 |
| Mild Steel Electrodes for Gas Metal-Arc<br>Welding-Specifications for .....   | AWS A5.18-69                 |
| Piles, Welded and Seamless Steel Pipe-<br>Specifications for .....  | ASTM A252-77                 |
| Pipe, Metal .....   | (See Plumbing and<br>Piping) |
| Reinforcement, Axle-Steel Deformed and Plain Bars for<br>Concrete-Specifications for .....  | ASTM A617-76                 |
| Reinforcement, Deformed and Plain Billet-Steel Bars for<br>Concrete-Specifications for .....  | ASTM A615-76a                |
| Reinforcement, Deformed Steel Wire for<br>Concrete-Specifications for .....   | ASTM A496-72                 |
| Reinforcement, Rail-Steel Deformed and Plain Bars for<br>Concrete-Specifications for .....  | ASTM A616-76                 |
| Reinforcement, Steel Wire, Cold-Drawn, for<br>Concrete-Specifications for .....   | ASTM A82-76                  |
| Reinforcement, Steel Wire, Welded Fabric for<br>Concrete-Specifications for .....   | ASTM A185-73                 |
| Reinforcement, Welded Deformed Steel Wire<br>Fabric for Concrete-Specifications for .....   | ASTM A497-72                 |
| Seven-Wire Stress-Relieved Strand, Uncoated,<br>for Prestressed Concrete-Specifications for .....   | ASTM A416-74                 |
| Steel Drill Screw Application of Gypsum<br>Sheet Material to Light Gauge Steel Stud .....   | ASTM C646-76a                |
| Sheet Piling Steel-Specifications for .....   | ASTM A328-75a                |
| Steel, Carbon and High-Strength, Low-Alloy Hot-Rolled<br>Sheet, Hot-Rolled Strip and Cold-Rolled Sheet,<br>General Requirements-Standards for .....   | ASTM A568-74                 |
| Steel, Cold-Rolled Sheet, Carbon Structural-<br>Specifications for .....  | ASTM A611-72                 |
| Steel Forgings, Carbon and Alloy for General Industrial<br>Use-Specifications for .....   | ASTM A668-77                 |
| Steel, Hot-Rolled and Cold-Rolled Sheet and<br>Strip, High-Strength, Low-Alloy Columbium<br>and/or Vanadium-Specifications for .....                  | ASTM A607-75                 |
| Steel, Hot-Rolled and Cold-Rolled Sheet and Strip,<br>High-Strength, Low Alloy with Improved Corrosion<br>Resistance-Specifications for .....         | ASTM A606-75                 |
| Steel Sheet, Zinc-Coated (Galvanized) by the Hot Dip<br>Process, General Requirements-Specifications for .....  | ASTM A525-73                 |
| Stainless and Heat-Resisting Chromium Steel Plate,<br>Sheet and Strip-Standard for .....  | ASTM A176-77                 |
| Stainless and Heat-Resisting Chromium-Nickel Steel<br>Plate, Sheet, and Strip-Standard for .....  | ASTM A167-77                 |
| Steel Structural Rivets-Specifications for .....  | ASTM A502-76                 |
| Non-Load (Axial) Bearing Steel Studs, Runners (Track),<br>and Rigid Furring Channels for Screw Application of<br>Gypsum Board-Specification for ..... | ASTM C645-77                 |

## Metal-continued

|   |              |
|---|--------------|
| Structural Steel-Specifications for .....   | ASTM A36-75  |
| Structural Steel, High-Strength-Specifications for .....  | ASTM A440-75 |
| Structural Steel, High-Strength Low-Alloy-Specifications for .....  | ASTM A242-75 |
| Structural Steel, High-Strength Low-Alloy Columbium Vanadium-Specifications for .....   | ASTM A572-77 |
| Structural Steel, High Strength Low-Alloy Manganese Vanadium-Specifications for .....   | ASTM A441-75 |
| Structural Steel, High-Yield Strength, Quenched and Tempered Alloy Steel Plate, Suitable for Welding-Specifications for ..... | ASTM A514-77 |
| Structural Steel with 42,000 psi Minimum Yield Point (½ in. Maximum Thickness)-Specification for .....                        | ASTM A529-75 |
| Uncoated Stress-Relieved Wire for Prestressed Concrete-Specifications for .....   | ASTM A421-76 |

## Plastics

|   |               |
|---|---------------|
| Definitions of Terms Relating to .....                                  | ASTM D883-76  |
| Deformation of, Under Load-Method of Test for .....                     | ASTM D621-76  |
| Density of Smoke from Burning or Decomposition-Method of Test for ..... | ASTM D2843-77 |
| Flammability of Flexible Plastic-Method of Test for .....               | ASTM D568-77  |
| Flammability of Self-Supporting Plastics-Methods of Test for .....      | ASTM D635-77  |
| Ignition Properties of-Method of Test for .....                         | ASTM D1929-77 |

## Plumbing and Piping

|   |              |
|---|--------------|
| Asbestos-Cement Non-Pressure Sewer Pipe-Specifications for .....                                  | ASTM C428-77 |
| Asbestos-Cement Pressure Pipe-Specifications for .....  | ASTM C296-76 |
| Brass Pipe, Seamless Red Brass-Specification for .....  | ASTM B43-76  |
| Cast Iron and Ductile Iron Pressure Pipe-Specifications for .....                                 | ASTM A377-77 |
| Cast Iron Soil Pipe and Fittings-Specifications for .....   | ASTM A74-75  |
| Clay Pipe   |              |
| -Compression Joints for Vitrified Pipe  |              |
| Bell and Spigot Pipe .....  | ASTM C425-75 |
| -Drain Tile-Specifications for .....  | ASTM C4-75   |
| -Extra Strength and Standard Strength Clay Pipe and Perforated Clay Pipe-Specifications for ..... | ASTM C700-75 |

## Plumbing and Piping-continued

## MATERIAL STANDARDS

## Concrete Pipe

- Culvert Storm Drain and Sewer, Reinforced
- Specifications for .....ASTM C76-76
- Sewer-Specifications for .....ASTM C14-75
- Copper Drainage Tube (DWV)-Specification for .....ASTM B306-76
- Copper Pipe, Seamless, Standard Sizes-
- Specifications for .....ASTM B42-76

## Steel Pipe

- Black and Hot Dipped Zinc Coated (Galvanized)
- Welded and Seamless, for Ordinary Uses-
- Specifications for .....ASTM A120-77
- Steel or Iron, Spiral-Welded-
- Specifications for .....ASTM A211-75
- Welded and Seamless-Specifications for .....ASTM A53-77

Tile, Clay Drain .....(See Clay Pipe)

## Tube and Tubing

- Brass, Seamless-Specifications for .....ASTM B135-74
- Copper, Seamless-Specifications for .....ASTM B75-77
- Copper, Seamless, Water-Specifications for .....ASTM B88-76
- Copper Brazed Steel Tubing-
- Specifications for .....ASTM A254-76
- Welded and Seamless Wrought Steel Pipe .....ANSI B36.10-75
- Valves, Flanges and Pipe Fittings, Gray
- Iron Castings-Specifications for .....ASTM A126-73

## Roofing and Siding

- Asphalt for Dampproofing and Waterproofing-
- Specifications for .....ASTM D449-73
- Asphalt for Use in Constructing Build-Up
- Roof Coverings-Specifications for .....ASTM D312-77
- Asphalt Roll Roofing Surfaced with
- Mineral Granules-Specifications for .....ASTM D249-73
- Asphalt Roll Roofing Surfaced with Powdered
- Talc or Mica-Specifications for .....ASTM D224-75
- Asphalt Shingles Surfaced with Mineral
- Granules-Specifications for .....ASTM D225-70
- Asphalt Siding Surfaced with Mineral
- Granules-Specifications for .....ASTM D699-70
- Fiberboard Nail-Base Sheathing-
- Standard Specification for .....ASTM D2277-75
- Fiber Insulation Board, Structural and Decorative
- Recommended Product and Application Specification
- ½-inch Fiberboard Nail-Base Sheathing .....ABPA-IB Spec. No. 2-75
- Recommended Product and Application Specification
- Structural Insulating Roof Deck .....APBPA-IB Spec. No. 1-75
- Method of Testing (Made from Cellulosic fiber) .....ASTM C209-72
- Specifications for (Made from Cellulosic fiber) .....ASTM C208-72
- Formboard, Structural Insulating (Made from
- Cellulosic Fibers)-Specifications for .....ASTM C532-74

## Roofing and Siding-continued

Grading Rules for CertiGrade Red Cedar Shingles .....RCSHSB-75  
 Gypsum Sheathing Board-Specifications for .....ASTM C79-76

## Wood and Wood Products

American Softwood Lumber Standard .....DOC PS20-70  
 Fire Retardant Pressure Treatment, Plywood.....AWPA C27-74  
 Fire Retardant Pressure Treatment,  
 Structural Lumber .....AWPA C20-74  
 Glued Laminated Structural Lumber Standards

-Appearance Grades .....AITC 110-76

-Dimensions of .....AITC 113-75

-"E" Rated and Visually Graded Lumber of Douglas

Fir, Southern Pine, Hem-Fir, Lodgepole pine .....AITC 120-74

-Electric Utility Framing and Crossarms .....AITC 114-74

-Structural Glued Laminated Members and  
 Laminations Before Gluing of Southern Pine,  
 Pacific Coast Douglas Fir and Western

Hemlock by Pressure Process .....AWPA C28-76

-Structural Glued Laminated Southern Pine .....SPIB-74

-Structural Glued Laminated Timber .....DOC PS 56-73

-Structural Glued Laminated Timber of  
 Douglas Fir, Western Larch, Southern Pine  
 and California Redwood .....AITC 117-76

-Supplement No. 2-Hem Fir .....AITC-73

-Supplement No. 3-Douglas Fir and Western Larch  
 Outer Laminations and Western Woods Core

Laminations .....AITC-74

-Supplement No. 5-Douglas Fir, Western Larch,  
 and Western Woods, for Small Beams of 20 Inches  
 Depth or Less .....AITC-76

Hardboard-Commercial Standard for .....DOC PS 58-73

Hardboard Siding, Voluntary Product Standard for .....DOC PS 60-73

Hardwood Glued Laminated Timber-Standard

Specifications for .....AITC 119-76

Laminated Hardwood Block Flooring-Standard for .....ANSI O10.2-75

Methods for Establishing Structural Grades and

Related Allowable Properties for Visually  
 Graded Lumber .....ASTM D245-74

Methods of Test for Durability of

Fire Retardant Treatment of Wood .....ASTM D2898-77

Particleboard-Commercial

Standard for .....DOC CS 236-66

Piles, Round Timber-

Establishing Design Stresses for .....ASTM D2899-74

Piles, Timber, Round-

Specifications for .....ASTM D25-73

Plywood

-Construction and Industrial-

Product Standard for .....DOC PS I-74

## Wood and Wood Products-continued

## MATERIAL STANDARDS

|   |                             |
|---|-----------------------------|
| -Hardwood and Decorative-<br>Product Standard for .....                               | DOC PS51-71                 |
| -Preservative Treatment for<br>Pressure Process .....                                 | AWPA C9-76                  |
| Preservative Treatment  |                             |
| -of Lumber, Timber, Bridge Ties, and<br>Mine Ties (All Species)-Standards for .....   | AWPA C2-76                  |
| -of Piles by Pressure Process-Standards for .....                                     | AWPA C3-76                  |
| -of Poles by Pressure Process-Standards for .....                                     | AWPA C4-75                  |
| -by Pressure Process-All Timber Products-<br>Standards for .....                      | AWPA C1-76                  |
| Preservatives for Wood  |                             |
| -Creosote-Standards for .....   | AWPA P 1-65                 |
| -Creosote and Creosote Solutions .....  | AWPA P 2-76                 |
| -Oil-Borne Preservatives-Standards for .....  | AWPA P 8-74                 |
| -Oil-Borne Solvents-Standards for .....   | AWPA P 9-76                 |
| -Water-Borne Preservatives-Standards for .....  | AWPA P 5-76                 |
| Quality Control Standards for Pressure-<br>Treated Lumber and Plywood                 |                             |
| -With Creosote or Creosote Coal Tar<br>Solution (For Above Ground Use) .....          | AWPB-LP-5-75                |
| -With Creosote or Creosote Coal Tar<br>Solution (For Ground Use) .....                | AWPB-LP-55-75               |
| -With Heavy Petroleum Solvent-Penta Solution<br>(For Above Ground Contact) .....      | AWPB-LP-7-75                |
| -With Heavy Petroleum Solvent-Penta Solution<br>(For Ground Contact) .....            | AWPB-LP-77-76               |
| -With Light Petroleum Solvent-Penta Solution<br>(For Above Ground Use) .....          | AWPB-LP-3-75                |
| -With Light Petroleum Solvent-Penta Solution<br>(For Ground Contact) .....            | AWPB-LP-33-75               |
| -With Volatile Petroleum Solvent (LPG)-Penta<br>Solution (For Above Ground Use) ..... | AWPB-LP-4-75                |
| -With Volatile Petroleum Solvent (LPG)-Penta<br>Solution (For Ground Contact) .....   | AWPB-LP-44-75               |
| -With Water-Borne Preservatives (For Above<br>Ground Use) .....                       | AWPB-LP-2-75                |
| -With Water-Borne Preservatives (For Ground<br>Contact) .....                         | AWPB-LP-22-75               |
| Shingles .....  | (See Roofing and<br>Siding) |
| Structural Timber Framing-Treating Standard for .....                                 | AITC 109-77                 |
| Tongue-and-Groove Heavy Timber Roof Decking-<br>Standard for .....                    | AITC 112-74                 |

## Unclassified Miscellaneous

|  |                 |
|--|-----------------|
| Felt-Methods of Testing .....              | ASTM D461-72    |
| Formboard, Gypsum-Specifications for ..... | ASTM C318-73    |
| Insulated Metal Roof Deck Standard .....   | FM-FMRC 4450-71 |

## Unclassified Miscellaneous-continued

|  |                |
|--|----------------|
| Laboratory Measurement of Airborne Sound<br>Transmission Loss of Building Partitions-<br>Standard Recommendation Practice for .....            | ASTM E90-75    |
| Laboratory Measurement of Impact Sound Transmission<br>Through Floor-Ceiling Assemblies Using the Tapping<br>Machine-Tentative Method of ..... | ASTM E492-73T  |
| Moisture-Density Relations of Soils Using<br>10-lb. Rammer and 18-in. Drop Standard<br>Test-Methods for .....                                  | ASTM D1557-70  |
| Nails, Brads, Staples and Spikes:<br>Wire, Cut and Wrought-Federal Specifications<br>for, with Amendment 3-1974 .....                          | FSFF-N-105B-71 |
| Nails for the Application of<br>Gypsum Wallboard-Standard .....  | ASTM C514-72   |
| Perlite Loose Fill Insulation-<br>Standard Specifications for .....  | ASTM C549-73   |
| Thickness of Solid Electrical Insulation-<br>Methods of Test for .....   | ASTM D374-74   |
| Vermiculite Loose Fill, Insulation-<br>Standard Specifications for .....   | ASTM C516-75   |

## APPENDIX D

## STRUCTURAL UNIT TEST STANDARDS

See also Appendices B and C for engineering practice standards and material standards which contain unit test methods.

## Concrete

|  |              |
|--|--------------|
| Coarse Aggregates, Resistance to Abrasion of Small Size, by use of the Los Angeles Abrasion Machine-Test for ..... | ASTM C131-76 |
| Fine and Coarse Aggregates, Sieve or Screen Analysis of-Test for .....   | ASTM C136-76 |
| Concrete, Obtaining and Testing Drilled Cores and Sawed Beams of .....   | ASTM C42-74  |
| Concrete Test Specimens in the Laboratory-Making and Curing .....  | ASTM C192-76 |
| Concrete, Molding Cylinders-Test for Compressive Strength of .....   | ASTM C39-72  |
| Lightweight Insulating Concrete, Compressive Strength-Test for .....   | ASTM C495-77 |
| Concrete Masonry Units-Sampling and Testing .....  | ASTM C140-75 |
| Concrete Masonry Units, Hollow Load Bearing-Specifications for .....   | ASTM C90-75  |
| Concrete Masonry Units, Solid Load Bearing-Specifications for .....  | ASTM C145-75 |
| Concrete, Hardened Portland Cement-Test for Cement Content of .....  | ASTM C85-73  |
| Concrete, Ready Mixed-Specifications for .....   | ASTM C94-74a |
| Sands for Concrete-Test for Organic Impurities in .....  | ASTM C40-75  |

## Interior Finishes

|   |               |
|---|---------------|
| Gypsum and Gypsum Products, Chemical Analysis of-Standard Methods for .....   | ASTM C471-75  |
| Gypsum Board Products, Gypsum Lath, Gypsum Partition Tile or Block, and Precast Reinforced Gypsum Slabs-Method of Physical Testing of ..... | ASTM C473-76  |
| Gypsum Concrete-Specifications for .....  | ASTM C317-75  |
| Gypsum Formboard-Specifications for .....   | ASTM C318-73  |
| Gypsum Lath-Specifications for .....  | ASTM C37-76   |
| Gypsum Plasters-Specifications for .....  | ASTM C28-76   |
| Gypsum Plasters and Gypsum Concrete, Physical Testing of-Standard Methods for .....   | ASTM C472-73  |
| Gypsum Sheathing Board-Specifications for .....   | ASTM C79-76   |
| Gypsum Wallboard-Specifications for .....   | ASTM C36-76   |
| Insulating Board (Made from Cellulosic Fiber), Structural and Decorative  |               |
| -Methods of Testing .....   | ASTM C209-72  |
| -Specifications for .....   | ASTM C208-72  |
| Lime .....  | (See Masonry) |

## Masonry

|   |                         |
|---|-------------------------|
| Aggregate for Masonry Mortar-Specifications for .....   | ASTM C144-76            |
| Bond Strength of Mortar to Masonry Units, Method<br>of Test for .....   | ASTM E148-76            |
| Brick, Concrete Building-Specifications for .....   | ASTM C55-76             |
| Brick and Structural Clay Tile-Sampling and Testing .....   | ASTM C67-73             |
| Cement, Masonry-Specifications for .....  | ASTM C91-73             |
| Ceramic Tile (Veneers) .....  | (See Interior Finishes) |
| Chemical Analysis of Limestone, Quicklime and<br>Hydrated Lime .....  | ASTM C25-72             |
| Concrete Masonry Units .....  | (See Concrete)          |
| Diagonal Tension (Shear) in Masonry Assemblages<br>-Method of Test for .....  | ASTM E519-74            |
| Flexural Bond Strength of Masonry<br>-Methods of Test for .....   | ASTM E518-76            |
| Glazed Units-Ceramic Glazed Structural Clay Facing Tile,<br>Facing Bricks, and Solid Masonry Units<br>-Specifications for ..... | ASTM C126-76            |
| Lime and Limestone Products-Methods of Sampling,<br>Inspection, Packing and Marking of .....                                    | ASTM C50-74             |
| Lime, Hydrated and Quick-Methods of Physical<br>Testing of .....  | ASTM C110-76a           |
| Lime, Hydraulic Hydrated for Structural Purposes-<br>Specifications for .....   | ASTM C141-72            |
| Mortars, Hydraulic Cement-Method of Test for<br>Compressive Strength of (Using 2-in. Cube<br>Specimens) .....                   | ASTM C109-77            |
| Mortars, Hydraulic Cement-Method of Test for<br>Tensile Strength of .....   | ASTM C190-77            |
| Stone, Natural Building-Methods of Test for<br>Absorption and Bulk Specific Gravity of .....                                    | ASTM C97-77             |
| Stone, Natural Building-Methods of Test for<br>Compressive Strength of .....  | ASTM C170-76            |
| Stone, Natural Building-Methods of Test for<br>Modulus of Ruptures of .....   | ASTM C99-76             |
| Water Permeance of Masonry<br>-Method of Test for .....   | ASTM E514-74            |
| Compressive Strength of Masonry Prisms-<br>Method of Test for .....   | ASTM E447-74            |
| Strength Tests of Panels for Building Construction-<br>Methods of Conducting .....  | ASTM E72-77             |
| Preconstruction and Construction Evaluation of Mortars<br>for Plain and Reinforced Unit Masonry .....                           | ASTM C780-74            |

## Metals

|  |              |
|--|--------------|
| Cast Iron-Method of Testing Compression of .....       | ASTM A256-76 |
| Metallic Materials-Methods of Tension Testing of ..... | ASTM E8-77a  |



STRUCTURAL UNIT TEST STANDARDS

Wood and Wood Products

- Evaluating the Properties of Wood-Base Fiber  
and Particle Panel Materials .....ASTM D1037-72a
- Timber, Small Clear Specimens-Method of Testing .....ASTM D143-72
- Timbers in Structural Sizes-Methods of Static Tests of ...ASTM D198-76
- Veneer, Plywood and Other Glued Veneer Construction-  
Methods of Testing .....ASTM D805-72

Unclassified Miscellaneous

- Cement, Hydraulic-Methods of Sampling .....ASTM C183-76
- Cement, Natural-Specifications for .....ASTM C10-76
- Cement, Portland-Specifications for .....ASTM C150-77
- Clay Pipe, Testing .....ASTM C301-76
- Plastics Under Load-Method of Test for Deformation of ..ASTM D621-75
- Tile, Clay Drain-Specification for .....ASTM C4-75

APPENDIX E

STRUCTURAL ASSEMBLY TEST STANDARDS

See also Appendix D for standards for tests of unit materials.

|  |               |
|--|---------------|
| Mechanical Fasteners in Wood, Testing of.....  | ASTM D1761-77 |
| Heavy Truss Asemblies, Testing .....   | ASTM E73-74   |
| Panels for Bulding Construction-Methods of<br>Conducting Strength Test of .....                            | ASTM E72-77   |
| Rate of Leakage Through Exterior<br>Windows, Curtain Walls and Doors,<br>Standard Method of Test for ..... | ASTM E283-73  |

## APPENDIX F

## DURABILITY TEST STANDARDS

See also Appendices C, D and E for tests of individual materials or unit assemblies.

## Concrete and Concrete Aggregate

- Concrete, Aggregate-Method of Tests for Voids in .....ASTM C30-70  
 Concrete, Air Content of Freshly Mixed, by the  
 Pressure Method-Method of Test for .....ASTM C231-75  
 Unit Weight, Yield and Air Content (Gravimetric)  
 of Concrete-Test for .....ASTM C40-75

## Masonry and Masonry Products

- Ceramic Glazed Structural Clay Facing Tile,  
 Facing Brick and Solid Masonry Units-  
 Specifications for .....ASTM C126-76  
 Freezing and Thawing Tests (see specifications  
 for material) .....ASTM C67-73  
 -Brick and Structural Clay Tile-Sampling  
 and Testing .....ASTM C4-75

## Plastics

- Water Asorption of Plastics-Methods of Test for .....ASTM D570-77

## Roofing and Siding

- Asphalt Roll Roofing, Cap Sheets, and Shingles-  
 Methods of Testing .....ASTM D228-69  
 Bituminous Materials, Accelerated Test of Weathering-  
 Recommended Practice for .....ASTM D529-73  
 Felted and Woven Fabrics Saturated with Bituminous  
 Substance for Use in Waterproofing and Roofing-  
 Methods of Sampling and Testing .....ASTM D146-72

## Unclassified Miscellaneous

- Evaluating the Properties of Wood-Base Fiber  
 and Particle .....ASTM D1037-72a  
 Gypsum and Gypsum Products, Chemical Analysis of-  
 Standard Methods for .....ASTM C471-75  
 Gypsum Board Products, Gypsum Lath, Gypsum  
 Partition Tile or Block, and Precast Reinforced .....ASTM C473-76  
 Gypsum Plasters and Gypsum Concrete, Physical  
 Testing of-Standard Methods for .....ASTM C472-73

## APPENDIX G

## FIRE TEST AND FLAME SPREAD TEST STANDARDS

## Combustible or Noncombustible Properties

Noncombustibility of Elementary Materials-  
Method of Test for Determining .....ASTM E136-73

## Fireresistance Properties

Building Construction and Materials-  
Methods of Fire Test of .....ASTM E119-76  
Ceiling Construction .....(See Building Construction)

Door Assemblies-Methods of  
Fire Tests of .....ASTM E152-76  
Fire Dampers .....UL 555-73  
Fire Tests for Flame-Resistant  
Textiles and Films-Standard Methods of .....NFIPA 701-76  
Roof Coverings-Methods of Fire Test of .....ASTM E108-75  
Modified FM E108

Tents, Grandstands and Air-Supported  
Structures Used for Places of  
Assembly-Standard for .....NF; PA 102-76  
Flame Retardant Tentage and Flammable Tentage .....527 CMR 19.00  
Flammable Definitions .....527 CMR 21.00  
Underlayment-Federal Specifications for .....DDC-C-001023

## Flame Spread Properties

Flooring Radiant Panel Test .....NFIPA 253-78  
Sound Controlling Blocks and Boards (Acoustical  
Tiles and Panels, Prefabricated) with amendment  
No. 4-1976 .....FS SS-118a-67  
Surface Burning Characteristics of Building Materials-  
Method of Test for .....ASTM E84-77

## Flash Point

Flash Point by Pensky-Masters Closed Tester-Method  
of Test for .....ASTM D93-73  
Flash Point by Tag Closed Tester-Method of Test for .....ASTM D56-75  
Flash and Fire Points by Cleveland Open Cup-  
Method of Test for .....ASTM D92-72

Unclassified Miscellaneous

|  |                 |
|--|-----------------|
| Surface Flammability of Carpets and Rugs-        |                 |
| Standard for the .....                           | DOC FF-1-70     |
| (Rain Test, Standard) Test for Fireresistance of |                 |
| Roof Covering Materials .....                    | UL 790-78       |
|  | (ASTM E 108-75) |

## APPENDIX H

## STANDARD TIME-TEMPERATURE FIRE TEST CONTROLS

| Time<br>h:min | Temperature,<br>deg F | Curve area above 68 F base |               | Temperature,<br>deg C | Curve area above 20 C base |               |
|---------------|-----------------------|----------------------------|---------------|-----------------------|----------------------------|---------------|
|               |                       | Deg. F. x min.             | Deg. F. x hr. |                       | Deg. C. x min.             | Deg. C. x hr. |
| 0:00          | 68                    | 00                         | 00            | 20                    | 00                         | 0             |
| 0:05          | 1,000                 | 2,330                      | 39            | 538                   | 1,290                      | 22            |
| 0:10          | 1,300                 | 7,740                      | 129           | 704                   | 4,300                      | 72            |
| 0:15          | 1,399                 | 14,150                     | 236           | 760                   | 7,860                      | 131           |
| 0:20          | 1,462                 | 20,970                     | 350           | 795                   | 11,650                     | 194           |
| 0:25          | 1,510                 | 28,050                     | 468           | 821                   | 15,590                     | 260           |
| 0:30          | 1,550                 | 35,360                     | 589           | 843                   | 19,650                     | 328           |
| 0:35          | 1,584                 | 42,860                     | 714           | 862                   | 23,810                     | 397           |
| 0:40          | 1,613                 | 50,510                     | 842           | 878                   | 28,060                     | 468           |
| 0:45          | 1,638                 | 58,300                     | 971           | 892                   | 32,390                     | 540           |
| 0:50          | 1,661                 | 66,200                     | 1,103         | 905                   | 36,780                     | 613           |
| 0:55          | 1,681                 | 74,220                     | 1,237         | 916                   | 41,230                     | 687           |
| 1:00          | 1,700                 | 82,330                     | 1,372         | 927                   | 45,740                     | 762           |
| 1:05          | 1,718                 | 90,540                     | 1,509         | 937                   | 50,300                     | 838           |
| 1:10          | 1,735                 | 98,830                     | 1,647         | 946                   | 54,910                     | 915           |
| 1:15          | 1,750                 | 107,200                    | 1,787         | 955                   | 59,560                     | 993           |
| 1:20          | 1,765                 | 115,650                    | 1,928         | 963                   | 64,250                     | 1,071         |
| 1:25          | 1,779                 | 124,180                    | 2,070         | 971                   | 68,990                     | 1,150         |
| 1:30          | 1,792                 | 132,760                    | 2,213         | 978                   | 73,760                     | 1,229         |
| 1:35          | 1,804                 | 141,420                    | 2,357         | 985                   | 78,560                     | 1,309         |
| 1:40          | 1,815                 | 150,120                    | 2,502         | 991                   | 83,400                     | 1,390         |
| 1:45          | 1,826                 | 158,890                    | 2,648         | 996                   | 88,280                     | 1,471         |
| 1:50          | 1,835                 | 167,700                    | 2,795         | 1,001                 | 93,170                     | 1,553         |
| 1:55          | 1,843                 | 176,550                    | 2,942         | 1,006                 | 98,080                     | 1,635         |
| 2:00          | 1,850                 | 185,440                    | 3,091         | 1,010                 | 103,020                    | 1,717         |
| 2:10          | 1,862                 | 203,330                    | 3,389         | 1,017                 | 112,960                    | 1,882         |
| 2:20          | 1,875                 | 221,330                    | 3,689         | 1,024                 | 122,960                    | 2,049         |
| 2:30          | 1,888                 | 239,470                    | 3,991         | 1,031                 | 133,040                    | 2,217         |
| 2:40          | 1,900                 | 257,720                    | 4,295         | 1,038                 | 143,180                    | 2,386         |
| 2:50          | 1,912                 | 276,110                    | 4,602         | 1,045                 | 153,390                    | 2,556         |
| 3:00          | 1,925                 | 294,610                    | 4,910         | 1,052                 | 163,670                    | 2,728         |
| 3:10          | 1,938                 | 313,250                    | 5,221         | 1,059                 | 174,030                    | 2,900         |
| 3:20          | 1,950                 | 332,000                    | 5,533         | 1,066                 | 184,450                    | 3,074         |
| 3:30          | 1,962                 | 350,890                    | 5,848         | 1,072                 | 194,940                    | 3,249         |
| 3:40          | 1,975                 | 369,890                    | 6,165         | 1,079                 | 205,500                    | 3,425         |
| 3:50          | 1,988                 | 389,030                    | 6,484         | 1,086                 | 216,130                    | 3,602         |
| 4:00          | 2,000                 | 408,280                    | 6,805         | 1,093                 | 226,820                    | 3,780         |

## APPENDIX I

## FIRE PROTECTION STANDARDS

## Alarm and Detecting Systems

|  |              |
|--|--------------|
| Alarm Systems, Public Fire Service Communications .....                            | NFiPA 73-75  |
| Automatic Fire Detectors-Standard for .....  | NFiPA 72E-74 |
| Signaling Systems-Standard for the Installation,<br>Maintenance and Use of         |              |
| -Auxiliary Protective-for Fire Alarm Service .....                                 | NFiPA 72B-75 |
| -Central Station Protective-for Guard, Fire Alarm<br>and Supervisory Service ..... | NFiPA 71-77  |
| -Household Fire Warning Equipment .....  | NFiPA 74-75  |
| -Local Protective-for Watchman, Fire Alarm<br>and Supervisory Service .....        | NFiPA 72A-75 |
| -Proprietary Protective-for Watchman, Fire Alarm<br>and Supervisory Service .....  | NFiPA 72D-75 |
| -Remote Station Protective .....   | NFiPA 72C-75 |
| Smoke Detectors, Single and Multiple Stations .....                                | UL 217-77    |

## Prevention of Spread of Fire

|   |                  |
|---|------------------|
| Air Conditioning and Ventilating Systems  |                  |
| -Other than Residence Type .....  | NFiPA 90A-76     |
| -Residence Type .....   | NFiPA 90B-76     |
| Aircraft Hangars-Standard on .....  | NFiPA 409-75     |
| Doors, Tin-Clad Fire .....  | UL 10A-73        |
| Dust Explosion Prevention .....   | (See Appendix B) |
| Fire Doors and Windows-Standard for .....   | NFiPA 80-77      |
| Hardware, Sliding, for Standard Horizontally Mounted<br>Tin-Clad Fire Doors ..... | UL 14B-73        |
| Hardware, Swinging, for Standard Tin-Clad Fire Doors .....                        | UL 24C-73        |

## Protection Systems

|  |             |
|--|-------------|
| Carbon Dioxide Extinguishing<br>Systems-Standard on .....  | NFiPA 12-77 |
| Dry Chemical Extinguishing System<br>-Standard for .....   | NFiPA 17-75 |
| Extinguishers, Portable Fire-<br>Standard for the Installation<br>and Maintenance of .....       | NFiPA 10-75 |
| Fire Suppression System for<br>Life Safety, Standard for the<br>Design and Installation of ..... | BOCA 100-78 |
| Foam Extinguishing Systems,<br>Standard for .....  | NFiPA 11-77 |

## Protection Systems--continued

|   |                                  |
|---|----------------------------------|
| Foam-Water Sprinkler Systems<br>and Foam-Water Spray Systems-<br>Standard for the Installation of ..... | NFiPA 16-74                      |
| Foam Systems-Standard for<br>High Expansion .....   | NFiPA 11A-76                     |
| Halogenated Fire Extinguishing Agent<br>Systems-Standard for<br>-Halon 1211 .....                       | NFiPA 12B-77                     |
| -Halon 1301 .....   | NFiPA 12A-77                     |
| Hose Systems .....  | (See Standpipe and Hose Systems) |
| Outside Protection (Yard<br>Piping)-Standard for .....  | NFiPA 24-77                      |
| Private Fire Brigades-Recommendations for<br>Organization, Training and Equipment of .....              | NFiPA 27-75                      |
| Pumps, Centrifugal Fire-Standard for the<br>Installation of .....                                       | NFiPA 20-76                      |
| Sprinkler Systems-Recommended Practice for the Care<br>and Maintenance of .....                         | NFiPA 13A-76                     |
| Sprinkler Systems-Standard for the Insulation of .....  | NFiPA 13-76                      |
| Standpipe and Hose Systems-Standard for the<br>Installation of .....                                    | NFiPA 14-76                      |
| Valves, Controlling Water Supplies for Fire<br>Protection-Standard for the Supervision of .....         | NFiPA 26-76                      |
| Water Spray Fixed Systems for Fire Protection-<br>Standard for .....                                    | NFiPA 15-77                      |
| Water Tanks for Private Fire Protection-<br>Standard for .....  | NFiPA 22-76                      |
| Wetting Agents-Standard for .....   | NFiPA 18-72                      |



## APPENDIX J

## UNIT DEAD LOADS FOR DESIGN PURPOSES

The intent of this appendix is to assist the designer and building official in establishing the minimum weights for materials commonly used in building construction. Some material assemblies have a range in weight. A typical figure is indicated, but when there is reason to suspect a considerable deviation, the actual weight should be determined.

## Note on Use of Appendix J Tables

When making calculations based on the tables in Appendix J, the weights of masonry include mortar but not plaster. For plaster, add five (5) pounds per square foot (psf) for each face plastered. Values given represent averages. In some cases there is a considerable range of weight for the same construction.

Table J-1  
UNIT DESIGN DEAD LOADS FOR CONCRETE SLABS

| Concrete slabs   | Pounds per square foot |
|--|------------------------|
| Concrete, reinforced-stone, per inch of thickness            | 12½                    |
| Concrete, reinforced-lightweight sand, per inch of thickness | 9½                     |
| Concrete, reinforced, lightweight, per inch of thickness     | 9                      |
| Concrete, plain stone, per inch of thickness                 | 12                     |
| Concrete, plain, lightweight, per inch of thickness          | 8½                     |

Table J-2  
UNIT DESIGN DEAD LOADS FOR RIBBED SLABS

| Ribbed slabs<br>Depth, in inches<br>(rib depth plus slab<br>thickness)* | Pounds per square foot  |     |     |     |   |   |
|---|-------------------------|-----|-----|-----|---|---|
|   | Width of rib, in inches |     |     |     |   |   |
|   | 4                       | 5   | 6   | 7   | 8 | 9 |
| 12 inch clay-tile fillers (normal weight concrete):                     |                         |     |     |     |   |   |
| 4 plus 2  | 49                      | 51  | 52  | 54  | — | — |
| 6 plus 2  | 60                      | 63  | 65  | 67  | — | — |
| 8 plus 2½   | 79                      | 82  | 85  | 87  | — | — |
| 10 plus 3   | 96                      | 100 | 103 | 106 | — | — |
| 12 plus 3   | 108                     | 112 | 116 | 120 | — | — |

\*Make appropriate allowances for tapered ends.

## UNIT DEAD LOADS FOR DESIGN PURPOSES

Table J-2 (cont'd.)  
UNIT DESIGN DEAD LOADS FOR RIBBED SLABS

| Ribbed slabs<br>Depth, in inches<br>(rib depth plus slab<br>thickness)* | Pounds per square foot  |     |     |     |     |     |
|---|-------------------------|-----|-----|-----|-----|-----|
|   | Width of rib, in inches |     |     |     |     |     |
|   | 4                       | 5   | 6   | 7   | 8   | 9   |
| 20 inch wide<br>forms:  |                         |     |     |     |     |     |
| 6 plus 2½   | 45                      | 48  | 50  | 50  | —   | —   |
| 8 plus 2½   | 51                      | 54  | 57  | 60  | —   | —   |
| 10 plus 2½  | 57                      | 60  | 64  | 68  | —   | —   |
| 12 plus 2½  | 63                      | 67  | 72  | 76  | —   | —   |
| 14 plus 2½  | —                       | 74  | 79  | 84  | —   | —   |
| 16 plus 2½  | —                       | —   | 88  | 93  | 98  | —   |
| 20 plus 2½  | —                       | —   | —   | 111 | 118 | —   |
| 30 inch wide<br>forms:  |                         |     |     |     |     |     |
| 6 plus 2½   | 41                      | 43  | 45  | 47  | —   | —   |
| 8 plus 2½   | 45                      | 47  | 50  | 53  | —   | —   |
| 10 plus 2½  | 49                      | 52  | 55  | 58  | —   | —   |
| 12 plus 2½  | 53                      | 57  | 60  | 64  | —   | —   |
| 14 plus 2½  | —                       | 62  | 66  | 70  | —   | —   |
| 16 plus 2½  | —                       | —   | 72  | 76  | 80  | —   |
| 20 plus 2½  | —                       | —   | —   | 90  | 95  | 101 |
| 2-way clay-tile fillers<br>(12 × 12):                                   |                         |     |     |     |     |     |
| 4 plus 2  | 61                      | 62  | 64  | —   | —   | —   |
| 6 plus 2  | 87                      | 89  | 90  | —   | —   | —   |
| 8 plus 2½   | 100                     | 103 | 107 | —   | —   | —   |
| 10 plus 3   | 121                     | 126 | 131 | —   | —   | —   |
| 12 plus 3   | 136                     | 141 | 146 | —   | —   | —   |

\*Make appropriate allowances for tapered ends.

Table J-3  
UNIT DESIGN DEAD LOADS FOR WAFFLE SLABS

| Waffle slabs<br>Depth, in inches<br>(Rib depth plus slab<br>thickness) | Pounds per square foot |
|--|------------------------|
| 19 × 19, 5 @ 24  |                        |
| 6 plus 2½  | 66                     |
| 8 plus 2½  | 78                     |
| 10 plus 2½   | 85                     |
| 12 plus 2½   | 101                    |
| 30 × 30, 6 @ 36  |                        |
| 8 plus 3   | 73                     |
| 10 plus 3  | 83                     |
| 12 plus 3  | 95                     |
| 14 plus 3  | 106                    |
| 16 plus 3  | 114                    |
| 20 plus 3  | 135                    |

## UNIT DEAD LOADS FOR DESIGN PURPOSES

Table J-4  
UNIT DESIGN DEAD LOADS FOR FLOOR FINISH

| Floor finish  | Pounds per square foot  |
|---|-------------------------|
| Double $\frac{7}{8}$ inch wood on sleepers, light-concrete fill | 19                      |
| Double $\frac{7}{8}$ inch wood on sleepers, stone-concrete fill | 28                      |
| Single $\frac{7}{8}$ inch wood on sleepers, light-concrete fill | 16                      |
| Single $\frac{7}{8}$ inch wood on sleepers, stone-concrete fill | 25                      |
| 3 inch wood block on mastic, no fill                            | 10                      |
| 1 inch cement finish on stone-concrete fill                     | 32                      |
| 1 inch terrazzo on stone-concrete fill                          | 32                      |
| Marble and mortar on stone-concrete fill                        | 33                      |
| Linoleum on stone concrete fill                                 | 32                      |
| Linoleum on light-concrete fill                                 | 22                      |
| 1½ inch asphalt mastic flooring                                 | 18                      |
| 3 inch wood block on ½ inch mortar base                         | 16                      |
| Solid flat tile on 1 inch mortar base                           | 23                      |
| 2 inch asphalt block, ½ inch mortar                             | 30                      |
| 1 inch terrazzo, 2 inch stone concrete                          | 32                      |
| Floor finish tile per inch depth                                | 12                      |
| Cement finish per inch depth                                    | 12                      |
| Gypsum slabs per inch depth                                     | 4                       |
| Precast concrete plank per inch depth                           | (as determined by test) |
| Hardwood flooring per inch depth                                | 4                       |
| Underflooring per inch depth                                    | 3                       |
| Linoleum  | 2                       |
| Asphalt tile  | 2                       |
| Brick pavers per inch thickness                                 | 10                      |

Table J-5  
UNIT DESIGN DEAD LOADS FOR WATERPROOFING

| Waterproofing     | Pounds per square foot |
|-------------------|------------------------|
| Five-ply membrane | 5                      |

Table J-6  
UNIT DESIGN DEAD LOADS FOR FLOOR FILL

| Floor fill                     | Pounds per square foot |
|--------------------------------|------------------------|
| Cinder fill, per inch          | 5                      |
| Cinder concrete, per inch      | 9                      |
| Lightweight concrete, per inch | 7                      |
| Sand, per inch                 | 8                      |
| Stone concrete, per inch       | 12                     |

## UNIT DEAD LOADS FOR DESIGN PURPOSES

Table J-7  
UNIT DESIGN DEAD LOADS FOR WOOD-JOIST FLOORS

| Wood-joint floors (no plaster)—double wood floor joist sizes in inches: | Pounds per square foot |               |
|---|------------------------|---------------|
|   | 12-in spacing          | 16-in spacing |
| 2 × 6 .....   | 6                      | 5             |
| 2 × 8 .....   | 6                      | 6             |
| 2 × 10 .....  | 7                      | 6             |
| 2 × 12 .....  | 8                      | 7             |
| 3 × 6 .....   | 7                      | 6             |
| 3 × 8 .....   | 8                      | 7             |
| 3 × 10 .....  | 9                      | 8             |
| 3 × 12 .....  | 11                     | 9             |
| 3 × 14 .....  | 12                     | 10            |

Table J-8  
UNIT DESIGN DEAD LOADS FOR MATERIALS

| Materials  | Pounds per cubic foot |
|--|-----------------------|
| Cast-stone masonry (cement, stone, sand) .....           | 144                   |
| Cinder fill .....  | 57                    |
| Concrete, plain:   |                       |
| Cinder .....   | 108                   |
| Expanded-slag aggregate .....                            | 100                   |
| Haydite (burned-clay aggregate) .....                    | 90                    |
| Slag .....   | 132                   |
| Stone (including gravel) .....                           | 144                   |
| Vermiculite and perlite aggregate, nonload-bearing ..... | 25-50                 |
| Other light aggregate, load-bearing .....                | 70-105                |
| Concrete, reinforced:                                    |                       |
| Cinder .....   | 111                   |
| Slag .....   | 138                   |
| Stone (including gravel) .....                           | 150                   |
| Earth (dry) .....  | 96                    |
| Earth (damp) .....                                       | 108                   |
| Earth (wet) .....  | 120                   |
| Cork .....   | 15                    |
| Masonry, ashlar:   |                       |
| Granite .....  | 168                   |
| Limestone, crystalline .....                             | 168                   |
| Limestone, oolitic .....                                 | 135                   |
| Marble .....   | 173                   |
| Sandstone .....  | 144                   |
| Masonry, rubble mortar:                                  |                       |
| Granite .....  | 153                   |
| Limestone, crystalline .....                             | 147                   |
| Limestone, oolitic .....                                 | 138                   |
| Marble .....   | 156                   |
| Sandstone .....  | 137                   |
| Rubber stone masonry .....                               | 156                   |
| Terra cotta, architectural:                              |                       |
| Voids filled .....                                       | 120                   |
| Voids unfilled .....                                     | 72                    |

## UNIT DEAD LOADS FOR DESIGN PURPOSES

Table J-8 (cont'd.)  
UNIT DESIGN DEAD LOADS FOR MATERIALS

| Materials                             | Pounds per cubic foot |
|---------------------------------------|-----------------------|
| Timber, seasoned:                     |                       |
| Ash, commercial white .....           | 41                    |
| Cypress, southern .....               | 32                    |
| Fir, Douglas, coast region .....      | 34                    |
| Oak, commercial reds and whites ..... | 45                    |
| Redwood .....                         | 28                    |
| Spruce, red, white, and Sitka .....   | 28                    |
| Southern pine, short leaf .....       | 39                    |
| Southern pine, long leaf .....        | 48                    |
| Timber, hemlock .....                 | 30                    |

Table J-9  
UNIT DESIGN DEAD LOADS FOR ROOF AND WALL COVERINGS

| Roof and wall coverings                        | Pounds per square foot |
|--|------------------------|
| Asphalt shingles .....                         | 2                      |
| Cement asbestos shingles .....                 | 4                      |
| Cement tile .....                              | 16                     |
| Clay tile (for mortar add 10 lb):              |                        |
| 2 inch book tile .....                         | 12                     |
| 3 inch book tile .....                         | 20                     |
| Roman .....                                    | 12                     |
| Spanish .....                                  | 19                     |
| Ludowici .....                                 | 10                     |
| Composition:                                   |                        |
| Three-ply ready roofing .....                  | 1                      |
| Four-ply felt and gravel .....                 | 5½                     |
| Five-ply felt and gravel .....                 | 6                      |
| Copper or tin .....                            | 1                      |
| Corrugated asbestos-cement roofing .....       | 4                      |
| Fiberboard, ½ inch .....                       | ¾                      |
| Formed sheet steel .....                       | 1-3                    |
| Formed steel decking .....                     | (see manufacturer)     |
| Gypsum sheathing, ½ inch .....                 | 2                      |
| Rigid insulation, ½ inch .....                 | ¾                      |
| Sheet lead .....                               | 3                      |
| Skylight, metal frame, ¾ inch wire glass ..... | 8                      |
| Slate, 3/16 inch .....                         | 7                      |
| Slate, ¼ inch .....                            | 10                     |
| Spanish tile .....                             | 20                     |
| Wood sheathing, per inch thickness .....       | 3                      |
| Wood shingles .....                            | 3                      |

## UNIT DEAD LOADS FOR DESIGN PURPOSES

Table J-10

## UNIT DESIGN DEAD LOADS FOR SUSPENDED CEILINGS

| Suspended ceilings                            | Pounds per square foot |
|---|------------------------|
| Cement on wood lath .....                     | 12                     |
| Cement on metal lath .....                    | 15                     |
| Gypsum on wood or metal lath .....            | 10                     |
| Plaster on tile or concrete .....             | 5                      |
| Suspended metal lath and gypsum plaster ..... | 10                     |
| Suspended metal lath and cement plaster ..... | 15                     |
| Plaster on wood lath .....                    | 8                      |

Table J-11

## UNIT DESIGN DEAD LOADS FOR UNPLASTERED WALLS AND PARTITIONS

| Walls and partitions (unplastered)                                      | Pounds per square foot |
|---|------------------------|
| 4 inch clay brick, high absorption .....                                | 34                     |
| 4 inch clay brick, medium absorption .....                              | 39                     |
| 4 inch clay brick, low absorption .....                                 | 46                     |
| 4 inch sand-lime brick .....  | 38                     |
| 4 inch concrete brick, heavy aggregate .....                            | 46                     |
| 4 inch concrete brick, light aggregate .....                            | 33                     |
| 8 inch clay brick, high absorption .....                                | 69                     |
| 8 inch clay brick, medium absorption .....                              | 79                     |
| 8 inch clay brick, low absorption .....                                 | 89                     |
| 8 inch sand-lime brick .....  | 74                     |
| 8 inch concrete brick, heavy aggregate .....                            | 89                     |
| 8 inch concrete brick, light aggregate .....                            | 68                     |
| 12 inch common brick .....  | 120                    |
| 12 inch pressed brick .....   | 130                    |
| 12 inch sand-lime brick .....   | 105                    |
| 12½ inch concrete brick, heavy aggregate .....                          | 130                    |
| 12½ inch concrete brick, light aggregate .....                          | 98                     |
| 17 inch clay brick, high absorption .....                               | 134                    |
| 17 inch clay brick, medium absorption .....                             | 155                    |
| 17 inch clay brick, low absorption .....                                | 173                    |
| 17 inch sand-lime brick .....   | 138                    |
| 17 inch concrete brick, heavy aggregate .....                           | 174                    |
| 17 inch concrete brick, light aggregate .....                           | 130                    |
| 22 inch clay brick, high absorption .....                               | 168                    |
| 22 inch clay brick, medium absorption .....                             | 194                    |
| 22 inch clay brick, low absorption .....                                | 216                    |
| 22 inch sand-lime brick .....   | 173                    |
| 22 inch concrete brick, heavy aggregate .....                           | 216                    |
| 22 inch concrete brick, light aggregate .....                           | 160                    |
| 4 inch brick, 4 inch load-bearing structural clay tile<br>backing ..... | 60                     |
| 4 inch brick, 8 inch load-bearing structural clay tile<br>backing ..... | 75                     |
| 8 inch brick, 4 inch load-bearing structural clay tile<br>backing ..... | 102                    |
| 8 inch combination brick and concrete block .....                       | 72                     |
| 12 inch combination brick and concrete block .....                      | 90                     |
| 8 inch load-bearing structural clay tile .....                          | 42                     |
| 12 inch load-bearing structural clay tile .....                         | 58                     |
| 8 inch concrete block, heavy aggregate .....                            | 55                     |

## UNIT DEAD LOADS FOR DESIGN PURPOSES

Table J-11 (cont'd.)  
 UNIT DESIGN DEAD LOADS FOR UNPLASTERED WALLS AND PARTITIONS

| Walls and partitions (unplastered)                                     | Pounds per square foot |
|--|------------------------|
| 12 inch concrete block, heavy aggregate                                | 85                     |
| 8 inch concrete block, light aggregate                                 | 38                     |
| 12 inch concrete block, light aggregate                                | 55                     |
| 2 inch furring tile, one side of masonry wall, add<br>to above figures | 12                     |
| 4 inch hollow concrete block—stone aggregate                           | 30                     |
| lightweight  | 20                     |
| 6 inch hollow concrete block—stone aggregate                           | 42                     |
| lightweight  | 30                     |
| 8 inch hollow concrete block—stone aggregate                           | 55                     |
| lightweight  | 38                     |
| 10 inch hollow concrete block—stone aggregate                          | 62                     |
| lightweight  | 46                     |
| 12 inch hollow concrete block—stone aggregate                          | 85                     |
| lightweight  | 55                     |
| 4 inch solid concrete block—stone aggregate                            | 45                     |
| lightweight  | 34                     |
| 6 inch solid concrete block—stone aggregate                            | 50                     |
| lightweight  | 37                     |
| 8 inch solid concrete block—stone aggregate                            | 67                     |
| lightweight  | 48                     |
| 10 inch solid concrete block—stone aggregate                           | 84                     |
| lightweight  | 62                     |
| 12 inch solid concrete block—stone aggregate                           | 108                    |
| lightweight  | 72                     |
| 4 inch load-bearing clay tile  | 24                     |
| 6 inch load-bearing clay tile  | 36                     |
| 2 inch non-load-bearing clay tile                                      | 11                     |
| 3 inch non-load-bearing clay tile                                      | 18                     |
| 4 inch non-load-bearing clay tile                                      | 20                     |
| 6 inch non-load-bearing clay tile                                      | 30                     |
| 8 inch non-load-bearing clay tile                                      | 36                     |
| 10 inch non-load-bearing clay tile                                     | 40                     |
| 4 inch non-load-bearing hollow concrete block                          | 20                     |
| 6 inch non-load-bearing hollow concrete block                          | 30                     |
| 8 inch non-load-bearing hollow concrete block                          | 40                     |
| T.C. 1½ inch split terra cotta furring                                 | 8                      |
| 2 inch split terra cotta furring                                       | 10                     |
| 3 inch split terra cotta furring                                       | 12                     |
| 2 inch hollow gypsum block   | 9½                     |
| 3 inch hollow gypsum block   | 10                     |
| 4 inch hollow gypsum block   | 15                     |
| 5 inch hollow gypsum block   | 18                     |
| 6 inch hollow gypsum block   | 24                     |
| 2 inch solid gypsum block  | 12                     |
| 3 inch solid gypsum block  | 18                     |
| 4 inch solid gypsum block  | 24                     |
| 2 inch facing tile   | 15                     |
| 4 inch facing tile   | 25                     |
| 6 inch facing tile   | 38                     |
| 2 inch solid plaster   | 20                     |
| 4 inch solid plaster   | 32                     |
| 4 inch hollow plaster  | 22                     |
| Wood studs 2 × 4, unplastered  | 4                      |
| Wood studs 2 × 4, plastered one side                                   | 12                     |
| Wood studs 2 × 4, plastered two sides                                  | 20                     |
| 4 inch glass block   | 18                     |

## UNIT DEAD LOADS FOR DESIGN PURPOSES

**Table J-12**  
**UNIT DESIGN DEAD LOADS FOR LATH AND PLASTER PARTITIONS\***

| Lath and plaster partitions  | Pounds per square foot |
|--|------------------------|
| 2 inch solid cement on metal lath .....                                    | .25                    |
| 2 inch solid gypsum on metal lath .....                                    | .18                    |
| 2 inch solid gypsum on gypsum lath .....                                   | .18                    |
| 2 inch metal studs gypsum and metal lath both sides .....                  | .18                    |
| 3 inch metal studs gypsum and metal lath both sides .....                  | .19                    |
| 4 inch metal studs gypsum and metal lath both sides .....                  | .20                    |
| 6 inch wood studs plaster and wood lath, both sides .....                  | .18                    |
| 6 inch wood studs plaster and metal lath, both sides .....                 | .18                    |
| 6 inch wood studs plaster and plaster boards, both sides .....             | .18                    |
| 6 inch wood studs unplastered gypsum board, both sides<br>(dry wall) ..... | .10                    |

\*See also ANSI A58.1-72

**Table J-13**  
**UNIT DESIGN DEAD LOADS FOR PLASTER WORK**

| Plaster work                                 | Pounds per square foot |
|--|------------------------|
| Gypsum (one side) .....                      | 5                      |
| Cement (one side) .....                      | 10                     |
| Gypsum on wood lath .....                    | 8                      |
| Gypsum on metal lath .....                   | 8                      |
| Gypsum on plaster board or fiber board ..... | 8                      |
| Cement on wood lath .....                    | 10                     |
| Cement on metal lath .....                   | 10                     |



## APPENDIX K

## UNIT WORKING STRESSES FOR ORDINARY MATERIAL

## K-100.0 General

K-100.1 Scope: Unless otherwise specified herein, the allowable working stresses and design capacities for ordinary materials, as defined in Sections 201.0 and 719.0, shall be reduced ten (10) per cent below the recommended values of the accepted engineering standards listed in Appendix B. When the structural material is identified in regard to manufacture and grade, and the identification is accompanied by satisfactory mill tests or the strength and stress grade of the materials are otherwise confirmed to the satisfaction of the building official, the allowable working stresses and design capacities may be increased to comply with the accepted engineering standards.

## K-101.0 Masonry stresses

K-101.1 Mortar for unit masonry: Mortar for unit masonry shall comply with either the proportion specifications as set out in Section 815.2, or shall meet the property specifications of the accepted material standard listed in Appendix C. Unless laboratory data are presented to show that the mortar meets the requirements of the property specifications, the proportion specifications shall govern.

K-101.2 Compressive stresses: Except as permitted in other sections of this code, the compressive stresses in masonry shall not exceed the values as shown in Table K-101.

K-101.3 Shear and tensile stresses: Except as permitted in other sections of this code, the allowable shear or tensile stresses in masonry shall not exceed the values permitted in the accepted engineering practice standards listed in Appendix B.

## K-102.0 Concrete

K-102.1 Concrete proportions: Concrete shall comply with either the maximum permissible water-cement ratios and minimum cement contents of Table K-102; or shall comply with the Standard Building Code Requirements for Reinforced Concrete listed in Appendix B for proportions based on strength tests of trial batches; or of concrete from the production facility representing similar materials and conditions.

K-102.2 Capacities and stresses: The allowable design capacities or working stresses for ordinary materials shall not exceed those in Section 40.0 for plain concrete and in the Standard Building Code Requirements for Reinforced Concrete listed in Appendix B, subject to the ten (10) per cent reduction specified for ordinary materials.

## UNIT WORKING STRESSES FOR ORDINARY MATERIALS

**Table K-101**  
**ALLOWABLE COMPRESSIVE STRESSES GROSS CROSS-SECTIONAL AREA**  
 (Except as noted)

| Type of masonry and grade of masonry unit<br>(psi gross area)                         | Type of mortar |     |     |     |
|---|----------------|-----|-----|-----|
|   | M              | S   | N   | O   |
|   | psi            | psi | psi | psi |
| Solid masonry of brick and other solid units of clay or shale; sand lime or concrete: |                |     |     |     |
| 8000 plus psi   | 400            | 350 | 300 | 200 |
| from 4500 or 8000 psi   | 250            | 225 | 200 | 150 |
| from 2500 to 4500 psi   | 175            | 160 | 140 | 100 |
| from 1500 to 2500 psi   | 125            | 115 | 100 | 75  |
| Grouted masonry of solid masonry units:   |                |     |     |     |
| from 4500 to 8000 psi   | 350            | 275 | 200 | —   |
| from 2500 to 4500 psi   | 275            | 215 | 155 | —   |
| from 1500 to 2500 psi   | 225            | 175 | 125 | —   |
| Solid masonry of solid concrete masonry units:  |                |     |     |     |
| 1800 plus psi   | 175            | 160 | 140 | 100 |
| from 1200 to 1800 psi   | 125            | 115 | 100 | 75  |
| Masonry of hollow units   | 85             | 75  | 70  | —   |
| Hollow walls (cavity or masonry bonded)*  |                |     |     |     |
| Solid masonry units   |                |     |     |     |
| 2500 plus psi   | 140            | 130 | 110 | —   |
| from 1500 to 2500 psi   | 100            | 90  | 80  | —   |
| Hollow masonry units  | 70             | 60  | 55  | —   |
| Stone ashlar masonry  |                |     |     |     |
| Granite   | 800            | 720 | 640 | 500 |
| Limestone or marble   | 500            | 450 | 400 | 325 |
| Sandstone or cast stone   | 400            | 360 | 320 | 250 |
| Rubble stone, coursed, rough or random  | 140            | 120 | 100 | 80  |

Note a. On gross cross-sectional area of wall minus area of cavity between wythes. The allowable compressive stresses for cavity walls are based upon the assumption that the floor loads bear upon but one (1) of the two (2) wythes. Where hollow walls are loaded concentrically, the allowable stresses may be increased by twenty-five (25) per cent.

**Table K-102**  
**MAXIMUM WATER-CEMENT RATIOS AND MINIMUM CEMENT CONTENTS**

| Specified compressive strength* (psi) | Minimum sacks of cement per cubic yard of concrete | Maximum permissible water-cement ratios |                                    |                          |                                    |
|---------------------------------------|--|---|------------------------------------|--------------------------|------------------------------------|
|                                       |  | Non-air-entrained concrete              |                                    | Air-entrained concrete   |                                    |
|                                       |  | Absolute ratio by weight                | U.S. gal. per 94 lb. bag of cement | Absolute ratio by weight | U.S. gal. per 94 lb. bag of cement |
| 2500                                  | 5  | 0.65                                    | 7.3                                | 0.54                     | 6.1                                |
| 3000                                  | 5½   | 0.58                                    | 6.6                                | 0.46                     | 5.2                                |
| 3500                                  | 6  | 0.51                                    | 5.8                                | 0.40                     | 4.5                                |

\*28 day strengths for cements meeting strength limits of ASTM C150, Type 1, 1A, II or IIA and 7 day strengths for type III and IIIA.

UNIT WORKING STRESSES FOR ORDINARY MATERIALS

K-103.0 Reinforced gypsum concrete

K-103.1 Stresses: When ordinary materials are used, the allowable working stresses shall be based on the following proportions, measured dry by weight with sufficient water to make a plastic mix that will fill the forms: one hundred (100) percent neat calcined gypsum; ninety-seven (97) per cent gypsum and three (3) per cent wood chips, shavings or fibers; and eighty-seven point five (87.5) per cent gypsum and twelve point five (12.5) per cent wood chips, shavings or fibers; with ultimate compressive strengths of one thousand eight hundred (1,800), one thousand (1,000) and five hundred (500) pounds per square inch respectively.

The working stresses shall not exceed the values prescribed in the Standard for Reinforced Gypsum Concrete listed in Appendix B subject to the ten (10) per cent reduction prescribed for ordinary materials.

K-104.0 Steel reinforcement

K-104.1 Stresses: The allowable working stresses for reinforcement specified in the Standard Building Code Requirements for Reinforced Concrete listed in Appendix B shall be used in all reinforced construction, including reinforced concrete, reinforced gypsum concrete and all forms of reinforced masonry, subject to the ten (10) per cent reduction specified for ordinary, unidentified materials.

K-105.0 Structural steel and cast steel

K-105.1 Stresses: The allowable working stresses for structural steel and cast steel contained in the Specification for Design, Fabrication and the Erection of Structural Steel for Buildings listed in Appendix B shall be used on all structural building construction, subject to the ten (10) per cent reduction specified for ordinary, unidentified materials.

K-106.0 Cast iron

K-106.1 Stresses: The maximum stress for cast iron shall be as indicated in Table K-106.

Table K-106  
CAST IRON STRESS

|   | Maximum stress<br>in pounds per square inch |
|---|---|
| Tension .....                                       | 3,000                                       |
| Extreme tension (fiber stress in bending) .....     | 3,000                                       |
| Extreme compression (fiber stress in bending) ..... | 16,000                                      |
| Shear .....   | 3,000                                       |
| Column compression .....                            | 9,000 minus $40 \frac{1}{r}$                |

Ratio  $\frac{1}{r}$  not to exceed seventy (70)

UNIT WORKING STRESSES FOR ORDINARY MATERIALS

K-107.0 Open-web steel joist

K-107.1 Stresses: The allowable working stresses specified for open-web steel joists shall be in accordance with the Standard Specifications for Steel Joist Construction listed in Appendix B. For all other steel joists, unless otherwise specifically approved and identified, the allowable working stresses specified by the standard shall be reduced ten (10) per cent.

K-108.0 Cold formed steel construction

K-108.1 Stresses: When ordinary materials which are not identified as to manufacture and grade are used, the allowable working stresses in the Specification for the Design of Cold-Formed Steel Structural Members listed in Appendix B shall be reduced ten (10) per cent.

K-109.0 Lumber

K-109.1 Stresses: When the grade of lumber is not identified as provided in Section 719.0 for controlled materials, the maximum allowable working stresses for the species of lumber used shall be determined in accordance with the principles for stress grade lumber as set forth in National Design Specifications for Wood Construction listed in Appendix B.

APPENDIX L IS DELETED.

## APPENDIX M

## RECOMMENDED NAILING SCHEDULE

| Building Element                           | Nail Size and Type       | Number and Location       |
|--|--------------------------|---------------------------|
| Stud to sole plate .....                   | 8d common                | 4 toe-nail or             |
|  | 16d common               | 2 direct nail             |
| Stud to cap plate .....                    | 16d common               | 2 toe-nail or             |
|  |                          | 2 direct nail             |
| Double studs .....                         | 10d common               | 12" o.c. direct           |
| Corner studs .....                         | 16d common               | 24" o.c. direct           |
| Sole plate to joist or blocking .....      | 16d common               | 16" o.c.                  |
| Double cap plate .....                     | 10d common               | 16" o.c. direct           |
| Cap plate laps .....                       | 10d common               | 2 direct-nail             |
| Ribbon strip, 6" or less .....             | 10d common               | 2 each direct bearing     |
|  |                          | 3 each direct bearing     |
| Ribbon strip, 6" or more .....             | 10d common               |                           |
| Roof rafter to plate .....                 | 8d common                | 3 toe-nail                |
| Roof rafter to ridge .....                 | 16d common               | 2 toe-nail or direct nail |
| Jack rafter to hip .....                   | 10d common               | 3 toe-nail or             |
|  | 16d common               | 2 direct nail             |
| Floor joists to studs .....                | 10d common               | 5 direct or               |
|  | (No ceiling joists)      | 10d common                |
| Floor joists to studs .....                | 10d common               | 2 direct                  |
|  | (With ceiling joists)    |                           |
| Floor joists to sill or girder .....       | 8d common                | 3 toe-nail                |
| Ledger strip .....                         | 16d common               | 3 each direct             |
| Ceiling joists to plate .....              | 16d common               | 3 toe-nail                |
| Ceiling joists (laps over partition) ..... | 10d common               | 3 direct nail             |
| Ceiling joists (parallel to rafter) .....  | 10d common               | 3 direct nail             |
| Collar beam .....                          | 10d common               | 3 direct                  |
| Bridging to joists .....                   | 8d common                | 2 each direct end         |
|  |                          | 2 each direct bearing     |
| Diagonal brace (to stud and plate) .....   | 8d common                | 1 each end                |
|  |                          | 4 sq. ft. floor area      |
| Tail beams to headers .....                | 20d common               | 1 each end                |
|  | (when nailing permitted) | 8 sq. ft. floor area      |
| Header beams to trimmers .....             | 20d common               | 1 each end                |
|  | (when nailing permitted) | 8 sq. ft. floor area      |
| 1" roof decking .....                      | 8d common                | 2 each direct rafter      |
|  | (6" or less in width)    |                           |
| 1" roof decking .....                      | 8d common                | 3 each direct rafter      |
|  | (over 6" in width)       |                           |

780 CMR: STATE BUILDING CODE COMMISSION

| Building Element  | Nail Size and Type  | Number and Location                                  |
|---|---|--|
| 1" sub-flooring (6" or less) .....                      | 8d common   | 2 each direct joist                                  |
| 1" sub-flooring (8" or more) .....                      | 8d common   | 3 each direct joist                                  |
| 2" sub-flooring .....                                   | 16d common  | 2 each direct joist                                  |
| 1" wall sheathing (8" or less in width) ..              | 8d common   | 2 each direct stud                                   |
| 1" wall sheathing (over 8" in width) ....               | 8d common   | 3 each direct stud                                   |
| Plywood roof and wall sheathing .....<br>(1/2" or less) | 6d common   | 6" o.c. direct edges and 12" o.c. intermediate       |
| (5/8" or greater) .....                                 | 8d common   | 6" o.c. direct edges and 12" o.c. intermediate       |
| (5/16", 3/8", or 1/2") .....                            | 16 ga. galvanized wire staples, 3/8" minimum crown; length of 1" plus plywood thickness | 4" o.c. edges and 8" o.c. intermediate               |
| (5/8") .....  | Same as immediately above   | 2 1/2" o.c. edges and 5" o.c. intermediate           |
| <b>Plywood subflooring:</b>                             |   |  |
| (1/2") .....  | 6d common or 6d annular or spiral thread  | 6" o.c. direct edges and 10" o.c. intermediate       |
| (5/8", 3/4") .....                                      | 8d common or 6d annular or spiral thread  | 6" o.c. direct edges and 10" o.c. intermediate       |
| (1", 1 1/8") .....                                      | 10d common or 8d ring shank or 8d annular or spiral thread                              | 6" o.c. direct edges and 6" o.c. direct intermediate |
| (1/2") .....  | 16 ga. galvanized wire staples  | 4" o.c. edges and 7" o.c. intermediate               |
| (5/8") .....  | 3/8" minimum crown, 1 5/8" length   | 2 1/2" o.c. edges and 4" o.c. intermediate           |

780 CMR: STATE BUILDING CODE COMMISSION

| Building Element                            | Nail Size and Type   | Number and Location                            |
|---|--|--|
| Built up girders and beams .....            | 20d common   | 32" o.c. direct                                |
| Continuous header to stud .....             | 8d common  | 4 toe-nail                                     |
| Continuous header, two pieces .....         | 16d common   | 16" o.c. direct                                |
| 1/2" fiberboard sheathing .....             | 1 1/2" galvanized roofing nail or 6d common nail or 16 gauge staple, 1 1/8" long with minimum crown of 7/16" | 3" o.c. exterior edge, 6" o.c. intermediate    |
| 25/32" fiberboard sheathing .....           | 1 3/4" galvanized roofing nail or 8d common nail or 16 gauge staple, 1 1/2" long with minimum crown of 7/16" | 3" o.c. exterior edge, 6" o.c. intermediate    |
| Gypsum sheathing .....                      | 12 gauge 1 3/4" large head corrosion-resistive   | 4" o.c. on edge, 8" o.c. immediate             |
| Particleboard (3/8" - 1/2") .....           | 6d common  | 6" o.c. direct edges and 8" o.c. intermediate  |
| (5/8" - 1/2") .....                         | 8d common  | 6" o.c. direct edges and 8" o.c. intermediate  |
| Particleboard sheathing (3/8" - 1/2") ..... | 6d common  | 6" o.c. direct edges and 12: o.c. intermediate |
| (5/8" - 3/4") .....                         | 8d common  | 6" o.c. direct edges and 12" o.c. intermediate |
| Shingles, wood* .....                       | No. 14 B&S corrosion-resistive   | 2 each bearing                                 |
| Weather boarding .....                      | 8d corrosion-resistive   | 2 each bearing                                 |

\* Shingle nails shall penetrate not less than three quarter (3/4) inch into nailing strips, sheathing or supporting construction except as otherwise provided in Section 854.4.4.



TABLE M-1  
 MAXIMUM SPACING OF GYPSUM WALLBOARD FASTENERS  
 (For non-fire rated construction assemblies)<sup>5</sup>

| Thickness of gypsum wallboard (inch)         | Plane of framing surface | Long dimension of gypsum wallboard sheets in relation to direction of framing members | Maximum spacing of framing members (center-to-center) (in inches) | Maximum spacing of fasteners (center-to-center) (in inches) |                     | Nails <sup>1</sup> to wood <sup>4</sup>   |
|--|--------------------------|---|---|---|---------------------|---|
|  |                          |   |   | Nails <sup>2</sup>  | Screws <sup>3</sup> |   |
| 1/2  | Horizontal               | Either direction  | 16  |   | 12                  | No. 13 gauge, 1-3/8" long, 19/64" head<br>No. .098 gauge, 1-1/4" long, Annular ringed 5d, cooler nail |
|  | Horizontal               | Perpendicular   | 24  | 7   | 12                  |   |
|  | Vertical                 |   | 24  | 8   | 12                  |   |
| 5/8  | Horizontal               | Either direction  | 16  | 7   | 12                  | No. 13 gauge, 1-5/8" long, 19/64" head<br>No. .098 gauge, 1-3/8" long, Annular ringed 6d, cooler nail |
|  | Horizontal               | Perpendicular   | 24  | 7   | 12                  |   |
|  | Vertical                 | Either direction  | 24  |   | 12                  |   |
| Fastening required with adhesive application |                          |   |   |   |                     |   |
| 1/2 or 5/8                                   | Horizontal               | Either direction  | 16  | 16  | 16                  | As required for 1/2" and 5/8" gypsum wallboard, see above   |
|  |                          | Perpendicular   | 24  | 12  | 16                  |   |
|  | Vertical                 | Either direction  | 24  | 24  | 24                  |   |
| 2-3/8 (3/4 total)                            | Horizontal               | Perpendicular   | 24  | 16  | 16                  | Base ply nailed as required for 1/2" gypsum wallboard and face ply placed with adhesive               |
|  | Vertical                 | Either direction  | 24  | 24  | 24                  |   |

Note 1. Where the metal framing has a clinching design formed to receive the nails by two edges of metal, the nails shall be not less than 5/8 inch longer than the wallboard thickness, and shall have ringed shanks. Where the metal framing has a nailing groove formed to receive the nails, the nails shall have barbed shanks or be 5d cooler nail (No. 13½ gauge, 15/8 inches long, 15/64 inch head) for ½ inch gypsum wallboard; 6d cooler nail (No. 13 gauge, 1 7/8 inches long, 15/64 inch head) for 5/8 inch gypsum wallboard.

Note 2. Two nails spaced not less than 2 inches apart, nor more than 2½ inches apart and pairs of nails spaced not more than 12 inches center-to-center may be used.

Note 3. Screws shall be No. 6 with tapered head and long enough to penetrate into wood framing not less than 5/8 inch and metal framing not less than ¼ inch.

Note 4. All nails shall meet ASTM C514 or Federal Specification FF-N-105C.

Note 5. For fireresistance rated construction see the pertinent fire test information.

NON-TEXT PAGE

## APPENDIX N

## METRIC EQUIVALENTS

|   |   |
|---|---|
| 1 inch equals 25.4 millimeters                                  | 1 horsepower equals 0.746 kilowatts                     |
| 1 inch equals 2.54 centimeters                                  | 1 millimeter equals 0.039 inch                          |
| 1 foot equals 0.305 meter or 30.48 centimeters                  | 1 centimeter equals 0.394 inch                          |
| 1 yard equals 0.914 meter                                       | 1 meter equals 3.281 feet                               |
| 1 mile equals 1,609 kilometers                                  | 1 meter equals 100 centimeters or 1000 millimeters      |
| 1 square inch equals 6.452 square centimeters                   | 1 kilometer equals 0.621 mile                           |
| 1 square foot equals 0.093 square meter                         | 1 kilometer equals 1000 meters                          |
| 1 square yard equals 0.836 square meter                         | 1 square centimeter equals 0.155 square inch            |
| 1 acre equals 0.405 hectare                                     | 1 square meter equals 10.764 square feet                |
| 1 cubic inch equals 16.387 cubic centimeters                    | 1 hectare equals 2.471 acres                            |
| 1 cubic foot equals 0.028 cubic meter                           | 1 cubic centimeter equals 0.061 cubic inch              |
| 1 cubic yard equals 0.765 cubic meter                           | 1 cubic meter equals 35.315 cubic feet                  |
| 1 quart (liquid) equals 0.946 liter                             | 1 cubic meter equals 1.308 cubic yards                  |
| 1 gallon equals 0.004 cubic meter                               | 1 liter equals 1.057 quarts (lq.)                       |
| 1 ounce (avoirdupois) equals 28.349 grams                       | 1 gram equals 0.035 ounces (avdp.)                      |
| 1 pound (avdp.) equals 0.454 kilogram                           | 1 kilogram equals 2.205 pounds (avdp.)                  |
| 1 ton (2000 pounds) equals 0.9072 metric ton or 907.2 kilograms | 1 metric ton equals 1.102 tons or 2204.6 pounds (avdp.) |
|   | 1 metric ton equals 1000 kilograms                      |
|   | 1 kilowatt equals 1.134 horsepower                      |

APPENDIX O

ACCREDITED AUTHORITATIVE AGENCIES

CONCRETE

American Concrete Institute  
 P. O. Box 4754 Redford Station  
 22400 West Seven Mile Road  
 Michigan 48219 .....ACI

Concrete Reinforcing Steel Institute  
 228 North LaSalle Street  
 Illinois 60601 .....CRSI

Gypsum Association  
 201 North Wells Street  
 Chicago, Illinois 60606 .....GA

National Concrete Masonry Association  
 2009 Fourteenth Street, North  
 Arlington, Virginia 22201 .....NCMA

National Lime Association  
 4000 Brandywine Street, N.W.  
 Washington, D.C. 20016 .....NLA

Portland Cement Association  
 5420 Old Orchard Road  
 Skokie, Illinois 60076 .....PCA

Institute of Electrical and  
 Electronics Engineers, Inc.  
 345 East 47th Street  
 New York, New York 10017 .....IEEE

Illuminating Engineers Society  
 345 East 47th Street  
 New York, New York 10017 .....IES

International Association of  
 Electrical Inspectors  
 802 Busse Highway  
 Park Ridge, Illinois 60068 .....IAEI

National Electrical Manufacturers  
 Association  
 155 East 44th Street  
 New York, New York 10017 .....NEMA

National Electric Sign Association  
 10922 South Western Avenue  
 Chicago, Illinois 60642 .....NESA

EQUIPMENT

Air-Conditioning and Refrigeration  
 Institute  
 1815 North Fort Meyer Drive  
 Arlington, Virginia 22209 .....ARI

American Gas Association  
 1032 East 62nd Street  
 Cleveland, Ohio 44103 .....AGA

American Petroleum Institute Detroit,  
 1625 K Street, N.W.  
 Washington, D.C. 20005 .....API

American Society of Heating,  
 Refrigerating and Air-Condition-  
 ing Engineers  
 United Engineering Center  
 345 East 47th Street  
 New York, New York 10017 ....ASHRAE

The American Society of Mechanical  
 Engineers  
 United Engineering Center  
 345 East 47th Street  
 New York, New York 10017 .....ASME

Home Ventilating Institute  
 230 North Michigan Avenue  
 Chicago, Illinois 60601 .....HVI

Incinerator Institute of American  
 2425 Wilson Boulevard  
 Arlington, Virginia 22201 .....IIA

The Institute of Boiler and  
 Radiator Manufacturers  
 393 Seventh Avenue, 10th Floor  
 New York, New York 10001 .....I-B-R

National Automatic Sprinkler and  
 Fire Control Association, Inc.  
 2 Holland Avenue  
 White Plains, New York 10603..NASFCA

|  |  |
|--|--|
| Superintendent of Documents<br>Government Printing Office<br>Washington, D.C. 20402 .....GPO                       | Federal Specifications<br>Superintendent of Documents<br>Government Printing Office<br>Washington, D.C. 20234 .....FS  |
| United States Department of<br>Agriculture<br>Washington, D.C. 20225 .....USDA                                     | Forest Products Laboratory<br>United States Department of<br>Agriculture<br>Madison, Wisconsin 53705 .....FPL  |
| United States Department<br>of Commerce<br>Construction Division<br>Washington, D.C. 20225 .....USDC               | Housing and Home Finance Agency<br>Division of Housing Research<br>Washington, D.C. 20410 .....HHFA  |
| United States Forest Service<br>Madison, Wisconsin 53705 .....USFS   | Joint Army-Navy Specifications<br>Bureau of Supplies and Accounts<br>Navy Department<br>Washington, D.C. 20225<br>Air Material Command<br>Wright-Patterson Air Force Base<br>Dayton, OH 45433 .....JAN |
| United States Department<br>of Health, Education, and Welfare<br>Washington, D.C. 20201 .....USHEW                 | National Bureau of Standards<br>(Department of Commerce)<br>Washington, D.C. 20234 .....NBS  |
| United States Naval Supply Depot<br>5801 Tabor Avenue<br>Philadelphia, PA 19120 .....USNSD                         | National Research Council of Canada<br>Division of Building Research<br>Ottawa, Ontario, Canada .....NRCC  |
| INTERIOR FINISHES AND MASONRY  | Naval Facilities Engineering<br>Command<br>(formerly Bureau of Yards and Docks)<br>Navy Department<br>Washington, D.C. 20390 .....NFEC   |
| Acoustical and Insulating Materials<br>Association<br>205 West Touhy Avenue<br>Park Ridge, Illinois 60068 ....AIMA | Navy Specifications<br>Bureau of Supplies and Accounts<br>Navy Department<br>Washington, D.C. 20225 .....NS  |
| American Hardboard Association<br>20 North Wacker Drive<br>Chicago, Illinois 60606 .....AHA                        | Product Standards Section<br>Office of Engineering Standards<br>Services<br>National Bureau of Standards<br>Washington, D.C. 20234 .....PS   |
| Asphalt and Vinyl Asbestos Tile<br>Institute<br>101 Park Avenue<br>New York, New York 10017 .....AVATI             | Public Health Service<br>Department of Health, Education<br>and Welfare<br>Washington, D.C. 20201 .....PHS   |
| Facing Tile Institute<br>333 North Michigan Avenue<br>Chicago, Illinois 60601 .....FTI                             |  |
| Gypsum Association<br>201 North Wells Street<br>Chicago, Illinois 60606 .....GA                                    |  |
| Marble Institute of America, Inc.<br>Pennsylvania Building<br>Washington, D.C. 20004 .....MIA                      |  |

National Elevator Industry, Inc.  
600 Third Avenue  
New York, New York 10016 .....NEI

National LP-Gas Association  
79 West Monroe Street  
Chicago, Illinois 60603 .....NLPGA

National Oil Fuel Institute, Inc.  
60 East 42nd Street  
New York, New York 10017 .....NOFI

National Environmental Systems  
Contractors Association  
221 N. LaSalle Street  
Chicago, Illinois 60601 .....NESCA

Uniform Boiler and Pressure Vessel  
Laws Society, Inc.  
57 Pratt Street  
Hartford, Connecticut 06103 ..UBPVLS

#### GOVERNMENT AGENCIES

Commonwealth of Massachusetts  
Department of Public Health  
Boston, Mass. 02111 .....Mass-DPH

Commonwealth of Massachusetts  
Department of Public Safety  
Boston, Mass. 02215 .....Mass-DPS

Commonwealth of Massachusetts  
Executive Office of Human Services  
Boston, Mass. 02202 .....Mass-EOHS

Commonwealth of Massachusetts  
Outdoor Advertising Board  
Boston, Mass. 02116 .....Mass-OAB

Department of Defense  
Office of Civil Defense  
Office of the Secretary of the Army  
Washington, D.C. 20390 .....DOD-OCD

Federal Aviation Agency  
Systems Research and Development  
Service  
Washington, D.C. 20553 .....FAA

Indiana Limestone Institute of  
America, Inc.  
400 East 7th Street, P. O. Box 489  
Bloomington, Indiana 47401 ....ILIA

National Building Granite Quarries  
Association, Inc.  
P. O. Box 444  
Concord, N.H. 03302 .....NBGQA

National Concrete Masonry Association  
2009 Fourteen Street, North  
Arlington, Virginia 22201 .....NCMA

National Lime Association  
4000 Brandywine Street, N.W.  
Washington, D.C. 20016 .....NLA

National Particleboard Association  
711 Fourteen Street, N.W.  
Washington, D.C. 20005 .....NPA

Perlite Institute, Inc.  
45 West 45th Street  
New York, New York 10036 .....PI

Portland Cement Association  
5420 Old Orchard Road  
Skokie, Illinois 60076 .....PCA

The Society of the Plastics  
Industry, Inc.  
250 Park Avenue  
New York, New York 10017 .....SPI

Brick Institute of America  
(formerly Structural Clay  
Products Institute)  
1750 Old Meadow Road  
McLean, Virginia 22101 .....BIA

Tile Council of America  
Research Center, P. O. Box 326  
Princeton, New Jersey 08540 .TCA

Vercimulite Institute  
141 West Jackson Blvd.  
Chicago, Illinois 60604 .....VI

## METAL AND STEEL

Aluminum Association  
750 Third Avenue  
New York, New York 10017 .....AA

American Institute of Steel  
Construction, Inc.  
101 Park Avenue  
New York, New York 10017 .....AISC

American Iron and Steel Institute  
150 East 42nd Street  
New York, New York 10017 .....AISI

American Welding Society  
2501 N.W. Seventh Street  
Miami, Florida 33125 .....AWS

Architectural Aluminum  
Manufacturers Association  
35 East Wacker Drive  
Chicago, Illinois 60601 .....AAMA

Cast Iron Soil Pipe Institute  
2029 K Street, N.W.  
Washington, D.C. 20006 .....CISPI

Concrete Reinforcing Steel Institute  
228 North LaSalle Street  
Chicago, Illinois 60601 .....CRSI

Copper Development Association, Inc.  
405 Lexington Avenue  
New York, New York 10017 .....CDA

Lead Industries Association, Inc.  
292 Madison Avenue  
New York, New York 10017 .....LIA

Metal Building Manufacturers  
Association  
2130 Keith Building  
Cleveland, Ohio 44115 .....MBMA

Metal Lath Association  
12703 Triskett  
Cleveland, Ohio 44111 .....MLA

National Association of Architectural  
Metal Manufacturers  
228 North LaSalle Street  
Chicago, Illinois 60601 .....NAAMM

Rail Steel Bar Association  
38 South Dearborn Street  
Chicago, Illinois 60603 .....RSBA

Research Council on Riveted and  
Bolted Structural Joints of the  
Engineering Foundation  
United Engineering Center  
345 East 47th Street  
New York, NY 10017 .....RCRBSJEF

Steel Deck Institute  
9836 W. Roosevelt Road  
Westchester, Illinois 60153 .....SDI

Steel Bar Mills Association  
(Association)  
38 South Dearborn Street  
Chicago, Illinois 60603 .....SBHA

Steel Door Institute  
2130 Keith Building  
Cleveland, OH 44115 .....SDI

Steel Joist Institute  
2001 Jefferson Davis Highway  
Arlington, Virginia 22202 .....SJI

Steel Scaffolding & Shoring Institute  
2130 Keith Building  
Cleveland, Ohio 44115 .....SSSI

The Steel Window Institute  
2130 Keith Building  
Cleveland, Ohio 44115 .....SWI

Wire Reinforcement Institute  
5034 Wisconsin Avenue, N.W.  
Washington, D.C. 20016 .....WRI

GENERAL STANDARDS AND  
TESTING LABORATORIES

American Insurance Association  
85 John Street  
New York, New York 10038 .....AIA

- American National Standards  
Institute, Inc.  
(formerly United States of America  
Standards Institute, Inc.,  
American Standards Association)  
1420 Broadway  
New York, New York 10018 .....ANSI
- American Society for Testing and  
Materials  
P. O. Box 7510  
Philadelphia, PA 19101 .....ASTM
- Factory Mutual Engineering Division  
Standards-Laboratories Department  
1511 Boston Providence Turnpike  
Norwood, Mass. 02062 .....FMED
- General Electric Company  
3198 Chestnut Street  
Philadelphia, PA 19101 .....GE
- National Fire Protection Association  
470 Atlantic Avenue  
Boston, Massachusetts .....NF; PA
- National Sanitation Foundation  
Testing Laboratory, Inc.  
School of Public Health  
P.O. Box 1468  
Ann Arbor, Michigan 48106 ....NSFTL
- United States of America  
Standards Institute, Inc.  
(See American National Standards  
Institute) .....USASI
- Underwriters' Laboratories, Inc.  
207 East Ohio Street  
Chicago, Illinois 60611 .....UL
- FIRE TESTING LABORATORIES**  
(floor, walls, roof, and  
similar tests)
- Commercial Testing Company, Inc.  
(For testing carpeting for E-84  
and the National Bureau of Standards  
Smoke Chamber Test only.)  
P. O. Box 94-407 Central Avenue  
Dalton, Georgia 30720 .....CTR
- Factory Mutual Engineering  
Corporation  
1151 Boston Providence Turnpike  
Norwood, Mass. 02062 .....FM
- National Bureau of Standards  
(Department of Commerce)  
Washington, D.C. 20234 .....NBS
- The Ohio State University  
Building Research Laboratory  
2070 Neil Avenue  
Columbus, Ohio 43210 .....OSU
- Underwriters' Laboratories, Inc.  
207 East Ohio Street  
Chicago, Illinois 60611 .....UL
- Underwriters' Laboratories, Inc.  
333 Pfingsten Road  
Northbrook, Illinois 60062 .....UL
- Underwriters' Laboratories, Inc.  
1655 Scott Boulevard  
Santa Clara, California 95050 ...UL
- University of California at Berkeley  
College of Engineering  
Berkeley, California 94720 .....UCB
- U.S. Testing Company, Inc.  
(For all tests listed in Appendix G  
except ASTM E-119, E-152, E-163.)  
1415 Park Avenue  
Hoboken, New Jersey 07030 .....UST
- Warnock Hersey Professional  
Services, Ltd.  
(For ASTM E-84, ASTM E-119, ASTM E-152  
and ASTM E-163 Fire Tests Only)  
125 East 4th Avenue  
Vancouver, British Columbia V5T164  
Canada .....WHPS
- FLAME SPREAD TESTING LABORATORIES**
- Factory Mutual Engineering  
Corporation  
1151 Boston Providence Turnpike  
Norwood, Mass. 02062 .....FM



Southwest Research Institute  
8500 Culebra Road  
San Antonio, Texas 78228 .....SWRI

Underwriters' Laboratories, Inc.  
1655 Scott Boulevard  
Santa Clara, California 95050 ...UL

Underwriters' Laboratories, Inc.  
333 Pfingston Road  
Northbrook, Illinois 60062 .....UL

U.S. Testing Company, Inc.  
(For all tests listed in Appendix G,  
except ASTM E-119, E-152, E-163.)  
1415 Park Avenue  
Hoboken, New Jersey 07030 .....UST

STRUCTURAL TESTING LABORATORIES

The Detroit Testing Laboratory, Inc.  
12800 Northend Avenue  
Detroit, Michigan 48237 .....DTL

Forest Products Laboratory  
United States Department  
of Agriculture  
Madison, Wisconsin 53705 .....FPL

General Electric Company  
3198 Chestnut Street  
Philadelphia, PA 19101 .....GE

Robert W. Hunt Company  
810 South Clinton  
Chicago, Illinois 60607 .....RWH

IIT Research Institute  
(formerly Armour Research  
Foundation)  
10 West 35th Street  
Chicago, Illinois 60616 .....IITRI

NAHB Research Foundation, Inc.  
Research Laboratory  
Rockville, Maryland .....NAHB

H. C. Nutting Company  
4120 Airport Road  
Cincinnati, Ohio 45226 .....HCN

The Ohio State University  
Building Research Laboratory  
2070 Neil Avenue  
Columbus, Ohio 43210 .....OSU

The Pennsylvania State University  
Research Institute  
University Park, PA 16802 .....PSU

Pittsburgh Testing Laboratory  
1330 Locust Street  
Pittsburgh, Pennsylvania 15219 ..PTL

University of Detroit  
Research Institute  
Detroit, Michigan 48221 .....UD

UNCLASSIFIED MISCELLANEOUS

The American Institute of Architects  
1735 New York Avenue, N.W.  
Washington, D.C. 20006 .....AIA

American Public Health Association  
1790 Broadway  
New York, New York 10017 .....APHA

American Society of Civil Engineers  
United Engineering Center  
345 East 47th Street  
New York, New York 10017 .....ASCE

American Society of Sanitary  
Engineering  
960 Illuminating Building  
Cleveland, Ohio 44113 .....ASSE

American Water Works Association  
2 Park Avenue  
New York, New York 10016 .....AWWA

Building Officials and Code  
Administrators International, Inc.  
17926 S. Halsted Street  
Homewood, Illinois, 60430 ....BOCA

Building Research Advisory Board  
Division of Engineering  
National Research Council  
2101 Constitution Avenue  
Washington, D.C. 20418 .....BRAB

|   |   |
|---|---|
| International Association of Plumbing<br>& Mechanical Officials<br>5032 Alhambra Avenue<br>Los Angeles, CA 90032 .....IAMPO       | National Research Council<br>Ottawa 2, Canada .....NRC  |
| International Conference of<br>Building Officials<br>5360 South Workman Mill Road<br>Whittier, California 90601 ....ICBO          | National Society of Professional<br>Engineers<br>2029 K Street, N.W.<br>Washington, D.C. 20006 .....NSPE  |
| Manufacturing Chemists' Association,<br>Inc.<br>1825 Connecticut Avenue, N.W.<br>Washington, D.C. 20006 .....MCA                  | Sheet Metal and Air Conditioning<br>Contractor's National<br>Association, Inc.<br>1611 North Kent Street<br>Arlington, Virginia 22209 ...SMACNA |
| Mineral Fiber Products Bureau<br>509 Madison Avenue<br>New York, New York 10022 .....MFPB   | Southern Building Code Congress<br>International<br>900 Montclair Road<br>Birmingham, Alabama 35213 ....SBCCI                                   |
| Mobile Homes Manufacturers<br>Association<br>20 North Wacker Drive<br>Chicago, Illinois 60606 .....MHMA                           | Truss Plate Institute, Inc.<br>Suite 800<br>919 Eighteenth Street, N.W.<br>Washington, D.C. 20006 .....TPI                                      |
| National Association of<br>Building Manufacturers<br>1619 Massachusetts Avenue, N.W.<br>Washington, D.C. 20036 .....NABM          | WOOD AND WOOD PRODUCTS  |
| National Association of Home<br>Builders<br>National Housing Center<br>1625 I Street, N.W.<br>Washington, D.C. 20036 .....NAHB    | Acoustical and Insulating Materials<br>Association<br>205 West Touhy Avenue<br>Park Ridge, Illinois .....AIMA                                   |
| National Clay Pipe Institute<br>P. O. Box 310<br>350 West Terra Cotta Avenue<br>Crystal Lake, Illinois 60014 ..NCPI               | American Hardboard Association<br>20 North Wacker Drive<br>Chicago, Illinois 60606 .....AHA   |
| National Insulation Manufacturers<br>Association<br>441 Lexington Avenue<br>New York, New York 10017 .....NIMA                    | American Institute of Timber<br>Construction<br>333 W. Hampden Avenue<br>Englewood, Colorado 80110 ....AITC                                     |
| National Mineral Wool Insulation<br>Association<br>Rockefeller Center<br>1270 Sixth Avenue<br>New York, New York 10020 .....NMWIA | American Wood Preservers'<br>Institute<br>1651 Old Meadow Road<br>McLean, Virginia 22101 .....AWPI  |
|   | Appalachian Hardwood<br>Manufacturers, Inc.<br>1015 Mercantile Library Building<br>414 Walnut Street<br>Cincinnati, Ohio 45202 .....AHM         |

Association of Timber and Timber  
Treatment of Inspection Agencies  
729 Fisher Road  
Grosse Pointe, MI 48230 .....ATTTIA

California Redwood Association  
617 Montgomery Street  
San Francisco, CA 94111 .....CRA

Hardwood Plywood Manufacturers  
Association  
P.O. Box 6246  
Arlington Virginia 22206 .....HPMA

National Forest Products Association  
1619 Massachusetts Avenue, N.W.  
Washington, D.C. 20036 .....NFoPA

National Particleboard Association  
2306 Perkins Place  
Silver Spring, MD 20910 .....NPA

Northeastern Lumber Manufacturers  
Association, Inc.  
13 South Street  
Glen Falls, New York 12801 ...NELMA

Northern Hardboard and Pine  
Manufacturers Association, Inc.  
Green Bay, Wisconsin 54301 ...NHPMA

Product Fabrication Service  
P. O. Box 5038  
Madison, Wisconsin 53705 .....PFS

Red Cedar Shingle and Handsplit  
Shake Bureau  
5510 White Building  
Seattle, Washington 98101 RCSHSB

Lumber Manufacturers Association  
805 Sterick Building  
Memphis, Tennessee 38103 .....SHLMA

Southern Forest Products  
Association  
(formerly Southern Pine Association)  
P. O. Box 52468  
New Orleans, Louisiana 70150 ....SFPA

Timber Engineering Company  
5530 Wisconsin Avenue, N.W.  
Washington, D.C. 20015 .....TECO

Truss Plate Institute, Inc.  
919-18th Street, N.W.  
Washington, D.C. 20006 .....TPI

Western Wood Products  
Association  
1500 Yeon Building  
Portland, Oregon 97204 .....WWPA

## APPENDIX P

SPECIALIZED MASSACHUSETTS RULES AND REGULATIONS  
OTHER THAN STATE BUILDING CODE COMMISSION

Specific numbers have been established by the Massachusetts Office of the Secretary of State to identify for reference purposes all rules and regulations promulgated by agencies of the Commonwealth of Massachusetts. These numbers are designated as "Code of Massachusetts Regulations" (CMRs).

EXECUTIVE OFFICE OF CONSUMER AFFAIRS,  
DIVISION OF REGISTRATION

Board of State Examiners of Plumbers and Gas Fitters  
 Massachusetts State Plumbing Code .....248 CMR 2.00  
 Massachusetts Fuel Gas Code .....248 CMR 3.00-8.00

EXECUTIVE OFFICE OF ENVIRONMENTAL AFFAIRS,  
OUTDOOR ADVERTISING DIVISION

Outdoor Advertising Board  
 Control and Restriction of Billboards,  
 Signs, and other Advertising Devices,  
 August 1, 1978-Rules and Regulations for .....311 CMR 3.00

EXECUTIVE OFFICE OF HUMAN SERVICES,  
DEPARTMENT OF PUBLIC HEALTH,  
DIVISION OF ENVIRONMENTAL HEALTH

Division of Health Care and Standards  
 Designer's Guide (Bureau of Planning and Construction)  
 Dispensaries and Clinics, December 21, 1966-  
 Rules and Regulations for the Licensure of .....105 CMR 140.000  
 Hospitals in Massachusetts, 1971-Licensure Rules  
 and Regulations for .....105 CMR 130.000  
 Intensive Care Unit Amendment, October 1, 1972 ....105 CMR 130.520  
 through 130.535

Long Term Care Facilities in Massachusetts,  
 September 29, 1972, General Standards of  
 Construction-Rules and Regulations for .....105 CMR 151.000

The State Sanitary Code  
 Camp Grounds, Developed Family Type-  
 Minimum Standards for .....310 CMR 18.00 ARTICLE VIII\*  
 Farm Labor Camps-  
 Housing and Sanitation Standards for ..105 CMR 420.000 ARTICLE II

Food Service Establishments-

- Minimum Sanitation Standards for .....105 CMR 595.000 ARTICLE X
- General Application and Administration ...105 CMR 400.000 ARTICLE I
- Human Habitation, Fitness-
  - Minimum Standards of .....105 CMR 410.000 ARTICLE II
- Recreational Camps for Children-
  - Sanitation Standards for .....105 CMR 430.000 ARTICLE IV
- Swimming Pools-Minimum Standards for ...310 CMR 16.00 ARTICLE VI\*

\*Articles VI and VIII of the State Sanitary Code have been transferred to the Department of Environmental Quality Engineering.

EXECUTIVE OFFICE OF MANPOWER AFFAIRS,  
DEPARTMENT OF LABOR AND INDUSTRIES

Division of Industrial Safety

- Accidents on Construction Operations-
  - Rules and Regulations for .....441 CMR 10.00  
Industrial Bulletin No. 12
- Accidents in Window Cleaning-Rules and Regulations  
for the Prevention of .....441 CMR 19.00  
Industrial Bulletin No. 21
- Care of Employees, Injured or Taken Ill  
in Industrial Establishments .....441 CMR 12.00  
Industrial Bulletin No. 14
- Lighting Code for Factories, Workshops,  
Manufacturing, Mercantile Establishments .....441 CMR 16.00  
Industrial Bulletin No. 18
- Structural Painting-Revised Rules and  
Regulations and Recommendations Pertaining to .....441 CMR 11.00  
Industrial Bulletin No. 13
- Toilets in Industrial Establishments .....441 CMR 2.00  
Industrial Bulletin No. 4

EXECUTIVE OFFICE OF PUBLIC SAFETY,  
DEPARTMENT OF PUBLIC SAFETY

Architectural Barriers Board

- Architectural Barriers Board-
  - Rules and Regulations of the .....521 CMR 3.00 (16-1AB)

Board of Boiler Rules

- Part 1 of Steam Boiler Rules .....522 CMR 2.00 (BLR-1)
- Part 1-A of Steam Boiler Rules,  
Atomic Energy Installations .....522 CMR 3.00 (BLR-1-A)
- Part II of Steam Boiler Rules,  
Power and Miniature Class .....522 CMR 4.00 (BLR-2)
- Low Pressure Steam-Heating Boilers .....522 CMR 5.00 (BLR-3)
- Part IV-Steam Boiler Rules .....522 CMR 6.00 (BLR-4)
- Part I-Air Tank Regulations,

|  |  |
|--|--|
| Installation and Inspection .....  | 522 CMR 7.00 (BLR-Part II-Air Tank Regulations,            |
| Installation and Inspection .....  | 522 CMR 8.00 (BLR-Refrigeration and Air Conditioning ..... |
| 522 CMR 9.00 (BLR-Material Specifications .....  | 522 CMR 10.00 (BLR-Welding Specifications .....            |
| 522 CMR 11.00 (BLR-Fiberglass-Reinforced Plastic Pressure Vessels ..   | 522 CMR 12.00 (BLR-  |
| <br>Board of Elevator Regulations  |  |
| Elevator and Escalator Regulations .....   | 524 CMR 2.00 (E through                                    |
| Elevator, Dumbwaiter, Escalator, and Moving Walk Regulations .....   | 524 CMR 15.00 (E through                                   |
| <br>Board of Fire Prevention Regulations   |  |
| Dry-Cleaning and Dry-Dyeing and the Keeping, Storage and Use of Cleaning and Dyeing Fluid in Connection Therewith-Rules and Regulations Governing .....  | 527 CMR 3.00 (E  |
| Fires, the Prevention of Fire and Fire Hazards, Remediying any Condition Found to Exist in or about any Building or Other Premises or on any Ship or Vessel in Respect to-Rules and Regulations for the purpose of .....   | 527 CMR 10.00 (E   |
| Flammable Decorations in Public Buildings, Places of Assembly, Hotels, Family Hotels, Stores, Public or Private Institutions, Public or Private School Buildings, Churches, Theaters, Special Halls, Public Halls or Miscellaneous Halls-Rules and Regulations Prohibiting or Regulating ..... | 527 CMR 21.00 (E   |
| Flammable Fluids, Solids or Gases, Keeping, Storage, Manufacture or Sale in Limited Quantities of-Rules and Regulations Governing .....  | 527 CMR 14.00 (E   |
| Garages, and the Related Storage, Keeping and Use of Gasoline, the Construction and Maintenance of Buildings or Other Structures used as-Rules and Regulations Governing .....   | 527 CMR 5.00 (E  |
| Liquefied Petroleum Gas Systems, Gas Piping and Appliance Installation in Building, the Construction, Location, Installation and Operation-Rules and Regulations Governing .....   | 527 CMR 6.00 (E  |
| Massachusetts State Electrical Code .....  | 527 CMR 12.00 (E   |
| Oil Burning Equipment and the Keeping, Storage and Use of Fuel Oil or Other Inflammable Liquid Products used in  |  |

|   |                      |
|---|----------------------|
| Connection Therewith-Rules and Regulations Governing the Construction, Installation, and Operation of ..... | 527 CMR 4.00 (FPR-3) |
| Plastics, Manufacturing and Handling of-Rules and Regulations Governing .....                               | 527 CMR 7.00 (FPR-6) |
| Tanks and Containers, Construction, Location, Use and Maintenance of-Rules and Regulations Governing .....  | 527 CMR 9.00 (FPR-8) |

APPENDIX Q

MASSACHUSETTS STATE BUILDING CODE COMMISSION RULES AND REGULATIONS

Concrete Testing Laboratories

Concrete Personnel

Class A, Field Concrete Technician

Class B, Plant Concrete Technician (Regulations Pending)

Class C, Field Concrete Inspections (Regulations Pending)

Licensing of Construction Supervisors

Manufactured Buildings, Building Components and Mobile Homes

Use of Native Lumber

Accreditation of Testing Laboratories to Test Solid Fuel Burning Heating Appliances



APPENDIX Q

RULES AND REGULATIONS FOR LICENSING OF CONCRETE TESTING LABORATORIES

PART I GENERAL

SECTION I ADMINISTRATION

1.1 TITLE

As authorized by Chapter 802 of the Acts of 1972, and in accordance with Section 128 of the State Building Code, establishing the Construction Materials Safety Board, the following Rules and Regulations are adopted for Licensing of Concrete Testing Laboratories.

1.2 DEFINITIONS

Unless otherwise expressly stated in the State Building Code, the following terms shall, for the purpose of these Rules and Regulations, have the meaning indicated in this Section:

**ACCREDITED LABORATORY:** A laboratory which has been licensed in accordance with these regulations by the State Building Code Commission.

**BOARD:** Construction Materials Safety Board (CMSB).

**BRANCH LABORATORIES:** A branch of a Testing Laboratory physically removed from the location of the headquarters or main testing facility of the Testing Laboratory.

**CODE:** Commonwealth of Massachusetts State Building Code (SBC).

**COMMISSION:** Commonwealth of Massachusetts State Building Code Commission (SBCC).

**LABORATORIES:** Testing laboratory, branch laboratory, and project laboratory.

**PERSON:** Individual, partnership, corporation, trust, joint venture, etc.

**PRE-QUALIFYING AGENCY:** Construction Materials Safety Board (CMSB).

**PROJECT LABORATORY:** A temporary on-site facility providing concrete testing services for a specific project under the direction of a testing or branch laboratory licensed by the Commonwealth of Massachusetts.

**TESTING AGENCY:** National Bureau of Standards Cement and Concrete Reference Laboratory (CCRL), the Army Corps of Engineers, or other agency designated by the SBCC.

TESTING LABORATORY: A proprietorship, corporation, partnership or agency which conforms to the requirements of ASTM E 329-72 as modified in these regulations.

### 1.3 LICENSING

All laboratories defined by these regulations as Testing Laboratories, Branch Laboratories and Project Laboratories which are engaged in the testing of concrete and concrete materials for use in buildings and structures subject to control according to the provisions of Section 127.0 of the Massachusetts State Building Code shall be licensed by the State Building Code Commission in accordance with these regulations.

### 1.4 APPLICATION FOR LICENSING

Each laboratory desiring to obtain such license shall make application to the Commission upon such form and in such manner as the Commission shall prescribe and shall furnish evidence satisfactory to the Commission that the laboratory equipment meets the requirements of Section 2 and its management personnel are qualified in accordance with Sections 4 and 5 of these Rules and Regulations. Such application shall also include payment of the licensing fee set forth in Section 1.8 of these Rules and Regulations.

### 1.5 PRE-QUALIFYING AGENCY

The Commission hereby designates the Construction Materials Safety Board as its Pre-Qualifying Agency, provided, however, that the Commission may revoke such designation at any time, and may designate any other agency or agencies which it deems qualified, from time to time, to act as its Pre-Qualifying Agency. The Pre-Qualifying Agency shall examine, or cause to be examined, the evaluation performed by the Testing Agency and the personnel on each Concrete Testing Laboratory application and make its recommendation to the Commission regarding such license.

### 1.6 TESTING AGENCY

The Commission hereby designates the Cement and Concrete Reference Laboratory of the National Bureau of Standards and the Army Corps of Engineers as the agencies to examine and evaluate all laboratories desiring to be licensed in the practice of concrete testing provided, however, that the Commission may revoke such designation at any time, and may designate any other agency or agencies which it deems qualified, from time to time, to act as its Testing Agency.

### 1.7 NOTIFICATION OF TESTING AND TESTING RESULTS

The Testing Agency shall notify the applicant of the date for evaluation. The Commission shall be informed by the Testing Agency, Pre-Qualifying Agency of the evaluation results and recommendations.

1.8 LICENSING FEE

The fee for licensing shall be one hundred (\$100.00) dollars per annum or in accordance with the fee schedule established by the Commission from time to time.

1.9 NUMBER AND CLASSIFICATION

Each laboratory so licensed by the Commission shall be issued a number and classification.

1.10 RENEWALS

Commencing January 1, 1978, all licenses issued shall expire on December 31 of the year issued. Within thirty (30) days before the expiration date of any such license, the Executive Director of the Commission shall forward to each laboratory so licensed an application form for renewal. Said renewals shall be returned to the State Building Code Commission by December 31. The said Executive Director, upon receipt of the completed form and fee, shall renew the license for a period of one (1) year or notify such applicant of the Commission's refusal with reasons thereof.

1.11 PENALTIES

Any such person and/or laboratory who fails to comply with the requirements of these rules and regulations or who files a false report shall be subject to the penalties and actions as prescribed in Section 121 of the Code.

SECTION 2 LABORATORY LICENSING REQUIREMENTS

2.1 ASTM TESTING REQUIREMENTS

Except as modified in these regulations, all testing laboratories including branch laboratories shall conform to Sections 5 and 6 of the ASTM E 329-72 standard requirements for testing of concrete and its constituent materials.

EXCEPTION: The following sections of ASTM E 329-72 shall not apply:

Sections 2.2; 2.3; 2.7; 3.2.7; 3.3; 3.4; C360 of 6.2; 7; 8; 9 and 10.

2.2 ASTM EQUIPMENT AND PERSONNEL REQUIREMENTS

All laboratories subject to these regulations shall be approved and licensed in accordance with the ASTM E 329-72 standard for the performance of those functions recommended in standard ASTM E 329-72, for equipment and personnel, as modified in these regulations.

SECTION 3 PRE-QUALIFICATION REQUIREMENTS FOR LABORATORIES

3.1 EVALUATION

- a) Testing and branch laboratories subject to these regulations shall be examined and evaluated, upon notification from the State Building Code Commission, by a testing agency designated by the SBCC. The interval between such examination and evaluation shall not exceed three (3) years.
- b) Project laboratory equipment which is used in the testing of concrete materials for use in buildings and structures subject to the provisions of the Massachusetts State Building Code Commission shall conform to the requirements of ASTM E 329-72 as modified by Section 2 of these Rules and Regulations.
- c) Reports of evaluations by the testing agency shall be filed with the State Building Code Commission within ten (10) days of receipt of the report by the laboratory, unless a waiver is granted by the laboratory to have the report sent directly to the State Building Code Commission by the testing agency.
- d) Laboratory deficiencies cited in the report of the testing agency shall be corrected within thirty (30) days of the date of issue of the report and shall be so certified by an affidavit submitted by the laboratory on a form supplied by the State Building Code Commission.

3.2 REVIEW OF DEFICIENCIES

Laboratories which fail to meet the requirements of items (c) and (d) shall be subject to review and revocation of their license by the State Building Code Commission.

3.3 TESTING MACHINES

Compression testing machines used for testing materials subject to these regulations shall be calibrated and verified, with equipment traceable to the National Bureau of Standards, at least annually or as required by the State Building Code Commission, and the results submitted to the Commission.

SECTION 4 PERSONNEL

The management and supervision of each laboratory subject to these regulations shall be in accordance with the following requirements:

## 4.1 REQUIRED

Each accredited licensed Concrete Testing Laboratory must have an individual approved by the Commission in each of three (3) distinctly different categories: Director of Testing Services, Supervisory Laboratory Technician and Supervisory Field Technician. An individual may fill more than one position at the particular laboratory if he meets all the qualifications for each position, but he may not fill positions concurrently at a separate (branch or project) laboratory. The project laboratory must have a full-time resident supervisory laboratory technician qualified in accordance with these Regulations.

## 4.2 FILING OF QUALIFICATIONS

Each individual being certified for a position must submit their credentials and qualifications under penalty of perjury with their signature notarized. Individuals applying for certification in more than one (1) category must file separate applications for each position as described in Section 5. Application for certification shall be filed within thirty (30) days of employment for such duties. It is the responsibility of the Director of Testing Services to notify the Commission within seven (7) days of any vacancy of any position. Any vacant position shall be filled within thirty (30) days.

## SECTION 5 QUALIFICATIONS

## 5.1 QUALIFICATIONS FOR DIRECTOR OF TESTING SERVICES

The testing services of each laboratory (main, branch or project) shall be under the direction of a Director of Testing Services who shall be a full-time resident employee of that laboratory and shall be qualified in accordance with any one (1) of the following three (3) sets of requirements:

- a) He shall be a Professional Engineer, registered in the Commonwealth of Massachusetts with at least five (5) years of experience in responsible charge of work related to Structural Engineering, Construction Engineering or Construction Materials Testing. He shall be subject to demonstrate his ability to interpret the results of tests of concrete and concrete aggregates as stated in ASTM E 329-72; or,
- b) He shall have a Bachelor's Degree in Engineering from an accredited institution and an additional total of three (3) years' experience performing tests on concrete and concrete materials which shall include two (2) years as a laboratory technician or supervisor. He shall be subject to demonstrate his ability to interpret the results of tests of concrete and concrete aggregates as stated in ASTM E 329-72; or

- c) He shall have at least eight (8) years' experience including five (5) years' experience as a laboratory technician or supervisor and shall be subject to demonstrate his ability to interpret the results of tests of concrete and concrete aggregates as stated in ASTM E 329-72.

## 5.2 QUALIFICATIONS FOR SUPERVISORY LABORATORY TECHNICIAN

A Supervisory Laboratory Technician shall have at least five (5) years' experience performing tests on construction materials including concrete and concrete aggregates. He shall be subject to demonstrate his ability to perform correctly tests of concrete and concrete aggregates as stated in ASTM E 329-72. "Class A" accreditation by the Pre-Qualifying Agency shall be required as qualification for concrete only. (See Rules and Regulations for Concrete Testing Personnel.)

## 5.3 QUALIFICATIONS FOR SUPERVISORY FIELD TECHNICIAN

A Supervisory Field Technician shall have at least five (5) years' experience performing tests on construction materials including concrete. He shall be subject to demonstrate either by oral or written examination, or both, his ability to perform correctly the tests of concrete as stated in ASTM E 329-72. "Class A" accreditation by the Pre-Qualifying Agency shall be required as qualification for concrete only. (See Rules and Regulations for Concrete Testing Personnel.)

## SECTION 6 PROJECT AFFIDAVIT

In accordance with Section 113.5.1 of this code, those structures subject to control as required in Section 127.0, affidavits must be submitted with the building permit application that the individuals and testing laboratories responsible for carrying out the duties of Section 127.0 have been licensed and registered by the Commission.

### 6.1 AFFIDAVIT

Form Number SBCC-L-303-76, as furnished by the licensed laboratory (sample submitted to each laboratory) shall be used by the licensed laboratory for each building project.

### 6.2 NOTICE OF TERMINATION

The building official shall receive written notification of the termination of laboratory functions certifying that the owner has also been so notified. Such termination shall be effective no earlier than three (3) working days from the notification received by the building official.

### 6.3 SUCCESSOR LABORATORY

If concrete testing is to be continued for the said project by a successor laboratory, such notice shall be given to the building official and a new project affidavit shall be filed with the building official.

## SECTION 7 REVOCATION AND SUSPENSION PROCEDURES

### 7.1 REVOCATION AND SUSPENSION

The State Building Code Commission on its own initiative or upon the recommendation of the Construction Materials Safety Board may suspend or revoke the license of any Testing Laboratory or Project Laboratory found to be in noncompliance with these Rules and Regulations, the State Building Code, or the standards of good practice. Notice of suspension or revocation of such license shall be in writing with the reasons for suspension or revocation clearly set forth therein, and served in accordance with Section 121.2.1 of this Code.

### 7.2 NOTICE AND CONFERENCE

Prior to suspension, revocation, or refusal to renew the license of an accredited laboratory, written notice of such intent shall be served by the Construction Materials Safety Board of SBCC in accordance with Section 121.2.1 of this Code. Within ten (10) calendar days of receipt of such notice, the affected accredited laboratory may request a conference before a three (3) member panel designated by the Chairman of the Construction Materials Safety Board, who will hear facts and make their recommendations to the Construction Materials Safety Board.

### 7.3 EFFECT OF

Upon suspension or revocation of the license, the accredited laboratory shall immediately cease engaging in the testing of concrete and concrete materials for use in buildings and structures which are subject to the provisions of the Massachusetts State Building Code and no action brought before the Board of Appeals as specified in Section 8.1 of these regulations or in any court of competent jurisdiction shall stay the said suspension or revocation unless said Board of Appeals or court shall issue an order for a stay of the Commission's suspension or revocation.

## SECTION 8 APPEALS

### 8.1 BUILDING CODE APPEALS BOARD

Any laboratory or individual aggrieved by the suspension or revocation of their license or by an interpretation, order, requirement, direction or failure to act under these Rules and Regulations may

appeal to the State Building Code Appeals Board as provided in Section 126 of this Code; however, entry of an appeal from the Commission's order of revocation or suspension shall not stay such revocation or suspension unless so ordered by the State Building Code Appeals Board in a preliminary hearing conducted expressly for the purpose of a stay in accordance with that part of Section 126.3.2 of this Code dealing with the procedure required for a hearing on such stay.



APPENDIX Q

RULES AND REGULATIONS FOR CONCRETE TESTING PERSONNEL

PART I GENERAL

SECTION I ADMINISTRATION

1.1 TITLE

As authorized by Chapter 802 of the Acts of 1972, and in accordance with Section 128 of the State Building Code establishing the Construction Materials Safety Board, the following Rules and Regulations are adopted for Concrete Testing Personnel.

1.2 DEFINITIONS

Unless otherwise expressly stated in the State Building Code, the following terms shall, for the purpose of these Rules and Regulations, have the meaning indicated in this Section.

BOARD: Construction Materials Safety Board (CMSB)

CODE: Commonwealth of Massachusetts State Building Code (SBC)

COMMISSION: Commonwealth of Massachusetts State Building Code Commission (SBCC)

CONCRETE TESTING PERSONNEL: A person issued a Class "A," "B," or "C" license by the Commission authorizing such person to test/inspect concrete.

FIELD CONCRETE TECHNICIAN: A person issued a Class "A" license by the Commission to test concrete in the field.

PRE-QUALIFYING AGENCY: Construction Materials Safety Board (CMSB)

TESTING AGENCY: Massachusetts Construction Industry Board (MCIB)

1.3 LICENSING

All Concrete Personnel engaged in the testing/inspection of concrete for use in buildings and structures subject to control according to the provisions of Section 127 of this code shall be licensed by the Commission in accordance with these regulations.

1.4 APPLICATION FOR LICENSING

Each person desiring to obtain such license shall make application to the Commission upon such form and in such manner as the Commission shall prescribe and shall furnish evidence satisfactory to the Commission that he is qualified to be licensed in accordance with these Rules and Regulations.

### 1.5 PRE-QUALIFYING AGENCY

The Commission hereby designates the Construction Materials Safety Board as its Pre-Qualifying Agency, provided however, that the Commission may revoke such designation at any time and may designate any other agency or agencies which it deems qualified, from time to time, to act as its Pre-Qualifying Agency. The Pre-Qualification Agency shall examine, or cause to be examined, the examination results and evaluation performed by the Testing Agency on each Concrete Testing Personnel Application and make its recommendation to the Commission regarding such license.

### 1.6 TESTING AGENCY

The Commission hereby designates the Massachusetts Construction Industry Board (MCIB) as the agency to examine and evaluate all persons desiring to be licensed in the practice of concrete testing, provided, however, that the Commission may revoke such designation at any time, and may designate any other agency or agencies which it deems qualified, from time to time, to act as its Testing Agency. The Testing Agency shall submit all examination results and evaluation on each Concrete Testing Application and make its recommendations to the Pre-Qualification Agency regarding such license.

### 1.7 EXAMINATION

Accompanied by the application, there shall be paid to the Testing Agency an initial examination fee to cover the cost of such testing. The Testing Agency may also assess fees for partial or complete retesting. The Testing Agency is authorized to require the applicant to provide all required test equipment.

### 1.8 NOTIFICATION OF EXAMINATION AND EXAMINATION RESULTS

The Testing Agency shall notify the applicant of the time and place for the examination. The Commission shall be informed by the Testing Agency/Pre-Qualifying Agency of the examination results, evaluation and recommendations. Within fourteen (14) days therefrom, the Commission shall notify the applicant of its decision. If the applicant fails fully or partially, he may request of the Testing Agency a retesting. If the applicant is notified by the Commission that he has met all the requirements herein established, he shall submit to the said Commission, the license fee in accordance with section 1.9 of these Rules and Regulations, and his 1½" x 1½", full face, black and white or color photograph.

### 1.9 LICENSING FEE

The fee for licensing is twenty (\$20) dollars in accordance with the fee schedule established by the Commission. Concrete Testing Personnel employed for that purpose by a municipality or county, or the federal government, or the Commonwealth or any department,

commission, agency or authority of, or created by, the Commonwealth, shall be exempt from this fee.

#### 1.10 NUMBER AND CLASSIFICATION

Each person so licensed by the Commission shall be issued a number and classification.

#### 1.11 RENEWALS

Licenses shall be valid for two (2) years. Within thirty (30) days before the expiration date of any such license, the Executive Director of the Commission shall forward to each person so licensed an application form for renewal. The said Executive Director, upon receipt of the completed form and fee, shall renew the license for a period of two (2) years or notify such applicant of the Commission's refusal with the reasons thereof. Upon successful completion of a Class A Technician's examination said applicant is eligible to be licensed upon submittal of an application and fee at any time without further testing, provided when unlicensed said applicant is not under suspension or revocation.

### SECTION 2 PRE-QUALIFICATION REQUIREMENTS FOR PERSONS DESIROUS OF BEING LICENSED FOR CONCRETE TESTING

#### 2.1 EVALUATION

Field Concrete Technicians, subject to these Regulations, shall be examined and evaluated by the Massachusetts Construction Industry Board to determine the applicant's knowledge and ability to perform the following ASTM Standard Test Procedures:

- a. ASTM C172: Sampling Fresh Concrete
- b. ASTM C143: Test for Slump
- c. ASTM C31: Making and Curing Test Specimens in the Field
- d. ASTM C231: Test for Air Content - Pressure Method
- e. ASTM C173: Test for Air Content - Volumetric Method
- f. ASTM C138: Test for Weight per Cubic Foot (Density)
- g. ASTM C192: Storage and Transportation of Test Cylinders

The applicant's performance of these tests is to be observed and evaluated by three (3) qualified jurors designated by the Testing Agency (MCIB), using detailed data sheets. The said jurors' evaluations are appraised by the Certification Committee of the Testing Agency and reappraised by the Board of Trustees of the said Testing Agency. Three (3) categories of performance are to be used in the final evaluation process as follows:

1. PASS: The applicant has satisfactorily completed the examination.

2. PARTIAL: The applicant has failed one (1) of the five (5) performance tests and must take a partial re-test.
3. FAIL: The applicant has failed two (2) or more of the five (5) performance tests and must take a complete re-test.

## SECTION 3 REVOCATION AND SUSPENSION PROCEDURES

### 3.1 REVOCATION AND SUSPENSION

The Commission on its own initiative or upon the recommendation of the Construction Materials Safety Board or the Massachusetts Construction Industry Board, may suspend or revoke the license of any one so engaged in the practice of Concrete Testing found to be in noncompliance with these Rules and Regulations, this Code or the standards of good practice. Notice of suspension or revocation of such license shall be in writing with the reasons for suspension or revocation clearly set forth therein, and served in accordance with Section 121.2.1 of this Code.

### 3.2 NOTICE OF CONFERENCE

Prior to suspension, revocation or refusal to renew such license, written notice of such intent shall be served by the Pre-Qualifying Agency or Commission in accordance with Section 121.2.1 of this Code. Within ten (10) calendar days of receipt of such notice, the affected licensee may request a conference before a three (3) member panel designated by the chairman of the said agency, who will hear facts and make their recommendations to the Pre-Qualifying Agency.

### 3.3 EFFECT OF

Upon suspension or revocation of the license, the licensee shall immediately cease engaging in the testing of concrete and concrete materials for use in buildings and structures which are subject to the provisions of this Code and no action brought before the State Building Code Appeals Board as specified in Section 4.1 of these Regulations or in any court of competent jurisdiction shall stay the said suspension or revocation unless said Appeals Board or court shall issue an order for a stay of the Commission's suspension or revocation.

## SECTION 4 APPEALS

### 4.1 MASSACHUSETTS STATE BUILDING CODE APPEALS BOARD

Any one engaged in the practice of Concrete Testing aggrieved by the suspension or revocation of their license or by an interpretation, order, requirement, direction or failure to act under these Rules and Regulations may appeal to the State Building Code Appeals Board as provided in Section 126 of this Code; however, entry of an

appeal from the Commission's order of revocation or suspension shall not stay such revocation or suspension unless so ordered by the said Appeals Board in a preliminary hearing conducted expressly for the purpose of a stay in accordance with that part of Section 126.3.2 of the Code dealing with the procedure required for a hearing on such stay.

APPENDIX Q

RULES AND REGULATIONS FOR MANUFACTURED BUILDINGS, BUILDING COMPONENTS AND MOBILE HOMES

TABLE OF CONTENTS

FORWARD

PART I.

GENERAL

- SECTION 1. ADMINISTRATION
  - 1.1 Title
  - 1.2 Definitions
  - 1.3 Scope
  - 1.4 Administration and Enforcement
  - 1.5 Authorization of Third Party Inspections
  - 1.6 Approvals and Compliance
  - 1.7 Time and Manufacture
  - 1.8 Retroactive Changes
  - 1.9 Amendments

- SECTION 2. COMPLIANCE ASSURANCE PROGRAMS
  - 2.1 Approval
  - 2.2 Suitability
  - 2.3 Requisites
  - 2.4 Notification of Disapproval
  - 2.5 Approval - evidence
  - 2.6 Approval - report
  - 2.7 Approval - variations
  - 2.8 Amendments - proposed
  - 2.9 Compliance Assurance Program

- SECTION 3. CERTIFICATION
  - 3.1 Manufacturers Data Plate
    - 3.1.1 Contents
  - 3.2 Labels
    - 3.2.1 Contents
    - 3.2.2 Issuance
  - 3.3 Records of Labels
  - 3.4 Attachment of Labels
  - 3.5 Suspension and Revocation
  - 3.6 Variations of Certified Units

- SECTION 4. INSPECTION BY THE STATE ENFORCEMENT AGENCIES OR THEIR AGENTS
  - 4.1 Inspection of Facilities
  - 4.2 Inspection according to Compliance Assurance Programs
  - 4.3 Inspection of Damaged Components

## TABLE OF CONTENTS (continued)

|            |         |   |
|------------|---------|---|
|            | 4.3.1   | Repairing Damaged Components  |
|            | 4.3.2   | Irreparably Damaged Components  |
| 4.4        |         | Monitoring Inspection Agency  |
|            | 4.4.1   | Prior to Approval   |
| 4.5        |         | Inspection by Disassembly   |
| SECTION 5. |         | LOCAL ENFORCEMENT AGENCY PROCEDURES AND INSPECTIONS                               |
| 5.1        |         | Permit Applications   |
|            | 5.1.1   | Permit Application - Statement of Content   |
|            | 5.1.2   | Permit Application - Building System  |
|            | 5.1.3   | Permit Application - Building System Approval                                     |
| 5.2        |         | Inspection of Site Preparation and Service Connections                            |
| 5.3        |         | Compliance with Instructions  |
|            | 5.3.1   | Disassembly Prohibited  |
|            | 5.3.2   | Opening Panels  |
| 5.4        |         | Disposition of Noncomplying New Units   |
| 5.5        |         | Certificates of Occupancy   |
| 5.6        |         | Reporting of Violations to Department of Public Safety                            |
| SECTION 6. |         | FEES  |
| 6.1        |         | Deposit for Application to the Commission   |
| 6.2        |         | Establishment of Fees   |
| SECTION 7. |         | NOTIFICATION OF CHANGES IN NAME, ADDRESS, OWNERSHIP OR LOCATION                   |
| 7.1        |         | Notification by Manufacturers   |
| 7.2        |         | Notification by Inspection Agencies   |
| SECTION 8  |         | PROPRIETARY INFORMATION   |
| PART II    |         | REQUIREMENTS FOR SUBMISSION OF BUILDING SYSTEMS AND COMPLIANCE ASSURANCE PROGRAMS |
| SECTION 9  |         | BUILDING SYSTEMS  |
| 9.1        |         | General Requirements  |
|            | 9.1.1   | Plans, Specifications and Documentation   |
|            | 9.1.2   | Form and Fees   |
|            | 9.1.3   | Identification  |
|            | 9.1.4   | Plans Showing Elements  |
|            | 9.1.5   | Application - Approved Architect or Engineer                                      |
|            | 9.1.6   | On Site Work Identified   |
|            | 9.1.7   | Space for State Administrative Agencies Approval Stamp                            |
|            | 9.1.8   | Material Grade and Quality  |
|            | 9.1.9   | Calculations and Test Reports   |
|            | 9.1.9.1 | Drawings to Scale   |

TABLE OF CONTENTS (continued)

|            |         |  |
|------------|---------|--|
|            | 9.1.9.2 | Label and Data-Plate Location  |
|            | 9.1.9.3 | Drawings Dated and Identified  |
| 9.2        |         | Required Construction Details  |
|            | 9.2.1   | General  |
|            | 9.2.2   | Building Classification  |
|            | 9.2.3   | Space and Fire Safety  |
|            | 9.2.4   | Structural Detail Requirements   |
|            | 9.2.5   | Mechanical Detail Requirements   |
|            | 9.2.6   | Plumbing Detail Requirements   |
|            | 9.2.7   | Electrical Detail Requirements   |
| SECTION 10 |         | COMPLIANCE ASSURANCE PROGRAMS FOR MANUFACTURED BUILDINGS AND BUILDING COMPONENTS |
|            | 10.1    | Organization Requirements  |
|            | 10.2    | Materials Control  |
|            | 10.3    | Production Control   |
|            | 10.4    | Finished Product Control   |
|            | 10.5    | Installation Control   |
|            | 10.6    | Permission for Inspection  |
|            | 10.7    | Inspections by The State Enforcement Agencies                                    |
| PART III   |         | APPROVAL OF INSPECTION AGENCIES  |
| SECTION 11 |         | REQUIREMENTS FOR SUBMISSION  |
|            | 11.1    | Articles of Incorporation  |
|            | 11.2    | Bylaws   |
|            | 11.3    | Business Affiliations of Members   |
|            | 11.4    | Stock Ownership  |
|            | 11.5    | Certifications   |
|            | 11.6    | Experience of Directors  |
|            | 11.7    | Experience of Employees  |
|            | 11.8    | Organization Chart   |
|            | 11.9    | Number and Location of Personnel   |
|            | 11.10   | Employees Training Programs  |
|            | 11.11   | Employee Supervision   |
|            | 11.12   | Non-employees Relationships  |
|            | 11.13   | Products Evaluated   |
|            | 11.14   | Frequency Capability   |
|            | 11.15   | States Approved In   |
| SECTION 12 |         | PROCEDURES FOR APPROVING INSPECTION AGENCIES                                     |
|            | 12.1    | Qualifications   |
|            | 12.2    | Suitability of Application   |
|            | 12.3    | Approvals  |
| SECTION 13 |         | SUSPENSION AND REVOCATIONS   |
|            | 13.1    | Grounds  |



TABLE OF CONTENTS (continued)

- 13.2 Procedures
  - 13.2.1 General
  - 13.2.2 Records
  - 13.2.3 Labels

PART IV RECIPROCITY

SECTION 14 PROCEDURES FOR GRANTING RECIPROCITY TO ANOTHER JURISDICTION

- 14.1 Evaluation
- 14.2 Methods of Extending Reciprocity
- 14.3 Rejections

SECTION 15 PROCEDURES FOR RECIPROCITY CERTIFYING MANUFACTURED BUILDINGS AND BUILDING COMPONENTS

SECTION 16 SUSPENSION AND REVOCATION

PART V APPEALS

SECTION 17 HEARINGS

PART VI SCHEDULE OF FEES

SECTION 18 ESTABLISHMENT

- 18.1 Compliance Assurance Programs and Building Systems
- 18.2 Third Party Inspection Agencies
- 18.3 Annual Renewal Fees
- 18.4 Labels

NON-TEXT PAGE

PART I GENERAL

SECTION I ADMINISTRATION

1.1 TITLE

The State Building Code Commission, Massachusetts Board of Fire Prevention Regulations (Massachusetts Board of State Examiners of Electricians), and the Massachusetts Board of State Examiners of Plumbers and Gas Fitters herewith adopt the Rules and Regulations for Manufactured Buildings, Building Components and Mobile Homes.

1.2 DEFINITIONS

Unless otherwise expressly stated in the State Building Code, the following terms shall, for the purpose of these Rules and Regulations, have the meaning indicated in this section:

**APPROVAL:** Approval by the State Building Code Commission.

**BUILDING COMPONENT:** Any subsystem, subassembly, or other system designed for use in or as part of a structure having concealed elements such as electrical, mechanical, plumbing and fire protection systems and other systems affecting health and safety.

**BUILDING SYSTEM:** Plans, specifications and documentation for a system of manufactured buildings or for a type or a system of building components, which may include structural, electrical, mechanical, plumbing and fire protection systems and other systems affecting health and safety, including variations which are submitted as part of the building system.

**CERTIFICATION:** Any manufactured building, building component or mobile home which meets the provisions of the applicable Codes and Rules and Regulations pursuant thereto; and which has been labeled accordingly.

**CODE:** The Commonwealth of Massachusetts State Building Code or Specialized Codes as defined herein.

**COMMISSION:** The Commonwealth of Massachusetts State Building Code Commission.

**DEPARTMENT - DPS:** The Department of Public Safety, Division of Inspections.

**INSPECTION AGENCIES:** Independent agency, sometimes referred to as "third-party agency", retained by the manufacturer and approved by the State Building Code Commission to perform inspections and evaluations of building systems, compliance assurance programs, manufactured buildings, and building components.

**INSTALLATION:** The process of affixing, or assembling and affixing a manufactured building, building component or mobile home on the building site, and connecting it to utilities, and/or to an existing building. Installation may also mean the connecting of two (2) or more mobile home units designed and approved to be so connected for use as a dwelling.

**LABEL:** An approved device or seal evidencing certification in accordance with the applicable Codes and Rules and Regulations promulgated pursuant thereto.

**LOCAL ENFORCEMENT AGENCY:** A department or agency in a municipality charged with the enforcement of this Code and appropriate specialized codes which include, but are not limited to, the State Plumbing and Gas Fitting Code and the State Electrical Code.

**MANUFACTURED BUILDING:** Any building which has concealed elements, such as electrical, mechanical, plumbing, fire protection, insulation, and other systems affecting health and safety, and which is manufactured or assembled in manufacturing facilities, on or off the building site. Also, any building as defined above which does not have concealed elements, but which has been approved by the Commission at the request of the manufacturer. "Manufactured building" does not mean "mobile home".

**MOBILE HOME:** A structure, transportable in one (1) or more sections, which is eight (8) body feet or more in width and is thirty-two (32) body feet or more in length, and which is built on a permanent chassis, and designed to be used as a dwelling with permanent foundation, when connected to the required utilities, and includes the plumbing, heating, air-conditioning and electrical systems contained therein.

**SPECIALIZED CODE:** All building codes, rules or regulations pertaining to building construction, reconstruction, alteration, repair or demolition promulgated by and under the authority of the various agencies which have been authorized from time to time by the General Court of the Commonwealth of Massachusetts. The specialized codes shall include, but not be limited to, the State Plumbing and Gas Fitting Code and Electrical Code.

**STATE ADMINISTRATIVE AGENCIES:** Boards, commissions, departments or agencies authorized to promulgate, adopt and amend codes and rules and regulations relating to buildings and structures and parts thereof and limited to the Massachusetts State Building Code Commission, Massachusetts Board of Fire Prevention Regulations, Massachusetts State Examiners of Electricians, and the Massachusetts Board of State Examiners of Plumbers and Gas Fitters.

STATE ENFORCEMENT AGENCIES: Boards, commissions, departments or agencies authorized to enforce the provisions of the codes and rules and regulations which have been promulgated, adopted and amended and which relate to buildings or structures and parts thereof and limited to the Department of Public Safety, Massachusetts Board of State Examiners of Plumbers and Gas Fitters, and the Massachusetts State Examiners of Electricians.

### 1.3 SCOPE

- A. These Rules and Regulations govern the design, manufacture, handling, storage, transportation and installation of manufactured buildings, and building components intended for installation in this State and/or manufactured in this State for shipment to any other state in which such building, building components, or mobile homes and the labels thereon are accepted.
- B. The Federal Mobile Home Construction and Safety Standards promulgated by the Department of Housing and Urban Development govern the design, manufacture, handling, storage and transportation of mobile homes for installation in this state.
- C. Subject to local zoning ordinances and by-laws, manufactured buildings, building components or mobile homes may be sold for, delivered to, or installed on, building sites located in any jurisdiction of this State if such buildings, building components or mobile homes have been approved and certified pursuant to the applicable Codes and these Rules and Regulations.

### 1.4 ADMINISTRATION AND ENFORCEMENT

The State Building Code Commission and the State Enforcement Agencies shall enforce all provisions of these Rules and Regulations. The State Enforcement Agencies shall have the responsibility for evaluating and recommending approval to the Commission of building systems, and for inspecting and recommending certification of manufactured buildings and building components for compliance with these Rules and Regulations and the applicable codes. The State Enforcement Agencies and the local enforcement agencies shall accept manufactured buildings, building components, building systems and compliance assurance programs labeled and certified by inspection agencies approved by the Commission and those mobile homes certified as in conformance with the Federal standards by the application of the applicable required HUD label.

### 1.5 AUTHORIZATION OF THIRD PARTY INSPECTIONS

Upon recommendation of the State Enforcement Agencies, the Commission may authorize inspection agencies, sometimes referred to

as third party inspection agencies, to perform all or part of the inspection and certification of manufactured buildings and building components, building systems and compliance assurance programs, including either or both the issuance and the attachment of labels thereto. The Commission may suspend or revoke such authorization for cause.

#### 1.6 APPROVALS AND COMPLIANCE

Upon the recommendation of the State Enforcement Agencies, the Commission may approve building systems and compliance assurance programs which comply with the codes, standards, specifications and requirements and these Rules and Regulations.

#### 1.7 TIME OF MANUFACTURE

For purposes of these regulations, a manufactured building, building component or mobile home is deemed to be manufactured at such time as the label is attached to it in accordance with the approved compliance assurance program.

#### 1.8 RETROACTIVE CHANGES

No changes in the codes, standards, specifications and requirements of these Rules and Regulations shall apply retroactively.

#### 1.9 AMENDMENTS

The State Administrative Agencies shall notify the Commission, and the Commission shall notify all interested parties including State Enforcement Agencies, inspection agencies, manufacturers with approved building systems, and local governmental jurisdictions of all amendments to these Rules and Regulations, and each manufacturer shall have no more than 180 days following the sending of notification to submit to the Commission compliance assurance program revisions in order to comply with such amendments. Where imminent danger to life safety is involved, the State Administrative Agencies may require that immediate effect be given such amendments to the codes, standards, specifications and requirements so adopted.

### SECTION 2 COMPLIANCE ASSURANCE PROGRAMS

#### 2.1 APPROVAL

In order to obtain approval for manufactured buildings or building components a manufacturer shall submit a building system for evaluation to the State Building Code Commission for approvals in accordance with these Rules and Regulations.

## 2.2 SUITABILITY

Prior to a full evaluation, the State Enforcement Agencies shall determine that building systems and/or the application for approval of the compliance assurance program submitted to it are suitable for processing. In the event that the application is found to be unsuitable for processing, the applicant shall be notified in writing of such unsuitability and the basis thereof, within thirty (30) days of the date the application is received by the Commission. In such event, all but twenty-five (\$25) dollars of the fee will be returned and the findings of unsuitability will be without prejudice. Any subsequent submission shall be treated as a new application.

## 2.3 REQUISITES

The State Enforcement Agencies may require tests to determine whether a compliance assurance program meets the codes, standards and requirements of the evaluation of plans, specifications and documentation. The procedures used shall be reviewed and evaluated by the Commission in accordance with these Rules and Regulations. The costs of such tests shall be borne by the applicant.

## 2.4 NOTIFICATION OF DISAPPROVAL

In the event a compliance assurance program is disapproved by the Commission, the Commission shall notify the applicant with a written explanation of the reasons for such disapproval thereto.

## 2.5 APPROVAL - EVIDENCE

Approval of a compliance assurance program shall be evidenced by a letter of certification issued by the Commission.

## 2.6 APPROVAL - REPORT

The State Enforcement Agencies shall prepare and the Commission shall issue to the applicant a building system approval report which shall include therein any conditions imposed for its use.

## 2.7 APPROVAL - VARIATIONS

A building system and compliance assurance program, or any amendment thereto which has been approved, shall not be varied in any way without prior written authorization by the Commission. All amendments shall be in writing and shall be made a part of the written record of the approval.

## 2.8 AMENDMENTS - PROPOSED

Amendments to compliance assurance programs may be proposed by submitting to the Commission for its approval, appropriate plans, specifications, or documentation showing the effect of the proposed amendment on each building system, and the required fee.

2.9 COMPLIANCE ASSURANCE PROGRAM

A manufacturer shall obtain approval from the Commission of a compliance assurance program for his building system. Buildings or building components shall be manufactured in accordance with an approved program in order to be certified. Compliance assurance programs shall be submitted to the Commission for its approval in accordance with these Rules and Regulations.

SECTION 3 CERTIFICATION

Manufactured buildings or building components or mobile homes, accepted by the State Enforcement Agencies and an inspection agency as having been manufactured according to an approved building system and an approved compliance assurance program, shall be certified by the Commission upon the recommendation of the State Enforcement Agencies as complying with the requirements of the applicable codes and these Rules and Regulations. Certification shall be evidenced by the attachment of a label to each certified manufactured building or building component (or groups of components).

3.1 MANUFACTURER'S DATA PLATE

3.1.1 CONTENTS

The following information shall be placed directly or by reference on one (1) or more permanent manufacturer's data plates in the vicinity of the electrical distribution panel, or in some other designated location acceptable to the State Enforcement Agencies, on the manufactured building or building component where it will be readily accessible for inspection:

- a) Manufacturer's name and address;
- b) Serial number of the unit;
- c) Label serial number;
- d) Name and date of applicable building, plumbing, gas and electrical codes and issue of their accumulative supplements complied with;
- e) Model designation and name of manufacturer of major factory-installed appliances;
- f) Identification of permissible type of gas for appliance and directions for water and drain connection;
- g) Snow, wind, seismic and other live loads;



- h) Electrical ratings - instructions and warnings on voltage;
- i) Special conditions or limitations on use of the units, including unsuitability for areas in which specified environmental conditions prevail;
- j) Methods of assembly or joining multiple units;
- k) Type of construction, including fire rating, occupancy class, and interior finish flame spread class;
- l) Building height and story limitation;
- m) Floor area; and
- n) Minimum side yard requirements for fire rating.

If, in the opinion of the State Administrative Agencies, the shape or size of a building component is such that this information cannot be attached to it permanently, the information may be placed in a manual crated with the component or on a tag attached to the crate in which the component is shipped, if the information is not such that the future occupant of the building should know it. If the occupant will need to know the information, it shall be contained in a manual which shall be presented to the occupant upon transfer of possession. If life safety is involved, the item in question shall be plainly labeled.

### 3.2 LABELS

Each manufactured building or building component which is certified pursuant to the applicable codes and these Rules and Regulations, shall have permanently attached thereto, in a visible location as shown on the approved building system, an approved label which cannot be removed therefrom without destroying such label.

#### 3.2.1 CONTENTS

An approved label shall bear the following information:

- a) "This label certifies that this building (or building component) has been manufactured in accordance with an approved building system and compliance assurance program approved by the Commonwealth of Massachusetts State Building Code Commission and inspected by \_\_\_\_\_.";
- b) Label serial number;
- c) Building system approval number;
- d) Manufacturer's serial number;

- e) The words "See data plate located on \_\_\_\_\_."; and
- f) Date of manufacture.

At the direction of the Commission labels and data plates may be limited in size and content for components whose shape and size does not permit the full information to be placed thereon.

### 3.2.2 ISSUANCE

The approved label shall be issued by the Commission or its agents in accordance with the following:

- a) If the Commission delegated the issuance of labels to an inspection agency, the agency shall be required to obtain approval from the Commission for the manner in which they are handled;
- b) Labels must be serially numbered;
- c) A manufacturer's compliance assurance program, submitted in accordance with the Rules and Regulations hereof, shall include requirements for issuance, possession of, attachment of and accounting for all labels to assure that labels are attached only to buildings, building components, or mobile homes manufactured pursuant to an approved building system and inspected pursuant to an approved compliance assurance program; and
- d) Upon request of the inspection agency, the Commission may determine that the manufacturer's record of compliance is such that the inspection agency need not maintain an inspector in a given plant at all times, inspection agency may entrust labels to the custody of one (1) or more employees of the manufacturer, who shall be charged with controlling the use of the such labels. Such employees shall not be given custody of more labels than are necessary. If the conditions of custody are violated, the Commission or an inspection agency shall immediately regain possession of all labels that have not been applied to the manufactured buildings or building components and shall take such further action with respect to buildings or components already labeled and with respect to future labeling, as it may deem necessary to assure compliance with the applicable codes and these Rules and Regulations.

### 3.3 RECORDS OF LABELS

Permanent records shall be kept of the handling of all labels, indicating at least how many labels have been applied to buildings or building components (or groups of components), which labels have

been applied to which buildings or building components, the disposition of any damaged or rejected labels, and the location and custody of all unused labels. Such records shall be maintained by the manufacturer or by the inspection agency. A copy of such records covering attachment of each label shall be sent to the Commission on the tenth of each month and the Commission shall forward all such records to the State Enforcement Agencies.

### 3.4 ATTACHMENT OF LABELS

The inspection agency shall attach in consecutive numerical sequence labels to buildings or building components manufactured in accordance with an approved building system and meeting the requirements of an approved compliance assurance program.

Manufacturers shall attach labels in the same manner to manufactured buildings or building components manufactured in accordance with an approved compliance assurance program, if custody of the labels has been entrusted to them in accordance with this section.

### 3.5 SUSPENSION AND REVOCATION

The State Enforcement Agencies or an inspection agency may suspend or revoke, or cause to be suspended or revoked, the certification of any manufactured building or building component which the State Enforcement Agencies or an inspection agency finds not to comply with the applicable codes or these Rules and Regulations, or which has been manufactured pursuant to a building system or a compliance assurance program for which approval has been suspended or revoked, or which has not been manufactured in accordance with the approved compliance assurance program. The State Enforcement Agencies or an inspection agency shall remove or cause to be removed, labels from any such manufactured building, building component or mobile home until it is brought into compliance with the applicable codes and these Rules and Regulations. Notice of suspension or revocation of certification shall be in writing with the reasons for suspension or revocation clearly set forth therein.

- a) Upon suspension or revocation of the approval of any building system or compliance assurance program, no further labels shall be attached to any manufactured buildings or building components manufactured pursuant to the building system or compliance assurance program with respect to which the approval was suspended or revoked. Upon termination of such suspension or revocation, labels may again be attached to the manufactured building or buildings component manufactured after the date approval was reinstated. Should any building or building component have been manufactured during the period of suspension or revocation, it shall not be labeled unless the State Enforcement Agencies or inspection agency have inspected such building or building component and is satisfied that all requirements for certification have been met.

If the State Enforcement Agency acts under this section, it must notify the inspection agency.

- b) The manufacturer shall return all labels allocated for a manufactured building or building component to the Commission no later than thirty (30) days from the effective date of any suspension or revocation of the State Enforcement Agencies or inspection agency, of the building system or compliance assurance program pursuant to which the manufactured building or building component is being manufactured. The manufacturer shall also return to the Commission all labels which it determines for any reason are no longer needed.

### 3.6 VARIATIONS OF CERTIFIED UNITS

Manufactured buildings, building components or mobile homes certified and labeled pursuant to the applicable codes and these Rules and Regulations shall not be varied in any way prior to the issuance of a certificate of occupancy without resubmission to the Commission for its approval of the variation and of the unit which includes the variation. The State Enforcement Agencies or an inspection agency shall inspect the building, building component or mobile home wherever it is located and such inspection may include such tests or destructive or nondestructive disassembly as the State Enforcement Agencies or an inspection agency deems necessary to assure compliance with the applicable Codes and these Rules and Regulations. Local Enforcement Agencies may be designated by the Commission or State Enforcement Agencies as inspection agencies for such purposes.

## SECTION 4 INSPECTION BY THE STATE ENFORCEMENT AGENCIES OR THEIR AGENTS

The State Enforcement Agencies shall make, or cause to be made, such inspections of the entire processing of manufacturing, certifying, handling, storing and transporting of manufactured buildings or building components produced pursuant to approved building systems as they deem necessary.

### 4.1 INSPECTION OF FACILITIES

As part of the process of evaluating building systems and compliance assurance programs, the State Enforcement Agencies shall inspect, or cause to be inspected, the manufacturing facilities in which the buildings or building components are to be manufactured.

### 4.2 INSPECTION ACCORDING TO COMPLIANCE ASSURANCE PROGRAMS

The State Enforcement Agencies or an inspection agency shall make such inspections as may be required by an approved compliance assurance program, or as may be deemed necessary by the State Enforcement Agencies.

#### 4.3 INSPECTION OF DAMAGED COMPONENTS

Prior to the issuance of a certificate of occupancy, the State Enforcement Agencies or an inspection agency shall inspect, or cause to be inspected, certified manufactured buildings or building components which it determines to have been sufficiently damaged after certification to warrant such inspection and to take such action with regard to such buildings or building components as is authorized hereof, or as is otherwise necessary to eliminate dangerous conditions. The local enforcement agencies may be designated by the Commission or the State Enforcement Agencies as the inspection agency.

##### 4.3.1 REPAIRING DAMAGED COMPONENTS

The State Enforcement Agencies or an inspection agency shall require manufactured buildings or building components which are so damaged as to no longer comply with the applicable Codes and these Rules and Regulations, to be repaired and made to comply within a reasonable time; or if they are so damaged that they cannot be brought into compliance, the State Enforcement Agencies or inspection agency shall order that the labels be removed from such buildings, building components or mobile homes. A report under this section shall be filed with the inspection agency, Commission and State Enforcement Agency.

##### 4.3.2 IRREPARABLY DAMAGED COMPONENTS

Irreparably damaged buildings or building components shall be disposed of by the manufacturer.

#### 4.4 MONITORING INSPECTION AGENCY

The State Enforcement Agencies or their designated agents shall examine each approved inspection agency, at any reasonable time, and without prior announcement, in order to monitor the reliability of each agency and of its monitoring of each compliance assurance program. Each such examination shall investigate the adequacy of all procedures used by the agency in monitoring compliance assurance programs including inspection, tests, production methods, process controls, operator performance, materials, receipts, storage and handling, workmanship standards, records and all other activities which implement the compliance assurance program in the manufacturing facility, during transport, on-site, and at critical subcontractors' facilities. The results of such examinations shall be filed with the office of the Commission. Copies of such reports shall be sent to the inspection agency and the State Enforcement Agencies. Inspection agencies shall be specifically notified by the Commission of any deficiencies and of the manner and time by which such deficiencies must be eliminated. If deemed necessary by the State Enforcement Agencies an inspection agency's approval may be suspended or revoked by the Commission as provided herein.

4.4.1 PRIOR TO APPROVAL

Such examinations may also be conducted before approving an inspection agency.

4.5 INSPECTION BY DISASSEMBLY

No inspection entailing disassembly, damage to or destruction of certified manufactured buildings, building components or mobile homes shall be conducted except to implement these Rules and Regulations.

SECTION 5 LOCAL ENFORCEMENT AGENCY PROCEDURES AND INSPECTIONS

5.1 PERMIT APPLICATIONS

Upon application in conformity with the provisions of the appropriate codes, local enforcement agencies shall issue appropriate permits for certified manufactured buildings, building components or mobile homes prior to installation, and shall not withhold approval of the appropriate permits for buildings containing certified building components which in all other respects comply with all applicable Codes, provided that any manufactured buildings, building components or mobile homes found by the State Enforcement Agencies not to comply with the appropriate codes or these Rules and Regulations shall be brought into compliance before such permit shall be issued. An application to local enforcement agencies for an appropriate permit shall, when requested, in addition to any other requirements contain:

5.1.1 PERMIT APPLICATION - STATEMENT OF CONTENT

A statement that the work to be performed under such permit is to include the installation of a certified manufactured building, building component or mobile home in accordance with the provisions of the applicable codes, the statement to be signed by the applicant or his agent, with the appropriate address.

5.1.2 PERMIT APPLICATION - BUILDING SYSTEM

A true copy of the approved building system with respect to which the manufactured building or building component was manufactured or is to be manufactured, where one has not previously been furnished to that local enforcement agency.

5.1.3 PERMIT APPLICATION - BUILDING SYSTEM APPROVAL

A copy of the Building System Report, as approved by the Commission, where it has not previously been furnished to the Local Enforcement Agency.

5.2 INSPECTION OF SITE PREPARATION AND SERVICE CONNECTIONS

Appropriate local enforcement agencies shall inspect site preparation work including foundations, not within the scope of the approval and certification, and the structural, mechanical, plumbing and electrical connections among units, for compliance with applicable law, rules and regulations.

5.3 COMPLIANCE WITH INSTRUCTIONS

Appropriate local enforcement agencies shall inspect all manufactured buildings, building components or mobile homes upon, or promptly after, installation at the building site to determine whether all instructions in the Building System Approval Report or conditions listed on the manufacturer's data plate have been followed.

This may include tests for tightness of plumbing and mechanical systems, and for malfunctions in the electrical system and a visual inspection for obvious nonconformity with the approved building system.

5.3.1 DISASSEMBLY PROHIBITED

Unauthorized destructive disassembly of certified buildings and building components and mobile homes shall not be performed in order to conduct such tests or inspections, except as provided in section 4.3, nor shall there be imposed standards or test criteria different from those adopted by the State Enforcement Agencies or specified in the Building System Approval Report, or the "HUD's" Mobile Home Construction and Safety Standards.

5.3.2 OPENING PANELS

Nondestructive disassembly may be performed only to the extent of opening access panels and cover plates.

5.4 DISPOSITION OF NONCOMPLYING NEW UNITS

Local enforcement agencies shall require the manufacturer to dispose of noncomplying manufactured buildings and building components after consultation with the State Enforcement Agencies and reasonable notice to the manufacturer or owner thereof, as the case may be, of the proposed disposition.

5.5 CERTIFICATES OF OCCUPANCY

Appropriate local inspectors shall issue certificates of occupancy for certified manufactured buildings and mobile homes containing certified building components which otherwise comply with all the applicable codes, after they have been installed and inspected pursuant to the applicable codes and these Rules and Regulations, provided

that any manufactured building or building component found not to comply with the Building System Approval Report or any mobile home found not to comply with "Hud's" Mobile Home Construction and Safety Standards shall be brought into compliance before such certificate of occupancy shall be issued.

#### 5.6 REPORTING OF VIOLATIONS TO DEPARTMENT OF PUBLIC SAFETY

When any local enforcement agency is making an inspection and finds violations or suspected violations, it shall report the details of the violations in writing to the Department. Where violations are hazardous to occupants, a certificate of occupancy shall not be issued and the building shall not be occupied before such hazards are corrected. If the violations are not hazardous, a provisional certificate of occupancy may be issued. The Department shall forward all such reports of violations to the Commission and the State Enforcement Agencies.

### SECTION 6 FEES

#### 6.1 DEPOSIT FOR APPLICATION TO THE COMMISSION

A deposit shall be required upon application to the Commission to perform any of the functions in these Rules and Regulations.

#### 6.2 ESTABLISHMENT OF FEES

Fees charged by the Commission for functions performed shall be in accordance with the fee schedule established by the State Administrative Agencies as specified in Part VI, Section 18 of these Rules and Regulations.

### SECTION 7 NOTIFICATION OF CHANGES IN NAME, ADDRESS, OWNERSHIP OR LOCATION

#### 7.1 NOTIFICATION BY MANUFACTURERS

Manufacturers shall notify the Commission in writing within ten (10) days of any of the following occurrences:

- a) The corporate name is changed;
- b) The main address of the company is changed;
- c) There is a change in twenty-five (25) percent or more of the ownership interest of the company within a twelve (12) month period;
- d) The location of any manufacturing facility is changed;



- e) A new manufacturing facility is established; or
- f) There are changes in principal officers of the firm.

The Commission shall notify the State Administrative Agencies of such occurrences.

## 7.2 NOTIFICATION BY INSPECTION AGENCIES

Inspection agencies shall notify the Commission in writing within ten (10) days of any of the following occurrences:

- a) The company name is changed;
- b) The main address of the company is changed;
- c) There is a change in twenty-five (25) percent or more of the ownership interest or control of the company within a twelve (12) month period;
- d) The location of any testing facility is changed;
- e) A new testing facility is established; or
- f) There are changes in principal officers and key supervisory and responsible personnel of the firm.

The Commission shall notify the State Administrative Agencies of such occurrences.

## SECTION 8 PROPRIETARY INFORMATION

All information relating to building systems and compliance assurance programs which the manufacturer or other party considers proprietary shall be so designated by him at the time of its submission, and shall be so held by the State Enforcement Agencies and State Administrative Agencies, except as the State Administrative Agencies determine in each case, that disclosure is necessary to carry out the purposes of the applicable codes and these Rules and Regulations.

## PART II REQUIREMENTS FOR SUBMISSION OF BUILDING SYSTEMS AND COMPLIANCE ASSURANCE PROGRAMS

### SECTION 9 BUILDING SYSTEMS

Building systems shall meet the requirements set forth below to be evaluated for compliance with the standards, specifications and requirements adopted by the State Administrative Agencies.

9.1 GENERAL REQUIREMENTS

9.1.1 PLANS, SPECIFICATIONS AND DOCUMENTATION

Building systems, including all plans, specifications and other documentation, shall be submitted in quadruplicate to the Commission who shall act as the depository and disbursing officer of all such items. The Commission shall forward to the appropriate State Enforcement Agencies plans, specifications and documentation for their recommendations.

9.1.2 FORM AND FEES

Building systems shall be submitted in the form prescribed by the Commission and shall be accompanied by all required fees.

9.1.3 IDENTIFICATION

All documents submitted with the application shall be identified to indicate the manufacturer's name, office address and address of the manufacturing facility.

9.1.4 PLANS SHOWING ELEMENTS

Plans shall be submitted showing all elements relating to specific systems on properly identifiable sheets.

9.1.5 APPLICATION - APPROVED ARCHITECT OR ENGINEER

Each building system application shall bear the signature and seal of an approved registered architect or registered professional engineer certifying that the building system complies with the applicable codes and standards promulgated herein.

9.1.6 ON-SITE WORK IDENTIFIED

All work to be performed on-site, including connection of all systems, equipment and appliances, shall be identified and distinguished from work to be performed in the manufacturing facility.

9.1.7 SPACE FOR STATE ADMINISTRATIVE AGENCIES APPROVAL STAMP

A 3" x 4" blank rectangular space shall be provided on all sheets of plans near the title box for the Commission's stamp of approval.

9.1.8 MATERIAL GRADE AND QUALITY

Grade, quality and identification of all material shall be specified.

### 9.1.9 CALCULATIONS AND TEST REPORTS

Design calculations and test reports shall be specified.

#### 9.1.9.1 DRAWINGS TO SCALE

Drawings shall be drawn to scale and be legible.

#### 9.1.9.2 LABEL AND DATA PLATE LOCATION

Drawings shall indicate the location of the approved label and data plate.

#### 9.1.9.3 DRAWINGS DATED AND IDENTIFIED

Drawings shall be dated and identified. The number of sheets in each set shall be indicated.

### 9.2 REQUIRED CONSTRUCTION DETAILS

Building systems for manufactured buildings shall provide or show, but not be limited to, the details listed below including the method of their testing or evaluation, or both. These requirements shall apply to the building systems for building components only to the extent deemed necessary by the State Enforcement Agencies to permit a proper evaluation of the building component.

#### 9.2.1 GENERAL

- a) Details and methods of installation of manufactured buildings or building components on foundations and/or to each other.
- b) All exterior elevations.
- c) Cross sections as necessary to identify major building components.
- d) Details of flashing, such as at openings and at penetrations through roofs and subcomponent connections. Indicate flashing material and gauge to be used.
- e) Attic access and attic ventilation.
- f) Exterior wall, roof and soffit material as well as finish.
- g) Interior wall and ceiling finish material.
- h) Fire separation walls.
- i) Sizes, locations and types of doors, windows and fire/smoke detectors.

- j) Recommended foundation plans, vents and underfloor access.

9.2.2 BUILDING CLASSIFICATION

- a) Occupancy or use.
- b) Area, height, and number of stories.
- c) Type of construction.
- d) Fireresistance ratings.

9.2.3 SPACE AND FIRE SAFETY

- a) Details of fire resistance rated assemblies for all stairway enclosures, doors, walls, floors, ceilings, partitions, columns, roof and shaft enclosures.
- b) Detail of Fire Protection Systems.
- c) Details as to width of all aisles, exits, corridors, passageways and stairway enclosures.
- d) Toxicity and flame spread classification of finished materials.

9.2.4 STRUCTURAL DETAIL REQUIREMENTS

- a) Engineer's calculations of structural members, where appropriate.
- b) Structural and framing details of all floors, roof and walls.
- c) Details and stress diagrams of roof trusses.
- d) Details of reinforcing steel.
- e) Complete loading schedule.
- f) Column loads and column schedule.
- g) Lintel schedule.
- h) Size, spacing and details of all structural elements.
- i) Grade or quality of all structural elements (lumber, steel, etc.).
- j) Elevation of structural elements, walls or sections thereof, providing resistance to vertical loads or lateral forces.
- k) Complete details of all structural connections.

9.2.5 MECHANICAL DETAIL REQUIREMENTS

- a) Location of all equipment and appliances. Indicate equipment and appliances listed or labeled by approved agencies.
- b) Heat loss and heat gain calculations.
- c) Manufacturer's name, make, model, number, BTU, input and output rating of all equipment and appliances, as appropriate, or the equal thereof.
- d) Duct and register locations, sizes, and materials.
- e) Clearances from combustible material or surfaces for all ducts, flues and chimneys.
- f) Method of providing required combustion air and return air.
- g) Location of flues, vents and chimneys and clearances from air intakes and other vents and flues.
- h) Details regarding dampers in ducts penetrating fire separations.
- i) Complete drawings of fire sprinkler system, standpipe system or smoke/fire alarm system, as required.
- j) Detail of elevator or escalator system, including method of emergency operation.
- k) Duct and piping insulation thickness.
- l) Ventilation air calculations.

9.2.6 PLUMBING DETAIL REQUIREMENTS.

- a) Plan or schematic drawing of the plumbing layout, including but not limited to, size of piping, fitting, traps and vents, cleanouts and valves, gas, water, and drainage system.
- b) Plumbing materials, and location of all equipment and appliances to be used. Indicate fixture unit capacity of system(s) and the make, model, and rating/capacity of equipment and appliances. Indicate equipment and appliances listed or labeled by approved agencies.
- c) Make and model of safety controls (such as for water heaters), their location, and whether listed or labeled by approved agencies.
- d) How piping is to be supported and intervals of support.

- e) Location of vents above roofs and required clearances, including but not limited to clearances from air intakes, other vents and flues.
- f) Methods of testing.

#### 9.2.7 ELECTRICAL DETAIL REQUIREMENTS

- a) Plan of service equipment, including service entrance, conductors, service raceway and clearances above ground and above structures.
- b) Method and detail for grounding service equipment.
- c) Single line diagram of the entire electrical installation.
- d) Load calculations for service and feeders.
- e) Sizes of all feeders and branch circuits.
- f) Size, rating and location of main disconnect/overcurrent protective devices.
- g) Method of interconnection between manufactured buildings or building components and location of connections.
- h) Location of all outlets and junction boxes.
- i) Method of mounting fixtures and wiring installations.
- j) Lighting power calculations.

#### SECTION 10 COMPLIANCE ASSURANCE PROGRAMS FOR MANUFACTURED BUILDINGS AND BUILDING COMPONENTS

Compliance assurance programs shall be approved if they meet the requirements set forth in this section. It is the manufacturer's responsibility to execute every aspect of this program. The manufacturer shall continue to be responsible for all corrective actions required and the contractual relationship between the manufacturer and the inspection agency shall not diminish such responsibility. The manufacturer shall cooperate with the inspection agency by providing the inspection agency with all necessary reports, information, documents, records, facilities, equipment, samples and other assistance for assuring compliance.

The manufacturer's compliance assurance program shall be submitted to the Commission in the form of a compliance assurance manual which shall contain complete documentation of all compliance assurance activities of both the manufacturer and the inspection agency. The manual shall be comprehensively indexed, and shall treat the material listed here in detail, as follows:

10.1 ORGANIZATION REQUIREMENTS:

- a) A procedure for periodic revision of the manual;
- b) An organizational structure for implementing and maintaining the compliance assurance program and its functional relationship to other elements of the organization structure of the manufacturer, which structure shall provide for independence from the production department;
  - 1) Company officers and employees in charge of the compliance assurance program must be identified, and their training and qualifications specified;
- c) A uniform system of audit (in-depth analysis of program effectiveness and means to identify deficiencies) to monitor program performance periodically;
- d) Complete and reliable records of manufacturing and site operations, if any (suitable means of storage, preservation and accessibility of copies of forms to be utilized shall be included);
- e) A system to control changes in production or inspection procedures;
- f) A system to assure that working drawings and specifications, working instructions and standards, procurement documents, etc. conform to the approved building system;
- g) A serial number system for buildings or building components; and
- h) The method of safekeeping, handling and attaching labels and identification of those employees responsible therefor.

0.2 MATERIALS CONTROL:

- a) Procedure to assure effective control over procurement sources to ensure that materials, supplies and other items used in production and site operations, if any, conform to the approved plans, specifications and quality requirements;
- b) Procedures for inspection of materials, supplies and other items at the point of receipt;
- c) Method of protection of materials, supplies and other items against deterioration prior to their incorporation in the certified buildings or building component; and
- d) Provision for disposal of rejected materials, supplies and other items.

10.3 PRODUCTION CONTROL:

- a) Procedures for timely remedial and preventive measures to assure product quality;
- b) Provision, maintenance and use of testing and inspection;
- c) Provision for frequency of sampling inspections;
- d) Provision of necessary authority to reject defective work and carry out compliance assurance functions, notwithstanding any conflict with production department goals and needs;
- e) A schematic of the manufacturing operation showing the location of inspection stations, and "hold" points for mandatory inspection characteristics;
- f) Inspection and test procedures, including accept/reject criteria and mandatory inspection characteristics;
- g) Standards of workmanship; and
- h) Provision of disposal of rejects.

10.4 FINISHED PRODUCT CONTROL:

- a) Procedure for final inspection of all manufactured buildings or building components before shipment to the site or storage point, including identification and labeling;
- b) Procedures for handling and storing all finished manufactured buildings or building components, both at the manufacturing plant or other storage point and after delivery to the building site;
- c) Procedures for packing, packaging and shipping operations and related inspections; and
- d) Procedures for transportation, including all measures to protect against damage while in transit, and setting forth the modes of transportation to be utilized and the carrying equipment and procedures.

10.5 INSTALLATION CONTROL

- a) Installation procedures including component placement, equipment and procedures, field erection and finishing work, utility connection instructions and all appropriate on-site inspection criteria and test descriptions; and



- b) Organizational provisions for field repair and disposal of rejects.

#### 10.6 PERMISSION FOR INSPECTION

The manufacturer shall provide the Commission with written permission, signed and notarized, for the State Enforcement Agencies to inspect his manufacturing facilities, his products, and building sites under his control at any reasonable time without prior announcement.

#### 10.7 INSPECTIONS BY THE STATE ENFORCEMENT AGENCIES

The Compliance Assurance Manual shall contain detailed plans for inspections by the State Enforcement Agencies or inspection agency.

### PART III APPROVAL OF INSPECTION AGENCIES

#### SECTION 11 REQUIREMENTS FOR SUBMISSION

An inspection agency seeking approval shall submit a quadruplicate application to the Commission which shall include the items listed in this section.

##### 11.1 ARTICLES OF INCORPORATION

The original Articles of Incorporation of the agency and all subsequent amendments thereto, as filed in the State of Incorporation.

##### 11.2 BY-LAWS

The by-laws of the organization, if any.

##### 11.3 BUSINESS AFFILIATIONS OF MEMBERS

The names, addresses and business affiliations of all members of the Board of Directors and of top management personnel.

##### 11.4 STOCK OWNERSHIP

Individual interests representing more than ten (10) percent of the outstanding ownership reflecting the financial interest of the agency's Board of Directors and top management personnel.

##### 11.5 CERTIFICATIONS

Certification by the agency that:

- a) Its Board of Directors, as a body, and its technical personnel, as individuals, can exercise independence of judgment; and

- b) Its activities pursuant hereto will result in no financial benefit to the agency via stock ownership, or other financial interests in any producer, supplier or vendor of products involved, other than through standard published fees for services rendered.

#### 11.6 EXPERIENCE OF DIRECTORS

Names, years of experience, state in which professionally registered and other qualifications of the directors of inspection or evaluation programs.

#### 11.7 EXPERIENCE OF EMPLOYEES

Names and years of experience of employees practicing in the following disciplines: architecture, structural engineering, mechanical engineering, electrical engineering, fire protection and other branches of engineering; the state in which each is registered and the service each performs.

#### 11.8 ORGANIZATION CHART

An organization chart showing management and supervisory persons including the number of graduate engineers and architects, and the names of all consulting engineers or architects, designating which are full-time and which are part-time employees.

#### 11.9 NUMBER AND LOCATION OF PERSONNEL

Number and location of factory inspectors, supervisors, and other technicians, including evaluators of factory inspectors and the qualifications of each specialized group, including records of work experience, licenses held and other pertinent qualifications; description of the types of work each group and each technician is expected to perform and the qualifications of each group and each technician to perform the work assigned.

#### 11.10 EMPLOYEES TRAINING PROGRAMS

An outline of the training program, if any, of the agency to assure that all inspectors, evaluators and other technicians are properly trained to do each job assigned to them.

#### 11.11 EMPLOYEE SUPERVISION

An outline of the general procedures for supervision of inspectors and evaluators, including checking and evaluation of their work.

11.12 NON-EMPLOYEES RELATIONSHIPS

All engineers, technicians and other personnel who will perform services for the organization but who are not employees of the organization, and the supervisory and other relationships which each will have to the agency.

11.13 PRODUCTS EVALUATED

Type of products, components, equipment, structures and other items which the organization has evaluated, tested or inspected and the number of years of experience the organization has had with each, and the type of codes, standards, specifications and requirements with respect to which the organization has had experience in providing evaluation, inspection or testing services, and the number of years experience with each.

11.14 FREQUENCY CAPABILITY

Description of the frequency with which the agency is capable of performing inspections or evaluations.

11.15 STATES APPROVED IN

List of the states in which the agency is now approved to inspect or evaluate manufactured buildings or building components or parts thereof for compliance with approved building systems.

SECTION 12 PROCEDURES FOR APPROVING INSPECTION AGENCIES

12.1 QUALIFICATIONS

Upon the recommendation of the State Enforcement Agencies, the Commission may approve inspection agencies which meet the requirements of the applicable codes and these Rules and Regulations and which the State Administrative Agencies find otherwise qualified to perform the functions proposed to be delegated to them.

12.2 SUITABILITY OF APPLICATION

Prior to a full evaluation of an application for approval, the Commission shall determine whether such application is unsuitable for processing. In the event the application is found to be suitable for processing, the applicant shall be notified in writing of such unsuitability and the basis thereof within thirty (30) days of the date of the application is received by the Commission.

In such event, all but twenty-five (\$25.00) dollars of the fee will be returned, and the rulings of unsuitability shall be without prejudice. Any subsequent submission shall be treated as a new application.

### 12.3 APPROVALS

In the event of approval of the Commission, an inspection agency shall be notified by a letter from the Commission indicating such approval and stating specifically the functions which the applicant has been approved to perform. Such approval shall not constitute the actual delegation of such functions.

## SECTION 13 SUSPENSION AND REVOCATION

### 13.1 GROUNDS

The Commission may suspend or revoke its approval of any inspection agency if the approval was issued in error; was issued on the basis of incorrect information; was issued in violation of any of the applicable Codes or these Rules and Regulations; if the inspection agency violates any of the applicable Codes or these Rules and Regulations; if examination discloses that the agency failed to perform properly; or for such other cause as may be deemed sufficient by the State Enforcement Agencies to warrant such action.

### 13.2 PROCEDURES

#### 13.2.1 GENERAL

If the Commission suspends or revokes the approval of an inspection agency, the inspection agency shall be given notice in writing from the Commission of the suspension or revocation with the reasons therefore set forth therein. Manufacturers being evaluated or inspected by such agencies, all local enforcement agencies within this State and the State Enforcement Agencies shall also be notified in writing of such suspension or revocation. Such notices shall contain instructions to the manufacturer and to the local enforcement agency as to the procedures to be followed regarding manufactured buildings or building components previously certified by an agency whose approval has been suspended or revoked.

#### 13.2.2 RECORDS

An inspection agency whose approval has been suspended or revoked shall within ninety (90) days of the suspension or revocation deliver to the custody of the Commission the originals of all records required to be maintained during the course of the inspection agency operations pursuant to the applicable codes and these Rules and Regulations.

#### 13.2.3 LABELS

An inspection agency for which approval has been suspended or revoked shall within ninety (90) days of the suspension or revocation deliver to the custody of the Commission all labels in the agency possession, under its control, or for which it is responsible pursuant to the applicable codes and these Rules and Regulations.

## PART IV RECIPROCITY

If the Commission finds that the standards for the manufacture and inspection of manufactured buildings or building components prescribed by statute or rules and regulations of another state, governmental agency or private agency meet the objectives of the applicable codes and these Rules and Regulations, and are enforced satisfactorily by such other state or other agency, or by their agents, the State Enforcement Agencies shall accept manufactured buildings or building components which have been certified by such other state or other agency, and the Commission shall assure or be assured that the appropriate label is attached thereto. The standards of another state or agency shall not be deemed to adequately be enforced unless such other state or agency provides for notification to the Department of suspensions or revocations of approvals issued by that other state or agency in a manner satisfactory to the Commission and State Enforcement Agencies and so notify the Commission. The Commission shall notify the State Enforcement Agencies of any action taken under this section.

## SECTION 14 PROCEDURES FOR GRANTING OR REFUSING RECIPROCITY TO ANOTHER JURISDICTION

## 14.1 EVALUATION

The State Enforcement Agencies may evaluate the statute, codes, rules and regulations of another state or other agency at any time.

## 14.2 METHODS OF EXTENDING RECIPROCITY

If the Commission find that the standards prescribed by the statute or rules and regulations of another state or another agency meet the objectives of the appropriate codes and that these rules and regulations are satisfactorily enforced, it may upon the recommendation of the State Enforcement Agencies, as provided in Section 2.1, extend reciprocity to that jurisdiction by:

- a) Giving notice to any requesting manufacturer;
- b) Giving notice to the Administrative Agency of the other jurisdiction;
- c) Giving notice to the State Enforcement Agencies and all local enforcement agencies in this state.

## 14.3 REJECTIONS

If the standards of the other state or other agency do not meet the objectives of the appropriate codes or are inadequately enforced, reciprocity shall not be extended. In that event, the Commission shall notify any requesting manufacturer and the Administrative Agency of the other state or other agency of the refusal and the reasons therefore.

SECTION 15 PROCEDURES FOR RECIPROCITY CERTIFYING MANUFACTURED BUILDINGS OR BUILDING COMPONENTS

A manufacturer from a jurisdiction to which reciprocity has been extended shall submit to the Commission evidence that his building system and compliance assurance program have been approved by such state or other agency. The Commission shall verify the approval and shall notify the State Enforcement Agencies, local enforcement agencies and the manufacturer in writing of such verification and that properly labeled buildings or building components of his manufacture will be accepted.

SECTION 16 SUSPENSION AND REVOCATION

The Commission shall suspend or revoke, or cause to be suspended or revoked, the acceptance or certification or both of such reciprocally certified manufactured buildings or building components if the State Enforcement Agencies determine that the standards for the manufacture and inspection of which manufactured buildings or building components of such other state or other agency do not meet the objectives of the appropriate codes and these Rules and Regulations, or that such standards are not being enforced to the satisfaction of the State Enforcement Agencies. If such other state or other agency or its agents should suspend or revoke its approval and certification, the acceptance or certification or both granted under this Part shall be revoked or suspended accordingly. Notice to the State Enforcement Agencies, local enforcement agencies, manufacturer and to the Administrative Agency of such other state or agency of such suspension or revocation shall be in writing with the reasons for such suspension or revocations set forth therein. Appeals from such suspension or revocations shall receive timely review.

PART V APPEALS

SECTION 17 HEARINGS

All hearings shall comply with the applicable sections of the applicable codes and the Rules and Regulations thereof established for the purpose of appeal.

PART VI SCHEDULE OF FEES

SECTION 18 ESTABLISHMENT

The following is the SCHEDULE OF FEES established by the Commission for certifying manufactured buildings or building components. Fees shall be made payable to the "Commonwealth of Massachusetts State Building Code Commission" and shall accompany all applications for certification.

18.1 COMPLIANCE ASSURANCE PROGRAMS AND BUILDING SYSTEMS

- a) An initial fee of five hundred (\$500.00) dollars shall be charged each manufacturer for its certified compliance assurance program for each plant desiring certification. There shall be an additional charge of five hundred (\$500.00) dollars for the certified building system, except that there shall be no such additional charge per building component. The maximum fee charged under this section shall be one thousand (\$1,000.00) dollars for each manufacturing plant.

18.2 THIRD PARTY INSPECTION AGENCIES

- a) An initial fee of five hundred (\$500.00) dollars shall be charged to each third party inspection agency.

18.3 ANNUAL RENEWAL FEES

- a) One year from the date of certification of the manufacturer and every year thereafter certification is in effect, there shall be paid an annual renewal fee of five hundred (\$500.00) dollars for each such certification.
- b) One year from the date of certification of the Third Party Inspection Agency, and every year thereafter certification is in effect, there shall be paid an annual renewal fee of two hundred and fifty (\$250.00) dollars.

18.4 LABELS

- a) A fee of twelve dollars and fifty cents (\$12.50) per unit of a manufactured building shall be charged for each label issued by the Commission.

Note: A "unit" as used in this section shall mean any building or proportion thereof which is towed or shipped separately to be somehow tied together at the site.

- b) A fee of one (\$1.00) dollar per building component shall be charged for each label issued by the Commission for building components.

Note: Manufacturers of building components shall be permitted to use any labels as approved by the Commission. If such labels are supplied by any source other than the Commission, there shall be no charge for such labels.

- c) Mutilated labels may be replaced at the option of the Commission at a cost of two (\$2.00) dollars each.

780 CMR: STATE BUILDING CODE COMMISSION

- d) Upon satisfactory proof to the Commission of lost or stolen labels, not the result of negligence, labels may be replaced at a cost of two (\$2.00) dollars each.
- e) Labels shall be purchased from the Commission by the inspection agency or manufacturer.

PI  
AC  
1.3  
in  
table  
8  
W/A



APPENDIX Q

RULES AND REGULATIONS CONTROLLING THE USE OF NATIVE LUMBER

PART I GENERAL

SECTION I ADMINISTRATION

1.1 TITLE

As authorized by Chapter 802 of the Acts of 1972, and in accordance with Section 128 of the State Building Code establishing the Construction Materials Safety Board, the following Rules and Regulations are adopted for Controlling the Use of Native Lumber.

1.2 DEFINITIONS

Unless otherwise expressly stated in the State Building Code, the following terms shall, for the purpose of these Rules and Regulations, have the meaning indicated in this section:

BOARD: Construction Materials Safety Board

CODE: Commonwealth of Massachusetts State Building Code

COMMISSION: Commonwealth of Massachusetts State Building Code Commission

NATIVE LUMBER: Native lumber is wood processed in the Commonwealth of Massachusetts by a mill registered in accordance with the regulations of the State Building Code Commission. Such wood is ungraded but is stamped or certified in accordance with the requirements of Section 852.1.1 of this Code. For the purpose of this definition, native lumber shall be restricted to use in one- and two-story dwellings, barns, sheds, agricultural and accessory buildings and structures and other uses as permitted by Section 852.1.1.

PERSON: Individual, partnership, corporation, trust, joint venture, etc.

WOOD PRODUCERS: Persons or corporations in the business of milling wood into native lumber within the Commonwealth of Massachusetts.

1.3 REGISTRANTS

No person shall engage in the producing of native lumber for use in buildings or structures within the Commonwealth of Massachusetts unless registered by the State Building Code Commission.

#### 1.4 APPLICATION FOR REGISTRATION

Each person desiring to obtain registration as a wood producer of native lumber shall make application to the Commission upon such form and in such manner as the Commission shall prescribe and shall furnish evidence satisfactory to the Commission that he is qualified to be registered in accordance with these rules and regulations.

#### 1.5 APPLICATION FEE

Applications shall be accompanied by a registration fee of twenty-five (\$25.00) dollars. This initial registration fee shall be for two (2) years. Registration shall be reviewed every two (2) years in accordance with the Rules and Regulations of the Commission. The fee thereafter for a two (2) year renewal shall be ten (\$10.00) dollars.

#### 1.6 RENEWALS

Registration shall be valid for two (2) years and shall be renewed biennially. Within thirty (30) days before the expiration date of any such registration, the Executive Director of the Commission shall forward to each person so registered an application form for renewal. The said Executive Director, upon receipt of the completed form and fee, shall renew the registration for a period of two (2) years or notify such applicant of his refusal with reasons thereof. Any application for renewal of registration which has expired shall require the payment of a new registration fee.

#### 1.7 PRE-QUALIFYING AGENCY

The Commission hereby designates the Massachusetts Wood Producers' Association as its pre-qualifying agency, providing, however, that the Commission may revoke such designation at any time and may designate any other agency or agencies which it deems qualified, from time to time, to act as its pre-qualifying agency for pre-examination registration.

#### 1.8 PENALTIES

Any such person who fails to comply with the requirements of these rules and regulations or who files a false report shall be subject to the penalties and actions as prescribed in Section 121 of the Code.

### SECTION 2 REGISTRATION

#### 2.1 STAMP

Each person registered by the Commission shall be issued a name and number for use in stamping or certifying the native lumber which he produces.

## 2.2 STAMP CONTENTS

Each stamp filed with this Commission shall be a minimum of two inches by four inches (2" x 4"), with a minimum of thirty-six (36) pt. letters and shall contain the following information:

- a) Name of native lumber producer;
- b) Registration number; and
- c) Species of wood.

## 2.3 STAMP USE

Each piece of native lumber produced shall bear the stamp so registered with this Commission.

## 2.4 STAMP - UNLAWFUL USE

Each registered mill shall be assigned an individual number. It shall be unlawful to use such registration number in any mill other than the mill so registered.

## 2.5 STAMP - MANUFACTURE

Each producer shall be responsible for the manufacture and use of his stamp in accordance with the requirements of the Commission and these Rules and Regulations.

## SECTION 3 REVOCATION AND SUSPENSION PROCEDURES

### 3.1 REVOCATION AND SUSPENSION

The State Building Code Commission on its own initiative or upon the recommendation of the Construction Materials Safety Board may suspend or revoke the registration of any such mill registered in accordance with these Rules and Regulations, the State Building Code or the standards of good practice. Notice of suspension or revocation of such registration shall be in writing with the reasons for suspension or revocation clearly set forth therein, and served in accordance with Section 121.2.1 of this Code.

### 3.2 NOTICE AND CONFERENCE

Prior to suspension or revocation of the registration of any such mill so registered, written notice of such intent shall be served by the Construction Materials Safety Board in accordance with Section 121.2.1 of the Basic Code. Within ten (10) calendar days of receipt of such notice, the affected mill may request a conference before a three (3) member panel designated by the Chairman of the Construction Materials Safety Board, who will hear facts and make their recommendations to the Construction Materials Safety Board.

3.3 EFFECT OF

Upon suspension or revocation of the registration of any such mill so registered, such mill shall immediately cease engaging in the stamping or certifying of native lumber. The filing of an appeal with the State Building Code Appeals Board shall stay such suspension or revocation subject to Section 126.3.2 of this Code.

SECTION 4 APPEALS

4.1 BUILDING CODE APPEALS BOARD

Anyone aggrieved by the decision of the Commission, the Construction Materials Safety Board, the Massachusetts Wood Producers' Association or others may appeal to the State Building Code Appeals Board in accordance with Section 126 of this Code.

SECTION 5 QUALIFICATION

5.1 EVALUATION

Evaluation by the pre-qualifying agency shall be required prior to registration of a mill subject to these Rules and Regulations. The agency shall examine and evaluate the application of all mills and make its recommendations to the Construction Materials Safety Board. The Construction Materials Safety Board shall make its recommendations to the Commission who shall act on the application of the mill so requesting registration.

APPENDIX Q

RULES AND REGULATIONS FOR LICENSING CONSTRUCTION SUPERVISORS AS DEFINED IN SECTION 109.1.1 OF THE MASSACHUSETTS STATE BUILDING CODE

PART I

SECTION 1. GENERAL

1.1 TITLE: As authorized by Chapter 802 of the Acts of 1972, the State Building Code Commission herewith establishes the Rules and Regulations for Licensing Construction Supervisors.

1.2 DEFINITIONS: Unless otherwise expressly stated in the State Building Code, the following terms shall, for the purpose of these Rules and Regulations, have the meaning indicated in this section:

BOARD OF EXAMINERS (BOARD): The Board(s) established by the Chairman of the Commission to carry out the function of licensing construction supervisors.

COMMISSION: The State Building Code Commission

CONSTRUCTION SUPERVISOR: Any individual directly supervising persons engaged in construction, reconstruction, alteration, repair, removal or demolition involving the structural elements of buildings and structures. Such term shall also apply to persons supervising themselves.

LICENSED DESIGNEE: Any individual designated by the license holder to be present, in the absence of said license holder, during any of the periods stated in Section 2.12. Such designee shall also hold a Construction Supervisor's License, but his name or license number need not be contained on the building permit application.

REGISTRATION: The approval by the Commission of an application and related documents by one desirous of being licensed as a construction supervisor.

1.3 SCOPE:

A. These rules and regulations govern the testing and licensing of individuals who are found to possess the requisite qualifications to be registered as qualified to have charge or control of construction, reconstruction, alteration, repair, removal or demolition of buildings or structures.

B. Except for those structures governed by Construction Control as regulated by Section 127.0 of the Code, any individual directly supervising persons engaged in construction, reconstruction, alteration, repair, removal or demolition involving the structural elements

Section 1: continued

of buildings and structures shall be licensed according to the rules and regulations.

1.4 ADMINISTRATION AND ENFORCEMENT: The State Building Code Commission shall administer and enforce the provisions of these Rules and Regulations. The Commission or those designated by it, shall administer examinations, under these Rules and Regulations, of persons desirous of being registered as qualified to receive a license as a construction supervisor.

1.5 BOARD OF EXAMINERS: The Chairman of the Commission shall appoint a Board of Examiners, hereafter referred to as the "Board", which shall consist of any three (3) members of the Commission who shall serve for one (1) year or until their successors are appointed, whichever is later. The said Chairman shall appoint a Chairman of the Board who shall serve until his successor is appointed. The Chairman of the Commission may establish and abolish as many Boards of Examiners as he feel appropriate from time to time.

1.6 The Board shall meet monthly and at such other times as the Chairman deems it necessary to carry out its function established herein by the Commission.

1.7 BOARD OF SURVEY: The Chairman of the Commission shall appoint a Board of Survey which shall consist of two (2) home builders and one (1) member of the Commission or designee who shall serve for one (1) year or until their successors are appointed, whichever is later.

1.7.1 For the purpose of informal disposition of complaints, the Commission shall establish nine (9) regions in the Commonwealth, each of which shall be served by three (3) members of the Board of Survey.

1.7.2 All decisions of the Board of Survey shall be forwarded to the Board for disposition.

1.8 CITIES AND TOWNS:

1.8.1 EXISTING LICENSED CONSTRUCTION SUPERVISORS: All individuals directly supervising persons engaged in construction, reconstruction, alteration, repair, removal or demolition involving structural elements of buildings or structures who are duly licensed and qualified on January 1, 1981 within any city or town shall be allowed to continue in such capacity under the Rules and Regulations established by such jurisdiction until December 31, 1981. Such duly licensed person shall only be allowed to engage in such practice only within the city or town granting such licensing.

SECTION 2. REGISTRATION AND LICENSING

2.1 Each applicant for license must prove to the Board that he has had at least three (3) years of experience in building construction or design in the field in which he desires to be licensed, together with any technical knowledge the Board may require him to possess.

2.1.1 Any person meeting one of the following requisites shall be licensed by the Board without testing until July 1, 1982.

A. Files with the Commission prior to July 1, 1982 an application and applicable documents including an affidavit on a form provided by the Commission attesting to his meeting the following qualifications:

- i. A registered professional architect or engineer; or
- ii. A four-year undergraduate degree in a field related to building construction or design and has at least one (1) year, out of the past ten (10) years, of experience in the supervision of building construction or design; or
- iii. At least three (3) years, out of the past ten years, of experience in the supervision of building construction or design and a general knowledge of the quality and strength of building materials; a general knowledge of the accepted requirements for building construction, fire prevention, light, ventilation and safe exits; and a general knowledge of other equipment and materials essential for safety, comfort and convenience of the occupants of a building or structure.

2.2 Examinations shall be held only by appointment. All applications must be on file at the office of the Board seven (7) days or earlier, prior to the date set for examination unless the Board shall otherwise determine.

2.3 A vote of two (2) members of the Board shall be required to grant a license.

2.4 Licenses issued pursuant to these rules and regulations shall expire five years from the date of issuance which shall be noted on said license and may be renewed.

A renewal of an original license shall be for periods of two years and a renewal license shall expire two years from the date of issuance which shall be noted on said license and may be renewed.

A license shall not be issued unless application therefore is made within four years of the date of expiration of the most recently issued license.

2.5 Any and all fees charged for examination, for license fees, or for license renewal fees shall be determined by the Commonwealth and enforced by the Commission.

2.51 The Commission shall grant a license at no fee to any employee of a municipality, school district or of the Commonwealth who, as a condition of their employment requires such license; provided that

## Section 2: continued

such person meets the necessary qualifications for licensure and provided further, that such license shall be authorized for use only during the course of their employment and shall be appropriately stamped to indicate as such.

## 2.6 PROCEDURE FOR OBTAINING A LICENSE:

2.6.1 Applications shall be submitted on forms supplied by the Commission.

2.6.2 The applicable forms may be mailed or brought by the applicant to the Commission at One Ashburton Place, Boston, Massachusetts, 02108. It shall be the responsibility of the applicant to assure that the required forms are received by the Commission. All forms shall be accompanied by the required license fee.

2.6.3 The Commission shall keep a record of the date the application and all pertinent documents are received.

2.6.4 Upon receipt of a fully completed application, an examination date shall be set and the applicant so notified.

2.7 Any false statement on the application or references shall be sufficient reason to refuse to issue a license, or to suspend or revoke a license if issued.

2.8 Any false statement on the application for license, or in answer to any subsequent request for information, shall be cause for suspension or revocation of license.

## 2.9 PROCEDURE FOR SUSPENSION AND/OR REVOCATION OF LICENSE

2.9.1 Upon receipt of a written complaint from a building official, or upon written complaint from other persons, or upon complaint of the Board itself, the Board of Survey in its discretion shall determine whether or not a hearing shall be held. It shall not be considered as a complaint if such work was performed prior to his/her being licensed or prior to January 1, 1982, whichever is later.

2.9.1.1 Only work related to a specific building permit shall be the basis of such complaint. Any work requiring a building permit which is performed without such permit shall be considered cause for suspension or revocation.

2.9.2 If the Board of Survey shall so determine that a hearing shall be held, it shall give at least seven (7) days notice to the complainant and license holder in accordance with Section 121.2.1 of the Code. The sending of notice to the address recorded on the records of the Commission shall be deemed sufficient notice to the license holder.



Section 2: continued

2.9.3 The notice of hearing shall contain:

- a. The name of the complainant.
- b. A copy of the complaint.
- c. The complete file is available for inspection at the Office of the Commission during its regular hours.
- d. The date, time and place of said hearing.
- e. Anyone may be represented by legal counsel.
- f. The license holder may present oral and written evidence to refute or mitigate any charge contained in the complaint and present witnesses in his behalf.

2.9.4 The Board of Survey in its discretion may continue the date for hearing upon request by the license holder or complainant or the Board of Survey.

2.9.5 The Board of Survey shall make a decision within ten (10) days after the hearing.

2.9.6 A vote of at least two (2) members of the Board of Survey is required to make a decision pursuant to Section 2.3 of these Rules.

2.9.7 This decision shall be forwarded to the Board who shall hold a hearing and vote on all recommendations of the Board of Survey by accepting, rejecting, or modifying such decision.

2.9.7.1 The Board shall hold a hearing, and shall give at least seven (7) days notice to the complainant and license holder in accordance with Section 121.2.1 of the Code. The sending of notice to the address recorded on the records of the Commission shall be deemed sufficient notice to the license holder.

2.9.7.2 The notice of hearing shall contain:

- a. The name of the complainant.
- b. A copy of the complaint.
- c. The complete file is available for inspection at the Office of the Commission during its regular hours.
- d. The date, time and place of said hearing.
- e. Anyone may be represented by legal counsel.
- f. The license holder may present oral and written evidence to refute or mitigate any charge contained in the complaint and present witnesses in his behalf.

2.9.7.3 The Board in its discretion may continue the date for hearing upon request by the license holder or complainant or the Board itself.

2.9.7.4 The Board shall make a decision within ten (10) days after the hearing.

2.9.7.5 A vote of at least two (2) members of the Board is required to make a decision pursuant to Section 2.3 of these Rules.

Section 2: continued

2.9.7.6 This decision shall be final and binding upon the license holder and the complainant.

2.9.8 If, after notice has been duly given, a licensee shall not attend a hearing, the Board may in its discretion immediately suspend/revoke said license or proceed with the hearing so scheduled and make decision on the evidence so presented, or continue the hearing to another date.

2.9.9 In the event that the Board votes to suspend or revoke said license pursuant to this hearing, the license holder upon notice of the decision shall immediately comply with the said orders. A refusal to comply shall automatically revoke the licensee's right to supervise construction.

2.9.9.1 Suspension by the Board shall be for a definite term.

2.9.9.2 Any licensee whose license has been revoked by the Board may reapply for a license in accordance with these Rules and Regulations only after seeking and receiving approval to reapply from the Board.

2.10 Any person aggrieved by a decision of the Board may appeal such decision to the State Building Code Appeals Board in accordance with Section 126 of the Code. Such appeal shall stay all proceedings in accordance with Section 126.3.2 of the Code.

2.11 The license holder shall have the responsibility of reporting any change of address and/or change of circumstance to the Commission. The information on file at the Commission shall be deemed accurate unless changed by the license holder.

2.12 A licensed individual or a licensed designee shall be present on the site at some point to approve construction, reconstruction, alterations, removal or demolition involving the following work:

- a. Excavation
- b. Foundation (pouring or other)
- c. Decking
- d. Rough framing
- e. Finished framing
- f. Chimneys
  1. Excavation/foundation
  2. At the top of the smoke chamber and support of the flue line
  3. When erection of the chimney is completed.

2.13 License holders are required to keep the license in their possession at any and all building sites. If said license is lost, stolen or mutilated, it shall be the responsibility of the license holder to notify the Commission.

2.14 Any building official may require the license holder to produce the license at any time on a job site.

Section 2: continued

2.15 RESPONSIBILITY OF EACH LICENSE HOLDER:

2.15.1 The license holder shall be fully and completely responsible for all work for which he is supervising. He shall be responsible for seeing that all work is done pursuant to the State Building Code and the drawings as approved by the Building Official.

2.15.2 The license holder shall be responsible to supervise the construction, reconstruction, alteration, repair, removal or demolition involving the structural elements of buildings and structures only pursuant to the State Building Code and all other applicable Laws of the Commonwealth even though he, the license holder, is not the permit holder but only a subcontractor or contractor to the permit holder.

2.15.3 The license holder shall immediately notify the building official in writing of the discovery of any violations which are covered by the building permit.

2.15.4 Any licensee who shall willfully violate Subsections 2.15.1, 2.15.2 or 2.15.3 or any other Sections of these Rules and Regulations and any procedures, as amended, shall be subject to revocation or suspension of license by the Board.

2.16 All building permit applications shall contain the name, signature and license number of the construction supervisor who is to supervise those persons engaged in construction, reconstruction, alteration, repair, removal or demolition as regulated by Section 109.1.1 of the Code and these Rules and Regulations. In the event that such licensee is no longer supervising said persons, the work shall immediately cease until a successor license holder is substituted on the records of the building department.

2.17 The term "he" as used in these Rules Regulations and Procedures shall include the pronoun "he" and/or "she."

SECTION 3 ADMINISTRATION:

3.1 The Commission shall issue a card including a photo I.D. card, or a certificate or other form of identification.

3.2 The Commission shall maintain a register which will be available to the public at the office of the Commission containing all licenses issued by the Commission.

3.3 The Board shall determine whether an examination shall be required, or shall be oral or written and shall determine the content of the examination, if applicable.

Section 3: continued

3.4 All persons licensed shall be subject to these regulations as well as other rules, regulations, and procedures promulgated by this Commission.

3.05 The license fees, examination fees, renewal fees, and registration fees shall be determined by the Commonwealth and enforced by the Commission.

APPENDIX Q

RULES AND REGULATIONS FOR THE ACCREDITATION OF TESTING LABORATORIES TO TEST SOLID FUEL BURNING HEATING APPLIANCES

Part 1 GENERAL

SECTION 1 ADMINISTRATIVE

1.1 SCOPE: As authorized by Chapter 802 of the Acts of 1972, and in accordance with Section 128 of the State Building Code, establishing the Construction Materials Safety Board, the following Rules and Regulations are adopted for the accreditation of testing laboratories to test Solid Fuel Burning Heating Appliances.

1.2 DEFINITION: Unless otherwise expressly stated in the State Building Code, the following terms shall, for the purpose of these Rules and Regulations, have the meaning indicated in this section.

ACCREDITED LABORATORY: A laboratory which has been accredited in accordance with these regulations by the State Building Code Commission.

BOARD: Construction Materials Safety Board (CMSB)

BRANCH LABORATORY: A branch of a Testing Laboratory will be accredited as a separate testing laboratory.

CODE: Commonwealth of Massachusetts State Building Code (SBC).

COMMISSION: Commonwealth of Massachusetts State Building Code Commission (SBCC).

LABORATORIES: Testing Laboratory

PERSON: Individual, partnership, corporation, trust, joint venture, etc.

PRE-QUALIFYING AGENCY: Construction Materials Safety Board (CMSB).

TESTING AGENCY: State Building Code Commission Staff.

TESTING LABORATORY: A proprietorship, corporation, partnership or agency which conforms to the requirements of these regulations.

1.3 ACCREDITATION: Laboratories defined by these Rules and Regulations as Testing Laboratories which are engaged in the testing of materi-

als, appliances, and devices, subject to the provisions of the State Building Code, for use in buildings and structures shall be accredited by the State Building Code Commission (SBCC) in accordance with these Rules and Regulations.

1.4 APPLICATION FOR ACCREDITATION: Each laboratory desiring to obtain such accreditation shall make application to the Commission in such a manner as the Commission shall prescribe and shall furnish evidence satisfactory to the Commission that the laboratory complies with all criteria contained herein. Fifteen (15) copies of such application shall be provided by the applicant. The applicant shall designate whether approval is desired to test solid fuel burning room heaters (Section 7); or solid and solid/liquid fuel central heating boilers and warm air furnaces (Section 8); or both.

1.5 PRE-QUALIFYING AGENCY: The Commission hereby designates the Construction Materials Safety Board as its pre-qualifying agency, provided, however, that the Commission may revoke such designation at any time, and may designate any other agency or agencies which it deems qualified, from time to time, to act as its pre-qualifying agency. The pre-qualifying agency shall examine, or cause to be examined, the evaluation performed by the Testing Agency regarding the on-site inspection and the application and makes its recommendation to the Commission regarding such accreditation.

1.6 TESTING AGENCY: The staff of the State Building Code Commission (SBCC) shall be the agency to examine and evaluate all laboratories desiring to be accredited.

1.7 NOTIFICATION OF TESTING AND TESTING RESULTS: The Testing Agency shall notify the applicant of the date of the Laboratory Quality Assurance Inspection in accordance with Section 2.7 of these Rules and Regulations. The Commission shall be informed by the Testing Agency/Pre-Qualifying Agency of the evaluation and recommendations.

1.8 ACCREDITATION FEE: The fee for initial accreditation, including one of the two specific test criteria specified herein, shall be four hundred (\$400) dollars or five hundred (\$500) dollars for both criteria, payable upon submittal of application for accreditation. The renewal fee shall be two hundred (\$200) dollars per annum for the basic accreditation, including one of the specific test criteria; or two hundred and fifty (\$250) dollars if it includes both criteria; or in accordance with the fee schedule established by the Commission from time to time. Inspection costs, including travel expenses and any additional relative expenses, shall be borne by the laboratory. On-site inspections, requiring fees, shall not be held more than once a year, unless a follow-up inspection is required by the Testing Agency or requested by the laboratory.

1.9 NUMBER AND CLASSIFICATION: Each laboratory so accredited by the Commission shall be issued a number and classification.

1.10 RENEWALS: Commencing July 1, 1979, all accreditations issued shall expire on June 30. At least thirty (30) days prior to the expiration date of any such accreditation, the Executive Director of the Commission shall forward to each laboratory so accredited an application form for renewal. The said Executive Director, upon receipt of the completed form and fee, shall renew accreditation for a period of one (1) year or notify such applicant of the Commission's refusal with reasons thereof.

1.11 PENALTIES: Any person and/or laboratory that fails to comply with the requirements of these Rules and Regulations or that files a false report shall be subject to the penalties and actions as prescribed by law as referenced in Section 121 of the Code.

## SECTION 2 LABORATORY ACCREDITATION REQUIREMENTS

2.1 GENERAL: To become accredited, an applicant laboratory must demonstrate to the satisfaction of the Massachusetts State Building Code Commission (SBCC) that it complies with the accreditation criteria listed below. Embodied are elements of organization, personnel and material resources, control and quality assurance, and professional and ethical business practices.

Accreditation will be determined through an examination process that emphasizes the evaluation and assessment of written information submitted by the laboratory relative to each criterion statement. The submitted information is subject to verification by on-site inspection.

### 2.2 LABORATORY ORGANIZATIONAL STRUCTURE

1. GENERAL: A description of the laboratory's organization shall be submitted, including:
  - a. Name, addresses, and telephone numbers of the facility.
  - b. The laboratory's principal ownership and management structure, including the names and positions of the principal officers and board of directors.
  - c. An outline or chart showing the titles or positions of all key management and supervisory personnel in each operating, support and service unit in the laboratory's functional organization.
  - d. A floor plan of the testing facility indicating location of all equipment necessary for accreditation to insure adequacy of facility in relation to parameters as specified by applicable test standards.

2.3 PERSONNEL

1. GENERAL: The management and supervision of each laboratory subject to these regulations shall be in accordance with the following requirements. Resumes of the education and work experience for those personnel required shall be submitted.
2. REQUIRED: Each accredited Testing Laboratory shall have individuals approved by the Commission who are qualified in two (2) distinctly different categories: Director of Testing Services and Supervisory Laboratory Technician. Any individual may fill more than one position at the particular laboratory if he meets all the qualifications for each position, but he may not fill positions concurrently at a separate branch laboratory.
3. FILING OF QUALIFICATIONS: Each individual being certified for a position must submit his credentials and qualifications under penalty of perjury. Each resume shall bear a notarized attestation of its truth and completeness, signed by the individual named therein. Individuals applying for certification in more than one (1) category must file separate applications for each position as described in Section 2.4. Application for certification shall be filed within thirty (3) days of employment of such duties. It is the responsibility of the Director of Testing Services to notify the Commission within ten (10) days of any vacancy or new appointments of any position.

2.4 QUALIFICATIONS:

1. QUALIFICATION FOR DIRECTOR OF TESTING SERVICES: The testing services of each laboratory shall be under the direction of a Director of Testing Services who shall be a full-time resident employee of the laboratory and shall be qualified in accordance with any one (1) of the following three (3) sets of requirements:
  - a. He shall be a Registered Professional Engineer, with at least five (5) years of experience in responsible charge of work related to Structural Engineering, Construction Engineering, Mechanical Engineering, or Construction Materials Testing. He shall be subject to demonstrate his ability to interpret the results of applicable nationally recognized standards; or
  - b. He shall have a bachelors degree in Engineering from an accredited institution and an additional total of three (3) years' experience performing tests on materials, appliances or devices which shall include two (2) years as a laboratory technician or supervisor. He shall be subject to demonstrate his ability to interpret the results of applicable nationally recognized standards; or



c. He shall have at least eight (8) years of experience including five (5) years experience as a laboratory technician or supervisor and shall be subject to demonstrate his ability to interpret the results of applicable nationally recognized standards.

2. QUALIFICATIONS FOR SUPERVISORY LABORATORY TECHNICIAN: A supervisory Laboratory Technician shall have at least five (5) years experience performing tests on materials, appliances or devices. He shall be subject to demonstrate his ability to perform applicable results in accordance with nationally recognized standards.

3. PERSONS PERFORMING THE TESTS: Personnel performing the tests shall be under the direct supervision of the Supervisory Laboratory Technician.

## 2.5 LABORATORY OPERATION

1. TEST REPORTS: The applicant shall submit two (2) typical test reports to verify their completeness and compliance with the test standard. The data sheets shall be in sufficient detail to provide for complete verification and evaluation of the operations and objectives, and shall include the signature of the personnel performing the test and shall also include the signature of the Director of Testing Services and/or Supervisory Laboratory Technicians.

2. RECORDS: Records shall be maintained and filed in an orderly and professional manner. Submit a description of the laboratory's system for maintaining records, including records of:

a. Test reports.

b. Data generated during testing.

c. Serial numbers, date, and manufacturers to which all labels have been issued.

d. Personnel performing the test.

3. VALIDITY: Submit evidence that the laboratory has a system for auditing and monitoring its test work, including:

a. Preventing or reducing testing errors and discrepancies.

b. Identifying and correcting known errors and discrepancies.

c. Obtaining, tracing the validity of, and responding to complaints.

2.6 LABORATORY QUALITY CONTROL

1. TESTING EQUIPMENT: Equipment requiring calibration and used for testing materials subject to these rules and regulations shall be calibrated and verified, with equipment traceable to the National Bureau of Standards, at least annually or as required by the State Building Code Commission, and the results submitted with an affidavit to the Commission with the annual renewal application as well as the initial application.
2. STANDARDIZATION: Submit a description of the laboratory's system for maintaining written descriptions of the standardization, calibration and verification procedures for all test equipment including:
  - a. Equipment description or name.
  - b. Name of manufacturer.
  - c. Model, style, and serial number or other identification.
  - d. Equipment variable subject to standardization.
  - e. Range of operation and range of standardization.
  - f. Resolution of the instrument and allowable error tolerance on readings.
  - g. Standardization Schedule (intervals).
  - h. Date and result of last standardization.
  - i. Name of laboratory person or standardization service providing the above standardization.
3. REFERENCE STANDARDS: Submit a list and evidence that the laboratory has a system for maintaining all applicable reference standards.

2.7 LABORATORY QUALITY ASSURANCE

1. EVALUATION: Testing laboratories subject to these Rules and Regulations shall be examined and evaluated by the testing agency.
2. REPORTS: Reports of evaluation and examination prepared by the Testing Agency shall be submitted to the State Building Code Commission.
3. DEFICIENCIES: Laboratory deficiencies cited in the report of the testing agency shall be corrected within ne (1) month of the date of issue of the report and shall be so certified by an affidavit sub-

mitted by the Director of Testing Services or the Supervisory Laboratory Technician.

4. REVOCATION: Laboratories which fail to meet the requirements of item 3 shall be subject to revocation of their accreditation by the State Building Code Commission.

## 2.8 MANUFACTURER'S COMPLIANCE ASSURANCE PROGRAM

1. REQUIRED: A laboratory shall submit evidence that it has the capability to provide and perform the manufacturer's compliance assurance program as outlined below.
2. NOTIFICATION OF CHANGE: The manufacturer shall inform the testing laboratory of all changes made to the labeled material, appliance or device.
3. INSPECTIONS: In order to assure quality control a follow-up inspection shall be performed by the laboratory or their designated representative. These inspections shall be performed a minimum of once every six months following the date of approval of the material, appliance or device. If major changes have occurred in the design or construction of the material, appliance or device subsequent to the original testing and labeling, retesting shall be performed.

## SECTION 3 STATEMENT OF INDEPENDENCE

3.1 GENERAL: The applicant must admit a notarized statement of independence with reference to products being tested. Such statement shall include:

1. Any managerial affiliations with any producer, supplier, or vendor.
2. Any securities or investments in the product line.
3. Any stock options in the product line.
4. The employment security of personnel is free from influence by any producer, supplier or vendor.
5. The laboratory is not owned, operated or controlled by any producer, supplier or vendor.

## SECTION 4 NOTIFICATION OF CHANGE

4.1 GENERAL: Testing laboratories listed under these Rules and Regulations shall notify the Massachusetts State Building Code Commission within 10 working days of any of the following changes:

1. Company name and/or address change.
2. Changes in major test equipment.
3. Changes in principal officers, key supervisory and responsible personnel in the company including the Director of Testing Services and the Supervisory Laboratory Technician.
4. Change in the acceptable Test Standards used.
5. Changes in independence status.

#### SECTION 5 REVOCATION AND SUSPENSION PROCEDURES

5.1 REVOCATION AND SUSPENSION: The Massachusetts State Building Code Commission, on its own initiative or upon the recommendation of the Construction Materials Safety Board, may suspend or revoke the accreditation of any Testing Laboratory found to be in non-compliance with these Rules and Regulations, the State Building Code, or the standards of good engineering practice. Notice of suspension or revocation of such accreditation shall be in writing with the reasons for suspension or revocation clearly set forth therein, and served in accordance with Section 121.2.1 of the Code.

5.2 NOTICE AND CONFERENCE: Prior to suspension, revocation, or refusal to renew the accreditation of a laboratory, written notice of such intent shall be served by the State Building Code Commission in accordance with Section 121.2.1 of the Code. Within ten (1) calendar days of receipt of such notice, the affected laboratory may request a conference before a three-member panel designated by the Chairman of the Construction Materials Safety Board, who will hear facts and make their recommendations to the Construction Materials Safety Board.

5.3 EFFECT OF: Upon suspension of the accreditation, the laboratory shall immediately cease engaging in the testing of solid fuel burning heating appliances for use in structures which are subject to the provisions of the Massachusetts State Building Code and no action brought before the Board of Appeals as specified in Section 5.1 of these regulations or in any court of competent jurisdiction shall stay the said suspension or revocation unless said Board of Appeals or court shall issue an order for a stay of the Commission's suspension or revocation.

#### SECTION 6 APPEALS

6.1 BUILDING CODE APPEALS BOARD: Any laboratory or individual aggrieved by the suspension or revocation of their accreditation or by an interpretation order, requirement, direction of failure to act under these Rules and Regulations may appeal to the State Building Code Appeals Board as provided in Section 126 of the Code; however, entry of an appeal from the Commission's order of revocation or suspension shall not

stay such revocation or suspension unless so ordered by the State Building Code Appeals Board in a preliminary hearing conducted expressly for the purpose of a stay in accordance with that part of Section 126.3.2 of the Code dealing with the procedure required for a hearing on such stay.

## SECTION 7 SPECIFIC TEST CRITERIA - ROOM HEATERS

7.1 Specific criteria for the testing of solid fuel burning heaters by ANSI/UL 737 and/or UL 1482:

1. TEST STANDARDS: All solid fuel burning room heaters shall be tested in accordance with ANSI/UL 737 and/or UL 1482 as applicable for the given appliance.
2. TEST SET-UP: Laboratories shall submit descriptions of all test set-ups, including a list of test instruments used. The description must be sufficiently detailed to indicate compliance with ANSI/UL 737 and UL 1482.
3. TEST EQUIPMENT: Laboratories shall submit a list of all test equipment necessary for accreditation, identified by manufacturer, model number, and serial number.
4. FABRICATED EQUIPMENT: Laboratories shall submit descriptions of all special or laboratory fabricated equipment. Laboratories shall also submit evidence that such equipment conforms to the requirements of ANSI/UL 737 and/or UL 1482 as applicable and that such equipment assures requisite accuracy and precision.

7.2 LABELING: Every solid fuel burning room heater shall bear a metal data plate, permanently attached at the factory by mechanical means under the control of the testing laboratory, having the following items of information etched or lithograph-printed thereupon:

1. Manufacturer's name or trademark
2. Model/identification name or number of the appliance
3. Type of fuel(s) approved
4. Testing laboratory's name or trademark and location
5. Date tested
6. Clearance to combustibles:
  - a. Side
  - b. Rear
7. Test Standard(s)
8. Label serial number

7.3 INFORMATION SUBMITTED: Laboratories shall submit a sample of an actual label, conforming to Section 7.2 of these Rules and Regulations, when making application for accreditation. In addition, accredited laboratories shall submit monthly, in a form acceptable to the Commission, a listing of all solid fuel burning room heaters tested and labeled to date.

Accredited laboratories shall also submit to the Commission a copy of the manufacturer's installation instructions for each new model tested and labeled.

SECTION 8 SPECIFIC TEST CRITERIA - SOLID AND SOLID/LIQUID FUEL BURNING HEATING BOILERS AND WARM AIR FURNACES

8.1 Specific criteria for the testing of solid and solid/liquid fuel burning central heating boilers and warm air furnaces:

1. TEST STANDARDS: All solid and solid/liquid fuel burning boilers and warm air furnaces shall be tested in accordance with Standards CSA B366-M 1979 and the ASME Boiler and Pressure Vessel Codes, as applicable for the given appliance.
2. TEST SET-UP: Laboratories shall submit descriptions of all test set-ups, including a list of test instruments used. The description must be sufficiently detailed to indicate compliance with CSA B366-M 1979 and the ASME Boiler and Pressure Vessel Code as applicable.
3. TEST EQUIPMENT: Laboratories shall submit a list of all test equipment necessary for accreditation, identified by manufacturer, model number, and serial number.
4. FABRICATED EQUIPMENT: Laboratories shall submit descriptions of all special laboratory fabricated equipment. Laboratories shall also submit evidence that such equipment conforms to the requirements of CSA B366-M 1979 and/or the ASME Boiler and Pressure Vessel Code as applicable and that such equipment assures requisite accuracy and precision.

8.2 LABELING: Every solid or solid/liquid fuel burning central heating boiler or warm air furnace shall bear a metal data plate, permanently attached at the factory by mechanical means under the control of the testing laboratory, having the following items of information etched, embossed or lithograph-printed thereupon:

1. Manufacturer's name or trademark
2. Model/identification name or number of the appliance
3. Types of fuels approved
4. Testing laboratory's name or trademark and location
5. Date tested
6. Clearance to combustibles:
  - a. Side
  - b. Rear
  - c. Top
  - d. Front
7. Test standard(s)
8. Label serial number

9. Type of appliance (boiler or warm air furnace)
10. Every boiler, pressure vessel or pressure relief device must be stamped in accordance with the requirements of the ASME Boiler and Pressure Vessel Code. ASME stamping shall also be required for boilers, pressure vessels and pressure relief devices produced outside the United States of America. Where required by the ASME Boiler and Pressure Vessel Code, ASME stamping may be affixed directly to the appliance in lieu of on the data plate.

NOTE: Additional information as required by the applicable test standard(s) may be affixed separately.

8.3 INFORMATION SUBMITTED: Laboratories shall submit a sample of an actual label, conforming to Section 8.2 of these Rules and Regulations, when making application for accreditation. In addition, accredited laboratories shall submit monthly, in a form acceptable to the Commission, a listing of all solid or solid/liquid central heating boilers or warm air furnaces tested and labeled to date. Accredited laboratories shall also submit to the Commission a copy of the test report and installation instructions for each new model tested and labeled.

## APPENDIX R

## TECHNICAL CODE COUNCIL

Bureau of Engineering and Construction  
Office of Health Facilities Department  
Department of Public Health  
80 Boylston Street  
Boston, MA 02109  
Mr. Richard Knapp, Director  
Tel. No. (617) 727-8985

Department of Public Health  
100 Cambridge Street, Room 2000  
Boston, MA 02202  
Mr. David Standley, Commissioner  
Tel. No. (617) 727-2150

Engineering and Maintenance  
Department of Mental Health  
160 N. Washington Street, Rm 450  
Boston, MA 02114  
Mr. George F. Atamian, Acting Dir.  
Tel. No. (617) 727-5647

Board of State Examiners of Plumbers  
and Gas Fitters  
100 Cambridge Street  
Boston, MA 02202  
Mr. Irving J. Risi, Executive Director  
Tel. No. (617) 727-3046

Board of State Examiners of Electricians  
Division of Registration  
100 Cambridge Street  
Boston, MA 02202  
Mr. John F. Cullen, Executive  
Secretary  
Tel. No. (617) 727-3050

Department of Labor and Industries  
100 Cambridge Street, 11th Floor  
Boston, MA 02202  
Mr. William M. Shippy, Commissioner  
Tel. No. (617) 727-3454

Department of Public Works  
100 Nashua Street  
Boston, MA 02114  
Mr. Frank Burke,  
Assistant to the Design Engineer  
Tel. No. (617) 727-5012

Department of Public Safety  
Division of Inspections  
One Ashburton Place, 13th Floor  
Boston, MA 02108  
Mr. John K. Olsen, Chief  
Tel. No. (617) 727-7551

Architectural Barriers Board  
Department of Public Safety  
One Ashburton Place, 13th Floor  
Boston, MA 02108  
Ms. Debra A. Ryan, Adminis-  
trative Secretary  
Tel. No. (617) 727-6257

Board of Boiler Rules  
Department of Public Safety  
One Ashburton Place, 13th Floor  
Boston, MA 02108  
Mr. William H. Dormer, Chairman  
Tel. No. (617) 727-7688

Board of Fire Prevention Regulations  
Department of Public Safety  
One Ashburton Place, 13th Floor  
Boston, MA 02108  
Mr. Samuel Gronich, Chairman  
Tel. No. (617) 727-6255

Board of Elevator Regulations  
Department of Public Safety  
One Ashburton Place, 13th Floor  
Boston, MA 02108  
Mr. John Otis  
Tel. No. (617) 727-6424

Environmental Quality Engineering  
Outdoor Advertising Division  
80 Boylston Street, Room 505  
Boston, MA 02116  
Ms. Beryl V. McPhail,  
Executive Director  
Tel. No. (617) 727-8392

Mobile Home Commission  
100 Cambridge Street, Room 704  
Boston, MA 02202  
Mr. Clark Taylor, Chairman  
Tel. No. (617) 727-3253



APPENDIX S

STATE BUILDING CODE COMMISSION ADVISORY  
BOARDS AND COMMITTEES

FIVE STANDING ADVISORY BOARDS/COMMITTEES

Construction Materials Safety Board (CMSB)

Professor Kentaro Tsutsumi, Chairman  
College of Engineering  
Tufts University

Professor Louis C. Tartaglione,  
Vice Chairman  
Department of Civil Engineering  
University of Lowell

Francis S. Harvey, P.E., R.A.  
State Building Code Commission

William Burke  
Laboratory Supervisor, Testing  
Laboratory  
Metropolitan District Commission

Richard D. Ellis  
Beacon Construction Company

Sanford Kaplan  
Sanford Construction Company

Ara Shrestinian, P.E.  
Vice President  
The Thompson & Lichtner Co., Inc.

Charles A. J. Theodore, P.E.  
Peabody Construction Company

Fire Prevention-Fire Protection Board (FP-FP)

Chief J. Herbert Wiggan, Chairman  
Westwood Fire Headquarters

Thomas McNicholas,  
Vice Chairman  
Boston Building Department

Felix J. Conti  
State Building Code Commission

Edward F. Hackett  
State Building Code Commission

Joseph A. O'Keefe, P.E.  
State Fire Marshal

Lieutenant Robert Chapman  
Weymouth Fire Headquarters

Chief Norman Clough  
Malden Fire Headquarters

Harold R. Cutler  
Fire Protection Engineer

Herbert W. Eisenberg, R.A.  
Eisenberg Haven Associates

Samuel Gronich  
Mass Board of Fire Prevention  
Regulations

Capt. John LaViska  
Saugus Fire Headquarters

John M. Murphy  
Int'l. Municipal Signalmen's  
Assn. Rep.

Commissioner George Paul  
Boston Fire Headquarters

Seismic Advisory Committee

- |  |  |
|--|--|
| Dr. Howard Simpson, P.E., Chairman<br>Simpson, Gumpertz & Heger, Inc.        | Dr. Edward B. Kinner, P.E.<br>Haley & Aldrich, Inc.                        |
| Dr. Othar Zaldastani, P.E.<br>Vice Chairman<br>Zaldastani Associates, Inc.   | Dr. Kenneth M. Leet, P.E.<br>Northeastern University                       |
| Dr. Rene W. Luft, P.E., Secretary<br>Simpson, Gumpertz & Heger, Inc.         | Fr. Daniel Linehan, P.E.<br>Weston Observatory                             |
| Francis S. Harvey, P.E., R.A.<br>State Building Code Commission              | Daniel M. McGee, P.E.<br>American Iron & Steel Institute                   |
| John E. Brennan, P.E.<br>LeMessurier Associates, Inc.                        | Maurice A. Reidy, Jr., P.E.<br>Maurice A. Reidy Engineers                  |
| Dr. Gonzalo Castro, P.E.<br>Geotechnical Engineers, Inc.                     | Norton S. Remmer, P.E.<br>Commissioner of Code Inspection<br>Worcester     |
| Stanislaw J. V. Gawlinski, P.E.<br>Maurice A. Reidy Engineers                | Mr. Peter J. Riordan, P.E.<br>Consulting Geotechnical Engineer             |
| Professor Myle J. Holley, Jr., P.E.<br>Massachusetts Institute of Technology | Professor Kentaro Tsutsumi, P.E.<br>Tufts University                       |
| Dr. Clifford A. Kaye<br>U.S. Geological Survey                               | Professor Robert V. Whitman, P.E.<br>Massachusetts Institute of Technology |

Soils Advisory Committee

- |  |  |
|--|--|
| Dr. Michael W. C. Emerson, P.E.,<br>Chairman<br>Geotechnical Consultants, Inc. | Edmund G. Johnson, P.E.<br>Haley & Aldrich Engineers             |
| Dr. Steve J. Poulos, P.E.,<br>Vice Chairman<br>Geotechnical Engineers          | William R. Langrill, P.E.<br>Western Foundations                 |
| Paul Donahue, P.E., Secretary<br>Public Facilities Department, Boston          | Asaf A. Qazilbash, P.E.<br>C. E. Maquire, Inc.                   |
| Felix J. Conti<br>State Building Code Commission                               | Peter J. Riordan, P.E.<br>Consulting Geotechnical Engineers      |
| Philip J. Bonanno, P.E.<br>J. F. White Contracting Company                     | Mr. Peter K. Taylor, P.E.<br>Stone and Webster Engineering Corp. |
| Donald T. Goldberg, P.E.<br>Goldberg, Zoino, Duncliff & Assoc., Inc.           |  |

## Energy Standards Committee

|   |  |
|---|--|
| William P. Kramer, Chairman<br>State Building Code Commission         | Lawrence Gingrow<br>Boston Gas Company                         |
| Arthur Abbood<br>Shooshanian Engineering Associates                   | Easley Hamner, R.A.<br>Hugh Stubbins and Associates            |
| Dr. Lawrence Ambs<br>University of Massachusetts                      | Stanley Kolodkin<br>Xenergy, Inc.                              |
| Peter A. Bryson<br>Inspector of Buildings<br>Danvers                  | Craig Lentz<br>Arthur D. Little, Inc.                          |
| Gary Davis<br>The Architects Collaborative, Inc.                      | Ronald W. Plutnicki, P.E.<br>New England Power Service Company |
| Garry DeLoss<br>Massachusetts Executive Office of<br>Energy Resources | Frederick L. Sanford<br>Inspector of Buildings<br>Natick       |
| David Elovitz, P.E.<br>Energy Economics                               | Kevin Sheehan<br>B.R. & A. Consulting Engineers,<br>Inc.       |
| Ken Farland, R.A.<br>Benjamin Thompson & Associates, Inc.             | Gary Vanderweil, P.E.<br>R. G. Vanderweil Engineers, Inc.      |
| Stephen Ferrari<br>Friendly Ice Cream Corporation                     | Roy Viklund, R.A.<br>Sasaki Associates                         |
| Earl R. Flansburgh, R.A.<br>Earl R. Flansburgh Associates, Inc.       |  |

## Lighting Standards Committee

|   |  |
|---|--|
| Dr. James A. Becker<br>The Beacon Companies                           | Herschel Denker<br>Zayre Corporation               |
| Cameron Beers<br>The Gillette Company                                 | Edward Guzovsky<br>Guzovsky Electrical Corporation |
| George W. Clark, P.E.<br>ETE - Sylvania Lighting Center               | Walter E. Henry, Jr.<br>Xenergy, Inc.              |
| Dale F. Cronan<br>Boston Edison                                       | Marvin C. Kaye<br>Long's Jewelers                  |
| Garry DeLoss<br>Massachusetts Executive Office of<br>Energy Resources | George Krasco<br>Keene Lighting Company            |

780 CMR: STATE BUILDING CODE COMMISSION

William M. C. Lam  
William Lam Associates

Alfred Lottero, P.E.  
Lottero and Mason Associates

Peter B. Manning  
University of Massachusetts

Thomas J. McNicholas  
Senior Electrical Engineer  
Boston

Frank Moran  
Inspector of Buildings  
Burlington

Verne G. Norman, P.E.  
Verne G. Norman Associates

Richard Omar  
Filene's Company

William Phipps  
Retailers Association of Massachusetts

Gordon Segal  
Crate and Barrel

Anand Seth, P.E.  
Massachusetts General Hospital

MASSACHUSETTS ADVISORY COMMITTEE ON CODE  
PROVISIONS FOR EXISTING BUILDINGS

Norton S. Remmer, Chairman  
Commissioner of Code Enforcement  
Worcester

Harold G. Bassar  
Taylor, Woodrow & Blitman Constr.  
Corp.

Peter F. DiMatteo  
Building Commissioner  
Lexington

Maximilian L. Ferro  
The Preservation Partnership

Paul M. Folkins  
Principal Structural and Safety Engineer  
Boston

Roger P. Lang, R.A.  
Perry, Dean, Stahl, and Rodgers

Laurie O'Brien  
New Construction Company

James H. Pielert  
National Bureau of Standards

David C. Macartney  
State Building Code Commission  
(Staff)

Loads Advisory Committee

|  |  |
|--|--|
| Hans William Hagen, P.E., Chairman<br>LeMessurier Associates/SCI       | Dr. Frank J. Heger, P.E.<br>Simpson, Gumpertz & Heger, Inc.    |
| Felix J. Conti<br>State Building Code Commission                       | Michael J. A. Joliffe, P.E.<br>Simpson, Gumpertz & Heger, Inc. |
| Professor John M. Biggs, P.E.<br>Massachusetts Institute of Technology | Richard W. Souza, P.E.<br>Souza and True, Inc.                 |
| Arthur L. Brown, Jr., P.E.<br>Brown & Rona, Inc.                       | Kenneth B. Weisner, P.E.<br>LeMessurier Associates/SCI         |
| Richard A. Foley, P.E.<br>Souza and True, Inc.                         | Rubin M. Zallen, P.E.<br>Simpson, Gumpertz & Heger, Inc.       |

ADVISORY COMMITTEES

Advisory Committee on Historic Buildings

|  |   |
|--|---|
| Maximillian L. Ferro, AIA, Chairman<br>President, Preservation Partnership     | William B. Hart<br>National Trust for Historic Preservation                   |
| Roger P. Lang, R.A., Co-Chairman<br>Perry, Dean, Stahl and Rodgers             | Bruce MacDougal<br>Society for the Preservation of<br>New England Antiquities |
| J. Timothy Anderson, AIA<br>Anderson, Notter, Inc.                             | Marcia Myers<br>Executive Director, Boston Landmarks<br>Commission            |
| Arthur Leonard Brown, P.E.<br>Brown and Rona, Inc.                             | Norton S. Remmer, P.E.<br>Commissioner of Code Inspection<br>Worcester        |
| Daniel J. Coolidge, AIA<br>Shepley, Bulfinch, Richardson<br>and Abbott         | Glen A. Steer, AIA<br>Codes and Standards Committee                           |
| Peter F. DiMatteo<br>Building Commissioner, Lexington                          | Lee S. Tabor<br>Staff Architect, Mass.<br>Historical Commission               |
| Paul M. Folkins<br>Principal Structural Engineer<br>Boston Building Department |   |
| John A. Harrell<br>Preservation Architect<br>Boston Redevelopment Authority    |   |

APPENDIX T

REFERENCE DATA FOR REPAIR, ALTERATION, ADDITION AND  
CHANGE OF USE OF EXISTING BUILDINGS

PART ONE-GUIDELINES FOR APPLICATION

T-101.0 Purpose

T-101.1 Intent of Article 22: The purpose of this guideline is to provide guidance to users of the Massachusetts State Building Code as to techniques of acceptable practice which can be used to assess the acceptability of various methods of meeting the intent of the code provisions of Article 22 on a case-by-case basis. The purpose of the code provisions in Article 22 and this guideline is to allow repair, alteration, addition and change of use of existing buildings without requiring the entire building to be brought up to new construction requirements, while still providing for the public health, safety and general welfare. The provisions of Article 22 and this guideline recognize that the provisions of the Massachusetts State Building Code for new construction reflect the latest improvements in materials, construction techniques, standards of living and safety and, therefore, may preclude the repair, alteration, addition, or change of use of existing buildings that have demonstrated their usefulness and safety.

T-102.0 Scope

T-102.1 Techniques: This guideline is intended to demonstrate techniques of analysis and compliance with Article 22 of the Massachusetts State Building Code in the repair, alteration, addition, and change of use of existing buildings.

T-103.0 Statement of concept

T-103.1 General conditions: Conceptually, it is the intent of Article 22 and these guidelines to allow repair, alteration, addition, or change of use of existing buildings without meeting all new construction requirements under the following general conditions:

1. all hazardous conditions must be corrected;
2. the existing building becomes the minimum performance standard and
3. the degree of compliance of the building after changes must not be below that existing before the changes, except that nothing in this section will require compliance with requirements more stringent than that required for new construction.

## T-104.0 Implementation

T-104.1 Framework: Implementation of the above concept requires that a framework be established for evaluating the condition of the building; determining the potential for modification; and establishing the acceptability of proposed changes.

T-104.2 Evaluation of existing building: Evaluation of existing conditions in a structure is required to determine the existence of any hazardous conditions, which must be corrected; and to provide a basis for evaluating the impact of the proposed changes on the performance of the building.

The following list of evaluation tools described in Sections T-104.2.1 through T-104.2.7 of this appendix can be used for determining the condition of the structure. However, this list is not necessarily complete and the use of other methods should not be precluded.

T-104.2.1 Available documentation of existing building: Prime sources of design information for existing buildings are the architectural and engineering drawings and specifications used in the construction of the building. Although the passing of time often obscures the identifies of depositories of such documents, the following are likely prospects in attempting to locate such information:

1. If the building is currently in use, an individual or office responsible for its management may have retained drawings and specifications to facilitate maintenance. A building manager, resident engineer, superintendant, custodian, stationary engineer or plant engineer may be the most direct contact at the building site.
2. Other potential sources (especially if the building is not in use) include the original designer-architect or engineer.
3. The building department which issued the permit for construction may have documentation.
4. Documentation may have been retained by the general contractor or numerous subcontractors. This presents the mason, carpenter, plumber, electrician, HVAC installer, steel erector, etc., as well as manufacturers of component parts, as potential sources of documentation.
5. In the case of large corporations or government agencies, a separate contracting officer may have developed a technical file on the erection of a building.
6. In some cases, individual consultants are contracted to serve as "clerk-of-the-works" and pursue the inspection of a building project from start to finish with the keeping of a file likely.
7. Insurance companies sometimes maintain drawings or records of their insured buildings.
8. Historical or archaeological societies may have considered a building to be important enough to develop a file of documentation.

## APPENDIX T

T-104.2.2 Field surveys: Having drawn upon available documentation to help evaluate a building's condition, such documentation may be augmented by on-site data acquired through field survey. The most obvious approach is to make use of detailed visual examination to confirm and/or alter any previously available information pertaining to the building.

T104.2.3 Testing: Testing is a tool that may be used in evaluating the condition of a building or structure or parts thereof when other methods of evaluation will not suffice. Testing may be initiated voluntarily on the part of the permit applicant or may be required by the building official in the absence of approved rules as indicated in Section 800.6 of the code. This section points out that ". . .the building official shall make or cause to be made the necessary tests and investigations, or he shall accept duly authenticated reports from recognized authoritative sources." The costs of all such tests are to be borne by the permit applicant and should, therefore, be required by the building official only when other methods of evaluation prove inadequate or insufficient. Such testing should be conducted by an approved testing agency under the supervision of a registered architect or engineer. The report of the tests shall be submitted to the building official and shall include the details of test procedures, references to any accepted test standards used, the results of the tests and any conclusions drawn from the test results.

T-104.2.4 Field tests: Both nondestructive and destructive test procedures can be applied to evaluate the condition of a building.

T-104.2.5 Nondestructive testing: This includes techniques where the structural integrity of the building is not affected, such as the following:

1. analyzing various portions of the building to determine dimensions, types and condition of materials, etc.;
2. portable apparatus for impact testing;
3. load application short of failure to determine capacity of materials and components;
4. magnetic methods for detecting flaws in ferrous metals;
5. proximity magnetometers (locating rebars in concrete, concealed ferrous fasteners, etc.);
6. electronic means for measuring the sonic modulus of elasticity of concrete and masonry in assessing its soundness;
7. ultrasonic transmission or reflective methods in detecting flaws in various materials; and
8. x-ray or infrared-ray photographic techniques used to evaluate portions of elements whose integrity is questionable.

T-104.2.6 Destructive testing: In destructive testing a sample of the building could be removed and tested (e.g., concrete core), or components of the building could be reconstructed and tested in the laboratory.



T-104.2.7 Laboratory analysis: In some cases, tests can be performed in the laboratory. Such tests might include the following:

1. chemical or metallurgical tests;
2. optical or electronic microscopic examination which can help identify and evaluate the soundness of materials where decay or other molecular degradation is involved;
3. conventional laboratory tests for determining physical properties (strength, ductility, absorption, solubility, permeability, stiffness, etc.; and/or
4. testing of a scale model of the building (computer model, wind tunnel model, etc.).

T-104.3 Evaluation of change in performance level: It is necessary to determine if the level of performance of the building after alteration is below that which existed before the change. The hazard level could be increased for certain attributes (such as fire safety) while decreased for other attributes (such as floor loads) for a given alteration. The evaluation of the change in hazard levels of each attribute can be accomplished using various tools singly or in combination as described below in Sections 104.3.1 through 104.3.5.

T-104.3.1 Data on archaic systems: Performance data on architectural and structural systems being encountered in existing buildings in the Commonwealth are tabulated in part four of this appendix. This data can be compared to the proposed altered systems to determine if the performance is being adversely affected.

T-104.3.2 Compliance alternatives: Alternate solutions tabulated in part two of this appendix were developed from appeal data and from accepted practice. The list is not all-inclusive and should not preclude consideration of other alternatives.

T-104.3.3 Analysis methods: Analytical methods based on good engineering practice may be used to determine changes in performance levels.

T-104.3.4 Test methods: Test procedures as discussed in Sections T-104.2.3 through T-104.2.6 of this appendix can be used to evaluate the performance of existing construction.

T-104.3.5 Professional judgment: Professional judgement based on previous experience with similar buildings should be used to the fullest extent possible.

## PART TWO-SUGGESTED COMPLIANCE ALTERNATIVES

T-201.0 Purpose and scope

T-201.1 Purpose: The purpose of this reference is to assist the building official and those regulated by this code in judging the accepta-

## APPENDIX T

bility of compliance alternatives to specific code provisions required by the code.

T-201.2 Application: This reference contains generally acceptable compliance alternatives and examples. The examples are solely for the purpose of illustrating principles which can be applied to the solution of code compliance problems and are not necessarily acceptable under all circumstances. It is recognized that all building systems interact with each other. Therefore, any consideration of compliance alternatives must take into account all existing and proposed conditions to determine their acceptability. The principles applied can be used for the solution of similar compliance problems in other buildings and occupancy groups. Commentaries are provided where the philosophy in establishing the alternatives is not obvious. The examples were developed from appeal data and accepted practice. They are not all-inclusive and should not preclude consideration of other alternatives.

Note: It is anticipated that additional compliance alternatives will be added to this reference through the mechanism of appeal decisions and from results of research being conducted by various organizations in the field of relative performance of life safety systems.

T-202.0 Compliance alternatives for egress requirements

T-202.1 Number of exits

T-202.1.1 General compliance alternatives:

1. Provide connecting fire balconies.
2. Provide alternate egress facilities (windows, etc.).
3. Provide a fire escape.
4. Provide fire-rated areas of refuge.

T-202.1.2 Examples: Example 1 involves a five-story "row house" of occupancy group B without a fire suppression system and with only one (1) means of egress.

Solution A. Add one (1) or more fire escapes as may be necessary to provide all tenants with reasonable access to two (2) means of egress in separate directions. Access to a street, public way or area of refuge shall be provided at the termination of the fire escape.

Section B. Add connecting fire balconies across fire walls if the above solution is impractical due to construction difficulties.

Example 2 involves a building of group R-2 occupancy with an apartment in the basement. There is only one (1) means of egress from the basement.

Solution A. Provide egress windows in each apartment that comply with Section 609.4.

## T-202.2 Travel distance

## T-202.2.1 General compliance alternatives:

1. Add detection system.
2. Add a partial fire suppression system.
3. Add smoke doors.
4. Increase fire resistance rating of corridor walls and doors.

T-202.2.2 Example: This example involves a four (4) story building of occupancy group R-2 without a fire suppression system. The length of exitway access travel is one hundred fifty (150) feet.

Solution A. Add a partial fire suppression system off the domestic water supply (if adequate) in the exit access corridor.

Solution B. Subdivide corridor into segments of less than one hundred 100 feet with smoke doors.

Solution C. If not required by other sections of the code, install smoke and fire detectors with audible alarms in the corridor.

Solution D. Increase the fire resistance rating of the exit access corridor from one (1) hour to two (2) hours and provide one-half hour (1/2) hour "B" label self-closing or automatic closing fire doors in all openings into the corridor.

## T-202.3 Enclosure of exitways

## T-202.3.1 General Compliance alternatives

1. Improve enclosure of exitway.
2. Add a partial fire suppression system.
3. Add a detection system.

T-202.3.2 Examples: This example involves a four (4) story row building of occupancy group R-2 with connecting fire balconies and an interior stair. The stair is enclosed with wood lath and plaster on wood stud partitions and paneled doors.

Solution A. Cover partitions on the apartment side with 5/8" Type X gypsum wallboard or its equivalent. Replace or build up panel doors until minimum solid portion is one and three-eighths (1 3/8") and install self-closers.

Solution B. Provide a heat and smoke detection system in the stairwell with an alarm audible to all tenants. Provide self-closers on all stairwell doors.

Solution C. Provide a partial fire suppression system in the stairwell off the domestic water supply (if adequate). Provide self-closers on all stairwell doors.

T-202.3.3 Commentary: The above example, while pertaining to a four (4) story group R-2 building, can also be applied to other buildings of various heights and occupancies. The principle that the degree of compliance may not be reduced should be remembered. If the existing encl-

## APPENDIX T

sure is of fireresistive construction, it must be maintained. The primary principle to remember, in the required enclosure of exitway, is that an enclosure must be provided, whether fireresistive or not, so as to provide a smoke barrier. The purpose of providing a smoke barrier is to prevent the passage of smoke from a fire on one (1) floor to the exitways and exit access corridors of other floors and thus render them unusable for egress. This principle is illustrated by solutions A, B, and C in the above example.

T-203.0 Compliance alternatives for fire hazards

T-203.1 Fire separations and partitions

T-203.1.1 General compliance alternatives:

1. Improve fire separation.
2. Add a fire suppression system.
3. Add a detection system.

T-203.1.2 Examples: Example 1 involves a three (3) story Type 3A building, of occupancy group M, on the first floor and occupancy group B on the second and third floors. The required separation is three (3) hours.

Solution A. Add a fire suppression system to the first and second floors.

Solution B. Add five-eighths (5/8) inch Type X gypsum wallboard or its equivalent to the underside of the second floor and install a system of smoke and heat detectors with audible alarms on the first and second floors.

Example 2 involves the separation between two (2) tenants of wood lath and plaster on a wood studs partition. The required separation is one (1) hour.

Solution A. Add five-eighths (5/8) inch Type X gypsum wallboard or its equivalent to either side of the existing partition.

Example 3 involves a building of occupancy B with unrated exit access corridors.

Solution A. Install a partial fire suppression system in the exit access corridors.

Solution B. Add five-eighths (5/8) inch Type X gypsum wallboard or its equivalent to either side of the corridor partition and install self-closers on all corridor doors.

Solution C. Install a smoke and heat detection system in the corridor with an alarm audible to all tenants on the floor and install self-closers on all corridor doors.

T-203.2 Openings and exterior wall protection

## T-203.2.1 General compliance alternatives:

1. Add fire suppression system.
2. Improve fireresistance.
3. Remove or improve openings.

T-203.2.2 Examples: Example 1 involves a two (2) story Type 4B building, of occupancy M, on the first floor with the basement and upper floors used for storage. The distance between the building and the side lot line is five (5) feet and between it and the adjacent building is ten (10) feet. The adjacent building is of Type 4B construction and of occupancy group R-2. The former occupant was a grocery store; the new occupant is a hardware store.

Solution A. Install a deluge sprinkler system along the interior side of the wall affected.

Solution B. Add five-eighths (5/8) inch Type X gypsum wallboard to interior side of the wall affected.

Example 2 is the same as example 1 but with double-hung wood windows in affected wall.

Solution A. Remove windows and close opening with one (1) hour fireresistive construction.

Solution B. Remove windows and install fire windows.

Solution C. Install a deluge sprinkler system as in solution A to example 1.

### PART THREE-DETAILED CLASSIFICATION OF OCCUPANCY BY HAZARD INDEX NUMBER AND USE GROUP

This part provides a more detailed guide for users of the code to determine hazard index numbers and use groups for various types of occupancies. It supplements Article 2 and Table 2204 contained in Article 22.

Table T-1  
HAZARD INDEX AND USE GROUP CLASSIFICATION

| Use of structure  | Hazard index number | Use group |
|---|---------------------|-----------|
| Advertising displays manufacture including billboards   | 3                   | S-1       |
| Airport or other aircraft landing or service facility (see also: Helicopter rooftop landing facility) | 3                   | F         |
| Amusement park, indoor  | 4                   | A-3       |
| Animal  |                     |           |
| Crematorium   | 3                   | F         |
| Hospital, kennel, pound   | 2                   | B         |
| Apartment (see Residences)  |                     |           |
| Appliances  |                     |           |
| Manufacture   | 3                   | F         |
| Sales   | 3                   | M         |
| Arenas  | 4                   | A-3       |
| Asphalt   |                     |           |
| Processing and products manufacture   | 8                   | H         |

## 780 CMR: STATE BUILDING CODE COMMISSION

Table T-1 (cont'd.)  
HAZARD INDEX AND USE GROUP CLASSIFICATION

| Use of structure                                    | Hazard index number | Use group         |
|---|---------------------|-------------------|
| Athletic equipment                                  |                     |                   |
| Manufacture   | 3                   | F                 |
| Sales   | 3                   | M                 |
| Auditoriums   | 6, 5 or 4           | A-1-A, A-1-B, A-3 |
| Automobile & other motor vehicles                   |                     |                   |
| Gasoline service station                            | 2                   | B                 |
| Rental agency within a building                     | 2                   | B                 |
| Repair  | 3                   | S-1               |
| Repair incidental to auto sales<br>with limitations | 3                   | S-1               |
| Sales within a building                             | 3                   | M                 |
| Wrecking  | 3                   | F                 |
| Washing   | 3                   | S-1               |
| Awning manufacturer                                 | 3                   | F                 |
| Baked goods shop                                    | 3                   | M                 |
| Bakeries  | 3                   | F                 |
| Banks   | 2                   | B                 |
| Banquet halls                                       | 5                   | A-3               |
| Barber shops  | 2                   | B                 |
| Beauty shops  | 2                   | B                 |
| Beverages   |                     |                   |
| Bottling  | 3                   | F                 |
| Manufacture   |                     |                   |
| Alcoholic   | 8                   | H                 |
| Less than 0.5% alcohol @ 60°                        | 3                   | F                 |
| Bicycle   |                     |                   |
| Manufacture   | 3                   | F                 |
| Rental or repair conducted<br>within a building     | 3                   | S-1               |
| Sales   | 3                   | M                 |
| Billiard parlor                                     | 4                   | A-3               |
| Blacksmith shops                                    | 3                   | F                 |
| Blueprinting, etc., establishments                  | 3                   | F                 |
| Boarding house                                      | 2                   | R-1 or R-2        |
| Boats or ships                                      |                     |                   |
| Building or repair of boats                         | 3                   | F                 |
| Bone distillation                                   | 3                   | F                 |
| Bowling alleys                                      | 4                   | A-3               |
| Broom or brush manufacture                          | 3                   | F                 |
| Building materials                                  |                     |                   |
| Wholesale business in roofed structures             | 3                   | M or S-1          |
| Bus terminals or stations                           | 4                   | A-3               |
| Business schools or colleges                        | 4                   | A-4               |
| Camera & other photo equipment                      |                     |                   |
| Manufacture except film sales                       | 3                   | F                 |
| Sales   | 3                   | M                 |
| Canvas or canvas products                           |                     |                   |
| Manufacture or repair                               | 3                   | F                 |
| Carpet & rug  |                     |                   |
| Cleaning establishments                             | 8 or 3              | H, F              |
| Manufacture or repair                               | 3                   | F                 |
| Catering for outside consumption                    | 3                   | F                 |

Table T-1 (cont'd.)  
HAZARD INDEX AND USE GROUP CLASSIFICATION

| Use of structure  | Hazard index number | Use group  |
|---|---------------------|--|
| Cemeteries  |                     |  |
| Crematory in cemetery   | 3                   | F  |
| Mausoleum, crypt, columbarium   | 1                   | S-2  |
| Mortuary chapel in cemetery   | 4                   | A-4  |
| Ceramic products manufacture  |                     |  |
| Including pottery, small glazed tile, & similar items                           | 3                   | F  |
| Charcoal, fuel, briquettes, or lampblack manufacture                            | 8                   | H  |
| Chemicals   |                     |  |
| Packaging   | 8 or 3              | H or F depending on nature of materials involved |
| Manufacture   | 8 or 3              | H or F depending on nature of materials involved |
| Churches or other places of worship   | 4                   | A-4  |
| Circuses, temporary   | 4                   | A-3  |
| Cleaning (see Drycleaning & dyeing; Laundries; Automobiles, washing)            |                     |  |
| Clothing  |                     |  |
| Manufacturing   | 8 or 3              | H or F depending on nature of materials involved |
| Rental Establishment  | 3                   | M  |
| Retail sales  | 3                   | M  |
| Tailoring, custom manufacture or repair (see also Feathers; Felt; Fur; Leather) | 3                   | M  |
| Clubs   |                     |  |
| Private   | 4                   | A-3 without residence                            |
| Nightclubs (see Eating & drinking establishments)                               |                     |  |
| Coal, coke or tar products, manufacture   | 8                   | H  |
| Colleges & universities   |                     |  |
| Classroom buildings   | 4                   | A-4  |
| Dormitories   | 2                   | R-1  |
| Fraternities or sororities  | 2                   | R-1  |
| Community centers   | 4 or 2              | A-3 or B   |
| Convalescent homes (see Nursing homes)  |                     |  |
| Convents  | 2                   | R-1  |
| Cosmetics or toiletries manufacture   | 8                   | H  |
| Cotton ginning  | 8                   | H  |
| Cotton wadding or linters manufacture   | 8                   | H  |
| Courthouses   | 2 or 4              | B or A-3   |
| Crematoriums  |                     |  |
| Animal  | 3                   | F  |
| Human   | 3                   | F  |
| Dance halls   | 7                   | A-2  |
| Day care agencies   | 4                   | I-2 or A-4                                       |
| Day nurseries   | 4                   | I-2  |
| Dental offices (see Medical & dental)   |                     |  |
| Department stores   | 3                   | M  |

## 780 CMR: STATE BUILDING CODE COMMISSION

Table T-1 (cont'd.)  
HAZARD INDEX AND USE GROUP CLASSIFICATION

| Use of structure   | Hazard index number | Use group                              |
|--|---------------------|--|
| Dormitories  | 2                   | R-1 or R-2                             |
| Dressmaking shops, custom                                    | 8                   | H                                      |
| Drinking places (see Eating & drinking establishments)       |                     |  |
| Drive-in restaurants   | 5                   | A-3                                    |
| Drive-in theaters  | 4                   | A-5                                    |
| Drug stores  | 3                   | M                                      |
| Dry cleaning & dyeing establishment                          | 8 or 3              | H or F depending on solvents used<br>B |
| Dwellings (see Residences)                                   |                     |  |
| Eating or drinking establishments                            |                     |  |
| Lunchrooms, restaurants, cafeterias, etc. primarily enclosed | 5                   | A-3                                    |
| Drive-in   | 4                   | A-3                                    |
| With entertainment or dancing                                | 7                   | A-2                                    |
| Electric   |                     |  |
| Power or steam generating plants                             | 3                   | F                                      |
| Substation   | 3                   | F                                      |
| Electrical appliances, bulbs, wiring supplies, etc.          |                     |  |
| Manufacture  | 3                   | F                                      |
| Sales  | 3                   | M                                      |
| Electronic components & supplies                             |                     |  |
| Manufacture or repair  | 3                   | F                                      |
| Feathers   |                     |  |
| Curing, dyeing, washing or bulk processing                   | 8                   | H                                      |
| Manufacturing exclusive of above                             | 8                   | H                                      |
| Felt   |                     |  |
| Curing, dyeing, washing or bulk processing                   | 3                   | F                                      |
| Products manufacture, exclusive of above                     | 3                   | F                                      |
| Fertilizers, manufacture                                     | 8                   | H                                      |
| Film, photographic, manufacture                              | 3 or 8              | F or H                                 |
| Storage and studios  | 3 or 8              | F or H                                 |
| Fire station   | 2                   | B                                      |
| Fish processing  | 3                   | F                                      |
| Florida shops  | 3                   | M                                      |
| Food   |                     |  |
| Product processing except meat and fish                      | 3                   | F                                      |
| Retail sales   | 3                   | M                                      |
| Fraternities or sororities                                   | 2                   | R-1 or R-2                             |
| Funeral establishments                                       | 4                   | A-3                                    |
| Fur  |                     |  |
| Curing, dyeing, finishing, tanning                           | 8                   | H                                      |
| Products manufacture exclusive of above                      | 3                   | F                                      |
| Garage (see Parking garage)                                  |                     |  |
| Garbage incineration or reduction                            | 3                   | F                                      |
| Garden supplies, produce or flowers                          | 3                   | M                                      |
| Gas  |                     |  |
| Manufacture  | 8                   | H                                      |
| Public utility stations for metering or regulating           | 2                   | B                                      |



780 CMR: STATE BUILDING CODE COMMISSION

Table T-1 (cont'd.)  
HAZARD INDEX AND USE GROUP CLASSIFICATION

| Use of structure  | Hazard index number | Use group |
|---|---------------------|-----------|
| Storage   |                     |           |
| 2500 cu. ft. or less  | 3                   | S-1       |
| More than 2500 cu. ft.  | 8                   | H         |
| Gasoline service stations<br>(see Automobiles)  |                     |           |
| Gelatin manufacture   | 3                   | F         |
| Generating plants, electric or steam  | 3                   | F         |
| Gift shops  | 3                   | M         |
| Glass products form previously manufactured   | 3                   | F         |
| Glue manufacture  | 3                   | F         |
| Golf  |                     |           |
| Indoor courses or driving ranges  | 4                   | A-3       |
| Gymnasiums  | 4                   | A-3       |
| Gypsum manufacture  | 3                   | F         |
| Grain storage   | 8                   | H         |
| Hair  |                     |           |
| Curing, dyeing, washing, bulk processing  | 3                   | F         |
| Product manufacture exclusive of above  | 3                   | F         |
| Hardware  |                     |           |
| Manufacture   | 3                   | F         |
| Retail sales  | 3                   | M         |
| Hat bodies manufacture  | 3                   | F         |
| Helicopter landing facility, rooftop  | 3                   | S-1       |
| Home occupations  | 2                   | B         |
| Homes for the aged  | 4                   | I-2       |
| Hosiery manufacture   | 3                   | F         |
| Hospitals   |                     |           |
| Including convalescent, nursing or rest homes, and<br>sanitariums, provided custodial care is not<br>provided for drug addicts, alcoholics,<br>mentally ill or mentally deficient | 4                   | I-2       |
| For care of drug addicts, mentally ill or<br>mentally deficient   | 5                   | I-1       |
| Research or teaching laboratories<br>(see also Animal hospitals)  | 2                   | B         |
| Hotels  | 2                   | R-1       |
| Ice manufacture (dry or natural)  | 3                   | F         |
| Ice skating rinks   | 4                   | A-3       |
| Incineration or reduction of garbage, offal,<br>or dead animals   | 3                   | F         |
| Industrial uses (see specific items)  |                     |           |
| Without resulting noise, vibration, special danger,<br>hazard, dust, smoke, fumes, etc.   | 3                   | F         |
| Other than above  | 3 or 8              | F or H    |
| Ink or inked ribbon manufacture   | 3                   | F         |
| Jewelry   | 3                   | F         |
| Kennels (see Animal)  |                     |           |
| Laboratories  |                     |           |
| Research laboratory not accessory<br>to school or hospital  | 2                   | B         |
| Scientific research or teaching laboratory,<br>non-profit, accessory to school or<br>hospital subject to limitations  | 2                   | B         |

## 780 CMR: STATE BUILDING CODE COMMISSION

Table T-1 (cont'd.)  
HAZARD INDEX AND USE GROUP CLASSIFICATION

| Use of structure  | Hazard index number | Use group |
|---|---------------------|-----------|
| Laundries   |                     |           |
| Hand laundry  | 2                   | B         |
| Self service; pick-up and delivery station of laundry or dry cleaner  | 2                   | B         |
| Steam laundries without limitations                                   | 3                   | F         |
| Leather   |                     |           |
| Curing, dyeing, finishing or tanning                                  | 3                   | F         |
| Product manufacture exclusive of above                                | 3                   | F         |
| Libraries   | 4                   | A-3       |
| Linoleum or oilcloth manufacture                                      | 3                   | F         |
| Liquor sales, package   | 3                   | M         |
| Luggage manufacture   | 3                   | F         |
| Lumber (see Wood)   |                     |           |
| Manufacturing   | 3 or 8              | F or H    |
| Matches manufacture   | 8                   | H         |
| Mattress manufacture and renovation                                   | 3                   | F         |
| Meat  |                     |           |
| Markets   | 3                   | M         |
| Slaughtering or packaging   | 3                   | F         |
| Medical and dental  |                     |           |
| Offices   | 2                   | B         |
| (See also Laboratories; Orthopedic and medical appliances; Hospitals) |                     |           |
| Meeting hall  | 4                   | A-3       |
| Metals, manufacture   | 3                   | F         |
| Reduction, refining or smelting                                       | 8                   | H         |
| Monasteries   | 2                   | R-1       |
| Motels  | 2                   | R-1       |
| Motor freight stations<br>(see Trucking terminals)                    |                     |           |
| Museums   | 4                   | A-3       |
| Musical instruments manufacture                                       | 3                   | F         |
| Newspaper publishing  | 3                   | F         |
| Newsstands  | 3                   | M         |
| Novelty products manufacture  | 3                   | F         |
| Nursing homes   | 4                   | I-2       |
| Offices   | 2                   | B         |
| Oilcloth manufacture  | 3                   | F         |
| Optical equipment or similar<br>precision instruments manufacture     | 3                   | F         |
| Orphanages  |                     | I-2       |
| Orthopedic or medical appliances manufacture                          | 3                   |           |
| Paint, turpentine or varnish  |                     | F         |
| Manufacture   | 8                   | H         |
| Spraying booths   | 8                   | H         |
| Paper products manufacture  | 3                   | F         |
| Parish houses   | 4                   | A-3       |
| Parking garages   | 3                   | S-1       |
| Petroleum or petroleum products                                       |                     |           |
| Refining  | 8                   | H         |
| Storage   | 3                   | S-1       |
| Pharmaceutical products manufacture                                   | 3                   | F         |
| Photography studio  | 2                   | B         |
| Plastics  |                     |           |
| Products manufacture  | 8                   | H         |
| Raw, manufacture  | 8                   | H         |

Table T-1 (cont'd.)  
HAZARD INDEX AND USE GROUP CLASSIFICATION

| Use of structure  | Hazard index number | Use group  |
|---|---------------------|------------|
| Police stations   | 2                   | B          |
| Pool rooms  | 2                   | A-3        |
| Post offices  | 2                   | B          |
| Printing  |                     |            |
| Plant   | 3                   | F          |
| Printing or newspaper publishing  | 3                   | F          |
| Prisons & other correctional or detention institutions  | 5                   | I-1        |
| Pumping station or substation, water or sewage  | 2                   | B          |
| Radio   |                     |            |
| Sales   | 3                   | M          |
| Studios with audience   | 5                   | A-1-B      |
| Studios without audience  | 2                   | B          |
| Railroad  |                     |            |
| Freight terminal  | 3                   | S-1        |
| Passenger station   | 4                   | A-3        |
| Recreation  |                     |            |
| Center, indoor  | 4                   | A-3        |
| Community center building   | 4                   | A-3        |
| Rectories   | 2                   | R-1        |
| Residences  |                     |            |
| One-family  | 2                   | R-3        |
| Two-family  | 2                   | R-3        |
| Apartment   | 2                   | R-2        |
| Temporary dwelling structure  | 2                   | R-3        |
| Boarding or lodging house   | 2                   | R-1 or R-2 |
| Dormitory   | 2                   | R-1 or R-2 |
| Fraternity or sorority  | 2                   | R-1 or R-2 |
| Hotel, motel, apartment hotel with accessory services   | 2                   | R-1        |
| Convents, monasteries, rectories  | 2                   | R-1        |
| Research laboratories (see Laboratories)  |                     |            |
| Restaurant, lunch room, cafeteria or other establishment primarily for eating                 | 5                   | A-3        |
| Retail business   | 3                   | M          |
| Stores with combustible or flammable goods constructing a high hazard                         | 8                   | H          |
| Rubber  |                     |            |
| Manufacture (natural or synthetic), including tires, tubes or similar products                | 8                   | H          |
| Products (exclusive or processing) including washers, gloves, footwear, bathing cap, and like | 3                   | F          |
| Sanatoriums   |                     |            |
| Not providing custodial care for drug addicts, alcoholics, mentally ill or mentally deficient | 4                   | I-2*       |
| Providing care for above  | 5                   | I-1        |
| Schools   | 4                   | A-4        |
| Seminaries  | 4 or 2              | A-4 & R-1  |
| Settlement houses (depending on nature of activities)   | 4 or 2              | A-3 or B   |

Table T-1 (cont'd.)  
HAZARD INDEX AND USE GROUP CLASSIFICATION

| Use of structure  | Hazard index number | Use group  |
|---|---------------------|--|
| Sewage  |                     |  |
| Disposal plant  | 3                   | F  |
| Pumping station   | 3                   | F  |
| Shoddy manufacture  | 8                   | H  |
| Shoes   |                     |  |
| Manufacture   | 3                   | F  |
| Repair shop   | 2                   | B  |
| Silverware, manufacture, plate or sterling  | 3                   | F  |
| Size manufacture  | 3                   | A-3  |
| Skating rinks   | 4                   | A-3  |
| Soap and detergents   |                     |  |
| Manufacturing, including fat rendering  | 8                   | H  |
| Packaging   | 3                   | F  |
| Solvent extracting  | 8                   | H  |
| Sporting or athletic goods  |                     |  |
| Manufacture   | 3                   | F  |
| Stores  | 3                   | M  |
| Stables   | 3                   | S-1  |
| Stadiums  | 4                   | A-5  |
| Wholesale business including accessory storage other than flammable liquids, gases and explosives, in roofed structures | 3 or 1              | S-1 or S-2 depending on nature of materials involved |
| Stores (see Retail stores; or specific items)   |                     |  |
| Tailor shops, custom  | 2                   | B  |
| Tanning (see Leather; Fur)  |                     |  |
| Taxidermist shops   | 3                   | M  |
| Telephone exchanges   |                     |  |
| Automatic   | 2                   | B  |
| Non-automatic   | 2                   | B  |
| Television  |                     |  |
| Sales   | 3                   | M  |
| Studios   | 6                   | A-1a with scenery                                    |
|   | 5                   | A-1b no scenery                                      |
|   | 2                   | B no audience  |
| Textiles  |                     |  |
| Manufacture, including knit goods, yard goods, thread or cordage; spinning, weaving, dyeing and printing                | 3                   | F  |
| Shoddy, manufacture   | 8                   | H  |
| Theaters  | 6                   | A-1a with scenery                                    |
|   | 5                   | A-1b no scenery<br>motion picture                    |
| Tires, manufacture  | 8                   | H  |
| Tobacco products manufacture including curing   | 3                   | F  |
| Tools and hardware  |                     |  |
| Manufacture   | 3                   | F  |
| Sales   | 3                   | M  |
| Toys  |                     |  |
| Manufacture   | 3                   | F  |
| Trailer park (see also Mobile homes)  |                     |  |
| Truck   |                     |  |
| Repairs   | 3                   | S-1  |
| Sales   | 3                   | M  |

Table T-1 (cont'd.)  
HAZARD INDEX AND USE GROUP CLASSIFICATION

| Use of structure         | Hazard index number | Use group  |
|--------------------------|---------------------|--|
| Trucking terminals       | 3                   | S-1  |
| Turpentine manufacture   | 8                   | H  |
| Warehouses               | 8, 3 or 1           | H, S-1, or S-2<br>depending on nature<br>of materials involved |
| Waterpumping stations    | 2                   | B  |
| Wax products manufacture | 8                   | H  |

#### PART FOUR-ARCHAIC CONSTRUCTION SYSTEMS

##### T-401.0 Purpose and Scope

T-401.1 Purpose: The purpose of this part of Appendix T is to assist the building official and those regulated by this code in evaluating the properties of archaic construction systems.

T-401.2 Scope: This part of Appendix T contains data on construction systems no longer in general use but which may be encountered in older existing buildings. It is meant to be used for assessing existing conditions when evaluating how proposed changes will impact upon the performance of the building.

T-401.3 Application: In any given problem, all available data should be collected and professional judgment exercised in arriving at decisions.

## APPENDIX T

Evaluative judgment should be used when test data does not exist or when applying the data contained in this standard.

#### T-402.0 Archaic fireresistive systems

T-402.1 General: This part of Appendix T contains a list of fire-resistive materials and construction which are not necessarily currently in common use. Some of the hourly ratings contained in the listing predate ASTM E-119 that is in current use. The hourly ratings may be higher or lower if tested according to ASTM E-119. In addition to the data contained herein, see Report BMS92, Building Materials and Structures, dated October 7, 1942, National Bureau of Standards. The data listed below is extracted from the Boston Building Code, circa 1943.

#### T-402.2 Fireresistive materials and construction

T-402.2.1 Minimum qualities: Materials, to be given the fireresistive ratings specified in this part, shall have the following minimum qualities: set forth in Sections T-402.2.2 through T-402.2.19.

T-402.2.2 Class 1 concrete: Concrete of Class 1 shall be so proportioned as to have a strength of at least fifteen hundred (1500) pounds per square inch (psi) and the coarse aggregate shall consist of limestone, trap rock, blast furnace slag, cinders containing not more than twenty (20) per cent of combustible material, burned clay or shale.

T-402.2.3 Class 2 concrete: Concrete of Class 2 shall be so proportioned as to have a strength of at least fifteen hundred (1500) pounds per square inch (psi), the coarse aggregate consisting of sandstone, granite, quartzite, siliceous gravel or other similar material not over one (1) inch in size.

T-402.2.4 Masonry: Masonry shall be laid in lime-cement or cement mortar, or approved masonry cement mortar, except that masonry of gypsum tile shall, and masonry of structural clay tile may, be laid in gypsum mortar. Masonry shall be thoroughly bonded by breaking joints in successive courses or by the use of metal ties.

T-402.2.5 Brick: Brick shall be burned clay or shale, concrete or sand-lime brick of Grade C or better.

T-402.2.6 Stone: Stone shall be limestone, marble, slate or equally fireresistive natural stone. Sandstone, granite or other stone which, because of its crystalline structure or for other reason, is less fireresistive, shall not be considered fire protection for structural metal, but may be used in a masonry wall not less than twelve (12) inches thick required to have fireresistance. Stone masonry shall have the same fireresistive rating as brick masonry.

T-402.2.7 Cast stone: Cast stone masonry shall have the same fire-resistive rating as brick masonry.

T-402.2.8 Concrete blocks: Concrete blocks, whether solid or hollow, shall have as coarse aggregate limestone, trap rock, blast furnace slag, cinders containing not more than twenty (20) per cent of combustible material, burned clay or shale.

T-402.2.9 Structural clay tile: Structural clay tile shall conform to the specifications for load-bearing tile, floor tile or partition tile. Where partition tile is specified, load-bearing tile may be used.

T-402.2.10 Gypsum: Gypsum tile or pre-cast gypsum concrete, whether solid or hollow, shall conform to Standard Specifications for Gypsum Partition Tile or Block of the American Society for Testing Materials and shall not contain more than three (3) per cent by weight of wood or other combustible binder or filler.

T-402.2.11 Gypsum concrete: Gypsum concrete shall not contain more than twelve and one-half (12 1/2) percent by weight of wood or other combustible binder or filler and shall have a compressive strength of at least five hundred (500) psi. It shall not be used where exposed to the elements.

T-402.2.12 Lath: Expanded metal or wire lath as a base or reinforcement for plastering shall weigh not less than two and two-tenths (2.2) pounds per square yard and shall have not less than two and one-half (2½) meshes per inch.

T-402.2.13 Metal mesh for masonry: Metal mesh reinforcement specified for masonry fire protection of structural metal shall consist of wire lath strips the full thickness of the masonry, laid in the beds thereof, or its approved equivalent.

T-402.2.14 Metal mesh for concrete: Metal mesh reinforcement specified for concrete fire protection of structural metal shall consist of wire mesh weighing not less than one and one-half (1½) pounds per square yard with wire spaced not over four (4) inches, or not less than No. 11 gauge steel wire spaced not over four (4) inches apart, or its approved equivalent.

T-402.2.15 Cement plaster: Cement plaster shall be proportioned of one (1) part Portland cement, and not more than two (2) parts of sand measured by volume dry and loose to which may be added lime putty or hydrated lime not exceeding fifteen (15) per cent of the cement.

T-402.2.16 Gypsum plaster: Gypsum plaster: Gypsum plaster, except where otherwise specified, may contain sand, not in excess of three (3) times the weight of the gypsum.

## APPENDIX T

T-402.2.17 Lime plaster: Lime plaster shall consist of a mixture of one (1) part lime, not over three (3) parts sand, and water.

T-402.2.18 Pneumatically projected mortar: Pneumatically projected mortar made of Portland cement, sand and water shall be rated for fire protection the same as Class 1 concrete.

T-402.2.19 Concrete fill: Concrete fill, where specified in this appendix in connection with hollow masonry units shall consist of Class 1 or Class 2 concrete poured in the hollow spaces of the units as they are laid.

T-402.2.20 Reinforced concrete: Portland cement concrete or gypsum concrete poured in place as fire protection for beams, trusses and other horizontal or inclined members of structural steel and pneumatically projected mortar applied to structural steel as fire protection shall be reinforced with metal mesh reinforcement. Concrete protection for vertical columns of structural metal shall have reinforcing consisting of No. 5 wire spaced not over eight (8) inches apart or its equivalent. Reinforcement shall be wrapped around the structural member and so arranged as to be completely embedded in the fire protection material and to ensure its integrity.

T-402.2.21 Reinforced plaster: Plaster used as fire protection or to resist the spread of fire shall be reinforced with metal lath, except plaster less than one (1) inch thick or masonry or concrete.

T-402.2.22 Replacement material: In the protection of structural metal including reinforcement, one-half ( $\frac{1}{2}$ ) inch of cement or gypsum plaster may replace an equal thickness of poured concrete or pneumatically projected mortar as protective material; and one (1) inch of cement or gypsum plaster reinforced with metal lath may replace an equal thickness of poured concrete, pneumatically projected mortar or masonry protection.

T-402.2.23 Plaster: Where plaster is required without other specification, it shall consist of one-half ( $\frac{1}{2}$ ) inch of cement or gypsum plaster, except that only gypsum plaster shall be used on gypsum masonry.

T-402.2.24 Thickness: In this appendix, except where otherwise specifically stated, the thickness given in a list of materials applies to the next following item only, and not to the total thickness where additional materials are specified.

T-402.2.25 Embedding limitations: Pipes, wires, conduits and ducts shall not be embedded in or placed behind the fire-protective materials required for the protection of structural steel or iron except as otherwise provided in this paragraph. Above fire-protective hung ceilings and within the enclosed space in buildings of Type 1 and Type 2 construc-



tion, within which, other than the enclosure, fire protection of steel is not required, pipes, wires, conduits and ducts may be placed, provided they are so arranged and so secured that they will not, either by expanding in the event of fire, or otherwise impair, the effectiveness of the enclosing protective materials. Electric conduits and wires and gas pipes may be embedded in concrete or masonry fire protection of structural steel where the protective material is reinforced with wire mesh, provided they shall have protective covering except over the tops of beams and girders, at least as thick as required for the steel.

T-402.2.26 Damage protection: In factories, garages, warehouses and other buildings in which the fire-protective covering required for steel or iron columns may be damaged by the movement of vehicles, materials or equipment, such covering shall be protected by metal or other material in a manner satisfactory to the building official.

T-402.2.27 Firestopping: Firestopping shall mean the stopping off or enclosure at the ends and wherever else specified of the spaces between studs of partitions, joists of floors and roofs and other similar spaces to prevent drafts of air and the communication of fire from one (1) such space to another. Fire-stopping shall consist of wood not less than one and one-half ( $1\frac{1}{2}$ ) inches thick, of sheet metal not less than No. 24 gauge or of masonry, or a combination of such materials. Firestopping shall be tightly fitted in the space to be filled, about pipes, wires and ducts and, if cut or disturbed in the placement of pipes, wires and ducts, shall be repaired.

### T-402.3 Fire protection of steel columns

T-402.3.1 Protective thickness: Structural steel columns required to have fire protection of a given rating shall be covered on all sides with protective material having not less than the thickness necessary for the required rating. Except where "no fill" is specified, re-entrant and other accessible spaces behind the specified outer protection shall be filled with concrete or brick masonry or the material of the outer protection.

T-402.3.2 Fireresistance rating: Materials shall be assumed to afford to steel columns fire protection of the rating indicated in the following Sections T-402.3.3 through T-402.3.6:

#### T-402.3.3 Four (4) hour rating:

1. Two (2) inches Class 1 concrete.
2. Three (3) inches Class 2 concrete, metal mesh reinforcement.
3. Three and one-half ( $3\frac{1}{2}$ ) inches brick masonry.
4. Two (2) layers two (2) inch structural clay partition tile masonry, metal mesh in beds.
5. Two (2) inches structural clay partition tile masonry, concrete fill, metal mesh in beds, three-fourths ( $\frac{3}{4}$ ) inch gypsum plaster.

6. Four (4) inches structural clay partition tile masonry, concrete fill, metal mesh in beds, five-eighths (5/8) inch lime plaster.
7. Four (4) inches structural clay partition tile or concrete block masonry, concrete fill, plaster.
8. Three (3) inches hollow gypsum tile masonry and plaster.
9. Two (2) inches gypsum concrete, metal mesh reinforcement.
10. Two (2) inches solid gypsum tile masonry and plaster.
11. Three (3) inches solid cinder concrete block masonry and plaster.
12. Four (4) inches hollow cinder concrete block masonry and plaster.

T-402.3.4 Three (3) hour rating:

1. One and three-fourths (1 3/4) inches Class 1 concrete.
2. Two (2) inches Class 2 concrete, metal mesh reinforcement.
3. Two (2) inches gypsum concrete.
4. Two (2) inches solid cinder concrete block masonry and plaster.
5. Two (2) inches structural clay partition tile masonry, concrete fill.
6. Four (4) inches structural clay partition tile masonry, concrete fill, metal mesh in beds, five-eighths (5/8) inch lime plaster.

T-402.3.5 Two (2) hour rating:

1. One and one-half (1½) inches Class 1 concrete.
2. Two (2) inches Class 2 concrete, metal mesh reinforcement.
3. One (1) inch Class 1 or Class 2 concrete encased in standard weight steel or wrought iron pipe.
4. Two (2) inches structural clay partition tile masonry and plaster.
5. Two (2) layers plaster, each on metal lath, with three-fourths (3/4) inch air space between, two (2) inches total thickness.
6. Two (2) inches gypsum concrete.
7. Two (2) inches solid or three (3) inches hollow gypsum tile masonry.

T-402.3.6 One (1) hour rating:

1. One (1) inch Class 1 concrete.
2. One and one-half (1½) inches Class 2 concrete with metal mesh reinforcement.
3. Two and one-fourth (2¼) inches brick masonry.
4. Two (2) inches structural clay partition tile or concrete block masonry.
5. One (1) inch cement or gypsum plaster on metal lath.

T-402.3.7 Thickness: The thickness of protection on the outer edges of lugs or brackets need not exceed one (1) inch.

T-402.4 Fire protection of cast iron columns

T-402.4.1 Protective thickness: Cast iron columns required to have fire protection of a given rating shall be covered on all sides with protective materials having not less than the thickness necessary for the re-

quired rating. Re-entrant spaces, if any, on the exterior of cast iron columns, and other accessible spaces behind the specified protection, shall be filled with Class 1 concrete or brick masonry or the material of the outer protection.

T-402.4.2 Fire-resistance rating: Materials shall be assumed to afford to cast iron columns fire protection of the rating indicating in the following Sections T-402.4.3 through T-402.4.5:

T-402.4.3 Four (4) hour rating: Cast iron columns shall not be used where the protection of a four (4) hour rating is required.

T-402.4.4 Three (3) hour rating

1. Two (2) inches Class 2 concrete.
2. Three (3) inches Class 2 concrete, metal mesh reinforcement.
3. Two (2) inches structural clay partition tile or concrete block masonry concrete fill.
4. One and one-half ( $1\frac{1}{2}$ ) inches cement or gypsum plaster on metal lath and metal furring to form one-half ( $\frac{1}{2}$ ) inch air space.
5. One and one-half ( $1\frac{1}{2}$ ) inches Class 1 concrete.
6. Two (2) inches Class 2 concrete with metal mesh reinforcement.

T-402.4.5 One (1) hour rating

1. One (1) inch Class 1 concrete.
2. One and one-half ( $1\frac{1}{2}$ ) inches Class 2 concrete with metal mesh reinforcement.
3. One (1) inch cement or gypsum plaster on metal lath.

T-402.5 Fire protection of steel in reinforced concrete columns

T-402.5.1 Protection thickness: The main steel reinforcement, including spiral reinforcement and ties larger than one-half ( $\frac{1}{2}$ ) inch, in reinforced concrete columns required to have fire protection of a given rating shall be covered with concrete having not less than the thickness listed in this section for the rating indicating in the following Sections T-402.5.2 through T-402.5.6:

T-402.5.2 Four (4) hour rating

1. One and one-half ( $1\frac{1}{2}$ ) inches Class 1 concrete.
2. Two (2) inches Class 2 concrete.

T-402.5.3 Three (3) hour rating: One and one-half ( $1\frac{1}{2}$ ) inches Class 1 or Class 2 concrete.

## T-402.5.4 Two (2) hour rating

1. One (1) inch Class 1 concrete.
2. One and one-half ( $1\frac{1}{2}$ ) inches Class 2 concrete.

T-402.5.5 One (1) hour rating: One (1) inch Class 1 or Class 2 concrete.

T-402.5.6 Ties less than one-half ( $\frac{1}{2}$ ) inch: The thickness of protection on column ties not larger than one-half ( $\frac{1}{2}$ ) inch may be one-half ( $\frac{1}{2}$ ) inch thinner than that listed above.

## T-402.6 Fire protection of steel beams, girders, and trusses

T-402.6.1 Protective thickness: Steel beams, girders and trusses or the members of trusses, required to have fire protection of a given rating, shall be covered on all sides with material having not less than the thickness necessary for the required rating.

T-402.6.2 Fireresistance rating: Materials shall be assumed to afford steel beams, girders and trusses, or the members thereof, fire protection of the rating indicated in the following Sections T-402.6.3 through T-402.6.6:

## T-402.6.3 Four (4) hour rating

1. Two (2) inches Class 1 concrete.
2. Three (3) inches Class 2 concrete.
3. Three (3) inches structural clay partition tile or concrete block masonry and plaster.
4. Three (3) inches hollow gypsum tile masonry and plaster.
5. Two (2) inches gypsum concrete.
6. Two (2) inches solid gypsum tile masonry and plaster.

## T-402.6.4 Three (3) hour rating

1. One and three-quarters ( $1\frac{3}{4}$ ) inches Class 1 concrete.
2. Two and one-half ( $2\frac{1}{2}$ ) inches Class 2 concrete.
3. Two (2) inches gypsum concrete.
4. Two (2) inches structural clay partition tile, or concrete block masonry and plaster.
5. Two (2) inches solid, or three (3) inches hollow gypsum tile masonry.

## T-402.6.5 Two (2) hour rating

1. One and one-half ( $1\frac{1}{2}$ ) inches Class 2 concrete.
2. Two (2) inches gypsum concrete.

## T-402.6.6 One (1) hour rating

1. One (1) inch Class 1 concrete.
2. One and one-half ( $1\frac{1}{2}$ ) inches Class 2 concrete.
3. Seven-eighths ( $7/8$ ) inch or cement or gypsum plaster on metal lath.

## T-402.7 Fire protection of steel in reinforced concrete beams

T-402.7.1 Protective thickness: The main steel reinforcement, including stirrups larger than one-half ( $\frac{1}{2}$ ) inch, in reinforced concrete beams, girders and trusses, including the ribs of reinforced concrete ribbed floors or roofs where one (1) or both sides of the ribs, in addition to the soffit, are exposed to fire, required to have fire protection of a given rating, shall be covered on all sides with concrete having not less than the thickness listed in this section for the required rating. Where a reinforced concrete floor or roof has a flush ceiling formed with approved permanent masonry fillers between ribs, the reinforcement shall have the protection required for reinforcing steel of floors and roofs in Section T-402.8.

## T-402.7.2 Four (4) hour rating:

1. One and one-half ( $1\frac{1}{2}$ ) inches Class 1 concrete.
2. Two (2) inches Class 2 concrete.

T-402.7.3 Three (3) hour rating: One and one-half ( $1\frac{1}{2}$ ) inches Class 1 or Class 2 concrete.

## T-402.7.4 Two (2) hour rating:

1. One (1) inch Class 1 concrete.
2. One and one-half ( $1\frac{1}{2}$ ) inches Class 2 concrete.

T-402.7.5 One (1) hour rating: One (1) inch Class 1 or Class 2 concrete.

T-402.7.6 Stirrups less than one-half ( $\frac{1}{2}$ ) inch: The thickness of protection on stirrups not larger than one-half ( $\frac{1}{2}$ ) inch may be less than that listed by not more than one-half ( $\frac{1}{2}$ ) inch.

## T-402.8 Fire protection of steel reinforcing in floors and roofs.

T-402.8.1 Protection thickness: The steel reinforcement in reinforced concrete floors and roofs with flush or plane ceilings, such that the exposure to fire is on the soffit only, required to have fire protection of a given rating, shall be covered with concrete having not less than the thickness listed in this section for the required rating. In floors or roofs having reinforced concrete ribs where the concrete surrounding the steel reinforcement is exposed to fire on one (1) or both sides in addition to the soffit, such reinforcement shall have the protection specified in Section T-402.7 for steel in reinforced concrete beams.

## T-402.8.2 Four (4) hour rating:

1. One (1) inch Class 1 concrete.
2. One and one-fourth ( $1\frac{1}{4}$ ) inches Class 2 concrete.

T-402.8.3 Three (3) hour rating: One (1) inch Class 1 or Class 2 concrete.

## T-402.8.4 Two (2) hour rating:

1. Three-fourths ( $\frac{3}{4}$ ) inch Class 1 concrete.
2. One (1) inch Class 2 concrete.

T-402.8.5 One (1) hour rating: Three-fourths ( $\frac{3}{4}$ ) inch Class 1 or Class 2 concrete.

## T-402.9 Fireresistive floor and roof construction

T-402.9.1 Protective thickness: Floors and roofs required to have resistance of a given rating to the spread of fire shall have such thickness of the materials of which it is constructed, as shall be necessary for the required rating, and structural metal forming a part of such floors or roofs shall have protection against fire of such required rating. Floors and roofs required to have two (2) hour or longer resistance to fire shall be constructed of noncombustible materials. Granolithic, burned clay tile, ceramic tile or other similar incombustible floor finish of a given thickness may be substituted for an equal thickness, and sand, cinder or other incombustible filling material, with or without embedded wooden screeds may be substituted for two-thirds ( $\frac{2}{3}$ ) its thickness, of the floor or roof construction material specified in this section, provided that such floors and roofs shall have adequate thickness for structural purposes.

T-402.9.2 Fireresistance rating: Floor or roof construction shall be assumed to afford resistance to the spread of fire of the rating indicated in the following Sections T-402.9.3 through T-402.9.6:

## 402.9.3 Four (4) hour rating

1. Four (4) inches solid slab of reinforced Portland cement concrete or reinforced precast gypsum concrete.
2. Four (4) inches solid masonry arches or slabs.
3. Four (4) inches structural clay floor tile masonry arches or slabs with top covering of not less than two (2) inches of solid masonry or reinforced concrete.
4. Five (5) inches combination reinforced Portland cement concrete slab consisting of permanent fillers of concrete block, gypsum or structural clay tile and one and one-half (1½) inches of concrete topping; but if structural clay partition tiles are used for fillers, they shall be plastered on the soffit.

## 402.9.4 Three (3) hour rating

1. Three (3) inches solid slab of reinforced Portland cement concrete or reinforced precast gypsum concrete.
2. Three (3) inches solid masonry arches or slabs.
3. Four (4) inches structural clay floor tile masonry, arches or slabs with top covering of not less than one and one-half (1½) inches of solid masonry or reinforced concrete.
4. Four (4) inches combination reinforced Portland cement concrete slab consisting of permanent fillers of concrete block, gypsum or structural clay tile and one (1) inch concrete topping; but if structural clay partition tiles are used for fillers, they shall be plastered on the soffit.

## 402.9.5 Two (2) hour rating

1. Two and one-half (2½) inches solid slab of reinforced Portland cement concrete or reinforced precast gypsum concrete.
2. Two and one-half (2½) inches solid masonry arches or slabs.
3. Three (3) inches structural clay floor tile masonry, arches or slabs with top covering of not less than one (1) inch of solid masonry or reinforced concrete.

## 402.9.6 One (1) hour rating

1. Three (3) inches structural clay floor tile masonry, arches or slabs with all joints thoroughly filled with cement or gypsum mortar.
2. Wood floor or roof construction with joists not less than one and five-eighths (1 5/8) inches in least dimension, firestopped, double board floor, approved asbestos felt between layers of boards, and with a ceiling of at least three-quarters (3/4) inch cement or gypsum plaster on metal lath.
3. Steel beams or steel joists not more than thirty-six (36) inches apart on centers with noncombustible floor and a ceiling of at least three-quarters (3/4) inch cement or gypsum plaster on metal lath metal furring.

## T-402.10 Fireresistive ceiling construction

T-402.10.1 Protective thickness: Ceilings required to afford fire protection of a given rating to the floor or roof framing under which it is supported shall be of fireresistive materials of at least the thickness necessary for the given rating. A fireresistive ceiling and all hangers and fastenings necessary for its support to the protected framing shall be of noncombustible materials. It shall be capable of sustaining its own weight without exceeding allowable stresses. Metal reinforcement in such ceiling shall be protected from fire as specified in Section T-402.8 for reinforcing in a floor.

T-402.10.2 Fireresistance rating: Ceiling construction shall be assumed to afford to floor or roof framing fire protection of the rating indicated in the following Sections T-402.10.3 through T-402.10.6.

## T-402.10.3 Four (4) hour rating

1. Two and one-half ( $2\frac{1}{2}$ ) inches solid slab of reinforced Portland cement concrete or reinforced precast gypsum concrete.
2. Two (2) inches precast reinforced gypsum concrete, plastered

## T-402.10.4 Three (3) hour rating

1. Two (2) inches solid slab of reinforced Portland cement concrete or reinforced precast gypsum concrete.
2. Two (2) inches precast reinforced gypsum concrete, lapped or rabbeted joints.

T-402.10.5 Two (2) hour rating: One and one-half ( $1\frac{1}{2}$ ) inches solid slab of reinforced Portland cement concrete or reinforced precast gypsum concrete.

T-402.10.6 One (1) hour rating: Three quarter ( $\frac{3}{4}$ ) inch cement gypsum plaster on metal lath.

## T-402.11 Fireresistive bearing walls and partitions

T-402.11.1 Protective thickness: Bearing walls and partitions required to have resistance to fire or the spread of fire of a given rating shall be constructed of fireresistive materials and shall have at least the thickness necessary for the required rating. Walls required to have two (2) hour or longer rating shall be of noncombustible materials. Steel reinforcement in reinforced concrete walls shall have the same protection for the given rating as is required in Section T-402.9 for floors.

T-402.11.2 Fireresistance rating: Bearing walls and partitions shall be assumed to have resistance to fire and the spread of fire of the rating indicated in the following Sections T-402.11.3 through T-402.11.6:



## T-402.11.3 Four (4) hour rating:

1. Eight (8) inches solid brick masonry.
2. Twelve (12) inches hollow wall of brick masonry, minimum eight (8) inch masonry thickness.
3. Twelve (12) inches structural clay load-bearing tile masonry with two (2) units and not less than three (3) cells in the thickness of the wall.
4. Eight (8) inches structural clay load-bearing tile masonry with one (1) unit and not less than two (2) cells in the thickness of the wall, plastered both sides.
5. Twelve (12) inches concrete block masonry with one (1) unit and not less than two (2) cells in the thickness of the wall.
6. Eight (8) inches one (1) piece concrete block masonry with shells and webs at least one and one-half (1½) inches thick, plastered both sides.
7. Twelve (12) inches total thickness of brick masonry facing bonded to structural clay load-bearing tile masonry backing.
8. Eight (8) inches solid concrete.
9. Six (6) inches solid reinforced concrete.
10. A steel or reinforced concrete frame bearing wall in which the steel has fire protection of four (4) hour rating, with panel filling as specified in Section T-402.12 for a nonbearing wall of four (4) hour rating.

## T-402.11.4 Three (3) hour rating:

1. Eight (8) inches structural clay load-bearing tile masonry with two (2) units and not less than four (4) cells in the thickness of the wall.
2. Twelve (12) inches structural clay load-bearing tile masonry with one (1) unit and not less than three (3) cells in the thickness of the wall.
3. Eight (8) inches one (1) piece concrete block masonry with shells and webs not less than one and one-half (1½) inches thick, plastered both sides.
4. Eight (8) inches one (1) piece concrete block masonry with shells and webs not less than two (2) inches thick.
5. Five (5) inches solid reinforced concrete.
6. A steel or reinforced concrete frame bearing wall in which the steel has fire protection of three (3) hour rating, with panel filling as specified in Section T-402.12 for a nonbearing wall of three (3) hour rating.

## T-402.11.5 Two (2) hour rating:

1. Eight (8) inches structural clay load-bearing tile masonry with not less than three (3) cells in the thickness of the wall.
2. Eight (8) inches concrete block masonry with shells and webs not less than one and one-half (1½) inches thick.

3. A steel or reinforced concrete frame bearing wall in which the steel has fire protection of two (2) hour rating, with panel filling as specified in Section T-402.12 for a nonbearing wall of two (2) hour rating.

T-402.11.6 One (1) hour rating:

1. A steel or wooden stud bearing wall covered on both sides with one (1) inch cement or gypsum plaster on metal lath, firestopped if of wood.
2. A steel or reinforced concrete frame bearing wall in which the steel has fire protection of one (1) hour rating, with panel filling as specified in Section T-402.12 for a nonbearing wall of one (1) hour rating.

T-402.12 Fireresistive nonbearing walls and partitions

T-402.12.1 Protective thickness: Nonbearing walls and partitions required to have resistance to fire and the spread of fire of a given rating shall be constructed of fireresistive materials and shall have at least the thickness necessary for the required rating. Walls required to have two (2) hour or longer rating shall be of incombustible materials. Steel reinforcement in reinforced concrete walls shall have the same protection for the given rating as is required in Section T-402.8.

T-402.12.2 Fireresistance rating: Nonbearing walls and partitions shall be assumed to have resistance to fire and the spread of fire of the rating indicated in the following Sections T-402.12.3 through T-402.12.6:

T-402.12.3 Four (4) hour rating:

1. Eight (8) inches solid brick masonry.
2. Three and one-half (3½) inches solid brick masonry, plastered on both sides.
3. Six (6) inches structural clay load-bearing tile, plastered on both sides.
4. Six (6) inches solid concrete.
5. Four (4) inches solid reinforced concrete.
6. Any wall which, as a bearing wall, has a three (3) hour or four (4) hour rating in Section T-402.11, except the steel or reinforced concrete frame bearing wall.

T-402.12.4 Three (3) hour rating:

1. Three and one-half (3½) inches solid brick masonry.
2. Four (4) inches structural clay load-bearing tile, plastered on both sides.
3. Four (4) inches solid concrete.
4. Three (3) inches reinforced concrete.

5. Any wall which, as a bearing wall, has a two (2) hour rating in Section T-402.11 except the steel or reinforced concrete frame bearing wall.

-402.12.5 Two (2) hour rating:

1. Three (3) inches gypsum tile masonry plastered both sides except in exterior walls.
2. Eight (8) inches structural clay partition tile masonry, plastered both sides.
3. Eight (8) inches structural clay load-bearing tile, with three (3) cells in the thickness of the wall.
4. Four (4) inches concrete block plastered both sides.
5. Two (2) inches solid neat, fibered, gypsum plaster on metal lath and noncombustible studding.

-402.12.6 One (1) hour rating:

1. Three (3) inches gypsum tile masonry.
2. Two (2) inches solid gypsum tile masonry plastered both sides.
3. Three (3) inches structural clay partition tile plastered both sides.
4. Two and one-half (2½) inches solid cement or sanded gypsum plaster on metal lath and noncombustible studding.
5. Three (3) inches total thickness of hollow wall, three-quarter (¾) inch cement or gypsum plaster on metal lath and noncombustible studding.
6. Three (3) inches total thickness of hollow wall, three-quarter (¾) inch cement or gypsum plaster on metal lath and wooden studding, firestopped.

-402.13 Fireresistive doors

-402.13.1 General: Doors which are required to be fire doors, fire-resistive doors, or of fireresistive construction shall conform to the requirements of this section and Section T-402.14.

-402.13.2 Classification: Fire doors shall be classified for the purposes of this code as Class A, Class B, and Class C.

-402.13.3 Class A fire doors: Class A fire doors shall be doors of the following construction and as specified in Section T-402.14:

1. Tin-clad, three (3) ply wood core, sliding.
2. Tin-clad, three (3) ply wood core, swinging single leaf, doorway not over six (6) feet wide.
3. Tin-clad, three (3) ply wood core, swinging in pairs, doorway not over (4) feet wide.

4. Hollow metal, swinging single leaf, doorway not over four (4) feet wide.
5. Hollow metal, swinging in pairs, doorway not over eight (8) feet wide.
6. Sheet metal, sliding, single, doorway not over ten (10) feet wide.
7. Sheet metal, sliding in pairs, doorway not over twelve (12) feet wide.
8. Sheet metal, swinging single leaf, doorway not over six (6) feet wide.
9. Sheet metal, swinging in pairs, doorway not over ten (10) feet wide.
10. Steel rolling doorway not over twelve (12) feet wide.
11. Steel plate, doorway not over four (4) feet wide.
12. Any other construction equal or superior to a tin-clad three (3) ply wood core door in a standard fire test, for resistance to fire, the spread of fire and smoke, and transmission of heat.

T-402.13.4 Class B fire doors: Class B fire doors shall be doors of the following construction and as specified in Section T-402.14:

1. Tin-clad, three (3) ply wood core.
2. Tin-clad, two (2) ply wood core, sliding, doorway not over ten (10) feet wide.
3. Tin-clad, two (2) ply wood core, swinging single leaf, doorway not over six (6) feet wide.
4. Tin-clad, two (2) ply wood core, swinging in pairs, doorway not over ten (10) feet wide.
5. Hollow metal, sliding, doorway not over eight (8) feet wide.
6. Metal-clad, paneled, swinging single leaf, doorway not over three (3) feet wide.
7. Metal-clad, paneled, swinging in pairs, doorway not over six (6) feet wide.
8. Any other construction equal or superior to a tin-clad two (2) ply wood core door in a standard fire test, for resistance to fire, the spread of fire and smoke, and transmission of heat.

T-402.13.5 Class C fire doors: Class C Fire doors shall be doors of the following construction and as specified in Section T-402.14:

1. Metal-clad, paneled, swinging single leaf, doorway not over four (4) feet wide.
2. Metal-clad, paneled, swinging in pairs, doorway not over eight (8) feet wide.

T-402.13.6 Substitution: A Class A door may be used where Class B or Class C is specified; a Class B door may be used where Class C is specified. Two (2) Class B or Class C doors on opposite sides of the wall may be used where a single Class A or Class B door is specified.

F-402.13.7 **Overlap:** Fireresistive doors, when closed, shall completely cover the doorways in the walls and partitions or the openings in the floors or roofs to which they are fitted. A swinging fire door shall either overlap both jambs and the head of the opening not less than four (4) inches or be fitted to a fireresistive frame with a rabbet the full thickness of the door and with not less than one half ( $\frac{1}{2}$ ) inch overlap on the door. A sliding fire door, except in enclosures about passenger elevators, shall overlap both jambs and the head of the opening not less than four (4) inches. A sliding fire door in an enclosure about a passenger elevator shall overlap jambs, head and adjoining panels not less than one half ( $\frac{1}{2}$ ) inch. Fire doors shall fit closely at the floor with clearance of not over one quarter ( $\frac{1}{4}$ ) inch.

F-402.13.8 **Thresholds:** In buildings with combustible floors, doorways required to have fire doors shall have noncombustible thresholds the full thickness of the wall, extending at least four (4) inches from the face of the wall where a door is hung and extending laterally at least six (6) inches behind each jamb of the doorway. Thresholds may be flush with the floor.

F-402.13.9 **Rabbeted frame:** The rabbeted frame of a swinging fire door shall be constructed of structural steel built into the concrete, masonry or other fireresistive material of the wall about the opening and secured thereto, except that the rabbeted frame of a Class B or C door may be of wood, covered with sheet metal not less than No. 26 gauge in thickness, secured to the wall in the opening.

F-402.13.10 **Fit:** Fire doors when closed shall fit tightly against the wall or frame so as to provide an effective stop for fire and smoke. Except for the metal-covered wooden frame specified in this section, combustible material shall not intervene between the door and the fireresistive material of the wall, floor or roof to which it is fitted.

F-402.13.11 **Hardware:** Hinge hardware for fire doors shall be of malleable iron or rolled structural steel not less than one quarter ( $\frac{1}{4}$ ) inch thick except that tubular steel track for sliding doors may be not less than one eighth ( $\frac{1}{8}$ ) inch thick. Equivalent thickness of solid bronze or brass may be used. Fire doors shall not depend upon cords, cables or chains to support them in closed position except in elevator shafts.

F-402.13.12 **Tracks:** Tracks for sliding fire doors shall be so supported that a track hanger comes at each door hanger when the door is closed. Track hangers shall be secured to wood stud walls by screws or bolts, to steel stud walls by bolts or rivets, to masonry walls by through bolts and to concrete walls by through bolts or approved built-in inserts. Expansion shields shall not be used to support fire doors.

F-402.13.13 **Hinges:** Hinges for swinging fire doors, except in wooden stud walls, shall be riveted or through-bolted to the structural steel frame of the opening, through-bolted to the wall if of masonry or con-

crete or secured by approved inserts in the concrete or built into masonry in an approved manner.

T-402.13.14 Strap hinges: Strap hinges and sliding door hangers shall be secured to fire doors by through-bolting, riveting or welding. Swinging fire doors in rabbeted frames, except tin-clad, wood core doors, may be hung on butts. Other swinging fire doors shall have strap hinges.

T-402.13.15 Straps, locks and latches: Sliding fire doors shall have adequate stops for the closed position. Swinging Class A fire doors shall have surface latches or unit locks. Class B and C doors shall have surface latches, unit or mortise locks. The latch bolts of unit or mortise locks on fire doors shall have a throw of three quarters (3/4) inch. When mounted in pairs, fire doors shall be rabbeted by means of an astragal or otherwise where they come together. One of a pair of swinging fire doors shall have push bolts at top and bottom with a throw of three quarters (3/4) inch and the other shall be held by latch to the first.

T-402.13.16 Opening hardware: Except in detention buildings, fire doors hung in required exits shall be so fitted with hardware that they can be opened from inside without use of a key when the building is occupied.

#### T-402.14 Fire door construction

T-402.14.1 Fastening: In the construction of fire doors, solder shall not be used except for filling joints. Sheet metal shall be fastened to wood by nailing and to metal frame by bolting, riveting or welding.

T-402.14.2 Glass: Class A doors shall not have glass panels. Class B doors may have glass panels not larger than one hundred (100) square inches in exposed area nor more than twelve (12) inches in width or height. Class C doors may have glass panels not larger than two thousand and sixteen (2,016) square inches in total exposed area, and any single light shall not have an exposed area exceeding twelve hundred and ninety-six (1,296) square inches. Glass in fire doors shall be wire glass not less than one quarter ( $\frac{1}{4}$ ) inch thick and shall be set five eighths ( $\frac{5}{8}$ ) inch in grooves three quarters ( $\frac{3}{4}$ ) of an inch deep.

T-402.14.4 Tin-clay, two (2) ply: In-clad, two (2) ply wood core doors shall be constructed in accordance with the specifications of the National Board of Fire Underwriters for such doors in Class B openings and shall bear the label of the Underwriters' Laboratories to this effect.

T-402.14.5 Hollow metals: Hollow metal doors shall have substantial stiles and rails of heavy pressed steel, reinforced for hinges and other hardware. Panels shall be of sheet filled with asbestos board or other approved insulating materials. The door shall be assembled by welding or riveting.

T-402.14.6 Sheet metals: Sheet metal doors shall be constructed with a rolled steel rigid frame covered both sides with one sixteenth (1/16) inch asbestos board and No. 26 gauge corrugated sheet metal, with corrugations vertical on one (1) side and horizontal on the other, bound on the edges with rolled steel or pressed steel shapes.

T-402.14.7 Steel rolling: A steel rolling fire door shall be constructed of sheet steel interlocking slats, sliding in grooves, counterweighted by springs, with the roller and mechanism enclosed in heavy sheet metal.

T-402.14.8 Steel plate: A steel plate fire door shall be constructed of not less than No. 12 gauge steel plate mounted on a rolled steel frame, assembled by welding or riveting.

T-402.14.9 Metal clad: A metal clad, paneled fire door shall have a wood core with stiles and rails not less than one and three quarters (1 3/4) inches thick covered with No. 26 gauge sheet steel; panels three quarters (3/4) inch thick covered with No. 26 gauge sheet steel, set three quarters (3/4) inch in grooves; joints of metal lapped and well nailed.

T-402.14.10 Class A label: A door properly bearing the Underwriters' label certifying that it is suitable for the protection of a Class A opening shall be acceptable as a Class A door.

T-402.14.11 Class B label: A door properly bearing the Underwriters' label certifying that it is suitable for the protection of a Class B opening shall be acceptable as a Class B door, except that metal clad doors wider than three (3) feet shall not be accepted as Class B doors.

T-402.14.12 Class C label: A door properly bearing the Underwriters' label certifying that it is suitable for the protection of a Class C opening shall be acceptable as a Class C door.

T-402.15 Fireresistive shutters: Shutters required to be fire shutters or fireresistive shutters shall be constructed and hung as specified for Class B fireresistive doors in Sections T-402.13 and T-402.14.

T-402.16 Fireresistive windows

T-402.16.1 General: Windows which are required to be fire windows, fireresistive windows, or of fireresistive construction shall conform to the requirements of this section.

T-402.16.2 Moveable: Fireresistive windows may be fixed or arranged to open and close. Fixed fireresistive windows shall be so secured in the walls in which they are placed that they may expand in case of fire without buckling. Moveable fireresistive windows shall be opened or closed in one (1) of the following manners:

1. One (1) or more sashes may slide horizontally in a fireresistive frame.
2. One (1) or more sashes may slide vertically with counterweights or with two (2) sashes counterbalanced and hung on chains. If a sash is closed in raised position, it shall have a fastening.
3. A sash may be hinged at top, bottom, or either side.
4. A sash may be pivoted at top and bottom or at the sides.
5. A sash may be arranged to open and close in any other approved manner, with approved hardware.

T-402.16.3 Sash: Moveable sashes in fireresistive windows shall be fitted to fireresistive frames of the same or similar construction. Both sashes and frames, and metal mullions between window units, shall be so fitted in the walls in which they are placed as to be continuous with the fireresistive material of the wall and so secured that they may expand in case of fire without buckling.

T-402.16.4 Glass: Glass in fireresistive windows shall be wired glass not less than one quarter ( $\frac{1}{4}$ ) inch thick and the area of a single light shall not exceed seven hundred and twenty (720) square inches. Glass shall be set three eighths ( $\frac{3}{8}$ ) inch in grooves at least one half ( $\frac{1}{2}$ ) inch deep. Glass shall be secured by glazing angles or moldings screwed to the sash and forming continuous grooves for the glass.

T-402.16.5 Construction: Fireresistive windows shall be of the following construction:

1. Hollow sheet metal sashes and frames fabricated by pressing, welding, riveting or crimping without the use of solder or other fusible alloy, except for filling joints, and bearing the label of Underwriters' Laboratories.
2. Rolled steel or pressed steel sashes fabricated by pressing, welding, riveting or crimping, of a make and style approved by the commissioner.
3. Any other approved constructions as fireresistive as that specified in item 1 above.

T-402.16.6 Hollow sheet metal: Fired fireresistive windows of hollow sheet metal construction shall not exceed seven (7) feet in width nor ten (10) feet in height. Fireresistive windows of hollow sheet metal construction with moveable sashes shall not exceed six (6) feet in width nor ten (10) feet in height.

T-402.16.7 Rolled steel: Fireresistive windows of rolled steel construction shall not exceed eighty-four (84) square feet in area nor twelve (12) feet in either height or width.

T-402.16.8 Wind pressure: Fireresistive windows and their fastenings shall be capable of resisting the wind pressure on the wall of the building.



applied either on the inside or the outside of the window without exceeding allowable stresses.

T-402.16.9 Substitution: Where fireresistive windows are required, wooden windows and plain glass may be substituted provided the openings are protected by fireresistive doors or shutters, or, in buildings of approved occupancy and construction, by an approved system of open sprinklers.

#### T-402.17 Fireresistive roof covering

T-402.17.1 Classification: Roof covering allowed under this code shall be classified as fire-retardant or ordinary, according to resistance to fire outside, as provided in this section. Fire-retardant roof covering is the more fireresistive and may be used on any building. Ordinary roof covering shall not be used where fire-retardant roofing is specified. Roof covering less fireresistive than ordinary roof covering shall not be used on any building.

T-402.17.2 Fire-retardant roofing: Fire-retardant roofing shall be any roof covering that meets the requirements of Class A or Class B roofing under the specifications of the Underwriters' Laboratories, Inc. The following roof covering shall be assumed to meet the requirements for fire-retardant roofing:

1. Built-up roofing consisting of successive layers of roofing felt impregnated with asphalt; a final layer of asphalt in which, while molten, is embedded a continuous layer of roofing gravel or slag.
2. Built-up roofing consisting of successive layers of roofing felt impregnated with coal tar; a final layer of tar in which, while molten, is embedded a continuous layer of roofing gravel or slag.
3. Built-up roofing consisting of successive layers of roofing felt impregnated with asphalt; a final layer of asbestos roofing felt impregnated with asphalt weighing not less than fourteen (14) pounds per hundred (100) square feet, or a final layer of asphalt-saturated prepared roofing coated with granulated slate or other similar material.
4. Built-up roofing consisting of successive layers of roofing felt impregnated with tar or asphalt and a finish of burned clay floor tile, stone flagging, cement concrete or other similar material.
5. Sheet metal with locked and soldered joints not less than No. 26 gauge in thickness.
6. Shingles of natural slate.
7. Shingles of burned clay tile.
8. Shingles of sheet metal not less than No. 26 gauge in thickness.
9. Shingles of asbestos board not less than one-eighth (1/8) inch thick.
10. Shingles of asphalt saturated felt surfaced with granulated slate or other similar material and carrying the Underwriters Class "C" label.

11. Corrugated sheet metal with lapped joints not less than No. 26 gauge in thickness.
12. Corrugated asbestos board not less than three-sixteenths (3/16) inch thick.

T-402.17.3 Ordinary roofing: Ordinary roofing shall be of any roof covering which meets the requirements of Class C roofing under the specifications of the Underwriters' Laboratories, Inc. The following roof covering shall be assumed to meet the requirements for ordinary roofing:

1. Built-up roofing consisting of successive layers of roofing felt impregnated with asphalt, coal tar or other approved material, not equal in fireresistance to a fire-retardant roofing.
2. Prepared roofing consisting of felt or fabric impregnated or coated, or both, with asphalt, tar or other approved material or shingles of such prepared roofing, not equal in fireresistance to fire-retardant roofing.
3. Canvas stretched tightly and coated with paint.

T-402.17.4 Means of securing: Built-up roofing shall be secured to the roof deck in the following manner:

1. Over masonry slab, the first layer shall be laid in molten asphalt or tar mopped on the roof deck, after the deck is properly primed, or by nailing a layer of building paper to nailing inserts other than wood placed in the deck.
2. Over wood decks, the built-up roofing shall be secured by nailing a layer of building paper to the roof deck over which the prepared roofing is to be laid with the first layer laid in molten asphalt or tar.
3. Roofings other than built-up roofings, such as shingles, slates, and tile roll roofing shall be well secured to the deck by nailing, bolting, wiring, or other approved methods.

## APPENDIX U

## HISTORIC STRUCTURES

Historic structures individually listed in the National Register of Historic Places, qualifying as totally preserved buildings (see Section 436.3).

|            |  |
|------------|--|
| Acton      | Faulkner Homestead, High Street  |
| Agawam     | Capt. Charles Leonard House, Main Street   |
| Amesbury   | Rocky Hill Meetinghouse, Portsmouth Road   |
| Arlington  | Fowle-Reed-Wyman House, 64 Old Mystic Street<br>Jason Russell, 7 Jason Street<br>Old Schwamb Mill, 17 Mill Lane  |
| Barre      | Barre Historical Society, Common Street  |
| Barnstable | Barnstable Custom House, Route 6A  |
| Bedford    | Job Lane House, 295 North Road   |
| Beverly    | John Balch House, 448 Cabot Street<br>Capt. John Cabot House, 117 Cabot Street<br>Rev. John Hale House, 39 Hale Street   |
| Boston     | Gleason House, Beacon Street<br>James Blake House, E. Cottage Street (Dor.)<br>Clapp Houses, 105 Boston Street (Dor.)<br>Loring-Greenough House, 12 South Street (JP)<br>Pierce House, 24 Oakten Avenue (Dor.)<br>South End Historical Soc., 532 Massachusetts<br>Avenue<br>Isabella Stewart Gardner Museum, 280 The<br>Fenway |
| Boxford    | Holyoke-French House, Elm Street<br>Sylvanius-Thayer Birthplace, 786 Washington<br>Street  |
| Brookline  | Edward Devotion House, 347 Harvard Street  |
| Burlington | Francis Wyman House, Francis Wyman Road  |
| Cambridge  | Cooper-Frost-Austin House, 21 Linnaean Street  |

780 CMR: STATE BUILDING CODE COMMISSION

|            |   |
|------------|---|
| Charlton   | Ryder Tavern, Stafford Street   |
| Chelmsford | Old Chelmsford Garrison House, 105 Garrison Road  |
| Chelsea    | Gov. Bellingham-Cary House, 34 Parker Street  |
| Cohasset   | Caleb Lothrop House, 14 Summer Street   |
| Danvers    | Fowler House, 166 High Street<br>Rebecca Nurse House<br>Glen Magna House  |
| Dennis     | Josiah Dennis Manse, Nobscuset Road<br>West Schoolhouse   |
| Duxbury    | Gershom Bradford House, 931 Tremont Street<br>King Caesar House, King Caesar Road   |
| Gloucester | Beauport, Eastern Pt. Blvd.<br>Hammond Castle, 80 Hesperus Avenue   |
| Hadley     | Hadley Farm Museum, Russell Street<br>Porter Phelps Huntinghouse, 130 River Drive   |
| Haverhill  | The Whittier House, 305 Whittier Road   |
| Holyoke    | Wisteriahurst, 238 Cabot Street   |
| Ipswich    | Castle Hill, Argilla Road   |
| Lee        | Merrell Tavern, Route 102   |
| Lexington  | Buckman Tavern, 1 Bedford Street<br>Sanderson House, 314 Massachusetts Avenue<br>Monroe Tavern, 1332 Massachusetts Avenue |
| Lincoln    | The Grange, Codman Road   |
| Lowell     | Whistler House, Worthen Street  |
| Lynnfield  | Meetinghouse  |
| Medford    | Peak House, 347 Main Street   |
| Milton     | Dr. Amos Holbrook House, 203 Adams Street<br>Daniel Vose House, 1370 Canton Avenue  |
| New Salem  | Whitaker-Clary House, Elm Street  |

## APPENDIX U

|               |   |
|---------------|---|
| Newbury       | Tristram Coffin House, 16 High Road<br>Spencer-Pierce-Little House, Little Lane   |
| Newton        | Jackson Homestead, 527 Washington Street  |
| North Andover | Parson Barnard House, Osgood Street   |
| North Easton  | Old Colony Railroad Station, Oliver Street  |
| Norwood       | Fred Holland Day, 93 Bay Street   |
| Orleans       | French Cable Station, Cove Road   |
| Oxford        | Clara Barton Homestead, Clara Barton Road   |
| Peabody       | Gen. Gideon Foster House, 35 Washington Street  |
| Pittsfield    | Herman Melville House, 78 Holmes Road   |
| Plymouth      | Plymouth Antiquarian Society, 126 Water Street<br>Harlow Old Ft. House, 19 Sandwich Street<br>Pilgrim Hall, 75 Court Street<br>Richard Sparrow House, 42 Summer Street  |
| Quincy        | Adams Academy, 8 Adams<br>Quincy Homestead, 34 Butler Street<br>Josiah Quincy House, 20 Muirhead Street   |
| Randolph      | Jonathan Belcher House, 360 N. Main   |
| Reading       | Parker Tavern, 103 Washington Street  |
| Rockport      | Old Castle, Castle Lane   |
| Salem         | House of 7 Gables, 46-54 Turner Street<br>Essex Institute, Essex Street<br>The Norbone House<br>Witch Museum<br>Crowningshield Bently, Essex Street<br>Gardner-Pingree House, 128 Essex Street<br>Gedney House, 21 High Street<br>Cox House, 19 High Street |
| Sandwich      | Hoxie House, 18 Water Street<br>Eldred House, 4 Water Street<br>Wing Fort House, Spring Hill Road   |

780 CMR: STATE BUILDING CODE COMMISSION

|                  |  |
|------------------|--|
| Sheffield        | Col. John Ashley House, Cooper Hill Road                                       |
| Shrewsbury       | Gen. Artemas Ward Homestead, Main Street                                       |
| Springfield      | Alexander House, State Street<br>George Walter Vincent Smith Art Museum        |
| Stockbridge      | Naumkeag, Prospect Hill  |
| Swansea          | The Luther Store, 160 Old Warren Road<br>The Martin House, 22 Stoney Hill Road |
| Taunton          | Old Colony Historical Society, 66 Church<br>Green<br>Parson Capen House        |
| Watertown        | Edmund Fowle House, 26 Marshall Street   |
| Wenham           | Claflin-Richard House, 132 Main  |
| West Springfield | Josiah Day House, 70 Park Street   |
| Weston           | Golden Ball Tavern, Old Post Road  |
| Woburn           | Loammi Baldwin Mansion, 2 Alfred Street  |
| Wilmington       | Harden Tavern, 436 Salem Street  |
| Worcester        | Timothy Paine House, 140 Lincoln Street  |

National Historic Landmarks

|          |  |
|----------|--|
| Amesbury | John Greenleaf Whittier Home, 86 Friend Street   |
| Boston   | African Meeting House, 8 Smith Court<br>Nichols House, 55 Mt. Vernon Street<br>Brook Farm, 678 Baker Street (Rox.)<br>Christ Church, 191 Salem Street<br>Faneuil Hall, Dock Square<br>1st Harrison Gray Otis House, 141 Beacon<br>Street<br>Paul Revere House, 19 North Street |
| Concord  | Ralph Waldo Emerson House, 28 Cambridge<br>Tpk.<br>The Old Manse<br>Orchard House, 299 Lexington Road  |

## APPENDIX U

|             |   |
|-------------|---|
| Dedham      | Fairbanks House   |
| Deerfield   | Old Deerfield Village Historic District   |
| Hancock     | Hancock Shaker Village  |
| Harvard     | Fruitlands, Prospect Street   |
| Hingham     | Old Ship Meetinghouse, Main Street  |
| Ipswich     | John Whipple House, 53 S. Main Street   |
| Lexington   | Hancock Clarke House, 35 Hancock Street   |
| Marblehead  | Jeremiah Lee House, Washington Street<br>King Hooper Mansion, Hooper Street                     |
| Marshfield  | Daniel Webster Law Office, Webster Street   |
| Medford     | Peter Tufts House, 350 Riverside Drive<br>Isaac Royal House, 15 George Street                   |
| Milton      | Capt. R. B. Forbes House, 215 Adams   |
| Nantucket   | Nantucket Historic District<br>Jethro Coffin House, Sunset Hill                                 |
| New Bedford | New Bedford Historic District   |
| Newburyport | Caleb Cushing House, 98 High Street   |
| Quincy      | John Adams Birthplace, 133 Franklin Street<br>John Quincy Adams Birthplace, 141 Franklin Street |
| Salem       | Peabody Museum<br>The Custom House, 178 Derby Street  |
| Saugus      | Scotch Boardman House, 117 Howard Street  |
| Stockbridge | Chesterwood, Williamsville Road<br>The Mission House, Main Street                               |
| Waltham     | The Vale, Lyman Street<br>Gore Place, 52 Gore Street  |

|           |  |
|-----------|--|
| Woburn    | Count Rumford Birthplace, 90 Elm Street            |
| Worcester | American Antiquarian Society, 185 Salisbury Street |

Historic structures individually listed in the National Register of Historic Places not qualifying as totally preserved buildings (see Partially preserved buildings, Section 436.5). Refer to:

1. National Register of Historic Places, U.S. Federal Register, February 1, 1978, Part II.
2. National Register of Historic Places (additions). Contact the Massachusetts Historical Commission at 294 Washington Street, Boston, 02108.

Historic districts listed in the National Register of Historic Places. Refer to:

1. National Register of Historic Places, U. S. Federal Register, February 1, 1979, Part II.
2. National Register of Historic Places (additions). Contact the Massachusetts Historical Commission at 294 Washington Street, Boston, 02108.

Structures proposed for certification as partially preserved not listed in the national register of historic places. Refer to Massachusetts Historical Commission Inventory Forms.

Contact the Massachusetts Historical Commission at 294 Washington Street, Boston, 02108.



## APPENDIX V

## REFERENCE DATA FOR BUILDING TEMPERATURE RESTRICTIONS

The following sections of the Building Temperature Restrictions as published in the July 5, 1979 Federal Register 44 FR 39354 shall be incorporated, as applicable, as part of the requirements of Section 2016.0:

1. 490.5 Definitions: All definitions are to be included except for the following: (r) owner, (x) secretary, and (bb) state.
2. 490.11 HVAC systems without capability for simultaneous heating and cooling.
3. 490.12 HVAC systems with capability for simultaneous heating and cooling.
4. 490.13 Requirement for accuracy of space-conditioning control devices.
5. 490.14 Regulation of building temperatures during unoccupied periods.
6. 490.15 Auxiliary heaters.
7. 490.16 Use of ventilation equipment.
8. 490.17 Measurement techniques.
9. 490.18 Exemptions for heating and cooling restrictions.
10. 490.21 Regulation of hot water controls.
11. 490.22 Measurement of domestic hot water temperature.
12. 490.23 Maintenance of hot water temperature control devices.
13. 490.24 Exemption from hot water restrictions.
14. 490.31 General exemptions.
15. 490.33 Limitation of exceptions or exemptions.
16. 490.34 Scope of exceptions of exemptions.
17. 490.43 Self-certification and filing of building compliance information form.

APPENDIX W

REFERENCE STANDARDS - ARTICLE 21

RS-21-1      Shower Compartment Finish

Glazed Ceramic Wall Tile Installed with Portland  
Cement Mortar ANSI A108.1,1967 - American National  
Standards Institute (ANSI) A108.1 - 1967

Ceramic Tile Installed with Chemical Resistant,  
Water Cleanable Tile-Setting and Grouting  
Epoxy-ANSI A108.6, 1969

Dry-Set Portland Cement Mortar (for installation of  
ceramic tile) - ANSI A118.1,1967

Organic Adhesives for Installation of Ceramic Tile-  
ANSI A136.1,1967 (Type I only in Shower Compart-  
ments) Standard Specification for Ceramic Tile-ANSI  
A137.1,1967

Ceramic Tile Installed with Dry-Set Portland Cement  
Mortar - ANSI A108.5,1967

Ceramic Mosaic Tile Installed with Portland Cement  
Mortar - ANSI A108.2,1967

Ceramic Tile Installed with Water-Resistant Organic  
Adhesives - ANSI A108.4,1968

RS-21-2      Glazing Materials

Glass. Federal Specification DD-G 451c

Safety Glazing Materials - ANSI Z97.1,1972

RS-21-3      Foundations

Building Brick and Facing Brick. (Made from Clay or  
Shale). Standard Specifications C62-58 and C216  
of the American Society for Testing and Materials  
(ASTM).

Sand-Lime Building Brick. Standard Specification  
C73-51 of ASTM.

Concrete Building Brick. Standard Specification  
C55-55 of ASTM.

Hollow Load-Bearing Concrete Masonry Units. Standard  
Specification C90-59 of ASTM.

Solid Load-Bearing Concrete Masonry Units. Standard Specification C145-59 of ASTM.

Method of Test for Concrete Masonry Units. Standard Specification C140-63T of ASTM.

Structural Clay Load-Bearing Wall Tile. Standard Specifications C34-62 and C112-60 of ASTM.

Cast Stone. Specification ACI 704-44 of the American Concrete Institute.

Cold-Drawn Steel Wire for Concrete Reinforcement. Standard Specification A82 of ASTM.

Cement, Masonry. Standard Specification C91-67 of ASTM.

Quicklime for Structural Purposes. Standard Specification C5-59 of ASTM.

Hydrated Lime for Masonry Purposes. Standard Specification C207-49 of ASTM.

Processed Pulverized Quicklime. Standard Specification C51-47 of ASTM.

Mortar for Masonry Other than Gypsum. Specifications C161-44T and C270-59T of ASTM.

Aggregate for Masonry Mortar. Specification C144-52T of ASTM.

Aggregates for Grout. Standard Specification C404 of ASTM.

Sampling and Testing Brick. Standard Specification C67-60 of ASTM.

Portland Cement. Standard Specifications C150-62 and C175-66 of ASTM.

Portland Blast Furnace Slag Cement. Specification C205-62T of ASTM.

Portland Pozzolan Cement. Specification C340-62T of ASTM.

Concrete Aggregates. Specification C33-61T of ASTM.

Concrete Proportions. ACI 613-54 and 613-59 of the American Concrete Institute.

Concrete Reinforcement. Specifications A615-68,  
A616-68, A617-68 and A82-66 of ASTM.

Steel Bar Mats. Standard Specifications A184-65,  
A615-68, A616-68 and A617-68 of ASTM.

Welded Steel Wire Fabric. Specification A185-61T of  
ASTM.

Admixtures for Concrete. Standard Specification  
C494-62T of ASTM.

Concrete Tests. Standard Specifications C31-62,  
C39-61, C42-61 and C192-62 of ASTM.

Splitting Tensile Strength. Specification C496-62T  
of ASTM.

Ready-Mixed Concrete. Standard Specification C94-62  
of ASTM.

Welding Reinforcing Steel, Metal Inserts and  
Connections in Reinforced Concrete Construction.  
AWS D12. 1-61 of the American Welding Society.

Hollow Brick. (Hollow Masonry Units Made from Clay  
or Shale) Standard Specification C652-70 of ASTM.

Building Brick and Facing Brick. (made from Clay or  
Shale) Standard Specifications C62-69 and C216 of  
ASTM.

Mortar for Masonry Other than Gypsum. Standard  
Specification C270-68 of ASTM.

Aggregate for Masonry Mortar. Standard Specification  
C144-70 of ASTM.

Aggregate for Masonry Grout. Standard Specification  
C404-70 of ASTM.

Methods of Sampling and Testing Brick. Standard  
Specification C67-66 of ASTM.

Applicable Standards or Publications in Referenced  
Standard RS-21-5.

RS-21-4      Preservatives

American Wood Preserves Bureau (AWPB) Standards  
CP-22, CP-33, CP-44, CP-55, and CP-77 for  
pressure treated poles.

AWPB Standards LP-2, LP-3, LP-4, LP-5 and LP-7 for pressure treated softwood lumber used above ground.

AWPB Standards LP-22, LP-33, LP-44, LP-55 and LP-77 for pressure treated softwood lumber used in contact with the ground.

RS-21-5      Wall Construction

Applicable Standards or Publications in Reference Standard RS-21-3.

Classification, Definition and Methods of Grading for all Species of Lumber. Standard D245-70 of ASTM; American Softwood Lumber Standards PS 20-70 of the U. S. Department of Commerce.

Design for Permanence, Wood Construction DATA #6 National Forest Products Association (NF.PA).

Eastern Pine, Jack Pine, Eastern Spruce, Balsam Fir, Eastern Hemlock and Tamarack. Grading Rules, Northern Hardwood and Pine Manufacturers Association (September 1, 1970).

House Framing. Manual for National Forest Products Association Wood Construction DATA #1.

National Design Specification for Stress-Grade Lumber and Its Fastenings. National Forest Products Association 1977 with Supplement.

Northeastern Lumber. Standard Grading Rules, Northeastern Lumber Manufacturers Association (April, 1977).

Pine, Southern. Grading Rules, Southern Pine Inspection Bureau (1977).

Redwood. Specifications for Grades of California Redwood Lumber of the Redwood Inspection Service (December, 1976).

Softwood Plywood. Construction and Industrial Product Standard PS 1-74 (August, 1974) of the U. S. Department of Commerce, Bureau of Standards.

Design Specifications for Light Metal Plate Connected Wood Trusses. Truss Plate Institute (TPI) 197.

West Coast Lumber. Standard Grading Rules, West Coast Lumber Inspection Bureau.

Western Lumber. Standard Grading Rules, Western Wood Products Association (1977).

Poles Building Design. American Wood Preservers Institute (November, 1972).

Plank-and-Beam Framing. Wood Construction Data No. 4, National Forest Products Association.

Fiberboard Nail-Base Sheathing and Structural Insulating Board. Standard Specifications D2277-66 and C208-66 of ASTM.

Particleboard. U. S. Department of Commerce-Commercial Standard CS 236-66.

Material Specifications for Structural Steel.

Standard Specifications A27, A36, A53, A148, A167, A235, A237, A242, A245, A252, A303, A307, A325, A354, A374, A375, A412, A440, A441, A446, A449, A490, A500, A501, A502, A514, A529, A570, A572 and A588 of ASTM.

Standard Specification for Structural Glued Laminated Timber Using "E" Rated and Visually Graded Lumber of Douglas Fir, Southern Pine, Hem-Fir and Lodepole Pine, American Institute of Timber Construction.

Canadian Lumber. Standard Grading Rules for Canadian Lumber, U. S. Edition (July 1, 1973). Approved by the American Lumber Standards Board of Review.

Specifications for Aluminum Structures of the Aluminum Association.

Connectors other than those specified in Section 2102.0 of this Code may be used in accordance with Table RS-21-6.

Specification for the Design, Fabrication and Erection of Structural Steel for Buildings, American Institute of Steel Construction, 1969 Edition and Supplements Nos. 1 and 2.

RS-21-6      Wall Covering

Applicable Standards and Publications in Reference Standards RS-21-2 and RS-21-5.

Aluminum Structures. Specifications for, by the Aluminum Association (November, 1967).

Plaster Liquid Bonding Agents. U. S. Government Military Specification MIL-B-19235 (Docks) (1965), and Standards Specifications of the California Lathing and Plastering Contractors Association (1965), and Recommendations of the Gypsum Association.

Adhesives for Fastening Gypsum Wallboard to Wood Framing. Specification C557-67 of ASTM.

Perlite, Vermiculite and Sand Aggregates for Gypsum and Portland Cement Plaster. Standards Specification C35-70 of ASTM.

Metal Lath, Wire Lath, Wire Fabric Lath and Metal Accessories. Approval Standard A42.4-1967 of ANSI.

Gypsum Wallboard Tape and Joint Compound. Standard Specifications C475-70 and C474-67 of ASTM.

Gypsum Backing Board. Standard Specification C442-67 of ASTM.

Gypsum Lath. Standard Specification C37-69 of ASTM.

Lime. Standard Specifications C206-68 and C6-49 of ASTM.

Gypsum Plasters. Standard Specification C28-68 of ASTM.

Gypsum Sheathing Board. Standards Specification C79-67 of ASTM.

Gypsum Veneer Plaster. Standards Specification C587-68 of ASTM.

Gypsum Veneer Base. Standard Specification C588-68 of ASTM.

Gypsum Wallboard. Standard Specification C36-70 of ASTM.

Keene's Cement. Standard Specification C61-64 of ASTM.

Gypsum Molding Plaster. Standard Specification C59-50 of ASTM.

Gypsum Plastering. Standard Specification A42.1-1964 of ANSI.

Interior Lathing and Furring. Standard Specifications 2.4-1967 of ASTM.

Application and Finishing of Gypsum Wallboard. Standard Specifications A97.1-65 of ANSI.

Surface Burning Characteristics of Building Materials. Standard Method of Test E84-70 of ASTM.

RS-21-7      Floors

Applicable Standards or Publications in Reference Standards RS-21-3 and RS-21-5.

Maximum Spans for Joists and Rafters. Technical Bulletin 2, of NFOPA.

Canadian Dimension Lumber, Revised edition 1972, Canadian Wood Council.

RS-21-8      Roof-Ceiling

Applicable Standards or Publications in Reference Standards RS-21-3 and RS-21-6.

Maximum Spans for Joists and Rafters. Technical Bulletin 2, of NFOPA.

Canadian Dimension Lumber. 1971, Canadian Wood Council.

RS-21-9      Roof Coverings

Aluminum Sheet Metal Work in Building Construction by the Aluminum Association (October, 1967).

Composition Roofing. Standard Specification 55-A (May, 1967) Underwriters' Laboratories, Inc.

Roofing Asphalt. Standard Specification D312-44 of ASTM.

Composition Roofing. Standard Specification 55-B. (April, 1962), Underwriters' Laboratories, Inc.

Sheet Metals. Standard Specifications A245-62aT, A361-63T and B209-70 of ASTM.



Corrosion-Resistant Metals. Standard Specifications A219-58, A239-41 and B209-70 of ASTM.

Composition Roofing Testing. Standard Specification 790 (September, 1958), Underwriters' Laboratories, Inc.

Hand-Split Shakes. Grading and Packing Rules, Hand-Split Red Cedar Shakes 1971, Red Cedar Shingle and Hand-Split Shake Bureau.

Asbestos-Cement Shingles. Standard Specification C222-60 of ASTM.

Slate Shingles. Standard Specification C406-57T of ASTM.

Wood Shingles. Commercial Standard CS31-52, U. S. Department of Commerce, National Bureau of Standards. Grading and Packing Rules for Red Cedar Shingles (1971) Red Cedar Shingles and Handsplit Shake Bureau.

Wire. Standard Specifications B134-62, B211-63, and B250-62 of ASTM.

RS-21-10      Chimney and Fireplace

Applicable Standards or Publications in Reference Standards RS-21-3 and RS-21-5.

RS-21-11      Mechanical Materials

Galvanized Sheet Metals. Standard Specification A525-64T of ASTM.

Tank Piping and Valves for Oil Burning Appliances. Pamphlet No. 31, June, 1965, of the NFIPA.

Nonmetallic Ducts. Standard No. 181 of the UL.

Refrigeration. Standard No. B9.1-1964 of the ANSI.

Wrought Steel and Wrought Iron Pipe. Standard B36.10-1959 of the ANSI.

Seamless Copper Tube, Copper Pipe and Red Brass Pipe. Standard Specifications B42-62, B43-62, B68-60, B88-66, B251-66 and B280-66 of ASTM.

Compression (neoprene) Gaskets (including hubless piping system) for Cast Iron Piping and Fittings in Condensate Drain Lines. Standard Specification C564-70 of ASTM, or CISPI Standards HSN-72 and 301-72.

Stainless Steel Coupling (hubless piping system) for Cast Iron Piping and Fittings in Condensate Drain Lines. CISPI Standard 301-72.

Load Calculation for Residential Winter and Summer Air-Conditioning. Manual J., Third Edition, of NISC.

Installation of Gas Appliances and Gas Piping. Standard No. 54, 1969 of the NFiPA.

Installation of Gas Piping and Gas Equipment on Industrial Premises and Certain Other Premises. Standard No. 54-A, 1969 of the NFiPA.

Chimneys, Fireplaces and Venting Systems. Standard No. 211, 1970 of the NFiPA.

Installation of Residence-Type Warm Air Heating and Air Conditioning Systems. Standard No. 90-B, 1971 of the NFiPA.

RS-21-12      Mechanical Equipment

Applicable Standards or Publications in Reference Standard RS-21-11.

Mechanical Ventilation. Testing and Rating Procedures of Home Ventilating Institute.

RS-21-13      Smoke/Heat Detectors

NFiPA Standard No. 101 of 1971-1972

NFiPA Standards No. 74 of 1971-1972

RS-21-14      Solid-Fuel Appliances

Factory-Built Chimneys. Standard No. 103, 1978 of the UL.

Factory-Built Fireplaces. Standard No. 127, 1972 of the UL.

Free-Standing Fireplaces. Standard No. 737, 1978 of the ANSI/UL.

Free-Standing Room Heaters. Standard No. 1482,  
1979 of the UL.

Solid and Solid/Liquid Fuel Burning Central Heating  
Boilers and Warm Air Furnaces. Standard No.  
B366-M, 1979 of the Canadian Standards Association  
(CSA).

NON-TEXT PAGE

## INDEX

by section number

A, use groups, assembly, 203.0  
 Abandoned structure, 2200.3.1  
 Absorption units, 2117.0  
   Identification, 2117.2  
 Accepted engineering practice, 110.2,  
   800.2  
 Access  
   Attic, 2106.5  
   Floor furnace, 2113.6  
   Panels, for fire department,  
     859.0  
   To roofs, 617.0  
   Warm air furnace, 2112.5  
 Accessory buildings  
   Use group T, temporary and  
   miscellaneous, 211.0  
 Adhesives  
   Glued construction, 818.0  
 Adjoining property  
   Existing buildings, 1305.0,  
     2203.15  
   Fences, 1309.0  
   Grade control, 1308.1  
   Notice to owners, 1307.1.3  
   Protection of, 1312.0  
   Support during excavations,  
     permanent, 1307.2  
   Support during excavations,  
     temporary, 1307.1  
 Administrative  
   Administration, Article 1  
   Alternate materials and  
     methods, 110.0  
   Application for permits, 113.0  
   Board of appeals, 126.0  
   Building classified by building  
     official, 212.0  
   Building official approves  
     plans, 113.5  
   Building official, definition  
     201.0  
   Building official qualifica-  
     tions, 107.0  
   Certificate of occupancy, 119.0  
   Conditions of permit, 115.0

Drawings and specifications  
   required, 113.0  
 Existing structures, 105.0  
 Foundation permits, 114.8  
 Inspections required, 111.0  
 Inspectors appointed, 107.2.2  
 Liability, 107.6  
 Maintenance of buildings, 104.0  
 Organization of building depart-  
   ment, 107.0  
 Permit fees, 118.0  
 Permits required, 113.1  
 Posting of floor loads, 120.1  
 Powers and duties of building  
   official, 108.0  
 Records of department, 108.7  
 Requirements not in code, 101.3  
 Restrictions on employees, 107.7  
 Revocation of permits, 114.2,  
   309.5  
   Right of entry on premises, 111.0  
   Scope of code, 100.2  
   Stop work orders, 122.0  
   Tests and test reports, 802.0  
   Unsafe structures, 123.0, 124.0  
   Validity of code, 140.0  
   Violations and penalties, 121.0  
 Aged, homes for,  
   Use group I-2, institutional,  
     207.3, 207.4, 433.0  
 Aggregates  
   Concrete, 816.0  
   For fire resistance purposes,  
     816.2  
   Masonry, mortar and grout, 815.0  
 Air-conditioned buildings, 603.0  
 Air conditioning, refrigeration and  
   mechanical ventilation (see Mechan-  
   ical Code listed in Appendix B)  
 Aircraft hangars  
   Height and areas allowed,  
     Table 305  
   Roof storage, 414.2.4  
   Use group S-1, moderate hazard,  
     210.2, 210.4  
 Air ducts (see Ducts)  
 Air intakes  
   Fresh air, 514.0  
   Projection booths, 408.3.3  
   To court, 516.5  
 Air leakage, 2124.0

- Air space  
 Around timber in masonry, 853.5.1
- Air supported structures  
 Additional requirements, 422.0  
 Use group T, temporary and miscellaneous, 211.0
- Aisles  
 Assembly use group, 417.5, 418.3, 418.4, 610.3  
 Churches, 418.3, 610.3  
 Illumination, 417.9, 624.0  
 Number of seats between, 417.4.2  
 Other use groups, 610.3
- Alarm systems (see Fire protection systems)
- Alcove rooms, 2101.5.1
- Alcoves, for light and ventilation, 507.0
- Alley  
 Definition, 201.0  
 Projection into, 312.1
- Allowable areas and heights of buildings  
 Area, allowable for buildings (see also Area, allowable), Table 305  
 Use group A, assembly, 203.7  
 Use group B, business, 204.2  
 Use group F, factory and industrial, 205.4  
 Use group H, high hazardous, 206.3  
 Use group I, institutional, 207.4  
 Use group M, mercantile, 208.2  
 Use group R, residential, 209.6  
 Use group S, storage, 210.4  
 Use group T, temporary and miscellaneous, 211.2
- Alloys and special steels, 832.0, 833.0
- Alternate materials, 2101.1.2  
 Appeal to board of adjustments and appeals, 126.0  
 Area and height limitations, 304.2  
 Certificate of occupancy, 119.2
- Definition, 201.0  
 Existing buildings, 106.0, 304.405.0, 2203.0, 2204.0  
 Increase in size, 106.0  
 Inspections, 111.0  
 New systems, 2203.3  
 Non-structural alterations and repairs, 102.1  
 Occupancy change, 2203.0  
 Permit fees, 118.0  
 Permit required, 113.1  
 Signs, 1401.4  
 Structural alterations and repairs, 106.0, 2203.0, 2204.0  
 To existing projections, 304.1.  
 To light and ventilation in existing buildings, 505.2
- Alternate materials and construction  
 Approved by building official, 110.0  
 Board of appeals, 126.1  
 Suitability of, 800.4
- Aluminum alloys, 833.0
- Amendments to plans, 113.8
- Amusement parks  
 Additional requirements, 419.0  
 Use group A-5, assembly, 203.6
- Anchorage, anchors  
 Flood plains, 744.0  
 Framing anchors, wood, 852.3.1, 852.5  
 Intersecting masonry walls, 835  
 Masonry general, 835.1, 835.4  
 Masonry, veneer, 854.4.1  
 Panel wall, 867.4  
 Projecting stone, 838.3  
 Structural, 715.3.1  
 Wood headers, 852.4  
 Wood, sill, 854.5
- Antennae, radio and television, 427.0
- Apartment house  
 Definition (see Dwelling), 201.  
 Use group R-2, residential, 209.3, 209.6
- Appeals, board of, 126.0
- Appendices, Table of Contents
- Appliances  
 Chimneys, 1000.2, 1003.0  
 High heat, 1100.0  
 Low heat, 1100.0  
 Medium heat, 1100.0

|   |  |
|---|--|
| Application for permit  | Floor definition, 201.0                              |
| Action by building official on application, 114.0   | For plastics, 1902.0, 1903.0                         |
| Application form, 113.2   | General areas and height limitations, 305.0          |
| Conditions of permit, 115.0   | Increase for area separation, 306.2                  |
| Drawings required, 113.5, 113.6   | Increase for sprinklers, 306.3                       |
| Existing buildings, 2202.0  | Increase not permitted, 304.2                        |
| For demolition of buildings, 116.0  | Separate building within fire walls, 305.1           |
| Foundation permits, 114.8   | School area increase, 306.4                          |
| Moving buildings, 117.0   | Unlimited areas, 307.0                               |
| Permit fees, 118.0  | Armories   |
| Plot diagram required, 113.6  | Use group A-3 assembly, 203.4, 203.7                 |
| Records to be kept, 108.7   | Asbestos   |
| Registered architect or engineer, 127.0   | For exterior weather boarding and veneers, 854.4     |
| Signs, 1401.0, 1402.0   | For proscenium curtains, 417.7.7                     |
| What required, 113.3, 113.5, 113.6, 113.8   | Asphalt  |
| When required, 113.1  | Paper in exterior walls, 820.5                       |
| Appointment of building official, 107.1   | Assembly buildings                                   |
| Approval  | Aisles with fixed seats, 418.3                       |
| Alternate materials and methods of construction, 804.0  | Aisles without fixed seats, 418.4                    |
| Building component, 1801.0  | Areas allowed, 203.7, 305.0, Table 305               |
| Certificate of occupancy, 119.0   | Classification of, 203.2, 203.3, 203.4, 203.5, 203.6 |
| For use of plastic material, 1900.2.2   | Determining capacity of exits, 608.0                 |
| Inspections, 110.0  | Existing, 2200.3, 2203.13                            |
| Manufactured building, 1801.0   | Exits, special requirements, 418.2                   |
| Mobile home, 1800.0   | Fire suppression requirements, 203.7, 1202.0, 1211.0 |
| Moving buildings, 117.0   | Occupancy load requirements, 606.0                   |
| Of plans for permit, 114.6  | Prohibited, with high hazard use, 417.2.1            |
| Prefabricated construction, 1801.0  | Special requirements for, 417.0, 418.0, 2203.13      |
| Approved definition, 201.0  | Theatre requirements (see Theatres)                  |
| Architect   | Use group A, 203.0                                   |
| Drawings and specifications, by, 113.5, 113.7, 127.0  | Attic  |
| Area  | Definition, 201.0                                    |
| Court, 516.3  | Firestopping, 875.6, 875.6.1                         |
| Method of figuring for exits, 608.0   | Habitable, definition, 201.0                         |
| Areas, allowable  | Ventilation of, 507.2                                |
| Allowable areas for buildings (see also Allowable areas and heights of buildings), 305.0, Table 305 | Auditoriums  |
| Definition, 201.0   | Use group, A-3, assembly, 203.4, 203.7               |
| Exception, 306.0, 2204.4  |  |
| Existing buildings, 304.2, Table 305, 2204.4  |  |

- Authority to enter buildings, 112.0  
 Automatic fire alarm systems, 1216.0,  
 2203.11  
 Automatic sprinklers (see Fire protec-  
 tion systems)  
 Automobile parking  
   Open parking structures, 429.0  
   Roofs over, 302.7  
   Parking lots, 423.0  
 Automotive service station  
   Definitions, 201.0  
   General requirements, 415.0  
   Storage of flammables, 415.2,  
   402.0  
   Use group B, business, 204.0  
 Awnings  
   Clearance, 313.0  
   Fixed, regulations, 313.2.2  
   Moveable, regulations, 313.2.1  
   Permit for, 313.1  
 B  
 B, use groups, business, 204.0  
 Balancing, 2127.0  
 Balcony  
   Emergency exits from, 417.3.4  
   Exits, 417.3.2, 417.3.4  
   Exterior balconies, 310.7  
   Exterior construction of, 924.4  
   Live loads, 706.0  
   Over public property, 310.7  
   Railings, 417.5.5, 709.4  
   Steps, 417.5.4  
 Balustrades, 616.5.2  
 Banner and cloth signs, 1413.1  
 Barricades  
   Construction, where required,  
   maintenance, 1306.2, 1307.1  
 Bars  
   Clear cover in concrete foot-  
   ings, 728.4  
   Reinforcing steel, 829.0  
 Basement  
   Assembly uses, 905.7.3  
   Definition, 201.0  
   Dry cleaning plants, 412.3.3,  
   412.3.7  
   Enclosure of stairways, 616.9.2  
   Fire suppression system re-  
   quired, 1202.13  
   Floors above, protection of, 905.7  
   Garages in basements, 414.2.2  
   Light and ventilation, 508.1  
   Motor fuel service stations,  
   415.1.3  
   Required exitways, 609.2  
   Stairway construction, 616.9,  
   616.9.3  
   Ventilation of garages, 414.3.1  
   Walls, 2102.4  
   Waterproofing, 872.0  
 Basic code provisions, 2100.1.1  
 Bathrooms  
   Light and ventilation, 512.0  
   Mechanical ventilation allowed,  
   512.6  
   Window area required for, 512.2,  
   512.3  
 Bay window  
   Construction of, 924.5  
   Definition, 201.0  
   Over public property, projection,  
   310.6  
 Beams  
   Fireproofing of, 911.0  
   Fireresistance, protected steel,  
   Table 214.0  
   Fireresistance, reinforced con-  
   crete, Table 214.0  
   Reinforced concrete, 841.0  
   Steel, formed, 827.0  
   Structural, glued laminated, 856.0  
   Wood, 855.0  
   Wood in heavy timber construction,  
   853.5.1  
 Bearing  
   On hollow masonry units, 839.0  
   For wood beams and girders, 852.5,  
   853.5.1  
   Bearing partitions (see Walls)  
   Bearing, soil capacity, 720.0  
   Bearing walls (see Walls)  
   Bleachers, 420.0  
   Blocks, concrete masonry units (see also  
   Masonry)  
   Fireresistance ratings required,  
   Table 214.0  
   Tests, 802.0  
   Board of appeals, 126.0  
   Boiler (see also Boiler room)  
   Construction of rooms, 1105.1,  
   400.6  
   Definition of, 201.0



- General requirements, 1100.0
- Required mounting and clearance, 1105.1
- Boiler room
  - Hazardous locations, 400.6
  - In public garages, 414.6
  - Location of, 1105.2
  - Special requirements, 1105.1
- Bond, masonry
  - Foundation walls, 869.2.5
  - General, 835.1
  - Masonry walls, 835.0
  - Veneered walls, 854.4.1, 854.4.2, 863.0, 864.0
- Borings, 722.0
- Bowling alleys
  - Use group A-3, assembly, 203.4, 203.7
- Bracing
  - Adjoining existing buildings, 1305.3
  - During erection, 1307.1
  - Exterior stud walls, 854.2.3
  - For stud walls and partitions, bearing, 854.2.1
  - Masonry walls, lateral, 836.0
- Brick (see Masonry)
- Bridges
  - Over sidewalks (wrecking), 1306.3
- Bridging, 854.7.1
- Buildings
  - Allowable areas and heights, 305.0, Table 305
  - Alterations of existing buildings, 106.0, 304.0, 2203.0, 2204.0
  - Certificate of use and occupancy, 119.0
  - Change in use, 105.1, 119.4, 2200.0, 2203.0, 2204.0
  - Classified by type of construction, 214.1
  - Classified by use or occupancy, 202.1
  - Condemnation of, 124.0
  - Definition, 201.0
  - Height, definition, 201.0
  - Height, exceptions 308.0, 2204.4
  - Heights, allowable, 305.0, Table 305, 307.1, 307.1.1
  - Highrise, 431.0
  - Historic, 436.0
  - Maintenance, 104.0, 2201.0
  - Moving, 117.0
  - Over public way, 309.0, 310.0, 311.0, 312.0
  - Regulated by fire limits, 302.0, 303.0, 2204.3
  - Temporary, 314.0
  - Unlimited area, 307.0
  - Unsafe, 123.0, 124.0
  - Unsafe appendages to, 124.0
- Building code
  - Administration, Article 1
  - Adopted, 100.1
  - Application, 100.3
  - Enforced, 108.1
  - Existing buildings, Article 22
  - Matters covered, 100.2
  - Modifications, 110.6
  - Remedial, 100.4
  - Requirements not covered, 101.3
  - Scope, 100.2
  - Validity, 131.0
  - Violations or penalties, 121.0, 121.3
- Building materials
  - Weights of, Appendix J
- Building official
  - Appoints inspectors, 107.0
  - Charge of building department, 107.1
  - Classifies building, 212.0
  - Definition, 201.0
  - Deputies, 107.2, 107.4
  - Inspections by, 108.4, 110.0
  - Issues permits, 108.2, 113.0
  - Liability, 107.6
  - May order occupancy of building discontinued, 124.1
  - May require plans to be sealed by licensed engineer or architect, 113.7
  - May require tests, 802.0, 2202.2
  - Powers and duties of, 108.0
  - Records, official, 107.9, 108.7
  - Record of permits required, 108.7
  - Reports, 108.8
  - Retention of plans, 114.6
  - Right of entry, 112.0
  - Rule-making authority, 109.1
  - Shall require reports, 110.5
  - Shall issue certificate of occupancy, 119.0
  - Stop work orders, 122.0
- Building official's authorization required
  - Before changing plans, 113.8

- For changes of use or occupancy, 105.0
  - For structural alterations, 106.0, 2202.0
  - Building paper, 820.5
  - Building permits (see Permits)
  - Building planning, 2101
  - Bus and passenger terminals, fire limits, 302.7
- C
- Caissons, special, 742.0
  - Canopies
    - Construction, 313.3, 313.5
    - On exterior walls, 313.3
    - Over public property, 313.1
    - Service stations, 415.1
  - Cast stone
    - Bonding, 835.0, 841.0
    - General requirements, 814.0
  - Cavity walls
    - Definition, 201.0
  - Ceilings
    - Boiler rooms, 1105.1
    - Definition (see Story), 201.0
    - Fireresistive rated assemblies, 912.0
    - Fireresistive required, basements or cellars, 905.7.2, 905.7.3
    - Height, 2101.6.1
    - Panels, 912.2
  - Cellar
    - Definition, 201.0
    - Fire protection required (see Fire protection system, where required)
  - Cement
    - Concrete, materials, mix, 816.0
    - Gypsum cement mortar, 816.0
    - Mortar types and materials, 815.0
    - Plastering, 821.0
  - Ceramic tile
    - Mortar, types and mixes, 815.0
  - Certificate of occupancy
    - Existing buildings, 119.3
    - Fitness for high hazard uses, 404.2
    - General, 119.0
    - Posting of, 120.0
    - Temporary occupancy, 119.5
  - Change of occupancy, 105.2, 119.5, 2203.0
  - Changes of use, 105.0, 119.4, 2200.3, 2200.4, 2203.0, 2204.0
  - Changes in plans, 113.9
  - Changes to buildings, 106.0, 2200.3, 2200.4, 2203.0, 2204.0
  - Chases (see Masonry and Walls)
  - Chemicals
    - Hazardous use groups, 206.2
  - Chimneys
    - Additional load, 2108.2.2
    - Appliances requiring, 1004.1
    - Classification of, 1003.1
    - Construction of, 1007.2
    - Definition, 201.0
    - Factory-built, 1002.2.1, 2108.4
    - Firestopping around, 1007.11, 2108.2.8
    - For fireplaces, 1007.1
    - Foundations, 1007.12
    - Flues, 2108.2.3, Table 2108-2, 2108.3.2.5
    - Flue lining required, 1007.3, 2108.3.2
    - General requirements, 1000.0, 1004.1, 2108.1
    - Inlet, 2108.2.6
    - Masonry, 2108.2, 2108.3
    - On existing buildings, 1005.0, 2200.4
    - Solid fuel burning appliances, 2109.0
    - Support, 2108.2
    - Termination, 2108.5
    - Wall thickness, 2108.3
    - Wood frame, spaced from, 1007.4
  - Churches
    - Use group A-4, assembly, 203.5, 203.7
  - Chutes
    - Refuse, 1107.0
  - Circulating air supply, 2112.10
    - Requirement, 2112.11
    - Source, 2112.12
    - Conditioned, 2112.13
  - City (see Jurisdiction)
  - Classification
    - Of buildings, by building official, 212.0
    - Of buildings, by occupancy, 202.0
    - Of buildings, by types of construction, 214.0
    - Of types of construction, 215.0, 216.0, 217.0, 218.0
  - Clay tile
    - Allowable stresses, 807.0
    - Bonding, 835.0

- Mortar, types and mix, 815.0  
Veneer, 854.4, 854.4.1, 861.0
- Clearances  
Around fireplaces, 1007.4  
Around reinforcing in concrete, 728.3.2  
Around timber in masonry, 853.5.1  
Awnings, moveable, 310.8, 310.9, 313.2  
Ducts, 1009.0  
Heating appliances, 1105.1  
Marquee awnings, 310.10  
Of balconies above grade, 310.7  
Of wood above grade, 854.6.1  
Projection over sidewalks, 310.0  
Under first floor joists, 507.3
- Clothes dryers, 2110.13  
Coal pockets, 410.5  
Coastal high hazard, 744.0  
Code, scope, 100.2
- Columns  
Cast iron construction 831.4.1  
Concrete filled pipe, 846.0  
Firerestistance and protection of, 911.0  
Firerestistance tests, 903.0  
Heavy timber construction, 855.3  
Live load reduction, 718.0  
Working stresses, cast iron and steel, 829.0
- Combustible  
Dusts, grain processing and storage, 410.0  
Fibers, use and storage, 409.0
- Combustibility tests, 903.5
- Combustible materials  
Decorative material restrictions, 923.0  
Definition, 201.0  
Flamerestistance tests, 904.0  
Insulation, 907.6, 876.0  
Interior finish, wood frame construction, 920.0  
Interior trim, 920.0, 922.0  
Prohibited in fire limits, 400.9  
Prohibited in Type 1 buildings, 215.0  
Prohibited in Type 2 buildings, 216.0
- Combustion air, 2111.0, 2112.2  
Attic, 2111.5  
Ducts, 2111.8  
Underfloor, 2111.6
- Compliance alternative, 2205.0  
Required documentation, 2203.4, 2203.5  
Compliance with permit, 115.2  
Computations, may be required, 113.7, 2202.2, 2202.3  
Concentrated loads, 707.0  
Concrete (see also Reinforced concrete)  
Aggregates, 816.0  
Caissons, 739.0  
Columns, concrete filled pipe, 846.0  
Definition, 201.0  
Footings, 728.0  
Gypsum reinforced concrete, 849.0  
Minimum dimensions, 848.0  
Piles, 732.0, 734.0, 736.0, 737.0  
Plain concrete, 840.0  
Pneumatic, 847.0  
Ready-mix, 817.0  
Reinforced (see also Reinforced concrete), 841.0  
Units (see also Masonry), 809.0  
Concrete, masonry blocks (See Blocks, concrete masonry units)  
Condition of permits, 115.0, 2203.2  
Connections  
In wood framing, 852.3.1  
Mechanical and welded, 826.0  
Construction  
Approval of materials, etc., 110.0, 804.0  
Classification of construction materials, 801.0  
Controls, 127.0  
Covered by code, 101.0  
Fences, 1306.2  
General requirements, 214.0, 800.0  
Masonry, 834.0  
Permitted outside fire limits, 303.0  
Permitted within fire limits, 302.0, 2204.3  
Prefabricated, Article 18  
Protection during, 1306.0  
Safeguards, 1300.0  
Stage, 417.7  
Steel, 826.0, 827.0, 828.0, 830.0  
Types of construction, 215.0, 216.0, 217.0, 218.0  
Wood, 852.0, 853.0, 854.0  
Controls, heating and cooling, 2126.0  
Humidity, 2126.2  
Set back and shut off, 2126.4

- Temperature, 2126.1
  - Zoning, 2126.3
  - Controlled materials procedure, 719.1
  - Convalescent homes
    - Use group I-2, institutional, 207.3, 207.4, 433.0
  - Conveyor systems
    - For dusts, stock and refuse, 1109.0
  - Cooking appliances, 2110.4
    - Range clearances, 2110.10, 2110.11, 2110.12
  - Cooling, comfort, 2116.0
    - Access, 2116.5
    - Circulating air supply source, 2116.6
    - Installation, 2116.4
    - Permits, 2116.3
    - Refrigerant piping, 2116.9
    - Return air limitation, 2116.7
    - Screen, 2116.8
  - Cooling towers, 925.9
  - Coordination of inspections of structures involving hazardous materials, 403.3
  - Corbelling
    - Foundation walls, 869.4
    - Masonry, 838.0
  - Cornices
    - Projection over public property, 310.0
    - Type of construction, 924.2
  - Corridors
    - Arrangements, 607.1, 610.1
    - Capacity of egress, width, 608.0, 2203.8
    - Fireresistive ratings, Table 214
    - Light and ventilation, 513.1.3
    - Obstructions, 610.1
    - Passageways and corridors, 610.0
    - Widths, 610.3
  - Corrosion protection, 733.0
  - Court
    - Definition, 201.0
    - Permissible encroachments, 311.0
  - Covered malls, 432.0
  - Coverings
    - Ducts, 1009.0
    - Exterior, plywood, 824.2
    - For exterior stairs, 619.1
    - Exterior wall, 2104.3
    - For exteriors, weather protection, 854.4
  - Interior floors, 824.3.2
  - Interior wall, 2104.2
  - Roofs, 926.0
  - Crawl space, ventilation, 507.3
  - Cupolas, type of construction, 925.10
  - Curtain, proscenium, 417.7.7
  - Curtain wall
    - Definition, 201.0
- D
- Dampers
    - Fire, approved type, 903.4.5
    - Stage ventilation, 417.7.9
    - Where required, 905.11
  - Dampproofing, 2102.6
  - Dance halls
    - Use group A-2, assembly, 203.3, 203.7
  - Dangerous structures, 123.0, 124.0
  - Day care centers, 434.0
  - Dead loads
    - Definition, 201.0
    - Design, 704.0
  - Decisions of board of appeals, 126.4
  - Decorative features,
    - Projections, 310.0
  - Decorative material restrictions, 923.0
  - Decorative trim restrictions, 920.0, 924.0
  - Definitions, 201.0, 2100.3
  - Deflection criteria, 702.2, 803.0
  - Degree days, 2101.3.2
  - Demolition
    - Permit, when required, 116.0
    - Unsafe buildings, 123.0
  - Depth
    - of foundations
    - Governed by frost line, 724.0
    - Governed by soil conditions, 723.0
  - Design
    - Approved by building official, 804.1
    - Cast-in-place concrete piles, 737.2
    - Composite piles, 741.1
    - Criteria, 2101.2
    - Dead load, 704.0
    - Fire protective requirements (see Fire protection systems)
    - Formed steel construction, 827
    - Foundation walls, 869.1

- General, 700.0
- Glass, glazing, 802.2, 857.5
- Live loads, 703.0, 706.0
- Lumber and timber construction, 852.1
- Masonry wall construction, 834.1
- Plain concrete, 840.2
- Plastics, 876.5, 1901.0
- Precast concrete piles, 736.2
- Prefabricated construction, Article 18
- Proscenium curtains, 417.7.7
- Reinforced brickwork, 851.0
- Reinforced concrete, 841.1
- Reinforced hollow block construction, 851.1
- Retaining walls, 870.2
- Safe load, 701.0
- Seismic (earthquake), 716.0
- Signs, general requirements, 1407.0
- Special steels, 832.1
- Steel joist construction, 828.0
- Steel pipe and tapered tubular piles, 738.3
- Temperatures, 2101.3.2
- Wind loads, 712.0, 713.0, 714.0, 715.0
- Detector, smoke (see Automatic fire alarm systems)
- Deviations
  - From code, 110.3, 2205.0
  - From plans, 115.5
- Devices for window cleaning, 521.0
- Dilapidated buildings
  - Condemnation of, 123.1
- Display of permit, 114.9
- Display sign, definition, 201.0
- Doors
  - Approved type, fire, 915.1, 915.2, 903.4.2
  - Automatic, 612.6
  - Automatic closing devices for, 915.5
  - Egress, means of, 612.0, 2203.12
  - Existing buildings, 604.0, 2203.12, 2204.6
  - Fire (see Fire doors)
  - Fire separation walls, 909.0
  - For fire separations, 917.2
  - In horizontal exits, 614.2, 614.3
  - Location of, 612.4, 607.0
  - Openings in mixed occupancy separation, 909.0
  - Openings in stairways or shaftways, 909.0, 2203.12
  - Panic hardware, 612.5.2
  - Power operated, 612.5.4
  - Rated fire door assemblies, 915.1
  - Required to open out, 612.2, 2204.6
  - Revolving, 613.0
  - Width of, 612.3, 2101.10.4
- Dormers, 925.7
- Dormitories
  - Definitions (see Dwellings), 201.0
  - Use group R-1, residential, 209.2, 209.6
- Downspouts, 2101.12
- Downspout
  - For roofs, 924.1
- Dressing rooms (see Theatres)
- Drive-in theatres
  - Use group A-5, assembly, 203.6, 203.7, 421.0
- Dry cleaning or similar high hazard uses
  - Classified, 412.2
  - Construction, 412.3
  - Fire protection system, 412.7
  - General requirements, 412.0
  - Use group H, high hazard, 206.0
  - Ventilation, 412.5
- Drying rooms, 1106.0
- Ducts
  - Construction of air-conditioning, heating and ventilating, 1009.0, 2115.2
  - Fire dampers required in, 905.11
  - Materials, 2115.1
  - Installation, 2115.3
  - Insulation, 2115.4, 2128.0
  - Shafts, vertical, 910.5
- Dumbwaiter, 1600.0
- Dusts, combustible, 410.0
- Duties
  - Of board of appeals, 126.0
  - Of building official, 108.0
  - Of employees, 107.5
- Dwellings
  - Area and height limitations, general, 305.0, Table 305
  - Ceiling height (see definition of Habitable space), 201.0
  - Definition, 201.0
  - Exits, existing, 604.0
  - Fire separation walls in, 909.1.2
  - Foundations, 869.0

- Number of exitways, 609.0  
Occupancy load, 606.0  
Use group R, residential, 209.0
- E
- Earthquake (seismic) design, 716.0, 2204.7
- Eaves design, 710.3  
Projection, 310.0  
Construction, 924.0
- Egress (see Means of egress)
- Electrical equipment and wiring, Article 15
- Elevators, 1600.0
- Emergency  
Controls, proscenium curtains, 417.7.7  
Exits from theatres, 417.3.3  
Lighting, 417.9.5, 624.0, 2203.10  
Signs for exits, 623.0, 2203.9
- Emergency measures, 124.0
- Employees, restrictions on, 107.5
- Enclosure  
Combustible construction allowed, 616.9.3, 909.3  
For elevators, 1600.0  
For interior stairs, 616.9.2  
For motion picture projection rooms, 408.3.1  
Of exterior stairways, 619.1, 2203.12, 2204.6  
Of moving stairways, 620.7.2  
Ramps, 615.0  
Vertical shafts and hoistways, 910.0
- Enclosure walls (see Walls)
- Encroachments  
Awnings and canopies, 310.8  
Existing, 309.6  
Special and temporary, 312.0  
Special and temporary, 312.0  
Street, 309.0  
Yard and court, 311.0
- Energy conservation, 2119.0, 2100.2  
Alternate systems, 2013.0, 2014.0  
Building enclosure elements, 2119.2  
Exceptions, 2000.1  
Existing buildings, 2203.14, 2100.2  
Exterior envelope requirements, 2007.0  
Residential buildings, 2009.1  
Other buildings, 2009.2  
Air leakage, 2009.5
- General, 2200.0  
In electrical distribution systems 2011.0  
Lighting power limits, 2012.0  
Lighting power limits for existing buildings, 2015.0  
Plans and specifications, 2003.0  
Scope, 2000.1
- Enforcement of code, 108.0
- Engineering practice, 110.2, 800.2, 2202.3
- Entry, right of, 112.0
- Escalators, 620.0, 1620.0
- Excavations  
Protection of, 1307.0  
Protection of adjoining property, 1312.0  
Walkways over, 1306.3
- Exhaust ventilation (see Ventilation)
- Existing buildings  
Additions, alterations, repairs, 102.1, 106.0, 304.0, Article 22  
Areas, allowable, 304.2, Table 305, 2204.4  
Certificate of occupancy, 119.3  
Change in existing use, 105.0, 106.7, 2203.0, 2204.0  
Change of occupancy, 119.4, 2203.0  
Condemnation of, 123.1  
Definition, 201.0, 2201.0  
Demolition, 116.0  
Entry, right of, 112.0  
Evaluation of, 2202.3  
Exits, 604.0, 2203.7, 2203.8  
Fire limits, 304.2, 2204.3  
General requirements, 105.0, 2200.3, 2200.4  
Inspection of, 111.4, 120.4  
Investigation of, 2202.2  
Maintenance, 104.0, 2200.3  
Moving, 117.0  
Non-structural alterations and repairs, 102.1, 2200.4  
Unsafe, 123.0, 2200.4
- Existing signs, 1404.0
- Exit lights, 623.0, 624.0, 2203.7, 2203.10
- Exit signs, 623.0, 2203.9
- Exits, exitways (see Means of egress)
- Expiration of permit, 113.2, 114.3
- Exterior hoists, 1315.0

- Exterior opening, protection required because of location on property, 914.0
- Exterior stairways, 619.0
- Exterior trim restrictions, 924.0
- F
- F, use group, factory and industrial, 205.0
- Faced (veneered) walls (see Walls)
- Factories  
Use group F, occupancy, 205.0  
Use group H, high hazard, 206.0
- Fallout shelters, 430.0
- Fees, 118.0
- Fences  
Excavations, 1307.0  
For construction purposes, 1306.2  
General requirements, 1309.0
- Fiberboard, 823.0
- Fibers, combustible, 409.0
- Filling stations (see Automotive service stations)
- Film  
Projection rooms, 408.3  
Storage and use of flammable film, 408.0
- Finish, interior (see Interior finish)
- Finishes, ceiling, 2106.4
- Fire  
Access panels, 859.0  
Alarm system (see Fire protection system)  
Dampers, 903.4.5, 905.11  
Emergency ventilating system, 519.0  
Firestopping, 875.0  
Sprinklers and standpipes (see Fire protection systems)  
Ventilation of open wells, 520.0
- Fire alarms (see also Fire protection systems and High rise buildings)
- Fire appliances during construction, 1318.0
- Fire dampers, 903.4.5, 905.11
- Fire detection systems (see Automatic fire alarm system, 1216.0)
- Fire department  
Central control station for, 1218.0  
Connections, 1213.0
- Fire doors  
Closures, 915.5, 2203.12  
Dressing rooms, 417.8.2  
General, 915.0, 903.4.2, 903.4.3
- On openings in exterior walls, 914.0
- On openings in fire walls, 908.3, 908.3.1
- On openings in proscenium walls, 417.7.6
- On openings in stage enclosures, 417.7.5
- Fire escapes  
As exits, 621.1  
Existing buildings, 621.0, 2203.8  
Maintenance of, 605.0
- Fire limits  
Establishment of, 301.0  
Restrictions on cooling towers in, 925.9  
Restrictions outside, 303.0  
Restrictions within, 302.0, 2204.3  
Roof coverings in, 302.2, 926.0  
Roof coverings, outside, 303.0, 926.0
- Fireplace  
Clearances, 2108.7.4  
Construction of, 1007.0  
Factory built, 2108.7.12  
Fire separation, 2101.16  
Firestopping, 2108.7.8  
Hearth, 2108.7.7, 2108.7.12.1  
Lintel, 2108.7.6  
Solid fuel-burning appliances, 2109.0  
Steel units, 2108.7.2  
Walls, 2108.7.2
- Fire protection  
For buildings under construction, 1318.7, 1318.8  
For spray booths, 411.6, 1202.14  
Requirements, detailed, Article 12
- Fire protection systems  
Areas increased by, 306.3  
Automatic fire alarm systems, 1216.0  
Automatic fire alarm, where required, 1216.3, 2203.11  
Carbon dioxide extinguishing system, 1208.0  
Dry chemical extinguishing system, 1210.0  
Fire department connection, 1213.0  
Foam extinguishing system, 1207.0  
General requirements, 1200.0

- Halogenated fire extinguishing system, 1209.0
- Height increased by, 308.1
- Limited area sprinkler system, 1205.0
- Manual fire alarm system, 1217.0
- Manual fire alarm system, where required, 1217.3
- Plans and specifications, 1201.0
- Standpipes, where required, 1211.2
- Supply media, 1214.0
- Suppression system selection, 1203.0
- Temporary standpipe requirements, 1212.0
- Water spray fixed systems, 1206.0
- Water sprinkler system, 1204.0
- Where required, 1202.0
- Yard hydrants, 1215.0
- Fire resistance rated construction
  - Assemblies, 903.1, 912.0
  - Ceilings and floors, 912.0
  - Construction requirements, general 900.0
    - Definition, 201.0
    - Fire hazard classification, 902.0
    - Plans and specifications, 901.1
    - Protection of structural members, 911.0
    - Roof coverings, 903.3, 926.0
    - Special requirements, 905.0, 2204.6
    - Tests, 903.0
- Fire resistance ratings of structural elements, Table 214
- Fire retardant treated wood
  - Tests, 903.6.1
  - Use limitations, 903.6.2
- Fire separation
  - Required for occupancy, 909.0
- Fire shutters, 916.0
- Firestopping
  - Architectural trim, 924.2.3, 875.7
  - Between chimneys and wooden construction, 1007.11
  - Between wood sleepers, 922.2
  - Floor/roof ceiling assemblies, 912.3, 912.4
  - General requirements, 919.0, 2103.7
  - Of attic spaces, 875.6, 875.6.1, 912.0, 919.0
- Fire towers (Smokeproof enclosure), 618.0
- Fire ventilation
  - Emergency ventilation system, 519.0
  - Of open wells, 520.0
- Fire walls, 907.0
- Fire windows, 916.0
- Flag poles, 925.1
- Flammable
  - Combustible dusts, grain processing and storage, 410.0
  - Combustible fibers, use and storage of, 409.0
  - Film, storage and use of, 408.0
  - Liquids (volatile), 402.0
- Flameresistance tests
  - General, 904.1
  - Interior finish materials, 904.2
  - Interior hangings and decorations, 904.5
- Flamespread, 2101.13
- Flashing, 2104.3.5.3
- Floodplain, 2101.15
- Floodproofing, 872.6
- Floor
  - Area, 305.0, Table 305, 306.0, 307.0
  - Combustible materials permitted in Type 1 and Type 11 buildings, 922.0
    - Concrete, 2105.3
    - Floor area, definition, 201.0
    - Metal, 2105.4
    - Particle board, 2105.5
    - Plywood sheathing, 824.0
    - Public garages, 414.2.5
    - Theatre stages, 417.7.2
    - Wood, 2105.2
  - Floor loads
    - Dead, 704.0
    - Design live, 703.0, 706.0
    - Existing buildings, 705.0, 2203.5
    - Reductions allowed, 718.0, 2203.5
    - Required to be posted, 120.0
- Flues
  - Area for fireplaces, 1007.8
  - Lining for chimneys, 1007.3
- Foam plastics, 920.4.1, 876.5, 2120.3, 2120.2.3
- Footings, 2101.3
  - Concrete, design, 728.0
  - Depth, 724.0
  - Design, general, 725.0, 726.0, 728.0



- Loads, 723.0
  - Of masonry, 729.0
  - Of reinforced concrete, 728.3.2
  - On public property, 309.2
  - Protection of steel in grillage footings, 727.0
  - Steel grillage, 727.0
  - Timber, 726.0
- Formed steel construction, 827.0
- Foundations, 2102.0
  - Allowable loads, 723.0
  - Caissons, 739.0
  - Design, 869.1
  - Footing design, 724.0, 725.0
  - For neighboring building, 1307.2
  - Kneewall, 2102.7
  - May project beyond property line, 309.2
  - Minimum depth, 724.0
  - Minimum thickness, 869.2
  - Piers, 731.0
  - Piles, 732.0, 735.0, 736.0, 737.0, 738.0, 740.0, 741.0, 742.0
  - Ratproofing, 873.0
  - Steel grillage, 727.0
  - Walls, 869.0
  - Wood and timber, 726.0
- Frame buildings in fire limits, 302.2, 2204.3
- Frame construction, wood
  - General requirements, 854.0
  - Restrictions within fire limits, 302.0, 400.9, 2204.3
- Frost
  - Depth of foundation, 724.1
- Fuel supply systems, 2118.0
  - Authority to disconnect, 2118.3
  - General, 2118.1
  - Liquid fuel supply, 2118.5
  - Location, 2118.2
  - Piping support, 2118.4
- Furnaces
  - Exterior, 2112.9
  - Floor, 2113.4
  - Wall, 2113.7
  - Warm air, 2112.0
  - Underfloor, 2112.8
- G
- Garages
  - Beneath a dwelling, 413.1.1
  - Construction of public garages, 414.2
- Definitions, 201.0
- Fire doors, 413.1.1
- Heating equipment, 414.5, 414.6
- On lot line (private), 303.2, 305.1
- Open parking structures, 429.0
- Private, 413.0, 2101.9
- Public, 414.0, 905.2
- Repair shops, motor vehicles, 416.0, 905.2
- Separations, 413.1.1, 413.1.2, 413.1.3, 414.2.3
- Service stations, motor fuel (see also Automotive service stations), 415.0, 905.2
- Storage of flammables, 414.4
- Ventilation, 414.3
- Garage, private
  - Connected to dwelling, 413.1.1, 413.3
  - Definition, 201.0
  - Use group T, temporary and miscellaneous, 211.0
- Garage, public
  - Classified, 201.0
  - Construction limited, 414.2
  - Definition, 201.0
  - Fire suppression system required, 1202.9, 1211.2.4
  - Special fire resistance requirements, 905.2
  - Use group S-1, storage, 210.2, 210.4
  - Ventilation required, 414.3
- Gas
  - Appliances, flues and vents for, 1006.0
  - Gas-fired equipment (see Mechanical code listed in Appendix B)
  - Liquefied petroleum, 406.0
- Gasoline service station (see also Automotive service station)
  - Defined as motor fuel service station, 201.0
  - General requirements, 415.0
- Glass
  - Area required, 506.2
  - Block walls, 812.0, 860.0
  - Dimensional tolerances, 857.5.3
  - Impact loads, 857.5.6
  - In fire doors, 917.1

- Jalousies, 857.5.5
  - Labeling and identity, 857.5.1
  - Specific hazardous locations, 857.5.6.1
  - Strength tests for, 802.2.1
  - Supports, 857.5.2
  - Veneer, structural, 862.0
  - Wind loads, 857.5.4
  - Wired glass, 917.0
  - Glazed masonry units, 808.0
  - Glazing, 2101.7
  - Glazing, plastics
    - Approved, 1900.2, 1900.2.1
    - Bathroom accessories, 1908.0
    - Exterior wall panels, 1903.0
    - Greenhouses, 1910.0
    - Of unprotected openings, 1902.0
    - Roof panels, 1904.0
    - Skylight assemblies, 1905.0
  - Glued laminated lumber construction, 856.0
  - Glues for wood, 818.0
  - Grade
    - Definition, 201.0
    - Depth of footings and foundations below, 726.0, 869.0
    - Marked lumber, 852.1
    - Marked plywood, 824.0
    - Passageways and lobbies, 611.0
  - Grading a lot, 1308.1
  - Grain processing and storage, 410.0
  - Grandstands, 420.0
  - Ground
    - At grade protection, wood construction, 854.6
    - Clearance of wood framework above, in crawl spaces, 507.3
    - Signs, 1408.0
  - Grounding
    - Metal roofs, 926.5, 926.5.1
    - Metal veneer, 864.4
    - Radio and television antennae, 427.3
    - Radio and television tower, 426.5
  - Group residence, 424.0
  - Guardrail, 2101.11
  - Gutters, 2101.12
    - Materials for roof drainage, 924.1
  - Gypsum
    - Concrete reinforced, 849.0
    - Units, 811.0
    - Wallboard, 2104.2.5
- H
- H, use groups, high hazard, 206.0
  - Habitable room, 2101.6.1
  - Habitable space
    - Definition, 201.0
  - Hall, width, 2101.10.4.4
  - Handicapped and aged, requirements for, 315.0
  - Handrails, 2101.11
    - For ramps, 615.2
    - For retaining walls, 870.5
    - For stairways, 616.5, 616.5.1, 616.5.2
  - Hardware on exit doors, 612.5
  - Hazard index (for existing structures) Table 2204
  - Hazardous
    - Certificate of fitness, 404.2
    - Equipment rooms, 400.8
    - Existing buildings, 405.1, 405.2, 2200.3.1, 2200.4
    - General, 400.0
    - High hazard (see Use group H), 206.2
    - Inspection of, 403.0
    - Low hazard (see Use group S-2), 210.3
    - Moderately hazardous (see Use group S-1), 210.2
    - Prohibited with assembly use, 417.2.1
    - Restrictions in fire limits, 400.9
    - Special permits, 404.1
    - Storage segregation, 400.0
  - Headers, 2103.2.6
  - Headroom
    - In dwelling (see definition of Habitable space), 201.0
    - In stairways, 616.2.2
  - Hearth for fireplace, 1007.10
  - Heating
    - Chimneys, 1007.1
    - Fireplaces, 1007.0
    - Furnace and boiler rooms, 400.6, 414.6, 1105.1
    - Gas fired equipment, 1100.2
    - General requirements, 1100.0
    - Heating, air-conditioning and ventilating ducts, 1009.0
    - Heating and ventilating equipment in hazardous occupancies, 1100.2

- Incinerators, 1008.0
  - Temporary during construction, 1318.2, 1318.3
- Heating appliances and systems
  - Access, 2110.8
  - Clearances, 2109.4, Table 2110-1, Table 2110-2, Figure 2109-4
  - Control Devices, 2110.0
  - Fuel Type, 2110.5
  - Industrial classification of, 1100.2
  - In existing buildings, 1103.1
  - Installation, 2110.7
  - Labelling, 2110.4
  - Oil burning installations, 1100.0
  - Oil, fuel tanks and equipment, 1100.0
  - Public garages, 414.5, 414.6
  - Shut-off valve, 2110.6
  - Temporary during construction, 1318.2
- Heavy timber construction (see Type 3-A construction), 853.0
- Height
  - Affect of wind loads, 712.0, 713.0, 714.0
  - Alterations for existing buildings, 304.2, 2204.4
  - Awnings, 310.8, 310.9
  - Definition, 201.1
  - Exceptions, 308.0
  - For unlimited area building, 307.1
  - Handrails or railings, 616.5.1, 870.5
  - Limitations, 305.3, 307.0
  - Marquees, 310.10.1
  - Masonry walls, 834.1
  - Of buildings, 305.0, Table 305
  - Permissible street projections, 310.0
  - Raising adjoining chimneys and vents, 1005.1
  - Restrictions, 305.3, 305.4, 307.1
  - Stairway, maximum vertical rise, 616.3.2
  - Towers, spires, cupolas, aerial supports, poles, etc., 925.0
  - Type of construction, 1, 2, 3 and 4, 305.0, Table 305
  - Use groups, 305.0, Table 305.0
  - Veneered walls, 854.4.3
- High hazard structures
  - Use group H, 206.0
- High rise buildings
  - Alarm and communications system, 431.5
  - Applicability, 431.1
  - Automatic fire suppression system option, 431.3.1
  - Central control station, 431.6
  - Elevators, 431.8
  - Emergency power, 431.9
  - Exits in, 431.10
  - Maintenance and inspection, 431.2
  - Smoke control, 431.7
  - Smoke detection systems, 431.4
- Historic buildings, 436.0, 2200.4
- Hoists for construction operations, 1315.0
- Homes for aged
  - Use group I-2, institutional, 207.3, 207.4, 433.0
- Horizontal exits
  - Definition, 201.0
  - General requirements, 614.0
- Hospitals
  - Use group I-2, institutional, 207.3, 207.4, 433.0
- Hotels
  - Definition (see Dwelling), 201.0
  - Use group R-1, residential, 209.2, 209.6
- Houses, lodging
  - Use group R, residential, 209.0
- Hydrants, fire-yard systems, 1215.1
- I
  - I, use groups, institutional, 207.0
  - Identification of employees, 108.4
  - Identification for plastics, 1900.2
  - Identification for signs, 1401.3
  - Illuminated signs, 1414.0
  - Implementation of Article 22, 2202.0
  - Incinerators, 1008.1
  - Industrial heating appliances, classification, 1100.0
  - Industrial lifts and loading ramps, 1616.0

|   |  |
|---|--|
| Industrial  | Restrictions in Types 1 and 2 buildings, 922.0       |
| Use group F, factory and industrial buildings, 205.0    | Use group requirements, Table 920.920.5              |
| Infirmeries   | Interior lot lines, definition, 201.0                |
| Use group I-2, institutional buildings, 207.0           |  |
| Inner court   | J  |
| Definition (see Court), 201.0                           |  |
| Insane asylums  | Jails  |
| Use group I-1, institutional buildings, 207.2, 207.4    | Use group I-1, institutional buildings, 207.2, 207.4 |
| Inspection  | Jalousies  |
| By building official, 108.4, 111.0, 1805.2              | Windows and doors, 857.5.5                           |
| Final, 111.3  | Jurisdiction   |
| Of amusement devices, 419.4                             | Adopting this code, 100.1                            |
| Of automatic fire alarm systems, 1216.10                | K  |
| Of electrical wiring, 1500.0                            | Kneewall, 2102.7                                     |
| Of existing buildings, 111.5, 2202.0                    | L  |
| Of hazardous uses and places of assembly, 403.0         | Labeling   |
| Of heating systems, 1102.0                              | Electrical appliance, 2110.15                        |
| Of prefabricated construction, 1800.0                   | Fuel burning appliance, 2110.14                      |
| Of signs, 1405.4  | Landing, 2101.10.5                                   |
| Of unsafe buildings, 123.0                              | Landing of stairs, 616.3                             |
| Preliminary, 111.1                                      | Landings of ramps, 615.3                             |
| Insulation  | Lath, interior, 2104.2.3                             |
| Blanket or battery, 2120.4                              | Leaders and gutters, 924.1                           |
| Building, 2120.0  | Licenses   |
| Fiber boards for roof, 823.4                            | Fees for, 118.0                                      |
| Fiber boards for wall, 823.5                            | Lifts, 1600.0  |
| Foam plastics, 920.4.1, 876.5, 2120.3                   | Light illumination                                   |
| Installation, 2120.2                                    | Alcoves, 507.1                                       |
| Perimeter, 2120.5                                       | Artificial, 504.0                                    |
| Thermal insulating material requirements, 876.0, 2006.0 | Assembly, rooms, 510.1                               |
| Typical requirements, Figure 2123-1                     | Basements and cellars, 508.0                         |
| Interior finish and trim                                | Bath and toilet rooms, 512.0                         |
| Application of, 921.0                                   | Court requirements for, 516.0                        |
| Classification of materials, 904.2, 920.5               | For exit signs, 623.0                                |
| Decorative material restrictions, 923.0                 | For existing buildings, 505.0, 2015.0, 2203.14       |
| Flameresistance tests, 904.0                            | For stairways and exitways, 513.0, 624.0             |
| Flame spread of, 904.2, 904.3                           | General, 500.0                                       |
| Foam plastics, 920.4.1                                  | Institutional buildings, 511.0                       |
| General requirements, 920.0                             | Natural, 502.1, 506.0                                |
| Other, 2104.2.7   | Power limits, 2012.0                                 |
|   | Rear yards for, 517.0                                |
|   | Theatre lighting, 417.3.9, 417.9                     |
|   | Window requirements, 506.2                           |

- Light and ventilation, 2101.5
- Lintel
  - Definition, 201.0
  - Fire protection, 911.2, 911.7, 911.7.1
  - Over openings, frame construction, 854.2.6
- Liquids
  - Flammable, explosive, 402.0, 406.0
  - Liquefied petroleum gases, 406.0
- Loads, design, 701.0, 702.0, 703.0, 704.0
- Loads, impact
  - Assembly structures, 708.5
  - Craneways, 708.4
  - Elevators, 708.2
  - General, 708.1
  - Machinery, 708.3
- Loads (live, head, floor)
  - Combination of, 717.0
  - Concentrated, 707.0
  - Craneways, 708.4
  - Definition, 201.0
  - Deflections allowable, 803.3
  - Existing buildings, 2204.7, 2204.8
  - Earthquake, 716.0, 2204.7
  - Floor loads, occupancy, 706.1, Table 706
  - For concrete footings, 725.0, 728.0
  - For retaining wall design, 709.2
  - Footings and foundations, 723.0, 725.0
  - Glass (see Loads, glass)
  - Impact, 708.0
  - Piles, allowable, 734.0
  - Posting of live loads, 706.3
  - Railings, 709.4
  - Reductions allowed, 718.0, 2203.5
  - Required to be posted, 706.3
  - Roof, 710.0, 714.0
  - Snow, 711.0
  - Soil, bearing capacity, 720.0
  - Special, 709.0
  - Tests, 701.2
  - Uniform, 706.0
  - Wind (see Loads, wind)
- Loads, glass
  - Impact loads, 857.5.5
  - Jalousies, 857.5.5
  - Wind (see Loads, wind)
- Loads, wind
  - Chimneys, 712.0, 715.0
  - Exterior walls, 713.0
  - General requirements, 712.0
  - Glass, 857.5.4
  - Roofs, 710.0, 714.0
  - Signs, 715.0
- Loading and shipping rooms, 905.4, 905.5
- Loading ramps, industrial, 1600.0
- Location on lot, 2101.4
- Lobbies, grade passageways and, 611.0
- Lodging houses
  - Definitions (see Dwelling), 201.0
  - Use group R, residential, 209.0
- Lot
  - Definition, 201.0
  - Interior lot line, definition, 201.0
  - Line fences, 1309.1
  - Plot plan required, 113.6
  - Regulations for, 1308.0
- Lumber (see also Wood construction)
  - Grade of, 852.1
- M
- M, use groups, mercantile, 208.0
- Maintenance
  - Of buildings and structures, 104.0, 2200.3, 2201.0
  - Of exit facilities, 605.2
  - Of fire protection systems, 1200.3
  - Of signs, 1405.2
- Malls, covered, 432.0
- Manlifts, 1600.0
- Mansard roofs, 925.6
- Manual fire alarm systems, 1217.0, 2203.11
- Marquees and canopies
  - Construction requirements, 310.10.5, 313.3, 313.5
  - Definition (see Signs), 201.0
  - Drainage of water, 310.10.3
  - Signs, 310.10, 1412.0
- Masonry
  - Bonding, 835.0
  - Brick, 806.0
  - Cast stone, 814.0
  - Cavity wall, 2103.8

- Chases and recesses, 837.0
- Chimneys, 1003.1
- Construction requirements, 834.0
- Corbelled and protected, 838.0
- Cornices, 838.3
- Definition, 201.0
- Design, 834.1
- Footings, 729.0
- Foundations, 869.0
- Freezing protection, 834.3
- Glass block, 811.0
- Glazed units, 808.0
- Grouted, 2103.9
- Gypsum units, 810.0, 2103.6
- Hollow, definition of, 201.0
- Hollow units, 809.2, 809.3
- Lateral bracing, 836.0
- Mortar, 815.0, 2204.8
- Reinforced, 850.0
- Reinforced grouted, 2103.10
- Reinforced hollow, 815.0, 2103.11
- Re-use of, 805.2
- Solid, definition of, 201.0
- Solid units, 809.4, 2103.7
- Stone, natural, 813.0
- Terra cotta, 812.0
- Tests, general, 800.0
- Thickness of walls, 866.0
- Tile, structural, 807.0
- Veneers, 861.0
- Masonry construction, 2103.5
- Matches
  - Use group H, high hazard, 206.0
- Materials
  - Alternate, 800.4
  - Approvals, 804.0
  - Brick units, 806.0
  - Cast stone, 814.0
  - Concrete aggregates, 816.0
  - Concrete units, 809.0
  - Glazed masonry units, 808.0
  - Gypsum units, 810.0
  - Mortar, 815.0, 2204.8
  - Natural stone, 813.0
  - Plastics, approved, 1900.2, 1900.2.1
  - Plywood, 824.0
  - Structural clay tile units, 807.0
  - Structural glass block units, 811.0
  - Structural wood glues, 818.0
- Material and equipment identification, 2101.1.1
- Means of Egress
  - Air conditioned buildings, 603.0
  - Aisles, corridors and passageways, required width for, 610.3
  - Arrangement of exits, 610.1, 602.0
  - Buildings with one stairway, 609.3
  - Capacity of exits, 608.0, 2200.4, 2203.8
  - Definition, 201.0
  - Doorways, 612.0, 616.6
  - Doors revolving, 613.0
  - Exit hallways, 610.0
  - Exit openings in exterior walls, 614.0
  - Exit signs, 623.0, 2203.9
  - Exterior exitway stairways, 619.0
  - Fire escapes, 621.0
  - From places of assembly, 417.3, 2200.3, 2203.13
  - General provisions, 600.0, 2101.10
  - Grade passageway and lobbies, 611.0
  - Hardware, 612.5
  - Hazards to, 625.0
  - Horizontal exits, 614.0
  - In existing buildings, 604.0
  - Interior exitway stairways, 616.0, 2203.12, 2304.6
  - Length of travel, 607.4, Table 607
  - Lighting, 624.0, 2203.10
  - Location and type of, 607.0
  - Maintenance of exitways, 605.0
  - Moving exitway stairways, 620.0
  - Number of exitways required, 609.0, 609.2, 612.2, 2203.7
  - Occupancy load, 606.0, 2200.4, 2203.8
  - Opening protectives, 610.4
  - Passageways and corridors, 610.0
  - Ramps, 615.0
  - Sidescapes, 622.0
  - Smokeproof enclosure, 618.0
  - Spiral stairways, 616.7
  - Stairway, construction, 616.9
  - Supplemental stairways, 616.8

- To roof, 617.0
- Units of egress widths, 608.1
- Unlimited one-story buildings, 307.0
- Measurement of height
  - Definition of height, 201.0
- Mechanical equipment, 2110.0
  - Massachusetts regulations, 2110.2, 2110.3, 2114.2
- Mechanical ventilation (see Ventilation)
- Metal, general, 2103.4
- Metal roofs
  - Grounding of, 926.5
- Metal siding
  - Corrosion protection, 854.6.2
  - Thickness, 854.4
- Metal smokestacks, 1003.0
- Mezzanine or mezzanine floor
  - Definition, 201.0
- Mill construction, 217.2
- Miscellaneous buildings
  - Use group T, temporary and miscellaneous, 211.0
- Miscellaneous signs, 1413.0
- Mixed occupancies, 213.0, 2200.3, 2204.2
- Mobile dwelling units, requirements, 1800.0
- Modification of code provisions
  - By board of appeals, 126.0
  - Of area, 306.0, 2204.4
  - Of height, 308.0, 2204.4
  - Variations, 110.6, 2203.0, 2204.0
- Mortar
  - For glass blocks, 860.2
  - For masonry, 815.0, 2204.8
- Motel
  - Use group R, residential, 209.0, 425.0
- Motion picture film storage, 408.2
- Motion picture projection rooms
  - Construction and design, 408.3.1
  - Exits, 408.3.2
  - Sanitary requirements, 408.3.6
  - Sprinkler requirements, 408.2.7
  - Ventilation, 408.3.3
- Motion picture theaters (see Assembly buildings and Theaters)
- Motion picture theater, drive-in type, 421.0
- Motion picture screening rooms, 408.4
- Motion picture studios, 408.6
- Motor fuel service stations (see Automotive service stations)
- Motor, auto garages
  - Definition, 201.0
  - Private garages, 413.0
  - Public garages, 414.0
- Motor vehicle repair
  - Shops, 416.0
  - Roof storage of, 415.0
- Multiple dwelling
  - Definition (see Dwelling), 201.0
  - Use group R-2, residential, 209.3, 209.6
- N
- Nails
  - Nailing schedule, Appendix M
- Native lumber, 2103.3
- New materials or methods of construction
  - Alternate materials and alternate methods of construction, 800.0
  - Board of adjustments and appeals, 126.1
- Nitro-cellulose products, 407.0
- Noncombustible construction
  - Definition, 201.0
  - General, 216.0
- Noncombustible material (see Definition), 201.0
- Notices
  - Of violations, 121.2, 2200.4
  - Posting occupancy load, 120.2
  - Posting permits, 114.9
  - Safe floor loads, 120.1
  - Stop work order, 122.0
  - Unsafe buildings, 123.3, 124.1
- Nursing homes, 433.0
- 0
- Occupancy
  - Certificate of, 119.0
  - Covered by code, 101.0
  - Definitions, 201.0
  - Doubtful classification, 212.1
  - Mixed uses and occupancy, 213.0, 2200.3, 2203.0, 2204.0
  - Change in use, 105.2, 2200.3, 2200.4, 2203.0, 2204.0
- Occupant load
  - Allowances, 606.0, Table 606
  - Definition, 201.0

- Office buildings
  - Use group B, business, 204.0
- Oil
  - Burning equipment installations, 1100.0
- Oil storage
  - Fuel oil tanks and equipment, 1100.2
  - Tank vents, 1100.2
- Openings
  - Exterior opening protectives, 914.0
    - Horizontal protection, 914.2
      - In fire partitions, 908.0
      - In shaft enclosure walls, 910.9
      - Protected with fire doors or windows, 903.4
    - Vertical protection, 914.3
      - On or near exterior stairways, 619.3
- Open parking structures
  - Height and area, 429.6
  - Protective railings, 429.8
  - Separations for, 429.3
  - Type of construction permitted, 429.2
    - Use group S-1, storage, moderate hazard, 210.2, 210.4
    - Wheels guards required, 429.9
- Oriel window
  - Definition, 201.0
- Owner
  - Definition, 201.0
- P
  - Paint
    - Spraying and spray booths, 411.0
    - Storage, 411.3.4
  - Panels
    - Fire access, 859.0
    - Stress skin, 855.0
  - Panel walls
    - Glass block, 860.0
    - Thickness of, hollow, 867.2
    - Thickness of, solid, 867.1
    - Weather resistance of, 867.3
  - Panic hardware, on exit doors, 612.5
  - Parking structure, open
    - Definition, 201.0
    - General requirements, 429.0
  - Parking lot requirements, 423.0
- Party walls
  - Affected by excavations, 1307.0
  - Carried to underside or above roof, 907.7
    - Construction of, 907.0
    - Definition, 201.0
    - Parapets required, 907.7, 2204.9
    - Size and construction of openings, 908.0
- Passenger and bus terminals (within fire limits), 302.7
- Passageways
  - Corridors, 610.0
  - Grade and lobbies, 611.0
  - Horizontal exits, 614.0
  - Obstructions prohibited, 605.1
- Penalties and violations, provided by code, 121.0
- Penthouse
  - Definition, 201.0
  - General requirements, 925.4
- Performance record, 2200.3.1
- Permits
  - Action on appliances, 114.1, 2202.4, 2202.5
  - Amendments to, 113.8
  - Application for, 113.0, 2202.0
  - Approval in part, 114.5
  - Awnings, 313.1
    - Conditions of, 115.0
    - Definition, 201.0
  - Electrical, 1500.0
  - Examination of drawings, 113.5
  - Expiration, 114.3
  - Fees, 118.0
    - For awnings and canopies, 313.1
  - Posting of, 114.9
  - Records to be kept, 109.2.1, 113.5
    - Revoked, 113.6, 309.5
  - Signs, 1401.0
  - Special permits, 404.1, 405.1
  - Suspension of, 114.7
  - Temporary, 114.8, 314.0
  - To move buildings, 117.0
  - To wreck buildings, 116.0
  - When required, 113.1
  - Validity, 131.0
- Person
  - Definition, 201.0
- Petroleum storage
  - Liquid petroleum gases, 406.0
  - Volatile flammables, 402.0



- Piles  
 Cast-in-place concrete, 737.0  
 Composite, 741.0  
 Corrosion-protected, 733.0  
 Foundations, 732.0  
 Loads allowable, 734.0  
 Precast concrete, 736.0  
 Special, 742.0  
 Steel pipe and tubular, 738.0  
 Structural steel, 740.0  
 Timber, 735.0
- Pipe  
 Columns, concrete-filled, 846.0  
 Insulation, 2129.0  
 Piles, 738.0  
 Shafts, 910.5
- Pits in garages, 415.1.3
- Planking  
 For combustible construction, 1313.2  
 For structural steel frames, 1313.3
- Plastering and lathing  
 Application, exterior, 820.1  
 Application, interior, 819.1  
 Combustible (wood) lath, 822.7  
 Fireresistance requirements, 918.0  
 General requirements, 819.1, 820.1  
 Gypsum lath, 822.2, 822.3  
 Gypsum plaster, 821.4  
 Interior lathing and plastering, 819.0, 2104.2.4  
 Lime, 821.3  
 Materials, 821.0  
 Metal and wire lath, accessories, 820.3, 822.4, 822.5  
 Over masonry, 820.7
- Plastics  
 Approved, 1900.2, 1900.2.1  
 Approval for use, 1900.2.2  
 Bathroom accessories, 1908.1  
 Design and installation, 1901.0  
 Fastenings, 1901.0  
 Foam, 920.4.1  
 Glazing of unprotected openings, 1902.0  
 Interior finish and trim, 920.0  
 Light diffusing systems, 1906.0  
 Of signs, 1407.4.2  
 Partitions, 1907.0  
 Pyroxylin, 407.0  
 Roof panels, 1904.0  
 Scope and use, 1900.1  
 Skylights, 1905.0  
 Structural requirements, 1901.1  
 Thermoplastics, definition, 201.0, 1900.2.1  
 Thermosetting, definition, 201.0, 1900.2.1  
 Veneer, 865.1  
 Wall panels exterior, 1903.0  
 Plenums, 905.10  
 Plenum chamber definition, 201.0  
 Plot plan, required, 113.6  
 Plumbing, 1700.0  
 Plywood, 824.0  
 Plywood application, 2104.3.5.1  
 Pneumatically placed concrete, 847.0  
 Portable signs, 1415.0
- Posting  
 Certificate of occupancy, 120.1, 120.2  
 Live loads, 120.1, 706.2  
 Permits, 114.9  
 Unsafe buildings, 123.1
- Prefabricated construction  
 (see manufactured buildings and building components)
- Pressure vessels, unfired, 1100.3
- Projecting signs, 1411.0
- Projections from buildings  
 Awnings and canopies, 310.8, 313.0  
 Bay windows, 310.6  
 Balconies and stairs, 310.7  
 Below sidewalk, 309.2  
 Belt courses, 310.3  
 Cornices and eaves, 310.2  
 General, 309.1  
 In alleys, 312.0  
 Marquees, 310.10  
 Signs, 1403.2.3, 1411.0, 1412.0  
 Special and temporary, 312.0  
 Street encroachments, 309.0  
 Street projections, permissible, 310.0  
 Yard and court, 311.0
- Projection rooms  
 Construction of, 408.3.1  
 General requirements, 408.3  
 Ventilation of, 403.3.3

- Protection against dampness
    - Of crawl spaces, 507.3
    - Of foundation walls, 872.4
  - Protection during construction
    - During wrecking, 1306.0
    - Of adjoining property, 1312.0
    - Of excavation, 1307.0
    - Of floor and wall openings, 1313.0
  - Protection of exterior openings
    - Of exterior wall, 914.0, 916.0
    - Of fire wall opening, 908.0
  - Public assembly
    - Use group A, assembly, 203.0
  - Public space, definition, 201.0
  - Pyroxylin plastics, 407.0
- Q
- Qualifications
    - Of board of appeals, 126.21
    - Of building official, 107.3, 107.4
- R
- R, use groups, residential, 209.0
  - Radio antennae and towers, 427.0
  - Railings (see Handrails)
  - Ramps, 615.0, 2204.5
  - Recesses (see Masonry and Walls)
  - Records
    - Of decisions, 126.4.4, 2203.5
    - Of departments, 108.7
  - Recreation buildings
    - Use group A, assembly, 203.0
  - Refineries
    - Use group H, high hazard, 206.0
  - Reformatories
    - Use group I-1, institutional, 207.2, 207.4
  - Refuse, chutes, 1107.0
  - Refuse vaults, 1108.0
  - Reinforced
    - Gypsum concrete, 849.0
    - Walls, 869.0
  - Reinforced concrete (see also Concrete)
    - Definition, 201.0
    - Design, 841.1
    - Footings, 728.3.2
    - Gypsum, 849.0
  - Reinforced gypsum concrete, 849.0
- Removal
    - Of buildings and structures, 123.0
    - Of waste during construction, 1311.0
  - Repair
    - Of existing buildings, 102.1, 106.0, 2200.3, 2203.0
    - Of unsafe buildings or structures, 2204.0
    - Permit not required, 102.1
    - To roofs of existing buildings, 926.2
  - Repair shops, motor vehicle
    - Definition (see Garages, public), 201.0
    - General, 416.0
    - Public garages, 414.0
    - Use group S-1, storage, moderate hazard, 210.2, 210.4
  - Residential buildings
    - Sound transmission control, 522.0
    - Use group R, 209.0
  - Restaurants
    - Use group A-3, assembly, 203.4, 203.7
  - Rest Homes, 433.0
  - Restrictions
    - Area, 305.2, 2204.4
    - Height, 305.3, 2204.0
    - On employees, 107.5
    - Outside fire limits, 303.0
    - Special occupancy, 400.0
    - Within fire limits, 302.0, 2204.3, 2203.4
  - Retail stores
    - Use group M, mercantile, 208.0
  - Retaining wall
    - Definition, 201.0
    - Design, 870.2
    - General, 870.1
    - Guard rails for, 870.5
  - Reviewing stands, 420.0
  - Revocation of permit, 113.6, 309.5
  - Revolving doors, 613.0
  - Risers for stairways (see Stairways)
  - Roof construction
    - As required by type of construction, 215.0, 216.0, 217.0, 218.0
    - Asbestos cement, 2107.5
    - Base sheet application, 2107.2
    - Built-up roofing, 2107.8
    - Ceiling construction, 2106.0
    - Cooling towers, 925.9

- Composition asphalt organic felt shingles, 2107.3  
 Covering, 926.0, 2102.0  
 Definition of roof structure, 201.0  
 Fire and party walls to extend to or above, 907.7  
 Fireresistance requirements, Table 214  
   General, 2102.0  
   Loads, 710.0, 714.0  
   Mansard or ordinary construction, 925.6  
   Metal, 2106.3, 2107.6  
   Of approved plastics, 1900.2.1, 1904.0  
   Over terraces, approved plastics, 1904.5  
   Slate, 2107.4  
   Solar Collectors, 2107.11, Table 2107.11  
   Tile, clay or concrete, 2107.7  
   Wind loads, 712.0  
   Wood, 2106.2  
   Wood construction, 854.8  
   Wood shakes, 2107.10  
   Wood shingles, 2107.9
- Roof covering**  
   Classified, 903.3, 926.3  
   Definitions, 201.0
- Roofing repairs on existing buildings, 926.2, 2200.3, 2203.0
- Roof signs, 1409.0
- Roof structures, 925.0
- Room dimensions, 506.5, 2101.6
- Rooming houses**  
   Use group R, residential, 209.0
- Rubbish chutes, 1107.0
- Rubble stone foundation walls, 869.2.4
- S**
- S, use group, storage, 210.0
- Safeguards during construction, 1300.0
- Safe loads on soil, 720.0
- Safety devices for window cleaning, 521.0
- Salamanders, 1318.2
- Sanitariums**  
   Use group I-2, institutional, 207.3, 207.4
- Sanitation, 2101.8
- Scaffolds, 1314.0
- Scale of plans, 113.5
- Schools**  
   Use group A-4, assembly, 203.5, 203.7
- Scope of code**  
   General, 100.0
- Screens for skylights, 925.5.3
- Scuttle**  
   Scuttle-size and construction, 925.2
- Seismic (earthquake) design, 716.0, 2203.6, 2204.7
- Shaft**  
   Definition, 201.0  
   Duct and pipe, 910.5  
   Enclosures, 910.2, 910.3  
   Top enclosures, 910.6  
   Ventilation of, 515.0  
   Vertical enclosures, 910.0
- Shall, definition of, 201.0
- Sheathing**  
   Floor, 824.3.1  
   For exterior lathing and stucco, 820.5  
   General requirements for, 825.1  
   Insulation board, 2104.3.6.2  
   Roof, 824.3.1, 854.8.1  
   Subfloor, 824.3.2  
   Wall, 825.0, 854.3
- Shed**  
   Sidewalk, 1306.4
- Sheet piling for excavations, 1307.1
- Shelter, fallout, 430.0
- Shingles and shakes**  
   Wood, 854.8.2
- Shower and bath compartments, 2104.2.6
- Shutters**  
   Shutters on exterior wall openings, 916.0
- Sidewalks**  
   Bridge, 1306.3
- Siding**  
   Minimum material requirements, 854.4
- Signs**  
   Alley, 1403.2.4  
   Alterations to, 1401.4  
   Banner and cloth, 1413.1  
   Bonds and liability insurance, 1406.0  
   Design loads, 1407.1, 1407.2, 1411.4  
   Exemptions, 1402.0

- Existing, 1404.0
- Extending over curb prohibited, 1411.2
  - For exits, 623.0
  - General requirements, 1407.0
  - Ground, 1408.0
  - Ground projecting, 1411.0
  - Illuminated, 1407.3, 1414.0
  - Inspection of, 1405.4
  - Maintenance, 1405.2
  - Marquee, 1412.0
  - Miscellaneous, 1413.0
  - Permit fees for, 118.0
  - Permits for, 1401.0
  - Plans and specifications, 1401.0
  - Plastics for, 1407.4.2, 1900.2
  - Pole, 1408.0
  - Roof, 1409.0
  - Temporary, 1413.0
  - Unsafe, unlawful, 1403.0
  - Wall, 1410.0
  - Wind loads, 715.0, 1407.2.1
- Skylights
  - Over shaft enclosures, 910.6.2
  - Over shafts and stairways, 515.2
  - Plastic, 1900.2, 1900.2.1, 1905.0
  - Screens, 925.3.3
- Slidescapes, 622.0
- Smoke detectors, 2101.14
- Smokeproof enclosure, 618.0, 2203.12
- Snow load, 711.0
- Soil
  - Bearing, allowable, 720.0
  - Bearing capacity, 720.0
  - Tests, 721.0, 722.0
- Solar Collectors, 2107.11
- Solid fuel burning heating appliances, 1110.0, 2109.0
  - Chimney connectors, 2109.6
  - Clearances, 2019.4, Table 2109.4, 2110-1, or Table 2110.2
  - Combustion air, 2109.5
  - Definitions, 2109.2
  - Fireplace installation, 2109.6
  - Hearth, 2109.3
  - Labeling, 2109.8
  - Solid fuel heaters, 2109.1
  - Used appliances, 2109.7
- Sound transmission control in residential buildings
  - Airborne noise, 522.2
  - Scope, 522.1
  - Structure-borne sound, 522.3
  - Tested assemblies, 522.2.1, 522.3.1
- Spandrels for vertical separation of windows, 906.3
- Spark arrestors, 1010.0
- Special fire resistance requirements
  - For grade floor protection, 905.7
  - For packing and shipping rooms, 905.4
  - For public garages, 905.2
  - For residential buildings, 905.6
  - For truck loading and shipping areas, 905.5
- Special occupancy, use and requirements
  - Assembly occupancies, 417.0
  - Explosion hazards, 401.0
  - Flammables, volatile, 402.0
  - General requirements, 400.0
  - Inspection of, 403.0
  - Scope, 400.1
  - Special industrial buildings, 400.0
- Spray painting
  - Booths, 411.0
  - Construction requirements for booths, 411.3
  - Fire protection, 411.5
  - Ventilation requirements, 411.4
- Sprinklers (see also Fire protection systems)
  - Area increase permitted, 306.3
  - Capacity per unit egress, width permitted, 608.2, Table 608
  - General requirements, 1200.0
  - Length of travel, increase permitted, 607.4, Table 607
  - Where required, 1202.0
- Stadiums
  - Use group A-5, assembly, 203.6, 203.7, 420.0
- Stage
  - Classification of occupancy, 417.1
  - Construction, 417.7
  - Curtain, proscenium, 417.7.7
  - Definition, 201.0
  - Exits from, 417.7.6
  - Floor construction, 417.7.2
  - Rooms, accessory, 417.8

- Separated from auditorium by wall,  
417.7.1, 417.7.6  
Switchboard, 417.7.4  
Ventilation of, 417.7.9
- Stairway, 2101.10.8, Figure 2101-1
- Stairways  
Access to roof, 617.0  
Definition, 201.0  
Door to stairway, 616.6, 2203.12  
Enclosure, combustible, 616.9.3,  
909.3  
Enclosures, exterior, 619.1  
Enclosures, interior, 616.9.2,  
2203.12, 2204.6  
Exterior, 619.0  
Fire escapes, 621.0, 2203.8  
Guard details, 616.5.2  
Handrails, 616.5, 616.5.1  
Headroom clearance, 616.2.2  
Interior, 616.0, 2203.12, 2204.6  
Landings, width, 613.3  
Light and ventilation, 514.0  
Lighting, 513.3, 2203.10  
Means of egress, 609.2, 616.0,  
2203.12, 2204.6  
Means of egress lighting, 624.0,  
2203.10  
Moving, 620.0, 1620.0  
Railings, 616.5  
Rise between landings, 616.3.2  
Sidescapes, 622.0  
Spiral stairway, 616.7  
Supplemental, 616.8  
Treads and risers, 616.4  
Width, 616.2.1, 2200.4, 2203.8  
Winders, 616.4.2, 2203.8
- Standing in aisles prohibited, 417.6
- Standpipes  
During construction, 1212.0  
Water supplies, 1214.0  
Wet standpipe requirements,  
1211.0
- Starting work  
Notice to building official,  
114.10
- Steel construction  
Buildings in fire limits, 302.0  
Cast iron construction, 831.0  
Cast steel construction, 830.0  
Fire escapes, 621.0  
Frame construction planking,  
1313.3  
Grillages in footings, 727.0  
Joists, open web construction,  
828.0  
Light gauge and formed steel  
construction, 827.0  
Reinforcing, 829.0  
Special steel, 832.0  
Structural, 826.0
- Steel piles  
Concrete filled, 738.1
- Stone  
Cast, 814.0  
Foundation walls, 869.2.4  
Natural stones, 813.0  
Veneer, 863.0
- Stop work orders, 122.0
- Storage  
Of combustible fibers, 409.0  
Of combustible dusts, grain  
processing and storage, 410.0  
Of flammable film, 408.2  
Of flammables, 402.0  
Of liquefied petroleum gas, 406.0  
Of pyroxylin plastics, 407.5,  
407.5.1  
Use group S, storage, 210.0
- Story, definition, 201.0
- Street  
Definition, 201.0  
Encroachments, 309.0  
Permissible projections, 310.0
- Structural clay tile, 807.0  
Structural glass block, 811.0  
Structural requirements for plastics,  
1901.0  
Structural steel (see Steel)
- Structure  
Definition, 201.0  
Unsafe, 123.0, 2200.4
- Summer camps for children, 435.0
- Swimming pools  
Change of use, 405.4.1  
Classification of, 428.2  
Design and construction, 428.5  
Permit and plans, 428.3  
Safety precaution, 428.8  
Water supply treatment, and drain-  
age system, 428.6
- System design, heating/cooling, 2125.0

T

- T, use groups, temporary and miscellaneous, 211.0
- Tanks
  - Storage of flammable liquids, 402.0
  - Storage of liquefied petroleum gas, 406.0
- Television antennae, 427.0
- Temporary
  - Boilers, 1318.3
  - Buildings of structures, 314.0, 422.0
  - Elevators, 1315.0
  - Heating devices, 1318.2
  - Occupancy, 119.4
  - Permits, 114.8, 314.1
  - Safeguards, 124.1
  - Signs, 1413.0
  - Stairs, 1316.1
  - Structures, use group T, 211.0
  - Structures in fire limits, 302.4
  - Termination of approval for temporary buildings, 314.3
- Tents, air-supported structures, requirements, 422.0
- Termite protection, 2102.8
  - Approved pressure preservation treatment of wood, 874.6, 874.7
  - Special, 847.1
- Tests
  - Fire, 802.7
  - Fireresistance, 903.0
  - Flameresistance, 904.0
  - General, 802.0, 2200.2
  - New materials and devices, 800.4
  - Of automatic fire alarm systems, 1217.8
  - Of construction equipment, 1302.0
  - Of construction equipment, 1302.0
  - Of sprinkler equipment, 1204.8
  - Pile capacity, 734.4
  - Prefabricated construction, 802.8, 1800.0
  - Procedure for soil, 722.0
  - Quality of material, 802.0
  - Soil bearing values, 720.0
  - Structural steel unit, 826.0
  - Working stresses, 719.0

Theatres

- Aisles, 417.5
- Balcony and gallery entrance and exits, 417.3.2
- Dressing and appurtenant rooms, 417.8
- Drive-in (see Drive-in Theatre)
- Egress requirements, 417.3, 417.8..
- Existing, 405.3, 2200.3, 2203.13
- Exitway discharge courts, 417.3.5
- Exitway doors, 417.3.7
- Exit lights, 417.3.8
- Fire protection requirements, 417.10
- Foyers, 417.6
- Horizontal exits, 417.3.1
- Interior wall and ceiling finish, 417.2.5, 417.8.3, 923.0
- Lighting, general, 417.9
- Motion picture projection booth, 408.3
- Proscenium curtain, 417.7.7
- Railings, 417.5.5
- Restrictions, 417.2
- Rewinding film, 408.3.5
- Seating, 417.4
- Stage construction, 417.7
- Standpipes, 417.10.2, 417.10.3
- Use group A-1, assembly, 203.2, 203.7, 417.0
- Ventilation of stage, 417.7.9
- Waiting space, 417.6.5
- Thermal insulating materials, 876.0
- Thermoplastics, accepted, Article 19
- Towers
  - Radio and television, requirements, 426.0
  - Wind, loads, 715.0, 426.4
- Travel, length of, to exits, 607.4
- Treads, stairs, 616.4
- Trim, exterior, 924.0
- Trim, interior (see Interior finish and trim)
- Trusses
  - Individual encasement, 913.1
  - Roof slabs and arches, 913.3
  - Roofs, 20 feet or higher, 913.2
- Tunnel flame spread test, 903.5.1
- Types of construction
  - Type 1, fireproof, 215.0
  - Type 2, noncombustible, 216.0
  - Type 3, exterior masonry walls, 217.0
  - Type 4, combustible, 218.0

## U

U, values of building components, 2123.0,  
Table 2123-1

Underpinning, 1305.3

Unfired pressure vessels, 1100.3

Underfloor space, 2102.9, 2121.2

Unlimited area, buildings, 307.0

## Unsafe

Structures, 123.0

## Use

Certificate of occupancy for, 119.0

Change in existing, 105.0, 2200.3,  
2200.4, 2203.0, 2204.0

Doubtful classification, 212.0

Group classification, 202.0

Of exitways, 602.0

Utilities, public discontinuance of

In demolition of structures, 116.1,  
1308.2

## V

## Validity

Of code, 131.0

Vapor barriers, 2122.0

Vaults, reuse, 1108.0

## Veneers

Demolition, 201.0

For frame construction, 854.4

Height of, for frame buildings,  
854.4.3

Metal, 864.0

Plastic, 865.0

Stone and tile, 863.0

Structural glass, 862.0

Wall facings and, 861.0

Ventilation, 2101.5, 2121.0, 2102.9

Attics, 507.2

Basements and cellars, 508.1, 514.0

Bath and toilet rooms, 512.0

Court requirements for, 516.0

Crawl space, 507.3

Dry cleaning plants, 412.5

Ducts through fire walls, 1009.0

Fire emergency ventilating systems,  
519.0

Fire ventilation of open wells,  
520.0

For existing buildings, 505.0

For stairways and exitways, 513.0

Garages, 414.3

General requirements, 500.0

Institutional buildings, 511.0

Mechanical, 504.0, 514.1, 2101.5.2

Minimum requirements, 514.0

Motion picture projection rooms,  
408.3.3

Natural, 503.1, 506.0

Of alcoves, 507.1

Rear yards for, 517.0

Required fresh air supply, 514.0

Shaft other than elevator and dumb-  
waiter, 515.0

Skylights, vent louvers, 512.5

Windows, 506.2

## Venting

Appliances, 2114.0

Room heaters, 2113.11

Type, 2114.3

Installation, 2114.4

Location, 2114.5

Clearances, 2114.6

Termination, 2114.7

Gravity, 2114.8

B or BW vent, 2114.9

L vent, 2114.10

Special vent, 2114.11

Size, 2114.12

Multiple, 2114.13

Existing, 2114.14

Draft hoods, 2114.15

## Vents

Appliances requiring, 1006.2

For listed appliances, 1006.1

Ventilators over stages, 417.7.9

Vent shafts, 910.0

Ventilating skylights, 513.1.2

Ventilating system, 519.9

## Vertical openings

Enclosures, 910.0

Shafts, 515.0

Vertical separation of windows, 906.3

## Violations and penalties

Abatements, 121.5

Notice of, 121.2

Penalties, 121.4

Stop-work, 122.0

Unsafe building, 123.0

Volatile, flammables, 402.0

W

## Wallboard (see also Sheathing)

- For frame construction, 854.3
- Gypsum, 823.6
- Plywood, 824.0

## Wall covering, general, 2104.0

## Walls (see also Masonry)

- Bearing, chases and recesses in, 837.0
- Bearing, lateral bracing of, 836.0, 2203.6, 2204.7
- Bearing, wood frame construction, 854.2.1
- Bonding of, 835.0
- Concrete masonry units, 809.0
- Concrete, ordinary, 843.0
- Corbeled and projecting masonry, 838.0
- Definitions, 201.0

## Design for wind on vertical surfaces, 712.0, 713.0

## Ducts in fire walls, 903.4.5, 905.11, 1009.0

## Enclosure for theatre stages, 417.7.1

## Enclosure walls required, 857.0

## Fire and party, 907.0, 2204.9

## Fire wall openings, 908.0

## Fire separation, 909.0

## Foundation walls, 869.0

## Glass block, 811.1, 862.0

## Gypsum, 810.0

## Hollow, 839.0

## Hollow panels, thickness of, 867.2

## Lateral support of bearing, 836.0, 2203.6, 2204.7

## Lintels, protection, 911.7

## Masonry wall construction, 834.0

## Panel, 867.0

## Penthouse, 925.4

## Plain concrete, 840.0

## Proscenium, 417.7.6

## Protection of exterior openings in, 914.0

## Protection of openings in, 858.0

## Reinforced concrete, 841.0

## Retaining, 870.0

## Roof structure, 925.0

## Shaft enclosure, 910.0

## Solid masonry, 866.0

## Stone, foundation, 869.2.4

## Thickness of panel, 867.0

## Thickness of solid, 866.0

## Veneers, glass, 862.0

## Veneers, metal, 864.0

## Veneers, plastic, 865.1

## Veneers, thickness of, 861.2

## Veneers, thin and tile, 863.0

## Wall signs, 1410.0

## Warehouse

## Use group S, storage, 210.0

## Warm air furnace, 2112.0

## Access, 2112.5

## Clearances, 2112.6

## Warm air heating systems, 1100.0

## Waste chutes, 1107.0

## Waste to be removed, 1311.0

## Watchman's shelters, 302.5

## Water tanks, 925.8

## Waterproofing, 2102.5

## Waterproofing of exterior structural elements, 872.0

## Waterproofing of foundation walls, 872.4

## Weather protection, 2104.3.5

## Weather resistant membrane, 2104.3.5.2

## Welding

## General requirements, 826.0

## Safeguards during construction, 1320.0

## Width

## Aisles, 610.3

## Lobbies used as an exitway element, 611.2

## Means of egress doors, 612.3

## Stair exitway doors, 616.6.1

## Units of exit width, 608.1, 2203.8

## Winders, 616.4.2

## Wind load design

## Buildings, 712.0

## Glass, 857.5.4

## Radio and television towers, 426.4

## Signs, 715.0, 1407.2.1

## Windows

## Cleaning safeguards, 521.0

## Dormer, 925.7

## Fire, 916.0

## Fireresistive design, 903.4.4

## Glass area required, 506.2

## In stairways and passageways, 513.0



- Required for light and ventilation, 506.0
- Vertical separation of, 906.3
- Window egress, 2101.10.3
- Designated type of, 218.1
- Fiberboards, 823.0
- Floor sheathing, 824.3.1
- Foundation anchorage, 854.5
- Foundation, general, 869.0
- Framing around fireplaces, 1007.4
- Framing around flues and chimneys, 875.4
- Header beam, 852.4
- Heavy timber construction, 853.0
- Minimum lumber dimensions, 852.2
- Nailing, 854.4.4, Appendix M
- Non-bearing walls, 854.2.2
- Piles, 735.0
- Plywood, 824.0
- Quality of materials, 824.1
- Restrictions within fire limits, 302.0, 2204.3
- Roof sheathing, 824.3.1, 854.8.1
- Sheathing lath, 854.3.1
- Shingles and shakes, 854.8.2
- Spans for plywood sheathing, 824.3, 824.3.1, 824.3.2
- Stressed skin panels, 855.0
- Structural glued laminated timber, 856.0
- Structural members, 852.0
- Structural wood glues, 818.0
- Stud spacing, 824.3.2
- Subfloors, 824.3.2
- Veneer, height of 854.4.3
- Veneer, masonry, 854.4.1
- Veneer, metal, 854.4.2
- Wall sheathing, 854.3
- Weatherboarding, exterior, 854.4
- Wood frame construction, 854.6
- Wood stoves, 1110.0
- Wine glass
- In fireresistive doors and windows, 917.0
- Wood construction
- At grade protection, 854.6
- Bearing walls, 854.2.1
- Bracing, 854.2.3
- Bridging, 854.7.1
- Buildings in fire limits, 302.0, 2204.3
- Buildings outside fire limits, 303.0
- Cambering, 852.3.2
- Connections, 852.3.1
- Cornices, 924.2.1
- Creosote treatment of footings, 782.2
- Cutting and notching, 852.3.3
- Wood framing, Table 2103.3, Figure 2103-1, Figure 2103-2, Figure 2103-3
- Wood wall construction, 2103.2, 2103.3
- Work
- Start, 114.10
- Stop order, 122.0
- Working stresses, allowable
- Controlled materials, 719.0
- Workmanship (see Articles 7 and 8)
- Test, 802.5
- Written notice
- Definition, 201.0
- Y
- Yard
- Definition, 201.0
- Obstruction of, 518.0
- Permissible encroachments, 311.0
- Rear yards, 517.0
- Yard system fire mains, 1215.0
- Z
- Zoning
- Restrictions, 101.2

