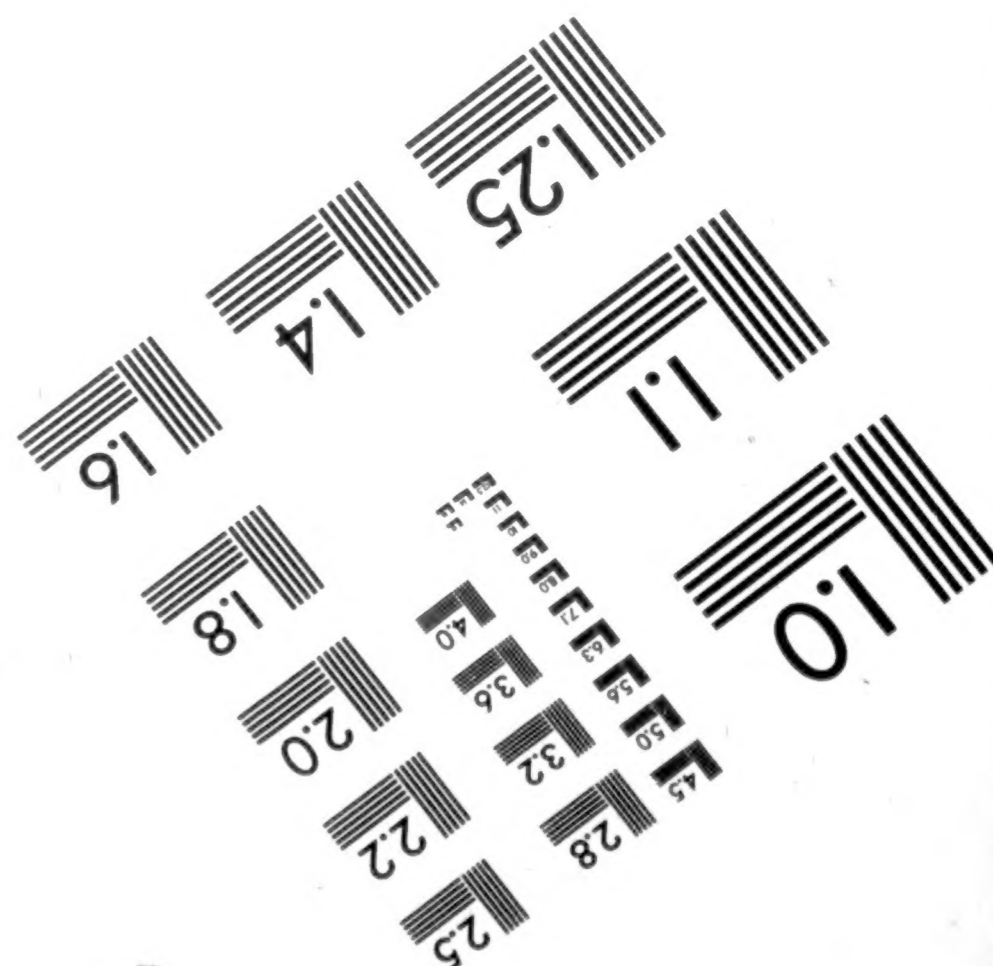
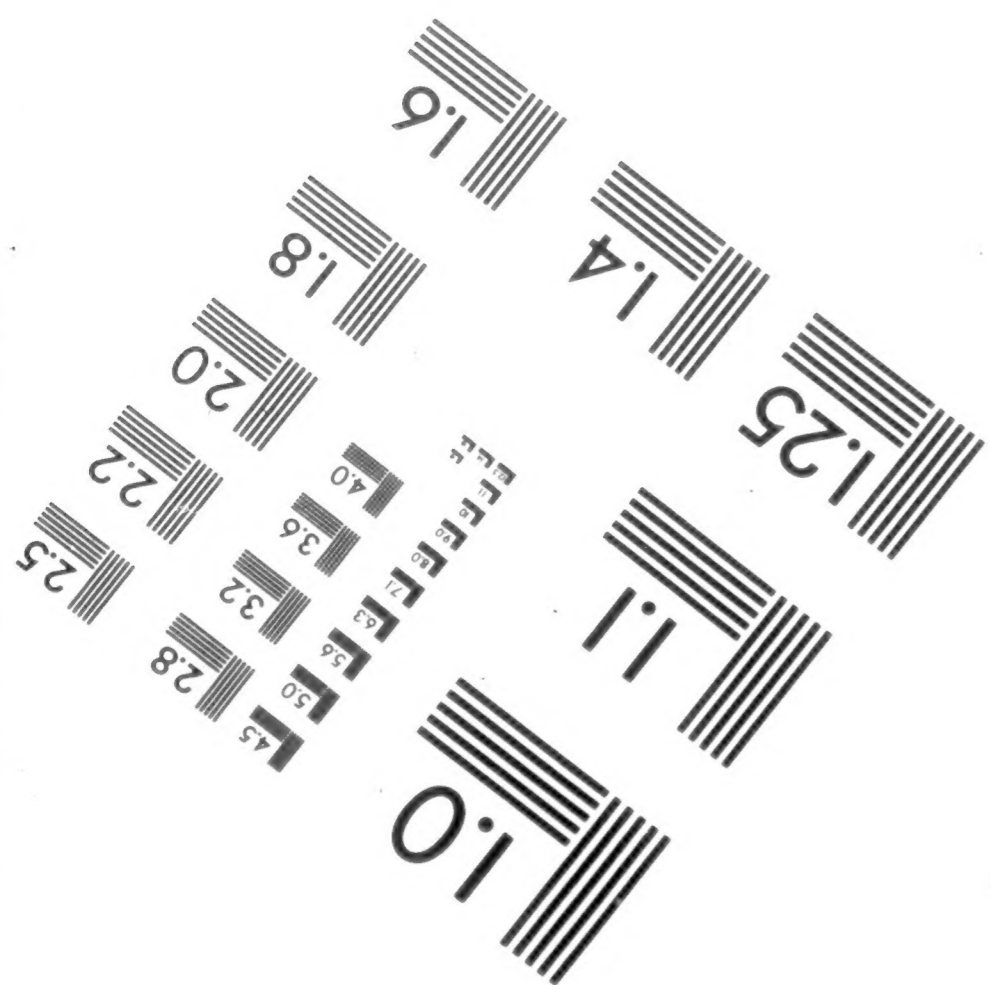
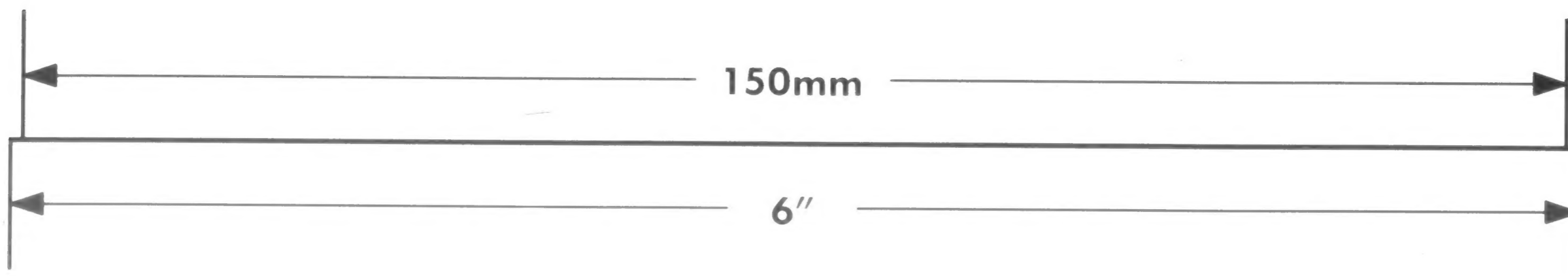
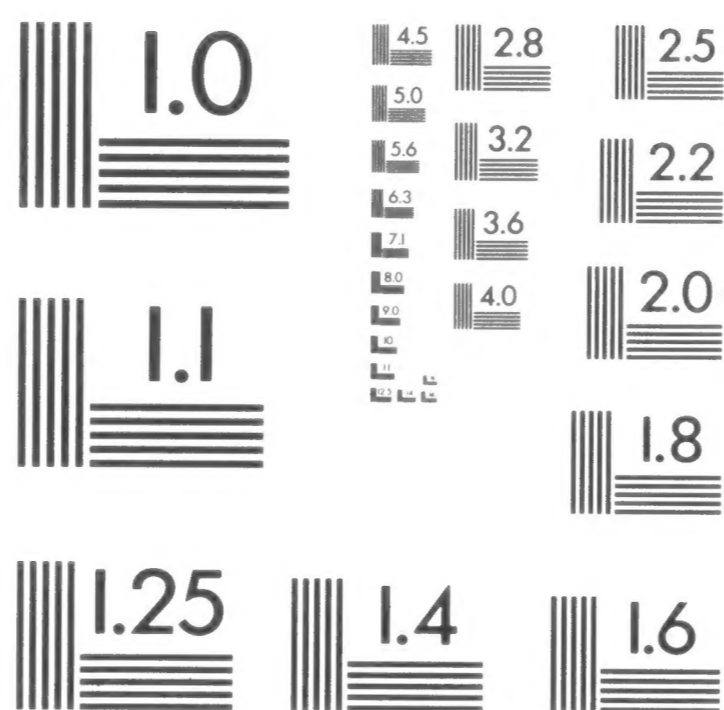
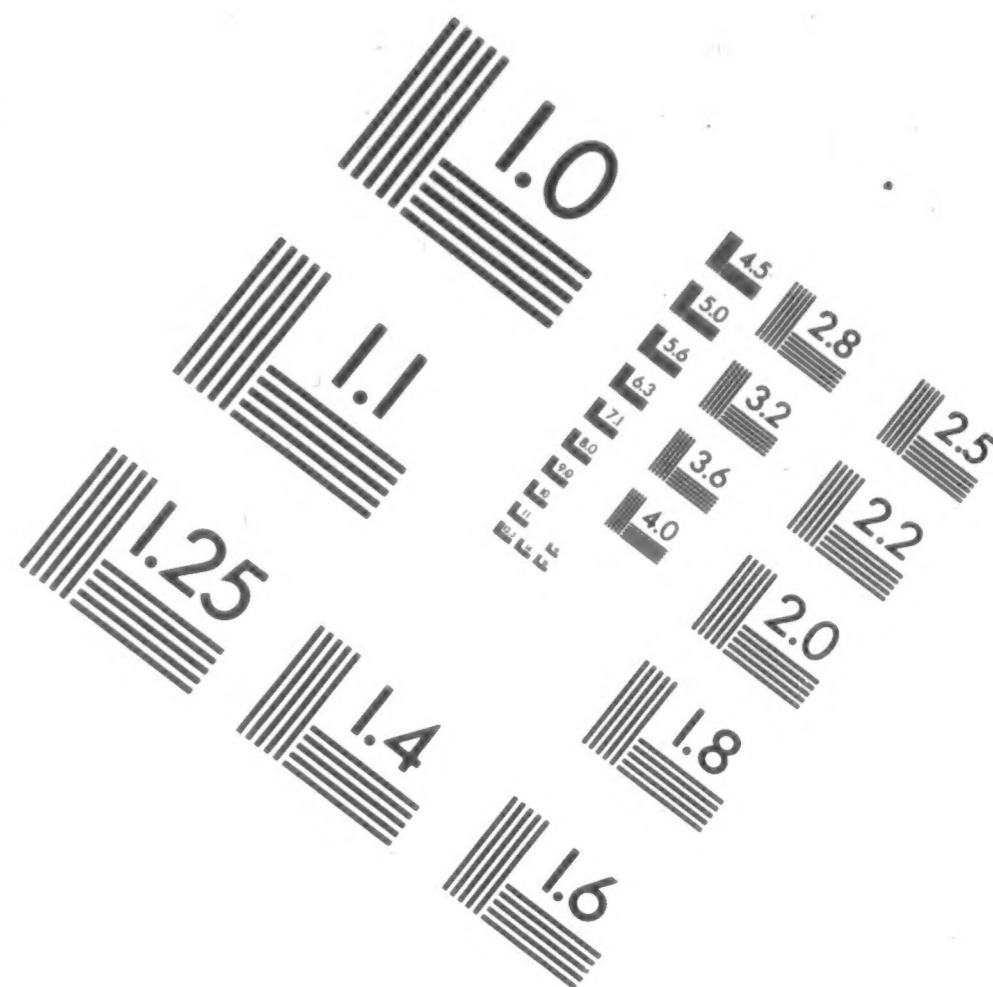
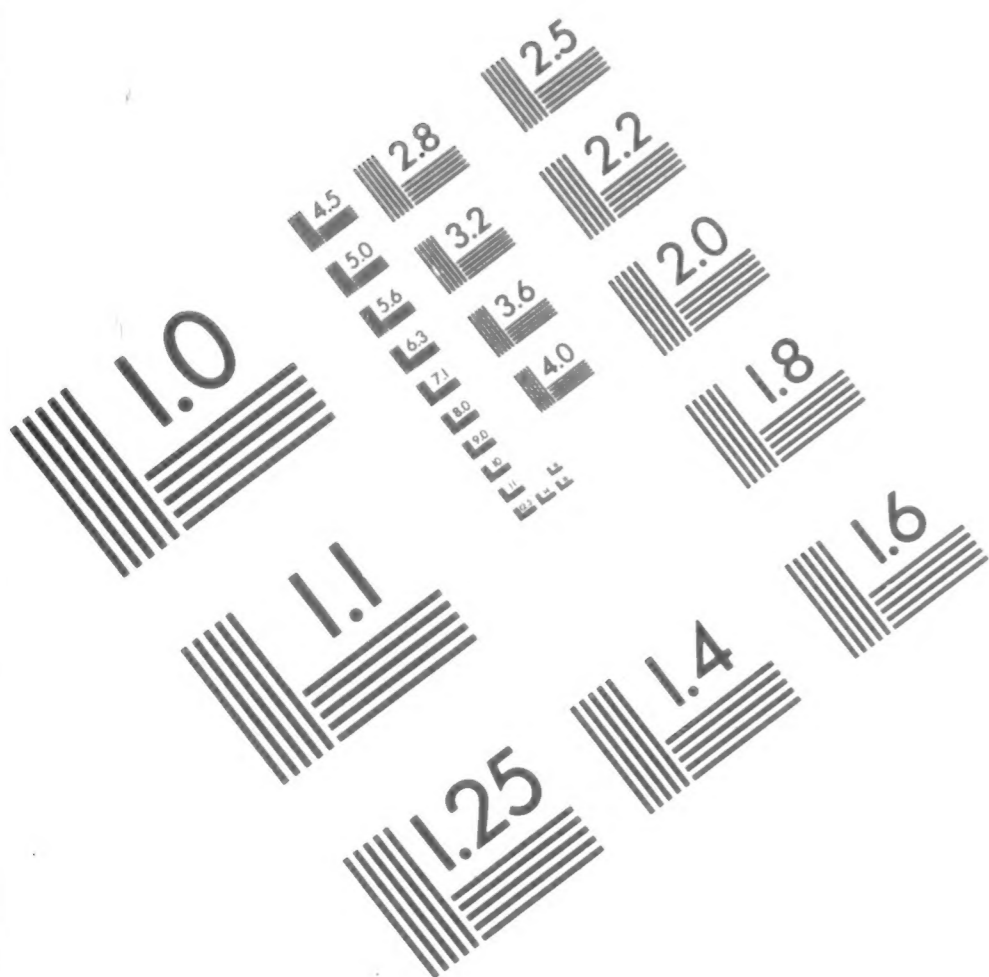


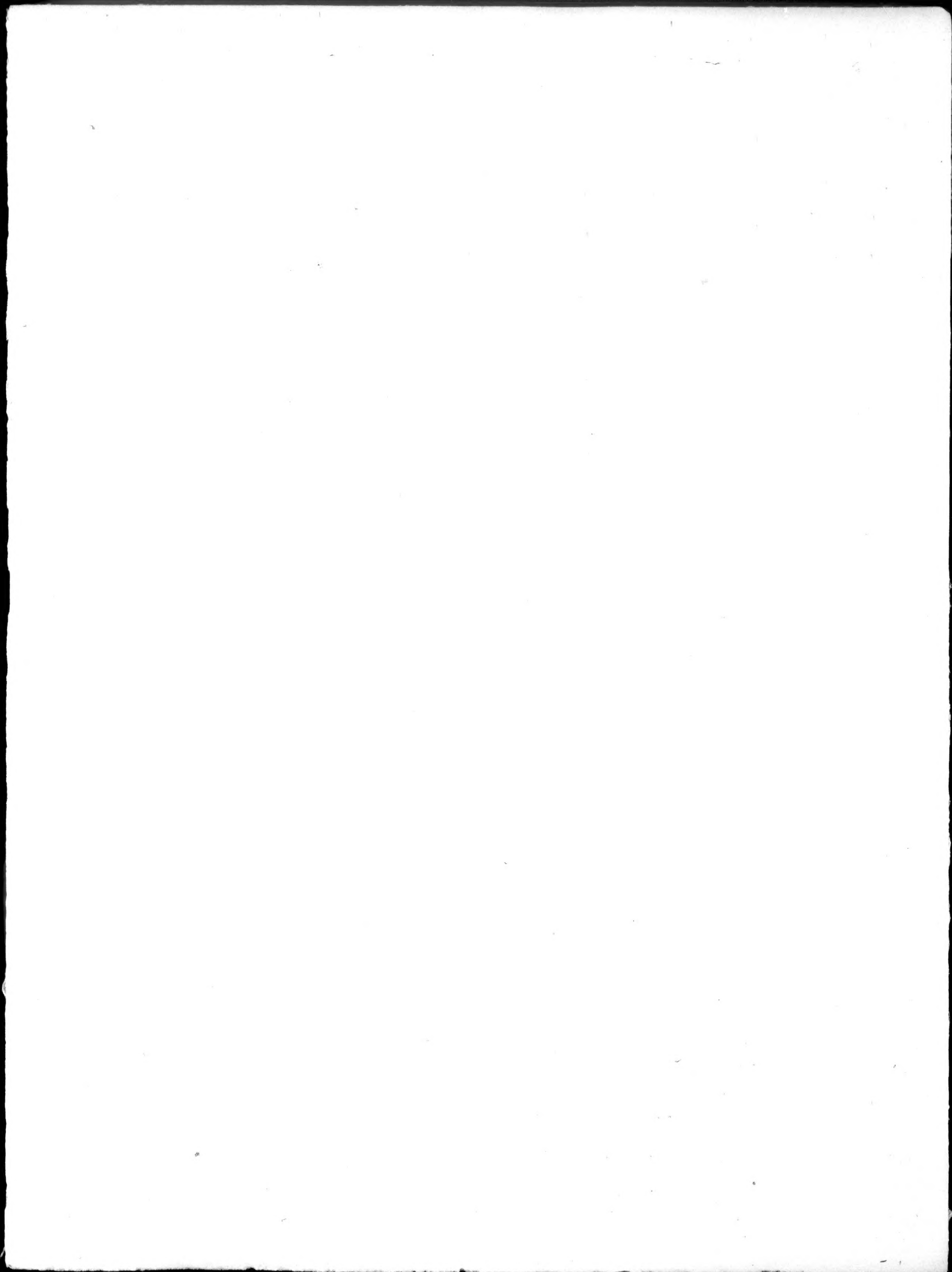
**NATIONAL
ARCHIVES
MICROFILM
PUBLICATIONS**

IMAGE EVALUATION TEST TARGET (QA-3)



APPLIED IMAGE, Inc
 1653 East Main Street
 Rochester, NY 14609 USA
 Phone: 716/482-0300
 Fax: 716/288-5989

© 1993, Applied Image, Inc., All Rights Reserved



National Archives at College Park



8601 Adelphi Road College Park MD 20740-6001

Sièh Loreta Z-1

OPERATOR

CAMERA

18 July, 1997 10

DATE FILMED

REDUCTION RATIO

03510107 AGFA

FILM EMULSION NUMBER

M1817 25

PROJECT NUMBER

ROLL NUMBER

MICROCOPY

1817

ROLL

25

M1817

COMPILED MILITARY SERVICE RECORDS OF
VOLUNTEER UNION SOLDIERS WHO SERVED WITH THE
UNITED STATES COLORED TROOPS:
1st Through 5th United States Colored Cavalry
5th Massachusetts Cavalry (Colored)
6th United States Colored Cavalry

Introduction by Michael E. Pilgrim

Records prepared for microfilming by members of
the Civil War Conservation Corps

Budge Weidman, Project Director

Pat Alfredson	Naomi Glass	Dave Murray
Phyllis Altrogge	Sue Goward*	Ray Puzio
Kenneth Ashton	Bert Greenstein	Bill Schneider
Sue Barnard*	Anne Greenwood	Sylvia Scott
Dee Benson	Jim Harris	Lynn Shearouse
Ann N. Brown	Walter Hayden	Mary Stack-Dunne
Robert Budway	Mary Hayden	Ben Stearns
MaryAnn Castellana*	Pat Ikonen	Bill Stormer*
Mary Lou Cole	Dick Ives	Pat Sullivan
Marjory Cooper	Sarah Jaffe	Gorman Tidball*
Giovanni Croce	Barbara Kemp	Cathy Tinston
B. H. Custer	Bev Manypenny	John Toole
Bob Denney	Frank Masterson	Maryellen Toole
Richard Dow	Joe Mazur	Milt Weatherhead
Yvette Fallin	Sarah McDougall	C. Lois Young
	Ben Miles	

Team leaders are indicated by the asterisk.

National Archives and Records Administration
1997

INTRODUCTION

On the 107 rolls of this microfilm publication, M1817, are reproduced the compiled military service records of volunteer Union soldiers belonging to the 1st through 5th United States Colored Cavalry, the 5th Massachusetts Cavalry (Colored), and the 6th United States Colored Cavalry. While the 5th Massachusetts did retain its state designation, these units were all part of the United States Colored Troops (USCT). The USCT included 7 numbered cavalry regiments; 14 numbered artillery regiments; 144 numbered infantry regiments; plus Brigade Bands Nos. 1 & 2 (Corps d'Afrique and US Colored Troops); Powell's Regiment Colored Infantry; Southard's Company Colored Infantry; Quartermaster Detachment; Pioneer Corps, 1st Division, 16th Army Corps; Unassigned Company A Colored Infantry and Unassigned USCT. The records reproduced are part of the Records of the Adjutant General's Office, 1780's-1917, Record Group (RG) 94.

Background

United States Colored Troops

Since the time of the American Revolution, African Americans have volunteered to serve their country in time of war. The Civil War was no exception. Official sanction was the difficulty. In the fall of 1862 there were four Union regiments of African Americans raised in New Orleans, LA: the 1st, 2d, and 3d Louisiana Native Guard, and the 1st Louisiana Heavy Artillery (African Descent). The 1st South Carolina Infantry (African Descent) was not officially organized until January 1863; however, three companies of the regiment were on coastal expeditions as early as November 1862. Similarly, the 1st Kansas Colored Infantry was not mustered into Federal service until January 1863, even though the regiment had already participated in the action at Island Mound, MO, on October 27, 1862. These early unofficial regiments received little Federal support, but they showed the strength of the African American soldier's desire to fight for freedom.

The first official authorization to employ African Americans in Federal service was the Second Confiscation and Militia Act of July 17, 1862. This act allowed President Abraham Lincoln to receive into the military or naval service persons of African descent and gave him permission to use them for any purpose "he may judge best for the public welfare." However, the President did not authorize use of African Americans until issuance of the Emancipation Proclamation on January 1, 1863.

In late January 1863, Gov. John Andrew of Massachusetts received permission to raise a regiment of African American soldiers. The pace of organizing additional regiments was very slow. In March Secretary of War Edwin M. Stanton sent Gen. Lorenzo Thomas to the lower Mississippi Valley to recruit

free and contraband African Americans. Thomas was given broad authority. He was to explain the administration's policy regarding African American soldiers and recruit volunteers to raise and command them. Stanton wanted all officers of such units to be white, but that policy was softened to allow African American surgeons and chaplains. By the end of the war, in addition to the chaplains and surgeons, there were some 87 African-American officers. Thomas's endeavor was very successful, and on May 22, 1863, the Bureau of Colored Troops was established to coordinate and organize regiments from all parts of the country. Created under War Department General Order No. 143, the bureau was responsible for handling "all matters relating to the organization of Colored Troops." The bureau was directly under the Adjutant General's Office and its procedures and rules were specific and strict. All African American regiments were now to be designated United States Colored Troops (USCT). At this time there were some African American regiments with state names and a few regiments in the Department of the Gulf designated as Corps d'Afrique. All these were ultimately assimilated into the USCT, even though some of the regiments, such as the 5th Massachusetts, retained their state designations.

To facilitate recruiting in the states of Maryland, Missouri, Tennessee, and eventually Kentucky, the War Department issued General Order No. 329 on October 3, 1863. Section 6 of the order stated that if any citizen should offer his or her slave for enlistment into the military service, that person would, "if such slave be accepted, receive from the recruiting officer a certificate thereof, and become entitled to compensation for the service or labor of said slave, not exceeding the sum of three hundred dollars, upon filing a valid deed of manumission and of release, and making satisfactory proof of title." For this reason, some records of manumission are contained in the compiled service records reproduced in this publication.

The USCT fought in 39 major engagements and over 400 lesser ones. Sixteen African American soldiers received Medals of Honor. As it was in other units, the death toll from disease was very high in the USCT. Deaths from disease and battle totaled 37,000. The last regiment of the USCT was mustered out of Federal service in December 1867.

Important sources for information about African American units in the Civil War are the War Department's *The War of the Rebellion: A Compilation of the Official Records of the Union and Confederate Armies* (Washington, DC: 1880-1901; reprinted Harrisburg, 1971 and 1985) and the Navy Department's *The War of the Rebellion; A Compilation of the Official Records of the Union and Confederate Navies* (Washington, DC: 1874-1922; reprinted Harrisburg, 1971 and 1985). These multivolume works contains reports of operations and other official correspondence.

1st United States Colored Cavalry

This regiment was organized at Camp Hamilton, VA, on December 22, 1863, and assigned to duty in the Department of Virginia and North Carolina. The 1st participated in Gen. Benjamin F. Butler's operations on the south side of the James River and against Petersburg and Richmond, May 4-28, 1864. These included the capture of Bermuda Hundred and City Point, VA, on May 5, and events leading up to and including the siege of Petersburg. In August 1864 it was transferred to the defenses of Portsmouth, District of Eastern Virginia. On June 10, 1865, the 1st sailed from City Point, VA, to Texas where it was assigned duty on the Rio Grande and various other areas of the state. The unit was mustered out on February 4, 1866. Compiled casualty figures are not available.

2d United States Colored Cavalry

This regiment was organized at Fort Monroe, VA, on December 22, 1863, and assigned to duty in the Department of Virginia and North Carolina. The 2d participated in Gen. Benjamin F. Butler's operations on the south side of the James River and against Petersburg and Richmond, May 4-28, 1864. These included the capture of Bermuda Hundred and City Point, VA, on May 5, and events leading up to and including the siege of Petersburg. In February 1865 it was transferred to Norfolk, District of Eastern Virginia. On June 10, 1865, the 2d sailed from City Point, VA, to Texas where it was assigned duty on the Rio Grande and various other areas of the state. The unit was mustered out on February 12, 1866. Losses included 19 killed in action and 161 dead from disease and other causes.

3d United States Colored Cavalry

Organized at Vicksburg, MS, on October 9, 1863, as the 1st Mississippi Cavalry (African Descent), this regiment was redesignated the 3d U.S. Colored Cavalry on March 11, 1864. From its organization until March 1864, the unit was attached to the District of Northeast Louisiana and from January to March 1864 participated in operations up the Yazoo River and the occupation of Yazoo City. The regiment was then transferred to the District of Vicksburg, Department of Tennessee, where it remained until December 1864. That month the unit moved to Memphis, TN, and from December 21, 1864, to January 5, 1865, participated in Gen. Benjamin Grierson's raid to destroy the Mobile & Ohio Railroad. The 3d remained on duty in Memphis and the District of West Tennessee and took part in the expedition from Memphis to Brownsville, MS, April 23-26, 1865. On April 29 the regiment returned to Vicksburg and operated around Natchez in search of fugitive Confederate President Jefferson Davis. The unit remained in the District of West Tennessee and Department of Mississippi until January 26, 1866, when it was mustered out. Losses included 37 killed in action and 367 dead from disease and other causes.

4th United States Colored Cavalry

Organized on September 12, 1863, as the 1st Corps d'Afrique Cavalry, this regiment was redesignated the 4th United States Colored Cavalry on April 4, 1864. From its organization until August 1864, it was attached to the Defenses of New Orleans, Department of the Gulf. On August 8, 1864, the 4th was ordered to Baton Rouge, LA, District of Port Hudson, and remained on duty at that post until July 1865 when it was transferred to the Department of Mississippi. It performed duties at various points in that department until it was mustered out on March 20, 1866. Compiled casualty figures are not available.

5th United States Colored Cavalry

This regiment was organized at Camp Nelson, KY, on October 24, 1864, and attached to the 1st Division, District of Kentucky, Department of Ohio. December 10-29, 1864, it participated in Stoneman's Raid into southwestern Virginia, including the capture of Saltville and the destruction of saltworks on December 20-21. In February 1865 the regiment was transferred to the Military District and Department of Kentucky until December of that year when it was ordered to the Department of Arkansas. During the latter period the unit performed mostly garrison duty. The regiment was mustered out March 20, 1866. Losses included 35 killed in action and 152 dead from disease and other causes.

5th Massachusetts Cavalry (Colored)

This regiment was organized at Camp Meigs, Reedville, MA, in the spring of 1864, and sent to Washington, DC, in May of that year. On May 13 the regiment moved to City Point, VA, where it was attached to the 18th Army Corps. Until June 16 it functioned as an infantry unit and participated in the siege of Petersburg. On June 30 it was moved to Point Lookout, MD, to guard prisoners of war. In July 1864 the regiment, still at Point Lookout, became part of the 22d Army Corps. It was transferred to the 25th Army Corps in March 1865 and ordered to the field near Richmond and Petersburg. In June the regiment was ordered to the Department of Texas where it was assigned duty at Clarksville until October 31, 1865, when it was mustered out. Losses included 7 men killed in action and 116 dead from disease and other causes.

6th United States Colored Cavalry

This regiment was organized at Camp Nelson, KY, on October 24, 1864, and attached to the 1st Division, District of Kentucky, Department of Ohio. December 10-29, 1864, it participated in Stoneman's Raid, including the destruction of the lead mines in southwestern Virginia. At the end of December the regiment returned to Camp Nelson and in February 1865 was transferred to the Military District and Department of Kentucky. It remained there until December

1865 when it was ordered to the Department of Arkansas. The unit was mustered out on April 15, 1866. Compiled casualty figures are not available.

Records Description

Compiled service records consist of a jacket-envelope for each soldier, labeled with his name, rank, unit, and card numbers. The compilation of service records of Union soldiers began in 1890 under the direction of Col. Fred C. Ainsworth, head of the Record and Pension Office of the Adjutant General's Office, Department of War. Information from muster rolls, regimental returns, descriptive books, and other records was copied verbatim onto cards. A separate card was prepared each time an individual name appeared on a document. These cards were numbered on the back, and these numbers were entered onto the outside jacket containing the cards. The carded information was verified by a separated operation of comparison; great care was taken to ensure that the cards were accurate.

A typical jacket contains card abstracts of entries found in original records relating to the soldier and original documents relating solely to that soldier. Examples of the latter include enlistment papers, substitute certificates, casualty sheets, death reports, prisoner-of-war memorandums, and correspondence. Unique to the records of the USCT are deeds of manumission, oaths of allegiance, proof of ownership, certificates of monetary award, and bills of sale. These items appear most frequently in units recruited in the border states of Kentucky, Missouri, and Maryland. These states remained in the Union but were slave states. Jackets and cards include a section labeled "bookmark" which was reserved for cross-references to other records relating to the individual or his unit. The service records are arranged by arm of service, thereunder numerically by regiment or independent battalion or company and thereunder alphabetically by name of the soldier. Records for officers are interfiled alphabetically by name with the records of enlisted men. If an individual served in more than one unit, which was typical for USCT officers, there will be a separate service record for each unit in which he served.

Related Records

Among the records of the Adjutant General's Office in the National Archives are many of the original records that were abstracted or "carded" by the Record and Pension Office. These include the individual unit's muster rolls, returns and descriptive books. Other series in RG 94 that contain information relating to volunteer Union soldiers who served with the USCT include carded records relating to Union staff officers, carded medical records of volunteer Union soldiers, unbound and bound regimental records and "record of events" cards. The regimental records of the 54th Massachusetts Infantry (Colored) have been

NATIONAL ARCHIVES MICROFILM PUBLICATIONS

reproduced as Microfilm Publication M1659, *Records of the Fifty-fourth Massachusetts Infantry Regiment (Colored), 1863-1865*.

The "record of events" cards include information copied from the unit's muster rolls and returns. They show the stations of the field and staff and those of the various companies of the regiment at the time the muster roll or return was prepared and sometimes mention battles, skirmishes, or other activities in which the regiment participated. The cards have been reproduced as Microfilm Publication M594 *Compiled Records Showing Service of Military Units in Volunteer Union Organizations*.

Record Group 94 also includes a card index for the USCT, reproduced as Microfilm Publication M589, *Index to Compiled Military Service Records of Volunteer Union Soldiers Who Served with U.S. Colored Troops*, which may be used to locate the regiment of USCT personnel. An index card gives the name of the soldier and his rank, as well as the unit in which he served; sometimes there is a cross-reference to his service in other units or organizations. The National Archives is continually producing microfilm publications of volunteer Union compiled military service records. A complete listing of finished publications can be found in the National Archives' *Microfilm Resources for Research: A Comprehensive Catalog* which is available online at <http://www.nara.gov>.

The Records of the Colored Troops Division, within RG 94, include division correspondence and records relating to recruiting, the appointment of officers, and the slave or free status of individuals; and a compilation of historical extracts and official papers concerning the military service of African Americans from the colonial period through the Civil War entitled *The Negro in the Military Service of the United States 1639-1886*. This compilation is reproduced as Microfilm Publication M858. The Records of the Bounty and Claims Division, also in RG 94, include correspondence of the division and records relating to bounties and claims paid to loyal owners of slaves by the Slave Claims Commissions of Delaware, Kentucky, Maryland, Missouri, Tennessee and West Virginia.

If an application for a pension was made, the pension application case file may be among the Records of the Veterans Administration (RG 15). Indexes to the pension applications have been reproduced as Microfilm Publication T288, *General Index to Pension Files, 1861-1934*, and T289, *Organizational Index to Pension Files of Veterans Who Served Between 1861 and 1900*.

If a soldier or officer was tried before a general court-martial or if an individual or his unit was the subject of a court of inquiry or military commission, transcripts of the proceedings may be among the Records of the Office of the Judge Advocate General (Army) (RG 153). The registers to the proceedings have been reproduced as Microfilm Publication M1105, *Registers of the Records of the Proceedings of the U.S. Army General Courts-Martial, 1809-1890*.

Other record groups having information pertaining to the USCT include Records of the Bureau of Refugees, Freedmen, and Abandoned Lands (RG 105); Records of the Provost Marshal General's Bureau (Civil War) (RG 110); Records of the Accounting Officers of the Department of the Treasury (RG 217); and Records of U.S. Army Continental Commands, 1821-1920 (RG 393).

ROLL LIST

Roll Description

1st United States Colored Cavalry

- 1 Akess, Alexander - Bom, John H.
- 2 Bomer, James - Cartwright, John
- 3 Casey, Thomas - Davenport, John J.
- 4 Davis, Augustus - Floyd, George
- 5 Fly, Benjamin - Griffin, Oliver
- 6 Griffin, Quinton - Holstead, Peter
- 7 Holt, George - Jones, Herbert
- 8 Jones, Howell - Macoy, Peter
- 9 Madry, Andrew - Mosley, Jacob
- 10 Moss, James - Polk, James
- 11 Pollard, Sipio - Sales, William
- 12 Sample, Abram (Abraham) - Smith, Ives
- 13 Smith, James - Times, Nelson
- 14 Tines, Archer - Wheldon, Charles M.
- 15 Whitby, Joseph - Wilson, Isaac
- 16 Wilson, James - Zoe (no first name)

2d United States Colored Cavalry

- 17 Abbot, John - Bell, Charles
- 18 Bell, Henry - Burns, Richard
- 19 Burroughs, George L. - Cotton, Samuel
- 20 Coues, Alexander - Duncan, Levi
- 21 Dunkins, Ezikiah James - Gardner, Richard
- 22 Garris, Henry - Harrison, Thomas
- 23 Harrison, William - Humphries, David
- 24 Hunter, Francis - Jones, Robert
- 25 Jones, Robert F. - Martin, Robert (Martin)
- 26 Martin, Thaddeus or Martin, Thaddeus W. - Osborne, Henry S.
- 27 Oulden, Jacob - Prior, Edward or Edmund
- 28 Proctor, David - Sawyer, Wilson
- 29 Scabber, Charles - Stanley, William
- 30 Stanley, Wright or Right - Upshear, Neverson
- 31 Upshear, Samuel - Whites, Joe
- 32 Whites, Silas - Zodrick, Isaiah A. or Isaiah

3d United States Colored Cavalry

- 33 Aaron, John - Black, David
- 34 Black, Richard - Cameron, Wyatt

NATIONAL ARCHIVES MICROFILM PUBLICATIONS

<u>Roll</u>	<u>Description</u>
35	Cammel, Austin - Cooper, Stephen
36	Coran, Joseph - Erving, Tilson
37	Erwin, Anderson - Gool, George
38	Gordon, Alfred - Haskins, Jasper
39	Hawkins, Frank - Jackson, Harvey
40	Jackson, Henry - Kembro, Abraham
41	Kenedy, Lemuel - Lott, Judge
42	Lott, Matton - Mitchell, Berry
43	Mitchell, George - Pettis, Edmond
44	Pettis, George - Roberson, Jefferson
45	Roberson, Wallace - Simpson, Levi
46	Sims, Anderson - Taylor, Phillip
47	Taylor, Richard - Washington, Isaac
48	Washington, Oscar - Williams, Mitchel
49	Williams, Moses - Young, Mathew

4th United States Colored Cavalry

50	Abraham, Randall - Blanchan, William
51	Blanchard, Moses - Clark, Moses
52	Clark, Theodore - Ellars, James
53	Ellars, John - Heath, Culbert
54	Henderson, George - Johnson, Henderson
55	Johnson, Henry - Mayberry, Nelson
56	Macomory, John - Oliver, Celestine
57	Olsten, Alexander - Robinson, William
58	Robinson, William E. - Thomas, Stephen
59	Thomas, William - Williams, Horace
60	Williams, Isaac - Zulia, Francois

5th United States Colored Cavalry

61	Abel, Fletcher - Biggs, Randall
62	Birch, Benjamin - Burly, Frank
63	Burly, James - Coffman, James D.
64	Coke, Samuel - Dudley, John
65	Duke, John - Givens, Peter
66	Glen, John - Harriden, Edmund
67	Harrigan, Harden - Hughes, Thomas
68	Hulse, James - Keller, Ephraim
69	Kelley, Franklin - Matthews, Benjamin
70	Maupin, Preston - Murry, Ned
71	Murtney, Morton - Ray, John
72	Ray, Thomas - Sherrod, William

NATIONAL ARCHIVES MICROFILM PUBLICATIONS

<u>Roll</u>	<u>Description</u>
73	Shrewsbury, Joseph - Stone, John
74	Stone, Lewis - Trye, Benjamin
75	Trueheart, Samuel - Williams, James
76	Williams, Jerry - Yowell, Joseph

5th Massachusetts Cavalry (Colored)

77	Abbey, David - Biers, William
78	Billings, Jeremiah - Burgess, Williams
79	Burnett, Lewis - Cook, Joseph T.
80	Cooper, Isaac - Dunmore, William
81	Durbin, Stephen - Furman, Seneca A.
82	Gadson, James - Gurley, Joseph L.
83	Guy, James - Hill, John W.
84	Hill, Richard - Johns, Thomas H.
85	Johnson, Aaron - Lambert, William
86	Lancaster, James - Mason, John
87	Mason, John H. - Nelson, Philip
88	Nelson, Preston - Preston, Thomas
89	Price, Adam - Sampson, George P.
90	Sanborn, Madison - Stringer, William
91	Strother, Frank - Vance, William H.
92	Van Hoesen, Charles - Wilkinson, Simon
93	Williams, Abram H. - Young, Thomas

6th United States Colored Cavalry

94	Abbot, John - Birch, James
95	Bivins, Gabriel - Buckner, George
96	Buckner, Henderson - Compton, James
97	Cook, Benjamin - Ellis, William
98	Ellis, Wyatt - Godley, Isaac
99	Gooch, Alexander - Herston, Abraham
100	Heywood, John R. - Johnson, Jackson
101	Johnson, James M. - Marshall, Lyman
102	Marshall, William - Neihardt, Isaac D.
103	Nelson, Joseph - Redd, Tiney
104	Redway, Hamilton K. - Sebree, Bob Woodcock
105	Sebree, Crittenden - Sumpter, John
106	Sutherland, Williams - Washington, Charles
107	Washington, George - Wren (no first name)

NATIONAL ARCHIVES MICROFILM PUBLICATIONS

Microfilm Publication M1817

COMPILED MILITARY SERVICE RECORDS OF VOLUNTEER UNION
SOLDIERS WHO SERVED WITH THE UNITED STATES COLORED
TROOPS: 1st Through 5th United States Colored Cavalry, 5th Massachusetts
Cavalry (Colored), 6th United States Colored Cavalry

Roll 25

2d United States Colored Cavalry

Jones, Roberts F. - Martin, Robert (Martin)

877

Jones Robert S.

Co C, 2 U. S. Col'd Cav.

Private

Private

CARD NUMBERS.

1	5315538	26
2	5320494	27
3	5320591	28
4	5320687	29
5	5320777	30
6	5320864	31
7	5320949	32
8	9087325	33
9	40055826	34
10	5387837	35
11	40726237	36
12		37
13		38
14		39
15		40
16		41
17		42
18		43
19		44
20		45
21		46
22		47
23		48
24		49
25		50

Book Mark:

See also

S-733113 - P Caff

S 855697 Zoff

8869730 - Poff

Q1313264 - P. D. Mann

S1384599 Poff

A1556302 Poff

S-1781552 and W.L.

H920695 J. A. R.

A. 2548386 and W.D.

D. Jordan
Ex

J | 2 Cav. | U.S.C.T.

Robert Jones

, Co. B, 2 Reg't U. S. Col'd Cav.

Appears on

Company Descriptive Book

of the organization named above.

DESCRIPTION.

Age 26 years; height 5 feet 7 inches.

Complexion *BeK*

Eyes *BeK*; hair *BeK*

Where born *Virginia*

Occupation *Laborer*

ENLISTMENT.

When *Mar. 11, 1865*

Where *Baltimore, Md.*

By whom *Capt. Clayton*; term *1 yr.*

Remarks: *Substitute for
Gollieb Mesger 3rd
Dis, Md.*

F. B. Smith

9 | 2 Cav. | U.S.C.T.

Robert Jones
Pet. Co. C, 2 Reg't U. S. Colored Cav.

Appears on Returns as follows:

Mar 1865 Garrison
Mar 24 or 25, 65
Camp Norfolk
Rec'd assigned to
Co C by order of
Maj Robert Wickham
2 U.S.C.C.

Book mark: _____

(546)

A. G. England
Copyist.

NO 6

J. | ² G | U.S.C.T.

Robert F Jones

Appears with rank of _____ on

Muster and Descriptive Roll of a Detachment of Substitutes forwarded

for the ^x 2 Reg't U. S. Co'd Cavalry. Roll dated
Not dated, 186

Where born Virginia

Age 26 y'rs; occupation Laborer

When enlisted Mch 11, 1865.

Where enlisted Baltimore, Md.

For what period enlisted 1 years.

Eyes Blk hair Blk

Complexion Blk; height 5 ft. 8 in.

When mustered in _____, 186

Where mustered in _____

Bounty paid \$ _____; due \$ 100

Where credited 3 Dist Md.

Company to which assigned _____

Remarks: Substitute for Gottlieb
Mezger.

* Rec'd from 6 U.S. Col'd Cav.

Not taken up on rolls great

Book mark:
Corrected Aug 27, 1865.

Conard

J | **2 Cav. | U.S.C.T.**

Robert F. Jones

Appears with the rank of _____ on
**Muster and Descriptive Roll of a Detach-
ment of Substitutes forwarded**

for the 2 Reg't U. S. Colored Cav. Roll dated
Baltimore Md, Moh 20, 1865.

Where born *Virginia*

Age *26* y'rs; occupation *Labourer*

When enlisted *Moh 11, 1865.*

Where enlisted *Baltimore, Md.*

For what period enlisted _____ years.

Eyes *Blk*; hair *Blk*

Complexion *dark*; height *5* ft. *8* in.

When mustered in _____, 186 .

Where mustered in _____

Bounty paid \$ *100*; due \$ *100*

Where credited _____

Company to which assigned _____

Remarks *Substitute for
Gottlieb Mezger 3
Dist. Md.*

Book mark: _____

R. Bayles
Copyist.

J | *2 Cav* | **U.S.C.T.**

Robert F. Jones
Priv., Co., *2* Reg't U. S. Col'd *Cav*

Age *26* years.

Appears on a

Detachment Muster-in Roll

of the organization named above. Roll dated
Baltimore, Md., Mar. 22, 1863.

Muster-in to date *Mar. 14, 1863.*

Joined for duty and enrolled:

When *Mar. 11*, 1863.

Where *Baltimore, Md*

Period *1* years.

Valuation of horse, \$ *100*

Valuation of horse equipments, \$ *100*

Remarks: *Substitute*

Book mark :

W. Beck
Copyst.

J | **2 Cav. | U.S.C.T.**

Robert Jones

Pat, Co. C, 2 Reg't U. S. Col'd Cavalry.

Appears on

Company Muster Roll

for *March & April*, 1865.

Present or absent *Present*

Stoppage, \$ *100* for

Due Gov't, \$ *100* for

Valuation of horse, \$ *100*

Valuation of horse equipments, \$ *100*

Remarks: *Substitute for Gattrey
Messenger, 3^d Dist. Md.
400 dollars on Check Book.*

Book mark:

J. L. Borris
(358) Copyist.

0

2 Cav. U.S.C.T.

Robert Jones

Prof, Co. C, 2 Reg't U. S. Col'd Cavalry.

Appears on

Company Muster Roll

for May 9 June, 1865.

Present or absent Present

Stoppage, \$ 100 for

Due Gov't, \$ 100 for

Valuation of horse, \$ 100

Valuation of horse equipments, \$ 100

Remarks: \$430. on Check Book.

Book mark:

J. L. Morris

J | 2 Cav. | U.S.C.T.

Robert Jones
Pvt, Co. C, 2 Reg't U. S. Col'd Cavalry.

Appears on

Company Muster Roll

for July & August, 1865.

Present or absent Present

Stoppage, \$ 100 for

Due Gov't, \$ 100 for

Valuation of horse, \$ 100

Valuation of horse equipments, \$ 100

Remarks: On check Book \$430.00

Book mark:

J. L. Borris

J | **2 Cav.** | **U.S.C.T.**

Robert Jones

Priv, Co. C, 2 Reg't U. S. Col'd Cavalry.

Appears on

Company Muster Roll

for *Sept & Oct*, 1865.

Present or absent *Present*

Stoppage, \$ *100* for

Due Gov't, \$ *100* for

Valuation of horse, \$ *100*

Valuation of horse equipments, \$ *100*

Remarks: *On Check Book \$430.*

Book mark :

G. W. Chase

J

2 Cav. | U.S.C.T.

Robert Jones

Priv, Co. C, 2 Reg't U. S. Col'd Cavalry.

Appears on

Company Muster Roll

for *Nov & Dec*, 186*5*.

Present or absent *Present*

Stoppage, \$ *100* for

Due Gov't, \$ *100* for

Valuation of horse, \$ *100*

Valuation of horse equipments, \$ *100*

Remarks: *On Check Book \$430.00*

Book mark:

G. W. Chase

J | **2 Cav.** | **U.S.C.T.**

Robert Jones
Priv, Co. *C*, 2 Reg't U. S. Col'd Cavalry.

Appears on **Co. Muster-out Roll**, dated
Brazos Santiago Tex, Feb 12, 1866.
Muster-out to date *Feb 12, 1866.*
Last paid to *June 30, 1865.*

Clothing account:

Last settled....., 186 ; drawn since \$.....100

Due soldier \$ *46* ^{*80*}/_{*100*}; due U. S. \$.....100

Am't for cloth'g in kind or money adv'd \$.....100

Due U. S. for arms, equipments, &c., \$.....100

Bounty paid \$.....100; due \$.....100

Remarks: *Joined as Substitute*
for Gottlieb, Merque 3 D. Md.
Free before Apr 19, 1861

Book mark :

G. W. Chase

James Robert J.

, Co. ,

Reg't U.S.C.I.

1 Enclosures.

Bed Cards	Final Statements
Burial Records	Furloughs or L. of A.
Certs. of Dis. for Discharge	Med. Certificates
C. M. Charges	Med. Des. Lists
Descriptive Lists	Orders
Discharge Certificates	Pris. of War Record
Enlistment Papers 1	Resignations

Other papers relating to—

Admission to Hosp'l	Furlough or L. of A.
Casualty Sheet	Med. Examination
Confinement	Misc. Information
Contracts	Pay or Clothing
Death or Effects	Personal Reports
Desertion	Rank
Discharge from Hosp'l	Transfer to Hosp'l
Discharge from Service	Transfer to V. R. C.
Duty	Transportation

DECLARATION OF SUBSTITUTE.

I, Robert S. Jones ^{Col^d}, desiring to ENLIST
in the ~~the~~ Army of the United States, for ~~THREE YEARS~~ ^{one}, **Do declare**, That I am
Twenty Six years and _____ months of age; that I have
never been discharged from the United States service on account of disability or by sentence of
a court martial; and I know of no impediment to my serving honestly and faithfully as a soldier
for ~~three~~ ^{one} year.

GIVEN at Baltimore Md
the 11 day of March

WITNESS:

Chas. N. Ellis

Robert S. Jones
^{Col}
mark

No. 96 19
Robert S. Jones
Enlisted at Baltimore Md
Robert

As Substitute for

Patrick McQueen

On the 11 day of March, 1863,

By

Edw. Henry Clayton

William Parks

Thos. H. Woodcock

Board of Enrollment,

35 Dist. of Maryland

SUBSTITUTE
VOLUNTEER ENLISTMENT.

STATE OF

TOWN OF



Maryland City *Baltimore*

I, *Robert J. Jones*, born in the State of *Virginia*; aged *Twenty Six* years, and by occupation a *Laborer*, Do HEREBY ACKNOWLEDGE to have agreed with

Gottlieb Mezger, Esq., of *101 Conway St 16th Ward City of Baltimore State of Maryland*

to become his **SUBSTITUTE** in the Military Service, for a sufficient consideration paid and delivered to me, on the *Eleventh* day of *March*, 1865;

and having thus agreed with said *Gottlieb Mezger*, I DO HEREBY ACKNOWLEDGE to have enlisted this *Eleventh* day of *March*,

1865, to serve as a **Soldier** in the **Army of the United States of America**, for the period of ~~THREE YEARS~~ *one*, unless sooner discharged by proper authority. I do also agree to accept such bounty, pay, rations, and clothing as are, or may be, established by law for soldiers. And I do solemnly swear that I will bear true and faithful allegiance to the **United States of America**; that I will serve them honestly and faithfully against all their enemies or opposers whomsoever; and that I will observe and obey the orders of the President of the United States and the orders of the officers appointed over me according to the Rules and Articles of War.

SWORN and subscribed to, at *Baltimore Md*

this *11* of *March*, 1865,
BEFORE *Capt Henry Clayton*
Prov. Mar & Dist Md

Robert J. Jones
made

We certify, on honor, That we have carefully examined the above-named Volunteer Substitute agreeably to the Regulations, and that, in our opinion, he is free from all bodily defects and mental infirmity which would in any way disqualify him from performing the duties of a soldier; that he was entirely sober when enlisted; that he is of lawful age, (not under 18 years;) and that, in accepting him as duly qualified to perform the duties of an able-bodied soldier, and as a Substitute in lieu of *Gottlieb Mezger* enrolled, drafted in, *16th Ward Balto City Md* *June*, 1865, we have strictly observed the Regulations which govern in such cases. This soldier has *Black* eyes, *woolly* hair, *Black* complexion; is *5* feet *8* inches high.

Henry Clayton
Capt & Provost Marshal.

William Brooks
Commissioner of Board.

H. J. Mumford
Surgeon of Board.

Board of Enrollment of *3* Dist. of *Maryland*

878

Jones, Sharpen

Co B, 2 U. S. Col'd Cav.

Private + Private

CARD NUMBERS.

1	5315611	26
2	5318521	27
3	5318638	28
4	5318757	29
5	5318869	30
6	5316320	31
7	5318984	32
8	5316632	33
9	5319088	34
10	5319191	35
11	5319295	36
12	5319394	37
13	5319492	38
14	5319586	39
15	5319671	40
16	9087198	41
17	40726226	42
18		43
19		44
20		45
21		46
22		47
23		48
24		49
25		50

Book Mark:

See also

2 Cav. | U.S.C.T.

J
Sharper Jones

, Co. B., 2 Reg't U. S. Col'd Cav.

Appears on

Company Descriptive Book

of the organization named above.

DESCRIPTION.

Age 18 years; height 5 feet 3 inches.

Complexion Dark

Eyes Black; hair Black

Where born Jones Lee, N. C.

Occupation Laborer

ENLISTMENT.

When Jan. 1, 1864.

Where Ft Monroe, Va

By whom Lee Lee; term 3 y'rs.

Remarks: Mustered Jan. 8/64 by Capt. F. Martin. Engaged in action at Drums Bluff May 16/64, on detached service in Ambulance Train 18th A. C. from Aug. 6/64 to Jan. 1/65.

F. B. Smith

Copist.

8 | 2 Cav. | U.S.C.T.

Sharper Jones

Pvt., Co. B. 2 Reg't U. S. Col'd Cavalry.

Appears on

Company Muster Roll

for *Dec. 22/63 to Feb. 29 1864.*

Present or absent *Present*

Stoppage, \$ 100 for

Due Gov't, \$ 100 for

Valuation of horse, \$ 100

Valuation of horse equipments, \$ 100

Remarks :

Book mark :

E. H. Hunter

J. 2 Cav. U.S.C.T.

Sharper Jones
Cpt., Co. *2*, Reg't U. S. Col'd *Cav*

Age years.

Appears on a

Detachment Muster-in Roll

of unattached recruits
of the organization named above. Roll dated
H. Monroe, Va, Jan. 8, 1864.

Muster-in to date *Jan. 8, 1864.*

Joined for duty and enrolled:

When *Jan. 1*, 1864.

Where *H. Monroe, Va*

Period *3* years.

Valuation of horse, \$ 100

Valuation of horse equipments, \$ 100

Remarks:

.....

.....

.....

Book mark:

.....

(337)

J. J. Kearney
Copyist.

J | 2 Cav. | U.S.C.T.

Sharper Jones

Priv., Co. B. 2 Reg't U. S. Col'd Cavalry.

Appears on

Company Muster Roll

for March & April, 1864

Present or absent Present

Stoppage, \$ 100 for

Due Gov't, \$ 100 for

Valuation of horse, \$ 100

Valuation of horse equipments, \$ 100

Remarks :

Book mark :

E. H. Hunter

J | **2 Cav.** | **U.S.C.T.**

Sharper Jones
Pvt., Co. B. 2 Reg't U. S. Col'd Cavalry.

Appears on

Company Muster Roll

for *May & June*, 186*4*

Present or absent *Present*

Stoppage, \$ 100 for

Due Gov't, \$ 100 for

Valuation of horse, \$ 100

Valuation of horse equipments, \$ 100

Remarks :

Book mark :

E. W. Hunter

2 Cav. | U.S.C.T.

James ...

Comate, Co. B. 2 Reg't U. S. Col'd Cavalry.

Appears on

Company Muster Roll

for *July - August*, 1864.

Present or absent *Absent*.

Stoppage, \$ 100 for

Due Gov't, \$ 100 for

Valuation of horse, \$ 100

Valuation of horse equipments, \$ 100

Remarks: *Detained in Corps Ambulance Train S.O. No. 84 dated 2d Div. 3rd Div. 18th A.C. Aug. 4, 1864.*

Book mark :

O. J. Markle,

G. L. Car | **U.S.C.T.**

Sharper Jones
Pvt, Co. *B*, *2* Reg't U. S. Col'd *Car*

Appears on a

Detachment Muster Roll

of the organization named above

for *July & Aug*, 186*7*.

Station *The Field Ia*

Present or absent *Present*

Stoppage, \$ *100* for

Due Gov't, \$ *100* for

Valuation of horse, \$ *100*

Valuation of horse equipments, \$ *100*

Remarks:

Book mark:

O. G. Smith

J | **2 Cav.** | **U.S.C.T.**

Juniper Jones

Private, Co. B. 2 Reg't U. S. Col'd Cavalry.

Appears on

Company Muster Roll

for *Sept & Oct*, 1864.

Present or absent *Absent*

Stoppage, \$ *100* for

Due Gov't, \$ *100* for

Valuation of horse, \$ *100*

Valuation of horse equipments, \$ *100*

Remarks: *Detached in Corps ambulance train S. O. no 84 dated H. 2. 3^d 18th An. C. Aug. 6, 1864.*

Book mark:

O. J. Markle,

J 12 Cav | U.S.C.T.

Charles Jones
Privt, Co. B, 2 Reg't U. S. Col'd Cavalry

Appears on a

Detachment Muster Roll

of the organization named above

for Sept & Oct, 1864

Station In the field Va

Present or absent Present

Stoppage, \$ 100 for

Due Gov't, \$ 100 for

Valuation of horse, \$ 100

Valuation of horse equipments, \$ 100

Remarks: Difference between White & Colored Soldiers' pay due from Jan 1/64 to Apr 30/64

Book mark:

(341) W. D. [Signature] Copyist.

J | **2 Cav.** | **U.S.C.T.**

Henry [unclear]

Private, Co. B. 2 Reg't U. S. Col'd Cavalry.

Appears on

Company Muster Roll

for *Oct. 3, 1864 to Feb. 28*, 1865.

Present or absent *Present*

Stoppage, \$ 100 for

Due Gov't, \$ 100 for

Valuation of horse, \$ 100

Valuation of horse equipments, \$ 100

Remarks :

Book mark :

(358)

O. J. Markle,

Copyist.

9 | **2 Cav.** | **U.S.C.T.**

Sharper Jones

Private, Co. B. 2 Reg't U. S. Col'd Cavalry.

Appears on

Company Muster Roll

for *Mar & Apr*, 1865.

Present or absent *Present*

Stoppage, \$ 100 for

Due Gov't, \$ 100 for

Valuation of horse, \$ 100

Valuation of horse equipments, \$ 100

Remarks :

Book mark :

no chance

J | **2 Cav. | U.S.C.T.**

Sharper Jones

Priv Co. B. 2 Reg't U. S. Col'd Cavalry.

Appears on

Company Muster Roll

for *May + June*, 1865 .

Present or absent *Present*

Stoppage, \$ 100 for

Due Gov't, \$ 100 for

Valuation of horse, \$ 100

Valuation of horse equipments, \$ 100

Remarks :
.....
.....
.....
.....
.....
.....
.....
.....
.....

Book mark :

W. Chance

J | 2 Cav. | U.S.C.T.

Sharper Jones
P. ... , Co. B. 2 Reg't U. S. Col'd Cavalry.

Appears on

Company Muster Roll

for July + Aug, 1865.

Present or absent Present.

Stoppage, \$ 100 for

Due Gov't, \$ 100 for

Valuation of horse, \$ 100

Valuation of horse equipments, \$ 100

Remarks :

Book mark :

M. O. Chance

2 Cav. U.S.C.T.

Sharper Jones

priv, Co. B. 2 Reg't U. S. Col'd Cavalry.

Appears on

Company Muster Roll

for *Sept. & Oct*, 186*5*

Present or absent *Present*

Stoppage, \$ 100 for

Due Gov't, \$ 100 for

Valuation of horse, \$ 100

Valuation of horse equipments, \$ 100

Remarks :

Book mark :

W. Harrison

(358)

Copyist.

J | **2 Cav.** | **U.S.C.T.**

Sharper Jones
priv, Co. B. 2 Reg't U. S. Col'd Cavalry.

Appears on

Company Muster Roll

for *Nov. & Dec*, 186*5*

Present or absent *Present*

Stoppage, \$ 100 for

Due Gov't, \$ 100 for

Valuation of horse, \$ 100

Valuation of horse equipments, \$ 100

Remarks :

Book mark :

M. Harrison

J | 2 Cav. | U.S.C.T.

Shearman Jones
Pt. B., Co. B., 2 Reg't U. S. Colored Cav.

Appears on Returns as follows:

Jan to July 1864
Ord Duty Co Cook
Aug to Sept 1864
Absent duty in
Armed Corps 18
A.C. no driver
Oct 1864 Absent
duty as Sharp
shooter
Nov 1864 Absent in
Armed Corps
no driver

Book mark :

(546) A. J. G. Copyist.

J | 2 Cav. | U.S.C.T.

Sharper Jones

Pvt, Co. B, 2 Reg't U. S. Col'd Cavalry.

Appears on Co. Muster-out Roll, dated

Brazos Santiago, Tex., Feb. 12, 1866.

Muster-out to date Feb. 12, 1866.

Last paid to June 30, 1865.

Clothing account:

Last settled....., 186 ; drawn since \$ 100

Due soldier \$ 100; due U. S. \$ 53 39 / 100

Am't for cloth'g in kind or money adv'd \$ 100

Due U. S. for arms, equipments, &c., \$ 100

Bounty paid \$ 100; due \$ 100

Remarks: Found a Rect-

Book mark: V, 35 P. 210-68.

W. Harrison

879

Jones Spencer

Co A, 2 U. S. Col'd Cav.

Private

Private

CARD NUMBERS.

1	5317238	26
2	5317311	27
3	5317401	28
4	5317489	29
5	5317568	30
6	5317659	31
7	5317748	32
8	5317836	33
9	5317963	34
10	5318380	35
11	9089085	36
12	40726228	37
13		38
14		39
15		40
16		41
17		42
18		43
19		44
20		45
21		46
22		47
23		48
24		49
25		50

Book Mark:

See also

2 Cav. | U.S.C.T.

J. Spencer Jones

Co. *A*, 2 Reg't U. S. Col'd Cav.

Appears on

Company Descriptive Book

of the organization named above.

DESCRIPTION.

Age *19* years; height *5* feet *6* inches.

Complexion *Black*

Eyes *Black*; hair *Black*

Where born

Occupation

ENLISTMENT.

When *Dec 22*, 186 .

Where *Ft Monroe*

By whom *Col. Hale*; term *3* y'rs.

Remarks:

L. B. Smith
Copyist.

J. | **2 Cav.** | **U.S.C.T.**

Spencer Jones

Pvt, Co. *A*, 2 Reg't U. S. Col'd Cavalry.

Age.....years.

Appears on

Company Muster-in Roll

of the organization named above. Roll dated

Ft Monroe Va, *Dec 22*, 186 *3*.

Muster-in to date *Dec 22*, 186 *3*

Joined for duty and enrolled:

When *Dec 22*, 186 *3*

Where *Ft Monroe Va*

Period *3* years.

Valuation of horse, \$.....100

Valuation of horse equipments, \$.....100

Remarks:.....

.....

.....

.....

Book mark:.....

.....

J. E. Chapin

J | **2 Cav.** | **U.S.C.T.**

Spencer Jones

Pvt, Co. A, 2 Reg't U.S. Col'd Cavalry.

Appears on

Company Muster Roll

for *from Enrollmt to Feb. 29*, 1864.

Present or absent. *Present*

Stoppage, \$ *100* for

Due Gov't, \$ *100* for

Valuation of horse, \$ *100*

Valuation of horse equipments, \$ *100*

Remarks:

Book mark:

J. E. Chapin

J | **2 Cav.** | **U.S.C.T.**

Spencer Jones

Pvt, Co. A, 2 Reg't U. S. Col'd Cavalry.

Appears on

Company Muster Roll

for *March & Apr*, 186 ~~4~~

Present or absent *Present*

Stoppage, \$ 100 for

Due Gov't, \$ 100 for

Valuation of horse, \$ 100

Valuation of horse equipments, \$ 100

Remarks:

Book mark: *...*

(358) *J. E. Chapin* Copyist.

J | **2 Cav.** | **U.S.C.T.**

Spencer Jones

Pvt, Co. A, 2 Reg't U. S. Col'd Cavalry.

Appears on

Company Muster Roll

for *May + June*, 1864.

Present or absent *Present*

Stoppage, \$ *100* for

Due Gov't, \$ *100* for

Valuation of horse, \$ *100*

Valuation of horse equipments, \$ *100*

Remarks:

Book mark:

J. E. Chapin

J | 2 Cav. | U.S.C.T.

Spencer Jones
Pot, Co. A, 2 Reg't U. S. Col'd Cavalry.

Appears on

Company Muster Roll

for July & Aug, 1864.

Present or absent Present

Stoppage, \$ 100 for

Due Gov't, \$ 100 for

Valuation of horse, \$ 100

Valuation of horse equipments, \$ 100

Remarks: Stoppages
One Currycombs brush \$1.01
" Cav. link 30
" Noise bag 1.50
" for spurs & straps .52

Book mark:

R. S. Helton

J | 2 Cav. | U.S.C.T.

Spencer Jones

Pvt, Co. A, 2 Reg't U. S. Col'd Cavalry.

Appears on

Company Muster Roll

for Sept Oct, 1864.

Present or absent Present

Stoppage, \$ 100 for

Due Gov't, \$ 100 for

Valuation of horse, \$ 100

Valuation of horse equipments, \$ 100

Remarks:

[Empty lines for remarks]

Book mark:

R. B. Shetton

J | **2 Cav.** | **U.S.C.T.**

Spencer Jones
Pvt, Co. A, 2 Reg't U. S. Col'd Cavalry.

Appears on

Company Muster Roll

for Nov & Dec, 1864.

Present or absent Present

Stoppage, \$ 100 for

Due Gov't, \$ 100 for

Valuation of horse, \$ 100

Valuation of horse equipments, \$ 100

Remarks:

.....
.....
.....
.....
.....
.....
.....
.....

Book mark:

R. S. Shelton

J | 2 Cav. | U.S.C.T.

Spencer Jones
Pol, Co. A, 2 Reg't U.S. Col'd Cavalry.

Appears on

Company Muster Roll

for Jan & Feb, 1865.

Present or absent Present

Stoppage, \$ 100 for

Due Gov't, \$ 100 for

Valuation of horse, \$ 100

Valuation of horse equipments, \$ 100

Remarks:

Book mark:

R. S. Shelton

J. | **2 Cav.** | **U.S.C.T.**

George Jones

Private, Co. A, 2 Reg't U. S. Col'd Cavalry.

Appears on

Company Muster Roll

for *March 1863*, 1863.

Present or absent.....

Stoppage, \$.....100 for.....

Due Gov't, \$.....100 for.....

Valuation of horse, \$.....100

Valuation of horse equipments, \$.....100

Remarks: *Died in Regt
Hos. at New York Army
on April 26 1863 of
pneumonia*

Book mark:

Wiley
Copyist.

J. | 2 Cav. | U.S.C.T.

Spencer Jones
Pot., Co. A, 2 Reg't U. S. Colored Cav.

Appears on Returns as follows:

Apr 1865 Died
Apr 26, 65 New
York News Va
of Pneumonia

Book mark :

(546)

A. J. G. [Signature]

Copyist.

J. | 2 Cav. | U.S.C.T.

Spencer Jones

Pvt, Co. A, 2 Reg't U. S. Col'd Cavalry.

Appears on Co. Muster-out Roll, dated Brazos Santiago Tex, 12 Feb, 1866.

Muster-out to date _____, 186 .
Last paid to _____, 186 .

Clothing account:

Last settled _____, 186 ; drawn since \$ _____ 100

Due soldier \$ _____ 100 ; due U. S. \$ _____ 100

Am't for cloth'g in kind or money adv'd \$ _____ 100

Due U. S. for arms, equipments, &c., \$ _____ 100

Bounty paid \$ _____ 100 ; due \$ _____ 100

Remarks: Joined original organization. Died of disease of 4th Inf. Armpnt Arms Va; Apl 25/65. Final statements inventory of effects forwarded May 10/65.

Book mark: _____

G. E. Dayton

Jones. Spencer
P, Co. A, 2 Reg't 1st Cav.

Enclosures.

Bed Cards	Descriptive Lists
Burial Records	Final Statements
Certs. of Dis. for Discharge	Furloughs
C. M. Charges	Med. Des. Lists
Med. Certificates	Orders

Other papers relating to—

Admission to Hosp'l	Furlough
Casualty Sheet (Officer's)	Med. Examination
Confinement	Misc. Information
Contracts	Pay or Clothing
Death or Effects	Personal Reports
Desertions	Rank
Discharge from Hosp'l	Transfer to Hosp'l
Discharge from Service	Transfer to V. R. C.
Duty	Transportation

CASUALTY SHEET

No. _____

— Spencer Jones —

• — Private — of Company "A"

2^d Regiment of U. S. C. Cav^y

State Volunteers.

NATURE OF CASUALTY.

— Death Apr 25 '65 —

CASUALTY SHEET.

Name: *Spencer Jones*

Rank: *Private* Company: *"H"* Regiment: *2^d*

Arm: *U. S. Cavalry* State: _____

Nature of Casualty: *Death*

CAUSE OF CASUALTY—(NAME OF DISEASE, &c.)

BY WHOM DISCHARGED.

DEGREE OF DISABILITY.

FROM WHAT SOURCE THIS INFORMATION WAS OBTAINED.

BY WHOM CERTIFIED.

*Muster roll for March & April '65
and M. O. roll of Co.*

Edw. P. Wilson

REMARKS.

Capt. 2^d U.S. Cavalry

*No record of him, vide Genl.
Genl's letter of 105. Vol. 11. p. 1. 1875.*

DATE OF DISCHARGE, DEATH, &c.

April 25th 1865

PLACE OF DISCHARGE, DEATH, &c.

Newport News Va

J. W. Lindsay

Clerk.

880

Jones Thomas

Co C, 2 U. S. Col'd Cav.

Private

Private

CARD NUMBERS.

1	5319794	26
2	5319870	27
3	5319957	28
4	5320045	29
5	5320128	30
6	5320218	31
7	5320310	32
8	5320395	33
9	5320491	34
10	5320619	35
11	5316953	36
12	5316998	37
13	5320992	38
14	9087317	39
15	3676-CJ-1884	40
16	40726236	41
17		42
18		43
19		44
20		45
21		46
22		47
23		48
24		49
25		50

Book Mark:

1884,

LB 16/979 + 3676.CJ.

See also

1105-741900.0.0.0.0.0

5105-8322 2000000000

Al Jordan
Co

2 Cav. | U.S.C.T.

Thomas Jones

, Co. B, 2 Reg't U. S. Col'd Cav.

Appears on

Company Descriptive Book

of the organization named above.

DESCRIPTION.

Age 40 years; height 5 feet 6 1/2 inches.

Complexion Black

Eyes Black; hair Black

Where born Gates, N. C.

Occupation Carpenter

ENLISTMENT.

When Dec 24, 1863.

Where Ft Monroe, Va.

By whom G. W. Cole; term 3 y'rs.

Remarks: Deserted at
Portsmouth Va. June 14th 1865
and returned.

F. B. Smith
Copyist.

J | 2 Cav. | U.S.C.T.

Thomas Jones
Pvt, Co. C, 2 Reg't U. S. Col'd Cavalry.

Age _____ years.

Appears on

Company Muster-in Roll

of the organization named above. Roll dated

1st Monrova Dec 24 1863.

Muster-in to date Dec 24, 1863.

Joined for duty and enrolled:

When Dec 24, 1863.

Where 1st Monrova

Period 3 years.

Valuation of horse, \$ _____ 100

Valuation of horse equipments, \$ _____ 100

Remarks:

Book mark: _____

Hadzield

2 Cav. U.S.C.T.

J. Thomas Jones

Pat, Co. C, 2 Reg't U. S. Col'd Cavalry.

Appears on

Company Muster Roll

for *Dated Feb 24*, 186*1*.

Present or absent *Present*

Stoppage, \$ 100 for _____

Due Gov't, \$ 100 for _____

Valuation of horse, \$ 100

Valuation of horse equipments, \$ 100

Remarks: _____

Book mark: _____

Madgill

J | **2 Cav.** | **U.S.C.T.**

Thomas Jones
Pat, Co. C, 2 Reg't U. S. Col'd Cavalry.

Appears on

Company Muster Roll

for *March-Apr*, 186*4*

Present or absent *Present*

Stoppage, \$.....*100* for

Due Gov't, \$.....*100* for

Valuation of horse, \$.....*100*

Valuation of horse equipments, \$.....*100*

Remarks:

Book mark:

Hadfield
Copyist.

2 Cav. U.S.C.T.

J. Thomas Jones

Put, Co. C, 2 Reg't U. S. Col'd Cavalry.

Appears on

Company Muster Roll

for *May 2 June*, 1864.

Present or absent *Present*

Stoppage, \$ 100 for

Due Gov't, \$ 100 for

Valuation of horse, \$ 100

Valuation of horse equipments, \$ 100

Remarks:

Book mark:

Hadfield

J | 2 Cav. | U.S.C.T.

Thomas Jones
Present, Co. C, 2 Reg't U. S. Col'd Cavalry.

Appears on

Company Muster Roll

for July & Aug, 1864.

Present or absent Present

Stoppage, \$ 100 for

Due Gov't, \$ 100 for

Valuation of horse, \$ 100

Valuation of horse equipments, \$ 100

Remarks:

Book mark:

W. D. Logg

J | 2 Cav. | U.S.C.T.

Thomas Jones
Pvt., Co. C, 2 Reg't U. S. Col'd Cavalry.

Appears on

Company Muster Roll

for Sept & Oct, 1864

Present or absent Present

Stoppage, \$ 100 for

Due Gov't, \$ 100 for

Valuation of horse, \$ 100

Valuation of horse equipments, \$ 100

Remarks:

Book mark:

W. B. [Signature]

MAR 41

J | 2 Cav. | U.S.C.T.

Thomas Jones
Print, Co. C, 2 Reg't U. S. Col'd Cavalry.

Appears on

Company Muster Roll

for Nov & Dec, 1864.

Present or absent Present

Stoppage, \$ 100 for

Due Gov't, \$ 100 for

Valuation of horse, \$ 100

Valuation of horse equipments, \$ 100

Remarks:

Book mark:

W. H. ...

J | **2 Cav.** | **U.S.C.T.**

Thomas Jones

Private, Co. C, 2 Reg't U. S. Col'd Cavalry.

Appears on

Company Muster Roll

for *Jan & Feb*, 186*5*.

Present or absent *Present*

Stoppage, \$.....*100* for

Due Gov't, \$.....*100* for

Valuation of horse, \$.....*100*

Valuation of horse equipments, \$.....*100*

Remarks:

Book mark:

(358)

W. D. ...

Copyist.

J | **2 Cav.** | **U.S.C.T.**

Thomas Jones
Priv, Co. C, 2 Reg't U. S. Col'd Cavalry.

Appears on

Company Muster Roll

for *March & April*, 1865.

Present or absent *Present*

Stoppage, \$ 100 for

Due Gov't, \$ 100 for

Valuation of horse, \$ 100

Valuation of horse equipments, \$ 100

Remarks:

Book mark:

J. L. Morris

J | **2 Cav.** | **U.S.C.T.**

Thomas James
Priv, Co. C, 2 Reg't U. S. Col'd Cavalry.

Appears on

Company Muster Roll

for *May & June*, 1865.

Present or absent

Stoppage, \$ 100 for

Due Gov't, \$ 100 for

Valuation of horse, \$ 100

Valuation of horse equipments, \$ 100

Remarks: *Deserted at Portsmouth*
7th June 14th. Due U.S. for
Ord. \$41.55

Book mark:

(358)

J. L. Norris
Copyist.

J | 2 Cav. | U.S.C.T.

Thomas Joseph
Pet. Co. 2 Reg't U. S. Colored Cav.

Appears on Returns as follows:

June 1865 Base June
14, 65 Portsmouth
Deserted & Mutinied
at Portsmouth
Va

Book mark:

(546)

A. G. ...
Copyist.

I | *2 Car* | **U.S.C.T.**

Tho^s Jones

Pvt, Co. *C*, *2* Reg't U. S. Col'd *Car*

Appears on

Descriptive List of Deserters

dated *Aug. 1*, 1865:

Deserted:

When *June 14*, 1865:

Where *Portsmouth, Va*

Arrested:

When _____, 186 .

Where _____

Remarks: *Due U. S. for Ordnance*

\$41.55

Book mark: _____

E. Proster

J | 2 Cav | U.S.C.T.

Thos Jones

Pvt., Co. C., 2 Reg't U. S. Col'd Cav

Appears on

Descriptive List of Deserters

dated Aug 1, 1865

Deserted:

When June 14, 1865

Where Portsmouth

Arrested:

When, 186 .

Where

Remarks: Duell'd for Ordinance

#41.55

Book mark:

E. Arstein

J | 2 Cav. | U.S.C.T.

Thomas Jones
Pvt., Co. C, 2 Reg't U. S. Col'd Cavalry.

Appears on Co. Muster-out Roll, dated
Brazos Santiago, Tex, Feb 12, 1866.
Muster-out to date _____, 186 .
Last paid to Dec. 31, 1864.

Clothing account:

Last settled _____, 186 ; drawn since \$ _____ 100
Due soldier \$ _____ 100; due U. S. \$ _____ 100
Am't for cloth'g in kind or money adv'd \$ _____ 100

Due U. S. for arms, equipments, &c., \$ 41 ⁵⁵/₁₀₀
Bounty paid \$ _____ 100; due \$ _____ 100

Remarks: Joined at org. org.
Deserted at Portsmouth, Va.
June 14, 1865.
Disc. List, furn. Aug. 1/65.

Book mark: Discharged June 14, 1865
L.B. 16979 (over)

G. W. Chase

JAN. - 7

5320992

☆ 1891 ☆

3676 C. J. 1884

J. L. Cav. U.S.A.
Thomas Jones
, Col. 2^d Regt U.S.C. Cav.

NOTATION.

Book mark: *L. B. 16/9-9 with.*
3676 C.S. 1884

War Department,

Adjutant General's Office,

Washington, *Dec. 5*, 18*84*.

The charge *of desertion of June 14.*
1865,

against this man *is* removed and he is discharged
to date *June 14.*, 186*5*, under the pro-
visions of the act of Congress, approved July 5, 1884.

Discharge certificate furnished by Adjutant General's
Office *Dec. 9.*, 18*84*.

(4436) *J. L. Robinson* Copyist.

881

Jones Thomas

Co D, 2 U. S. Col'd Cav.

Private

Private

CARD NUMBERS.

1	5321620	26
2	5321720	27
3	5321822	28
4		29
5		30
6		31
7		32
8		33
9		34
10		35
11		36
12		37
13		38
14		39
15		40
16		41
17		42
18		43
19		44
20		45
21		46
22		47
23		48
24		49
25		50

Book Mark:

See also

J. | 2 Cav. | U.S.C.T.

Thomas Jones

Priv., Co. D, 2 Reg't U. S. Col'd Cavalry.

Appears on

Company Muster Roll

for May & April, 1865.

Present or absent Present

Stoppage, \$ 100 for

Due Gov't, \$ 100 for

Valuation of horse, \$ 100

Valuation of horse equipments, \$ 100

Remarks: Permitted from Depot

Enrolled mustered in
Mch. 16/65 at Baltimore
for 1 yr

Book mark:

C. W. Hillard

J | **2 Cav.** | **U.S.C.T.**
Thomas Jones
2d Co. D, 2 Reg't U. S. Col'd Cavalry.

Appears on

Company Muster Roll

for *May & June*, 1865:

Present or absent *Present*

Stoppage, \$ *100* for

Due Gov't, \$ *100* for

Valuation of horse, \$ *100*

Valuation of horse equipments, \$ *100*

Remarks: *Recruit from Depot*

Book mark:

C. W. Hillard

J | **2 Cav.** | **U.S.C.T.**

Thomas Jones

Plt, Co. D, 2 Reg't U. S. Col'd Cavalry.

Appears on

Company Muster Roll

for *April 30 to Aug 31, 1865*

Present or absent *Present*

Stoppage, \$ *100* for

Due Gov't, \$ *100* for

Valuation of horse, \$ *100*

Valuation of horse equipments, \$ *100*

Remarks: *Due U.S. for Ord #122*

*Name not borne on sub,
Rolls of Co.*

Book mark:

S. W. Hiltner

1882

Jones William

Co d, 2 U. S. Col'd Cav.

Private

Private

CARD NUMBERS.

1	5315539	26
2	5327714	27
3	5327808	28
4	5327938	29
5	5327988	30
6	5316977	31
7	5328103	32
8	5317211	33
9	5328153	34
10	9087890	35
11	4055827	36
12	5387835	37
12	34364385	38
14	40726240	39
15		40
16		41
17		42
18		43
19		44
20		45
21		46
22		47
23		48
24		49
25		50

Book Mark:

See also

2 Cav. | U.S.C.T.

William Jones

, Co. D, 2 Reg't U. S. Col'd Cav.

Appears on

Company Descriptive Book

of the organization named above.

DESCRIPTION.

Age 28 years; height 5 feet 9 inches.

Complexion Dark

Eyes Black; hair Black

Where born Virginia

Occupation Laborer

ENLISTMENT.

When March 13, 1865

Where Baltimore, Md.

By whom Capt. Calbraut, term 3 y'rs.

Remarks: Substitute for
Jacob F. Matthews 2^d Dist
Md. Amount on check
Book G. O. No. 305 - \$410
Mustered into the ser-
vice by Lt Sykes. Deserted
August 15/65 - at Clarksville
Texas. Returned from
desertion Oct. 3-66.

(3830)

F. B. Smith

Copyist.

J | 2 Cav | U.S.C.T.

William Jones

Riv., Co., 2 Reg't U. S. Col'd Cav

Age 28 years.

Appears on a

Detachment Muster-in Roll

of the organization named above. Roll dated

Baltimore, Md., Mar. 22, 1865.

Muster-in to date Mar. 14, 1865.

Joined for duty and enrolled:

When Mar. 13, 1865.

Where Baltimore, Md.

Period 3 years.

Valuation of horse, \$ 100

Valuation of horse equipments, \$ 100

Remarks: Substitute

Book mark :

Beck

J | ² 6 # | U.S.C.T.

William Jones

Appears with rank of _____ on
Muster and Descriptive Roll of a Detachment of Substitutes forwarded

for the ^{*}2 Reg't U. S. Col'd Cavalry. Roll dated
Not dated, _____, 186 .

Where born Virginia

Age 28 y'rs; occupation Laborer

When enlisted March 13, 1865.

Where enlisted Baltimore, Md.

For what period enlisted 3 years.

Eyes Blk hair Blk

Complexion Blk; height 5 ft. 9 in.

When mustered in _____, 186 .

Where mustered in _____

Bounty paid \$ _____; due \$ 100

Where credited 2" Dist. Md.

Company to which assigned _____

Remarks: Substitute for Jacob F. Matthews (over)

Became a Soldier

Corrected Aug 1897. End

Book mark: _____

Leonard
Copyist.

MAR 79

J | **2 Cav.** | **U.S.C.T.**

William Jones

Appears with the rank of _____ on

Muster and Descriptive Roll of a Detachment of Substitutes forwarded

for the 2 Reg't U. S. Colored Cav. Roll dated

Baltimore Md, Mch 20, 186 5.

Where born *Virginia*

Age *28* y'rs; occupation *laborer*

When enlisted *Mch 13, 186 5.*

Where enlisted *Baltimore Md.*

For what period enlisted *3* years.

Eyes *Blk*; hair *Blk*

Complexion *dark*; height *5* ft. *9* in.

When mustered in _____, 186 .

Where mustered in _____

Bounty paid \$ *100*; due \$ *100*

Where credited _____

Company to which assigned _____

Remarks *Substitute for Jacob F Matthews 2 Desr. Md.*

Book mark: _____

R. V. Bayle

J | 2 Cav. | U.S.C.T.

William Jones

for, Co. I, 2 Reg't U. S. Col'd Cavalry.

Appears on

Company Muster Roll

for Mch & Apr, 1865.

Present or absent Absent

Stoppage, \$ 100 for

Due Gov't, \$ 100 for

Valuation of horse, \$ 100

Valuation of horse equipments, \$ 100

Remarks: In arrest for
desertion

Book mark:

(358)

D. J. Griffith

Copyist.

MAR 31

J | **2 Cav.** | **U.S.C.T.**

William Jones

priv, Co. I, 2 Reg't U. S. Col'd Cavalry.

Appears on

Company Muster Roll

for *May & June*, 186*5*.

Present or absent *Present*

Stoppage, \$ 100 for

Due Gov't, \$ 100 for

Valuation of horse, \$ 100

Valuation of horse equipments, \$ 100

Remarks: *Due Soldier on
check book \$ 410.00*

Book mark:

D. J. Griffith

(358)

Copyist.

J | 2 Cav. | U.S.C.T.

William Jones

Private, Co. I, 2 Reg't U. S. Col'd Cavalry.

Appears on

Company Muster Roll

for July & August, 1865.

Present or absent

Stoppage, \$ 100 for

Due Gov't, \$ 100 for

Valuation of horse, \$ 100

Valuation of horse equipments, \$ 100

Remarks: Deserted Aug 15, 1865 at Clarksville Texas. Deserted with set of equipments. Due U.S. for Ordnance \$43.50 Due Soldier on check book \$410.00

Book mark:

D. J. Crippen

J. | 2 Cav. | U.S.C.T.

William Jones.

Priv, Co. I, 2 Reg't U. S. Col'd Cavalry.

Appears on

Company Muster Roll

for Sept. & Oct., 1862.

Present or absent Absent.

Stoppage, \$ 100 for

Due Gov't, \$ 100 for

Valuation of horse, \$ 100

Valuation of horse equipments, \$ 100

Remarks: Absent sick in U.S. G. Hospital.

Book mark:

Pol

J 1 26av US67
Wm Jones
Pvt, Co. I, 2 Reg't US6avy

Appears on

Descriptive List of Deserters

from 3 Division, 25 Army Corps,

dated Sept 1, 1865.

Age 28 years; height, 5 feet 9 inches.

Complexion DK; eyes BLK; hair BLK

Where born Virginia

Occupation Laborer

When enlisted Mch 13, 1865.

Where enlisted Baltimore

When mustered in Mch 13, 1865.

Where mustered in Baltimore

For what period mustered in 3 years

Deserted:

When Aug 15, 1865.

Where Clarksville Tex

Remarks:

Book mark:

J | 2 Cav | U.S.C.T.

William Jones

Pvt., Co. D, 2 Reg't U. S. Col'd Cav

Appears on

Descriptive List of Deserters

dated Sept 12, 1865

Deserted:

When Aug 15, 1865

Where Clarksville Texas

Arrested:

When, 186

Where

Remarks:

Book mark:

E. Weston

1865
I | 2 Cav | U.S.C.T.

William Jones
Pvt., Co. I, 2 Reg't U. S. Col'd Cav

Appears on

Descriptive List of Deserters

dated Nov 1, 1865.

Deserted :

When _____, 186 .

Where _____

~~Arrested:~~ Joined from Desertion

When July, 1865.

Where Clarksville Texas.

Remarks : _____

Book mark : _____

E. Arsten.

J. | 2 Cav. | U.S.C.T.

William Jones.

Priv, Co. I, 2 Reg't U. S. Col'd Cavalry.

Appears on

Company Muster Roll

for Nov. T Dec, 1865.

Present or absent Absent.

Stoppage, \$ 100 for

Due Gov't, \$ 100 for

Valuation of horse, \$ 100

Valuation of horse equipments, \$ 100

Remarks: Absent sick in Hospital.

Book mark:

Pol

2 Cav. U.S.C.T.

Wm A Jones
Pot, Co. I, 2 Reg't U. S. Colored Cav.

Appears on Returns as follows:

Mar 1865 Gam, Mar
23, 65 Norfolk
Va Reit from
depot for 3 yr
May 1865 Has a
deserter taken
up twice on last
monthly return
Aug 1865 Deserted
Aug 15, 65 Clarke
ville
Oct 1865 Train joined
Train deserter
Oct 22, 65 Clarke
ville Tex
Dec 1865 Absent in
arrest at Post
Guard House
Jan 1866 Absent
in arrest at Key
Fortugas Fla

Book mark:

(546)

A Douglas
Copyist.

J. | 2 Cav. | U.S.C.T.

William Jones.

Priv., Co. I, 2 Reg't U. S. Col'd Cavalry.

Appears on Co. Muster-out Roll, dated Brazos Santiago Tex, Feb. 12, 1866.

Muster-out to date, 1866.

Last paid to Enrollment, 1866.

Clothing account:

Last settled, 1866; drawn since \$100

Due soldier \$100; due U. S. \$100

Am't for cloth'g in kind or money adv'd \$100

Due U. S. for arms, equipments, &c., \$100

Bounty paid \$100; due \$100

Remarks: joined as recruit due U.S. for ordnance / canteen, some equipments \$43.50. Absent at dry tortugas with descriptive list awaiting sentence of G.B.M. at hard labor for 2 months. No discharge given.

Book mark: V137.P.191.72.

Pol,

Jones, W/m
Co. D, 2 U.S.C. Cav. Reg't

9 Enclosures.

Bed Cards	Final Statements
Burial Records	Furloughs or L. of A
Certs. of Dis. for Discharge	Med. Certificates
C. M. Charges 2	Med. Des. Lists
Descriptive Lists 1	Orders 1
Discharge Certificates	Pris. of War Record
Enlistment Papers 1	Resignations

Other papers relating to—

Admission to Hosp'l	Furlough or L. of A
Casualty Sheet	Med. Examination
Confinement 1	Misc. Information 1
Contracts	Pay or Clothing
Death or Effects	Personal Reports
Desertion 2	Rank
Discharge from Hosp'l	Transfer to Hosp'l
Discharge from Service 1	Transfer to V. R. C.
Duty	Transportation

William Jones

Co I 2nd U.S. Col. Inf.

Wm Ellbrook

I

110678

Adjutant General's Office,

COLORED TROOPS BRANCH,

August 12th, 1874

Mr. Ellertson Vol. C. T., 187

Wanted in case of

2^d Reg't William Jones, Private, Co. ,
1865. About "An arrest for desertion" and on Roll for March and April
August 1865. "Deserted Aug 15th 1865. at Clarksville, Texas."
Please furnish date of return to his company for duty, and
Sentence if tried.

Respectfully,

 A Woodward

Chief Clerk.

 J. Halton,

Adjutant General's Office.

, 187

Vol. C. T., 187

Reply in case of , Co. ,

Reg't

D. Book reports William Jones, deserted Aug. 15th '65 at
Clarksville, Texas. Returned from desertion Oct. 13th '65.
Mor. reports prior to July '65. not filed. Reports Aug 14th
'65. William Jones reported as a deserter, Oct. 19th '65.
H^{on} R. Jones returned from desertion, Oct 23rd '65.
H^{on} R. Jones sent to Hospital, Dec. 21st '65 H^{on} Jones
returned from G. H. Hospital. Records of Regiment
and Genl. Order 3rd Div. 25th Corps furnish no evidence
of trial.

B.

H. G. Co. Cavalry Brigade
Camp Smith May 24/65

Special Order
No 7 I

Relieving Private B.
A. Jones from duty
in the Company Dept
Cavalry Brigade
2 U. S. C. C.

Head Quarters, Cav. Brigade 25th. A.C.
Camp Sincere Va. May 21st. 1865

Special Orders.
No. 7

Extract.

I The following named Enlisted
men are hereby relieved from duty in the Commissary
Department and ordered to report to their respective Company
Commanders for duty.

Priv. R. W. Jones 2^d U. S. C. Cal.

+ x - x

By Order of Brig. Gen. Geo. W. Cole,
Muller D. Munson Comdg. Cav. Brigade
A. A. A. Genl. 25th. A.C.
Cav. Brigades

Comdg. Officer 2^d U. S. C. Cal.

Charge and Specification
against

Priv William R. Jones
C. J. 2nd Class Car
M. 130. (Eva) 18/5,

C. M. C.



copy

Charges & Specifications against Private
Wm R. Jones Co. I. 2nd U.S. Col. Cav.

Charge 1st

Violation of the 20th Article of War

Specification 1st

In this that the said Private William R. Jones Co. I.
2nd U.S. Col. Cav., having been duly enlisted, and mustered
into the service of the United States, did desert the
same. This at or near Norfolk Va. on or about the
3rd day of April 1865

Officer Preferring Charges
H. Peterson

Capt. Co. I. 2nd U.S. Col. Cav.

Witnesses

1. St. A. E. Palmer

2nd U.S. Col. Cav.

1. Srgt. Rudolph Driver

Co. I. 2nd U.S. Col. Cav.

" George Honeaty

"

Office Provost Marshal
Dist. of E. Va.,
Suffolk, Va. May 11th 1865

Respectfully forward
ed to Col. Cole, with reference
to endorsement of Dist. Hd. Qrs.

O. D. Mann

Colonel Provost Marshal
Dist. of E. Va.

Mrs. R. Jones
P. 2700 E. Co.

C. 711. C

Cross Enc

Office Provost Marshal
Suffolk May 12th 1865

Mann. O. Le.
Sr Col & Provost Marshal

Returns Charges against
3 En. men charged with
desertion. But the men
were not returned herewith

W. D. M

(4 Enclosures)

Recd RHQ May 11th 1865

NOVA 99

RICHMOND, VIRGINIA,

April 23 1866.

W. H. Stanton
PAYMASTER, U. S. ARMY.

Receipts for Muster-Out and Pay Rolls.

*2/10/66
P. S. R. C. Co.*

Received at C. S. O.
COMMISSARY OF
MUSTERS.
April 23, 1866.
Dept. of Virginia.

Richmond, Va., April 23 1866.

Received of Brevet Major FRED MARTIN, Chief Commissary of
Musters, Department of Virginia, the Muster-Out and Pay Rolls of
the following named officers and enlisted men.

RANK.	NAME.	Company.	REGIMENT.
Private	William Jones	D	2nd U.S. Cavalry

F. S. Martin
Paymaster, U. S. A.

Provosts Marshal Office
Norfolk April 22^d 1865

Outcliffe Haman
1st Lt & Asst P. M.

Forwards Priv R
Jones Co I 2nd USCC
arrested as deserter
by Sergt. Brown, A. E.

(1 Enclosure)

Deserter

Recd R HQ 2nd USCC
8 P.M. Apr. 22^d 1865

OFFICE PROVOST MARSHAL,

DISTRICT OF EASTERN VIRGINIA,

Norfolk, Va., April 22^d

1865.

Col. Cole

Comdg 2^d U.S. Col'd Cavalry.

Colonel.

I have the honor to forward herewith the following named Man suspected of desertion from your regiment.

Viz. — R. Jones, Priv. Co. 9th U.S. C. Cavalry.

Please acknowledge receipt

Very Respectfully

Your Obedient Servant

Haman Sutcliffe

Lieut & Asst Provost Marshal

Dist of Va., Va.

per Dykes JR

DECLARATION OF SUBSTITUTE.

I, William Jones Col, desiring to ENLIST in the Army of the United States, for THREE YEARS, **Do declare**, That I am Twenty Eight years and _____ months of age; that I have never been discharged from the United States service on account of disability or by sentence of a court martial; and I know of no impediment to my serving honestly and faithfully as a soldier for three years.

GIVEN at Baltimore Md
the 13th day of March 1865

WITNESS:
Wm O. Jones

William Jones
mark

26

No. _____

William Jones Col

Enlisted at Baltimore Md

As Substitute for

James M. Matthews

On the 13th day of March, 1865,

By

William Jones Col

James M. Matthews

Wm O. Jones

Board of Enrollment,

2nd Dist. of Maryland

(No. 39.)

SUBSTITUTE VOLUNTEER ENLISTMENT.

STATE OF

TOWN OF

Maryland



Baltimore

I, *William Jones* *love*, born in the State of *Virginia*, aged *Twenty Eight* years, and by occupation a *Laborer*, Do HEREBY ACKNOWLEDGE to have agreed with *Jacob S. Matthews*, Esq., of *18th Sub Dist* *D. Dist Maryland*

to become his **SUBSTITUTE** in the Military Service, for a sufficient consideration paid and delivered to me, on the *Thirteenth* day of *March*, 186*5*; and having thus agreed with said *Jacob S. Matthews*, I DO HEREBY ACKNOWLEDGE to have enlisted this *Thirteenth* day of *March*, 186*5*, to serve as a **Soldier** in the **Army of the United States of America**, for the period of **THREE YEARS**, unless sooner discharged by proper authority. I do also agree to accept such bounty, pay, rations, and clothing as are, or may be, established by law for soldiers. And I do solemnly swear that I will bear true and faithful allegiance to the **United States of America**; that I will serve them honestly and faithfully against all their enemies or opposers whomsoever; and that I will observe and obey the orders of the President of the United States and the orders of the officers appointed over me, according to the Rules and Articles of War.

SWORN and subscribed to, at *Balt. Md.*
this *13th* of *March*, 186*5*,
BEFORE *Robert Leather*
Capt. U.S. Mar. D. Dist Md.

William ^{his} *Jones*
mark

We certify, on honor, That we have carefully examined the above-named Volunteer Substitute agreeably to the Regulations, and that, in our opinion, he is free from all bodily defects and mental infirmity which would in any way disqualify him from performing the duties of a soldier; that he was entirely sober when enlisted; that he is of lawful age, (not under 18 years;) and that, in accepting him as duly qualified to perform the duties of an able-bodied soldier, and as a Substitute in lieu of *Jacob S. Matthews* *Enrolled for Draft*, drafted in *18th Sub Dist D. Dist Md.*, 186*5*, we have strictly observed the Regulations which govern in such cases. This soldier has *Black* eyes, *Black* hair, *Black* complexion; is *5* feet *9* inches high.

Robert Leather
Capt. Provost Marshal.

J. S. Chapman
Commissioner of Board.

J. Robt. Ward
Surgeon of Board.

Board of Enrollment of *D. Dist. of Maryland*

Respectfully re-
ferred to Captain
H. Peterson & Co
for information

To be returned
at once with facts
of the within case
By order of George
Candy Res

W. D. Munson
J. St. Adolph

The two copies
- April 2nd 1861

Respectfully return with information
that the said private - is a member
of Co 2nd Regt, is a substitute for Jacob
Matthews 2nd Dist Regt, enlisted April
1st 1861.

Henry Peterson
Capt Co 2nd Regt

PROVOST MARSHAL'S OFFICE,

Portsmouth, Va., April 22^d 1865.

Lieut. Col. O. L. Mann
Provost Marshal, Norfolk Va
Colonel

I have the honor to forward herewith Priv. R. Jones, Co. D. 2 U. S. C. Cav. who was arrested by Seryt. Lewis Boone (Co. E. of the above named Regt.) who claims that Jones is a deserter from this Regiment. Jones claims, however, that he has never been mustered into the U. S. Service. Perhaps it would be well to refer the case to Col. Cole, Comdg 2 U. S. C. Cav.

Very Respectfully
Your Obedt. Servt.

J. F. Williamson
Maj. & Prov. Marshal

1965 APR 22

3-684 Write nothing below this line.

Commitment of
James P. Jones
2nd World War.
April 22, 1965

Office Provost Marshal, Dist. E. Va.,

Norfolk, Va. *Apr 22* 1865.

OFFICER IN CHARGE CITY JAIL

Will confine until further orders,

*Wm R. Jones
Co. S. 2nd Regt. S. V. C.
Charges
Desertion*

Gordon
By Order Brig. Gen. SHEPLEY:

Assistant
Capt. J. [unclear] Provost Marshal, Dist. E. Va.

above this line.

37

MUSTER-OUT ROLL

✓

^{OF}
Wm Jones
Priv. Co
2nd U.S.C.

Co. W.F.

Received A. G. O., April 25, 1866

To be filed with personal papers
By order of Dr. Amisworth
J. C. B.

Wm
W.B.

OFFICE OF THE
COMMISSIONER OF
MUSTERS
April 23, 1866.
Dist. of Virginia.

MUSTER-OUT ROLL

of Captain Henry Peterson's late Company the Second Regiment of Volunteer Cavalry, commanded at Fort Monroe Va (the place of general rendezvous) on the twenty second day of March, 1866, to serve for the term of thence to [when last paid] to the twelfth day of March, 1866, when mustered out. The Company was organized by Capt Wm S. Phelps where it arrived the under S.O. No. 8, a distance of 13 miles from Richmond Va.

NUMBER OF EACH GRADE.	NAMES. PRESENT AND ABSENT. <small>(Privates in alphabetical order - the first christian name to be written full length.)</small>	RANK.	AGE.	JOINED FOR SERVICE AND ENROLLED AT GENERAL RENDEZVOUS - COMMENCEMENT OF FIRST PAYMENT BY TIME.				MUSTERED INTO SERVICE.			LAST PAID.		TRAVELING		
				WHEN.	WHERE.	BY WHOM.	PERIOD.	WHEN.	WHERE.	BY WHOM.	BY PAYMASTER.	TO WHAT TIME.	To place of rendezvous, No. of miles.	From home, of miles.	
30	<u>James William</u>	<u>Private</u>	<u>28</u>	<u>1865</u>	<u>March 13</u>	<u>Baltimore Md</u>	<u>Capt Albraut</u>	<u>3 yrs</u>	<u>1865</u>	<u>March 13</u>	<u>Baltimore Md</u>	<u>Capt Albraut</u>	<u>Pay due from Enrollment</u>		

Extract

certify on honor that this roll is a correct extract from the Muster Roll of Co "J" 2nd Regt Cavalry in case of James William Jones. Amount of Clothing issued on Jan'y 10th 1866 (date describing list was issued) \$79.20 Amount of Clothing drawn at Fort Monroe Va. on March 15th 1866 amount in check \$100.00

Fred Martin
Brig Major U.S. Army

RECAPITULATION.		Captain.	1st Lieutenant.	2d Lieutenant.	Sergeants.	Corporals.	Buglers.	Drummers.	Officers.	Farmers & Bk's.	Artificers.	Privates.	Total.	AGGREGATE.	Total last muster.
PRESENT...	For duty.....														
	Extra duty.....														
	Sick.....														
ABSENT...	In arrest or confinement...														
	Detached service.....														
	Furlough.....														
	In arrest or confinement...														
	Sick.....														
Prisoners of war.....															

RECAPITULATION.		Captain.	1st Lieutenant.	2d Lieutenant.	Sergeants.	Corporals.	Buglers.	Drummers.	Officers.	Farmers & Bk's.	Artificers.	Privates.	Total.	AGGREGATE.	Total last muster.
STRENGTH—PRESENT AND ABSENT.....															
No. JOINED..	By Enrollment.....														
	By Transfer.....														
	From Desertion.....														
No. DISCHARGED	Expiration of service.....														
	For Disability.....														
	No. Transferred.....														
No. Died.....															
No. of Desertions.....															

DIRECTIONS TO MUSTERING OFFICERS.

The Mustering Officer will see that five copies of this Roll are made out, four of which he will retain, the fifth will be retained by the Company Commander, or, in case of Field and Staff and Officers and Men mustered out of service separately or in squads, by the Senior Officer, Non-commissioned Officer, or Private standing first on the list of persons so mustered out. The Mustering Officer will dispose of the four copies retained by him, as follows: One will be sent to the Adjutant-General of the Army, and one to the "Bounty Bureau," Washington, D. C., and two to the Paymaster by whom the troops are to be paid.

J. L. [Signature]

rs, commanded by Colonel Geo. H. Cole called into the service of the United States by the President
 rm of three years, from the date of enrollment, unless sooner discharged; from the thirtieth day of June, 1865,
 by Capt. James G. Cole at _____, in the month of _____, 1865, and marched
Texas miles.

TRAVELING.		SUBSISTENCE AND FORAGE.		AMOUNT		VALUE OF		VALUATION,		REMARKS.
To place of rendezvous, No. of miles.	From place of discharge, No. of miles.	Furnished by themselves since the muster into service.		for clothing in kind, or in money advanced.		equipments, arms, &c., received from the United States, to be paid for if lost or destroyed.		in dollars, of—		
		SUBSISTENCE.	FORAGE.	Dolls.	Cts.	Dolls.	Cts.	Horses.	Horse Equipments.	
		No. days.	No. days.							1. Under the head of REMARKS the date of an officer or soldier's joining from any absence; the date of an officer's assuming, or being relieved, from any command or special duty; the description of any special extra, or daily duty, on which officers or soldiers may be; all changes of rank, by promotion, appointment or reduction, with date of same; all authorized stoppages, fines, sentences, with No., date, &c., of order, &c.; in case of absence, its nature and commencement, No., date, &c., of order, and period assigned for same (to be repeated on every roll while it lasts); if wounded in battle, or injured on duty,—if sick, or confined, a remark to that effect, &c., &c.—must be carefully stated opposite to the name of the person concerned, with everything else necessary, either to account fully for every individual of the company,—to guide the paymaster,—or ensure justice to the name of the person concerned, with everything else necessary, either to account fully for every individual of the company. 2. All articles which are to be paid for will be stated by the captain opposite to the name of the soldier. 3. Every man whose name is on previous rolls must be accounted for on this one. The exchange of men by substitution, and the exchanging, swapping or loaning of horses, after muster into service, are strictly forbidden.
										James as substitute. Dressed for Ordnance 1. Thoug. Amel. wiper and crew dinner \$ 0. 7/8 absent at Dry Tortugas with descriptive list. Entered by G.C.M. at Harbor for 2 months

I CERTIFY, ON HONOR, that this Muster Roll exhibits the true state of Captain Henry Peterson's
Company the 2nd Regt. U.S. Cavalry for the period herein mentioned;
 that each man answers to his own proper name in person; that the remarks set opposite the name of each officer and soldier are accurate and just, and that the valuation of all horses and horse equipments since the muster into service, was made by disinterested and good judges, and at fair and just rates.

(Signed) Henry Peterson
Capt 2nd Regt. U.S. Cavalry
 Commanding the Company

I CERTIFY, ON HONOR, that I have at Drago Santiago Texas on this twelfth
 day of February, 1866, carefully examined this Roll, and, as far as practicable, caused the allowances, stoppages, and remarks to be justly and properly stated, and mustered the Company
 for discharge; and it is hereby honorably discharged from the service of the United States.

(Signed) David H. Mann
1st Lieut. 2nd U.S. Cavalry
 Mustering Officer.

MUSTER... { Date, February 12th 1866
 Station, Drago Santiago Texas

883

Jordan Andrew

Co G, 2 U. S. Col'd Cav.

Private

corporal

CARD NUMBERS.

1	5324641	26
2	5324717	27
3	5324876	28
4	5324895	29
5	5324985	30
6	5316254	31
7	5325077	32
8	5325171	33
9	5325255	34
10	5325312	35
11	5325407	36
12	5325502	37
12	5325588	38
14	5325667	39
15	5325741	40
16	9087690	41
17	40726165	42
18		43
19		44
20		45
21		46
22		47
23		48
24		49
25		50

Book Mark:

See also

J | 2 Cav. | U.S.C.T.

Andrew Jordan

, Co. G, 2 Reg't U. S. Col'd Cav.

Appears on

Company Descriptive Book

of the organization named above.

DESCRIPTION.

Age 30 years; height 5 feet 11 inches.

Complexion Dark

Eyes Dark; hair Dark

Where born Highford, Va.

Occupation Laborer

ENLISTMENT.

When Dec. 25, 1863.

Where Norfolk, Va.

By whom Col G.W. Cole; term 3 y'rs.

Remarks: Promoted to
serge April 11, 1865
Engaged in action
at Dury's Bluff, Va.
May 16-65
New Market Heights
Sept 29-65.

F. B. Smith
Copyist.

J | **2 Cav.** | **U.S.C.T.**

Andrew Jordan
Pvt, Co. *G*, 2 Regt U. S. Col'd Cavalry.

Age *30* years.

Appears on

Company Muster-in Roll

of the organization named above. Roll dated

H Mour Va July 8, 186 *4*

Muster-in to date *July 8*, 186 *4*

Joined for duty and enrolled:

When *Nov*, 186 .

Where *Norfolk Va*

Period *3* years.

Valuation of horse, \$ 100

Valuation of horse equipments, \$ 100

Remarks :

Book mark: -----

A. M. Harmon
(356) Copyist.

J | **2 Cav.** | **U.S.C.T.**

Andrew Jordan
Pr., Co. G, 2 Reg't U. S. Col'd Cavalry.

Appears on

Company Muster Roll

for *March 29*, 186*4*.

Present or absent *Absent*

Stoppage, \$ 100 for

Due Gov't, \$ 100 for

Valuation of horse, \$ 100

Valuation of horse equipments, \$ 100

Remarks:

Book mark: -----

J. M. Harmon

J | **2 Cav.** | **U.S.C.T.**

Andrew Jordan
Prf, Co. G, 2 Reg't U. S. Col'd Cavalry.

Appears on

Company Muster Roll

for *Mar & Apr*, 1864.

Present or absent *Present*

Stoppage, \$ *100* for

Due Gov't, \$ *100* for

Valuation of horse, \$ *100*

Valuation of horse equipments, \$ *100*

Remarks:

Book mark: -----

J. W. Harmon

J | 2 Cav. | U.S.C.T.

Andrew Jordan

Prs., Co. G, 2 Reg't U. S. Col'd Cavalry.

Appears on

Company Muster Roll

for *May June*, 186 *4*

Present or absent *Present*

Stoppage, \$ 100 for

Due Gov't, \$ 100 for

Valuation of horse, \$ 100

Valuation of horse equipments, \$ 100

Remarks: *Payover \$ per mo.*
Since Jan 1

Book mark:

J. M. Harrison

J | 2 Cav. | U.S.C.T.

Andrew Jordan

Priv, Co. G, 2 Reg't U. S. Col'd Cavalry.

Appears on

Company Muster Roll

for July & Aug, 1864.

Present or absent absent

Stoppage, \$ 100 for

Due Gov't, \$ 100 for

Valuation of horse, \$ 100

Valuation of horse equipments, \$ 100

Remarks: Detached in
A.M. & as Teamster.

Book mark:

(358)

J. Brown Copyist.

J | *L* *bar* | **U.S.C.T.**

Andrew Jordan
Pri, Co., *L* Reg't U. S. Col'd *bar*

Appears on a

Detachment Muster Roll

of the organization named above

for *Dated Sept 1*, 186*4*.

Station *In the field*

Present or absent *Present*

Stoppage, \$ *100* for

Due Gov't, \$ *100* for

Valuation of horse, \$ *100*

Valuation of horse equipments, \$ *100*

Remarks:

Book mark:

A. Smith

F | **2 Cav.** | **U.S.C.T.**

Andrew Jordan

Priv, Co. G, 2 Reg't U. S. Col'd Cavalry.

Appears on

Company Muster Roll

for *Sept & Oct*, 186*4*.

Present or absent *present*

Stoppage, \$ *100* for

Due Gov't, \$ *100* for

Valuation of horse, \$ *100*

Valuation of horse equipments, \$ *100*

Remarks:

Book mark: -----

J. Brown
Copyist.

2 | 2 Cav. | U.S.C.T.

Andrew Jordan

Pris, Co. G, 2 Reg't U. S. Col'd Cavalry.

Appears on

Company Muster Roll

for *Nov + Dec*, 1864

Present or absent *present*

Stoppage, \$ *100* for

Due Gov't, \$ *100* for

Valuation of horse, \$ *100*

Valuation of horse equipments, \$ *100*

Remarks:

Book mark:

J. J. Brown
(358) Copyist.

J | **2 Cav. | U.S.C.T.**

Andrew Jordan

Pr....., Co. G, 2 Reg't U. S. Col'd Cavalry.

Appears on

Company Muster Roll

for *Jan + Feb*, 1865.

Present or absent *present*

Stoppage, \$..... *100* for

Due Gov't, \$..... *100* for

Valuation of horse, \$..... *100*

Valuation of horse equipments, \$..... *100*

Remarks:

Book mark:

J. A. Brown

J. | **2 Cav.** | **U.S.C.T.**

Andrew Jordan

Corpl., Co. G, 2 Reg't U. S. Col'd Cavalry.

Appears on

Company Muster Roll

for *McK + Apr*, 1865.

Present or absent *Present*

Stoppage, \$ *100* for

Due Gov't, \$ *100* for

Valuation of horse, \$ *100*

Valuation of horse equipments, \$ *100*

Remarks: *Promoted Apr 1/65, as per
S. O. No. dated Apr 2^d 1865.*

Book mark: *100*

J. E. Chapin

J | **2 Cav.** | **U.S.C.T.**

Andrew Jordan
Capt., Co. G, 2 Reg't U. S. Col'd Cavalry.

Appears on

Company Muster Roll

for *May + June*, 186*5*.

Present or absent *present.*

Stoppage, \$ *100* for

Due Gov't, \$ *100* for

Valuation of horse, \$ *100*

Valuation of horse equipments, \$ *100*

Remarks: *Promoted Capt.*
April 1, 1865.

Book mark:

E. J. ...

J | **2 Cav.** | **U.S.C.T.**

Andrew Jordan
Capt., Co. G, 2 Reg't U. S. Col'd Cavalry.

Appears on

Company Muster Roll

for *July & Aug.*, 186*5*.

Present or absent *present.*

Stoppage, \$ *100* for

Due Gov't, \$ *100* for

Valuation of horse, \$ *100*

Valuation of horse equipments, \$ *100*

Remarks: *Promoted Capt April*
65.

Book mark:

Fulton

J | **2 Cav.** | **U.S.C.T.**

Andrew Jordan
Corpl., Co. G, 2 Reg't U. S. Col'd Cavalry.

Appears on

Company Muster Roll

for *Sept. & Oct.*, 186*5*.

Present or absent *Present*

Stoppage, \$ *100* for

Due Gov't, \$ *100* for

Valuation of horse, \$ *100*

Valuation of horse equipments, \$ *100*

Remarks:

Book mark: -----

(358)

C. J. McLaughlin
Copyist.

J | **2 Cav.** | **U.S.C.T.**

Andrew Jordan
Corpl., Co. G, 2 Reg't U. S. Col'd Cavalry.

Appears on

Company Muster Roll

for Nov. & Dec., 1865.

Present or absent Present

Stoppage, \$ 100 for

Due Gov't, \$ 100 for

Valuation of horse, \$ 100

Valuation of horse equipments, \$ 100

Remarks:

Book mark:

(358)

Les W. Langhlin
Copyist.

J | 2 Cav. | U.S.C.T.
x
Andrew Jordan
Pat. Co. G, 2 Reg't U. S. Colored Cav.

Appears on Returns as follows:

July & Aug 1864 Ab-
sent det serdoo
teamster for \$0.40
Hd Qrs 2 B. I did
18 A.C.

Sept 1864 On duty
Co Cook

Nov 1864 Absent on
A.C. by letter from
Corps Hd Qrs

Dec 1864 Absent sick
in Genl Haspel

June 1865 Absent
det in 2nd Me Depot

Does not appear also on
Jordan's

Book mark:

(546) A. J. Gougeon Copyist.

J | **2 Cav.** | **U.S.C.T.**

Andrew Jordan
Capt, Co. G., 2 Reg't U. S. Col'd Cavalry.

Appears on **Co. Muster-out Roll**, dated
Vezoz. Santiago, Feb 12, 1866.
Muster-out to date Feb. 12, 1866.
Last paid to June 30, 1865.

Clothing account:

Last settled....., 186 ; drawn since \$..... 100
Due soldier \$ 13 ⁷⁰ / 100; due U. S. \$..... 100
Am't for cloth'g in kind or money adv'd \$..... 100

Due U. S. for arms, equipments, &c., \$..... 100
Bounty paid \$..... 100; due \$ 300 ⁰⁰ / 100

Remarks: Joined at Orig.
Org. Promoted Capt.
Apr. 1, 65.
Free before Apr. 19/65

Book mark :

C. M. Laughlin
(361) Copyist.

884

Jordan Willis

Co G, 2 U. S. Col'd Cav.

Private | Private

CARD NUMBERS.

1	5324642	26
2	5324716	27
3	5324807	28
4	5324896	29
5	5324986	30
6	5376472	31
7	5325078	32
8	5376585	33
9	5325172	34
10	5325256	35
11	5325348	36
12	5325445	37
12	5325539	38
14	5325654	39
15	5325818	40
16	9087690	41
17	40726250	42
18		43
19		44
20		45
21		46
22		47
23		48
24		49
25		50

Book Mark:

See also

J | 2 Cav. | U.S.C.T.

Willis Jordan

, Co. H, 2 Reg't U. S. Col'd Cav.

Appears on
Company Descriptive Book
of the organization named above.

DESCRIPTION.

Age 40 years; height 5 feet 4 inches.

Complexion Dark

Eyes Dark; hair Dark

Where born Edenton, N. C.

Occupation Svt.

ENLISTMENT.

When Dec 25, 1863.

Where Norfolk Va.

By whom Col. G. W. Cole; term 3 y'rs.

Remarks: Engaged in action at Drury's Bluff, Va, May 16-65. On Det. Serv. in Sub. Train 18 A. C. from Aug. 4 to Jan. 1-65. Died in U. S. Genl. Hosp't New Orleans La. Sept. 17 1865 of Darrhorea. Descriptive List furnished when he was sent to Hospital

F. B. Smith

J | **2 Cav.** | **U.S.C.T.**

Willis Jordan
Pvt, Co. *G*, 2 Reg,t U. S. Col'd Cavalry.

Age *45* years.

Appears on

Company Muster-in Roll

of the organization named above. Roll dated

St. Manor Va, *Jan 8*, 186*4*

Muster-in to date *Jan 8*, 1864.

Joined for duty and enrolled:

When *Dec 20*, 186

Where *Norfolk Va*

Period *3* years.

Valuation of horse, \$ *100*

Valuation of horse equipments, \$ *100*

Remarks :

Book mark :

J M Harmon

J | **2 Cav.** | **U.S.C.T.**

Willis Jordan

Prvt., Co. G, 2 Reg't U. S. Col'd Cavalry.

Appears on

Company Muster Roll

for dated Feb 29, 1864.

Present or absent Present

Stoppage, \$ 100 for

Due Gov't, \$ 100 for

Valuation of horse, \$ 100

Valuation of horse equipments, \$ 100

Remarks:

Book mark:

J. M. Harmon

J | **2 Cav. U.S.C.T.**

Willis Jordan
Pvt, Co. G, 2 Reg't U. S. Col'd Cavalry.

Appears on

Company Muster Roll

for *Mar & Apr*, 186 *4*.

Present or absent *Present*

Stoppage, \$ *100* for

Due Gov't, \$ *100* for

Valuation of horse, \$ *100*

Valuation of horse equipments, \$ *100*

Remarks:

Book mark: -----

J. W. Harmon

J | 2 Cav. | U.S.C.T.

Willis Jordan
Capt., Co. G, 2 Reg't U. S. Col'd Cavalry.

Appears on

Company Muster Roll

for May & June, 1864.

Present or absent Present

Stoppage, \$ 100 for

Due Gov't, \$ 100 for

Valuation of horse, \$ 100

Valuation of horse equipments, \$ 100

Remarks: Payor \$ 7 per mo.
due since Jan. 1

Book mark:

M. Harmon

J | **2 Cav.** | **U.S.C.T.**

Willis Jordan

Pr....., Co. G, 2 Reg't U. S. Col'd Cavalry.

Appears on

Company Muster Roll

for *July & Aug*....., 186*4*.

Present or absent *absent*.....

Stoppage, \$..... *100* for.....

Due Gov't, \$..... *100* for.....

Valuation of horse, \$..... *100*

Valuation of horse equipments, \$..... *100*

Remarks: *Detached in Ambulance boys.*

Book mark:.....

(358) *J. Brown* Copyist.

L. Taylor | U.S.C.T.

William Adam
Co. 1st, Co. *1st* Reg't U. S. Col'd *Cal*

Appears on a

Detachment Muster Roll

of the organization named above

for *July & Aug*, 1864.

Station *On the Field, Va-*

Present or absent *Present*

Stoppage, \$ *100* for

Due Gov't, \$ *100* for

Valuation of horse, \$ *100*

Valuation of horse equipments, \$ *100*

Remarks:

Book mark:

W. Adam

J | **2 Cav.** | **U.S.C.T.**

Willis Jordan

Pri, Co. G, 2 Reg't U.S. Col'd Cavalry.

Appears on

Company Muster Roll

for *Sept & Oct*, 186*4*.

Present or absent *absent*

Stoppage, \$ *100* for

Due Gov't, \$ *100* for

Valuation of horse, \$ *100*

Valuation of horse equipments, \$ *100*

Remarks: *Detached in
Amb corps 18" al*

Book mark: _____

(358)

J. T. Brown
Copyist.

J | *2^d Cav.* | **U.S.C.T.**

Willis Gordon
Date, Co. *E.*, *2^d* Reg't U. S. Col'd *Cav.*

Appears on a

Detachment Muster Roll

of the organization named above

for *Sept & Oct*, 186*4*.

Station *near Chahins Farm Va*

Present or absent *Present*

Stoppage, \$ *100* for

Due Gov't, \$ *100* for

Valuation of horse, \$ *100*

Valuation of horse equipments, \$ *100*

Remarks:

Book mark:

W. Gordon

2

2 Cav.

U.S.C.T.

Willie Jordan

Priv, Co. G, 2 Reg't U. S. Col'd Cavalry.

Appears on

Company Muster Roll

for *Nov + Dec*, 1864

Present or absent *present*

Stoppage, \$ 100 for

Due Gov't, \$ 100 for

Valuation of horse, \$ 100

Valuation of horse equipments, \$ 100

Remarks:
.....
.....
.....
.....
.....
.....
.....
.....
.....

Book mark:

(358) *J. P. Brown* Copyist.

2 Cav. U.S.C.T.

Willie Jordan

Pri, Co. G, 2 Reg't U. S. Col'd Cavalry.

Appears on

Company Muster Roll

for *Jan & Feb*, 1865.

Present or absent *present*

Stoppage, \$ *100* for

Due Gov't, \$ *100* for

Valuation of horse, \$ *100*

Valuation of horse equipments, \$ *100*

Remarks:

Book mark: *21*

(358)

J. Brown

Copyist.

J. | **2 Cav.** | **U.S.C.T.**

Willet's Jordan

Prv, Co. G, 2 Reg't U. S. Col'd Cavalry.

Appears on

Company Muster Roll

for *March & Apr*, 1865:

Present or absent *Present*

Stoppage, \$ *100* for

Due Gov't, \$ *100* for

Valuation of horse, \$ *100*

Valuation of horse equipments, \$ *100*

Remarks:

Book mark:

J. C. Chapin

J | **2 Cav.** | **U.S.C.T.**
Willis Jordan
Pvt., Co. G, 2 Reg't U. S. Col'd Cavalry.

Appears on

Company Muster Roll

for *May & June*, 186*5*.

Present or absent *present.*

Stoppage, \$.....100 for

Due Gov't, \$.....100 for

Valuation of horse, \$.....100

Valuation of horse equipments, \$.....100

Remarks:.....

Book mark:.....

Fulton

J | **2 Cav.** | **U.S.C.T.**

Willis Jordan

Pr, Co. G, 2 Reg't U. S. Col'd Cavalry.

Appears on

Company Muster Roll

for *July & Aug*, 1865.

Present or absent *Absent*

Stoppage, \$.....100 for

Due Gov't, \$.....100 for

Valuation of horse, \$.....100

Valuation of horse equipments, \$.....100

Remarks: *Absent sick since Aug. 11, 65.*

Book mark:

W. J. G. T. M.

MAR 14

J

2 Cav. U.S.C.T.

Willis Jordan

Priv, Co. G, 2 Reg't U. S. Col'd Cavalry.

Appears on

Company Muster Roll

for *Sept. & Oct.*, 186*5*.

Present or absent

Stoppage, \$ 100 for

Due Gov't, \$ 100 for

Valuation of horse, \$ 100

Valuation of horse equipments, \$ 100

Remarks: *Died in U.S. Genl. Hospital, New Orleans, La Sept. 17. 1865*

Book mark:

C. M. Langhli

(358)

Copyist.

J | 2 Cav. | U.S.C.T.

Willis Jordan
Priv. Co., 2 Reg't U. S. Colored Cav.

Appears on Returns as follows:

Jan to July 1864
On duty Co Cook
since Jan 7, 64
Aug to Nov 1864 Ab-
sent detach in
Ambul Corps by
letter from Corps
Ad 2rs since Aug 4/64
Dec 1864 to July 1865
On duty Co Cook
Aug 1865 Absent sick
US Genl Hosp.
Sept 1865 Died in
Gen Hosp New
Orleans La Sept
17, 65

None appears as
Jordan

Book mark:

(546) A. Gouglas Copyist.

J | 2 Cav. | U.S.C.T.

Mellis Jordan
Co. H, 2 Reg't U. S. Col'd Cavalry.

Appears on Co. Muster-out Roll, dated
Brazos Santiago Tex, Feb. 12, 1861.
Muster-out to date _____, 186 .
Last paid to _____, 186 .

Clothing account:

Last settled _____, 186 ; drawn since \$ _____ 100
Due soldier \$ _____ 100; due U. S. \$ _____ 100
Am't for cloth'g in kind or money adv'd \$ _____ 100

Due U. S. for arms, equipments, &c., \$ _____ 100
Bounty paid \$ _____ 100; due \$ _____ 100

Remarks: *Joined at Orizg Vrg.
Died in camp'd Africa
At Hospital New
Orleans. Got Dis
Sept. 17/65. Final
Status sent Dec 31/65*

Book mark: *V. 237. P 96-776. V 88 P 95/69
(over)*

C. S. McLaughlin
(361) Copyist.

JAN.-7

5325818

☆ 1891 ☆

48. P. 48/77.

2963, 1882.

Jordan Willis

Co. G, 2 U.S.C. Cav. Reg't

5 Enclosures.

Bed Cards	Final Statements
Burial Records	Furloughs or L. of A
Certs. of Dis. for Discharge	Med. Certificates
C. M. Charges	Med. Des. Lists
Descriptive Lists	Orders
Discharge Certificates	Pris. of War Record
Enlistment Papers	Resignations

Other papers relating to—

Admission to Hosp'l	Furlough or L. of A
Casualty Sheet	Med. Examination
Confinement	Misc. Information
Contracts	Pay or Clothing
Death or Effects	Personal Reports
Desertion	Rank
Discharge from Hosp'l	Transfer to Hosp'l
Discharge from Service	Transfer to V. R. C.
Duty	Transportation

ARTICLES OF WAR.

ART. 95. When any non-commissioned officer or soldier shall die, or be killed in the service of the United States, the then commanding officer of the troop or company shall, in the presence of two other commissioned officers, take an account of what effects he died possessed of, above his arms and accoutrements, and transmit the same to the office of the Department of War, which said effects are to be accounted for, and paid to the representatives of such deceased non-commissioned officer or soldier. And in case any of the officers, so authorized to take care of the effects of deceased officers and soldiers, should, before they have accounted to their representatives for the same, have occasion to leave the regiment or post, by preferment or otherwise, they shall, before they be permitted to quit the same, deposit in the hands of the commanding officer, or of the assistant military agent, all the effects of such deceased non-commissioned officers and soldiers, in order that the same may be secured for, and paid to, their respective representatives.

ARMY REGULATIONS—EDITION OF 1861.

DECEASED SOLDIERS.

Par. 152. Inventories of the effects of deceased non-commissioned officers and soldiers, required by the 95th Article of War, will be forwarded to the Adjutant General, by the commander of the company to which the deceased belonged, and a duplicate of the same to the colonel of the regiment. Final statements of pay, clothing, &c., will be sent with the inventories. When a soldier dies at a post or station absent from his company, it will be the duty of his immediate commander to furnish the required inventory, and, at the same time, to forward to the commanding officer of the company to which the soldier belonged, a report of his death, specifying the date, place, and cause; to what time he was last paid, and the money or other effects in his possession at the time of his decease; which report will be noted on the next muster roll of the company to which the man belonged. Each inventory will be endorsed, "Inventory of the effects of _____, late of company (—) _____ regiment of _____, who died at _____, the _____ day of _____, 186—." If a legal representative receive the effects, it will be stated in the report. If the soldier leave no effects, the fact will be reported.

Par. 153. Should the effects of a deceased non-commissioned officer or soldier not be administered upon within a short period after his decease, they shall be disposed of by a Council of Administration, under the authority of the commanding officer of the post, and the proceeds deposited with the Paymaster, to the credit of the United States, until they shall be claimed by the legal representatives of the deceased.

Par. 154. In all such cases of sales by the Council of Administration, a statement in detail, or account of the proceeds, duly certified by the Council and commanding officer, accompanied by the Paymaster's receipt for the proceeds, will be forwarded by the commanding officer to the Adjutant General. The statement will be endorsed, "Report of the proceeds of the effects of _____, late of company (—) _____ regiment of _____, who died at _____, the _____ day of _____, 186—."

NOTE 1.—The effects in all cases, when called for, should be turned over to the legal representative, without further authority from the Adjutant General. When the effects are turned over to the relatives of the deceased before these inventories are sent to the Adjutant General, their receipts therefor should be attached to the inventories. In all other cases, one copy will be sent with a letter of transmittal direct to the Adjutant General, and a duplicate retained by the officer.

NOTE 2.—Particular care should be taken to take receipts in duplicate from the Paymaster for any funds turned over to him; one copy should be sent direct to the Adjutant General and one retained by the officer.

Copy
he had no Descriptive Roll.
INVENTORY OF THE EFFECTS

OF

Private Willis Jordan
Late of Company *G*
2^d Reg't of *U.S.C. Cavalry*
Volunteers, who died at *New Orleans La*
on the *17th* day of *September* 1865.

Inventory of the effects of William Jordan late
 a Private of Captain _____ Company G of
 the 2^d Regiment of U.S. Col. Cav. Volunteers, who was enrolled as
 a _____ at _____ in the State of _____ on
 the _____ day of _____ 186 , and mustered into the service of the United
 States as a _____ on the _____ day of _____ 186 , at _____
 in Company _____, _____ Regiment of _____ Volunteers, to serve _____
 years or during the war; he was born in _____ in the State
 of _____; he was _____ years of age, _____ feet _____ inches
 high, _____ complexion, _____ eyes, _____ hair, and by occupation, when enrolled,
 a _____; he died in Camp Aprique U.S. Col. Cav. at
New Orleans La. on the 17th day of Sept 1865, by
 reason of Dysentery chronic.

INVENTORY.					
ARTICLES.	No.	ARTICLES.	No.	ARTICLES.	No.
Hats.....		Pairs trousers.....	1	Knapsacks.....	
Caps.....		Pairs flannel drawers.....		<u>Rubber Blower</u>	1
Forage caps.....		Pairs cotton drawers.....		<u>Combs</u>	1
Great coats.....		Flannel shirts.....			
Uniform coats.....		Cotton shirts.....			
Uniform jackets.....		Pairs boots.....			
Flannel sack coats.....		Pairs shoes.....			
Blouses.....		Pairs socks.....			
Stable frocks.....		Blankets.....	1	MONEY.	
Fatigue overalls.....		Haversacks.....		Specie.....	\$
				Notes.....	\$

I CERTIFY, ON HONOR, that the above inventory comprises all the effects of Private
William Jordan, deceased, and that the effects are in the hands
 of Surgeon in Charge at Camp Aprique U.S. Col. Cav.,
New Orleans La. to be disposed of by a Council of Administration.

(DUPLICATES.)

STATION: New Orleans La.

Commanding the Company.

DATE: September 17th 1865

Extract from Act of Congress.

SEC. 12. And be it further enacted, That the fees of agents and attorneys for making out and causing to be executed the papers necessary to establish a claim for a pension, bounty, and other allowance before the Pension Office, under this act, shall not exceed the following rates: For making out and causing to be duly executed a declaration by the applicant, with the necessary affidavits, and forwarding the same to the Pension Office, with the requisite correspondence, ten dollars; which sum shall be received by such agent or attorney in full for all services in obtaining such pension, and shall not be demanded or received, in whole or in part, until such pension shall be obtained; and the sixth and seventh sections of an act entitled "An act to grant pensions," approved July [fourteenth,] eighteen hundred and sixty-two, are hereby repealed.

SEC. 13. And be it further enacted, That any agent or attorney who shall, directly or indirectly, demand or receive any greater compensation for his services under this act than is prescribed in the preceding section of this act, or who shall contract or agree to prosecute any claim for a pension, bounty, or other allowance under this act, on the condition that he shall receive a per centum upon any portion of the amount of such claim, or who shall wrongfully withhold from a pensioner or other claimant the whole or any part of the pension or claim allowed and due to such pensioner or claimant, shall be deemed guilty of a high misdemeanor, and, upon conviction thereof, shall, for every such offense, be fined not exceeding three hundred dollars, or imprisoned at hard labor not exceeding two years, or both, according to the circumstances and aggravations of the offense.

Approved July 4, 1864.

NOTE. 10.—If any soldier is charged a higher fee than that allowed by the above act, he should report the fact and the name of the agent to the Adjutant General, in order that steps may be taken to have the same refunded.

W. C. Dec 28 1865
Co of 11 down & P. M.
sent for 50 22nd 2nd Aug 1866

ADJUTANT GENERAL'S OFFICE
Jan 24 1866
Duplicate with Inventory sent 2d Auditor.

FINAL STATEMENT.

11.0801 A. S. R. C. 2. 1865

OF
Phillip Jordan
2nd Regt of U. S. Army

VOLUNTEERS.

Dec Sept 17 1865

NOTE 1.—Two of these certificates (or duplicates) are to be given to each Volunteer Soldier or drafted man who may be discharged without being mustered out (Final Statements are never given to men mustered out of service,) that he may at once receive from the Paymaster the pay, &c., due to him, and the captain or other commissioned officer commanding the company will certify to the act of the delivery of the duplicate certificates; with these certificates the Soldier is "entitled to" his discharge, and should also present his discharge to the Paymaster to have the payment endorsed on it. The discharge is to be given back to the Soldier by the Paymaster; the latter only retaining as his vouchers the duplicate certificates.

NOTE 2.—If the Soldier is entitled to pay for the use of his horse, the Company Commander will certify to that fact on the back of both these final statements, and also to the time he has pay due for having been so mounted on his own horse.

NOTE 3.—When a Soldier is furnished with final statements, his descriptive list, if he has one, should be taken up by the officer who gives the Soldier these statements, and endorsed with a statement to this effect by the officer. The endorsement should exhibit a full statement of the time for which the Soldier was allowed pay on his final statements, the clothing account, and all other charges against him or in his favor, so as to comprise a complete exhibit of his account. It will then be transmitted to the Company Commander of the Soldier, who will enter all the data necessary to a full understanding of the Soldier's account on the muster roll upon which the Soldier's discharge is reported. The descriptive list will then be destroyed. The object of this is, that the remaining portion of the Soldier's account may be settled upon the receipt of these muster rolls, and the Soldier receive any pay or allowances that may be due him at the time of his discharge, and which may not appear on his last final statements from the fact that his descriptive list is incomplete. These accounts for back pay, &c., are settled by the 2d Auditor of the Treasury Department.

NOTE 4.—Charges for loss or injury to ordnance, horse equipments, and other miscellaneous charges, should appear under the heading of "Other Stoppages."

NOTE 5.—Bounty paid by State authorities, and not by the United States, will not be entered on this statement.

NOTE 6.—Amounts due the Sutler and Laundress must be entered on the muster roll on which the discharge, death, desertion, &c., is reported, as well as on the final statement, otherwise the amount cannot be collected from the United States.

NOTE 7.—This blank will be used for deceased volunteers and drafted men, as well as for others.

NOTE 8.—Where a Soldier dies in Hospital or on detached service, his descriptive list, if he has one, should be sent with his final statements, in duplicate, to the Adjutant General, Washington, D. C.

NOTE 9.—If the soldier is a drafted man or substitute, the space for time, &c., of enrolled, should contain only the word *drafted* or *substitute*, as the case may be. If the Soldier is a "VETERAN," (or RECRUIT,) the words *as a veteran*, (or *recruit*,) as the case may be, should be interlined after the words *mustered into the service of the U. S.* A statement of all the installments of *Veteran* or *Recruit* Bounty RECEIVED by the Soldier must be made on the back of each final statement.

11.0801
23
1865

I certify, on honor, that Willis Jordan, a Private of
 Captain Ernest B Wood Company (F) of the 2nd Regiment of U S Col Bay
Volunteers, of the State of U S, born in Edenton State
 of North Carolina, aged 40 years; 5 feet 4 inches high; Dark complexion,
Dark eyes, Dark hair, and by occupation a Servant, who joined for service
 and was enrolled (see Note 9) on the 25 day of December, 1863, at Warfolk Va
 by Ed Geo Wade, for the period of three years, and mustered into
 the service of the United States on the Eighth day of January, 1864, at
Fort Monroe Va, by Capt Fred Martin; and having served
HONESTLY and **FAITHFULLY** with his Company to the present date, is now entitled to a
DISCHARGE by reason of Death

(Died in U S Genl Hospital New Orleans La Sept 17-63)

The said Willis Jordan was last paid by Paymaster
May M^cConnell, to include the 31st day of December, 1863, and
 has pay due him from that time to the present date; he is entitled to pay and subsistence for
TRAVELING to place of enrollment, and whatever other allowances are authorized to volunteer
 soldiers, drafted men, or militia, so discharged. He has received from the United States **CLOTHING**
 amounting to 69.47 dollars, since the 25 day of December,
 1863, when his clothing account was last settled. He has received from the United States
100 dollars advanced **BOUNTY**.

There is to be stopped from him, on account of the State of _____, or other
 authorities, for **CLOTHING**, &c., received on entering service, _____ dollars; and
 for other stoppages, viz: _____

_____ dollars.
 He has been furnished with **TRANSPORTATION** in kind from the place of his discharge to
 _____; and he has been **Subsisted** for **Traveling** to his
 place of enrollment, up to the _____, 186 .

He is indebted to _____, **Sutler**, _____ dollars.
 He is indebted to _____, **Laundress**, _____ dollars.

Given in Duplicate, at Barros Santiago Is, this 17 day
 of September, 1863.

Ernest B Wood
Capt U S Army "G"
 Commanding Company

WAR 1865

CASUALTY SHEET

No. _____

Willis Jordan,

Priv of Company *C.*

2^d Regiment of *W. G. C. Cav.*

State Volunteers.

NATURE OF CASUALTY.

Died Sept 14th 1865.

CASUALTY SHEET.

Name: *Willis Jordan*

Rank: *Priv* Company: *9* Regiment: *25*

Arm: *U.S. Cavalry* State: _____

Nature of Casualty: *Death.*

CAUSE OF CASUALTY—(NAME OF DISEASE, &c.)

BY WHOM DISCHARGED.

FROM WHAT SOURCE THIS INFORMATION WAS OBTAINED.

DEGREE OF DISABILITY.

*Roll of Honor
Co. 9/124*

BY WHOM CERTIFIED.

REMARKS.

*J. M. Moore
Adj. M. U. S. A.*

DATE OF DISCHARGE, DEATH, &c.

Sept. 17/1865

PLACE OF DISCHARGE, DEATH, &c.

*Buried
New Orleans*

J. P.

Clerk.

Inventory of the effects of *Willis Jordan*
 Company "G", 2^d Regiment U.S.C. Corp.
 who died in the Bay of Aquique General Hospital New Orleans
 La. Sept. 17th, 1865.

CAPS		BLANKETS	1
DRESS COATS		KNAPSACKS <i>R. Blomker</i>	1
OVERCOATS		CANTEENS	1
JACKETS		HAVERSACKS	
TROUSERS	1	MUSKETS	
SHIRTS		BAYONETS	
DRAWERS		CARTRIDGE BOX	
BOOTS, pairs		BELT	
SHOES, pairs		MONEY	
STOCKINGS			

Coffee
 He had no Descriptive Roll

INVENTORY

OF THE EFFECTS OF

Willis Jordan
 Late of Company "G", 2^d Regiment
 U.S.C. Corp., who died
 at Bay of Aquique U.S. General
 Hospital New Orleans Sum-17th
 1865.



355 176

Camp Apone U. S. Army General Hospital,
New Orleans Sept. 17th, 1865.

Commanding Officer, "G" Company,
2^d Regiment U. S. C. Cav.

I have to inform you
that Willis Gordon of your Company died in this
Hospital on 17th September 1865 of
Chronic Diarrhoea.

~~I enclose his Descriptive List, with Pay and Clothing Account,~~
~~and Inventory of his effects.~~

Very respectfully, yours, &c.,

F. E. Piquette

Surgeon U. S. A.,

In charge of General Hospital

COPY OF RECORD

FOR THE

ADJUTANT GENERAL, U. S. ARMY.



No. 2.

RECORD OF DEATH AND INTERMENT.

Name and number of person interred,	Willis Jordan
Number and locality of the Grave,	
Hospital number of the deceased,	43460
Regiment, rank and company,	2 ^d U.S. Cavalry - Private - G
Residence before enlistment,	
Marital condition, (and if married,	}
residence of the widow,	
Cause of death,	} Chronic Diarrhoea
Age of the deceased,	
Sex,	
References and remarks,	
Date of death and burial,	September 17 th 1865

Adj Genl U.S. Army

SIR :

It becomes my duty to inform you that the person above described died at this hospital as herein stated, and that it is desired his remains should be interred with the usual Military honors.

Respectfully,

F. E. Piquette

SURGEON, U. S. ARMY.

Adj. Genl. U.S. Army
in Charge

MILITARY HOSPITAL, *Camp de l'Asile New Orleans,*
La.

885

Jordan, Wilson,
Co B, 2 U. S. Col'd Cav.

Private

Private

CARD NUMBERS.

1	26
2	27
3	28
4	29
5	30
6	31
7	32
8	33
9	34
10	35
11	36
12	37
13	38
14	39
15	40
16	41
17	42
18	43
19	44
20	45
21	46
22	47
23	48
24	49
25	50

Book Mark:

See also

886

Jorman, Wiley
Co F, 2 U. S. Col'd Cav.

Private Private

CARD NUMBERS.

1	26
2	27
3	28
4	29
5	30
6	31
7	32
8	33
9	34
10	35
11	36
12	37
13	38
14	39
15	40
16	41
17	42
18	43
19	44
20	45
21	46
22	47
23	48
24	49
25	50

See Jorman Wiley

Book Mark:

See also

NUMBER

887

Jordan Wilson

Co C, 2 U. S. Col'd Cav.

Private

Private

CARD NUMBERS.

1	5319799	26
2	5319875	27
3	5319962	28
4	5320050	29
5	5320133	30
6	5320223	31
7	5320315	32
8	5320400	33
9	5320497	34
10	5320590	35
11	5320688	36
12	5320774	37
13	5320861	38
14	5320945	39
15	9087372	40
16	40726166	41
17		42
18		43
19		44
20		45
21		46
22		47
23		48
24		49
25		50

Book Mark:

See also

2 Cav. U.S.C.T.

Wilson Jordan
Co. B, 2 Reg't U. S. Col'd Cav.

Appears on
Company Descriptive Book
of the organization named above.

DESCRIPTION.

Age 18 years; height 5 feet 6 1/2 inches.
Complexion Black
Eyes Black; hair Black
Where born Suffolk Va.
Occupation Laborer

ENLISTMENT.

When Dec. 24, 1863.
Where Ft Monroe Va.
By whom G. Cole; term 3 y'rs.

Remarks:

F. B. Smith
Copist.

J | 2 Cav. | U.S.C.T.

Milson Jordan
Pot, Co. C, 2 Reg't U. S. Col'd Cavalry.

Age.....years.

Appears on

Company Muster-in Roll

of the organization named above. Roll dated
Ft Monrovia Dec 24, 1863.

Muster-in to date Dec 24, 1863.

Joined for duty and enrolled:

When Dec 24, 1863.

Where Ft Monrovia

Period 3 years.

Valuation of horse, \$.....100

Valuation of horse equipments, \$.....100

Remarks:
.....
.....
.....

Book mark:.....

Hadfield

2 Cav. | U.S.C.T.

J
Nilson Jordan
1st, Co. C, 2 Reg't U. S. Col'd Cavalry.

Appears on

Company Muster Roll

for *Dated Feb 29*, 186*4*.

Present or absent *Present*

Stoppage, \$ 100 for

Due Gov't, \$ 100 for

Valuation of horse, \$ 100

Valuation of horse equipments, \$ 100

Remarks:

Book mark:

Madgill

2 Cav. U.S.C.T.

J. Wilson Jordan
Pot, Co. C, 2 Reg't U. S. Col'd Cavalry.

Appears on

Company Muster Roll

for Mar & Apr, 1864.

Present or absent Present

Stoppage, \$ 100 for

Due Gov't, \$ 100 for

Valuation of horse, \$ 100

Valuation of horse equipments, \$ 100

Remarks:

Book mark:

Hadfield

2 Cav. U.S.C.T.

J. Wilson Jordan
Sgt, Co. C, 2 Reg't U. S. Col'd Cavalry.

Appears on

Company Muster Roll

for *May 2 June*, 1864.

Present or absent *Present*

Stoppage, \$ 100 for

Due Gov't, \$ 100 for

Valuation of horse, \$ 100

Valuation of horse equipments, \$ 100

Remarks:

Book mark:

(358)

Hadfield

Copyist.

J | 2 Cav. | U.S.C.T.

Wilson Jourdan

Priv., Co. C, 2 Reg't U. S. Col'd Cavalry.

Appears on

Company Muster Roll

for July, Aug., 1864.

Present or absent Present

Stoppage, \$ 100 for

Due Gov't, \$ 100 for

Valuation of horse, \$ 100

Valuation of horse equipments, \$ 100

Remarks:

Book mark:

W. J. Wilson

J | 2 Cav. | U.S.C.T.

Wilson Jordan
Prest, Co. C, 2 Reg't U. S. Col'd Cavalry.

Appears on

Company Muster Roll

for Sept & Oct, 1864.

Present or absent. Present

Stoppage, \$ 100 for

Due Gov't, \$ 100 for

Valuation of horse, \$ 100

Valuation of horse equipments, \$ 100

Remarks:

Book mark:

(358)

W. J. Blogg

Copyist.

J | 2 Cav. | U.S.C.T.
Wilson Joudan
Privt, Co. C, 2 Reg't U. S. Col'd Cavalry.

Appears on

Company Muster Roll

for Nov & Dec, 1864.

Present or absent Present

Stoppage, \$ 100 for

Due Gov't, \$ 100 for

Valuation of horse, \$ 100

Valuation of horse equipments, \$ 100

Remarks:

Book mark:

w. b. l. o. z.

J | 2 Cav. | U.S.C.T.

Wilson Jordan
Prest, Co. C, 2 Reg't U. S. Col'd Cavalry.

Appears on

Company Muster Roll

for Jan & Feb, 1865

Present or absent Present

Stoppage, \$ 100 for

Due Gov't, \$ 100 for

Valuation of horse, \$ 100

Valuation of horse equipments, \$ 100

Remarks:

Book mark:

W. D. [Signature]

J | **2 Cav.** | **U.S.C.T.**

Wilson Jourdan

Priv, Co. C, 2 Reg't U. S. Col'd Cavalry.

Appears on

Company Muster Roll

for *March & April*, 1865.

Present or absent *Present*

Stoppage, \$ 100 for

Due Gov't, \$ 100 for

Valuation of horse, \$ 100

Valuation of horse equipments, \$ 100

Remarks:

Book mark: -----

(358) *J. L. Morris* Copyist.

J | **2 Cav. | U.S.C.T.**

Wilson Jordan

Priv, Co. C, 2 Reg't U. S. Col'd Cavalry.

Appears on

Company Muster Roll

for *May & June*, 1865.

Present or absent *Present*

Stoppage, \$ *100* for

Due Gov't, \$ *100* for

Valuation of horse, \$ *100*

Valuation of horse equipments, \$ *100*

Remarks:

Book mark:

J. L. Harris

J | **2 Cav.** | **U.S.C.T.**

Wilson Jordan

Priv, Co. C, 2 Reg't U. S. Col'd Cavalry.

Appears on

Company Muster Roll

for *July & August*, 1865.

Present or absent *Present*

Stoppage, \$ 100 for

Due Gov't, \$ 100 for

Valuation of horse, \$ 100

Valuation of horse equipments, \$ 100

Remarks:

Book mark: -----

(358) *J. L. Borris* Copyist.

J | 2 Cav. | U.S.C.T.

Wilson Jourdan

Pvt., Co. C, 2 Reg't U. S. Col'd Cavalry.

Appears on

Company Muster Roll

for Sept & Oct, 1865.

Present or absent Present

Stoppage, \$ 100 for

Due Gov't, \$ 100 for

Valuation of horse, \$ 100

Valuation of horse equipments, \$ 100

Remarks:

Book mark:

G. W. Chase

J | **2 Cav.** | **U.S.C.T.**

Wilson Jordan

Priv, Co. C, 2 Reg't U. S. Col'd Cavalry.

Appears on

Company Muster Roll

for *Nov & Dec*, 186*5*.

Present or absent *Present*

Stoppage, \$ 100 for

Due Gov't, \$ 100 for

Valuation of horse, \$ 100

Valuation of horse equipments, \$ 100

Remarks:

Book mark:

G. W. Chase

J | 2 Cav. | U.S.C.T.

Wilson Jordan
Pot, Co. C, 2 Reg't U. S. Colored Cav.

Appears on Returns as follows:

Mar 1865 Absent
sick Balfour
Lene Haspe Ports-
mouth Va
Apr 1865 Absent sick
in Balfour Haspe
Portsmouth Va

Book mark:

(546)

A. G. Gault
Copyist.

J | **2 Cav. U.S.C.T.**

Wilson Jordan
Priv, Co. *C*, 2 Reg't U. S. Col'd Cavalry.

Appears on **Co. Muster-out Roll**, dated
Brazos Santiago, Tex, Feb 12, 1866.
Muster-out to date *Feb 12, 1866.*
Last paid to *June 30, 1865.*

Clothing account:

Last settled....., 186 ; drawn since \$ 100
Due soldier \$ 100; due U. S. \$ *50* 29/100
Am't for cloth'g in kind or money adv'd \$ 100

Due U. S. for arms, equipments, &c., \$ 100
Bounty paid \$ 100; due \$ 100

Remarks: *Joined at org. org.*

Book mark: *V. 116, P. 116. 70*
V. 35 - 227. 168

G. W. Chase

888

Jubilee Samuel

Co I, 2 U. S. Col'd Cav.

Private

Private

CARD NUMBERS.

1 5316130
 2 5327444
 3 5327537
 4 5327627
 5 5327716
 6 5327810
 7 5327900
 8 5327987
 9 5328072
 10 5328152
 11 9087869
 12 40726246
 13
 14
 15
 16
 17
 18
 19
 20
 21
 22
 23
 24
 25

26
 27
 28
 29
 30
 31
 32
 33
 34
 35
 36
 37
 38
 39
 40
 41
 42
 43
 44
 45
 46
 47
 48
 49
 50

Book Mark:

See also

J | 2 Cav. | U.S.C.T.

Samuel Jubilee

Co. D, 2 Reg't U. S. Col'd Cav.

Appears on

Company Descriptive Book

of the organization named above.

DESCRIPTION.

Age 26 years; height 5 feet 5 inches.

Complexion Dark

Eyes Black; hair Black

Where born Accomac Va.

Occupation Laborer

ENLISTMENT.

When Sept. 21, 1864.

Where Newport News

By whom St. Morris; term 3 y'rs.

Remarks: credited to
leaving at large.

F. B. Smith
Copyist.

MAR 1864

J | **2 Cav. | U.S.C.T.**

Samuel Jubilee

Appears with rank of *Private* on

Muster and Descriptive Roll of a Detachment of U. S. Vols. forwarded

for the 2 Reg't U. S. Col'd Cavalry. Roll dated

Newport News Va, Oct., 1864.

Where born *Accomac Co. Va.*

Age *26* y'rs; occupation *Laborer*

When enlisted *Sept 21*, 1864.

Where enlisted *Newport News*

For what period enlisted *3* years.

Eyes *black*; hair *black*

Complexion *dark*; height *5 ft. 5 in.*

When mustered in *Sept. 21*, 1864.

Where mustered in *Newport News.*

Bounty paid \$ *100* ¹⁰⁰; due \$ ¹⁰⁰

Where credited *Comm. at large.*

Company to which assigned

Remarks :

Book mark :

F. D. Neale

2 Cav. U.S.C.T.

Samuel Jubilee

M, Co. I, 2 Reg't U. S. Col'd Cavalry.

Appears on

Company Muster Roll

for Sept & Oct, 1867

Present or absent Present

Stoppage, \$ 100 for

Due Gov't, \$ 100 for

Valuation of horse, \$ 100

Valuation of horse equipments, \$ 100

Remarks: Credited to Comm. at Large Paid bounty \$100.00

Book mark:

C. G. Smith

(358)

Copyist.

7

2 Cav. U.S.C.T.

Samuel Jubilee

Orin, Co. *C*, 2 Reg't U. S. Col'd Cavalry.

Appears on

Company Muster Roll

for *Nov & Dec*, 186 *4*

Present or absent *Present*

Stoppage, \$ *100* for

Due Gov't, \$ *100* for

Valuation of horse, \$ *100*

Valuation of horse equipments, \$ *100*

Remarks:

Book mark: *6*

G. Smith

J | **2 Cav.** | **U.S.C.T.**

Samuel Jubilee

Pri....., Co. I, 2 Reg't U. S. Col'd Cavalry.

Appears on

Company Muster Roll

for *Jan & Feb*....., 186*5*.

Present or absent *Present*

Stoppage, \$..... *100* for.....

Due Gov't, \$..... *100* for.....

Valuation of horse, \$..... *100*

Valuation of horse equipments, \$..... *100*

Remarks:.....
.....
.....
.....
.....
.....
.....
.....
.....
.....

Book mark:.....

C G Smith

J | **2 Cav.** | **U.S.C.T.**

Samuel Jubilee

seri, Co. I, 2 Reg't U. S. Col'd Cavalry.

Appears on

Company Muster Roll

for *Mch & Apr*, 1865.

Present or absent *Present*

Stoppage, \$ 100 for

Due Gov't, \$ 100 for

Valuation of horse, \$ 100

Valuation of horse equipments, \$ 100

Remarks:

Book mark:

D. J. Griffith

J | **2 Cav.** | **U.S.C.T.**

Samuel Jubilee
Jr, Co. I, 2 Reg't U. S. Col'd Cavalry.

Appears on

Company Muster Roll

for *May & June*, 186*5*.

Present or absent *Present*

Stoppage, \$ *100* for

Due Gov't, \$ *100* for

Valuation of horse, \$ *100*

Valuation of horse equipments, \$ *100*

Remarks:

Book mark:

(358)

D. J. Griffith
Copyist.

J | **2 Cav.** | **U.S.C.T.**

Samuel Jubilee

Jubilee, Co. I, 2 Reg't U. S. Col'd Cavalry.

Appears on

Company Muster Roll

for *July & August*, 186 *5*.

Present or absent *Present*

Stoppage, \$ 100 for

Due Gov't, \$ 100 for

Valuation of horse, \$ 100

Valuation of horse equipments, \$ 100

Remarks:

Book mark:

D. J. Gruppick

J. | **2 Cav.** | **U.S.C.T.**

Samuel Jubilee

Poir, Co. I, 2 Reg't U. S. Col'd Cavalry.

Appears on

Company Muster Roll

for Sept. & Oct., 1865.

Present or absent Present.

Stoppage, \$ 100 for

Due Gov't, \$ 100 for

Valuation of horse, \$ 100

Valuation of horse equipments, \$ 100

Remarks:

Book mark:

Poir

J | **2 Cav.** | **U.S.C.T.**

Samuel Jubilee

Priv, Co. I, 2 Reg't U. S. Col'd Cavalry.

Appears on

Company Muster Roll

for *Nov. & Dec.*, 186*5*.

Present or absent *Present*

Stoppage, \$ *100* for

Due Gov't, \$ *100* for

Valuation of horse, \$ *100*

Valuation of horse equipments, \$ *100*

Remarks:

Book mark:

Pol

J | 2 Cav. | U.S.C.T.

Samuel J. J. J.
Pat, Co. I, 2 Reg't U. S. Colored Cav.

Appears on Returns as follows:

Oct 1864 Fair Oct
29, 64 In the
field Recd as
signed to Co I
2 M.S.C.C

Book mark:

(546)

A. J. J. J.
Copyist.

J | 2 Cav. | U.S.C.T.

Samuel Jubilee

Priv, Co. J, 2 Reg't U. S. Col'd Cavalry.

Appears on Co. Muster-out Roll, dated Brazos Santiago Tex, Feb. 12, 1866.

Muster-out to date Feb. 12, 1866.

Last paid to June 30, 1866.

Clothing account:

Last settled, 186 ; drawn since \$ 100

Due soldier \$ 100; due U. S. \$ 60. 62 / 100

Am't for cloth'g in kind or money adv'd \$ 100

Due U. S. for arms, equipments, &c., \$ 100

Bounty paid \$ 100. 00 / 100; due \$ 100

Remarks: Joined as recruit. Free before Apr 19-1861. Due U.S. one revolver \$20.00.

Book mark:

Pol,

Jubilee, Samuel

....., Co., Reg't *2nd U.S.C. Cav.*

Enclosures.

Bed Cards	Final Statements
Burial Records	Furloughs or L. of A
Certs. of Dis. for Discharge	Med. Certificates
C. M. Charges	Med. Des. Lists
Descriptive Lists	Orders
Discharge Certificates	Pris. of War Record
Enlistment Papers	Resignations

Other papers relating to—

Admission to Hosp'l	Furlough or L. of A
Casualty Sheet	Med. Examination
Confinement	Misc. Information
Contracts	Pay or Clothing
Death or Effects	Personal Reports
Desertion	Rank
Discharge from Hosp'l	Transfer to Hosp'l
Discharge from Service	Transfer to V. R. C.
Duty	Transportation

NOTE 1.—This blank will be used for both enlistments and re-enlistments—enlistment of veterans, &c., &c., in the volunteer service. They will be made out in duplicate in all cases—one to accompany the recruiting return of the superintendent (not the recruiting officer) to the Adjutant General, and one to accompany the accounts of the officer who pays bounty, &c. The Regiment and Company in which the soldier last served should be given on the back.

NOTE 2.—An enlistment holds to service. A muster-in must, in all cases, precede payment of pay, bounty, pension, &c. A muster-in roll must, in all cases, be filed in the Adjutant General's Office as evidence of muster-in. The mustering officer, commissary, or assistant commissary of musters, as the case may be, will countersign both enlistments as having mustered the soldier into the service of the United States before either of them is given to the disbursing officer.

DECLARATION OF RECRUIT.

I, Samuel Jubilee desiring to VOLUNTEER as a Soldier in the Army of the United States, for the term of THREE YEARS, Do Declare, That I am Twenty Six years and _____ months of age; that I have never been discharged from the United States service on account of disability or by sentence of a court-martial, or by order before the expiration of a term of enlistment; and I know of no impediment to my serving honestly and faithfully as a soldier for three years.

GIVEN at Accomac Co the Seventeenth day of Sept 1864

Witness: Francis Leonard Samuel Jubilee
must

No. 235

Samuel Jubilee

Volunteered at Marshall Point

Sept 21 1864,

By W. Monroe

37 Regiment of W. 65

2 W. 65

enlistment; last served in Company ()

Reg't of _____

Discharged _____ 18 _____

CONSENT IN CASE OF MINOR.

I, _____ Do CERTIFY, That I am the _____ of _____; that the said _____ is _____ years of age; and I do hereby freely give my CONSENT to his volunteering as a SOLDIER in the ARMY OF THE UNITED STATES for the period of THREE YEARS.

GIVEN at _____ the _____ day of _____

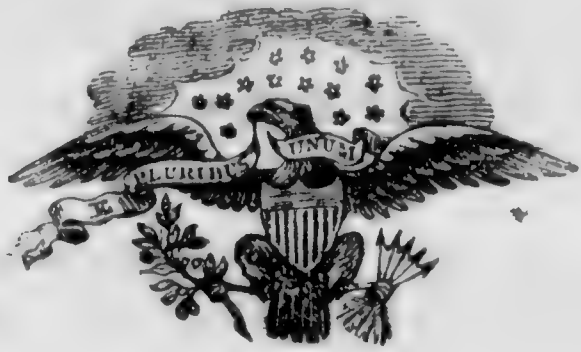
Witness: _____

NOV 19 1864

VOLUNTEER ENLISTMENT.

STATE OF

Connecticut



TOWN OF

at Lyme

I, *Samuel Jubilee* born in *Accomac Co*
in the State of *Virginia* aged *Twenty six* years,
and by occupation a *Sabre* DO HEREBY ACKNOWLEDGE to have
volunteered this *Nineteenth* day of *Sept* 1864,
to serve as a **Soldier** in the **Army of the United States of America**, for the
period of **THREE YEARS**, unless sooner discharged by proper authority: Do also
agree to accept such bounty, pay, rations, and clothing, as are, or may be, estab-
lished by law for volunteers. And I, *Samuel Jubilee* do
solemnly swear, that I will bear true faith and allegiance to the **United States
of America**, and that I will serve them honestly and faithfully against all their
enemies or opposers whomsoever; and that I will observe and obey the orders of
the President of the United States, and the orders of the officers appointed over
me, according to the Rules and Articles of War.

Sworn and subscribed to, at *Newport News*
on this *Twenty fifth* day of *Sept* 1864,
BEFORE *J. M. Monroe*
Lt. 37th U.S.C.T.

Samuel Jubilee
mark

I CERTIFY, ON HONOR, That I have carefully examined the above-named Volunteer, agreeably
to the General Regulations of the Army, and that, in my opinion, he is free from all bodily defects and
mental infirmity, which would in any way disqualify him from performing the duties of a soldier.

W. H. Gray
Assy Surg 1st U.S.C.T.
EXAMINING SURGEON.

I CERTIFY, ON HONOR, That I have minutely inspected the Volunteer, *Jubilee*
previously to his enlistment, and that he was entirely sober when enlisted; that, to the best of my
judgment and belief, he is of lawful age; and that, in accepting him as duly qualified to perform the duties
of an able-bodied soldier, I have strictly observed the Regulations which govern the recruiting service.
This soldier has *Blk* eyes, *Blk* hair, *dark* complexion, is *Five* feet
Five inches high.

James M. Monroe
Lt 37th Regiment of *U.S.C.T.*
RECRUITING OFFICER.

Mustered into the service of the United States, in Company *D*
the *21* day of *Sept* 1864 at *Newport News*
Samuel Jubilee
at Lyme
Regiment of *Volunteers*, on
James M. Monroe
at Lyme

889

Jubilee William

Co L, 2 U. S. Col'd Cav.

Private

Private

CARD NUMBERS.

1	5316129	26
2	5327445	27
3	5327538	28
4	5327628	29
5	5327717	30
6	5327817	31
7	5327901	32
8	5327985	33
9	5328104	34
10	5328196	35
11	9087868	36
12	8117-03-1869	37
13	30852779	38
14	30854324	39
15	40726247	40
16		41
17		42
18		43
19		44
20		45
21		46
22		47
23		48
24		49
25		50

Book Mark: 8117-03-1869

See also

J | **2 Cav. | U.S.C.T.**

William Jubilee

....., Co. *D*, 2 Reg't U. S. Col'd Cav.

Appears on

Company Descriptive Book

of the organization named above.

DESCRIPTION.

Age *44* years; height *5* feet *9* inches.

Complexion *Dark*

Eyes *Black*; hair *Black*

Where born *Acomae, Va.*

Occupation *Laborer*

ENLISTMENT.

When *Sept. 12, 1864.*

Where *Newport News*

By whom *Lt Moore*; term *3* y'rs.

Remarks: *credited to
lemon at Large
died July 23-65 at
Cruz's Santiago.*

A. B. Smith

J | **2 Cav. | U.S.C.T.**

William Jubilee

Appears with rank of *Private* on

Muster and Descriptive Roll of a Detachment of U. S. Vols. forwarded

for the 2 Reg't U. S. Col'd Cavalry. Roll dated

Newport News Va., Oct, 1864.

Where born *Accomac Co. Va.*

Age *44* y'rs; occupation *Laborer*

When enlisted *Sept. 12*, 1864.

Where enlisted *Newport News*

For what period enlisted *3* years.

Eyes *black*; hair *black*

Complexion *dark*; height *5 ft. 9 in.*

When mustered in *Sept. 12*, 1864.

Where mustered in *Newport News*

Bounty paid \$ *100*; due \$ *100*

Where credited *Comm. at large.*

Company to which assigned

Remarks :

Book mark : *J. 117-05-1869*

F. D. Neal

J | **2 Cav.** | **U.S.C.T.**

Jym Jubilee

Pri, Co. I, 2 Reg't U. S. Col'd Cavalry.

Appears on

Company Muster Roll

for *Sept & Oct*, 1864.

Present or absent *Present*

Stoppage, \$ 100 for

Due Gov't, \$ 100 for

Valuation of horse, \$ 100

Valuation of horse equipments, \$ 100

Remarks: *Credited to Comm.
at Large Paid Bounty
\$100.00*

Book mark:

O G Smith

2 | **2 Cav. U.S.C.T.**

William Jubilee

Pvt, Co. I, 2 Reg't U. S. Col'd Cavalry.

Appears on

Company Muster Roll

for *Nov & Dec*, 186*4*.

Present or absent *Present*

Stoppage, \$ *100* for

Due Gov't, \$ *100* for

Valuation of horse, \$ *100*

Valuation of horse equipments, \$ *100*

Remarks:

Book mark:

O. G. Smith

J | **2 Cav. U.S.C.T.**

William Jubilee

Pri, Co. I, 2 Reg't U. S. Col'd Cavalry.

Appears on

Company Muster Roll

for *Jan & Feb*, 186*5*

Present or absent *Present*

Stoppage, \$ *100* for

Due Gov't, \$ *100* for

Valuation of horse, \$ *100*

Valuation of horse equipments, \$ *100*

Remarks:

Book mark: -----

C. G. Smith

J | **2 Cav.** | **U.S.C.T.**

William Jubilee

seri, Co. I, 2 Reg't U. S. Col'd Cavalry.

Appears on

Company Muster Roll

for *Mch & Apr*, 1865.

Present or absent *Present*

Stoppage, \$ 100 for

Due Gov't, \$ 100 for

Valuation of horse, \$ 100

Valuation of horse equipments, \$ 100

Remarks:

Book mark: -----

D. J. Griffith

J | **2 Cav.** | **U.S.C.T.**

Wm Jubilee

Jri, Co. I, 2 Reg't U. S. Col'd Cavalry.

Appears on

Company Muster Roll

for *May + June*, 186*5*.

Present or absent *Present*

Stoppage, \$ 100 for

Due Gov't, \$ 100 for

Valuation of horse, \$ 100

Valuation of horse equipments, \$ 100

Remarks:

Book mark:

D. J. Griffith

(358)

Copyist.

J | **2 Cav.** | **U.S.C.T.**

William Jubilee

ser., Co. I, 2 Reg't U. S. Col'd Cavalry.

Appears on

Company Muster Roll

for *July & August*, 186*5*.

Present or absent *Absent*

Stoppage, \$ *100* for

Due Gov't, \$ *100* for

Valuation of horse, \$ *100*

Valuation of horse equipments, \$ *100*

Remarks: *Sick in Genl Hospt*
since Aug 30 - 65

Book mark:

D. J. Giffith

J. | 2 bar. | U. S. A.

William Tubbs
4th Co. 2 Reg't U. S. A.

Appears on

Hospital Muster Roll

of Corps d'Afrique U. S. A. General Hospital,

at New Orleans, La.,

for July & Aug, 1865.

Attached to hospital:

When, 186 .

How employed

Last paid by Maj.

to, 186 .

Bounty paid \$ 100; due \$ 100

Present or absent present

Remarks:

Book mark:

J. Tubbs

J. | 2 Cav. | U.S.C.T.

William Jubilee

Priv, Co. I, 2 Reg't U. S. Col'd Cavalry.

Appears on

Company Muster Roll

for Sept. & Oct., 1865.

Present or absent Absent

Stoppage, \$ 100 for

Due Gov't, \$ 100 for

Valuation of horse, \$ 100

Valuation of horse equipments, \$ 100

Remarks: Absent sick in U.S. G. Hospital

Book mark:

Poe

NOV 25

J. L. Law West.
William Jubilee
Priv., Co. D, 2d Reg't U.S. Cavalry

Appears on
Hospital Muster Roll

of **Corps d'Afrique U. S. A. General Hospital,**

at **New Orleans, La.,**

for Sept Oct, 1865.

Attached to hospital:

When _____, 186 .

How employed _____

Last paid by Maj. _____

to _____, 186 .

Bounty paid \$ 100; due \$ 100

Present or absent _____

Remarks: Died Oct 26

Book mark: _____

(843)

Willey
Copyist.

J. | **2 Cav.** | **U.S.C.T.**

Wm Jubilee.

Priv., Co. I, 2 Reg't U. S. Col'd Cavalry.

Appears on

Company Muster Roll

for *Nov, & Dec.*, 186*6*.

Present or absent

Stoppage, \$ 100 for

Due Gov't, \$ 100 for

Valuation of horse, \$ 100

Valuation of horse equipments, \$ 100

Remarks: *Died.*

Book mark:

Joe

J | 2 Cav. | U.S.C.T.

Wm Jubilee
Pet. Co. J, 2 Reg't U. S. Colored Cav.

Appears on Returns as follows:

Oct 1864 Gain Oct
29, 64 In the field
Rec'd assigned to
Co I 2 U.S.C.

Aug & Sept 1865
Absent sick in
U.S. Genl Hosp

Oct 1865 Absent sick
N.O.

Nov 1865 Decid
Nov 23, 65 Hosp
New Orleans La

Comp. of [unclear]
[unclear]

Book mark:

(546) A. J. Angles Copyist.

J | **2 Cav.** | **U.S.C.T.**

Wm. Jubilee

Priv, Co. *I*, 2 Reg't U. S. Col'd Cavalry.

Appears on **Co. Muster-out Roll**, dated *Brazos Santiago Tex, Feb. 12*, 1866.

Muster-out to date _____, 186 .

Last paid to _____, 186 .

Clothing account:

Last settled _____, 186 ; drawn since \$ _____ 100

Due soldier \$ _____ 100 ; due U. S. \$ _____ 100

Am't for cloth'g in kind or money adv'd \$ _____ 100

Due U. S. for arms, equipments, &c., \$ _____ 100

Bounty paid \$ _____ 100 ; due \$ _____ 100

Remarks: *Joined as recruit pt from enlistment. Died July 23-65 at Brazos Texas. Final statements & inventory of effects sent sec. 6. 1865.*

Book mark: *PV12.P195:69/Oct 26/65 (over)*

Pol

JAN.-7

5328196

★ 1891 ★

E. B. Vol 8, P 140.

WAR 219
J. 2nd Cav. U.S.C. & G.
William Jubilee
, Co. D., 2nd Reg't U.S.C. & G.

NOTATION.

Book mark:

J. 117.6.3. 1869.

Record and Pension Office,

WAR DEPARTMENT.

This book mark refers only to a report from the medical records, made by the Surgeon General to the Adjutant General, relative to the above-named man. As the medical records have since been carded, no transcript of this report is made hereon.

(491)

E. P. Conaway

Copyist.

Jubilee, Wm

P, Co. *I*, *2* Reg't *USC (Cav)*

3

Enclosures.

4

Bed Cards	Descriptive Lists
Burial Records <i>1</i>	Final Statements
Certs. of Dis. for Discharge	Furloughs
C. M. Charges	Med. Des. Lists
Med. Certificates	Orders

Enlistment pp 1

Other papers relating to—

Admission to Hosp'l	Furlough
Casualty Sheet (Officer's) <i>1</i>	Med. Examination
Confinement	Misc. Information
Contracts	Pay or Clothing
Death or Effects <i>1</i>	Personal Reports
Desertions	Rank
Discharge from Hosp'l	Transfer to Hosp'l
Discharge from Service	Transfer to V. R. C.
Duty	Transportation

ARTICLES OF WAR.

ART. 95. When any non-commissioned officer or soldier shall die, or be killed in the service of the United States, the then commanding officer of the troop or company shall, in the presence of two other commissioned officers, take an account of what effects he died possessed of, above his arms and accoutrements, and transmit the same to the office of the Department of War, which said effects are to be accounted for, and paid to the representatives of such deceased non-commissioned officer or soldier. And in case any of the officers, so authorized to take care of the effects of deceased officers and soldiers, should, before they have accounted to their representatives for the same, have occasion to leave the regiment or post, by preferment or otherwise, they shall, before they be permitted to quit the same, deposit in the hands of the commanding officer, or of the assistant military agent, all the effects of such deceased non-commissioned officers and soldiers, in order that the same may be secured for, and paid to, their respective representatives.

DIRECTIONS.

NOTE 1.—One copy of the inventories of the effects of deceased non-commissioned officers and soldiers, required by the 95th Article of War, will be forwarded to the Adjutant General, by the commander of the company to which the deceased belonged, and a duplicate of the same to the colonel of the regiment. Final statements of pay, clothing, &c., in duplicate, will be sent to the Adjutant General with one copy of the inventory. Both inventory and final statements should be forwarded, as a general rule, through Regimental Headquarters. When a soldier dies at a post or station absent from his company, it will be the duty of his immediate commander to furnish, direct to the Adjutant General, the required inventory and final statements, and, at the same time, to forward to the commanding officer of the company to which the soldier belonged, a report of his death, specifying the date, place, and cause; to what time he was last paid, and the money or other effects in his possession at the time of his decease; which report will be noted on the next muster roll of the company to which the man belonged. Each inventory will be endorsed, "Inventory of the effects of _____, late of company (—) _____ regiment of _____, who died at _____, the _____ day of _____, 186—." If a legal representative receive the effects, it will be stated in the report. If the soldier leave no effects, the fact will be reported on the blank for inventory.

NOTE 2.—Should the effects of a deceased non-commissioned officer or soldier not be administered upon within a short period after his decease, they shall be disposed of by a Council of Administration, under the authority of the commanding officer of the post, and the proceeds deposited with the Paymaster, to the credit of the United States, until they shall be claimed by the legal representatives of the deceased.

NOTE 3.—In all such cases of sales by the Council of Administration, a statement in detail, or account of the proceeds duly certified by the Council and commanding officer, (Form 5,) accompanied by the Paymaster's receipt for the proceeds, will be forwarded by the commanding officer to the Adjutant General. The statement will be endorsed, "Report of the proceeds of the effects of _____, late of company (—) _____ regiment of _____, who died at _____, the _____ day of _____, 186—."

NOTE 4.—The effects in all cases, when called for, should be turned over to the legal representative, without further authority from the Adjutant General. When the effects are turned over to the relatives of the deceased before these inventories are sent to the Adjutant General, their receipts therefor should be attached to the inventories. In all other cases, one copy will be sent with a letter of transmittal direct to the Adjutant General, and a duplicate retained by the officer.

NOTE 5.—Particular care should be taken to take receipts in duplicate from the Paymaster for any funds turned over to him; one copy should be sent direct to the Adjutant General and one retained by the officer.

Copy
No Descriptive List
INVENTORY OF THE EFFECTS

OF

Private William J. [unclear]

Late of Company *I*

2nd Reg't of *USC Army*

Volunteers, who died at *New Orleans La*

on the *26th* day of *October* 186*5*.

INVENTORY

Inventory of the effects of William Jubilee late
 a Sir of Captain Company I of
 the 2nd Regiment of USC Army Volunteers, who was enrolled as
 a _____ at _____ in the State of _____ on
 the _____ day of _____ 186 , and mustered into the service of the United
 States as a _____ on the _____ day of _____ 186 , at _____
 in Company _____, _____ Regiment of _____ Volunteers, to serve _____
 years or during the war; he was born in _____ in the State
 of _____; he was _____ years of age, _____ feet _____ inches
 high, _____ complexion, _____ eyes, _____ hair, and by occupation, when enrolled,
 a _____; he died in Camp d'Epique New Orleans, at
New Orleans La on the 26 day of October 1865, by
 reason of Pneumonia

INVENTORY.					
ARTICLES.	No.	ARTICLES.	No.	ARTICLES.	No.
Hats.....		Pairs trowsers.....		Knapsacks.....	
Caps.....		Pairs flannel drawers.....		<i>No Effects</i>	
Forage caps.....		Pairs cotton drawers.....			
Great coats.....		Flannel shirts.....			
Uniform coats.....		Cotton shirts.....			
Uniform jackets.....		Pairs boots.....			
Flannel sack coats.....		Pairs shoes.....			
Blouses.....		Pairs socks.....			
Stable frocks.....		Blankets.....			
Fatigue overalls.....		Haversacks.....			
					MONEY.
				Specie.....	\$
				Notes.....	\$

I CERTIFY, ON HONOR, that the above inventory comprises all the effects of _____
 _____, deceased, and that the effects are in the hands
 of _____ at _____
 _____ to be disposed of by a Council of Administration.

(DUPLICATES.) _____

STATION: New Orleans La

 Commanding the Company.

DATE: Oct 26, 1865

Adjutant General's Office.

Oct. 4th 1869.

L. B. vol. 8. Page 140.

The Muster Out Roll of Co.

"D" 2nd U.S. Colored Cavalry reports the death of Private William Jubilee at Brazos, Texas July 23rd 1865.

The Company Muster Roll for Nov. and Dec. 1865, reports the fact but not the date of death.

Statements from the "Record of death and Entombment" that the man died Oct. 26th 1865, at New Orleans, La.

Said record of death and place of death is held to be correct, and the Company Muster and Muster Out Roll will be amended accordingly.

H. R. Ricketts

Br. Col. U.S. Army.

In Charge Bureau and Troops.

[Signature]
10th
7.16.

In letter of Oct 13. 69 to W. S. Land

CASUALTY SHEET

No. _____

William Jubilee
Priv of Company D.
2nd Regiment of U.S.C.V.

State Volunteers.

NATURE OF CASUALTY.

Died Oct 26/65

CASUALTY SHEET.

Name: William Jubilee
 Rank: Priv Company: C Regiment: 2^d
 Arm: U.S.C. Cav. State: _____
 Nature of Casualty: Death

CAUSE OF CASUALTY—(NAME OF DISEASE, &c.)

BY WHOM DISCHARGED.

FROM WHAT SOURCE THIS INFORMATION WAS OBTAINED.

DEGREE OF DISABILITY.

Roll of Honor
Sa. P. 124

BY WHOM CERTIFIED.

REMARKS.

J. M. Snow
W. J. M. W. G.

DATE OF DISCHARGE, DEATH, &c.

Oct 26 1865

PLACE OF DISCHARGE, DEATH, &c.

Buried
New Orleans

J. P.
 Clerk.

William Jubilee
Co "I"
2nd U.S. Army

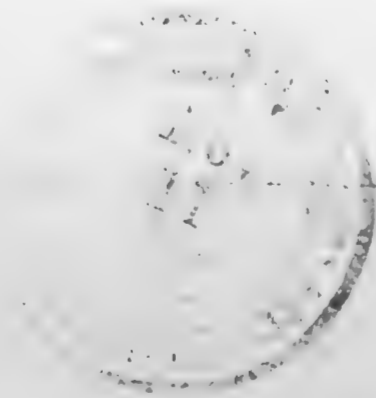
COPY OF RECORD

also Oct 20/66

Dr of effects sent
2nd Auditor

BB,C

FOR THE
ADJUTANT GENERAL U. S. ARMY.



Small vertical text on the right edge of the page, likely bleed-through from the reverse side.

No. 2.

RECORD OF DEATH AND INTERMENT.

Name and number of person interred,	William Tuttle
Number and locality of the Grave,	
Hospital number of the deceased,	7005
Regiment, rank and company,	2 regt. Cavalry - Private - I
Residence before enlistment,	
Conjugal condition, (and if married,	}
The residence of the widow,	
Cause of death,	} Pneumonia
Age of the deceased,	
Nativity,	
References and remarks,	
Date of death and burial,	October 26 th 1865

To *Adj. Genl U.S. Army*
 SIR:

It becomes my duty to inform you that the person above described died at this Hospital as herein stated, and that it is desired his remains should be interred with the usual Military honors.

Respectfully,

F. E. Pyette
 SURGEON, U. S. ARMY.
36 regt. Infantry
 in Charge

MILITARY HOSPITAL, *Corps d'Afrique New Orleans*
La

NOTE 1.—This blank will be used for both enlistments and re-enlistments—enlistment of veterans, &c., &c., in the volunteer service. They will be made out in duplicate in all cases—one to accompany the recruiting return of the superintendent (not the recruiting officer) to the Adjutant General, and one to accompany the accounts of the officer who pays bounty, &c. The Regiment and Company in which the soldier last served should be given on the back.

NOTE 2.—An enlistment holds to service. A muster-in must, in all cases, precede payment of pay, bounty, pension, &c. A muster-in roll must, in all cases, be filed in the Adjutant General's Office as evidence of muster-in. The mustering officer, commissary, or assistant commissary of musters, as the case may be, will countersign both enlistments as having mustered the soldier into the service of the United States before either of them is given to the disbursing officer.

DECLARATION OF RECRUIT.

I, William Jubilee desiring to VOLUNTEER as a Soldier in the Army of the United States, for the term of THREE YEARS, Do Declare, That I am Twenty-four years and _____ months of age; that I have never been discharged from the United States service on account of disability or by sentence of a court-martial, or by order before the expiration of a term of enlistment; and I know of no impediment to my serving honestly and faithfully as a soldier for three years.

GIVEN at Accomac Co the 5th day of Sept 1864

Witness: James Leonard William Jubilee
Major

No. 24
William Jubilee
 Volunteered at Accomac Mass
Sept 12 1864,
 By W. M. Murre
37 Regiment of Vol
W. M. Murre
 Discharged _____ 18 ____
 _____ enlistment; last served in Company ()
 _____ Reg't of _____

CONSENT IN CASE OF MINOR.

I, _____ Do CERTIFY, That I am the _____ of _____; that the said _____ is _____ years of age; and I do hereby freely give my CONSENT to his volunteering as a SOLDIER in the ARMY OF THE UNITED STATES for the period of THREE YEARS.

GIVEN at _____ the _____ day of _____

Witness: _____

NOV 21 1864

VOLUNTEER ENLISTMENT.

STATE OF



TOWN OF

Connecticut

at large

I, *William Jubilee* born in *Accomac Co*
in the State of *Virginia* aged *forty four* years,
and by occupation a *Labourer* Do HEREBY ACKNOWLEDGE to have
volunteered this *sixth* day of *September* 1864,
to serve as a **Soldier** in the **Army of the United States of America**, for the
period of **THREE YEARS** unless sooner discharged by proper authority: Do also
agree to accept such bounty, pay, rations, and clothing, as are, or may be, estab-
lished by law for volunteers. And I, *William Jubilee* do
solemnly swear, that I will bear true faith and allegiance to the **United States**
of America, and that I will serve them honestly and faithfully against all their
enemies or opposers whomsoever; and that I will observe and obey the orders of
the President of the United States, and the orders of the officers appointed over
me, according to the Rules and Articles of War.

Sworn and subscribed to, at *Newport News*
on this *12th* day of *Sept* 1864, } *William Jubilee*
BEFORE *J. M. Monroe* } *mark*
Lt. Recr. Officer

I CERTIFY, ON HONOR, That I have carefully examined the above-named Volunteer, agreeably
to the General Regulations of the Army, and that, in my opinion, he is free from all bodily defects and
mental infirmity, which would in any way disqualify him from performing the duties of a soldier.

W. J. Gray
Asst Surg U.S.A.
EXAMINING SURGEON.

I CERTIFY, ON HONOR, That I have minutely inspected the Volunteer, *W. Jubilee*
previously to his enlistment, and that he was entirely sober when enlisted; that, to the best of my
judgment and belief, he is of lawful age; and that, in accepting him as duly qualified to perform the duties
of an able-bodied soldier, I have strictly observed the Regulations which govern the recruiting service.
This soldier has *Blk* eyes, *Blk* hair, *copper* complexion, is *five* feet
nine inches high.

James M. Monroe
Lt 37th Regiment of *U.S.C.T.* Volunteers.
RECRUITING OFFICER.

Mustered into the service of the United States, in Company *Newport News*,
the *12* day of *Sept*, 1864, at *Newport News*,
Detached from said at large
Company *Volunteers* of *the 37th* Regiment of *U.S.C.T.* Volunteers, on
Sept 12 1864
W. Jubilee

890

Judson Andrew

Co E, 2 U. S. Col'd Cav.

Private

Private

CARD NUMBERS.

1	5315675	26
2	5322244	27
3	5322331	28
4	5322416	29
5	5322497	30
6	5316433	31
7	5322583	32
8	5316555	33
9	5322666	34
10	5322748	35
11	5322831	36
12	5322931	37
12	5323039	38
14	5323116	39
15	5323228	40
16	5323397	41
17	9097486	42
18	34364120	43
19	34669630	44
20	40726245	45
21		46
22		47
23		48
24		49
25		50

Book Mark:

See also

J | 2 Cav. | U.S.C.T.

Andrew Judson

Co. E, 2 Reg't U. S. Col'd Cav.

Appears on

Company Descriptive Book

of the organization named above.

DESCRIPTION.

Age / 8 years; height 5 feet 6 inches.

Complexion Dark

Eyes Blue; hair Blue

Where born Frederick, Md.

Occupation Waiter

ENLISTMENT.

When Jan. 1, 1864.

Where Fort Monroe

By whom Col. Cole; term 3 y'rs.

Remarks:

F. B. Smith

J. | 2 | Co. | U.S.C.T.

Andrew Judson

Co., Co. 2, Reg't U. S. Col'd Co.

Age _____ years.

Appears on a

Detachment Muster-in Roll

of unattached recruits
of the organization named above. Roll dated

Le. Mourae, Va., Jan. 11, 1864.

Muster-in to date Jan. 11, 1864.

Joined for duty and enrolled:

When Jan 1, 1864.

Where Le. Mourae, Va.

Period 3 years.

Valuation of horse, \$ _____ 100

Valuation of horse equipments, \$ _____ 100

Remarks: _____

Book mark: _____

J. J. Harney
Copyist.

NO 223

J | **2 Cav.** | **U.S.C.T.**

Andrew Judson
Bugler, Co. E, 2 Reg't U. S. Col'd Cavalry.

Appears on

Company Muster Roll

for *Enrollment to Feb. 29*, 1864.

Present or absent *Present*

Stoppage, \$.....100 for

Due Gov't, \$.....100 for

Valuation of horse, \$.....100

Valuation of horse equipments, \$.....100

Remarks:

Book mark:

(358)

J. C. Taylor

Copyist.

MAR 24

7 | **2 Cav.** | **U.S.C.T.**

Andrew Judson

Bugler, Co. E, 2 Reg't U. S. Col'd Cavalry.

Appears on

Company Muster Roll

for *Mar. and Apr.*, 1864.

Present or absent *Present*

Stoppage, \$ 100 for

Due Gov't, \$ 100 for

Valuation of horse, \$ 100

Valuation of horse equipments, \$ 100

Remarks:

Book mark: -----

(358)

A. C. Taylor

Copyist.

J | **2 Cav.** | **U.S.C.T.**

Andrew Judson
Bugler, Co. E, 2 Reg't U. S. Col'd Cavalry.

Appears on

Company Muster Roll

for May and June, 1864.

Present or absent Present

Stoppage, \$ 100 for

Due Gov't, \$ 12 100 for ordnance

Valuation of horse, \$ 100

Valuation of horse equipments, \$ 100

Remarks: _____

Book mark: _____

T. C. Taylor

J. | **2 Cav.** | **U.S.C.T.**

Andrew Judson
Bugler, Co. E, 2 Reg't U. S. Col'd Cavalry.

Appears on

Company Muster Roll

for *July & Aug*, 186*4*.

Present or absent *Absent*

Stoppage, \$ *100* for

Due Gov't, \$ *100* for

Valuation of horse, \$ *100*

Valuation of horse equipments, \$ *100*

Remarks: *Stoppage for*
Remington Revolver \$12.00
Detailed in Ambulance Corps

Book mark:

Waukegan

L. L. ... | U.S.C.T.

Frederick ...
..., Co. *E*, 2nd Reg't U. S. Col'd *...*

Appears on a

Detachment Muster Roll

of the organization named above

for *...* *...*, 1864.

Station *...*

Present or absent *Present*

Stoppage, \$ *100* for

Due Gov't, \$ *100* for

Valuation of horse, \$ *100*

Valuation of horse equipments, \$ *100*

Remarks:

Book mark:

L. L. ...

J. | **2 Cav.** | **U.S.C.T.**

Andrew Judson
Bugler, Co. E, 2 Reg't U. S. Col'd Cavalry.

Appears on

Company Muster Roll

for *Sept. and Oct.*, 186 *4*

Present or absent *Absent*

Stoppage, \$ *100* for

Due Gov't, \$ *100* for

Valuation of horse, \$ *100*

Valuation of horse equipments, \$ *100*

Remarks: *Detailed in Ambulance Corps*

Book mark:

Waddington

1 | 2nd Cav. | U.S.C.T.

Andrew G. Brown

Bush, Co. E., 2nd Reg't U. S. Col'd Cav.

Appears on a

Detachment Muster Roll

of the organization named above

for Capt. G. H. ... 1864.

Station near Chapin's Farm Va

Present or absent Present

Stoppage, \$ 100 for

Due Gov't, \$ 100 for

Valuation of horse, \$ 100

Valuation of horse equipments, \$ 100

Remarks: Due U. S. for Advance 72.00

Book mark:

G. H. ...

J | **2 Cav.** | **U.S.C.T.**

Andrew Judson
Bugler, Co. E, 2 Reg't U. S. Col'd Cavalry.

Appears on

Company Muster Roll

for *Nov & Dec.*, 1864.

Present or absent *Absent*

Stoppage, \$ *100* for

Due Gov't, \$ *100* for

Valuation of horse, \$ *100*

Valuation of horse equipments, \$ *100*

Remarks: *Detailer in*
Ambulance Corps

Book mark:

W. D. ...

J | 2 Cav. | U.S.C.T.

Andrew Judson
Bugler, Co. E, 2 Reg't U. S. Col'd Cavalry.

Appears on

Company Muster Roll

for Jan & Feb., 1865.

Present or absent Absent

Stoppage, \$ 100 for

Due Gov't, \$ 100 for

Valuation of horse, \$ 100

Valuation of horse equipments, \$ 100

Remarks: Detached in
Ambulance Corp.

Book mark:

Waddington

| **2 Cav.** | **U.S.C.T.**

Andrew Jackson

Bepler, Co. E, 2 Reg't U. S. Col'd Cavalry.

Appears on

Company Muster Roll

for March & April, 1865.

Present or absent Absent

Stoppage, \$ 100 for

Due Gov't, \$ 100 for

Valuation of horse, \$ 100

Valuation of horse equipments, \$ 100

Remarks: Detached in Ambulance
Co.

Book mark: -----

R Braden

J | 2 lev | USLT
Andrew Judson
Bugler 2 Regt USCC

Appears on

Muster Roll

of Detachment Ambulance Corps, 2 Division,
25 Army Corps,

for Mch & Apr , 1865.
Station Near Petersburg Va

Clothing account:

Last settled _____, 186 ; drawn since \$ _____ 100

Present or absent present

Remarks: _____

Book mark: _____

 Waddington
(520) Copyist.

J | **2 Cav.** | **U.S.C.T.**

Andrew Judson
Bugler, Co. E, 2 Reg't U. S. Col'd Cavalry.

Appears on

Company Muster Roll

for *May Term*, 186^{*5*}

Present or absent *Present*

Stoppage, \$ *100* for

Due Gov't, \$ *100* for

Valuation of horse, \$ *100*

Valuation of horse equipments, \$ *100*

Remarks:

Book mark:

J. H. Brady
(358) Copyist.

J | 2 Cav. | U.S.C.T.

Andrew Judson
Bugler, Co. E, 2 Reg't U. S. Col'd Cavalry.

Appears on

Company Muster Roll

for July & Aug, 1865.

Present or absent Present

Stoppage, \$ 100 for

Due Gov't, \$ 100 for

Valuation of horse, \$ 100

Valuation of horse equipments, \$ 100

Remarks:

Book mark:

J. H. J. Orndy

J | **2 Cav. | U.S.C.T.**

Andrew Jackson

Angler, Co. E, 2 Reg't U. S. Col'd Cavalry.

Appears on

Company Muster Roll

for *Sept and Oct*, 1865.

Present or absent *Absent*

Stoppage, \$ *100* for

Due Gov't, \$ *100* for

Valuation of horse, \$ *100*

Valuation of horse equipments, \$ *100*

Remarks: *On detached service at
Hd. Qrs 25 A. Q. , New Dordie \$6,
per month from Jan 1 64 to April 20 64
on increase of pay*

Book mark:

N. H. Merrill

J 12 Cav. U.S.C.

Andrew Judson
Pnt Co. E 2^d U.S.C. Cav.

Appears on

Muster Roll

of a detachment of the 1 and 2 Regiments U. S.
Colored Cavalry, serving at Brownsville, Texas,

for Sept & Oct, 1865.

Station Brownsville Texas

Clothing account:

Last settled _____, 186 ; drawn since \$ 100

Present or absent present

Remarks: Detailed per O. O.
No. 255 Hd. Qrs. 25th A. C.
Oct. 14/65.

Book mark: _____

Long

J | **2 Cav. | U.S.C.T.**

Andrew Judson

Priv, Co. E, 2 Reg't U. S. Col'd Cavalry.

Appears on

Company Muster Roll

for *Nov. and Dec*, 1863.

Present or absent *Absent*

Stoppage, \$ *100* for

Due Gov't, \$ *100* for

Valuation of horse, \$ *100*

Valuation of horse equipments, \$ *100*

Remarks: *Detached Hd. Qrs. 25 A. C.*
100 \$ 6 per month from Jan 16 to Apr 30, 64
increase of pay

Book mark:

N. H. Merrill

J 12 Cav. U.S.C.

Andrew Judson
Plat Co. E 2^d U.S.C. Cav.

Appears on

Muster Roll

of a detachment of the 1 and 2 Regiments U. S.
Colored Cavalry, serving at Brownsville, Texas,

for *Nov + Dec*, 1865.

Station *Brownsville Texas*

Clothing account:

Last settled _____, 186 ; drawn since \$ 100

Present or absent *Present*

Remarks: *Detailed per S. O. 255*
Ad. Ins. 25th A. C. Oct. 14/65.

Book mark: _____

Long

NO 249

J | 2 Cav. | U.S.C.T.

Andrew Jackson
Baylor Co. E, 2 Reg't U. S. Colored Cav.
Pot

Appears on Returns as follows:

Aug to Nov 1864
Absent det serv
in Ambul Corps
3 Dec 1864 same
Aug 5, 64 for 50
84 Ad 2rs 2 Dec
1864 Aug 4, 64
Dec 1864 + Jan 1865
Absent, det'd in
Ambul Corps
Feb to April 1865 Ab-
sent det in
Amb Corps
Dis 25 A. C.
Oct to Dec 1865
Absent det serv
Ad 2rs 25 A. C.
(Pot)

Book mark:

(546)

A Douglas

Copyist.

2 Cav. | U.S.C.T.

Urbain J. ...

Co. *E*, 2 Reg't U. S. Col'd Cavalry.

Appears on **Co. Muster-out Roll**, dated

June 12, 1866 .

Muster-out to date *June 12*, 1866 .

Last paid to *June 30*, 1865 .

Clothing account:

Last settled....., 186 ; drawn since \$.....¹⁰⁰

Due soldier \$ *4* ^{*21*}/₁₀₀; due U. S. \$.....¹⁰⁰

Am't for cloth'g in kind or money adv'd \$.....¹⁰⁰

Due U. S. for arms, equipments, &c., \$.....¹⁰⁰

Bounty paid \$.....¹⁰⁰; due \$.....¹⁰⁰

Remarks: *Sold at ...*

.....
.....
.....
.....
.....

Book mark :

W. H. ...

Next number.
891a

⁸⁹¹
Gen. Talbot

Co D, 2 U. S. Col'd Cav.

Private

Private

CARD NUMBERS.

1	26
2	27
3	28
4	29
5	30
6	31
7	32
8	33
9	34
10	35
11	36
12	37
13	38
14	39
15	40
16	41
17	42
18	43
19	44
20	45
21	46
22	47
23	48
24	49
25	50

Book Mark:

See also

891a

William Levin

Co H, 2 U. S. Col'd Cav.

Private

Private

CARD NUMBERS.

1	5325858	26	
*2	5325926	27	
3	5325934	28	
4	5326023	29	
5	5326112	30	
6	5326196	31	
7	5326283	32	
8	5326360	33	
9	5326437	34	
10	5326519	35	
11	5326601	36	
12	5326684	37	
12	5326766	38	
14	5326840	39	
15	5326912	40	
16	R.P. 327531	41	
17		42	
18		43	
19		44	
20		45	
21		46	
22		47	
23		48	
24		49	
25		50	

*Card withdrawn and filed in packet of Beckett, George where it properly belongs. Mable. 7.97

Book Mark: R.P. 327531.

See also

RD 327.531

RD 490.760.

D. 3214464 Pommer

H Street
Es

B | **2 Cav.** | **U.S.C.T.**

True name, Levin. Kellam.
Levin Beckett

Out, Co. *No.*, 2 Reg't U. S. Col'd Cav.

Age *19* years.

Appears on

Company Muster-in Roll

of the organization named above. Roll dated

Fort Monroe Va, Jan 8, 1864.

Muster-in to date *Jan 8*, 1864.

Joined for duty and enrolled:

When *Jan 1*, 1864.

Where *Pongatigue Va*

Period *3* years.

Valuation of horse, \$ *100*

Valuation of horse equipments, \$ *100*

Remarks :

Book mark: *R+D 327,531*

(356) *A. J. Anderson* Copyist.

B | **2 Cav.** | **U.S.C.T.**

True name, Levin. Kellam.

Levin Beckett

Put, Co. H, 2 Reg't U. S. Col'd Cavalry.

Appears on

Company Muster Roll

for *From date of Enrollment to Feb 29*, 1864.

Present or absent *Present*

Stoppage, \$ 100 for

Due Gov't, \$ 100 for

Valuation of horse, \$ 100

Valuation of horse equipments, \$ 100

Remarks:

Book mark:

(358) *A. J. Anderson* Copyist.

B | **2 Cav.** | **U.S.C.T.**

True name, Levin. Kellam.

Levin Beckett

Priv, Co. H, 2 Reg't U. S. Col'd Cavalry.

Appears on

Company Muster Roll

for *March & April*, 1864.

Present or absent *Present*

Stoppage, \$ 100 for

Due Gov't, \$ 100 for

Valuation of horse, \$ 100

Valuation of horse equipments, \$ 100

Remarks:

Book mark:

A. J. Anderson

B | 2 Cav. | U.S.C.T.

True name, Levin. Kellam.

Levin Beckitt

Cvt, Co. H, 2 Reg't U. S. Col'd Cavalry.

Appears on

Company Muster Roll

for *May & June*, 1864.

Present or absent *Present*

Stoppage, \$ *100* for

Due Gov't, \$ *100* for

Valuation of horse, \$ *100*

Valuation of horse equipments, \$ *100*

Remarks: *Stoppage for Spurs & Straps 52 ct.*

Book mark:

A J Anderson

Q | **2 Cav.** | **U.S.C.T.**

True name, **Levin Kellam.**

Levin Beckett

Priv, Co. H, 2 Reg't U. S. Col'd Cavalry.

Appears on

Company Muster Roll

for *May 1" to Sep 1"*, 1864.

Present or absent *Present*

Stoppage, \$ *100* for

Due Gov't, \$ *100* for

Valuation of horse, \$ *100*

Valuation of horse equipments, \$ *100*

Remarks: *Stoppage for
pure bed traps 0.52*

Book mark: _____

(358)

W B Ferguson

Copyist.

B | **2 Cav. U.S.C.T.**

True name, Levin, Kellam.

Levin Beckett

Priv, Co. H, 2 Reg't U. S. Col'd Cavalry.

Appears on

Company Muster Roll

for *Sept & Oct.*, 1864.

Present or absent *Present*

Stoppage, \$ 100 for

Due Gov't, \$ 100 for

Valuation of horse, \$ 100

Valuation of horse equipments, \$ 100

Remarks:

Book mark: -----

W. H. Ferguson

Q | **2 Cav.** | **U.S.C.T.**

True name, *Levin Kellam.*

Levin Beckett

Priv, Co. H, 2 Reg't U. S. Col'd Cavalry.

Appears on

Company Muster Roll

for *Nov. & Dec.*, 1864.

Present or absent *Present*

Stoppage, \$ *100* for

Due Gov't, \$ *100* for

Valuation of horse, \$ *100*

Valuation of horse equipments, \$ *100*

Remarks:

Book mark:

W. B. Ferguson

Q | **2 Cav. U.S.C.T.**

True name, **Levin. Kellam.**

Levin Beckett

Priv, Co. H, 2 Reg't U. S. Col'd Cavalry.

Appears on

Company Muster Roll

for *Jan. & Feb.*, 1865.

Present or absent *Present*

Stoppage, \$ 100 for

Due Gov't, \$ 100 for

Valuation of horse, \$ 100

Valuation of horse equipments, \$ 100

Remarks:

Book mark:

W. Ferguson

(358)

Copyist.

B | **2 Cav.** | **U.S.C.T.**

True name, Levin. Kellam.
Leven Beckett

Private, Co. H, 2 Reg't U. S. Col'd Cavalry.

Appears on

Company Muster Roll

for *March and April*, 1865.

Present or absent *absent*

Stoppage, \$ *100* for

Due Gov't, \$ *100* for

Valuation of horse, \$ *100*

Valuation of horse equipments, \$ *100*

Remarks:
Dismounted Camp, Petersburgh, Va.

Book mark:

C. G. Powell

B | **2 Cav.** | **U.S.C.T.**

True name, Levin. Kellam.

Levin Beckett

Private, Co. H, 2 Reg't U. S. Col'd Cavalry.

Appears on

Company Muster Roll

for *May and June*, 1865.

Present or absent *Present*

Stoppage, \$.....100 for

Due Gov't, \$.....100 for

Valuation of horse, \$.....100

Valuation of horse equipments, \$.....100

Remarks:.....

Book mark:.....

O. G. Powell

B | 2 Cav. | U.S.C.T.

True name, Leyin. Kellam.

Seven Beckett

Private, Co. H, 2 Reg't U. S. Col'd Cavalry.

Appears on

Company Muster Roll

for *July and Aug.*, 186*5*.

Present or absent *Present*

Stoppage, \$ *100* for

Due Gov't, \$ *100* for

Valuation of horse, \$ *100*

Valuation of horse equipments, \$ *100*

Remarks:

Book mark:

C. J. Powell

B | **2 Cav.** | **U.S.C.T.**

True name, *Levin Kellam.*

Levin Kellam

Co., Co. H, 2 Reg't U. S. Col'd Cavalry.

Appears on

Company Muster Roll

for *Sep & Oct*, 186*5*.

Present or absent *Present*

Stoppage, \$ *100* for

Due Gov't, \$ *100* for

Valuation of horse, \$ *100*

Valuation of horse equipments, \$ *100*

Remarks:

Book mark:

W. J. Whitt
Copyist.

AB | **2 Cav.** | **U.S.C.T.**

True name, *Levin Kellam*
Levin Beckett

Plt, Co. H, 2 Reg't U. S. Col'd Cavalry.

Appears on

Company Muster Roll

for *Nov & Dec*, 1865.

Present or absent *Present*

Stoppage, \$ 100 for

Due Gov't, \$ 100 for

Valuation of horse, \$ 100

Valuation of horse equipments, \$ 100

Remarks:

Book mark: -----

W. J. Kelly
Copyist.

W | **2 Cav. | U.S.C.T.**

True name, *Levin. Kellam.*
Levin Beckett

B, Co., 2 Reg't U. S. Col'd Cavalry.

Appears on **Co. Muster-out Roll**, dated
Bravo Santiago, Tex Feb 12, 1866.

Muster-out to date *Feb 12, 1866.*

Last paid to *June 30, 1865.*

Clothing account:

Last settled....., 186 ; drawn since \$..... $\frac{100}{100}$

Due soldier \$..... $\frac{100}{100}$; due U. S. \$ *64* $\frac{39}{100}$

Am't for cloth'g in kind or money adv'd \$..... $\frac{100}{100}$

Due U. S. for arms, equipments, &c., \$..... $\frac{77}{100}$

Bounty paid \$..... $\frac{100}{100}$; due \$ *300* $\frac{100}{100}$

Remarks: *joined at orig orgn*
free before April 19/61
Step can comm'd & serv'd
driv Henry & Frank wiper

Book mark:

K. 12 Cav. U.S.C.
 True name, Levin Kellam.
 Levin Beckett
 Pvt., Co. H, 2 Reg't U.S.C. Cav.

NOTATION.

Book mark: P. P. 327 531

Record and Pension Office,

WAR DEPARTMENT,
 Washington, Nov. 30, 1897.

It has been determined from evidence before this Department that the true name of this soldier is
 Levin Kellam
 and a discharge certificate as of that name was furnished to him (thro' his attorney) on *November 20*, 1897, upon application and proof of identity, under the provisions of the act of Congress, approved April 14, 1890.

The original discharge certificate of the soldier has been ~~cancelled and filed in this office.~~ *lost.*

Proof of loss filed with application.

A. G. N.

Previous number.

892
Keller Henderson

Co A, 2 U. S. Col'd Cav.

Private Private

CARD NUMBERS.

1	26
2	27
3	28
4	29
5	30
6	31
7	32
8	33
9	34
10	35
11	36
12	37
13	38
14	39
15	40
16	41
17	42
18	43
19	44
20	45
21	46
22	47
23	48
24	49
25	50

See Kelly Henderson

Book Mark:

See also

893
Kelum Alfred

Co B, 2 U. S. Col'd Cav.

Private Private

CARD NUMBERS.

1	5315414	26
2	5318525	27
3	5318642	28
4	5318815	29
5	5319735	30
6	9087182	31
7	40726254	32
8		33
9		34
10		35
11		36
12		37
13		38
14		39
15		40
16		41
17		42
18		43
19		44
20		45
21		46
22		47
23		48
24		49
25		50

Book Mark:

See also

K | 2 Cav. | U.S.C.T.

Alfred Kellum
 , Co. B, 2 Reg't U. S. Col'd Cav.

Appears on

Company Descriptive Book

of the organization named above.

DESCRIPTION.

Age 23 years; height 5 feet 2 inches.

Complexion dark

Eyes Black; hair Black

Where born Accomack Co., Va.

Occupation Laborer

ENLISTMENT.

When Jan'y, 20, 1864.

Where Ft Monroe, Va.

By whom Col. Cook; term 3 y'rs.

Remarks: Mustered Jan'y,
 27/64 by Capt F. Martin
 Engaged in action at
 Suffolk Va, March 9/64
 Killed in action
 at Chester Station, Va,
 May 16/64. Final
 statement forwarded
 to Washington.

F. B. Smith

R | 2 Cav, | U.S.C.T.

Alfred Kellum

Priv., Co., 2 Reg't U. S. Col'd Cav.

Age years.

Appears on a

Detachment Muster-in Roll

of the organization named above. Roll dated

Fort Monroe, Va, Jan. 27, 1864.

Muster-in to date Jan 27, 1864.

Joined for duty and enrolled:

When Jan 20, 1864.

Where Fort Monroe, Va,

Period 3 years.

Valuation of horse, \$.....100

Valuation of horse equipments, \$.....100

Remarks:.....

.....

.....

.....

Book mark : 3128

.....

Q Beck

K | **2 Cav.** | **U.S.C.T.**

Alfred Kellum
Priv., Co. B. 2 Reg't U. S. Col'd Cavalry.

Appears on

Company Muster Roll

for Dec. 22/63 to Feb. 29, 1864

Present or absent Present

Stoppage, \$ 100 for

Due Gov't, \$ 100 for

Valuation of horse, \$ 100

Valuation of horse equipments, \$ 100

Remarks :

Book mark :

E. H. Merritt

K-1 | **2 Cav.** | **U.S.C.T.**

Alfred Kellum

Pvt., Co. B. 2 Reg't U. S. Col'd Cavalry.

Appears on

Company Muster Roll

for *March & April*, 1864.

Present or absent *Present*

Stoppage, \$ 100 for

Due Gov't, \$ 100 for

Valuation of horse, \$ 100

Valuation of horse equipments, \$ 100

Remarks :

Book mark :

E. H. Hunter

(358)

Copyist.

R | **2 Cav. | U.S.C.T.**

Alfred Kellum
Priv.; Co. B. 2 Reg't U. S. Col'd Cavalry.

Appears on

Company Muster Roll

for *May & June*, 1864.

Present or absent

Stoppage, \$ 100 for

Due Gov't, \$ 100 for

Valuation of horse, \$ 100

Valuation of horse equipments, \$ 100

Remarks: *Killed in action
at or near Chester Sta-
tion Va May 16th/64*

Book mark:

E. W. Hunter

A | **2 Cav.** | **U.S.C.T.**

Alfred Kellum
B Co. B., 2 Reg't U. S. Colored Cav.

Appears on Returns as follows:

*Feb to Apr 1864, on duty
det'd in the Harvier
Detachment attached to
the Regt.*

*May 1864, Loss, May 16,
Drury's Bluff, Killed
in action.*

Book mark : _____

A. M. Hammer

K | **2 Cav.** | **U.S.C.T.**

Alfred Kellum
privt, Co. B, 2 Reg't U. S. Col'd Cavalry.

Appears on **Co. Muster-out Roll**, dated
Brazos Santiago Tex, Feb. 12, 186*6*.

Muster-out to date 186 .
 Last paid to 186 .

Clothing account:

Last settled....., 186 ; drawn since \$..... 100
 Due soldier \$..... 100; due U. S. \$..... 100
 Am't for cloth'g in kind or money adv'd \$..... 100

Due U. S. for arms, equipments, &c., \$..... 100
 Bounty paid \$..... 100; due \$..... 100

Remarks: *found a Rect. Died*
at Chester Station, Va. of
wounds received in ac-
tion May 16, 64. Final
statements and Inventory
sent May 30, '64.

Book mark: *P.V. 12, P. 196, 69,*

W. Harrison
 (361) Copyist.

Kellum, Alfred.
Pri, Co. D, 2 Reg't U.S.C. (art)

Enclosures.

Bed Cards	Descriptive Lists
Burial Records	Final Statements /
Certs. of Dis. for Discharge	Furloughs
C. M. Charges	Med. Des. Lists
Med. Certificates	Orders

Other papers relating to—

Admission to Hosp'l	Furlough
Casualty Sheet (Officer's)	Med. Examination
Confinement	Misc. Information
Contracts	Pay or Clothing
Death or Effects	Personal Reports
Desertions	Rank
Discharge from Hosp'l	Transfer to Hosp'l
Discharge from Service	Transfer to V. R. C.
Duty	Transportation

[OFFICE INDORSEMENT.]

War Department,

ADJUTANT GENERAL'S OFFICE,

....., 187

The *Death* of *Alfred Hillman*
Private, Co. *D*, *2^d* Reg't U. S.
 Colored *U. S. C. C.*, is reported as follows:—

On Company Muster Roll.
 For *Mayth & June*, 1864 *killed in action May 16th*, 1864
 Company Muster-out Roll.
Died of wounds rec^d in action May 16th, 1864
 Company Descriptive Book.
 , 186
 Company Morning Reports.
 , 186
 Soldier's Final Statement.
Died May 16th, 1864
 Soldier's Record of Death and Interment.
 , 186
 Soldier's Inventory of Effects.
 , 186
 Soldier's Certificate of Disability for Discharge.
 , 186
 Soldier's Individual Muster-out Roll.
 , 186
 Regimental Return.
 For , 186 , , 186
 Regimental Quarterly Returns.
 , 186
 Regimental Descriptive Book.
 , 186
 By Surgeon General.
 (*May 16*) , 186
 is held to be
 the correct date, and the Company Muster
 Roll will be amended accordingly.

Noted on Register

Asst. Adj. Gen.

ms

ADJUTANT GENERAL'S OFFICE.

Aug 27th 1864

Duplicate with Inventory sent 2d Auditor.

FINAL STATEMENT

OF

Asper Helling
Reg't of *91st Ind^{ns} Regt*

VOLUNTEERS.

Rec'd May 16 1864

NOTE 1.—Two of these certificates (or duplicates) are to be given to each Volunteer Soldier or drafted man who may be discharged previously to the discharge of his company, that he may at once receive from the Paymaster the pay, &c., due him, and the captain or other COMMISSIONED officer commanding the company will certify to the act of the delivery of the duplicate certificates; on these certificates the Soldier is "entitled to" his discharge, and should also present his discharge to the Paymaster to have the payment endorsed on it. The discharge is to be given back to the Soldier by the Paymaster; the latter only retaining as his voucher the duplicate certificates.

NOTE 2.—If the Soldier is entitled to pay for the use of his horse, the Company Commander will certify to that fact on the back of both these final statements, and also to the time he has pay due for having been so mounted on his own horse.

NOTE 3.—When a Soldier is furnished with final statements, his descriptive list, if he has one, should be taken up by the officer who gives the Soldier these statements, and endorsed with a statement to this effect by the officer. This endorsement should exhibit a full statement of the time for which the Soldier was allowed pay on his final statements, the clothing account, and all other charges against him or in his favor, so as to comprise a complete exhibit of his account. It will then be transmitted to the Company Commander of the Soldier, who will enter all the data necessary to a full understanding of the Soldier's account on the muster roll upon which the Soldier's discharge is reported. The descriptive list will then be destroyed. The object of this is, that the remaining portion of the Soldier's account may be settled upon the receipt of these muster rolls, and the Soldier receive any pay or allowances that may be due him at the time of his discharge, and which may not appear on his final statements from the fact that his descriptive list is incomplete. These accounts for back pay, &c., are settled by the 2d Auditor of the Treasury Department.

NOTE 4.—Charges for loss or injury to ordnance, horse equipments, and other miscellaneous charges, should appear under the heading of "Other Stoppages."

NOTE 5.—Bounty paid by State authorities, and not by the United States, will not be entered on this statement.

NOTE 6.—Amounts due the Sutler and Laundress must be entered on the muster roll on which the discharge, death, desertion, &c., is reported, as well as on the final statement, otherwise the amount cannot be collected from the United States.

NOTE 7.—This blank will be used for deceased volunteers and drafted men, as well as for others.

NOTE 8.—Where a Soldier dies in Hospital or on detached service, his descriptive list, if he has one, should be sent with his final statements, in duplicate, to the Adjutant General, Washington, D. C.

ADJUTANT GENERAL'S OFFICE.
May 27 1864
Duplicate with Inventory sent 2d Auditor.



2-12

I certify, on honor, that Alfred Kellum a Private of
 Captain Abraham Company (B) of the 2nd Regiment of Volunteers
VOLUNTEERS, of the State of _____, born in Accomack Co, State
 of Virginia, aged 23 years; 5 feet 2 inches high; Dark complexion,
Black eyes, Black hair, and by occupation a Laborer, having joined the company on
 its original organization at Fort Monroe Va, and enrolled in it at the muster into
 the service of the United States at Fort Monroe Va, on the 20th day
 of January, 1864, (or was mustered in service as a recruit, by _____
 _____, at _____, on the _____ day of _____,
 1864, or was drafted and mustered into the service of the United States from the _____
 Enrollment District of the State of _____, at _____,
 on the _____ day of _____, 1864) to serve in the Regiment, for
 the term of three years or the war: and having served **HONESTLY** and
FAITHFULLY with his Company in _____ to the present date, is now
 entitled to a **DISCHARGE** by reason of Death
(Died Dec 11 1864 in service)

The said Alfred Kellum was last paid by Paymaster
May Walker to include the 29th day of February, 1864, and has
 pay due him from that time to the present date; he is entitled to pay and subsistence for
TRAVELING to place of enrollment, and whatever other allowances are authorized to volunteer
 soldiers, drafted men, or militia, so discharged. He has received from the United States **CLOTHING**
 amounting to fifty five $\frac{75}{100}$ dollars, since the 20th day of January,
 1864, when his clothing account was last settled. He has received from the United States
 _____ $\frac{100}{100}$ dollars advanced **BOUNTY**.

There is to be stopped from him, on account of the State of _____, or other
 authorities, for **CLOTHING**, &c., received on entering service, _____ $\frac{100}{100}$ dollars; and
 for other stoppages, viz: _____

_____ $\frac{100}{100}$ dollars.
 He has been furnished with **TRANSPORTATION** in kind from the place of his discharge to
 _____; and he has been **SUBSISTED** for **TRAVELING** to his
 place of enrollment, up to the _____, 1864.

He is indebted to _____, **SUTLER**, _____ $\frac{100}{100}$ dollars.
 He is indebted to _____, **LAUNDRESS**, _____ $\frac{100}{100}$ dollars.

Given in Duplicate, at Near Petersburg Va, this 23rd day
 of August, 1864.

Abraham
Capt

 Commanding Company.

894

Kellum Anthony
Co I, 2 U. S. Col'd Cav.

CARD NUMBERS.

1	26
2	27
3	28
4	29
5	30
6	31
7	32
8	33
9	34
10	35
11	36
12	37
12	38
14	39
15	40
16	41
17	42
18	43
19	44
20	45
21	46
22	47
23	48
24	49
25	50

See Kellum

Anthony

Book Mark:

See also

895
William Henry

Co A, 2 U. S. Col'd Cav.

CARD NUMBERS.

1	26
2	27
3	28
4	29
5	30
6	31
7	32
8	33
9	34
10	35
11	36
12	37
13	38
14	39
15	40
16	41
17	42
18	43
19	44
20	45
21	46
22	47
23	48
24	49
25	50

See William Henry

Book Mark:

See also

NOV 27 1896

⁸⁹⁶
Kellum John

Co. *K*, **2** U. S. Col'd Cav.

Private Private

CARD NUMBERS.

1	5328251	26
2	5328332	27
3	5328418	28
4	5328532	29
5	5376917	30
6	5329436	31
7	9087943	32
8	40726255	33
9		34
10		35
11		36
12		37
13		38
14		39
15		40
16		41
17		42
18		43
19		44
20		45
21		46
22		47
23		48
24		49
25		50

Book Mark:

See also

NR 276

S 636 955 PO aff
10

S-2074234-PO NITM

L Ballou

K | **2 Cav.** | **U.S.C.T.**

John Kellum

, Co. *K*, 2 Reg't U. S. Col'd Cav.

Appears on

Company Descriptive Book

of the organization named above.

DESCRIPTION.

Age *21* years; height *5* feet *8* inches.

Complexion *Black*

Eyes *Black*; hair *Black*

Where born *Norfolk Va.*

Occupation *Labourer*

ENLISTMENT.

When *Jan. 1*, 1864.

Where *Fort Monroe*

By whom *Levi Cole*; term *3* y'rs.

Remarks: *Deserted from "Point of Rocks" June 2nd 1864.*

D. B. Smith

Y.S. | **2 Cav.** | **U.S.C.T.**

John Sellum

Priv., Co. K; 2 Reg't U. S. Col'd Cav.

Age 23 years.

Appears on

Company Muster-in Roll

of the organization named above. Roll dated

Fort Monroe, Va., Jan. 8, 1864.

Muster-in to date Jan. 8, 1864.

Joined for duty and enrolled:

When Jan 1st, 1864.

Where Accomac, Va.

Period 3 years.

Valuation of horse, \$ 100

Valuation of horse equipments, \$ 100

Remarks : _____

filed with John Sellum
terminated by L Ballant Jr

Book mark: _____

(356)

J. E. Brooke

Copyist.

K. | **2 Cav.** | **U.S.C.T.**

John Kellum

Pvt., Co. K, 2 Reg't U. S. Col'd Cav.

Appears on

Company Muster Roll

for Enrollment to Feb. 29, 1864.

Present or absent Present

Stoppage, \$ 100 for

Due Gov't, \$ 100 for

Valuation of horse, \$ 100

Valuation of horse equipments, \$ 100

Remarks: (Enrolled Jan 1/64
mustered in Jan 8/64 at
St-Monroe Va for 3 years)

Book mark:

J. E. Brooks,
Copyist.

K | **2 Cav.** | **U.S.C.T.**

John Kellum
Priv., Co. K, 2 Reg't U. S. Col'd Cav.

Appears on

Company Muster Roll

for Mar. & April, 1864.

Present or absent Present

Stoppage, \$ 100 for

Due Gov't, \$ 100 for

Valuation of horse, \$ 100

Valuation of horse equipments, \$ 100

Remarks: due U.S. for
Ord. \$1.01.

Book mark:

(358)

J. E. Brooks
Copyist.

K. | **2 Cav.** | **U.S.C.T.**

John Kellum
Plt, Co. K, 2 Reg't U. S. Col'd Cav.

Appears on

Company Muster Roll

for May + June, 1864.

Present or absent _____

Stoppage, \$ _____ 100 for _____

Due Gov't, \$ _____ 100 for _____

Valuation of horse, \$ _____ 100

Valuation of horse equipments, \$ _____ 100

Remarks: Presented from
Point of Rocks,
June 19, 1864.

Book mark: _____

(358)

J. E. Brooks

Copyist.

K | *2 Cav* | **U.S.C.T.**

Jack Kellum

Pvt., Co. *K*, *2* Reg't U. S. Col'd *Cav*

Appears on

Descriptive List of Deserters

dated *May 29*, 1865:

Deserted:

When *June 19*, 1864.

Where *Pt. of Rocks*

Arrested:

When _____, 186 .

Where _____

Remarks:

Book mark:

E. Weston

K | **2 Cav.** | **U.S.C.T.**

+ John Kellerman
Pvt., Co. K., 2 Reg't U. S. Colored Cav.

Appears on Returns as follows:

June 1864, absent without
leave since June 27, '64

X per M.C.W.

Book mark:

A. M. Shannon

K | *2 Cav* | **U. S. C. T.**

John Kellum
Pr, *Co K*, *2* Reg't U. S. Col'd *Cav*

Appears on **Co. Muster-out Roll**, dated
Brazos Santiago Tex, *Feb 12*, 1866.

Muster-out to date _____, 186 .

Last paid to *April 30*, 1864 .

Clothing account:

Last settled _____, 186 ; drawn since \$ _____ 100

Due soldier \$ _____ 100 ; due U. S. \$ _____ 100

Am't for cloth'g in kind or money adv'd \$ _____ 100

Due U. S. for arms, equipments, &c., \$ _____ 100

Bounty paid \$ _____ 100 due \$ _____ 100

Remarks: *joined at Regt Regu Pvt*
from Enrollment Deserted
from Pt of Rocks June 19. 64
Desct. List given June 30. 64

Book mark: _____

S. Duncan

⁸⁹⁷
Kelly George

Co *K*, 2 U. S. Col'd Cav.

Private Private

CARD NUMBERS.

1	5315415	26
2	5328333	27
3	5328419	28
4	5328506	29
5	5328588	30
6	5328678	31
7	5328769	32
8	5328655	33
9	5328898	34
10	5328991	35
11	5329079	36
12	5329166	37
13	5329251	38
14	5329373	39
15	9087944	40
16	30852782	41
17	30853909	42
18	30854577	43
19	30854858	44
20	40726256	45
21		46
22		47
23		48
24		49
25		50

Book Mark:

See also

S 936028 - P. rtd.
R 5-38999
S-2866208 and. N. 12

L. D. D. D. D.

K | **2 Cav.** | **U.S.C.T.**

George Kelly

, Co. *K* 2 Reg't U. S. Col'd Cav.

Appears on

Company Descriptive Book

of the organization named above.

DESCRIPTION.

Age *26* years; height *5* feet *7* inches.

Complexion *Dark*

Eyes *Black*; hair *Black*

Where born *Northampton, Va*

Occupation *Laborer*

ENLISTMENT.

When *Jan. 20, 1864.*

Where *Fort Monroe*

By whom *Col. Cole*; term *3* y'rs.

Remarks:

F. B. Smith
Copyist.

K | 2 Cav | **U.S.C.T.**

George Kelley
Priv., Co. _____, 2 Reg't U. S. Col'd Cav.

Age _____ years.

Appears on a

Detachment Muster-in Roll

of the organization named above. Roll dated

Fort Monroe, Va., Jan. 27, 1864.

Muster-in to date Jan. 27, 1864.

Joined for duty and enrolled:

When Jan. 20, 1864 .

Where Fort Monroe, Va.

Period 3 years.

Valuation of horse, \$ _____ 100

Valuation of horse equipments, \$ _____ 100

Remarks: _____

Book mark : _____

O Beck

K. | **2 Cav.** | **U.S.C.T.**

George Kelly
Pvt., Co. K, 2 Reg't U. S. Col'd Cav.

Appears on

Company Muster Roll

for *Enrollment to Feb. 29*, 1864.

Present or absent *Present*

Stoppage, \$ *100* for

Due Gov't, \$ *100* for

Valuation of horse, \$ *100*

Valuation of horse equipments, \$ *100*

Remarks:

Book mark:

(358)

J. E. Brooks,
Copyist.

K. | **2 Cav.** | **U.S.C.T.**

George Keller

Co. K., Co. K, 2 Reg't U. S. Col'd Cav.

Appears on

Company Muster Roll

for *March April*, 1864.

Present or absent *Present*

Stoppage, \$ 100 for

Due Gov't, \$ 100 for

Valuation of horse, \$ 100

Valuation of horse equipments, \$ 100

Remarks:

Book mark: -----

(358)

J. E. Brooks
Copyist.

K | **2 Cav.** | **U.S.C.T.**

George Kelley

Plt., Co. K, 2 Reg't U. S. Col'd Cav.

Appears on

Company Muster Roll

for May & June, 1864.

Present or absent Present

Stoppage, \$ 100 for

Due Gov't, \$ 100 for

Valuation of horse, \$ 100

Valuation of horse equipments, \$ 100

Remarks:

Book mark: -----

(358)

J. E. Brooks
Coptst.

Ko | **2 Cav.** | **U.S.C.T.**

George Kelly

Privt., Co. K, 2 Reg't U. S. Col'd Cav.

Appears on

Company Muster Roll

for *July* or *Aug.*, 186*4*.

Present or absent *Present*

Stoppage, \$ 100 for

Due Gov't, \$ 100 for

Valuation of horse, \$ 100

Valuation of horse equipments, \$ 100

Remarks: *Due to U.S. for*
ord # 2. 36.

Book mark: _____

L. M. Kennedy

(358)

Copyist.

76 | **2 Cav.** | **U.S.C.T.**

George Kelly
Privt., Co. K, 2 Reg't U. S. Col'd Cav.

Appears on

Company Muster Roll
for *Sept. 11. Oct.*, 186*4*.

Present or absent *Present*

Stoppage, \$ *100* for

Due Gov't, \$ *100* for

Valuation of horse, \$ *100*

Valuation of horse equipments, \$ *100*

Remarks:

Book mark: -----

(358)

D. M. Kennedy
Copyist.

K | **2 Cav.** | **U.S.C.T.**

George Kelly
Privt., Co. K, 2 Reg't U. S. Col'd Cav.

Appears on

Company Muster Roll

for *Nov, n, Dec*, 1864.

Present or absent *Present*

Stoppage, \$ *100* for

Due Gov't, \$ *100* for

Valuation of horse, \$ *100*

Valuation of horse equipments, \$ *100*

Remarks:

Book mark: -----

(358) *D. M. Kennedy* Copyist.

K | **2 Cav.** | **U.S.C.T.**

Geo. Kelly

Privt., Co. K, 2 Reg't U. S. Col'd Cav.

Appears on

Company Muster Roll

for *Jan. v. Feb.*, 186*5*.

Present or absent *Present.*

Stoppage, \$ *100* for -----

Due Gov't, \$ *100* for -----

Valuation of horse, \$ *100*

Valuation of horse equipments, \$ *100*

Remarks: -----

Book mark: -----

D. M. Kennedy

Copyist.

K | **2 Cav.** | **U.S.C.T.**

Geo. Kelly

Capt., Co. K, 2 Reg't U. S. Col'd Cav.

Appears on

Company Muster Roll

for *Mar & Apr*, 1865.

Present or absent *Present*

Stoppage, \$ *100* for

Due Gov't, \$ *100* for

Valuation of horse, \$ *100*

Valuation of horse equipments, \$ *100*

Remarks: *App'd Capt March 1/65*

Book mark: -----

(358)

Kiefer

Copyist.

K. | **2 Cav.** | **U.S.C.T.**

George Kelley

Capt. Co. K, 2 Reg't U. S. Col'd Cav.

Appears on

Company Muster Roll

for *May & June*, 186*5*.

Present or absent *Present*

Stoppage, \$.....*100* for

Due Gov't, \$.....*100* for

Valuation of horse, \$.....*100*

Valuation of horse equipments, \$.....*100*

Remarks:

Book mark:

(358)

Keeper
Copyist.

K | **2 Cav.** | **U.S.C.T.**

George Kelly

Capt., Co. K, 2 Reg't U. S. Col'd Cav.

Appears on

Company Muster Roll

for *July & Aug.*, 1863.

Present or absent *Absent*

Stoppage, \$ *100* for

Due Gov't, \$ *100* for

Valuation of horse, \$ *100*

Valuation of horse equipments, \$ *100*

Remarks: *Sick in Hospital at Brasos de Santiago since July 25/63.*

Book mark:

Keefe.

K | 2 bar. | U.S.G.T.

George Kelly
Co. K, 2 Reg't U.S.G. bar.

Appears on

Hospital Muster Roll

of Corps d'Afrique U. S. A. General Hospital,

at New Orleans, La.,

for July & Aug, 1865.

Attached to hospital:

When _____, 186 .

How employed _____

Last paid by Maj. _____

to _____, 186 .

Bounty paid \$ 100; due \$ 100

Present or absent present

Remarks: _____

Book mark: _____

K | **2 Cav.** | **U.S.C.T.**

George Kelley
Coupl, Co. K, 2 Reg't U. S. Col'd Cav.

Appears on

Company Muster Roll

for *Sept & Oct*, 186*3*.

Present or absent *Absent*

Stoppage, \$ 100 for

Due Gov't, \$ 100 for

Valuation of horse, \$ 100

Valuation of horse equipments, \$ 100

Remarks: *Absent sick since July 10th 1865*

Book mark:

S. Duncan

K | 2 Cav USCT

George Kelly
Capt. Co. K, 2 Regt US Cav

Appears on

Hospital Muster Roll

of Corps d'Afrique U. S. A. General Hospital,

at New Orleans, La.,

for *Sept & Oct*, 186*5*.

Attached to hospital:

When....., 186 .

How employed.....

Last paid by Maj.

to, 186 .

Bounty paid \$ 100 due \$ 100

Present or absent *Present*

Remarks:.....

Book mark:.....

Stewart
Coppist.

K

2 Cav.

U.S.C.T.

George Ribby

Capt, Co. K, 2 Reg't U. S. Col'd Cav.

Appears on

Company Muster Roll

for *Nov & Dec*, 1865.

Present or absent *Absent*

Stoppage, \$ 100 for

Due Gov't, \$ 100 for

Valuation of horse, \$ 100

Valuation of horse equipments, \$ 100

Remarks: *Absent sick since July 6th 1865*

Book mark:

S. Duncan

K 1 2 C WSCD

George Kelly

Corpl, Co. K, 2 Reg' WSCC

Appears on

Hospital Muster Roll

of Corps d'Afrique U. S. A. General Hospital,

at New Orleans, La.,

for *Nov & Dec*, 186*5*.

Attached to hospital:

When....., 186 .

How employed.....

Last paid by Maj.

to, 186 .

Bounty paid \$ *100* due \$ *100*

Present or absent *Present*

Remarks:.....

.....
.....
.....
.....
.....
.....
.....
.....

Book mark:.....

J. J. [Signature]

K 2 @ usca

George Kelly

Corp, Co K, 2 Reg't usca

Appears on

Hospital Muster Roll

of Corps d'Afrique U. S. A. General Hospital,

at New Orleans, La.,

for *Jan & Feb*, 186*6*.

Attached to hospital:

When....., 186 .

How employed.....

Last paid by Maj.

to, 186 .

Bounty paid \$ 100; due \$ 100

Present or absent

Remarks: *Returned to duty Jan 23/66*

Book mark:

[Signature]
(843) Copyst.

NA 393
A 2 Cav. U.S.C.T.

George Kelly
Capt, Co. K, 2 Reg't U. S. Colored Cav.

Appears on Returns as follows:

Aug 1865, absent sick at
Brazos since July 25
65

Sept. 1865, absent sick in
U.S. Gen Hospital.

Oct 1865, absent sick since
Oct 10 65.

Nov 1865, absent sick N. O La
or Brazos Santiago Texas

Dec 1865, absent sick since
July 6 65.

Book mark:

A. M. Hammer

K | **2 Cav. | U.S.C.T.**

George Kelly
Priv., Co. K, 2 Reg't U. S. Col'd Cavalry.

Appears on **Co. Muster-out Roll**, dated
Brazos Santiago Tex, Feb 12, 1866.
Muster-out to date Feb 12, 1866.
Last paid to Dec 31, 1864.

Clothing account:

Last settled....., 186 ; drawn since \$.....100

Due soldier \$ 30 ⁸⁰ 100; due U. S. \$.....100

Am't for cloth'g in kind or money adv'd \$.....100

Due U. S. for arms, equipments, &c., \$.....100

Bounty paid \$.....100; due \$.....100

Remarks: joined a Reet.
Priv. till Mch 1.65 then
Capt Dec 31.65 then Priv.
Pay due as Capt from
+ ~~Jan 30~~ Mch-65 to Dec 31.65

+ as it appears on Roll

Book mark: 1907. 1882. 444.951
(over)

S. Duncan

NOV 30 1967

JAN. - 7

5329373

7.891 *

Q35 P. 190.68

11

⁸⁹⁸
Kelly Henderson

Co *H*, **2** U. S. Col'd Cav.

Private | *Private*

CARD NUMBERS.

1	5316190	26
2	5326458	27
3	5326543	28
4	5326624	29
5	5326703	30
6	5326783	31
7	5326883	32
8	5326979	33
9	30853898	34
10	30854800	35
11	40726252	36
12		37
13		38
14		39
15		40
16		41
17		42
18		43
19		44
20		45
21		46
22		47
23		48
24		49
25		50

Book Mark:

See also

NOV 20 1899

S. 644755. 2nd Aug.
S. 644756 2nd Aug.

L Ballard ✓

A | **2 Cav.** | **U.S.C.T.**

Henderson Keller

Appears with rank of *Private* on

Muster and Descriptive Roll of a Detachment of U. S. Vols. forwarded

for the 2 Reg't U. S. Col'd Cavalry. Roll dated

Newport News Va. Jan'y 3, 1865.

Where born *Southampton Va.*

Age *36* y'rs; occupation *Laborer*

When enlisted *Jan'y 7*, 1865.

Where enlisted *Portfolk Va.*

For what period enlisted *3* years.

Eyes *black*; hair *black*

Complexion *black*; height *5* ft. *5 1/2* in.

When mustered in *Jan'y 11*, 1865.

Where mustered in *Newport News*

Bounty paid \$ *100* ¹⁰⁰; due \$ ¹⁰⁰

Where credited *Mass. at large.*

Company to which assigned

Remarks:

Book mark: *387-00*

J. D. Neal

10 | **2 Cav.** | **U.S.C.T.**

Henderson Kelley
Priv, Co. H, 2 Reg't U. S. Col'd Cavalry.

Appears on

Company Muster Roll
for *Jan. & Feb.*, 1865.

Present or absent *Present*

Stoppage, \$ *100* for

Due Gov't, \$ *100* for

Valuation of horse, \$ *100*

Valuation of horse equipments, \$ *100*

Remarks:

Book mark: _____

(358)

W. B. Ferguson
Copyist.

K | **2 Cav.** | **U.S.C.T.**

Henderson Kelley

Private, Co. H, 2 Reg't U. S. Col'd Cavalry.

Appears on

Company Muster Roll

for *March and April*, 1865.

Present or absent *Absent*

Stoppage, \$ *100* for

Due Gov't, \$ *100* for

Valuation of horse, \$ *100*

Valuation of horse equipments, \$ *100*

Remarks:

Disint'd Camp, Petersburgh, Va.

Book mark:

C. G. Powell

K | **2 Cav.** | **U.S.C.T.**

Henderson Kelley
Private, Co. H, 2 Reg't U. S. Col'd Cavalry.

Appears on

Company Muster Roll

for *May and June*, 186*5*.

Present or absent *Present*

Stoppage, \$ *100* for

Due Gov't, \$ *100* for

Valuation of horse, \$ *100*

Valuation of horse equipments, \$ *100*

Remarks:

Book mark:

C. G. Powell

K | 2 Cav. | U.S.C.T.

Henderson Kelly

Private, Co. H, 2 Reg't U. S. Col'd Cavalry.

Appears on

Company Muster Roll

for July and Aug., 1864.

Present or absent Absent

Stoppage, \$ 100 for

Due Gov't, \$ 100 for

Valuation of horse, \$ 100

Valuation of horse equipments, \$ 100

Remarks: Absent sick in Hospital.

Book mark:

C. Y. Powell

71 | **2 Cav.** | **U.S.C.T.**

Henderson Kelly

Pvt., Co. H, 2 Reg't U. S. Col'd Cavalry.

Appears on

Company Muster Roll

for *Sep & Oct*, 1865.

Present or absent *Absent*

Stoppage, \$ *100* for

Due Gov't, \$ *100* for

Valuation of horse, \$ *100*

Valuation of horse equipments, \$ *100*

Remarks: *Absent sick in U.S. G. Hospital*

Book mark:

(358)

U.S. Army
Copyist.

To 2 Car & SGT

Henderson Keller
Priv, Co H, 2 Regt U.S.C. Cav

Appears on

Hospital Muster Roll

of Corps d'Afrique U. S. A. General Hospital,

at New Orleans, La.,

for *Sept & Oct*, 186*5*.

Attached to hospital:

When....., 186 .

How employed.....

Last paid by Maj.

to, 186 .

Bounty paid \$ 100 due \$ 100

Present or absent *Present.*

Remarks:.....

Book mark:.....

Shaw

H | **2 Cav.** | **U.S.C.T.**

Henderson Kelley

Pat, Co. H, 2 Reg't U. S. Col'd Cavalry.

Appears on

Company Muster Roll

for *Nov & Dec*, 1865.

Present or absent.....

Stoppage, \$.....100 for.....

Due Gov't, \$.....100 for.....

Valuation of horse, \$.....100

Valuation of horse equipments, \$.....100

Remarks: *Died at U.S. Genl Hosp
N. Orleans La Nov 25/65*

Book mark:.....

G. D. H. J.
Copyist.

K 1 2 C WSCA

Denderson Keller

Priv, Co. A, 2 Regt WSCA

Appears on

Hospital Muster Roll

of Corps d'Afrique U. S. A. General Hospital,

at New Orleans, La.,

for *Nov & Dec*, 186*5*.

Attached to hospital:

When....., 186 .

How employed.....

Last paid by Maj.

to, 186 .

Bounty paid \$ 100; due \$ 100

Present or absent

Remarks: *Died Nov 24/65*

Book mark *308-200*

F. A. Johnson

K 2 Cav. | U. S. C. T.

Henderson Kelly *

Rot, Co. *76*, 2 Reg't U. S. Cav'd Cav.

Appears on Returns as follows:

*Feb'y 1865 Gain: Recruit
from Depot*

Aug 1865 Absent sick in Hosp

Sept. 1865 Absent sick New Orleans La

Dec 1865 + Jan'y 1866 Absent sick

*Dec 1865 Loss: Nov. 25/65, N.
Orleans, Died at Hosp*

** name appears also as
Hendon Kealey, Henderson
Keller * So on return*

Book mark:

J. Cottrell

H | **2 Cav. | U.S.C.T.**

Henderson Kelly
Pvt, Co *H*, 2 Reg't U. S. Col'd Cavalry.

Appears on **Co. Muster-out Roll**, dated
Brazos Santiago Tex, Feb 12, 1866.
Muster-out to date _____, 186 .
Last paid to _____, 186 .

Clothing account:

Last settled _____, 186 ; drawn since \$ _____ ¹⁰⁰
Due soldier \$ _____ ¹⁰⁰; due U. S. \$ _____ ¹⁰⁰
Am't for cloth'g in kind or money adv'd \$ _____ ¹⁰⁰

Due U. S. for arms, equipments, &c., \$ _____ ¹⁰⁰
Bounty paid \$ _____ ¹⁰⁰; due \$ _____ ¹⁰⁰

Remarks: *joined a Recruit*
Died of disease at U.S. Gen Hosp
N. Orleans La Nov 25 1865
Final statements & Inv of Effects
forwd Jan 5 1866

Book mark : _____

Y. D. Kelly
Copyist.

Keller, Henderson

P, Co. H, 2 Reg't. U.S.C. Cav.

4 Enclosures.

Bed Cards	Descriptive Lists
Burial Records /	Final Statements /
Certs. of Dis. for Discharge	Furloughs
C. M. Charges	Med. Des. Lists
Med. Certificates	Orders
<i>Enlistments</i>	

Other papers relating to—

Admission to Hosp'l	Furlough
Casualty Sheet (Officer's)	Med. Examination
Confinement	Misc. Information
Contracts	Pay or Clothing
Death or Effects /	Personal Reports
Desertions	Rank
Discharge from Hosp'l	Transfer to Hosp'l
Discharge from Service	Transfer to V. R. C.
Duty	Transportation

NOV 20 1865

NOTE 1. — This blank will be used for both enlistments and re-enlistments — enlistment of veterans, &c., &c., in the volunteer service. They will be made out in duplicate in all cases — one to accompany the recruiting return of the superintendent (not the recruiting officer) to the Adjutant-General, and one to accompany the accounts of the officer who pays bounty, &c. The Regiment and Company in which the soldier last served should be given on the back.

NOTE 2. — An enlistment holds to service. A muster-in must, in all cases, precede payment of pay, bounty, pension, &c. A muster-in roll must, in all cases, be filed in the Adjutant-General's Office as evidence of muster-in. The mustering officer, commissary, or assistant-commissary of musters, as the case may be, will countersign both enlistments as having mustered the soldier into the service of the United States before either of them is given to the disbursing officer.

DECLARATION OF RECRUIT.

I, *Henderson Keller* desiring to VOLUNTEER as a Soldier in the Army of the United States, for the term of THREE YEARS, Do Declare, That I am *36* years and *11* months of age; that I have never been discharged from the United States service on account of disability or by sentence of a court-martial, or by order before the expiration of a term of enlistment; and I know of no impediment to my serving honestly and faithfully as a soldier for three years.

GIVEN at *Norfolk Va* the *7th* day of *January 1865*

Witness:

J. B. Parsons

Henderson Keller
mark

Discharged

18

Reg't of

enlistment; last served in Company ()

By *Det. J. M. Warner*
37th Regiment of Col. A.S.

Volunteered at

Norfolk 1865

Henderson Keller

No.

6

CONSENT IN CASE OF MINOR.

I, _____ Do CERTIFY, That I am _____; that the he _____ of _____; that the said _____ is _____ years of age; and I do hereby freely give my CONSENT to his volunteering as a SOLDIER in the ARMY OF THE UNITED STATES for the period of THREE YEARS.

GIVEN at _____ the _____ day of _____

Witness:

VOLUNTEER ENLISTMENT.

STATE OF



TOWN OF

Massachusetts

I, *Henderson Keller* born in *Southampton*
 in the State of *Virginia* aged *36* years,
 and by occupation a *Suborer* Do HEREBY ACKNOWLEDGE to have
 volunteered this *7th* day of *July* 1865,
 to serve as a **Soldier** in the **Army of the United States of America**, for the
 period of **THREE YEARS**, unless sooner discharged by proper authority: Do also
 agree to accept such bounty, pay, rations, and clothing, as are, or may be, estab-
 lished by law for volunteers. And I, *Henderson Keller* do
 solemnly swear that I will bear true faith and allegiance to the **United States**
of America, and that I will serve them honestly and faithfully against all their
 enemies or opposers whomsoever; and that I will observe and obey the orders of
 the President of the United States, and the orders of the officers appointed over
 me, according to the Rules and Articles of War.

Sworn and subscribed to, at *Norfolk Va*
 this *7th* day of *Jan* 1865, *Henderson Keller*
 BEFORE *J. M. Morrow*
Lt 57th U.S. C.T.

I CERTIFY, ON HONOR, That I have carefully examined the above-named Volunteer, agreeably
 to the General Regulations of the Army, and that, in my opinion, he is free from all bodily defects and
 mental infirmity, which would in any way disqualify him from performing the duties of a soldier.

W. W. Berry
Asst. Surg. 1st U.S. C.T.
 EXAMINING SURGEON.

I CERTIFY, ON HONOR, That I have minutely inspected the Volunteer, *Keller*
 previously to his enlistment, and that he was entirely sober when enlisted; that, to the best of my
 judgment and belief, he is of lawful age; and that, in accepting him as duly qualified to perform the duties
 of an able-bodied soldier, I have strictly observed the Regulations which govern the recruiting service.
 This soldier has *Blue* eyes, *Black* hair, *Black* complexion, is *5* feet
5th inches high.

James M. Morrow
Lt 57th U.S. C.T. Volunteers.
 RECRUITING OFFICER.

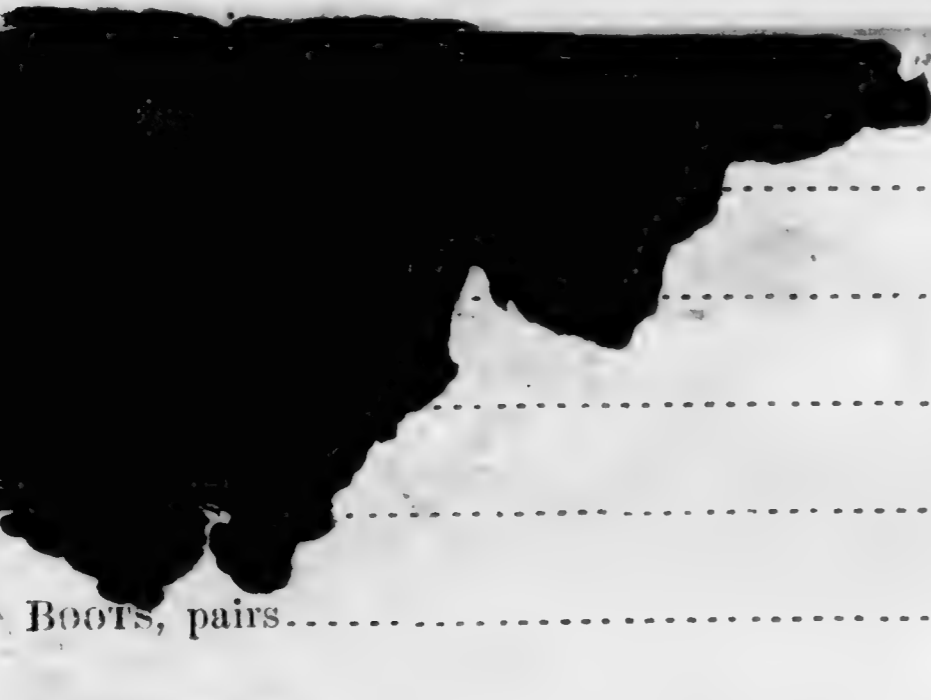
(A. G. O. No. 74 & 75.)

Mustered into the service of the United States, in Company *D*
 the *11th* day of *January*, 1865, at *New Port News, Va.*
Credited to Massachusetts
 Regiment of *U.S. Cavalry* Volunteers, on

Wm. Morrow
Major 6th U.S. Cavalry
Chief Muster Officer

3333 3333

Inventory of the effects of Henderson Keller
Company "H", 2^d Regiment U.S. Col. Cav.
who died in the Goymer Ojique General Hospital New Orleans
La, Nov, 25th, 1865.

CAPS	1	BLANKETS	1
DRESS COATS		KNAPSACKS	
		CANTEENS	
		HAVERSACKS	
		MUSKETS	
		BAYONETS	
BOOTS, pairs		CARTRIDGE BOX	
SHOES, pairs		BELT	
STOCKINGS		MONEY	

copy

Henderson Keller

INVENTORY

OF THE EFFECTS OF

Priv. Henderson Keller

Late of Company "H", 2^d Regiment

U.S. Col. Cav., who died

at Goymer Ojique General

Hospital New Orleans Nov. 25th,

1865.

NOV 25

U. S. Army General Hospital,

....., 186 .

Commanding Officer, Company,

..... Regiment

I have to inform you

that of your Company died in this

Hospital on of

.....

I enclose his Descriptive List, with Pay and Clothing Account,
and Inventory of his effects.

Very respectfully, yours, &c.,

.....
Surgeon U. S.,

In charge of General Hospital.

NOV 25 1865

No. 2.

RECORD OF DEATH AND INTERMENT.

Name and number of person interred,	- - -	<i>New person Keller</i>
Number and locality of the Grave,	- - -	
Hospital number of the deceased,	- - -	<i>7343</i>
Regiment, rank and company,	- - -	<i>Private Co H, 2^d reg C bay</i>
Residence before enlistment,	- - -	
Conjugal condition, (and if married,	- - -	}
The residence of the widow,	- - -	
Cause of death,	- - -	}
Age of the deceased,	- - -	
Nativity,	- - -	<i>Pennsylvania</i>
References and remarks,	- - -	
Date of death and burial,	- - -	<i>November 25 1865</i>

To *Adj't Genl U.S. Army*
 SIR:

It becomes my duty to inform you that the person above described died at this Hospital as herein stated, and that it is desired his remains should be interred with the usual Military honors.

Respectfully,

F. E. Piquette
 SURGEON, ~~U.S. ARMY.~~
8th Regt. Infantry
in Charge

MILITARY HOSPITAL, *Corps d'Infanterie New Orleans*
La

NOV 27 1865

FINAL STATEMENT

OF

Private Hannason Keller

2nd Reg't of U.S. Col. Cavalry

Died Nov 25 1865
VOLUNTEERS.

NOTE 1.—Two of these certificates (or duplicates) are to be given to each Volunteer Soldier or drafted man who may be discharged previously to the discharge of his company, that he may at once receive from the Paymaster the pay, &c., due him, and the captain or other COMMISSIONED officer commanding the company will certify to the act of the delivery of the duplicate certificates; on these certificates the Soldier is "entitled to" his discharge, and should also present his discharge to the Paymaster to have the payment endorsed on it. The discharge is to be given back to the Soldier by the Paymaster; the latter only retaining as his voucher the duplicate certificates.

NOTE 2.—If the Soldier is entitled to pay for the use of his horse, the Company Commander will certify to that fact on the back of both these final statements, and also to the time he has pay due for having been so mounted on his own horse.

NOTE 3.—When a Soldier is furnished with final statements, his descriptive list, if he has one, should be taken up by the officer who gives the Soldier these statements, and endorsed with a statement to this effect by the officer. This endorsement should exhibit a full statement of the time for which the Soldier was allowed pay on his final statements, the clothing account, and all other charges against him or in his favor, so as to comprise a complete exhibit of his account. It will then be transmitted to the Company Commander of the Soldier, who will enter all the data necessary to a full understanding of the Soldier's account on the muster roll upon which the Soldier's discharge is reported. The descriptive list will then be destroyed. The object of this is, that the remaining portion of the Soldier's account may be settled upon the receipt of these muster rolls, and the Soldier receive any pay or allowances that may be due him at the time of his discharge, and which may not appear on his final statements from the fact that his descriptive list is incomplete. These accounts for back pay, &c., are settled by the 2d Auditor of the Treasury Department.

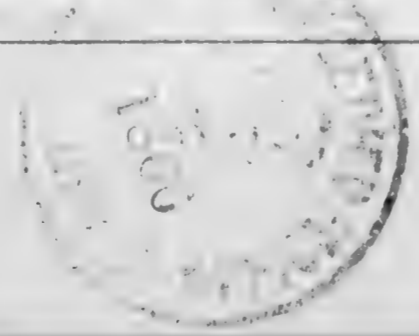
NOTE 4.—Charges for loss or injury to ordnance, horse equipments, and other miscellaneous charges, should appear under the heading of "Other Stoppages."

NOTE 5.—Bounty paid by State authorities, and not by the United States, will not be entered on this statement.

NOTE 6.—Amounts due the Sutler and Laundress must be entered on the muster roll on which the discharge, death, desertion, &c., is reported, as well as on the final statement, otherwise the amount cannot be collected from the United States.

NOTE 7.—This blank will be used for deceased volunteers and drafted men, as well as for others.

NOTE 8.—Where a Soldier dies in Hospital or on detached service, his descriptive list, if he has one, should be sent with his final statements, in duplicate, to the Adjutant General, Washington, U. C.



[Handwritten signature]

*M.C. Rec 28/1865
J.C. of Adams & Co. Inc.
receives 7.12th Dec 2nd Aud.
J.A.*

*Due 76.8. for Clothing
drawn in Hospital,
\$13.40. see P. 79. Vol. 3.
R. C. 7. 1866.*

13.

B 79 Vol. 3 R.C. 7. 1866

ADJUTANT GENERAL'S OFFICE
March 1st 1866
Duplicate with Inventory sent 2d Auditor.

James C. ... Description of the ... I have deducted from ...

I certify, on honor, that Renderson Kelles a Private of Captain James C. Lewis Company ("H") of the Second Regiment of U.S. Col. Cav. VOLUNTEERS, of the State of _____, born in _____, State of _____, aged _____ years; _____ feet _____ inches high; _____ complexion, _____ eyes, _____ hair, and by occupation a _____, having joined the company on its original organization at Norfolk Va. and enrolled in it at the muster into the service of the United States at Norfolk Va., on the Seventh day of January, 1865, (or was mustered in service as a recruit, by _____, at _____, on the _____ day of _____, 1865, or was drafted and mustered into the service of the United States from the Enrollment District of the State of _____, at _____, on the _____ day of _____, 1865) to serve in the Regiment, for the term of Three Years; and having served HONESTLY and FAITHFULLY with his Company in the Field, till sent to Hos. to the present date, is now entitled to a **DISCHARGE** by reason of death Died at Camp de Urgues, Ind. Hos. November 25th 1865.

The said Private Renderson Kelles has not been paid, and has no pay due from enlistment, was last paid by Paymaster _____ to include the _____ day of _____, 1865, and has pay due him from that time to the present date; he is entitled to pay and subsistence for TRAVELING to place of enrollment, and whatever other allowances are authorized to volunteer soldiers, drafted men, or militia, so discharged. He has received from the United States **CLOTHING** amounting to 10⁰⁰ (10) ⁵/₁₀₀ dollars, since the Twenty first day of October, 1865, when his clothing account was last settled. He has received from the United States 10⁰⁰ dollars advanced **BOUNTY**.

There is to be stopped from him, on account of the State of _____, or other authorities, for **CLOTHING**, &c., received on entering service, 10⁰⁰ dollars; and for other stoppages, viz: _____ dollars.

He has been furnished with TRANSPORTATION in kind from the place of his discharge to _____; and he has been SUBSISTED for TRAVELING to his place of enrollment, up to the _____, 1865.

He is indebted to _____, **SUTLER**, _____ dollars.
He is indebted to _____, **LAUNDRESS**, _____ dollars.

Given in Duplicate, at Brasserie Santiago Texas, this 5th day of January, 1866.

A. H. Brown
2nd Lt. 2nd U.S. Cavalry
Commanding Company. "H."

899
Kendricks Joshua

Co. B., 2 U. S. Col'd Cav.

Private Private

CARD NUMBERS.

1	5315676	26
2	5319877	27
3	5319964	28
4	5320052	29
5	5320135	30
6	5320225	31
7	5320317	32
8	5320402	33
9	5320499	34
10	5320593	35
11	5320689	36
12	5320778	37
13	5320865	38
14	5320948	39
15	9087326	40
16	32525663	41
17	40726257	42
18		43
19		44
20		45
21		46
22		47
23		48
24		49
25		50

Book Mark:

See also

K | **2 Cav. | U.S.C.T.**

Joshua Kendrick
 _____, Co. *B*, 2 Reg't U. S. Col'd Cav.

Appears on

Company Descriptive Book

of the organization named above.

DESCRIPTION.

Age *24* years; height *5* feet *8 1/2* inches.

Complexion *Black*

Eyes *Black*; hair *Black*

Where born *Nansemond, Va.*

Occupation *Laborer*

ENLISTMENT.

When *Jan. 1*, 186*4*.

Where *Ft Monroe Va.*

By whom *G. Cole*; term *3* y'rs.

Remarks: *wounded in the left hand at New Market Heights, Va. Sept. 29/64.*

F. B. Smith

 Copyist.

K. | 2 | Coar | U.S.C.T.

Joshua Kendrick
Ant, Co. 2 Reg't U. S. Col'd Coar

Age _____ years.

Appears on a

Detachment Muster-in Roll

of unattached recruits
of the organization named above. Roll dated

Ft. Monroe, Va, Jan. 11, 1864.

Muster-in to date Jan. 11, 1864.

Joined for duty and enrolled:

When Jan 1, 1864.

Where Ft. Monroe, Va

Period 3 years.

Valuation of horse, \$ 100

Valuation of horse equipments, \$ 100

Remarks : _____

Book mark : _____

(337) J. J. Kearney Copyist.

N 7 9 3 3 2
K ' 2 Cav. U. S. A.

Joshua Kendrick
Pr., Co. C, 2 Reg't U. S. Col. Cav.

Appears on

Hospital Muster Roll

of U. S. A. General Hospital,

at Hampton, Va.,

for Jan & Feb, 1864.

Attached to hospital:

When, 186 .

How employed

Last paid by Maj.

to, 186 .

Bounty paid \$ 100; due \$ 100

Present or absent Present,

Remarks: No descriptive List

Book mark:

C. S. Harris

M | **2 Cav.** | **U.S.C.T.**

Joshua Kendrick
Rot, Co. C, 2 Reg't U. S. Col'd Cavalry.

Appears on

Company Muster Roll

for *Dated Feb 29*, 186*4*.

Present or absent *Absent*

Stoppage, \$ *100* for

Due Gov't, \$ *100* for

Valuation of horse, \$ *100*

Valuation of horse equipments, \$ *100*

Remarks: *Went to hospital since February 27 1864*

Book mark: _____

Hadfield

K | **2 Cav.** | **U.S.C.T.**

Joshua Kendrick
Pvt, Co. C, 2 Reg't U. S. Col'd Cavalry.

Appears on

Company Muster Roll

for *Mar & Apr*, 186*1*/.

Present or absent *Present*

Stoppage, \$ 100 for

Due Gov't, \$ 100 for

Valuation of horse, \$ 100

Valuation of horse equipments, \$ 100

Remarks:

Book mark:

Ho djield

N | **2 Cav.** | **U.S.C.T.**

Joshua Kendrick
Wt, Co. C, 2 Reg't U. S. Col'd Cavalry.

Appears on

Company Muster Roll

for *May 7 June*, 186*4*.

Present or absent *Present*

Stoppage, \$ *100* for

Due Gov't, \$ *100* for

Valuation of horse, \$ *100*

Valuation of horse equipments, \$ *100*

Remarks:

Book mark:

Bradfield
Copyist.

K | **2 Cav.** | **U.S.C.T.**

Joshua Kendrick
Prnt, Co. C, 2 Reg't U. S. Col'd Cavalry.

Appears on

Company Muster Roll

for *July & Aug*, 186*4*.

Present or absent *Present*

Stoppage, \$.....100 for

Due Gov't, \$.....100 for

Valuation of horse, \$.....100

Valuation of horse equipments, \$.....100

Remarks:

Book mark:

W. H. ...

K | **2 Cav.** | **U.S.C.T.**

Joshua Kendrick
Prnt, Co. C, 2 Reg't U. S. Col'd Cavalry.

Appears on

Company Muster Roll

for *Sept & Oct*, 186*4*.

Present or absent *Present*

Stoppage, \$.....100 for

Due Gov't, \$.....100 for

Valuation of horse, \$.....100

Valuation of horse equipments, \$.....100

Remarks:

Book mark:

W. D. O'Z

K | **2 Cav.** | **U.S.C.T.**

Joshua Kendrick

Privt., Co. C, 2 Reg't U. S. Col'd Cavalry.

Appears on

Company Muster Roll

for Nov + Dec, 1864.

Present or absent Present

Stoppage, \$ 100 for

Due Gov't, \$ 100 for

Valuation of horse, \$ 100

Valuation of horse equipments, \$ 100

Remarks:

Book mark:

W. B. Doe

K | 2 Cav. | U.S.C.T.

Joshua Kendrick
Private, Co. C, 2 Reg't U. S. Col'd Cavalry.

Appears on

Company Muster Roll

for Jan & Feb, 1865.

Present or absent Present

Stoppage, \$ 100 for

Due Gov't, \$ 100 for

Valuation of horse, \$ 100

Valuation of horse equipments, \$ 100

Remarks: Back pay due since enrollment

Book mark:

W. D. Log

No | 2 Cav. | U.S.C.T.

Joshua Hendrick
Pvt, Co. C, 2 Reg't U. S. Col'd Cavalry.

Appears on

Company Muster Roll

for March & April, 1865.

Present or absent Present

Stoppage, \$ 100 for

Due Gov't, \$ 100 for

Valuation of horse, \$ 100

Valuation of horse equipments, \$ 100

Remarks:

Book mark:

J. Laborris

no 1
16

2 Cav. U.S.C.T.

Joshua Kendrick

Priv, Co. C, 2 Reg't U. S. Col'd Cavalry.

Appears on

Company Muster Roll

for *May & June*, 1865.

Present or absent *Present*

Stoppage, \$ 100 for

Due Gov't, \$ 100 for

Valuation of horse, \$ 100

Valuation of horse equipments, \$ 100

Remarks:

Book mark: -----

J. L. Morris

76 | **2 Cav.** | **U.S.C.T.**

Joshua Kendrick
Priv, Co. C, 2 Reg't U. S. Col'd Cavalry.

Appears on

Company Muster Roll

for *July & August*, 1865.

Present or absent *Present*

Stoppage, \$ *100* for

Due Gov't, \$ *100* for

Valuation of horse, \$ *100*

Valuation of horse equipments, \$ *100*

Remarks:

Book mark:

J. L. Borris

K | **2 Cav.** | **U.S.C.T.**

Joshua Kendrick
Priv, Co. C, 2 Reg't U. S. Col'd Cavalry.

Appears on

Company Muster Roll

for Sept & Oct, 1865.

Present or absent Present

Stoppage, \$ 100 for

Due Gov't, \$ 100 for

Valuation of horse, \$ 100

Valuation of horse equipments, \$ 100

Remarks:

Book mark:

G. W. Chase

K | **2 Cav.** | **U.S.C.T.**

Joshua Kendrick

Pvt, Co. C, 2 Reg't U. S. Col'd Cavalry.

Appears on

Company Muster Roll

for *Nov & Dec*, 186*5*.

Present or absent *Present*

Stoppage, \$ 100 for

Due Gov't, \$ 100 for

Valuation of horse, \$ 100

Valuation of horse equipments, \$ 100

Remarks:

Book mark:

G. W. Chase

A. | 2 Cav. | U.S.C.T.

Joshua Kendrick
Pvt, Co. C, 2 Reg't U. S. Colored Cav.

Appears on Returns as follows:

Feb 1864 Absent sick in
Gen Hospl.

March 1864 Absent sick in
Gen Hospl at Hampton

Oct 1864, Oct 20, Returned
from Hospl.

Book mark :

Amthann

K | 2 Cav. | U.S.C.T.

Joshua Kendrick
Co. C, 2 Reg't U. S. Col'd Cavalry.

Appears on **Co. Muster-out Roll**, dated
Brazos Santiago, Tex, Feb 12, 1866.
Muster-out to date Feb 12, 1866.
Last paid to June 30, 1865.

Clothing account:

Last settled....., 186 ; drawn since \$..... 100
Due soldier \$..... 100; due U. S. \$..... 14 82
Am't for cloth'g in kind or money adv'd \$..... 100

Due U. S. for arms, equipments, &c., \$..... 100

Bounty paid \$..... 100; due \$..... 100

Remarks: Joined at orgl. org.

Book mark: V. 35. P. 229. / 68

G. W. Chase

⁹⁰⁰
Kennedy Mases

Co I, 2 U. S. Col'd Cav.

Private

Private

CARD NUMBERS.

1	5315739	26
2	5327104	27
3	5327191	28
4	5327280	29
5	5327361	30
6	5327487	31
7	5328215	32
8	908782H	33
9	R.P. 327602.	34
10		35
11		36
12		37
13		38
14		39
15		40
16		41
17		42
18		43
19		44
20		45
21		46
22		47
23		48
24		49
25		50

Book Mark: R.P. 327602.

See also

REP 327602,
REP 339185,
S-785530-PO mem

11912977 - 11/15/50
R.P. 705967

L. D. Ballary & Co

K | 2 Cav. | U.S.C.T.

Moses Kennedy

, Co D, 2 Reg't U. S. Col'd Cav.

Appears on

Company Descriptive Book

of the organization named above.

DESCRIPTION.

Age 18 years; height 5 feet 3 inches.

Complexion Dark

Eyes Black; hair Black

Where born Newbern, N. C.

Occupation Cornfield hand.

ENLISTMENT.

When Jan 10, 1864

Where Fort Monroe, Va.

By whom Col. Leve; term 3 y'rs.

Remarks: Deserted Sept 21/64, near Deep Bottom Va.

* as appears on Roll

F. B. Smith

Copist.

K. | 2 Cav. | U.S.C.T.

Moses Kennedy

Regt, Co. 2 Reg't U. S. Col'd Cav.

Age _____ years.

Appears on a

Detachment Muster-in Roll
of *unattached recruits* the organization named above. Roll dated

Yf. Monroe, Va, Jan. 19, 1864.

Muster-in to date Jan. 19, 1864.

Joined for duty and enrolled:

When Jan. 10, 1864.

Where Yf. Monroe, Va

Period 3 years.

Valuation of horse, \$ 100

Valuation of horse equipments, \$ 100

Remarks: _____

Book mark: R. 9 327, 602.

J. J. Kearney
Copyist.

K | **2 Cav.** | **U.S.C.T.**

Grove Kennedy
Put, Co. I, 2 Reg't U. S. Col'd Cavalry.

Appears on

Company Muster Roll

for *Enrollment to Feb 29, 1864.*

Present or absent *Present*

Stoppage, \$ 100 for

Due Gov't, \$ 100 for

Valuation of horse, \$ 100

Valuation of horse equipments, \$ 100

Remarks:

Book mark: -----

O. A. Ward

R | **2 Cav.** | **U.S.C.T.**

Moses Kennedy
Sut

Co. I, 2 Reg't U. S. Col'd Cavalry.

Appears on

Company Muster Roll

for *Mar 9 Apr*, 186*4*.

Present or absent *Present*

Stoppage, \$ 100 for

Due Gov't, \$ 100 for

Valuation of horse, \$ 100

Valuation of horse equipments, \$ 100

Remarks:

Book mark:

D. A. Ward

R | **2 Cav.** | **U.S.C.T.**

Groves Kennedy
Out, Co. I, 2 Reg't U. S. Col'd Cavalry.

Appears on

Company Muster Roll

for *May & June*, 1864.

Present or absent *Present*

Stoppage, \$ *100* for

Due Gov't, \$ *100* for

Valuation of horse, \$ *100*

Valuation of horse equipments, \$ *100*

Remarks:

Book mark:

D. A. Ward

B | **2 Cav. U.S.C.T.**

Moses Kennedy
Pi....., Co. I, 2 Reg't U. S. Col'd Cavalry.

Appears on

Company Muster Roll

for *July & Aug*....., 186*7*

Present or absent *Absent*

Stoppage, \$..... *100* for.....

Due Gov't, \$..... *100* for.....

Valuation of horse, \$..... *100*

Valuation of horse equipments, \$..... *100*

Remarks: *Absent without leave*

Book mark:.....

O. Smith

K | **2 Cav.** | **U.S.C.T.**

Moses Kennedy
Pri, Co. I, 2 Reg't U. S. Col'd Cavalry.

Appears on

Company Muster Roll

for *Sept & Oct*, 186*7*.

Present or absent.....

Stoppage, \$.....¹⁰⁰ for.....

Due Gov't, \$.....¹⁰⁰ for.....

Valuation of horse, \$.....¹⁰⁰

Valuation of horse equipments, \$.....¹⁰⁰

Remarks: *Deserted near Deep*
Bottom Va. Sept. 11/67. Due
US for Ordnance. Sabre
Ball & Plate \$1.95

Book mark:.....

C. G. Smith

K | **2 Cav.** | **U.S.C.T.**

Moses Kennedy.

Priv, Co. *A*, 2 Reg't U. S. Col'd Cavalry.

Appears on **Co. Muster-out Roll**, dated

Brazos, Santiago, Tex, Feb. 12, 1866.

Muster-out to date _____, 186 .

Last paid to _____, 186 .

Clothing account:

Last settled _____, 186 ; drawn since \$ _____ 100

Due soldier \$ _____ 100; due U. S. \$ _____ 100

Am't for cloth'g in kind or money adv'd \$ _____ 100

Due U. S. for arms, equipments, &c., \$ _____ 100

Bounty paid \$ _____ 100; due \$ _____ 100

Remarks: *Joined at org orgz. Ph. from
enlistment. Deserted Sept.
4-4 at camp bottom va.
Descriptive list forward-
ed sep. 30-1869.*

Book mark: *505-1879.*

Pol

NO 347
K | 2" Cav U.S.A.

Moses Kennedy

, Co. I, 2" Reg't U.S.A. Cav.

NOTATION.

Book mark:

R. & P. 327602

War Department,

Record and Pension Division,

Washington,

May 18, 1892

Application for removal of the charge of desertion and
for an honorable discharge has been denied.

A. Hammack

(437)

Copyist.

MAR 30

901

Kenny, John

Co *L*, **2** U. S. Col'd Cav.

Private

Private

CARD NUMBERS.

1		26	
2	<i>See Thompson</i>	27	<i>John</i>
3		28	
4		29	
5		30	
6		31	
7		32	
8		33	
9		34	
10		35	
11		36	
12		37	
13		38	
14		39	
15		40	
16		41	
17		42	
18		43	
19		44	
20		45	
21		46	
22		47	
23		48	
24		49	
25		50	

Book Mark:

See also

Kent Frank D.

Co *King's* **2** U. S. Col'd Cav.

Captain | *Major*

CARD NUMBERS.

1	5315337	26
2	5328275	27
3	5328363	28
4	5328452	29
5	5328536	30
6	5328621	31
7	5328710	32
8	5328799	33
9	5328882	34
10	5328975	35
11	5329064	36
12	5316852	37
13	5315338	38
14	5329399	39
15	5329235	40
16	5317150	41
17	5317163	42
18	5317176	43
19	9435785	44
20	9435847	45
21	32579817	46
22	40726258	47
23	42987549	48
24	42727153	49
25	42727190	50

Book Mark:

See also *3 N.Y. Cav*

No. 1. Co. U.S.C.T.

Frank D. Kent,
1st Co., 1. Reg't U. S. Col'd Cav.

Appears on

Regimental Descriptive Book

(List of Commissioned Officers)

of the regiment named above.

Rank 1st Lieut.

Date of appointment 1st Dec 1863

Remarks:

[Empty dashed lines for remarks]

Dayton,

No. | 1. Cav. | U.S. T.
Frank D. Kent,
1st Co., 1. Reg't U.S. Col'd Cav.

Appears on

Regimental Descriptive Book

(List of Commissioned Officers)

of the regiment named above.

Rank 1 Lieut.

Date of appointment Dec 7, 1862.

Remarks:

Prot'd Capt in
2nd U.S. Cav. Jan
10/64.

Dayton,
Cypriat

²
N | 1. Cav. | U. S. C.

F. De Kent,

1. Lieut. 1st U. S. Col. Cav.

Return

of the Sub-District of the Pamlico, Army and District of North Carolina, Department of Virginia and North Carolina,

for the month of December, 1863, dated Washington.

January 5, 1864,

shows the following with regard to the officer named above:

Post or station Washington N.C.

Remarks: Recruiting officer.

Attached.

Book mark:

C. Howard

K | 2nd Cav. | U.S.C.T.

Frank D Kerst

Capt., Co., 2nd Reg't U. S. Col'd Cav'y

Age 26 years.

Appears on an

Individual Muster-in Roll

of the organization named above. Roll dated Fortres, Moursel, Va., Jan. 29, 1864.

Muster-in to date Dec. 14, 1863.

Joined for duty and enrolled :

When Dec. 14, 1863.

Where Camp. Hamilton, Va.

Period 3 years.

Valuation of horse, \$ 100

Valuation of horse equipments, \$ 100

Remarks: Promoted from Sergt, 3rd New York Cavalry, Mustered in pursuant to authority from War Dept. dated Dec. 26, 1863.

Book mark :

C. R. Owen,

K. | **2 Cav.** | **U.S.C.T.**

Frank H. Kent.

Capt., Co. K, 2 Reg't U. S. Col'd Cav.

Appears on

Company Muster Roll

for Enrollment to Feb. 29, 1864.

Present or absent Present.

Stoppage, \$ 100 for

Due Gov't, \$ 100 for

Valuation of horse, \$ 100

Valuation of horse equipments, \$ 100

Remarks:

Book mark:

J. E. Brooks,
Copyist.

K | 2 Cav. | U.S.C.T.

Frank D. Kent

Capt., Co. K, 2 Reg't U. S. Col'd Cav.

Appears on

Company Muster Roll

for *March & April*, 1864.

Present or absent *Present*

Stoppage, \$ *100* for

Due Gov't, \$ *100* for

Valuation of horse, \$ *100*

Valuation of horse equipments, \$ *100*

Remarks: *Pay due as Capt from Dec. 14 1863 to Feb. 1864, by error on last roll.*

Book mark:

Chas. R. Miller

(358)

Comptroller

Copyist.

K. | 2 Cav. | U.S.C.T.

Frank D. Kent

Capt., Co. K, 2 Reg't U. S. Col'd Cav.

Appears on

Company Master Roll

for May + June, 1864.

Present or absent Absent

Stoppage, \$ 100 for

Due Gov't, \$ 100 for

Valuation of horse, \$ 100

Valuation of horse equipments, \$ 100

Remarks: Pay due as Capt. from Dec. 14/63 to Jan. 29/64 by error on Jan. + Feb. pay roll. Sick in McCallum Hospital since June 28, 1864.

Book mark:

J. E. Brooks Copyist.

K | 2 Cav | U.S.C.

Frank D Kent

Capt, Co. K, 2 Reg't U.S.C.

Appears on

Hospital Muster Roll

of Chesapeake U. S. A. General Hospital,

at Fort Monroe, Va.,

for May 1st, 1864.

Attached to hospital:

When 186 .

How employed

Last paid by Maj.

to 186 .

Bounty paid \$ 100; due \$ 100

Present or absent Present

Remarks :

.....
.....
.....
.....
.....
.....

Book mark :

.....
.....

Ko | **2 Cav.** | **U.S.C.T.**

Frank D. Kent

Capt., Co. K, 2 Reg't U. S. Col'd Cav.

Appears on

Company Muster Roll

for July & Aug., 186 4

Present or absent Present.

Stoppage, \$ 100 for

Due Gov't, \$ 100 for

Valuation of horse, \$ 100

Valuation of horse equipments, \$ 100

Remarks: Pay due as Captain
from Dec. 14 '63 to Jan
29 " 64 by error on Feb.
Pay Roll.

Book mark:

J. M. Kennedy

K | **2 Cav.** | **U.S.C.T.**

Frank G. Kent

Capt, Co. K, 2 Reg't U. S. Col'd Cav.

Appears on

Company Muster Roll

for *Sept. v. Oct*, 186*4*.

Present or absent *Present*.

Stoppage, \$ 100 for

Due Gov't, \$ 100 for

Valuation of horse, \$ 100

Valuation of horse equipments, \$ 100

Remarks:

Book mark:

D. M. Kennedy

(358)

Copyist.

No

2 Cav.

U.S.C.T.

Frank D. Kent

Capt., Co. K, 2 Reg't U. S. Col'd Cav.

Appears on

Company Muster Roll

for Nov. & Dec., 1864.

Present or absent Absent.

Stoppage, \$ 100 for

Due Gov't, \$ 100 for

Valuation of horse, \$ 100

Valuation of horse equipments, \$ 100

Remarks: On furlough thirty days Dec. 1864.

Book mark:

D. M. Kennedy

(358)

Copyist.

K | **2 Cav.** | **U.S.C.T.**

Frank D. Kent
Capt, Co. K, 2 Reg't U. S. Col'd Cav.

Appears on

Company Muster Roll

for Jan. v. Feb., 1865.

Present or absent Present.

Stoppage, \$ 100 for

Due Gov't, \$ 100 for

Valuation of horse, \$ 100

Valuation of horse equipments, \$ 100

Remarks:

Book mark:

D. M. Kennedy

(358)

Copyist.

A | 2 bar | US 6 J

Frank D. Kent
Capt - 2 Reg US 6 bar

Return

of the Post of Newport News, Va.,

for the month of March, 1865,

dated March 1, 1865,

shows the following with regard to the person
named above:

Post or station Newport News Va

Remarks: Present commanding

Book mark: _____

(600)

W. H. Crosby
Copyist.

K | **2 Cav.** | **U.S.C.T.**

Frank D. Kent

Capt., Co. K, 2 Reg't U. S. Col'd Cav.

Appears on

Company Muster Roll

for *Mar & Apr.*, 186*5*.

Present or absent *Present*

Stoppage, \$ 100 for

Due Gov't, \$ 100 for

Valuation of horse, \$ 100

Valuation of horse equipments, \$ 100

Remarks: *Pay due for Com.
K Co for Sep Oct, Nov.
& Dec 1864.*

Book mark:

Keeper.

(358)

Copyist.

R | *2 bar* | *1865*

Frank D Kent
Capt Co R 2 Reg US 66

Return

of the Post of Newport News, Va.,

for the month of *April*, 1865,

dated *Apr 30*, 1865,

shows the following with regard to the person
named above:

Post or station _____

Remarks: *Present*

Book mark: _____

(600)

Albrosby
Copyist.

K

2 Cav.

U.S.C.T.

Frank J. Kent

Capt., Co. K, 2 Reg't U. S. Col'd Cav.

Appears on

Company Muster Roll

for *May & June*, 186*5*.

Present or absent *Present*

Stoppage, \$ *100* for

Due Gov't, \$ *100* for

Valuation of horse, \$ *100*

Valuation of horse equipments, \$ *100*

Remarks:

Book mark:

Keeper

K | **2 Cav.** | **U.S.C.T.**

Frank J. Kent

Capt., Co. K, 2 Reg't U. S. Col'd Cav.

Appears on

Company Muster Roll

for *July & Aug.*, 1865.

Present or absent *Present*

Stoppage, \$ 100 for

Due Gov't, \$ 100 for

Valuation of horse, \$ 100

Valuation of horse equipments, \$ 100

Remarks:

Book mark:

Keeper.

N. I. Cav. U.S.C.T.

Frank J. Hunt

Capt., Co. 2 Reg't U. S. Col'd Cav.

Appears on an

Individual Muster-out Roll

of the organization named above, Roll dated

Cracksville Texas Sept 1, 1865.

Muster-out to date May 31, 1865.

Last paid to May 31, 1865.

Clothing account:

Last settled, 186 ; drawn since \$ 100

Due soldier \$ 100; due U. S. \$ 100

Am't for cloth'g in kind or money adv'd \$ 100

Due U. S. for arms, equipments, &c., \$ 100

Bounty paid \$ 100 due \$ 100

Remarks: Mustered out on promotion.

Last paid May 31 65 by Maj. Howell
Pay due for responsibility as Comdg. Officer
Co. K. 2 U.S.C. for the months of October
November & December 1864 and January
and April 1865.

Book mark:

J. J. Smith

K. 12 Co., U.S.C.T.

Frank D. Kent

Major, Co., 2nd Reg't U. S. Col'd Cav.,

Age 28 years.

Appears on an

Individual Muster-in Roll

of the organization named above. Roll dated

Clarksville, Tex, Sept: 1, 1865.

Muster-in to date Sept: 1, 1865.

Joined for duty and enrolled :

When Sept: 1, 1865.

Where Clarksville, Texas

unexpired term
Period Reg't. years.

Valuation of horse, \$ 100

Valuation of horse equipments, \$ 100

Remarks: Promoted from
Captain to fill an original
vacancy.

Book mark :

A. Owen,

K | **2 Cav.** | **U.S.C.T.**

Frank D. Kent

Capt, Co. K, 2 Reg't U. S. Col'd Cav.

Appears on

Company Muster Roll

for *Sept & Oct*, 1865.

Present or absent.....

Stoppage, \$.....100 for.....

Due Gov't, \$.....100 for.....

Valuation of horse, \$.....100

Valuation of horse equipments, \$.....100

Remarks: *Discharged to accept promotion as Maj. 2 U.S. C. Cav. Sept 1st 1865*

Book mark:.....

S. Duncan

K | *2 Co* | **U.S.C.T.**

Frank S. Kent

Rank *Maj*, *2* Reg't U. S. Col'd *Co*

Appears on

Field and Staff Muster Roll

for *Sept & Oct* 1865.

Present or absent *Absent*

Stoppage, \$ *100* for

Due Gov't, \$ *100* for

Valuation of horse, \$ *100*

Valuation of horse equipments, \$ *100*

Remarks: *Ill. Rail Road Co.*

No 43 1st Div 3 Div 25 A
Co. Sept 8/65

Book mark:

Bryer

K | *2 Car* | **U.S.C.T.**

Frank J. Kent

Rank *Maj*, *2* Reg't U. S. Col'd *Car*

Appears on

Field and Staff Muster Roll

for *Nov & Dec* 1865.

Present or absent *Present*

Stoppage, \$ *100* for

Due Gov't, \$ *100* for

Valuation of horse, \$ *100*

Valuation of horse equipments, \$ *100*

Remarks: *Sick in Quarters,*

Book mark:

Dreyer

K | *2 Co* | **U.S.C.T.**

Frank J. Kern

Rank *Major*, *2* Reg't U. S. Col'd *Co*

Appears on a

Field and Staff Muster-out Roll

of the organization named above. Roll dated

Cruzos Santiago Tex, Feb 12, 1866

Muster-out to date _____, 186 .

Last paid to _____, 186 .

Clothing account:

Last settled _____, 186 ; drawn since \$ _____ 100

Due soldier \$ _____ 100; due U. S. \$ _____ 100

Am't for cloth'g in kind or money adv'd \$ _____ 100

Due U. S. for arms, equipments, &c., \$ _____ 100

Bounty paid \$ _____ 100; due \$ _____ 100

Remarks: *Absent on leave under
Special orders 112 Hd Qrs
Sept Tex July 23/66
No discharge furnished.*

*Discharge given and officer
Paid at Richmond Va.
Mch 13, 64.*

Book mark: *996. Dis Jan 9/67*

Breyer

K | **2 Cav.** | **U.S.C.T.**

Frank S. Kent

Capt, Co. K, 2 Reg't U. S. Colored Cav.
Major

Appears on Returns as follows:

Jan to May 1864, Present,

Ordered for duty Jan 3 '64.

June 1864, absent wounded in
Gen Asst's Gt' mortar, Va.

since June 28 '64.

July 1864 absent sick since

June 28 '64.

Aug to Nov 1864, Present.

Dec 1864, absent on thirty days
leave Dec 8 '64.

Jan to Aug 1865, Present.

Sept 1865, Pass, Promoted Maj't
mustered Sept. 1865.

Sept & Oct 1865 absent on D.S.
Rail Road I.O. 413 Ad Des

3 Div 25- a.C. Sept 8 '65

Promoted from Capt of Co. K,

Sept 1865. (Major)

Nov 1865, Present.

Dec 1865, Present second Reg't.

Jan 1866, absent with leave

Book mark:

(over)

Amshannon

K | 2 Cav | U. S. C. T.

Frank D. Kent

Capt Co. K, 2 Reg't U. S. Col'd Cav.

Appears on **Co. Muster-out Roll**, dated

Brazos Santiago Tex, Feb 12, 1866.

Muster-out to date _____, 186 .

Last paid to _____, 186 .

Clothing account:

Last settled _____, 186 ; drawn since \$ _____ 100

Due soldier \$ _____ 100 ; due U. S. \$ _____ 100

Am't for cloth'g in kind or money adv'd \$ _____ 100

Due U. S. for arms, equipments, &c., \$ _____ 100

Bounty paid \$ _____ 100 due \$ _____ 100

Remarks: *Disch'd & Promoted Maj. Aug 31. 65*

Book mark: _____

S. Duncan

Kent, Frank J.
Major, Co. _____, *2* Reg't *U.S. Cav.*

~~18~~ **Enclosures.**

Bed Cards	Final Statements
Burial Records	Furloughs or L. of A.
Certs. of Dis. for Discharge	Med. Certificates <i>1</i>
C. M. Charges	Med. Des. Lists
Descriptive Lists	Orders <i>46</i>
Discharge Certificates	Pris. of War Record
Enlistment Papers	Resignations <i>1</i>

Other papers relating to—

Admission to Hosp'l	Furlough or L. of A. <i>4</i>
Casualty Sheet	Med. Examination
Confinement	Misc. Information <i>1</i>
Contracts	Pay or Clothing
Death or Effects	Personal Reports
Desertion	Rank
Discharge from Hosp'l	Transfer to Hosp'l
Discharge from Service <i>1</i>	Transfer to V. R. C.
Duty	Transportation

MICROFILM PUBLICATION M 1818

COMPILED MILITARY SERVICE RECORDS
OF VOLUNTEER UNION SOLDIERS WHO
SERVED WITH THE USCT (US COLORED TROOPS)
2ND REGIMENT OF CAVALRY

PERSONAL PAPERS' TARGET SHEET

PLEASE NOTE THE CHECKED INFORMATION ABOUT THE PERSONAL PAPERS IN
THIS FILE:

- NO PERSONAL PAPERS WERE FOUND IN THIS FILE WHEN THE
RECORDS WERE ARRANGED FOR MICROFILMING.
- 16 PERSONAL PAPER(S) FOUND IN THIS FILE WHEN THE RECORDS
WERE ARRANGED FOR MICROFILMING.

1897
Stet. Dep. Dept. of War
Port Monrovia, Jan 10th 1894

Special orders
No 10

1st Lt Frank D. Kent
to be Captain

Kent, Frank D.

Head Quarters Dept. of Virginia and North Carolina,

Fort Monroe, Va. *July 10th* 1864

SPECIAL ORDERS,

No. 10

III

EXTRACT.

The following Appointments are hereby made in the 2d Regiment United States Colored Cavalry, subject to the approval of the President of the United States:

1st Lt. Frank D. Kent. 1st U.S. C. Cav. to be Captain

By Command of Major General BUTLER.

Henry J. Schroeder

H. J. Schroeder Assistant Adjutant General.

To C.O. 1st U.S. C. Cav.

Officers Gen Hospital
Dept of Va & M.C.
July 6th 1864

George Bayles A. Surge M.A.

Certificate of disability in the case of
Capt W. D. Kent 2^d M.C. leave

11999 999

Capt Frank D. Kent of the 2nd Regt U.S. Cavalry
having applied for a certificate of disability for leave
of absence I do hereby certify that I have carefully
examined this officer and find that he is wounded by
gun shot in left leg and although a leave of absence
is not necessary in order to preserve life or to prevent
permanent disability I declare my belief that he will
not be fit for duty in a less period than twenty (20) days

Dated at Officers Gen Hospital Dept of Va of A. S.
this 8th day of July 1864

F. B. Taylor
Acting Surgeon

J. D. Kent.
Capt. 2d U. S. C. Co.

orders.

1000 392

HEAD QUARTERS DEPARTMENT OF VIRGINIA & NORTH CAROLINA,
ARMY OF THE JAMES,

In the Field. October 19th 1864.

SPECIAL ORDERS, }

No. 300. }

EXTRACT:

1. Captain F. A. Hunt, 2^d
U. S. Colored Cavalry is relieved from
duty as Provost Marshal at Deep Bottom,
and will rejoin his Regiment.

BY COMMAND OF MAJOR GENERAL BUTLER:

E. M. Smith
Assistant Adjutant General.

C. O. 2^d U. S. C. C.
from the [unclear]

Hqrs 25th ac
Army of James
Capt Sewall
May 14, 1865

Frank de Kent
Capt

S. C. No. 130

Leave of absence

Granting Leave of absence
of four days to Capt.
F. de Kent. 2 USCC

Rich R Hq 2 USCC
May 15, 1865

Head Quarters Twenty fifth Army Corps
Army of the James
Camp Lincoln Va May 14th 1865

Special Orders

No 1 130

Extract

Leave of Absence to go out of the Department is hereby granted
to the following named Officers:

Captain Frank D Kent 2^d US Colored Cavalry
for four days

+

+

+

By Command of Major General Hitzel

A A General

1535-25 A.C.

Hd Qrs 2^d US. Cav
Luther Field May 14th 1865

Went. Frank D.
Capt. 2^d US Col. 1st Cav.

Requests Leave of
Absence to go out of camp
for four or five days -

1535
May 14.

Hd Qrs 2^d US. Cav
Luther Field May 14th 1865

Approved and
respectfully forwarded

Geo. Cole
Colonel 2^d US. Cav
Brigadier General
Comd'g Regt

Done

767 20 11 5. 12

in the field on May 13th 1845

Maj G. L. Tucker

Asst Adj't Gen

Sir

I have the honor

to request leave of absence to go out of the Department for four (4) days to attend to private business

I have the honor to be

Yours Sir Obedtly

Frank D. Hunt

Infantry 1st U.S.C.

Ad. Gen. Post City Point
May 20 1868

S. O. 444

Directs Capt F. D. Kent
Maj. C. C. Spencer to
recomm. to execute
usual instructions -
and return after
performing his duty

Recd May 22 - 68

1865

La. Grs Post City Louis 7th
May 20th 1865

Special Order No 11
Extract
4 Capt James D. Kent
2nd Regt C. is hereby directed to proceed
to Richmond to execute instructions
verbally communicated - this duty
performed he will return to this Post.

By Order of
Wm. B. Ruffin
3d The Satchels
Capt M. A. S. G.

Official
James D. Kent
1st Regt Artillery

No 10
Camp Smiths May 24/66

Special Orders
No 10

Direct that Capt
F. D. Hunt 9th W. S. B.
to receive the Ordnance
& Ordnance stores of
this Command

Head Quarters, Cavalry Brigade 25th Ar.
Camp 2, Lincoln Va. May 31st 1862.

Special Order
No. 10

I Capt. Frank C. Root, D. M. S. C. C.
will proceed to City Point and receive the Ordnance
and Ammunition Stores for this Command, receiving
for the same to the Ordnance Officer having it in charge.



Walter M. Mason
A. A. S. M.
Cav. Brigade
Comdg. Officer D. M. S. C. C.

By Order of Brig. Gen. G. M. Cole
Comdg. Cavalry Brigade
25th Army Corps.

H^d Qrs Cavalry Brigade
Camp Smith's Pt August 18

T. D. Kent
Capt.

Special Orders
No 16

Leave of absence

Granting leave to
Capt Kent for (24)
days.

Head Qrs. Cav. Brigade 20th A. C.
Camp Lincoln, Va. June 9, 1865

Special Orders }
No. 16 }

I The following named Officer
having been excused from duty by the Surgeon
of the 2^d U.S. Cavalry, and complied with
General Order No. 17 from these Head Qrs
is hereby granted permission to be absent
from Camp. for twenty four (24) hours.

Captain J. D. Kent. 2^d U.S. Cav.

x

x

x

By order of Brig. Gen. Cole
Commanding Cav. Brigade

Walter M. ...
1st U.S. Cavalry.
S. Capt. Kent.
H. C. ...

The enclosed
copy

Frank L. Kent
Capt

Agree that a copy
should be sent to
the commandant
of the 1st Regt
of the 1st Div
of the 1st Army

Wm. C. P.
Major Commanding

Wm. C. P.
Major Commanding



Head Quarters 2nd U.S. Col. Cav.
Belleville Texas July 9th 1865

Suit W. D. Munson
A. A. S. Cav. Brigade

Suit

I have the honor
to request that a regimental Court Martial
be convened at the Head Qrs of this Regt.
to be composed of Capt Frank D. Kent 2nd
U.S. Col. for the purpose of trying such cases
as may come within his power.

Very Respectfully Yours

Obedient Servant

Edward P. Wilson

Maj. 2nd U.S. Col.

Comd'g Regt

Office Company Muster
25th Army Corps
Brownsville Texas Sept 1865

Recd of Genl
W. D.

Have the Honor to enclose
amended Muster Roll of Capt
J. D. Hunt 2^d U.S. Cav. with a
request that it be substituted
for the one forwarded during the
past week

Have the Honor to be
Very respectfully,
Wm. H. Hayes
Capt. 2^d U.S. Cav.
B. H. H.

Kent

Hdqs Fort of Braxs Santiago
Texas
Nov 6th 1865-

S.O. No 88- # II

Relieving
Major Frank D Kent
from duty on Rail Road

2nd U. S. C. Cav.

P. 3-

Headquarters, 3d Division, 25th A. C.

BRAZOS SANTIAGO, TEXAS.

November 6 1865.

Special Orders, }

No. 38.

Extract.

I. " Do much of Par. I. S. O. 43^d E. S. from these Headquarters as assigns Major Frank D. Kent 2^d U. S. C. to duty on U. S. M. & R. is hereby revoked and Major Kent will rejoin his Regiment without delay.

x

x

x

By order of

BRIG. GEN'L W. T. CLARK.

C. C. 2d U. S. C. Co.
Frank D. Kent

John G. Garrison

Capt. & Actg. Assistant Adjutant General.

Adj. 3^d Div. 25th A. C.
Jan'y 4 1866

S. O. 1
3.

May Kent
2 U.S.C.

HEADQUARTERS 499
Headquarters, 3d Division, 25th A. C.

BRAZOS SANTIAGO, TEXAS.

January 4th 1866

Special Orders, }

No. 3

I. At the request of Major F. D. Kent, 2d U. S. C. E., a Court of Inquiry is hereby appointed to meet at the quarters of Brig. Genl. Geo. W. Cole at 2 o'clock P. M. this day or as soon thereafter as practicable to examine into certain statements said to have been made by a Mr. Burch citizen relative to Major Kent's being connected with and having sold arms to the so-called Imperial Government of Mexico.

Detail for the Court:

Lieut. Col. <u>F. J. White</u>	2d U. S. C. E.
Lieut. Col. <u>W. H. Teip</u>	1st U. S. C. E.
Maj. <u>E. P. Wilson</u>	2d U. S. C. E.

By order of Brig. Genl. Geo. W. Cole
~~BRIG. GENL. W. J. CLARK.~~

C. H. Q.

Walter Hunsdon

Capt. 2d U. S. C. E. & Ag. Assistant Adjutant General.

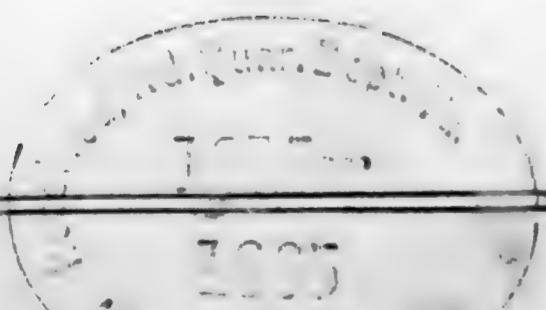
N. 103. (D. U.) 65.
K 111. (E. No) 1875.

Hqrs 2nd U.S. Cav. Cad
Norfolk Va March 15th 1865

Kerr, Frank D.
Capt - 2nd U.S.C.C.

Tenders his resignation
as Capt - 2nd U.S.C.C.

S. D. Aoff - 247 - 65



Rec'd at Hqrs 2nd U.S. Cav. March 14, 1865.

Hq. 2nd U.S. Cav. Cavalry
Norfolk Va March 16th - 65

Respectfully forwarded
approved
S. D. Aoff
advised

Ex. No. 498 - 65
Hq. 2nd U.S. Cav. Cavalry
Norfolk Va March 17th 65
Respectfully forwarded
approved
S. D. Aoff
Very pr

Head Quarters Dist Centre Va
Norfolk Va. March 14. 65.
Approved and
respectfully forwarded
S. D. Aoff
Very pr

Approved
S. D. Aoff

H^d Qrs. 2nd U.S. Col^d Cav
Norfolk Va March 15th 1865

Capt- Israel R. Sealey,
A. A. Gen.

Sir:-

I have the honor hereby
to tender my resignation as Captain
in the 2nd U.S. Col^d Cav. for the fol-
lowing reasons, viz:

1st - To accept a civil appointment
from the State (N.Y.) of higher grade.

2nd - Have served, as a volunteer, in
the United States Army three years
and a half; holding every position to
my present grade, but one

3rd - Have a business and property
that imperatively requires my presence
in the state

I have the honor to be

Yours Sir Obley
Frank D Kent
Capt- 2nd U.S. C^d Cav

NO 39 412

Officers Gen Hospital
No. 2. ✓ Dept of Va & Me
July 8th 1864

Capt Frank D Kent 2nd U.S. Cavalry
application for leave of absence for
twenty (20) days

M. D. O. July 12th 1864.
Approved and respectfully
forwarded.

Em Bullard
Asst. Surg^{en} U.S.A.
& Asst. Med. Director
Department.



S.O. 199/1 ————— 1864

Frank D Kent
Capt. 2nd U.S. Cav.

Officers Gen Hospital
Dept of Va & M. C.
July 8th 1864

Major I have the honor to apply for leave of
absence for twenty (20) days to visit my home on
the grounds set forth in the accompanying
certificate

Very Respectfully
Yours
Frank L. ^{to} ^{the} ^{hon} ^{of} ^{the} ^{U.S.} ^{Army}
Capt ^{to} ^{the} ^{hon} ^{of} ^{the} ^{U.S.} ^{Army}

Mark Davis
Chief of Staff General
Dept of Va & M. C.

Lizma.

Sp. C.
K. 18 (b. 5. 7/8)

Tent

file

States that her
did on course
for light duty
by learned that
with his comp
short outline of
son & requests to
consistent with
assign her son
where he may
reposed

Capt Seck

Reg. no

Resigned

Hager, answer
tent has not

Lima, Livingston Co.
A. D. Novbr 17 1864
K. 18 (S. T. Vag W. Co. 1864.

Kent Maria In
file

States that her son was wounded
and in consequence detailed
for light duty, but has recently
learned that he is again
with his company. Gives a
short outline of the history of her
son & requests the General if
consistent with the service, to
assign her son to some position
where he may not be so much
exposed

Capt Seck
Not Kent
Resigned 7/5/63
Hager, answer -
Kent has not resigned

Mr
Sir
file

Frank D. Keck
Capt - 2 U S C C
Lima, Livingston Co., N. Y., Nov, 17, 1864

General Butler

Dear Sir

Do not think me
presumptuous or impudent if I come
to you with a petition, for a Mother's love
and solicitude constrain me

I have a noble son in your command
Frank D. Keck Capt 2nd U S Cavalry, Co. D.
who received a injury from a spent shell
before Petersburg from the effects of which
he has not recovered. In his last letter
to me written from Deep Bottom he said that
he had been detailed to do Post Provost Marshal
Duty and it was a great relief to him for
his hip troubled him very much when
exposed to the cold and he was hardly able
to do Field Duty - yesterday I came by a

letter from his wife that he was with his com-
 -pany again. I thought struck and I would
 write to General Butler not that he is of more
 importance than thousands of others, but he is
 my youngest - his older brother is in the Army
 and his father and myself are also in our old
 age, but should prefer to have sons to give to the Army.

He is a brave generous soldier was run
 into the U.S. Service August, 1861, as Cavalry
 Sergeant Co., 3rd U.S. Cavalry. The Regiment
 has been under Generals Banks, Burnside, Foster
 and others but General Butler is his favourite
 of all Generals.

He has a good practical and Academic
 education and much experience for one of his
 age, having been entirely round the globe by land
 and sea. As to his Patriotism and Loyalty
 there can be no doubt, for he enlisted without
 the excitement of war meetings, or receiving any
 bounty, has pass through several battles and
 been honorably mentioned in the reports of his
 superior Officers. My request is if
 consistent with your Gen Butler's ordinary duties

he can assign my son ^{to} some position where
 his health is not so much exposed I do not
 ask for promotion nor ^{exemption from} his share of danger.

I write this without his knowledge knowing
 that he is too nervous to manifest any wish
 of his own - If General Butler is a Parent
 he will excuse the liberty I have taken

With much respect I subscribe myself
 yours very truly

Maria Hunt

Gen Butler May 1861

2

Extract

MUSTER-OUT ROLL

OF

Frank D. Keut

Major

2nd US Cal Cavalry

Received A. G. O. March 19. 1866

To be filed with personal papers.

By order of Dr. Ainsworth

J. B.

REGISTRY OF
MUSTERS.
March 17, 1866.
Post. of V. M. ...

H. H. C.
Deer

MUSTER-OUT ROLL of *the Field Staff*

in the *Second* Regiment of *U. S. Colored Cavalry* Volunteers
 at *Fort Monroe Va* (the place of general rendezvous) on the *22nd* day of *December*, 186*3*, to serve for the term
 (when *last paid*) to the *twelfth* day of *February*, 1866, when mustered out under *No. 2*. The Company was organized
 thence to _____, where it arrived the _____ of _____, a distance of *8 No. 2 Dept of Pa*

NUMBER OF EACH GRADE.	NAMES. PRESENT AND ABSENT. (Privates in alphabetical order—the first christian name to be written full length.)	RANK.	AGE.	JOINED FOR SERVICE AND ENROLLED AT GENERAL RENDEZVOUS— COMMENCEMENT OF FIRST PAYMENT BY TIME.				MUSTERED INTO SERVICE.			LAST PAID.	
				WHEN.	WHERE.	BY WHOM.	PERIOD.	WHEN.	WHERE.	BY WHOM.	BY PAYMASTER.	TO WHAT TIME.
	<i>Frank D. Kent</i>	<i>Major</i>		<i>Dec 21 1863</i>	<i>Fort Monroe Va</i>	<i>Gul. Butler</i>	<i>3 yrs</i>	<i>Sept 1st 1865</i>	<i>Brownsville Tex</i>	<i>Capt. Hughes</i>	<i>Maj. Sickey</i>	<i>Sept 30th 1865</i>

RECAPITULATION.		Captain.	1st Lieutenant.	2d Lieutenant.	Sergeants.	Corporals.	Buglers.	Drummers.	Fifers.	Farmers & Ek sm.	Artificers.	Privates.	Total.	AGGREGATE.	Total last muster.
PRESENT.	For duty.....														
	Extra duty.....														
	Sick.....														
	In arrest or confinement.....														
ABSENT.	Detached service.....														
	Furlough.....														
	In arrest or confinement.....														
	Sick.....														
	Prisoners of war.....														

RECAPITULATION.		Captain.	1st Lieutenant.	2d Lieutenant.	Sergeants.	Corporals.	Buglers.	Drummers.	Fifers.	Farmers & Ek sm.	Artificers.	Privates.	Total.	AGGREGATE.	Total last muster.
STRENGTH—PRESENT AND ABSENT.....	No. JOINED.														
	No. DISCHARGED.														
	No. of Desertions.....														
	No. of Deaths.....														

DIRECTIONS TO MUSTERING OFFICERS.

The Mustering Officer will see that five copies of this Roll are made out, four of which he will retain, the fifth will be retained by the Company Commander, or, in case of Field and Staff and Officers and Men mustered out of service separately or in squads, by the Senior Officer, Non-commissioned Officer, or Private standing first on the list of persons so mustered out. The Mustering Officer will dispose of the four copies retained by him, as follows: One will be sent to the Adjutant-General of the Army, and one to the "Bounty Bureau," Washington, D. C., and two to the Paymaster by whom the troops are to be paid.

Volunteers, commanded by Colonel Geo W Cole called into the service of the United States by the President for the term of _____, from the date of enrollment, unless sooner discharged; from the 1st day of June, 1865 was organized by Capt. _____ at _____, in the month of _____, 1865, and marched

Dept of Texas thru dates January 23/66

WHAT TIME.	TRAVELLING.		SUBSISTENCE AND FORAGE, Furnished by themselves since the muster into service.		AMOUNT for clothing in kind, or in money advanced.		VALUE OF equipments, arms, &c., received from the United States, to be paid for if lost or destroyed.		VALUATION, in dollars, of—		REMARKS.
	To place of rendezvous, No. of miles.	From place of discharge home, No. of miles.	SUBSISTENCE. No. days.	FORAGE. No. days.	Dolls.	Cts.	Dolls.	Cts.	Horses.	Horse Equipments.	
<u>Sept 30/65</u>											<p>.. Under the head of REMARKS the date of an officer or soldier's joining from any absence; the date of an officer's assuming, or being relieved, from any command or special duty; the description of any special, extra, or daily duty, on which officers or soldiers may be; all changes of rank, by promotion, appointment, or reduction, with date of same; all authorized stoppages, fines, sentences, with No., date, &c., of order, &c.; in case of Absence, its nature and commencement, No., date, &c., of order, and period assigned for same (to be repeated on every roll while it lasts); if wounded in battle, or injured on duty,—if sick, or confined, a remark to that effect, &c., &c.—must be carefully stated opposite to the name of the person concerned, with everything else necessary, either to account fully for every individual of the company,—to guide the paymaster,—or ensure justice to the soldier, and to the United States.</p> <p>2.. All articles which are to be paid for will be stated by the captain opposite to the name of the soldier.</p> <p>3.. Every man whose name is on previous rolls must be accounted for on this one. The exchange of men by substitution, and the exchanging, swapping, or loaning of horses, after muster into service, are strictly forbidden.</p>
											<p>Absent on leave under S. Orders 112. No. 285 Dept of Texas Jan'y 23/66.</p> <p>Office Com. Muster Dept of Va. Richmond Va. March 13th 1866.</p> <p>I certify on honor that this roll is a correct Extract of the Muster-roll of the Field and Staff 2nd US Col Cavalry in case of Major Frank <u>Frank</u> and <u>and</u> his <u>his</u> company <u>company</u> was <u>was</u> absent at muster-out, but present at date of final payment of the Regiment.</p> <p><u>Fred Martin</u> 1st Lt. 38th US Cavalry Dept of Texas</p>

I CERTIFY, ON HONOR, that this Muster Roll exhibits the true state of the Field and Staff of the 2nd US Col Cavalry for the period herein mentioned; that each man answers to his own proper name in person; that the remarks set opposite the name of each officer and soldier are accurate and just, and that the valuation of all horses and horse equipments since the muster into service, was made by disinterested and good judges, and at fair and just rates.

Geo W Cole
 Colonel 2nd US Col. Cav.
 Commanding the Regiment

I CERTIFY, ON HONOR, that I have at Brasas Santiago Texas on this twelfth day of Feb'mary, 1866, carefully examined this Roll, and, as far as practicable, caused the allowances, stoppages, and remarks to be justly and properly stated; and mustered the Field & Staff for discharge; and Regane hereby honorably discharged from the service of the United States.

Rigned David Mann
 1st Lt. 38th US Cavalry
 Mustered on 25th Feb 1866
 Mustered at Brasas Santiago Texas

Key George W. ⁹⁰³

Co *F*, 2 U. S. Col'd Cav.

Private Private

CARD NUMBERS.

1	5-315-612	26
2	5-323427	27
3	5-3235-12	28
4	5-3235-99	29
5	5-323687	30
6	5-323776	31
7	5-323867	32
8	5-323955	33
9	5-324041	34
10	5-324136	35
11	5-324247	36
12	5-324372	37
13	5-324460	38
14	5-324548	39
15	9087564	40
16	40726259	41
17		42
18		43
19		44
20		45
21		46
22		47
23		48
24		49
25		50

Book Mark:

See also

S. 2190343 common
D 2299937 P.O. Rtd

L. Ballantyne

K | **2 Cav.** | **U.S.C.T.**

Geo. W. Keys

....., Co. *F*, 2 Reg't U. S. Col'd Cav.

Appears on

Company Descriptive Book
of the organization named above.

DESCRIPTION.

Age *28* years; height *5* feet *8 1/2* inches.

Complexion *Fair*

Eyes *dark*; hair *dark*

Where born *Buport N. C.*

Occupation *Farmer*

ENLISTMENT.

When *Jan 1*, 1864.

Where *Fort Monroe*

By whom *Col. Cole*; term *3* y'rs.

Remarks: *Promoted to
Sergeant Sept 1st 64 Gen.
Order No 6 from Regt
Hd Quarters 2 U. S. C. C.
Reduced June 19th 65
at his own request.*

F. B. Smith

No. 12 Coar | **U.S.C.T.**

George Hayes

Pvt, Co. 2 Reg't U. S. Col'd Coar

Age.....years.

Appears on a

Detachment Muster-in Roll
of unattached recruits
of the organization named above. Roll dated

St. Mourae, Va Jan. 8, 1864.

Muster-in to date Jan. 8, 1864.

Joined for duty and enrolled:

When Jan. 1, 1864.

Where St. Mourae, Va

Period 3 years.

Valuation of horse, \$ 100

Valuation of horse equipments, \$ 100

Remarks :

.....

.....

.....

.....

Book mark:

.....

J. J. Kearney
Copyist.

4 | **2 Cav.** | **U.S.C.T.**

Serge Kins

1864, Co. F, 2 Reg't U. S. Col'd Cavalry.

Appears on

Company Muster Roll

for 1864, 1864

Present or absent Present

Stoppage, \$ 100 for

Due Gov't, \$ 100 for

Valuation of horse, \$ 100

Valuation of horse equipments, \$ 100

Remarks: Present from private
in 1864
and quarters from 11. 1864

Book mark:

W. C. Green

A | **2 Cav.** | **U.S.C.T.**

Geo. H. Ross

1st Lt., Co. F, 2 Reg't U.S. Col'd Cavalry.

Appears on

Company Muster Roll

for March - April, 1864

Present or absent present

Stoppage, \$ 100 for

Due Gov't, \$ 100 for

Valuation of horse, \$ 100

Valuation of horse equipments, \$ 100

Remarks:

Book mark:

J. C. [Signature]

A | **2 Cav.** | **U.S.C.T.**

George H. Reed

C. Capt., Co. F, 2 Reg't U. S. Col'd Cavalry.

Appears on

Company Muster Roll

for May & June, 1864.

Present or absent present

Stoppage, \$ 100 for

* Due Gov't, \$ 100 for

Valuation of horse, \$ 100

Valuation of horse equipments, \$ 100

Remarks:

Book mark:

J. C. ...

A | **2 Cav.** | **U.S.C.T.**

George A. Keys
Co. F, Co. F, 2 Reg't U.S. Col'd Cavalry.

Appears on

Company Muster Roll

for *July & Aug.*, 1864.

Present or absent *Present*

Stoppage, \$ *100* for

Due Gov't, \$ *100* for

Valuation of horse, \$ *100*

Valuation of horse equipments, \$ *100*

Remarks:

Book mark:

J. S. Paul
Copyist.

A. | **2 Cav.** | **U.S.C.T.**

Geo. M. Hayes
W. S., Co. F, 2 Reg't U. S. Col'd Cavalry.

Appears on

Company Muster Roll

for *Sept. & Oct.*, 186*7*.

Present or absent *Present*

Stoppage, \$ *100* for

Due Gov't, \$ *100* for

Valuation of horse, \$ *100*

Valuation of horse equipments, \$ *100*

Remarks:

Book mark: -----

(358)

J. H. Paulley
Copyist.

2 | **2 Cav.** | **U.S.C.T.**

Geo. W. Keys

Co. F, Co. F, 2 Reg't U. S. Col'd Cavalry.

Appears on

Company Muster Roll

for *Nov. & Dec.*, 186*7*.

Present or absent *Present*

Stoppage, \$ *100* for

Due Gov't, \$ *100* for

Valuation of horse, \$ *100*

Valuation of horse equipments, \$ *100*

Remarks:

Book mark:

(358)

J. A. Powell

Copyist.

2 | **2 Cav.** | **U.S.C.T.**

Wm. H. Keys

C. S., Co. F, 2 Reg't U. S. Col'd Cavalry.

Appears on

Company Muster Roll

for *Jan. & Feb.*, 186 *5*.

Present or absent *Not stated.*

Stoppage, \$ *100* for

Due Gov't, \$ *100* for

Valuation of horse, \$ *100*

Valuation of horse equipments, \$ *100*

Remarks:

Book mark:

(358)

J. H. Paul
Copyist.

K | **2 Cav.** | **U.S.C.T.**

George H. Keys
C. S., Co. F, 2 Reg't U. S. Col'd Cavalry.

Appears on

Company Muster Roll

for *Mar & Apr*, 1865.

Present or absent *Present*

Stoppage, \$ *100* for

Due Gov't, \$ *100* for

Valuation of horse, \$ *100*

Valuation of horse equipments, \$ *100*

Remarks:

Book mark:

D. C. W.

K | **2 Cav.** | **U.S.C.T.**

George W. Keys
Com 194, Co. F, 2 Reg't U. S. Col'd Cavalry.

Appears on

Company Muster Roll

for *May & June*, 1865.

Present or absent *Present*

Stoppage, \$ 100 for

Due Gov't, \$ 100 for

Valuation of horse, \$ 100

Valuation of horse equipments, \$ 100

Remarks:

Book mark:

Sams

K | **2 Cav.** | **U.S.C.T.**

George W Keys

1st, Co. F, 2 Reg't U. S. Col'd Cavalry.

Appears on

Company Muster Roll

for *July & Aug*, 1865.

Present or absent *absent*

Stoppage, \$ *100* for

Due Gov't, \$ *100* for

Valuation of horse, \$ *100*

Valuation of horse equipments, \$ *100*

Remarks: *See in gent
Hospl since Aug 14/64
Pay due as Srgt from
Dec 3/64 to June 30/65*

Book mark:

S Davis

K. | **2 Cav.** | **U.S.C.T.**

Geo. W. Keys
Priv., Co. F, 2 Reg't U. S. Col'd Cavalry.

Appears on

Company Muster Roll

for *Sept. & Oct.*, 1865.

Present or absent *Present*

Stoppage, \$ 100 for

Due Gov't, \$ 100 for

Valuation of horse, \$ 100

Valuation of horse equipments, \$ 100

Remarks:

Book mark: -----

J. H. Thomas
Copyist.

N 7 9 4 3 4
N. | 2 Cav. | U.S.C.T.

Geo W Keys
Seri., Co. F, 2 Reg't U. S. Col'd Cavalry.

Appears on

Company Muster Roll

for *Nov. 7 Dec.*, 1865.

Present or absent *Present*

Stoppage, \$ 100 for

Due Gov't, \$ 100 for

Valuation of horse, \$ 100

Valuation of horse equipments, \$ 100

Remarks:

Book mark:

(358)

J. Stearns
Copyist.

NO 435
K. | 2 Cav. | U.S.C.T.

Geo. W. Key
Sgt., Co. F, 2 Reg't U. S. Colored Cav.

Appears on Returns as follows:

Aug 1865. Absent in
U.S. Gen Hospl Aug
14 65.

Book mark:

A. Mohammed

(546)

Copyist.

H. | **2 Cav.** | **U.S.C.T.**

George W. Key

Co. B, 2 Reg't U. S. Col'd Cavalry.

Appears on **Co. Muster-out Roll**, dated

September 20, *1864*.

Muster-out to date *Feb. 1*, 186*5*.

Last paid to *George W. Key*, 186*4*.

Clothing account:

Last settled....., 186 ; drawn since \$.....100

Due soldier \$.....100; due U. S. \$.....100

Am't for cloth'g in kind or money adv'd \$.....100

Due U. S. for arms, equipments, &c., \$.....100

Bounty paid \$.....100; due \$.....100

Remarks: *Discharged*
Sept 20 1864
by order of
Genl. Sherman

Book mark:

George W. Key
(361) Copyist.

904

Keys George W
Co F, 2 U. S. Col'd Cav.

CARD NUMBERS.

1	26
2	27
3	28
4	29
5	30
6	31
7	32
8	33
9	34
10	35
11	36
12	37
13	38
14	39
15	40
16	41
17	42
18	43
19	44
20	45
21	46
22	47
23	48
24	49
25	50

Book Mark:

See also

⁹⁰⁵
Kilby John

Co E, 2 U. S. Col'd Cav.

Private Private

CARD NUMBERS.

1	5322199	26
2	5322278	27
3	5322365	28
4	5322450	29
5	5322530	30
6	5322617	31
7	5322700	32
8	5322781	33
9	5322875	34
10	5322968	35
11	5323063	36
12	5323149	37
13	5323229	38
14	5323308	39
15	9087520	40
16	40726260	41
17		42
18		43
19		44
20		45
21		46
22		47
23		48
24		49
25		50

Book Mark:

See also

S 732640 P.O. 90
Rep 308588.

- S-920558 - 90 747 211
- D 2410350 P.O. 100
- D 2465860 P.O. 101
- D 2489966 P.O. 102
- D 2491635 P.O. 103
- S 2566961 and W.D.

L Ballantyne

K | **2 Cav.** | **U.S.C.T.**

John Kilby
....., Co. *E*....., 2 Reg't U. S. Col'd Cav.

Appears on

Company Descriptive Book
of the organization named above.

DESCRIPTION.

Age *32* years; height *5* feet *9* inches.

Complexion *Black*

Eyes *Black*; hair *Black*

Where born *Nansemond Co. Va.*

Occupation *Laborer*

ENLISTMENT.

When *Dec. 25, 1863*

Where *Norfolk Va.*

By whom *Cole, Cole*; term *3* y'rs.

Remarks:

.....
.....
.....
.....
.....
.....
.....
.....
.....
.....

A. B. Smith
Copist.

K | **2 Cav.** | **U.S.C.T.**

John Kilby
Pat. Co. *E*, 2 Reg't U. S. Col'd Cavalry.

Age *32* years.

Appears on

Company Muster-in Roll

of the organization named above. Roll dated

Fort Monroe, Va. Jan. 8, 1864.

Muster-in to date *Jan. 8*, 1864.

Joined for duty and enrolled:

When *December 25*, 186*3*.

Where *Norfolk, Va.*

Period *3* years.

Valuation of horse, \$ *100*

Valuation of horse equipments, \$ *100*

Remarks : _____

Book mark : _____

P. C. Taylor

MAR 4 1864

K | 2 Cav. | U.S.C.T.

John Kilby
Private, Co. E, 2 Reg't U. S. Col'd Cavalry.

Appears on

Company Muster Roll

for Enrollment to Feb. 29, 1864.

Present or absent Present

Stoppage, \$ 100 for

Due Gov't, \$ 100 for

Valuation of horse, \$ 100

Valuation of horse equipments, \$ 100

Remarks:

Book mark:

J. C. Taylor

K | **2 Cav.** | **U.S.C.T.**

John Kilby

Priv., Co. E, 2 Reg't U. S. Col'd Cavalry.

Appears on

Company Muster Roll

for *Mar. and Apr.*, 1864.

Present or absent *Present*

Stoppage, \$ 100 for

Due Gov't, \$ 100 for

Valuation of horse, \$ 100

Valuation of horse equipments, \$ 100

Remarks:

Book mark: _____

(358)

J. C. Taylor

Copyist.

K | **2 Cav.** | **U.S.C.T.**

John Kilby
Priv., Co. E, 2 Reg't U. S. Col'd Cavalry.

Appears on

Company Muster Roll

for *May and June*, 1864.

Present or absent. *Present*

Stoppage, \$ 100 for

Due Gov't, \$ 1 ⁰¹ / 100 for *advance*

Valuation of horse, \$ 100

Valuation of horse equipments, \$ 100

Remarks: _____

Book mark: _____

(358)

J. C. Taylor

Copyist.

K | **2 Cav.** | **U.S.C.T.**

John Kilby

Priv, Co. E, 2 Reg't U.S. Col'd Cavalry.

Appears on

Company Muster Roll

for *July & Aug*, 186*4*.

Present or absent *Absent*

Stoppage, \$ 100 for

Due Gov't, \$ 100 for

Valuation of horse, \$ 100

Valuation of horse equipments, \$ 100

Remarks: *Stoppage for Curry
Comb & Brush #101 Detailed
in S.M. Dept as Teamster*

Book mark: 2

Wauwington

K | **2 Cav.** | **U.S.C.T.**

John Kilby

Priv, Co. E, 2 Reg't U. S. Col'd Cavalry.

Appears on

Company Muster Roll

for *Sept & Oct*, 186*4*

Present or absent *Absent*

Stoppage, \$ *100* for

Due Gov't, \$ *100* for

Valuation of horse, \$ *100*

Valuation of horse equipments, \$ *100*

Remarks: *Detailed for guard in ammunition train*

Book mark:

Wauwington

K | **2 Cav.** | **U.S.C.T.**

John Kilby
Private, Co. E, 2 Reg't U. S. Col'd Cavalry.

Appears on

Company Muster Roll

for *Nov & Dec*, 186 *4*

Present or absent *Absent*

Stoppage, \$ 100 for

Due Gov't, \$ 100 for

Valuation of horse, \$ 100

Valuation of horse equipments, \$ 100

Remarks: *Detailed in guard for Ammunition Train*

Book mark:

Waddington

K | **2 Cav.** | **U.S.C.T.**

John Kilby

Priv, Co. E, 2 Reg't U.S. Col'd Cavalry.

Appears on

Company Muster Roll

for *Jan & Feb*, 186 *5*

Present or absent *Present*

Stoppage, \$ *100* for

Due Gov't, \$ *100* for

Valuation of horse, \$ *100*

Valuation of horse equipments, \$ *100*

Remarks: *Due U.S. for
Clothing overdrawn \$22.02*

Book mark:

Waddington

K | **2 Cav.** | **U.S.C.T.**

John Kilby

Private, Co. E, 2 Reg't U. S. Col'd Cavalry.

Appears on

Company Muster Roll

for *March & April*, 186*5*.

Present or absent *Present*.

Stoppage, \$ 100 for

Due Gov't, \$ 100 for

Valuation of horse, \$ 100

Valuation of horse equipments, \$ 100

Remarks:

Book mark: *2-20-65*

R. Braden

K | **2 Cav.** | **U.S.C.T.**

John Kelby

Pvt, Co. E, 2 Reg't U. S. Col'd Cavalry.

Appears on

Company Muster Roll

for *May & June*, 186*5*.

Present or absent *Present*

Stoppage, \$ *100* for

Due Gov't, \$ *100* for

Valuation of horse, \$ *100*

Valuation of horse equipments, \$ *100*

Remarks:

Book mark: -----

(358)

B. Nelson
comparer. Copyist.

A | **2 Cav.** | **U.S.C.T.**

John Kilby

Got, Co. E, 2 Reg't U. S. Col'd Cavalry.

Appears on

Company Muster Roll

for *July Aug*, 186^{*5*}.

Present or absent *Present*

Stoppage, \$ *100* for

Due Gov't, \$ *100* for

Valuation of horse, \$ *100*

Valuation of horse equipments, \$ *100*

Remarks:

Book mark: -----

J. H. [Signature]

MAR 4 1865

116 | 2 Cav. | U.S.C.T.

John Kilby

Priv, Co. E, 2 Reg't U. S. Col'd Cavalry.

Appears on

Company Muster Roll

for *Sept and Oct*, 1865.

Present or absent *Present*

Stoppage, \$ *100* for

Due Gov't, \$ *100* for

Valuation of horse, \$ *100*

Valuation of horse equipments, \$ *100*

Remarks: *Recd \$ 6. per month from Jan. 1.64 to Apr. 30.64 as increase of pay*

Book mark:

N. H. Merrill

(358)

Copyist.

No

2 Cav.

U.S.C.T.

John Kilby

Priv

, Co. E, 2 Reg't U. S. Col'd Cavalry.

Appears on

Company Muster Roll

for *Nov, and Dec*, 1865.

Present or absent *Present*

Stoppage, \$ 100 for

Due Gov't, \$ 100 for

Valuation of horse, \$ 100

Valuation of horse equipments, \$ 100

Remarks:

Book mark:

N. H. Merrill

K | **2 Cav.** | **U.S.C.T.**

John Kelly
Pvt., Co. *E*, 2 Reg't U. S. Colored Cav.

Appears on Returns as follows:

*July & Aug 1864, Absent under
 per my assignment & in
 July 18. 64 per Par 11
 A.O. no 40 Ad Dis & Brig
 3 Dec 18 U.S.*

*Oct 1864, Absent detached as
 guard for Artillery train.
 Nov 22 1864, Absent as guard
 for Ammunition train.*

Book mark:

A. M. Shannon

No | 2 Cav. | U.S.C.T.

John Kilby

Pvt, Co. *E*, 2 Reg't U. S. Col'd Cavalry.

Appears on **Co. Muster-out Roll**, dated

Prisco Santiago Tex., *Feb. 12*, 186*6*.

Muster-out to date *Feb. 12*, 186*6*.

Last paid to *June 30*, 186*5*.

Clothing account:

Last settled....., 186 ; drawn since \$..... $\overline{100}$

Due soldier \$..... $\overline{100}$; due U. S. \$..... $\overline{22 \frac{11}{100}}$

Am't for cloth'g in kind or money adv'd \$..... $\overline{100}$

Due U. S. for arms, equipments, &c., \$..... $\overline{\frac{27}{100}}$

Bounty paid \$..... $\overline{100}$; due \$..... $\overline{100}$

Remarks: *joined at org. orgn.*

stop and they are Rec'd up

Book mark:

W. H. Merrill

⁹⁰⁶
Kilby Joseph

Co A, 2 U. S. Col'd Cav.

Private Private

CARD NUMBERS.

1	5315742	26
2	5317317	27
3	5317407	28
4	5317495	29
5	5317575	30
6	5317665	31
7	5317753	32
8	5317841	33
9	5317935	34
10	5318055	35
11	5316947	36
12	5318396	37
13	9087091	38
14	6757-A-1889	39
15	40726261	40
16		41
17		42
18		43
19		44
20		45
21		46
22		47
23		48
24		49
25		50

Book Mark: 6757-A-1889

See also

R | **2 Cav. | U.S.C.T.**

Joseph Kilby
....., Co. *A*, 2 Reg't U. S. Col'd Cav.

Appears on
Company Descriptive Book
of the organization named above.

DESCRIPTION.

Age *38* years; height *5* feet *9* inches.

Complexion *Mucato*

Eyes *Black*; hair *Black*

Where born *Suffolk, Va.*

Occupation *Servant*

ENLISTMENT.

When *Jan, 10*, 186*4*.

Where *Ft. Monroe*

By whom *lev. Cole*; term *3* y'rs.

Remarks: *Company book*

F. B. Smith
Copyist.

NARA 450
K. | 2 Cav. | **U.S.C.T.**

Joseph Kilby
Pvt., Co., 2 Reg't U. S. Col'd Cav.,

Age years.

Appears on a

Detachment Muster-in Roll

of unattached recruits
of the organization named above. Roll dated

St. Maurice, Va. Jan. 19, 1864.

Muster-in to date Jan. 19, 1864.

Joined for duty and enrolled:

When Jan. 10, 1864.

Where St. Maurice, Va.

Period 3 years.

Valuation of horse, \$ 100

Valuation of horse equipments, \$ 100

Remarks :

Book mark: 6757-A-1889

K | **2 Cav.** | **U.S.C.T.**

Joseph Kilby

Pro....., Co. A, 2 Reg't U. S. Col'd Cavalry.

Appears on

Company Muster Roll

for *from Enrollent to Feb. 29*, 1864.

Present or absent *Present*

Stoppage, \$.....100 for

Due Gov't, \$.....100 for

Valuation of horse, \$.....100

Valuation of horse equipments, \$.....100

Remarks: *On daily duty as Company Cook since Jan. 18, 1864.*

Book mark:

J. E. Chapin

H | **2 Cav.** | **U.S.C.T.**

Company Muster Roll

20, Co. A, 2 Reg't U.S. Col'd Cavalry.

Appears on

Company Muster Roll

for *March & Apr*, 186 .

Present or absent *Present*

Stoppage, \$ *100* for

Due Gov't, \$ *100* for

Valuation of horse, \$ *100*

Valuation of horse equipments, \$ *100*

Remarks: *On daily duty at Co. Cook since Jan 18, 1864.*

Book mark:

J. E. Chapin

K | **2 Cav.** | **U.S.C.T.**

Joseph Kilbey

Pw, Co. A, 2 Reg't U. S. Col'd Cavalry.

Appears on

Company Muster Roll

for *May & June*, 186*4*.

Present or absent *Present*

Stoppage, \$ *100* for

Due Gov't, \$ *100* for

Valuation of horse, \$ *100*

Valuation of horse equipments, \$ *100*

Remarks:

Book mark:

J. E. Chapin

K | **2 Cav.** | **U.S.C.T.**

Joseph Tilby
Priv, Co. A, 2 Reg't U. S. Col'd Cavalry.

Appears on

Company Muster Roll

for *July & Aug*, 186*4*

Present or absent *Present*

Stoppage, \$ 100 for

Due Gov't, \$ 100 for

Valuation of horse, \$ 100

Valuation of horse equipments, \$ 100

Remarks: *Detailed as Co. Cook.*

Book mark: _____

R. S. Shelton

K | **2 Cav.** | **U.S.C.T.**

Joseph Kilby
Priv, Co. A, 2 Reg't U. S. Col'd Cavalry.

Appears on

Company Muster Roll

for *Sept & Oct*, 1864.

Present or absent *Present*

Stoppage, \$ *100* for

Due Gov't, \$ *100* for

Valuation of horse, \$ *100*

Valuation of horse equipments, \$ *100*

Remarks: *On daily duty
as Company Cook,*

Book mark:

R D Shelton

K | **2 Cav. U.S.C.T.**

Joseph Hilby
Cvt, Co. A, 2 Reg't U. S. Col'd Cavalry.

Appears on

Company Muster Roll

for *Nov & Dec*, 1864.

Present or absent *Present*

Stoppage, \$ *100* for

Due Gov't, \$ *100* for

Valuation of horse, \$ *100*

Valuation of horse equipments, \$ *100*

Remarks: *On daily duty*
as Co. Cook.

Book mark:

R. B. Shelton

K | **2 Cav.** | **U.S.C.T.**

Joseph Kilby

Col, Co. A, 2 Reg't U. S. Col'd Cavalry.

Appears on

Company Muster Roll

for *Jan + Feby*, 1865.

Present or absent *Present*

Stoppage, \$ *100* for

Due Gov't, \$ *100* for

Valuation of horse, \$ *100*

Valuation of horse equipments, \$ *100*

Remarks: *On daily duty as
Co. Cook.*

Book mark:

R. S. Shelton

K | **2 Cav.** | **U.S.C.T.**

Joseph Kelly
Pat

Co. A, 2 Reg't U. S. Col'd Cavalry.

Appears on

Company Muster Roll

for *May 7, 1863*, 1863.

Present or absent *Present*

Stoppage, \$ *100* for

Due Gov't, \$ *100* for

Valuation of horse, \$ *100*

Valuation of horse equipments, \$ *100*

Remarks: *On duty, det. as
ser. Co. A.*

Book mark:

Wiley

N. | **2 Cav.** | **U.S.C.T.**

Joseph Kilby
Priv., Co. A, 2 Reg't U. S. Col'd Cavalry.

Appears on

Company Muster Roll

for *May & June*, 1865.

Present or absent

Stoppage, \$ 100 for

Due Gov't, \$ 100 for

Valuation of horse, \$ 100

Valuation of horse equipments, \$ 100

Remarks: *Desertion, Dec 28*
for Ordnance P. & H. Co.
taken by desertion.
\$30.06, Que. W. Hewart
Order 20 US, cc \$14

Book mark:

Kilby
Copyst.

K | 2 Car | **U.S.C.T.**

Joseph Kilby
Port, Co. A, 2 Reg't U. S. Col'd Car

Appears on

Descriptive List of Deserters

dated Aug 1, 1865

Deserted:

When June 14, 1865

Where Portsmouth, Va.

Arrested:

When _____, 186 .

Where _____

Remarks : _____

Book mark : _____

E Weston

K | **2 Cav. | U.S.C.T.**

Joseph Kilby
Co. *A*, 2 Reg't U. S. Colored Cav.

Appears on Returns as follows:

*Jan to Aug 1864 on duty
detailed as lee cook Jan 23,
Oct & Nov 1864 on duty lee cook,
Dec 1864 on extra or daily duty,
Jan to Apr 1865, on duty as
lee, cook.*

*May 1865. on extra or daily
duty,*

*June 1865, Loss, Deserted at
Portsmouth Va. June 13 '65
during the trouble in re-
gard to coming to Texas,
taking arms & accoutre-
ments & C. & B. which
was charged on the muster
rolls.*

Name appears on

Book mark :

A. M. Shannon

K 2 Cav. U.S. Sold.

Joseph Kilby

Co. A, 2 Reg't U.S. Cav

NOTATION.

Book mark: 6757 A 1589

War Department,

Record and Pension Division,

Washington, Sept. 27, 1892.

The notation of Aug 28, 1889, is canceled.

The charge of desertion of June 16, 1865, against this soldier, was removed by this Department on August 28, 1889, and he was discharged to date June 16, 1865, under the provisions of the act of Congress approved March 2, 1889.

Discharge certificate prepared by War Department and filed September 27, 1892.

F. Dunn.

No. | **2 Cav.** | **U.S.C.T.**

Joseph Kilby
Plt, Co. *A*, 2 Reg't U. S. Col'd Cavalry.

Appears on **Co. Muster-out Roll**, dated
Brazos Santiago Tex 12 Feb, 1866.

Muster-out to date _____, 186 .

Last paid to *31 Dec*, 1864.

Clothing account:

Last settled _____, 186 ; drawn since \$ _____ 100

Due soldier \$ _____ 100; due U. S. \$ _____ 100

Am't for cloth'g in kind or money adv'd \$ _____ 100

Due U. S. for arms, equipments, &c., \$ _____ 100

Bounty paid \$ _____ 100; due \$ _____ 100

Remarks: *Joined as Recruit.*
Deserted Portsmouth Va:
June 16/65.
Des List forwarded
July 25/64

Book mark : _____

G. E. Dayton

907
Kellum John

Co I, 2 U. S. Col'd Cav.

CARD NUMBERS.

1	26
2	27
3	28
4	29
5	30
6	31
7	32
8	33
9	34
10	35
11	36
12	37
13	38
14	39
15	40
16	41
17	42
18	43
19	44
20	45
21	46
22	47
23	48
24	49
25	50

See Kellum John

Book Mark:

See also

908
Killum Anthony

Co I, 2 U. S. Col'd Cav.

Private Corporal

CARD NUMBERS.

1	5315738	26
2	5327138	27
3	5327189	28
4	5327278	29
5	5327360	30
6	5327447	31
7	5327540	32
8	5327630	33
9	5327720	34
10	5327775	35
11	5327866	36
12	5328022	37
13	5328192	38
14	9087825	39
15	32528547	40
16	40726764	41
17		42
18		43
19		44
20		45
21		46
22		47
23		48
24		49
25		50

Book Mark: 1110 C.V. 1879

See also

K | **2 Cav.** | **U.S.C.T.**

Anthony Killum

....., Co. *D*, 2 Reg't U. S. Col'd Cav.

Appears on

Company Descriptive Book

of the organization named above.

DESCRIPTION.

Age *23* years; height *5* feet *8 1/2* inches.

Complexion *Dark*

Eyes *Black*; hair *Black*

Where born *Wilmington N. C.*

Occupation *Farmer*

ENLISTMENT.

When *Jan. 10, 1864.*

Where *Fort Monroe Va.*

By whom *Col. Cole*; term *3* y'rs.

Remarks:

.....
.....
.....
.....
.....
.....
.....
.....
.....

F. B. Smith
Copyist.

K. | 2 lev. | U.S.C.T.

Anthony William
Pat, Co., 2 Reg't U. S. Col'd lev.

Age years.

Appears on a

Detachment Muster-in Roll

of unattached recruits
of the organization named above. Roll dated

St. Maurice, Va Jan. 19, 1864.

Muster-in to date Jan. 19, 1864.

Joined for duty and enrolled:

When Jan. 10, 1864.

Where St. Maurice, Va

Period 3 years.

Valuation of horse, \$ 100

Valuation of horse equipments, \$ 100

Remarks :

.....

.....

.....

Book mark :

.....

J. J. Kearney
Copyist.

R | **2 Cav.** | **U.S.C.T.**

Anthony Kelum
Sgt, Co. I, 2 Reg't U. S. Col'd Cavalry.

Appears on

Company Muster Roll

for *Enrollment to Feb 29*, 1864.

Present or absent *Present*

Stoppage, \$ *100* for

Due Gov't, \$ *100* for

Valuation of horse, \$ *100*

Valuation of horse equipments, \$ *100*

Remarks:

Book mark: -----

P. A. Ward
(358) Copyist.

K | **2 Cav.** | **U.S.C.T.**

Anthony Killum

Privet, Co. I, 2 Reg't U. S. Col'd Cavalry.

Appears on

Company Muster Roll

for *Mar & Apr*, 1864.

Present or absent *Present*

Stoppage, \$..... 100 for.....

Due Gov't, \$..... 100 for.....

Valuation of horse, \$..... 100

Valuation of horse equipments, \$..... 100

Remarks :.....

Book mark :.....

D. A. Ward

R | **2 Cav.** | **U.S.C.T.**

Anthony Killum

Put, Co. I, 2 Reg't U. S. Col'd Cavalry.

Appears on

Company Muster Roll

for *May & June*, 1864.

Present or absent *Absent*

Stoppage, \$ *100* for

Due Gov't, \$ *100* for

Valuation of horse, \$ *100*

Valuation of horse equipments, \$ *100*

Remarks: *Absent sick in
U. S. G. Hopt., since
April 1864.*

Book mark:

O. A. Ward

Ko 1 2 leav. Mfc. T.

Anthony Kellum^x

Privt, Co. K, 2 Reg't Mfc. Cav.

Appears on

Hospital Muster Roll

of **U. S. A. General Hospital,**

at **Hampton, Va.,**

for *May + June, 1864*

Attached to hospital:

When....., 186 .

How employed.....

Last paid by Maj.

to, 186 .

Bounty paid \$ 100; due \$ 100

Present or absent *Present*

Remarks :

.....
.....
.....

^x *Kellum in prev. col.*

Book mark :

L. H. Harris

K | **2 Cav.** | **U.S.C.T.**

Anthony Killum
Di....., Co. *I*, 2 Reg't U. S. Col'd Cavalry.

Appears on

Company Muster Roll

for *July & Aug*....., 186*4*.

Present or absent *Present*

Stoppage, \$..... *100* for.....

Due Gov't, \$..... *100* for.....

Valuation of horse, \$..... *100*

Valuation of horse equipments, \$..... *100*

Remarks:

.....
.....
.....
.....
.....
.....
.....
.....
.....

Book mark:

O. G. Smith

K | **2 Cav.** | **U.S.C.T.**

Anthony Killum

Qui....., Co. I, 2 Reg't U. S. Col'd Cavalry.

Appears on

Company Muster Roll

for *Sept & Oct*....., 186*7*.

Present or absent *Present*

Stoppage, \$..... *100* for.....

Due Gov't, \$..... *100* for.....

Valuation of horse, \$..... *100*

Valuation of horse equipments, \$..... *100*

Remarks:.....
.....
.....
.....
.....
.....
.....
.....
.....
.....

Book mark:.....

O. G. Smith

K | **2 Cav.** | **U.S.C.T.**

Anthony William

Pi, Co. I, 2 Reg't U. S. Col'd Cavalry.

Appears on

Company Muster Roll

for *Nov Dec*, 1864.

Present or absent *Present*

Stoppage, \$ 100 for

Due Gov't, \$ 100 for

Valuation of horse, \$ 100

Valuation of horse equipments, \$ 100

Remarks:

Book mark:

C. Smith

B | **2 Cav.** | **U.S.C.T.**

Anthony Killum
Pri....., Co. I, 2 Reg't U. S. Col'd Cavalry.

Appears on

Company Muster Roll

for *Jan & Feb*....., 1865.

Present or absent *Present*.....

Stoppage, \$..... *100* for.....

Due Gov't, \$..... *100* for.....

Valuation of horse, \$..... *100*

Valuation of horse equipments, \$..... *100*

Remarks:.....
.....
.....
.....
.....
.....
.....
.....
.....
.....
.....

Book mark:.....

C. G. Smith

A | **2 Cav.** | **U.S.C.T.**

Anthony Killum

seri, Co. I, 2 Reg't U. S. Col'd Cavalry.

Appears on

Company Muster Roll

for *Mch & Apr*, 186*5*.

Present or absent *Present*

Stoppage, \$ 100 for

Due Gov't, \$ 100 for

Valuation of horse, \$ 100

Valuation of horse equipments, \$ 100

Remarks:

Book mark: -----

(358) *D. J. Griffith* Copyist.

A | **2 Cav.** | **U.S.C.T.**

Anthony Killum

Corpl, Co. I, 2 Reg't U. S. Col'd Cavalry.

Appears on

Company Muster Roll

for *May + June*, 1865.

Present or absent *Present*

Stoppage, \$ *100* for

Due Gov't, \$ *100* for

Valuation of horse, \$ *100*

Valuation of horse equipments, \$ *100*

Remarks: *Promoted to Corpl
May 1 - 1865 per Red D.O.
No 36 per Original Vacancy*

Book mark:

A. J. Giffith

A | **2 Cav.** | **U.S.C.T.**

Anthony Killum

Corpl, Co. I, 2 Reg't U. S. Col'd Cavalry.

Appears on

Company Muster Roll

for *July & August*, 186*5*.

Present or absent *Present*

Stoppage, \$ 100 for

Due Gov't, \$ 100 for

Valuation of horse, \$ 100

Valuation of horse equipments, \$ 100

Remarks:

Book mark:

D. J. Gippich

H. | **2 Cav.** | **U.S.C.T.**

Anthony Killam.

Priv, Co. I, 2 Reg't U. S. Col'd Cavalry.

Appears on

Company Muster Roll

for *Sept. & Oct.*, 186*5*.

Present or absent

Stoppage, \$ 100 for

Due Gov't, \$ 100 for

Valuation of horse, \$ 100

Valuation of horse equipments, \$ 100

Remarks: *Died at New Orleans Hospital.*

Book mark: *Died Sept. 26. '65 - S. B. 12,660 + 100 (over)*

K | **2 Cav. | U.S.C.T.**

Anthony Williams
Pl, Co. *I*, 2 Reg't U. S. Colored Cav.
capt

Appears on Returns as follows:

May to July 1864, absent with
in Gen. Harp since May
12 64.

July 1865, absent with
Gen. Harp. (capt)

Sept 1865. Loss Sept 26 65 -
Przas Santiago, died
of disease.

X *Williams* *J*

Book mark:

Wm Shannard

11 | **2 Cav.** | **U.S.C.T.**

Anthony Killum.
Corpl, Co. *9*, 2 Reg't U. S. Col'd Cavalry.

Appears on **Co. Muster-out Roll**, dated
Brazos Santiago Tex, Feb. 12, 1866.

Muster-out to date _____, 186 .
 Last paid to _____, 186 .

Clothing account:

Last settled _____, 186 ; drawn since \$ _____ 100
 Due soldier \$ _____ 100 ; due U. S. \$ _____ 100
 Am't for cloth'g in kind or money adv'd \$ _____ 100

Due U. S. for arms, equipments, &c., \$ _____ 100
 Bounty paid \$ _____ 100 ; due \$ _____ 100

Remarks: *joined at Brazos pt m*
till May 1-1865. then Corpl.
died at Brazos Texas of scur-
vy Sept 30" 1865. Final
statements & inventory of
affects forwarded Oct. 2-1865.

Book mark: *Pv9-P70.69.V88P129.69. See*
(over)

(361) *Pal* Copyist.

JAN. - 7

5328192

1891 *

*E.P. Vol. 7. P. n. 79. ~~Oct 8/65~~
Died September 26. 1865 - S. B. 12.
660. 7 1110. C. J. 1879.*

** as it appears on roll.*

Wellum, Anthony

Co. *I.*

2 Regt U. S. C. Cav.

5

Enclosures.

Bed Cards	Descriptive Lists
Burial Records	Final Statements
Certs. of Dis. for Discharge	Furloughs
C. M. Charges	Med. Des. Lists
Med. Certificates	Orders

Other papers relating to—

Admission to Hosp'l	Furlough
Casualty Sheet (Officer's) <i>3</i>	Med. Examination
Confinement	Misc. Information <i>1</i>
Contracts	Pay or Clothing <i>1</i>
Death or Effects	Personal Reports
Desertions	Rank
Discharge from Hosp'l	Transfer to Hosp'l
Discharge from Service	Transfer to V. R. C.
Duty	Transportation

MICROFILM PUBLICATION M 1818

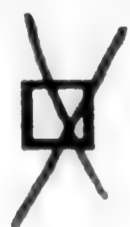
COMPILED MILITARY SERVICE RECORDS
OF VOLUNTEER UNION SOLDIERS WHO
SERVED WITH THE USCT (US COLORED TROOPS)
2ND REGIMENT OF CAVALRY

PERSONAL PAPERS' TARGET SHEET

PLEASE NOTE THE CHECKED INFORMATION ABOUT THE PERSONAL PAPERS IN
THIS FILE:



NO PERSONAL PAPERS WERE FOUND IN THIS FILE WHEN THE
RECORDS WERE ARRANGED FOR MICROFILMING.



8 PERSONAL PAPER(S) FOUND IN THIS FILE WHEN THE RECORDS
WERE ARRANGED FOR MICROFILMING.

U. S. GENERAL HOSPITAL,
Fort Monroe, Va.

August 15, 1864.

To *Major J. W. Adams* (*Major*)
1st Regiment U.S. Colored Cav

I have to report that *William C. Adams*
of Company, *A* *1st* Regiment, *U.S. Colored Cav*

has received the following Clothing at this Hospital.

	No.
Cap,	
Great Coat,	
Flannel Jack Coat,	
Blanket,	
Uniform Coat,	
Trowsers,	
Shirts,	
Drawers, prs.	
(1) Boots, prs.	<i>no 2, 2</i>
Boots, prs.	
(1) Stockings, prs.	<i>no 35</i>

You are respectfully requested to acknowledge the receipt of this communication.

Very Respectfully, Your Obedt Servt.

Supt Robert Cullen

Act. Reserve Corps.

2p. 7 inv. sent for to the 25th of
Aug 22, 1865

Completed
CASUALTY SHEET

No. _____

Anthony Kelley

Private of Company *D*

2nd Regiment of *Ab. C. Bay*

State Volunteers.

NATURE OF CASUALTY.

Died Sept 26, 1865.

*Believed to be killed in action with
Kellum.*

E

CASUALTY SHEET.

Name: Anthony Kelley
Rank: Priv Company: I Regiment: 2^d
Arm: Reg. C. Cav State: _____
Nature of Casualty: Death

CAUSE OF CASUALTY—(NAME OF DISEASE, &c.)

Ch. Dysentery

BY WHOM DISCHARGED.

FROM WHAT SOURCE THIS INFORMATION WAS OBTAINED.

Roll of Honor Pg 25
Texas

DEGREE OF DISABILITY.

BY WHOM CERTIFIED.

James M. Moore
A. J. M.

DATE OF DISCHARGE, DEATH, &c.

Sept. 26, 1865

PLACE OF DISCHARGE, DEATH, &c.

Brazos Santiago

REMARKS.

Died Sept 26 '1865. of Chronic
Dysentery. at Post Hosp Brazos
Santiago, Texas. Vide
letter from Chief Med Dir 5
mil Dist 2113

James Beetham
Clerk.

Pls. sent for to Co. C. Jan. 27, 66

CASUALTY SHEET.

No.

Anthony Calhoun

Cpl of Company D

2 Regiment of W. H. Bay

State Volunteers.

Died Sept. 30, 1865

NATURE OF CASUALTY.

Spined by Anthony
Killman

NOV 19 1865

CASUALTY SHEET.

Name: *Anthony Galhoun*
Rank: *Cpl* Company: *D* Regiment: *2^d*
Arm: *U.S. Cavalry* State: _____
Nature of Casualty: _____
Death

CAUSE OF CASUALTY—(NAME OF DISEASE, & C.)

Disease

BY WHOM DISCHARGED.

FROM WHAT SOURCE THIS INFORMATION WAS
OBTAINED.

Colly. Reg. Sec. Jones's
Sept 30th 1865

DEGREE OF DISABILITY.

BY WHOM CERTIFIED.

Frank White
Lt Col.

DATE OF DISCHARGE, DEATH, & C.

Sept 30th 1865

PLACE OF DISCHARGE, DEATH, & C.

Krago's

REMARKS.

D. H. Cole

Clerk.

From Hospital
Major Santiago Cross
about 30th 1867
Respectfully returned with
the information that John
Anthony Kelly Co I
5th U.S. C. Cavalry was
admitted to this Hospital
with Chr. Dysentery the 27/1865
and reported died the 28/1865.
No effects no description but
no final account.

2 Capt. A. L. Norris
Apr. Aug. 114 Regt.
in charge

RESPECTFULLY returned to the
Adjutant General, U. S. A.
Washington, D. C. with
reference to endorsement
of Asst. Surg. A. L. Norris,
114 Regt. C. & G. I.

The desired papers
cannot be furnished or
procured by this Office.



L. S. F. Allen
Bot Brig. Gen. and Surg. U. S. A., Medical Director.

Head Quarters Sub Dist R. G.
Office Chief Med. Officer
Brownsville Mar 26/67.

Respectfully returned to the
Chief Med. Officer Dist of
Texas with reference to
previous endorsement.

E. Fowler
Capt. & Asst. Surg. U. S. A.
Chief Med. Officer

EB 30 P. M. No. 256 P. 133

Head Quarters Dist. of Texas
Office of Chief Med. Officer
Galveston Tex April 8 1867

Respectfully returned to Brig.
Brig. Gen. Tho. A. M. Parke Surg
7 regt. Med. Dir. 5th Dist with
reference to foregoing endorsements.

Wm. H. Fryer
Bat Lt. Col. Surgeon Regt.
Chief Med. Officer

Headquarters Department of the Gulf,
5th Mil. Dist.
MEDICAL DIRECTOR'S OFFICE,

New Orleans, La., Apr 13th 1867.

RESPECTFULLY returned to the
Adjutant General, U. S. A.,
Washington, D. C. with
reference to endorsement
of Asst. Surg. A. L. Harris,
114th West C & Qd

The desired papers
cannot be furnished or
procured by this Office.



L. S. Garrison

Bot Brig. Gen. and Surg. U. S. A., Medical Director.

Head Quarters Sub Dist R. G.
Office Chief Med. Officer
Brownsville Mar 26th 67.

Respectfully returned to the
Chief Med. Officer, Dist. of
Texas with reference to
previous endorsement.

E. Fowler
Capt. & Asst. Surg. U. S. A.
Chief Med. Officer.

P. B. 30 P. M. No 256 1133

Head Quarters Dist. of Texas
Office of Chief Med. Officer
Galveston Tex April 8 1867

Respectfully returned to Brig.
Gen. Thos. A. M. Parker Surg
7th Regt. Med. Dir. 5th Mil. Dist. with
reference to foregoing endorsements.

Wm. J. Taylor
Bat. Lt. Col. Surgeon Regt.
Chief Med. Officer

WAR DEPARTMENT,

ADJUTANT GENERAL'S OFFICE,

WASHINGTON, *Aug. 22^d*, 186*6*.

SIR:

Final Statements in the cases of deceased soldiers are required to be sent to the Adjutant General's Office in duplicate, with one copy of the Inventory of Effects. The Descriptive List should also be sent to this Office in cases where the soldier was absent from his Company at the time of his death. Where there were no effects, it should be so stated on a blank Inventory, properly signed.

Certificates of Disability should be sent in duplicate. Special care should be taken that the date of discharge and signature of the discharging officer should be affixed.

No. of the Final Statement or Inventory, has been received in the case of *Priv. Anthony Kelley*, of Co. *A*, *2^d* Regiment of *W. S. C. Co.,* Volunteers, whose papers were forwarded to this Office. You will please forward the missing papers without delay.

I have the honor to be, sir,

Very respectfully,

Your obedient servant,

*Reported Dead
Sept. 26, 1865
Texas*

Seckford

Assistant Adjutant General.

(110)

~~COMMANDING OFFICER~~

Medical Director Dept. Gulf.

If final papers cannot be furnished please give date, place and cause of death if possible.

B.

Adjutant General's Office
Washington, D.C. March 15, 1869.

The Quarterly Return of Deceased soldiers of the 2nd
71st Colored Cavalry for
the 4th quarter of 1865, reports
the death of Private Anthony
Kellam, Co. "I", as having oc-
curred Oct. 5th 1865.

The Company Muster-out
Roll, and Descriptive and Morn-
ing Report Books, report date
of death September thirtieth
(30th) 1865.

The latter date is held to
be correct and the Quarterly
Returns and Casualty Sheet
will be amended accordingly.

H. R. Rathbone
Brevet Colonel U.S.A.
CWJ
dated March 22^d 1869

In witness whereof
March 23^d 1869
The Adjutant General

Approved for the Adj. Gen. Jan 27, 1868

CASUALTY SHEET.

No. _____

Anthony Kellam
Private of Company I
2 Regiment of U. S. Cavalry
State Volunteers.

NATURE OF CASUALTY.

Dead Sept 30 1865

[OFFICE ENDORSEMENT.]

War Department,

ADJUTANT GENERAL'S OFFICE,

July 15th, 1879

The Health of Capt. Anthony
Kellam, Co. "I", 7th Reg't U.S.
Colored Cavalry, is reported as follows:

On Company Muster Roll.	1865
For Sept. Oct., 1865, no date, 1865	
Company Muster-out Roll.	1865
September 30, 1865	
Company Descriptive Book.	1865
Company Morning Reports.	1865
Soldier's Final Statement.	1865
Soldier's Record of Death and Interment.	1865
Soldier's Inventory of Effects.	1865
Soldier's Certificate of Disability for Discharge.	1865
Soldier's Individual Muster-out Roll.	1865
Regimental Return.	1865
For Sept., 1865, Sept. 26, 1865	
Regimental Quarterly Returns.	1865
Regimental Descriptive Book.	1865
In Surgeon General.	1865
(1110.99.99) September 26, 1865	

is held to be the correct date, and the Company Muster Rolls will be amended accordingly.

J. M. [Signature]
Assistant Adjutant General.

CCWJ
Noted in file

Vertical handwritten notes on the right margin of the War Department page, including "1865" and "Sept 30 1865".

CASUALTY SHEET.

Name: Anthony Kellam

Rank: Private Company: "D" Regiment: 2^d

Arm: U.S. Navy State:

Nature of Casualty: Death

Descriptive Book of Co. I 2^d U.S. C. Cav. reports Anthony Kellam died Sept. 30th 1865 at Brazos Santiago Texas.

Morning Report of Co. for Sept. 30/65 gives same report.
Record Room
March 16/69

H.S.

DATE OF DISCHARGE, DEATH, &c.

September 30th 1865

PLACE OF DISCHARGE, DEATH, &c.

Brazos Texas

W.D. Cole

Clerk.

CASUALTY SHEET.

Name: *Anchovy Kellam*

Rank: *Private* Company: *D* Regiment: *2*

Arm: *U.S. Army* State: _____

Nature of Casualty: *Death*

USE OF CASUALTY—(NAME OF DISEASE, &c.)

Unknown

BY WHOM DISCHARGED.

FROM WHAT SOURCE THIS INFORMATION WAS OBTAINED.

*Atty Rich Desobois
Jan 31 1865*

DEGREE OF DISABILITY.

BY WHOM CERTIFIED.

*Frank W. Kenb
Major*

REMARKS.

DATE OF DISCHARGE, DEATH, &c.

*September 30th
1865*

PLACE OF DISCHARGE, DEATH, &c.

Brazos Texas

W. B. Cole

Clerk.

WAR 704

909

William John

Co I, 2 U. S. Col'd Cav.

Private

Private

CARD NUMBERS.

1	5315737	26
2	5327103	27
3	5327190	28
4	5327279	29
5	5327395	30
6	5328214	31
7	9087823	32
8	40726262	33
9		34
10		35
11		36
12		37
13		38
14		39
15		40
16		41
17		42
18		43
19		44
20		45
21		46
22		47
23		48
24		49
25		50

Book Mark:

See also

Rep 362 330.
J-1260275-POM 4m

L Ballauf 4m

K | **2 Cav.** | **U.S.C.T.**

John Killum 2
 _____, Co. *2*, 2 Reg't U. S. Col'd Cav.

Appears on

Company Descriptive Book

of the organization named above.

DESCRIPTION.

Age *27* years; height *5* feet *5* inches.

Complexion *Dark*

Eyes *Black*; hair *Black*

Where born *Onslow Co., N. C.*

Occupation *Farmer*

ENLISTMENT.

When *Jan. 10, 1864*.

Where *Fort Monroe, Va.*

By whom *Col. Cole*; term *3* y'rs.

Remarks: *Deserted in the field Va. near Peters-
 -burg, Va. July 3rd / 1864,*

F. B. Smith
 Copyist.

K. | 2 Cav. | U.S.C.T.

John Killum

Plt, Co. 2 Reg't U. S. Col'd Cav.

Age _____ years.

Appears on a

Detachment Muster-in Roll

of unattached recruits
of the organization named above. Roll dated

Fort Monroe, Va, Jan. 19, 1864.

Muster-in to date Jan. 19, 1864.

Joined for duty and enrolled:

When Jan. 10, 1864.

Where Fort Monroe, Va.

Period 3 years.

Valuation of horse, \$ 100

Valuation of horse equipments, \$ 100

Remarks : _____

Book mark : _____

J. J. Stearns
Copyist.

AK | **2 Cav. | U.S.C.T.**

John Killin

Plt, Co. I, 2 Reg't U. S. Col'd Cavalry.

Appears on

Company Muster Roll

for *Enrollment to Feb 29*, 1864.

Present or absent *Present*

Stoppage, \$ *100* for

Due Gov't, \$ *100* for

Valuation of horse, \$ *100*

Valuation of horse equipments, \$ *100*

Remarks:

Book mark:

P. A. Ward

NOV 1864

K | **2 Cav.** | **U.S.C.T.**

John Kellin

Put, Co. I, 2 Reg't U. S. Col'd Cavalry.

Appears on

Company Muster Roll

for *Mar & Apr*, 1864.

Present or absent *Present*

Stoppage, \$ *100* for

Due Gov't, \$ *100* for

Valuation of horse, \$ *100*

Valuation of horse equipments, \$ *100*

Remarks:

Book mark:

J. A. Ward
(358) Copyist.

K | **2 Cav. | U.S.C.T.**

John Killin
Plat, Co. I, 2 Reg't U. S. Col'd Cavalry.

Appears on

Company Muster Roll

for *May & June*, 1864.

Present or absent *Present*

Stoppage, \$ 100 for

Due Gov't, \$ 100 for

Valuation of horse, \$ 100

Valuation of horse equipments, \$ 100

Remarks:

Book mark: *507-1-18*

O-A. Ward
(358) Copyist.

K | **2 Cav. | U.S.C.T.**

John Killian

Pi, Co. I, 2 Reg't U. S. Col'd Cavalry.

Appears on

Company Muster Roll

for *July & Aug*, 1864.

Present or absent

Stoppage, \$ 100 for

Due Gov't, \$ 100 for

Valuation of horse, \$ 100

Valuation of horse equipments, \$ 100

Remarks: *Deserted July 3/64 in the field Va near Petersburg Va. Due U.S. for Ordnance 1 Revolver \$14.95*

Book mark:

A. Smith

A | **2 Cav.** | **U.S.C.T.**

John Allen
Post, Co. *D*, 2 Reg't U. S. Colored Cav.

Appears on Returns as follows:

*July 1864. Loss July 2 in 11
near Petersburg Va.
Deserted.*

Book mark:

A. M. Shannon

(546)

Copyist.

AL. | **2 Cav.** | **U.S.C.T.**

John Killum,
Priv, Co. *F*, 2 Reg't U. S. Col'd Cavalry.

Appears on **Co. Muster-out Roll**, dated
Brazos Santiago Tex, Feb. 12, 1866.

Muster-out to date _____, 186 .

Last paid to _____, 186 .

Clothing account:

Last settled _____, 186 ; drawn since \$ _____ 100

Due soldier \$ _____ 100 ; due U. S. \$ _____ 100

Am't for cloth'g in kind or money adv'd \$ _____ 100

Due U. S. for arms, equipments, &c., \$ _____ 100

Bounty paid \$ _____ 100 ; due \$ _____ 100

Remarks: *joined at org orgz. Pt.*
from enlistment. Deserted
July 4-6th near Petersburg Va.
Administrative list forwarded
Sept. 30-186th.

x Corrected April 3/93. HcaJ

Book mark: *P.V. 15. P. 2. 69. VII 2. P. 183/70.*

Pol

910
Kilpatrick Richard

Co D, 2 U. S. Col'd Cav.

Private | Private

CARD NUMBERS.

1	5321015	26
2	5321104	27
3	5321192	28
4	5321278	29
5	5316395	30
6	5316517	31
7	5321362	32
8	5321442	33
9	5321527	34
10	5316730	35
11	5376788	36
12	5321622	37
13	5321722	38
14	5321824	39
15	5322158	40
16	9087402	41
17	858-05-1874	42
18	40726263	43
19		44
20		45
21		46
22		47
23		48
24		49
25		50

Book Mark: 858-05-1874

See also

1176772 - Aud 402

51233749 Aud 402
2305640 P. O. aff.

2307162 P. O. aff.

L. Gallary & Co

R | **2 Cav.** | **U.S.C.T.**

Richard Kilpatrick
....., Co. *D*, 2 Reg't U. S. Col'd Cav.

Appears on

Company Descriptive Book
of the organization named above.

DESCRIPTION.

Age *32* years; height *5* feet *10* inches.

Complexion *Black*

Eyes *Dark*; hair *Dark*

Where born *Gloucester Co., Va.*

Occupation *Waiter*

ENLISTMENT.

When *Dec 24, 1863.*

Where *Fort Monroe*

By whom *Col. Cole*; term *3* y'rs.

Remarks: *Engaged in*
action at Suffolk Va,
Mch, 9" 1864, Jones Bridge
Chickohominy River
May 6" + near Peters-
-burgh Va, June 6" 12"
7 18" 1864.

F. B. Smith

NA 317

K | **2 Cav. | U.S.C.T.**

Richard Kilpatrick

Plt, Co. *D*, 2 Reg't U. S. Col'd Cavalry.

Age: years.

Appears on

Company Muster-in Roll

of the organization named above. Roll dated

Fort Monroe Va., Dec 24, 1863.

Muster-in to date *Dec 24, 1863.*

Joined for duty and enrolled:

When *Dec 24*, 1863.

Where *Fort Monroe Va.*

Period *3* years.

Valuation of horse, \$ *100*

Valuation of horse equipments, \$ *100*

Remarks :

Book mark: *858-05-1874*

Hearn

K | **2 Cav.** | **U.S.C.T.**

Richard Kilpatrick

Plt, Co. D, 2 Reg't U. S. Col'd Cavalry.

Appears on

Company Muster Roll

for *from Enrollment to July 29, 1864.*

Present or absent *Present*

Stoppage, \$ *100* for

Due Gov't, \$ *100* for

Valuation of horse, \$ *100*

Valuation of horse equipments, \$ *100*

Remarks:

Book mark:

Gearst

K | **2 Cav.** | **U.S.C.T.**

Richard Kilpatrick

Plt, Co. D, 2 Reg't U. S. Col'd Cavalry.

Appears on

Company Muster Roll

for *Mch 3 Apl*, 1864.

Present or absent *Present*

Stoppage, \$ *100* for

Due Gov't, \$ *100* for

Valuation of horse, \$ *100*

Valuation of horse equipments, \$ *100*

Remarks: *Due the U.S. for 1 spur
& straps 60¢*

Book mark:

Heard

K | **2 Cav.** | **U.S.C.T.**

Richard Killpatrick

Pl, Co. D, 2 Reg't U. S. Col'd Cavalry.

Appears on

Company Muster Roll

for *May & June*, 186 *4*.

Present or absent *Absent*.

Stoppage, \$ *100* for

Due Gov't, \$ *100* for

Valuation of horse, \$ *100*

Valuation of horse equipments, \$ *100*

Remarks: *Sick in Genl Hosp'l at City Point Va. Due U.S. for 1 Carbin socket & 1 spur & straps 98**

Book mark:

Heard

R | *2 Cas* | **U.S.C.T.**

Richard Kilpatrick
Pi, Co. *L*, *2* Reg't U. S. Col'd *Cas*

Appears on a

Detachment Muster Roll

of the organization named above

for *July & Aug*, 186*7*.

Station *Camp in the field Va*

Present or absent *Present*

Stoppage, \$ *100* for

Due Gov't, \$ *100* for

Valuation of horse, \$ *100*

Valuation of horse equipments, \$ *100*

Remarks: *Due U.S. 96/100*

Book mark :

O. G. Smith

E. C. 2 Cav | U.S.C.T.

Richard Kiepatnick
Co. C, 2 Reg't U. S. Col'd

Appears on a

Detachment Muster Roll

of the organization named above

for *Sept + Oct*, 186*f*.

Station *Before Richmond Va*

Present or absent

Stoppage, \$ 100 for

Due Gov't, \$ 100 for

Valuation of horse, \$ 100

Valuation of horse equipments, \$ 100

Remarks: *Relief of Gray between*
White & Calvert soldiers
the from June 14th to Feb-
29th.

Book mark:

E. C. Thompson
(344) Copyist.

E | 2 Cav. | U.S.C.T.

Richard McPatrick

Co., Co. D, 2 Reg't U. S. Col'd Cavalry.

Appears on

Company Muster Roll

for *June 30th Oct 31*, 1864.

Present or absent *Absent.*

Stoppage, \$.....100 for

Due Gov't, \$.....100 for

Valuation of horse, \$.....100

Valuation of horse equipments, \$.....100

Remarks *On detached service in ambulance train.*

Book mark:

Sabine

K | 2 Cav. | U.S.C.T.

Richard K. Patrick

Coy, Co. D, 2 Reg't U. S. Col'd Cavalry.

Appears on

Company Muster Roll

for *Nov + Dec*, 186*4*

Present or absent *Absent*.

Stoppage, \$.....100 for

Due Gov't, \$.....100 for

Valuation of horse, \$.....100

Valuation of horse equipments, \$.....100

Remarks *On detached ser-
vice in ambulance
train.*

Book mark:

Sabine
Copyist.

M | **2 Cav.** | **U.S.C.T.**

Richard M. Patrick

Co. D, Co. D, 2 Reg't U. S. Col'd Cavalry.

Appears on

Company Muster Roll

for *Jan + Feb*, 1865.

Present or absent *Absent*

Stoppage, \$ *100* for

Due Gov't, \$ *100* for

Valuation of horse, \$ *100*

Valuation of horse equipments, \$ *100*

Remarks: *in ambulance corps.*

Book mark:

Carine

N | 2 bar. | U.S.C.T.

Richard Kilpatrick

Privt, Co D, 2 Reg't U. S. Col'd Cavalry

Appears on a

Detachment Muster Roll

of the organization named above

for Oct 31/64 to Feb 28, 1865.

Station Bermuda Hundred, Va.

Present or absent Absent

Stoppage, \$ 100 for

Due Gov't, \$ 100 for

Valuation of horse, \$ 100

Valuation of horse equipments, \$ 100

Remarks: Absent with Com-
mand at Wilmington,
N.C. Def. in pay bet.
white & colored soldiers
due from Jan 1/64 to
Aug 31/64

Book mark:

(344) *no doc*)

Copyist.

K | 2 Levy | U.S.C.T.

Richard Kilpatrick

But, Co. D, 2 Reg't U. S. Col'd Levy

Appears on a

Detachment Muster Roll

of the organization named above

for *April & April*, 1863.

Station *Goldston U. S.*

Present or absent *Absent*

Stoppage, \$ *100* for

Due Gov't, \$ *100* for

Valuation of horse, \$ *100*

Valuation of horse equipments, \$ *100*

Remarks: *Absent since
March 20, 1863.*

*All men of this Co have
rec'd but \$7. pr med. up
to Feb. 29/64. Dif bet \$7 &
\$13. is due from Jan*

Book mark: *(over)*

Montague

JAN. - 7

5316788

★ 1891 ★

1/64 or from earliest
moment of later than
Jan 1 & prior to Feb: 29/64
to said date, non-com-
missioned Officers have
used but 87 per cent.
up to Feb 29/64.

K | **2 Cav.** | **U.S.C.T.**

Bushrod Kilpatrick
204, Co. D, 2 Reg't U. S. Col'd Cavalry.

Appears on

Company Muster Roll

for *May & April*, 1865.

Present or absent *Absent*

Stoppage, \$ *100* for

Due Gov't, \$ *100* for

Valuation of horse, \$ *100*

Valuation of horse equipments, \$ *100*

Remarks: *Detached in Ambulance*
Corps per letter of instruction
Aug 1st 1864

Book mark:

G. M. Hillier

A | **2 Cav. | U.S.C.T.**

Richard Kilpatrick

Pvt, Co. D, 2 Reg't U. S. Col'd Cavalry.

Appears on

Company Muster Roll

for *May & June*, 186*5* :

Present or absent *Absent*

Stoppage, \$ *100* for

Due Gov't, \$ *100* for

Valuation of horse, \$ *100*

Valuation of horse equipments, \$ *100*

Remarks: *Detached in Amb. Corps
Aug 1/64*

Book mark :

C. W. Hillard

R | **2 Cav. | U.S.C.T.**

Richard Gilpatrick

Pvt, Co. D, 2 Reg't U. S. Col'd Cavalry.

Appears on

Company Muster Roll

for *April 30 to Aug 31, 1865*

Present or absent

Stoppage, \$ *100* for

Due Gov't, \$ *100* for

Valuation of horse, \$ *100*

Valuation of horse equipments, \$ *100*

Remarks:

Book mark: *Rec'd April 2/65 E.B. VIII Pg. 2*

S. W. Hill

K | **2 Cav.** | **U.S.C.T.**

Richard Kilpatrick

Plt., Co. L., 2 Reg't U. S. Colored Cav.

Appears on Returns as follows:

June 1864. Absent sick in Corps
Gen. Hoptl Point of Rocks,
Va. since June 27, 64,
July 1864. Absent sick since
June 27, 64,
Aug 1864. Absent on det. service
I.O. 3 Div 18 A.B.,
Sept + Oct 1864. Absent detached
service in ambulance Corps.
Nov 1864. Lost Nov 9, 64,
from camp. Missing
in action, from detached service,
Dec 1864 + Jan 1865. Absent
sick in Gen. Hoptl,
Feb 1865. Absent in ambulance
Corps 25 A.B.,
March 1865. Absent detached in
Ambulance Corps,
Apr 1865. Absent detached in
amb Corps per letter of instruc-
tions dated Hd Qrs 3 Div 25 A.B.

Book mark:

(over)

J. M. Shannon

JAN. 18

40726263

1899.

May 1863 - absent detached
in ambulance corps for
letter of instructions dated

Ad Dis 18 A & B,

June 1863 - absent detached in
ambulance corps M. Lea.

July 1863 - absent det in
ambulance corps.

K | **2 Cav. | U.S.C.T.**

Richard Killpatrick
Priv, Co *D*, 2 Reg't U. S. Col'd Cavalry.

Appears on **Co. Muster-out Roll**, dated
Gonzales Santiago Tex Feb 12, 1866.

Muster-out to date _____, 186 .

Last paid to _____, 186 .

Clothing account:

Last settled _____, 186 ; drawn since \$ _____ 100

Due soldier \$ _____ 100; due U. S. \$ _____ 100

Am't for cloth'g in kind or money adv'd \$ _____ 100

Due U. S. for arms, equipments, &c., \$ _____ 100

Bounty paid \$ _____ 100; due \$ _____ 100

Remarks: *Joined reg regm.*
died in us Gen Hosp at
Wilmington June 20, 65.
Final statements & Inv of
effects found

Book mark: *Died April 2, 65*

E. B. V. P. 62. M. G. P. 185

S. W. Jones ^{over}

JAN. - 7

5322158

1891 *

69. V 37. P 53/69. S 68.
V 10. C J. 1874.

R | 2^d Cav. U.S.C.S.

Richard Kilpatrick
, Co. D, 2^d Reg't U.S.C. Cav.

NOTATION.

Book mark: *S-58-C-J-1874.*

Record and Pension Office,

WAR DEPARTMENT.

This book mark refers only to a report from the medical records, made by the Surgeon General to the Adjutant General, relative to the above-named man. As the medical records have since been carded, no transcript of this report is made hereon.

Kilpatrick Richard
 , Co. *D* , Reg't *2* *U.S.C. Cav.*

Enclosures.

Bed Cards	Final Statements
Burial Records	Furloughs or L. of A
Certs. of Dis. for Discharge	Med. Certificates
C. M. Charges	Med. Des. Lists
Descriptive Lists	Orders
Discharge Certificates	Pris. of War Record
Enlistment Papers	Resignations

Other papers relating to—

Admission to Hosp'l	Furlough or L. of A
Casualty Sheet	Med. Examination
Confinement	Misc. Information
Contracts	Pay or Clothing
Death or Effects	Personal Reports
Desertion	Rank
Discharge from Hosp'l	Transfer to Hosp'l
Discharge from Service	Transfer to V. R. C.
Duty	Transportation

WAR 999

[OFFICE INDORSEMENT.]

War Department,

ADJUTANT GENERAL'S OFFICE,

May 5, 1874

The Death of Richard Kilpatrick
Private, Co "D", 2^d Reg't U. S.

Colored Cavalry, is reported as follows:

Last appears On Company Muster Roll.

For Julyth & Aug, 1865, At "Without remarks" 186

Company Muster-out Roll.

June 20th, 1865

Company Descriptive Book.

, 186

Company Morning Reports.

, 186

Soldier's Final Statement.

, 186

Soldier's Record of Death and Interment.

, 186

Soldier's Inventory of Effects.

, 186

Soldier's Certificate of Disability for Discharge.

, 186

Soldier's Individual Muster-out Roll.

, 186

Regimental Return.

For _____, 186 _____, 186

Regimental Quarterly Returns.

, 186

Regimental Descriptive Book.

, 186

By Surgeon General.

✓ (5865/1074) April 2, 1865

April 2, 1865, is held to be

the correct date, and the Company Muster Roll will be amended accordingly.

Thomas M. Sweet

E. B. ¹¹/₁₀₂ Noted Assistant Adjutant General.

flatt -

Notes on Register

See letter of June 9, 1874, to 2^d Aud.

CASUALTY SHEET

No. _____

Richard Kilpatrick
"D" of Company 2^d

Regiment of U. S. C.

State Volunteers.

NATURE OF CASUALTY.

Death 10/2/65

CASUALTY SHEET.

Name: *Richard Kilpatrick Swatte*

Rank: _____ Company: *"D"* Regiment: *2^d U.S. Cav*

Arm: _____ State: _____

Nature of Casualty: *Death*

CAUSE OF CASUALTY—(NAME OF DISEASE, &c.)

BY WHOM DISCHARGED.

FROM WHAT SOURCE THIS INFORMATION WAS OBTAINED.

A. C. Raiter Company

DEGREE OF DISABILITY.

BY WHOM CERTIFIED.

Wm J Guackenbush
Sr Lieut Co D 2^d U.S. Cav

DATE OF DISCHARGE, DEATH, &c.

REMARKS.

PLACE OF DISCHARGE, DEATH, &c.

U.S. Genl Hosp. Wilmington N.C.

J. H. Jenkins

Clerk.

WAR 549

King Ananias
King Ananias

Co *L*, **2** U. S. Col'd Cav.

Private | *Private*

CARD NUMBERS.

1	5316016	26
2	5329485	27
3	5329581	28
4	5329680	29
5	5329772	30
6	5329903	31
7	5329995	32
8	9088402	33
9	30852783	34
10	30854336	35
11	40726266	36
12		37
13		38
14		39
15		40
16		41
17		42
18		43
19		44
20		45
21		46
22		47
23		48
24		49
25		50

Book Mark:

See also

K | **2 Cav.** | **U.S.C.T.**

Amias King
Priv, Co. *L*, 2 Reg't U. S. Col'd Cav.

Appears on

Company Descriptive Book

of the organization named above.

DESCRIPTION.

Age *21* years; height *5* feet *6 1/2* inches.

Complexion *Dark*

Eyes *Blue*; hair *Blue*

Where born *Florida*

Occupation *Steer*

ENLISTMENT.

When *March 3*, 1865.

Where *Phil*

By whom *Dist Pa*; term *1* y'rs.

Remarks: *Substitute for*
mm. J. Swain 5-Ward
Phil, Pa. & Sub 1 long
Dist Pa.
Died Nov. 7/65.

N 7 9 4 2
N | 2 Cav. | U.S.C.T.

Amias King

Appears with rank of *Private* on

Muster and Descriptive Roll of a Detachment of Substitutes forwarded

for the *2* Reg't U. S. Col'd *Cav.* Roll dated

Cheltenham Hills, Pa., Mar. 23, 1865.

Where born *Florida*

Age *21* y'rs; occupation *Steward*

When enlisted *Not Stated*, 186 .

Where enlisted *Not Stated*

For what period enlisted *1* years.

Eyes *Blk*; hair *Blk*

Complexion *Dark*; height *5 ft. 6 1/2 in.*

When mustered in *Mar. 3*, 1865.

Where mustered in *Phila., 1st Dist., Pa.*

Bounty paid \$ *100*; due \$ *100*

Where credited *5th Ward, Phila., Pa.,*

4th Sub. Dist., 1st Cong. Dist.
Company to which assigned

Remarks:

Book mark:

D. C. Taylor

K | **2 Cav.** | **U.S.C.T.**

Annannias King
Private, Co *L* 2 Reg't U. S. Col'd Cavalry.

Age years.

Appears on

Company Muster Roll*

for *Enrollment to* *Apr 30*, 1865.

Joined for duty and enrolled:

When, 186 .

Where

Period *1* years.

Mustered in:

When *Mar 3*, 1865.

Where *Philada*

Present or absent *Present-*

Stoppage, \$ *100* for

Due Gov't \$ *100* for

Valuation of horse, \$ *100*

Valuation of horse equipments, \$ *100*

Remarks:

*First current roll. No muster-in roll of this company on file.

Book mark:

C. S. Rozzelle
(3586) Copyist.

K | **2 Cav.** | **U.S.C.T.**

Ammanias King

Private, Co. L, 2 Reg't U. S. Col'd Cavalry.

Appears on

Company Muster Roll

for *May + June*, 1865.

Present or absent *Present*

Stoppage, \$ *100* for

Due Gov't, \$ *100* for

Valuation of horse, \$ *100*

Valuation of horse equipments, \$ *100*

Remarks:

Book mark:

(358)

C. S. Rozzell

Copyist.

No | 2 bars. | U.S.A.

Ananias King

Sgt, Co. *D*, 2 Reg't *U.S.A.*

Appears on

Hospital Muster Roll

of Corps d'Afrique U. S. A. General Hospital,

at New Orleans, La.,

for *July - Aug*, 1865.

Attached to hospital:

When _____, 186 .

How employed _____

Last paid by Maj. _____

to _____, 186 .

Bounty paid \$ 100; due \$ 100

Present or absent *present*

Remarks:

Book mark: _____

F. J. King

A | **2 Cav.** | **U.S.C.T.**

Amias King

Priv....., Co. L, 2 Reg't U. S. Col'd Cavalry.

Appears on

Company Muster Roll

for *July + Aug*....., 1865.

Present or absent *Absent*

Stoppage, \$.....100 for

Due Gov't, \$.....100 for

Valuation of horse, \$.....100

Valuation of horse equipments, \$.....100

Remarks: *Absent sick in Gen Hospital since July 14th 1865-*

Book mark:

(358) *C. S. Rozzell* Copyist.

K. 12 Cav. MS. 12

Ananias King
Pvt., Co. L, 2 Reg't 12 Cav.

Appears on

Hospital Muster Roll

of Corps d'Afrique U. S. A. General Hospital,

at New Orleans, La.,

for Sept-Oct, 1865.

Attached to hospital:

When _____, 186 .

How employed _____

Last paid by Maj. _____

to _____, 186 .

Bounty paid \$ 100; due \$ 100

Present or absent _____

Remarks: Died Oct 16

Book mark: _____

Willey

R | **2 Cav.** | **U.S.C.T.**

Asmanias King

Priv, Co. L, 2 Reg't U. S. Col'd Cavalry.

Appears on

Company Muster Roll

for *Sept & Oct*, 1865.

Present or absent *Absent*

Stoppage, \$ *100* for

Due Gov't, \$ *100* for

Valuation of horse, \$ *100*

Valuation of horse equipments, \$ *100*

Remarks: *Absent sick since Aug. 1, 1865*

Book mark:

F. B. Smith

K | **2 Cav.** | **U.S.C.T.**

Armanias King

Priv, Co. L, 2 Reg't U. S. Col'd Cavalry.

Appears on

Company Muster Roll

for Nov + Dec, 1860.

Present or absent.....

Stoppage, \$.....100 for.....

Due Gov't, \$.....100 for.....

Valuation of horse, \$.....100

Valuation of horse equipments, \$.....100

Remarks: died in U. S.
Genl. Hospital, N. O.
Nov. 7th, 1860.

Book mark: died Oct. 16/60-
E. B. N. 11. P. 178.

J. B. Smith

K | **2 Cav.** | **U.S.C.T.**

Amramas King
Pl, Co. *L*, 2 Reg't U. S. Colored Cav.

Appears on Returns as follows:

July 1865, Absent sick at
Brazos Santiago penit
July 8,
Aug 1865, Absent sick in
Gen Hospital,
Sept 1865, Absent sick at
Brazos or New Orleans,
Oct 1865, Absent sick in
Gen Hospital,
Nov 1865, Pass Nov 7. 65
M.O. Out of disease,

Book mark : _____

A. M. Shannon

NARA 551

K | **2 Cav.** | **U.S.C.T.**

Ananias King
Private, Co. *L*, 2 Reg't U. S. Col'd Cavalry.

Appears on **Co. Muster-out Roll**, dated
Prague Santiago, Tex, Feb. 12, 1866.

Muster-out to date _____, 186 .

Last paid to _____, 186 .

Clothing account:

Last settled _____, 186 ; drawn since \$ _____ 100

Due soldier \$ _____ 100; due U. S. \$ _____ 100

Am't for cloth'g in kind or money adv'd \$ _____ 100

Due U. S. for arms, equipments, &c., \$ _____ 100

Bounty paid \$ _____ 100; due \$ _____ 100

Remarks: *He died. Joined as*
Recruit. Died in U. S.
Genl. Hosp. N. Orleans
Oct. 16/65 of Diarrhoea
Chronic, Fine Stats. & Ins.
of Eff's. furnished Oct. 27/65

Book mark: *133.072 H. B. V.*

89.642

J. B. Smith

(361)

Copyist.

King, Amias

P, Co. *L*, *2* Reg't *McCaw*

2 Enclosures.

Bed Cards	Descriptive Lists
Burial Records <i>1</i>	Final Statements
Certs. of Dis. for Discharge	Furloughs
C. M. Charges	Med. Des. Lists
Med. Certificates	Orders

Other papers relating to—

Admission to Hosp'l	Furlough
Casualty Sheet (Officer's)	Med. Examination
Confinement	Misc. Information
Contracts	Pay or Clothing
Death or Effects <i>1</i>	Personal Reports
Descritions	Rank
Discharge from Hosp'l	Transfer to Hosp'l
Discharge from Service	Transfer to V. R. C.
Duty	Transportation

ARTICLES OF WAR.

ART. 95. When any non-commissioned officer or soldier shall die, or be killed in the service of the United States, the then commanding officer of the troop or company shall, in the presence of two other commissioned officers, take an account of what effects he died possessed of, above his arms and accoutrements, and transmit the same to the office of the Department of War, which said effects are to be accounted for, and paid to the representatives of such deceased non-commissioned officer or soldier. And in case any of the officers, so authorized to take care of the effects of deceased officers and soldiers, should, before they have accounted to their representatives for the same, have occasion to leave the regiment or post, by preferment or otherwise, they shall, before they be permitted to quit the same, deposit in the hands of the commanding officer, or of the assistant military agent, all the effects of such deceased non-commissioned officers and soldiers, in order that the same may be secured for, and paid to, their respective representatives.

DIRECTIONS.

NOTE 1.—One copy of the inventories of the effects of deceased non-commissioned officers and soldiers, required by the 95th Article of War, will be forwarded to the Adjutant General, by the commander of the company to which the deceased belonged, and a duplicate of the same to the colonel of the regiment. Final statements of pay, clothing, &c., in duplicate, will be sent to the Adjutant General with one copy of the inventory. Both inventory and final statements should be forwarded, as a general rule, through Regimental Headquarters. When a soldier dies at a post or station absent from his company, it will be the duty of his immediate commander to furnish, direct to the Adjutant General, the required inventory and final statements, and, at the same time, to forward to the commanding officer of the company to which the soldier belonged, a report of his death, specifying the date, place, and cause; to what time he was last paid, and the money or other effects in his possession at the time of his decease; which report will be noted on the next muster roll of the company to which the man belonged. Each inventory will be endorsed, "Inventory of the effects of ———, late of company (—) ——— regiment of ———, who died at ———, the ——— day of ———, 186—." If a legal representative receive the effects, it will be stated in the report. If the soldier leave no effects, the fact will be reported on the blank for inventory.

NOTE 2.—Should the effects of a deceased non-commissioned officer or soldier not be administered upon within a short period after his decease, they shall be disposed of by a Council of Administration, under the authority of the commanding officer of the post, and the proceeds deposited with the Paymaster, to the credit of the United States, until they shall be claimed by the legal representatives of the deceased.

NOTE 3.—In all such cases of sales by the Council of Administration, a statement in detail, or account of the proceeds duly certified by the Council and commanding officer, (Form 5,) accompanied by the Paymaster's receipt for the proceeds, will be forwarded by the commanding officer to the Adjutant General. The statement will be endorsed, "Report of the proceeds of the effects of ———, late of company (—) ——— regiment of ———, who died at ———, the ——— day of ———, 186—."

NOTE 4.—The effects in all cases, when called for, should be turned over to the legal representative, without further authority from the Adjutant General. When the effects are turned over to the relatives of the deceased before these inventories are sent to the Adjutant General, their receipts therefor should be attached to the inventories. In all other cases, one copy will be sent with a letter of transmittal direct to the Adjutant General, and a duplicate retained by the officer.

NOTE 5.—Particular care should be taken to take receipts in duplicate from the Paymaster for any funds turned over to him; one copy should be sent direct to the Adjutant General and one retained by the officer.

Copy
no Descriptive List
INVENTORY OF THE EFFECTS

OF

Private Amos King

Late of Company

2^d Reg't of W. Col. Cary

Volunteers, who died at

New Orleans

on the *16th* day of *October* 186*e.*

Inventory of the effects of American King late
 a Private of Captain _____ Company "E" of
 the 2^d Regiment of U.S. Col. Cav. Volunteers, who was enrolled as
 a _____ at _____ in the State of _____ on
 the _____ day of _____ 186 , and mustered into the service of the United
 States as a _____ on the _____ day of _____ 186 , at _____
 in Company _____, _____ Regiment of _____ Volunteers, to serve _____
 years or during the war; he was born in _____ in the State
 of _____; he was _____ years of age, _____ feet _____ inches
 high, _____ complexion, _____ eyes, _____ hair, and by occupation, when enrolled,
 a _____; he died in Camp of Officers U.S. Gen. Hosp. at
New Orleans La. on the 16th day of October 186 , by
 reason of Dysentery chronic

INVENTORY.					
ARTICLES.	No.	ARTICLES.	No.	ARTICLES.	No.
Hats.....		Pairs trousers.....	1	Knapsacks.....	1
Caps.....		Pairs flannel drawers.....		<u>Canteen</u>	1
Forage caps.....		Pairs cotton drawers.....		<u>R. Blanket</u>	1
Great coats.....		Flannel shirts.....	1		
Uniform coats.....		Cotton shirts.....			
Uniform jackets.....	1	Pairs boots.....			
Flannel sack coats.....		Pairs shoes.....	1		
Blouses.....		Pairs socks.....			
Stable frocks.....		Blankets.....	1		
Fatigue overalls.....		Haversacks.....			
				MONEY.	
				Specie.....	\$
				Notes.....	\$

I CERTIFY, ON HONOR, that the above inventory comprises all the effects of Private
American King, deceased, and that the effects are in the hands
 of Surgeon in Charge at Camp of Officers U.S. Gen. Hosp.
New Orleans to be disposed of by a Council of Administration.

(DUPLICATES.)

STATION: New Orleans La.
 DATE: October 16th 1865

 Commanding the Company.

Ananias King
Co "L"
2nd Regt Cavalry

also, Dec 28/65
P.C. of Adm. for P.M.
rec'd for # 2 sent
2^d. Auditor B.B.S.

Also, Oct 20/66
Inv of effects sent
2^d. Auditor B.B.S.
No Debit

COPY OF RECORD
FOR THE
ADJUTANT GENERAL, U.S. ARMY.

[OFFICE INDORSEMENT.]
War Department,

ADJUTANT GENERAL'S OFFICE,

Sept 22, 1874

The death of Ananias King
Private, Co. L, 2nd Regt U.S.
Colored Cavalry, is reported as follows:

On Company Muster Roll.	
For March Dec., 1865, Nov 7", 1865	
Company Muster-out Roll.	
October 16", 1865	
Company Descriptive Book.	
	1865
Company Morning Reports.	
	1865
Soldier's Final Statement.	
	1865
Soldier's Record of Death and Interment.	
October 16", 1865	
Soldier's Inventory of Effects.	
	1865
Soldier's Certificate of Disability for Discharge.	
	1865
Soldier's Individual Muster-out Roll.	
	1865
Regimental Return.	
For , 1865 ,	1865
Regimental Quarterly Returns.	
	1865
Regimental Descriptive Book.	
	1865
By Surgeon General.	
(Oct 16 , 1865	1865

is held to be the correct date, and the Company Muster Roll will be amended accordingly.

Filed
J.M.
Thomas M. Stewart
Noted on R. 178
Assistant Adjutant General.

The above is correct as per R. 178

NOV 20 1865

No. 2.

RECORD OF DEATH AND INTERMENT.

Name and number of person interred,	- - -	Ananias King
Number and locality of the Grave,	- - -	
Hospital number of the deceased,	- - -	7004
Regiment, rank and company,	- - -	2 U.S. Cavalry - Private - D
Residence before enlistment,	- - -	
Conjugal condition, (and if married,	- - -	}
The residence of the widow,	- - -	
Cause of death,	- - -	} Chronic Diarrhoea
Age of the deceased,	- - -	
Nativity,	- - -	
References and remarks,	- - -	
Date of death and burial,	- - -	October 16 th 1865

To *Adj't Genl U.S. Army,*
 Sir:

It becomes my duty to inform you that the person above described died at this Hospital as herein stated, and that it is desired his remains should be interred with the usual Military honors.

Respectfully,

F. E. Pyquette
 SURGEON, U.S. ARMY.
80 U.S. Inftry
 in Charge

MILITARY HOSPITAL, *Camp de l'Epique New Orleans*
La

912
King Anthony

Co *49*, 2 U. S. Col'd Cav.

Private Private

CARD NUMBERS.

1	5318434	26
2	5318524	27
3	5318641	28
4	5318760	29
5	5316321	30
6	5318871	31
7	5316633	32
8	5318986	33
9	5319089	34
10	5319190	35
11	5319296	36
12	5319395	37
13	5319533	38
14	5319734	39
15	9087181	40
16	4072626	41
17		42
18		43
19		44
20		45
21		46
22		47
23		48
24		49
25		50

Book Mark:

See also

K | **2 Cav.** | **U.S.C.T.**

Anthony King
....., Co. B, 2 Reg't U. S. Col'd Cav.

Appears on
Company Descriptive Book
of the organization named above.

DESCRIPTION.

Age 38 years; height 5 feet 6 1/2 inches.
Complexion Dark
Eyes Black; hair Black
Where born Norfolk Va.
Occupation Laborer

ENLISTMENT.

When Decr 22, 1863.
Where Ft Monroe Va.
By whom lev. corp.; term 3 y'rs.

Remarks: Mustered Decr 22/63 by Lt W L Horton
Engaged in action at Suffolk Va March 9/64
At Drums Bluff May 16/64, in detached service in Ambulance Train 18" A. C. from Aug. 6/64 to Jan 1/65
(over)

F. B. Smith
Copyist.

MAY. 12

9087181

1891

Died in Genl.
Hospital at Brazos
Santiago, Tex, Oct. 8/64,
of Remittent Fever.

K | **2 Cav.** | **U.S.C.T.**

Anthony King
Pvt., Co. *B*, 2 Reg't U. S. Col'd Cavalry.

Age.....years.

Appears on

Company Muster-in Roll

of the organization named above. Roll dated

Fortress Monroe, Va, Dec 22, 1863

Muster-in to date *Dec. 22, 1863*

Joined for duty and enrolled:

When *Dec. 22*, 1863.

Where *Fort. Monroe Va.*

Period *3* years.

Valuation of horse, \$.....100

Valuation of horse equipments, \$.....100

Remarks:.....

Book mark:.....

E. H. Hunter

K | **2 Cav.** | **U.S.C.T.**

Anthony King

Pvt., Co. B. 2 Reg't U. S. Col'd Cavalry.

Appears on

Company Muster Roll

for *Dec. 29/63 to Feb. 29 1864*

Present or absent *Present*

Stoppage, \$ 100 for

Due Gov't, \$ 100 for

Valuation of horse, \$ 100

Valuation of horse equipments, \$ 100

Remarks :

Book mark :

E. H. Hunter

K | **2 Cav.** | **U.S.C.T.**

Anthony King
Priv., Co. B. 2 Reg't U. S. Col'd Cavalry.

Appears on

Company Muster Roll

for *March & April, 1864*

Present or absent *Present*

Stoppage, \$ 100 for

Due Gov't, \$ 100 for

Valuation of horse, \$ 100

Valuation of horse equipments, \$ 100

Remarks :

Book mark :

E. H. Hunter

NOV 1864

R | **2 Cav.** | **U.S.C.T.**

Anthony King
Pvt., Co. B. 2 Reg't U. S. Col'd Cavalry.

Appears on

Company Muster Roll

for *May & June*, 186*4*

Present or absent *Present*

Stoppage, \$ 100 for

Due Gov't, \$ 100 for

Valuation of horse, \$ 100

Valuation of horse equipments, \$ 100

Remarks :

Book mark :

E. H. Hunter

NARA 364

K | **2 Cav.** | **U.S.C.T.**

Anthony King

Private, Co. B. 2 Reg't U. S. Col'd Cavalry.

Appears on

Company Muster Roll

for *July - Aug.*, 186 *4*.

Present or absent *Absent.*

Stoppage, \$ *100* for

Due Gov't, \$ *100* for

Valuation of horse, \$ *100*

Valuation of horse equipments, \$ *100*

Remarks: *Sp for 1 Curny Comb & brush \$1.01 - 1 B. spur & Straps \$2. Detained in Corps Ambulance Train S.O. no. 84 dated & d. 2nd 3rd Div. 18th A.C. Aug. 4, 1864.*

Book mark: _____

O. J. Markle

K | *2 bars* | **U.S.C.T.**

Anthony King
Pr, Co. *2*, Reg't U. S. Col'd *bars*

Appears on a

Detachment Muster Roll

of the organization named above

for *July & Aug*, 186*7*.

Station *The Field Va*

Present or absent *Present*

Stoppage, \$ *100* for

Due Gov't, \$ *100* for

Valuation of horse, \$ *100*

Valuation of horse equipments, \$ *100*

Remarks: *Due U.S. 147/100 Doll*
for Ordnance lost

Book mark:

Asst. Surg.

71 | 2 Cav. | U.S.C.T.

Anthony, John

te, Co. B² Reg't U. S. Col'd Cavalry.

Appears on

Company Muster Roll

for *Sept 1864*, 1864

Present or absent *Present*

Stoppage, \$ 100 for

Due Gov't, \$ 100 for

Valuation of horse, \$ 100

Valuation of horse equipments, \$ 100

Remarks: *Embodied in Co's Ambu-
lance train J. S. No. 84
H. Q. 3rd Ar. C. Aug. 6, 1864.*

Book mark :

O. J. Markle

K | 2 Cav. | U.S.C.T.

Anthony King
Pvt., Co. B, Reg't U.S. Col'd Cavalry

Appears on a

Detachment Muster Roll

of the organization named above

for Sept & Oct, 1864.

Station In the field, Va

Present or absent Present

Stoppage, \$ 100 for

Due Gov't, \$ 100 for

Valuation of horse, \$ 100

Valuation of horse equipments, \$ 100

Remarks: Difference between white and colored soldiers pay due from Jan 1 to Apr 30/64

Book mark:

W. J. Blue

K | **2 Cav. | U.S.C.T.**

Antony King
Private, Co. B. 2 Reg't U. S. Col'd Cavalry.

Appears on

Company Muster Roll

for *Oct. 31, 1864 to Feb 28, 1865.*

Present or absent *Present.*

Stoppage, \$ 100 for

Due Gov't, \$ 100 for

Valuation of horse, \$ 100

Valuation of horse equipments, \$ 100

Remarks :

Book mark :

O. J. Markle,
Copyist.

K. | 2 Cav. | U.S.C.T.

Anthony King

Private, Co. B. 2 Reg't U. S. Col'd Cavalry.

Appears on

Company Muster Roll

for Mar & Apr, 1865.

Present or absent Present.

Stoppage, \$ 100 for

Due Gov't, \$ 100 for

Valuation of horse, \$ 100

Valuation of horse equipments, \$ 100

Remarks:

Book mark:

Mochance

1 | **2 Cav.** | **U.S.C.T.**

Anthony King
Private, Co. B. 2 Reg't U. S. Col'd Cavalry.

Appears on
Company Muster Roll
for May & June, 1865.
Present or absent Present.

Stoppage, \$ 100 for

Due Gov't, \$ 100 for

Valuation of horse, \$ 100

Valuation of horse equipments, \$ 100

Remarks :

Book mark :

M. O. Chance

N 9 9 9 7 1

K. | 2 Cav. | U.S.C.T.

D. Anthony King
No., Co. B. 2 Reg't U. S. Col'd Cavalry.

Appears on

Company Muster Roll

for July & Aug, 1865.

Present or absent Present.

Stoppage, \$ 100 for

Due Gov't, \$ 100 for

Valuation of horse, \$ 100

Valuation of horse equipments, \$ 100

Remarks :

Book mark :

W. H. Chance

K | **2 Cav.** | **U.S.C.T.**

Antony King
prnt, Co. B. 2 Reg't U. S. Col'd Cavalry.

Appears on

Company Muster Roll

for *Sept & Oct*, 186*5*.

Present or absent

Stoppage, \$ 100 for

Due Gov't, \$ 100 for

Valuation of horse, \$ 100

Valuation of horse equipments, \$ 100

Remarks: *Died in U. S. G.*
Hospital, Brazos Oct. 8,
'65.

Book mark:

W. Harrison

(358)

Copyist.

NARA 570
K | 2 Cav. | U.S.C.T.

Antony King
Pt., Co. B., 2 Reg't U. S. Colored Cav.

Appears on Returns as follows:

Aug 1864, absent det'd in
Amb Corps. 18 U.S.,
Sept to Nov 1864, absent in
Amb Corps. as driver,
March to Aug 1865 - on duty
det'd as Co Cook,

Sept 1865 - absent in Post
Hospl Brazos Santiago.

Oct 1865 Loss Oct 8 65 -
Brazos Texas. Died in
San Hospl Brazos Santiago.

Book mark:

J. M. Shannon

(546)

Copyist.

K | **2 Cav.** | **U.S.C.T.**

Anthony King
privt, Co. *B*, 2 Reg't U. S. Col'd Cavalry.

Appears on **Co. Muster-out Roll**, dated
Brazos Santiago Tex, *Feb. 12*, 186*6*.
Muster-out to date _____, 186 .
Last paid to _____, 186 .

Clothing account:

Last settled _____, 186 ; drawn since \$ _____ *100*
Due soldier \$ _____ *100*; due U. S. \$ _____ *100*
Am't for cloth'g in kind or money adv'd \$ _____ *100*

Due U. S. for arms, equipments, &c., \$ _____ *100*
Bounty paid \$ _____ *100*; due \$ _____ *100*

Remarks: *found at Orgl Org, died*
at Post Hospital, Brazos,
Santiago, Tex, of Remittent
fever Oct 8, 65.
Descriptive list furnished
Sept 15, '65.

Book mark: *139-017*

M. Harrison
(361) Copyist.

King, Adney.
Priv. Co. B, 2 Reg't U.S.C. Cav.

3 Enclosures.

Bed Cards	Descriptive Lists
Burial Records	Final Statements
Certs. of Dis. for Discharge	Furloughs
C. M. Charges	Med. Des. Lists
Med. Certificates	Orders

Other papers relating to—

Admission to Hosp'l	Furlough
Casualty Sheet (Officer's) 2	Med. Examination
Confinement	Misc. Information /
Contracts	Pay or Clothing
Death or Effects	Personal Reports
Desertions	Rank
Discharge from Hosp'l	Transfer to Hosp'l
Discharge from Service	Transfer to V. R. C.
Duty	Transportation

Info. sent for to Co C Jan 27. 66

CASUALTY SHEET.

No. *Complete*

Anthony King

Pvt of Company *B*

2 Regiment of *U S Heavy*

State Volunteers.

NATURE OF CASUALTY.

Died Oct. 8" 1865.

Sp. 2100 sent for to M. A. B. G. G. G.
Aug. 23, 1865,

CASUALTY SHEET

No. _____

Adney King
Priv of Company *D*
2 Regiment of *W. F. C. Cav.*
State Volunteers.

NATURE OF CASUALTY.

Died Oct. 8, 1865,

CASUALTY SHEET.

Name: Abney King
Rank: Priv Company: B Regiment: 3rd
Arm: Reg. C. Cav State: _____
Nature of Casualty: Death

CAUSE OF CASUALTY—(NAME OF DISEASE, &c.)

BY WHOM DISCHARGED.

DEGREE OF DISABILITY.

FROM WHAT SOURCE THIS INFORMATION WAS OBTAINED.

BY WHOM CERTIFIED.

Roll of Honor Pg 25
Sept

DATE OF DISCHARGE, DEATH, &c.

REMARKS.

PLACE OF DISCHARGE, DEATH, &c.

James M. Moore
Capt

Oct. 8, 1865

James Beckwith
Clerk.

Post Hospital
Brasas Santiago, Tex. as
March 30 1867
Respectfully returned with
the information that the
name of the Adm. Surg.
King Co B - 2nd U.S. Cav.
did not appear upon
the records of this hospital

A. L. Norris.

Asst. Surg. U.S. Army
in charge

MEDICAL DIRECTOR'S OFFICE,

New Orleans, La., July 27, 1867.

RESPECTFULLY returned to the
Adjutant General, U. S. A.,
Washington, D. C. The
desired papers cannot be
furnished or procured by
this office. Private Adm. Surg.
King, Co. B. 2nd U. S. Cav.
died in post Hospital Brasas
Santiago, Tex. Oct. 8, 1865.
Cause of death not stated.

J. A. McParlin

Brig. Gen. and Surg. U. S. A., Medical Director.

Office A. I. M.
In charge General Operations
2d Mil Dist
New Orleans La July 26 1867

Respectfully returned to Brig
Genl J. A. McParlin Med
Director 5th Mil Dist. No evidence
of the death of this man can
be found on Records on file
in this Office.

Chas Barnard

Capt V. I. M.
U. S. Vol.



Headquarters, District of Texas.

Post Hospital
Brasas Santiago
June 24th 1865

Respectfully returned to
Captain B. Cowles C. M.
U. S. A. R with the inform
ation that Private Adm
Surg King Co B 2nd U
S Cav died at
this Hospital October
8th 1865.

No further records
of B. L. Bauer
A. West Surg USA

NOV 20 1865

Post Hospital
Brownsville Texas
June 24th 1865

Head Quarters Sub Dist N. O.
Office Chief Med. Officer
Brownsville Texas June 16th 65
Case M 210-2-VI-67
Respectfully returned to the
Surgeon in charge Post Hosp
Brownsville Texas for
further investigation and report.
It appears from the
records of this Office that
Priv. Adney King Co B
2d U.S. Cav. died in Post
Hosp. Brownsville Texas, Sept 8
1865.

Respectfully returned to
Captain R Cowles C.M.
U. S. A. with the inform-
ation that Private Ad-
ney King Co B 2d U.S.
Cav. died at
this Hospital October
8th 1865.

No further orders
J. B. Bauer
W. A. King M.D.

Headquarters Fifth Military District,
MEDICAL DIRECTOR'S OFFICE,

New Orleans, La., July 27, 1867.

RESPECTFULLY returned to the
Adjutant General U. S. A.
Washington D. C. The
desired papers cannot be
furnished or procured by
this office. Private Adney
King, Co. B. 2d U. S. Cav.
died in Post Hospital Brownsville
Texas on Oct. 8, 1865.
Cause of death not stated.

J. M. S. A.
Col. Brig. Gen. and Surg. U. S. A., Medical Director.

R. Cowles
Capt. and Asst. Surg. U. S. A.
Chief Medical Officer.

210-1107

R. Cowles
Captain and Assistant Surgeon U. S. A.,
Chief Medical Officer.

Enclosure 550 249
Headquarters, District of Texas.

Headquarters Fifth Military District,
MEDICAL DIRECTOR'S OFFICE,

New Orleans, La., July 27th 1867.

RESPECTFULLY returned to the
Adjutant General U. S. A.
Washington, D. C. The
desired papers cannot be
furnished or procured by
this office. Private Admiral
King, Co. B. 2nd U. S. C. B. W.
died in post Hospital Brazos
Santiago Tex Oct. 8th 1865
Cause of death not stated.

J. M. Patton
Brig. Gen. and Surg. U. S. A., Medical Director.

Eqy M 218-1-V1-17

Headquarters, Sub-District of the Rio Grande,
Office of Chief Medical Officer,

Brownsville, Texas, June 20th 1867.

Respectfully returned to the
Chief Med. Officer Dist of
Texas with reference to previous
endorsements of June 16th &
20th 1867

A. Cowles

Captain and Assistant Surgeon U. S. A.,
Chief Medical Officer.

Enrolled 550 249
Headquarters, District of Texas.

OFFICE CHIEF MEDICAL OFFICER,

Galveston, Texas, July 5th 1867.

Respectfully returned to the
Dir of 5th Dist. District
with reference to foregoing
endorsements.

George Taylor

J. W. L.
Brig. Maj. & Asst Surgeon U. S. A.,
Chief Medical Officer in charge of office.

Post Hospital
Brazos Santiago
June 24th 1865

Respectfully returned to
Captain A. Cowles C. M.
C. S. D. R. with the inform-
ation that Private Ad-
miral King Co. B. 2nd U. S.
C. B. W. died at
this Hospital October
8th 1865.

No further orders
of A. D. Bauer
A. Asst Surg USA

WAR DEPARTMENT,

ADJUTANT GENERAL'S OFFICE,

WASHINGTON, *Aug. 22*, 186*6*



SIR:

Final Statements in the cases of deceased soldiers are required to be sent to the Adjutant General's Office in duplicate, with one copy of the Inventory of Effects. The Descriptive List should also be sent to this Office in cases where the soldier was absent from his Company at the time of his death. Where there were no effects, it should be so stated on a blank Inventory, properly signed.

Certificates of Disability should be sent in duplicate. Special care should be taken that the date of discharge and signature of the discharging officer should be affixed.

No of the Final Statement or Inventory, has been received in the case of *Adney King* Private, of Co. *D*, *2^d* Regiment of *6th U.S. Cav.* Volunteers, whose papers were forwarded to this Office. You will please forward the missing papers without delay.

I have the honor to be, sir,

Very respectfully,

Your obedient servant,

*Reported Dead
Oct. 8, 1865,
Texas*

Assistant Adjutant General.
(110)

~~COMMANDING OFFICER~~

Medical Director, Dept. Gulf.

If final papers cannot be furnished, please give date, place, and cause of death, if possible.

J.B.

OFFICE CHIEF MEDICAL DEPARTMENT

983

King Cornelius

Co F, 2 U. S. Col'd Cav.

Private | Private

CARD NUMBERS.

1	5315613	26
2	5323466	27
3	5323556	28
4	5323677	29
5	53246011	30
6	40926267	31
7		32
8		33
9		34
10		35
11		36
12		37
13		38
14		39
15		40
16		41
17		42
18		43
19		44
20		45
21		46
22		47
23		48
24		49
25		50

Book Mark: 21018, 1882

See also

K. | 2 Cav | U.S.C.T.

Cornelius King
Pvt, Co. 2, Reg't U. S. Col'd Cav.

Age _____ years.

Appears on a

Detachment Muster-in Roll
of unattached recruits
of the organization named above. Roll dated
H. Monroe, Va., Jan. 8, 1864.

Muster-in to date Jan. 8, 1864.

Joined for duty and enrolled:

When Jan. 1, 1864.

Where H. Monroe, Va.

Period 3 years.

Valuation of horse, \$ 100

Valuation of horse equipments, \$ 100

Remarks: _____

Book mark: _____

J. J. Kearney
Copyist.

A | **2 Cav.** | **U.S.C.T.**

Amos King

Co. F, Co. F, 2 Reg't U. S. Col'd Cavalry.

Appears on

Company Muster Roll

for *Sept 27*, 186

Present or absent *Present*

Stoppage, \$ 100 for

Due Gov't, \$ 100 for

Valuation of horse, \$ 100

Valuation of horse equipments, \$ 100

Remarks: *In Army since 20 February 1864.*

Book mark:

W. C. King

A | **2 Cav.** | **U.S.C.T.**

Comelius King

1st, Co. F, 2 Reg't U. S. Col'd Cavalry.

Appears on

Company Muster Roll

for *March - April*, 186*4*.

Present or absent *Present*

Stoppage, \$ *100* for

Due Gov't, \$ *100* for

Valuation of horse, \$ *100*

Valuation of horse equipments, \$ *100*

Remarks:

Book mark:

J. M. ...

R | **2 Cav.** | **U.S.C.T.**

Cornelius King

....., Co. F, 2 Reg't U. S. Col'd Cavalry.

Appears on

Company Muster Roll

for *May & June*, 186*4*.

Present or absent

Stoppage, \$.....100 for

Due Gov't, \$.....100 for

Valuation of horse, \$.....100

Valuation of horse equipments, \$.....100

Remarks: *Sick May 12th*
of wounds received in return
from Drums Bluff.
** Recd U.S. one nose bag one*
pair spurs & straps \$2.02

* *Entered by company*

Book mark: *E.B. Vol 7 page 187*

W. Cullen

over

JAN. - 7

5323677

1891

also died May 12. 1804 at
Middletown Vt of Pneumonia.

A. | **2 Cav. | U.S.C.T.**

Cornelius King

Plt., Co. *F*, 2 Reg't U. S. Colored Cav.

Appears on Returns as follows:

*March 1st 1864, on duty
Co Cook since March
1. 1864*

Book mark:

A. M. Shammur

R. Dean | U. S. C. T.

Leovaluis King

....., Co. *H*, *2* Reg't U. S. Col'd *Dean*

Appears on **Co. Muster-out Roll**, dated
Bray's Sanitary Tents, *Feb. 12*, 186*2*.

Muster-out to date, 186 .

Last paid to, 186 .

Clothing account:

Last settled, 186 ; drawn since \$.....¹⁰⁰

Due soldier \$.....¹⁰⁰; due U. S. \$.....¹⁰⁰

Am't for cloth'g in kind or money adv'd \$.....¹⁰⁰

Due U. S. for arms, equipments, &c., \$.....¹⁰⁰

Bounty paid \$.....¹⁰⁰ due \$.....¹⁰⁰

Remarks: *Died.*

Book mark: *P. V. 5 P. 22, 1862*
Dean

R. Dean

JAN. - 7

5324601

1881

See E. B. V. 7. P. 189.
Died Mar 12, 1864
Williamsburg Va of
Pneumonia
21018 1882.

King, Cornelius,
Pri, Co. G, 2 Reg't U.S.C. Cav.

4 Enclosures.

Bed Cards	Descriptive Lists
Burial Records	Final Statements 2
Certs. of Dis. for Discharge	Furloughs
C. M. Charges	Med. Des. Lists
Med. Certificates	Orders

Other papers relating to—

Admission to Hosp'l	Furlough
Casualty Sheet (Officer's)	Med. Examination
Confinement	Misc. Information
Contracts	Pay or Clothing
Death or Effects 2	Personal Reports
Desertions	Rank
Discharge from Hosp'l	Transfer to Hosp'l
Discharge from Service	Transfer to V. R. C.
Duty	Transportation

MICROFILM PUBLICATION M 1818

COMPILED MILITARY SERVICE RECORDS
OF VOLUNTEER UNION SOLDIERS WHO
SERVED WITH THE USCT (US COLORED TROOPS)
2ND REGIMENT OF CAVALRY

PERSONAL PAPERS' TARGET SHEET

PLEASE NOTE THE CHECKED INFORMATION ABOUT THE PERSONAL PAPERS IN
THIS FILE:

- NO PERSONAL PAPERS WERE FOUND IN THIS FILE WHEN THE
RECORDS WERE ARRANGED FOR MICROFILMING.
- 6 PERSONAL PAPER(S) FOUND IN THIS FILE WHEN THE RECORDS
WERE ARRANGED FOR MICROFILMING.

The name of Cornelius King is not
found on the Descriptive Book of Company
I. 2nd U.S. Cavalry - no Regimental Disc
Book with records.

Records Room
A. S. O. April 8/69. A. W. G.

411 Ellersworth

Regt Return for May 1864 reports date of death. — "May 12 1864, at Williamsburg Va. of Pneumonia"

Final Statement — "Death from wounds received in action, near Hurray's Bluff Va. May 15, 1864." He is not accounted for on Moul's Roll of the Co.
W.S.

ARTICLES OF WAR.

ART. 95. When any non-commissioned officer or soldier shall die, or be killed in the service of the United States, the then commanding officer of the troop or company shall, in the presence of two other commissioned officers, take an account of what effects he died possessed of, above his arms and accoutrements, and transmit the same to the office of the Department of War, which said effects are to be accounted for, and paid to the representatives of such deceased non-commissioned officer or soldier. And in case any of the officers, so authorized to take care of the effects of deceased officers and soldiers, should, before they have accounted to their representatives for the same, have occasion to leave the regiment or post, by preferment or otherwise, they shall, before they be permitted to quit the same, deposit in the hands of the commanding officer, or of the assistant military agent, all the effects of such deceased non-commissioned officers and soldiers, in order that the same may be secured for, and paid to, their respective representatives.

ARMY REGULATIONS—EDITION OF 1861

DECEASED SOLDIERS.

Par. 152. Inventories of the effects of deceased non-commissioned officers and soldiers, required by the 95th Article of War, will be forwarded to the Adjutant General, by the commander of the company to which the deceased belonged, and a duplicate of the same to the colonel of the regiment. Final statements of pay, clothing, &c., will be sent with the inventories. When a soldier dies at a post or station absent from his company, it will be the duty of his immediate commander to furnish the required inventory, and, at the same time, to forward to the commanding officer of the company to which the soldier belonged, a report of his death, specifying the date, place, and cause; to what time he was last paid, and the money or other effects in his possession at the time of his decease; which report will be noted on the next muster roll of the company to which the man belonged. Each inventory will be endorsed, "Inventory of the effects of _____, late of company (—) _____ regiment of _____, who died at _____, the _____ day of _____, 186—." If a legal representative receive the effects, it will be stated in the report. If the soldier leave no effects, the fact will be reported.

Par. 153. Should the effects of a deceased non-commissioned officer or soldier not be administered upon within a short period after his decease, they shall be disposed of by a Council of Administration, under the authority of the commanding officer of the post, and the proceeds deposited with the Paymaster, to the credit of the United States, until they shall be claimed by the legal representatives of the deceased.

Par. 154. In all such cases of sales by the Council of Administration, a statement in detail, or account of the proceeds, duly certified by the Council and commanding officer, accompanied by the Paymaster's receipt for the proceeds, will be forwarded by the commanding officer to the Adjutant General. The statement will be endorsed, "Report of the proceeds of the effects of _____, late of company (—) _____ regiment of _____, who died at _____, the _____ day of _____, 186—."

NOTE 1.—The effects in all cases, when called for, should be turned over to the legal representative, without further authority from the Adjutant General. When the effects are turned over to the relatives of the deceased before these inventories are sent to the Adjutant General, their receipts therefor should be attached to the inventories. In all other cases, one copy will be sent with a letter of transmittal direct to the Adjutant General, and a duplicate retained by the officer.

NOTE 2.—Particular care should be taken to take receipts in duplicate from the Paymaster for any funds turned over to him; one copy should be sent direct to the Adjutant General and one retained by the officer.

INVENTORY OF THE EFFECTS

OF

Cornelius King

Late of Company *C*

2^d Reg't of *A S Col Cavalry*

Volunteers, who died at *of Wounded Wreath*

in action

on the *15* day of *May* 186*4*



Inventory of the effects of Cornelius King late
 a Private of Captain Thos R Herbert Company F of
 the 2nd Regiment of U S Col Cavalry Volunteers, who was enrolled as
 a Private at Fort Monroe in the State of Virginia on
 the 1st day of January 1864, and mustered into the service of the United
 States as a Private on the 8th day of January 1864, at Fort Monroe
 in Company F, 2nd Regiment of U S Col Cavalry Volunteers, to serve 3
 years or during the war; he was born in Pitt County in the State
 of North Carolina; he was 22 years of age, 5 feet 7 inches
 high, Dark complexion, Dark eyes, Dark hair, and by occupation, when enrolled,
 a Farmer; he died in of wounds received in action at
Near Dureys bluff on the 15 day of May 1864, by
 reason of _____

INVENTORY.					
ARTICLES.	No.	ARTICLES.	No.	ARTICLES.	No.
Hats.....		Pairs trousers.....		Knapsacks.....	
Caps.....		Pairs flannel drawers.....			
Forage caps.....		Pairs cotton drawers.....			
Great coats.....		Flannel shirts.....			
Uniform coats.....		Cotton shirts.....			
Uniform jackets.....		Pairs boots.....			
Flannel sack coats.....		Pairs shoes.....			
Blouses.....		Pairs socks.....			
Stable frocks.....		Blankets.....			
Fatigue overalls.....		Haversacks.....			
				MONEY.	
				Specie.....	\$
				Notes.....	\$

I CERTIFY, ON HONOR, that the above inventory comprises all the effects of Private
Cornelius King, deceased, and that the effects are in the hands
of John Burd on him at Near Dureys bluff
Virginia to be disposed of by a Council of Administration.

(DUPLICATES.)

Thos R Herbert
Captain
 Commanding the Company.

STATION: Near Petersburg Va

DATE: August 13 1864

ARTICLES OF WAR.

ART. 95. When any non-commissioned officer or soldier shall die, or be killed in the service of the United States, the then commanding officer of the troop or company shall, in the presence of two other commissioned officers, take an account of what effects he died possessed of, above his arms and accoutrements, and transmit the same to the office of the Department of War, which said effects are to be accounted for, and paid to the representatives of such deceased non-commissioned officer or soldier. And in case any of the officers, so authorized to take care of the effects of deceased officers and soldiers, should, before they have accounted to their representatives for the same, have occasion to leave the regiment or post, by preferment or otherwise, they shall, before they be permitted to quit the same, deposit in the hands of the commanding officer, or of the assistant military agent, all the effects of such deceased non-commissioned officers and soldiers, in order that the same may be secured for, and paid to, their respective representatives.

ARMY REGULATIONS—EDITION OF 1861.

DECEASED SOLDIERS.

Par. 152. Inventories of the effects of deceased non-commissioned officers and soldiers, required by the 95th Article of War, will be forwarded to the Adjutant General, by the commander of the company to which the deceased belonged, and a duplicate of the same to the colonel of the regiment. Final statements of pay, clothing, &c., will be sent with the inventories. When a soldier dies at a post or station absent from his company, it will be the duty of his immediate commander to furnish the required inventory, and, at the same time, to forward to the commanding officer of the company to which the soldier belonged, a report of his death, specifying the date, place, and cause; to what time he was last paid, and the money or other effects in his possession at the time of his decease; which report will be noted on the next muster roll of the company to which the man belonged. Each inventory will be endorsed, "Inventory of the effects of _____, late of company (—) _____ regiment of _____, who died at _____, the _____ day of _____, 186—." If a legal representative receive the effects, it will be stated in the report. If the soldier leave no effects, the fact will be reported.

Par. 153. Should the effects of a deceased non-commissioned officer or soldier not be administered upon within a short period after his decease, they shall be disposed of by a Council of Administration, under the authority of the commanding officer of the post, and the proceeds deposited with the Paymaster, to the credit of the United States, until they shall be claimed by the legal representatives of the deceased.

Par. 154. In all such cases of sales by the Council of Administration, a statement in detail, or account of the proceeds, duly certified by the Council and commanding officer, accompanied by the Paymaster's receipt for the proceeds, will be forwarded by the commanding officer to the Adjutant General. The statement will be endorsed, "Report of the proceeds of the effects of _____, late of company (—) _____ regiment of _____, who died at _____, the _____ day of _____, 186—."

NOTE 1.—The effects in all cases, when called for, should be turned over to the legal representative, without further authority from the Adjutant General. When the effects are turned over to the relatives of the deceased before these inventories are sent to the Adjutant General, their receipts therefor should be attached to the inventories. In all other cases, one copy will be sent with a letter of transmittal direct to the Adjutant General, and a duplicate retained by the officer.

NOTE 2.—Particular care should be taken to take receipts in duplicate from the Paymaster for any funds turned over to him; one copy should be sent direct to the Adjutant General and one retained by the officer.

INVENTORY OF THE EFFECTS

OF

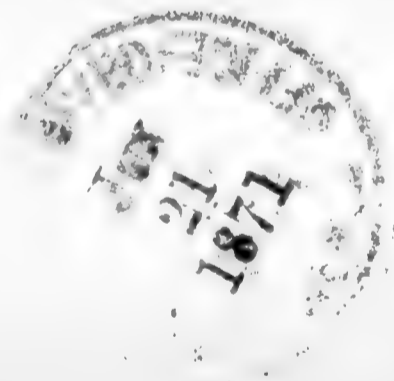
Cornelius Hoing

Late of Company *D*

2nd Reg't of *U S Col Cavalry*

Volunteers, who died at *of a wound received in action*

on the *15* day of *May* 1864.



Inventory of the effects of Cornelius King late
 a Private of Captain Thos R Herbert Company E of
 the 2^d Regiment of U.S. Col Cavalry Volunteers, who was enrolled as
 a Private at St Monroe in the State of Virginia on
 the 1st day of January 1864, and mustered into the service of the United
 States as a Private on the 18 day of January 1864, at St Monroe
 in Company E, 2^d Regiment of U.S. Col Cavalry Volunteers, to serve 3
 years or during the war; he was born in Pitt County in the State
 of North Carolina; he was 22 years of age, 5 feet 7 inches
 high, Dark complexion, Dark eyes, Dark hair, and by occupation, when enrolled,
 a Farmer; he died in Wounds received in action at
Near Dury Bluff Va on the 15 day of May 1864, by
 reason of _____

INVENTORY.					
ARTICLES.	No.	ARTICLES.	No.	ARTICLES.	No.
Hats.....		Pairs trowsers.....		Knapsacks.....	
Caps.....		Pairs flannel drawers.....			
Forage caps.....		Pairs cotton drawers.....			
Great coats.....		Flannel shirts.....			
Uniform coats.....		Cotton shirts.....			
Uniform jackets.....		Pairs boots.....			
Flannel sack coats.....		Pairs shoes.....			
Blouses.....		Pairs socks.....			
Stable frocks.....		Blankets.....			
Fatigue overalls.....		Haversacks.....			
				MONEY.	
				Specie.....	\$
				Notes.....	\$

I CERTIFY, ON HONOR, that the above inventory comprises all the effects of Private
Cornelius King, deceased, and that the effects are in the hands
 of Where buried on him at Near Dury Bluff
Virginia to be disposed of by a Council of Administration.

(DUPLICATES.)

Thos R Herbert
Captain
 Commanding the Company.

STATION: Near Peterburg Va
 DATE: August 13 1864

NARA 600

FINAL STATEMENT

OF

Cornelius King
2^d Reg't of *U.S. Cav.*

VOLUNTEERS.

NOTE 1.—Two of these certificates (or duplicates) are to be given to each Volunteer Soldier or drafted man who may be discharged previously to the discharge of his company, that he may at once receive from the Paymaster the pay, &c., due him, and the captain or other COMMISSIONED officer commanding the company will certify to the act of the delivery of the duplicate certificates; on these certificates the Soldier is "entitled to" his *discharge*, and should also present his discharge to the Paymaster to have the payment endorsed on it. The discharge is to be given back to the Soldier by the Paymaster; the latter only retaining as his voucher the duplicate certificates.

NOTE 2.—If the Soldier is entitled to pay for the use of his horse, the Company Commander will certify to that fact on the back of both these final statements, and also to the time he has pay due for having been so mounted on his own horse.

NOTE 3.—When a Soldier is furnished with final statements, his descriptive list, if he has one, should be taken up by the officer who gives the Soldier these statements, and endorsed with a statement to this effect by the officer. This endorsement should exhibit a full statement of the time for which the Soldier was allowed pay on his final statements, the clothing account, and all other charges against him or in his favor, so as to comprise a complete exhibit of his account. It will then be transmitted to the Company Commander of the Soldier, who will enter all the data necessary to a full understanding of the Soldier's account on the muster roll upon which the Soldier's discharge is reported. The descriptive list will then be destroyed. The object of this is, that the remaining portion of the Soldier's account may be settled upon the receipt of these muster rolls, and the Soldier receive any pay or allowances that may be due him at the time of his discharge, and which may not appear on his final statements from the fact that his descriptive list is incomplete. These accounts for back pay, &c., are settled by the 2d Auditor of the Treasury Department.

NOTE 4.—Charges for loss or injury to ordnance, horse equipments, and other miscellaneous charges, should appear under the heading of "Other Stoppages."

NOTE 5.—Bounty paid by State authorities, and not by the United States, will not be entered on this statement.

NOTE 6.—Amounts due the Sutler and Laundress must be entered on the muster roll on which the discharge, death, desertion, &c., is reported, as well as on the final statement, otherwise the amount cannot be collected from the United States.

NOTE 7.—This blank will be used for deceased volunteers and drafted men, as well as for others.

NOTE 8.—Where a Soldier dies in Hospital or on detached service, his descriptive list, if he has one, should be sent with his final statements, in duplicate, to the Adjutant General, Washington, D. C.

1864



I certify, on honor, that Cornelius King a Private of
 Captain J. R. Herbert Company (21) of the 2^d Regiment of 1st Cavalry
VOLUNTEERS, of the State of _____, born in Pitt County, State
 of North Carolina aged 22 years; 5 feet 7 inches high; Dark complexion,
Dark eyes, Dark hair, and by occupation a Farmer, having joined the company on
 its original organization at Fort Monroe, and enrolled in it at the muster into
 the service of the United States at Fort Monroe, on the 8th day
 of January, 1864, (or was mustered in service as a recruit, by _____
 _____, at _____, on the _____ day of _____,
 186 _____, or was drafted and mustered into the service of the United States from the _____
 Enrollment District of the State of _____, at _____,
 on the _____ day of _____, 186 _____,) to serve in the Regiment, for
 the term of _____: and having served **HONESTLY** and
FAITHFULLY with his Company in _____ to the present date, is now
 entitled to a **DISCHARGE** by reason of Death from wound received
In action near Dureys Bluff May 15th 1864

The said _____ was last paid by Paymaster
Wacker to include the 29 day of February, 1864, and has
 pay due him from that time to the present date; he is entitled to pay and subsistence for
TRAVELING to place of enrollment, and whatever other allowances are authorized to volunteer
 soldiers, drafted men, or militia, so discharged. He has received from the United States **CLOTHING**
 amounting to Two hundred dollars, since the _____ day of _____,
 186 _____, when his clothing account was last settled. He has received from the United States
 _____ dollars advanced **BOUNTY**.

There is to be stopped from him, on account of the State of United States, or other
 authorities, for **CLOTHING**, &c., received on entering service, _____ dollars; and
 for other stoppages, viz: One nose bag, 1 pair Spurs and Straps
Value two dollars and two cents
 _____ dollars.

He has been furnished with **TRANSPORTATION** in kind from the place of his discharge to
 _____; and he has been **SUBSISTED** for **TRAVELING** to his
 place of enrollment, up to the _____, 186 _____.

He is indebted to _____, **SUTLER**, _____ dollars.
 He is indebted to _____, **LAUNDRESS**, _____ dollars.

Given in Duplicate, at Near Petersburg Va, this 13th day
 of August, 1864

J. R. Herbert
Captain
 Commanding Company.

FINAL STATEMENT

OF

Cornelius King
2nd Reg't of U.S. Col. Cav.

VOLUNTEERS.

Died May 15th 1864

NOTE 1.—Two of these certificates (or duplicates) are to be given to each Volunteer Soldier or drafted man who may be discharged previously to the discharge of his company, that he may at once receive from the Paymaster the pay, &c., due him, and the captain or other COMMISSIONED officer commanding the company will certify to the act of the delivery of the duplicate certificates; on these certificates the Soldier is "entitled to" his discharge, and should also present his discharge to the Paymaster to have the payment endorsed on it. The discharge is to be given back to the Soldier by the Paymaster; the latter only retaining as his voucher the duplicate certificates.

NOTE 2.—If the Soldier is entitled to pay for the use of his horse, the Company Commander will certify to that fact on the back of both these final statements, and also to the time he has pay due for having been so mounted on his own horse.

NOTE 3.—When a Soldier is furnished with final statements, his descriptive list, if he has one, should be taken up by the officer who gives the Soldier these statements, and endorsed with a statement to this effect by the officer. This endorsement should exhibit a full statement of the time for which the Soldier was allowed pay on his final statements, the clothing account, and all other charges against him or in his favor, so as to comprise a complete exhibit of his account. It will then be transmitted to the Company Commander of the Soldier, who will enter all the data necessary to a full understanding of the Soldier's account on the muster roll upon which the Soldier's discharge is reported. The descriptive list will then be destroyed. The object of this is, that the remaining portion of the Soldier's account may be settled upon the receipt of these muster rolls, and the Soldier receive any pay or allowances that may be due him at the time of his discharge, and which may not appear on his final statements from the fact that his descriptive list is incomplete. These accounts for back pay, &c., are settled by the 2d Auditor of the Treasury Department.

NOTE 4.—Charges for loss or injury to ordnance, horse equipments, and other miscellaneous charges, should appear under the heading of "Other Stoppages."

NOTE 5.—Bounty paid by State authorities, and not by the United States, will not be entered on this statement.

NOTE 6.—Amounts due the Sutler and Laundress must be entered on the muster roll on which the discharge, death, desertion, &c., is reported, as well as on the final statement, otherwise the amount cannot be collected from the United States.

NOTE 7.—This blank will be used for deceased volunteers and drafted men, as well as for others.

NOTE 8.—Where a Soldier dies in Hospital or on detached service, his descriptive list, if he has one, should be sent with his final statements, in duplicate, to the Adjutant General, Washington, D. C.

ADJUTANT GENERAL'S OFFICE.

Aug 19th 1864

Duplicate with Inventory sent 2d Auditor.



Adjutant General's Office
Washington, D.C., April 15, 1869.

E.D. vol. 7. page 189

The Muster-Out Roll of Co. "F" 2nd U.S. Colored Cavalry does not account for Private Cornelius King of said Company.

On Muster Roll of the Company for May and June 1864 he is reported "Died May 12th of wounds received in action near Drury's Bluff, Va." and the Final Statement of the soldier reports "Death from wounds received in action near Drury's Bluff, Va., May 15, 1864."

The Regimental Return for May 1864 (the first record of the soldier's death) reports death May 12th 1864 at Williamsburg, Va., of Pneumonia.

The latter record is confirmed by the records of the Surgeon General, and is held to be correct.

The remark "Died May 12th 1864 at Williamsburg, Va., of Pneumonia" will be noted opposite the soldier's name on the Muster-Out Roll, and all other records whereon a different date and cause of death is given will be amended accordingly.

J.R. Raittome

Brevet Colonel U.S.A.

In Chg Bureau Col'd Troops.

E.W. [unclear]

Received & 2d Aud. of [unclear] April 21, 1869

Noted April 20 1869 W.H.C.

I certify, on honor, that Cornelius King a Private of
Captain T. R. Herbert Company (21) of the 2^d Regiment of U.S. Col. Cavalry
VOLUNTEERS, of the State of _____, born in Pitt County, State
of North Carolina aged 23 years; 5 feet 7 inches high; Dark complexion,
Dark eyes, Dark hair, and by occupation a Farmer, having joined the company on
its original organization at Camp Monroe, and enrolled in it at the muster into
the service of the United States at Camp Monroe, on the 8th day
of January, 1864, (or was mustered in service as a recruit, by _____
at _____, on the _____ day of _____,

186 , or was drafted and mustered into the service of the United States from the _____
Enrollment District of the State of _____, at _____,
on the _____ day of _____, 186) to serve in the Regiment, for
the term of Three Years : and having served **HONESTLY** and
FAITHFULLY with his Company in _____ to the present date, is now

entitled to a **DISCHARGE** by reason of Death from wounds received
In action near Burgess bluff Va May 15th 1864

The said Cornelius King was last paid by Paymaster
Wacker to include the 29 day of February, 1864, and has
pay due him from that time to the present date; he is entitled to pay and subsistence for
TRAVELING to place of enrollment, and whatever other allowances are authorized to volunteer
soldiers, drafted men, or militia, so discharged. He has received from the United States **CLOTHING**
amounting to Book account ^{lost} 100 dollars, since the _____ day of _____,
186 , when his clothing account was last settled. He has received from the United States
100 dollars advanced **BOUNTY**.

There is to be stopped from him, on account of the State of United States or other
authorities, for **CLOTHING**, &c., received on entering service, _____ 100 dollars; and
for other stoppages, viz: One Nose bag One pair of Spurs & Straps
Value two Dollars and two cents
_____ 100 dollars.

He has been furnished with **TRANSPORTATION** in kind from the place of his discharge to
_____ ; and he has been **SUBSISTED** for **TRAVELING** to his
place of enrollment, up to the _____, 186 .

He is indebted to _____, **SUTLER**, _____ 100 dollars.
He is indebted to _____, **LAUNDRESS**, _____ 100 dollars.

Given in Duplicate, at Near Petersburg Va, this _____
of August, 1864.

Thos R Herbert
Captain
Commanding Company.

911A

King Daniel

Co I, 2 U. S. Col'd Cav.

Private | Private

CARD NUMBERS.

1	5315740	26
2	5327105	27
3	5327192	28
4	5327281	29
5	5327362	30
6	5327448	31
7	5327541	32
8	5327631	33
9	5327721	34
10	5327814	35
11	5327904	36
12	5327990	37
13	5328074	38
14	5328155	39
15	9087826	40
16		41
17		42
18		43
19		44
20		45
21		46
22		47
23		48
24		49
25		50

Book Mark:

See also

REP 460752

S. 1404197 P.O. MICH

L. Ballantyne

K | 2 Cav. | U.S.C.T.

Daniel King

, Co. D, 2 Reg't U. S. Col'd Cav.

Appears on

Company Descriptive Book

of the organization named above.

DESCRIPTION.

Age 18 years; height 5 feet 8 inches.

Complexion Dark

Eyes Black; hair Black

Where born Menoah Co., N. C.

Occupation Farmer

ENLISTMENT.

When Jan. 10, 1864.

Where Fort Monroe, Va.

By whom Geo. Cole; term 3 y'rs.

Remarks:

F. B. Smith
Copyist.

K. | 2 | Coar | U.S.C.T.

Daniel King

Priv., Co., 2 Reg't U. S. Col'd Coar

Age years.

Appears on a

Detachment Muster-in Roll

of unattached recruits
of the organization named above. Roll dated

St. Maurice, Va. Jan. 19, 1864.

Muster-in to date Jan. 19, 1864.

Joined for duty and enrolled:

When Jan. 10, 1864.

Where St. Maurice, Va.

Period 3 years.

Valuation of horse, \$ 100

Valuation of horse equipments, \$ 100

Remarks :

Book mark :

(337)

J. J. Kearney Copyist.

A | **2 Cav.** | **U.S.C.T.**

Daniel King
Sgt

Co. I, 2 Reg't U. S. Col'd Cavalry.

Appears on

Company Muster Roll

for *Enrollment to Feb 29, 1864.*

Present or absent *Present*

Stoppage, \$ 100 for

Due Gov't, \$ 100 for

Valuation of horse, \$ 100

Valuation of horse equipments, \$ 100

Remarks:

Book mark:

D. A. Ward

R | **2 Cav.** | **U.S.C.T.**

Samuel King
Put, Co. I, 2 Reg't U. S. Col'd Cavalry.

Appears on

Company Muster Roll
for *Mar & Apr*, 1864.

Present or absent *Present*

Stoppage, \$ *100* for

Due Gov't, \$ *100* for

Valuation of horse, \$ *100*

Valuation of horse equipments, \$ *100*

Remarks:

Book mark:

D. A. Ward

K | **2 Cav.** | **U.S.C.T.**

Daniel King
Put, Co. I, 2 Reg't U. S. Col'd Cavalry.

Appears on

Company Muster Roll

for *May & June*, 186*4*

Present or absent *Present*

Stoppage, \$ *100* for

Due Gov't, \$ *100* for

Valuation of horse, \$ *100*

Valuation of horse equipments, \$ *100*

Remarks:

Book mark:

D. A. Ward

H | **2 Cav.** | **U.S.C.T.**

Daniel King

Qi....., Co. I, 2 Reg't U. S. Col'd Cavalry.

Appears on

Company Muster Roll

for *July & Aug*, 186 *7*.

Present or absent *Present*

Stoppage, \$..... *100* for.....

Due Gov't, \$..... *100* for.....

Valuation of horse, \$..... *100*

Valuation of horse equipments, \$..... *100*

Remarks:.....

Book mark:.....

G. Smith

15 | 2 Cav. | U.S.C.T.

Daniel King
Pri, Co. I, 2 Reg't U.S. Col'd Cavalry.

Appears on

Company Muster Roll

for Sept & Oct, 1864.

Present or absent Present

Stoppage, \$ 100 for

Due Gov't, \$ 100 for

Valuation of horse, \$ 100

Valuation of horse equipments, \$ 100

Remarks:

Book mark:

C. G. Smith

15 | **2 Cav.** | **U.S.C.T.**

Daniel King

Co. I, Co. I, 2 Reg't U.S. Col'd Cavalry.

Appears on

Company Muster Roll

for Nov - Dec, 1864.

Present or absent Present

Stoppage, \$ 100 for

Due Gov't, \$ 100 for

Valuation of horse, \$ 100

Valuation of horse equipments, \$ 100

Remarks:

Book mark:

O. G. Smith

NA 99 614

K | **2 Cav.** | **U.S.C.T.**

Daniel King
Pri....., Co. I, 2 Reg't U. S. Col'd Cavalry.

Appears on

Company Muster Roll

for *Jan & Feb*....., 1865.

Present or absent *Present*.....

Stoppage, \$..... 100 for.....

Due Gov't, \$..... 100 for.....

Valuation of horse, \$..... 100

Valuation of horse equipments, \$..... 100

Remarks:.....

Book mark:.....

O. G. Smith

K | **2 Cav.** | **U.S.C.T.**

Daniel King

seri, Co. I, 2 Reg't U. S. Col'd Cavalry.

Appears on

Company Muster Roll

for *Mch & Apr*, 1865.

Present or absent *Present*

Stoppage, \$ *100* for

Due Gov't, \$ *100* for

Valuation of horse, \$ *100*

Valuation of horse equipments, \$ *100*

Remarks:

Book mark:

D. J. Giffith

A | **2 Cav.** | **U.S.C.T.**

Daniel King

Private, Co. I, 2 Reg't U. S. Col'd Cavalry.

Appears on

Company Muster Roll

for *May & June*, 186*5*.

Present or absent *Present*

Stoppage, \$ *100* for

Due Gov't, \$ *100* for

Valuation of horse, \$ *100*

Valuation of horse equipments, \$ *100*

Remarks:

Book mark:

D. J. Griffen

A | **2 Cav.** | **U.S.C.T.**

Daniel King

Private, Co. I, 2 Reg't U. S. Col'd Cavalry.

Appears on

Company Muster Roll

for *July & August*, 1865.

Present or absent *Present*

Stoppage, \$ *100* for

Due Gov't, \$ *100* for

Valuation of horse, \$ *100*

Valuation of horse equipments, \$ *100*

Remarks:

Book mark:

D. J. Gifford

N. | **2 Cav.** | **U.S.C.T.**

Daniel King.

Priv, Co. I, 2 Reg't U. S. Col'd Cavalry.

Appears on

Company Muster Roll

for *Sept. & Oct.*, 186*5*.

Present or absent *Present.*

Stoppage, \$ *100* for

Due Gov't, \$ *100* for

Valuation of horse, \$ *100*

Valuation of horse equipments, \$ *100*

Remarks:

Book mark:

Poe

Copyist.

K. | **2 Cav.** | **U.S.C.T.**

Daniel King.

Priv, Co. I, 2 Reg't U. S. Col'd Cavalry.

Appears on

Company Muster Roll

for *Nov. 1 Dec.*, 186*5*.

Present or absent *Present.*

Stoppage, \$ *100* for

Due Gov't, \$ *100* for

Valuation of horse, \$ *100*

Valuation of horse equipments, \$ *100*

Remarks:

Book mark:

Pal

St. | **2 Cav.** | **U.S.C.T.**

Daniel King.

Priv., Co. *D*, 2 Reg't U. S. Col'd Cavalry.

Appears on **Co. Muster-out Roll**, dated

Brazos Santiago Tex, *Feb. 12*, 1866.

Muster-out to date *Feb. 12*, 1866.

Last paid to *June 30*, 1865.

Clothing account:

Last settled....., 186 ; drawn since \$..... 100

Due soldier \$..... 100; due U. S. \$ *26* . *49* / 100

Am't for cloth'g in kind or money adv'd \$..... 100

Due U. S. for arms, equipments, &c., \$..... 100

Bounty paid \$..... 100; due \$..... 100

Remarks: *joined at org orgz.*

Book mark: *V114.P456. 70.*

Pol

King Greene

Co, **2** U. S. Col'd Cav.

Private | *Private*

CARD NUMBERS.

1	5315741	26
2	5327106	27
3	5327193	28
4	5327282	29
5	5327363	30
6	5327449	31
7	5327542	32
8	5327632	33
9	5327722	34
10	5327815	35
11	5327905	36
12	5327991	37
13	5328105	38
14	5328197	39
15	9087827	40
16	30852781	41
17	30854335	42
18	40726268	43
19		44
20		45
21		46
22		47
23		48
24		49
25		50

Book Mark:

See also

K | 2 Cav. | U.S.C.T.

Greene King
Co I, 2 Reg't U. S. Col'd Cav.

Appears on
Company Descriptive Book
of the organization named above.

DESCRIPTION.

Age 25 years; height 5 feet 6 1/2 inches.
Complexion Dark
Eyes Black; hair Black
Where born Menawah, Va.
Occupation Farmer

ENLISTMENT.

When Jan. 10, 1864.
Where Fort Monroe, Va.
By whom Lee Lee; term 3 y'rs.

Remarks:

F. D. Smith
Copyist.

K. | *2* *Comp.* | **U.S.C.T.**

Green King

Art, Co. *2* Reg't U. S. Col'd *Comp.*

Age _____ years.

Appears on a

Detachment Muster-in Roll
of unattached company
of the organization named above. Roll dated

Ft. Monroe, Va., *Jan. 19*, 1864.

Muster-in to date *Jan. 19*, 1864.

Joined for duty and enrolled:

When *Jan. 10*, 1864.

Where *Ft. Monroe, Va.*

Period *3* years.

Valuation of horse, \$ 100

Valuation of horse equipments, \$ 100

Remarks : _____

Book mark : _____

J. J. Kearney
Copyist.

K | **2 Cav.** | **U.S.C.T.**

Green King
Put, Co. I, 2 Reg't U. S. Col'd Cavalry.

Appears on

Company Muster Roll

for *Enrollment to Feb 29, 1864.*

Present or absent *Present*

Stoppage, \$ *100* for

Due Gov't, \$ *100* for

Valuation of horse, \$ *100*

Valuation of horse equipments, \$ *100*

Remarks:

Book mark:

D. A. Ward

R | **2 Cav.** | **U.S.C.T.**

Lyman King
Put, Co. I, 2 Reg't U. S. Col'd Cavalry.

Appears on

Company Muster Roll

for *Mar & Apr*, 186*4*.

Present or absent *Present*

Stoppage, \$ 100 for

Due Gov't, \$ 100 for

Valuation of horse, \$ 100

Valuation of horse equipments, \$ 100

Remarks:

Book mark:

J. A. Ward

A | **2 Cav.** | **U.S.C.T.**

Greene King
Put, Co. I, 2 Reg't U.S. Col'd Cavalry.

Appears on

Company Muster Roll

for *May & June*, 1864.

Present or absent *Absent*

Stoppage, \$ *100* for

Due Gov't, \$ *100* for

Valuation of horse, \$ *100*

Valuation of horse equipments, \$ *100*

Remarks: *Absent sick in
Corps Hospt. since
June 27/64.*

Book mark:

J. A. Ward

45 | 2 Cav. | U.S.C.T.

Greene Kinn
Pie, Co. I, 2 Reg't U. S. Col'd Cavalry.

Appears on

Company Muster Roll

for July & Aug, 1864

Present or absent Present

Stoppage, \$ 100 for

Due Gov't, \$ 100 for

Valuation of horse, \$ 100

Valuation of horse equipments, \$ 100

Remarks:

Book mark:

O. G. Smith

15 | **2 Cav.** | **U.S.C.T.**

Greene King
Pr, Co. I, 2 Reg't U.S. Col'd Cavalry.

Appears on

Company Muster Roll

for Sept & Oct, 1867

Present or absent Present

Stoppage, \$ 100 for

Due Gov't, \$ 100 for

Valuation of horse, \$ 100

Valuation of horse equipments, \$ 100

Remarks:

Book mark: _____

O. G. Smith

10 | 2 Cav. | U.S.C.T.

Green King

Pr, Co. I, 2 Reg't U. S. Col'd Cavalry.

Appears on

Company Muster Roll

for Nov & Dec, 1864.

Present or absent Present

Stoppage, \$ 100 for

Due Gov't, \$ 100 for

Valuation of horse, \$ 100

Valuation of horse equipments, \$ 100

Remarks:

Book mark:

O. G. Smith

K | **2 Cav.** | **U.S.C.T.**

Greene King
Pi....., Co. I, 2 Reg't U. S. Col'd Cavalry.

Appears on

Company Muster Roll

for *Jan & Feb*, 1865.

Present or absent *Present*

Stoppage, \$ *100* for

Due Gov't, \$ *100* for

Valuation of horse, \$ *100*

Valuation of horse equipments, \$ *100*

Remarks:.....
.....
.....
.....
.....
.....
.....
.....
.....
.....

Book mark:.....

O. J. Smith

K | **2 Cav.** | **U.S.C.T.**

Greene King

Private, Co. I, 2 Reg't U. S. Col'd Cavalry.

Appears on

Company Muster Roll

for *March & April*, 186*5*.

Present or absent *Present*

Stoppage, \$ *100* for

Due Gov't, \$ *100* for

Valuation of horse, \$ *100*

Valuation of horse equipments, \$ *100*

Remarks:

Book mark:

D. J. Griffith

K | **2 Cav.** | **U.S.C.T.**

Greene King,

pri....., Co. I, 2 Reg't U. S. Col'd Cavalry.

Appears on

Company Muster Roll

for *May & June*....., 186*5*.

Present or absent *Present*.....

Stoppage, \$..... *100* for.....

Due Gov't, \$..... *100* for.....

Valuation of horse, \$..... *100*

Valuation of horse equipments, \$..... *100*

Remarks:.....

Book mark:.....

D. J. Griffith

A | **2 Cav.** | **U.S.C.T.**

Greene King

pr, Co. I, 2 Reg't U. S. Col'd Cavalry.

Appears on

Company Muster Roll

for *July & August*, 1865.

Present or absent *Absent*

Stoppage, \$ *100* for

Due Gov't, \$ *100* for

Valuation of horse, \$ *100*

Valuation of horse equipments, \$ *100*

Remarks: *Due U.S. for Ordnance \$0.77 Sick in Genl Hosp't since July 1. 65*

Book mark:

G. J. Griffitch

K3 | 2 bar. | U.S.A.

Green King

Co. I, 2 Reg't U.S.A.

Appears on

Hospital Muster Roll

of Corps d'Afrique U. S. A. General Hospital,

at New Orleans, La.,

for July & Aug, 1865.

Attached to hospital:

When, 186 .

How employed

Last paid by Maj.

to, 186 .

Bounty paid \$ 100; due \$ 100

Present or absent present

Remarks:

Book mark:

J. Morrison

St. | **2 Cav.** | **U.S.C.T.**

Green King,

Priv, Co. I, 2 Reg't U. S. Col'd Cavalry.

Appears on

Company Muster Roll

for *Sept. 7 Oct.*, 186*5*.

Present or absent *Absent.*

Stoppage, \$ *100* for

Due Gov't, \$ *100* for

Valuation of horse, \$ *100*

Valuation of horse equipments, \$ *100*

Remarks: *Absent sick in
W.S. G. Hospital.*

Book mark:

Pol

K. 12 bar 1 (USAR)

Green King

Pos, Co. I 2, Reg't 126 bar

Appears on

Hospital Muster Roll

of **Corps d'Afrique U. S. A. General Hospital,**

at **New Orleans, La.,**

for *Sept Oct*, 186*5*.

Attached to hospital:

When _____, 186 .

How employed _____

Last paid by Maj. _____

to _____, 186 .

Bounty paid \$ 100; due \$ 100

Present or absent _____

Remarks: *Med Oct 14*

Book mark: _____

Willey

K. | **2 Cav.** | **U.S.C.T.**

Green King

Priv, Co. I, 2 Reg't U. S. Col'd Cavalry.

Appears on

Company Muster Roll

for *Nov. 7 Dec.*, 1865.

Present or absent

Stoppage, \$ 100 for

Due Gov't, \$ 100 for

Valuation of horse, \$ 100

Valuation of horse equipments, \$ 100

Remarks: *Died*

Book mark: *Died Oct 14/65 G.B.V. 11.P. 13-5.*

Pol

NA 9 639

K | **2 Cav.** | **U.S.C.T.**

Grané King
Pat., Co. *I*, 2 Reg't U. S. Colored Cav.

Appears on **Returns** as follows:

June 1864. absent sick
in Corps Hosp't since
June 27. '64.

July to Sept 1865. absent
sick in U.S. Gen. Hosp't.

Oct 1865. Absent sick N.O.

Nov 1865. Loss. Died Nov.
5 '65, Hosp't New
Orleans, La.

Book mark :

J. M. Sherrin

(546)

Copyist.

N | **2 Cav.** | **U.S.C.T.**

Greene King.

Priv, Co. *F*, 2 Reg't U. S. Col'd Cavalry.

Appears on **Co. Muster-out Roll**, dated

Brazos Santiago, Tex. Feb. 12, 1866.

Muster-out to date _____, 186 .

Last paid to _____, 186 .

Clothing account:

Last settled _____, 186 ; drawn since \$ _____ 100

Due soldier \$ _____ 100 ; due U. S. \$ _____ 100

Am't for cloth'g in kind or money adv'd \$ _____ 100

Due U. S. for arms, equipments, &c., \$ _____ 100

Bounty paid \$ _____ 100 ; due \$ _____ 100

Remarks: *Joined at org org pt*
from enlistment. Died Oct
14. 65 of Chronic diarrhea
at New Orleans La. Final
statements & inventory of
effects + Nov. 10" 1865.
x Roll torn.

Book mark: *Pv 9. P142. 69. V88. P127. 69.*

Pal

King, Green
Pri, Co. D, 2 Reg't U.S.C. Cav.

3 Enclosures.

Bed Cards	Descriptive Lists
Burial Records /	Final Statements
Certs. of Dis. for Discharge	Furloughs
C. M. Charges	Med. Des. Lists
Med. Certificates	Orders

Other papers relating to—

Admission to Hosp'l	Furlough
Casualty Sheet (Officer's) /	Med. Examination
Confinement	Misc. Information
Contracts	Pay or Clothing
Death or Effects /	Personal Reports
Desertions	Rank
Discharge from Hosp'l	Transfer to Hosp'l
Discharge from Service	Transfer to V. R. C.
Duty	Transportation

CASUALTY SHEET

No. _____

Green King

Priv of Company *I*

2^d Regiment of *W.C. Cav.*

State Volunteers.

NATURE OF CASUALTY.

Died Oct. 14, 1865

CASUALTY SHEET.

Name: Green King

Rank: Priv Company: I Regiment: 25

Arm: U.S. Cavalry State: _____

Nature of Casualty: Death

CAUSE OF CASUALTY—(NAME OF DISEASE, &c.)

BY WHOM DISCHARGED.

FROM WHAT SOURCE THIS INFORMATION WAS OBTAINED.

DEGREE OF DISABILITY.

Roll of Honor
Sa. Pg. 124

BY WHOM CERTIFIED.

REMARKS.

J. M. Moore
Adj. M. Gen.

DATE OF DISCHARGE, DEATH, &c.

Oct. 14, 1865

PLACE OF DISCHARGE, DEATH, &c.

Buried
New Orleans
Sa

[Signature]
Clerk.

Copy

No Descriptive List
INVENTORY OF THE EFFECTS

ARTICLES OF WAR.

ART. 95. When any non-commissioned officer or soldier shall die, or be killed in the service of the United States, the then commanding officer of the troop or company shall, in the presence of two other commissioned officers, take an account of what effects he died possessed of, above his arms and accoutrements, and transmit the same to the office of the Department of War, which said effects are to be accounted for, and paid to the representatives of such deceased non-commissioned officer or soldier. And in case any of the officers, so authorized to take care of the effects of deceased officers and soldiers, should, before they have accounted to their representatives for the same, have occasion to leave the regiment or post, by preferment or otherwise, they shall, before they be permitted to quit the same, deposit in the hands of the commanding officer, or of the assistant military agent, all the effects of such deceased non-commissioned officers and soldiers, in order that the same may be secured for, and paid to, their respective representatives.

ARMY REGULATIONS—EDITION OF 1861.

DECEASED SOLDIERS.

Par. 152. Inventories of the effects of deceased non-commissioned officers and soldiers, required by the 95th Article of War, will be forwarded to the Adjutant General, by the commander of the company to which the deceased belonged, and a duplicate of the same to the colonel of the regiment. Final statements of pay, clothing, &c., will be sent with the inventories. When a soldier dies at a post or station absent from his company, it will be the duty of his immediate commander to furnish the required inventory, and, at the same time, to forward to the commanding officer of the company to which the soldier belonged, a report of his death, specifying the date, place, and cause; to what time he was last paid, and the money or other effects in his possession at the time of his decease; which report will be noted on the next muster roll of the company to which the man belonged. Each inventory will be endorsed, "Inventory of the effects of _____, late of company (—) _____ regiment of _____, who died at _____, the _____ day of _____, 186—." If a legal representative receive the effects, it will be stated in the report. If the soldier leave no effects, the fact will be reported.

Par. 153. Should the effects of a deceased non-commissioned officer or soldier not be administered upon within a short period after his decease, they shall be disposed of by a Council of Administration, under the authority of the commanding officer of the post, and the proceeds deposited with the Paymaster, to the credit of the United States, until they shall be claimed by the legal representatives of the deceased.

Par. 154. In all such cases of sales by the Council of Administration, a statement in detail, or account of the proceeds, duly certified by the Council and commanding officer, accompanied by the Paymaster's receipt for the proceeds, will be forwarded by the commanding officer to the Adjutant General. The statement will be endorsed, "Report of the proceeds of the effects of _____, late of company (—) _____ regiment of _____, who died at _____, the _____ day of _____, 186—."

NOTE 1.—The effects in all cases, when called for, should be turned over to the legal representative, without further authority from the Adjutant General. When the effects are turned over to the relatives of the deceased before these inventories are sent to the Adjutant General, their receipts therefor should be attached to the inventories. In all other cases, one copy will be sent with a letter of transmittal direct to the Adjutant General, and a duplicate retained by the officer.

NOTE 2.—Particular care should be taken to take receipts in duplicate from the Paymaster for any funds turned over to him; one copy should be sent direct to the Adjutant General and one retained by the officer.

OF

Priv. Wm King

Late of Company *D*

2^d Reg't of *W.C. Army*

Volunteers, who died at *New Orleans*

on the *14* day of *Octr* 186*5*.

Inventory of the effects of Green King late
 a Private of Captain _____ Company C of
 the 2^d Regiment of Volunteers Volunteers, who was enrolled as
 a _____ at _____ in the State of _____ on
 the _____ day of _____ 186____, and mustered into the service of the United
 States as a _____ on the _____ day of _____ 186____, at _____
 in Company _____, _____ Regiment of _____ Volunteers, to serve _____
 years or during the war; he was born in _____ in the State
 of _____; he was _____ years of age, _____ feet _____ inches
 high, _____ complexion, _____ eyes, _____ hair, and by occupation, when enrolled,
 a _____; he died in Camp St. Andrew at
New Orleans, La on the 14th day of Oct 1865, by
 reason of Typhoid Dysentery

INVENTORY.					
ARTICLES.	No.	ARTICLES.	No.	ARTICLES.	No.
Hats.....		Pairs trousers.....	/	Knapsacks.....	
Caps.....		Pairs flannel drawers.....	/		
Forage caps.....		Pairs cotton drawers.....			
Great coats.....		Flannel shirts.....	/		
Uniform coats.....		Cotton shirts.....			
Uniform jackets.....	/	Pairs boots.....			
Flannel sack coats.....		Pairs shoes.....			
Blouses.....		Pairs socks.....			
Stable frocks.....		Blankets..... <u>Rubber</u>	/		
Fatigue overalls.....		Haversacks.....			
				MONEY.	
				Specie.....	\$ _____
				Notes.....	\$ _____

I CERTIFY, ON HONOR, that the above inventory comprises all the effects of _____
 _____, deceased, and that the effects are in the hands
 of _____ at _____
 _____ to be disposed of by a Council of Administration.

(DUPLICATES.)

STATION: New Orleans La
 DATE: Oct 14th 1865

 Commanding the Company.

NOV 20 1874

Green King
Co B
2nd U.S. Colored

ADJUTANT GENERAL U. S. ARMY.

COPY OF RECORD

FOR THE

also Oct 20/66
In of effects
sent 2nd Auditor
BB:0

also, Dec 20/65
P.C of Adm. & P.M
rect for \$ $1\frac{35}{100}$ sent
2nd Auditor
BB:0

No Dec List

[OFFICE INDORSEMENT.]

War Department,

ADJUTANT GENERAL'S OFFICE,

August 12th, 1874

The Death of Green King
Private, Co. B, 2nd Reg't U. S.
Colored Co., is reported as follows:

- On Company Muster Roll.
- For Novth & Dec, 1865, the date, 186
- Company Muster-out Roll.
- October 14th, 1865
- Company Descriptive Book.
- , 186
- Company Morning Reports.
- , 186
- Company Morning Reports.
- , 186
- Casualty Sheet
- Soldier's ~~Muster-out~~ ^{Casualty Sheet}
- October 14th, 1865
- Soldier's Record of Death and Interment.
- October 14th, 1865

Soldier's Certificate of Disability for Discharge. , 186

Soldier's Individual Muster-out Roll. , 186

Regimental Return. For , 186 , , 186

Regimental Quarterly Returns. , 186

Regimental Descriptive Book. , 186

By Surgeon General. , 186

Oct 14, 1866, is held to be the correct date, and the Company Muster Roll will be amended accordingly.

Thomas M. Sargent

Assistant Adjutant General.

Noted on Dec letter to 2nd Adm. Dept. 29th 1874
EB. 11/155. Noted 86.11.

No. 2.

RECORD OF DEATH AND INTERMENT.

Name and number of person interred,	- - -	Green W. King
Number and locality of the Grave,	- - -	
Hospital number of the deceased,	- - -	6487
Regiment, rank and company,	- - -	2 U.S. Cavalry - Private - I
Residence before enlistment,	- - -	
Conjugal condition, (and if married,	- - -	}
The residence of the widow,	- - -	
Cause of death,	- - -	} Chronic Diarrhoea
Age of the deceased,	- - -	
Nativity,	- - -	
References and remarks,	- - -	
Date of death and burial,	- - -	October 24 1865

To *Sgt Genl U.S. Army*

SIR :

It becomes my duty to inform you that the person above described died at this Hospital as herein stated, and that it is desired his remains should be interred with the usual Military honors.

Respectfully,

F. E. Piquette
 SURGEON, U.S. ARMY.
H. W. C. Ingham
 in Charge

MILITARY HOSPITAL, *Corps d'Asiatic Ten Orleans*
La

WAR 647

King Jackson

Co E, 2 U. S. Col'd Cav.

Private | *Private*

CARD NUMBERS.

1	5322200	26
2	5322280	27
3	5322366	28
4	5322451	29
5	5322568	30
6	5316446	31
7	5322701	32
8	5322782	33
9	5322876	34
10	5322969	35
11	5323065	36
12	5323150	37
13	5323230	38
14	5323309	39
15	9087521	40
16	33101631	41
17	31633402	42
18	31633442	43
19	31636500	44
20	31636836	45
21	40726257	46
22		47
23		48
24		49
25		50

Book Mark:

See also

000000

SS. to the Rec. in the Quack.

C. Barker.

11-14-25

L. Ballantyne

K | **2 Cav.** | **U.S.C.T.**

Jackson King

....., Co. *E*, 2 Reg't U. S. Col'd Cav.

Appears on

Company Descriptive Book
of the organization named above.

DESCRIPTION.

Age *43* years; height *5* feet *8* inches.

Complexion *Black*

Eyes *Black*; hair *Black*

Where born *Nansemond Co., Va.*

Occupation *Laborer*

ENLISTMENT.

When *Dec 20, 1863*

Where *Norfolk, Va.*

By whom *Levi Cole*; term *3* y'rs.

Remarks:

.....
.....
.....
.....
.....
.....
.....
.....
.....
.....

F. B. Smith
Copyist.

K | **2 Cav.** | **U.S.C.T.**

Jackson King
Plt., Co. *E*, 2 Regt U. S. Col'd Cavalry.

Age *43* years.

Appears on

Company Muster-in Roll

of the organization named above. Roll dated

Fort Monroe, Va. Jan. 8, 1864.

Muster-in to date *Jan. 8*, 1864.

Joined for duty and enrolled:

When *December 25*, 186*3*.

Where *Norfolk, Va.*

Period *3* years.

Valuation of horse, \$.....*100*

Valuation of horse equipments, \$.....*100*

Remarks :
.....
.....
.....
.....

Book mark :

T. C. Taylor

K | **2 Cav.** | **U.S.C.T.**

Jackson King
Prvt., Co. E, 2 Reg't U. S. Col'd Cavalry.

Appears on

Company Muster Roll

for *Enrollment to Feb. 29, 1864.*

Present or absent *Present*

Stoppage, \$ *100* for

Due Gov't, \$ *100* for

Valuation of horse, \$ *100*

Valuation of horse equipments, \$ *100*

Remarks:
.....
.....
.....
.....
.....
.....
.....
.....
.....

Book mark:

(358)

J. C. Taylor

Copyist.

K | **2 Cav.** | **U.S.C.T.**

Jackson King

Out., Co. E, 2 Reg't U. S. Col'd Cavalry.

Appears on

Company Muster Roll

for *Mar. and Apr.*, 1864.

Present or absent *Present*

Stoppage, \$-----100 for -----

Due Gov't, \$-----100 for -----

Valuation of horse, \$-----100

Valuation of horse equipments, \$-----100

Remarks:-----

Book mark:-----

(358)

P. C. Taylor

Copyist.

NARR 653

K | **2 Cav.** | **U.S.C.T.**

Jackson King
Out., Co. E, 2 Reg't U. S. Col'd Cavalry.

Appears on

Company Muster Roll

for *May and June*, 1864.

Present or absent *Present*

Stoppage, \$.....100 for

Due Gov't, \$.....100 for

Valuation of horse, \$.....100

Valuation of horse equipments, \$.....100

Remarks:.....
.....
.....
.....
.....
.....
.....
.....
.....

Book mark:.....
.....

(358) *J. C. Taylor* Copyist.

M | **2 Cav.** | **U.S.C.T.**

Jackson King
Priv., Co. E, 2 Reg't U. S. Col'd Cavalry.

Appears on

Company Muster Roll

for *July & Aug*, 186 *4*

Present or absent.....

Stoppage, \$.....*100* for.....

Due Gov't, \$.....*100* for.....

Valuation of horse, \$.....*100*

Valuation of horse equipments, \$.....*100*

Remarks: *Deserted from*
detached service in
Ambulance Corps 18th A.C.
Aug. 12-64

Book mark:.....

Wauvington

W | 2000 USCT

* Jackson King
Priv., Co. E, 2 Reg't Life Cav

Appears on

Hospital Muster Roll

of Summit House U. S. A. General Hospital,

at Philadelphia, Pa.,

for July & Aug, 1864.

Attached to hospital:

When....., 186 .

How employed.....

Last paid by Maj.

to, 186 .

Bounty paid \$ 100; due \$ 100

Present or absent Not stated

Remarks:.....

.....

Ward 6

* Entry cancelled

Book mark:.....

J Anderson

K | 2 Cav Msc

Jackson King
Pvt, Co. E, 2 Reg't Msc Cav

Appears on

Hospital Muster Roll

of Summit House U. S. A. General Hospital,

at Philadelphia, Pa.,

for July & Aug, 186 4.

Attached to hospital:

When....., 186 .

How employed.....

Last paid by Maj.

to, 186 .

Bounty paid \$ 100 due \$ 100

Present or absent Present

Remarks:.....

.....

Ward 6

.....

.....

Book mark:.....

J. Anderson

K | *2 Cav* | *U.S.C.T.*

Jackson King
Pr, Co. *E*, *2* Reg't *U.S.C. Cav*

Appears on

Hospital Muster Roll

of *Satterlee U. S. A. General Hospital,*

at *West Philadelphia, Pa.,*

for *July & Aug*, 1864.

Attached to hospital:

When....., 186 .

How employed.....

Last paid by Maj.....

to....., 186 .

Bounty paid \$ *100*; due \$ *100*

Present or absent.....

Remarks:

*Transferred to Summit
House Hoptl Phila Pa
Aug 19/64*

Book mark :.....

Geo J. Drew

A. L. Car | U.S.C.T.

Jackson King
Co. C, 2^d Reg't U. S. Col'd Cav.

Appears on a

Detachment Muster Roll

of the organization named above

for *July & Aug.*, 186*4*.

Station *On the Field, Va*

Present or absent

Stoppage, \$ *100* for

Due Gov't, \$ *100* for

Valuation of horse, \$ *100*

Valuation of horse equipments, \$ *100*

Remarks: *Deserted*

Not borne on rolls Nov Dec /64

Book mark:

A. L. Car

K | 2 Cav. | U.S.C.T.

Jackson King
Priv., Co. E, 2 Reg't U. S. Col'd Cavalry.

Appears on

Company Muster Roll

for *Nov & Dec*, 186 *4*

Present or absent *Absent*

Stoppage, \$ 100 for

Due Gov't, \$ 100 for

Valuation of horse, \$ 100

Valuation of horse equipments, \$ 100

Remarks: *Sick in Genl*
Hospit. Returned from
desertion to Abst. sick

Book mark: _____

Waddington

K1 2 Cav. 1 U.S.C.

Jackson King
Sgt, Co. B, 2 Reg't U.S.C. Cav.

Appears on

Hospital Muster Roll

(Colored Guard)

of **Summit House U. S. A. General Hospital,**

at **Philadelphia, Pa.,**

for Nov & Dec, 1864.

Attached to hospital:

When Aug 11, 1864.

How employed.....

Last paid by Maj.....

to Aug 31, 1864.

Bounty paid \$ 100; due \$ 100

Present or absent present

Remarks: Mustered for
Sept. Oct. Nov. & Dec
1864.

Book mark :.....

Cancel

K | **2 Cav.** | **U.S.C.T.**

Jackson King
Pir, Co. E, 2 Reg't U. S. Col'd Cavalry.

Appears on

Company Muster Roll

for *Jan & Feb*, 186*5*

Present or absent *Present*

Stoppage, \$ *100* for

Due Gov't, \$ *100* for

Valuation of horse, \$ *100*

Valuation of horse equipments, \$ *100*

Remarks:

Book mark:

Waddington

N. L. Cav. U.S.C.T.

Jackson String
Pvt., Co. E, 2 Reg't U.S.C.T. Cav.

Appears on

Hospital Muster Roll

of Summit House U. S. A. General Hospital,

at Philadelphia, Pa.,

for *Jan. & Feb.*, 1865.

Attached to hospital:

When *Aug. 17.*, 1864.

How employed

Last paid by Maj. *Stryker*
to *Dec. 31.*, 1864.

Bounty paid \$ 100; due \$ 100

Present or absent

Remarks: *Returned to duty*
July, 65,

Book mark:

Attest

K. | **2 Cav.** | **U.S.C.T.**

Jackson King.

Private, Co. E, 2 Reg't U. S. Col'd Cavalry.

Appears on

Company Muster Roll

for *March & April*, 186 *5*.

Present or absent *Present*.

Stoppage, \$ *100* for

Due Gov't, \$ *100* for

Valuation of horse, \$ *100*

Valuation of horse equipments, \$ *100*

Remarks:

Book mark:

R. Bradin

K | **2 Cav.** | **U.S.C.T.**

Jackson King

Priv, Co. E, 2 Reg't U. S. Col'd Cavalry.

Appears on

Company Muster Roll

for *May & June*, 1863:

Present or absent *Present*

Stoppage, \$ *100* for

Due Gov't, \$ *100* for

Valuation of horse, \$ *100*

Valuation of horse equipments, \$ *100*

Remarks:

Book mark:

(358)

B. Nelson

Comptroller.

Copyist.

W | **2 Cav. | U.S.C.T.**

Jackson King
Dot, Co. E, 2 Reg't U.S. Col'd Cavalry.

Appears on

Company Muster Roll
for *July & Aug*, 186*5*.
Present or absent *Present*

Stoppage, \$ *100* for

Due Gov't, \$ *100* for

Valuation of horse, \$ *100*

Valuation of horse equipments, \$ *100*

Remarks:

Book mark: -----

(358) *J. H. [Signature]* Copyist.

No | 2 Cav. | U.S.C.T.

Jackson King

Priv., Co. E, 2 Reg't U. S. Col'd Cavalry.

Appears on

Company Muster Roll

for Sept and Oct, 1865.

Present or absent Present

Stoppage, \$ 100 for

Due Gov't, \$ 100 for

Valuation of horse, \$ 100

Valuation of horse equipments, \$ 100

Remarks: Will \$ 6. per month from Jan. 1, 64 to Apr. 30, 64 as increase of pay

Book mark:

N. H. Merrill

16 | 2 Cav. | U.S.C.T.

Jackson King

Present, Co. E, 2 Reg't U.S. Col'd Cavalry.

Appears on

Company Muster Roll

for Nov. and Dec, 1865.

Present or absent Present

Stoppage, \$ 100 for

Due Gov't, \$ 100 for

Valuation of horse, \$ 100

Valuation of horse equipments, \$ 100

Remarks: Over # 6 per month from Jan. 1 64 to April 30, 64 increased pay

Book mark:

N. H. Merrill

A | **2 Cav.** | **U.S.C.T.**

Jackson King
Priv., Co. *E*, 2 Reg't U. S. Colored Cav.

Appears on **Returns** as follows:

July 1864 Absent Detd. in Q. M. Dept

Aug 1864. Loss Aug 10/64
in Petersburg.

Deserted while on
detd. service in
Amb. Corps

Oct + Nov. 1864. Absent
Detd. in Q. M. Dept

Dec 1864. Gain Dec 30/64
in the field, from
desertion to duty.

Dec 1864 + Jan 1865
Absent sick

Book mark :

J. F. Duntton
 (646) Copyist.

16

2 Cav. U.S.C.T.

Jackson King

Pvt., Co. E., 2 Reg't U. S. Col'd Cavalry.

Appears on Co. Muster-out Roll, dated

Brazos Santiago Tex., Feb. 12, 1866.

Muster-out to date Feb. 12, 1866.

Last paid to June 30, 1865.

Clothing account:

Last settled....., 186 ; drawn since \$ 100

Due soldier \$ 100; due U. S. \$ 5 09/100

Am't for cloth'g in kind or money adv'd \$ 100

Due U. S. for arms, equipments, &c., \$ 27/100

Bounty paid \$ 100; due \$ 100

Remarks: Joined at exp. exp.

New soldier & per month increase of pay

from Jan 1, 64 to Apr 30, 64

Stop on King and Rank & pay

Book mark: V 37, P 63, / 64.

N. H. Merrill

Wing. Jackson

, Co. E, 2 Reg't 11th Cav.

Enclosures.

Bed Cards	Descriptive Lists
Burial Records	Final Statements
Certs. of Dis. for Discharge	Furloughs
C. M. Charges	Med. Des. Lists
Med. Certificates	Orders

Other papers relating to—

Admission to Hosp'l	Furlough
Casualty Sheet (Officer's)	Med. Examination
Confinement	Misc. Information
Contracts	Pay or Clothing
Death or Effects	Personal Reports
Descrptions	Rank
Discharge from Hosp'l	Transfer to Hosp'l
Discharge from Service	Transfer to V. R. C.
Duty	Transportation

Hospital Number 3841. 8 2

Name Jackson, King

Age 45. Nativity Virginia

Married or Single Married

Residence Norfolk, Va.

Post Office address of wife or nearest relative. Mrs King Norfolk Va

Rank Co. E. Regiment 2 U.S. Col.

When admitted Aug 18. 1864.

From what source City Point Hosp

Diagnosis: (in surgical cases state explicitly seat and character of wound or injury.)

U.S. Col. 2nd Regt.

Summit House G. H.

Philadelphia, Pa.

On what occasion wounded City Point

Date August 9th 1864

Nature of missile or weapon Shell

TREATMENT.

[HERE NOTE IMPORTANT COMPLICATIONS AND ALL OPERATIONS.]

Cold water dressing

RESULT AND DATE.

transferred to Guard
Nov 2 1864

Wm Shapley

Returned to Gasparusa
July
2. 6. /64

⁹¹⁷
King Slade

Co A, 2 U. S. Col'd Cav.

Private | Private

CARD NUMBERS.

1	5317244	26
2	5317318	27
3	5317408	28
4	5317496	29
5	5317576	30
6	5317666	31
7	5317712	32
8	5317796	33
9	5317886	34
10	5317986	35
11	5318082	36
12	5318162	37
13	5318238	38
14	5318311	39
15	9087092	40
16	40726269	41
17		42
18		43
19		44
20		45
21		46
22		47
23		48
24		49
25		50

Book Mark:

See also

NO 674

S-1633396 - P.C. - MY - m
P. 1633568 And W2

L. Ballantyne

R | **2 Cav. | U.S.C.T.**

Shade King

, Co. *A*, 2 Reg't U. S. Col'd Cav.

Appears on

Company Descriptive Book

of the organization named above.

DESCRIPTION.

Age *27* years; height *5* feet *8* inches.

Complexion *Tawny*

Eyes *Black*; hair *Black*

Where born *Morton Co, N. C.*

Occupation

ENLISTMENT.

When *Dec 24* 186*6*

Where *St. Monroe*

By whom *Col. Cole*; term *3* y'rs.

Remarks: *Promoted to
Sergeant Saddle
Nov. 1st 1864,*

J. B. Smith

Copyist.

K | **2 Cav.** | **U.S.C.T.**

Slade King
Pvt., Co. *A*, 2 Reg't U. S. Col'd Cavalry.

Age years.

Appears on

Company Muster-in Roll

of the organization named above. Roll dated
Ft Monroe Va, *Dec 22*, 1863.

Muster-in to date *Dec 22*, 1863.

Joined for duty and enrolled:

When *Dec 22* 1863.

Where *Ft Monroe Va*

Period *3* years.

Valuation of horse, \$ 100

Valuation of horse equipments, \$ 100

Remarks :

Book mark:

(356) *J. E. Chapin* Copyist.

K | **2 Cav.** | **U.S.C.T.**

Slade King

Pro, Co. A, 2 Reg't U. S. Col'd Cavalry.

Appears on

Company Muster Roll

for *from Enrolment to Feb 29*, 1864.

Present or absent *Present*

Stoppage, \$ 100 for

Due Gov't, \$ 100 for

Valuation of horse, \$ 100

Valuation of horse equipments, \$ 100

Remarks:

Book mark:

J. E. Chapin

K | **2 Cav.** | **U.S.C.T.**

Slade King

Priv, Co. A, 2 Reg't U. S. Col'd Cavalry.

Appears on

Company Muster Roll

for *McK & Apr*, 1864.

Present or absent *Present*

Stoppage, \$ 100 for

Due Gov't, \$ 100 for

Valuation of horse, \$ 100

Valuation of horse equipments, \$ 100

Remarks:

Book mark:

C. E. Chapin

K | **2 Cav.** | **U.S.C.T.**

Stade King

Pvt, Co. A, 2 Reg't U. S. Col'd Cavalry.

Appears on

Company Muster Roll

for *May & June*, 1864.

Present or absent *Present*

Stoppage, \$ 100 for

Due Gov't, \$ 100 for

Valuation of horse, \$ 100

Valuation of horse equipments, \$ 100

Remarks:

Book mark:

J. E. Chapin

2 Cav. U.S.C.T.

Slade King

Plt, Co. A, 2 Reg't U. S. Col'd Cavalry.

Appears on

Company Muster Roll

for July & Aug, 1864.

Present or absent Present

Stoppage, \$ 100 for

Due Gov't, \$ 100 for

Valuation of horse, \$ 100

Valuation of horse equipments, \$ 100

Remarks: Stoppages
One nose bag \$1.50
" Cav. lint \$.30
" Curry comb & brush 1.01

Book mark:

R. S. Shelton

W | **2 Cav. U.S.C.T.**

Blade King

Priv, Co. A, 2 Reg't U. S. Col'd Cavalry.

Appears on

Company Muster Roll

for *Sept Oct*, 1864.

Present or absent *Present*

Stoppage, \$ 100 for

Due Gov't, \$ 100 for

Valuation of horse, \$ 100

Valuation of horse equipments, \$ 100

Remarks:

Book mark:

R S Shelton

K | **2 Cav.** | **U.S.C.T.**

Slade King
Saddler, Co. A, 2 Reg't U. S. Col'd Cavalry.

Appears on

Company Muster Roll

for *Nov & Dec*, 1864.

Present or absent *Present*

Stoppage, \$ 100 for

Due Gov't, \$ 100 for

Valuation of horse, \$ 100

Valuation of horse equipments, \$ 100

Remarks: *Appointed Nov 4, 1864*

Book mark:

R S Shetton

N | **2 Cav.** | **U.S.C.T.**

Slade King
Saddler, Co. A, 2 Reg't U. S. Col'd Cavalry.

Appears on

Company Muster Roll

for *Jerry Gebby*, 1865.

Present or absent *Present*

Stoppage, \$ 100 for

Due Gov't, \$ 100 for

Valuation of horse, \$ 100

Valuation of horse equipments, \$ 100

Remarks: *Appointed Nov. 12th 1864.*

Book mark:

R. S. Shelton

N. | **2 Cav.** | **U.S.C.T.**

Glade King

Saddler, Co. A, 2 Reg't U. S. Col'd Cavalry.

Appears on

Company Muster Roll

for *March*, 1865.

Present or absent *absent*

Stoppage, \$ 100 for

Due Gov't, \$ 100 for

Valuation of horse, \$ 100

Valuation of horse equipments, \$ 100

Remarks: *On spl. service
with Regiment at
Horsfield Va.*

Book mark: _____

Wiley

H. | **2 Cav.** | **U.S.C.T.**

Slade King
Saddler, Co. A, 2 Reg't U. S. Col'd Cavalry.

Appears on

Company Muster Roll

for *May & June*, 1865.

Present or absent *Present*

Stoppage, \$ *100* for

Due Gov't, \$ *100* for

Valuation of horse, \$ *100*

Valuation of horse equipments, \$ *100*

Remarks: *Due U.S. for sold
22000000 cost \$4.12*

Book mark:

Wiley

K | **2 Cav.** | **U.S.C.T.**

Slide King

Saddler, Co. A, 2 Reg't U.S. Col'd Cavalry.

Appears on

Company Muster Roll

for *July & Aug*, 1865.

Present or absent *Present.*

Stoppage, \$ *100* for

Due Gov't, \$ *100* for

Valuation of horse, \$ *100*

Valuation of horse equipments, \$ *100*

Remarks: *On daily duty as
Co Cook. Due U.S. for
ordnance \$9.64.*

Book mark:

Wiley

NARA 687
H. | 2 Cav. | U.S.C.T.

Slade King
Saddler, Co. A, 2 Reg't U. S. Col'd Cavalry.

Appears on

Company Muster Roll

for Sep + Oct, 1865.

Present or absent present

Stoppage, \$ 100 for

Due Gov't, \$ 100 for

Valuation of horse, \$ 100

Valuation of horse equipments, \$ 100

Remarks: Co. Cook.
Due U. S. for Ordnance \$962
100

Book mark: _____

G. E. Dayton

K. | **2 Cav.** | **U.S.C.T.**

Slave King
Sadler, Co. A, 2 Reg't U.S. Col'd Cavalry.

Appears on

Company Muster Roll

for *Nov + Dec*, 1865.

Present or absent *present.*

Stoppage, \$ 100 for

Due Gov't, \$ 100 for

Valuation of horse, \$ 100

Valuation of horse equipments, \$ 100

Remarks: *Due U.S. for
bonance \$7.62.*

Book mark: _____

G. E. Dayton

of | **2 Cav. | U.S.C.T.**

Slade J. King

Saddler

Pr, Co. *A.*, 2 Reg't U. S. Colored Cav.

Appears on **Returns** as follows:

*April 1865 - absent on detail
examining passes
at Princess Anne Road,
near Norfolk, Va.*

*July 1865 - to Jan 1866, (Pr)
on duty as cook.*

*appeared as
a detail.*

Book mark :

J. M. Shannon

NARA 699
K. | 2 Cav. | U.S.C.T.

Stade King,
Saddle Co., 2 Reg't U. S. Col'd Cavalry.

Appears on **Co. Muster-out Roll**, dated
Brazos Santiago Tex 12 Feb, 1866.
Muster-out to date 12 Feb, 1866.
Last paid to B. H. H. 1865.

Clothing account:

Last settled....., 186 ; drawn since \$..... $\overline{100}$
Due soldier \$..... $\overline{100}$; due U. S. \$..... $28 \frac{43}{100}$
Am't for cloth'g in kind or money adv'd \$..... $\overline{100}$

Due U. S. for arms, equipments, &c., \$..... $\overline{100}$

Bounty paid \$..... $\overline{100}$; due \$..... $\overline{100}$

Remarks: Joined original
reg't; was Pvt until
Oct 20/64 when
apt to Saddle

Book mark:

G. S. Dayton

⁹⁸
King Stephen

Co *l*, 2 U. S. Col'd Cav.

Private | Private

CARD NUMBERS.

1	5319801	26
2	5319876	27
3	5319963	28
4	5320051	29
5	5320134	30
6	5320224	31
7	5320316	32
8	5320401	33
9	5320498	34
10	6320592	35
11	5320638	36
12	5320727	37
13	5320815	38
14	5320900	39
15	9087327	40
16		41
17		42
18		43
19		44
20		45
21		46
22		47
23		48
24		49
25		50

Book Mark:

See also

8.773673 P.O. off

A.2038782 P.O. mem.

A.3001314 P.O. mem.

To Ballary &c

K | **2 Cav. | U.S.C.T.**

Stephen King
....., Co. *C*, 2 Reg't U. S. Col'd Cav.

Appears on
Company Descriptive Book
of the organization named above.

DESCRIPTION.

Age *23* years; height *5* feet *6* inches.

Complexion *Black*

Eyes *Black*; hair *Black*

Where born *Murfreesboro, N.C.*

Occupation *Labourer*

ENLISTMENT.

When *Dec. 24*, 1863.

Where *Ft Monroe, Va.*

By whom *G.W. Cole*; term *3* y'rs.

Remarks:
.....
.....
.....
.....
.....
.....
.....
.....
.....
.....

F.B. Smith
.....
Copyist.

16 | 2 Cav. | U.S.C.T.

Stephen King
Pvt., Co. C, 2 Reg't U. S. Col'd Cavalry.

Age.....years.

Appears on

Company Muster-in Roll

of the organization named above. Roll dated

Ft Monroe Va, Dec 24, 1863.

Muster-in to date Dec 24, 1863.

Joined for duty and enrolled:

When Dec 24, 1863.

Where Ft Monroe Va

Period 3 years.

Valuation of horse, \$ 100

Valuation of horse equipments, \$ 100

Remarks:

Book mark:

Hadfield

10 | 2 Cav. | U.S.C.T.

Stephen King
Private, Co. C, 2 Reg't U. S. Col'd Cavalry.

Appears on

Company Muster Roll

for status Feb 29, 1864

Present or absent Present

Stoppage, \$ 100 for

Due Gov't, \$ 100 for

Valuation of horse, \$ 100

Valuation of horse equipments, \$ 100

Remarks:

Book mark:

Hadfield

K | **2 Cav. | U.S.C.T.**

Stephen King
Sgt, Co. C, 2 Reg't U. S. Col'd Cavalry.

Appears on

Company Muster Roll

for *Mar & Apr*, 1864.

Present or absent *Present*

Stoppage, \$ *100* for

Due Gov't, \$ *100* for

Valuation of horse, \$ *100*

Valuation of horse equipments, \$ *100*

Remarks:

Book mark: -----

Hadfield
(358) Copyist.

K | **2 Cav.** | **U.S.C.T.**

Stephen King

1st, Co. C, 2 Reg't U. S. Col'd Cavalry.

Appears on

Company Muster Roll

for *May & June*, 186*4*.

Present or absent *Present*

Stoppage, \$ 100 for

Due Gov't, \$ 100 for

Valuation of horse, \$ 100

Valuation of horse equipments, \$ 100

Remarks:

Book mark: *...*

Hendricks

K | **2 Cav.** | **U.S.C.T.**

Stephen King
Prnt, Co. C, 2 Reg't U. S. Col'd Cavalry.

Appears on

Company Muster Roll

for *July, 1 Aug*, 186*4*.

Present or absent *Present*

Stoppage, \$ 100 for

Due Gov't, \$ 100 for

Valuation of horse, \$ 100

Valuation of horse equipments, \$ 100

Remarks:

Book mark:

(358) *W. S. D. C.* Copyist.

K | **2 Cav.** | **U.S.C.T.**

Stephen King
Prnt, Co. C, 2 Reg't U. S. Col'd Cavalry.

Appears on

Company Muster Roll

for *Sept 20* Oct, 186 *4*.

Present or absent *Present*

Stoppage, \$ 100 for

Due Gov't, \$ 100 for

Valuation of horse, \$ 100

Valuation of horse equipments, \$ 100

Remarks:

Book mark:

W. J. Hoag

NA 700

K | **2 Cav.** | **U.S.C.T.**

Stephen King

Privt, Co. C, 2 Reg't U. S. Col'd Cavalry.

Appears on

Company Muster Roll

for *Nov & Dec*, 186*4*.

Present or absent *Present*

Stoppage, \$.....*100* for

Due Gov't, \$.....*100* for

Valuation of horse, \$.....*100*

Valuation of horse equipments, \$.....*100*

Remarks:

Book mark:

W. S. L. O. Z.

K | **2 Cav.** | **U.S.C.T.**

Stephen King
Privt, Co. C, 2 Reg't U. S. Col'd Cavalry.

Appears on

Company Muster Roll

for *Jan & Feb*, 186 *U*

Present or absent *Present*

Stoppage, \$ *100* for

Due Gov't, \$ *100* for

Valuation of horse, \$ *100*

Valuation of horse equipments, \$ *100*

Remarks:
.....
.....
.....
.....
.....
.....
.....
.....

Book mark:

W. D. ...

10 | **2 Cav.** | **U.S.C.T.**

Stephen King
Priv, Co. C, 2 Reg't U. S. Col'd Cavalry.

Appears on

Company Muster Roll

for *March & April*, 1865.

Present or absent *Present*

Stoppage, \$ *100* for

Due Gov't, \$ *100* for

Valuation of horse, \$ *100*

Valuation of horse equipments, \$ *100*

Remarks:

Book mark:

J. L. Morris

No. | 2 Cav. | U.S.C.T.

Stephen King
Priv., Co. C, 2 Reg't U. S. Col'd Cavalry.

Appears on

Company Muster Roll

for May & June, 1865.

Present or absent Present

Stoppage, \$ 100 for

Due Gov't, \$ 100 for

Valuation of horse, \$ 100

Valuation of horse equipments, \$ 100

Remarks:

Book mark:

J. L. Harris

76 | 2 Cav. | U.S.C.T.

Stephen King
Corpl, Co. C, 2 Reg't U. S. Col'd Cavalry.

Appears on

Company Muster Roll

for July & August, 1865.

Present or absent Present

Stoppage, \$ 100 for

Due Gov't, \$ 100 for

Valuation of horse, \$ 100

Valuation of horse equipments, \$ 100

Remarks: Dur U.S. for Ordnance 85^{cts.}
Promoted from Private S.O.
dated Aug 4/65.

Book mark:

(358)

J. L. Borris

Copyist.

K | **2 Cav.** | **U.S.C.T.**

Stephen King
Corp, Co. C, 2 Reg't U. S. Col'd Cavalry.

Appears on

Company Muster Roll

for *Sept & Oct*, 186 *5*.

Present or absent *Present*

Stoppage, \$ *100* for

Due Gov't, \$ *100* for

Valuation of horse, \$ *100*

Valuation of horse equipments, \$ *100*

Remarks: *Due U.S. ordnance*
85 cts.

Book mark:

G. W. Chase

K | **2 Cav.** | **U.S.C.T.**

Stephen King
Corp, Co. C, 2 Reg't U. S. Col'd Cavalry.

Appears on

Company Muster Roll

for *Nov & Dec*, 186 *5*.

Present or absent *Present*

Stoppage, \$ *100* for

Due Gov't, \$ *100* for

Valuation of horse, \$ *100*

Valuation of horse equipments, \$ *100*

Remarks:

Book mark:

G. W. Chase

K | **2 Cav.** | **U.S.C.T.**

Stephen King
Comp, Co. C, 2 Reg't U. S. Col'd Cavalry.

Appears on **Co. Muster-out Roll**, dated
Brazos Santiago, Tex, Feb 12, 1864.
Muster-out to date Feb 12, 1864.
Last paid to June 30, 1865.

Clothing account:

Last settled....., 186 ; drawn since \$..... $\frac{100}{100}$
Due soldier \$..... $\frac{100}{100}$; due U. S. \$ 41 $\frac{89}{100}$
Am't for cloth'g in kind or money adv'd \$..... $\frac{100}{100}$

Due U. S. for arms, equipments, &c., \$..... $\frac{60}{100}$
Bounty paid \$..... $\frac{100}{100}$; due \$ 100 $\frac{100}{100}$

Remarks: Joined at org'l org.
Was Pvt. till Aug. 4/65.
Free before Apr. 19/61
Wtop for one cap box.

Book mark :

G. W. Chase

NAME 700

King Washington

Co. 2 U. S. Col'd Cav.

Private Corporal

CARD NUMBERS.

1	5321014	26
2	5321072	27
3	5321161	28
4	5321246	29
5	5316396	30
6	5316518	31
7	5316757	32
8	5321528	33
9	5321621	34
10	5321721	35
11	5321823	36
12	5321891	37
13	5321977	38
14	5322065	39
15	9087401	40
16	40726270	41
17		42
18		43
19		44
20		45
21		46
22		47
23		48
24		49
25		50

Book Mark:

See also

K | **2 Cav.** | **U.S.C.T.**

Washington King
....., Co. *D*, 2 Reg't U. S. Col'd Cav.

Appears on
Company Descriptive Book
of the organization named above.

DESCRIPTION.

Age *26* years; height *5* feet *6* inches.
Complexion *Light*
Eyes *Dark*; hair *Dark*
Where born *Gloucester Co., Va.*
Occupation *Waiter*

ENLISTMENT.

When *Dec. 24, 1863.*
Where *Fort Monroe*
By whom *Col. Cole*; term *3* y'rs.

Remarks: *Appointed Ser-*
-geant per Special
Order no. 5 dated
4th Dec, 2nd U. S. C. Cav.
Feb'y, 27" 1864, Engaged
in action at Suffolk Va.
March 9" 1864, Jones Bridge
Chickohominy River
May 6" + netar (over)

F. B. Smith
.....
Covist.

MAY. 12

9087401

1891

Petersburgh Va.
June 6th 12th & 18th 1864
Reduced to the ranks
per order dated Hd.
Qrs. 2nd U. S. C. C. July 1864.

K | **2 Cav.** | **U.S.C.T.**

Washington King
Priv, Co. *D*, 2 Reg,t U. S. Col'd Cavalry.

Age _____ years.

Appears on

Company Muster-in Roll

of the organization named above. Roll dated
Fort Monroe, Va., Dec 24, 1863.

Muster-in to date *Dec 24, 1863.*

Joined for duty and enrolled:

When *Dec 24, 1863.*

Where *Fort Monroe Va.*

Period *3* years.

Valuation of horse, \$ _____ 100

Valuation of horse equipments, \$ _____ 100

Remarks : _____

Book mark : _____

Heard

NO 712

X | **2 Cav.** | **U.S.C.T.**

Washington King

Serjt., Co. D, 2 Reg't U. S. Col'd Cavalry.

Appears on

Company Muster Roll

for *from Enrollment to Feby 29*, 186*4*.

Present or absent *Present.*

Stoppage, \$ *100* for

Due Gov't, \$ *100* for

Valuation of horse, \$ *100*

Valuation of horse equipments, \$ *100*

Remarks: *Appointed Sergeant per Special Order No. 5 dated. Hd Quarters 2nd U.S.C. Feby 27th/64.*

Book mark:

Hearst

K | **2 Cav.** | **U.S.C.T.**

Washington King

Serjt., Co. D, 2 Reg't U. S. Col'd Cavalry.

Appears on

Company Muster Roll

for *March & April*, 1864.

Present or absent *Present*

Stoppage, \$ *100* for

Due Gov't, \$ *100* for

Valuation of horse, \$ *100*

Valuation of horse equipments, \$ *100*

Remarks:

Book mark:

Hearst

X | **2 Cav.** | **U.S.C.T.**

Washington King

Serjt., Co. D, 2 Reg't U. S. Col'd Cavalry.

Appears on

Company Muster Roll

for *May & June*, 1864.

Present or absent *Present*

Stoppage, \$ *100* for

Due Gov't, \$ *100* for

Valuation of horse, \$ *100*

Valuation of horse equipments, \$ *100*

Remarks: *Due \$ for horse bag,
1 pr spur & straps, 1 link,
1 horse brush & C comb
\$ 3.33*

Book mark:

Hearst

H | *2 Car* | **U.S.C.T.**

Washington King
Pri, Co. *A*, *2* Reg't U. S. Col'd *Car*

Appears on a

Detachment Muster Roll

of the organization named above

for *July & Aug*, 186*4*.

Station *Camp in the field Va*

Present or absent *Present*

Stoppage, \$ 100 for

Due Gov't, \$ 100 for

Valuation of horse, \$ 100

Valuation of horse equipments, \$ 100

Remarks: *Due U.S. \$3 ³³/₁₀₀*

Book mark :

W. Smith

A. L. Loring | U.S.C.T.

Washington Mining
Co., Col., 2nd Reg't U. S. Col'd Cav

Appears on a

Detachment Muster Roll

of the organization named above

for *Sept to Oct*, 186*4*.

Station *Before Federal Sta-*

Present or absent *Present*

Stoppage, \$ 100 for

Due Gov't, \$ 100 for

Valuation of horse, \$ 100

Valuation of horse equipments, \$ 100

Remarks: *Life of Coy between*
White & Col'd Sections
and from Jan 1st /64 to
Oct. 27th /64.

Book mark:

A. L. Loring

K | 2 Cav. | U.S.C.T.

Washington King
Pvt, Co. D, 2 Reg't U. S. Col'd Cavalry

Appears on a

Detachment Muster Roll

of the organization named above

for Oct 31/64 to Feb 28, 1865.

Station Bermuda Hundred, Va

Present or absent

Stoppage, \$ 100 for

Due Gov't, \$ 100 for

Valuation of horse, \$ 100

Valuation of horse equipments, \$ 100

Remarks: Transferred - Re-
turned to Regiment
per D.O. 21, Col's Ord. 21
D.C. Jan 28/65

Book mark:

W F Roy

55 | **2 Cav.** | **U.S.C.T.**

Washington Irving
Co, Co. D, 2 Reg't U. S. Col'd Cavalry.

Appears on

Company Muster Roll

for *Jan 1st*, 1865.

Present or absent *Present*.

Stoppage, \$ *100* for

Due Gov't, \$ *100* for

Valuation of horse, \$ *100*

Valuation of horse equipments, \$ *100*

Remarks:

Book mark:

Sabine
Copyist.

N | **2 Cav.** | **U.S.C.T.**

Washington King
22, Co. D, 2 Reg't U. S. Col'd Cavalry.

Appears on

Company Muster Roll

for *Mar. & April*, 1865.

Present or absent *Present*

Stoppage, \$ *100* for

Due Gov't, \$ *100* for

Valuation of horse, \$ *100*

Valuation of horse equipments, \$ *100*

Remarks:
.....
.....
.....
.....
.....
.....
.....
.....
.....
.....

Book mark:

S. W. Hillard

K | **2 Cav.** | **U.S.C.T.**

Washington King
221, Co. D, 2 Reg't U. S. Col'd Cavalry.

Appears on

Company Muster Roll

for *May & June*, 1865.

Present or absent *Present*

Stoppage, \$ *100* for

Due Gov't, \$ *100* for

Valuation of horse, \$ *100*

Valuation of horse equipments, \$ *100*

Remarks:

Book mark: -----

S. W. Hillard

MAR 7 1863

Q | **2 Cav. U.S.C.T.**

Washington King
Pot, Co. D, 2 Reg't U. S. Col'd Cavalry.

Appears on

Company Muster Roll

for *April 30 to Aug 31, 1863.*

Present or absent *Present*

Stoppage, \$ *100* for

Due Gov't, \$ *100* for

Valuation of horse, \$ *100*

Valuation of horse equipments, \$ *100*

Remarks: *Due U.S. for Ord. #592*

Book mark:

S. W. Hill

No | **2 Cav.** | **U.S.C.T.**

Washington King
Cople, Co. D, 2 Reg't U. S. Col'd Cavalry.

Appears on

Company Muster Roll

for *Sept & Oct*, 186*5*.

Present or absent *Present*

Stoppage, \$ *100* for

Due Gov't, \$ *5 92* for *Crd*

Valuation of horse, \$ *100*

Valuation of horse equipments, \$ *100*

Remarks:

Book mark:

J W Jones

Co | **2 Cav.** | **U.S.C.T.**

Washington King
Coppe, Co. D, 2 Reg't U. S. Col'd Cavalry.

Appears on

Company Muster Roll

for Nov & Dec, 1865.

Present or absent Present

Stoppage, \$ 100 for

Due Gov't, \$ 5 92 for Ordinance

Valuation of horse, \$ 100

Valuation of horse equipments, \$ 100

Remarks:

Book mark:

S W Forrest
Copyist.

N | **2 Cav.** | **U.S.C.T.**

Washington King

Pvt., Co. L, 2 Reg't U. S. Colored Cav.
Corp

Appears on **Returns** as follows:

June 1865, on duty orderlie
for Maj. Dollard.

Aug 1865, absent on detached
service.

Sept 1865, absent sick.

Oct 1865, (corp) on duty car-
penter R Q M. P.

Nov 1865 to Jan 1866, on duty
R Q M. P.

Book mark :

A. M. Shannon

K | **2 Cav.** | **U.S.C.T.**

Washington King
Cope, Co. *D*, 2 Reg't U. S. Cav'd Cavalry.

Appears on **Co. Muster-out Roll**, dated

Sanchez Santiago Tex Feb 12, 1866.

Muster-out to date *Feb 12, 1866.*

Last paid to *June 30, 1865.*

Clothing account:

Last settled....., 186 ; drawn since \$..... 100

Due soldier \$ *11* ^{*30*} / 100; due U. S. \$..... 100

Am't for cloth'g in kind or money adv'd \$..... 100

Due U. S. for arms, equipments, &c., \$ *5* ^{*47*} / 100

Bounty paid \$..... 100; due \$..... 100

Remarks: *Joined org orgn. was
left till May 2, 64. Then
Coppel. Stole for 1 screw driver
1 thong & brush W 1 spare cone
1 belt & plate. sling & swivel
cut box & cap box \$5 47.*

Book mark :

J W Forrest

King, Washington

Sgt, Co. 10,

2 Regt. S. C. Cav.

2 Enclosures.

Bed Cards	Descriptive Lists
Burial Records	Final Statements
Certs. of Dis. for Discharge	Furloughs
C. M. Charges 2	Med. Des. Lists
Med. Certificates	Orders

Other papers relating to—

Admission to Hosp'l	Furlough
Casualty Sheet (Officer's)	Med. Examination
Confinement	Misc. Information
Contracts	Pay or Clothing
Death or Effects	Personal Reports
Desertions	Rank
Discharge from Hosp'l	Transfer to Hosp'l
Discharge from Service	Transfer to V. R. C.
Duty	Transportation

Red Drs 2nd U.S. Cavalry

Charges & Specifications
agst Washington
King Seryt Lev 2nd

U.S. Cavalry

Charge 1st

Disobedience of Orders

Specification 1st In this the said Sergt. Washington Comp. D 2^d U. S. C. & G. being duly enlisted and mustered into the service of the U. S. in the said Regt. having been ordered by his superior Officer Lieut. J. W. Jones of same Regt. to lay down some boards and go to his quarters, replied the boards belonged to him and wilfully refused to obey said order. This in Camp 2^d U. S. Col. Cav. in the field near Petersburg Va. on or about July 12th 1864.

To which charge and Specifications the accused Sergt. W. King pleaded as follows

To the charge, Not Guilty

To the Specification, Not Guilty

The Court after mature consideration of the evidence finds the accused Sergt. King Comp. D 2^d U. S. Col. Cav. as follows

Of the Charge Guilty

Of the Specification, Guilty, Except the word "wilfully"

and the Court does therefore sentence him the said
Sergt Washington King Comp D 2^d U. S. C. C. ~~as follows~~
To be reduced to the ranks and to forfeit Ten (10) Dollars
of his monthly pay

The Court is thus lenient as the accused seems to have
acted rather from ignorance than malice, but warns him
and other enlisted men that they are bound to obey the
lawful orders of their superior Officers without regard
whether they are attached to the same company or not

Head Quarters, 2nd U.S. C.C.
H. & M. 98.

Record of a Regt. Ct. Martial
in the case of Washington King
Sergeant, Comp. D, 2nd U.S. C.C.

Respectfully referred to the
Decision of Refrimental forward
2nd U.S. C. Cavalry.

Al. Abbott
Major 2nd U.S. C.C.

Approved & referred
forwarded
G. W. Cole
Capt 2nd U.S. C.C.

M. Chas

Head Quarters 2nd U.S. C.C.
July 9 1864

Head Quarters 2nd U.S. C.C.
18th A.C. July 19 1864

Respectfully returned to
Col Geo W. Cole Comd
2nd U.S. C.C. The ^{Prisoner} findings
and sentence in the
case of Sgt Washington
King Co D. 2nd U.S. C.C. are
approved and Col Cole
will cause the sentence
to be executed

By Command of
Col S. A. Dimes
S. W. Vanmeyer
Capt & a. a. a.

Before a Regimental Court Martial convened by virtue of Special Order No. 20
by Major was tried before Major A. E. Colbraut, 2nd U.S. Col. Cavalry
Sergeant Washington King
Comp D, 2nd U.S. C.C.
Charge 1st

Disobedience of Orders.
Specification 1st

In this that the said Sergeant Washington King, Comp D, 2nd U.S. C.C. being duly enlisted & mustered into the service of the U.S. in the said Regiment having been ordered by his Superior Officer 1st Lieut. J. W. Jones of same Regiment to lay down some boards & go to his quarters, replied the boards belonged to him & wilfully refused to obey said order, this in Camp 2nd U.S. Col. Cavalry in the Field nr Petersburg Va on or about July 12th 1864.

To which charge & Specification the accused Sergt. W. King pleaded as follows

To the Charge "Not Guilty"

To the Specification "Not Guilty"

Lieut. J. W. Jones being duly sworn testifies that on or about the 12th July aforesaid, Sergt. W. King being ordered by him to lay down some boards brought to camp for building quarters, refused to do so, he also wilfully refused to obey the said Lieut's peremptory order to go to his quarters. Lieut. Thomas Hutton, Comp F, 2nd U.S. C.C. corroborates so far as refusing to go to his quarters, Sergt. King dropped the boards after a little hesitation.

The accused Sergt. W. King makes a statement to the effect that he had been ordered by the Sergt. Williams, 1st Sergeant

of his Troop to get the boards & also that he did not think he was bound to obey the orders of an officer belonging to another Company.

The Court after mature consideration of the evidence finds the accused Sergeant Washington King, Comp: D, 2nd U.S.C.C. as follows

Of the Charge "Guilty"
 Of the Specification "Guilty, except the word 'wilfully'"
 & the Court does therefore sentence him the said Sgt. W. King to be reduced to the Ranks and to forfeit Ten (10) Dollars of his monthly pay.

The Court is thus lenient as the accused seems to have acted rather from ignorance than malice, but warns him & other enlisted men that they are bound to obey the lawful orders of their superior Officers without regard to whether they are attached to the same company or not.

Albion
 Major 2nd U.S. Cavalry.

Henry

Co. *H*, 2 U. S. Col'd Cav.

Private

Private

CARD NUMBERS.

1	5325881	26
2	5325965	27
3	5326052	28
4	5326140	29
5	5326221	30
6	5326304	31
7	5326379	32
8	5326460	33
9	5326542	34
10	5326625	35
11	5326704	36
12	5326785	37
13	5326857	38
14	5326929	39
15	40726272	40
16		41
17		42
18		43
19		44
20		45
21		46
22		47
23		48
24		49
25		50

Book Mark:.....

See also.....

8791440. Rogo.
D. 1169147 P.O. Mtm

L. Ballary Cur

K | **2 Cav.** | **U.S.C.T.**

Henry Knock

Cpt., Co. H., 2 Reg't U. S. Col'd Cav.

Age 30 years.

Appears on

Company Muster-in Roll

of the organization named above. Roll dated

Fort Monroe Va., Jan 8, 1864.

Muster-in to date Jan 8, 1864.

Joined for duty and enrolled:

When Jan 1, 1864.

Where Ponchartraine Va.

Period 3 years.

Valuation of horse, \$ 100

Valuation of horse equipments, \$ 100

Remarks :

Book mark :

A. J. Anderson

A | **2 Cav.** | **U.S.C.T.**

Henry + J. Knock
Church
Cpl, Co. H, 2 Reg't U. S. Col'd Cavalry.

Appears on

Company Muster Roll

From date of Enlistment to *Feb 29*, 1864.

Present or absent *Present*

Stoppage, \$ *100* for

Due Gov't, \$ *100* for

Valuation of horse, \$ *100*

Valuation of horse equipments, \$ *100*

Remarks:

+ Corrected by L Ballard & r

Book mark:

A. J. Anderson

A | **2 Cav.** | **U.S.C.T.**

Henry Knock
Cvt, Co. H, 2 Reg't U. S. Col'd Cavalry.

Appears on

Company Muster Roll

for *March & April*, 1864.

Present or absent *Present*

Stoppage, \$ *100* for

Due Gov't, \$ *100* for

Valuation of horse, \$ *100*

Valuation of horse equipments, \$ *100*

Remarks:

Book mark:

A. J. Anderson

H | **2 Cav.** | **U.S.C.T.**

Henry Knorr

Pat, Co. H, 2 Reg't U. S. Col'd Cavalry.

Appears on

Company Muster Roll

for *May & June*, 1864.

Present or absent *Present*

Stoppage, \$ *100* for

Due Gov't, \$ *100* for

Valuation of horse, \$ *100*

Valuation of horse equipments, \$ *100*

Remarks:

Book mark:

A. J. Anderson

N | **2 Cav.** | **U.S.C.T.**

Henry Knock
Priv, Co. H, 2 Reg't U. S. Col'd Cavalry.

Appears on

Company Muster Roll

for *May 1" to Sep 1"*, 186*4*.

Present or absent *Present*

Stoppage, \$ *100* for

Due Gov't, \$ *100* for

Valuation of horse, \$ *100*

Valuation of horse equipments, \$ *100*

Remarks:

Book mark: -----

W. G. Ferguson
Copyist.

16 | **2 Cav.** | **U.S.C.T.**

Henry Brock
Priv, Co. H, 2 Reg't U. S. Col'd Cavalry.

Appears on

Company Muster Roll

for *Sept & Oct.*, 1864.

Present or absent *Present*

Stoppage, \$ 100 for

Due Gov't, \$ 100 for

Valuation of horse, \$ 100

Valuation of horse equipments, \$ 100

Remarks:

Book mark:

(358)

W. J. Ferguson
Copyist.

10 | 2 Cav. | U.S.C.T.

Henry Knock

Priv., Co. H, 2 Reg't U. S. Col'd Cavalry.

Appears on

Company Muster Roll

for *Nov. & Dec.*, 1864.

Present or absent *Present*

Stoppage, \$ 100 for

Due Gov't, \$ 100 for

Valuation of horse, \$ 100

Valuation of horse equipments, \$ 100

Remarks: *On daily duty as
Co. Cook*

Book mark: *5000000000*

W B Ferguson

10 | 2 Cav. | U.S.C.T.

Benny Brock
Priv, Co. H, 2 Reg't U. S. Col'd Cavalry.

Appears on

Company Muster Roll

for *Jan. to Feb.*, 1865.

Present or absent *Absent*

Stoppage, \$ 100 for

Due Gov't, \$ 100 for

Valuation of horse, \$ 100

Valuation of horse equipments, \$ 100

Remarks: *Absent at Norfolk Va.*

Book mark:

W. Ferguson
Copyist.

✓

2 Cav. U.S.C.T.

Henry Knock
Private, Co. H, 2 Reg't U. S. Col'd Cavalry.

Appears on

Company Muster Roll

for March and April, 1865.

Present or absent absent -

Stoppage, \$ 100 for

Due Gov't, \$ 100 for

Valuation of horse, \$ 100

Valuation of horse equipments, \$ 100

Remarks:
Sicento Camp, Petersburg,
Va.

Book mark:

C. J. Powell

K | **2 Cav.** | **U.S.C.T.**

Henry Knock
Private, Co. H, 2 Reg't U. S. Col'd Cavalry.

Appears on

Company Muster Roll

for May and June, 1865.

Present or absent Present

Stoppage, \$ 100 for

Due Gov't, \$ 100 for

Valuation of horse, \$ 100

Valuation of horse equipments, \$ 100

Remarks:

Book mark:

C. J. Powell

K | **2 Cav.** | **U.S.C.T.**

Henry Knock

Private, Co. H, 2 Reg't U. S. Col'd Cavalry.

Appears on

Company Muster Roll

for *July and Aug.*, 1865.

Present or absent *Present*

Stoppage, \$ *100* for

Due Gov't, \$ *100* for

Valuation of horse, \$ *100*

Valuation of horse equipments, \$ *100*

Remarks: -----

Book mark: -----

C. J. Powell

H | **2 Cav. U.S.C.T.**

Henry Knorr
Sgt, Co. H, 2 Reg't U. S. Col'd Cavalry.

Appears on

Company Muster Roll

for *Sep & Oct*, 1865.

Present or absent *Present*

Stoppage, \$ *100* for

Due Gov't, \$ *100* for

Valuation of horse, \$ *100*

Valuation of horse equipments, \$ *100*

Remarks:

Book mark:

W. A. Wiley
Copyist.

H | **2 Cav.** | **U.S.C.T.**

Henry Knott
PT, Co. H, 2 Reg't U. S. Col'd Cavalry.

Appears on

Company Muster Roll

for *Nov & Dec*, 1865.

Present or absent *Present*

Stoppage, \$ 100 for

Due Gov't, \$ 100 for

Valuation of horse, \$ 100

Valuation of horse equipments, \$ 100

Remarks:

Book mark:

Upthief
Copyist.

N | **2 Cav.** | **U.S.C.T.**

Henry Knock,

Pr., Co. N, 2 Reg't U. S. Colored Cav.

Appears on **Returns** as follows:

Jan 1844 to Jan 1845, on
duty company cook.

May 1845 to Jan 1866, on duty
as company cook.

Book mark :

A. M. Shanness

H | **2 Cav.** | **U.S.C.T.**

Henry Knocks

Plt, Co. *H*, 2 Reg't U. S. Col'd Cavalry.

Appears on **Co. Muster-out Roll**, dated *Brayos Santiago Tex Feb 12*, 1866.

Muster-out to date *Feb 12*, 1866.

Last paid to *Jan 30*, 1865.

Clothing account:

Last settled....., 186 ; drawn since \$.....¹⁰⁰

Due soldier \$.....¹⁰⁰; due U. S. \$*36*¹⁸.....¹⁰⁰

Am't for cloth'g in kind or money adv'd \$.....¹⁰⁰

Due U. S. for arms, equipments, &c., \$.....¹⁰⁰

Bounty paid \$.....¹⁰⁰; due \$.....¹⁰⁰

Remarks: *joined at orig reg't*

.....
.....
.....
.....
.....

Book mark:

E. G. Hill
Copyist.

927 Jacob
Knock Jake

Co H, 2 U. S. Col'd Cav.

Private | Private

CARD NUMBERS.

1	5325882	26
2	5325964	27
3	5326051	28
4	5326139	29
5	5326219	30
6	5326303	31
7	5326378	32
8	5326459	33
9	5326541	34
10	5326626	35
11	5326705	36
12	5326784	37
13	5326856	38
14	5326928	39
15	40726273	40
16		41
17		42
18		43
19		44
20		45
21		46
22		47
23		48
24		49
25		50

Book Mark:

See also

K | **2 Cav.** | **U.S.C.T.**

Jack Thorne

Plt, Co. 76, 2 Reg't U. S. Col'd Cav.

Age 35 years.

Appears on

Company Muster-in Roll

of the organization named above. Roll dated

Fort Monroe Va, Jan 8, 1864.

Muster-in to date Jan 8, 1864.

Joined for duty and enrolled:

When Jan 1, 1864.

Where Pangatigue Va

Period 3 years.

Valuation of horse, \$ 100

Valuation of horse equipments, \$ 100

Remarks : _____

Book mark : _____

A. J. Anderson

MAR 7 1864

H | **2 Cav. | U.S.C.T.**

Jacob Kurch

Plt, Co. H, 2 Reg't U. S. Col'd Cavalry.

Appears on

Company Muster Roll

for *Term date of Enrolment to Feb 29*, 1864.

Present or absent *Present*

Stoppage, \$.....100 for

Due Gov't, \$.....100 for

Valuation of horse, \$.....100

Valuation of horse equipments, \$.....100

Remarks:

.....

.....

.....

.....

.....

.....

Book mark:

.....

A. J. Anderson

A | **2 Cav.** | **U.S.C.T.**

Jacob Knock

Plt, Co. H, 2 Reg't U. S. Col'd Cavalry.

Appears on

Company Muster Roll

for *March & April*, 1864.

Present or absent *Present*

Stoppage, \$ 100 for

Due Gov't, \$ 100 for

Valuation of horse, \$ 100

Valuation of horse equipments, \$ 100

Remarks:

Book mark:

A. J. Anderson

K | **2 Cav.** | **U.S.C.T.**

Jacob Knorr

Pvt., Co. H, 2 Reg't U. S. Col'd Cavalry.

Appears on

Company Muster Roll

for *May & June*, 1864.

Present or absent *Present*

Stoppage, \$ *100* for

Due Gov't, \$ *100* for

Valuation of horse, \$ *100*

Valuation of horse equipments, \$ *100*

Remarks:

Book mark:

A. J. Anderson

NA 75

h | **2 Cav. | U.S.C.T.**

Jacob Knock
Priv, Co. H, 2 Reg't U. S. Col'd Cavalry.

Appears on

Company Muster Roll

for *May 1* " *to Sep. 1* ", 186 *4*.

Present or absent *Present*

Stoppage, \$ *100* for

Due Gov't, \$ *100* for

Valuation of horse, \$ *100*

Valuation of horse equipments, \$ *100*

Remarks:

Book mark: -----

(358)

W. B. Ferguson
Copyist.

10 | 2 Cav. | U.S.C.T.

Jacob Knock
Priv, Co. H, 2 Reg't U. S. Col'd Cavalry.

Appears on

Company Muster Roll

for Sept. & Oct., 1864.

Present or absent Present

Stoppage, \$ 100 for

Due Gov't, \$ 100 for

Valuation of horse, \$ 100

Valuation of horse equipments, \$ 100

Remarks:

Book mark:

W. B. Ferguson
Copyist.

10 | 2 Cav. | U.S.C.T.

Jacob Knock
Private, Co. H, 2 Reg't U. S. Col'd Cavalry.

Appears on

Company Muster Roll

for Nov. & Dec., 1864.

Present or absent Present

Stoppage, \$ 100 for

Due Gov't, \$ 100 for

Valuation of horse, \$ 100

Valuation of horse equipments, \$ 100

Remarks:

Book mark:

W B Ferguson
Copyist.

10 | **2 Cav.** | **U.S.C.T.**

Jacob Knock
Priv, Co. H, 2 Reg't U. S. Col'd Cavalry.

Appears on

Company Muster Roll

for *Jan. & Feb.*, 1865.

Present or absent *Present*

Stoppage, \$ *100* for

Due Gov't, \$ *100* for

Valuation of horse, \$ *100*

Valuation of horse equipments, \$ *100*

Remarks:

Book mark: -----

(358)

W. B. Ferguson

Copyist.

K | **2 Cav.** | **U.S.C.T.**

Jacob Knock
Private, Co. H, 2 Reg't U. S. Col'd Cavalry.

Appears on

Company Muster Roll

for March and April, 1865.

Present or absent Present

Stoppage, \$ 100 for

Due Gov't, \$ 100 for

Valuation of horse, \$ 100

Valuation of horse equipments, \$ 100

Remarks:

Book mark: 512

C. J. Powell

K | **2 Cav.** | **U.S.C.T.**

Joseph Knock
Private, Co. H, 2 Reg't U. S. Col'd Cavalry.

Appears on

Company Muster Roll

for *May and June*, 186*5*.

Present or absent *Present*

Stoppage, \$ *100* for

Due Gov't, \$ *100* for

Valuation of horse, \$ *100*

Valuation of horse equipments, \$ *100*

Remarks:

Book mark:

C. Powell

K | **2 Cav.** | **U.S.C.T.**

Jacob Knott
Private, Co. H, 2 Reg't U. S. Col'd Cavalry.

Appears on

Company Muster Roll

for July and Aug., 1865.

Present or absent Present

Stoppage, \$ 100 for

Due Gov't, \$ 100 for

Valuation of horse, \$ 100

Valuation of horse equipments, \$ 100

Remarks:

Book mark:

C. J. Powell

R | **2 Cav.** | **U.S.C.T.**

Jacob Knook
Pvt, Co. H, 2 Reg't U. S. Col'd Cavalry.

Appears on

Company Muster Roll

for *Sep 9 Oct*, 186*5*.

Present or absent *Present*

Stoppage, \$ 100 for

Due Gov't, \$ 100 for

Valuation of horse, \$ 100

Valuation of horse equipments, \$ 100

Remarks:

Book mark: _____

G. M. Kelly
Copyist

NOV 7 1865

H | **2 Cav.** | **U.S.C.T.**

Jacob Knook
PT, Co. H, 2 Reg't U. S. Col'd Cavalry.

Appears on

Company Muster Roll

for *Nov & Dec*, 1865.

Present or absent *Present*

Stoppage, \$ *100* for

Due Gov't, \$ *100* for

Valuation of horse, \$ *100*

Valuation of horse equipments, \$ *100*

Remarks:

Book mark: -----

(358)

W. D. Hill
Coryist.

K | **2 Cav.** | **U.S.C.T.**

^{*}
Jacob Knock

Pr, Co. *H*, 2 Reg't U. S. Colored Cav.

Appears on **Returns** as follows:

*Sept 1865 on daily duty in
Repl Qm Dept.*

*Oct 1865 on duty in Qm,
Dept. profession unknown.*

*Nov 1865 to Jan 1866 on duty
in Qm Dept as
carpenter.*

Book mark :

A M Shannors

N | **2 Cav.** | **U.S.C.T.**

Jacob Knocks

Plt., Co. *H*, 2 Reg't U. S. Col'd Cavalry.

Appears on **Co. Muster-out Roll**, dated *Bravo Santiago Tex, Feb. 12*, 1866.

Muster-out to date *Feb. 12*, 1866.

Last paid to *June 30*, 1865.

Clothing account:

Last settled....., 186 ; drawn since \$..... 100

Due soldier \$..... 100; due U. S. \$ /..... ⁵⁸100

Am't for cloth'g in kind or money adv'd \$..... 100

Due U. S. for arms, equipments, &c., \$..... ³⁷100

Bounty paid \$..... 100; due \$..... 100

Remarks: *joined at orig orgⁿ*
Step Seru done commens

Book mark :

J. G. Kelly
Coylist.

922 Jacob
Knock Jake

Co. A, 2 U. S. Col'd Cav.

Private Sergeant

CARD NUMBERS.

1	5325880	26
2	5325918	27
3	5326006	28
4	5326095	29
5	5326181	30
6	5326268	31
7	5326342	32
8	5326415	33
9	5326498	34
10	5326580	35
11	5326663	36
12	5326746	37
13	5326820	38
14	5326892	39
15		40
16		41
17		42
18		43
19		44
20		45
21		46
22		47
23		48
24		49
25		50

Book Mark:

See also

N | **2 Cav. | U.S.C.T.**

Jacob Knack

Pvt., Co. 76, 2 Reg't U. S. Col'd Cav.

Age 21 years.

Appears on

Company Muster-in Roll

of the organization named above. Roll dated

Fort Sumner Va, Jan 8, 1864.

Muster-in to date Jan 8, 1864.

Joined for duty and enrolled:

When Jan 1, 1864.

Where Conestoga Va

Period 30 years.

Valuation of horse, \$ 100

Valuation of horse equipments, \$ 100

Remarks :

Book mark :

(356) A. J. Anderson Copyist.

K | **2 Cav. | U.S.C.T.**

Jake Smith

Capt, Co. H, 2 Reg't U. S. Col'd Cavalry.

Appears on

Company Muster Roll

for *from date of Enrollment to Feb 29*, 1864.

Present or absent *Present*

Stoppage, \$ *100* for

Due Gov't, \$ *100* for

Valuation of horse, \$ *100*

Valuation of horse equipments, \$ *100*

Remarks: *Septth leave Jan 1st / 64. per G.O. No. 5. "Red grs. 2 U.S. Col'd Cav. leave."*

Book mark:

A. J. Anderson

2 | **2 Cav. | U.S.C.T.**

Jake Snook
Capt, Co. H, 2 Reg't U. S. Col'd Cavalry.

Appears on

Company Muster Roll

for *March & April*, 1864.

Present or absent *Present*

Stoppage, \$ *100* for

Due Gov't, \$ *100* for

Valuation of horse, \$ *100*

Valuation of horse equipments, \$ *100*

Remarks:

Book mark:

A. J. Anderson

A | **2 Cav. U.S.C.T.**

John Knott

kn, Co. H, 2 Reg't U. S. Col'd Cavalry.

Appears on

Company Muster Roll

for *May & June*, 1864.

Present or absent *Present*

Stoppage, \$ 100 for

Due Gov't, \$ 100 for

Valuation of horse, \$ 100

Valuation of horse equipments, \$ 100

Remarks:

Book mark:

A. J. Anderson

N | **2 Cav.** | **U.S.C.T.**

Lake Brock
Cop, Co. H, 2 Reg't U. S. Col'd Cavalry.

Appears on

Company Muster Roll

for *May 1" to Sep. 1"*, 1864.

Present or absent *Present*

Stoppage, \$ *100* for

Due Gov't, \$ *100* for

Valuation of horse, \$ *100*

Valuation of horse equipments, \$ *100*

Remarks:

Book mark:

W. B. Ferguson

16 | **2 Cav.** | **U.S.C.T.**

Jake Brock
Coppl, Co. H, 2 Reg't U. S. Col'd Cavalry.

Appears on

Company Muster Roll

for *Sept. & Oct.*, 1864.

Present or absent *Absent*

Stoppage, \$ *100* for

Due Gov't, \$ *100* for

Valuation of horse, \$ *100*

Valuation of horse equipments, \$ *100*

Remarks: *Absent sick in
Genl. Hospital.*

Book mark:

W. Ferguson

K

2 Cav.

U.S.C.T.

Jake Brock

Capt., Co. H, 2 Reg't U. S. Col'd Cavalry.

Appears on

Company Muster Roll

for *Nov. & Dec.*, 1864.

Present or absent *Present*

Stoppage, \$ *100* for

Due Gov't, \$ *100* for

Valuation of horse, \$ *100*

Valuation of horse equipments, \$ *100*

Remarks:

Book mark:

W. H. Ferguson

10 | 2 Cav. | U.S.C.T.

Jake Knock
Sergt., Co. H, 2 Reg't U. S. Col'd Cavalry.

Appears on

Company Muster Roll

for *Jan. & Feb.*, 1865.

Present or absent *Present*

Stoppage, \$ *100* for

Due Gov't, \$ *100* for

Valuation of horse, \$ *100*

Valuation of horse equipments, \$ *100*

Remarks: *App'td. Sergt. from
Corpl. Jan. 1865.*

Book mark:

(358)

W. B. Ferguson

Copyist.

K | 2 Cav. | U.S.C.T.

John Knock
Dubly
Serjeant, Co. H, 2 Reg't U. S. Col'd Cavalry.

Appears on

Company Muster Roll

for *March and April*, 1865.

Present or absent *absent*

Stoppage, \$ 100 for

Due Gov't, \$ 100 for

Valuation of horse, \$ 100

Valuation of horse equipments, \$ 100

Remarks:
present at camp, Peters-
Burgh. Va

Book mark:

C. G. Powell

K | **2 Cav.** | **U.S.C.T.**

Jake Knock
Sergt, Co. H, 2 Reg't U. S. Col'd Cavalry.

Appears on

Company Muster Roll

for *May and June*, 1865.

Present or absent *Present*

Stoppage, \$ 100 for

Due Gov't, \$ 100 for

Valuation of horse, \$ 100

Valuation of horse equipments, \$ 100

Remarks:
.....
.....
.....
.....
.....
.....
.....
.....

Book mark:

C. J. Powell

K | **2 Cav.** | **U.S.C.T.**

Just Knock

Sergeant, Co. H, 2 Reg't U. S. Col'd Cavalry.

Appears on

Company Muster Roll

for *July and Aug.*, 186*5*.

Present or absent *Present*

Stoppage, \$ *100* for

Due Gov't, \$ *100* for

Valuation of horse, \$ *100*

Valuation of horse equipments, \$ *100*

Remarks:

Book mark:

C. Powell

K | **2 Cav.** | **U.S.C.T.**

Jacob Knorr

Serjt, Co. H, 2 Reg't U. S. Col'd Cavalry.

Appears on

Company Muster Roll

for *Sep & Oct*, 186*5*.

Present or absent *Present*

Stoppage, \$.....*100* for

Due Gov't, \$.....*100* for

Valuation of horse, \$.....*100*

Valuation of horse equipments, \$.....*100*

Remarks:

Book mark:

Y. Whitt
Copyist.

K | **2 Cav.** | **U.S.C.T.**

Jacob Knob

Sgt, Co. H, 2 Reg't U. S. Col'd Cavalry.

Appears on

Company Muster Roll

for *Nov & Dec*, 1865.

Present or absent *Present*

Stoppage, \$ 100 for

Due Gov't, \$ 100 for

Valuation of horse, \$ 100

Valuation of horse equipments, \$ 100

Remarks:

Book mark: -----

(358)

V. J. Phillips
Copyist

K

N | **2 Cav.** | **U.S.C.T.**

Jacob Knocks

Serjt, Co. *H*, 2 Reg't U. S. Col'd Cavalry.

Appears on **Co. Muster-out Roll**, dated

Brazos Santiago Tex Feb 12, 1866.

Muster-out to date *Feb 12*, 1866.

Last paid to *June 30*, 1865.

Clothing account:

Last settled....., 186 ; drawn since \$..... $\frac{100}{100}$

Due soldier \$..... $\frac{100}{100}$; due U. S. \$ *33* $\frac{75}{100}$

Am't for cloth'g in kind or money adv'd \$..... $\frac{100}{100}$

Due U. S. for arms, equipments, &c., \$..... $\frac{100}{100}$

Bounty paid \$..... $\frac{100}{100}$; due \$..... $\frac{100}{100}$

Remarks: *joined at orig orgn was private to Jan 29/64 when appt serjt*

Book mark:

W. H. Ship
Copyist.

923
Knox Henry

Co I, 2 U. S. Col'd Cav.

Private | Private

CARD NUMBERS.

1	5327026	26
2	5327102	27
3	5327188	28
4	5327277	29
5	5327359	30
6	5327446	31
7	5327539	32
8	5327629	33
9	5327719	34
10	5327813	35
11	5327903	36
12	5327989	37
13	5328073	38
14	5328154	39
15	9087822	40
16		41
17		42
18		43
19		44
20		45
21		46
22		47
23		48
24		49
25		50

Book Mark: EB-12-377

See also

K | **2 Cav.** | **U.S.C.T.**

Henry Knox

....., Co. *D*, 2 Reg't U. S. Col'd Cav.

Appears on

Company Descriptive Book

of the organization named above.

DESCRIPTION.

Age *38* years; height *5* feet *3 1/2* inches.

Complexion *Dark*

Eyes *Black*; hair *Black*

Where born *Wekamack, Va.*

Occupation *Farmer*

ENLISTMENT.

When *Jan. 1*, 186*4*.

Where *Pongetaque, Va.*

By whom *Col. Cole*; term *3* y'rs.

Remarks :
.....
.....
.....
.....
.....
.....
.....
.....
.....
.....

F. B. Smith
Copyist.

K | **2 Cav.** | **U.S.C.T.**

Henry Knox

Put Co. *I*, 2 Reg't U. S. Col'd Cav.

Age *36* years.

Appears on

Company Muster-in Roll

of the organization named above. Roll dated

Fortress Monroe Va *Jan 8* 1864.

Muster-in to date *Jan 8*, 1864.

Joined for duty and enrolled:

When *Jan 1*, 1864.

Where *Pungoteague Va.*

Period *3* years.

Valuation of horse, \$ 100

Valuation of horse equipments, \$ 100

Remarks :

Book mark :

O. A. Ward

A | **2 Cav.** | **U.S.C.T.**

Henry Knox
Sgt, Co. I, 2 Reg't U. S. Col'd Cavalry.

Appears on

Company Muster Roll

for *Enrollment to Feb 29, 1864*

Present or absent *Present*

Stoppage, \$ 100 for

Due Gov't, \$ 100 for

Valuation of horse, \$ 100

Valuation of horse equipments, \$ 100

Remarks:

Book mark: -----

P. A. Ward

H | **2 Cav. U.S.C.T.**

Henry Knox

Put, Co. I, 2 Reg't U. S. Col'd Cavalry.

Appears on

Company Muster Roll

for *Mar 2 Apr*, 186*4*.

Present or absent *Present*

Stoppage, \$ *100* for

Due Gov't, \$ *100* for

Valuation of horse, \$ *100*

Valuation of horse equipments, \$ *100*

Remarks:

Book mark:

P. A. Ward

A | **2 Cav.** | **U.S.C.T.**

Henry Knox
Sgt, Co. I, 2 Reg't U. S. Col'd Cavalry.

Appears on

Company Muster Roll

for *May & June* 1864

Present or absent *Present*

Stoppage, \$ *100* for

Due Gov't, \$ *100* for

Valuation of horse, \$ *100*

Valuation of horse equipments, \$ *100*

Remarks:

Book mark:

D. A. Ward

K | **2 Cav.** | **U.S.C.T.**

Henry Knox
Pi Co. I, 2 Reg't U. S. Col'd Cavalry.

Appears on

Company Muster Roll

for *July & Aug*, 186 *7*

Present or absent *Present*

Stoppage, \$ *100* for

Due Gov't, \$ *100* for

Valuation of horse, \$ *100*

Valuation of horse equipments, \$ *100*

Remarks:

Book mark: -----

O. G. Smith

H | **2 Cav.** | **U.S.C.T.**

Henry Knox

Pri, Co. I, 2 Reg't U. S. Col'd Cavalry.

Appears on

Company Muster Roll

for *Sept & Oct*, 1867.

Present or absent *Present*

Stoppage, \$ *100* for

Due Gov't, \$ *100* for

Valuation of horse, \$ *100*

Valuation of horse equipments, \$ *100*

Remarks:

Book mark: -----

O. Smith

K | **2 Cav.** | **U.S.C.T.**

Henry King
Pri, Co. I, 2 Reg't U. S. Col'd Cavalry.

Appears on

Company Muster Roll

for *Nov & Dec*, 1864.

Present or absent *Present*

Stoppage, \$ 100 for

Due Gov't, \$ 100 for

Valuation of horse, \$ 100

Valuation of horse equipments, \$ 100

Remarks:

Book mark:

C. G. Smith

15 | **2 Cav.** | **U.S.C.T.**

Henry Knox
Pri, Co. I, 2 Reg't U. S. Col'd Cavalry.

Appears on

Company Muster Roll

for Jan - Feb, 1865.

Present or absent Present

Stoppage, \$ 100 for

Due Gov't, \$ 100 for

Valuation of horse, \$ 100

Valuation of horse equipments, \$ 100

Remarks:

Book mark:

C. G. Smith

K | **2 Cav.** | **U.S.C.T.**

Henry Knox

ser, Co. I, 2 Reg't U. S. Col'd Cavalry.

Appears on

Company Muster Roll

for *Mch & Apr*, 186*5*.

Present or absent *Present*

Stoppage, \$ *100* for

Due Gov't, \$ *100* for

Valuation of horse, \$ *100*

Valuation of horse equipments, \$ *100*

Remarks:

Book mark:

D. J. Gifford

A | **2 Cav.** | **U.S.C.T.**

Henry Knox

Private, Co. I, 2 Reg't U. S. Col'd Cavalry.

Appears on

Company Muster Roll

for *May & June*, 186*5*.

Present or absent *Present*

Stoppage, \$ *100* for

Due Gov't, \$ *100* for

Valuation of horse, \$ *100*

Valuation of horse equipments, \$ *100*

Remarks:

Book mark:

(358)

P. J. Griffith

Copyist.

A | **2 Cav.** | **U.S.C.T.**

Henry Knox

priv, Co. I, 2 Reg't U. S. Col'd Cavalry.

Appears on

Company Muster Roll

for *July & August, 1865.*

Present or absent *Present*

Stoppage, \$ *100* for

Due Gov't, \$ *100* for

Valuation of horse, \$ *100*

Valuation of horse equipments, \$ *100*

Remarks:

Book mark:

D. J. Giffith

H. | **2 Cav.** | **U.S.C.T.**

Henry Knott

Priv, Co. I, 2 Reg't U. S. Col'd Cavalry.

Appears on

Company Muster Roll

for *Sept. 7 Oct.*, 186*5*.

Present or absent *Present*

Stoppage, \$ *100* for

Due Gov't, \$ *100* for

Valuation of horse, \$ *100*

Valuation of horse equipments, \$ *100*

Remarks:

Book mark:

Poe

N. | **2 Cav.** | **U.S.C.T.**

Henry Keot.
Priv, Co. I, 2 Reg't U. S. Col'd Cavalry.

Appears on

Company Muster Roll

for *Nov. & Dec.*, 186*5*.

Present or absent *Present.*

Stoppage, \$ *100* for

Due Gov't, \$ *100* for

Valuation of horse, \$ *100*

Valuation of horse equipments, \$ *100*

Remarks:

Book mark: -----

Pol

H. | **2 Cav.** | **U.S.C.T.**

Henry Knox,

Priv, Co. *I*, 2 Reg't U. S. Col'd Cavalry.

Appears on **Co. Muster-out Roll**, dated
Brazos Santiago Tex, Feb. 12, 1866.
Muster-out to date *Feb. 12*, 1866.
Last paid to *June 30*, 1865.

Clothing account:

Last settled....., 186 ; drawn since \$.....100
Due soldier \$ *25-07*/₁₀₀; due U. S. \$.....100
Am't for cloth'g in kind or money adv'd \$.....100

Due U. S. for arms, equipments, &c., \$.....100
Bounty paid \$.....100; due \$.....100

Remarks: *Joined at orig orgg.*

Book mark: *V117.P43.C.70-PB.12.P.377.*
(over)

Pol

JAN. - 7

5328154

★ 1891 ★

See CB. 12-377. Died on
or about March 29th 66 at
Castroville Va. of small Pox
Contracted in the line of
duty as a soldier subse-
quently to the muster-out
of his Co. & prior to its final
payment.

924

Knowl Henry C.

Co B & K, 2 U. S. Col'd Cav.

2nd Lt Lieutenant | *1st Lt* Lieutenant

CARD NUMBERS.

1	5315340	26
2	5318468	27
3	5318581	28
4	5318701	29
5	5318920	30
6	5319721	31
7	5316853	32
8	5315339	33
9	5328537	34
10	5328622	35
11	5328711	36
12	5328800	37
13	5328883	38
14	5329061	39
15	5329398	40
16	40726274	41
17	42722154	42
18	42722191	43
19	43225712	44
20		45
21		46
22		47
23		48
24		49
25		50

Book Mark: *3610-C. I. 84*

See also

K | 2 Cav, | U.S.C.T.

Henry Lorenzo Knox

2nd Lieut Co., 2nd Reg't U. S. Col'd Cav'y,

Age 36 years.

Appears on an

Individual Muster-in Roll

of the organization named above. Roll dated

Ft. Monroe, Va., Jan. 28, 1864.

Muster-in to date Jan. 10, 1864.

Joined for duty and enrolled :

When Jan. 10, 1864 .

Where Ft. Monroe, Va.

Period 3 years.

Valuation of horse, \$ 100

Valuation of horse equipments, \$ 100

Remarks : Promoted from Private
118th New York Vols, Mustered
pursuant to authority dated
War Dept. A.G.O. Dec. 26, 1863,

Book mark :

C. Owen

K | **2 Cav.** | **U.S.C.T.**

Henry T. Knox
2^d Lieut, Co. B. 2 Reg't U. S. Col'd Cavalry.

Appears on

Company Muster Roll

for *Dec. 22/63 to Feb. 29, 1864.*

Present or absent *Present*

Stoppage, \$ 100 for

Due Gov't, \$ 100 for

Valuation of horse, \$ 100

Valuation of horse equipments, \$ 100

Remarks :

Book mark :

E. H. Hewster

K | **2 Cav.** | **U.S.C.T.**

Henry T. Knox
20 Lt., Co. B. 2 Reg't U. S. Col'd Cavalry.

Appears on

Company Muster Roll

for *March & April*, 1864.

Present or absent *Present*

Stoppage, \$ 100 for

Due Gov't, \$ 100 for

Valuation of horse, \$ 100

Valuation of horse equipments, \$ 100

Remarks :

Book mark :

E. H. Winter

K | **2 Cav.** | **U.S.C.T.**

Henry T. Knox
2^d Lt., Co. B. 2 Reg't U. S. Col'd Cavalry.

Appears on

Company Muster Roll

for *May & June*, 1864.

Present or absent *Present*

Stoppage, \$ 100 for

Due Gov't, \$ 100 for

Valuation of horse, \$ 100

Valuation of horse equipments, \$ 100

Remarks: *In arrest*

Book mark:

E. H. Hunter

15 | 9 Cav. | U.S.C.T.

Henry J. Snow

2^d Lt., Co. D Reg't U. S. Col'd Cav.

Appears on an

Individual Muster-out Roll

of the organization named above. Roll dated

Pennada Hundred Pa, June 30, 1864.

Muster-out to date June 29, 1864.

Last paid to Apr. 30, 1864.

Clothing account:

Last settled _____, 186 ; drawn since \$ 100

Due soldier \$ 100; due U. S. \$ 100

Am't for cloth'g in kind or money adv'd \$ 100

Due U. S. for arms, equipments, &c., \$ 100

Bounty paid \$ 100 due \$ 100

Remarks: Mustered out for Promotion. This muster to date June 29, 1864.

Book mark:

J. Smith

K. L. Carr | **U.S.C.T.**

Henry I. Knox

1st Lt., Co. _____, 2nd Reg't U. S. Col'd Cavalry.

Age 36 years.

Appears on an

Individual Muster-in Roll

of the organization named above. Roll dated

Remunda Hundred, Va. June 30, 1864.

Muster-in to date June 30, 1864.

Joined for duty and enrolled :

When June 30, 1864 .

Where In the field

Period 3 years.

Valuation of horse, \$ 100

Valuation of horse equipments, \$ 100

Remarks : Promoted from 2nd Lieut. vice Van Lear killed in action.

Book mark :

C. R. Owen,

K | **2 Cav.** | **U.S.C.T.**

Henry J. Knox
Lieut, Co. K, 2 Reg't U. S. Col'd Cav.

Appears on

Company Muster Roll

for *July* or *Aug.*, 186*4*.

Present or absent *Present*

Stoppage, \$ 100 for

Due Gov't, \$ 100 for

Valuation of horse, \$ 100

Valuation of horse equipments, \$ 100

Remarks: *Promoted from 2^d*
Lieut Co. B. June 30th 64

Book mark:

L. M. Kennedy
Copyist.

7 | **2 Cav. | U.S.C.T.**

Henry T. Knox
2nd Lieut. Co. B. 2 Reg't U. S. Col'd Cavalry.

Appears on
Company Muster Roll

for *July + Aug.*, 1864.

Present or absent

Stoppage, \$ 100 for

Due Gov't, \$ 100 for

Valuation of horse, \$ 100

Valuation of horse equipments, \$ 100

Remarks: *Transferred. Promoted
1st Lieut. Co. B. July 1st, 1864.*

Book mark:

O. J. Markle,

K | **2 Cav.** | **U.S.C.T.**

Henry J. Konosc
Lieut, Co. K, 2 Reg't U. S. Col'd Cav.

Appears on

Company Muster Roll

for *Sept. & Oct.*, 186*4*.

Present or absent *Present*

Stoppage, \$ *100* for

Due Gov't, \$ *100* for

Valuation of horse, \$ *100*

Valuation of horse equipments, \$ *100*

Remarks:

Book mark:

D. M. Kennedy
Copyist.

No. | 2 Cav. | U.S.C.T.

Henry J. Knorr
Lieut., Co. K, 2 Reg't U. S. Col'd Cav.

Appears on

Company Muster Roll

for Nov. v. Dec., 1864.

Present or absent Present.

Stoppage, \$ 100 for

Due Gov't, \$ 100 for

Valuation of horse, \$ 100

Valuation of horse equipments, \$ 100

Remarks:

Book mark:

(358)

J. M. Kennedy
Copyist.

K | **2 Cav.** | **U.S.C.T.**

Henry G. Knose
Lieut, Co. K, 2 Reg't U. S. Col'd Cav.

Appears on

Company Muster Roll

for *Jan. & Feb.*, 186*5*.

Present or absent *Present*

Stoppage, \$ 100 for

Due Gov't, \$ 100 for

Valuation of horse, \$ 100

Valuation of horse equipments, \$ 100

Remarks:

Book mark: -----

(358)

D. M. Kennedy
Cpyist.

K | 2 bar | US67

Henry J Knox
171 12 Reg US6 bar

Return

of the Post of Newport News, Va.,

for the month of March, 1865,

dated March 1, 1865,

shows the following with regard to the person
named above:

Post or station Newport News Va

Remarks: Present

Book mark: _____

(600)

Ambrosy Copyist.

K | **2 Cav.** | **U.S.C.T.**

Henry J. Knox

1st Lt., Co. K, 2 Reg't U. S. Col'd Cav.

Appears on

Company Muster Roll

for *Mar & Apr.*, 1865.

Present or absent *Present*

Stoppage, \$ *100* for

Due Gov't, \$ *100* for

Valuation of horse, \$ *100*

Valuation of horse equipments, \$ *100*

Remarks:

Book mark:

(358)

Keefe

Copyist.

K | 26av | 4867

Henry J Knox
1st Col 2 Reg US66

Return

of the Post of Newport News, Va.,

for the month of April, 1865,

dated Apr 30, 1865,

shows the following with regard to the person
named above :

Post or station _____

Remarks: Present

Book mark : _____

(600)

Alberoby
Copyist.

K | **2 Cav.** | **U.S.C.T.**

Henry J. Kuman
1st Lt., Co. K, 2 Reg't U. S. Col'd Cav.

Appears on

Company Muster Roll

for May & June, 1865.

Present or absent.....

Stoppage, \$.....100 for.....

Due Gov't, \$.....100 for.....

Valuation of horse, \$.....100

Valuation of horse equipments, \$.....100

Remarks: Discharged per S. O.
131 Hd Qrs. Dept. Va.
May 14-1865

Book mark: Discharged May 13/65
(over)

(358) Keeper Copyist.

44 00 00 00 00 00

7-12

5329061

1688

L. B. 42/388 99 Vol 14C
F. 179.

A | **2 Cav.** | **U.S.C.T.**

Henry J. Knox

2^d Lt., Co. B, 2 Reg't U. S. Colored Cav.
1st Lt. " " "

Appears on **Returns** as follows:

Jan to March 1864 Present.

April 21 (1st Lt. Co. B) Present.

Joined for duty Jan 27 '64

Promoted from 2^d Lt. Co. B,

2 U.S. Col. Apr 27 '64

May 1864 Present. Joined for

duty May 1 '64 Promoted

from 2^d Lt. Co. B 2 U.S. Col.

Apr 27 '64 per S.O. no 117.

Dept Va 4th U.S. Col.

June 1864 Present in arrest.

July 1864 Present. (Signs Return

and g. the Co.)

Aug to Nov 1864 Present.

Dec 1864 Present. (Signs return

and g. the Co.)

Jan 1865 absent on leave of

absence since Jan 13 '65 for

25 days.

Feb 1865 Present.

March 1865 Present. (Signs

Book mark :

(over)

Wm. H. Harrison

JAN. 18

40726274

1899.

*Return sendy the Leo.
Apr 1895 - Present.*

K | *2 Cav* | **U. S. C. T.**

Henry J. Knox

2^d Lt, Co. *B*, *2* Reg't U. S. Col'd *Cavry*

Appears on **Co. Muster-out Roll**, dated

3razos Santiago Tex, Feb. 12, 1866.

Muster-out to date _____, 186 .

Last paid to _____, 186 .

Clothing account:

Last settled _____, 186 ; drawn since \$ _____ 100

Due soldier \$ _____ 100 ; due U. S. \$ _____ 100

Am't for cloth'g in kind or money adv'd \$ _____ 100

Due U. S. for arms, equipments, &c., \$ _____ 100

Bounty paid \$ _____ 100 due \$ _____ 100

Remarks: *Promoted 1st Lieut*
July 1, '64 and assigned
to Co. "K."

Book mark: _____

W. Harrison

K | *2 Cav.* | **U. S. C. T.**

Henry T. Knox
1st York, *2* Reg't U. S. Col'd *Cav*

Appears on **Co. Muster-out Roll**, dated
Brazos Santiago Tex Feb 12, 1866.

Muster-out to date _____, 186 .

Last paid to _____, 186 .

Clothing account:

Last settled _____, 186 ; drawn since \$ _____ 100

Due soldier \$ _____ 100; due U. S. \$ _____ 100

Am't for cloth'g in kind or money adv'd \$ _____ 100

Due U. S. for arms, equipments, &c., \$ _____ 100

Bounty paid \$ _____ 100 due \$ _____ 100

Remarks: *Dischgd per S. O.*
No 131 Hdqrs Dept of Wa
May 14, '65

Book mark: *3610. C.S. 84. K 14*
(over)

S. Duncan

JAN. - 7

5329398

✧ 1891 ✧

. D. 10. C. J. 74.
Discharged May 15. 65
L. B. 12/388. 99. Vol 14
C. J. 79

H | *2 Cav. U.S.C.T.*

W. T. Knox

1 Lt. 2 Regt. U. S. Cold Cav.

Appears on

General Order

No. *65*, dated War Department, Adjutant General's Office, *June 22*, 1867.

Appointed to be

Captain

BY BREVET

in the Volunteer Force, Army of the United States, for *faithful and meritorious services*

To date from *May 15*, 1865.

J. A. Johnson

Knox Henry J.
L. K. 2, Co. *2*, Reg't *U.S. 6. Cav.*

12 Enclosures.

Bed Cards	Final Statements
Burial Records	Furloughs or L. of A.
Certs. of Dis. for Discharge	Med. Certificates
C. M. Charges <i>2</i>	Med. Des. Lists
Descriptive Lists	Orders <i>2</i>
Discharge Certificates	Pris. of War Record
Enlistment Papers	Resignations <i>1</i>

Other papers relating to—

Admission to Hosp'l	Furlough or L. of A.
Casualty Sheet	Med. Examination
Confinement	Misc. Information <i>1</i>
Contracts	Pay or Clothing
Death or Effects	Personal Reports
Desertion	Rank <i>1</i>
Discharge from Hosp'l	Transfer to Hosp'l
Discharge from Service	Transfer to V. R. C.
Duty	Transportation

MICROFILM PUBLICATION M 1818

COMPILED MILITARY SERVICE RECORDS
OF VOLUNTEER UNION SOLDIERS WHO
SERVED WITH THE USCT (US COLORED TROOPS)
2ND REGIMENT OF CAVALRY

PERSONAL PAPERS' TARGET SHEET

PLEASE NOTE THE CHECKED INFORMATION ABOUT THE PERSONAL PAPERS IN
THIS FILE:

- NO PERSONAL PAPERS WERE FOUND IN THIS FILE WHEN THE
RECORDS WERE ARRANGED FOR MICROFILMING.
- 13 PERSONAL PAPER(S) FOUND IN THIS FILE WHEN THE RECORDS
WERE ARRANGED FOR MICROFILMING.

Camp 2^d U. S. C. C.
near Point of Rocks Ca

June 8th 1864
Wm. T. Knox

1st Lt 2^d U. S. Col. Cavalry

Tenders his resignation as
1st Lt in the 2^d U. S. C. C. on
Surgeons certificate of disability.

Adj. Gen. 2^d U. S. C. C.
near Point of Rocks Ca

June 8th 1864
approved and respectfully
forwarded

Col. Bond 2^d U. S. C. C.

At. to discharge
from service

Walthall Landing Va.

June 8th 1864.

Major R. S. Davis

Assistant Adjutant General
18th Army Corps.

Major,

I do myself the honor respectfully to submit this my application, for permission to resign my Commission as 1st Lieut^t in the 2^d U.S.C. Cavalry, for the consideration of the General Commanding, in consequence of my total inability, through broken down health, brought on through previous hard service, of performing the active duties of my profession.

I beg leave to enclose a medical Certificate corroborating the above statement.

I am, Major

Very Respectfully

Your Obedient Servant

Henry Lorenzo Brown

1st Lieut 2^d U.S.C. Cavalry

C. 192. ✓

1864.

Camp 2^d U.S. C. Va
Near Point of Rocks Va

June 13th 1864

General H. Lane
Adjutant 2^d U.S. C. Va.

requests that his approval
of the resignation of 1st Lt. J. H. [unclear]
and 1st Lt. [unclear] of Company K
2^d U.S. C. Va. be revoked

[Faint handwritten mark]



Per H. Lane (copy) June 15th 1864

Hd. Quarters 2^d U.S. Brigade
Near Pt. of Rocks Va. June 14th 64

Respectfully forwarded
and approved

[Signature]

Col. G. S. Ohio Reels.

Comdg. Brigade.

2^d U.S. Forces
Point of Rocks Va

June 14th 1864

Respy forwarded
[Signature]

in H. Lane

Brig Genl Bondy

Hd. Quarters of Dept.
Near New Bottom Church June 15th 64

C. B. [unclear] 1000

Approved & respectfully forwarded

[Signature]
Brig Genl

Headquarters 2^d U.S. Colored Cavalry
 Seal Point of Rocks Va

June 13th 1864

Major G. W. Lewis
 U. S. Army

I have the honor to request that
 your approval of the resignation of Private Henry S. Knox
 of my Regiment be withheld. A charge has been preferred
 against him for gross drunkenness on guard.

I have the honor to be
 Your most Obedient Servant
 G. W. Lewis
 Colonel Commanding 2^d U.S. Col. Cav.

C-7. 2 Div 1000 1864.
Camp 2^d U.S. Col. Cav
near Point of Rocks Va

June 13th 1864
George W. Cole
Capt Comdr Regt 2^d U.S. Col.

Proper charges and Specifi-
cations against 1st Lt.
Henry T. Knox Company "B"
2^d U.S. Col. Cav

Ad Gen U.S. Forces
Point of Rocks Va
June 14 1864

To be tried
By order of Brig Gen Sumner
P. A. Davis
Capt & adjt

F

Head Quarters Fords Brigade,
near Pt. of Rocks, Va
June 14th 1864

Respectfully forwarded
approved
J. W. Wood
Col. 62^d Ohio Inf.,
comd'g. Brigade

Charges and Specifications preferred against
1st Lieut Henry S Knox Company "K"
2^d U. S. Colored Cavalry

Charge 1st

Drunkenness on Guard
Specification. In this the said Henry S Knox Company
"K" 2^d U. S. Colored Cavalry being in Charge
of the Guard at the Camp of the 2^d U. S. Col Cav
did become so much intoxicated as to disable
him from his proper duty, this, at or near Point
of Rocks Va on or about the 13th day of June 1864

Charge 2nd

Quitting his Guard in violation of the 50th Article of War
Specification. In this the said Henry S Knox 1st Lieut
Company "K" 2^d U. S. Colored Cavalry being
Officer of the Guard at the Camp of the 2^d
U. S. Colored Cavalry, did leave his Guard with-
out urgent necessity and without leave from
his Superior Officer, for several hours, this, at or
near Point of Rocks Va on or about the 13th day of
June 1864

Geo W Lee
Colonel Comd'g 2^d U. S. Colored Cavalry

Chitrus

Lieut Colonel Nathan P. Ford 2^d U.S. Col. Cav
Capt Frank W. Kent " " " "

to C. M. Cole
June 13th 1864

George M. Cole
about 2^d W. C. C.

Indiscreet charges against
Genl. Lemuel T. Ross
to R. M. W. C.

C. M. C.

Charges and Specifications preferred against
1st Lieut Henry J Knox Company "K" 2^d
U.S. Colored Cavalry

Charge 1st

Drunkenness on board
Specification, In this the said Henry J Knox 1st
Lieut Company "K" 2^d U.S. Colored Cavalry
being in charge of the Guard at the Camp
of the 2^d U.S. Colored Cavalry did become
so much intoxicated as to disable him
from the proper discharge of his duties
this at or near Point of Rocks Va order
about the 12th day of June 1864

Charge 2^d

Quitting his Guard in violation of the
50th Article of War.
Specification, In this the said Henry J Knox 1st
Lieut Company "K" 2^d U.S. Col. being Officer
of the Guard at the Camp of the 2^d
U.S. Colored Cavalry did leave his Guard
without urgent necessity and without
leave from his superior Officer for several
hours

J. M. Cole
Adj. Geny 2^d U.S. Col.

Witness Lieut Colt Pfond 2^d U.S. Co
Capt Frank Kent. " " "

W. C. Davis
Nov 13th 1864

George M. West

Witness 27th U.S. Co

Prepared charges against
Lieut Pfond & Capt
Kent

C. M. A.

Co 80. ✓ 1864

Brown Hill Va

Col Geo W. Cole
2^d U.S.C.

Recommends 2^d Lieut
Henry S. Knox for pro-
motion to 1st Lieut.

filed 12-6-75

to the Dept Va & U.C. Apr 7 64

NOV 9 1864

Camp at Bowers Hill -
Maj Davis A.A.G.

Maj

I have
the honor to recommend for pro-
motion to 1st Lt. Co. K. 2nd W.S.C., - 2nd Lt
Henry T. Knapp - This promotion
is to fill the place 1st Lt. M. Vause -
Killed at Suffolk, and at the
request of Cap. Kent, Co. K, as well
as for meritorious conduct &
bravery -

I have the honor to remain
with sincere respect

Yours

Geo. D. Cole

Col. 2nd W.S.C.

Ad. gr. Sept 17th
Army of the James
Richmond Va
May 15-765

Henry T. Knox
1st. 2nd. 3rd. 4th
S. O. 181

Discharge of Lt. Knox
2nd Regt.

Order

Recd. Ad. gr. 2nd Regt.
May 17/65

Ed. Dept. of Virginia
Army of James

Richmond Va. May 15th 1865

Special Order
No 131 } (Extract)

4... The following named Officers having ten-
tered their resignations, are hereby honorably discharged
the service of the United States, with condition that they
shall receive no final payment until they have satisfied the
Pay Department that they are not indebted to the Gov-
ernment.

1st Lieut. Henry S. Dwyer 2^d U.S. Cav.

Official Copy -

Francis Dwyer
Pay Dept Army Adj't

By order of Major Gen. Ord
Edw. Smith
A.A.S.

Copy.

Hdqrs. Dept. of Virginia,
Army of the James,
Richmond, Va., May 15, 1865.

Special Orders
No. 131.

— Extract —

4. The following named officers having tendered their resignations are hereby honorably discharged the Service of the United States, with condition that they shall receive no final payment until they have satisfied the Pay Department that they are not indebted to the Government:

1. Lieut. Henry T. Knott,

2. U.S. Colored Cavalry.

By command of
Major Genl. Ord.
(Sgd) Edw. Smith
a. a. c.

JCA
37/79

NOV 29 1866

Henry J. Knod
1st Lieut Co. K 2nd Regt

Mr Ellersbrook R.

✓

Signed / Ed. W. Smith
Capt. Adjt. Genl.

} noted on A
JTB

Adjutant General's Office,

COLORED TROOPS, BRANCH,

September 21st, 1877

Mr Ellubrook Vol. C. T., 187

Wanted in case of Henry T. Knox, 1st Lieut., Co. K,
2^d Reg't W. S. C. C. Copy of S. O. No 131. Hd Qrs
Dept of Virginia. May 14th 1865.

Respectfully,

E. A. Woodward,

Chief Clerk.

per S. B.

Adjutant General's Office,

, 1877

Vol. C. T., 187

Reply in case of
Reg't H. Qrs. Department of Virginia
Army of the James
Richmond, Va. May 15th 1865.

Special Orders of
No. 131 (Extract)

4. "The following named Officers
having tendered their resignations, are hereby honorably
discharged the service of the United States, with condition
that they shall receive no final payment until they have
satisfied the Pay Department, that they are not
indebted to the Government.
1st Lieut. Henry T. Knox, 2^d U. S. Col'd. Cav.

1 over

By Command of
Maj. Genl. Ord.
Signed / Ed. W. Smith
Asst. Adjt. Genl.

Henry J. Kimball
1. South Co. 1st Regt.

Wm. S. Kimball

11/17/62
718

NRRA 941

Mr Allen

was this year honorably
discharged on account of resigna-
tion.

Respectfully
Yours
Woodward

He was,
J. C. Allen

NOV 20 1864

Pay Department, U. S. A.,

Jan'y 18th 1865

Paymaster of the ^{1st} Reg't U.S.A.

I have this day paid Dr. J. L. Henry, J. May

Co. \$ 33⁵⁰ in full from Aug 31 - 1864

to New Or 1864

Wm. C. Barr

Paymaster U. S. A. *[Signature]*

Pay Department, U. S. A.,

January 14, 1865

Paymaster of the 2^d Reg't W.C. Cav

I have this day paid Henry J. Knox 1st Co. \$ 111.11, in full from Dec 1, 1864 to Dec 31, 1864.

Geo. Brown Riché
Paymaster U. S. A.

Pay Department, U. S. A.,

January 31, 1865

Paymaster of the 2^d Reg't U.S. Cav

I have this day paid 2^d Lt Henry J. Knox Co. K. \$ 111¹³, in full from January 1, 1865 to January 31, 1865.

Saml Beech
Paymaster U. S. A.

1815 (E. Va) 1815.
Ad Lts. 2^d US Cavalry
Norfolk May 8. 1815

1815 (E. Va) 1815.
Norfolk May 7. 1815.

1st Lt. Henry J.
1st Lt. C. H. 2^d US. Cavalry

Indus his resignation
as 1st Lt in 2^d US Cavalry
Cavalry. & states name

Regt. C. H. 1815.

Recd. at Norfolk Va. May 23. 1815.
1815

Ad Lts. 2^d US Cavalry
Norfolk. May 9. 1815.

Approved, sincerely and
respectfully forwarded.

J. W. Lewis
Col. 2^d US Cavalry
Brig. Genl.
Comd. Regt.

Recd. at Norfolk, Va. May 11. 1815.
Respectfully forwarded
approved

James K. Huber
Brig. Genl.

Head Quarters District E. Va
Norfolk. Va. May 12. 1815.

Respectfully forwarded,
approved.
W. A. Smith
Brig. Genl. Comd.

Head Quarters Department of Virginia.
ARMY OF THE JAMES,
Richmond Va. In the Field, 15th May, 1865.
Station: In the Field.
Special Orders, No. 131 Par. 4
Date: May 15. 1865.
Respectfully forwarded to the Adjutant General of
the Army.
C. O. C. Ord
Maj. Gen. Comd.

NOV 19 1863

@ Norfolk Va
May 8th 1863

To the
Adjt-Genl
Dept Virginia

Sir;

I herewith have the
honor to tender my resignation as 1st
Lieut & 2nd U.S. Col^l Cal and trust that
after three (3) Years service and the War
being now concluded, I may respectfully
claim an honorable Discharge

I have the honor to be
Very respectfully

Your Obedt. Servant

Henry J. Stroop.
1st Lieut. Co. 8th U.S.C.

To
St Col Edw Smith
Asst Adjt General
Dept. Va.

Kramer ⁹²⁵ Ad

Co D, 2 U. S. Col'd

2nd Lieutenant | 2nd Lieutenant

CARD NUMBERS.

1	5315341	26
2	5321965	27
3	5322053	28
4	40726275	29
5		30
6		31
7		32
8		33
9		34
10		35
11		36
12		37
13		38
14		39
15		40
16		41
17		42
18		43
19		44
20		45
21		46
22		47
23		48
24		49
25		50

Book Mark:

See also

NAME 046

Kramer ⁹²⁵ Adam

Co D, 2 U. S. Col'd Cav.

2nd Lieutenant 2nd Lieutenant

CARD NUMBERS.

1	5315341	26
2	5321965	27
3	5322053	28
4	40726275	29
5		30
6		31
7		32
8		33
9		34
10		35
11		36
12		37
13		38
14		39
15		40
16		41
17		42
18		43
19		44
20		45
21		46
22		47
23		48
24		49
25		50

Book Mark:

See also

K | 2nd Cav, | U.S.C.T.

Adam Kramer

2nd Lt; Co., 2nd Reg't U. S. Col'd Cav'y,

Age 27 years.

Appears on an

Individual Muster-in Roll

of the organization named above. Roll dated

Brazos Santiago, Tex, Dec. 7, 1865.

Muster-in to date Dec. 7, 1865.

Joined for duty and enrolled:

When Dec. 7, 1865.

Where Brazos Santiago

Period 3 years.

Valuation of horse, \$ 100

Valuation of horse equipments, \$ 100

Remarks: Appointed as 2nd Lieut. 2nd W. S. C. Cavalry by Commission from Sec. of War, dated (over)

Book mark ::

C. R. Owen,

JAN: - 7

5315341

* 1687 *

October 6th, 1865 and
migrated into Co. "D"
same Regt. by order
of the War Dept.
dated Washington, DC
Oct. 24th, 1865.

Copy of order appended,

Ko | 2 Cav. | U.S.C.T.

Adam Krumer
2 Lt., Co. D, 2 Reg't U. S. Col'd Cavalry.

Appears on

Company Muster Roll

for Nov & Dec, 1865.

Present or absent Present

Stoppage, \$ 100 for

Due Gov't, \$ 100 for

Valuation of horse, \$ 100

Valuation of horse equipments, \$ 100

Remarks: Mustered per order of the War Dept dated Washington D.C Oct 24 1865

Book mark:

S W Forrest
Copyist.

K | **2 Cav.** | **U.S.C.T.**

Adam Warner

2^d Lt., Co. D., 2 Reg't U. S. Colored Cav.

Appears on **Returns** as follows:

Dec 1865. Present, Gauri
Dec 7, Brazos Santiago
Tex. Mustered in to date
Dec 7 '65. (Signs return
of Co B as comd'g Co.)

Jan 1866 Present. Mustered
Dec 7, '65.

Book mark :

A. M. Shannon

K | 2 Cav. | U.S.C.T.

Adam Kramer
2 Lt, Co. D., 2 Reg't U. S. Col'd Cavalry.

Appears on **Co. Muster-out Roll**, dated
Gracias Santiago Tex. Feb 12, 1866.
Muster-out to date Feb 12, 1866.
Last paid to Pay due for enlistment

Clothing account:
Last settled....., 186 ; drawn since \$..... 100
Due soldier \$..... 100; due U. S. \$..... 100
Am't for cloth'g in kind or money adv'd \$..... 100

Due U. S. for arms, equipments, &c., \$..... 100
Bounty paid \$..... 100; due \$..... 100

Remarks: Apt 2 Lemus 24th 66
from civil life by Sec of
War Oct 6. 65. Washington
D. C. Mus in at Gracias
Santiago Tex Dec 7. 65.
Filed Certificate of non
indebtedness and a Affi

Book mark:

S W Forrest
(361) Copyist.

JAN.-7

5322053

☆ 1891 ☆

- dovit that all returns
reports have been properly
rendered.

926
Krause Henry

Co D, 2 U. S. Col'd Cav.

Private

CARD NUMBERS.

1	26
2	27
3	28
4	29
5	30
6	31
7	32
8	33
9	34
10	35
11	36
12	37
13	38
14	39
15	40
16	41
17	42
18	43
19	44
20	45
21	46
22	47
23	48
24	49
25	50

See Rawle Henry

Book Mark:

See also

927

Labarth Charles

Co B, 2 U. S. Col'd Cav.

2nd Lieutenant 2nd Lieutenant

CARD NUMBERS.

1	5-315342	26
2	5-318933	27
3	5-319039	28
4	5-319140	29
5	5-319243	30
6	5-319344	31
7	5-319712	32
8	40726276	33
9	42722188	34
10		35
11		36
12		37
13		38
14		39
15		40
16		41
17		42
18		43
19		44
20		45
21		46
22		47
23		48
24		49
25		50

Book Mark:

See also - N.Y. Mtd Rifles

S | **2 Cav. | U.S.C.T.**

Charles Sabarth

Sabarth, Co. B. 2 Reg't U. S. Col'd Cavalry.

Appears on

Company Muster Roll

for *Oct. 31, 1864 to Feb 28*, 1865.

Present or absent *Absent.*

Stoppage, \$ 100 for

Due Gov't, \$ 100 for

Valuation of horse, \$ 100

Valuation of horse equipments, \$ 100

Remarks: *Absent with leave
since Feb. 10, 1865.*

x *written on the Roll.*

Book mark:

O. J. Markle,

L. W. Coor, U.S.C.T.

Charles Laubert

2nd Lt; Co., 2nd Reg't U. S. Col'd Cavalry,

Age 27 years.

Appears on an

Individual Muster-in Roll

of the organization named above. Roll dated

Warina, Va., Oct. 25, 1864.

Muster-in to date Sept. 21, 1864.

Joined for duty and enrolled:

When Sept. 21, 1864.

Where Deep Bottom, Va.

Period 3 years.

Valuation of horse, \$ 100

Valuation of horse equipments, \$ 100

Remarks: Promoted from Sergeant New York mounted Rifles, discharged from that Regiment dated Sept. 20, 1864.

Book mark:

R. Owen

7 | **2 Cav. | U.S.C.T.**

Charles South

Co. B, Co. B. 2 Reg't U. S. Col'd Cavalry.

Appears on

Company Muster Roll

for *Sept & Oct.*, 186 *7*.

Present or absent *Present*

Stoppage, \$ *100* for

Due Gov't, \$ *100* for

Valuation of horse, \$ *100*

Valuation of horse equipments, \$ *100*

Remarks :

Book mark :

G. S. Marble

L. | 2 Cav. | U.S.C.T.

Charles Labarth

2^d Lt., Co. B. 2 Reg't U. S. Col'd Cavalry.

Appears on

Company Muster Roll

for Mar & Apr, 1865.

Present or absent Present.

Stoppage, \$ 100 for

Due Gov't, \$ 100 for

Valuation of horse, \$ 100

Valuation of horse equipments, \$ 100

Remarks: Due him \$10. per mo.
Since Nov 1st 1864 for respon-
sibility as company commander.

Book mark:

M. O. Chance

L | 2 bar | US 6 J

Charles Labarthe

2 If-60 6 2 Reg 1866

Return

of the Post of Newport News, Va.,

for the month of April, 1865,

dated Apr 30, 1865,

shows the following with regard to the person
named above:

Post or station

Remarks: Present

Book mark:

(600)

W. Crosby
Copyist.

L

2 Cav.

U.S.C.T.

Chas. LaBarth

Lieut., Co. B. 2 Reg't U. S. Col'd Cavalry.

Appears on

Company Muster Roll

for May & June, 1865.

Present or absent Absent.

Stoppage, \$ 100 for

Due Gov't, \$ 100 for

Valuation of horse, \$ 100

Valuation of horse equipments, \$ 100

Remarks: Due him \$10. per month
since Nov 1/64 as Command
Officer - Absent sick.

Book mark :

M D Chance

L. | 2 Cav. | U.S.C.T.

Charles Labarth

2^d Lt., Co. B. 2 Reg't U. S. Col'd Cavalry.

Appears on

Company Muster Roll

for July & Aug., 1865.

Present or absent Absent.

Stoppage, \$ 100 for

Due Gov't, \$ 100 for

Valuation of horse, \$ 100

Valuation of horse equipments, \$ 100

Remarks: Absent sick in 25th
Corps Hosp.

Book mark:

Mochance

L | 2 Cav. | U.S.C.T.

Charles Labarth
 2 Lt., Co. B., 2 Reg't U. S. Colored Cav.

Appears on Returns as follows:

Sept & Oct 1864. Present.
 Appointed Sept 21/64.
 Nov & Dec 1864. Absent.
 Detached per. SO. 178
 Hd. Qrs. 18 ac. Nov.
 3 1864.

Jan'y 1865 - Present.
 Feb'y 1865 - Absent
 with ~~leave~~ since
 Feb'y 12. 1865.

March & April 1865. Present.
 Sign Return as
 2^d Lt. U.S. Army Co.

May to Aug 1865 -
 Absent & sick in
 Genl Hoapl. since
 May 15 1865.

Sept 1865. Absent & sick
 in Genl Hoapl City
 Point since May 17/65.
 A. H. M.

Book mark :

A. H. M. Copyist.

000000000000

JAN. 18

40726276

1899.

Dep. 1865. Nischyd
per S.O. 407 War
Sept. Aug. 23/65.

L | 2 Cav. | U.S.C.T.

Charles Labrath

2^d/₄ Lt, Co. B, 2 Reg't U. S. Col'd Cavalry.

Appears on Co. Muster-out Roll, dated
Brazos Santiago, Tex, Feb. 12, 1866.

Muster-out to date _____, 186 .

Last paid to _____, 186 .

Clothing account:

Last settled _____, 186 ; drawn since \$ _____ 100

Due soldier \$ _____ 100; due U. S. \$ _____ 100

Am't for cloth'g in kind or money adv'd \$ _____ 100

Due U. S. for arms, equipments, &c., \$ _____ 100

Bounty paid \$ _____ 100; due \$ _____ 100

Remarks: Discharged. Per Special
Order No. 454 War Dept.
A.G.O. Aug. 28/68.

Book mark: _____

W. Harrison
(361) Copyist.

LABARTE CHAS

Labarth Chas.

2 Lt, Co. 2 2 Regt U.S.C. Cav.

7 Enclosures.

Bed Cards	Descriptive Lists
Burial Records	Final Statements
Certs. of Dis. for Discharge	Furloughs
C. M. Charges	Med. Des. Lists
Med. Certificates	Orders 4

Other papers relating to—

Admission to Hosp'l	Furlough
Casualty Sheet (Officer's)	Med. Examination
Confinement	Misc. Information
Contracts	Pay or Clothing 2
Death or Effects	Personal Reports
Desertions	Rank /
Discharge from Hosp'l	Transfer to Hosp'l
Discharge from Service	Transfer to V. R. C.
Duty	Transportation

Pay Department, U. S. A.,

31st January, 1865.

Paymaster of the 2^d Reg't U.S. Cavalry

I have this day paid 2^d Lt. Chas Labarth

Co. \$111⁰⁰ in full from 30th November 1864,

to 31st December 1864.

W. D. Stuart

Paymaster U. S. A.
W. D. Stuart

Pay Department, U. S. A.,

Richmond, Va., 1865.

Paymaster of the 2^d Reg't U.S. Cavalry

I have this day paid Charles Labarth, 2nd Lieut

Co. \$396⁰⁰ in full from February 1st, 1865,

to April 30th, 1865.

Wm. D. Stewart

Paymaster U. S. A.

Not of 2^d Cav C

Recd. Dec 1. per 26th Dec
Sutter Field Mich 3rd 1865

• Asst. Adj. General

Lt. Col. Striban 2^d
Having been recom-
mended for promotion
requests ~~to~~ ^{for} relative
Appointment

Head Quarters 1st Div 25th A. I.
In the file Va
March 31/65.

Colonel

The following named Officers have been recommended
for promotion by the Board of Examination
Please state vice whom and give the letter of the
Company to which the nominee shall be
Appointed

2^d Lieut. C. H. Libraw 2^d U. S. C. C.

I Am Colonel
Very Respectfully
Your Obedt. Servt
J. S. S. S. S.
a. a. S.

Commanding Officers
2^d Regt. U. S. Co. F. Cav.

War Department
Adjutant General's Office
Washington, Aug 23, 1865,

Special Orders
No. 454.

Extract.

+ + + + +
33. 2nd Lieutenant Charles Sabarth,
2nd U. S. Colored Cavalry is hereby honorably
discharged the service of the United States,
on account of physical disability, with
condition that he shall receive no final
payments until he has satisfied the Pay
Department that he is not indebted to
the Government.

By order of the Secretary of War,
Official: D. D. [Signature] Asst. Adj. Genl.
Lieut Col & a/cy,

Original Copy sent
as 2nd copy left

Special Order No. 454
Cassact

23. 2^d Lieutenant Charles
Lobarth 2^d Regt. C. C.
is honorable Discharged

Order

SPECIAL ORDERS, } WAR DEPARTMENT,
No. 454. } ADJUTANT GENERAL'S OFFICE,
Washington, August 23d, 1865.

(Extract.)

* * * * *
33. 2d Lieutenant *Charles Labarth*, 2d U. S. Colored Cavalry, is hereby honorably discharged the service of the United States, on account of physical disability, with condition that he shall receive no final payments, until he has satisfied the Pay Department that he is not indebted to the Government.
* * * * *

By order of the Secretary of War:

E. D. TOWNSEND,
Assistant Adjutant General.

OFFICIAL:
E. D. Townsend

Assistant Adjutant General.

*C. O. 2^d U. S. Colored Cavalry
thru
Dept. Texas.*

Charles LePart
241.

WAR 973
Head Quarters Twenty-fifth Army Corps.
In the Field Va. February 8th 1865.

Special Orders,
No. 38.

Extract.

3. Leaves of absence to go out of the Department
are hereby granted to the following named officers.

Viz 2^d Lieut. Charles Seibert 2^d U. S. Colored Cavalry
for Twenty five days.

Special Copy

By Order of Maj. Gen. Heckman
W^m H. Abel
Asst. Adjt. General.

1899 074

Labarth Char.
2. 21 2 11. 0. 1. 0. 0.

C. J. ...

1899 074

HEADQUARTERS 18TH ARMY CORPS,

November 3rd 1864.

Special Orders, }

No. 178 }

[EXTRACT.]

2nd Lieut Geo. Labarthe
2nd U.S. Cavalry is hereby detailed to
the command of the Guard of the Sup-
ply Ammunition Train of the Artillery
Brigade and will report to Capt. C. Hart
Acting Ordnance Officer Artillery
Brigade, 18th Army Corps for duty with-
out delay

+ x x x x x

do do U.S. Cavalry

By command of ^{Brevet} Major General

G. Weitzel
J. Schuler

Assistant Adjutant General.

928

Lafayette Isome

Co E, 2 U. S. Col'd Cav.

Private

Private

CARD NUMBERS.

1	5-316180	26
2	5-3224051	27
3	5-322486	28
4	5-322849	29
5	5-322972	30
6	5-323064	31
7	5-323153	32
8	5-323232	33
9	5-323311	34
10	40726277	35
11		36
12		37
13		38
14		39
15		40
16		41
17		42
18		43
19		44
20		45
21		46
22		47
23		48
24		49
25		50

Book Mark:

See also

1 5868 511 P.O. W. Y. M.

Dec. 2013

5-1-26th

Dec. 2014 5/24/26th

L. Ballouyer

W. Y. M.

L | **2 Cav.** | **U.S.C.T.**

Isome Lafayette

Appears with rank of *Priv* on

Muster and Descriptive Roll of a Detachment of U. S. Vols. forwarded

for the 2 Reg't U. S. Col'd Cavalry. Roll dated

Varina Va, Dec. 3, 1864.

Where born *Pittsylvania Va.*

Age *21* y'rs; occupation *Farmer*

When enlisted *Dec. 3,* 1864.

Where enlisted *Varina Va.*

For what period enlisted *3* years.

Eyes *Dark*; hair *Black*

Complexion *dark*; height *5 ft. 11 in.*

When mustered in *Dec 3,* 1864.

Where mustered in *Varina Va*

Bounty paid \$ *100*; due \$ *300*^{*100*}

Where credited

Company to which assigned

Remarks:

Book mark:

J. D. Neale

L | **2 Cav. | U.S.C.T.**

Isom Lafayette
Priv, Co. E, 2 Reg't U. S. Col'd Cavalry.

Appears on

Company Muster Roll

for *Apr & Dec*, 186 *4*

Present or absent *Present*

Stoppage, \$ *100* for

Due Gov't, \$ *100* for

Valuation of horse, \$ *100*

Valuation of horse equipments, \$ *100*

Remarks:

Book mark:

Wauverington

L | **2 Cav.** | **U.S.C.T.**

Isaac Lafayette
Perrin, Co. E, 2 Reg't U. S. Col'd Cavalry.

Appears on

Company Muster Roll

for *Jan & Feb*, 186 *5*.

Present or absent *Present*

Stoppage, \$ 100 for

Due Gov't, \$ 100 for

Valuation of horse, \$ 100

Valuation of horse equipments, \$ 100

Remarks:

Book mark:

Waddington

L. | **2 Cav.** | **U.S.C.T.**

Isom Seargeants

Private, Co. E, 2 Reg't U. S. Col'd Cavalry.

Appears on

Company Muster Roll

for *March & April*, 1865.

Present or absent *Present*.

Stoppage, \$ 100 for

Due Gov't, \$ 100 for

Valuation of horse, \$ 100

Valuation of horse equipments, \$ 100

Remarks: *See Soldier \$100, 1st instau-
ment, U. S. Bounty.*

Book mark:

B. Bradin

L | 2 Cav. | U.S.C.T.

Sam Lafayette

Pvt., Co. E, 2 Reg't U.S. Col'd Cavalry.

Appears on

Company Muster Roll

for May June, 1865

Present or absent Present

Stoppage, \$ 100 for

Due Gov't, \$ 100 for

Valuation of horse, \$ 100

Valuation of horse equipments, \$ 100

Remarks: New Soldier 100. U.S. Bounty first in- stallment

Book mark:

(358) H. J. Hardy Copyist.

L | 2 Cav. | U.S.C.T.

Sam L Lafayette

Det

Co. E, 2 Reg't U. S. Col'd Cavalry.

Appears on

Company Muster Roll

for July 1863, 1863

Present or absent Present

Stoppage, \$ 100 for

Due Gov't, \$ 100 for

Valuation of horse, \$ 100

Valuation of horse equipments, \$ 100

Remarks:

Book mark:

(358)

J. H. Schrey

Copyist.

Lo

2 Cav.

U.S.C.T.

Isom Leajay, Jr.

Pr, Co. E, 2 Reg't U. S. Col'd Cavalry.

Appears on

Company Muster Roll

for *Sept and Oct*, 1865.

Present or absent *Present*

Stoppage, \$ 100 for

Due Gov't, \$ 100 for

Valuation of horse, \$ 100

Valuation of horse equipments, \$ 100

Remarks:

Book mark:

N. H. Merrill

NARA 885

L | **2 Cav.** | **U.S.C.T.**

Isom Lafayette

P 170, Co. E, 2 Reg't U. S. Col'd Cavalry.

Appears on

Company Muster Roll

for *Nov. and Dec*, 1865 .

Present or absent *Present*

Stoppage, \$ *100* for

Due Gov't, \$ *100* for

Valuation of horse, \$ *100*

Valuation of horse equipments, \$ *100*

Remarks:

Book mark: -----

N. H. Merrill

L | 2 Cav. | U.S.C.T.

Isom Laffayett
Pr., Co. E, 2 Reg't U. S. Colored Cav.

Appears on Returns as follows:

Dec. 1864. Gained
Dec. 3/64. Various
Va. Enlisted in
the Co.

Book mark :

A. H. Ellis
Copyist.

L | **2 Cav. | U.S.C.T.**

Isaac Lafayette

Pvt, Co. *E*, 2 Reg't U. S. Col'd Cavalry.

Appears on **Co. Muster-out Roll**, dated *Battle Santiago Tex.*, *Feb. 12*, 186*6*.

Muster-out to date *Feb. 12*, 186*6*.

Last paid to *June 30*, 186*5*.

Clothing account:

Last settled....., 186 ; drawn since \$..... $\frac{100}{100}$

Due soldier \$..... $\frac{100}{100}$; due U. S. \$..... $\frac{68}{100}$ $\frac{57}{100}$

Am't for cloth'g in kind or money adv'd \$..... $\frac{100}{100}$

Due U. S. for arms, equipments, &c., \$..... $\frac{72}{100}$

Bounty paid \$..... $\frac{100}{100}$; due \$..... $\frac{100}{100}$

Remarks: *joined org. org'n*

stop on pay - driver Theysana Buck wiper

Book mark: *V. 159. P 26. 73*

H. H. M... ..

929

Lamb Marshal

Co. H, 2 U. S. Col'd Cav.

CARD NUMBERS.

1	26
2	27
3	28
4	29
5	30
6	31
7	32
8	33
9	34
10	35
11	36
12	37
13	38
14	39
15	40
16	41
17	42
18	43
19	44
20	45
21	46
22	47
23	48
24	49
25	50

Book Mark: _____

See also _____

N A R R A R Y

Lamb Marshal ⁹³⁰

Co H, 2 U. S. Col'd Cav.

Private | Private

CARD NUMBERS.

1	5-3 16191	26
2	5-3 26461	27
3	5-3 26545	28
4	5-3 26627	29
5	5-3 26706	30
6	5-3 26786	31
7	5-3 26858	32
8	5-3 26930	33
9	40726278	34
10		35
11		36
12		37
13		38
14		39
15		40
16		41
17		42
18		43
19		44
20		45
21		46
22		47
23		48
24		49
25		50

Book Mark:

See also

J. 1614694 P.O. Box
D. 2125126 P.O. Box
S.S. O.B. 7-13-28

L. Ballantyne

W. H. Ballantyne

L | 2 Cav. | U.S.C.T.

Marshal Lamb

Appears with rank of *Private* on

Muster and Descriptive Roll of a Detachment of U. S. Vols. forwarded

for the 2 Reg't U. S. Col'd Cavalry. Roll dated

Newport News Va. Jan'y 31, 1865.

Where born *Prince Anne Co. Va.*

Age *21* y'rs; occupation *laborer*

When enlisted *Jan'y 9*, 1865.

Where enlisted *Worfolk Va*

For what period enlisted *3* years.

Eyes *brown*; hair *black*

Complexion *brown*; height *5 ft. 10 in.*

When mustered in *Jan'y 11*, 1865.

Where mustered in *Newport News*

Bounty paid \$ *100*¹⁰⁰; due \$ *100*¹⁰⁰

Where credited *Pass. at large*

Company to which assigned

Remarks:

Book mark: *35181000*

L

2 Cav.

U.S.C.T.

Marshall Land
Priv, Co. H, 2 Reg't U. S. Col'd Cavalry.

Appears on

Company Muster Roll

for Jan. & Feb., 1865.

Present or absent Present

Stoppage, \$ 100 for

Due Gov't, \$ 100 for

Valuation of horse, \$ 100

Valuation of horse equipments, \$ 100

Remarks:

Book mark:

W. Ferguson

(358)

Copyist.

L | 2 Cav. | U.S.C.T.

Marshal Lam

Private, Co. H, 2 Reg't U. S. Col'd Cavalry.

Appears on

Company Muster Roll

for March and April, 1865.

Present or absent Present

Stoppage, \$ 100 for

Due Gov't, \$ 100 for

Valuation of horse, \$ 100

Valuation of horse equipments, \$ 100

Remarks:

Book mark:

C. J. Powell

L | 2 Cav. | U.S.C.T.

Marshal Laird

Private, Co. H, 2 Reg't U. S. Col'd Cavalry.

Appears on

Company Muster Roll

for May and June, 1864.

Present or absent Present

Stoppage, \$ 100 for

Due Gov't, \$ 100 for

Valuation of horse, \$ 100

Valuation of horse equipments, \$ 100

Remarks:

Book mark:

C. J. Powell

L | **2 Cav.** | **U.S.C.T.**

Marshal Loud
Private, Co. H, 2 Reg't U. S. Col'd Cavalry.

Appears on

Company Muster Roll

for *July and Aug.*, 1865.

Present or absent *Present*

Stoppage, \$ 100 for

Due Gov't, \$ 100 for

Valuation of horse, \$ 100

Valuation of horse equipments, \$ 100

Remarks:

Book mark: -----

C. J. Powell

L | **2 Cav.** | **U.S.C.T.**

Marshal Land

Pat, Co. H, 2 Reg't U. S. Col'd Cavalry.

Appears on

Company Muster Roll

for *Sep & Oct*, 186*5*.

Present or absent *Present*

Stoppage, \$ *100* for

Due Gov't, \$ *100* for

Valuation of horse, \$ *100*

Valuation of horse equipments, \$ *100*

Remarks:

Book mark:

W. H. Kelly
Copyist

L | **2 Cav.** | **U.S.C.T.**

Marshall Land

PT, Co. H, 2 Reg't U. S. Col'd Cavalry.

Appears on

Company Muster Roll

for *Nov & Dec*, 1865.

Present or absent *Present*

Stoppage, \$ *100* for

Due Gov't, \$ *100* for

Valuation of horse, \$ *100*

Valuation of horse equipments, \$ *100*

Remarks:

Book mark: _____

J. G. Phillips
Copyist.

L | 2 Cav. | U.S.C.T.

Marshal Land.

....., Co. H., 2 Reg't U. S. Colored Cav.

Appears on **Returns** as follows:

July 1865 - Gain
Recruit from
depot -

Book mark :

A. H. Ellis

C | **2 Cav.** | **U.S.C.T.**

Marshall Land

Co. H, 2 Reg't U. S. Col'd Cavalry.

Appears on **Co. Muster-out Roll**, dated

Brayos Santiago Tex, Feb 12, 1865.

Muster-out to date *Feb 12, 1865.*

Last paid to *June 30, 1865.*

Clothing account:

Last settled....., 186 ; drawn since \$..... $\frac{100}{100}$

Due soldier \$ *11* $\frac{75}{100}$; due U. S. \$..... $\frac{100}{100}$

Am't for cloth'g in kind or money adv'd \$..... $\frac{100}{100}$

Due U. S. for arms, equipments, &c., \$..... $\frac{40}{100}$

Bounty paid \$..... $\frac{100}{100}$; due \$ *100* $\frac{100}{100}$

Remarks: *joined a secret*
step Henry & bank wiper

Book mark:

Y. D. Hill
Copyist.

Lamb Marshal

, Co. , 2 Reg't US Cav.

Enclosures.

Bed Cards	Final Statements
Burial Records	Furloughs or L. of A.
Certs. of Dis. for Discharge	Med. Certificates
C. M. Charges	Med. Des. Lists
Descriptive Lists	Orders
Discharge Certificates	Pris. of War Record
Enlistment Papers	Resignations

Other papers relating to—

Admission to Hosp'l	Furlough or L. of A.
Casualty Sheet	Med. Examination
Confinement	Misc. Information
Contracts	Pay or Clothing
Death or Effects	Personal Reports
Desertion	Rank
Discharge from Hosp'l	Transfer to Hosp'l
Discharge from Service	Transfer to V. R. C.
Duty	Transportation

NOTE 1.—This blank will be used for both enlistments and re-enlistments—enlistment of veterans, &c., &c., in the volunteer service. They will be made out in duplicate in all cases—one to accompany the recruiting return of the superintendent (not the recruiting officer) to the Adjutant-General, and one to accompany the accounts of the officer who pays bounty, &c. The Regiment and Company in which the soldier last served should be given on the back.

NOTE 2.—An enlistment holds to service. A muster-in must, in all cases, precede payment of pay, bounty, pension, &c. A muster-in roll must, in all cases, be filed in the Adjutant-General's Office as evidence of muster-in. The mustering officer, commissary, or assistant-commissary of musters, as the case may be, will countersign both enlistments as having mustered the soldier into the service of the United States before either of them is given to the disbursing officer.

DECLARATION OF RECRUIT.

I, Marshall Lamb desiring to VOLUNTEER as a Soldier in the Army of the United States, for the term of THREE YEARS, Do Declare, That I am thirty one years and _____ months of age; that I have never been discharged from the United States service on account of disability or by sentence of a court-martial, or by order before the expiration of a term of enlistment; and I know of no impediment to my serving honestly and faithfully as a soldier for three years.

GIVEN at Norfolk Va the 9th day of July 1865

Witness: H. H. Harkness Marshall Lamb

No. 7
Marshall Lamb
 Volunteered at Norfolk
January 9th 1865
 By Chas. J. McWhorter
3rd Regiment of Vol. I. C. S.
Richmond
 Discharged _____ 18 ____
 enlistment; last served in Company ()
 Reg't of _____
Jan-11
one 1/2

CONSENT IN CASE OF MINOR.

I, _____ Do CERTIFY, That I am _____ the _____ of _____; that the said _____ is _____ years of age; and I do hereby freely give my CONSENT to his volunteering as a SOLDIER in the ARMY OF THE UNITED STATES, for the period of THREE YEARS.

GIVEN at _____ the _____ day of _____

Witness: _____

VOLUNTEER ENLISTMENT.

STATE OF



TOWN OF

Mass

I, *Marshall Lamb* born in *Pompano Am. Ck*
in the State of *Virginia* aged *twenty one* years,
and by occupation a *Laborer* Do HEREBY ACKNOWLEDGE to have
volunteered this *ninth* day of *July* 186*5*,
to serve as a **Soldier** in the **Army** of the **United States** of **America**, for the
period of **THREE YEARS**, unless sooner discharged by proper authority: Do also
agree to accept such bounty, pay, rations, and clothing, as are, or may be, estab-
lished by law for volunteers. And I, *Marshall Lamb* do
solemnly swear that I will bear true faith and allegiance to the **United States**
of America, and that I will serve them honestly and faithfully against all their
enemies or opposers whomsoever; and that I will observe and obey the orders of
the President of the United States, and the orders of the officers appointed over
me, according to the Rules and Articles of War.

Sworn and subscribed to, at

this

Norfolk Va
9th day of *Jan* 186*5*,
Marshall Lamb
St. 37th U.S. C.T.

BEFORE

I CERTIFY, ON HONOR, That I have carefully examined the above-named Volunteer, agreeably
to the General Regulations of the Army, and that, in my opinion, he is free from all bodily defects and
mental infirmity, which would in any way disqualify him from performing the duties of a soldier.

W. H. Gray
Asst. Surg. 1st U.S. C.T.
EXAMINING SURGEON.

I CERTIFY, ON HONOR, That I have minutely inspected the Volunteer, *M Lamb*
previously to his enlistment, and that he was entirely sober when enlisted; that, to the best of my
judgment and belief, he is of lawful age; and that, in accepting him as duly qualified to perform the duties
of an able-bodied soldier, I have strictly observed the Regulations which govern the recruiting service.

This soldier has *blue* eyes, *black* hair, *light* complexion, is *five* feet
ten inches high.

James M. Monroe
St. 37th Regiment of *U.S. C.T.* Volunteers,
RECRUITING OFFICER.

Mustered into the service of the United States, in Company
the *11th* day of *January*, 186*5*; at *Newport News, Va.*
Credited to Massachusetts,

2nd Regiment of *U.S. Col. Bay* Volunteers, 6th

Major 6th U.S. Cavalry
Chief Mustang Officer
John M. ...

931
Land Marshall

Co H, 2 U. S. Col'd Cav.

CARD NUMBERS.

1	26
2	27
3	28
4	29
5	30
6	31
7	32
8	33
9	34
10	35
11	36
12	37
13	38
14	39
15	40
16	41
17	42
18	43
19	44
20	45
21	46
22	47
23	48
24	49
25	50

See Lamb Marshall

Book Mark:

See also

932
Landon Jacob

Co A, 2 U. S. Col'd Cav.

Private | Private

CARD NUMBERS.

1	5-3 17 24 6	26
2	5-3 14 3 2 0	27
3	5-3 17 4 1 0	28
4	5-3 17 4 9 8	29
5	5-3 17 5 7 8	30
6	5-3 17 6 6 8	31
7	5-3 17 7 5 5	32
8	5-3 17 8 4 3	33
9	5-3 17 9 3 7	34
10	5-3 18 0 2 2	35
11	5-3 18 1 1 6	36
12	5-3 18 1 9 6	37
13	5-3 18 2 7 2	38
14	5-3 18 3 4 4	39
15	62 97 9 6 3	40
16	90 87 0 9 4	41
17	40 72 6 2 7 9	42
18		43
19		44
20		45
21		46
22		47
23		48
24		49
25		50

Book Mark:

See also

S-973727 - P. G. M. & M.
S1298887 - P.O. rtd

L Ballany 4th

2nd | 2 Cav. | U.S.C.T.

Jake Landon

, Co. A, 2 Reg't U. S. Col'd Cav.

Appears on

Company Descriptive Book

of the organization named above.

DESCRIPTION.

Age 24 years; height 5 feet 10 1/2 inches.

Complexion Tawny

Eyes Black; hair Black

Where born Enfield, N. C.

Occupation

ENLISTMENT.

When Dec. 22, 186

Where Ft. Monroe

By whom Col. Cole; term 3 y'rs.

Remarks:

L | **2 Cav.** | **U.S.C.T.**

Jacob Landon

Pro, Co. *A*, 2 Reg't U. S. Col'd Cavalry.

Age.....years.

Appears on

Company Muster-in Roll

of the organization named above. Roll dated

At Monroe Va, *Dec 22*, 186 *3*.

Muster-in to date *Dec 22*, 186 *3*.

Joined for duty and enrolled:

When *Dec 22*, 186 *3*

Where *At Monroe Va*

Period *3* years.

Valuation of horse, \$.....100

Valuation of horse equipments, \$.....100

Remarks:.....

Book mark:.....

J. E. Chapin

L | **2 Cav.** | **U.S.C.T.**

Jake Lundon

Pro, Co. A, 2 Reg't U. S. Col'd Cavalry.

Appears on

Company Muster Roll

for *from Enrollmt to Feb. 29*, 186*4*.

Present or absent *Present*

Stoppage, \$ *100* for

Due Gov't, \$ *100* for

Valuation of horse, \$ *100*

Valuation of horse equipments, \$ *100*

Remarks:

Book mark:

J. E. Chapin

2 | **2 Cav.** | **U.S.C.T.**

Wm. Lane

Wm., Co. A, 2 Reg't U. S. Col'd Cavalry.

Appears on

Company Muster Roll

for *March & April*, 1864.

Present or absent *Present*

Stoppage, \$ *100* for

Due Gov't, \$ *100* for

Valuation of horse, \$ *100*

Valuation of horse equipments, \$ *100*

Remarks:

Book mark:

J. E. Chapin

L | **2 Cav.** | **U.S.C.T.**

Jake Laudon

Pvt, Co. A, 2 Reg't U. S. Col'd Cavalry.

Appears on

Company Muster Roll

for May & June, 1864

Present or absent Present

Stoppage, \$ 100 for

Due Gov't, \$ 100 for

Valuation of horse, \$ 100

Valuation of horse equipments, \$ 100

Remarks:

Book mark:

J. E. Chapin

L | **2 Cav.** | **U.S.C.T.**

Jacke Landon

Priv, Co. A, 2 Reg't U. S. Col'd Cavalry.

Appears on

Company Muster Roll

for July & Aug, 1864.

Present or absent Present

Stoppage, \$ 100 for

Due Gov't, \$ 100 for

Valuation of horse, \$ 100

Valuation of horse equipments, \$ 100

Remarks: Stoppages

One for Spurs & Straps \$ 5.2

" Horse bag 1.50

" Curry Comb & brush 1.01

Book mark:

R. S. Shelton

S. | **2 Cav.** | **U.S.C.T.**

Jack Sandon

Plt, Co. A, 2 Reg't U. S. Col'd Cavalry.

Appears on

Company Muster Roll

for *Sept & Oct*, 1864.

Present or absent *Present*

Stoppage, \$ *100* for

Due Gov't, \$ *100* for

Valuation of horse, \$ *100*

Valuation of horse equipments, \$ *100*

Remarks:

Book mark:

R. S. Shelton

1864
S | 2 Cav. | U.S.C.T.

Jacob Landon
Pvt., Co. A, 2 Reg't U.S. Col'd Cavalry.

Appears on

Company Muster Roll

for Nov & Dec, 1864.

Present or absent Present

Stoppage, \$ 100 for

Due Gov't, \$ 100 for

Valuation of horse, \$ 100

Valuation of horse equipments, \$ 100

Remarks: Detailed in
the Band.

Book mark:

R. S. Shelton

L | 2 Cav. | U.S.C.T.

Jacob Landor
Pvt, Co. A, 2 Reg't U. S. Col'd Cavalry.

Appears on

Company Muster Roll

for Jan & Feb, 1865.

Present or absent Present

Stoppage, \$ 100 for

Due Gov't, \$ 100 for

Valuation of horse, \$ 100

Valuation of horse equipments, \$ 100

Remarks: Detailed in Band

Book mark:

R. S. Shelton

J | **2 Cav.** | **U.S.C.T.**

Jacob Landon
Plt, Co. A, 2 Reg't U. S. Col'd Cavalry.

Appears on

Company Muster Roll

for *Mgt*, 186*5*.

Present or absent *absent*

Stoppage, \$ *100* for

Due Gov't, \$ *100* for

Valuation of horse, \$ *100*

Valuation of horse equipments, \$ *100*

Remarks: *Over special ser-*
vise with Reg't as stor-
fol to various Bands

Book mark:

Wiley
Copyist.

S. | **2 Cav.** | **U.S.C.T.**

George Goodwin
1st, Co. A, 2 Reg't U. S. Col'd Cavalry.

Appears on

Company Muster Roll

for *May 2, 1865*, 186*5*.

Present or absent *Present*

Stoppage, \$ *100* for

Due Gov't, \$ *100* for

Valuation of horse, \$ *100*

Valuation of horse equipments, \$ *100*

Remarks: *On duty duty in*
Regiment, 2nd Reg't U.S.
for ordnance lost
\$0.77

Book mark:

W. L. Kelley
Copyist.

MAY 17

L. | **2 Cav.** | **U.S.C.T.**

Jacob Landrum
1st, Co. A, 2 Reg't U. S. Col'd Cavalry.

Appears on

Company Muster Roll

for *July 1861*, 186 *1*.

Present or absent *Present*

Stoppage, \$ *100* for

Due Gov't, \$ *100* for

Valuation of horse, \$ *100*

Valuation of horse equipments, \$ *100*

Remarks: *On duty in
Band, 1st U.S. Col'd
Cavalry &c.*

Book mark:

Mellor

L | 2 Cav. | U.S.C.T.

Jacob Landon
Priv, Co. A, 2 Reg't U. S. Col'd Cavalry.

Appears on

Company Muster Roll

for Sept Oct, 1865.

Present or absent present

Stoppage, \$ 100 for

Due Gov't, \$ 100 for

Valuation of horse, \$ 100

Valuation of horse equipments, \$ 100

Remarks: Dually for ordnance
77 cts

Book mark:

G. E. Dayton

L. | **2 Cav.** | **U.S.C.T.**

Jacob Landan

Priv, Co. A, 2 Reg't U. S. Col'd Cavalry.

Appears on

Company Muster Roll

for *Nov + Dec*, 186*5*.

Present or absent *absent*

Stoppage, \$ *100* for

Due Gov't, \$ *100* for

Valuation of horse, \$ *100*

Valuation of horse equipments, \$ *100*

Remarks: *On detached service
at Ft 2rs 3 Div 25ac*

Book mark:

G. E. Dayton

L. | 2 Cav. | U.S.C.T.

Jacob Linden
M., Co. A, 2 Reg't U. S. Col'd Inf.

Appears on a

Detachment Muster Roll

of the organization named above

for Nov. & Dec., 1865.

Station

Present or absent Present

Stoppage, \$ 100 for

Due Gov't, \$ 100 for

Remarks: Detailed per
SO, #156 Ex. II. No.
2 no Post ap Brazos
Tex.

Book mark:

Alce

L | 2 Cav. | U.S.C.T.

Jake Landon
Co. A, 2 Reg't U. S. Colored Cav.

Appears on Returns as follows:

Dec 1864 to Feb 1865.
On duty - detailed
in Band.
Mch 1865. On extra
or daily duty -
Apr 1865. Absent on
det. service in 2^d
USCC Band at
Norfolk, Va.
May to Aug 1865 -
On duty in Band

Name appears also as
Jacob Landon

Book mark :

A. H. Ellis

L | 2 Cav. | U.S.C.T.

Jacob London
Co. A, 2 Reg't U. S. Col'd Cavalry.

Appears on Co. Muster-out Roll, dated
Brazos Santiago, Tex / Feb, 1866.
Muster-out to date Feb, 1866.
Last paid to 30 June, 1865.

Clothing account:

Last settled....., 186 ; drawn since \$ 100
Due soldier \$ 100; due U. S. \$ 4⁵²/₁₀₀
Am't for cloth'g in kind or money adv'd \$ 100

Due U. S. for arms, equipments, &c., \$ 7⁷/₁₀₀

Bounty paid \$ 100; due \$ 100

Remarks: joined original
organization
Staff / Cone & March
Abrash stripes.

Book mark:

G. E. Dayton

--	--	--

Linden, Jacob
P., Co. *A.*, **2** Reg. **U. S. C. Cav.**

Enclosures.

Bed Cards	Descriptive Lists
Burial Records	Final Statements
Certs. of Dis. for Discharge	Furloughs
C. M. Charges	Med. Des. Lists
Med. Certificates	Orders /

Other papers relating to—

Admission to Hosp'l	Furlough
Casualty Sheet (Officer's)	Med. Examination
Confinement	Misc. Information
Contracts	Pay or Clothing
Death or Effects	Personal Reports
Desertions	Rank
Discharge from Hosp'l	Transfer to Hosp'l
Discharge from Service	Transfer to V. R. C.
Duty	Transportation

HEAD POST OFFICE
NO 924

Head Post Office
December 28/65

S.O. No 106 Paris

Details via Paris
London to A.
2^d N.S.C.C.

Recd Dec 28. 1865.

Headquarters Post of Brazos Santiago, Texas,

December 28th 1865

Special Orders, }
No. 156

Extract

The following are selected
men who are detained as prisoners at this
post and will report without delay

Private Jacob S. Miller Co. B. 2nd U.S. Inf.

By order of A. H. King, Genl. Col. C.

~~BRIG. GEN'L W. T. CLARK.~~

C. O. 2nd U.S. Inf.
Adj. C. O. 1st Brigade

Henry H. Henson
Capt. 2nd U.S. Inf.
Adj. Assistant Adjutant General.

Lane Jordan ⁹³³

Co *G*, 2 U. S. Col'd Cav.

Private | Private

CARD NUMBERS.

1	5-3 1 5-6 15	26
2	5-3 2 3 4 7 0	27
3	5-3 2 3 5 5 9	28
4	5-3 2 3 6 8 0	29
5	5-3 2 4 6 1 5	30
6	4097-05-1886	31
7	4097-05-1886	32
8	40726281	33
9		34
10		35
11		36
12		37
13		38
14		39
15		40
16		41
17		42
18		43
19		44
20		45
21		46
22		47
23		48
24		49
25		50

Book Mark: 4097-05-1886

See also

Rep 347379.

S 1969190 Ans CVD.

D 2158008 Pomini

L Ballou 4/18

L. | 2 Cav. | U.S.C.T.

Jordan Lanes

Prk, Co. 2 Reg't U. S. Col'd Cav.

Age _____ years.

Appears on a

Detachment Muster-in Roll
of *unattached recruits* the organization named above. Roll dated

Ft. Monroe, Va., Jan. 8, 1864.

Muster-in to date Jan. 8, 1864.

Joined for duty and enrolled:

When Jan. 1, 1864.

Where Ft. Monroe, Va.

Period 3 years.

Valuation of horse, \$ 100

Valuation of horse equipments, \$ 100

Remarks: _____

Book mark: _____

J. J. Kearney
Cpyist.

a | **2 Cav.** | **U.S.C.T.**

London Lane

priv, Co. F, 2 Reg't U. S. Col'd Cavalry.

Appears on

Company Muster Roll

for *date May 20*, 186*4*

Present or absent *present*

Stoppage, \$ *100* for

Due Gov't, \$ *100* for

Valuation of horse, \$ *100*

Valuation of horse equipments, \$ *100*

Remarks:

Book mark:

H. B. Smith

2 Cav. U.S.C.T.

Indian Love

1st, Co. F, 2 Reg't U. S. Col'd Cavalry.

Appears on

Company Muster Roll

for *March & April*, 186*4*

Present or absent *present*

Stoppage, \$ *100* for

Due Gov't, \$ *100* for

Valuation of horse, \$ *100*

Valuation of horse equipments, \$ *100*

Remarks:

Book mark:

J. C. Curtis

a | 2 Cav. | U.S.C.T.

William Lane

....., Co. F, 2 Reg't U. S. Col'd Cavalry.

Appears on

Company Muster Roll

for *May & June*, 1864.

Present or absent.....

Stoppage, \$.....100 for.....

Due Gov't, \$.....100 for.....

Valuation of horse, \$.....100

Valuation of horse equipments, \$.....100

Remarks: *Deserted near Strasburg Va. June 26. ec. Due U.S. for 1 Rem revolver 1 Cut. 1 sabre 1 sabre belt 1 book 1 Cut bag 1 cap br 1 post halster 1 combing string & sword. \$56 77*

Book mark: *V. 139 P. 89. 72.*

Inserted by Compr.

McClelland

L | 2 Cav. | U.S.C.T.

Jordan Lane
Co. F., 2 Reg't U. S. Colored Cav.

Appears on Returns as follows:

June 1864 - Loss
June 26/64 near
Petersburg -
Deserted -

Book mark :

A. H. Collins

L. O'Leary | *O'Leary* | **U. S. C. T.**

Jordan Lane

O, Co. *F*, *2* Reg't U. S. Col'd *O'Leary*

Appears on **Co. Muster-out Roll**, dated
Trujillo Santiago Texas, Feb. 12, 1864.

Muster-out to date _____, 186 .

Last paid to _____, 186 .

Clothing account:

Last settled _____, 186 ; drawn since \$ _____ 100

Due soldier \$ _____ 100; due U. S. \$ _____ 100

Am't for cloth'g in kind or money adv'd \$ _____ 100

Due U. S. for arms, equipments, &c., \$ _____ 100

Bounty paid \$ _____ 100 due \$ _____ 100

Remarks: *Deserted.*

Book mark: *Deserted June 26 / 64*
used

W. Stearns

JAN. -7

5324615

1891

near Petersburg, Va.

E. B. V. 10. P. 116.

4097 G. T. 1886.

L. 2nd Cav U.S. 6th

Jordan Lane

Co. F, 2nd Reg't U.S. 6th Cav.

NOTATION.

Book mark: 4097-6.3-1886

War Department,

Adjutant General's Office,

Washington, March 3rd, 1887.

Application for removal of the charge of desertion and for an honorable discharge has been denied.

E. P. Conner

(4376)

Copyist.

L. | 2d Cav. | U.S.A.

Jordan Lewis

, Co. F, 2d Reg't U.S. Cav.

NOTATION.

E.B. 10. 116 L. 17. C. 9. 1872.
Book mark: with 4097-05-1886

War Department,

Adjutant General's Office,

Washington, June 29th, 1872.

Accepted June 26. 1862.

A. M. Muzzey

Lane, Jordan

P, Co. F, 2 Reg't 750th Air.

Enclosures.

Bed Cards	Final Statements
Burial Records	Furloughs or L. of A.
Certs. of Dis. for Discharge	Med. Certificates
C. M. Charges	Med. Des. Lists
Descriptive Lists	Orders
Discharge Certificates	Pris. of War Record
Enlistment Papers	Resignations

Other papers relating to—

Admission to Hosp'l	Furlough or L. of A.
Casualty Sheet	Med. Examination
Confinement	Misc. Information
Contracts	Pay or Clothing
Death or Effects	Personal Reports
Desertion	Rank
Discharge from Hosp'l	Transfer to Hosp'l
Discharge from Service	Transfer to V. R. C.
Duty	Transportation

MEMORANDUM

MEMORANDUM FROM PRISONER OF WAR RECORDS.

No. _____

(This blank to be used only in the arrangement of said records.)

NAME.	RANK.	ORGANIZATION.				INFORMATION OBTAINED FROM—				
		No. of Reg't.	State.	Arm of Service.	Co.	Records of—	Vol.	Page.	Vol.	Page.
<i>Lane Jordan</i>	<i>P</i>	<i>2</i>	<i>W.S.C.</i>	<i>C</i>	<i>A</i>	<i>Piles & Ratings</i>				
						<i>Meis Insp</i>				
						<i>Do 39</i>				
						<i>Lab. 4</i>				

Captured at _____, 186 , confined at Richmond, Va., _____, 186 .

No record subsequent to June 25/64

Admitted to Hospital at _____

where he died _____, 186 , of _____

Paroled at _____, 186 ; reported at Camp Parole, Md., _____, 186 .

Altd. care to W.C.T. Branch 2.25.87

See 2nd No 4647-C-1886

Copied by *FMP 2-23-86*

934
Lanford Peter

Co E, 2 U. S. Col'd Cav.

Private Private

CARD NUMBERS.

1	5-315-540	26
2	5-322882	27
3	5-322974	28
4	5-323069	29
5	5-323178	30
6	5-323349	31
7	40055828	32
8	5387839	33
9	43153152	34
10	40726282	35
11		36
12		37
13		38
14		39
15		40
16		41
17		42
18		43
19		44
20		45
21		46
22		47
23		48
24		49
25		50

Book Mark:

See also

L | *2 Cav* | **U.S.C.T.**

Peter Langford
Priv., Co., *2* Reg't U. S. Col'd *Cav.*

Age *33* years.

Appears on a

Detachment Muster-in Roll

of the organization named above. Roll dated
Baltimore, Md., *Mar. 22*, 186*3*.

Muster-in to date *Mar 14*, 186*3*.

Joined for duty and enrolled:

When *Mar. 3*, 186*3*.

Where *Baltimore, Md*

Period *3* years.

Valuation of horse, \$.....*100*

Valuation of horse equipments, \$.....*100*

Remarks: *Substitute*

Book mark :

L | ² ² ^{Co}
 W.C.T

Peter Langford. (Co'st)

Appears with rank of Cor. on

Muster and Descriptive Roll

of Detachments of Substitute
 - enlisted forwarded
Balto. Co. Md. Roll dated
Ellicotts Mills, Md Mar 13 1865.

Where born Hunting Creek Va

Age 35 y'rs; occupation Laborer

~~Enlisted~~
 Drafted and mustered in:

When Mar 13, 1865.

Where Ellicotts Mills Md.

Enrollment district By whom Capt. J. C. Holland

Period _____ years.

Eyes Black; hair Black

Complexion Black; height 5 ft. 6 in.

Bounty paid \$ _____ 100; due \$ _____ 100

Clothing account:

Last settled _____, 186 ; drawn since \$ 27⁹²/₁₀₀

Date of commencement of service Mar. 13, 1865.

Company to which assigned _____

Remarks: 5th Cong Dist. Md.
Substitute for Wm G. Lucas
4th Sub Dist. him to draft. Pay
due from Mar. 13, 1865.

Book mark: _____

R. W. Fish

L | ²/₆ | U.S.C.T.

Peter Langford

Appears with rank of _____ on

Muster and Descriptive Roll of a Detachment of Substitutes forwarded

for the ^x2 Reg't U. S. Col'd Cavalry. Roll dated
Not dated, 186 .

Where born *Hunting Creek, Virginia.*

Age 35 y'rs; occupation *Laborer*

When enlisted *Mch 13*, 1865.

Where enlisted *Ellicott's Mills, Md.*

For what period enlisted *3* years.

Eyes *Blk* hair *Blk*

Complexion *Blk*; height *5 ft. 6 in.*

When mustered in _____, 186 .

Where mustered in _____

Bounty paid \$ _____; due \$ 100

Where credited *5* *Dist. Md.*

Company to which assigned _____

Remarks: *Substitute for William G. Lucas.*

~~*Became U.S. Col'd Cavalry*~~

~~*Connected with 747. C. M.*~~
Book mark:

~~*Name not taken up in Rolls Cause.*~~

Conard

Copyist.

A L L D
This card was erroneously made from an unsigned M. & D. roll. B. & P. 330-37.

L | **2 Cav.** | **U.S.C.T.**

Peter Langford

Appears with the rank of _____ on
**Muster and Descriptive Roll of a Detach-
ment of Substitutes forwarded**

for the 2 Reg't U. S. Colored Cav. Roll dated
Baltimore Md, Mch 20, 1865.

Where born *Hunting Creek, Virginia*

Age *35* y'rs; occupation *laborer*

When enlisted *Mch 13, 1865.*

Where enlisted *Scotts Mills*

For what period enlisted *3* years.

Eyes *Blk*; hair *Blk*

Complexion *dark*; height *5* ft. *6* in.

When mustered in _____, 186 .

Where mustered in _____

Bounty paid \$ *100*; due \$ *100*

Where credited _____

Company to which assigned _____

Remarks *Substitute for
William G Lucas
5th Dist. Md.*

Book mark: _____

R. T. Bayles

1. | **2 Cav.** | **U.S.C.T.**

Peter Langford,

Private, Co. E, 2 Reg't U. S. Col'd Cavalry.

Appears on

Company Muster Roll

for March & April, 1865.

Present or absent Present.

Stoppage, \$ 100 for

Due Gov't, \$ 100 for

Valuation of horse, \$ 100

Valuation of horse equipments, \$ 100

Remarks: Amount due on Check
Book \$70.

Book mark:

R. Braxton

L | 2 Cav. | U.S.C.T.

Peter Luny for

For, Co. E, 2 Reg't U. S. Col'd Cavalry.

Appears on

Company Muster Roll

for May June, 1860.

Present or absent Present

Stoppage, \$ 100 for

Due Gov't, \$ 100 for

Valuation of horse, \$ 100

Valuation of horse equipments, \$ 100

Remarks: amount due on
Check for \$50.

Book mark:

(358) J. H. Schrock Copyist.

L | 2 Cav. | U.S.C.T.

Peter Langford
Private, Co. E, 2 Reg't U.S. Col'd Cavalry.

Appears on

Company Muster Roll
for July & Aug, 1863.

Present or absent Absent

Stoppage, \$ 100 for

Due Gov't, \$ 100 for

Valuation of horse, \$ 100

Valuation of horse equipments, \$ 100

Remarks: Absent sick in
Hospital

Book mark:

(358) J. H. Schudy Copyist.

L | 2 Cav. | U.S.C.T.

Peter Langford

Pvt, Co. E, 2 Reg't U. S. Col'd Cavalry.

Appears on

Company Muster Roll

for Sept. & Oct., 1865

Present or absent

Stoppage, \$ 100 for

Due Gov't, \$ 100 for

Valuation of horse, \$ 100

Valuation of horse equipments, \$ 100

Remarks: Died in Hospital
Brazos Santiago, Tex. July
15/65

Book mark:

(358)

B. Nelson
Comptroller

Copyist

L | 2 Cav. | U. S. C. T.

Peter Langford*
Pot, Co. E, 2 Reg't U. S. Col'd Cav.

Appears on Returns as follows:

Mch 1865 - Gain: Mch 25, Norfolk,
Recruit from depot

July 1865 Absent sick in Hosp.
at Brazos Santiago, Texas
Aug & Sept 1865 Absent sick in Genl
Hosp since July 1865
Oct 1865. Loss: July 15, Brazos,
Died in Hosp

*Name appears also as
Peter Langley

Book mark:

S. Cottrell

20 | **2 Cav. | U.S.C.T.**

Peter Sanford

Co. A, Co. *A*, 2 Reg't U. S. Col'd Cavalry.

Appears on **Co. Muster-out Roll**, dated *Green Springs Tex*, *July 12*, 186*6*.

Muster-out to date _____, 186 .

Last paid to _____, 186 .

Clothing account:

Last settled _____, 186 ; drawn since \$ _____ 100

Due soldier \$ _____ 100; due U. S. \$ _____ 100

Am't for cloth'g in kind or money adv'd \$ _____ 100

Due U. S. for arms, equipments, &c., \$ _____ 100

Bounty paid \$ _____ 100; due \$ _____ 100

Remarks: *Died joined as recruit*
died in Post Hosp Boston Tex July 15
Rec'd notf. Sep. 2. 65 Fr its 9 1/2 of effects
Sept. 15. 65

Book mark: *V 135 P 143. 72*
died July 15. 65 E R V. 10 P 56.

H. W. Merrill
(361) Copyist.

Langford, Peter

P, Co. E, 2 Reg't U.S.C.C.

1 Enclosures.

Bed Cards	Descriptive Lists
Burial Records	Final Statements
Certs. of Dis. for Discharge	Furloughs
C. M. Charges	Med. Des. Lists
Med. Certificates	Orders

Other papers relating to—

Admission to Hosp'l	Furlough
Casualty Sheet (Officer's) /	Med. Examination
Confinement	Misc. Information
Contracts	Pay or Clothing
Death or Effects	Personal Reports
Desertions	Rank
Discharge from Hosp'l	Transfer to Hosp'l
Discharge from Service	Transfer to V. R. C.
Duty	Transportation

4 C Jan 27 66

CASUALTY SHEET.

No.

Peter Langford

Private of Company E

2^d Regiment of W.G. Cav

State Volunteers.

died July 17, 1865

NATURE OF CASUALTY.

Adjutant General's Office

Washington D. C. February 26, 1872

The Muster-out Roll of Co. "E"

2nd U. S. Colored Cavalry report date of death of

Private Peter Langford - July 6th 1865.

Company Muster Roll for September & October 1865 and "Quarterly Return of Decensed soldiers for the 4th Quarter 1865" June 15th 1865.

The latter date [June 15th 1865] is held to be correct and the Company Muster-out Roll will be amended accordingly.

Thoma M. Smeent
E. B. 10
MAJ. 30 Assistant Adjutant General
Noted
H.M.

See letter of March 1st 1872 to Second Auditor

Notes on Muster
Jms

* For June 15, 1865, read July 15, 1865, which date is held to be that of the soldier's death.
Thoma M. Smeent
Mch 25 72

Vertical handwritten notes on the right margin, including a large 'E' and other illegible characters.

CASUALTY SHEET.

Name: Peter Langford

Rank: Private Company: C Regiment: 2^d

Arm: U.S. Navy State:

Nature of Casualty: Death

CAUSE OF CASUALTY—(NAME OF DISEASE, &c.)

Unknown

BY WHOM DISCHARGED.

FROM WHAT SOURCE THIS INFORMATION WAS OBTAINED.

Atty. Gen. W. C. Folger
Dec 31st 1865

DEGREE OF DISABILITY.

BY WHOM CERTIFIED.

Frank L. Kent
Major

DATE OF DISCHARGE, DEATH, &c.

July 15th 1865

PLACE OF DISCHARGE, DEATH, &c.

Krazos Texas

REMARKS.

F. S. Cole

(119) Clerk.

Lang Joshua ⁹³⁵

Co ~~A~~, 2 U. S. Col'd Cav.

Private | Private

CARD NUMBERS.

1	5-3 2 5-8 8 3	26
2	5-3 2 5-9 6 6	27
3	5-3 2 6 0 5-3	28
4	5-3 2 6 1 4 1	29
5	5-3 2 6 2 2 0	30
6	5-3 2 6 3 0 5	31
7	5-3 2 6 4 0 4	32
8	5-3 2 6 4 6 2	33
9	3 3 2 2 6 2 2 7	34
10		35
11		36
12		37
13		38
14		39
15		40
16		41
17		42
18		43
19		44
20		45
21		46
22		47
23		48
24		49
25		50

Book Mark:

See also

L | **2 Cav.** | **U.S.C.T.**

Joshua Lang
Plt, Co. 76, 2 Reg't U. S. Col'd Cav.

Age 40 years.

Appears on

Company Muster-in Roll

of the organization named above. Roll dated

Fort Monroe Va, Jan 8, 1864.

Muster-in to date Jan 8, 1864.

Joined for duty and enrolled:

When Jan 1, 1864.

Where Pongatigue Va

Period 3 years.

Valuation of horse, \$ 100

Valuation of horse equipments, \$ 100

Remarks :

Book mark: 5

(356)

A. J. Anderson

Copyist.

L | 2 Cav. | U.S.C.T.

Joshua Lang
Private, Co. H, 2 Reg't U. S. Col'd Cavalry.

Appears on

Company Muster Roll

for *From date of enrollment to Feb 29*, 1864.

Present or absent *Present*

Stoppage, \$ *100* for

Due Gov't, \$ *100* for

Valuation of horse, \$ *100*

Valuation of horse equipments, \$ *100*

Remarks:

Book mark:

(358)

A. J. Anderson

Copyist.

a | **2 Cav. | U.S.C.T.**

Josiah Lang
Co, Co. H, 2 Reg't U. S. Col'd Cavalry.

Appears on

Company Muster Roll

for *March & April*, 1864.

Present or absent *Present*

Stoppage, \$ *100* for

Due Gov't, \$ *100* for

Valuation of horse, \$ *100*

Valuation of horse equipments, \$ *100*

Remarks:

Book mark: -----

(358) *A. J. Anderson* Copyist.

L | 2 Cav. | U.S.C.T.

John Lanza
Private, Co. H, 2 Reg't U. S. Col'd Cavalry.

Appears on

Company Muster Roll

for May Term, 1864.

Present or absent Present

Stoppage, \$ 100 for

Due Gov't, \$ 100 for

Valuation of horse, \$ 100

Valuation of horse equipments, \$ 100

Remarks:

Book mark:

A. J. Anderson

L

2 Cav. U.S.C.T.

Joshua Lang
Priv, Co. H, 2 Reg't U. S. Col'd Cavalry.

Appears on

Company Muster Roll

for *May 1st to Sep. 1st*, 186*4*.

Present or absent *Present*

Stoppage, \$ *100* for

Due Gov't, \$ *100* for

Valuation of horse, \$ *100.*

Valuation of horse equipments, \$ *100*

Remarks:

Book mark:

(358)

W. B. Ferguson
Copyist.

L | **2 Cav.** | **U.S.C.T.**

Joshua Lamy
Priv, Co. H, 2 Reg't U. S. Col'd Cavalry.

Appears on

Company Muster Roll

for *Sept. & Oct.*, 1864.

Present or absent *Absent*

Stoppage, \$ *100* for

Due Gov't, \$ *100* for

Valuation of horse, \$ *100*

Valuation of horse equipments, \$ *100*

Remarks: *Absent sick in*
Genl. Hoapt.

Book mark:

W. J. Ferguson

L | 2 cav. | U.S.C.T.

J. Lang
Priv. Co. H, 20 Reg't U.S.C.T.

Appears on

Hospital Muster Roll

of U. S. A. General Hospital,

at Fort Monroe, Va.,

for Sept. & Oct., 1864.

Attached to hospital :

When _____, 186 .

How employed _____

Last paid by Maj. _____

to _____, 186 .

Bounty paid \$ 100 ; due \$ 100

Present or absent Present.

Remarks : No descriptive list.

Section 4. New Camp.

Book mark : _____

Armstrong

L | **2 Cav.** | **U.S.C.T.**

Joshua Lang
Priv, Co. H, 2 Reg't U. S. Col'd Cavalry.

Appears on

Company Muster Roll

for *Nov. & Dec.*, 1864.

Present or absent

Stoppage, \$ 100 for

Due Gov't, \$ 100 for

Valuation of horse, \$ 100

Valuation of horse equipments, \$ 100

Remarks: *Discharged by*
Surgeons Certificate
Dec 8/64

Book mark: *died Nov 11/64 E. B. V. H. P. 131.*

W. B. Ferguson

L | 2 Cav. | U.S.C.T.

Joshua Lang
Pr., Co. H, 2 Reg't U. S. Colored Cav.

Appears on Returns as follows:

Return to April 1864 - On
extra duty in
27m Sept. per S.O. -
May + June 1864 -
On duty Becksmith
in R. 27m. Sept.

Sept + Nov. 1864 - Absen-
sion in Genl Hosp.

Book mark :

A. H. Collins
Copyist.

2 Cav. | U.S.C.T.

Joshua Lang
Pat, Co. *H*, 2 Reg't U. S. Col'd Cavalry.

Appears on **Co. Muster-out Roll**, dated
Brazos Santiago Tex Feb 12, 1866.
Muster-out to date _____, 186 .
Last paid to _____, 186 .

Clothing account:

Last settled _____, 186 ; drawn since \$ _____ 100
Due soldier \$ _____ 100 ; due U. S. \$ _____ 100
Am't for cloth'g in kind or money adv'd \$ _____ 100

Due U. S. for arms, equipments, &c., \$ _____ 100
Bounty paid \$ _____ 100 ; due \$ _____ 100

Remarks: *joined at Orig Orgⁿ*
Discharged on Surgⁿ Cert. of
disability at Ft Monroe Va Dec 15/64
Disch^d & final statement furnished
same date.

Book mark: *Discharged Nov 11/64*
E. B. V. N. P. 131.

W. H. Kelly
Copyist.

Lang Joshua

Pt. H, Co. 2, Reg't U.S.C. Co.

2 Enclosures.

Bed Cards	Final Statements
Burial Records	Furloughs or L. of A
Certs. of Dis. for Discharge	Med. Certificates
C. M. Charges	Med. Des. Lists
Descriptive Lists	Orders
Discharge Certificates	Pris. of War Record
Enlistment Papers	Resignations

Other papers relating to—

Admission to Hosp'l	Furlough or L. of A
Casualty Sheet	Med. Examination
Confinement	Misc. Information
Contracts	Pay or Clothing
Death or Effects	Personal Reports
Desertion	Rank
Discharge from Hosp'l	Transfer to Hosp'l
Discharge from Service	Transfer to V. R. C.
Duty	Transportation

MICROFILM PUBLICATION M 1818

COMPILED MILITARY SERVICE RECORDS
OF VOLUNTEER UNION SOLDIERS WHO
SERVED WITH THE USCT (US COLORED TROOPS)
2ND REGIMENT OF CAVALRY

PERSONAL PAPERS' TARGET SHEET

PLEASE NOTE THE CHECKED INFORMATION ABOUT THE PERSONAL PAPERS IN
THIS FILE:



NO PERSONAL PAPERS WERE FOUND IN THIS FILE WHEN THE
RECORDS WERE ARRANGED FOR MICROFILMING.



3 PERSONAL PAPER(S) FOUND IN THIS FILE WHEN THE RECORDS
WERE ARRANGED FOR MICROFILMING.

FINAL STATEMENT

OF

Joshua L. Gama
2^d Reg't of *1st Cal. Inf.*

VOLUNTEERS.

NOTE 1.—Two of these certificates (or duplicates) are to be given to each Volunteer Soldier or drafted man who may be discharged previously to the discharge of his company, that he may at once receive from the Paymaster the pay, &c., due him, and the captain or other COMMISSIONED officer commanding the company will certify to the act of the delivery of the duplicate certificates; on these certificates the Soldier is "entitled to" his discharge, and should also present his discharge to the Paymaster to have the payment endorsed on it. The discharge is to be given back to the Soldier by the Paymaster; the latter only retaining as his voucher the duplicate certificates.

NOTE 2.—If the Soldier is entitled to pay for the use of his horse, the Company Commander will certify to that fact on the back of both these final statements, and also to the time he has pay due for having been so mounted on his own horse.

NOTE 3.—When a Soldier is furnished with final statements, his descriptive list, if he has one, should be taken up by the officer who gives the Soldier these statements, and endorsed with a statement to this effect by the officer. This endorsement should exhibit a full statement of the time for which the Soldier was allowed pay on his final statements, the clothing account, and all other charges against him or in his favor, so as to comprise a complete exhibit of his account. It will then be transmitted to the Company Commander of the Soldier, who will enter all the data necessary to a full understanding of the Soldier's account on the muster roll upon which the Soldier's discharge is reported. The descriptive list will then be destroyed. The object of this is, that the remaining portion of the Soldier's account may be settled upon the receipt of these muster rolls, and the Soldier receive any pay or allowances that may be due him at the time of his discharge, and which may not appear on his final statements from the fact that his descriptive list is incomplete. These accounts for back pay, &c., are settled by the 2d Auditor of the Treasury Department.

NOTE 4.—Charges for loss or injury to ordnance, horse equipments, and other miscellaneous charges, should appear under the heading of "Other Stoppages."

NOTE 5.—Bounty paid by State authorities, and not by the United States, will not be entered on this statement.

NOTE 6.—Amounts due the Sutler and Laundress must be entered on the muster roll on which the discharge, death, desertion, &c., is reported, as well as on the final statement, otherwise the amount cannot be collected from the United States.

NOTE 7.—This blank will be used for deceased volunteers and drafted men, as well as for others.

NOTE 8.—Where a Soldier dies in Hospital or on detached service, his descriptive list, if he has one, should be sent with his final statements, in duplicate, to the Adjutant General, Washington, D. C.

I certify, on honor, that Joshua Lang a Private of
 Captain E. P. Deacons Company (H) of the 2^d Regiment of W. C. Cav
VOLUNTEERS, of the State of _____, born in Pangloss Eastern Shore, State
 of Virginia, aged 40 years; 5 feet 4 inches high; Black complexion,
dark eyes, gray hair, and by occupation a Blacksmith, having joined the company on
 its original organization at Ft. Monroe Va, and enrolled in it at the muster into
 the service of the United States at Ft. Monroe Va, on the first day
 of January, 1864, (or was mustered in service as a recruit, by Quirk
 _____, at Ft. Monroe, on the eight day of January,
 1864, or was drafted and mustered into the service of the United States from the _____
 Enrollment District of the State of _____, at _____,
 on the _____ day of _____, 1864,) to serve in the Regiment, for
 the term of Three Years: and having served **HONESTLY** and
FAITHFULLY with his Company in the Field to the present date, is now
 entitled to a **DISCHARGE** by reason of Surgeon's Certificate of
Disability

The said Joshua Lang was last paid by Paymaster
Mag. Howell to include the 31st day of August, 1864, and has
 pay due him from that time to the present date; he is entitled to pay and subsistence for
TRAVELING to place of enrollment, and whatever other allowances are authorized to volunteer
 soldiers, drafted men, or militia, so discharged. He has received from the United States **CLOTHING**
 amounting to thirty five $\frac{45}{100}$ dollars, since the first day of January,
 1864, when his clothing account was last settled. He has received from the United States
 _____ $\frac{100}{100}$ dollars advanced **BOUNTY**.

There is to be stopped from him, on account of the State of _____, or other
 authorities, for **CLOTHING**, &c., received on entering service, _____ $\frac{100}{100}$ dollars; and
 for other stoppages, viz: _____
 _____ $\frac{100}{100}$ dollars.

He has been furnished with **TRANSPORTATION** in kind from the place of his discharge to
 _____; and he has been **SUBSISTED** for **TRAVELING** to his
 place of enrollment, up to the _____, 1864.

He is indebted to _____, **SUTLER**, _____ $\frac{100}{100}$ dollars.
 He is indebted to _____, **LAUNDRESS**, _____ $\frac{100}{100}$ dollars.

Given in Duplicate, at Camp Pickens, this 30th day
 of September, 1864.

J. A. Gay
1st Lieut

 Commanding Company. H
2^d U.S. Cav.

Fort Monroe
Genl. H.

FINAL STATEMENT

OF

George G. [unclear]
Reg't of *W. Col. [unclear]*

VOLUNTEERS.

NOTE 1.—Two of these certificates (or duplicates) are to be given to each Volunteer Soldier or drafted man who may be discharged previously to the discharge of his company, that he may at once receive from the Paymaster the pay, &c., due him, and the captain or other COMMISSIONED officer commanding the company will certify to the act of the delivery of the duplicate certificates; on these certificates the Soldier is "entitled to" his discharge, and should also present his discharge to the Paymaster to have the payment endorsed on it. The discharge is to be given back to the Soldier by the Paymaster; the latter only retaining as his voucher the duplicate certificates.

NOTE 2.—If the Soldier is entitled to pay for the use of his horse, the Company Commander will certify to that fact on the back of both these final statements, and also to the time he has pay due for having been so mounted on his own horse.

NOTE 3.—When a Soldier is furnished with final statements, his descriptive list, if he has one, should be taken up by the officer who gives the Soldier these statements, and endorsed with a statement to this effect by the officer. This endorsement should exhibit a full statement of the time for which the Soldier was allowed pay on his final statements, the clothing account, and all other charges against him or in his favor, so as to comprise a complete exhibit of his account. It will then be transmitted to the Company Commander of the Soldier, who will enter all the data necessary to a full understanding of the Soldier's account on the muster roll upon which the Soldier's discharge is reported. The descriptive list will then be destroyed. The object of this is, that the remaining portion of the Soldier's account may be settled upon the receipt of these muster rolls, and the Soldier receive any pay or allowances that may be due him at the time of his discharge, and which may not appear on his final statements from the fact that his descriptive list is incomplete. These accounts for back pay, &c., are settled by the 2d Auditor of the Treasury Department.

NOTE 4.—Charges for loss or injury to ordnance, horse equipments, and other miscellaneous charges, should appear under the heading of "Other Stoppages."

NOTE 5.—Bounty paid by State authorities, and not by the United States, will not be entered on this statement.

NOTE 6.—Amounts due the Sutler and Laundress must be entered on the muster roll on which the discharge, death, desertion, &c., is reported, as well as on the final statement, otherwise the amount cannot be collected from the United States.

NOTE 7.—This blank will be used for deceased volunteers and drafted men, as well as for others.

NOTE 8.—Where a Soldier dies in Hospital or on detached service, his descriptive list, if he has one, should be sent with his final statements, in duplicate, to the Adjutant General, Washington, D. C.

I certify, on honor, that Johna Sang a Private of
 Captain E. P. Adams Company (A) of the 2^d Regiment of Volunteers
VOLUNTEERS, of the State of _____, born in Langston Station, State
 of Virginia, aged 40 years; 5 feet 4 inches high; Black complexion,
Dark eyes, Grey hair, and by occupation a Blacksmith, having joined the company on
 its original organization at Flat Mountain, and enrolled in it at the muster into
 the service of the United States at Flat Mountain, on the first day
 of January, 1864, (or was mustered in service as a recruit, by Surgeon
Hortler, at Flat Mountain, on the eight day of January,
 1864, or was drafted and mustered into the service of the United States from the _____
 Enrollment District of the State of _____, at _____,
 on the _____ day of _____, 186) to serve in the Regiment, for
 the term of Three Years and having served **HONESTLY** and
FAITHFULLY with his Company in the Field to the present date, is now
 entitled to a **DISCHARGE** by reason of _____

The said Johna Sang was last paid by Paymaster
May Howell to include the 30th day of August, 1864, and has
 pay due him from that time to the present date; he is entitled to pay and subsistence for
TRAVELING to place of enrollment, and whatever other allowances are authorized to volunteer
 soldiers, drafted men, or militia, so discharged. He has received from the United States **CLOTHING**
 amounting to thirty five $\frac{45}{100}$ dollars, since the first day of January,
 1864, when his clothing account was last settled. He has received from the United States
 _____ $\frac{100}{100}$ dollars advanced **BOUNTY**.

There is to be stopped from him, on account of the State of _____, or other
 authorities, for **CLOTHING**, &c., received on entering service, _____ $\frac{100}{100}$ dollars; and
 for other stoppages, viz: _____
 _____ $\frac{100}{100}$ dollars.

He has been furnished with **TRANSPORTATION** in kind from the place of his discharge to
 _____; and he has been **SUBSISTED** for **TRAVELING** to his
 place of enrollment, up to the _____, 186 .

He is indebted to _____, **SUTLER**, _____ $\frac{100}{100}$ dollars.
 He is indebted to _____, **LAUNDRESS**, _____ $\frac{100}{100}$ dollars.

Given in Duplicate, at Camp Middle Deep Bottom, this 25th day
 of September, 1864.

Johna Sang

 Commanding Company. A
W. G. Carr

[OFFICE INDORSEMENT.]
War Department,

ADJUTANT GENERAL'S OFFICE,

July 28th, 1874
 Discharge of *Joshua Lang*
 Private, Co. H, 2^d Regt U. S.
 Colored Troop, is reported as follows:
 On Company Muster Roll.
 For *Nov Dec*, 1864, *Dec 8th*, 1864
 Company Muster-out Roll.
December 15th, 1864
 Company Descriptive Book.
Not on file, 186
 Company Morning Reports.
Not on file, 186
 Soldier's Final Statement.
 , 186
 Soldier's Record of Death and Interment.
 , 186
 Soldier's Inventory of Effects.
 , 186
 Soldier's Certificate of Disability for Discharge.
November 11th, 1864
 Soldier's Individual Muster-out Roll.
 , 186
 Regimental Return.
 For , 186 , , 186
 Regimental Quarterly Returns.
 , 186
 Regimental Descriptive Book.
Not on file, 186
 By Surgeon General.
 () , 186

November 11th, 1864, is held to be
 the correct date, and the Company Muster-out Roll
 will be amended accordingly.

S. M. Carter
 Assistant Adjutant General.
 See letter to Second Auditor
 E.B. 11 Aug. 10 1874.
 131.

E.B. 1399 3^d Div. 18th at 1864

CERTIFICATE OF DISABILITY FOR DISCHARGE
 IN THE CASE OF

P. M. Lenny
 Private Co. H

2^d Reg't of *MSA*
 Mo. D. D. Dep't 5th Dec. 1864.
 Ft. Monroe Va 8th Nov 1864.

Respectfully forwarded
 approved.

St. Johnston
 Asst Surg Regt
 & Asst M. S. Dir
 Department

Head Quarter
 Army of the James
 In the field Nov. 11th 1864

To be discharged

By Command of
Genl. M. K. Terry
W. B. Terry
 Asst. Adjt. Genl.

RECEIVED.
 U. S. GENERAL HOSPITAL
 Dec 6, 1864
 FT. MONROE,
 VIRGINIA.

RECEIVED
 DEC 5 1864
 OFFICE OF THE
 ADJUTANT GENERAL
 WASHINGTON

Received (A) *W. B. Terry*, 1864
 Capt. on *W. B. Terry*
 3^d Div. 18th at 1864

and a statement of the facts known to him concerning the disease or wound, or cause of disability of the soldier; the time, place, manner, and all the circumstances under which the injury occurred, or disease originated or appeared; the duty, or service, or situation of the soldier at the time the injury was received or disease contracted, stating particularly whether the injury was received or the disease contracted in the line of his duty; and whatever other facts may aid a judgment as to the cause, immediate or remote, of the disability, and the circumstances attending it.

When the facts are not known to the company commander, the certificate of any officer, or affidavit of other person having such knowledge, will be appended—as the surgeon in charge of a hospital, the officer commanding a detachment of recruits, &c., &c.

NOTE 2.

When a probable case for pension, special care must be taken to state the degree of disability—as $\frac{1}{2}$, $\frac{3}{4}$, &c., &c.; to describe particularly the disability, wound, or disease, the extent of which it deprives him of the use of any limb or faculty, or affects his health, strength, activity, constitution, or capacity to labor or earn his subsistence. The surgeon will add, from his knowledge of the facts and circumstances, and from the evidence in the case, his professional opinion of the cause or origin of the disability. In the case of discharges by Medical Inspectors, the last paragraph will state that the "discharge was given by consent of the soldier, after a personal examination, and for disability, the nature, degree, and origin of which are correctly described in the within certificate."

Par. 1260 Regulations, Edit. 1861.

Medical officers, in giving certificates of disability, are to take particular care in all cases that have not been under their charge; and especially in epilepsy, convulsions, chronic rheumatism, derangement of the urinary organs, ophthalmia, ulcers, or any obscure disease liable to be feigned or purposely produced; and in no case shall such certificate be given until after sufficient time and examination to detect any attempt at deception.

DIRECTIONS.

This certificate will be made out in duplicate by the soldier's company commander, or other officer commanding the separate detachment to which he belongs, and sent by him to the surgeon who has charge of the hospital where the soldier is sick. The surgeon will then fill out and sign the surgeon's certificate, and forward these papers to the regimental, detachment, or post commander, who will forward them, with his action endorsed thereon, through the proper channel, to his division commander; or, if the troops are not attached to a division, to his corps, department, or other commander or officer to whom the authority to discharge enlisted men may be specially delegated.

These certificates, after having received the action of the highest authority to which they are required to be sent, will be returned through the same channel to the regimental, post, or detachment commander, who will, if the discharge is authorized by the endorsement of the proper authority, sign the soldier's certificate, and the certificate on the reverse side shall be furnished with the proper final statements in duplicate, and forward BOTH of these certificates direct to the Adjutant General United States Army, at Washington, D. C.; they will not, under any circumstances, be given into the hands of the soldier.

ADJUTANT GENERAL'S OFFICE
 Duplicate sent the Pension Office.

EB 1399 3rd Div. 18th Feb 1864

CERTIFICATE OF DISABILITY FOR DISCHARGE
 IN THE CASE OF

P. Mena Gentry
 Private Co. 11th

2nd Reg't of *MSA*
 Md. D.C. Dep't 7th Dec 1864
 Ft. Monroe Va 8th Nov 1864

Respectfully forwarded
 approved.

Embellan
 Asst Surg regt
 & Asst Mus Dir
 Department

Head Quarters
 Army of the James
 In the field Nov. 11th 1864

To be discharged

By command of
 Brevet Maj Gen Terry
Frank Peak
 Asst. Adjt Genl.

RECEIVED
 U. S. GENERAL HOSPITAL
 Dec 6, 1864
 FT. MONROE,
 VIRGINIA

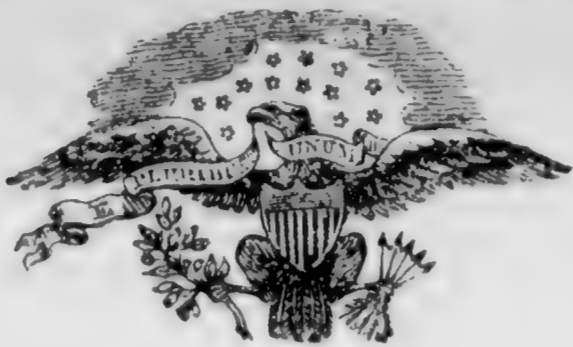
RECEIVED
 Dec 5 1864
 ADJUTANT GENERAL'S OFFICE

Received (A. G. Office) 1864
Carson
 Adjt Gen 3rd Div. 1864

ARMY OF THE UNITED STATES.

CERTIFICATE

OF DISABILITY FOR DISCHARGE.



Blacksmith John Lang, of Captain E. P. Leacock's
 Company, (A) of the 2nd Regiment of the United States
 was enlisted by Col. George W. Cole of
 the 1st Regiment of W. Va. Cav. at Fayetteville, Va.
 on the 1st day of January, 1864, to serve Three years; he was born
 in Pennsylvania in the State of Virginia, is
 years of age, feet inches high, complexion, eyes,
 hair, and by occupation when enlisted a chemist. During the last two

months said soldier has been unfit for duty 60 days. *and some time previous*
in the first organization of the Co he did some service as a blacksmith
but since then he has become unfit for duty by description caused
by old age and feeble constitution.

STATION: *Rich Bottom*
 DATE: *Dec 5th 1864*

J. C. Gray
1st Lieut. U.S. Cavalry
 Commanding Company H.

I CERTIFY, that I have carefully examined the said *John Lang*
 of Captain *E. P. Leacock's* Company, and find him incapable of performing the duties of a
 soldier because of *Old age and general debility*
He worked as a blacksmith very well
for an old man for then a few months
since that time he has rapidly failed. He
is more than 60 yrs old and his debility
has not been acquired in the service.

W. H. McNeill Surgeon.

DISCHARGED, this *11th* day of *November*, 1864, at *Rich Bottom*
Va

George W. Cole
 Col
 Commanding the Reg't.

The Soldier desires to be addressed at

Town *Perrydine* County *Perrydine* State *W. Va.*

* See Note 1 on the back of this. † See Note 2 on the back of this.

936
Langford Peter

Co E, 2 U. S. Col'd Cav.

Private | Private

CARD NUMBERS.

1	26
2	27
3	28
4	29
5	30
6	31
7	32
8	33
9	34
10	35
11	36
12	37
13	38
14	39
15	40
16	41
17	42
18	43
19	44
20	45
21	46
22	47
23	48
24	49
25	50

See Langford Peter

Book Mark:

See also

937
Langston Isaiah

Co E, 2 U. S. Col'd Cav.

Private | Private

CARD NUMBERS.

1	5-315678	26
2	5-322284	27
3	5-322370	28
4	5-322455	29
5	5-322569	30
6	5-316443	31
7	5-322881	32
8	5-322973	33
9	5-323068	34
10	5-323154	35
11	5-323256	36
12	5-323350	37
13	9087525	38
14	B7-OJ-1870	39
15	30852785	40
16	30854327	41
17	40726314	42
18		43
19		44
20		45
21		46
22		47
23		48
24		49
25		50

Book Mark: B7-OJ-1870

See also

NOV 975

S.643347-2 and,

S.760660-2nd Aud. Petd.

D 1760881 and W.D.

L. J. Dallan & Co

L | **2 Cav. | U.S.C.T.**

Isiah Lankston

....., Co. *E*, 2 Reg't U. S. Col'd Cav.

Appears on

Company Descriptive Book

of the organization named above.

DESCRIPTION.

Age *32* years; height *5* feet *6* inches.

Complexion *Dark*

Eyes *Black*; hair *Black*

Where born *Nansemond les, Va.*

Occupation *Laborer*

ENLISTMENT.

When *Jan. 1*, 186*4*.

Where *Fort Monroe*

By whom *Col. Cole*; term *3* y'rs.

Remarks:

.....
.....
.....
.....
.....
.....
.....
.....
.....
.....

W. B. Smith

L. | 2 Cav | U.S.C.T.

Isaiah Larkston
Pvt, Co. 2 Reg't U. S. Col'd Cav

Age years.

Appears on a

Detachment Muster-in Roll

of *unattached recruits* of the organization named above. Roll dated

Ft. Monroe, Va, Jan 11, 1864.

Muster-in to date *Jan 11, 1864*.

Joined for duty and enrolled:

When *Jan 1*, 1864.

Where *Ft. Monroe, Va*

Period *3* years.

Valuation of horse, \$ 100

Valuation of horse equipments, \$ 100

Remarks :

.
.
.

Book mark: *B7-05-1870*

J. J. Kearney

L | **2 Cav.** | **U.S.C.T.**

Isiah Sankster

Priv., Co. E, 2 Reg't U. S. Col'd Cavalry.

Appears on

Company Muster Roll

for Enrollment to Feb. 29, 1864.

Present or absent Present

Stoppage, \$ 100 for

Due Gov't, \$ 100 for

Valuation of horse, \$ 100

Valuation of horse equipments, \$ 100

Remarks:

Book mark:

P. C. Taylor

(358)

Copyist.

S | **2 Cav.** | **U.S.C.T.**

Isiah Sankston
Prvt., Co. E, 2 Reg't U. S. Col'd Cavalry.

Appears on

Company Muster Roll

for *Mar. and Apr.*, 186⁴.

Present or absent *Present*

Stoppage, \$ 100 for

Due Gov't, \$ 100 for

Valuation of horse, \$ 100

Valuation of horse equipments, \$ 100

Remarks:

Book mark: -----

(358) *A. C. Taylor* Copyist.

S | **2 Cav.** | **U.S.C.T.**

Isiah Sankston
Plt., Co. E, 2 Reg't U. S. Col'd Cavalry.

Appears on

Company Muster Roll

for *May and June*, 186*4*.

Present or absent *Present*

Stoppage, \$.....*100* for

Due Gov't, \$.....*100* for

Valuation of horse, \$.....*100*

Valuation of horse equipments, \$.....*100*

Remarks:

Book mark:

J. C. Taylor

L | 2 Cav. | U.S.C.T.

Isiah Lankston
Spir, Co. E, 2 Reg't U. S. Col'd Cavalry.

Appears on

Company Muster Roll

for July & Aug, 1864

Present or absent

Stoppage, \$ 100 for

Due Gov't, \$ 100 for

Valuation of horse, \$ 100

Valuation of horse equipments, \$ 100

Remarks: Stoppage for Curry
Comb & Brush \$1.00 Spurs
Deserted from Detached Service
in Ambulance Corps 18th Ac
Aug. 12. 64

Book mark:

Washington

N. L. Cair | U.S.C.T.

James Van Kester
Co. C, 2nd Reg't U. S. Col'd Cav.

Appears on a

Detachment Muster Roll

of the organization named above

for *June & Aug.*, 1864.

Station *In the Field Va*

Present or absent

Stoppage, \$ 100 for

Due Gov't, \$ 100 for

Valuation of horse, \$ 100

Valuation of horse equipments, \$ 100

Remarks: *absent*

Next time on roll Mar & Apr/65

Book mark:

J. W. Simpson

1 | **2 Cav. | U.S.C.T.**

Isaiah Kingston,
Private, Co. E, 2 Reg't U. S. Col'd Cavalry.

Appears on

Company Muster Roll

for *March & April*, 1865.

Present or absent *Present.*

Stoppage, \$ 100 for

Due Gov't, \$ 100 for

Valuation of horse, \$ 100

Valuation of horse equipments, \$ 100

Remarks: *Returned to duty, by ser-
vice of G. C. M. March 11/65*

Book mark:

R. Braden

L | 2 Cav. | U.S.C.T.

Isaiah Langston

904, Co. E, 2 Reg't U. S. Col'd Cavalry.

Appears on

Company Muster Roll

for May June, 1865

Present or absent Present

Stoppage, \$ 100 for

Due Gov't, \$ 100 for

Valuation of horse, \$ 100

Valuation of horse equipments, \$ 100

Remarks: Returned to duty by
Sentence of G.C.M., Mch
11/65

Book mark:

(358)

J. H. Schody

Copyist.

L | 2 Cav. | U.S.C.T.

Isiah Lurpton

Post, Co. E, 2 Reg't U. S. Col'd Cavalry.

Appears on

Company Muster Roll

for July 1864, 1865

Present or absent Absent

Stoppage, \$ 100 for

Due Gov't, \$ 100 for

Valuation of horse, \$ 100

Valuation of horse equipments, \$ 100

Remarks: Absent since in Hospital

Book mark:

(358) J. H. [Signature] Copyist.

L. | 2 Cav. | U. S. A.

Isaiah Langston
Sgt., Co. A, 2 Reg't U. S. Cav.

Appears on

Hospital Muster Roll

of **Corps d'Afrique U. S. A. General Hospital,**

at **New Orleans, La.,**

for July + Aug, 1865.

Attached to hospital:

When _____, 186 .

How employed _____

Last paid by Maj. _____

to _____, 186 .

Bounty paid \$ 100; due \$ 100

Present or absent present

Remarks: _____

Book mark: _____

J. J. J. J.
Copyist.

Lo

2 Cav. | U.S.C.T.

Isaac Langston

Priv, Co. E, 2 Reg't U. S. Col'd Cavalry.

Appears on

Company Muster Roll

for *Sept and Oct*, 1865 .

Present or absent *Absent*

Stoppage, \$ *100* for

Due Gov't, \$ *100* for

Valuation of horse, \$ *100*

Valuation of horse equipments, \$ *100*

Remarks: *Absent sick in US G Hosp*

Book mark :

N. H. Merrill

L 12 bar 1864

Isiah Langston
Pvt, Co. A, 2 Reg't 12 bar

Appears on

Hospital Muster Roll

of Corps d'Afrique U. S. A. General Hospital,

at New Orleans, La.,

for Sept 10 Oct, 1865.

Attached to hospital:

When _____, 186 .

How employed _____

Last paid by Maj. _____

to _____, 186 .

Bounty paid \$ 100; due \$ 100

Present or absent _____

Remarks: See d Sept 29

Book mark: _____

Willey

Lo | **2 Cav.** | **U.S.C.T.**

Isaiab Langston

Priv, Co. E, 2 Reg't U. S. Col'd Cavalry.

Appears on

Company Muster Roll

for Nov. and Dec., 1865.

Present or absent

Stoppage, \$ 100 for

Due Gov't, \$ 100 for

Valuation of horse, \$ 100

Valuation of horse equipments, \$ 100

Remarks: Wied U.S. Hospital
New Orleans Dec 15, 65

Book mark:

N. H. Merrill

L | **2 Cav.** | **U.S.C.T.**

Isaiah Langston
 Pt., Co. E, 2 Reg't U. S. Colored Cav.

Appears on **Returns** as follows:

Aug 1864 - Lost Aug.
 12/64 at Petersburg
 Deserted while
 on det. service
 in Amb. Corps.

Oct 1864 - Absent -
 det. as guard
 for artillery train
 Nov 1864 - Absent guard
 for ammunition
 train -

Dec 1864 - Absent as
 guard for Ammunition
 Train -

March 1865 - Gained
 March 15 - Norfolk -
 Returned from
 desertion by sentence
 of General Court Mar-
 tial -

Book mark : _____

Mellin

JAN. 18

40726314

1899.

July 1865 - Absent sick
in Hosp. at Brazos
Santiago Texas -
Aug & Sept 1865 -
Absent sick in
Genl Hosp. since
July 1865 -
Oct & Nov 1865 - Absent
sick.
Dec 1865 - Lost Dec
15/65 - N.O. Died
in Genl. Hosp.
New Orleans -
Dec 15/65 -

x From appears also as
Isiah Lawson
Ira do

L

2 Cav.

U.S.C.T.

Isiah Langston

Co. E, 2 Reg't U. S. Col'd Cavalry.

Appears on Co. Muster-out Roll, dated

Bravo Santiago Tex, Feb. 12, 1866.

Muster-out to date, 1866.

Last paid to, 1866.

Clothing account:

Last settled, 1866; drawn since \$100

Due soldier \$100; due U. S. \$100

Am't for cloth'g in kind or money adv'd \$100

Due U. S. for arms, equipments, &c., \$100

Bounty paid \$100; due \$100

Remarks: Dieb joined at my orgn.

Dieb in Gen. Hosp. New Orleans La.

Dec. 20. 65 He is' furnished with

sent to hosp.

Book mark: 115,637 141. P. 66. / 4

(U. S. O. filed Sep 29. 65)

W. J. Marshall

(361)

Copyist.

L 1 2nd Cav. U.S.C.

Isaiah Langston

, Co. E, 2nd Reg't U.S.C. Cav.

NOTATION.

Book mark:

L. 22. C. J. 1874 with
B. 7. C. J. 1870

War Department,

Adjutant General's Office,

Washington, Jun 1st, 1874.

Call from

returned with report.

The above book mark was noted on rolls in order to
preserve results of search in this case.

E. P. Conner

Langston. Saiah

P, Co. B, 2 Reg't 2nd Cav.

5 Enclosures.

Bed Cards	Descriptive Lists
Burial Records 1	Final Statements 2
Certs. of Dis. for Discharge	Furloughs
C. M. Charges	Med. Des. Lists
Med. Certificates	Orders

Other papers relating to—

Admission to Hosp'l	Furlough
Casualty Sheet (Officer's) 1	Med. Examination
Confinement	Misc. Information
Contracts	Pay or Clothing
Death or Effects 1	Personal Reports
Desertions	Rank
Discharge from Hosp'l	Transfer to Hosp'l
Discharge from Service	Transfer to V. R. C.
Duty	Transportation

MICROFILM PUBLICATION M 1818

COMPILED MILITARY SERVICE RECORDS
OF VOLUNTEER UNION SOLDIERS WHO
SERVED WITH THE USCT (US COLORED TROOPS)
2ND REGIMENT OF CAVALRY

PERSONAL PAPERS' TARGET SHEET

PLEASE NOTE THE CHECKED INFORMATION ABOUT THE PERSONAL PAPERS IN
THIS FILE:

- NO PERSONAL PAPERS WERE FOUND IN THIS FILE WHEN THE
RECORDS WERE ARRANGED FOR MICROFILMING.
- 6 PERSONAL PAPER(S) FOUND IN THIS FILE WHEN THE RECORDS
WERE ARRANGED FOR MICROFILMING.

CASUALTY SHEET

No. —

Isaiah Langston

Priv of Company *C*

2^d Regiment of *W.C. Cav.*

State Volunteers.

NATURE OF CASUALTY.

Died Sept 29th / 65

CASUALTY SHEET.

Name: *Isiah Langston*

Rank: *Priv* Company: *E* Regiment: *2^d*

Arm: *U.S. Army* State: _____

Nature of Casualty: *Death*

CAUSE OF CASUALTY—(NAME OF DISEASE, &c.)

BY WHOM DISCHARGED.

FROM WHAT SOURCE THIS INFORMATION WAS OBTAINED.

DEGREE OF DISABILITY.

Roll of Honor
Co. Pg. 127

BY WHOM CERTIFIED.

J. M. Moore
A. G. M. U. G.

REMARKS

DATE OF DISCHARGE, DEATH, &c.

Sept 29, 1865

PLACE OF DISCHARGE, DEATH, &c.

Buried
New Orleans,

J. B.
Clerk.

1865

Copy

ARTICLES OF WAR.

INVENTORY OF THE EFFECTS

ART. 95. When any non-commissioned officer or soldier shall die, or be killed in the service of the United States, the then commanding officer of the troop or company shall, in the presence of two other commissioned officers, take an account of what effects he died possessed of, above his arms and accoutrements, and transmit the same to the office of the Department of War, which said effects are to be accounted for, and paid to the representatives of such deceased non-commissioned officer or soldier. And in case any of the officers, so authorized to take care of the effects of deceased officers and soldiers, should, before they have accounted to their representatives for the same, have occasion to leave the regiment or post, by preferment or otherwise, they shall, before they be permitted to quit the same, deposit in the hands of the commanding officer, or of the assistant military agent, all the effects of such deceased non-commissioned officers and soldiers, in order that the same may be secured for, and paid to, their respective representatives.

ARMY REGULATIONS—EDITION OF 1861.

DECEASED SOLDIERS.

Par. 152. Inventories of the effects of deceased non-commissioned officers and soldiers, required by the 95th Article of War, will be forwarded to the Adjutant General, by the commander of the company to which the deceased belonged, and a duplicate of the same to the colonel of the regiment. Final statements of pay, clothing, &c., will be sent with the inventories. When a soldier dies at a post or station absent from his company, it will be the duty of his immediate commander to furnish the required inventory, and, at the same time, to forward to the commanding officer of the company to which the soldier belonged, a report of his death, specifying the date, place, and cause; to what time he was last paid, and the money or other effects in his possession at the time of his decease; which report will be noted on the next muster roll of the company to which the man belonged. Each inventory will be endorsed, "Inventory of the effects of _____, late of company (—) _____ regiment of _____, who died at _____, the _____ day of _____, 186—." If a legal representative receive the effects, it will be stated in the report. If the soldier leave no effects, the fact will be reported.

Par. 153. Should the effects of a deceased non-commissioned officer or soldier not be administered upon within a short period after his decease, they shall be disposed of by a Council of Administration, under the authority of the commanding officer of the post, and the proceeds deposited with the Paymaster, to the credit of the United States, until they shall be claimed by the legal representatives of the deceased.

Par. 154. In all such cases of sales by the Council of Administration, a statement in detail, or account of the proceeds, duly certified by the Council and commanding officer, accompanied by the Paymaster's receipt for the proceeds, will be forwarded by the commanding officer to the Adjutant General. The statement will be endorsed, "Report of the proceeds of the effects of _____, late of company (—) _____ regiment of _____, who died at _____, the _____ day of _____, 186—."

NOTE 1.—The effects in all cases, when called for, should be turned over to the legal representative, without further authority from the Adjutant General. When the effects are turned over to the relatives of the deceased before these inventories are sent to the Adjutant General, their receipts therefor should be attached to the inventories. In all other cases, one copy will be sent with a letter of transmittal direct to the Adjutant General, and a duplicate retained by the officer.

NOTE 2.—Particular care should be taken to take receipts in duplicate from the Paymaster for any funds turned over to him; one copy should be sent direct to the Adjutant General and one retained by the officer.

OF

Private Isaiah Langston

Late of Company *E*

2^d Reg't of *U.S. Cav.*

Volunteers, who died at *New Orleans La.*

on the *28th* day of *September* 1865.

INVENTORY

Inventory of the effects of Isajah Langston late
 a Private of Captain J. H. Tucker Company E of
 the 2^d Regiment of U.S. Cavalry Volunteers, who was enrolled as
 a Private at Ft. Monroe in the State of Virginia on
 the 1 day of January 1864, and mustered into the service of the United
 States as a Private on the 11th day of January 1864, at Ft. Monroe Va
 in Company E, 2^d Regiment of U.S. Cav. Volunteers, to serve Three
 years or during the war; he was born in Nausemond Co in the State
 of Virginia; he was 32 years of age, 5 feet 6 inches
 high, Dark complexion, Dark eyes, Dark hair, and by occupation, when enrolled,
 a Laborer; he died in Corps d'Afrique U.S. Gen. Hospit. at
New Orleans La. on the 29th day of September 1865, by
 reason of Diarrhoea Chronic.

INVENTORY.					
ARTICLES.	No.	ARTICLES.	No.	ARTICLES.	No.
Hats.....		Pairs trousers.....	1	Knapsacks.....	1
Caps.....		Pairs flannel drawers.....		<u>I.R. Blanket</u>	1
Forage caps.....		Pairs cotton drawers.....		<u>S. Tent</u>	1/2
Great coats.....		Flannel shirts.....			
Uniform coats.....		Cotton shirts.....	1		
Uniform jackets.....		Pairs boots.....			
Flannel sack coats.....		Pairs shoes.....			
Blouses.....		Pairs socks.....			
Stable frocks.....		Blankets..... <u>Wool.</u>	1		
Fatigue overalls.....		Haversacks.....			
				MONEY.	
				Specie.....	\$ —
				Notes.....	\$ —

I CERTIFY, ON HONOR, that the above inventory comprises all the effects of Private
Isajah Langston, deceased, and that the effects are in the hands
 of Surgeon in Charge at Corps d'Afrique U.S. Gen. Hospit.
New Orleans La. to be disposed of by a Council of Administration.

(DUPLICATES.)

STATION: New Orleans La.

Commanding the Company.

DATE: September 29th 1865.

Sept 29 1865
Copy

FINAL STATEMENT

OF

Private Isaiah Langston
2^d Reg't of Col. C. C. Bar.

VOLUNTEERS,

A. d. H. Hook

NOTE 1.—Two of these certificates (or duplicates) are to be given to each Volunteer Soldier or drafted man who may be discharged previously to the discharge of his company, that he may at once receive from the Paymaster the pay, &c., due him, and the captain or other COMMISSIONED officer commanding the company will certify to the act of the delivery of the duplicate certificates; on these certificates the Soldier is "entitled to" his discharge, and should also present his discharge to the Paymaster to have the payment endorsed on it. The discharge is to be given back to the Soldier by the Paymaster; the latter only retaining as his voucher the duplicate certificates.

NOTE 2.—If the Soldier is entitled to pay for the use of his horse, the Company Commander will certify to that fact on the back of both these final statements, and also to the time he has pay due for having been so mounted on his own horse.

NOTE 3.—When a Soldier is furnished with final statements, his descriptive list, if he has one, should be taken up by the officer who gives the Soldier these statements, and endorsed with a statement to this effect by the officer. This endorsement should exhibit a full statement of the time for which the Soldier was allowed pay on his final statements, the clothing account, and all other charges against him or in his favor, so as to comprise a complete exhibit of his account. It will then be transmitted to the Company Commander of the Soldier, who will enter all the data necessary to a full understanding of the Soldier's account on the muster roll upon which the Soldier's discharge is reported. The descriptive list will then be destroyed. The object of this is, that the remaining portion of the Soldier's account may be settled upon the receipt of these muster rolls, and the Soldier receive any pay or allowances that may be due him at the time of his discharge, and which may not appear on his final statements from the fact that his descriptive list is incomplete. These accounts for back pay, &c., are settled by the 2d Auditor of the Treasury Department.

NOTE 4.—Charges for loss or injury to ordnance, horse equipments, and other miscellaneous charges, should appear under the heading of "Other Stoppages."

NOTE 5.—Bounty paid by State authorities, and not by the United States, will not be entered on this statement.

NOTE 6.—Amounts due the Sutler and Laundress must be entered on the muster roll on which the discharge, death, desertion, &c., is reported, as well as on the final statement, otherwise the amount cannot be collected from the United States.

NOTE 7.—This blank will be used for deceased volunteers and drafted men, as well as for others.

NOTE 8.—Where a Soldier dies in Hospital or on detached service, his descriptive list, if he has one, should be sent with his final statements, in duplicate, to the Adjutant General, Washington, D. C.

I certify, on honor, that Isaiah Langston a Private of
 Captain J. H. Tucker Company (C) of the 2^d Regiment of Vol. C. Cal.
VOLUNTEERS, of the State of _____, born in Wasserman Co., State
 of Virginia, aged 32 years; 5 feet 6 inches high; Dark complexion,
Dark eyes Dark hair, and by occupation a Laborer, having joined the company on
 its original organization at Ft. Monroe Va., and enrolled in it at the muster into
 the service of the United States at Ft. Monroe Va., on the 1st day
 of January, 1864, ^{and} was mustered in service as a recruit, by Captain
Martin, at Ft. Monroe, on the 11th day of January,
 1864, or was drafted and mustered into the service of the United States from the _____
 Enrollment District of the State of _____, at _____,
 on the _____ day of _____, 186) to serve in the Regiment, for
 the term of Three Years: and having served **HONESTLY** and
FAITHFULLY with his Company in Ref. Service to the present date, is now
 entitled to a **DISCHARGE** by reason of Death from Diarrhoea Chronic
at New Orleans La September 29 1865.

The said Private Isaiah Langston was last paid by Paymaster
Unknown to include the 11th day of March, 1865, and has
 pay due him from that time to the present date; he is entitled to pay and subsistence for
TRAVELING to place of enrollment, and whatever other allowances are authorized to volunteer
 soldiers, drafted men, or militia, so discharged. He has received from the United States **CLOTHING**
 amounting to forty four $\frac{89}{100}$ dollars, since the 1st day of January,
 1864, when his clothing account was last settled. He has received from the United States
 $\frac{00}{100}$ dollars advanced **BOUNTY**.

There is to be stopped from him, on account of the State of _____, or other
 authorities, for **CLOTHING**, &c., received on entering service, _____ $\frac{00}{100}$ dollars; and
 for other stoppages, viz: _____
 _____ $\frac{00}{100}$ dollars.

He has been furnished with **TRANSPORTATION** in kind from the place of his discharge to
 _____; and he has been **SUBSISTED** for **TRAVELING** to his
 place of enrollment, up to the _____, 186 .

He is indebted to _____, **SUTLER**, _____ $\frac{00}{100}$ dollars.
 He is indebted to _____, **LAUNDRESS**, _____ $\frac{00}{100}$ dollars.

Given in Duplicate, at New Orleans La, this 21st day
 of September, 1865.

*U.S.A.
Adj. Gen. Office
Oct 14 1865
Duplicate with Inventory sent 2d Auditor.*

FINAL STATEMENT

OF

Private Isaiah Langston

2^d Reg't of Col. C. C. Bar

VOLUNTEERS.

Given Sept 27 1865

NOTE 1.—Two of these certificates (or duplicates) are to be given to each Volunteer Soldier or drafted man who may be discharged previously to the discharge of his company, that he may at once receive from the Paymaster the pay, &c., due him, and the captain or other COMMISSIONED officer commanding the company will certify to the act of the delivery of the duplicate certificates; on these certificates the Soldier is "entitled to" his discharge, and should also present his discharge to the Paymaster to have the payment endorsed on it. The discharge is to be given back to the Soldier by the Paymaster; the latter only retaining as his voucher the duplicate certificates.

NOTE 2.—If the Soldier is entitled to pay for the use of his horse, the Company Commander will certify to that fact on the back of both these final statements, and also to the time he has pay due for having been so mounted on his own horse.

NOTE 3.—When a Soldier is furnished with final statements, his descriptive list, if he has one, should be taken up by the officer who gives the Soldier these statements, and endorsed with a statement to this effect by the officer. This endorsement should exhibit a full statement of the time for which the Soldier was allowed pay on his final statements, the clothing account, and all other charges against him or in his favor, so as to comprise a complete exhibit of his account. It will then be transmitted to the Company Commander of the Soldier, who will enter all the data necessary to a full understanding of the Soldier's account on the muster roll upon which the Soldier's discharge is reported. The descriptive list will then be destroyed. The object of this is, that the remaining portion of the Soldier's account may be settled upon the receipt of these muster rolls, and the Soldier receive any pay or allowances that may be due him at the time of his discharge, and which may not appear on his final statements from the fact that his descriptive list is incomplete. These accounts for back pay, &c., are settled by the 2d Auditor of the Treasury Department.

NOTE 4.—Charges for loss or injury to ordnance, horse equipments, and other miscellaneous charges, should appear under the heading of "Other Stoppages."

NOTE 5.—Bounty paid by State authorities, and not by the United States, will not be entered on this statement.

NOTE 6.—Amounts due the Sutler and Laundress must be entered on the muster roll on which the discharge, death, desertion, &c., is reported, as well as on the final statement, otherwise the amount cannot be collected from the United States.

NOTE 7.—This blank will be used for deceased volunteers and drafted men, as well as for others.

NOTE 8.—Where a Soldier dies in Hospital or on detached service, his descriptive list, if he has one, should be sent with his final statements, in duplicate, to the Adjutant General, Washington, D. C.

ADJUTANT GENERAL'S OFFICE
Oct 14 1865
Duplicate with Inventory sent 2d Auditor.

Stamp: ADJUTANT GENERAL'S OFFICE, WASHINGTON, D.C., OCT 14 1865

I certify, on honor, that Isaiah Langston a Private of
 Captain J. H. Tucker Company (E) of the 2^d Regiment of Vol. C. Cav.
VOLUNTEERS, of the State of _____, born in Nussemond Co., State
 of Virginia, aged 32 years; 5 feet 6 inches high; Dark complexion,
Dark eyes, Dark hair, and by occupation a Laborer, having joined the company on
 its original organization at Ft Monroe Va, and enrolled in it at the muster into
 the service of the United States at Ft Monroe Va, on the 1st day
 of January, 1864, ^{and} (or was mustered in service as a recruit, by Captain
Martin, at Ft Monroe, on the 11th day of January,
 1864, or was drafted and mustered into the service of the United States from the _____
 Enrollment District of the State of _____, at _____,
 on the _____ day of _____, 186) to serve in the Regiment, for
 the term of Three Years : and having served **HONESTLY** and
FAITHFULLY with his Company in U.S. Service to the present date, is now
 entitled to a **DISCHARGE** by reason of Death from Malaria chronic
at New Orleans La September 29th 1865.

The said Private Isaiah Langston was last paid by Paymaster
Unknown to include the 11th day of March, 1865, and has
 pay due him from that time to the present date; he is entitled to pay and subsistence for
TRAVELING to place of enrollment, and whatever other allowances are authorized to volunteer
 soldiers, drafted men, or militia, so discharged. He has received from the United States **CLOTHING**
 amounting to forty four $\frac{89}{100}$ dollars, since the 1st day of January,
 1864, when his clothing account was last settled. He has received from the United States
 $\frac{7}{100}$ dollars advanced **BOUNTY**.

There is to be stopped from him, on account of the State of _____, or other
 authorities, for **CLOTHING**, &c., received on entering service, _____ $\frac{100}{100}$ dollars; and
 for other stoppages, viz: _____
 _____ $\frac{100}{100}$ dollars.

He has been furnished with **TRANSPORTATION** in kind from the place of his discharge to
 _____; and he has been **SUBSISTED** for **TRAVELING** to his
 place of enrollment, up to the _____, 186 .

He is indebted to _____, **SUTLER**, _____ $\frac{100}{100}$ dollars.
 He is indebted to _____, **LAUNDRESS**, _____ $\frac{100}{100}$ dollars.

Given in Duplicate, at New Orleans La, this 29th day
 of September, 1865.

F. E. Payette
 Surgeon in Charge
 Commanding Company,
 Corps d'Afrique U.S. Gen Hopt.

RECEIVED

COPY OF RECORD

FOR THE

ADJUTANT GENERAL, U. S. ARMY.

RECEIVED
OFFICE-ADJUTANT
16
1895

No. 2.

RECORD OF DEATH AND INTERMENT.

Name and number of person interred,	- - -	Isaian Lanston
Number and locality of the Grave,	- - -	- 6933 -
Hospital number of the deceased,	- - -	
Regiment, rank and company,	- - -	2 ^d U.S. Cavalry, Private - C
Residence before enlistment,	- - -	
Conjugal condition, (and if married,	- - -	}
The residence of the widow,	- - -	
Cause of death,	- - -	} Chronic Diarrhoea
Age of the deceased,	- - -	
Nativity,	- - -	
References and remarks,	- - -	
Date of death and burial,	- - -	Sept 29 th 1865

To *Adj. Gen. U.S. Army*
11
 SIR:

It becomes my duty to inform you that the person above described died at this Hospital as herein stated, and that it is desired his remains should be interred with the usual Military honors.

Respectfully,

F. C. Squier
 SURGEON, U. S. ARMY.
1st Regt. Infantry
in charge

MILITARY HOSPITAL, *Camp of Engineers & Crews*
La

Headquarters 26th Ab.
Jan 13th 1865

Respectfully forwarded
to the Comdg Officer
2nd U S Col Cavalry
with the same intention
referred to

Henry McPhillips
Asst Prov March
26th Ab.

Henry Langster
A. E. 2 reg C in

Asst in

Office of the Provost Marshal,

Department of Virginia and North Carolina, Army of the James,

BERMUDA HUNDRED, VA. January 12th 1865.

Lieut. K. G. Phillips

Asst. Prov. Marshal, 15th Army Corps,
Lieutenant.

I have the honor to forward herewith Private Josiah Langster Co "E" 2nd U.S. C. Cavalry, arrested at Portsmouth Va, on charge of desertion, and received from Provost Marshal's Office, Fort Monroe, Va, yesterday.

Very respectfully,
Your obt. servant
James A. Scott
Lieut and Asst.
Provost Marshal

938
Langston Nathan

Co E, 2 U. S. Col'd Cav.

Private Private

CARD NUMBERS.

1	5315677	26
2	5322283	27
3	5322369	28
4	5322454	29
5	5322533	30
6	5322620	31
7	5322704	32
8	5322785	33
9	5322911	34
10	5323338	35
11	9087524	36
12	31633284	37
13	31634163	38
14	40726285	39
15		40
16		41
17		42
18		43
19		44
20		45
21		46
22		47
23		48
24		49
25		50

Book Mark:

See also

S. 1340898, P.O. netter

D-1340682- P.O. aff

D-1340680- P.O. aff

S 1482726 P.O. aff

S 1482727 P.O. aff

L Ballant 41

NARA 1010

L | 2 Cav. | U.S.C.T.

Nathan Lankston

....., Co. E, 2 Reg't U. S. Col'd Cav.

Appears on

Company Descriptive Book
of the organization named above.

DESCRIPTION.

Age ^x 35 years; height 5 feet 10 inches.

Complexion Dark

Eyes Black; hair Black

Where born Nansmond les. Va.

Occupation Laborer

ENLISTMENT.

When Jan. 1, 1864.

Where Fort Monroe

By whom Col. Cole; term 3 y'rs.

Remarks:

.....
.....
.....
.....
.....

^x as appears on Roll.

F. B. Smith
Copyist.

S | **2 Cav.** | **U.S.C.T.**

Nathan Sanksten
Priv., Co. E, 2 Reg't U. S. Col'd Cavalry.

Appears on

Company Muster Roll

for Enrollment to Feb. 29, 1864.

Present or absent Absent

Stoppage, \$ 100 for

Due Gov't, \$ 100 for

Valuation of horse, \$ 100

Valuation of horse equipments, \$ 100

Remarks: Sick in McClellan
Gen. Hosp. since Jan.
15, 1864.

Book mark:

J. C. Taylor

(358)

Copyist.

L. | 2 Cav | U.S.C.T.

Nathan Luckston

Priv, Co. 2 Reg't U. S. Col'd Cav.

Age _____ years.

Appears on a

Detachment Muster-in Roll
of unattached recruits
of the organization named above. Roll dated

Ft. Monroe, Va, Jan. 11, 1864.

Muster-in to date Jan. 11, 1864.

Joined for duty and enrolled:

When Jan. 1, 1864.

Where Ft. Monroe, Va

Period 3 years.

Valuation of horse, \$ 100

Valuation of horse equipments, \$ 100

Remarks : _____

Book mark : _____

J. J. Kearney
Copyist.

L | **2 Cav.** | **U.S.C.T.**

Nathan Sankston
Priv., Co. E, 2 Reg't U. S. Col'd Cavalry.

Appears on

Company Muster Roll

for Mar. and Apr., 1864.

Present or absent Present

Stoppage, \$ 100 for

Due Gov't, \$ 100 for

Valuation of horse, \$ 100

Valuation of horse equipments, \$ 100

Remarks:

Book mark: -----

(358) P. C. Taylor Copyist.

S | **2 Cav.** | **U.S.C.T.**

Nathan Sankston
Priv., Co. E, 2 Reg't U. S. Col'd Cavalry.

Appears on

Company Muster Roll

for *May and June*, 1864.

Present or absent *Absent*

Stoppage, \$ 100 for

Due Gov't, \$ 100 for

Valuation of horse, \$ 100

Valuation of horse equipments, \$ 100

Remarks: *Sick in Gen. Hospital at Point of Rocks since June 26, 1864.*

Book mark: _____

(358)

J. C. Taylor

Copyist.

L | **2 Cav.** | **U.S.C.T.**

Nathan Lankston
Sir, Co. E, 2 Reg't U. S. Col'd Cavalry.

Appears on

Company Muster Roll

for *July & Aug*, 186*4*

Present or absent *Absent*

Stoppage, \$ 100 for

Due Gov't, \$ 100 for

Valuation of horse, \$ 100

Valuation of horse equipments, \$ 100

Remarks: *Sent to Hospital*
at Point of Rocks
June 26, 1864.

Book mark:

Wauclington
(358) Copyist.

Le | 2 Cav | USC

Nathan Langston
Pvt, Co. E, 2 Reg't USC Cav

Appears on

Hospital Muster Roll

of Summit House U. S. A. General Hospital,

at Philadelphia, Pa.,

for July & Aug, 186 4

Attached to Hospital:

When....., 186 .

How employed.....

Last paid by Maj.

to, 186 .

Bounty paid \$ 100; due \$ 100

Present or absent Present

Remarks:.....

.....

Ward II

.....

Book mark :

J. Anderson

L | **2 Cav.** | **U.S.C.T.**

Nathan Parkstein
Priv, Co. E, 2 Reg't U. S. Col'd Cavalry.

Appears on

Company Muster Roll
for *Sept & Oct*, 186*4*.
Present or absent *Absent*

Stoppage, \$ *100* for

Due Gov't, \$ *100* for

Valuation of horse, \$ *100*

Valuation of horse equipments, \$ *100*

Remarks: *Detailed for*
guard in ammunition
train

Book mark:

(358)

Wauwington

Copyst.

S | 2 cav | USC

Nathan Lancaster
Pvt, Co. E, 2 Reg't USCCav

Appears on

Hospital Muster Roll

of Summit House U. S. A. General Hospital,

at Philadelphia, Pa.,

for *Sep Oct*, 186*4*

Attached to hospital:

When _____, 186 .

How employed _____

Last paid by Maj. _____

to _____, 186 .

Bounty paid \$ 100; due \$ 100

Present or absent _____

Remarks: *Returned to duty Sep 22 1864*

Book mark : _____

D M Campbell

L | **2 Cav. U.S.C.T.**

Nathan Rankston

Priv, Co. E, 2 Reg't U. S. Col'd Cavalry.

Appears on

Company Muster Roll

for *Apr + Dec*, 186 *4*

Present or absent *Absent*

Stoppage, \$ *100* for

Due Gov't, \$ *100* for

Valuation of horse, \$ *100*

Valuation of horse equipments, \$ *100*

Remarks: *Detailed as guard
for Ammunition Train*

Book mark:

Wauverton

L | **2 Cav. | U.S.C.T.**

Nathan Langston
Pris, Co. E, 2 Reg't U.S. Col'd Cavalry.

Appears on

Company Muster Roll

for *Jan & Feb*, 1865.

Present or absent *Present*

Stoppage, \$ *100* for

Due Gov't, \$ *100* for

Valuation of horse, \$ *100*

Valuation of horse equipments, \$ *100*

Remarks: *Due soldier for clothing not drawn in kind \$ 20.51*

Book mark:

Waddington

NOV 1861

L | **2 Cav.** | **U.S.C.T.**

Nathan Langston

pot, Co. E, 2 Reg't U. S. Col'd Cavalry.

Appears on

Company Muster Roll

for *March & April*, 1861 ^B

Present or absent

Stoppage, \$ 100 for

Due Gov't, \$ 100 for

Valuation of horse, \$ 100

Valuation of horse equipments, \$ 100

Remarks: *Discharged April 1st
By command of Major
Genl Ord.*

Book mark: *Discharged Apr 21st*

(358) *J. H. Schrey* Copyist. *cut*

JAN. - 7

5322911

☆ 1891 ☆

1865. E.P. V-11-R-18-

L | 2 Cav. | U.S.C.T.

Nathan Lanston
Pt., Co. E., 2 Reg't U. S. Colored Cav.

Appears on Returns as follows:

Jan'y 1864. Absent
sick in Genl Hoopl
since Jan'y 17/64.

Feb'y 1864. Absent sick
in M. Lellan's Genl
Hoopl since Jan'y
15/64 -

Mar' 1864 -
Mar' 24" Bowen's Hill
Discharged from M. Lellan's
Genl Hoopl to report
to his Co. for duty.

June 1864. Absent sick
in Corps Genl Hoopl
Point of Rocks Va
since June 26/64.

July + Aug 1864. Absent
sick in Hoopl. at
Point of Rocks. June
26/64 -

Book mark : _____

M. Elliott

NOV 1924

JAN. 18

40726285

1899.

Sept 1864. Absent
sick in Guelph

Apr 1865. Last Apr 21.
- 22 or 23 Discharged
for disability.

2 more appeared also on
William Langston
Wm Launston.

L | **2 Cav. | U.S.C.T.**

Mathias Langston

Pvt, Co. *E*, 2 Reg't U. S. Col'd Cavalry.

Appears on **Co. Muster-out Roll**, dated
Bureau Santiago Tex, *July 12*, 186*6*.
Muster-out to date _____, 186 .
Last paid to _____, 186 .

Clothing account:

Last settled _____, 186 ; drawn since \$ _____ *100*
Due soldier \$ _____ *100*; due U. S. \$ _____ *100*
Am't for cloth'g in kind or money adv'd \$ _____ *100*

Due U. S. for arms, equipments, &c., \$ _____ *100*
Bounty paid \$ _____ *100*; due \$ _____ *100*

Remarks: *Discharged*
Joined at org. orgn. Wisch April 4 64
By order 'Major' Gen. E. C. Ord Comd'g Dep't Va.

Book mark: *Disch. April 21.65 E B Vol 11 P 14*
V 243, P 170.77

H. H. Merrill

Langston, Nathan
P, Co. E, 2 Reg't U.S.C.C.

2 Enclosures.

Bed Cards	/	Descriptive Lists
Burial Records		Final Statements
Certs. of Dis. for Discharge	/	Furloughs
C. M. Charges		Med. Des. Lists
Med. Certificates		Orders

Other papers relating to—

Admission to Hosp'l	Furlough
Casualty Sheet (Officer's)	Med. Examination
Confinement	Misc. Information
Contracts	Pay or Clothing
Death or Effects	Personal Reports
Desertions	Rank
Discharge from Hosp'l	Transfer to Hosp'l
Discharge from Service	Transfer to V. R. C.
Duty	Transportation

Hospital Number 3565 8
 Name ~~Langston Edwards~~
 Age 39 Nativity Massachusetts
 Married or Single Single
 Residence Nesermina River Va
 Post Office address of wife or nearest relative. Wirt, Clarissa Lynn
Norfolk Va
 Rank Private Co. B Regiment 26th
Me. Inf. Regt.
 When admitted August 17th 1864
 From what source Camp Hunter

Diagnosis: (in surgical cases state explicitly seat and character of wound or injury.)

*Rheumatism &
 Injury of Back*

Summit House G. H.
 Philadelphia, Pa.

On what occasion wounded.....
 Date.....
 Nature of missile or weapon.....
Ree 2074

TREATMENT.

[HERE NOTE IMPORTANT COMPLICATIONS AND ALL OPERATIONS.]

R. Fenit. Buchu ℥i.
Hb. m. Lule ℥ii m. S. —
a tablespoon 3 times a day.

Chlor. Potas ℥ii. V. Myrrh ℥ii,
Aqua ℥iii. Use as (Sargle)

R. Bi. Chlor. Mer gms iij
Sodide Potas ℥ii m. S.
Aqua a teaspoon 3 times a day.
Haw, Dec, Syphilis,

RESULT AND DATE.

Transferred to Hospit.
Board duty, Sept 16th 1864,

Gas M. Mackey A. A. S.

NOV 18 1865

[OFFICE INDORSEMENT.]

War Department,

ADJUTANT GENERAL'S OFFICE,

March 9, 1874,

The Discharge of Nathan Langston

Private, Co. "E", 2^d Reg't U. S.

Colored Cavalry, is reported as follows:

On Company Muster Roll.

For Mar 4 April, 1865, April 21st, 1865

Company Muster-out Roll.

April 4th, 1865

Company Descriptive Book.

, 186

Company Morning Reports.

, 186

Soldier's Final Statement.

, 186

Soldier's Record of Death and Interment.

, 186

Soldier's Inventory of Effects.

, 186

Soldier's Certificate of Disability for Discharge.

April 21st, 1865

Soldier's Individual Muster-out Roll.

, 186

Regimental Return.

For April, 1865, April 21st, 1865

Regimental Quarterly Returns.

, 186

Regimental Descriptive Book.

, 186

By Surgeon General.

April 21, 1865, is held to be

the correct date, and the Company Muster Out Roll will be amended accordingly.

Thomas M. Freeman

Assistant Adjutant General.

Noted on Regular April 2^d 1874.

CERTIFICATE OF DISABILITY FOR DISCHARGE

IN THE CASE OF

Nathan Langston

a Private Co. E

Second Reg't of U.S. Col. Cavalry

Office Surg in Chief

Portsmouth Va April 8th 1865

Respectfully forwarded

"Approved"

R. A. Smith

Surg U.S.V.

Surg in Chief

Med Dept Virginia
Richmond Va 13th April 1865

Approved.

W. A. Linn

St. Col. Acty Med Director
Dept Va.

Received (A. G. Office) 1865

Ent on [Signature] April 15.

14

Ed. 3rd Dep of Va
Richmond Va

Apr. 15th 1865

To be Discharged

By Command of

Maj Gen Ord

Edw Smith

a.d.s

U

NOV 19 1865

NOTE 1.

The company commander will here add a statement of all the facts known to him concerning the disease or wound, or cause of disability of the soldier; the time, place, manner, and all the circumstances under which the injury occurred, or disease originated or appeared; the duty, or service, or situation of the soldier at the time the injury was received or disease contracted, stating particularly whether the injury was received or the disease contracted in the line of his duty; and whatever other facts may aid a judgment as to the cause, immediate or remote, of the disability, and the circumstances attending it.

When the facts are not known to the company commander, the certificate of any officer, or affidavit of other person having such knowledge, will be appended—as the surgeon in charge of a hospital, the officer commanding a detachment of recruits, &c., &c.

NOTE 2.

When a probable case for pension, special care must be taken to state the degree of disability—as $\frac{1}{2}$, $\frac{3}{4}$, &c., &c.; to describe particularly the disability, wound, or disease, the extent of which it deprives him of the use of any limb or faculty, or affects his health, strength, activity, constitution, or capacity to labor or earn his subsistence. The surgeon will add, from his knowledge of the facts and circumstances, and from the evidence in the case, his professional opinion of the cause or origin of the disability. In the case of discharges by Medical Inspectors, the last paragraph will state that the "discharge was given by consent of the soldier, after a personal examination, and for disability, the nature, degree, and origin of which are correctly described in the within certificate."

Par. 1260 Regulations, Edit. 1861.

Medical officers, in giving certificates of disability, are to take particular care in all cases that have not been under their charge; and especially in epilepsy, convulsions, chronic rheumatism, derangement of the urinary organs, ophthalmia, ulcers, or any obscure disease liable to be feigned or purposely produced; and in no case shall such certificate be given until after sufficient time and examination to detect any attempt at deception.

DIRECTIONS.

This certificate will be made out in duplicate by the soldier's company commander, or other officer commanding the separate detachment to which he belongs, and sent by him to the surgeon who has charge of the hospital where the soldier is sick. The surgeon will then fill out and sign the surgeon's certificate, and forward these papers to the regimental, detachment, or post commander, who will forward them, with his action endorsed thereon, through the proper channel, to his division commander; or, if the troops are not attached to a division, to his corps, department, or other commander or officer to whom the authority to discharge enlisted men may be specially delegated.

These certificates, after having received the action of the highest authority to which they are required to be sent, will be returned through the same channel to the regimental, post, or detachment commander, who will, if the discharge is authorized by the endorsement of the proper authority, sign the soldier's discharge, and the last certificate on this paper; see that the soldier is furnished with the proper final statements in duplicate, and forward BOTH of these certificates direct to the Adjutant General United States Army, at Washington, D. C.; they will not, under any circumstances, be given into the hands of the soldier.

ADJUTANT GENERAL'S OFFICE

May 4th 1865

Duplicate sent the Pension Office.

CERTIFICATE OF DISABILITY FOR DISCHARGE
IN THE CASE OF

14
1543
Nathan Layston
Private Co. E
Second Reg't of U.S. Cal. Cavalry

Office Surg in Chief
Portsmouth Va April 8th 1865

Respectfully forwarded

"Approved"

P. A. Smith

Surg U.S.V.

Surg in Chief

Head Dept Virginia
Richmond Va 13 April 1865

Approved.

W. A. Morrison

Lt-Col. Acty Med Director
Dep't Va.

Received (A. G. Office) 1865

Entered in A. G. Office
Apr 15

Ed. Ino Dept of Va
Richmond Va
Apr. 15th 1865

To be Discharged
By Command of
Maj Gen Bd
Edwards
a.d.s

U

ARMY OF THE UNITED STATES.

CERTIFICATE

OF DISABILITY FOR DISCHARGE.



Pvt. Nathan Langston of Captain John H. Suckers Company, (E) of the Second Regiment of the United States Col'd Cavalry was enlisted by Colonel George H. Cole of the Second Regiment of U.S. Col'd Cavalry at Fort Monroe on the First day of January, 1864, to serve Three years; he was born in Hansemond in the State of Virginia, is Forty five years of age, Five feet Ten inches high, dark complexion, Black eyes, Black hair, and by occupation when enlisted a Laborer. During the last two months said soldier has been unfit for duty 60 days.* He has done but very little duty the last year and none the past winter.

STATION: Norfolk Va
 DATE: March 31st 1865

John M. Wether
 Capt. 2nd U.S.C.C.
 Commanding Company "E"

I CERTIFY, that I have carefully examined the said Private Nathan Langston of Captain John H. Suckers Company, and find him incapable of performing the duties of a soldier because of Syphilis. He has Chronic Diarrhoea, Incontinence of urine and is broken down in constitution. He has done no duty for the last four months. His disability was not contracted in the line of his duty and is unfit for Veteran Reserve Corps. M. M. Hardy

Surgeon.
 J. A. W. S. C. C.

DISCHARGED, this 21st day of April, 1865, at Norfolk Va. In authority on back of Certificate.

George Cole
 Brig. Gen. U.S.A.
 Commanding the Reg't.

The Soldier desires to be addressed at
 Town County State

* See Note 1 on the back of this. † See Note 2 on the back of this.
 [A. G. O. No. 100 & 101—First.] [DUPLICATES.]

NOV 1902

939
Lankston Isaiah

Co E, 2 U. S. Col'd Cav.

Private

CARD NUMBERS.

1	26
2	27
3	28
4	29
5	30
6	31
7	32
8	33
9	34
10	35
11	36
12	37
13	38
14	39
15	40
16	41
17	42
18	43
19	44
20	45
21	46
22	47
23	48
24	49
25	50

See Lankston Isaiah

Book Mark:

See also

940

Langston Nathan

Co E, 2, U. S. Col'd Cav.

CARD NUMBERS.

1	26
2	27
3	28
4	29
5 See Langston	30 Nathan
6	31
7	32
8	33
9	34
10	35
11	36
12	37
13	38
14	39
15	40
16	41
17	42
18	43
19	44
20	45
21	46
22	47
23	48
24	49
25	50

Book Mark:

See also

941
Laguerre Green

Co *E*, **2** U. S. Col'd Cav.

CARD NUMBERS.

1	26
2	27
3	28
4	29
5 <i>See Lenoir</i>	30 <i>Green</i>
6	31
7	32
8	33
9	34
10	35
11	36
12	37
13	38
14	39
15	40
16	41
17	42
18	43
19	44
20	45
21	46
22	47
23	48
24	49
25	50

Book Mark:

See also

942 or Harry
Laster Henry

Co A, 2 U. S. Col'd Cav.

Private Private

CARD NUMBERS.

1	5-316079	26
2	5-323730	27
3	5-323821	28
4	5-323877	29
5	5-323965	30
6	5-324051	31
7	5-324145	32
8	5-324281	33
9	5-324375	34
10	5-324463	35
11	5-324557	36
12	9087006	37
13	40726286	38
14		39
15		40
16		41
17		42
18		43
19		44
20		45
21		46
22		47
23		48
24		49
25		50

Book Mark:

See also

2 | 2 Cav. | U.S.C.T.

Harry Foster

Co. F, 2 Reg't U. S. Col'd Cav.

Appears on

Company Descriptive Book

of the organization named above.

DESCRIPTION.

Age 57 years; height 5 feet 9 inches.

Complexion

Eyes; hair

Where born Hertford N. C.

Occupation Farmer

ENLISTMENT.

When March 1, 1864

Where Plym, N. C.

By whom Lt. French; term 3 y'rs.

Remarks: Promoted Corp per Gen order dated Hd Qrs 2 U S C C dated Nov 1864.

Reduced July 1/65 per order dated Regt Hd Qrs.

F. B. Smith

L | **2 Cav.** | **U.S.C.T.**

Henry Laster

Appears with rank of *Private* on

Muster and Descriptive Roll of a Detachment of U. S. Vols. forwarded

for the 2 Reg't U. S. Col'd Cavalry. Roll dated

Petersburg Va. June 29, 1864.

Where born *Hertford Co. No. Ca.*

Age *42* y'rs; occupation *laborer*

When enlisted *March 1*, 1864.

Where enlisted *Plymouth N.C.*

For what period enlisted *3* years.

Eyes *black*; hair *black*

Complexion *black*; height *5 ft. 8 in.*

When mustered in *June 29*, 1864.

Where mustered in *Bermuda Hundred*

Bounty paid \$ *100*; due \$ *100*

Where credited _____

Company to which assigned _____

Remarks: *Escaped slave &*

not credited to any state.

x Inserted by Compt.

Book mark: _____

J. D. Neale

101 | **2 Cav. | U.S.C.T.**

Vary Laster

Priv, Co. F, 2 Reg't U. S. Col'd Cavalry.

Appears on

Company Muster Roll

for *July & Aug*, 186*4*.

Present or absent *Present*

Stoppage, \$ *100* for

Due Gov't, \$ *100* for

Valuation of horse, \$ *100*

Valuation of horse equipments, \$ *100*

Remarks:

Book mark:

J. A. Pull
Copyist.

al | **2 Cav. | U.S.C.T.**

Harry Lester
Priv, Co. F, 2 Reg't U. S. Col'd Cavalry.

Appears on

Company Muster Roll

for *Sept. & Oct.*, 1864.

Present or absent *Present*

Stoppage, \$ 100 for

Due Gov't, \$ 100 for

Valuation of horse, \$ 100

Valuation of horse equipments, \$ 100

Remarks:

Book mark:

J. H. Paul
Copyist.

2 Cav. U.S.C.T.

Harry Laster
Co. F, 2 Reg't U.S. Col'd Cavalry.

Appears on

Company Muster Roll

for Nov. & Dec., 1864

Present or absent Present

Stoppage, \$ 100 for

Due Gov't, \$ 100 for

Valuation of horse, \$ 100

Valuation of horse equipments, \$ 100

Remarks:

Book mark:

(358) J. S. Pauld Copyist.

L | **2 Cav.** | **U.S.C.T.**

Harry Laster

Corp., Co. F, 2 Reg't U.S. Col'd Cavalry.

Appears on

Company Muster Roll

for *Jan. & Feb.*, 186 *5*.

Present or absent *Not stated*

Stoppage, \$ *100* for

Due Gov't, \$ *100* for

Valuation of horse, \$ *100*

Valuation of horse equipments, \$ *100*

Remarks:

Book mark:

(358)

J. S. Paul

Copyist.

L | **2 Cav.** | **U.S.C.T.**

Harry Lester
Capt, Co. F, 2 Reg't U. S. Col'd Cavalry.

Appears on

Company Muster Roll

for *Mar & Apr*, 1865.

Present or absent *Present*

Stoppage, \$ 100 for

Due Gov't, \$ 100 for

Valuation of horse, \$ 100

Valuation of horse equipments, \$ 100

Remarks:

Book mark: -----

Sams

NOV 19 1863

L | **2 Cav.** | **U.S.C.T.**

Harry Laster
Corpl, Co. F, 2 Reg't U. S. Col'd Cavalry.

Appears on

Company Muster Roll

for *May & June*, 186*5*.

Present or absent *Present*

Stoppage, \$ *100* for

Due Gov't, \$ *100* for

Valuation of horse, \$ *100*

Valuation of horse equipments, \$ *100*

Remarks:

Book mark: _____

James

L | **2 Cav.** | **U.S.C.T.**

Harry Laster

Pvt., Co. F, 2 Reg't U. S. Col'd Cavalry.

Appears on

Company Muster Roll

for July & Aug, 1865.

Present or absent absent

Stoppage, \$ 100 for

Due Gov't, \$ 100 for

Valuation of horse, \$ 100

Valuation of horse equipments, \$ 100

Remarks: Sent to Genl
Hospl since Aug
1/1/64. Pay due as Capt
from Dec 3/6 June
30/65

Book mark:

Sawb

MAR 18 1845

L.C. | **2 Cav.** | **U.S.C.T.**

Chas. Gaster

Co. F, Co. F, 2 Reg't U. S. Col'd Cavalry.

Appears on

Company Muster Roll

for *Sept. & Oct.*, 186*5*.

Present or absent *Present*

Stoppage, \$ 100 for

Due Gov't, \$ 100 for

Valuation of horse, \$ 100

Valuation of horse equipments, \$ 100

Remarks:

Book mark:

J. H. Curtis

L. | **2 Cav.** | **U.S.C.T.**

Harry Gaster
Pl', Co. F, 2 Reg't U. S. Col'd Cavalry.

Appears on

Company Muster Roll

for *Nov. & Dec.*, 1865.

Present or absent *Present.*

Stoppage, \$ 100 for

Due Gov't, \$ 100 for

Valuation of horse, \$ 100

Valuation of horse equipments, \$ 100

Remarks:

Book mark: -----

J. Stearns
Copyist.

L | 2 Cav. | U. S. C. T.

Mary Laster*

Pvt., Co. F, 2 Reg't U. S. Col'd Cav.

Appears on Returns as follows:

July 1864 Gain: July 29/64
In Petersburg Retreat

Aug 1865 Absent sick in
U.S. Genl Hosp, Aug 17, '65

*Name appears also as
Henry Dasher

Book mark: _____

Hottel

J. H. | **2 Cav. | U.S.C.T.**

Henry ...

..., Co. *...*, 2 Reg't U. S. Col'd Cavalry.

Appears on **Co. Muster-out Roll**, dated

..., 186*...*

Muster-out to date *...*, 186*...*

Last paid to *...*, 186*...*

Clothing account:

Last settled *...*, 186*...*; drawn since \$ *...* 100

Due soldier \$ *...* 100; due U. S. \$ *...* 100

Am't for cloth'g in kind or money adv'd \$ *...* 100

Due U. S. for arms, equipments, &c., \$ *...* 100

Bounty paid \$ *...* 100; due \$ *...* 100

Remarks: *...*

...

...

Book mark: *...*

...

Latham John ⁹⁴³

Co B, 2 U. S. Col'd Cav.

Private | Private

CARD NUMBERS.

1	5-315464	26
2	5-318527	27
3	5-318644	28
4	5-318762	29
5	5-318843	30
6	5-318988	31
7	5-319091	32
8	5-319193	33
9	5-319298	34
10	5-319397	35
11	5-319494	36
12	5-319588	37
13	5-319673	38
14	9087184	39
15	40726288	40
16		41
17		42
18		43
19		44
20		45
21		46
22		47
23		48
24		49
25		50

Book Mark:

See also

NOV 19 1950

51186141 P.O. M.V.M.

D 1402318 P.O. R.F.B.

[Faint, illegible handwritten notes]

J. Ballantyne

L | 2 Cav. | U.S.C.T.

John Latham

, Co. B, 2 Reg't U. S. Col'd Cav.

Appears on

Company Descriptive Book

of the organization named above.

DESCRIPTION.

Age 39 years; height 5 feet 3 inches.

Complexion Dark

Eyes Black; hair Black

Where born Washington Co., N. C.

Occupation Blacksmith

ENLISTMENT.

When Feb. 1, 1864.

Where Ft Monroe, Va.

By whom Col. Cole; term 3 y'rs.

Remarks: Mustered Feb. 8/64 by Capt. F. Martin. On detached service as Blacksmith during term of service.

F. B. Smith

Copyist.

S | *2 Cav* | **U.S.C.T.**

John Satham
River, Co., *2* Reg't U. S. Col'd *Cav*

Age years.

Appears on a

Detachment Muster-in Roll

of the organization named above. Roll dated

Ft Monroe, Va, Feb 8, 1864.

Muster-in to date *Feb 8*, 1864.

Joined for duty and enrolled:

When *Feb 1*, 1864.

Where *Ft Monroe, Va*

Period *3* years.

Valuation of horse, \$.....¹⁰⁰

Valuation of horse equipments, \$.....¹⁰⁰

Remarks:.....

.....

.....

.....

Book mark :.....

.....

L | **2 Cav.** | **U.S.C.T.**

John Latham

Priv., Co. B. 2 Reg't U. S. Col'd Cavalry.

Appears on

Company Muster Roll

for Dec. 29/63 to Feb 29, 1864

Present or absent Present

Stoppage, \$ 100 for

Due Gov't, \$ 100 for

Valuation of horse, \$ 100

Valuation of horse equipments, \$ 100

Remarks :

Book mark :

E. H. Hunter

L | **2 Cav. | U.S.C.T.**

John Latham
Put., Co. B. 2 Reg't U. S. Col'd Cavalry.

Appears on

Company Muster Roll

for March & April, 1864

Present or absent Present

Stoppage, \$ 100 for

Due Gov't, \$ 100 for

Valuation of horse, \$ 100

Valuation of horse equipments, \$ 100

Remarks :

Book mark :

E. M. Hunter

L | **2 Cav.** | **U.S.C.T.**

John Latham
Priv., Co. B. 2 Reg't U. S. Col'd Cavalry.

Appears on

Company Muster Roll

for May & June, 1864

Present or absent Present

Stoppage, \$ 100 for

Due Gov't, \$ 100 for

Valuation of horse, \$ 100

Valuation of horse equipments, \$ 100

Remarks :

Book mark :

E. H. Hunter

27

2 Cav. | U.S.C.T.

John Nathan

Nathan, Co. B. 2 Reg't U. S. Col'd Cavalry.

Appears on

Company Muster Roll

for *July - August*, 186 ⁴

Present or absent *Present*

Stoppage, \$ 100 for

Due Gov't, \$ 100 for

Valuation of horse, \$ 100

Valuation of horse equipments, \$ 100

Remarks :

Book mark :

G. Markle

L | **2 Cav.** | **U.S.C.T.**

John Cutham

Wate, Co. B. 2 Reg't U. S. Col'd Cavalry.

Appears on

Company Muster Roll

for *Sept - Oct.*, 186*4*.

Present or absent *Present.*

Stoppage, \$ 100 for

Due Gov't, \$ 100 for

Valuation of horse, \$ 100

Valuation of horse equipments, \$ 100

Remarks :

Book mark :

O. J. Markle,
Copyist.

L | **2 Cav.** | **U.S.C.T.**

John Luthans
.....
Private, Co. B. 2 Reg't U. S. Col'd Cavalry.

Appears on

Company Muster Roll

for *Oct. 31, 1864 to Feb. 28, 1865*

Present or absent *Present*

Stoppage, \$ 100 for

Due Gov't, \$ 100 for

Valuation of horse, \$ 100

Valuation of horse equipments, \$ 100

Remarks: *Let. re. blacksmith in*
Reg. L. in. Dept.

Book mark :

O. J. Markle

L

2 Cav. U.S.C.T.

John Latham

Priv, Co. B. 2 Reg't U. S. Col'd Cavalry.

Appears on

Company Muster Roll

for Mar & Apr, 1865.

Present or absent Present.

Stoppage, \$ 100 for

Due Gov't, \$ 100 for

Valuation of horse, \$ 100

Valuation of horse equipments, \$ 100

Remarks :

Book mark :

20105

Mochance

L | 2 Cav. | U.S.C.T.

John Latham
P. *Trw*, Co. B. 2 Reg't U. S. Col'd Cavalry.

Appears on

Company Muster Roll

for *May & June*, 1865.

Present or absent *Present.*

Stoppage, \$ 100 for

Due Gov't, \$ 100 for

Valuation of horse, \$ 100

Valuation of horse equipments, \$ 100

Remarks :

Book mark :

M D Chance

L. | 2 Cav. | U.S.C.T.

John Latham

Priv., Co. B. 2 Reg't U. S. Col'd Cavalry.

Appears on

Company Muster Roll

for July + Aug, 1865.

Present or absent Absent

Stoppage, \$ 100 for

Due Gov't, \$ 100 for

Valuation of horse, \$ 100

Valuation of horse equipments, \$ 100

Remarks: A.S Detached service 25th

A. C. Hrd Dr since Aug 12/65.

Book mark :

no chance

L | 2 Cav. | U.S.C.T.

John Latham
Pvt., Co. B. 2 Reg't U. S. Col'd Cavalry.

Appears on

Company Muster Roll

for Sept & Oct, 1865

Present or absent Absent

Stoppage, \$ 100 for

Due Gov't, \$ 100 for

Valuation of horse, \$ 100

Valuation of horse equipments, \$ 100

Remarks: On detached service, Hd. Qrs 25th A.C.

Book mark:

M. Harrison

L | **2 Cav.** | **U.S.C.T.**

John Latham

priv, Co. B, 2 Reg't U. S. Col'd Cavalry.

Appears on

Company Muster Roll

for Nov. & Dec, 1865.

Present or absent Absent

Stoppage, \$ 100 for

Due Gov't, \$ 100 for

Valuation of horse, \$ 100

Valuation of horse equipments, \$ 100

Remarks: On De S. at Hd.

Prs. 25th A. C.

Book mark:

W. Harrison

L | 2 Cav. | U.S.C.T.

John Latham
 Co. B., 2 Reg't U. S. Colored Cav.

Appears on Returns as follows:

Feb'y to Apr'l 1864. On duty
 with the Reg't.
 2nd Reg't as Blacksmith
 per S.O. No. 3 Hd. Qrs.
 2 USC.

May + June 1864 -
 On duty Blacksmith
 July 1864. On duty
 Blacksmith on Hd. Qrs.
 Sept 1864 to Feb'y 1865.
 On duty Blacksmith.

Apr'l 1865. Absent det.
 as Blacksmith as per
 S.O. No. 13 Hd. Qrs.
 Newport News,
 dated April 21-65.
 July to Nov 1865. Absent
 Blacksmith at Camp
 Hd. Qrs. per S.O. No. 42
 dated Hd. Qrs. 2 USC. July 14/65.

Book mark : _____

A. H. Collins
 Copyist.

JAN. 18

40726288

1899.

Geo. H. 5. Absent on
det. service Hd. Qr.
25 - aq.

L | 2 Cav. | U.S.C.T.

John Latham
Sgt, Co. B, 2 Reg't U. S. Col'd Cavalry.

Appears on Co. Muster-out Roll, dated
Brazos Santrago Tex, Feb. 12, 1866.
Muster-out to date Feb. 12, 1866.
Last paid to Dec 31, 1864.

Clothing account:

Last settled....., 186 ; drawn since \$.....100
Due soldier \$ 26 ¹⁴/₁₀₀; due U. S. \$.....100
Am't for cloth'g in kind or money adv'd \$.....100

Due U. S. for arms, equipments, &c., \$.....100
Bounty paid \$.....100; due \$.....100

Remarks: found a Rect.

Book mark: V. 35 P. 208/68

W. Harrison
(361) Copyist.

MAR 1917

Latham John
Co. 2, Reg't U.S.C. Cav.

Enclosures.

- | | |
|------------------------------------|----------------------------|
| Bed Cards | Final Statements |
| Burial Records | Furloughs or L. of A. |
| Certs. of Dis. for Discharge | Med. Certificates |
| C. M. Charges | Med. Des. Lists |
| Descriptive Lists | Orders |
| Discharge Certificates | Pris. of War Record |
| Enlistment Papers | Resignations |

Other papers relating to—

- | | |
|------------------------------|---------------------------|
| Admission to Hosp'l | Furlough or L. of A. |
| Casualty Sheet | Med. Examination |
| Confinement | Misc. Information |
| Contracts | Pay or Clothing |
| Death or Effects | Personal Reports |
| Desertion | Rank |
| Discharge from Hosp'l | Transfer to Hosp'l |
| Discharge from Service | Transfer to V. R. C. |
| Duty | Transportation |

John Latham

P. B. 2 N.Y.C. Co.

Duty

Report of Enlisted men of 2nd U. S. Colored Cavalry on duty in Dr. Masters Dept. No 25th A. C. for December 1865

No.	Name.	Rank	Co.	Occupation	Remarks
1	John Latham	Serjeant	B	Blksmith	Transf'd by Lieut Cooper at 2 m Dec 1 st 1865 He and date of order attached

J. P. Richard
Lieut. 4th A. S. I. M.
No 4, 25th A. C.

944
Latham Marcellus

Co B, 2 U. S. Col'd Cav.

Private Private

CARD NUMBERS.

1	5-315-614	26
2	5-318526	27
3	5-318643	28
4	5-318761	29
5	5-318872	30
6	5-316322	31
7	5-316634	32
8	5-318487	33
9	5-319090	34
10	5-319192	35
11	5-319297	36
12	5-319396	37
13	5-319493	38
14	5-319587	39
15	5-319672	40
16	9087183	41
17	40726289	42
18		43
19		44
20		45
21		46
22		47
23		48
24		49
25		50

Book Mark:

See also

2 | 2 Cav. | U.S.C.T.

Marcellus Latham

Co. B, 2 Reg't U. S. Col'd Cav.

Appears on

Company Descriptive Book

of the organization named above.

DESCRIPTION.

Age 22 years; height 5 feet 8 inches.

Complexion Dark

Eyes Black; hair Black

Where born Hyde Co, N. C.

Occupation Labour

ENLISTMENT.

When Jan. 1, 1864.

Where Ft Monroe Va.

By whom Col. Cole; term 3 y'rs.

Remarks: Mustered Jan. 8/64 by Capt. J. Martin. Engaged in action at Spicket, Va, March 9/64. At Drury's Bluff May 16/64. Detached service in Ambulance Train 18" A. C. from Aug. 6/64 to Jan. 1/65.

L. B. Smith

L. | 2 Cav | U.S.C.T.

Marcellus Latham
Pr't, Co. 2 Reg't U. S. Col'd Cav.

Age years.

Appears on a

Detachment Muster-in Roll,
of unattached recruits
of the organization named above. Roll dated
St. Monroe, Va., Jan. 8, 1864.

Muster-in to date Jan. 8, 1864.

Joined for duty and enrolled:

When Jan. 1, 1864.

Where St. Monroe, Va.

Period 3 years.

Valuation of horse, \$ 100

Valuation of horse equipments, \$ 100

Remarks :

.....
.....
.....

Book mark :

.....

J. J. Kearney
Coyist.

MAR 1973

L | 2 Cav. | U.S.C.T.

Marcellus Latham

Private, Co. B. 2 Reg't U. S. Col'd Cavalry.

Appears on

Company Muster Roll

for Dec. 22nd 1863 to Feb. 29, 1864.

Present or absent Present

Stoppage, \$ 100 for

Due Gov't, \$ 100 for

Valuation of horse, \$ 100

Valuation of horse equipments, \$ 100

Remarks :

Book mark :

E. W. Hunter

L | **2 Cav.** | **U.S.C.T.**

Marcellus Latham
Pvt., Co. B. 2 Reg't U. S. Col'd Cavalry.

Appears on

Company Muster Roll

for *March & April, 1864*

Present or absent *Present*

Stoppage, \$ 100 for

Due Gov't, \$ 100 for

Valuation of horse, \$ 100

Valuation of horse equipments, \$ 100

Remarks :

Book mark :

E. M. Hunter

(358)

Copyist.

L | **2 Cav.** | **U.S.C.T.**

Marcellus Latham
Put., Co. B. 2 Reg't U. S. Col'd Cavalry.

Appears on

Company Muster Roll

for *May & June*, 186*4*.

Present or absent *Present*

Stoppage, \$ 100 for

Due Gov't, \$ 100 for

Valuation of horse, \$ 100

Valuation of horse equipments, \$ 100

Remarks :

Book mark :

E. H. Hunter

20 | 2 bars | **U.S.C.T.**

Marcellus Latham
Pvt, Co. B, 2 Reg't U. S. Col'd bars

Appears on a

Detachment Muster Roll

of the organization named above

for July & Aug, 1864.

Station The Field Va

Present or absent Present

Stoppage, \$ 100 for

Due Gov't, \$ 100 for

Valuation of horse, \$ 100

Valuation of horse equipments, \$ 100

Remarks: _____

Book mark: 100000

W Smith

L^d | **2 Cav. | U.S.C.T.**

Marcellus L. Latham

Company, Co. B. 2 Reg't U. S. Col'd Cavalry.

Appears on

Company Muster Roll

for *August*, 1864.

Present or absent *Present*

Stoppage, \$ 100 for

Due Gov't, \$ 100 for

Valuation of horse, \$ 100

Valuation of horse equipments, \$ 100

Remarks: *Subscribed in Corp's Ambu-
lance Train O. O. no. 84 dated
H. S. 2^d Div. 18th A. C., Aug. 4,
1864.*

Book mark:

C. J. Markle

L 12 Cav. | U.S.C.T.

Marcellus Latham
Priv., Co. B, 2 Reg't U. S. Col'd Cavalry

Appears on a

Detachment Muster Roll

of the organization named above

for Sept + Oct, 1864.

Station In the field, Va

Present or absent Present

Stoppage, \$ 100 for

Due Gov't, \$ 100 for

Valuation of horse, \$ 100

Valuation of horse equipments, \$ 100

Remarks: Difference be-
tween white and
colored soldiers
pay due from Jan
1/64 to Apr 30/64

Book mark:

W F Boy

L | 2 Cav. | U.S.C.T.

Marcellus Pitham

Private, Co. B. 2 Reg't U. S. Col'd Cavalry.

Appears on

Company Muster Roll

for Sept. - Oct., 1864.

Present or absent Absent.

Stoppage, \$ 100 for

Due Gov't, \$ 100 for

Valuation of horse, \$ 100

Valuation of horse equipments, \$ 100

Remarks: Detained in Corps Ambulance train v. O. no. 84 dated H. 2. 3 18th Ar. O. Aug. 6, 1864.

Book mark:

O. J. Markle

S | **2 Cav. | U.S.C.T.**

Marcellus Pitman

Private, Co. B. 2 Reg't U. S. Col'd Cavalry.

Appears on

Company Muster Roll

for *Oct. 31, 1864 to Feb. 28, 1865*.

Present or absent *Present*

Stoppage, \$ 100 for

Due Gov't, \$ 100 for

Valuation of horse, \$ 100

Valuation of horse equipments, \$ 100

Remarks :

Book mark :

C. J. Markle,
Copyist.

L. | 2 Cav. | U.S.C.T.

Marcellus Latham

Private, Co. B. 2 Reg't U. S. Col'd Cavalry.

Appears on

Company Muster Roll

for Mar & Apr, 1865.

Present or absent Present.

Stoppage, \$ 100 for

Due Gov't, \$ 100 for

Valuation of horse, \$ 100

Valuation of horse equipments, \$ 100

Remarks :

Book mark :

No chance

L

2 Cav.

U.S.C.T.

Marcellus Latham

D. Priv

, Co. B. 2 Reg't U. S. Col'd Cavalry.

Appears on

Company Muster Roll

for May & June, 1865.

Present or absent Present.

Stoppage, \$ 100 for

Due Gov't, \$ 100 for

Valuation of horse, \$ 100

Valuation of horse equipments, \$ 100

Remarks :

Book mark :

M. Chance

L. | 2 Cav. | U.S.C.T.

Marcellas Latham
Priv., Co. B. 2 Reg't U. S. Col'd Cavalry.

Appears on

Company Muster Roll

for July + Aug, 1865.

Present or absent Present.

Stoppage, \$ 100 for

Due Gov't, \$ 100 for

Valuation of horse, \$ 100

Valuation of horse equipments, \$ 100

Remarks :

Book mark :

no chance

L | **2 Cav.** | **U.S.C.T.**

Marcellus Latham
Sgt, Co. B. 2 Reg't U. S. Col'd Cavalry.

Appears on

Company Muster Roll

for Sept. & Oct, 1865.

Present or absent Present

Stoppage, \$ 100 for

Due Gov't, \$ 100 for

Valuation of horse, \$ 100

Valuation of horse equipments, \$ 100

Remarks :

Book mark :

M. Harrison

L | **2 Cav.** | **U.S.C.T.**

Marcellus Latham
priv, Co. B. 2 Reg't U. S. Col'd Cavalry.

Appears on

Company Muster Roll

for *Nov. & Dec*, 1865.

Present or absent *Present*

Stoppage, \$ *100* for

Due Gov't, \$ *100* for

Valuation of horse, \$ *100*

Valuation of horse equipments, \$ *100*

Remarks: *Charge value of one cone wrench 32cts*

Book mark :

W. Harrison
(358) Copyist.

L | **2 Cav.** | **U.S.C.T.**

Marcellus Latham

Pr., Co. B, 2 Reg't U. S. Colored Cav.

Appears on **Returns** as follows:

Jan. to May 1864 -
 on duty - detailed
 as Hospital Nurse
 S.O. 700-1-

Aug 1864 - Absent
 det. in Amb. Corps.
 18 a. l.

Sept 1864 - Absent in
 Amb. Corps as driver

Oct 1864 - Absent
 det. as Sharpshooter

Nov 1864 - Absent in
 Ambulance Corps
 as driver.

Book mark :

A. H. Elliott

L | **2 Cav.** | **U.S.C.T.**

Marcellus Latham

privt, Co. *B*, 2 Reg't U. S. Col'd Cavalry.

Appears on **Co. Muster-out Roll**, dated

Brazos Santiago Tex, *Feb. 12*, 186*6*.

Muster-out to date *Feb. 12*, 186*6*.

Last paid to *June 30*, 186*5*.

Clothing account:

Last settled....., 186 ; drawn since \$..... $\overline{100}$

Due soldier \$..... $\overline{100}$; due U. S. \$ *20* $\frac{05}{100}$

Am't for cloth'g in kind or money adv'd \$..... $\overline{100}$

Due U. S. for arms, equipments, &c., \$..... $\frac{37}{100}$

Bounty paid \$..... $\overline{100}$; due \$..... $\overline{100}$

Remarks: *Send a Rect, Stop*
for one Screw Driver
and Cone Wrench.

Book mark: *V. 220, P. 223, 75.*

W. Harrison

945

Laughinghouse George

Co *F*, **2** U. S. Col'd Cav.

CARD NUMBERS.

1	26
2	27
3	28
4	29
5 <i>See Laughinghouse George</i>	30
6	31
7	32
8	33
9	34
10	35
11	36
12	37
12	38
14	39
15	40
16	41
17	42
18	43
19	44
20	45
21	46
22	47
23	48
24	49
25	50

Book Mark: _____

See also _____

946
Lavenhouse George

Co A, 2 U. S. Col'd Cav.

Private | Private

CARD NUMBERS.

1	5-315616	26
2	5-323469	27
3	5-323558	28
4	5-323639	29
5	5-323728	30
6	5-323820	31
7	5-323914	32
8	5-324002	33
9	5-324091	34
10	5-324184	35
11	5-324280	36
12	5-324374	37
13	5-324462	38
14	5-324550	39
15	9087005	40
16		41
17		42
18		43
19		44
20		45
21		46
22		47
23		48
24		49
25		50

Book Mark:

See also

REF ID: A66999
PAP 347110 -
MS. 1090890

L. T. Ballary 42

L | **2 Cav. | U.S.C.T.**

Geo Levenhouse

....., Co. *F*, 2 Reg't U. S. Col'd Cav.

Appears on

Company Descriptive Book

of the organization named above.

DESCRIPTION.

Age *16* years; height *5* feet *6* inches.

Complexion

Eyes; hair

Where born *Rufort N. C.*

Occupation *Farm.*

ENLISTMENT.

When *Jan. 1*, 186 *4*.

Where *Fort Mon*

By whom *Col. Cole*; term *3* y'rs.

Remarks:

.....
.....
.....
.....
.....
.....
.....
.....

F. B. Smith

NOV 11 1892

L. | 2 Cav | U.S.C.T.

George Laughinghouse
Art., Co., 2 Reg't U. S. Col'd Cav.

Age years.

Appears on a

Detachment Muster-in Roll
of unattached recruits
of the organization named above. Roll dated
St. Monroe, Va., Jan. 8, 1864.

Muster-in to date Jan. 8, 1864.

Joined for duty and enrolled:

When Jan. 1, 1864.

Where St. Monroe, Va.

Period 3 years.

Valuation of horse, \$.....100

Valuation of horse equipments, \$.....100

Remarks :

.....

.....

.....

Book mark :

(337)

J. J. Kearney
Cpyist.

a | **2 Cav. | U.S.C.T.**

George A. ...

..., Co. F, 2 Reg't U. S. Col'd Cavalry.

Appears on

Company Muster Roll

for *...*, 186 *4*.

Present or absent *Present*

Stoppage, \$ *100* for

Due Gov't, \$ *100* for

Valuation of horse, \$ *100*

Valuation of horse equipments, \$ *100*

Remarks:

Book mark:

H. ...

2 Cav. U.S.C.T.

Henry A. Luskhouse

priv, Co. F, 2 Reg't U. S. Col'd Cavalry.

Appears on

Company Muster Roll

for *March & April*, 186*4*

Present or absent *present*

Stoppage, \$ *100* for

Due Gov't, \$ *100* for

Valuation of horse, \$ *100*

Valuation of horse equipments, \$ *100*

Remarks:

Book mark:

J. J. Quinn

a | **2 Cav.** | **U.S.C.T.**

James A. Williams

James A. Williams, Co. F, 2 Reg't U. S. Col'd Cavalry.

Appears on

Company Muster Roll

for *Nov 1 June*, 186*4*.

Present or absent *present*

Stoppage, \$ 100 for

Due Gov't, \$ 100 for

Valuation of horse, \$ 100

Valuation of horse equipments, \$ 100

Remarks: *Due 100 for one
mule key & one brass
spurs & straps \$202*

Book mark:

A. Williams

2 Cav. | U.S.C.T.

George L. Overhouser
Present, Co. F, 2 Reg't U. S. Col'd Cavalry.

Appears on

Company Muster Roll

for July & Aug., 1864.

Present or absent Present

Stoppage, \$ 100 for

Due Gov't, \$ 100 for

Valuation of horse, \$ 100

Valuation of horse equipments, \$ 100

Remarks: Stopped 1 horse
bag 1.50 per horse &
straps 5.20

Book mark:

J. A. Paul

2 Cav. U.S.C.T.

George Greenhouse
Private, Co. F, 2 Reg't U. S. Col'd Cavalry.

Appears on

Company Muster Roll

for Sept & Oct, 1867.

Present or absent Present

Stoppage, \$ 100 for

Due Gov't, \$ 100 for

Valuation of horse, \$ 100

Valuation of horse equipments, \$ 100

Remarks:

Book mark:

J. S. Paul
Copyist.

L. | **2 Cav.** | **U.S.C.T.**

Geo. L. Levenhouse
Priv., Co. F, 2 Reg't U. S. Col'd Cavalry.

Appears on

Company Muster Roll

for Nov. & Dec., 1867.

Present or absent Present

Stoppage, \$ 100 for

Due Gov't, \$ 100 for

Valuation of horse, \$ 100

Valuation of horse equipments, \$ 100

Remarks:

Book mark:

J. S. Paul
Copyist.

A | **2 Cav.** | **U.S.C.T.**

George Leavenhouse
Priv., Co. F, 2 Reg't U. S. Col'd Cavalry.

Appears on

Company Muster Roll

for *Jan. & Feb.*, 186*5*.

Present or absent *Not stated*

Stoppage, \$ *100* for

Due Gov't, \$ *100* for

Valuation of horse, \$ *100*

Valuation of horse equipments, \$ *100*

Remarks:

Book mark:

J. S. Quill
Copyist.

L | **2 Cav.** | **U.S.C.T.**

George Lavenhouse
Priv, Co. F, 2 Reg't U. S. Col'd Cavalry.

Appears on

Company Muster Roll

for Mar & Apr, 1865.

Present or absent Present

Stoppage, \$ 100 for

Due Gov't, \$ 100 for

Valuation of horse, \$ 100

Valuation of horse equipments, \$ 100

Remarks:

Book mark:

Sams

L | 2 Cav. | U.S.C.T.

George Levenhouse
Out, Co. F, 2 Reg't U. S. Col'd Cavalry.

Appears on

Company Muster Roll

for May & June, 1865.

Present or absent Present

Stoppage, \$ 100 for

Due Gov't, \$ 100 for

Valuation of horse, \$ 100

Valuation of horse equipments, \$ 100

Remarks:

Book mark:

Saints

L | **2 Cav.** | **U.S.C.T.**

George Lavenhouse

Bot, Co. F, 2 Reg't U. S. Col'd Cavalry.

Appears on

Company Muster Roll

for July & Aug, 1863.

Present or absent Present

Stoppage, \$ 100 for

Due Gov't, \$ 100 for

Valuation of horse, \$ 100

Valuation of horse equipments, \$ 100

Remarks:

Book mark:

Sams

L. | **2 Cav.** | **U.S.C.T.**

Geo Havenhouse
Pvt., Co. F, 2 Reg't U. S. Col'd Cavalry.

Appears on

Company Muster Roll

for *Sept. & Oct.*, 186*5*.

Present or absent *Present.*

Stoppage, \$ 100 for

Due Gov't, \$ 100 for

Valuation of horse, \$ 100

Valuation of horse equipments, \$ 100

Remarks:

Book mark: :

[Signature]

G. | **2 Cav.** | **U.S.C.T.**

Geo. Havenhouse

Chi., Co. F, 2 Reg't U. S. Col'd Cavalry.

Appears on

Company Muster Roll

for Nov + Dec., 1865.

Present or absent Present

Stoppage, \$ 100 for

Due Gov't, \$ 100 for

Valuation of horse, \$ 100

Valuation of horse equipments, \$ 100

Remarks:

Book mark:

W. Stearns
Copyist.

2 Cav. | U.S.C.T.

Company

Co. 4, 2 Reg't U. S. Col'd Cavalry.

Appears on **Co. Muster-out Roll**, dated

Sept 10, 1864, 186 .

Muster-out to date *Sept 10*, 186 .

Last paid to *Sept 10*, 186 .

Clothing account:

Last settled....., 186 ; drawn since \$.....100

Due soldier \$.....100; due U. S. \$.....100

Am't for cloth'g in kind or money adv'd \$.....100

Due U. S. for arms, equipments, &c., \$.....100

Bounty paid \$.....100; due \$.....100

Remarks : *...*

Book mark : *2814, 179, V. 108, P. 132, 10.*

(361)

Copyist.

947

Lawrence Albert G.

Co. G, 2 U. S. Col'd Cav.

Captain | Captain

CARD NUMBERS.

1	5315343	26	42848229
2	5327050	27	42888178
3	5327139	28	42888194
4	5327228	29	42888207
5	5327311	30	42888224
6	5327484	31	42848692
7	5325030	32	42722202
8	5325120	33	42848718
9	5325207	34	42848740
10	5325294	35	43224324
11	5325393	36	43226600
12	5325491	37	43218582
13	5325651	38	43217771
14	5324321	39	43217884
15	5324411	40	43226451
16	5325802	41	43222593
17	5328182	42	
18	5324499	43	
19	31670610	44	
20	40726290	45	
21	42875088	46	
22	42875110	47	
23	42875729	48	
24	42875749	49	
25	4287576	50	

Book Mark: 473. C.S. 77

See also

Co | 2 Cav, | U.S.C.T.

Albert G. Lawrence
Capt., Co. 2nd, Reg't U. S. Col'd Cav'y
Age 22 years.

Appears on an

Individual Muster-in Roll

of the organization named above. Roll dated
Fort, Mound, Va, Feb. 17, 1864.

Muster-in to date Feb. 17, 1864.

Joined for duty and enrolled :

When Feb. 12, 1864.

Where Fort Mound, Va,

Period 3 years.

Valuation of horse, \$ 100

Valuation of horse equipments, \$ 100

Remarks: Mustered pursuant
to authority from War
Dept. letter dated Decem-
ber 26th, 1864.

Book mark : _____

C. H. Owen,

L | **2 Cav.** | **U.S.C.T.**

Albert G. Lawrence
Capt, Co. I, 2 Reg't U. S. Col'd Cavalry.

Appears on

Company Muster Roll

for *Enrollment to Feb 29*, 1864.

Present or absent *Present*

Stoppage, \$ *100* for

Due Gov't, \$ *100* for

Valuation of horse, \$ *100*

Valuation of horse equipments, \$ *100*

Remarks: *Appointed Capt.*
Feb 12th by order Maj.
Genl. Butler.

Book mark:

P. A. Ward

L | **2 Cav.** | **U.S.C.T.**

A. G. Lawrence
Capt, Co. I, 2 Reg't U. S. Col'd Cavalry.

Appears on

Company Muster Roll

for *Mar 9 Apr*, 1864.

Present or absent *Present*

Stoppage, \$ *100* for

Due Gov't, \$ *100* for

Valuation of horse, \$ *100*

Valuation of horse equipments, \$ *100*

Remarks:

Book mark: -----

P. A. Ward

L | **2 Cav.** | **U.S.C.T.**

L. J. Lawrence
Capt, Co. I, 2 Reg't U. S. Col'd Cavalry.

Appears on

Company Muster Roll

for *May & June*, 1864

Present or absent *Absent*

Stoppage, \$ *100* for

Due Gov't, \$ *100* for

Valuation of horse, \$ *100*

Valuation of horse equipments, \$ *100*

Remarks: *absent on de-
tached service, May 29,
1864.*

Book mark:

P. A. Ward

L. 1 2^d Cav (USCT)
U. S. Lawrence
Captain, 2^d US Col Cav.

Return

of the 2d Division, 18th Army Corps,

for the month of June, 1864,

dated In the field to,

June 30, 1864,

shows the following with regard to the officer named above:

Post or station

In the field to

Remarks:

A. B. C. Assigned to
 duty by J. O. No 46, Par 21
 dated Ord 42 18 "A. C. June 11"
 1864.

Book mark:

W. M. Moore

L 1 2 Co USCS
M G Lawrence
Captain 2d US Col Coy

Return

of the 2d Division, 18th Army Corps,

for the month of July, 1864,

dated In the field Va

July 31, 1864,

shows the following with regard to the officer
named above:

Post or station In the field Va

Remarks: A B C

Book mark:

[Signature]

20 | 2 Cav. | U.S.C.T.

A. G. Lawrence
Capt, Co. I, 2 Reg't U. S. Col'd Cavalry.

Appears on

Company Muster Roll

for July & Aug, 1864.

Present or absent Absent

Stoppage, \$ 100 for

Due Gov't, \$ 100 for

Valuation of horse, \$ 100

Valuation of horse equipments, \$ 100

Remarks: Absent on detached service since May 29-1864.

Book mark:

O. G. Smith

L1 2^d Cav USCT

A G Lawrence
Captain 2^d MS Col^d Cav

Return

of the 2d Division, 18th Army Corps,

for the month of Aug, 1864,

dated In the field Va

Aug 31, 1864,

shows the following with regard to the officer
named above:

Post or station In the field Va

Remarks: A B C

Book mark:

G M Now

L. I. & Co. U.S.C.S.
A. G. Lawrence
Captain 2d U.S. Col. Cav.

Return

of the 2d Division, 18th Army Corps,

for the month of *Sept*, 1864,

dated *In the field Va*
Sept 30, 1864,

shows the following with regard to the officer
named above:

Post or station *In the field Va*

Remarks: *A.D.C.*

Book mark: _____

J. W. How

2 | 2 Cav. | U.S.C.T.

A. G. Lawrence

Capt., Co. G, 2 Reg't U. S. Col'd Cavalry.

Appears on

Company Muster Roll

for Sept & Oct, 1864

Present or absent Absent

Stoppage, \$ 100 for

Due Gov't, \$ 100 for

Valuation of horse, \$ 100

Valuation of horse equipments, \$ 100

Remarks: Transferred from
Co D by G. O. No 35 dated
16th Dec. 2nd 76. S. O. Oct 20th
64 vice Perrin cashired.
In Act^l service since
May 21/64.

Book mark:

(358)

J. Brown

Copyist.

L | **2 Cav.** | **U.S.C.T.**

A. G. Lawrence

capt, Co. I, 2 Reg't U. S. Col'd Cavalry.

Appears on

Company Muster Roll

for *Sept & Oct*, 186*4*.

Present or absent

Stoppage, \$ 100 for

Due Gov't, \$ 100 for

Valuation of horse, \$ 100

Valuation of horse equipments, \$ 100

Remarks: *Transferred to Co. G. vice Capt. Perrin dismissed for Reg. G.O. 35*

Book mark:

A. G. Hunt

L 1 2 Cav USCT

Lawrence

Capt 2^d US Col^d Cav.

Return

of the 2d Division, 18th Army Corps,

for the month of Oct, 1864,

dated In the field Va

Oct 31, 1864,

shows the following with regard to the officer named above:

Post or station

Remarks: U. D. C.

Reported to Gen Ames,

Book mark:

AMM

L 1 2^d Coy U.S. Inf.
A. G. Lawrence
Captain, 2^d U.S. C. Coy

Return

of the 1st Division, 10th Army Corps,
for the month of Oct, 1864,
dated Before Richmond Va
Oct 31, 1864,
shows the following with regard to the officer
named above:

Post or station Before Richmond Va
Remarks Aide de Camp,
Assigned to Staff of Genl Ames
per instructions from Hd Qrs.
18th A. C.

Book mark:

G. M. New

L | **2 Cav.** | **U.S.C.T.**

A. G. Lawrence

Capt, Co. G, 2 Reg't U. S. Col'd Cavalry.

Appears on

Company Muster Roll

for *Nov + Dec*, 1864.

Present or absent *Not stated*

Stoppage, \$ *100* for

Due Gov't, \$ *100* for

Valuation of horse, \$ *100*

Valuation of horse equipments, \$ *100*

Remarks:

Book mark:

J. Brown
(358) Copyist.

L | 2 Cav | USCS

A G Lawrence
Capt 2 Regt USCC

Return

of the 2d Division, 24th Army Corps,

for the month of Dec, 1864,

dated Near Richmond Va

Dec 31, 1864,

shows the following with regard to the officer
named above:

Post or station

Remarks: Gain. AADC.
Assigned to duty with
General Ames.
(No order received)

Book mark:

Wm L Lee

(548)

Copyist.

See

L | 2 Cav USCS

A G Lawrence
Capt 2 Regt US CC

Return

of the 2d Division, 24th Army Corps,

for the month of Jan, 1865,

dated Fort Fisher NC

March 13, 1865,

shows the following with regard to the officer
named above:

Post or station

Remarks: A A 10 Co Assigned
to duty (no order received).
Sick.

Book mark:

Wm C Lee

L | **2 Cav.** | **U.S.C.T.**

A. G. Lawrence

Capt., Co. G, 2 Reg't U. S. Col'd Cavalry.

Appears on

Company Muster Roll

for *Jan'y + Feby*, 1865.

Present or absent *absent*

Stoppage, \$ *100* for

Due Gov't, \$ *100* for

Valuation of horse, \$ *100*

Valuation of horse equipments, \$ *100*

Remarks: *On detached service.*

Book mark:

J. P. Brown Copyist.

NARRATIVE

L | 2 Cav USCS

A G Lawrence
Capt 2 Regt USCS

Return

of the 2d Division, 24th Army Corps,

for the month of Feb, 1865,

dated Wilmington NC

March 14, 1865,

shows the following with regard to the officer
named above:

Post or station

Remarks: AAC Assigned
to duty (no order
received). Sick.

Book mark:

Wm L Lee

L | 2 Cav | USCT

A G Lawrence
Capt 2 Regt USCT

Return

of the 2d Division, 24th Army Corps,

for the month of March, 1865,

dated Faison's Station NC

March, 1865,

shows the following with regard to the officer
named above:

Post or station Faison's Station NC

Remarks: A A D C Absent
sick

Book mark:

Wm L Lee

L | **2 Cav.** | **U.S.C.T.**

Albert G. Lawrence

Capt., Co. G, 2 Reg't U. S. Col'd Cavalry.

Appears on

Company Muster Roll

for *March & April*, 186 *57*

Present or absent *Present*

Stoppage, \$ *100* for

Due Gov't, \$ *100* for

Valuation of horse, \$ *100*

Valuation of horse equipments, \$ *100*

Remarks: *In detached service*

Book mark:

C. C. Chapin

L | 26 | U.S.C.T.

A. B. Lawrence
Capt. 2^d U.S.C.C.

Return

of the 2d Division, 10th Army Corps,

for the month of April, 1865,

dated Raleigh, N.C.

May, 1865,

shows the following with regard to the officer
named above:

Post or station Newport, R.I.

Remarks:

A.A.D.C. Absent sick
since Jan. 15, 1865.

Book mark:

C. M. Clark

L | 2 Cav | 1865

Albert G Lawrence
Capt-Co G 2 Reg US Cav

Return

of the Post of Newport News, Va.,

for the month of April, 1865,

dated Apr 30, 1865,

shows the following with regard to the person
named above:

Post or station

Remarks: Absent on detached
duty as A.D.C. on Genl
Wheeler's staff per S.O. No 40
Hd qrs 18th Cav June 1-1864

Book mark:

(600)

W. Crosby
Copyist.

L. | U.S.G.T.

Albert G. Lawrence

Capt. 2 Colored Cav.

Appears on

General Order

No. 77, dated War Department, Adjutant General's Office, May 26, 1865.

Appointed to be

Major

BY BREVET

in the Volunteer Force, Army of the United States, for gallant and distinguished services in the capture of Fort Fisher.

To date from March 21, 1865.

L. P. Attochu

L.

U.S. Vols.

Albert G. Lawrence

Brevet Major U.S. Vols.

Appears on

General Order

No. 97, dated War Department, Adjutant General's Office, May 26, 1865.

Appointed to be

Lieutenant Colonel

BY BREVET

in the Volunteer Force, Army of the United States, for gallant and distinguished services in the capture of Fort Fisher

To date from March 21, 1865.

L. P. ...

(400)

Copyist.

62

L

U. S. Vols.

A. G. Lawrence,
Bvt. Major, U. S. Vols.

Appears on

General Order

No. 133, dated War Department, Adjutant Gen-
eral's Office, Aug. 22., 1865.

Appointed to be

Lieutenant Colonel,

BY BREVET

in the Volunteer Force, Army of the United
States, for gallant and meri-
-torious conduct at the
storming of Fort Fisher, N. C.

To date from March 13., 1865.

(400)

J. C. Bay

Copyist.

1865

L | 2 Cav. | U.S.C.T.

Albert G. Lawrence
Capt, Co. G, 2 Reg't U. S. Col'd Cavalry.

Appears on

Company Muster Roll

for May & June, 1865.

Present or absent absent.

Stoppage, \$ 100 for

Due Gov't, \$ 100 for

Valuation of horse, \$ 100

Valuation of horse equipments, \$ 100

Remarks: On detached service
at 3rd Div. Hd. qtr. 24 A.C.

Book mark:

Fulton

L. | 2 Cav. | U.S. 67

A. J. Lawrence
Capt. 1st U.S. C.T.

Return

of the 2d Division, 10th Army Corps,

for the month of June, 1865,

dated Raleigh, N. C.

June, 1865,

shows the following with regard to the officer
named above:

Post or station

Remarks:

A. J. C. Absent sick
since June, 1864.

Book mark:

C. M. Clark

L. | 2 cav | 1 | U.S. 65.

A. J. Lawrence
Capt. 1 U.S. 65.

Return

of the 2d Division, 10th Army Corps,
for the month of July, 1865,
dated Raleigh N.C.
July 31, 1865,
shows the following with regard to the officer
named above:

Post or station _____

Remarks: _____

Loss.
A. J. Lawrence dropped absent
sick since June, 1864.

Book mark: _____

B. M. Clark

L | **2 Cav.** | **U.S.C.T.**

Albert G. Lawrence
Capt, Co. G, 2 Reg't U. S. Col'd Cavalry.

Appears on

Company Muster Roll

for *July & Aug.*, 186 *5*

Present or absent *Absent.*

Stoppage, \$ _____ *100* for _____

Due Gov't, \$ _____ *100* for _____

Valuation of horse, \$ _____ *100*

Valuation of horse equipments, \$ _____ *100*

Remarks: *On detached service since June 1864 by A.O. No. 1, dated Feb. 18th a.c.*

Book mark: _____

Tutton

2 car MSBJ

L

A. G. Lawrence

Bot Lt. Col, Co. , Reg't

Appears on

Hospital Muster Roll

of Lovell U. S. A. General Hospital,

at Portsmouth Grove, R. I.,

for July & Aug, 1865

Attached to hospital:

When , 186 .

How employed

Last paid by Maj.

to , 186 .

Bounty paid \$ 100; due 100

Present or absent Not stated

Remarks.

Book mark :

M Stewart

B. | **2 Cav.** | **U.S.C.T.**

Albert Lawrence

Capt.; Co. F, 2 Reg't U. S. Col'd Cavalry.

Appears on

Company Muster Roll

for *Sept. & Oct.*, 1865.

Present or absent *Absent*

Stoppage, \$ *100* for

Due Gov't, \$ *100* for

Valuation of horse, \$ *100*

Valuation of horse equipments, \$ *100*

Remarks: *On Det Service
as per S. O. No 46
Feb. Dec. 18 S. O.*

Book mark :

J. Stearns

MAR 11 1865

L | **2 Cav.** | **U.S.C.T.**

Albert G Lawrence

Capt., Co. G, 2 Reg't U. S. Col'd Cavalry.

Appears on

Company Muster Roll

for *Sept. & Oct.*, 186*5*.

Present or absent.....

Stoppage, \$.....100 for.....

Due Gov't, \$.....100 for.....

Valuation of horse, \$.....100

Valuation of horse equipments, \$.....100

Remarks: *Transferred to Co. F. 2d U.S. Col. band by virtue of G.O. No 14, dated Hd. Qrs. 2nd U.S. Col. Camp Clark Texas, Oct. 10, 1865.*

Book mark:.....

(358)

A M Laughlin
Copyist.

G. | **2 Cav.** | **U.S.C.T.**

A. G. Lawrence
Capt.; Co. F, 2 Reg't U. S. Col'd Cavalry.

Appears on

Company Muster Roll

for *Nov. & Dec.*, 1865.

Present or absent *Absent.*

Stoppage, \$ 100 for

Due Gov't, \$ 100 for

Valuation of horse, \$ 100

Valuation of horse equipments, \$ 100

Remarks: *On Let Service*
as per S.O. No. 46
dated 4th Dec
18. A.C.

Book mark:

J. J. Stearns
Copyist.

L | 2 Cav. | U.S.C.T.

Albert G. Lawrence
Capt., Co. D, 2 Reg't U. S. Colored Cav.

Appears on Returns as follows:

Feb'y to Apr 1864. (Co. D)

Present - Joined for duty on the 12th of Feb'y. May & June 1864. Absent. Ordered to report to Maj Gen Smith 18th a.c. May 28th by S.O. from Maj Gen Butler.

July 1864 - Present.

Aug & Sept 1864. Absent. Det. since May 28/64

Oct 1864. Last Oct. 20/64 In the field - Transfd to Co. G. per G.O. No. 35.

Oct. 1864 - (Co. G.) Absent. Assigned to Co. G. vice Perrin Cashiered per G.O. No. 35 - dated Hd. Qrs. 2. N.S.C.C.

over

Book mark :

M. Collins

JAN. 18

40726290

1899

Nov 1864. to Sept 1865 -
Absent on det.
service since June
1864. as per S.O. 46.
dated Hd. Qrs. 18 ac
June 11. 1864 - on Genl
Arms Staff -
Oct 1865. Loss - Transfd
to Co. F. 2 U.S.C. by
S.O. No. 14 Hd. Qrs.
2 U.S.C. - Camp
Clark Tex. Oct 10/65.
Oct 1865 - (Co. F.) Absent
Transferred from Co. B.
as per S.O. No. 14 Hd. Qrs.
U.S.C.
Nov 1865 - to Jan 1866.
absent on det.
service.

MAR 11 1866

L. C. Dean | **U.S.C.T.**

Private

Wapt, Co. 7, 2 Reg't U. S. Col'd Dean

Appears on **Co. Muster-out Roll**, dated
Blanco Santiago, Texa, Feb. 12, 1866 .

Muster-out to date 186 .

Last paid to 186 .

Clothing account:

Last settled 186 ; drawn since \$ 100

Due soldier \$ 100 ; due U. S. \$ 100

Am't for cloth'g in kind or money adv'd \$ 100

Due U. S. for arms, equipments, &c., \$ 100

Bounty paid \$ 100 ; due \$ 100

Remarks: Over Detached Service
Account No. 46 Dated
March 21 1866. Amount
5.00

Book mark: 1863 C. T. 100

JAN. - 7

5324499

★ 1891 ★

Le. 21. V. 11 C. T. 13
Discharged. S. M. No. 11
Jan 6 1891

L | 2 Cav. | U.S.C.T.

Albert G. Lawrence
Capt. 2 Regt. U.S. Colored Cav.

Appears on

General Order

No. 65, dated War Department, Adjutant Gen-

eral's Office, June 22, 1867.

Appointed to be

Major

BY BREVET

in the Volunteer Force, Army of the United

States, for gallant and
distinguished services
at the capture of
Fort Fisher, N.C.

To date from Mar 21, 1865.

A. W. Moses

(400)

Copyist.

L 1 2 Cav. U.S.C.T.

Albert G. Lawrence
Capt. 2 Regt U.S. Col. Cav.

Appears on

General Order

No. 65, dated War Department, Adjutant Gen-
 eral's Office, June 22, 1867.

Appointed to be

Lieutenant Colonel

BY BREVET

in the Volunteer Force, Army of the United
 States, for gallant and distinguished
services in the capture
of Fort Fisher, North
Carolina.

To date from March 21, 1865.

(400) J. Escabi Copyist.

L 1 2 | U.S.G.T.

A. G. Lawrence
Capt 2 Regt US Cold Inf

Appears on

General Order

No. 67, dated War Department, Adjutant Gen-
eral's Office, July 16, 1867.

Appointed to be

Colonel

BY BREVET

in the Volunteer Force, Army of the United
States, for gallant and merito-
rious services during the
war.

To date from Mch 25, 1865.

J. Williams
(400) Copyist.

L | 2 | U.S.C.T.

A. G. Lawrence
Capt 2 Regt U.S. Cold Inf

Appears on

General Order

No 67, dated War Department, Adjutant Gen-
eral's Office, July 16, 1867.

Appointed to be

Brigadier General

BY BREVET

in the Volunteer Force, Army of the United
States, for gallant and distin-
guished services during
the war.

To date from Mch 25, 1865.

(400) J. W. Williams Copyist.

NOV 14 1866

L. | **2 Cav.** | **U.S.C.T.**

Albert G Lawrence,
Capt, Co. I, 2 Reg't U. S. Col'd Cavalry.

Appears on **Co. Muster-out Roll**, dated
Brazos Santiago Tex, Feb. 12, 1866.

Muster-out to date _____, 186 .

Last paid to _____, 186 .

Clothing account:

Last settled _____, 186 ; drawn since \$ _____ 100

Due soldier \$ _____ 100 ; due U. S. \$ _____ 100

Am't for cloth'g in kind or money adv'd \$ _____ 100

Due U. S. for arms, equipments, &c., \$ _____ 100

Bounty paid \$ _____ 100 ; due \$ _____ 100

Remarks: Transferred to Co. G.
2 U.S.C.C. Oct. 24th per General
Order No 35- Hd Qrs, 2nd
U.S. Col. Cav. x General order
No 35- Hd Qrs 2 U.S. C. Cav

x as it appears on roll.

Book mark: _____

Pol,

MAY 14 1865

L | **2 Cav.** | **U.S.C.T.**

Albert G. Lawrence
Capt., Co. G, 2 Reg't U. S. Col'd Cavalry.

Appears on **Co. Muster-out Roll**, dated
Brazos Santiago T., Feb 12, 1866.

Muster-out to date 186 .

Last paid to 186 .

Clothing account:

Last settled 186 ; drawn since \$ 100

Due soldier \$ 100 ; due U. S. \$ 100

Am't for cloth'g in kind or money adv'd \$ 100

Due U. S. for arms, equipments, &c., \$ 100

Bounty paid \$ 100 ; due \$ 100

Remarks: *Transferred to Co.*
G. by virtue of Reg.
G. O. No 14. Dated
Hd. Qrs. 2 U.S.C. Co.
Oct. 10/65.

Book mark:

(361)

A. M. Laughlin

Copyist.

Lawrence, A. G.

Capt., Co. 2, U.S.C. Cav. Reg't

12 Enclosures.

Bed Cards	Final Statements
Burial Records	Furloughs or L. of A.
Certs. of Dis. for Discharge	Med. Certificates 2
C. M. Charges	Med. Des. Lists
Descriptive Lists	Orders
Discharge Certificates	Pris. of War Record
Enlistment Papers	Resignations 1

Other papers relating to—

Admission to Hosp'l	Furlough or L. of A.
Casualty Sheet	Med. Examination
Confinement	Misc. Information
Contracts	Pay or Clothing
Death or Effects	Personal Reports 1
Desertion	Rank
Discharge from Hosp'l	Transfer to Hosp'l
Discharge from Service	Transfer to V. R. C.
Duty 1	Transportation

MICROFILM PUBLICATION M 1818

COMPILED MILITARY SERVICE RECORDS
OF VOLUNTEER UNION SOLDIERS WHO
SERVED WITH THE USCT (US COLORED TROOPS)
2ND REGIMENT OF CAVALRY

PERSONAL PAPERS' TARGET SHEET

PLEASE NOTE THE CHECKED INFORMATION ABOUT THE PERSONAL PAPERS IN
THIS FILE:

- NO PERSONAL PAPERS WERE FOUND IN THIS FILE WHEN THE
RECORDS WERE ARRANGED FOR MICROFILMING.

- 14 PERSONAL PAPER(S) FOUND IN THIS FILE WHEN THE RECORDS
WERE ARRANGED FOR MICROFILMING.

Albert G. Lawrence was mustered in as Capt 2d
Regt U. S. C. Cav's Feb'y 12, 1864 On Return
of that Regt for the month of Nov. 1865 (latest
on file) He is reported "A. S. C. 10th A. C. S. C.
4th Regt 18th A. C. June 3, 1864
Strength Com'd. 28
" Enlisted. — 941
No personal report from him. W.S.

APR 15 1863

A. S. Lawrence
Capt U.S.C. Bat.

order.

Head Quarters 18th Army Corps
In the field Va June 8th 1864.

Special Orders
No 43

XVII Capt. A. G. Lawrence 2^d U.S.
Colored Cavalry, is hereby relieved from duty with
General W. F. Smith, and will report to the Comdg
Officer of his Regiment for duty.

By Command of Major General Smith
Nicholas Bowen
Asst. Adjt. Genl.

W. Cole
Comdg

A. Lawrence,
Capt. 2d U.S.C. Co.

order

Head Quarters 18th Army Corps
Army of the Potomac. In the field &c.
June 11th 1864.

Special Order }
No 46 }

VII Captain A. G. Lawrence 2nd
W.D. Co. 1st Regt. will report in person to Brig Genl
A. H. Martindale Commanding 2nd Division 18th
Army Corps, for duty

By Command of Major General Smith
Wm Russell Jr
Asst Adj't Genl

100 2nd Div 18th Army Corps

WAR DEPARTMENT

SPECIAL ORDERS, }
No. 323. }

WAR DEPARTMENT,
ADJUTANT GENERAL'S OFFICE,
Washington, June 22d, 1865.

(Extract.)

* * * * *

31. Brevet Lieutenant-Colonel A. G. Lawrence, Captain, 2d U. S. Colored Cavalry, is hereby relieved from duty on the staff of Brevet Major-General Ames, 10th Army Corps, and will join his regiment in the 25th Army Corps, without delay.

* * * * *

By order of the Secretary of War:

E. D. TOWNSEND,
Assistant Adjutant General.

OFFICIAL:

Assistant Adjutant General.

Colonel Duck

War Dept Adjutants Genls Office
Washington D C June 22 1865

Special Order 323

Relieving Capt Lawrence
from Genl Ames Staff 10
Army Corps and ordered to
his regiment

L. U. S. C. C.

Order 323

SPECIAL ORDERS, }
No. 323. }

WAR DEPARTMENT,
ADJUTANT GENERAL'S OFFICE,
Washington, June 22d, 1865.

(Extract.)

* * * * *

31. Brevet Lieutenant-Colonel *A. G. Lawrence*, Captain, 2d U. S. Colored Cavalry, is hereby relieved from duty on the staff of Brevet Major-General *Ames*, 10th Army Corps, and will join his regiment in the 25th Army Corps, without delay.

* * * * *

By order of the Secretary of War:

E. D. TOWNSEND,

Assistant Adjutant General.

OFFICIAL:



Assistant Adjutant General.

C. C. Lilly, Colonel Cavalry

The Military Division of the South West

W^d Qrs. Dept. of the East.
New York City July 19. 03.

D. J. Van Buren. Col. 9
Asst. Adjt. General.

(Special orders. No. 166)
Directs Capt. A. G. Lawrence
1st Lt. Col. to report to
the Med. Director for ad-
mission to Hosp. in this
Dept.

2 weeks long

R. & P. O.
Rec'd from S. G. O.

Aug 12 ~~1903~~ 1903.

Headquarters Department of the East,

New York City, July 19th 1865.

SPECIAL ORDERS, }
No. 116.

11... Captain A. G. Lawrence Bvt. Lieut.

Col. lately a patient at Ladies Home Hospital in this City will report to Medical Director for admission to another Hospital in this Dept.

x

x

x

Admitted Powell Aug 3. 65
Transferred Knight Sept 2. 65

BY COMMAND OF MAJOR-GENERAL HOOKER :

Medical Director *[Signature]*

[Signature]

Assistant Adjutant General.

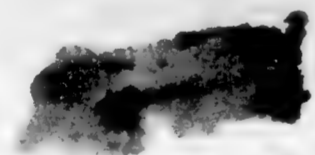
*This office is under the supervision of the Medical Director
and the Hospital. No orders will be issued
without the signature of the Medical Director
or the Adjutant General.*

MS. A. 9. 2

2

L1 C. J. R. B. 1856

L2 (yinda) 1866



///

Medical Director's Office,

DEPARTMENT OF THE EAST,

No. 125 Bleecker Street,

New York, Sept. 21st 1865.

Capt. A. G. Lawrence, Port. Lt. Col.
2nd U. S. Colored Cavalry, being de-
sirous of resigning his commission,
this is to certify that I have exam-
ined this Officer, and find that
he lost his left arm in battle, was
wounded in the neck, in the
right arm and left shoulder;
which incapacitate him for
active service.

Wm. V. Sloan
Brig. Gen. - Surgeon USA
Med. Dir. Dept East.

De Camp General Hospital
Davids Island. NYHC
January 3. 1866.

A. G. Lawrence.
Capt & Adj. Gen. 1st Regt. Col. 11th.

States cause of his absence
from his Regiment.

Dr. C. G. W. 13, 1866

Dr (M.D.) 1866

RECORDED

Decamp. Gen. Hospital David's
Island. Department of the East.
January 3rd 1866,

General.

I have the honour to acknowledge a communication from the War Department dated Dec 23rd 65, signed U. W. Foster - A. A. Genl Vols - directing me immediately to rejoin my regiment in the Department of Texas or to show to this Office, why ^{you} should not be discharged from the Service of the United States for absence without leave - On the 15th of January last I was wounded in the attack at Fort Fisher. - I was directed by a Telegram from Lt Gen Grant, in answer to a Telegram to him from B. G. Br. Gen Com. stock. To go north for medical treatment - Upon my arrival in New York I was carried to Ladies Home Hospital - Dr. A. Mott - Surgeon in Charge - and treated in that Hospital for my wounds. - On July - 1865 - I reported to Dr. Sloan - Med. Director Dept of the East - pursuant to the following order - Head Quarters Department of the East - New York City July 19th 1865

Special Orders
No 166.

|| Captain A. G. Lawrence
Bd Lt Col lately a patient at Ladies
Home Hospital in this City will report
to Medical Director for admission in
another hospital in this Dept.

By Command of Maj. Gen Hooker
D Van Buren
Adj. Adj. Gen.

I was ordered by him to Portsmouth
Grove Hospital - thence to Knights Gen
Hospital - N. Haven & in Dec. to
Decamps Gen Hospital - Davis Island,
whence I have the honour to address this
Communication. - Upon perusing the
accompanying Certificate, you will see
General - that personally I could not
report in writing as I had no use of
my arms, on account of wounds, and
was informed by the Surgeon in Charge
and also by the Medical Director that
the order, about reporting did not refer

to Officers - actually patients in a U
S. Hospital -

I hope that this letter will prove
a satisfactory explanation and that
I will receive from the Department
a withdrawal of the harsh undecorated
communication that I have received
from it.

Very respectfully,

A. G. Lawrence

Capt. 2. U. S. C. Cav.

1st Lt. Col of Vols

Major Gen Townsend.
A. G. U. S. A.

Spencer, J. R. Capt. U.S.A.
Laysan Island, N. H. I.
Lt. (M.A.) U.S.A.

A. G. Lawrence,
Capt. & U. S. Col. Cav. 1st Reg. U.S.

Tenders his resignation per
name stated within.

Surgeon's Certification
accompanied with
letter explaining reasons
for continued absence
from Regt in reply
to communication
dated Dec 23rd 1864
directing him to report
to Regt in Dept Texas
or to show why he should
not be discharged the
service of the United
States.

Two Enclosures
Regt 24th Jan 9, 1864
The HQ (M.A.) Jan 5/64

1866
Camp. Gen Hospital, Davis
Island Dept of the East
Jan 3rd 1866

General.

I have the honour to tender my
resignation - based on the accompanying
Certificate of disability. I would request
to be mustered out of the service of the
United States as soon as consistent with
the convenience of the Department.

Very respectfully -

A. G. Lawrence

Capt 2. U.S. Ct.
Bt Lt Col of Vols.

May. Gen Townsend
A. G. U. S. A.

S. O. R. B. 1866

20. 3. (D.E.) 1866.
HEADQUARTERS DEPARTMENT OF THE EAST.

NEW YORK CITY, January 6th 1866

Respectfully forwarded to the A. G. O., through
Headquarters Military Division of the Atlantic.

Sept Hooker

per D. H. B. B. B.
A. G.

for Hooker is unable to sign his
name.

Sydney J. May 1866
Major General
Comd'g

Headquarters
Military Division of the Atlantic
Orla, Jan 8. 1866.

Respectfully forwarded
to the Adjutant General.

Geo. G. Meade
Major General
Comd'g

File

(Copy)

War Department,
Adjutant General's Office,
Washington, January 10th 1866.

Special Order
2 10 11

- Extract -

Captain W. G. Lawrence, 2nd U. S. Col. Cav. Bot. Lt. Col. U. S. Vol. having tendered his resignation, is hereby honorably discharged from the service of the U. S. on account of physical disability from wounds received in action, with condition that he shall receive no final pay until he has satisfied the Pay Department that he is not indebted to the Government.

Orders

By order of the Secy of War,
Signed: G. D. Sisson,
Adj. Gen.

Capt W. G. Lawrence,
Adjutant Director,
Capt of the Coast,
N. Y. City.

A. G. Lawrence

2nd W. S. Childs

$\frac{11}{6}$

SPECIAL ORDERS, }
No. 11. }

WAR DEPARTMENT,
ADJUTANT GENERAL'S OFFICE,
Washington, January 10th, 1866.

(Extract.)

* * * * *

6. Captain *A. G. Laurence*, 2d U. S. Colored Cavalry, Brevet Lieutenant-Colonel, U. S. Volunteers, having tendered his resignation, is hereby honorably discharged the service of the United States, on account of physical disability from wounds received in action, with condition that he shall receive no final payments, until he has satisfied the Pay Department that he is not indebted to the Government.

* * * * *

By order of the Secretary of War:

E. D. TOWNSEND,
Assistant Adjutant General.

OFFICIAL:

E. D. Townsend
Assistant Adjutant General.

Paymaster General
U.S.A.

174

C-135 - 79 1865
C-39 (E10) 1815
1st. Gen. 2^d U. S. C. Cav. Feb 7th 1865

Col. Conroy
Col. Conroy

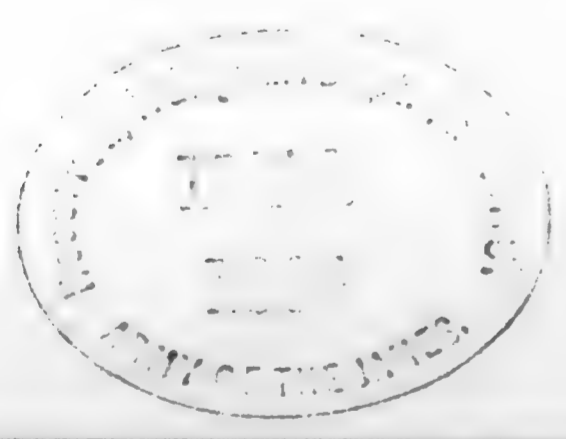
Requests that Capt. A. G. Lawrence be returned to duty with his regiment

E. B. 1056 - Va - Feb 8th 1865

Head Quarters Dept of Virginia
Before Richmond Va
12th March 1865

Respy. returned this officer cannot be returned at present.

By order of
Maj. Gen. Ord.
R. P. Davis
a.c.f.



E. B. no. 122 1852
Head Quarters 25th Feb 25th 1865
In the field Va Feb 8th 1865

Respectfully forwarded approved
E. W. A. Wild
Brig. Gen. Conroy

Head Quarters 25th Army Corps
Lynchburg Va February 8th 1865
E. B. 919

Respectfully forwarded -
This officer was badly wounded at Fort Fisher, and I understand is not likely to recover

C. C. Stebbins
Brig. Gen. Ord.

Head Quarters Dept. of Virginia
Before Richmond
11th February 1865

Respy. referred to Maj. Gen. Ord. Fort Fisher.

By Command of
Maj. Gen. Ord.
C. C. Stebbins
a.c.f.

Rec. Room. H. Q. 25th Feb 8th 1865

Head Quarters, Prov. Corps
Wilmington N.C. Feb 1st 1865

Respectfully returned to
Maj. Gen. Ord.

Captain Lawrence was very severely wounded in the assault on Fort Fisher & is now absent from this command as it is supposed at Newfort R.I. whether he will be able ever to return to duty is doubtful, but should he do so I respectfully recommend that he be allowed to remain as an A. D. C. on the staff of Brig. Gen. Ord. by whom he is most highly esteemed for capacity and gallantry.
Respy. R. P. Davis
M. G. Ord.

WAR 175
Hd. Qrs. 2nd U.S. Col. Cavalry
In the Field 11th Feb. 7th 1863

Sir

I have the honor to request that Capt. A. J. Lawrence, may be returned to duty with his regiment. He was detached per S.O. No. 46 Hd. Qrs. 18th U.S. as A. A. D. C. to Maj. Genl. Smith, but is at present on duty with Brig. Genl. Ames 24th U.S.

I have the honor to be
Sir

Very Respectfully Yours &c,
Geo. Cole.

Capt. G. D. Miller
A. A. Genl. 25th U.S.

Col. 2nd U.S. Col. Cav. Genl. Regt

Head Quarters Dist E Va
Norfolk. Va March 16/15.
Respectfully returned with
reference to endorsement
of Head Quarters Depot.

By Order of.

Brig Genl Gordon

William H. Murray
Quartermaster

Edinburgh, Pa. 10th Dec 1863

Portsmouth, Va. March 17/63

Respy transmitted
with reference to
existing endorsement

By order of

Wm H. Murray

Quartermaster

Quartermaster

APR 17 1866

~~213 5720000 78~~

MEDICAL DIRECTOR'S OFFICE,

DEPARTMENT OF THE EAST,

New-York, Jan 11 1866

Respectfully transmitted to Adm's

Dept of the East

Wm J. Storr

Bvt. Colonel and Surgeon U. S. Army,
Medical Director, Dep't of the East.

*noted
by
7 Jan 9 66 to col
Sawyer, dated
D. 726 Vol 5 C. 11 1865
and S. O. no 11
Jan 6. 1866 (Jan 11)*

De Camp Genl. Hospital

Navide Island. NYH

January 3, 1868.

Communications of Lieut A. G.
Lawrence, & Lt. S. Col. C. H. C. &
Col. U. S. Col. respectfully forwarded
to the Adjutant General, U. S. Army
through the Medical Director, Dept
of the East.

WARREN W. BLES

3rd Maj & Asst Surg. USA
Camp Hospital.

948

Lawrence John

Co *A*, 2 U. S. Col'd Cav.

Private | *Private*

CARD NUMBERS.

1	5316080	26
2	5323729	27
3	5323822	28
4	5323915	29
5	5324003	30
6	5324092	31
7	5324185	32
8	5324278	33
9	5324373	34
10	5324461	35
11	5324549	36
12	9087607	37
13	40726292	38
14		39
15		40
16		41
17		42
18		43
19		44
20		45
21		46
22		47
23		48
24		49
25		50

Book Mark:

See also

NOV 11 1899

L | **2 Cav. | U.S.C.T.**

John Lawrence
....., Co. *F*, 2 Reg't U. S. Col'd Cav.

Appears on
Company Descriptive Book
of the organization named above.

DESCRIPTION.

Age *20* years; height *5* feet *8* inches.

Complexion

Eyes; hair

Where born *Matthews Va.*

Occupation *Farm*

ENLISTMENT.

When *Jan. 1*, 186*4*.

Where *New N. C.*

By whom *S. Smith*; term *3* y'rs.

Remarks:

F. B. Smith
Copyist.

L | **2 Cav.** | **U.S.C.T.**

John Lawrence

Appears with rank of *Private* on

Muster and Descriptive Roll of a Detachment of U. S. Vols. forwarded

for the 2 Reg't U. S. Col'd Cavalry. Roll dated

at Petersburg Va, June 29 1864.

Where born *Clark Co. Ohio*

Age *14* y'rs; occupation *Laborer*

When enlisted *Jan'y 1*, 1864.

Where enlisted *Newberne N. C.*

For what period enlisted *3* years.

Eyes *black*; hair *black*

Complexion *black*; height *5 ft. 7 in.*

When mustered in *June 29*, 1864.

Where mustered in *Bermuda Hundred,*

Bounty paid \$ *100*; due \$ *100*

Where credited _____

Company to which assigned _____

Remarks: *Escaped slave*

and not credited to any state.

Book mark: _____

L | **2 Cav.** | **U.S.C.T.**

John Lawrence
Priv., Co. F, 2 Reg't U. S. Col'd Cavalry.

Appears on

Company Muster Roll

for July & Aug., 1864.

Present or absent Present

Stoppage, \$ 100 for

Due Gov't, \$ 100 for

Valuation of horse, \$ 100

Valuation of horse equipments, \$ 100

Remarks: On daily duty
in Reg't B Band

Book mark:

A. S. Paul
Copyist.

S. | **2 Cav.** | **U.S.C.T.**

John Lawrence
Pr.
....., Co. F, 2 Reg't U. S. Col'd Cavalry.

Appears on

Company Muster Roll

for *Sept. & Oct.*, 1864.

Present or absent *Present*

Stoppage, \$.....100 for

Due Gov't, \$.....100 for

Valuation of horse, \$.....100

Valuation of horse equipments, \$.....100

Remarks: *On daily duty*
in Regt. B. and

Book mark:50

J. S. Paul,
Copyist.

L. | **2 Cav.** | **U.S.C.T.**

John Lawrence
Pvt., Co. F, 2 Reg't U. S. Col'd Cavalry.

Appears on

Company Muster Roll

for *Nov. & Dec.*, 1864.

Present or absent *Present*

Stoppage, \$ 100 for

Due Gov't, \$ 100 for

Valuation of horse, \$ 100

Valuation of horse equipments, \$ 100

Remarks: *On daily duty
in Reg't Band.*

Book mark: *✓*

J. P. Paul
(358) Copyist.

L. | **2 Cav.** | **U.S.C.T.**

John Lawrence
.....
Lawrence, Co. F, 2 Reg't U. S. Col'd Cavalry.

Appears on

Company Muster Roll

for *Jan. & Feb.*, 1865.

Present or absent *Not stated*

Stoppage, \$ *100* for

Due Gov't, \$ *100* for

Valuation of horse, \$ *100*

Valuation of horse equipments, \$ *100*

Remarks: *Wm D. & J.
Reg't. Bands*

Book mark:

J. S. Paul
Copyist.

L | **2 Cav.** | **U.S.C.T.**

John Lawrence
Priv, Co. F, 2 Reg't U. S. Col'd Cavalry.

Appears on

Company Muster Roll

for Mar & Apr, 1865.

Present or absent Present

Stoppage, \$ 100 for

Due Gov't, \$ 100 for

Valuation of horse, \$ 100

Valuation of horse equipments, \$ 100

Remarks:

Book mark:

L. Law

L | 2 Cav. | U.S.C.T.

John Lawrence
Pot, Co. F, 2 Reg't U. S. Col'd Cavalry.

Appears on

Company Muster Roll

for May & June, 1865.

Present or absent Present

Stoppage, \$ 100 for

Due Gov't, \$ 100 for

Valuation of horse, \$ 100

Valuation of horse equipments, \$ 100

Remarks:

Book mark:

Sams

L | 2 Cav. | U.S.C.T.

John Lawrence
Pot, Co. F, 2 Reg't U. S. Col'd Cavalry.

Appears on

Company Muster Roll

for July & Aug, 1862.

Present or absent Present

Stoppage, \$ 100 for

Due Gov't, \$ 100 for

Valuation of horse, \$ 100

Valuation of horse equipments, \$ 100

Remarks:

Book mark:

Jacob

G. | **2 Cav.** | **U.S.C.T.**

John Lawrence
Wm.; Co. F, 2 Reg't U. S. Col'd Cavalry.

Appears on

Company Muster Roll

for *Sept.* & *Oct.*, 186*5*.

Present or absent *Present*

Stoppage, \$ *100* for

Due Gov't, \$ *100* for

Valuation of horse, \$ *100*

Valuation of horse equipments, \$ *100*

Remarks:

Book mark: -----

A. W. Stewart
Copyist.

G. | **2 Cav.** | **U.S.C.T.**

John Lawrence
Ch, Co. F, 2 Reg't U. S. Col'd Cavalry.

Appears on

Company Muster Roll

for Nov. 1st Dec., 1863.

Present or absent Present

Stoppage, \$ 100 for

Due Gov't, \$ 100 for

Valuation of horse, \$ 100

Valuation of horse equipments, \$ 100

Remarks:

Book mark:

J. Stearns
Copyist.

L | **2 Cav.** | **U.S.C.T.**

John Lawrence

Pvt., Co. *F*, 2 Reg't U. S. Colored Cav.

Appears on **Returns** as follows:

July 1864. Gained
July 29-64 near
Petersburg - Recruit.
Aug 1864 to Jan'y 1866.
On duty in Regt
Band.

Book mark : _____

A. H. Ellman

4 | **2 Cav.** | **U.S.C.T.**

John Thompson

112, Co. *4*, 2 Reg't U. S. Col'd Cavalry.

Appears on **Co. Muster-out Roll**, dated

December 10th, 186 .

Muster-out to date *January 1st*, 186 .

Last paid to *100*, 186 \$.

Clothing account:

Last settled....., 186 ; drawn since \$..... 100

Due soldier \$..... 100; due U. S. \$..... 100

Am't for cloth'g in kind or money adv'd \$..... 100

Due U. S. for arms, equipments, &c., \$..... 100

Bounty paid \$..... 100; due \$..... 100

Remarks: *Discharged*

April 11, 1864

Book mark: *1124 P. 21*

John Thompson
(361) Copyist.

949
Lawrence William

Co B, 2 U. S. Col'd Cav.

Private | Private

CARD NUMBERS.

1	5319802	26
2	5319878	27
3	5319992	28
4	5320981	29
5	9087328	30
6	40726293	31
7		32
8		33
9		34
10		35
11		36
12		37
13		38
14		39
15		40
16		41
17		42
18		43
19		44
20		45
21		46
22		47
23		48
24		49
25		50

Book Mark: 1072 } b. J. 1879
12 659 }

See also

L | **2 Cav. | U.S.C.T.**

William Lawrence
....., Co. *C*, 2 Reg't U. S. Col'd Cav.

Appears on
Company Descriptive Book
of the organization named above.

DESCRIPTION.

Age *25* years; height *5* feet *5* inches.
Complexion *Yellow*
Eyes *Black*; hair *Black*
Where born *Suffolk, Va*
Occupation *Laborer*

ENLISTMENT.

When *Dec 24*, 186*3*.
Where *Fort Monroe*
By whom *Geo. W. Cole*; term *3* y'rs.

Remarks: *died of wounds*
rec'd at Suffolk Va
at Powers Hill, Va. March
10th / 1864

F. B. Smith
Copyist.

L | **2 Cav.** | **U.S.C.T.**

William Lawrence
Pat, Co. C, 2 Reg't U. S. Col'd Cavalry.

Age years.

Appears on

Company Muster-in Roll

of the organization named above. Roll dated
Fort Monroe Va, Dec 24, 1863.

Muster-in to date Dec 24, 1863.

Joined for duty and enrolled:

When Dec 24, 1863

Where Fort Monroe Va

Period 3 years.

Valuation of horse, \$ 100

Valuation of horse equipments, \$ 100

Remarks:

Book mark:

Hadzill

A | **2 Cav.** | **U.S.C.T.**

William Lawrence

Pr, Co. C, 2 Reg't U. S. Col'd Cavalry.

Appears on

Company Muster Roll

for *Winter 1864*, 1864.

Present or absent *Present*

Stoppage, \$ *100* for

Due Gov't, \$ *100* for

Valuation of horse, \$ *100*

Valuation of horse equipments, \$ *100*

Remarks:

Book mark:

Hadfield

L 2 Cav. U.S.C.T.

William Lawrence
Pvt, Co. C, 2 Reg't U. S. Col'd Cavalry.

Appears on

Company Muster Roll

for Mar & Apr, 1864.

Present or absent

Stoppage, \$ 100 for

Due Gov't, \$ 100 for

Valuation of horse, \$ 100

Valuation of horse equipments, \$ 100

Remarks: Died of wounds
received in action at
Suffolk Va on the
9th March 1864

Book mark: Died March 10 1864
Orr

Hadfield

JAN. - 7

5319992

1891

L. B. 12 659 & 1072
C 5 1879

L | **2 Cav.** | **U.S.C.T.**

Mr Lawrence

Pr, Co. *C*, 2 Reg't U. S. Colored Cav.

Appears on **Returns** as follows:

*March 1864. Lost Mich.
Gettys Station.
Died from wounds
rec'd in action
reported the 14"*

Book mark :

A. J. Ellison

L | **2 Cav.** | **U.S.C.T.**

William Lawrence

Privt, Co. *C*, 2 Reg't U. S. Col'd Cavalry.

Appears on **Co. Muster-out Roll**, dated
Brazos Santiago, Tex Feb 12 1864

Muster-out to date _____, 186 .

Last paid to _____, 186 .

Clothing account:

Last settled _____, 186 ; drawn since \$ _____ 100

Due soldier \$ _____ 100; due U. S. \$ _____ 100

Am't for cloth'g in kind or money adv'd \$ _____ 100

Due U. S. for arms, equipments, &c., \$ _____ 100

Bounty paid \$ _____ 100; due \$ _____ 100

Remarks: *Joined at org'l. org.*
Died of wounds rec'd in action
at Suffolk, Va. Mar. 9/64.
Inv. of eff. & Fin. Stat.
for Mch. 31/64

Book mark: *Died Mch. 10/64, L. B*
12/659 & 1072 C.T. 1879 (over)

G. W. Chase

JAN. - 7

5320981

☆ 1891 ☆

498 . 1883

3042 / 79 P. V. 38. P. 133. 77

1147 . 1880

L. 69. Vol. 8 C. J. 1869

Lawrence, Wm.
 P, Co. B, 2 Reg't U.S. C.C.

1 Enclosures.

Bed Cards	Descriptive Lists
Burial Records	Final Statements
Certs. of Dis. for Discharge	Furloughs
C. M. Charges	Med. Des. Lists
Med. Certificates	Orders

Other papers relating to—

Admission to Hosp'l	Furlough
Casualty Sheet (Officer's)	Med. Examination
Confinement	Misc. Information
Contracts	Pay or Clothing
Death or Effects	Personal Reports
Desertions	Rank
Discharge from Hosp'l	Transfer to Hosp'l
Discharge from Service	Transfer to V. R. C.
Duty	Transportation

NARA 1293

[OFFICE ENDORSEMENT.]

War Department,

ADJUTANT GENERAL'S OFFICE,

July 15th, 1879

The Health of William Lawrence,
Private, Co. "E", 25th Reg't U.S.
Colored Cavalry, is reported as follows:

On Company Muster Roll,
For March 1864, March 9, 1864
Company Muster-out Roll,
died of wounds rec'd at Suffolk, March 9, 1864
Company Descriptive Book.

....., 1864
Company Morning Reports.

....., 1864
Soldier's Final Statement.

....., 1864
Soldier's Record of Death and Interment.

....., 1864
Soldier's Inventory of Effects.

....., 1864
Soldier's Certificate of Disability for Discharge.

....., 1864
Soldier's Individual Muster-out Roll.

....., 1864
Regimental Return.

For March, 1864, March 10, 1864
Regimental Quarterly Returns.

....., 1864
Regimental Descriptive Book.

....., 1864
By Surgeon General.

(1092.2.29) March 10, 1864
March 10, 1864, is held to be

the correct date, and the Company Muster-out
Rolls will be amended accordingly.

J. N. Mickelson
Assistant Adjutant General.

L.B. 124654 noted AS
checked

CASUALTY SHEET

No.

Wm Lawrence
Private of Company "E"

25th Regiment of U.S.C.

State Volunteers.

NATURE OF CASUALTY.

Died March 9/64

1864

CASUALTY SHEET.

Name: *Wm Lawrence*
 Rank: *Private* Company: *"C"* Regiment: *2^d*
 Arm: *U.S. Cavalry* State: _____
 Nature of Casualty: *Death*

CAUSE OF CASUALTY—(NAME OF DISEASE, &c.)

*Of wounds rec^d in
action.*

DEGREE OF DISABILITY.

BY WHOM CERTIFIED.

*Walter D. Simpson
Capt U.S. Army*

DATE OF DISCHARGE, DEATH, &c.

March 9th 1864

PLACE OF DISCHARGE, DEATH, &c.

Suffolk Va

BY WHOM DISCHARGED.

FROM WHAT SOURCE THIS INFORMATION WAS OBTAINED.

Mc Hall of Co.

REMARKS.

J. T. Lindsay

Clerk.

950
Leavitt Lewis

Co C, 2 U. S. Col'd Cav.

CARD NUMBERS.

1	26
2	27
3	28
4	29
5 See Leavitt Lewis	30
6	31
7	32
8	33
9	34
10	35
11	36
12	37
13	38
14	39
15	40
16	41
17	42
18	43
19	44
20	45
21	46
22	47
23	48
24	49
25	50

Book Mark:

See also

951

Leater George

Co K, 2 U. S. Col'd Cav.

CARD NUMBERS.

1	26
2	27
3	28
4	29
5	30
6	31
7	32
8	33
9	34
10	35
11	36
12	37
13	38
14	39
15	40
16	41
17	42
18	43
19	44
20	45
21	46
22	47
23	48
24	49
25	50

See Leater

George

Book Mark:

See also

952
Leatus George

Co K, 2 U. S. Col'd Cav.

Private Corporal

CARD NUMBERS.

1	5328252	26
2	5328334	27
3	5328420	28
4	5328507	29
5	5328589	30
6	5328679	31
7	5328770	32
8	5328856	33
9	5328941	34
10	5329033	35
11	5329120	36
12	5329207	37
13	5329292	38
14	5329335	39
15	6297965	40
16	9087945	41
17	40726296	42
18		43
19		44
20		45
21		46
22		47
23		48
24		49
25		50

Book Mark:

See also

L | 2 Cav. | U.S.C.T.

George Lecator

, Co. K, 2 Reg't U. S. Col'd Cav.

Appears on

Company Descriptive Book

of the organization named above.

DESCRIPTION.

Age 27 years; height 5 feet 6 1/4 inches.

Complexion Dark

Eyes Black; hair Black

Where born Northampton, Va.

Occupation Laborer

ENLISTMENT.

When Jan. 1, 1864.

Where Fort Monroe

By whom local levee; term 3 y'rs.

Remarks:

F. B. Smith

L. | **2 Cav.** | **U.S.C.T.**

George Lecatus

Co. K., 2 Reg't U. S. Col'd Cav.

Age 27 years.

Appears on

Company Muster-in Roll

of the organization named above. Roll dated

Port Monroe, Va. Jan. 8, 1864.

Muster-in to date

Jan. 8, 1864.

Joined for duty and enrolled:

When Jan. 1st, 1864.

Where Accomac, Va.

Period 3 years.

Valuation of horse, \$ 100

Valuation of horse equipments, \$ 100

Remarks : _____

Book mark : _____

J. E. Brooks

L. | **2 Cav.** | **U.S.C.T.**

George Lecotos
Priv., Co. K, 2 Reg't U. S. Col'd Cav.

Appears on

Company Muster Roll

for Enrollment to Feb. 29, 1864.

Present or absent Present

Stoppage, \$ 100 for

Due Gov't, \$ 100 for

Valuation of horse, \$ 100

Valuation of horse equipments, \$ 100

Remarks: Reduced from
Corpl. Feb. 1st, 1864.
Appointed Corpil.
Jan. 11th, 1864.

Book mark:

(358)

J. E. Brooks,
Copyist.

L. | 2 Cav. | U.S.C.T.

George Lecator
Cvt., Co. K, 2 Reg't U. S. Col'd Cav.

Appears on

Company Muster Roll

for Mar. & April, 1864

Present or absent Present

Stoppage, \$ 100 for

Due Gov't, \$ 100 for

Valuation of horse, \$ 100

Valuation of horse equipments, \$ 100

Remarks: Due U.S. for
Ord. \$100.

Book mark:

(358)

J. E. Brooks
Copyist.

NOV 12 12

L. | 2 Cav. | U.S.C.T.

George Lecator
Priv., Co. K, 2 Reg't U. S. Col'd Cav.

Appears on

Company Muster Roll

for May + June, 1864

Present or absent Present

Stoppage, \$ 100 for

Due Gov't, \$ 100 for

Valuation of horse, \$ 100

Valuation of horse equipments, \$ 100

Remarks:

Book mark: -----

J. E. Brooks
Copyist.

L | **2 Cav.** | **U.S.C.T.**

George Lecator
Privt., Co. K, 2 Reg't U. S. Col'd Cav.

Appears on

Company Muster Roll

for *July* v. *Aug.*, 186*4*.

Present or absent *Present*

Stoppage, \$ *100* for

Due Gov't, \$ *100* for

Valuation of horse, \$ *100*

Valuation of horse equipments, \$ *100*

Remarks: *Due to U.S. for*
ord. # 2. 68.

Book mark:

J. M. Kennedy

L | **2 Cav.** | **U.S.C.T.**

George Locator
Privt., Co. K, 2 Reg't U. S. Col'd Cav.

Appears on

Company Muster Roll

for *Sept. 11, Oct.*, 186*4*.

Present or absent *Present*

Stoppage, \$.....100 for

Due Gov't, \$.....100 for

Valuation of horse, \$.....100

Valuation of horse equipments, \$.....100

Remarks:.....

Book mark:.....

J. M. Kennedy
Copyist.

L | 2 Cav. | U.S.C.T.

George Lecator
Privt, Co. K, 2 Reg't U. S. Col'd Cav.

Appears on

Company Muster Roll

for Nov. & Dec, 1864.

Present or absent Present

Stoppage, \$ 100 for

Due Gov't, \$ 100 for

Valuation of horse, \$ 100

Valuation of horse equipments, \$ 100

Remarks:

Book mark:

D. M. Kennedy

L | **2 Cav.** | **U.S.C.T.**

Geo. Lecator

Privt., Co. K, 2 Reg't U. S. Col'd Cav.

Appears on

Company Muster Roll

for *Jan. & Feb.*, 186 *5*

Present or absent *Present.*

Stoppage, \$ *100* for

Due Gov't, \$ *100* for

Valuation of horse, \$ *100*

Valuation of horse equipments, \$ *100*

Remarks:

Book mark:

J. M. Kennedy

(358)

Copyist.

L | **2 Cav.** | **U.S.C.T.**

Geo. Lecator

Private, Co. K, 2 Reg't U. S. Col'd Cav.

Appears on

Company Muster Roll

for Mar. & Apr., 1865.

Present or absent Present

Stoppage, \$ 100 for

Due Gov't, \$ 100 for

Valuation of horse, \$ 100

Valuation of horse equipments, \$ 100

Remarks: _____

Book mark: _____

(358) Keefe Copyist.

L

2 Cav.

U.S.C.T.

George Lesatur

Private, Co. K, 2 Reg't U. S. Col'd Cav.

Appears on

Company Muster Roll

for *May & June*, 1865.

Present or absent *Present*

Stoppage, \$ 100 for

Due Gov't, \$ 100 for

Valuation of horse, \$ 100

Valuation of horse equipments, \$ 100

Remarks:

Book mark:

Keeper

L | **2 Cav.** | **U.S.C.T.**

George Lecator
Private, Co. K, 2 Reg't U. S. Col'd Cav.

Appears on

Company Muster Roll

for July & Aug., 1868.

Present or absent Present

Stoppage, \$ 100 for

Due Gov't, \$ 100 for

Valuation of horse, \$ 100

Valuation of horse equipments, \$ 100

Remarks:

Book mark: -----

Keeper
Copyist.

L | **2 Cav.** | **U.S.C.T.**

George Lecater
Plt, Co. K, 2 Reg't U. S. Col'd Cav.

Appears on

Company Muster Roll

for *Sept & Oct*, 1865.

Present or absent *Present*

Stoppage, \$ 100 for

Due Gov't, \$ 100 for

Valuation of horse, \$ 100

Valuation of horse equipments, \$ 100

Remarks:

Book mark:

(358)

S. Bureau

Copyist.

L | **2 Cav.** | **U.S.C.T.**

George Scatter
Pol, Co. K, 2 Reg't U. S. Col'd Cav.

Appears on

Company Muster Roll

for *Nov & Dec*, 1865.

Present or absent. *Absent*

Stoppage, \$ 100 for

Due Gov't, \$ 100 for

Valuation of horse, \$ 100

Valuation of horse equipments, \$ 100

Remarks: *Detached per S. O. No. 107 Hd qrs 3^d Div. 25th A.C. Oct 18. 1865*

Book mark:

S. Duncan

L. | 2 Car. | U.S.C.T.

George Lecatur

Ch., Co. K, 2 Reg't U. S. Col'd Inf.

Appears on a

Detachment Muster Roll

of the organization named above

for Nov & Dec, 1865.

Station

Present or absent

Present

Stoppage, \$ 100 for

Due Gov't, \$ 100 for

Remarks:

Detailed per S.O. # 107 & Co. Hd. Qrs Part of Brazos

Book mark:

Atch

L | **2 Cav.** | **U.S.C.T.**

Gen. Leaton

Co. K., 2 Reg't U. S. Colored Cav.

Appears on **Returns** as follows:

Sept + Oct 1865 - On
duty - Orderly for
Co-Commander
Nov + Dec 1865. Absent
Orderly at Hd Qrs
3 Dir per S.O. No. 107
Hd Qrs. 3 Dir. 25-26
Oct 1865.

Book mark :

M. E. Kelly

L | **2 Cav.** | **U.S.C.T.**

George Lecater
Coupl, Co. K, 2 Reg't U. S. Col'd Cavalry.

Appears on **Co. Muster-out Roll**, dated
Brazos Santiago Tex, Feb 12, 1866.
Muster-out to date Feb 12, 1866.
Last paid to June 30, 1865.

Clothing account:

Last settled....., 186 ; drawn since \$..... 100
Due soldier \$..... 100; due U. S. \$ 22/100
Am't for cloth'g in kind or money adv'd \$..... 100

Due U. S. for arms, equipments, &c., \$..... 100
Bounty paid \$..... 100; due \$ 300/100

Remarks: joined at Regt Argn
Prvt till Jan 1. 66 then Coupl
free before Apl 19. 61

Book mark :

S. Linnan

Lecatur George

P, Co. C., 2 Regt U. S. C. Cav.

2 Enclosures.

Bed Cards	Descriptive Lists
Burial Records	Final Statements
Certs. of Dis. for Discharge	Furloughs
C. M. Charges	Med. Des. Lists
Med. Certificates	Orders 2

Other papers relating to—

Admission to Hosp'l	Furlough
Casualty Sheet (Officer's)	Med. Examination
Confinement	Misc. Information
Contracts	Pay or Clothing
Death or Effects	Personal Reports
Desertions	Rank
Discharge from Hosp'l	Transfer to Hosp'l
Discharge from Service	Transfer to V. R. C.
Duty	Transportation

Adj Gen Post of Brazos
Santiago Jan. 9. 1864

Special Orders No 4 #1

Relieves from duty at
said Regt of 1.

To Wm G. Leander

Co 2nd Regt

Headquarters Post of Brazos Santiago, Texas,

January 7th 1860

Special Orders,)

No. 4

Extract.

I. " " The following names enlisted may be hereby
 relieved from duty at these Headquarters and will report to the
 Comdg. Officer of his Regiment in order to receive promotions.
 Private George Martin B. K. P. H. J. & Co.

x

x

x

By order of ~~Brig. Gen. W. T. Clark~~ Brigadier Genl. Geo W. Cole

Walter D. Burson

c. o 22 U. S. A. C.

Thro' c. o 1st Regt.

Capt. 2^d U. S. A. C.
& Actg. Assistant Adjutant General.

George Lecatur

P. R. 2nd M. S. C. C.

Order

E. S.

Head Quarters Fort Bragg
January 7, 1866

Special Orders 3
W H Extract.

+ + +
1. The following named enlisted
man is hereby relieved from duty at these
Head Quarters and will report to the Command
Officer of his Regiment in order to receive
promotion.

+ + +
Priv George Deaton W. R. H. Co.



By order of Col. Brig Genl A. W. Cole

Official Walter Thomas
William H. Cook Capt 2nd Reg
S. I. Estabrook and Adjt

C. O. C. G.

2953
Lee Ole

Co H, 2 U. S. Col'd Cav.

Private | Private

CARD NUMBERS.

1	5315468	26
2	5325967	27
3	5326008	28
4	5326096	29
5	5326182	30
6	5326306	31
7	5326380	32
8	5326462	33
9	5326544	34
10	5326628	35
11	5326707	36
12	5326787	37
13	5326859	38
14	5326931	39
15	31633588	40
16	31635245	41
17	31636228	42
18	31636678	43
19	40726297	44
20		45
21		46
22		47
23		48
24		49
25		50

Book Mark:

See also

NARRA 1231

L | 2 Cav | U.S.C.T.

Eli Lee

Priv., Co., 2 Reg't U. S. Col'd. Cav

Age years.

Appears on a

Detachment Muster-in Roll

of the organization named above. Roll dated

Fort Monroe, Va, Feb 8, 1864.

Muster-in to date Feb 8, 1864.

Joined for duty and enrolled:

When Feb 1, 1864.

Where Fort Monroe, Va.

Period 3 years.

Valuation of horse, \$.....100

Valuation of horse equipments, \$.....100

Remarks:.....

.....

.....

.....

.....

Book mark :.....

.....

W Beck
Copied.

L | **2 Cav.** | **U.S.C.T.**

Eli Lee

Priv, Co. H, 2 Reg't U. S. Col'd Cavalry.

Appears on

Company Muster Roll

for *From date of Enrollment to Feb 29*, 1864 .

Present or absent *Present*

Stoppage, \$ *100* for

Due Gov't, \$ *100* for

Valuation of horse, \$ *100*

Valuation of horse equipments, \$ *100*

Remarks:

Book mark:

A. J. Anderson

L | **2 Cav.** | **U.S.C.T.**

Eli Lee

Comp., Co. II, 2 Reg't U. S. Col'd Cavalry.

Appears on

Company Muster Roll

for *March & April*, 1864.

Present or absent *Present*

Stoppage, \$ *100* for

Due Gov't, \$ *100* for

Valuation of horse, \$ *100*

Valuation of horse equipments, \$ *100*

Remarks: *Septth Comp. April 1864 per S.O.
No 10 letth yrs. 2 U.S. le. leave*

Book mark:

A. J. Anderson

3 | **2 Cav.** | **U.S.C.T.**

Eli See

Comp., Co. H, 2 Reg't U. S. Col'd Cavalry.

Appears on

Company Muster Roll

for *May & June*, 1864.

Present or absent *Absent*

Stoppage, \$ 100 for

Due Gov't, \$ 100 for

Valuation of horse, \$ 100

Valuation of horse equipments, \$ 100

Remarks: *Absent sick in Genl Hospital.*

Book mark: _____

A J Anderson

L | **2 Cav.** | **U.S.C.T.**

Ch. Lee

Corp, Co. H, 2 Reg't U. S. Col'd Cavalry.

Appears on

Company Muster Roll

for *May 1 " to Sep. 1 "*, 1864.

Present or absent *Absent*

Stoppage, \$ 100 for

Due Gov't, \$ 100 for

Valuation of horse, \$ 100

Valuation of horse equipments, \$ 100

Remarks: *Absent sick in
Genl. Hospital*

Book mark:

W. B. Ferguson

L | 2 car. | Ab SCG

Elia Lee

Capt., Co H, 2 Reg't U S C

Appears on

Hospital Muster Roll

of **Summit House U. S. A. General Hospital,**

at **Philadelphia, Pa.,**

for July & Aug, 1864

Attached to hospital:

When _____, 1864

How employed _____

Last paid by Maj. _____

to _____, 1864

Bounty paid \$ 100, due \$ 100

Present or absent Present

Remarks: _____

Book mark: _____

(343)

J Underwood

Copyist.

L | **2 Cav.** | **U.S.C.T.**

Oli Lee

Priv, Co. H, 2 Reg't U. S. Col'd Cavalry.

Appears on

Company Muster Roll

for *Sept & Oct*, 1864.

Present or absent *Absent*

Stoppage, \$ *100* for

Due Gov't, \$ *100* for

Valuation of horse, \$ *100*

Valuation of horse equipments, \$ *100*

Remarks: *Redu to Ranko*
Absent sick in
Genl Hoapt.

Book mark:

H. P. Ferguson

L | 2 Cav | Use

Eli Lee

Corpl, Co. H, 2 Reg't US Caval

Appears on

Hospital Muster Roll

of Summit House U. S. A. General Hospital,

at Philadelphia, Pa.,

for Sep Oct, 1864

Attached to hospital:

When....., 186 .

How employed.....

Last paid by Maj.

to Aug 31, 1864

Bounty paid \$ 100; due \$ 100

Present or absent Present

Remarks: Mustered for
Sep Oct 1864

Ward 4

Book mark:

J. M. Humphrey

L | **2 Cav.** | **U.S.C.T.**

Oli Lee

Priv, Co. H, 2 Reg't U. S. Col'd Cavalry.

Appears on

Company Muster Roll

for *Nov. & Dec.*, 186 *4*.

Present or absent *Absent*

Stoppage, \$ *100* for

Due Gov't, \$ *100* for

Valuation of horse, \$ *100*

Valuation of horse equipments, \$ *100*

Remarks: *Absent sick in Genl. Hospital*

Book mark:

W. B. Ferguson

(358)

Copyist.

L | *2 Cav. U.S.C.P.*

Eli Lee

Co. H, 2 Reg't U.S.C. Cav.

Appears on

Hospital Muster Roll

of **Summit House U. S. A. General Hospital,**

at **Philadelphia, Pa.,**

for *Nov 12*, 186*4*.

Attached to hospital:

When *Aug 17*, 186*4*.

How employed _____

Last paid by Maj. _____

to *Aug 31*, 186*4*.

Bounty paid \$ 100; due \$ 100

Present or absent *present*

Remarks: *Mustered to 1
Sept., Oct., Nov., and
Dec. '64.*

None

Book mark: _____

Calder

G | **2 Cav.** | **U.S.C.T.**

Oli Lee

Priv, Co. H, 2 Reg't U. S. Col'd Cavalry.

Appears on

Company Muster Roll

for *Jan. & Feb.*, 1865.

Present or absent *Absent*

Stoppage, \$ *100* for

Due Gov't, \$ *100* for

Valuation of horse, \$ *100*

Valuation of horse equipments, \$ *100*

Remarks: *Absent sick in
A.H. Place unknown*

Book mark: *...*

W. P. Ferguson

L. | L. Cav. | U. S. A.

Chas Lee

Capt., Co. H, 2 Reg't U. S. A. Cav.

Appears on

Hospital Muster Roll

of Summit House U. S. A. General Hospital,

at Philadelphia, Pa.,

for Jan. & Feb., 1865.

Attached to hospital:

When Aug. 17, 1864

How employed _____

Last paid by Maj. Stryker

to Dec. 31, 1864

Bounty paid \$ 100; due \$ 100

Present or absent _____

Remarks: Returned to duty
Feb. 8/65.

Book mark: _____

A. L. ...

L | 2 Cav. | U.S.C.T.

Eli Lee

Private, Co. H, 2 Reg't U. S. Col'd Cavalry.

Appears on

Company Muster Roll

for March and April, 1865.

Present or absent. Absent

Stoppage, \$ 100 for

Due Gov't, \$ 100 for

Valuation of horse, \$ 100

Valuation of horse equipments, \$ 100

Remarks: Dismissed Camp, Petersburg, Va.

Book mark:

Ch. Jewell

L | 2 Cav. | U.S.C.T.

Eli Lee

Private, Co. H, 2 Reg't U. S. Col'd Cavalry.

Appears on

Company Muster Roll

for May and June, 1865.

Present or absent Present

Stoppage, \$ 100 for

Due Gov't, \$ 100 for

Valuation of horse, \$ 100

Valuation of horse equipments, \$ 100

Remarks:

Book mark:

C. J. Powell

L | 2 Cav. | U.S.C.T.

Eli Lee

Present, Co. H, 2 Reg't U. S. Col'd Cavalry.

Appears on

Company Muster Roll

for July and Aug., 1865.

Present or absent absent

Stoppage, \$ 100 for

Due Gov't, \$ 100 for

Valuation of horse, \$ 100

Valuation of horse equipments, \$ 100

Remarks:

absent sick in Hospital.

Book mark:

C. Powell

NA 991246

L | **2 Cav.** | **U.S.C.T.**

Eli Lee

Pat, Co. H, 2 Reg't U. S. Col'd Cavalry.

Appears on

Company Muster Roll

for *Sep & Oct*, 186*5*.

Present or absent *Present*

Stoppage, \$ *100* for

Due Gov't, \$ *100* for

Valuation of horse, \$ *100*

Valuation of horse equipments, \$ *100*

Remarks:

Book mark:

W. A. Kelly
Copyist.

L | **2 Cav.** | **U.S.C.T.**

Eli Lee

Pat, Co. H, 2 Reg't U. S. Col'd Cavalry.

Appears on

Company Muster Roll

for *Nov & Dec*, 1865.

Present or absent *Present*

Stoppage, \$ *100* for

Due Gov't, \$ *100* for

Valuation of horse, \$ *100*

Valuation of horse equipments, \$ *100*

Remarks: *Back pay due for months of May, June, July, Aug, Sep, Oct, Nov, Dec 64.*

Book mark:

W. H. H. H.
Copyist.

L | 2 Cav. | U. S. C. T.

Eli Lee

Priv., Co. H, 2 Reg't U. S. Col'd Cav.
Corpl

Appears on Returns as follows:

Feb'y 1864 Priv. Feb'y 8, Fort
Monroe, Recruit

Apr 1864. Apr. 1 Ballyhack Station,
Va. Promoted corpl

June 1864 (Corpl) Absent sick in
Gen Hosp Pt Rocks, Va. since
June 25/64

July to Sept. 1864. Absent sick in Gen
Hosp since June 25/64

Oct 1864 to Jan'y 1865 (Priv) Absent
sick in Gen Hosp

July 1865 On duty as Cook

Aug 1865 Absent sick in Hosp

Oct 1865 to Jan'y 1866. On duty in
2. M. Dept as Carpenter

Book mark:

S. J. Spurrall

2 Cav. U.S.C.T.

Eli Lee

Plt, Co. *H*, 2 Reg't U. S. Col'd Cavalry.

Appears on **Co. Muster-out Roll**, dated

Brazos Santiago Tex Feb 12, 1865.

Muster-out to date *Feb 12*, 1866.

Last paid to *June 30*, 1865.

Clothing account:

Last settled....., 186 ; drawn since \$..... 100

Due soldier \$ *17* ^{*29*}/₁₀₀; due U. S. \$..... 100

Am't for cloth'g in kind or money adv'd \$..... 100

Due U. S. for arms, equipments, &c., \$..... 100

Bounty paid \$..... 100; due \$ *300* 100

Remarks: *joined at orig regⁿ*
was Private to Jan 8/64 then
Com Srgt to Sep 19/64 when
reduced to ranks.
Free before April 19/61

Book mark :

Wm D. Hill
 Copyist.

2 Cav.

Lee, Eli.

Co. N, 1st Reg't U.S.C.

Enclosures.

Bed Cards	Descriptive Lists
Burial Records	Final Statements
Certs. of Dis. for Discharge	Furloughs
C. M. Charges	Med. Des. Lists
Med. Certificates	Orders

Other papers relating to—

Admission to Hosp'l	Furlough
Casualty Sheet (Officer's)	Med. Examination
Confinement	Misc. Information
Contracts	Pay or Clothing
Death or Effects	Personal Reports
Desertions	Rank
Discharge from Hosp'l	Transfer to Hosp'l
Discharge from Service	Transfer to V. R. C.
Duty	Transportation

Hospital Number 3558 327

Name Eli Lee

Age 40 Nativity North Carolina

Married or Single Married 44.

Residence Lenoir Co. N.C.

Post Office address of wife or nearest relative. } Eliza Davis (Wife) Newbern N.C.

Rank Capt. Co. H. Regiment 23rd Me.

When admitted Aug 24th 1864

From what source 1st Ward

Diagnosis: (in surgical cases state explicitly seat and character of wound or injury.)

Amputation

Summit House G. H. Philadelphia, Pa.

On what occasion wounded.....

Date.....

Nature of missile or weapon.....

TREATMENT.

[HERE NOTE IMPORTANT COMPLICATIONS AND ALL OPERATIONS.]

Lumbriculi.

RESULT AND DATE.

Transferred to ward 5 Dec 16/63, W. W. Shapley
Returned to duty. A. A. S. J. G. A.
Feb. 8th 1865. G. A. Miller
A. A. S. J. G. A.

954

Lee George

Co I, 2 U. S. Col'd Cav.

Private | *Private*

CARD NUMBERS.

1	5315744	26
2	5327107	27
3	5327194	28
4	5327283	29
5	5327396	30
6	5328216	31
7	9087828	32
8	40726298	33
9		34
10		35
11		36
12		37
13		38
14		39
15		40
16		41
17		42
18		43
19		44
20		45
21		46
22		47
23		48
24		49
25		50

Book Mark:

See also

2 Cav. | U.S.C.T.

George Lee

, Co. D, 2 Reg't U. S. Col'd Cav.

Appears on

Company Descriptive Book

of the organization named above.

DESCRIPTION.

Age 27 years; height 5 feet 5 inches.

Complexion Dark

Eyes Black; hair Black

Where born Newbern N. C.

Occupation Farmer

ENLISTMENT.

When Jan. 10, 1864.

Where Fort Monroe, Va.

By whom Col. Cole; term 3 y'rs.

Remarks: Deserted
Aug. 23, 1864, near
Deep Bottom, Va.

F. B. Smith

L. | 2 Cav. | U.S.C.T.

George Lee

Co., Co. 2 Reg't U. S. Col'd Cav.

Age _____ years.

Appears on a

Detachment Muster-in Roll .

of unattached recruits
of the organization named above. Roll dated

Fort Monroe, Va, Jan. 17, 1864.

Muster-in to date Jan. 17, 1864.

Joined for duty and enrolled:

When Jan. 10, 1864.

Where Fort Monroe, Va

Period 3 years.

Valuation of horse, \$ 100

Valuation of horse equipments, \$ 100

Remarks : _____

Book mark : _____

J. J. Kearney
Cpyist.

L | **2 Cav.** | **U.S.C.T.**

George Lee
Private, Co. I, 2 Reg't U. S. Col'd Cavalry.

Appears on

Company Muster Roll

for Enrollment to Feb 29 1864

Present or absent Present

Stoppage, \$ 100 for

Due Gov't, \$ 100 for

Valuation of horse, \$ 100

Valuation of horse equipments, \$ 100

Remarks:

Book mark: -----

P. A. Ward

L | **2 Cav.** | **U.S.C.T.**

George Lee
Private

Co. I, 2 Reg't U. S. Col'd Cavalry.

Appears on

Company Muster Roll

for *Mar & Apr*, 1864.

Present or absent *Present*

Stoppage, \$ 100 for

Due Gov't, \$ 100 for

Valuation of horse, \$ 100

Valuation of horse equipments, \$ 100

Remarks:

Book mark:

P. A. Ward

L | **2 Cav.** | **U.S.C.T.**

George Lee
Pvt, Co. I, 2 Reg't U. S. Col'd Cavalry.

Appears on

Company Muster Roll

for *May & June*, 1864.

Present or absent *Present*

Stoppage, \$ *100* for

Due Gov't, \$ *100* for

Valuation of horse, \$ *100*

Valuation of horse equipments, \$ *100*

Remarks:

Book mark: -----

O. A. Ward
(358) Copyist.

L | **2 Cav.** | **U.S.C.T.**

George Lee

M Co. I, 2 Reg't U. S. Col'd Cavalry.

Appears on

Company Muster Roll

for *July & Aug*, 186*7*.

Present or absent

Stoppage, \$ *100* for

Due Gov't, \$ *100* for

Valuation of horse, \$ *100*

Valuation of horse equipments, \$ *100*

Remarks: *Deserted Aug. 22, 64*
in the field Va near
Petersburg Va. Due U.S.
for Ordnance, Revolver
\$14.95

Book mark:

W. Smith

L | **2 Cav.** | **U.S.C.T.**

Geo. Lee

Pr., Co. *D*, 2 Reg't U. S. Colored Cav.

Appears on **Returns** as follows:

Aug 1864. Loss
Aug. 22/64 near
Petersburg -
Deserted -

Book mark :

A. H. Collins

L. | 2 Cav. | U.S.C.T.

George Lee

Priv, Co. *B*, 2 Reg't U. S. Col'd Cavalry.

Appears on **Co. Muster-out Roll**, dated
Brazos Santiago Tex Feb. 12, 1866.

Muster-out to date _____, 186 .

Last paid to _____, 186 .

Clothing account:

Last settled _____, 186 ; drawn since \$ _____ 100

Due soldier \$ _____ 100; due U. S. \$ _____ 100

Am't for cloth'g in kind or money adv'd \$ _____ 100

Due U. S. for arms, equipments, &c., \$ _____ 100

Bounty paid \$ _____ 100; due \$ _____ 100

Remarks: *joined at org orgz Pt.
from enlistment. Deserted
Aug. 23-69 at Duff Bot-
tom va. Descriptive list
forwarded Sept. 30-1869.*

Book mark: _____

Pol

955
Lee Masses

Co F, 2 U. S. Col'd Cav.

Private | *Private*

CARD NUMBERS.

1	5323397	26
2	5323468	27
3	5323557	28
4	5323638	29
5	5323726	30
6	5323819	31
7	5323913	32
8	5324001	33
9	5324090	34
10	5324183	35
11	5324279	36
12	5324409	37
13	5324602	38
14	9087604	39
15	40726294	40
16		41
17		42
18		43
19		44
20		45
21		46
22		47
23		48
24		49
25		50

Book Mark:

See also

L | 2 Cav. | U.S.C.T.

Moses Lee

....., Co. F, 2 Reg't U. S. Col'd Cav.

Appears on

Company Descriptive Book

of the organization named above.

DESCRIPTION.

Age 21 years; height 5 feet 6 inches.

Complexion dark

Eyes dark; hair dark

Where born Warren Miss

Occupation Farm

ENLISTMENT.

When Dec 24, 1863.

Where Fort Mon.

By whom Col. Cole; term 3 y'rs.

Remarks: Died at White Ranch Texas on the 3 of Sept 1865.

F. B. Smith

a | **2 Cav.** | **U.S.C.T.**

William Lee

Co. 1, Co., 2 Reg,t U. S. Col'd Cavalry.

Age *21* years.

Appears on

Company Muster-in Roll

of the organization named above. Roll dated

Fort Monroe Va, Dec 31, 1863.

Muster-in to date *Dec 31*, 1863.

Joined for duty and enrolled:

When *Dec 24*, 1863 .

Where *Fort Monroe Va*

Period *3* years.

Valuation of horse, \$ *100*

Valuation of horse equipments, \$ *100*

Remarks :

Book mark :

Wm Lee

2 Cav. | U.S.C.T.

John A. ...

..., Co. F, 2 Reg't U. S. Col'd Cavalry.

Appears on

Company Muster Roll

for *...*, 186*...*

Present or absent *...*

Stoppage, \$ 100 for *...*

Due Gov't, \$ 100 for *...*

Valuation of horse, \$ 100

Valuation of horse equipments, \$ 100

Remarks: *...*

Book mark: *...*

F. J. ...

a | **2 Cav.** | **U.S.C.T.**

Mass Lee

pt, Co. F, 2 Reg't U. S. Col'd Cavalry.

Appears on

Company Muster Roll

for *March & April*, 186*4*

Present or absent *present*

Stoppage, \$ *100* for

Due Gov't, \$ *100* for

Valuation of horse, \$ *100*

Valuation of horse equipments, \$ *100*

Remarks:

Book mark:

H. J. ...

a | **2 Cav.** | **U.S.C.T.**

Pass fee

100, Co. F, 2 Reg't U. S. Col'd Cavalry.

Appears on

Company Muster Roll

for *May + June*, 186*4*

Present or absent *present*

Stoppage, \$ *100* for

Due Gov't, \$ *100* for

Valuation of horse, \$ *100*

Valuation of horse equipments, \$ *100*

Remarks: *Due 100 for the
nose band & the pair
spurs & straps 52 52*

Book mark:

H. C. Green

1 | **2 Cav. | U.S.C.T.**

Moses Lee

Lee, Co. F, 2 Reg't U. S. Col'd Cavalry.

Appears on

Company Muster Roll

for *July & Aug.*, 186*4*.

Present or absent *Present*

Stoppage, \$ *100* for

Due Gov't, \$ *100* for

Valuation of horse, \$ *100*

Valuation of horse equipments, \$ *100*

Remarks: *Stoppage 100
bag \$150 1 pair spurs
& straps 5.20*

Book mark:

J. S. Paul

L | **2 Cav.** | **U.S.C.T.**

Moses Lee

Priv., Co. F, 2 Reg't U. S. Col'd Cavalry.

Appears on

Company Muster Roll

for Sept. & Oct., 1864.

Present or absent Present

Stoppage, \$ 100 for

Due Gov't, \$ 100 for

Valuation of horse, \$ 100

Valuation of horse equipments, \$ 100

Remarks:

Book mark: -----

(358)

J. H. Paul,
Copyist.

L. | **2 Cav.** | **U.S.C.T.**

Moses L. Lee

Private, Co. F, 2 Reg't U. S. Col'd Cavalry.

Appears on

Company Muster Roll

for *Nov. & Dec.*, 1864.

Present or absent *Present*

Stoppage, \$ *100* for

Due Gov't, \$ *100* for

Valuation of horse, \$ *100*

Valuation of horse equipments, \$ *100*

Remarks:

Book mark:

(358)

J. H. Paul

Copyist.

L. | **2 Cav.** | **U.S.C.T.**

Moses Lee

Priv., Co. F, 2 Reg't U. S. Col'd Cavalry.

Appears on

Company Muster Roll

for *Jan. & Feb.*, 186*5*.

Present or absent *Not stated*

Stoppage, \$.....100 for

Due Gov't, \$.....100 for

Valuation of horse, \$.....100

Valuation of horse equipments, \$.....100

Remarks:

.....
.....
.....
.....
.....
.....
.....
.....
.....
.....

Book mark:

J. S. Paulle

L | 2 Cav. | U.S.C.T.

Moses Lee

Pvt, Co. F, 2 Reg't U. S. Col'd Cavalry.

Appears on

Company Muster Roll

for Mar & Apr, 1865.

Present or absent Present

Stoppage, \$ 100 for

Due Gov't, \$ 100 for

Valuation of horse, \$ 100

Valuation of horse equipments, \$ 100

Remarks:

Book mark:

Saw

L | **2 Cav.** | **U.S.C.T.**

Moses Lee

Plt, Co. F, 2 Reg't U. S. Col'd Cavalry.

Appears on

Company Muster Roll

for *May & June*, 1865.

Present or absent *Present*

Stoppage, \$ *100* for

Due Gov't, \$ *100* for

Valuation of horse, \$ *100*

Valuation of horse equipments, \$ *100*

Remarks:

Book mark:

James

L | 2 Cav. | U.S.C.T.

Moses Lee

Bot, Co. F, 2 Reg't U. S. Col'd Cavalry.

Appears on

Company Muster Roll

for July & Aug, 1865.

Present or absent Present

Stoppage, \$ 100 for

Due Gov't, \$ 100 for

Valuation of horse, \$ 100

Valuation of horse equipments, \$ 100

Remarks:

Book mark:

Sams

L | **2 Cav. | U.S.C.T.**

Moses Lee

Priv., Co. F, 2 Reg't U. S. Col'd Cavalry.

Appears on

Company Muster Roll

for *Sept. + Oct.*, 186*5*.

Present or absent.....

Stoppage, \$.....100 for.....

Due Gov't, \$.....100 for.....

Valuation of horse, \$.....100

Valuation of horse equipments, \$.....100

Remarks: *Died in Camp*
Sept 2, 1865.

Book mark:.....

A. Stearns
Copyist.

L | 2 Cav. | U.S.C.T.

Moses Lea.

Pr., Co. F., 2 Reg't U. S. Colored Cav.

Appears on Returns as follows:

Sept 1865. Lost
Sept-2. Died in
Camp at White
Ranch, Tex.

Book mark :

A. H. Ellison

L. J. Davis | **U. S. C. T.**

John Lee

Co. A, 2 Reg't U. S. Col'd *Tex.*

Appears on **Co. Muster-out Roll**, dated
Benjamin's Texas, Feb. 12, 186*4*.

Muster-out to date -----, 186 .

Last paid to -----, 186 .

Clothing account:

Last settled -----, 186 ; drawn since \$ ----- 100

Due soldier \$ ----- 100; due U. S. \$ ----- 100

Am't for cloth'g in kind or money adv'd \$ ----- 100

Due U. S. for arms, equipments, &c., \$ ----- 100

Bounty paid \$ ----- 100 due \$ ----- 100

Remarks: *✓* *rec'd at original*
org. Dred at White's Ranch
Tex. Sept. 2/65 final Statement
& Inventory of effects forwarded
Sept 12/65

Book mark: *V. 81. P. 85/69*
(over)

J. H. Davis

NO 1270

JAN. - 7

5324602

1891 *

V. 243. P. 26. 77.
P-V. 4. P. 110. /68

Lea, Moses
P., Co. *F.*, *2* Reg't *U. S. C.*

Enclosures.

Bed Cards	Descriptive Lists
Burial Records	Final Statements
Certs. of Dis. for Discharge	Furloughs
C. M. Charges	Med. Des. Lists
Med. Certificates	Orders

Other papers relating to—

Admission to Hosp'l	Furlough
Casualty Sheet (Officer's) /	Med. Examination
Confinement	Misc. Information
Contracts	Pay or Clothing
Death or Effects	Personal Reports
Desertions	Rank
Discharge from Hosp'l	Transfer to Hosp'l
Discharge from Service	Transfer to V. R. C.
Duty	Transportation

App. sent to for the Co. C. Apr 27, 1866

W

CASUALTY SHEET.

No.

Moses Lew

Driver of Company F

2 Regiment of N York

State Volunteers.

NATURE OF CASUALTY.

Wounded in action
Sept 21 1865

CASUALTY SHEET.

Name: *Moses Lea*

Rank: *Ser* Company: *G* Regiment: *2^d*

Arm: *U.S. Army* State: _____

Nature of Casualty: *Death*

CAUSE OF CASUALTY—(NAME OF DISEASE, &C.)

Disease

BY WHOM DISCHARGED.

FROM WHAT SOURCE THIS INFORMATION WAS OBTAINED.

*Atty Gen Sec of War's
Sept 30th 1865*

DEGREE OF DISABILITY.

BY WHOM CERTIFIED.

*Frank P. White
Lt Col*

REMARKS.

DATE OF DISCHARGE, DEATH, &c.

Sept 2^d 1865

PLACE OF DISCHARGE, DEATH, &c.

In Camp

B.D. Cole

Clerk.

955 1/2

Lee Samuel
Co D, 2 U.S. Col'd Troops. ^{Cav.}

Prvt.

Prvt.

CARD NUMBERS.

1	5315914	26
2	5321625	27
3	5321724	28
4	5321826	29
5	5321928	30
6	5322017	31
7	5322105	32
8	9087405	33
9	40726300	34
10		35
11		36
12		37
13		38
14		39
15		40
16		41
17		42
18		43
19		44
20		45
21		46
22		47
23		48
24		49
25		50

Number of personal papers herein.....

Book Mark:

See also

L | 2 Cav. | U.S.C.T.

* Samuel Lee

....., Co. D, 2 Reg't U. S. Col'd Cav.

Appears on

Company Descriptive Book

of the organization named above.

DESCRIPTION.

Age / 8 years; height feet inches.

Complexion

Eyes; hair

Where born

Occupation

ENLISTMENT.

When, 186 .

Where

By whom; term y'rs.

Remarks:

.....

* No description given

F. B. Smith

S | **2 Cav.** | **U.S.C.T.**

Samuel See

Not, Co. D, 2 Reg't U. S. Col'd Cavalry.

Appears on

Company Muster Roll

for *May & June*, 1865.

Present or absent *Present*

Stoppage, \$ *100* for

Due Gov't, \$ *100* for

Valuation of horse, \$ *100*

Valuation of horse equipments, \$ *100*

Remarks: *Recruit from Depot*

Book mark:

S. W. Hillard

(358)

Copyist.

S | **2 Cav.** | **U.S.C.T.**

Samuel Lee
Pat, Co. D, 2 Reg't U. S. Col'd Cavalry.

Appears on

Company Muster Roll

for *March & April*, 1865.

Present or absent *Present*

Stoppage, \$ *100* for

Due Gov't, \$ *100* for

Valuation of horse, \$ *100*

Valuation of horse equipments, \$ *100*

Remarks: *Recruit from Depot*

Book mark:

S. W. Hillen

S | *2 Cav* | **U.S.C.T.**

Samuel See

Appears with rank of *Private* on

Muster and Descriptive Roll of a Detachment of Substitutes forwarded

for the *2* Reg't U. S. Col'd *Cav* Roll dated

Chelton Hills, Pa., Mar. 23, 1865.

Where born *Pa.*

Age *17* y'rs; occupation *Saboteur*

When enlisted _____, 186 .

Where enlisted _____

For what period enlisted *1* years.

Eyes *Blk*; hair *Curly*

Complexion *Col'd*; height *5* ft. in.

When mustered in *Feb. 13*, 186*5*.

Where mustered in *Harrisburg, 14th Dist, Pa.*

Bounty paid \$ *100*; due \$ *100*

Where credited *Harrisburg, 2nd Ward, Pa., 4th Sub Dist, 14th Cong. Dist.*
Company to which assigned _____

Remarks: _____

Book mark: _____

J. C. Taylor

L | **2 Cav. U.S.C.T.**

Samuel Lee
Private, Co. D, 2 Reg't U. S. Col'd Cavalry.

Appears on

Company Muster Roll

for Sept & Oct, 1865.

Present or absent Present

Stoppage, \$ 100 for -

Due Gov't, \$ 100 for -

Valuation of horse, \$ 100

Valuation of horse equipments, \$ 100

Remarks:
.....
.....
.....
.....
.....
.....
.....
.....
.....

Book mark:

(358) S W Forrest
Copyist.

L | **2 Cav.** | **U.S.C.T.**

Samuel Lee
M....., Co. D, 2 Reg't U. S. Col'd Cavalry.

Appears on

Company Muster Roll

for *Nov & Dec*....., 186 *5*.

Present or absent *Present*.....

Stoppage, \$..... *100* for.....

Due Gov't, \$..... *100* for.....

Valuation of horse, \$..... *100*

Valuation of horse equipments, \$..... *100*

Remarks:.....
.....
.....
.....
.....
.....
.....
.....
.....

Book mark:.....

J W Forrest
(858) Copyist.

L | **2 Cav. | U.S.C.T.**

Samuel Lee

2nd, Co. D, 2 Reg't U. S. Col'd Cavalry.

Appears on

Company Muster Roll

for *April 30 to Aug 31*, 1865.

Present or absent *Present*

Stoppage, \$ *100* for

Due Gov't, \$ *100* for

Valuation of horse, \$ *100*

Valuation of horse equipments, \$ *100*

Remarks:

Book mark:

S. W. Hilliard

L | 2 Cav. | U.S.C.T.

Samuel Lee

Priv. Co. D, 2 Reg't U. S. Colored Cav.

Appears on Returns as follows:

March 1865. Gained

March 23/65 - Norfolk

Recruit from depot.

Book mark :

A. H. Ellison

L | **2 Cav.** | **U.S.C.T.**

Samuel Lu
Private, Co. D, 2 Reg't U. S. Col'd Cavalry.

Appears on **Co. Muster-out Roll**, dated
Grays Santiago Tex, Feb 12, 1866.
Muster-out to date Feb 17, 1866.
Last paid to June 30, 1866.

Clothing account:

Last settled....., 186 ; drawn since \$..... 100
Due soldier \$..... 100; due U. S. \$ 25 79/100
Am't for cloth'g in kind or money adv'd \$..... 100

Due U. S. for arms, equipments, &c., \$..... 100
Bounty paid \$..... 100; due \$ 66 66/100

Remarks: joined a recruit

Book mark :

S W Forrest
(361) Copyist.

1956
Lee Samuel

Co. *K*, **2** U. S. Col'd Cav.

Private | *Private*

CARD NUMBERS.

1	5-315416	26
2	5-328335	27
3	5-328421	28
4	5-328508	29
5	5-328617	30
6	5-316931	31
7	5-329437	32
8	9087946	33
9	40726299	34
10		35
11		36
12		37
13		38
14		39
15		40
16		41
17		42
18		43
19		44
20		45
21		46
22		47
23		48
24		49
25		50

Book Mark:

See also

L | **2 Cav.** | **U.S.C.T.**

Samuel Lee

, Co. *K* 2 Reg't U. S. Col'd Cav.

Appears on

Company Descriptive Book

of the organization named above.

DESCRIPTION.

Age *20* years; height *5* feet *11 3/4* inches.

Complexion *Black*

Eyes *Black*; hair *Black*

Where born *St Marys Co, Md.*

Occupation *Laborer*

ENLISTMENT.

When *Jan 20, 1864.*

Where *Fort Monroe*

By whom *Col. Cole*; term *3* y'rs.

Remarks: *Deserted from
bed at Level Va, Aug. 25
1864*

T. B. Smith

L | *2 Cav.* | **U.S.C.T.**

Samuel Lee

Priv., Co....., *2* Reg't U. S. Col'd *Cav.*

Age years.

Appears on a

Detachment Muster-in Roll

of the organization named above. Roll dated

Fort Monroe, Va., Jan 27, 1864.

Muster-in to date *Jan 27, 1864.*

Joined for duty and enrolled:

When *Jan 20*....., 1864 .

Where *Fort Monroe, Va.*

Period *3*.....years.

Valuation of horse, \$.....100

Valuation of horse equipments, \$.....100

Remarks:

.....

.....

.....

Book mark:

L. | **2 Cav.** | **U.S.C.T.**

Samuel Lee
Priv., Co. K, 2 Reg't U. S. Col'd Cav.

Appears on

Company Muster Roll

for Enrollment to Feb. 29, 1864.

Present or absent Present.

Stoppage, \$ 100 for

Due Gov't, \$ 100 for

Valuation of horse, \$ 100

Valuation of horse equipments, \$ 100

Remarks:
.....
.....
.....
.....
.....
.....
.....
.....
.....

Book mark:

(358)

J. E. Brooks.

Copyist.

L. | 2 Cav. | U.S.C.T.

Samuel Lee

Co. K, 2 Reg't U. S. Col'd Cav.

Appears on

Company Muster Roll

for Mar. & April, 1864.

Present or absent Present

Stoppage, \$ 100 for

Due Gov't, \$ 100 for

Valuation of horse, \$ 100

Valuation of horse equipments, \$ 100

Remarks: Blue U. S. for
Ord. \$1.01.

Book mark:

(358)

J. E. Brooks,
Copyist.

L | 2. Cav | U.S.C.T.

Samuel Lee

Pvt., Co. K, 2 Reg't U. S. Col'd Cav

Appears on

Descriptive List of Deserters

dated May 29, 1865.

Deserted:

When Aug 25, 1864.

Where Cedar Levil,

Arrested:

When _____, 186 .

Where _____

Remarks: Due U.S. for Ordnance
\$ 14.01

Book mark: _____

E Weston

L. | **2 Cav.** | **U.S.C.T.**

Samuel Lee
Priv., Co. K, 2 Reg't U. S. Col'd Cav.

Appears on

Company Muster Roll

for May + June, 1864.

Present or absent Present

Stoppage, \$ 100 for

Due Gov't, \$ 100 for

Valuation of horse, \$ 100

Valuation of horse equipments, \$ 100

Remarks:

Book mark: _____

(358) J. E. Brooks
Copyist.

* *A* | 2 Cav. | U.S.C.T.

Samuel * *Lee*

Privt., Co. K, 2 Reg't U. S. Col'd Cav.

Appears on

Company Muster Roll

for *July v Aug.*, 1864.

Present or absent

Stoppage, \$ 100 for

Due Gov't, \$ 100 for

Valuation of horse, \$ 100

Valuation of horse equipments, \$ 100

Remarks: *Deserted from Cedar Level Aug. 25 64*
Due to U.S for ordnance
\$ 14. 10.

* *connected by Ed Safford*

Book mark:

D. M. Kennedy
Comd'g.

L | **2 Cav.** | **U.S.C.T.**

Samuel Lee

Pr., Co. *K*, 2 Reg't U. S. Colored Cav.

Appears on **Returns** as follows:

*Aug 1864 - Loss
Aug 25 - Cedar
Levee - deserted*

Book mark :

A. H. Collins

L | 2 Cav. | U. S. C. T.

Samuel Lee

Pvt., Co K, 2 Reg't U. S. Col'd Cav

Appears on **Co. Muster-out Roll**, dated

Brazos Santiago Tex, Feb 12, 1866.

Muster-out to date _____, 186 .

Last paid to April 30, 1864.

Clothing account:

Last settled _____, 186 ; drawn since \$ _____ 100

Due soldier \$ _____ 100; due U. S. \$ _____ 100

Am't for cloth'g in kind or money adv'd \$ _____ 100

Due U. S. for arms, equipments, &c., \$ _____ 100

Bounty paid \$ _____ 100 due \$ _____ 100

Remarks: joined a Regt. Pvt.
from Enrollment Deserted
from Cedar Level Aug 25. 64
Desct List given Aug 31. 64

Book mark: _____

S. Duncan

957
Lemear Hance

Co D, 2 U. S. Col'd Cav.

Private | Private

CARD NUMBERS.

1	5315746	26
2	5327108	27
3	5327195	28
4	5327284	29
5	5327364	30
6	5327450	31
7	5327503	32
8	5327592	33
9	5327723	34
10	5327816	35
11	5327906	36
12	5327992	37
13	5328075	38
14	5328156	39
15	9087829	40
16		41
17		42
18		43
19		44
20		45
21		46
22		47
23		48
24		49
25		50

Book Mark:

See also

1999 300

S.677102 R.O.'90
S-1265348 PO in am
MSVA 6/16/32 CEP.

L. D. Gallant Jr

L | 2 Cav. | U.S.C.T.

Hance Linear

, Co. I, 2 Reg't U. S. Col'd Cav.

Appears on

Company Descriptive Book

of the organization named above.

DESCRIPTION.

Age 18 years; height 5 feet 5 inches.

Complexion Dark

Eyes Black; hair Black

Where born Dupland N.C.

Occupation Farmer

ENLISTMENT.

When Jan 10, 1864.

Where Fort Monroe, Va.

By whom Col. Cole; term 3 y'rs.

Remarks: Promoted to
sergeant Nov 1/64, 2nd
Reg. U. S. Col'd Cav.

F. B. Smith

Copyist.

L. | 2 Comp | U.S.C.T.

Hance Linear

Bt, Co., 2 Reg't U. S. Col'd Comp

Age years.

Appears on a

Detachment Muster-in Roll

of *unattached recruits* the organization named above. Roll dated

Fort Monroe, Va, Jan 19, 1864.

Muster-in to date Jan 19, 1864.

Joined for duty and enrolled:

When Jan 10, 1864.

Where Ft. Monroe, Va

Period 3 years.

Valuation of horse, \$ 100

Valuation of horse equipments, \$ 100

Remarks :

Book mark :

J. J. Kearney

L | **2 Cav.** | **U.S.C.T.**

James Linear

Det, Co. I, 2 Reg't U. S. Col'd Cavalry.

Appears on

Company Muster Roll

for *Enrollment to Feb 29, 1864.*

Present or absent *Present*

Stoppage, \$ *100* for

Due Gov't, \$ *100* for

Valuation of horse, \$ *100*

Valuation of horse equipments, \$ *100*

Remarks:

Book mark:

O. A. Rank

L | **2 Cav.** | **U.S.C.T.**

Hans Linear

Put, Co. I, 2 Reg't U. S. Col'd Cavalry.

Appears on

Company Muster Roll

for *Mar & Apr*, 1864.

Present or absent *Present*

Stoppage, \$ 100 for

Due Gov't, \$ 100 for

Valuation of horse, \$ 100

Valuation of horse equipments, \$ 100

Remarks:

Book mark:

D. A. Mann

L | **2 Cav.** | **U.S.C.T.**

Lance Lincoln

Put, Co. I, 2 Reg't U. S. Col'd Cavalry.

Appears on

Company Muster Roll

for *May & June*, 1864.

Present or absent *Present*

Stoppage, \$ *100* for

Due Gov't, \$ *100* for

Valuation of horse, \$ *100*

Valuation of horse equipments, \$ *100*

Remarks: *To be taken from pay 1 pr spurs & straps & 0.52.*

Book mark:

P. A. Ward

L | **2 Cav.** | **U.S.C.T.**

Thence Linear

Pr, Co. I, 2 Reg't U. S. Col'd Cavalry.

Appears on

Company Muster Roll

for *July & Aug*, 186 *4*.

Present or absent *Present*

Stoppage, \$ *100* for

Due Gov't, \$ *100* for

Valuation of horse, \$ *100*

Valuation of horse equipments, \$ *100*

Remarks: *Due U.S. for Insurance*
1 Pr. Spurs & Straps 520

Book mark:

Ag. Smith

L | 2 Cav. | U.S.C.T.

Hance Linear

Pi, Co. I, 2 Reg't U. S. Col'd Cavalry.

Appears on

Company Muster Roll

for Sept & Oct, 1867

Present or absent Present

Stoppage, \$ 100 for

Due Gov't, \$ 100 for

Valuation of horse, \$ 100

Valuation of horse equipments, \$ 100

Remarks:

Book mark:

O. G. Smith

L | 2 Cav. | U.S.C.T.

Hance Linear
Corp., Co. I, 2 Reg't U. S. Col'd Cavalry.

Appears on

Company Muster Roll

for Nov & Dec, 1867.

Present or absent Present

Stoppage, \$ 100 for

Due Gov't, \$ 100 for

Valuation of horse, \$ 100

Valuation of horse equipments, \$ 100

Remarks: Promoted to Corp.
G.O. No. 36

Book mark:

O. G. Smith

L | 2 Cav. | U.S.C.T.

Hance Linear Corp., Co. I, 2 Reg't U. S. Col'd Cavalry.

Appears on

Company Muster Roll

for Jan & Feb, 1865.

Present or absent Present

Stoppage, \$ 100 for

Due Gov't, \$ 100 for

Valuation of horse, \$ 100

Valuation of horse equipments, \$ 100

Remarks:

Book mark:

C. W. Smith

L | 2 Cav. | U.S.C.T.

Hance Lineas

pr, Co. I, 2 Reg't U. S. Col'd Cavalry.

Appears on

Company Muster Roll

for *March & Apr*, 186*5*.

Present or absent *Present*

Stoppage, \$ *100* for

Due Gov't, \$ *100* for

Valuation of horse, \$ *100*

Valuation of horse equipments, \$ *100*

Remarks:

Book mark:

D. J. Griffith

L | 2 Cav. | U.S.C.T.

Wance Lincas

571, Co. I, 2 Reg't U. S. Col'd Cavalry.
Appears on

Company Muster Roll

for *May & June*, 1865.

Present or absent *Present*

Stoppage, \$ *100* for

Due Gov't, \$ *100* for

Valuation of horse, \$ *100*

Valuation of horse equipments, \$ *100*

Remarks:

Book mark:

D. J. Griffith
Copyist.

L | 2 Cav. | U.S.C.T.

Hance Lineas

pr, Co. I, 2 Reg't U. S. Col'd Cavalry.

Appears on

Company Muster Roll

for *July + August*, 186*5*.

Present or absent *Present*

Stoppage, \$ *100* for

Due Gov't, \$ *100* for

Valuation of horse, \$ *100*

Valuation of horse equipments, \$ *100*

Remarks:

Book mark:

D. J. Gippich

L. | **2 Cav.** | **U.S.C.T.**

Hance Linear.

Priv., Co. I, 2 Reg't U. S. Col'd Cavalry.

Appears on

Company Muster Roll

for *Sept & Oct.*, 186 *5.*

Present or absent *Present.*

Stoppage, \$ *100* for

Due Gov't, \$ *100* for

Valuation of horse, \$ *100*

Valuation of horse equipments, \$ *100*

Remarks:

Book mark: _____

[Signature]
Copyist.

L. | **2 Cav.** | **U.S.C.T.**

Hance Lesueur.

Priv., Co. I, 2 Reg't U. S. Col'd Cavalry.

Appears on

Company Muster Roll

for Nov. 7 Dec., 1865.

Present or absent Present.

Stoppage, \$ 100 for

Due Gov't, \$ 100 for

Valuation of horse, \$ 100

Valuation of horse equipments, \$ 100

Remarks:

Book mark:

Pol

L. | **2 Cav.** | **U.S.C.T.**

Hance Leneer.

Priv, Co. *I*, 2 Reg't U. S. Col'd Cavalry.

Appears on **Co. Muster-out Roll**, dated *Brazos Santiago Tex, Feb. 12*, 1866.

Muster-out to date *Feb. 12*, 1866.

Last paid to *June 30*, 1865.

Clothing account:

Last settled....., 186 ; drawn since \$..... 100

Due soldier \$..... 100; due U. S. \$ *36. 54* / 100

Am't for cloth'g in kind or money adv'd \$..... 100

Due U. S. for arms, equipments, &c., \$..... 100

Bounty paid \$..... 100; due \$..... 100

Remarks: *Joined at org org.*

Book mark: *V37.P.5/69.V75.P151/69.*

Pol

958
Linear McLean

Co I, 2 U. S. Col'd Cav.

Private | *Private*

CARD NUMBERS.

1	5315745	26
2	5327109	27
3	5327196	28
4	5327285	29
5	5327365	30
6	5327451	31
7	5327543	32
8	5327633	33
9	5327724	34
10	5327817	35
11	5327907	36
12	5327993	37
13	5328076	38
14	5328157	39
15	9087830	40
16		41
17		42
18		43
19		44
20		45
21		46
22		47
23		48
24		49
25		50

Book Mark:

See also

L | 2 Cav. | U.S.C.T.

McLean Linnear

Co. I, 2 Reg't U. S. Col'd Cav.

Appears on

Company Descriptive Book

of the organization named above.

DESCRIPTION.

Age 18 years; height 5 feet 6 1/2 inches.

Complexion Dark

Eyes Black; hair Black

Where born Dupland, N. C.

Occupation Farmer

ENLISTMENT.

When Jan. 10, 186

Where Fort Monroe, Va.

By whom Col. Cole; term 3 y'rs.

Remarks:

[Empty lines for remarks]

F. B. Linnear
Copyist.

L. | 2 Cav. | U.S.C.T.

McLean Linear
Part, Co., 2 Reg't U. S. Col'd Cav.

Age years.

Appears on a

Detachment Muster-in Roll
of unattached recruits
of the organization named above. Roll dated
Ft. Monroe, Va., Jan 19, 1864.

Muster-in to date Jan. 19, 1864.

Joined for duty and enrolled:

When Jan. 10, 1864.

Where Ft. Monroe, Va.,

Period 3 years.

Valuation of horse, \$ 100

Valuation of horse equipments, \$ 100

Remarks :
.....
.....
.....
.....

Book mark :
.....

(337)

J. J. Kearney
Copyist.

L | 2 Cav. | U.S.C.T.

Wm. Isaac Linear
Put, Co. I, 2 Reg't U. S. Col'd Cavalry.

Appears on

Company Muster Roll

for *Enrollment to Feb 29*, 1864.

Present or absent *Present*

Stoppage, \$ 100 for

Due Gov't, \$ 100 for

Valuation of horse, \$ 100

Valuation of horse equipments, \$ 100

Remarks:

Book mark: -----

D. A. Ward

L | **2 Cav.** | **U.S.C.T.**

McLean Linear

Put, Co. I, 2 Reg't U. S. Col'd Cavalry.

Appears on

Company Muster Roll

for *Mar & Apr*, 186*4*

Present or absent *Absent*

Stoppage, \$ _____ 100 for _____

Due Gov't, \$ _____ 100 for _____

Valuation of horse, \$ _____ 100

Valuation of horse equipments, \$ _____ 100

Remarks: _____

Book mark: _____

O. A. Ward

L | **2 Cav.** | **U.S.C.T.**

McLean Linear
Put

....., Co. I, 2 Reg't U. S. Col'd Cavalry.

Appears on

Company Muster Roll

for *May & June*, 186*4*.

Present or absent *Present*

Stoppage, \$..... 100 for.....

Due Gov't, \$..... 100 for.....

Valuation of horse, \$..... 100

Valuation of horse equipments, \$..... 100

Remarks:.....

Book mark:.....

O. A. Ward

L | **2 Cav.** | **U.S.C.T.**

McLean Lincoln

Pie....., Co. I, 2 Reg't U. S. Col'd Cavalry.

Appears on

Company Muster Roll

for *July & Aug*....., 186*7*.

Present or absent *Present*

Stoppage, \$..... 100 for.....

Due Gov't, \$..... 100 for.....

Valuation of horse, \$..... 100

Valuation of horse equipments, \$..... 100

Remarks: *Due U.S. for Ordnance
1 Pr. Spurs & Straps 52¢*

Book mark:

C. G. Smith

L | **2 Cav.** | **U.S.C.T.**

McLain Lincoln

Pr....., Co. I, 2 Reg't U. S. Col'd Cavalry.

Appears on

Company Muster Roll

for Sept & Oct, 1867.

Present or absent Present

Stoppage, \$..... 100 for.....

Due Gov't, \$..... 100 for.....

Valuation of horse, \$..... 100

Valuation of horse equipments, \$..... 100

Remarks:.....

Book mark:.....

O. G. Smith

L | 2 Cav. | U.S.C.T.

McLean Linear

Co. I, 2 Reg't U. S. Col'd Cavalry.

Appears on

Company Muster Roll

for Nov & Dec, 1864.

Present or absent Present

Stoppage, \$ 100 for

Due Gov't, \$ 100 for

Valuation of horse, \$ 100

Valuation of horse equipments, \$ 100

Remarks:

Book mark:

C. S. Smith

20 | 2 Cav. | U.S.C.T.

McLean Linear

Co. I, 2 Reg't U. S. Col'd Cavalry.

Appears on

Company Muster Roll

for Jan & Feb, 1865

Present or absent Present

Stoppage, \$ 100 for

Due Gov't, \$ 100 for

Valuation of horse, \$ 100

Valuation of horse equipments, \$ 100

Remarks:

Book mark:

J. G. Smith

L | 2 Cav. | U.S.C.T.

McClellan Lineas

mi, Co. I, 2 Reg't U. S. Col'd Cavalry.

Appears on

Company Muster Roll

for *Mich & Apr*, 186*5*.

Present or absent *Present*

Stoppage, \$ 100 for

Due Gov't, \$ 100 for

Valuation of horse, \$ 100

Valuation of horse equipments, \$ 100

Remarks:

Book mark:

D. J. Griffith

L | 2 Cav. | U.S.C.T.

McLean Lines

Smith, Co. I, 2 Reg't U. S. Col'd Cavalry.

Appears on

Company Muster Roll

for *May & June*, 1865.

Present or absent *Present*

Stoppage, \$ *100* for

Due Gov't, \$ *100* for

Valuation of horse, \$ *100*

Valuation of horse equipments, \$ *100*

Remarks:

Book mark:

D. J. Griffith

(358)

Copyist.

L | **2 Cav.** | **U.S.C.T.**

McLean Lincas

ser, Co. I, 2 Reg't U. S. Col'd Cavalry.

Appears on

Company Muster Roll

for July & August, 1865.

Present or absent Present

Stoppage, \$ 100 for

Due Gov't, \$ 100 for

Valuation of horse, \$ 100

Valuation of horse equipments, \$ 100

Remarks:

Book mark:

D. J. Grippick

(358)

Copyist.

G. | **2 Cav.** | **U.S.C.T.**

McLean Leonard

Priv, Co. I, 2 Reg't U. S. Col'd Cavalry.

Appears on

Company Muster Roll

for *Sept & Oct*, 186*5*.

Present or absent *Present*

Stoppage, \$..... 100 for

Due Gov't, \$..... 100 for

Valuation of horse, \$..... 100

Valuation of horse equipments, \$..... 100

Remarks:
.....
.....
.....
.....
.....
.....
.....
.....
.....
.....

Book mark:

Pol

L. | **2 Cav.** | **U.S.C.T.**

McLean Lemar.

Priv., Co. I, 2 Reg't U. S. Col'd Cavalry.

Appears on

Company Muster Roll

for *Nov. & Dec.*, 1865.

Present or absent *Present.*

Stoppage, \$ *100* for

Due Gov't, \$ *100* for

Valuation of horse, \$ *100*

Valuation of horse equipments, \$ *100*

Remarks:

Book mark:

Poe

L. | **2 Cav.** | **U.S.C.T.**

McLean Spear

Priv, Co. *A*, 2 Reg't U. S. Col'd Cavalry.

Appears on **Co. Muster-out Roll**, dated *Brazos Santiago Tex, Feb. 12*, 1866.

Muster-out to date *Feb. 12*, 1866.

Last paid to *June 30*, 1865.

Clothing account:

Last settled....., 186 ; drawn since \$..... 100

Due soldier \$..... 100; due U. S. \$ *61. 62* / 100

Am't for cloth'g in kind or money adv'd \$..... 100

Due U. S. for arms, equipments, &c., \$..... 100

Bounty paid \$..... 100; due \$..... 100

Remarks: *Joiner at Org Orgz.*

Book mark: *V41, P86. 69.*

Pol,

959
Lemair Green

Co E, 2 U. S. Col'd Cav.

Private | Private

CARD NUMBERS.

1	5-316181	26
2	5-322706	27
3	5-322487	28
4	5-322880	29
5	5-323009	30
6	5-316956	31
7	5-323369	32
8	40726302	33
9		34
10		35
11		36
12		37
13		38
14		39
15		40
16		41
17		42
18		43
19		44
20		45
21		46
22		47
23		48
24		49
25		50

Book Mark:

See also

A 2 Cav. | U.S.C.T.

Green Lyman

Appears with rank of Private on

Muster and Descriptive Roll of a Detachment of U. S. Vols. forwarded

for the 2 Reg't U. S. Col'd Cavalry. Roll dated

Warina Va., Dec. 3, 1864.

Where born Danville Va.

Age 22 y'rs; occupation Farmer

When enlisted Dec. 3, 1864.

Where enlisted Warina Va.

For what period enlisted 3 years.

Eyes dark; hair black

Complexion dark; height 5 ft. 3 in.

When mustered in Dec. 3, 1864.

Where mustered in Warina Va.

Bounty paid \$ 100; due \$ 300¹⁰⁰

Where credited

Company to which assigned

Remarks:

as it appears on roll

Book mark:

25-180

F. M. Male

MAR 1867

L | 2 Cav. | U.S.C.T.

Gene Lequien
Pvt, Co. E, 2 Reg't U. S. Col'd Cavalry.

Appears on

Company Muster Roll

for *Nov & Dec*, 1864.

Present or absent *Present*

Stoppage, \$ 100 for

Due Gov't, \$ 100 for

Valuation of horse, \$ 100

Valuation of horse equipments, \$ 100

Remarks:

Book mark: -----

(358) *Waddington* Copyist.

L | 2 Cav. | U.S.C.T.

Greene Lequire

Pri, Co. E, 2 Reg't U. S. Col'd Cavalry.

Appears on

Company Muster Roll

for *Law & List*, 1865.

Present or absent *Present*

Stoppage, \$ 100 for

Due Gov't, \$ 100 for

Valuation of horse, \$ 100

Valuation of horse equipments, \$ 100

Remarks:

Book mark:

Washington

L. | **2 Cav.** | **U.S.C.T.**

Lycius Liguiera

Private, Co. E, 2 Reg't U. S. Col'd Cavalry.

Appears on

Company Muster Roll

for March & April, 1863.

Present or absent Present.

Stoppage, \$ 100 for

Due Gov't, \$ 100 for

Valuation of horse, \$ 100

Valuation of horse equipments, \$ 100

Remarks: Due Soldier \$100 first inv.
Statement U.S. Bounty

Book mark:

R. Bradie

1865

L | 2 Cav. | U.S.C.T.

Guen Laquiere

Rot, Co. E, 2 Reg't U. S. Col'd Cavalry.

Appears on

Company Muster Roll

for May June, 1865

Present or absent

Stoppage, \$ 100 for

Due Gov't, \$ 100 for

Valuation of horse, \$ 100

Valuation of horse equipments, \$ 100

Remarks: Deserted at Fort Smith June 14/65 Taken the following arms & equipments one carbine \$30, one cap punch \$50, one cartridge box \$1.05, Cutlery \$1.25

Book mark:

(358) J. H. Cook Copyist.

JAN. - 7

5323009

1891

one Swiss 7^{cts} one
Colt. revolver \$20, one
Holster 7.5^{cts} one Cartridge
box 60^{cts} one key punch
45 one saw \$1.50 one
screw bit & plate \$1.10
Total \$63.70

L | 2 Cav | U.S.C.T.

Green Lagune
Pvt., Co. E, 2 Reg't U. S. Col'd Cav

Appears on

Descriptive List of Deserters

dated Aug 1, 1865.

Deserted:

When June 14, 1865.

Where Portsmouth, Va

Arrested:

When _____, 186 .

Where _____

Remarks: Due U. S. for Ordnance
63.70.

Book mark: _____

E. Proster

L | 2 Cav. | U.S.C.T.

Green Requite

Pr., Co. C., 2 Reg't U. S. Colored Cav.

Appears on Returns as follows:

Dec 1864. Gained Lic.
3/64 Varina Va
(Enlisted in the Co.)

March 1865. On extra
or daily duty -
Apr & May 1865 -
on duty in Regt
Band -
June 1865 - Loss -
Deserted -

Name appears also as
Green Laniere
Green Laquire

Book mark :

M. Collins

L | **2 Cav.** | **U.S.C.T.**

Geo. Stone

No., Co. *E*, 2 Reg't U. S. Col'd Cavalry.

Appears on **Co. Muster-out Roll**, dated
Proviso Jan 1 1864, *Feb 15*, 186*4*.

Muster-out to date _____, 186*4*.

Last paid to *Apr 30*, 186*4*.

Clothing account:

Last settled _____, 186*4*; drawn since \$ 100

Due soldier \$ 100; due U. S. \$ 100

Am't for cloth'g in kind or money adv'd \$ 100

Due U. S. for arms, equipments, &c., \$ 100

Bounty paid \$ 100; due \$ 100

Remarks: *Discharged Jan 1 1864*
Reserted at Portsmouth Va. June 14 65
Mrs. Rich Garrison 2000 65

Book mark : _____

W H Merrill

960
Leonard Ebenezer

Co B, 2 U. S. Col'd Cav.

Private Private

CARD NUMBERS.

1	5316029	26
2	5315562	27
3	5320501	28
4	5320545	29
5	5320690	30
6	5320779	31
7	5320866	32
8	5320949	33
9	9087331	34
10	40726301	35
11		36
12		37
13		38
14		39
15		40
16		41
17		42
18		43
19		44
20		45
21		46
22		47
23		48
24		49
25		50

Book Mark:

See also

L | 2 Cav. | U.S.C.T.

Ebenezer Leonard

, Co. C, 2 Reg't U. S. Col'd Cav.

Appears on

Company Descriptive Book

of the organization named above.

DESCRIPTION.

Age 18 years; height 5 feet 5 1/4 inches.

Complexion Blk

Eyes Blk; hair Blk

Where born Caroline Co, Md

Occupation Laborer

ENLISTMENT.

When Feb. 17, 1865

Where Eastern Md, Substitute

By whom Capt. Stafford; term 3 y'rs.

Remarks: Substitute for
Conroy B. Peaks
1st List, Md, \$180 on
Ch. Book

F. B. Smith

L 2 Cav U.S.C.T.

Ebenzer Leonard

Appears with rank of _____ on _____

Muster and Descriptive Roll of a Detachment of Substitutes forwarded

for the 2 Reg't U. S. Col'd Cav Roll dated

_____ , 186 .

Where born Caroline Co., Md.

Age 18 y'rs; occupation Laborer

When enlisted Feb. 17 , 186 .

Where enlisted Easton

For what period enlisted 3 years.

Eyes Blk. Blk.

Complexion Bright height 5 ft. 5 1/4 in.

When mustered in _____ , 186 .

Where mustered in _____

Bounty paid \$ _____ due \$ 100

Where credited _____

Company to which assigned _____

Remarks: Substitute for
Corneggs B. Peacock
1st Dist., Md.

Book mark: _____

P. C. Taylor

(340b)

Copyist.

NOV 1947

CAUTION
This card was made from an insurance
policy and must not be used as the basis
of an official report. R. P. 485576

S | *2 Cav* | **U.S.C.T.**

Ebenezer Leonard
....., Co., *2* Reg't U. S. Col'd *Cav.*

Age *18* years.

Appears on a

Detachment Muster-in Roll

of the organization named above. Roll dated

Baltimore, Md., Mar. 23, 1865.

Muster-in to date *Mar. 18, 1865.*

Joined for duty and enrolled:

When *Feb. 17* 1865 .

Where *Easton*

Period *3* years.

Valuation of horse, \$ 100

Valuation of horse equipments, \$ 100

Remarks: *Substitute*

.....
.....
.....

Book mark :

.....
.....
Beck

(337)

Copyist.

L | 2 Cav. | U.S.C.T.

Ernest Leonard
Priv., Co. C, 2 Reg't U. S. Col'd Cavalry.

Appears on

Company Muster Roll

for March & April, 1865.

Present or absent Present

Stoppage, \$ 100 for

Due Gov't, \$ 100 for

Valuation of horse, \$ 100

Valuation of horse equipments, \$ 100

Remarks: Substituted for Privates
B. Parks, 12th Dist. Mea.
180 dollars on Check Book.

Book mark:

J. L. Morris

L | 2 Cav. | U.S.C.T.

Eleazer Leonard
Plt, Co. C, 2 Reg't U. S. Col'd Cavalry.

Appears on

Company Muster Roll

for May 9 June, 1865.

Present or absent Present

Stoppage, \$ 100 for

Due Gov't, \$ 100 for

Valuation of horse, \$ 100

Valuation of horse equipments, \$ 100

Remarks: \$180 dollars on Check Book.

Book mark:

J. L. Morris
Copyist.

L | 2 Cav. | U.S.C.T.

Ebenzer Leonard
Priv, Co. C, 2 Reg't U. S. Col'd Cavalry.

Appears on

Company Muster Roll

for *July & August*, 1865.

Present or absent *Present*

Stoppage, \$ *100* for

Due Gov't, \$ *100* for

Valuation of horse, \$ *100*

Valuation of horse equipments, \$ *100*

Remarks: *On Check Book \$18000*

Book mark:

J. L. Harris

L | 2 Cav. | U.S.C.T.

Ebenezer Leonard
Put, Co. C, 2 Reg't U. S. Col'd Cavalry.

Appears on

Company Muster Roll

for Sept & Oct, 1865.

Present or absent Present

Stoppage, \$ 100 for

Due Gov't, \$ 100 for

Valuation of horse, \$ 100

Valuation of horse equipments, \$ 100

Remarks: On Check Book \$180.

Book mark:

G. W. Chase

L | 2 Cav. | U.S.C.T.

Ebenezer Leonard

Pvt, Co. C, 2 Reg't U. S. Col'd Cavalry.

Appears on

Company Muster Roll

for *Nov & Dec*, 1865.

Present or absent *Present*

Stoppage, \$ *100* for

Due Gov't, \$ *100* for

Valuation of horse, \$ *100*

Valuation of horse equipments, \$ *100*

Remarks: *On Check Book \$180.00*

Book mark:

G. W. Chase

L | **2 Cav.** | **U.S.C.T.**

Ebenzer Leonard
Pr., Co. *C*, 2 Reg't U. S. Colored Cav.

Appears on Returns as follows:

March 1865. Gained
March 24 or 29 '65 -
Camp Norfolk -
Recruit assigned
to Co. C. by order of
Maj. Robert Dillard
2. U.S.C.C.

June 1865 - Absent
Det. service
Nov 1865. On duty
Chief Cook since
Nov. 1865

Dec 1865 + Jan 1866.
Co. Cook.

Book mark :

A. Holliman
Copyist.

L | 2 Cav. | U.S.C.T.

Ebenezer Leonard
Priv., Co. C, 2 Reg't U. S. Col'd Cavalry.

Appears on Co. Muster-out Roll, dated
Grazos Santiago Tex, Feb 12, 1866.
Muster-out to date Feb. 12, 1866.
Last paid to June 30, 1865.

Clothing account:
Last settled....., 186 ; drawn since \$ 100
Due soldier \$ 22 ⁰¹/₁₀₀; due U. S. \$ 100
Am't for cloth'g in kind or money adv'd \$ 100

Due U. S. for arms, equipments, &c., \$ 100
Bounty paid \$ 100; due \$ 100

Remarks: Joined as Substitute for
Leoniges Peake 1 D. Md.
Free before Apr. 19, 1861

Book mark: V. 135, P. 150, 72
V. 88, P. 144, 109

G. W. Chase

961

Lequire Green

Co E, 2 U. S. Col'd Cav.

CARD NUMBERS.

1	26
2	27
3	28
4	29
5 <i>See Lenoir</i>	30 <i>Green</i>
6	31
7	32
8	33
9	34
10	35
11	36
12	37
13	38
14	39
15	40
16	41
17	42
18	43
19	44
20	45
21	46
22	47
23	48
24	49
25	50

Book Mark:

See also

1962
Lavenhouse George

Co *F*, 2 U. S. Col'd Cav.

CARD NUMBERS.

1	26
2	27
3	28
4	29
5	30
6	31
7	32
8	33
9	34
10	35
11	36
12	37
13	38
14	39
15	40
16	41
17	42
18	43
19	44
20	45
21	46
22	47
23	48
24	49
25	50

See Lavenhouse George

Book Mark:

See also

⁹⁶³
Levitt Louis

Co *b*, **2** U. S. Col'd Cav.

Private | Private

CARD NUMBERS.

1	5319804	26
2	5319880	27
3	5319966	28
4	5320054	29
5	5320137	30
6	5320226	31
7	5320318	32
8	5320403	33
9	5320500	34
10	5320594	35
11	5320709	36
12	5316854	37
13	5320971	38
14	9087330	39
15	33226226	40
16	33228901	41
17	33232355	42
18	40726295	43
19		44
20		45
21		46
22		47
23		48
24		49
25		50

Book Mark:

See also

L | 2 Cav. | U.S.C.T.

Lewis Levitt

, Co. B, 2 Reg't U. S. Col'd Cav.

Appears on

Company Descriptive Book

of the organization named above.

DESCRIPTION.

Age 52 years; height 5 feet 3 inches.

Complexion Black

Eyes Black; hair Black

Where born Princess Anne, N. C.

Occupation Laborer

ENLISTMENT.

When Dec. 24, 1863.

Where Fort Monroe

By whom Geo. W. Cole; term 3 y'rs.

Remarks: discharged June 24, 1865 - Norfolk Va. by order of Secy. of War.

F. B. Smith

B | **2 Cav.** | **U.S.C.T.**

Louis Levitt

Rot, Co. *C*, 2 Reg't U. S. Col'd Cavalry.

Age.....years.

Appears on

Company Muster-in Roll

of the organization named above. Roll dated
Fort Monroe Va Dec 24, 1863.

Muster-in to date *Dec 24*, 1863.

Joined for duty and enrolled:

When *Dec 24*, 1863.

Where *Fort Monroe Va*

Period *3* years.

Valuation of horse, \$.....100

Valuation of horse equipments, \$.....100

Remarks:.....

Book mark:.....

Hadfield

S | **2 Cav.** | **U.S.C.T.**

Lewis Lovitt

Priv, Co. C, 2 Reg't U. S. Col'd Cavalry.

Appears on

Company Muster Roll

for *dated Feb 29*, 1864.

Present or absent *Present*

Stoppage, \$ *100* for

Due Gov't, \$ *100* for

Valuation of horse, \$ *100*

Valuation of horse equipments, \$ *100*

Remarks:

Book mark:

Madfield
Copyist.

No. | 2 Cav. | U.S.C.T.

Lewis K. Levitt

Private, Co. C, 2 Reg't U. S. Col'd Cavalry.

Appears on

Company Muster Roll

for March April, 1864.

Present or absent Present

Stoppage, \$ 100 for

Due Gov't, \$ 100 for

Valuation of horse, \$ 100

Valuation of horse equipments, \$ 100

Remarks:

Book mark:

Madfield

S^r | 2 Cav. | U.S.C.T.

Dennis Levitt

Sgt, Co. C, 2 Reg't U. S. Col'd Cavalry.

Appears on

Company Muster Roll

for *May June*, 1864.

Present or absent *Present*

Stoppage, \$ 100 for

Due Gov't, \$ 100 for

Valuation of horse, \$ 100

Valuation of horse equipments, \$ 100

Remarks:

Book mark:

Shadfield

L | 2 Cav. | U.S.C.T.

Lewis Leavitt
Present, Co. C, 2 Reg't U. S. Col'd Cavalry.

Appears on

Company Muster Roll

for July & Aug, 1864

Present or absent Present

Stoppage, \$ 100 for

Due Gov't, \$ 100 for

Valuation of horse, \$ 100

Valuation of horse equipments, \$ 100

Remarks:

Book mark:

W. S. [Signature]

L | 2 Cav. | U.S.C.T.

Lewis Leavitt
Private, Co. C, 2 Reg't U. S. Col'd Cavalry.

Appears on

Company Muster Roll

for Sept & Oct, 1864.

Present or absent Absent

Stoppage, \$ 100 for

Due Gov't, \$ 100 for

Valuation of horse, \$ 100

Valuation of horse equipments, \$ 100

Remarks: Sick in 15th
A.C. Hospital

Book mark:

W. S. Logg

L | 2 cav. | U.S.C.T.

Lewis Larett
Priv., Co. C, 2 Reg't U.S.C.T.

Appears on

Hospital Muster Roll

of U. S. A. General Hospital,

at Fort Monroe, Va.,

for Sept. & Oct., 1864.

Attached to hospital :

When _____, 186 .

How employed _____

Last paid by Maj. _____

to _____, 186 .

Bounty paid \$ 100 ; due \$ 100

Present or absent *Present*

Remarks : *No descriptive list.*

Section H. New Camp.

Book mark : _____

MAN 1367

L | 2 Cav. | U.S.C.T.

Lewis Levitt
Privt, Co. C, 2 Reg't U. S. Col'd Cavalry.

Appears on

Company Muster Roll
for Arr + Dec, 1864

Present or absent Absent

Stoppage, \$ 100 for

Due Gov't, \$ 100 for

Valuation of horse, \$ 100

Valuation of horse equipments, \$ 100

Remarks: Absent sick
in 25th Corps. Gen
Hos. Point of Rocks,
Va, since Oct 15/64

Book mark:

(358) *W. H. [Signature]* Copyist.

L 2 cav. *USG*
Lewis Lovitt
1st, Co. *C*, *2* Reg't *USG*

Appears on

Hospital Muster Roll

of U. S. A. General Hospital,

at Fort Monroe, Va.

for *Nov & Dec*, 186*4*.

Attached to hospital :

When _____, 186 .

How employed _____

Last paid by Maj. _____

to _____, 186 .

Bounty paid \$ 100; due \$ 100

Present or absent *present*

Remarks : *No Descriptive list*

5 Sect. (New Camp)

Book mark : _____

Lewis

1865

L | 2 Cav. | U.S.C.T.

Lewis Leavitt
Point, Co. C, 2 Reg't U. S. Col'd Cavalry.

Appears on

Company Muster Roll

for Jan to Feb, 1865.

Present or absent Absent

Stoppage, \$ 100 for

Due Gov't, \$ 100 for

Valuation of horse, \$ 100

Valuation of horse equipments, \$ 100

Remarks: Absent sick
in Gen. Hospital
Point of Rocks
Va since, Oct 15
64

Book mark:

W. D. H. [Signature]

(358)

Copyist.

L 1 2 cav. usct

Lewis Lovett

1st, Co. C, 2 Reg't usct

Appears on

Hospital Muster Roll

of U. S. A. General Hospital,

at Fort Monroe, Va.,

for Jan 25, 1865.

Attached to hospital :

When _____, 186 .

How employed _____

Last paid by Maj. _____

to _____, 186 .

Bounty paid \$ 100 ; due \$ 100

Present or absent present

Remarks : no desc list

5 Sect (2 Div)

Book mark : _____

Harrison

L | **2 Cav.** | **U.S.C.T.**

Lewis Leavitt
Prof, Co. C, 2 Reg't U. S. Col'd Cavalry.

Appears on

Company Muster Roll

for March & April, 1865.

Present or absent Present

Stoppage, \$ 100 for _____

Due Gov't, \$ 100 for _____

Valuation of horse, \$ 100

Valuation of horse equipments, \$ 100

Remarks: _____

Book mark: _____

J. L. Morris
Copyist.

L | 2 Cav. | U.S.C.T.

Lewis Hewitt
Sgt, Co. C, 2 Reg't U. S. Col'd Cavalry.

Appears on

Company Muster Roll

for May 7 June 1865.

Present or absent Present

Stoppage, \$ 100 for

Due Gov't, \$ 100 for

Valuation of horse, \$ 100

Valuation of horse equipments, \$ 100

Remarks: Absent sick in Genl
Hosp at Fort Monroe

Book mark:

J. L. Morris

L | 2 Cav. | U.S.C.T.

Lewis Leavitt

Pop, Co. C, 2 Reg't U. S. Col'd Cavalry.

Appears on

Company Muster Roll

for July & August, 1865.

Present or absent

Stoppage, \$ 100 for

Due Gov't, \$ 100 for

Valuation of horse, \$ 100

Valuation of horse equipments, \$ 100

Remarks: Honorably discharged
per S. Order War Dept.
May 3rd 1865, June 2nd

Book mark:

(358)

J. Laborris

Copyist.

S. W. C. M. | **U.S.C.T.**

Lewis Jewitt
Co. C, 2 Reg't U. S. Col'd *Gen.*

Appears on an

Individual Muster-out Roll

of the organization named above. Roll dated

Fort Monroe, Va., *June 21*, 1863.

Muster-out to date *June 21*, 1863.

Last paid to *Oct 31*, 1864.

Clothing account:

Last settled *Dec 31*, 1864; drawn since \$ 100

Due soldier \$ 100; due U. S. \$ 100

Am't for cloth'g in kind or money adv'd \$ ⁵⁵ 100

Due U. S. for arms, equipments, &c., \$ 100

Bounty paid \$ 100 due \$ 100

Remarks: *Mustered out by order of War Dept. dated May 3rd 1865. Patient in U.S. Gen. Hospital Fort Monroe, Va.*

Book mark:

A. G. Smith
Copyist.

L | 2 Cav. | U.S.C.T.

Lewis Leavitt

Pr., Co. C., 2 Reg't U. S. Colored Cav.

Appears on Returns as follows:

Oct 1864. Absent & sick in
18. A.C. Kaspl.

Nov 1864. Absent & sick
in 18. A.C. Kaspl at
Point Rocks, Va.

Dec 1864. Absent & sick
in 3 Div. 25 Corps
Kaspl P. & Rocks Va.

Jan & Feb 1865. Absent
sick in Hampton Bay
Kaspl Fort Monro Va.

Mar 1865. Returned
from Kaspl Fort M.

May 1865. Absent sick in
K. since May 2/65.

June 1865. Absent sick
at Balfour G.H. at
Portsmouth.

July 1865. Absent sick in
Gene Kaspl.

Book mark :

JAN. 18

40726295

1899.

*Aug 1865. Lost
June 21/65 - Norfolk Va.
Discharged by order
of Secy. of War.*

L | 2 Cav. | U.S.C.T.

Lewis Leavitt

Pvt., Co. C, 2 Reg't U. S. Col'd Cavalry.

Appears on **Co. Muster-out Roll**, dated
Brazos Santiago, Tex, Feb 12, 1866.

Muster-out to date _____, 186 .

Last paid to _____, 186 .

Clothing account:

Last settled _____, 186 ; drawn since \$ _____ 100

Due soldier \$ _____ 100 ; due U. S. \$ _____ 100

Am't for cloth'g in kind or money adv'd \$ _____ 100

Due U. S. for arms, equipments, &c., \$ _____ 100

Bounty paid \$ _____ 100 ; due \$ _____ 100

Remarks: *Joined at org'l. org.
Mustered out by order of War
Dept. dated May 3/65 at
Norfolk, Va. June 21/65.
Dist. List furn. May 21/65*

Book mark: *419, 230*

G. W. Chase

Lewis ⁹⁶⁴ Cato

Co E, 2 U. S. Col'd Cav.

Private Corporal

CARD NUMBERS.

1	5322202	26
2	5322282	27
3	5322368	28
4	5322453	29
5	5322532	30
6	5322619	31
7	5322703	32
8	5322784	33
9	5322878	34
10	5322971	35
11	5323066	36
12	5323151	37
13	5323197	38
14	5323276	39
15	9087523	40
16	40726304	41
17		42
18		43
19		44
20		45
21		46
22		47
23		48
24		49
25		50

Book Mark:

See also

S-1524484 PO aff
D 1533427 POWNUM
RTP 508777
D. 1580162 POWNUM
A 1746676 P.O. NEWY
S 1778525 P.O. NEWY
A 1912603 P.O. NEWY
A 1915682 P.O. NEWY
RTP 619286

L Dallery & Co

L | 2 Cav. | U.S.C.T.

Leato Lewis

, Co. E, 2 Reg't U. S. Col'd Cav.

Appears on

Company Descriptive Book

of the organization named above.

DESCRIPTION.

Age 32 years; height 6 feet - inches.

Complexion Black

Eyes Black; hair Black

Where born Gates Co, N. C.

Occupation Farmer

ENLISTMENT.

When Dec. 25, 1863.

Where Norfolk, Va.

By whom Col. Cole; term 3 y'rs.

Remarks:

J. D. Smith

I | **2 Cav.** | **U.S.C.T.**

Cato Lewis

Plt., Co. E, 2 Reg,t U. S. Col'd Cavalry.

Age *32* years.

Appears on

Company Muster-in Roll

of the organization named above. Roll dated

Fort Monroe, Va. Jan. 8, 1864.

Muster-in to date *Jan. 8*, 1864.

Joined for duty and enrolled:

When *December 25*, 186*3*.

Where *Norfolk, Va.*

Period *3* years.

Valuation of horse, \$ *100*

Valuation of horse equipments, \$ *100*

Remarks : -----

Book mark : -----

J. C. Taylor

L | **2 Cav.** | **U.S.C.T.**

Cato Lewis
Prnt., Co. E, 2 Reg't U. S. Col'd Cavalry.

Appears on

Company Muster Roll

for Enrollment to Feb. 29, 1864.

Present or absent Present

Stoppage, \$ 100 for

Due Gov't, \$ 100 for

Valuation of horse, \$ 100

Valuation of horse equipments, \$ 100

Remarks:

Book mark:

(358)

P. C. Taylor

Copyist.

L | **2 Cav.** | **U.S.C.T.**

Cato Lewis
Priv., Co. E, 2 Reg't U. S. Col'd Cavalry.

Appears on

Company Muster Roll

for Mar. and Apr., 1864.

Present or absent Present

Stoppage, \$ 100 for

Due Gov't, \$ 100 for

Valuation of horse, \$ 100

Valuation of horse equipments, \$ 100

Remarks:

Book mark:

(358)

T. C. Taylor

Copyist.

S | **2 Cav.** | **U.S.C.T.**

Cato Lewis
Put., Co. E, 2 Reg't U. S. Col'd Cavalry.

Appears on

Company Muster Roll

for *May and June*, 186 *4*.

Present or absent *Present*

Stoppage, \$.....*100* for

Due Gov't, \$.....*100* for

Valuation of horse, \$.....*100*

Valuation of horse equipments, \$.....*100*

Remarks:

Book mark:

P. C. Taylor
(358) Copyist.

L | **2 Cav.** | **U.S.C.T.**

Gato Lewis
Priv, Co. E, 2 Reg't U. S. Col'd Cavalry.

Appears on

Company Muster Roll

for July & Aug, 186 4

Present or absent Absent

Stoppage, \$ 100 for

Due Gov't, \$ 100 for

Valuation of horse, \$ 100

Valuation of horse equipments, \$ 100

Remarks: Detailed in 2nd
Dept. as teamster

Book mark:

Wauwington
(358) Copyist.

L | 2 Cav. | U.S.C.T.

Lato Lewis

Pr, Co. E, 2 Reg't U.S. Col'd Cavalry.

Appears on

Company Muster Roll

for Sept. & Oct., 1864

Present or absent Absent

Stoppage, \$ 100 for

Due Gov't, \$ 100 for

Valuation of horse, \$ 100

Valuation of horse equipments, \$ 100

Remarks: detailed for guard in ammunition train

Book mark:

B. Nelson
Comparer. Copyist.

L | **2 Cav.** | **U.S.C.T.**

Leato Lewis
Priv, Co. E, 2 Reg't U. S. Col'd Cavalry.

Appears on

Company Muster Roll

for *Nov & Dec*, 186 *4*

Present or absent *Absent*

Stoppage, \$ 100 for

Due Gov't, \$ 100 for

Valuation of horse, \$ 100

Valuation of horse equipments, \$ 100

Remarks: *Detailed as quartermaster for Ammunition train*

Book mark:

Waddington
Copyist.

L | **2 Cav.** | **U.S.C.T.**

Cato Lewis
Priv, Co. E, 2 Reg't U. S. Col'd Cavalry.

Appears on

Company Muster Roll

for Jan & Feb, 1865.

Present or absent Present

Stoppage, \$ 100 for

Due Gov't, \$ 100 for

Valuation of horse, \$ 100

Valuation of horse equipments, \$ 100

Remarks: Due U.S. for
Clothing worn down \$12.24

Book mark:

Waddington

L | **2 Cav.** | **U.S.C.T.**

Cato Lewis

Priv, Co. E, 2 Reg't U. S. Col'd Cavalry.

Appears on

Company Muster Roll

for *Mch. & Apl.*, 186*5*!

Present or absent *Present*

Stoppage, \$ 100 for

Due Gov't, \$ 100 for

Valuation of horse, \$ 100

Valuation of horse equipments, \$ 100

Remarks:

Book mark:

(358)

B. Nelson
Comparer. Copyist.

L | 2 Cav. | U.S.C.T.

Lato Lewis

Pvt, Co. E, 2 Reg't U. S. Col'd Cavalry.

Appears on

Company Muster Roll

for May June, 1865

Present or absent Present

Stoppage, \$ 100 for

Due Gov't, \$ 100 for

Valuation of horse, \$ 100

Valuation of horse equipments, \$ 100

Remarks:

Book mark:

J. H. Schrey Copyist.

L | 2 Cav. | U.S.C.T.

Gato Lewis

Got, Co. E, 2 Reg't U. S. Col'd Cavalry.

Appears on

Company Muster Roll

for July & Aug, 1865

Present or absent Present

Stoppage, \$ 100 for

Due Gov't, \$ 100 for

Valuation of horse, \$ 100

Valuation of horse equipments, \$ 100

Remarks:

Book mark:

(358)

J. H. Schuch Copyist.

Lo

2 Cav.

U.S.C.T.

Cato Lewis

Pvt, Co. E, 2 Reg't U. S. Col'd Cavalry.

Appears on

Company Muster Roll

for *Sept and Oct*, 1865.

Present or absent *Present*

Stoppage, \$ *100* for

Due Gov't, \$ *100* for

Valuation of horse, \$ *100*

Valuation of horse equipments, \$ *100*

Remarks:

Book mark:

N. H. Merrill

Lo | **2 Cav.** | **U.S.C.T.**

Cato Lewis

Corp, Co. E, 2 Reg't U. S. Col'd Cavalry.

Appears on

Company Muster Roll

for *Nov and Dec*, 1865.

Present or absent *Present*

Stoppage, \$ *100* for

Due Gov't, \$ *100* for

Valuation of horse, \$ *100*

Valuation of horse equipments, \$ *100*

Remarks:

Book mark:

N. H. Merrill

L | 2 Cav. | U.S.C.T.

Cato Lewis

Priv., Co. E, 2 Reg't U. S. Colored Cav.

Appears on Returns as follows:

July 1864 - Absent -
det'd as Teamster -

Aug 1864. Absent on
det. service as
Teamster since

July 18/64 per Par.
II S.O. 7040 Hd. Qr.

2^d Brig. 3^d Div. 18th A.C.

Sept 1864. Absent det.
as guard for
artillery train -

Nov 1864. Absent
as guard for
ammunition train.

Book mark :

A. M. Ellis

(546)

Copyist.

26 | **2 Cav.** | **U.S.C.T.**

Walter Lewis

Corp, Co. *E*, 2 Reg't U. S. Col'd Cavalry.

Appears on **Co. Muster-out Roll**, dated
Previous Santiago Tex, *Feb. 2*, 1866.

Muster-out to date *Feb 12*, 1866.

Last paid to *June 30*, 1865.

Clothing account:

Last settled....., 186 ; drawn since \$..... 100

Due soldier \$..... 100; due U. S. \$..... 41 ⁵⁸ 100

Am't for cloth'g in kind or money adv'd \$..... 100

Due U. S. for arms, equipments, &c., \$..... 100

Bounty paid \$..... 100; due \$..... 100

Remarks: *Discharged at expiration of service to*
Nov. 5 27 1865 Corp.

Book mark :

W. H. Merrill

965

Lewis Daniel

Co G, 2 U. S. Col'd Cav.

CARD NUMBERS.

1		26
2		27
3		28
4		29
5	<i>See Locus</i>	30 <i>Daniel</i>
6		31
7		32
8		33
9		34
10		35
11		36
12		37
13		38
14		39
15		40
16		41
17		42
18		43
19		44
20		45
21		46
22		47
23		48
24		49
25		50

Book Mark:

See also

Lewis James

Co G, 2 U. S. Col'd Cav.

Private | *Private*

CARD NUMBERS.

1	5316030	26
2	5315563	27
3	5325349	28
4	5325446	29
5	5325540	30
6	5325623	31
7	5325702	32
8	5325774	33
9	9087764	34
10	40726305	35
11		36
12		37
13		38
14		39
15		40
16		41
17		42
18		43
19		44
20		45
21		46
22		47
23		48
24		49
25		50

Book Mark:

See also

REP 426790

S. 1259143-*and*

REP 468833

S. 1426707 *and* M. Q.

S. 2384550 P. O. *and*

S. 2900789 *and* W. D.

Left 1/15/21

L. D. Gallary 4/1

L | 2 Cav. | U.S.C.T.

James Lewis

, Co. G, 2 Reg't U. S. Col'd Cav.

Appears on

Company Descriptive Book

of the organization named above.

DESCRIPTION.

Age 21 years; height 5 feet 7 inches.

Complexion *Blk*

Eyes *Blk*; hair *Blk*

Where born *Kent les, Del.*

Occupation *Farmer*

ENLISTMENT.

When *March 14*, 1865.

Where *Wilmington*

By whom *Capt. Wilmer*; term *1 yr.*

Remarks: *Accepted into
service March 14/65
Ball's Lt. Sykes
Substitute for T. K. S.
Kent les, Delaware
Has due on les, Book
\$4 80.00*

1 | 2 Cav | **U.S.C.T.**

James Lewis
Pvt., Co., 2 Reg't U. S. Col'd Cav

Age 21 years.

Appears on a

Detachment Muster-in Roll

of the organization named above. Roll dated
Baltimore, Md., Mar. 25, 1865.

Muster-in to date Mar. 18, 1865.

Joined for duty and enrolled:

When Mar. 14, 1865.

Where Wilmington

Period 1 years.

Valuation of horse, \$ 100

Valuation of horse equipments, \$ 100

Remarks: Substitute

Book mark:

W Beck
Copyist.

L 2 Cav. U.S.C.T.

James Lewis

Appears with rank of _____ on _____

Muster and Descriptive Roll of a Detachment of Substitutes forwarded

for the *L* Reg't U. S. Col'd *Cav* Roll dated

Not dated, _____, 186 .

Where born *Del.*

Age *21* y'rs; occupation *Sabver*

When enlisted *March 14*, 186 *5*

Where enlisted *Wilmington*

For what period enlisted *1* years

Eyes *Dark* *Dark*

Complexion *Dark* Height *5* ft. *4* in.

When mustered in _____, 186 .

Where mustered in _____

Bounty paid \$ *100* due \$ *100*

Where credited _____

Company to which assigned _____

Remarks: *Substitute for J. H. George Kent Co, Del.*

Book mark: _____

J. C. Taylor

CAUTION
This board was made from an unregistered roll and must not be used as the basis of an official report.
B. & P. 486676

NRH 1482

L | **2 Cav.** | **U.S.C.T.**

James Lewis

Priv, Co. G, 2 Reg't U.S. Col'd Cavalry.

Appears on

Company Muster Roll

for *men & arms*, 1865.

Present or absent *Present*

Stoppage, \$ 100 for

Due Gov't, \$ 100 for

Valuation of horse, \$ 100

Valuation of horse equipments, \$ 100

Remarks: *Due soldier on Check Book \$480.*

Book mark:

C. E. Chapin

L | 2 Cav. | U.S.C.T.

James Lewis
Col., Co. G, 2 Reg't U. S. Col'd Cavalry.

Appears on

Company Muster Roll

for May & June, 1865

Present or absent present

Stoppage, \$ 100 for

Due Gov't, \$ 100 for

Valuation of horse, \$ 100

Valuation of horse equipments, \$ 100

Remarks:

Book mark:

E. J. M.

L | **2 Cav.** | **U.S.C.T.**

James Lewis
Cvt, Co. G, 2 Reg't U. S. Col'd Cavalry.

Appears on

Company Muster Roll

for *July & Aug*, 186*5*.

Present or absent *present.*

Stoppage, \$ 100 for

Due Gov't, \$ 100 for

Valuation of horse, \$ 100

Valuation of horse equipments, \$ 100

Remarks:

Book mark: _____

E. J. [unclear]
Copyist.

L | **2 Cav.** | **U.S.C.T.**

James Lewis

Cpl., Co. G, 2 Reg't U. S. Col'd Cavalry.

Appears on

Company Muster Roll

for *Sept. & Oct.*, 1863.

Present or absent *Present*

Stoppage, \$ *100* for

Due Gov't, \$ *100* for

Valuation of horse, \$ *100*

Valuation of horse equipments, \$ *100*

Remarks: *Wm Soldier on
check Book \$4.80
by Genl. Order
from adj office
No 305 of 1864*

Book mark:

(358)

C. M. Laughlin
Copyist.

L | **2 Cav.** | **U.S.C.T.**

James Lewis

Co., Co. G, 2 Reg't U. S. Col'd Cavalry.

Appears on

Company Muster Roll

for Nov. & Dec, 1865.

Present or absent Present

Stoppage, \$ 100 for

Due Gov't, \$ 100 for

Valuation of horse, \$ 100

Valuation of horse equipments, \$ 100

Remarks: One Soldier on
check book, \$480.
by send. order 305
Adgt. Office, of 64.

Book mark:

A. M. Langh

L | **2 Cav.** | **U.S.C.T.**

James Lewis
Cor., Co. *G.*, 2 Reg't U. S. Colored Cav.

Appears on **Returns** as follows:

March 1865. Gained
March 30/65. Camp
near Norfolk -
Recruit assigned
to Co. by order Maj
Lillard.

Book mark : _____

(648)

A. H. Ellery
Coppist.

L | **2 Cav.** | **U.S.C.T.**

James Lewis

Pr., Co. A, 2 Reg't U. S. Col'd Cavalry.

Appears on **Co. Muster-out Roll**, dated

Brazos Santiago, Feb 12, 1866.

Muster-out to date Feb 12, 1866.

Last paid to June 30, 1865.

Clothing account:

Last settled....., 186 ; drawn since \$..... 100

Due soldier \$..... 100; due U. S. \$..... 36 ²²/₁₀₀

Am't for cloth'g in kind or money adv'd \$..... 100

Due U. S. for arms, equipments, &c., \$..... 100

Bounty paid \$..... 100; due \$..... 100

Remarks: Joined as Rec't.

Due Soldier on let B

\$4.80. as per G. O.

305. let also. 1864.

Book mark: 3256

C. M. Langhlin

(361)

Copyist.

Lewis, James

G 2 Co. Reg't 110 C. Cav.

1 Enclosures.

Bed Cards	Final Statements
Burial Records	Furloughs or L. of A.
Certs. of Dis. for Discharge	Med. Certificates
C. M. Charges	Med. Des. Lists
Descriptive Lists	Orders
Discharge Certificates	Pris. of War Record
Enlistment Papers	Resignations

Other papers relating to—

Admission to Hosp'l	Furlough or L. of A.
Casualty Sheet	Med. Examination
Confinement	Misc. Information
Contracts	Pay or Clothing
Death or Effects	Personal Reports
Desertion	Rank
Discharge from Hosp'l	Transfer to Hosp'l
Discharge from Service	Transfer to V. R. C.
Duty	Transportation

DECLARATION OF SUBSTITUTE.

I, James Lewis (Col), desiring to ENLIST in the Army of the United States, for ~~THREE YEARS~~, Do declare, That I am twenty one years and _____ months of age; that I have never been discharged from the United States service on account of disability or by sentence of a court martial; and I know of no impediment to my serving honestly and faithfully as a soldier for ~~three years~~ one.

GIVEN at Wilmington N.C.
the 14th day of March 1865

WITNESS:

Sam B. ...

James Lewis
mark

2/65-

No.

James Lewis (Col)
Enlisted at Wilmington

As Substitute for

Thomas H. ...
On the 14th day of March, 1865

By

Samuel ...
Samuel ...
A. ...

Board of Enrollment,

Dist. of Del

SUBSTITUTE VOLUNTEER ENLISTMENT.

STATE OF

TOWN OF

Delaware

Wilmington



I, *James Lewis (col)*, born in the State of *Delaware*, aged *twenty one* years, and by occupation a *Labourer*, Do HEREBY ACKNOWLEDGE to have agreed with *Thomas C. Green*, Esq., of *West Haverhill Kent County Delaware*

to become his **SUBSTITUTE** in the Military Service, for a sufficient consideration paid and delivered to me, on the *fourteenth* day of *March*, 1863; and having thus agreed with said *Thomas C. Green*, I DO HEREBY ACKNOWLEDGE to have enlisted this *fourteenth* day of *March*, 1863, to serve as a **Soldier** in the **Army of the United States of America**, for the period of ~~THREE~~ **YEARS**, unless sooner discharged by proper authority. I do also agree to accept such bounty, pay, rations, and clothing as are, or may be, established by law for soldiers. And I do solemnly swear that I will bear true and faithful allegiance to the **United States of America**; that I will serve them honestly and faithfully against all their enemies or opposers whomsoever; and that I will observe and obey the orders of the President of the United States and the orders of the officers appointed over me, according to the Rules and Articles of War.

SWORN and subscribed to, at *Wilmington* this *14th* of *March*, 1863, BEFORE *[Signature]*

James Lewis his *mark*

Not entitled to bounty (single)

We certify, on honor, That we have carefully examined the above-named Volunteer Substitute agreeably to the Regulations, and that, in our opinion, he is free from all bodily defects and mental infirmity which would in any way disqualify him from performing the duties of a soldier; that he was entirely sober when enlisted; that he is of lawful age, (not under 18 years;) and that, in accepting him as duly qualified to perform the duties of an able-bodied soldier, and as a Substitute in lieu of *Thomas C. Green*, drafted in *West Haverhill Kent Co Delaware July 20*, 1863, we have strictly observed the Regulations which govern in such cases. This soldier has *dark* eyes, *dark* hair, *dark* complexion; is *5 3/4* feet *4* inches high.

[Signature]
Provost Marshal.

[Signature]
Commissioner of Board.

[Signature]
Surgeon of Board.

967
Lewis Newsome

Co L, 2 U. S. Col'd Cav.

Private Private

CARD NUMBERS.

1	5315917	26
2	5329488	27
3	5329640	28
4	5329994	29
5	9088045	30
6	40726315	31
7		32
8		33
9		34
10		35
11		36
12		37
13		38
14		39
15		40
16		41
17		42
18		43
19		44
20		45
21		46
22		47
23		48
24		49
25		50

Book Mark:

See also

L | 2 Cav. | U.S.C.T.

Newsom Lewis
Pvt, Co. L, 2 Reg't U. S. Col'd Cav.

Appears on

Company Descriptive Book

of the organization named above.

DESCRIPTION.

Age 19 years; height 5 feet 9 1/2 inches.

Complexion Black

Eyes Blue; hair Blue

Where born Georgia

Occupation Tailor

ENLISTMENT.

When March 13, 1865.

Where Norristown

By whom C. Dist Pa; term 3 y'rs.

Remarks: Substitute for Wm
Stahler Norristown W
m P, Sub C Long Dist
Pa.

Died May 20"/65-

F. B. Smith
Copyst.

L *2 Cav.* **U.S.C.T.**

Newsome Lewis

Appears with rank of *Private* on

Muster and Descriptive Roll of a Detachment of Substitutes forwarded

for the *2* Reg't U. S. Col'd *Cav.* Roll dated

Chelton Hills, Pa., Mar. 23, 1865.

Where born *Georgia*

Age *19* y'rs; occupation *Sabotier*

When enlisted *Not stated*, 186

Where enlisted *Not stated*

For what period enlisted *3* years.

Eyes *Blk.*; hair *Blk.*

Complexion *Blk.*; height *5 ft. 9 1/2 in.*

When mustered in *March 13, 1865.*

Where mustered in *Norristown, Dist., Pa.*

Bounty paid \$ *100*; due \$ *100*

Where credited *Norristown, W. U., Pa.,*
1st Sub-Dist., 6th Cong. Dist.
Company to which assigned

Remarks:

Book mark:

P. C. Taylor

L | **2 Cav.** | **U.S.C.T.**

Newsome Lewis
Private, Co. *L*, 2 Reg't U. S. Col'd Cavalry.

Age years.

Appears on

Company Muster Roll*

for *Enrollment to Apr 30*, 1865.

Joined for duty and enrolled:

When, 186 .

Where

Period *3* years.

Mustered in:

When *March 15*, 1865.

Where *Normistown*

Present or absent *Present*

Stoppage, \$ 100 for

Due Gov't \$ 100 for

Valuation of horse, \$ 100

Valuation of horse equipments, \$ 100

Remarks:

*First current roll. No muster-in roll of this company on file.

Book mark:

(3586)

C. S. Rozzell
Copyist.

L | **2 Cav.** | **U.S.C.T.**

Newsome Lewis

Private, Co. L, 2 Reg't U. S. Col'd Cavalry.

Appears on

Company Muster Roll

for May + June, 1865.

Present or absent _____

Stoppage, \$ _____ 100 for _____

Due Gov't, \$ _____ 100 for _____

Valuation of horse, \$ _____ 100

Valuation of horse equipments, \$ _____ 100

Remarks: Died in Hospital
at - Portsmouth Va May
20th 1865

Book mark: _____

(358)

C S Rozzell

Copyist.

L | **2 Cav.** | **U.S.C.T.**

Newsom Lewis
Priv., Co. *L*, 2 Reg't U. S. Colored Cav.

Appears on **Returns** as follows:

May 1865 - Absent
sick in G.H. since
Apr. 11. 65 -

Book mark :

(546)

A. H. Ellison
Copyist.

L | 2 Cav. | U.S.C.T.

Newson Lewis

Private, Co. L, 2 Reg't U. S. Col'd Cavalry.

Appears on **Co. Muster-out Roll**, dated

Brazos Santiago Tex, Feb. 12, 1866.

Muster-out to date -----, 186 .

Last paid to -----, 186 .

Clothing account:

Last settled -----, 186 ; drawn since \$ ----- 100

Due soldier \$ ----- 100; due U. S. \$ ----- 100

Am't for cloth'g in kind or money adv'd \$ ----- 100

Due U. S. for arms, equipments, &c., \$ ----- 100

Bounty paid \$ ----- 100; due \$ ----- 100

Remarks: Died. Joined as
Recruit. Died at Ft. Mon-
-roe, Va, May 20/66 of
Pneumonia. Final Stats,
& list of Eff's furnished
May 29/66.

Book mark: -----

J. B. Smith

(361)

Copyist.

Lewis, Newton

Co. L, 2 Reg't 11th Cav.

2 Enclosures.

Bed Cards	Descriptive Lists
Burial Records	Final Statements /
Certs. of Dis. for Discharge	Furloughs
C. M. Charges	Med. Des. Lists
Med. Certificates	Orders

Other papers relating to—

Admission to Hosp'l	Furlough
Casualty Sheet (Officer's)	Med. Examination
Confinement	Misc. Information
Contracts	Pay or Clothing
Death or Effects /	Personal Reports
Desertions	Rank
Discharge from Hosp'l	Transfer to Hosp'l
Discharge from Service	Transfer to V. R. C.
Duty	Transportation

INVENTORY of the effects of *Newton Lewis* of
 Company *S.* *2^d* Regiment *W.S. Cold Caval.*
 who died in *Balfour U. S. General Hospital, Portsmouth, Va., May 20th* 1865.

Caps.....	/	Stockings.....
Dress Coats.....		Blankets.....
Overcoats.....		Knapsacks.....
Blouses.....		Canteens.....
Jackets.....	/	Haversacks.....
Trowsers.....	/	Muskets.....
Shirts.....		Bayonets.....
Drawers.....		Cartridge Box.....
Boots, prs.....		Belt.....
Shoes, prs.....	/	Money.....

INVENTORY
 of the effects of *Private*
Newton Lewis
 late of *Co. L 2^d* Regiment.
W.S. Cold Caval., who died at
Balfour U. S. General Hospital, Ports-
mouth, Va., May 20th 1865.

Balfour U. S. Army General Hospital,

PORTSMOUTH, VA.,

May 22^d 1865.

Commanding Officer

S

Company

2^d Regiment.

W. S. C. Cav^y

I have to inform you that
died in this Hospital on

Newton Lewis

of your Company,

May 20th 1865

of Pneumonia

I enclose inventory of his effects.

Very respectfully, yours, &c.,

J. S. Russell
1st St. V. C. and Military Dept

Extract from Act of Congress.

SEC. 12. *And be it further enacted,* That the fees of agents and attorneys for making out and causing to be executed the papers necessary to establish a claim for a pension, bounty, and other allowance before the Pension Office, under this act, shall not exceed the following rates: For making out and causing to be duly executed a declaration by the applicant, with the necessary affidavits, and forwarding the same to the Pension Office, with the requisite correspondence, ten dollars; which sum shall be received by such agent or attorney in full for all services in obtaining such pension, and shall not be demanded or received, in whole or in part, until such pension shall be obtained; and the sixth and seventh sections of an act entitled "An act to grant pensions," approved July [fourteenth,] eighteen hundred and sixty-two, are hereby repealed.

SEC. 13. *And be it further enacted,* That any agent or attorney who shall, directly or indirectly, demand or receive any greater compensation for his services under this act than is prescribed in the preceding section of this act, or who shall contract or agree to prosecute any claim for a pension, bounty, or other allowance under this act, on the condition that he shall receive a per centum upon any portion of the amount of such claim, or who shall wrongfully withhold from a pensioner or other claimant the whole or any part of the pension or claim allowed and due to such pensioner or claimant, shall be deemed guilty of a high misdemeanor, and, upon conviction thereof, shall, for every such offense, be fined not exceeding three hundred dollars, or imprisoned at hard labor not exceeding two years, or both, according to the circumstances and aggravations of the offense.

Approved July 4, 1864.

NOTE 10.—If any soldier is charged a higher fee than that allowed by the above act, he should report the fact and the name of the agent to the Adjutant General, in order that steps may be taken to have the same refunded.

ADJUTANT GENERAL'S OFFICE.

Aug 21 1864

Duplicate with Inventory sent to Auditor.

✓
FINAL STATEMENT

OF

Private James Lewis

2d Reg't of U.S. Army

VOLUNTEERS.

Rec'd May 20 1864

NOTE 1.—Two of these certificates (or duplicates) are to be given to each Volunteer Soldier or drafted man who may be discharged without being mustered out, (Final Statements are never given to men mustered out of service) that he may at once receive from the Paymaster the pay, &c., due him, and the captain or other COMMISSIONED officer commanding the company will certify to the act of the delivery of the duplicate certificates; with these certificates the Soldier is "entitled to" his discharge, and should also present his discharge to the Paymaster to have the payment endorsed on it. The discharge is to be given back to the Soldier by the Paymaster; the latter only retaining as his vouchers the duplicate certificates.

NOTE 2.—If the Soldier is entitled to pay for the use of his horse, the Company Commander will certify to that fact on the back of both these final statements, and also to the time he has pay due for having been so mounted on his own horse.

NOTE 3.—When a Soldier is furnished with final statements, his descriptive list, if he has one, should be taken up by the officer who gives the Soldier these statements, and endorsed with a statement to this effect by the officer. The endorsement should exhibit a full statement of the time for which the Soldier was allowed pay on his final statements, the clothing account, and all other charges against him or in his favor, so as to comprise a complete exhibit of his account. It will then be transmitted to the Company Commander of the Soldier, who will enter all the data necessary to a full understanding of the Soldier's account on the muster roll upon which the Soldier's discharge is reported. The descriptive list will then be destroyed. The object of this is, that the remaining portion of the Soldier's account may be settled upon the receipt of these muster rolls, and the Soldier receive any pay or allowances that may be due him at the time of his discharge, and which may not appear on his last final statements from the fact that his descriptive list is incomplete. These accounts for back pay, &c., are settled by the 2d Auditor of the Treasury Department.

NOTE 4.—Charges for loss or injury to ordnance, horse equipments, and other miscellaneous charges, should appear under the heading of "Other Stoppages."

NOTE 5.—Bounty paid by State authorities, and not by the United States, will not be entered on this statement.

NOTE 6.—Amounts due the Sutler and Laundress must be entered on the muster roll on which the discharge, death, desertion, &c., is reported, as well as on the final statement, otherwise the amount cannot be collected from the United States.

NOTE 7.—This blank will be used for deceased volunteers and drafted men, as well as for others.

NOTE 8.—Where a Soldier dies in Hospital or on detached service, his descriptive list, if he has one, should be sent with his final statements, in duplicate, to the Adjutant General, Washington, D. C.

NOTE 9.—If the soldier is a drafted man or substitute, the space for time, &c., of enrolled, should contain only the word *drafted* or *substitute*, as the case may be. If the Soldier is a "VETERAN," (or RECRUIT) the words *as a veteran*, (or *recruit*.) as the case may be, should be interlined after the words *mustered into the service of the U. S.* A statement of all the installments of *Veteran* or *Recruit Bounty RECEIVED* by the Soldier must be made on the back of each final statement.

I certify, on honor, that Newsome Lewis, a Private of
 Captain _____ Company (E) of the 2^d Regiment of U.S. Col.
VOLUNTEERS, of the State of _____, born in _____, State
 of Georgia, aged 17 years; 5 feet 9 inches high; Blk complexion,
Blk eyes, Blk hair, and by occupation a Laborer, who joined for service
 and was enrolled (see Note 9) on the 2^d day of February, 1867, at _____
 by _____, for the period of Three years, and mustered into
 the service of the United States on the fourth day of March, 1867, at
Acornstown, by 8th Dist Penna.; and having served
 HONESTLY and FAITHFULLY with his Company to the present date, is now entitled to a
DISCHARGE by reason of Death (died in Balfour Gen
 Hospital May 20 1865)

The said Newsome Lewis has was last paid by Paymaster
never been paid, to include the _____ day of _____, 1867, and
 has pay due him from date of enrollment ~~that time~~ to the present date; he is entitled to pay and subsistence for
TRAVELING to place of enrollment, and whatever other allowances are authorized to volunteer
 soldiers, drafted men, or militia, so discharged. He has received from the United States **CLOTHING**
 amounting to Thirty three ⁶¹/₁₀₀ dollars, since the 13 day of March,
 1867, when his clothing account was last settled. He has received from the United States
 _____ ¹⁰⁰/₁₀₀ dollars advanced **BOUNTY**.

There is to be stopped from him, on account of the State of _____, or other
 authorities, for **CLOTHING**, &c., received on entering service, Twenty five ⁵⁰/₁₀₀ dollars; and
 for other stoppages, viz: _____

He has been furnished with **TRANSPORTATION** in kind from the place of his discharge to _____
 _____; and he has been **SUBSISTED** for **TRAVELING** to his
 place of enrollment, up to the _____, 1867.

He is indebted to _____ **SUTLER**, _____ ¹⁰⁰/₁₀₀ dollars.
 He is indebted to _____ **LAUNDRESS**, _____ ¹⁰⁰/₁₀₀ dollars.

Given in Duplicate, at Camp Meade near City Point, this 20th day
 of May, 1867.

Francis G. Gage
Lieut 2^d U.S. Col.
 Commanding Company

968
J. Linear Hance

Co *J*, **2** U. S. Col'd Cav.

Private

CARD NUMBERS.

1	26
2	27
3	28
4	29
5 <i>See Linear</i>	30 <i>Hance</i>
6	31
7	32
8	33
9	34
10	35
11	36
12	37
13	38
14	39
15	40
16	41
17	42
18	43
19	44
20	45
21	46
22	47
23	48
24	49
25	50

Book Mark:

See also

969

Linear McLean

Co I, 2 U. S. Col'd Cav.

CARD NUMBERS.

1	26
2	27
3	28
4	29
5 <i>See Linear</i>	30 <i>McLean</i>
6	31
7	32
8	33
9	34
10	35
11	36
12	37
13	38
14	39
15	40
16	41
17	42
18	43
19	44
20	45
21	46
22	47
23	48
24	49
25	50

Book Mark:

See also

970

Livia Homes
Co G, 2 U. S. Col'd Cav.

CARD NUMBERS.

1		26
2		27
3		28
4		29
5	<i>See Conner</i>	<i>Levi</i>
6		31
7		32
8		33
9		34
10		35
11		36
12		37
13		38
14		39
15		40
16		41
17		42
18		43
19		44
20		45
21		46
22		47
23		48
24		49
25		50

Book Mark:

See also

97
Lloyd Ellis

Co K, 2 U. S. Col'd Cav.

Private Sergeant

CARD NUMBERS.

1	26
2	27
3	28
4	29
5	30
6	31
7	32
8	33
9	34
10	35
11	36
12	37
13	38
14	39
15	40
16	41
17	42
18	43
19	44
20	45
21	46
22	47
23	48
24	49
25	50

See Ellis, Lloyd,

Book Mark:

See also

972
Loachi Peter

Co C, 2 U. S. Col'd Cav.

CARD NUMBERS.

1	26
2	27
3	28
4	29
5	30
6	31
7	32
8	33
9	34
10	35
11	36
12	37
13	38
14	39
15	40
16	41
17	42
18	43
19	44
20	45
21	46
22	47
23	48
24	49
25	50

See Locke Peter

Book Mark:

See also

Loche 973 Peter

Co. 6, 2 U. S. Col'd Cav.

Private Boyler

CARD NUMBERS.

1	5319803	26
2	5319879	27
3	5319965	28
4	5320053	29
5	5320136	30
6	5320177	31
7	5320274	32
8	5320360	33
9	5320444	34
10	5320543	35
11	5320641	36
12	5320733	37
13	5320822	38
14	5320907	39
15	9087329	40
16		41
17		42
18		43
19		44
20		45
21		46
22		47
23		48
24		49
25		50

Book Mark:

See also

L Ballan

Loche 973 Peter

Co B, 2 U. S. Col'd Cav.

Private Boyles

CARD NUMBERS.

1	5319803	26
2	5319879	27
3	5319965	28
4	5320053	29
5	5320136	30
6	5320177	31
7	5320274	32
8	5320360	33
9	5320444	34
10	5320543	35
11	5320641	36
12	5320733	37
13	5320822	38
14	5320907	39
15	9087329	40
16		41
17		42
18		43
19		44
20		45
21		46
22		47
23		48
24		49
25		50

Book Mark:

See also

S 864281. P.O. aff.
S-95-8977 - P.O. aff.
S 1989636. P.O. m. m.

L Ballany & Co

L | 2 Cav. | U.S.C.T.

Peter Liche

, Co. 6, 2 Reg't U. S. Col'd Cav.

Appears on

Company Descriptive Book

of the organization named above.

DESCRIPTION.

Age / 5 years; height 5 feet 1 inches.

Complexion Black

Eyes Black; hair Black

Where born Newburn, N. C.

Occupation Laborer

ENLISTMENT.

When Dec 24, 1863.

Where Fort Monroe

By whom Geo. W. Cole term 3 y'rs.

Remarks:

F. B. Smith

B | **2 Cav.** | **U.S.C.T.**

Peter Boche

Pot, Co. ©, 2 Reg't U. S. Col'd Cavalry.

Age.....years.

Appears on

Company Muster-in Roll

of the organization named above. Roll dated

Ft Monroe Va Dec 24, 1863.

Muster-in to date Dec 24, 1863.

Joined for duty and enrolled:

When Dec 24, 1863.

Where Ft Monroe Va

Period 3 years.

Valuation of horse, \$.....100

Valuation of horse equipments, \$.....100

Remarks :.....

Book mark :.....

Hadfield

J. | **2 Cav.** | **U.S.C.T.**

Peter Roche

1st, Co. C, 2 Reg't U. S. Col'd Cavalry.

Appears on

Company Muster Roll

for *dated Feb 29*, 186*4*.

Present or absent *Present*

Stoppage, \$.....100 for

Due Gov't, \$.....100 for

Valuation of horse, \$.....100

Valuation of horse equipments, \$.....100

Remarks:.....
.....
.....
.....
.....
.....
.....
.....
.....
.....

Book mark:.....
.....

Hadfield

L | 2 Cav. | U.S.C.T.

Peter Roche

Private, Co. C, 2 Reg't U. S. Col'd Cavalry.

Appears on

Company Muster Roll

for March & April, 1864.

Present or absent Present

Stoppage, \$ 100 for

Due Gov't, \$ 100 for

Valuation of horse, \$ 100

Valuation of horse equipments, \$ 100

Remarks:

Book mark:

(358)

H. Selfield

Copyist.

J | **2 Cav.** | **U.S.C.T.**

Peter Siche

Pat, Co. C, 2 Reg't U. S. Col'd Cavalry.

Appears on

Company Muster Roll

for *March June*, 186 *4*

Present or absent *Present*

Stoppage, \$ *100* for

Due Gov't, \$ *100* for

Valuation of horse, \$ *100*

Valuation of horse equipments, \$ *100*

Remarks:

Book mark:

Hadfield

L | 2 Cav. | U.S.C.T.

Peter Loachi

Private, Co. C, 2 Reg't U. S. Col'd Cavalry.

Appears on

Company Muster Roll

for July & Aug, 1864.

Present or absent Present

Stoppage, \$ 100 for

Due Gov't, \$ 100 for

Valuation of horse, \$ 100

Valuation of horse equipments, \$ 100

Remarks:

Book mark:

W. D. ...

L | 2 Cav. | U.S.C.T.

Peter L'ouch

Byler, Co. C, 2 Reg't U. S. Col'd Cavalry.

Appears on

Company Muster Roll

for Sept + Oct, 1864.

Present or absent Present

Stoppage, \$ 100 for

Due Gov't, \$ 100 for

Valuation of horse, \$ 100

Valuation of horse equipments, \$ 100

Remarks:

Book mark:

Woblog

L | 2 Cav. | U.S.C.T.

Peter Poche

Bugler, Co. C, 2 Reg't U. S. Col'd Cavalry.

Appears on

Company Muster Roll

for Nov & Dec, 1864.

Present or absent Present

Stoppage, \$ 100 for

Due Gov't, \$ 100 for

Valuation of horse, \$ 100

Valuation of horse equipments, \$ 100

Remarks:

[Empty lines for remarks]

Book mark:

Woblog

L | 2 Cav. | U.S.C.T.

Peter Loach
Byler, Co. C, 2 Reg't U. S. Col'd Cavalry.

Appears on

Company Muster Roll

for Jan Feb, 1865

Present or absent Present

Stoppage, \$ 100 for

Due Gov't, \$ 100 for

Valuation of horse, \$ 100

Valuation of horse equipments, \$ 100

Remarks:

Book mark:

(358)

W. D. L.

Copyist.

L | 2 Cav. | U.S.C.T.

Peter Locher

Bugler, Co. C, 2 Reg't U. S. Col'd Cavalry.

Appears on

Company Muster Roll

for March & April, 1865.

Present or absent Present

Stoppage, \$ 100 for

Due Gov't, \$ 100 for

Valuation of horse, \$ 100

Valuation of horse equipments, \$ 100

Remarks:

Book mark:

J. L. Norris

L | 2 Cav. | U.S.C.T.

Peter Roche

Bugler, Co. C, 2 Reg't U. S. Col'd Cavalry.

Appears on

Company Muster Roll

for *May & June*, 1865.

Present or absent *Present*

Stoppage, \$ 100 for

Due Gov't, \$ 100 for

Valuation of horse, \$ 100

Valuation of horse equipments, \$ 100

Remarks:

Book mark:

J. L. Morris

L | 2 Cav. | U.S.C.T.

Peter Locke

Bugler, Co. C, 2 Reg't U. S. Col'd Cavalry.

Appears on

Company Muster Roll

for *July & August*, 1865.

Present or absent *Present*

Stoppage, \$ 100 for

Due Gov't, \$ 100 for

Valuation of horse, \$ 100

Valuation of horse equipments, \$ 100

Remarks: *Due U.S. for Ordnance 85 cts.*

Book mark:

J. L. Morris

L | 2 Cav. | U.S.C.T.

Peter Loche

Bugler, Co. C, 2 Reg't U. S. Col'd Cavalry.

Appears on

Company Muster Roll

for Sept & Oct, 1865.

Present or absent Present

Stoppage, \$ 100 for

Due Gov't, \$ 100 for

Valuation of horse, \$ 100

Valuation of horse equipments, \$ 100

Remarks: Due U.S. for ordnance 85 cts.

Book mark:

G. W. Chase

L | 2 Cav. | U.S.C.T.

Peter Loche

Bugler, Co. C, 2 Reg't U. S. Col'd Cavalry.

Appears on

Company Muster Roll

for Nov & Dec, 1865.

Present or absent Present

Stoppage, \$ 100 for

Due Gov't, \$ 100 for

Valuation of horse, \$ 100

Valuation of horse equipments, \$ 100

Remarks:

Book mark:

G. W. Chase

MAR 14 1865

L | 2 Cav. | U.S.C.T.

Peter Loche

Bugler, Co. C, 2 Reg't U. S. Col'd Cavalry.

Appears on Co. Muster-out Roll, dated Brazos Santiago, Tex Feb 12, 1864.

Muster-out to date Feb 12, 1864.

Last paid to June 30, 1865.

Clothing account:

Last settled, 186 ; drawn since \$ 100

Due soldier \$ 100; due U. S. \$ 42 58 / 100

Am't for cloth'g in kind or money adv'd \$ 100

Due U. S. for arms, equipments, &c., \$ 100

Bounty paid \$ 100; due \$ 100

Remarks: Joined at org. l org. Was Pvt. till Apr. 1/65

Book mark: V. 37, P. 76. 69

G. W. Chase

MAR 14 1896

974
Locus Daniel

Co G, 2 U. S. Col'd Cav.

Private Private

CARD NUMBERS.

1	5-315-743	26
2	5-324-718	27
3	5-324-808	28
4	5-324-897	29
5	5-324-987	30
6	5-316-255	31
7	5-325-079	32
8	5-316-692	33
9	5-325-143	34
10	5-325-257	35
11	5-325-356	36
12	5-325-485	37
13	5-316-962	38
14	5-325-835	39
15	9087727	40
16	40726308	41
17		42
18		43
19		44
20		45
21		46
22		47
23		48
24		49
25		50

Book Mark:

See also

L | 2 Cav. | U.S.C.T.

Daniel Loew

, Co. G, 2 Reg't U. S. Col'd Cav.

Appears on

Company Descriptive Book

of the organization named above.

DESCRIPTION.

Age 40 years; height 5 feet 8 inches.

Complexion Dark

Eyes Dark; hair Dark

Where born Natick, N. C.

Occupation Laborer

ENLISTMENT.

When Jan. 10, 1864.

Where Ft Munn

By whom Col. G. W. Cole; term 3 y'rs.

Remarks: Engaged in action at New Market Heights Sept. 29-64, deserted June 14, 1865 at Portsmouth, Va.

F. B. Smith
Copyist.

L. | 2 Cav. | U.S.C.T.

Daniel Lucas

Pvt., Co. 2, Reg't U. S. Col'd Cav.

Age years.

Appears on a

Detachment Muster-in Roll

of unattached recruits of the organization named above. Roll dated

St. Maurice, Va. Jan. 19, 1864.

Muster-in to date Jan. 19, 1864.

Joined for duty and enrolled:

When Jan. 10, 1864.

Where St. Maurice, Va.

Period 3 years.

Valuation of horse, \$ 100

Valuation of horse equipments, \$ 100

Remarks :

Book mark :

G. J. Kearney Copyist.

S | **2 Cav.** | **U.S.C.T.**

Daniel Lucas
Plt, Co. G, 2 Reg't U. S. Col'd Cavalry.

Appears on

Company Muster Roll

for *Dated Feb 29*, 186*4*.

Present or absent *Present*

Stoppage, \$ 100 for

Due Gov't, \$ 100 for

Valuation of horse, \$ 100

Valuation of horse equipments, \$ 100

Remarks:

Book mark: -----

J M Harmon

Lt | **2 Cav.** | **U.S.C.T.**

Daniel Locus

Pvt., Co. G, 2 Reg't U. S. Col'd Cavalry.

Appears on

Company Muster Roll

for *Mar & Apr*, 186 *4*

Present or absent *Present*

Stoppage, \$ *100* for

Due Gov't, \$ *100* for

Valuation of horse, \$ *100*

Valuation of horse equipments, \$ *100*

Remarks:

Book mark:

A. M. Harmon

L | **2 Cav.** | **U.S.C.T.**

David Lucas

Pr., Co. G, 2 Reg't U. S. Col'd Cavalry.

Appears on

Company Muster Roll

for *May & June*, 186 *4*

Present or absent *Present*

Stoppage, \$ *100* for

Due Gov't, \$ *2⁶⁹/₁₀₀* for *ordnance*

Valuation of horse, \$ *100*

Valuation of horse equipments, \$ *100*

Remarks: *Pay over \$7 per mo,
due since Jan 1*

Book mark:

J. M. Harmon

L | **2 Cav.** | **U.S.C.T.**

Daniel Locus

Priv, Co. G, 2 Reg't U. S. Col'd Cavalry.

Appears on

Company Muster Roll

for *July & Aug*, 1864.

Present or absent *Absent*

Stoppage, \$ *100* for

Due Gov't, \$ *2 69* for *ordnance*

Valuation of horse, \$ *100*

Valuation of horse equipments, \$ *100*

Remarks: *Detached in
Q. M. D. at Leinster.*

Book mark:

J. P. Brown

20 | *2 bar* | U.S.C.T.

Daniel Locust

20, Co. *2*, Reg't U. S. Col'd *bar*

Appears on a

Detachment Muster Roll

of the organization named above

for *Dated Sept.*, 1867.

Station *In the field*

Present or absent *Present*

Stoppage, \$ *100* for

Due Gov't, \$ *100* for

Valuation of horse, \$ *100*

Valuation of horse equipments, \$ *100*

Remarks: *Stoppage for
Ordnance \$2.69*

Book mark:

G. Smith

L | **2 Cav.** | **U.S.C.T.**

Daniel Locus

Pr, Co. G, 2 Reg't U. S. Col'd Cavalry.

Appears on

Company Muster Roll

for *Sept & Oct*, 1864.

Present or absent *Present*

Stoppage, \$ *100* for

Due Gov't, \$ *100* for

Valuation of horse, \$ *100*

Valuation of horse equipments, \$ *100*

Remarks:

Book mark:

J. Brown
Copyist.

L | 2 Cav. | U.S.C.T.

Daniel Focus

Priv., Co. G, 2 Reg't U. S. Col'd Cavalry

Appears on a

Detachment Muster Roll

of the organization named above

for Nov Dec, 1864

Station Field before Richmond, Va

Present or absent Present

Stoppage, \$ 100 for

Due Gov't, \$ 100 for

Valuation of horse, \$ 100

Valuation of horse equipments, \$ 100

Remarks:

Book mark:

W. B. ...

L | **2 Cav.** | **U.S.C.T.**

Daniel Lewis

Pri, Co. G, 2 Reg't U.S. Col'd Cavalry.

Appears on

Company Muster Roll

for *Nov + Dec*, 186*4*.

Present or absent *Absent*

Stoppage, \$ *100* for

Due Gov't, \$ *100* for

Valuation of horse, \$ *100*

Valuation of horse equipments, \$ *100*

Remarks: *Absent on detached service No. Q. 25 A.C.*

Book mark:

J. T. Brown
Copyist.

L | **2 Cav.** | **U.S.C.T.**

Daniel Locus

Pri, Co. G, 2 Reg't U. S. Col'd Cavalry.

Appears on

Company Muster Roll

for *Jany & Feb*, 1865.

Present or absent *present*

Stoppage, \$ *100* for

Due Gov't, \$ *100* for

Valuation of horse, \$ *100*

Valuation of horse equipments, \$ *100*

Remarks:

Book mark:

J. Brown
Copyist.

L | **2 Cav.** | **U.S.C.T.**

Daniel Locus

Prv, Co. G, 2 Reg't U.S. Col'd Cavalry.

Appears on

Company Muster Roll

for *Mc'h + Apr*, 1865

Present or absent *Absent*

Stoppage, \$ *100* for

Due Gov't, \$ *100* for

Valuation of horse, \$ *100*

Valuation of horse equipments, \$ *100*

Remarks: *With Regt. at Norfolk. Was
as per instructions from Regtl
Comdr.*

Book mark:

J. E. Chapin

L | **2 Cav.** | **U.S.C.T.**

Daniel Locus

Pl, Co. G, 2 Reg't U.S. Col'd Cavalry.

Appears on

Company Muster Roll

for *May & June*, 186*6*.

Present or absent

Stoppage, \$ 100 for

Due Gov't, \$ 100 for

Valuation of horse, \$ 100

Valuation of horse equipments, \$ 100

Remarks: *Deserted June 14, '66,*
at Portsmouth, Va, with
Arms & Accoutrements

Total cost \$41.55

See Mr. W. Stuart Sutter
2^d U.S. Col. Cav. #15⁰⁰

Book mark:

Guetra

L | 2. Cav | U.S.C.T.

Daniel Lucas

Pvt., Co. G, 2 Reg't U. S. Col'd Cav

Appears on

Descriptive List of Deserters

dated Aug 1, 1865.

Deserted:

When June 14, 1865.

Where Portsmouth, Va.

Arrested:

When _____, 186 .

Where _____

Remarks: See U.S. for Ordnance

Book mark: _____

E. M. Weston

L | 2 Cav. | U.S.C.T.

Daniel Locus
Pr., Co. G, 2 Reg't U. S. Colored Cav.

Appears on Returns as follows:

July 1864. Absent
on det. service as
Teamster -

Aug 1864. Absent on
detached service as
Teamster per S.O. 40
Hd. Qrs. 20, 3 Div. Pac.

Dec 1864. Absent - det.
on Prov. Guard at
Hd. Qrs. 26 - A.C.

March 1865 - On duty
at Indian Pole Bridge
doing guard duty
by virtue of S.O. 49
dated Hd. Qrs. 2 268
C.C. March 2 - 1865 -

April 1865. Absent on det.
service at Indian Pole
Bridge -

June 1865 - Loss:
Deserted -

Book mark :

022

M. E. Elliot

JAN. 18

40726308

1899.

*ye name appears also as
Daniel Lione.*

L | **2 Cav.** | **U.S.C.T.**

Daniel Lucas

Pr., Co. G, 2 Reg't U. S. Col'd Cavalry.

Appears on **Co. Muster-out Roll**, dated

Brazos Santiago Tex, Feb 12, 1866.

Muster-out to date _____, 186 .

Last paid to Dec 31, 1864.

Clothing account:

Last settled _____, 186 ; drawn since \$ _____ 100

Due soldier \$ _____ 100; due U. S. \$ _____ 100

Am't for cloth'g in kind or money adv'd \$ _____ 100

Due U. S. for arms, equipments, &c., \$ _____ 100

Bounty paid \$ _____ 100; due \$ _____ 100

Remarks: Joined as recruit.

Deserted, at Reulmout.

Was June 13, 1865,

descriptive list sent

Sept. 30, 65.

Book mark : _____

C. J. McLaughlin
(361) Copyist.

London Thomas

Co I, 2 U. S. Col'd Cav.

Private Private

CARD NUMBERS.

1	5-3 2 7 3 6 6	26
2	5-3 2 7 4 5 2	27
3	5-3 2 7 5 4 4	28
4	5-3 2 7 6 3 4	29
5	5-3 2 7 7 2 5 1	30
6	5-3 2 7 8 1 8	31
7	5-3 2 7 9 0 8	32
8	5-3 2 7 9 9 4	33
9	5-3 2 8 0 7 7	34
10	5-3 2 8 1 5 7 8	35
11	9 0 8 7 8 6 1	36
12	4 0 7 2 6 7 3 3	37
13		38
14		39
15		40
16		41
17		42
18		43
19		44
20		45
21		46
22		47
23		48
24		49
25		50

Book Mark:

See also

S. 924632 - P.O. aff
D 1290194 P.O. aff
A. 1425873 P.O. aff.
R. + P. 527884

L. Ballantyne

2 | **2 Cav.** | **U.S.C.T.**

Thomas London

....., Co. *D*, 2 Reg't U. S. Col'd Cav.

Appears on
Company Descriptive Book

of the organization named above.

DESCRIPTION.

Age *20* years; height *5* feet inches.

Complexion *Black*

Eyes *Black*; hair *Black*

Where born *Norfolk, Va.*

Occupation *Laborer*

ENLISTMENT.

When *April 20, 1864.*

Where *Ft Monroe, Va.*

By whom *St Hudson*; term *3* y'rs.

Remarks: *Mustered June 27-64 at Bermuda Hundred Va. by Capt Martin.*

F. B. Smith

L | **2 Cav.** | **U.S.C.T.**

Thomas London

Pi, Co. I, 2 Reg't U. S. Col'd Cavalry.

Appears on

Company Muster Roll

for *July & Aug*, 1864.

Present or absent *Present*

Stoppage, \$ *100* for

Due Gov't, \$ *100* for

Valuation of horse, \$ *100*

Valuation of horse equipments, \$ *100*

Remarks: *enrolled Apr 20/64
at - Ft Monroe - Mustered in
June 29/64 at Bermuda
Hundred Va for 3 years)*

Book mark:

C. J. Smith

L | 2 Cav. | U.S.C.T.

Thomas London

Pri, Co. I, 2 Reg't U. S. Col'd Cavalry.

Appears on

Company Muster Roll

for Sept & Oct, 1867.

Present or absent Present

Stoppage, \$ 100 for

Due Gov't, \$ 100 for

Valuation of horse, \$ 100

Valuation of horse equipments, \$ 100

Remarks:

Book mark:

O. G. Smith

L | **2 Cav.** | **U.S.C.T.**

Thomas London

Api....., Co. I, 2 Reg't U. S. Col'd Cavalry.

Appears on

Company Muster Roll

for *Nov & Dec*....., 186*7*.

Present or absent *Present*.....

Stoppage, \$..... *100* for.....

Due Gov't, \$..... *100* for.....

Valuation of horse, \$..... *100*

Valuation of horse equipments, \$..... *100*

Remarks:.....
.....
.....
.....
.....
.....
.....
.....
.....
.....

Book mark:.....

O. G. Smith

L | **2 Cav.** | **U.S.C.T.**

Thomas London

Pr....., Co. I, 2 Reg't U. S. Col'd Cavalry.

Appears on

Company Muster Roll

for Jan & Feb, 1865.

Present or absent Present

Stoppage, \$ 100 for

Due Gov't, \$ 100 for

Valuation of horse, \$ 100

Valuation of horse equipments, \$ 100

Remarks:
.....
.....
.....
.....
.....
.....
.....
.....
.....
.....

Book mark:

G. Smith

L | **2 Cav.** | **U.S.C.T.**

Thomas Loudon

Qui, Co. I, 2 Reg't U. S. Col'd Cavalry.

Appears on

Company Muster Roll

for *Mch & Apr*, 1865.

Present or absent *Present*

Stoppage, \$ 100 for

Due Gov't, \$ 100 for

Valuation of horse, \$ 100

Valuation of horse equipments, \$ 100

Remarks:

Book mark: _____

A. J. Griffith

L | 2 Cav. | U.S.C.T.

Thomas Loudene

seri, Co. I, 2 Reg't U. S. Col'd Cavalry.

Appears on

Company Muster Roll

for May & June, 1865.

Present or absent Present

Stoppage, \$ 100 for

Due Gov't, \$ 100 for

Valuation of horse, \$ 100

Valuation of horse equipments, \$ 100

Remarks:

Book mark:

D. J. Griffith

L | **2 Cav.** | **U.S.C.T.**

Thomas London

ser, Co. I, 2 Reg't U. S. Col'd Cavalry.

Appears on

Company Muster Roll

for *July & August*, 186*5*.

Present or absent *Present*

Stoppage, \$ 100 for

Due Gov't, \$ 100 for

Valuation of horse, \$ 100

Valuation of horse equipments, \$ 100

Remarks:

Book mark:

D. J. Grippick

L. | **2 Cav.** | **U.S.C.T.**

Thomas Gordon.

Priv., Co. I, 2 Reg't U. S. Col'd Cavalry.

Appears on

Company Muster Roll

for *Sept. 7 Oct.*, 186*5*.

Present or absent *Present.*

Stoppage, \$ *100* for

Due Gov't, \$ *100* for

Valuation of horse, \$ *100*

Valuation of horse equipments, \$ *100*

Remarks:

Book mark: -----

Pol,

G. | **2 Cav.** | **U.S.C.T.**

Thomas London,

Priv, Co. I, 2 Reg't U. S. Col'd Cavalry.

Appears on

Company Muster Roll

for *Nov 7 Dec*, 186*5*.

Present or absent *Present*

Stoppage, \$..... 100 for

Due Gov't, \$..... 100 for

Valuation of horse, \$..... 100

Valuation of horse equipments, \$..... 100

Remarks:

Book mark:

Pal

T | 2 Cav. | U.S.C.T.

London Thomas

Pat, Co. I, 2 Reg't U. S. Colored Cav.

Appears on Returns as follows:

July 1864 Garrison
July 26 In the
Field. Rec't
attached to Co

Book mark:

(540)

A. J. Anglat
Copyist.

L. | 2 Cav. | U.S.C.T.

Thomas London,

Priv., Co. I, 2 Reg't U. S. Col'd Cavalry.

Appears on Co. Muster-out Roll, dated
Brownsville Tex, Feb. 12, 1866.

Muster-out to date Feb. 12, 1866.

Last paid to June 30, 1865.

Clothing account:

Last settled....., 186 ; drawn since \$..... 100

Due soldier \$..... 100; due U. S. \$ 10, ⁹⁴/₁₀₀

Am't for cloth'g in kind or money adv'd \$..... 100

Due U. S. for arms, equipments, &c., \$..... 100

Bounty paid \$..... 100; due \$ ~~100~~ ¹⁰⁰/₁₀₀

Remarks: joined as recruit.
* Free before Apr 19-66 Es-
caped slave.

* As it appears on roll.

Book mark: 2409. 1880.

Pal,

976

Loney John

Co A, 2 U. S. Col'd Cav.

CARD NUMBERS.

1	26
2	27
3	28
4	29
5	30
6	31
7	32
8	33
9	34
10	35
11	36
12	37
13	38
14	39
15	40
16	41
17	42
18	43
19	44
20	45
21	46
22	47
23	48
24	49
25	50

See Loney John

Book Mark:

See also

977
Looney John

Co A, 2 U. S. Col'd Cav.

Private Garrison

CARD NUMBERS.

1	5317247	26
2	5317321	27
3	5317411	28
4	5317499	29
5	5317579	30
6	5317669	31
7	5317756	32
8	5317844	33
9	5318081	34
10	5317938	35
11	5317985	36
12	5318161	37
13	5318237	38
14	5318310	39
15	9087095	40
16	40726309	41
17		42
18		43
19		44
20		45
21		46
22		47
23		48
24		49
25		50

Book Mark:

See also

L | 2 Cav. | U.S.C.T.

John Loney
Co. A, 2 Reg't U. S. Col'd Cav.

Appears on

Company Descriptive Book

of the organization named above.

DESCRIPTION.

Age 28 years; height _____ feet _____ inches.

Complexion _____ Black

Eyes Black; hair Black

Where born _____

Occupation _____

ENLISTMENT.

When _____ Dec 22, 186 _____

Where Ft Monroe

By whom Col. Cole; term 3 y'rs.

Remarks: Is a good
Blacksmith

F. B. Smith

L | **2 Cav.** | **U.S.C.T.**

John Lacey
....., Co. *A*, 2 Reg't U. S. Col'd Cavalry.

Age years.

Appears on

Company Muster-in Roll

of the organization named above. Roll dated

Fort Monroe Va, *Dec 22*, 186 *3*.

Muster-in to date *Dec 22*, 186 *3*.

Joined for duty and enrolled:

When *Dec 22*, 186 *3*

Where *Fort Monroe Va*

Period *3* years.

Valuation of horse, \$.....100

Valuation of horse equipments, \$.....100

Remarks :
.....
.....
.....
.....

Book mark :
.....

(356) *J. E. Chapin* Copyist.

L | **2 Cav.** | **U.S.C.T.**

John Loney

Pvt, Co. A, 2 Reg't U. S. Col'd Cavalry.

Appears on

Company Muster Roll

for *from Enrollment to Feb. 29*, 1864.

Present or absent *Present*

Stoppage, \$ *100* for

Due Gov't, \$ *100* for

Valuation of horse, \$ *100*

Valuation of horse equipments, \$ *100*

Remarks:

Book mark:

J. E. Chapin

L | **2 Cav.** | **U.S.C.T.**

Tom Loney
.....
Pr....., Co. A, 2 Reg't U. S. Col'd Cavalry.

Appears on

Company Muster Roll

for *March Apr*....., 1864.

Present or absent *Present*.....

Stoppage, \$.....100 for

Due Gov't, \$.....100 for

Valuation of horse, \$.....100

Valuation of horse equipments, \$.....100

Remarks: *on duty as blacksmith*
since March 24/64,

Book mark:

J. E. Chapin

L | **2 Cav.** | **U.S.C.T.**

John Loney

Pvt, Co. A, 2 Reg't U. S. Col'd Cavalry.

Appears on

Company Muster Roll

for *May & June*, 186*4*.

Present or absent *Present*

Stoppage, \$ *100* for

Due Gov't, \$ *100* for

Valuation of horse, \$ *100*

Valuation of horse equipments, \$ *100*

Remarks:

Book mark:

(358) *J. E. Chapin* Copyist.

L | **2 Cav.** | **U.S.C.T.**

John Loney

Priv, Co. A, 2 Reg't U.S. Col'd Cavalry.

Appears on

Company Muster Roll

for *July & Aug*, 1864.

Present or absent *Present*

Stoppage, \$ 100 for

Due Gov't, \$ 100 for

Valuation of horse, \$ 100

Valuation of horse equipments, \$ 100

Remarks: *Stoppages*

One nose bag \$ 1.50

" Curry Comb .26

" Cav. line \$.30

Book mark:

R B Shelton

S | **2 Cav.** | **U.S.C.T.**

John Loney
Priv, Co. A, 2 Reg't U. S. Col'd Cavalry.

Appears on

Company Muster Roll
for *Sept & Oct*, 1864.

Present or absent *Present*

Stoppage, \$ 100 for

Due Gov't, \$ 100 for

Valuation of horse, \$ 100

Valuation of horse equipments, \$ 100

Remarks:

Book mark: _____

R. S. Shelton
Copyist.

L | **2 Cav.** | **U.S.C.T.**

John Loney
Plt, Co. A, 2 Reg't U. S. Col'd Cavalry.

Appears on

Company Muster Roll

for *Nov + Dec*, 1864.

Present or absent *Present*

Stoppage, \$ *100* for

Due Gov't, \$ *100* for

Valuation of horse, \$ *100*

Valuation of horse equipments, \$ *100*

Remarks:

Book mark: -----

R S Shelton

S | **2 Cav.** | **U.S.C.T.**

John Loney
Cvt, Co. A, 2 Reg't U. S. Col'd Cavalry.

Appears on

Company Muster Roll

for *Jan + Feb*, 1865.

Present or absent *Present*

Stoppage, \$ *100* for

Due Gov't, \$ *100* for

Valuation of horse, \$ *100*

Valuation of horse equipments, \$ *100*

Remarks:

Book mark:

R S Shelton

L | 2 Cav. | U.S.C.T.

John Conroy
Sgt., Co. A, 2 Reg't U. S. Col'd Cavalry.

Appears on

Company Muster Roll

for *Sept 20th*, 1865.

Present or absent *Present*

Stoppage, \$ *100* for

Due Gov't, \$ *100* for

Valuation of horse, \$ *100*

Valuation of horse equipments, \$ *100*

Remarks:

Book mark : _____

Miller
Copyst.

L | 2 Cav. | U.S.C.T.

John Loney
Squad Leader, Co. A, 2 Reg't U.S. Col'd Cavalry.

Appears on

Company Muster Roll

for May & June, 1865.

Present or absent Present.

Stoppage, \$ 100 for

Due Gov't, \$ 100 for

Valuation of horse, \$ 100

Valuation of horse equipments, \$ 100

Remarks: Appointed from
private June 18 1865
vice Connor.

Book mark:

L. | 2 Cav. | U.S.C.T.

John Lenny
Farrier Co. A, 2 Reg't U. S. Col'd Cavalry.

Appears on

Company Muster Roll

for July & Aug, 1865.

Present or absent Present.

Stoppage, \$ 100 for

Due Gov't, \$ 100 for

Valuation of horse, \$ 100

Valuation of horse equipments, \$ 100

Remarks: Appointed from
Private to Farrier
June 16/65.

Book mark:

Melby
Copyist.

Lo. | 2 Cav. | U.S.C.T.

John Loney
Farrier, Co. A, 2 Reg't U. S. Col'd Cavalry.

Appears on

Company Muster Roll

for Sep + Oct, 1865.

Present or absent present

Stoppage, \$ 100 for

Due Gov't, \$ 100 for

Valuation of horse, \$ 100

Valuation of horse equipments, \$ 100

Remarks: Appt'd June 16/65

Book mark:

G. E. Dayton

Lo. | **2 Cav.** | **U.S.C.T.**

John Loney
Farris, Co. A, 2 Reg't U. S. Col'd Cavalry.

Appears on

Company Muster Roll

for Nov + Dec, 1865.

Present or absent present.

Stoppage, \$ 100 for

Due Gov't, \$ 100 for

Valuation of horse, \$ 100

Valuation of horse equipments, \$ 100

Remarks:

Book mark:

G. E. Dayton

2 Cav. | U.S.C.T.

John Loney

*Co. A., 2 Reg't U. S. Colored Cav.
Farrier.*

Appears on **Returns** as follows:

*March 1864 On daily
duty as Blacksmith
March 3/64 -*

*May 1864. On duty
Blacksmith in
R. I. M. Dept -*

*June 1865 (Farrier)
On duty with horse
from City Point Va.*

Book mark :

A. H. Elliott

L. | 2 Cav. | U.S.C.T.

John Rooney
Amies, Co. & 2 Reg't U. S. Col'd Cavalry.

Appears on Co. Muster-out Roll, dated
Brazos Santiago Tex, 12 Feb, 1866.
Muster-out to date 12 Feb, 1866.
Last paid to 30 June, 1865.

Clothing account:

Last settled....., 186 ; drawn since \$ 100
Due soldier \$ 100; due U. S. \$ 24 31 / 100
Am't for cloth'g in kind or money adv'd \$ 100

Due U. S. for arms, equipments, &c., \$ 100
Bounty paid \$ 100; due \$ 100

Remarks: *Joined original
company; was mustered
Jan 16/65. when appt'd
Bugler.*

Book mark:

G. E. Dayton

Loper ⁹⁷⁸ Henry

Co L, 2 U. S. Col'd Cav.

Private | Private

CARD NUMBERS.

1	5315915	26
2	5329486	27
3	5329582	28
4	5329681	29
5	5329773	30
6	5329858	31
7	5329938	32
8	9088043	33
9	43156900	34
10		35
11		36
12		37
13		38
14		39
15		40
16		41
17		42
18		43
19		44
20		45
21		46
22		47
23		48
24		49
25		50

Book Mark:

See also

L | **2 Cav.** | **U.S.C.T.**

Henry Lopez

Priv, Co. *L*, 2 Reg't U. S. Col'd Cav.

Appears on

Company Descriptive Book

of the organization named above.

DESCRIPTION.

Age *18* years; height *5* feet *6* inches.

Complexion *Black*

Eyes *Blk*; hair *Blk*

Where born *Virginia*

Occupation *La*

ENLISTMENT.

When *Feb 24*, 1865

Where *Lancaster*

By whom *9 Dist Pa*; term *1* y'rs.

Remarks: *Substitute for John Brackbill
Salsbery Pa, 49 Sub
9 long Dist Pa.*

A. B. Smith

L | 2 bar W. 65.

Henry Lopez

Appears with rank of Private on

Muster and Descriptive Roll

of Detachment of Substitutes
mustered into the service of
the U. S. ^{Wm Penn. Chelton Hills Pa} forwarded to Co. Roll dated
Lancaster, Penn., Feb. 28, 1865.

Where born Virginia

Age 18 y'rs; occupation Laborer

Drafted and mustered in:

When Feb. 24, 1865.

Where Lancaster Pa

Enrollment district Ninth

Period 1 years.

Eyes Black; hair Black

Complexion Black; height 5 ft. 6 in.

Bounty paid \$ 100; due \$ 100

Clothing account:

Last settled _____, 186 ; drawn since \$ 17 ⁰⁰/₁₀₀

Date of commencement of service Feb 24, 1865.

Company to which assigned _____

Remarks: Substitute for John La
Brackbill. Name of Sub. Dist. Salis-
bury Twp. No. of Sub. Dist. 49. No. of
Enrollment Dist 9. No marks

Book mark : _____

(356m) J. W. Neilman Copyist.

L Cav. U.S.C.T.

Henry Soper

Appears with rank of *Private* on

Muster and Descriptive Roll of a Detachment of Substitutes forwarded

for the *2* Reg't U. S. Col'd *Cav.* Roll dated

Cheltenham Hills, Pa., Mar. 23, 1865.

Where born *Virginia*

Age *18* y'rs; occupation *Saboteur*

When enlisted *Not stated*, 186

Where enlisted *not stated*

For what period enlisted *1* years.

Eyes *Blk.*; hair *Blk.*

Complexion *Blk.*; height *5* ft. *6* in.

When mustered in *Feb. 24*, 1865.

Where mustered in *Lancaster, 9th Dist, Pa.*

Bounty paid \$ *100*; due \$ *100*

Where credited *Salisbury, Pa., 9th Dist,*

Company to which assigned *9th Cong. Dist.*

Remarks:

Book mark:

D. C. Taylor

L | **2 Cav.** | **U.S.C.T.**

Henry Lopez
Private, Co. *L*, 2 Reg't U. S. Col'd Cavalry.

Age years.

Appears on

Company Muster Roll*

for *Enrollment to Apl 30*, 1865.

Joined for duty and enrolled:

When, 186 .

Where

Period *1* years.

Mustered in:

When *Feb 24*, 1865.

Where *Lancaster*

Present or absent *Present-*

Stoppage, \$ *100* for

Due Gov't \$ *100* for

Valuation of horse, \$ *100*

Valuation of horse equipments, \$ *100*

Remarks:

*First current roll. No muster-in roll of this company on file.

Book mark:

C. S. Rozzell
(3586) Copyist.

L | **2 Cav.** | **U.S.C.T.**

Henry Lopez

Private, Co. L, 2 Reg't U. S. Col'd Cavalry.

Appears on

Company Muster Roll

for *May + June*, 1865.

Present or absent *Present*

Stoppage, \$ 100 for

Due Gov't, \$ 100 for

Valuation of horse, \$ 100

Valuation of horse equipments, \$ 100

Remarks:

Book mark: -----

(358)

C. S. Rozzell

Copyist.

RECORDED

J | **2 Cav.** | **U.S.C.T.**

Henry Lauer

Private, Co. L, 2 Reg't U. S. Col'd Cavalry.

Appears on

Company Muster Roll

for *July & Aug*, 1865.

Present or absent *Present*

Stoppage, \$ 100 for

Due Gov't, \$ 100 for

Valuation of horse, \$ 100

Valuation of horse equipments, \$ 100

Remarks: -----

Book mark: -----

(358)

C. J. Rogge

Copyist.

L | **2 Cav.** | **U.S.C.T.**

Henry Lopez

Private, Co. L, 2 Reg't U. S. Col'd Cavalry.

Appears on

Company Muster Roll

for Sept to Oct, 1865.

Present or absent Present

Stoppage, \$ 100 for

Due Gov't, \$ 100 for

Valuation of horse, \$ 100

Valuation of horse equipments, \$ 100

Remarks:

Book mark: -----

A. B. Smith
Copyist,

L | **2 Cav.** | **U.S.C.T.**

Henry Loper

Priv, Co. L, 2 Reg't U. S. Col'd Cavalry.

Appears on

Company Muster Roll

for Nov & Dec, 1865.

Present or absent Present

Stoppage, \$ 100 for

Due Gov't, \$ 100 for

Valuation of horse, \$ 100

Valuation of horse equipments, \$ 100

Remarks:

Book mark: -----

F. B. Smith

L | **2 Cav.** | **U.S.C.T.**

Henry Lopez

Private, Co. *L*, 2 Reg't U. S. Col'd Cavalry.

Appears on **Co. Muster-out Roll**, dated

Bragas Santiago, Tex, Feb. 12, 1866.

Muster-out to date *Feb. 12, 1866.*

Last paid to *June 30, 1865.*

Clothing account:

Last settled....., 186 ; drawn since \$.....¹⁰⁰

Due soldier \$.....¹⁰⁰; due U. S. \$.....⁹¹₁₀₀

Am't for cloth'g in kind or money adv'd \$.....¹⁰⁰

Due U. S. for arms, equipments, &c., \$.....¹⁰⁰

Bounty paid \$.....¹⁰⁰; due \$.....¹⁰⁰

Remarks: *Joined as Recruit*

Book mark :

J. B. Smith

979
Lord David

Co L, 2 U. S. Col'd Cav.

Private Private

CARD NUMBERS.

1	5315916	26
2	5329487	27
3	5329583	28
4	5329682	29
5	5329774	30
6	5316817	31
7	5329860	32
8	5329939	33
9	6297964	34
10	9088044	35
11	40726310	36
12		37
13		38
14		39
15		40
16		41
17		42
18		43
19		44
20		45
21		46
22		47
23		48
24		49
25		50

Book Mark:

See also

A 2321945 *Pomona*
02629400 and rd.

L. Ballou 4th

10.11.11

L | **2 Cav.** | **U.S.C.T.**

David Lord

Prk, Co. L, 2 Reg't U. S. Col'd Cav.

Appears on

Company Descriptive Book

of the organization named above.

DESCRIPTION.

Age 18 years; height 5 feet 3 1/4 inches.

Complexion Black

Eyes Black; hair Black

Where born Penn

Occupation Tan

ENLISTMENT.

When March 4, 1865

Where Ridgeway

By whom 19 Dist Pa, term 1 y'rs.

Remarks: Substitute for Nelson Holby ben-
-cord Tp Erie Cos Pa,
19 being Dist Pa.

T B Smith

L | *2 Cav.* | **U.S.C.T.**

David Sord

Appears with rank of *Private* on

Muster and Descriptive Roll of a Detachment of Substitutes forwarded

for the *2* Reg't U. S. Col'd *Cav.* Roll dated

Chelton Hills, Pa., Nov. 23 186*3.*

Where born *Pa.*

Age *18* y'rs; occupation *Farmer*

When enlisted *Not stated*, 186*3.*

Where enlisted *Not stated.*

For what period enlisted *1* years.

Eyes *Hazel*; hair *Blk.*

Complexion *Gold*; height *5* ft. *3 3/4* in.

When mustered in *March 4*, 186*3.*

Where mustered in *Ridgeway, 19th Dist., Pa.*

Bounty paid \$ *100*; due \$ *100*

Where credited *Concord Twp., Erie Co., Pa., 19th Cong. Dist.*
Company to which assigned

Remarks:

Book mark:

D. C. Taylor

NARA 1510

L | **2 Cav.** | **U.S.C.T.**

David Lord

Private, Co. L 2 Reg't U. S. Col'd Cavalry.

Age years.

Appears on

Company Muster Roll*

for Enrollment to Apl 30, 1865.

Joined for duty and enrolled:

When, 186 .

Where

Period 1 years.

Mustered in:

When Mch 4, 1865.

Where Ridgeway

Present or absent Present

Stoppage, \$ 100 for

Due Gov't \$ 100 for

Valuation of horse, \$ 100

Valuation of horse equipments, \$ 100

Remarks:

*First current roll. No muster-in roll of this company on file.

Book mark:

(3586)

C S Rozzell

Copyist.

L | 2 Cav. | U.S.C.T.

David Lord

Private, Co. L, 2 Reg't U. S. Col'd Cavalry.

Appears on

Company Muster Roll

for *May + June*, 1865.

Present or absent *Present*

Stoppage, \$ 100 for

Due Gov't, \$ 100 for

Valuation of horse, \$ 100

Valuation of horse equipments, \$ 100

Remarks:

Book mark:

C. S. Rozzell

(358)

Copyist.

NARA 1912

L | **2 Cav.** | **U.S.C.T.**

David Ford

Private, Co. L, 2 Reg't U. S. Col'd Cavalry.

Appears on

Company Muster Roll

for *July + Aug*, 1865.

Present or absent *Present*

Stoppage, \$ 100 for

Due Gov't, \$ 100 for

Valuation of horse, \$ 100

Valuation of horse equipments, \$ 100

Remarks:

Book mark: -----

(358)

E. J. Cogzall
Copyist.

L | 2 Cav. | U.S.C.T.

David Lord

Private, Co. L, 2 Reg't U.S. Col'd Cavalry.

Appears on

Company Muster Roll

for Sept & Oct, 1860.

Present or absent Absent

Stoppage, \$ 100 for

Due Gov't, \$ 100 for

Valuation of horse, \$ 100

Valuation of horse equipments, \$ 100

Remarks: Met Ser. H. L. L.,
3" Div. 2 5" A. C. Per,
S. O. No. 66.

Book mark:

J. B. Smith

(358)

Copyist.

L | 2 Cavalry | U.S.C.T.

Davis L Fred

Plt, Co. L, 2 Reg't U. S. Col'd Cavalry

Appears on a

Detachment Muster Roll

of the organization named above

for Sept & Oct, 1863.

Station Brazos Santiago, Tex

Present or absent Present

Stoppage, \$ 100 for

Due Gov't, \$ 100 for

Valuation of horse, \$ 100

Valuation of horse equipments, \$ 100

Remarks: Detailed by S. O. 70 S. 65th Reg. Inf. 3rd Div 25th A. C.

Book mark:

Uontague

L | **2 Cav.** | **U.S.C.T.**

David Lord

Pvt, Co. L, 2 Reg't U. S. Col'd Cavalry.

Appears on

Company Muster Roll

for Nov + Dec, 1865.

Present or absent Absent

Stoppage, \$ 100 for

Due Gov't, \$ 100 for

Valuation of horse, \$ 100

Valuation of horse equipments, \$ 100

Remarks: D. Lord, lives
At H. Q. since Oct 12/65

Book mark:

J. B. Smith

(358)

Copyist.

L. 12 Cav. | U.S.C.T.

David Lord

Pl., Co. L, 2 Reg't U. S. Col'd ^{Cav.} Inf.

Appears on a

Detachment Muster Roll

of the organization named above

for Nov & Dec, 1865.

Station

Present or absent

Present

Stoppage, \$ 100 for

Due Gov't, \$ 100 for

Remarks: Detailed per
S.C. # 70 & 65
No. 2 no. 3 Div. 25 AC

Book mark:

Steale

L | **2 Cav.** | **U.S.C.T.**

David Lord

Pr., Co. L, 2 Reg't U. S. Colored Cav.

Appears on **Returns** as follows:

Oct 1865: Absent on
det serv. at Hd Qrs,
3 Div. 25-a.c. on at
Hd. Qrs. 25-a.c.
Nov 1865 - to Jan 1866.
Absent - Ord Dir.
Hd Qrs. since Oct
12/65 -

Book mark :

A. H. Ellison

L | **2 Cav.** | **U.S.C.T.**

David Lord

Private, Co. *L*, 2 Reg't U. S. Col'd Cavalry.

Appears on **Co. Muster-out Roll**, dated

Brazos Santiago, Tex, Feb. 12, 1866.

Muster-out to date *Feb. 12*, 1866.

Last paid to *June 30*, 1866.

Clothing account:

Last settled....., 186 ; drawn since \$..... 100

Due soldier \$..... 100; due U. S. \$..... 86

Am't for cloth'g in kind or money adv'd \$..... 100

Due U. S. for arms, equipments, &c., \$..... 100

Bounty paid \$..... 100; due \$..... 100

Remarks: *Joined as Recruit*

Book mark:

A. B. Smith

MAR 1919

Lord David (Col'd)

, Co. K, 2 Reg't 1st Cavalry

Enclosures.

Bed Cards	Final Statements
Burial Records	Furloughs or L. of A.
Certs. of Dis. for Discharge	Med. Certificates
C. M. Charges	Med. Des. Lists
Descriptive Lists	Orders
Discharge Certificates	Pris. of War Record
Enlistment Papers	Resignations

Other papers relating to—

Admission to Hosp'l	Furlough or L. of A.
Casualty Sheet	Med. Examination
Confinement	Misc. Information
Contracts	Pay or Clothing
Death or Effects	Personal Reports
Desertion	Rank
Discharge from Hosp'l	Transfer to Hosp'l
Discharge from Service	Transfer to V. R. C.
Duty	Transportation

DECLARATION OF SUBSTITUTE.

I, David Lord (Lord) desiring to ENLIST in the Army of the United States, for ~~THREE YEARS~~, ^{one} **Do declare**, That I am Eighteen (18) years and Two (2) months of age; that I have never been discharged from the United States service on account of disability or by sentence of a court martial; and I know of no impediment to my serving honestly and faithfully as a soldier for ~~three years~~ ^{one} year.

GIVEN at Keokuk Iowa the 4th day of March 1865

WITNESS:

P. C. Boyd David Lord

No. _____

Enlisted at Keokuk Iowa

As Substitute for

William Woodley

On the 4th day of March 1865

By

H. J. Campbell

Edward Southen

John M. Martin

Board of Enrollment,

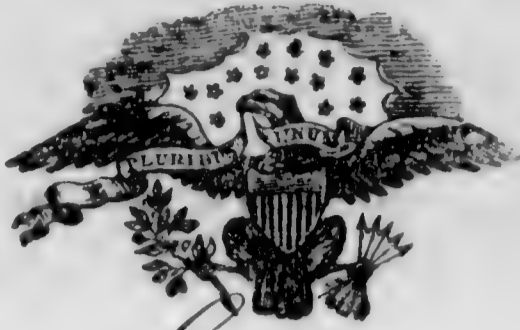
1st Dist. of Iowa

SUBSTITUTE VOLUNTEER ENLISTMENT.

STATE OF

TOWN OF

Pennsylvania



Ridgway

I, David Lord born in the State of Pennsylvania, aged Eighteen (18) years, and by occupation a Harvester

DO HEREBY ACKNOWLEDGE to have agreed with

Nelson Halsey, Esq., of Concord Twp
Eric Co. Penna

to become his **SUBSTITUTE** in the Military Service, for a sufficient consideration paid and delivered to me, on the Fourth (4) day of March, 1865; and having thus agreed with said Nelson Halsey, I DO HEREBY ACKNOWLEDGE to have enlisted this Fourth (4) day of March, 1865 to serve as a **Soldier** in the **Army of the United States of America**, for the period of ~~THREE YEARS~~, unless sooner discharged by proper authority: I do also agree to accept such bounty, pay, rations, and clothing, as are, or may be, established by law for soldiers. And I do solemnly swear that I will bear true and faithful allegiance to the **United States of America**; that I will serve them honestly and faithfully against all their enemies or opposers whomsoever; and that I will observe and obey the orders of the President of the United States, and the orders of the Officers appointed over me, according to the Rules and Articles of War.

SWORN and subscribed to, at Ridgway Pa

this 4th day of March 1865

David Lord

BEFORE

J. J. Humphrey
Capt for 1st Dist Pa

We certify, on honor, That we have carefully examined the above-named Volunteer Substitute agreeably to the Regulations, and that, in our opinion, he is free from all bodily defects and mental infirmity which would in any way disqualify him from performing the duties of a soldier; that he was entirely sober when enlisted; that he is of lawful age, (not under 18 years;) and that, in accepting him as duly qualified to perform the duties of an able-bodied soldier, and as a Substitute in lieu of Nelson Halsey, Enrolled drafted in Concord Twp Eric Co Pa, 1865, we have strictly observed the Regulations which govern in such cases. This soldier has Black eyes, Black hair, Black complexion; is 5 feet 3 3/4 inches high.

J. J. Humphrey
Provost Marshal

Edw. Cuthbert
Commissioner of Board

Chas. M. Watson
Surgeon of Board

Board of Enrollment of 19 Dist. of Penna

Lorey ⁹⁸⁰ John

Co A, 2 U. S. Col'd Cav.

Private | Farris

CARD NUMBERS.

1	26
2	27
3	28
4	29
5	30
6	31
7	32
8	33
9	34
10	35
11	36
12	37
13	38
14	39
15	40
16	41
17	42
18	43
19	44
20	45
21	46
22	47
23	48
24	49
25	50

Book Mark:

See also

Lauck's Selma ⁹⁸¹

Co L, 2 U. S. Col'd Cav.

Private | *Private*

CARD NUMBERS.

1	5315918	26
2	5329489	27
3	5329585	28
4	5329683	29
5	5329775	30
6	5329861	31
7	5329940	32
8	9088046	33
9	40726311	34
10		35
11		36
12		37
13		38
14		39
15		40
16		41
17		42
18		43
19		44
20		45
21		46
22		47
23		48
24		49
25		50

Book Mark:

See also

L | 2 Cav. | U.S.C.T.

Selma Loucks

Ort, Co. L, 2 Reg't U. S. Col'd Cav.

Appears on

Company Descriptive Book

of the organization named above.

DESCRIPTION.

Age 35 years; height 5 feet 4 inches.

Complexion Black

Eyes Blue; hair Blue

Where born N. Y., New York

Occupation Farm

ENLISTMENT.

When Feb. 28, 1865.

Where William

By whom / 8 Dist Pa; term / y'rs.

Remarks: Substitute for
S. S. Parling, Wash-
-ington Tp. Lycombe
Pa. 72 Sub 18 long
Dist Pa.

J. B. Smith

NOV 17 1865

S *2 Cav.* **U. S. C. T.**

Selma Soucks

Appears with rank of *Private* on

Muster and Descriptive Roll of a Detachment of Substitutes forwarded

for the *2* Reg't U. S. Col'd *Cav.* Roll dated

Chelton Hills, Pa, Mar. 23, 1865.

Where born *New York*

Age *35 1/2* y'rs; occupation *Salvager*

When enlisted *not stated*, 186

Where enlisted *not stated*

For what period enlisted *1* years.

Eyes *Dark*; hair *Dark*

Complexion *Dark*; height *5* ft. *4* in.

When mustered in *Feb. 28*, 1865.

Where mustered in *Wineport, 18th Dist, Pa.*

Bounty paid \$ *100*; due \$ *100*

Where credited *Washington Tp, Sycamore Co, Pa, 72nd Sub Dist, 18th Cong. Dist.*
Company to which assigned

Remarks:

Book mark:

D. C. Taylor

(340b)

Copyist.

L | 2 Cav. | U.S.C.T.

Selma Lanches

Private, Co. L, 2 Reg't U. S. Col'd Cavalry.

Age years.

Appears on

Company Muster Roll*

for Enrollment to Sept 30, 1865.

Joined for duty and enrolled:

When, 186 .

Where

Period / years.

Mustered in:

When Feb 28, 1865.

Where Williamsport.

Present or absent Present.

Stoppage, \$ 100 for

Due Gov't \$ 100 for

Valuation of horse, \$ 100

Valuation of horse equipments, \$ 100

Remarks:

*First current roll. No muster-in roll of this company on file.

Book mark:

(3586)

C. S. Rozzell

Copyist.

L | **2 Cav.** | **U.S.C.T.**

Selma Loucks

Private, Co. L, 2 Reg't U. S. Col'd Cavalry.

Appears on

Company Muster Roll

for *May + June*, 1865.

Present or absent *Present*

Stoppage, \$ *100* for

Due Gov't, \$ *100* for

Valuation of horse, \$ *100*

Valuation of horse equipments, \$ *100*

Remarks:

Book mark: _____

C S Rozzell

2 | 2 Cav. | U.S.C.T.

Delma Locks

3rd, Co. L, 2 Reg't U. S. Col'd Cavalry.

Appears on

Company Muster Roll

for *July + Aug*, 1865.

Present or absent *Present*

Stoppage, \$ 100 for

Due Gov't, \$ 100 for

Valuation of horse, \$ 100

Valuation of horse equipments, \$ 100

Remarks:

Book mark : -----

(358) - *W. B. Zell* Copyist.

L | 2 Cav. | U.S.C.T.

Selma Loucks

Priv., Co. L, 2 Reg't U.S. Col'd Cavalry.

Appears on

Company Muster Roll

for Sept & Oct, 1865.

Present or absent Absent

Stoppage, \$ 100 for

Due Gov't, \$ 100 for

Valuation of horse, \$ 100

Valuation of horse equipments, \$ 100

Remarks: Let. Ser. Hd. Lrs
9" Hiv. 25" A C. Pen
S. O. No. 66.

Book mark:

D. B. Smith

L | 2 Cav. | U.S.C.T.

Selma Loucks

Pris, Co. L, 2 Reg't U. S. Col'd Cavalry.

Appears on

Company Muster Roll

for Nov + Dec, 1865.

Present or absent Absent

Stoppage, \$ 100 for

Due Gov't, \$ 100 for

Valuation of horse, \$ 100

Valuation of horse equipments, \$ 100

Remarks: D. S. Carpenter
Post G. M. slept since
Oct 20"/65.

Book mark:

J. B. Smith

L | 2 Cav. | U.S.C.T.

Selma Loucks

Co. L, 2 Reg't U. S. Colored Cav.

Appears on Returns as follows:

Sept 1865. Absent on det. service per so. No. 3 Hd. In. 3" Dir. 25-a. Aug 30/65. Oct 1865. Absent on det. service at Hd. In. 3" Dir. 25-a. or at Hd. In. 25-a. Nov 1865. Absent Carpenter at Dir 29m Dept per so. No. 10 dated Hd. In. Post of Brazos Oct. 21/65.

Name appears also as Sel. Loucks.

Book mark :

A. H. Ellison

L | **2 Cav.** | **U.S.C.T.**

Selma Loucks
Private, Co. L, 2 Reg't U. S. Col'd Cavalry.

Appears on **Co. Muster-out Roll**, dated
Brazos Santiago, Tex, Feb. 12, 1866.
Muster-out to date Feb. 12, 1866.
Last paid to June 30, 1865.

Clothing account:

Last settled....., 186 ; drawn since \$.....100
Due soldier \$ 26 ⁴⁰ / 100; due U. S. \$.....100
Am't for cloth'g in kind or money adv'd \$.....100

Due U. S. for arms, equipments, &c., \$.....100

Bounty paid \$.....100; due \$.....100

Remarks: Joined as Recruit

Book mark :

J. B. Smith

Lonck's. Salem

P. L., Co. L., 2 Regt U.S.C. Cay.

2 Enclosures.

Bed Cards	Descriptive Lists
Burial Records	Final Statements
Certs. of Dis. for Discharge	Furloughs
C. M. Charges	Med. Des. Lists
Med. Certificates	Orders

EP 1

Other papers relating to—

Admission to Hosp'l	Furlough
Casualty Sheet (Officer's)	Med. Examination
Confinement	Misc. Information
Contracts	Pay or Clothing
Death or Effects	Personal Reports
Desertions	Rank
Discharge from Hosp'l	Transfer to Hosp'l
Discharge from Service	Transfer to V. R. C.
Duty	Transportation

1866
Hd. Qrs. Fort of Brazos Santiago
Jan 9th. 1866.

Special Orders No 6-#1,

Relieved from duty in
the G. M. D.

Point Sahu Locals,
Co. L. 2nd U.S. Cavalry

Rec'd Hd. Qrs 27th Dec 9/66

Headquarters Post of Brazos Santiago, Texas,

January 9th 1860

Special Orders, }
No.

Extract.

I. The following named enlisted man is hereby relieved from duty in the Quartermaster's Dept. & will report to the Comdg. Officer of his Regiment without delay.

Private Salem Louels Co. 2^d 22^d U. S. C.

x x x

By order of Det. Major
GEN'L W. T. CLARK.

C. C. 2^d U. S. C.
Thos. G. 1st U. S. C.

Chas. H. Henshaw
Capt. 2^d U. S. C. & A. etg. Assistant Adjutant General.

DECLARATION OF SUBSTITUTE.

I, Selma Loucks, desiring to ENLIST in the Army of the United States, for ~~three~~ ^{one} YEAR, Do declare, That I am thirty five years and nine months of age; that I have never been discharged from the United States service on account of disability or by sentence of a court martial; and I know of no impediment to my serving honestly and faithfully as a soldier for ~~three~~ ^{one} years.

GIVEN at Williamsport the 28th day of February 1865

WITNESS:

Geo. A. Kramer

Selma Loucks

2 No. C. Car

2021

No. 110

Selma Loucks

Enlisted at Williamsport

As Substitute for

J. H. ...

On the 28 day of Feb, 1865,

By

Wm. ...

R. ...

W. ...

Board of Enrollment,

18 Dist. of ...

This paper was prepared in accordance with the P.O.

*Pen
colored
1921*

(No. 716.)

(No. 39.)

SUBSTITUTE VOLUNTEER ENLISTMENT.

STATE OF



TOWN OF

Pennsylvania *Williamsport*

I, *Selma Loucks* (*Colored*), born in the State of *New York*, aged *thirty five* years, and by occupation a *Laborer*, Do HEREBY ACKNOWLEDGE to have agreed with

J. S. Pauling, Esq., of *Washington, Pa.* *Lycoming Co. Sub Dist No () 18th Dist of Penna*

to become his **SUBSTITUTE** in the Military Service, for a sufficient consideration paid and delivered to me, on the *twenty eighth* day of *February*, 1865; and having thus agreed with said *J. S. Pauling*, I DO HEREBY ACKNOWLEDGE to have enlisted this *twenty eighth* day of *February*, 1865, to serve as a **Soldier** in the **Army of the United States of America**, for the period of ~~one~~ **YEAR**, unless sooner discharged by proper authority. I do also agree to accept such bounty, pay, rations, and clothing as are, or may be, established by law for soldiers. And I do solemnly swear that I will bear true and faithful allegiance to the **United States of America**; that I will serve them honestly and faithfully against all their enemies or opposers whomsoever; and that I will observe and obey the orders of the President of the United States and the orders of the officers appointed over me, according to the Rules and Articles of War.

SWORN and subscribed to, at *Williamsport*

this *28th* of *February*, 1865,

BEFORE *Geo. A. Kramer*

Selma Loucks



We certify, on honor, That we have carefully examined the above-named Volunteer Substitute agreeably to the Regulations, and that, in our opinion, he is free from all bodily defects and mental infirmity which would in any way disqualify him from performing the duties of a soldier; that he was entirely sober when enlisted; that he is of lawful age, (not under 18 years;) and that, in accepting him as duly qualified to perform the duties of an able-bodied soldier, and as a Substitute in lieu of *J. S. Pauling*

(Enrolled), drafted in *Washington, Pa. Lycoming Co.* *Penna. February 28*, 1865, we have strictly observed the Regulations which govern

in such cases. This soldier has *dark* eyes, *dark* hair, *dark* complexion; is *5* feet *4* inches high.

Wm. Blair

Provost Marshal.

R. B. Sawyer

Commissioner of Board.

W. L. Loran

Member of Board.

Board of Enrollment of *18* Dist. of *Penna*

982
Loverick Alfred

Co A, 2 U. S. Col'd Cav.

Private | Private

CARD NUMBERS.

1	5317245	26
2	5317319	27
3	5317409	28
4	5317497	29
5	5317577	30
6	5317667	31
7	5317754	32
8	5317842	33
9	5317936	34
10	5318021	35
11	5318115	36
12	5318195	37
13	5318271	38
14	5318343	39
15	9087092	40
16		41
17		42
18		43
19		44
20		45
21		46
22		47
23		48
24		49
25		50

Book Mark:

See also

S-9255-03 - P.O. m x m.
P. 2477984 P.O. Retd

SS, VA, 10-27-32

L Ballantyne & Co

2 | 2 Cav. | U.S.C.T.

Alfred Lovick

Co A, 2 Reg't U. S. Col'd Cav.

Appears on

Company Descriptive Book

of the organization named above.

DESCRIPTION.

Age 19 years; height 5 feet 7 inches.

Complexion Black

Eyes Black; hair Black

Where born Moah Co, N.C.

Occupation

ENLISTMENT.

When Dec 22, 186

Where Ft Monroe

By whom Col. Cole; term 3 y'rs.

Remarks:

F. B. Smith

2 | **2 Cav.** | **U.S.C.T.**

Alfred Loverick
Plow, Co. A, 2 Reg't U. S. Col'd Cavalry.

Age years.

Appears on

Company Muster-in Roll

of the organization named above. Roll dated

Fort Monroe Va Dec 22, 1863.

Muster-in to date Dec 22, 1863.

Joined for duty and enrolled:

When Dec 22, 1863.

Where Fort Monroe Va

Period 3 years.

Valuation of horse, \$.....100

Valuation of horse equipments, \$.....100

Remarks :
.....
.....
.....
.....

Book mark :
.....

(356) J. E. Chapin Copyist.

L | **2 Cav.** | **U.S.C.T.**

Alfred Loren

Pvt, Co. A, 2 Reg't U. S. Col'd Cavalry.

Appears on

Company Muster Roll

for *from Enrollment to Feb. 29, 1864.*

Present or absent *Present*

Stoppage, \$ 100 for

Due Gov't, \$ 100 for

Valuation of horse, \$ 100

Valuation of horse equipments, \$ 100

Remarks:

Book mark: *1 2 3 4 5 6 7 8 9 10*

(358) *J. E. Chapin* Copyist.

L | **2 Cav.** | **U.S.C.T.**

Alfred Lovick

W

, Co. A, 2 Reg't U. S. Col'd Cavalry.

Appears on

Company Muster Roll

for *men + Apr*, 186 *4*

Present or absent *Present*

Stoppage, \$ 100 for

Due Gov't, \$ 100 for

Valuation of horse, \$ 100

Valuation of horse equipments, \$ 100

Remarks:

Book mark:

J. E. Chapin

L | **2 Cav.** | **U.S.C.T.**

Alfred Lovick

Pvt, Co. A, 2 Reg't U. S. Col'd Cavalry.

Appears on

Company Muster Roll

for *May & June*, 186 *4*

Present or absent. *Present*

Stoppage, \$ *100* for

Due Gov't, \$ *100* for

Valuation of horse, \$ *100*

Valuation of horse equipments, \$ *100*

Remarks:
.....
.....
.....
.....
.....
.....
.....
.....
.....
.....

Book mark:

(358) *J. E. Chapin* Copyist.

L | 2 Cav. | U.S.C.T.

Alfred Lovick
Pvt, Co. A, 2 Reg't U. S. Col'd Cavalry.

Appears on

Company Muster Roll

for July & Aug, 1864.

Present or absent Present

Stoppage, \$ 100 for

Due Gov't, \$ 100 for

Valuation of horse, \$ 100

Valuation of horse equipments, \$ 100

Remarks: Stoppages

One Curry comb & brush \$ 1.01

" Nose bag 1.50

" Pr spurs & Straps .52

Book mark:

R S Shelton

L | 2 Cav. | U.S.C.T.

Alfred Lovick
Priv., Co. A, 2 Reg't U. S. Col'd Cavalry.

Appears on

Company Muster Roll
for Sept & Oct, 1864.

Present or absent Present

Stoppage, \$ 100 for

Due Gov't, \$ 100 for

Valuation of horse, \$ 100

Valuation of horse equipments, \$ 100

Remarks:

Book mark:

R. S. Shelton

L | **2 Cav.** | **U.S.C.T.**

Alfred Lovick
Plt, Co. A, 2 Reg't U. S. Col'd Cavalry.

Appears on

Company Muster Roll

for *Nov & Dec*, 1864.

Present or absent *Present*

Stoppage, \$ *100* for

Due Gov't, \$ *100* for

Valuation of horse, \$ *100*

Valuation of horse equipments, \$ *100*

Remarks:

Book mark: *200*

R S Shelton

L | **2 Cav.** | **U.S.C.T.**

Alfred Lovick

Priv, Co. A, 2 Reg't U. S. Col'd Cavalry.

Appears on

Company Muster Roll

for *Jan + Feb*, 1865.

Present or absent *Present*

Stoppage, \$ 100 for

Due Gov't, \$ 100 for

Valuation of horse, \$ 100

Valuation of horse equipments, \$ 100

Remarks:

Book mark:

R S Shelton

L | 2 Cav. | U.S.C.T.

Alfred Loucks

Pat., Co. A, 2 Reg't U.S. Col'd Cavalry.

Appears on

Company Muster Roll

for Mch 24th, 1865.

Present or absent Present

Stoppage, \$ 100 for

Due Gov't, \$ 100 for

Valuation of horse, \$ 100

Valuation of horse equipments, \$ 100

Remarks:

Book mark:

W. J. ... Copyist.

L | **2 Cav.** | **U.S.C.T.**

Alfred Louick
Plt, Co. A, 2 Reg't U. S. Col'd Cavalry.

Appears on

Company Muster Roll

for *May 1861*, 186 .

Present or absent *Present*

Stoppage, \$ 100 for

Due Gov't, \$ 100 for

Valuation of horse, \$ 100

Valuation of horse equipments, \$ 100

Remarks:
.....
.....
.....
.....
.....
.....
.....
.....

Book mark:

W. H. Miller
.....
(358) Copyst.

L. | **2 Cav.** | **U.S.C.T.**

Alfred Hancock
Co. A, Co. A, 2 Reg't U. S. Col'd Cavalry.

Appears on

Company Muster Roll

for July & Aug, 1864.

Present or absent Present

Stoppage, \$ 100 for

Due Gov't, \$ 100 for

Valuation of horse, \$ 100

Valuation of horse equipments, \$ 100

Remarks:

Book mark: -----

T

Melby
Copyist.

L. | **2^d Cav.** | **U.S.C.T.**

Alfred Lovernick
Pvt, Co. A, 2 Reg't U.S. Col'd Cavalry.

Appears on

Company Muster Roll

for *Sep Oct*, 186*5*.

Present or absent *present*

Stoppage, \$ *100* for

Due Gov't, \$ *100* for

Valuation of horse, \$ *100*

Valuation of horse equipments, \$ *100*

Remarks:

Book mark: _____

G. E. Dayton

Lo. | **2 Cav.** | **U.S.C.T.**

Alfred Lovick

Pvt, Co. A, 2 Reg't U. S. Col'd Cavalry.

Appears on

Company Muster Roll

for Nov + Dec, 1865.

Present or absent present

Stoppage, \$ 100 for

Due Gov't, \$ 100 for

Valuation of horse, \$ 100

Valuation of horse equipments, \$ 100

Remarks:

Book mark:

G. E. Dayton

L. | **2 Cav.** | **U.S.C.T.**

Alfred Lurick
Priv., Co. *C*, 2 Reg't U. S. Col'd Cavalry.

Appears on **Co. Muster-out Roll**, dated
Bazon Quintago, *12 Feb*, 1866.

Muster-out to date *12 Feb*, 1866.

Last paid to *30 June*, 1865.

Clothing account:

Last settled....., 186 ; drawn since \$.....¹⁰⁰

Due soldier \$.....¹⁰⁰; due U. S. \$ *21*⁸⁹/₁₀₀

Am't for cloth'g in kind or money adv'd \$.....¹⁰⁰

Due U. S. for arms, equipments, &c., \$.....¹⁰⁰

Bounty paid \$.....¹⁰⁰; due \$.....¹⁰⁰

Remarks: *Joined original organization*

Book mark:

G. E. Dayton

983
Lovick Alfred

Co A, 2 U. S. Col'd Cav.

CARD NUMBERS.

1	26
2	27
3	28
4	29
5	30
6	31
7	32
8	33
9	34
10	35
11	36
12	37
13	38
14	39
15	40
16	41
17	42
18	43
19	44
20	45
21	46
22	47
23	48
24	49
25	50

See Lovick

Alfred

Book Mark:

See also

984
Lucas Daniel

Co G, 2 U. S. Col'd Cav.

CARD NUMBERS.

1	26
2	27
3	28
4	29
5	30
6	31
7	32
8	33
9	34
10	35
11	36
12	37
12	38
14	39
15	40
16	41
17	42
18	43
19	44
20	45
21	46
22	47
23	48
24	49
25	50

See Lucas

Daniel

Book Mark:

See also

985

Lucas, Henderson

Co H, U.S. Col'd Troops.

Private | Private

CARD NUMBERS.

1	53 06 192	26
2	53 26 546	27
3	53 26 629	28
4	53 26 708	29
5	53 26 788	30
6	53 26 860	31
7	526 881	32
8	53 26 961	33
9	53 26 463	34
10	3085 2784	35
11	3085 3899	36
12	3085 4618	37
13	4072 6312	38
14		39
15		40
16		41
17		42
18		43
19		44
20		45
21		46
22		47
23		48
24		49
25		50

Number of personal papers herein.....

Book Mark:

See also

1582569

8622184 - Road
L. 1582569 common

NOV 1865

L | **2 Cav.** | **U.S.C.T.**

Alexander Lucas

Appears with rank of Private on

Muster and Descriptive Roll of a Detachment of U. S. Vols. forwarded

for the 2 Reg't U. S. Col'd Cavalry. Roll dated

Newport News Va. Jan'y 3, 1865.

Where born Wach Co. No. Ca.

Age 25 y'rs; occupation Farmer

When enlisted Jan'y 7, 1865.

Where enlisted Portfolk Va.

For what period enlisted 3 years.

Eyes black; hair black

Complexion brown; height 5 ft. 11 in.

When mustered in Jan'y 11, 1865.

Where mustered in Newport News

Bounty paid \$ 100 ¹⁰⁰; due \$ 100

Where credited Pay. at large

Company to which assigned _____

Remarks: _____

Book mark: _____

E. D. Neal

L | **2 Cav.** | **U.S.C.T.**

Henderson Lovace
Priv, Co. H, 2 Reg't U. S. Col'd Cavalry.

Appears on

Company Muster Roll

for *Jan. & Feb.*, 1865.

Present or absent *Present*

Stoppage, \$ *100* for

Due Gov't, \$ *100* for

Valuation of horse, \$ *100*

Valuation of horse equipments, \$ *100*

Remarks:
.....
.....
.....
.....
.....

filed with Henderson Lucas
Book mark:

M. Ferguson

L, | 2 Cav. | U.S.C.T.

Henderson Lucas

Private, Co. H, 2 Reg't U. S. Col'd Cavalry.

Appears on

Company Muster Roll

for March and April, 1865.

Present or absent Absent

Stoppage, \$ 100 for

Due Gov't, \$ 100 for

Valuation of horse, \$ 100

Valuation of horse equipments, \$ 100

Remarks:

Dismt'd Camp. Petersburg, Va.

Book mark:

C. J. Powell

L | **2 Cav.** | **U.S.C.T.**

Henderson Lucas

Private, Co. H, 2 Reg't U. S. Col'd Cavalry.

Appears on

Company Muster Roll

for May and June, 1867.

Present or absent Present

Stoppage, \$ 100 for

Due Gov't, \$ 100 for

Valuation of horse, \$ 100

Valuation of horse equipments, \$ 100

Remarks:

Book mark:

C. G. Powell

L | 2 Cav. | U.S.A.

Henderson Lucas

priv., Co. H, 2 Reg't U.S.A. Cav.

Appears on

Hospital Muster Roll

of Corps d'Afrique U. S. A. General Hospital,

at New Orleans, La.,

for July & Aug, 1865.

Attached to hospital:

When, 186 .

How employed:

Last paid by Maj.

to, 186 .

Bounty paid \$ 100; due \$ 100

Present or absent present

Remarks:

Book mark:

Furniss

L | 2 Cav USCT

Henderson Lucas
Priv, Co H, 2 Reg US Cav.

Appears on

Hospital Muster Roll

of Corps d'Afrique U. S. A. General Hospital,

at New Orleans, La.

for Sept & Oct, 1865.

Attached to hospital:

When _____, 186 .

How employed _____

Last paid by Maj *never paid*
to _____, 186 .

Bounty paid \$ 100 due \$ 100

Present or absent *Present*

Remarks:

Book mark: _____

(343) *Stewart* Copyist.

L | 2 Cav. | U.S.C.T.

Henderson Lucas
Private, Co. H, 2 Reg't U. S. Col'd Cavalry.

Appears on

Company Muster Roll

for July and Aug, 1865.

Present or absent absent

Stoppage, \$ 100 for

Due Gov't, \$ 100 for

Valuation of horse, \$ 100

Valuation of horse equipments, \$ 100

Remarks: Absent in Hospital

Book mark:

C. J. Powell

NOV 1865

L | **2 Cav.** | **U.S.C.T.**

Henderson Lucas

Plt, Co. H, 2 Reg't U. S. Col'd Cavalry.

Appears on

Company Muster Roll

for *Sep & Oct*, 186*5*.

Present or absent *absent*

Stoppage, \$ *100* for

Due Gov't, \$ *100* for

Valuation of horse, \$ *100*

Valuation of horse equipments, \$ *100*

Remarks: *Absent sick in U.S.*
G. J. Casper

Book mark:

(358)

G. J. Casper
Copyist.

L | 2 Cav | U.S.C.A.
Henderson Lucas
Priv., Co. H, 2 Reg't U.S.C.A.

Appears on

Hospital Muster Roll

of Corps d'Afrique U. S. A. General Hospital,

at New Orleans, La.,

for Nov & Dec, 1865.

Attached to hospital:

When....., 186 .

How employed.....

Last paid by Maj.

to, 186 .

Bounty paid \$ 100; due \$ 100

Present or absent.....

Remarks: Discharged
on Surg Cert of
disability Dec 15/65
F.D. given

Book mark:

[Signature]

L | **2 Cav.** | **U.S.C.T.**

x Henderson Lucas

Pat, Co. H, 2 Reg't U. S. Col'd Cavalry.

Appears on

Company Muster Roll

for *Nov & Dec*, 1865.

Present or absent *not stated*

Stoppage, \$ *100* for

Due Gov't, \$ *100* for

Valuation of horse, \$ *100*

Valuation of horse equipments, \$ *100*

Remarks:

x Entire entry cancelled by a line drawn through it

Book mark:

J. G. Wiley
Copyist.

L | 2 Cav. | U.S.C.T.

Lucas, Henderson

Pat, Co. H, 2 Reg't U. S. Col'd Cavalry.

Appears on

Company Muster Roll

for *Nov & Dec*, 1865.

Present or absent

Stoppage, \$ 100 for

Due Gov't, \$ 100 for

Valuation of horse, \$ 100

Valuation of horse equipments, \$ 100

Remarks: *Discharged on Surg's
Cert. of disability from
G. de A. U. S. Hospital New
Orleans La Dec 15/65. Final
Statement given*

** Corrected by E. H. Perry. E. H.*

Book mark:

L | **2 Cav. | U.S.C.T.**

Henderson Lucas

Plt, Co *H*, 2 Reg't U. S. Col'd Cavalry.

Appears on **Co. Muster-out Roll**, dated
Brazos Santiago Tex, Feb 12, 186*6*.

Muster-out to date 186 .

Last paid to 186 .

Clothing account:

Last settled....., 186 ; drawn since \$.....*100*

Due soldier \$.....*100*; due U. S. \$.....*100*

Am't for cloth'g in kind or money adv'd \$.....*100*

Due U. S. for arms, equipments, &c., \$.....*100*

Bounty paid \$.....*100*; due \$.....*100*

Remarks: *joined as Recruit*
Discharged on Surg's Cert. of
Disability in U.S. Gen'l Hosp
New Orleans La Dec 15/65
Disch & final statement furnished
same date

Book mark :

U. S. Army
Copyist.

L | **2 Cav.** | **U.S.C.T.**

Henderson Lucas

Pr. Co. H, 2 Reg't U. S. Colored Cav.

Appears on Returns as follows:

July 1865 - Gain -
Recruit from
Depot -

June to Aug 1865 -
Absent sick in Genl.
Hosp.

Sept + Oct 1865 - Absent
sick in Hospital
at New Orleans La.

Nov 1865 - Absent sick
in Hospital.

Dec 1865 - Lost Dec 17
65 - N.G. Discharged
Corps d'Afrique
Genl Hosp.

Book mark :

A. H. Collins

Lucas, Henderson
P., Co. H, 2 Reg't U. S. C. C.

2 Enclosures.

- | | |
|------------------------------------|-------------------------|
| Bed Cards | Descriptive Lists |
| Burial Records | Final Statements |
| Certs. of Dis. for Discharge | Furloughs |
| C. M. Charges | Med. Des. Lists |
| Med. Certificates | Orders |

Enlistments /

Other papers relating to—

- | | |
|----------------------------------|----------------------------|
| Admission to Hosp'l | Furlough |
| Casualty Sheet (Officer's) | Med. Examination |
| Confinement | Misc. Information |
| Contracts | Pay or Clothing |
| Death or Effects | Personal Reports |
| Desertions | Rank |
| Discharge from Hosp'l | Transfer to Hosp'l |
| Discharge from Service | Transfer to V. R. C. |
| Duty | Transportation |

Note 1. — This blank will be used for both enlistments and re-enlistments — enlistment of veterans, &c., &c., in the volunteer service. They will be made out in duplicate in all cases — one to accompany the recruiting return of the superintendent (not the recruiting officer) to the Adjutant-General, and one to accompany the accounts of the officer who pays bounty, &c. The Regiment and Company in which the soldier last served should be given on the back.

Note 2. — An enlistment holds to service. A muster-in must, in all cases, precede payment of pay, bounty, pension, &c. A muster-in roll must, in all cases, be filed in the Adjutant-General's Office as evidence of muster-in. The mustering officer, commissary, or assistant-commissary of musters, as the case may be, will countersign both enlistments as having mustered the soldier into the service of the United States before either of them is given to the disbursing officer.

DECLARATION OF RECRUIT

I, *Henderson Lucas* desiring to VOLUNTEER as a Soldier in the Army of the United States, for the term of THREE YEARS, Do Declare, That I am *25* years and *0* months of age; that I have never been discharged from the United States service on account of disability or by sentence of a court-martial, or by order before the expiration of a term of enlistment; and I know of no impediment to my serving honestly and faithfully as a soldier for three years.

GIVEN at *Norfolk Va* the *7* day of *January* 18*65*

Witness: *J. B. Parsons* *Henderson Lucas*
Mark

Discharged *18*

Reg't of *2nd* enlistment; last served in Company ()

By *Wm. H. McNamee* 18*65*
3rd Regiment of *Black A. S.*

Volunteered at *Norfolk*

No. *8*
Henderson Lucas

CONSENT IN CASE OF MINOR.

I, _____ Do CERTIFY, That I am _____; that the he _____ of _____; that the said _____ is _____ years of age; and I do hereby freely give my CONSENT to his volunteering as a SOLDIER in the ARMY OF THE UNITED STATES for the period of THREE YEARS.

GIVEN at _____ the _____ day of _____

Witness: _____

VOLUNTEER ENLISTMENT.

STATE OF



TOWN OF

Massachusetts

I, Henderson Lucas born in Nash Co in the State of N. C. aged 25 years, and by occupation a Farmer Do HEREBY ACKNOWLEDGE to have volunteered this 7th day of January 1865, to serve as a Soldier in the Army of the United States of America, for the period of THREE YEARS, unless sooner discharged by proper authority: Do also agree to accept such bounty, pay, rations, and clothing, as are, or may be, established by law for volunteers. And I, H Lucas do solemnly swear that I will bear true faith and allegiance to the United States of America, and that I will serve them honestly and faithfully against all their enemies or opposers whomsoever; and that I will observe and obey the orders of the President of the United States, and the orders of the officers appointed over me, according to the Rules and Articles of War.

Sworn and subscribed to, at Norfolk Va this 7th day of Jan 1865, before J. M. Monroe Lt. 57th U.S. C.T. Henderson Lucas

I CERTIFY, ON HONOR, That I have carefully examined the above-named Volunteer, agreeably to the General Regulations of the Army, and that, in my opinion, he is free from all bodily defects and mental infirmity, which would in any way disqualify him from performing the duties of a soldier.

W. B. Evans Asst Surg. 1st U.S. C.T. EXAMINING SURGEON.

I CERTIFY, ON HONOR, That I have minutely inspected the Volunteer, Lucas previously to his enlistment, and that he was entirely sober when enlisted; that, to the best of my judgment and belief, he is of lawful age; and that, in accepting him as duly qualified to perform the duties of an able-bodied soldier, I have strictly observed the Regulations which govern the recruiting service. This soldier has blk eyes, blk hair, brown complexion, is five feet eleven inches high.

James M. Monroe Lt. 57th Regiment of U.S. C.T. Volunteers, RECRUITING OFFICER.

Mustered into the service of the United States, in Company G, 1st Regt of Mass Heavy Arty, 1865, at New York City. Henderson Lucas

Headquarters, Department of Louisiana,

New Orleans, La., Dec. 12th 1865.

To be discharged.

By order of Major-General E. K. S. Canby:

E. A. Howell
Captain and A. A. G.

When the facts are not known to the company commander, the certificate of any officer, or affidavit of other person having such knowledge, will be appended—as the surgeon in charge of a hospital, the officer commanding a detachment of recruits, &c., &c.

NOTE 2.

When a probable case for pension, special care must be taken to state the degree of disability—as *h, s, &c.*, &c.; to describe particularly the disability, wound, or disease; the extent to which it deprives him of the use of any limb or faculty, or affects his health, strength, activity, constitution, or capacity to labor or earn his subsistence. The surgeon will add, from his knowledge of the facts and circumstances, and from the evidence in the case, his professional opinion of the cause or origin of the disability. In the case of discharges by Medical Inspectors, the last paragraph will state that the "discharge was given by consent of the soldier, after a personal examination, and for disability, the nature, degree, and origin of which are correctly described in the within certificate."

Par. 1260 Regulations, Edit. 1861.

Medical officers, in giving certificates of disability, are to take particular care in all cases that have not been under their charge; and especially in epilepsy, convulsions, chronic rheumatism, derangement of the urinary organs, ophthalmia, ulcers, or any obscure disease liable to be feigned or purposely produced; and in no case shall such certificate be given until after sufficient time and examination to detect any attempt at deception.

DIRECTIONS.

This certificate will be made out in duplicate by the soldier's company commander, or other officer commanding the separate detachment to which he belongs, and sent by him to the surgeon who has charge of the hospital where the soldier is sick. The surgeon will then fill out and sign the surgeon's certificate, and forward these papers to the regimental, detachment, or post commander, who will forward them, with his action endorsed thereon, through the proper channel, to his division commander; or, if the troops are not attached to a division, to his corps, department, or other commander or officer to whom the authority to discharge enlisted men may be specially delegated.

These certificates, after having received the action of the highest authority to which they are required to be sent, will be returned through the same channel to the regimental, post, or detachment commander, who will, if the discharge is authorized by the endorsement of the proper authority, sign the soldier's discharge, and the last certificate on this paper; see that the soldier is furnished with the proper final statements in duplicate, and forward BOTH of these certificates direct to the Adjutant General United States Army, at Washington, D. C.; they will not, under any circumstances, be given into the hands of the soldier.

ADJUTANT GENERAL'S OFFICE

Jan 8th 1866

Duplicate sent the Pension Office.

CERTIFICATE OF DISABILITY FOR DISCHARGE

IN THE CASE OF

✓ 1145-10
W. S. Henderson

Henderson

a *Private* Co. "H"

2^d Reg't of U.S.C. Gov.

Corps d' Afrique U. S. General Hospital.

New Orleans, La., Dec 11th 1865

Respectfully Forwarded,
Approved by board of
examination

F. E. Piquette
Surgeon 36th U.S. Infantry
President of board

Received (A. G. Office)

Out on *W. S. Henderson*
1866

Louisiana

New Orleans Dec 11th 5-

Respectfully forwarded to
Hon. Secy of War, Dept of
the Dept. of War

J. H. Linton
Col. Colonel Surgeon U.S. Army
Medical Director

ARMY OF THE UNITED STATES CERTIFICATE OF DISABILITY FOR DISCHARGE.



Private Henderson Lucas, of Captain James K. Jones Company, ("H") of the Seconder Regiment of United States Infantry was enlisted by Lieut. Morrison of the Seconder Regiment of Missouri at New Orleans, La. on the 22nd day of June, 1865, to serve three years; he was born in England in the State of Virginia, is twenty three years of age, five feet six inches high, fair complexion, blue eyes black hair, and by occupation when enlisted a laborer. During the last two months said soldier has been unfit for duty 60 days.*

STATION: Camp U.S. Gen. Hospital, New Orleans, La.
 DATE: New Orleans, La. Dec. 8th 1865.

F. E. Pyquette
 Surgeon in Charge,
 Commanding Company.

I CERTIFY that I have carefully examined the said Henderson Lucas Private of Captain J. C. Jones Company, and find him incapable of performing the duties of a soldier because of Secondary Syphilis contracted since enlistment rendering him unfit for any branch of the service; he is entitled to no degree of disability one third but not entitled to a pension

J. Jackson
 Act. Asst. Surgeon.

DISCHARGED, this fifteenth day of December, 1865, at New Orleans, La.
Camp U.S. Gen. Hospital

F. E. Pyquette
 Surgeon in Charge,
 Commanding the Reg't

The Soldier desires to be addressed at
 Town _____ County _____ State _____

* See Note 1 on the back of this. † See Note 2 on the back of this.

986

Lunday William

Co E, 2 U. S. Col'd Cav.

Private Private

CARD NUMBERS.

1	5322201	26
2	5322281	27
3	5322367	28
4	5322452	29
5	5322531	30
6	5322618	31
7	5322702	32
8	5322783	33
9	5322877	34
10	5322970	35
11	5323064	36
12	5323152	37
13	5323231	38
14	5323310	39
15	9087522	40
16	31633286	41
17	31635053	42
18	31636431	43
19	31637264	44
20	31637494	45
21	30976511	46
22	31645264	47
23	33117546	48
24	33121306	49
25	40726313	50

Book Mark:

See also

⁹⁸⁶
Lunday William

Co E, 2 U. S. Col'd Cav.

Private Private

CARD NUMBERS.

1	5322201	26
2	5322281	27
3	5322367	28
4	5322452	29
5	5322531	30
6	5322618	31
7	5322702	32
8	5322783	33
9	5322877	34
10	5322970	35
11	5323064	36
12	5323152	37
13	5323231	38
14	5323310	39
15	9087522	40
16	31633286	41
17	31635053	42
18	31636431	43
19	31637264	44
20	31637444	45
21	30970511	46
22	31645264	47
23	33117546	48
24	33121306	49
25	40726313	50

Book Mark:

See also

S. 680484. P.O. aff -

S. 684768. P.O. aff -

S-759750- P.O. aff -

S. 1605066 P.O. aff -

St Ballary 4r

2^d | 2 Cav. | U.S.C.T.

William Sunday
Co. E, 2 Reg't U. S. Col'd Cav.

Appears on
Company Descriptive Book
of the organization named above.

DESCRIPTION.

Age 20 years; height 5 feet 8 inches.
Complexion Black
Eyes Black; hair Black
Where born Southampton Co, Va
Occupation Laborer

ENLISTMENT.

When Dec 25, 1863.
Where Norfolk, Va.
By whom Col. Cole; term 3 y'rs.

Remarks:

F. B. Smith
Copyist.

S | **2 Cav.** | **U.S.C.T.**

William Lunday
....., Co. *E*, 2 Reg,t U. S. Col'd Cavalry.

Age *20* years.

Appears on

Company Muster-in Roll

of the organization named above. Roll dated

Fort Monroe, Va. Jan. 8, 1864.

Muster-in to date

Jan. 8, 1864.

Joined for duty and enrolled:

When *December 25*, 186*3*.

Where *Norfolk, Va.*

Period *3* years.

Valuation of horse, \$.....*100*

Valuation of horse equipments, \$.....*100*

Remarks :

Book mark :

J. C. Taylor

L | **2 Cav.** | **U.S.C.T.**

William Sunday

Priv., Co. E, 2 Reg't U. S. Col'd Cavalry.

Appears on

Company Muster Roll

for *Enrollment to Feb. 29, 1864.*

Present or absent *Present*

Stoppage, \$.....100 for

Due Gov't, \$.....100 for

Valuation of horse, \$.....100

Valuation of horse equipments, \$.....100

Remarks:.....

Book mark:.....

A. C. Taylor

S | **2 Cav.** | **U.S.C.T.**

William Sunday
Pvt., Co. E, 2 Reg't U.S. Col'd Cavalry.

Appears on

Company Muster Roll

for *Mar. and Apr.*, 1864.

Present or absent *Present*

Stoppage, \$ 100 for

Due Gov't, \$ 100 for

Valuation of horse, \$ 100

Valuation of horse equipments, \$ 100

Remarks:

Book mark:

P. C. Taylor

S | **2 Cav.** | **U.S.C.T.**

William Sunday

Plt., Co. E, 2 Reg't U. S. Col'd Cavalry.

Appears on

Company Muster Roll

for *May and June*, 1864.

Present or absent *Present*

Stoppage, \$ 100 for

Due Gov't, \$ *85* 100 for *ordnance*

Valuation of horse, \$ 100

Valuation of horse equipments, \$ 100

Remarks:

Book mark:

A. C. Taylor

L | 2 Cav. | U.S.C.T.

William Lunday
Priv., Co. E, 2 Reg't U. S. Col'd Cavalry.

Appears on

Company Muster Roll

for July & Aug, 1864

Present or absent Absent

Stoppage, \$ 100 for

Due Gov't, \$ 100 for

Valuation of horse, \$ 100

Valuation of horse equipments, \$ 100

Remarks: Stoppage for Sabre #750. Belt & Plate #135
Detailed in 2nd Dept as
transfer

Book mark:

Waudington

L 1 2 car USCT

William Lundy

Cvt., Co. E, 2 Reg't U.S.C. Cav.

Appears on

Hospital Muster Roll

of Summit House U. S. A. General Hospital,

at Philadelphia, Pa.,

for July & Aug, 1864.

Attached to hospital:

When _____, 186 .

How employed _____

Last paid by Maj. _____

to _____, 186 .

Bounty paid \$ 100; due \$ 100

Present or absent Present

Remarks: _____

Hand 11

Book mark: _____

J. Lundy

MAR 1864

L | **2 Cav.** | **U.S.C.T.**

Wm Sunday
Spr....., Co. E, 2 Reg't U. S. Col'd Cavalry.

Appears on

Company Muster Roll
for *Sept & Oct*....., 186 *4*.

Present or absent *Absent*.....

Stoppage, \$.....*100* for.....

Due Gov't, \$.....*100* for.....

Valuation of horse, \$.....*100*

Valuation of horse equipments, \$.....*100*

Remarks: *Detailed in 2nd M
Department*

Book mark:.....

(358)

Waundering Fox
Copyist.

L | 2 cav USC
from Sunday
Pvt, Co. E 2 Reg't USC

Appears on

Hospital Muster Roll

of Summit House U. S. A. General Hospital,

at Philadelphia, Pa.,

for Sept Oct, 1864

Attached to hospital:

When _____, 186 .

How employed _____

Last paid by Maj. _____

to Aug 31, 1864.

Bounty paid \$ 100 due \$ 100

Present or absent Present

Remarks: Mustered
for Sep Oct
1864

Ward 11

Book mark: _____

W M Campbell

L | 2 Cav. | U.S.C.T.

William Lundy
Priv, Co. E, 2 Reg't U. S. Col'd Cavalry.

Appears on

Company Muster Roll

for *Nov & Dec*, 186 *4*

Present or absent *Absent*

Stoppage, \$ *100* for

Due Gov't, \$ *100* for

Valuation of horse, \$ *100*

Valuation of horse equipments, \$ *100*

Remarks: *Detailed as Dr Mr*
Dept. Learner

Book mark:

(358)

Waddington

Copyist.

L 1 2 Cav. | U.S.C.P.

Wm Lundy
1st, Co. D, 2 Reg't U.S.Cav.

Appears on

Hospital Muster Roll

of Summit House U. S. A. General Hospital,

at Philadelphia, Pa.,

for *Nov 1864*, 1864.

Attached to hospital:

When *Aug 17*, 1864.

How employed

Last paid by Maj.

to *Aug 31*, 1864.

Bounty paid \$ 100; due \$ 100

Present or absent *present*

Remarks: *Mustered for Sept., Oct., Nov and Dec. 1864.*

Ward 11.

Book mark :

Calcutt

L | **2 Cav. | U.S.C.T.**

William Lundy

Sir..., Co. E, 2 Reg't U. S. Col'd Cavalry.

Appears on

Company Muster Roll

for *Jan Feb*..., 186 *5*.

Present or absent *Absent*

Stoppage, \$ *100* for

Due Gov't, \$ *100* for

Valuation of horse, \$ *100*

Valuation of horse equipments, \$ *100*

Remarks: *Absent Sick
in Genl Hospit*

Book mark:

Waudrington

L. L. Cav. U.S.C.T.

Wm Sunday

Pvt., Co. E, 2 Reg't U. S. Cav

Appears on

Hospital Muster Roll

of Summit House U. S. A. General Hospital,

at Philadelphia, Pa.,

for Jan. & Feb., 1865.

Attached to hospital:

When Aug. 17, 1864.

How employed _____

Last paid by Maj. Stryker,

to Dec 31, 1864.

Bounty paid \$ 100; due \$ 100

Present or absent present,

Remarks:

Mustard for Jan. & Feb., 1865,

Ward 3.

Book mark : _____

Albion

L | **2 Cav.** | **U.S.C.T.**

William Sunday

Private Co. E, 2 Reg't U. S. Col'd Cavalry.

Appears on

Company Muster Roll

for March & April, 1868.

Present or absent Absent.

Stoppage, \$ 100 for

Due Gov't, \$ 100 for

Valuation of horse, \$ 100

Valuation of horse equipments, \$ 100

Remarks: Absent sick in Genl Hospital.

Book mark:

R. Bredin

L | 2 leav. | U.S.C.

Wm. Lundy
Inf., Co. E, 2 Reg't U.S.C. I Cav.

Appears on

Hospital Muster Roll

of Summit House U. S. A. General Hospital,

at Philadelphia, Pa.,

for *March & Apr.*, 186*4*.

Attached to hospital:

When *Aug. 17*, 186*4*.

How employed

Last paid by Maj. *Stryker*

to *Dec. 31*, 186*4*.

Bounty paid \$ *100*; due \$ *100*

Present or absent

Remarks: *Transfd March 29/65
to Gen. Hospl. Beverly, N. J.
in compl. with cir. 175
Med. dir. Off. Phila. March 28/
65.*

Book mark:

Andrew

L. 12 Cav N. J. C.

William Lundy
Co. E, 2 Regt N. J. C.

Appears on

Hospital Muster Roll

of U. S. A. General Hospital,

at Beverly, N. J.,

for *Mar & Apr*, 1865.

Attached to hospital:

When *Mar 29*, 1865.

How employed

Last paid by Maj.

to _____, 1865.

Bounty paid \$ *100*; due \$ *100*

Present or absent *Present*

Remarks:

*Mr D. L. Mustered
for Mar & Apr 1865.*

Ward 1

Book mark :

Smith

NOV 17 1865

L. | **2 Cav.** | **U.S.C.T.**

William Lundy

Pat, Co. E, 2 Reg't U. S. Col'd Cavalry.

Appears on

Company Muster Roll

for *May June*, 186⁵.

Present or absent *Absent*

Stoppage, \$ 100 for

Due Gov't, \$ 100 for

Valuation of horse, \$ 100

Valuation of horse equipments, \$ 100

Remarks: *Absent Sept in General Hospital*

Book mark:

W. Schudy
(358) Copyist.

L 12 cav. 12507

William Lundy
Priv., Co. E., 2 Reg't U. S. I. C. P.

Appears on

Hospital Muster Roll

of White Hall U. S. A. General Hospital,

at Near Bristol, Pa.,

for May & June, 1865.

Attached to hospital:

When....., 186 .

How employed.....

Last paid by Maj.....

to....., 186 .

Bounty paid \$ 100; due \$ 100

Present or absent

Remarks: Transferred
June 26/65 to McClellan
Hosp.

Book mark :

McSmith

L 12 " Cav. | U.S.C.T.

William Lundy
priv., Co. E, 2 Reg't U.S. Cav.

Appears on

Hospital Muster Roll

of Satterlee U. S. A. General Hospital,

at West Philadelphia, Pa.

for May & June, 1865.

Attached to hospital:

When....., 186 .

How employed.....

Last paid by Maj.....

to....., 186 .

Bounty paid \$.....¹⁰⁰; due \$.....¹⁰⁰

Present or absent present

Remarks:.....

.....
.....
.....
.....

Ward 1

Book mark :.....

Gustav

L | 2 Cav. | U.S.C.T.

William Lundy

Pat, Co. E, 2 Reg't U. S. Col'd Cavalry.

Appears on

Company Muster Roll

for July & Aug, 1865

Present or absent Absent

Stoppage, \$ 100 for

Due Gov't, \$ 100 for

Valuation of horse, \$ 100

Valuation of horse equipments, \$ 100

Remarks: Absent sick in Hospital

Book mark:

J. H. Schrey

L | 2 cav | U. S. C.

William Sunday

Plt, Co. C, 2 Reg't U. S. C. Cav.

Appears on

Hospital Muster Roll

of Satterlee U. S. A. General Hospital,

at West Philadelphia, Pa.,

for July range, 1865.

Attached to hospital:

When _____, 186 .

How employed _____

Last paid by Maj. _____

to _____, 186 .

Bounty paid \$ 100; due \$ 100

Present or absent _____

Remarks: Returned to duty
July 31, 1865

Book mark : _____

W. D. Brown

L

2 Cav. | U.S.C.T.

William Lamy

Priv, Co. E, 2 Reg't U. S. Col'd Cavalry.

Appears on

Company Muster Roll

for *Sept and Oct*, 1865.

Present or absent *Present*

Stoppage, \$ *100* for

Due Gov't, \$ *100* for

Valuation of horse, \$ *100*

Valuation of horse equipments, \$ *100*

Remarks:

Book mark:

N. K. Merrill

L

2 Cav.

U.S.C.T.

Wm Lundy

Priv

, Co. E, 2 Reg't U. S. Col'd Cavalry.

Appears on

Company Muster Roll

for *Nov. and Dec*, 1865.

Present or absent *Present*

Stoppage, \$ *100* for

Due Gov't, \$ *100* for

Valuation of horse, \$ *100*

Valuation of horse equipments, \$ *100*

Remarks: *Due \$ 6. per month from Jan 1. 64 to April 30. 64 increase of pay*

Book mark:

N. H. Merrill

L | 2 Cav. | U. S. C. T.

William Lunday*
 Pvt., Co. E., 2 Reg't U. S. Cav.

Appears on Returns as follows:

Mch & Apr 1864 On duty as teamster
 May & June 1864 On duty teamster
 in R. D. M. Dept
 July 1864 Absent det as teamster
 Aug 1864 Absent on det serv. as
 teamster since July 18/64 per
 Par II S.O. no 40 Hd Qrs 2^d Brig
 3^d Div. 18th AC
 Sept 1864 Absent on det service with
 Amb. Corps, 18 AC
 Oct 1864 to Jan 1865 Absent det in
 R. M. Dept
 Feb to Apr 1865 Absent sick
 May & June 1865 Absent sick in
 Genl Hosp.
 July 1865 Absent sick in Hosp
 Dept Va.
 Aug 1865 Absent sick in G. H.

* Name appears also as
 Lockey

Book mark:

Storrill

Lo | **2 Cav.** | **U.S.C.T.**

William Lundy

Pri, Co. *E*, 2 Reg't U. S. Col'd Cavalry.

Appears on **Co. Muster-out Roll**, dated

Amos Santiago Fox, *Feb 12*, 186*6*.

Muster-out to date *Feb 12*, 186*6*.

Last paid to *June 30*, 186*5*.

Clothing account:

Last settled....., 186 ; drawn since \$..... $\overline{100}$

Due soldier \$..... $\overline{100}$; due U. S. \$..... $10 \frac{6.2}{100}$

Am't for cloth'g in kind or money adv'd \$..... $\overline{100}$

Due U. S. for arms, equipments, &c., \$..... $\frac{20}{100}$

Bounty paid \$..... $\overline{100}$; due \$..... $\overline{100}$

Remarks: *Joined at reg. camp*

*New soldier \$6 per month increase of pay
from Jan 1, 64 to Apr 30, 64*

Stop on thing and break pipe

Book mark :

W. A. Merrill

987
Lorrick Alfred

Co A., 2 U. S. Col'd Cav.

CARD NUMBERS.

1	26
2	27
3	28
4 See Lorrick	29 Alfred
5 Lorrick	30 Alfred
6	31
7	32
8	33
9	34
10	35
11	36
12	37
13	38
14	39
15	40
16	41
17	42
18	43
19	44
20	45
21	46
22	47
23	48
24	49
25	50

Book Mark:

See also

Lyles ⁹⁸⁸ James A.

Co., 2 U. S. Col'd Cav.

Private | Private

CARD NUMBERS.

1	5315513	26
2	5316224	27
3	53168531	28
4	4055791	29
5		30
6		31
7		32
8		33
9		34
10		35
11		36
12		37
13		38
14		39
15		40
16		41
17		42
18		43
19		44
20		45
21		46
22		47
23		48
24		49
25		50

Book Mark:

See also

L | 2 Cav. | U.S.C.T.

James A. Lyles

Appears with the rank of _____ on

Muster and Descriptive Roll of a Detachment of U. S. Vols. forwarded

for the 2 Reg't U. S. Colored Cav. Roll dated

Baltimore, Md, Feb 20, 1865.

Where born Balto. Co. Maryland

Age 18 y'rs; occupation Farmer

When enlisted Mar. 14, 1865.

Where enlisted Baltimore, Md.

For what period enlisted 1 years.

Eyes Blue; hair Black

Complexion Black; height 5 ft. 8 in.

When mustered in Mar. 14, 1865.

Where mustered in Baltimore, Md

Bounty paid \$ 100; due \$ 100

Where credited _____

Company to which assigned _____

Remarks This man has left

Power of Attorney to collect

bounty

Book mark: _____

E. H. Spang

Copyist.

S | *2 Cav* | **U.S.C.T.**

James A. Syles
Priv., Co....., *2* Reg't U. S. Col'd *Cav.*

Age *18* years.

Appears on a

Detachment Muster-in Roll

of the organization named above. Roll dated
Baltimore, Md., Mar. 22, 1863:

Muster-in to date *Mar. 18, 1863*:

Joined for duty and enrolled:

When *Mar, 14*, 1863.

Where *Baltimore, Md.*

Period *1* years.

Valuation of horse, \$.....¹⁰⁰

Valuation of horse equipments, \$.....¹⁰⁰

Remarks: *Enlisted*

.....
.....
.....

Book mark :

.....
.....

L | 2 Cav. | U.S.C.T.

* James H. Lyles

Pvt., Co., 2 Reg't U. S. Col'd Cav.

Appears on an

Individual Muster-out Roll

of the organization named above. Roll dated

Baltimore, May, 1865.

Muster-out to date May 24, 1865.

Last paid to never paid, 186 .

Clothing account:

Last settled, 186 ; drawn since \$ 100

Due soldier \$ 100; due U. S. \$ 100

Am't for cloth'g in kind or money adv'd \$ 100

Due U. S. for arms, equipments, &c., \$ 100

Bounty paid \$ 100 due \$ 100

Remarks: Rec'd. Bounty money due \$ 33 1/3 due U.S. for clothing overdrawn \$ 19 1/4.

* M.O. in accordance with tele gram dated A. S. O. Washington DC May 4/ 1865

* A. S. O. appearance roll.

* Inceidit by Compr

Book mark:

J. H. Smith

L | 2 Cav. | U.S.C.T.

James A Lyles

Appears with rank of _____ on

Muster and Descriptive Roll of a Detachment of U. S. Vols. forwarded

for the 2 Reg't U. S. Col'd Cavalry. Roll dated

Not dated, _____, 186 .

Where born Baltimore Md

Age 18 yrs; occupation Farmer

When enlisted March 14, 1865.

Where enlisted Baltimore Md

For what period enlisted 1 years.

Eyes blk hair blk

Complexion blk height 5 ft. 8 in.

When mustered in March 14, 1865.

Where mustered in Baltimore Md

Bounty paid \$ 100 due \$ 100

Where credited _____

Company to which assigned _____

Remarks : _____

Roll not signed

Book mark : _____

S. J. York

CANCELLED. This card was erroneously made from an assigned M. & D. Roll. See Roll from R. & P. 186576 signed roll.

Lyles ⁹⁸⁹ *John J.*

Co D, 2 U. S. Col'd Cav.

Private

CARD NUMBERS.

1	26
2	27
3	28
4	29
5	30
6	31
7	32
8	33
9	34
10	35
11	36
12	37
13	38
14	39
15	40
16	41
17	42
18	43
19	44
20	45
21	46
22	47
23	48
24	49
25	50

See Lyles Thomas

Book Mark:

See also

990 or Thomas S
or Thomas J
Lyles Thomas

Co D, 2 U. S. Col'd Cav.

Private Private

CARD NUMBERS.

1	5-316225-	26
2	5315514	27
3	5321623	28
4	5321723	29
5	5321927	30
6	5322016	31
7	5322104	32
8	9087403	33
9	R0380028	34
10	5321825-	35
11	40055792	36
12		37
13		38
14		39
15		40
16		41
17		42
18		43
19		44
20		45
21		46
22		47
23		48
24		49
25		50

Book Mark: R0380028

See also

S-726791-P. G. aff.
S-95-4272 - P.O. M + M
S-95-3789 - P.O. aff
S-960101 - P.O. aff
D-2963897 - And N.D.

L Ballard Jr .

L | **2 Cav. | U.S.C.T.**

John T. Lyles
 , Co. *D*, 2 Reg't U. S. Col'd Cav.

Appears on

Company Descriptive Book
 of the organization named above.

DESCRIPTION.

Age *24* years; height *5* feet *6 1/2* inches.

Complexion *Black*

Eyes *Black*; hair *Black*

Where born *Howard, Md.*

Occupation *Farmer*

ENLISTMENT.

When *Mar. 14*, 186*5*.

Where *Baltimore*

By whom *Col. Bowman*; term *1* y'rs.

Remarks:

.....

F. B. Smith
 Copyist.

L | 2 Cav. | U.S.C.T.

John F Lyles

Appears with rank of _____ on

Muster and Descriptive Roll of a Detachment of U. S. Vols. forwarded

for the 2 Reg't U. S. Col'd Cavalry. Roll dated

Not datee, _____, 186 .

Where born Howard Co Md

Age 24 y'rs; occupation Farmer

When enlisted March 14, 1865.

Where enlisted Baltimore Md

For what period enlisted 1 years.

Eyes blk hair blk

Complexion blk height 5 ft. 6 1/2 in.

When mustered in Mch 14, 1865.

Where mustered in Balto Md

Bounty paid \$ _____ due \$ 100

Where credited _____

Company to which assigned _____

Remarks: _____

Roll not signed

Book mark: R 380028

S. P. York

This card was originally filed in the roll of the 2nd Reg't U.S. Col'd Cavalry, R. & P. 48657. It was assigned M. & L. roll, R. & P. 48657. CANCELLED.

L. | 2 Cav. | U.S.C.T.

John T. Lyles

Appears with the rank of _____ on

Muster and Descriptive Roll of a Detachment of U. S. Vols. forwarded

for the 2 Reg't U. S. Colored Cav. Roll dated

Baltimore Md, *March 20*, 1865.

Where born *Howard Co. Maryland*

Age *24* y'rs; occupation *Farmer*

When enlisted *Mar. 14*, 1865.

Where enlisted *Baltimore. Md.*

For what period enlisted *1* years.

Eyes *Blue*; hair *Black*

Complexion *Black*; height *5* ft. *6 1/2* in.

When mustered in *Mar. 14*, 1865.

Where mustered in *Baltimore. Md.*

Bounty paid \$ *100*; due \$ *100*

Where credited _____

Company to which assigned _____

Remarks: *This man has left Power of Attorney to collect bounty.*

Book mark: _____

E. H. Spang
Copyist.

L | *2 Cav* | **U.S.C.T.**

John T. Syles
Priv., Co., *2* Reg't U. S. Col'd *Cav*

Age *24* years.

Appears on a

Detachment Muster-in Roll

of the organization named above. Roll dated

Baltimore, Md., Mar. 22, 1863

Muster-in to date *Mar. 18, 1863*

Joined for duty and enrolled:

When *Mar. 14*, 1863.

Where *Baltimore, Md.*

Period *1* years.

Valuation of horse, \$ *100*

Valuation of horse equipments, \$ *100*

Remarks: *Enlisted*

Book mark :

Beck

2 Cav. U.S.C.T.

John G. Syle

Pvt., Co. D, 2 Reg't U. S. Col'd Cavalry.

Appears on

Company Muster Roll

for *May & April*, 1865.

Present or absent *Present*

Stoppage, \$ *100* for

Due Gov't, \$ *100* for

Valuation of horse, \$ *100*

Valuation of horse equipments, \$ *100*

Remarks: *Recruit from Depot*

Book mark:

C. W. Hillard

L | **2 Cav.** | **U.S.C.T.**

William Syle

Pvt, Co. D, 2 Reg't U. S. Col'd Cavalry.

Appears on

Company Muster Roll

for *April 30 to Aug 31*, 1865.

Present or absent *Present*

Stoppage, \$ *100* for

Due Gov't, \$ *100* for

Valuation of horse, \$ *100*

Valuation of horse equipments, \$ *100*

Remarks:

appears on Roll

Book mark: *Dead June 18/65 E.M.P.*

100.00 24.00 100.00 & cancelled

See notation of Jan 94
S. M. Hill

1865

✓

2 Cav. U.S.C.T.

John G. Lyle

Co. D, 2 Reg't U. S. Col'd Cavalry.

Appears on

Company Muster Roll

for May & June, 1865

Present or absent Present

Stoppage, \$ 100 for

Due Gov't, \$ 100 for

Valuation of horse, \$ 100

Valuation of horse equipments, \$ 100

Remarks: Recruit from Depot

Next name on roll Sept Oct 65

Book mark:

S. W. Hillard

(358)

Copyist.

L | **2 Cav.** | **U.S.C.T.**

Thomas T Lyles

mi, Co. D, 2 Reg't U. S. Col'd Cavalry.

Appears on

Company Muster Roll

for *Sept & Oct*, 1865.

Present or absent *Present*

Stoppage, \$ 100 for

Due Gov't, \$ 100 for

Valuation of horse, \$ 100

Valuation of horse equipments, \$ 100

Remarks:

Book mark:

A W Forrest
(358) Copyist.

20 | **2 Cav.** | **U.S.C.T.**

Thomas S. Lyles
Private, Co. D, 2 Reg't U. S. Col'd Cavalry.

Appears on

Company Muster Roll

for Nov 18 Dec, 1866.

Present or absent Present

Stoppage, \$ 100 for

Due Gov't, \$ 100 for

Valuation of horse, \$ 100

Valuation of horse equipments, \$ 100

Remarks:

Book mark:

S W Forrest

L | **2 Cav.** | **U.S.C.T.**

Thomas Lyles
Private, Co. D, 2 Reg't U. S. Col'd Cavalry.

Appears on **Co. Muster-out Roll**, dated
Prayer Santiago Tex Feb 12, 1866.
Muster-out to date Feb 12, 1866.
Last paid to June 3, 1865.

Clothing account:

Last settled....., 186 ; drawn since \$..... 100

Due soldier \$ 16 ¹⁴/₁₀₀; due U. S. \$..... 100

Am't for cloth'g in kind or money adv'd \$..... 100

Due U. S. for arms, equipments, &c., \$..... 100

Bounty paid \$..... 100; due \$ 66 ⁶⁶/₁₀₀

Remarks: joined a recruit
left power of attorney to
collect bounty at date of
enlist

Book mark: V 88. P 150. 69.

J W Forrest
(361) Copyist.

L. 12 Cav. U.S.C.

John J. Syles
Priv., Co. A, 2 Reg't U.S.C. Cav.

NOTATION.

Book mark: R. & P. 380028

Record and Pension Office,

WAR DEPARTMENT,

Washington, Jan. 16, 1894.

It has this day (Jan. 16, 1894,)

been determined by this Department from records on file that the name William Syles, shown as present on roll for July and Aug. 1865, is regarded by this office as referring to John J. Syles, who was mustered out of service with the company.

a.g.m.

Lyles, Wm.

, Co. D, 2 Reg't U.S.C.C.

1
Enclosures.

Bed Cards	Descriptive Lists
Burial Records	Final Statements
Certs. of Dis. for Discharge	Furloughs
C. M. Charges	Med. Des. Lists
Med. Certificates	Orders

Other papers relating to—

Admission to Hosp'l	Furlough
Casualty Sheet (Officer's)	Med. Examination
Confinement	Misc. Information
Contracts	Pay or Clothing
Death or Effects	Personal Reports
Desertions	Rank
Discharge from Hosp'l	Transfer to Hosp'l
Discharge from Service	Transfer to V. R. C.
Duty	Transportation

CASUALTY SHEET

No. _____
Wm. Lyles
of Company *D*
Regiment of *26th Col*
State Volunteers.

NATURE OF CASUALTY.

Death died June 18/65

[OFFICE INDORSEMENT.]

War Department,

ADJUTANT GENERAL'S OFFICE,

July 13th, 1874
The Death of *Wm. Lyles*
Private, Co. "*D*", *2^d* Reg't U. S.
Colored Cavalry, is reported as follows:
On Company Muster Roll. *name first borne on Roll May & June '65*
For *July & Aug*, 1865, *Present for duty*, 186
Company Muster-out Roll.
June 24th, 1865
✓ Company Descriptive Book.
June 24th, 1865.
✓ Company Morning Reports.
Commencing Aug. 14th 1865. No Record, 186
Soldier's Final Statement. _____, 186
Soldier's Record of Death and Interment. _____, 186
Soldier's Inventory of Effects. _____, 186
Soldier's Certificate of Disability for Discharge. _____, 186
Soldier's Individual Muster-out Roll. _____, 186
Regimental Return. _____, 186
For _____, 186, _____, 186
Regimental Quarterly Returns. _____, 186
✓ Regimental Descriptive Book.
Not on file, 186
By Surgeon General.
(Squ. V. I. O. C. 37) June 18th, 1865
June 18th, 1865, is held to be
the correct date, and the Company Muster-out
Roll will be amended accordingly.

Thoma M. Stewart

Assistant Adjutant General.

EB 12/14 *Noted on R. I. B.*
See letter to Secord and
Aug 10th 1874.
Bel. MK

CASUALTY SHEET.

Name: *Wm Tyles* *Private*

Rank: *"K"* Company: *2^d* Regiment: *1st S.C. Cav'*

Arm: _____ State: _____

Nature of Casualty: *Death*

CAUSE OF CASUALTY—(NAME OF DISEASE, &c.)

Disease

BY WHOM DISCHARGED.

FROM WHAT SOURCE THIS INFORMATION WAS OBTAINED.

M. C. Hall of Co.

DEGREE OF DISABILITY.

BY WHOM CERTIFIED.

Wm P. Guachambush
1st Lieut 2^d U.S.C.

REMARKS.

DATE OF DISCHARGE, DEATH, &c.

PLACE OF DISCHARGE, DEATH, &c.

Aboard U.S. Transport Steamer "Sitor"

E. W. Lindsay
Clerk.

⁹⁹¹
Lyles William H. G.

Co *D*, 2 U. S. Col'd Cav.

Private Private

CARD NUMBERS.

1	5-316226	26
2	5-3155157	27
3	5-321624	28
*	5-321825	29
5	5-322153	30
6	9087404	31
7	40055793	32
8	894-05-1874	33
9		34
10		35
11		36
12		37
13		38
14		39
15		40
16		41
17		42
18		43
*	Card withdrawn and	
20	filed in envelope of	
21	Lyles Thomas where it	
22	properly belongs.	
23	48	Jan. 1879
24	49	Mag.
25	50	

Book Mark: 894-05-1874

See also

L | 2 Cav. | U.S.C.T.

William H. Lyles

....., Co. D, 2 Reg't U. S. Col'd Cav.

Appears on

Company Descriptive Book

of the organization named above.

DESCRIPTION.

Age 18 years; height 5 feet 8 inches.

Complexion Black

Eyes Black; hair Black

Where born Baltimore Md.

Occupation Farmer

ENLISTMENT.

When Mar. 14, 1862

Where Baltimore

By whom Col. Bourne; term 1 yr.

Remarks:

.....
.....
.....
.....
.....
.....
.....
.....
.....
.....

F. B. Smith

L | 2 Cav. | U.S.C.T.

William H. G. Lyles

Appears with rank of _____ on

Muster and Descriptive Roll of a Detachment of U. S. Vols. forwarded

for the 2 Reg't U. S. Col'd Cavalry. Roll dated

Not dated, 186 .

Where born Balto Co Md

Age 18 y'rs; occupation Farmer

When enlisted March 14, 186 J.

Where enlisted Baltimore Md

For what period enlisted 1 years.

Eyes blk hair blk

Complexion blk; height 5 ft. 8 in.

When mustered in Me 14, 186 J.

Where mustered in Balto Md

Bounty paid \$ _____ due \$ 100

Where credited _____

Company to which assigned _____

Remarks: _____

Roll not signed

Book mark: S 94-05-1874

J. P. York

Copyist.

This card was originally made from an Ensigned M. & Dr. R. & I signed roll.

L. | 2 Cav. | U.S.C.T.

William H. G. Lyles

Appears with the rank of _____ on

Muster and Descriptive Roll of a Detachment of U. S. Vols. forwarded

for the 2 Reg't U. S. Colored Cav. Roll dated

Baltimore Md, Feb 20, 1865.

Where born Balto Co. Maryland

Age 18 y'rs; occupation Farmer

When enlisted Feb 14, 1865.

Where enlisted Baltimore Md.

For what period enlisted 1 years.

Eyes Blue; hair Blue

Complexion Blue; height 5 ft. 8 in.

When mustered in Feb 14, 1865.

Where mustered in Baltimore Md

Bounty paid \$ 100; due \$ 100

Where credited _____

Company to which assigned _____

Remarks This man has left
power of attorney to collect
bounty

Book mark: _____

E. H. Spang

S | *2 Cav* | **U.S.C.T.**

William H. G. Syles
Priv., Co., *2* Reg't U. S. Col'd *Cav*

Age *18* years.

Appears on a

Detachment Muster-in Roll

of the organization named above. Roll dated

Baltimore, Md, Mar. 22, 1863

Muster-in to date *Mar. '8, 1863*

Joined for duty and enrolled:

When *Mar 14*, 1863.

Where *Baltimore, Md,*

Period *1* years.

Valuation of horse, \$ *100*

Valuation of horse equipments, \$ *100*

Remarks: *Enlisted*

Book mark : *100*

Beck

L | **2 Cav. | U.S.C.T.**

William Lyle

2d, Co. D, 2 Reg't U. S. Col'd Cavalry.

Appears on

Company Muster Roll

for *Mar & April*, 1865.

Present or absent *Present*

Stoppage, \$ *100* for

Due Gov't, \$ *100* for

Valuation of horse, \$ *100*

Valuation of horse equipments, \$ *100*

Remarks: *Recruit from Depot*

Book mark:

C. W. Hill

L | 2600 | **U. S. C. T.**

William Lyles
Prs, Co. D, 2 Reg't U. S. Col'd Car

Appears on **Co. Muster-out Roll**, dated
George Santiago Tex, Feb 12, 1866
Muster-out to date _____, 186 .
Last paid to _____, 186 .

Clothing account:
Last settled _____, 186 ; drawn since \$ _____ 100
Due soldier \$ _____ 100; due U. S. \$ _____ 100
Am't for cloth'g in kind or money adv'd \$ _____ 100

Due U. S. for arms, equipments, &c., \$ _____ 100
Bounty paid \$ _____ 100 due \$ _____ 100

Remarks: Joined a recruit
Died on board of US
Transport Steamer Meteor
June 24. 65. of disease
Final statement & list of
effects furnished

Book mark: Died June 18. 65
CB N 11. Pg 24. 18 94 N 10
S W Foster

NOV 19 1874

L. 1 2nd Cav. U.S.C.

William H. G. Lyles,
, Co. , 2nd Reg't U.S.C. Cav.

NOTATION.

Book mark : S. G. C. J. 1874.

Record and Pension Office,

WAR DEPARTMENT.

This book mark refers only to a report from the medical records, made by the Surgeon General to the Adjutant General, relative to the above-named man. As the medical records have since been carded, no transcript of this report is made hereon.

(491)

E. P. Conrazier

Copyist.

992
Mace Riley

Co A, 2 U. S. Col'd Cav.

Private Private

CARD NUMBERS.

1	5323400	26
2	5323474	27
3	5323562	28
4	5323642	29
5	5323733	30
6	5323824	31
7	5323917	32
8	5324005	33
9	5324094	34
10	5324187	35
11	5324283	36
12	5324377	37
13	5324465	38
14	5324553	39
15	7087610	40
16	30853900	41
17	30854519	42
18	30854859	43
19	40726335	44
20		45
21		46
22		47
23		48
24		49
25		50

Book Mark:

See also

NOV 18 1863

M | **2 Cav.** | **U.S.C.T.**

Riley Maice

....., Co. *F*, 2 Reg't U. S. Col'd Cav.

Appears on
Company Descriptive Book
of the organization named above.

DESCRIPTION.

Age *18* years; height *5* feet *4* inches.

Complexion

Eyes; hair

Where born *N. Carolina*

Occupation

ENLISTMENT.

When *Dec. 24*, 1863.

Where *Fort Mon.*

By whom *Col. Cole*; term *3* y'rs.

Remarks:

.....
.....
.....
.....
.....
.....
.....
.....
.....
.....

F. B. Smith
Copyist.

111 | **2 Cav.** | **U.S.C.T.**

Riley, Willie

Co. 1, 2 Reg,t U. S. Col'd Cavalry.

Age *15* years.

Appears on

Company Muster-in Roll

of the organization named above. Roll dated

Sept 20th, *Dec 5th*, 1863.

Muster-in to date *Dec 30th*, 1863.

Joined for duty and enrolled:

When *Dec 24th*, 1863.

Where *Sumner NC*

Period *3* years.

Valuation of horse, \$ 100

Valuation of horse equipments, \$ 100

Remarks : _____

Book mark : _____

W. H. ...

211 | **2 Cav. | U.S.C.T.**

Alvin H. Hise

117, Co. F, 2 Reg't U. S. Col'd Cavalry.

Appears on

Company Muster Roll

for Sept 20, 1864.

Present or absent Present

Stoppage, \$ 100 for

Due Gov't, \$ 100 for

Valuation of horse, \$ 100

Valuation of horse equipments, \$ 100

Remarks:

Book mark:

Alvin H. Hise

M | **2 Cav. | U.S.C.T.**

Riley Hance

pt, Co. F, 2 Reg't U. S. Col'd Cavalry.

Appears on

Company Muster Roll

for *March & April*, 1864.

Present or absent *present*

Stoppage, \$ 100 for

Due Gov't, \$ 100 for

Valuation of horse, \$ 100

Valuation of horse equipments, \$ 100

Remarks:

Book mark:

W. C. ...

M | **2 Cav.** | **U.S.C.T.**

Riley Morse

2nd, Co. F, 2 Reg't U. S. Col'd Cavalry.

Appears on

Company Muster Roll

for *May + June*, 186*4*.

Present or absent *present*

Stoppage, \$ *100* for

Due Gov't, \$ *100* for

Valuation of horse, \$ *100*

Valuation of horse equipments, \$ *100*

Remarks: *Due 100 for one
nose bag + one pair
spurs + straps \$7 07*

Book mark: *100*

W. C. ...

M | **2 Cav.** | **U.S.C.T.**

Riley Maice

Priv., Co. F, 2 Reg't U. S. Col'd Cavalry.

Appears on

Company Muster Roll

for *July & Aug.*, 186*7*.

Present or absent *Present*

Stoppage, \$ *100* for

Due Gov't, \$ *100* for

Valuation of horse, \$ *100*

Valuation of horse equipments, \$ *100*

Remarks: *Stop for 1 more
6.09 \$1.50 & 1 pair spurs
& straps 5.24*

Book mark:

J. H. Paul
Copyist.

M. | **2 Cav.** | **U.S.C.T.**

Riley Maize

Priv., Co. F, 2 Reg't U.S. Col'd Cavalry.

Appears on

Company Muster Roll

for *Sept. & Oct.*, 1864.

Present or absent *Present*

Stoppage, \$ 100 for

Due Gov't, \$ 100 for

Valuation of horse, \$ 100

Valuation of horse equipments, \$ 100

Remarks:

Book mark:

J. S. Paul
Copyist.

100 | **2 Cav.** | **U.S.C.T.**

Richard Maurice

Paul, Co. F, 2 Reg't U. S. Col'd Cavalry.

Appears on

Company Muster Roll

for Nov & Dec, 1864.

Present or absent Present

Stoppage, \$ 100 for

Due Gov't, \$ 100 for

Valuation of horse, \$ 100

Valuation of horse equipments, \$ 100

Remarks:

Book mark:

J. Paul

127 | **2 Cav.** | **U.S.C.T.**

Riley Mace
Pvt., Co. F, 2 Reg't U. S. Col'd Cavalry.

Appears on

Company Muster Roll

for Jan. & Feb., 1865.

Present or absent Not stated

Stoppage, \$ 100 for

Due Gov't, \$ 100 for

Valuation of horse, \$ 100

Valuation of horse equipments, \$ 100

Remarks:

Book mark : -----

J. S. Paull,
Copyist.

MAR 16 45

M | **2 Cav.** | **U.S.C.T.**

Riley Maice
Pvt, Co. F, 2 Reg't U. S. Col'd Cavalry.

Appears on

Company Muster Roll

for *Mar & Apr*, 186 *2*.

Present or absent *Present*

Stoppage, \$ *100* for

Due Gov't, \$ *100* for

Valuation of horse, \$ *100*

Valuation of horse equipments, \$ *100*

Remarks:

Book mark: _____

Sams

M | **2 Cav.** | **U.S.C.T.**

Reley Mace

Plt, Co. F, 2 Reg't U. S. Col'd Cavalry.

Appears on

Company Muster Roll

for *May & June*, 1865.

Present or absent *Present*

Stoppage, \$ *100* for

Due Gov't, \$ *100* for

Valuation of horse, \$ *100*

Valuation of horse equipments, \$ *100*

Remarks:

Book mark:

Seaver

M | 2 Cav. | U.S.C.T.

Riley Maice

Plt, Co. F, 2 Reg't U. S. Col'd Cavalry.

Appears on

Company Muster Roll

for July & Aug, 1865.

Present or absent absent

Stoppage, \$ 100 for

Due Gov't, \$ 100 for

Valuation of horse, \$ 100

Valuation of horse equipments, \$ 100

Remarks: Sick in tent
Hospital since Aug 26/64

Book mark:

Sims

M. | **2 Cav.** | **U.S.C.T.**

Riley Maise

Pr., Co. F, 2 Reg't U. S. Col'd Cavalry.

Appears on

Company Muster Roll

for *Sept & Oct*, 186*5*.

Present or absent *Not stated*

Stoppage, \$ 100 for

Due Gov't, \$ 100 for

Valuation of horse, \$ 100

Valuation of horse equipments, \$ 100

Remarks:

Book mark:

[Signature]
Copyist.

M | 2 Cav USCT

Riley Mace
Priv. Co. 2 Reg. US C. Cav.

Appears on

Hospital Muster Roll

of Corps d'Afrique U. S. A. General Hospital,

at New Orleans, La.,

for *Sept & Oct*, 1865.

Attached to hospital:

When....., 186 .

How employed.....

Last paid by Maj.

to, 186

Bounty paid \$ 100; due \$ 100

Present or absent *Present*

Remarks:.....

.....
.....
.....
.....
.....
.....

Book mark:

Stewart
(343) *Stewart* Copyist.

M. | 2 Cav. | U.S.C.T.

Riley Maize

Co. F, 2 Reg't U. S. Col'd Cavalry.

Appears on

Company Muster Roll

for Nov. & Dec., 1865.

Present or absent Present.

Stoppage, \$ 100 for

Due Gov't, \$ 100 for

Valuation of horse, \$ 100

Valuation of horse equipments, \$ 100

Remarks: Absent since since Aug 29/65 in U. S. Gen Hospital.

Book mark:

J. Stearns

M 1 2 C USCT

Riley Mace

Priv., Co. F, 2 Regt USCT

Appears on

Hospital Muster Roll

of Corps d'Afrique U. S. A. General Hospital,

at New Orleans, La.,

for *Nov & Dec*, 1865.

Attached to hospital:

When....., 186 .

How employed.....

Last paid by Maj.

to....., 186 .

Bounty paid \$ 100 due \$ 100

Present or absent *Present*

Remarks:.....

Book mark:.....

D. J. [Signature]

216 | 2 Cav. | U.S.C.T.

Riley Maurice
Co. I, 2 Reg't U. S. Colored Cav.

Appears on Returns as follows:

Anglo Dec 1865
Absent sick in
U.S. Genl Hosp
since Aug 24, 65

Book mark:

(546) *A. J. G. G. G.* Copyist.

M | 20 USC

Riley Mace
Sgt. Co. F, 2 Reg't USCA

Appears on

Hospital Muster Roll

of Corps d'Afrique U. S. A. General Hospital,

at New Orleans, La.,

for *Jan & Feb*, 186 *6*

Attached to hospital:

When....., 186 .

How employed.....

Last paid by Maj.

to, 186 .

Bounty paid \$ 100; due \$ 100

Present or absent

Remarks: *Returned to duty Jan 23/66*

Book mark:

D. Johnson

Al. | **2 Cav.** | **U.S.C.T.**

William H. ...

Co. F, Co. *F,* 2 Reg't U. S. Col'd Cavalry.

Appears on **Co. Muster-out Roll**, dated
September 11, 1864, 186*4*.

Muster-out to date *Sept. 11,* 186*4*.

Last paid to *Oct. 31,* 186*4*.

Clothing account:

Last settled....., 186 ; drawn since \$..... 100

Due soldier \$ *1* / *100* ; due U. S. \$..... 100

Am't for cloth'g in kind or money adv'd \$..... 100

Due U. S. for arms, equipments, &c., \$..... 100

Bounty paid \$..... 100; due \$..... 100

Remarks: *...*

...

Book mark: *V. 88. P. 49. 57*

...

2 Cav. | U.S.C.T.

....., Co., 2 Reg't U. S. Col'd Cavalry.

Appears on **Co. Muster-out Roll**, dated

....., 186 ..

Muster-out to date 186 ..

Last paid to 186 ..

Clothing account:

Last settled....., 186 ; drawn since \$ 100

Due soldier \$ 100; due U. S. \$ 100

Am't for cloth'g in kind or money adv'd \$ 100

Due U. S. for arms, equipments, &c., \$ 100

Bounty paid \$ 100; due \$ 100

Remarks:

Book mark: *W. R. P. P.*

993

Mackie Anson

Co B, 2 U. S. Col'd Cav.

Private Corporal

CARD NUMBERS.

1	5315618	26
2	5318528	27
3	5318645	28
4	5318763	29
5	5318874	30
6	5316323	31
7	5318989	32
8	5316635	33
9	5319054	34
10	5319155	35
11	5319257	36
12	5319358	37
13	5319458	38
14	5319553	39
15	5319641	40
16	9087186	41
17	40726027	42
18		43
19		44
20		45
21		46
22		47
23		48
24		49
25		50

Book Mark:

See also

MAR 16 1866

M | 2 Cav. | U.S.C.T.

Amson Mackey
Co. B, 2 Reg't U. S. Col'd Cav.

Appears on

Company Descriptive Book

of the organization named above.

DESCRIPTION.

Age 21 years; height 5 feet 7 inches.

Complexion Dark

Eyes Black; hair Black

Where born Hyde Co., N. C.

Occupation Laborer

ENLISTMENT.

When Jan. 1, 1864.

Where Ft. Monroe, Va.

By whom Col. Case; term 3 y'rs.

Remarks: Mustered Jan. 8/64 by Capt. F. Martin.
Engaged in action at Suffolk, Va. March 9/64.
At Drury's Bluff May 16/64. In detached service in Ambulance Train 18" A. C. from Aug. 6/64 to Jan. 1/65.
(over)

S. B. Smith

MAY. 12

9087186

★ 1891 ★

*Appointed Corp.
Sept. 1/04,*

Mc | 2 Co | **U.S.C.T.**

Arsen Mackie

Pvt, Co....., 2 Reg't U. S. Col'd Co

Age.....years.

Appears on a

Detachment Muster-in Roll
of unattached recruits
of the organization named above. Roll dated

Fort Monroe, Va, Jan. 8, 1864.

Muster-in to date Jan. 8, 1864.

Joined for duty and enrolled:

When Jan 1, 1864.

Where Fort Monroe, Va

Period 3 years.

Valuation of horse, \$.....100

Valuation of horse equipments, \$.....100

Remarks :
.....
.....
.....

Book mark:

J. J. Kearney
Copyist.

W | **2 Cav.** | **U.S.C.T.**

Anson Mackie

Pvt., Co. B. 2 Reg't U. S. Col'd Cavalry.

Appears on

Company Muster Roll

for *Dec. 22/63 to Feb. 29, 1864*

Present or absent *Present*

Stoppage, \$ 100 for

Due Gov't, \$ 100 for

Valuation of horse, \$ 100

Valuation of horse equipments, \$ 100

Remarks :

Book mark :

E. H. Hunter

M | **2 Cav.** | **U.S.C.T.**

Anson Mackie
Pvt, Co. B. 2 Reg't U. S. Col'd Cavalry.

Appears on

Company Muster Roll

for *March & April*, 186*4*

Present or absent *Present*

Stoppage, \$ 100 for

Due Gov't, \$ 100 for

Valuation of horse, \$ 100

Valuation of horse equipments, \$ 100

Remarks :

Book mark :

E. H. Hunter

M | **2 Cav.** | **U.S.C.T.**

Anson Mackie

Pvt., Co. B. 2 Reg't U. S. Col'd Cavalry.

Appears on

Company Muster Roll

for May & June, 1864

Present or absent Present

Stoppage, \$ 100 for

Due Gov't, \$ 100 for

Valuation of horse, \$ 100

Valuation of horse equipments, \$ 100

Remarks :

Book mark :

E. H. Hunter

MAR 1862

M | **2 Cav.** | **U.S.C.T.**

Amson Mackie

Private, Co. B. 2 Reg't U. S. Col'd Cavalry.

Appears on

Company Muster Roll

for July & Aug., 1864.

Present or absent Present

Stoppage, \$ 100 for

Due Gov't, \$ 100 for

Valuation of horse, \$ 100

Valuation of horse equipments, \$ 100

Remarks: Two for Army Court -
\$1.04 - for horse & traps
1.00 - horse had \$1.00. Detailed
in corps Ambulance Train S.O.
no. 84 dated Hd. Qrs. 3rd Dist.
18th A.C. Aug. 4, 1864.

Book mark: _____

A. L. Markle

No 12 bar | **U.S.C.T.**

Anson Mackey
Pvt, Co. *B 2* Reg't U. S. Col'd *Bar*

Appears on a

Detachment Muster Roll

of the organization named above

for *July & Aug*, 186*4*.

Station *The field Va*

Present or absent *Present*

Stoppage, \$ *100* for

Due Gov't, \$ *100* for

Valuation of horse, \$ *100*

Valuation of horse equipments, \$ *100*

Remarks *Due U.S. 297/100 Doll*
for Ordnance lost

Book mark : *100*

Olshmitt

MAR 1864

71 | **2 Cav. | U.S.C.T.**

Amson Mackie

Private, Co. B. 2 Reg't U. S. Col'd Cavalry.

Appears on

Company Muster Roll

for Sept. & Oct., 186 4.

Present or absent Absent

Stoppage, \$ 100 for

Due Gov't, \$ 100 for

Valuation of horse, \$ 100

Valuation of horse equipments, \$ 100

Remarks: Detached in Comp.

Book mark: -----

O. J. Markle,
Copyist.

M 12 Cav. U.S.C.T.

Amson Mackey
Priv, Co. B, 7 Reg't U.S. Col'd Cavalry

Appears on a

Detachment Muster Roll

of the organization named above

for Sept & Oct, 1864.

Station In the field. Va

Present or absent Present

Stoppage, \$ 100 for

Due Gov't, \$ 100 for

Valuation of horse, \$ 100

Valuation of horse equipments, \$ 100

Remarks: Difference be-
tween White and
colored soldiers
pay due from
Jan 1/64 to Apr 30
64

Book mark:

W F B O Z

NOV 1866

M | **2 Cav.** | **U.S.C.T.**

Anson Macie

Captain, Co. B. 2 Reg't U. S. Col'd Cavalry.

Appears on

Company Muster Roll

for *Oct. 31, 1864 to Feb. 28, 1865*.

Present or absent *Present.*

Stoppage, \$ 100 for

Due Gov't, \$ 100 for

Valuation of horse, \$ 100

Valuation of horse equipments, \$ 100

Remarks: *From private to date
Nov. 1, 1864 - serv. Reg. O.*

Book mark: _____

O. J. Markle

M. | **2 Cav.** | **U.S.C.T.**

Alceon Mackie

Capt, Co. B. 2 Reg't U. S. Col'd Cavalry.

Appears on

Company Muster Roll

for Mar & Apr, 1865.

Present or absent Present

Stoppage, \$ 100 for

Due Gov't, \$ 100 for

Valuation of horse, \$ 100

Valuation of horse equipments, \$ 100

Remarks :

Book mark :

Mackie

M | 2 Cav. | U.S.C.T.

Amerson Mackay

Corpl, Co. B. 2 Reg't U. S. Col'd Cavalry.

Appears on

Company Muster Roll

for May & June, 1865.

Present or absent Present

Stoppage, \$ 100 for

Due Gov't, \$ 100 for

Valuation of horse, \$ 100

Valuation of horse equipments, \$ 100

Remarks :

Book mark :

Mackay

M. | 2 Cav. | U.S.C.T.

Anderson Mackey

Corpl, Co. B. 2 Reg't U. S. Col'd Cavalry.

Appears on

Company Muster Roll

for July & Aug, 1865.

Present or absent absent.

Stoppage, \$ 100 for

Due Gov't, \$ 100 for

Valuation of horse, \$ 100

Valuation of horse equipments, \$ 100

Remarks: A.S. Sick in Genl Hospit since Aug 15/65.

Book mark:

Mochance

M | **2 Cav.** | **U.S.C.T.**

Anderson Mackay
Cpl, Co. B. 2 Reg't U. S. Col'd Cavalry.

Appears on

Company Muster Roll

for *Sept. & Oct*, 186*5*.

Present or absent *Present*

Stoppage, \$ 100 for

Due Gov't, \$ 100 for

Valuation of horse, \$ 100

Valuation of horse equipments, \$ 100

Remarks :

Book mark :

W Harrison

M | **2 Cav.** | **U.S.C.T.**

Anderson Mackey
Cpl, Co. B. 2 Reg't U. S. Col'd Cavalry.

Appears on

Company Muster Roll

for *Nov. & Dec*, 186*5*.

Present or absent *Present*

Stoppage, \$ *100* for

Due Gov't, \$ *100* for

Valuation of horse, \$ *100*

Valuation of horse equipments, \$ *100*

Remarks :
.....
.....
.....
.....
.....
.....
.....
.....
.....
.....

Book mark :
.....

W. Harrison
(358) Copyist.

M | 2 Cav. | U. S. C. T.

⁺ *Green* Mackie*

Priv, Co. *B*, 2 Reg't U. S. Col'd Cav.

Corpl Appears on Returns as follows:

Aug 1864. Absent det'd in Amb Corps 18 AC.

Sept. 1864. Absent in Amb Corps as driver

Oct 1864. Absent det'd as Sharpshooter

Nov. 1864. Absent in Amb Corps as driver

Aug 1865. Absent sick in Genl Hosp. New Orleans, La. (Corpl)

⁺ *Private*

* *Name appears also as Anderson Mackey*

Book mark:

J. Cottrell

M | 2 Cav. | U.S.C.T.

Anson Mackie

Plt, Co. B, 2 Reg't U. S. Col'd Cavalry.

Appears on Co. Muster-out Roll, dated

Brazos Santiago Tex, Feb. 12, 1866.

Muster-out to date Feb. 12, 1866.

Last paid to June 30, 1865.

Clothing account:

Last settled....., 186 ; drawn since \$ 100

Due soldier \$ 100; due U. S. \$ 45 / 100

Am't for cloth'g in kind or money adv'd \$ 100

Due U. S. for arms, equipments, &c., \$ 100

Bounty paid \$ 100; due \$ 300 100

Remarks: Joined a Regt. Pro-
moted Corp. Sept. 1,
'64.

Free before April
19/ '61.

Book mark:

W. Harrison

994

Mackie James R.

Co D, 2 U. S. Col'd Cav.

Private Comm. Sergeant

CARD NUMBERS.

1	5315617	26
2	5318482	27
3	5318594	28
4	5318714	29
5	5318828	30
6	5316290	31
7	5318944	32
8	5316603	33
9	5319045	34
10	5319146	35
11	5319249	36
12	5319347	37
13	5319447	38
14	5319542	39
15	5319630	40
16	9087185	41
17	40726328	42
18	.	43
19		44
20		45
21		46
22		47
23		48
24		49
25		50

Book Mark:

See also

M | **2 Cav.** | **U.S.C.T.**

James Mackey
....., Co. *B*, 2 Reg't U. S. Col'd Cav.

Appears on
Company Descriptive Book
of the organization named above.

DESCRIPTION.

Age *18* years; height *5* feet *7* inches.
Complexion *Lt. Brown*
Eyes *Black*; hair *Black*
Where born *Hydeler, N.C.*
Occupation *Labour*

ENLISTMENT.

When *Jan'y 1*, 1864.
Where *Ft Monroe, Va.*
By whom *Col. Cole*; term *3* y'rs.

Remarks: *Mustered Jan'y 8/64 by Capt F. Martin. Appointed Corp. Feb. 1/64. Seryt. Sept. 1/64. Engaged in action at Suffolk, Va, March 9/64, at Scurry Bluff May 16/64. On Detached Service in Ambulance Train (over)*

F. B. Smith

MAY. 12

9087185

1891

18" A. C. from Aug. 6/04
to Jan. 1/05.

M. | 2 Cav | U.S.C.T.

James R. Mackie
Pvt., Co. 2, Reg't U. S. Col'd Cav.

Age years.

Appears on a

Detachment Muster-in Roll
of the *of unattached recruits* organization named above. Roll dated

Fort Monroe, Va, Jan. 8, 1864.

Muster-in to date Jan. 8, 1864.

Joined for duty and enrolled:

When Jan. 1, 1864.

Where Fort Monroe, Va

Period 3 years.

Valuation of horse, \$ 100

Valuation of horse equipments, \$ 100

Remarks :
.....
.....
.....
.....

Book mark :
.....

J. J. Kearney Copyist.

M | **2 Cav.** | **U.S.C.T.**

James R. Mackie
Corpl., Co. B. 2 Reg't U. S. Col'd Cavalry.

Appears on

Company Muster Roll

for *Dec. 22/63* to *Feb. 29, 1864*.

Present or absent *Present*

Stoppage, \$ *100* for

Due Gov't, \$ *100* for

Valuation of horse, \$ *100*

Valuation of horse equipments, \$ *100*

Remarks *Appointed corporal*
per Regt. Order No. 6 dated
Oct. 2nd. 2^d Regt. U.S. C. & G.
Camp Hamilton Va.
Jan. 11th 1864.

Book mark :

E. W. Hunter

M | **2 Cav.** | **U.S.C.T.**

James R. Mackie
Capt., Co. B. 2 Reg't U. S. Col'd Cavalry.

Appears on

Company Muster Roll

for *March & April*, 186*4*

Present or absent *Present*

Stoppage, \$ 100 for

Due Gov't, \$ 100 for

Valuation of horse, \$ 100

Valuation of horse equipments, \$ 100

Remarks :
.....
.....
.....
.....
.....
.....
.....
.....
.....

Book mark :

E. H. Hunter

RECORDED

M | **2 Cav.** | **U.S.C.T.**

James R. Mackie
Corp., Co. B. 2 Reg't U. S. Col'd Cavalry.

Appears on

Company Muster Roll

for May & June, 1864

Present or absent Present

Stoppage, \$ 100 for

Due Gov't, \$ 100 for

Valuation of horse, \$ 100

Valuation of horse equipments, \$ 100

Remarks :
.....
.....
.....
.....
.....
.....
.....
.....
.....
.....

Book mark :
.....

E. H. Hunter

NARRAGANSETT

W | **2 Cav.** | **U.S.C.T.**

James P. Markle
Co. B. 2 Reg't U. S. Col'd Cavalry.

Appears on

Company Muster Roll

for *July & August*, 1864.

Present or absent *Absent*

Stoppage, \$ 100 for

Due Gov't, \$ 100 for

Valuation of horse, \$ 100

Valuation of horse equipments, \$ 100

Remarks: *Stoppage paid to Markle
\$3.00 - horse base \$1.50. Detained
in work's Ambulance Train S.O.
No. 84 dated 7th 2nd 3rd Div.
18th A.C. Aug. 4, 1864.*

Book mark:

O. J. Markle,

No 12 Car | U.S.C.T.

James Mackey
Corp, Co. B., 2 Reg't U. S. Col'd Car

Appears on a

Detachment Muster Roll

of the organization named above

for July & Aug, 1867.

Station The field Va

Present or absent Present

Stoppage, \$ 100 for

Due Gov't, \$ 100 for

Valuation of horse, \$ 100

Valuation of horse equipments, \$ 100

Remarks: Due U.S. 3.75/100 Dolts
for Ordnance lost

Book mark:

O. G. Smith

NOV 1863

M | **2 Cav.** | **U.S.C.T.**

James P. Melkie
Co. B., Co. B. 2 Reg't U. S. Col'd Cavalry.

Appears on

Company Muster Roll

for *Sept. & Oct.*, 186 *4*

Present or absent *Absent*

Stoppage, \$ 100 for

Due Gov't, \$ 100 for

Valuation of horse, \$ 100

Valuation of horse equipments, \$ 100

Remarks: *Detached in Corps.*

Book mark:

O. J. Markle

M | 2 Cav | U.S.C.T.

James Mackey
Cnpl, Co. B, 2 Reg't U. S. Col'd Cavalry

Appears on a

Detachment Muster Roll

of the organization named above

for Sept & Oct, 1864.

Station In the field, Va

Present or absent Present

Stoppage, \$ 100 for

Due Gov't, \$ 100 for

Valuation of horse, \$ 100

Valuation of horse equipments, \$ 100

Remarks: Difference between white and colored soldiers pay due from Jan 1 up to Apr 30/64

Book mark:

W. S. [Signature]

M | **2 Cav.** | **U.S.C.T.**

James R. Mackie

Singl., Co. B. 2 Reg't U. S. Col'd Cavalry.

Appears on

Company Muster Roll

for *Oct. 31, 1864 to Feb. 28, 1865*

Present or absent *Present*

Stoppage, \$ 100 for

Due Gov't, \$ 100 for

Valuation of horse, \$ 100

Valuation of horse equipments, \$ 100

Remarks: *Comm. fr. Corp. to date
Nov. 1, 1864 per S. Reg. O.*

Book mark :

O. J. Markle

M. | 2 Cav. | U.S.C.T.

James R. Mackie

Sgt., Co. B. 2 Reg't U. S. Col'd Cavalry.

Appears on

Company Muster Roll

for Mar & Apr, 1865 .

Present or absent Present.

Stoppage, \$ 100 for

Due Gov't, \$ 100 for

Valuation of horse, \$ 100

Valuation of horse equipments, \$ 100

Remarks :

Book mark :

Mackie

NOV 1867

M | 2 Cav. | U.S.C.T.

James R. MacKaic
Sergt, Co. B. 2 Reg't U. S. Col'd Cavalry.

Appears on

Company Muster Roll

for May & June, 1865.

Present or absent Present

Stoppage, \$ 100 for

Due Gov't, \$ 100 for

Valuation of horse, \$ 100

Valuation of horse equipments, \$ 100

Remarks :

Book mark :

MacKaic

M. | 2 Cav. | U.S.C.T.

James R. Mackey
C. Sgt., Co. B. 2 Reg't U. S. Col'd Cavalry.

Appears on

Company Muster Roll

for July + Aug, 1865.

Present or absent Present.

Stoppage, \$ 100 for

Due Gov't, \$ 100 for

Valuation of horse, \$ 100

Valuation of horse equipments, \$ 100

Remarks :

Book mark :

W. Chance

M | **2 Cav.** | **U.S.C.T.**

James R. Mackay
Co. Sgt., Co. B. 2 Reg't U. S. Col'd Cavalry.

Appears on

Company Muster Roll

for *Sept. & Oct*, 186 *5*.

Present or absent *Present*

Stoppage, \$ *100* for

Due Gov't, \$ *100* for

Valuation of horse, \$ *100*

Valuation of horse equipments, \$ *100*

Remarks :
.....
.....
.....
.....
.....
.....
.....

Book mark :

W. Harrison

M

2 Cav. | U.S.C.T.

James R. Mackay

Em. Sgt. Co. B. 2 Reg't U. S. Col'd Cavalry.

Appears on

Company Muster Roll

for *Nov. & Dec* -----, 186 *5*.

Present or absent *Present* -----

Stoppage, \$ 100 for -----

Due Gov't, \$ 100 for -----

Valuation of horse, \$ 100

Valuation of horse equipments, \$ 100

Remarks : -----

Book mark : -----

M. Harrison

M | **2 Cav.** | **U.S.C.T.**

I Mackie
Spec. Co. B, 2 Reg't U. S. Colored Cav.

Appears on Returns as follows:

Sept 1864 Absent
in Ambul
Cooper as driver
Oct 1864 Absent till
as sharpshooter
Nov 1864 Absent in
Ambul. Cooper
as driver
Dec 1864 Absent
Guard for Am
munition train

Book mark :

(546)

A. S. Ogden

Copyist.

M | **2 Cav. | U.S.C.T.**

James R. Mackie
 Com. Sgt, Co. B, 2 Reg't U. S. Col'd Cavalry.

Appears on **Co. Muster-out Roll**, dated
Brazos Santiago, Tex, *Feb. 12*, 1866.
 Muster-out to date *Feb. 12*, 1866.
 Last paid to *June 30*, 1865.

Clothing account:

Last settled....., 186 ; drawn since \$.....¹⁰⁰

Due soldier \$.....¹⁰⁰; due U. S. \$.....¹⁰⁰

Am't for cloth'g in kind or money adv'd \$ *15* ^{*62*}/_{*100*}

Due U. S. for arms, equipments, &c., \$.....¹⁰⁰

Bounty paid \$.....¹⁰⁰; due \$ *300* ^{*100*}

Remarks: *Found a Rect. Pro-*
moted Capt. Feb. 1, '64.
Promoted Serjt. Sept.
1, '64.
Free before April 19,
'61.

Book mark: *V. 88, P. 115, 69-*

W. Harrison
 (361) Copyist.

995

Next Number

995-a

Mackley, Charles

Co C, 2 U. S. Col'd Cav.

Private Private

CARD NUMBERS.

1	5319813	26
2	5319886	27
3	5319972	28
4	5320060	29
5	5320143	30
6	5320231	31
7	5320275	32
8	5320361	33
9	5320513	34
10	5320606	35
11	5320700	36
12	5320790	37
13	5320876	38
14	5320958	39
15	9087339	40
16	40726325	41
17		42
18		43
19		44
20		45
21		46
22		47
23		48
24		49
25		50

Book Mark:

See also

M | **2 Cav.** | **U.S.C.T.**

Charles Mackley

....., Co. *B*, 2 Reg't U. S. Col'd Cav.

Appears on

Company Descriptive Book

of the organization named above.

DESCRIPTION.

Age *21* years; height *5* feet *4 1/2* inches.

Complexion *Black*

Eyes *Black*; hair *Black*

Where born *Macklinburg, Va.*

Occupation *Laborer*

ENLISTMENT.

When *Dec. 24, 1863.*

Where *At Monroe*

By whom *Geo. W. Cole*; term *3* y'rs.

Remarks:

F. B. Smith
 Copyist.

M | 2 Cav. | U.S.C.T.

Charles Mackley

Priv., Co. C, 2 Regt U. S. Col'd Cavalry.

Age years.

Appears on

Company Muster-in Roll

of the organization named above. Roll dated

Ft Monroe Va Dec 24, 1863.

Muster-in to date Dec 24, 1863.

Joined for duty and enrolled:

When Dec 24, 1863.

Where Ft Monroe Va

Period 3 years.

Valuation of horse, \$ 100

Valuation of horse equipments, \$ 100

Remarks :

.....
.....
.....
.....

Book mark :

Hadfield

M | 2 Cav. | U.S.C.T.

Charles Mackley
Pvt, Co. C, 2 Reg't U. S. Col'd Cavalry.

Appears on

Company Muster Roll

for dated Feb 29, 1864.

Present or absent Present

Stoppage, \$ 100 for

Due Gov't, \$ 100 for

Valuation of horse, \$ 100

Valuation of horse equipments, \$ 100

Remarks:

Book mark:

Headfield

M | **2 Cav.** | **U.S.C.T.**

Charles Mackley
Priv, Co. C, 2 Reg't U. S. Col'd Cavalry.

Appears on

Company Muster Roll

for *Mar & Apr*, 186*4*.

Present or absent *Present*

Stoppage, \$ 100 for

Due Gov't, \$ 100 for

Valuation of horse, \$ 100

Valuation of horse equipments, \$ 100

Remarks:

Book mark:

Hadfield

M | 2 Cav. | U.S.C.T.

Charles Mackley

Pvt., Co. C, 2 Reg't U. S. Col'd Cavalry.

Appears on

Company Muster Roll

for May & June, 1864.

Present or absent Present

Stoppage, \$ 100 for

Due Gov't, \$ 100 for

Valuation of horse, \$ 100

Valuation of horse equipments, \$ 100

Remarks:

Book mark:

Madgill Copyist.

M | **2 Cav.** | **U.S.C.T.**

Charles Maclain

Privt, Co. C, 2 Reg't U. S. Col'd Cavalry.

Appears on

Company Muster Roll

for *July, Aug*, 186*4*.

Present or absent *Present*

Stoppage, \$ *100* for

Due Gov't, \$ *100* for

Valuation of horse, \$ *100*

Valuation of horse equipments, \$ *100*

Remarks:

Book mark:

W. S. ...

NARRATIVE

M | **2 Cav.** | **U.S.C.T.**

Charles Macklin

Privt, Co. C, 2 Reg't U. S. Col'd Cavalry.

Appears on

Company Muster Roll

for Sept & Oct, 1864.

Present or absent Present

Stoppage, \$ 100 for

Due Gov't, \$ 100 for

Valuation of horse, \$ 100

Valuation of horse equipments, \$ 100

Remarks:

Book mark: _____

W. B. Logg

M | 2 Cav. | U.S.C.T.

Charles Macklin

Bugler, Co. C, 2 Reg't U. S. Col'd Cavalry.

Appears on

Company Muster Roll

for Nov & Dec, 1864.

Present or absent Present

Stoppage, \$ 100 for

Due Gov't, \$ 100 for

Valuation of horse, \$ 100

Valuation of horse equipments, \$ 100

Remarks:

Book mark:

W. S. [Signature]

M | 2 Cav. | U.S.C.T.

Charles Macklin
Bugler, Co. C, 2 Reg't U. S. Col'd Cavalry.

Appears on

Company Muster Roll

for Jan & Feb, 1865.

Present or absent Present

Stoppage, \$ 100 for

Due Gov't, \$ 100 for

Valuation of horse, \$ 100

Valuation of horse equipments, \$ 100

Remarks:

Book mark:

W. H. [Signature]

NOV 17 1865

M | **2 Cav.** | **U.S.C.T.**

Charles MacKlin
Priv, Co. C, 2 Reg't U. S. Col'd Cavalry.

Appears on

Company Muster Roll

for *March & April*, 1865.

Present or absent *Present*

Stoppage, \$ 100 for

Due Gov't, \$ 100 for

Valuation of horse, \$ 100

Valuation of horse equipments, \$ 100

Remarks: *Detained in Reg't Band.*

Book mark:

(358)

J. L. Harris

Copyist.

No | **2 Cav.** | **U.S.C.T.**

Charles Macklin
Privt, Co. C, 2 Reg't U. S. Col'd Cavalry.

Appears on

Company Muster Roll

for *May 9 June*, 1865.

Present or absent *Present*

Stoppage, \$ 100 for

Due Gov't, \$ 100 for

Valuation of horse, \$ 100

Valuation of horse equipments, \$ 100

Remarks: *Detained in Band.*

Book mark:

J. L. Morris

No | **2 Cav.** | **U.S.C.T.**

Charles Macklin

Priv, Co. C, 2 Reg't U. S. Col'd Cavalry.

Appears on

Company Muster Roll

for *July & August*, 1865.

Present or absent *Present*

Stoppage, \$ *100* for

Due Gov't, \$ *100* for

Valuation of horse, \$ *100*

Valuation of horse equipments, \$ *100*

Remarks: *Detained in Band*

Book mark:

J. L. Morris

Mr | **2 Cav.** | **U.S.C.T.**

Charles Machlin

Priv, Co. C, 2 Reg't U. S. Col'd Cavalry.

Appears on

Company Muster Roll

for *Sept & Oct*, 1865.

Present or absent *Present*

Stoppage, \$ 100 for

Due Gov't, \$ 100 for

Valuation of horse, \$ 100

Valuation of horse equipments, \$ 100

Remarks: *Detailed in Band.*

Book mark:

G. W. Chase

Me | **2 Cav. | U.S.C.T.**

Charles Macklin

Priv, Co. C, 2 Reg't U. S. Col'd Cavalry.

Appears on

Company Muster Roll

for *Nov & Dec*, 1865.

Present or absent *Present*

Stoppage, \$ 100 for

Due Gov't, \$ 100 for

Valuation of horse, \$ 100

Valuation of horse equipments, \$ 100

Remarks:

Book mark:

G. W. Chase

W | **2 Cav.** | **U.S.C.T.**

Charles Macklin

Priv. Co. C, 2 Reg't U. S. Colored Cav.

Appears on Returns as follows:

Mar 1865 to Jan
1866 Det'd in
Reg'l Band since
Sept 14, 64

Book mark:

(546)

A. G. Gougeon
Copyist.

Mc | **2 Cav.** | **U.S.C.T.**

Charles Macklin

Sgt, Co. *C*, 2 Reg't U. S. Col'd Cavalry.

Appears on **Co. Muster-out Roll**, dated *Brazos Santiago, Tex Feb 12, 1866.*

Muster-out to date *Feb 12, 1866.*

Last paid to *June 30, 1865.*

Clothing account:

Last settled....., 186 ; drawn since \$ $\frac{100}{100}$

Due soldier \$ $\frac{100}{100}$; due U. S. \$ $2 \frac{75}{100}$

Am't for cloth'g in kind or money adv'd \$ $\frac{100}{100}$

Due U. S. for arms, equipments, &c., \$ $\frac{100}{100}$

Bounty paid \$ $\frac{100}{100}$; due \$ $100 \frac{100}{100}$

Remarks: *Joined at org'l. org.*
Free before Apr. 19. 1861.

Book mark: *479, 082*
V. 209, P. 237

G. W. Chase

943 - 2

Madley, Lewis

Co. A, 2 U. S. Cold Cavalry

Private

Private

REFERENCE ENVELOPE.

Cards filed with

Madley, Lewis

Previous number 995-a 996

Magee Arnold

Co Q, 2 U. S. Col'd Cav.

Private Private

CARD NUMBERS.

1	5319808	26
2	5319892	27
3	5319978	28
4	5320066	29
5	5320149	30
6	5320236	31
7	5320327	32
8	5320412	33
9	5320511	34
10	5320605	35
11	5320699	36
12	5320789	37
13	5320875	38
14	5320957	39
15	9087345	40
16	33226216	41
17	33228902	42
18	33232356	43
19	33236003	44
20	33238429	45
21	33239744	46
22	33240766	47
23	40726326	48
24		49
25		50

Book Mark:

See also

RRR 712

Rep 346171.
D1580683 P0 211774

Thos C. Hatch
Ex.

NOV 17 1913

M | **2 Cav.** | **U.S.C.T.**

Arnold Maggee
....., Co. *b*., 2 Reg't U. S. Col'd Cav.

Appears on

Company Descriptive Book
of the organization named above.

DESCRIPTION.

Age *46* years; height *5* feet *7* inches.

Complexion *Black*

Eyes *Black*; hair *Black*

Where born *Hertford, N.C.*

Occupation *Laborer*

ENLISTMENT.

When *Dec. 24*, 186 ..

Where *Fort Monroe*

By whom *Geo. W. Cole*; term *3* y'rs.

Remarks:

.....
.....
.....
.....
.....
.....
.....
.....

F. B. Smith
Copyist.

M | 2 Cav. | U.S.C.T.

Arnold Magee

Reg't, Co. C, 2 Reg't U. S. Col'd Cavalry.

Age years.

Appears on

Company Muster-in Roll

of the organization named above. Roll dated Ft Monroe Va Dec 24, 1863.

Muster-in to date Dec 24, 1863.

Joined for duty and enrolled:

When Dec 24, 1863.

Where Ft Monroe Va

Period 3 years.

Valuation of horse, \$ 100

Valuation of horse equipments, \$ 100

Remarks:

Book mark:

Hadfield

NOV 17 1864

M | **2 Cav.** | **U.S.C.T.**

Arnold Muggie
Pot, Co. C, 2 Reg't U. S. Col'd Cavalry.

Appears on

Company Muster Roll

for *Rated Feb 29*, 1864.

Present or absent *Present*

Stoppage, \$ 100 for

Due Gov't, \$ 100 for

Valuation of horse, \$ 100

Valuation of horse equipments, \$ 100

Remarks:

Book mark: -----

(358)

Hadfield

Copyist.

M | 2 Cav. | U.S.C.T.

Arnold Magger
Pot, Co. C, 2 Reg't U. S. Col'd Cavalry.

Appears on

Company Muster Roll

for Mar & Apr, 1864.

Present or absent Present

Stoppage, \$ 100 for

Due Gov't, \$ 100 for

Valuation of horse, \$ 100

Valuation of horse equipments, \$ 100

Remarks:

Book mark:

(358)

Hadfield Copyist.

MA | **2 Cav.** | **U.S.C.T.**

Amos Daggie
1st, Co. C, 2 Reg't U. S. Col'd Cavalry.

Appears on

Company Muster Roll

for May June, 1864.

Present or absent Present

Stoppage, \$ 100 for

Due Gov't, \$ 100 for

Valuation of horse, \$ 100

Valuation of horse equipments, \$ 100

Remarks:

Book mark: _____

Hadfield
Copyist.

M | **2 Cav.** | **U.S.C.T.**

Arnold Maggee

Privt, Co. C, 2 Reg't U. S. Col'd Cavalry.

Appears on

Company Muster Roll

for *July & Aug*, 186*4*.

Present or absent *Present*

Stoppage, \$.....100 for

Due Gov't, \$.....100 for

Valuation of horse, \$.....100

Valuation of horse equipments, \$.....100

Remarks:

Book mark:

Woodroff

M | **2 Cav.** | **U.S.C.T.**

Arnold Magge
Privt, Co. C, 2 Reg't U. S. Col'd Cavalry.

Appears on

Company Muster Roll

for *Sept & Oct*, 186*4*.

Present or absent *Absent*

Stoppage, \$ 100 for

Due Gov't, \$ 100 for

Valuation of horse, \$ 100

Valuation of horse equipments, \$ 100

Remarks: *Sick in*
18th a. c. Hospital

Book mark: *?*

W. H. [Signature]

No | *2 cav.* | *U.S.C.T.*

A. Moagie

Priv, Co. *C*, *2* Reg't *U.S.C.T.*

Appears on

Hospital Muster Roll

of **U. S. A. General Hospital,**

at **Fort Monroe, Va.,**

for *Sept. & Oct*, 186*4*.

Attached to hospital :

When, 186 .

How employed

Last paid by Maj.

to, 186 .

Bounty paid \$ 100 ; due \$ 100

Present or absent *Present.*

Remarks : *No descriptive list.*

Section 4. New Camp.

Book mark :

Armstrong

(343)

Copyist.

NOV 17 1864

M | 2 Cav. | U.S.C.T.

Arnold Maggee

Privt, Co. C, 2 Reg't U. S. Col'd Cavalry.

Appears on

Company Muster Roll

for Nov + Dec, 1864

Present or absent Absent

Stoppage, \$ 100 for

Due Gov't, \$ 100 for

Valuation of horse, \$ 100

Valuation of horse equipments, \$ 100

Remarks: Absent sick w 25th Corps. Gen Hospital, Point of Rocks. Va since 15th Octo. 64

Book mark:

W. D. [Signature]

M 2 car. U.S.G.

Arnold Maggie
pt, Co. C, 2 Reg't U.S.G.

Appears on

Hospital Muster Roll

of U. S. A. General Hospital,

at Fort Monroe, Va.,

for Nov 2 Dec, 1864.

Attached to hospital :

When, 186 .

How employed

Last paid by Maj.

to, 186 .

Bounty paid \$ 100 ; due \$ 100

Present or absent present

Remarks: No descriptive list

5 Sect (New Camp)

Book mark :

Combs

MAR 17 20

M | 2 Cav. | U.S.C.T.

Arnold Maggee
Private, Co. C, 2 Reg't U. S. Col'd Cavalry.

Appears on

Company Muster Roll

for Jan & Feb, 1865.

Present or absent Absent

Stoppage, \$ 100 for

Due Gov't, \$ 100 for

Valuation of horse, \$ 100

Valuation of horse equipments, \$ 100

Remarks: Absent sick
in Gen'l Hospital
Point Rocks, since
15th Oct 64

Book mark:

W. B. Log

M | 2 cav. - usct

Arnold Maggie

priv., Co. 6, 2 Reg't usct

Appears on

Hospital Muster Roll

of U. S. A. General Hospital,

at Fort Monroe, Va.,

for Jan & Feb, 1865.

Attached to hospital :

When _____, 186 .

How employed _____

Last paid by Maj. _____

to _____, 186 .

Bounty paid \$ 100 ; due \$ 100

Present or absent present

Remarks : no desc list

5 Recd / 2 Div

Book mark : _____

A. Harrison

M | **2 Cav.** | **U.S.C.T.**

Arnold Maggee
Plt, Co. C, 2 Reg't U. S. Col'd Cavalry.

Appears on

Company Muster Roll

for *March & April*, 1865.

Present or absent *Absent*

Stoppage, \$ *100* for

Due Gov't, \$ *100* for

Valuation of horse, \$ *100*

Valuation of horse equipments, \$ *100*

Remarks: *Absent sick in Genl Hoosp.*
Fort Monroe since Oct 15, 1864.
Paid by Maj Howell for the
months of Nov & Dec at U.S.
Hoosp, Fort Monroe, 1864

Book mark:

J. L. Norris
Copyist.

M. | 2 Cav U.S.C.P.

Arnold Maggie
Priv., Co. C, 2 Reg't U.S.C. Cav

Appears on

Hospital Muster Roll

of U. S. A. General Hospital,

at Fort Monroe, Va.,

for Mar & Apr, 186⁵.

Attached to hospital :

When, 186 .

How employed

Last paid by Maj. Howell
to Dec 31, 186⁴.

Bounty paid \$ 100; due \$ 100

Present or absent Present

Remarks: Back pay due soldier
for the months of Sept
& Oct 1864.

(Sect 12 Div)

Book mark :

Price

Mc | **2 Cav.** | **U.S.C.T.**

Arnold Maggee
Priv, Co. C, 2 Reg't U. S. Col'd Cavalry.

Appears on

Company Muster Roll

for *May & June*, 1865.

Present or absent *Absent*

Stoppage, \$ 100 for

Due Gov't, \$ 100 for

Valuation of horse, \$ 100

Valuation of horse equipments, \$ 100

Remarks: *Absent sick in Hampton Hospital. Paid for the months of Nov & Dec 1864 by Maj Howell.*

Book mark:

J. L. Morris

M 12 Cav. (Col'd) U.S.C.S.

Arnold Maggie
Pvt., Co. C, 2 Reg't W.D.C.C.

Appears on

Hospital Muster Roll

of U. S. A. General Hospital,

at Fort Monroe, Va.,

for May & June, 1865.

Attached to hospital :

When, 186 .

How employed

Last paid by Maj. Howell
to Dec. 31, 1864.

Bounty paid \$ 100 ; due \$ 100

Present or absent present.

Remarks : Back pay due soldier for
the months of Sept. & Oct., 1864!

8 Dec. 2 Div.

Book mark :

Woods

M | **2 Cav.** | **U.S.C.T.**

Arnold Maggia
Priv, Co. C, 2 Reg't U. S. Col'd Cavalry.

Appears on

Company Muster Roll

for *July & August*, 1865.

Present or absent *Absent*

Stoppage, \$ 100 for

Due Gov't, \$ 100 for

Valuation of horse, \$ 100

Valuation of horse equipments, \$ 100

Remarks: *Absent sick in Hampton
Hospital since Oct 24. 1864*

Book mark: _____

J. L. Borris

M 2^d Cav. U.S.C.T
Arnold Maggii
Det., Co. C, 2^d Reg't U.S.C.T

Appears on

Hospital Muster Roll

of U. S. A. General Hospital,

at Fort Monroe, Va.,

for July & Aug, 1865.

Attached to hospital:

When _____, 186 .

How employed _____

Last paid by Maj. Howell
to Dec 31st, 1864.

Bounty paid \$ 100; due \$ 100

Present or absent Present

Remarks: Back pay due for
the months of Sept. & Oct. 64

Book mark: _____

Jawhite

Me | **2 Cav.** | **U.S.C.T.**

Arnold Maggie

Priv, Co. C, 2 Reg't U. S. Col'd Cavalry.

Appears on

Company Muster Roll

for *Sept 2 Oct*, 1865.

Present or absent *Absent*

Stoppage, \$ *100* for

Due Gov't, \$ *100* for

Valuation of horse, \$ *100*

Valuation of horse equipments, \$ *100*

Remarks: *Absent sick in
Hampton Hoasp. Va. since
Oct. 24/64.*

Book mark:

G. W. Chase

M 12 Cav U.S.C.T.

Arnald Maggie
Pri, Co. C, 2 Reg't U.S.C.Cav.

Appears on

Hospital Muster Roll

of U. S. A. General Hospital,

at Fort Monroe, Va.,

for Sept + Oct, 1861

Attached to hospital :

When _____, 186 .

How employed _____

Last paid by Maj _____

to _____, 186 .

Bounty paid \$ ¹⁰⁰ ; due \$ ¹⁰⁰

Present or absent Present

Remarks :

Book mark : _____

A. Neal
Copyist.

Mc | **2 Cav.** | **U.S.C.T.**

Arnold Maggie

Priv, Co. C, 2 Reg't U. S. Col'd Cavalry.

Appears on

Company Muster Roll

for *Nov & Dec*, 186*5*.

Present or absent *Absent*

Stoppage, \$ *100* for

Due Gov't, \$ *100* for

Valuation of horse, \$ *100*

Valuation of horse equipments, \$ *100*

Remarks: *Absent sick in hospital since Oct. 23/64.*

Book mark: _____

G. W. Chase

76 | **2 Cav.** | **U.S.C.T.**

Arnold Maggee
 Pvt., Co. C, 2 Reg't U. S. Colored Cav.

Appears on Returns as follows:

Oct & Nov 1864 Absent
 sick in 18 A Co
 Hosp at Point
 Rocks Va

Dec 1864 Absent sick
 25 A, G.H Point
 of Rocks Va

Jan to April 1865
 Absent sick in
 Hampton Genl Hosp
 Ft Monroe Va

May 1865 Absent sick
 in G.H since Oct
 24, 64

June 1865 Absent sick
 at Balfour G.H at
 Portsmouth

July 1865 Absent sick
 in Gen Hosp

Aug & Sept 1865
 Absent sick at
 Owen

Book mark:

(546)

A. J. G. G. G. G.
 Copyist.

JAN. 18

40726326

1899.

Amesbury G. H.
since Oct 24, 64
Oct 10 Dec 1865 Ab.
Sent sick since
Oct 24, 64

M | **2 Cav.** | **U.S.C.T.**

Arnold Maggie
Pvt, Co. *C*, 2 Reg't U. S. Col'd Cavalry.

Appears on **Co. Muster-out Roll**, dated
Brazos Santiago, Tex, Feb 12, 1866.

Muster-out to date *Feb 12, 1866.*

Last paid to *Aug. 31, 1864.*

Clothing account:

Last settled....., 186 ; drawn since \$..... 100

Due soldier \$ *4* ^{*26*}/₁₀₀; due U. S. \$..... 100

Am't for cloth'g in kind or money adv'd \$..... 100

Due U. S. for arms, equipments, &c., \$..... 100

Bounty paid \$..... 100; due \$..... 100

Remarks: *Joined at org'l. org.*

Book mark: *V. 35, P. 230. / 68*

G. W. Chase

Maggie Arnold

, Co. C, 2 Reg't U.S.C. Cav.

3

Enclosures.

Bed Cards	Final Statements
Burial Records	Furloughs or L. of A
Certs. of Dis. for Discharge	Med. Certificates
C. M. Charges	Med. Des. Lists
Descriptive Lists	Orders
Discharge Certificates	Pris. of War Record
Enlistment Papers	Resignations

Other papers relating to—

Admission to Hosp'l	Furlough or L. of A
Casualty Sheet	Med. Examination
Confinement	Misc. Information
Contracts	Pay or Clothing
Death or Effects	Personal Reports
Desertion	Rank
Discharge from Hosp'l	Transfer to Hosp'l
Discharge from Service	Transfer to V. R. C.
Duty	Transportation

MICROFILM PUBLICATION M 1818

COMPILED MILITARY SERVICE RECORDS
OF VOLUNTEER UNION SOLDIERS WHO
SERVED WITH THE USCT (US COLORED TROOPS)
2ND REGIMENT OF CAVALRY

PERSONAL PAPERS' TARGET SHEET

PLEASE NOTE THE CHECKED INFORMATION ABOUT THE PERSONAL PAPERS IN
THIS FILE:

- NO PERSONAL PAPERS WERE FOUND IN THIS FILE WHEN THE
RECORDS WERE ARRANGED FOR MICROFILMING.

- 2 PERSONAL PAPER(S) FOUND IN THIS FILE WHEN THE RECORDS
WERE ARRANGED FOR MICROFILMING.

Arnold Wagner
of Clothing
Apr. 1865

U. S. GENERAL HOSPITAL,
Fortress Monroe, Va.,

11/11/65, 1865.

COMMANDING OFFICER

Co. *1st* Regt. *1st* *1st* *1st*

Sir

I have to Report that

of your Company, has received the following Clothing at this Hospital.

ARTICLES.	No.	VALUE.	
		DOLLS.	CTS.
<i>1</i> CAP,	<i>1</i>	<i>1</i>	<i>00</i>
GREAT COAT,			
FLANNEL SACK COAT,			
BLANKET,			
UNIFORM COAT,			
TROWSERS,			
SHIRTS,			
DRAWERS,			
BOOTEES, Prs.,			
BOOTS, Prs.,			
<i>1</i> STOCKINGS, Prs.,	<i>1</i>	<i>1</i>	<i>08</i>

You are respectfully requested to acknowledge the receipt of this communication.

Very Respectfully, Your Obedt. Servt.

Robert Cullen

LIEUT. VET. RESERVE CORPS,
AND A. A. Q. M.

Agree to Wagon
etc etc
at the Dept at Port
Memorandum

U. S. GENERAL HOSPITAL.

Fortress Monroe, Va.

November 18th, 1864.

COMMANDING OFFICER

C. L. "Regt." U. S. Col. Cav.

Sir:

I have to Report that Arnold Maggii
of your Company, has received the following Clothing at this Hospital.

	No.	
Cap,	-	-
Great Coat,	-	-
Flannel Sack Coat,	-	-
Blanket,	-	-
Uniform Coat,	-	-
(1) Trowsers,	one	\$3.10
Shirts,	-	-
(1) Drawers, pris.	one	1.00
(1) Boots, pris.	one	2.20
Boots, pris.	-	-
(1) Stockings, pris	one	\$.35

Present

You are respectfully requested to acknowledge the receipt of this communication.

Very Respectfully, Your Obedt. Servt.

Robert F. Culler
Lieut. Vet. Reserve Corps.

997

Maine Thomas B,
Co F, 2 U. S. Col'd Cav.

2 Lieutenant / Lieutenant

CARD NUMBERS.

1	5315348	26
2	5323420	27
3	5323509	28
4	5323673	29
5	5324591	30
6	40726330	31
7		32
8		33
9		34
10		35
11		36
12		37
13		38
14		39
15		40
16		41
17		42
18		43
19		44
20		45
21		46
22		47
23		48
24		49
25		50

Book Mark:

See also

M 12 Corp., U.S.C.T.

Thomas B. Mainw

3rd Lt., Co., 2nd Reg't U. S. Col'd Car'y,

Age 27 years.

Appears on an

Individual Muster-in Roll

of the organization named above. Roll dated

Fort Monroe, Va., Feb. 2, 1864.

Muster-in to date Dec. 14, 1863.

Joined for duty and enrolled:

When Dec. 14, 1863.

Where Camp Hamilton, Va.

Period 3 years.

Valuation of horse, \$ 100

Valuation of horse equipments, \$ 100

Remarks: Mustered in pursuant to authority from War Dept. letter dated Dec. 16th, 1863. Promoted from Sergt. 3rd New York Cavalry.

Book mark:

C. R. Owen,

111 | **2 Cav. | U.S.C.T.**

James B. ...

25th, Co. F, 2 Reg't U. S. Col'd Cavalry.

Appears on

Company Muster Roll

for *dated Feb 27*, 186 *4*

Present or absent *Present*

Stoppage, \$ *100* for

Due Gov't, \$ *100* for

Valuation of horse, \$ *100*

Valuation of horse equipments, \$ *100*

Remarks: *Present from
1st Lieut. Jan. 3. 1864*

** Surrendered by corps.*

Book mark:

The ...

21 | **2 Cav. | U.S.C.T.**

Wm. B. Wain

1st Lt., Co. F, 2 Reg't U. S. Col'd Cavalry.

Appears on

Company Muster Roll

for *March - April*, 1864.

Present or absent *present*

Stoppage, \$ 100 for

Due Gov't, \$ 100 for

Valuation of horse, \$ 100

Valuation of horse equipments, \$ 100

Remarks: *I have comment due me as 2^d Lieut from Dec. 12th to Feb 2^d 1864.*

Book mark: _____

W. B. Wain

M | **2 Cav.** | **U.S.C.T.**

Jas B. Morris

1 Lt, Co. F, 2 Reg't U. S. Col'd Cavalry.

Appears on

Company Muster Roll

for *May & June*, 186*4*

Present or absent

Stoppage, \$ 100 for

Due Gov't, \$ 100 for

Valuation of horse, \$ 100

Valuation of horse equipments, \$ 100

Remarks: *Killed in action
May 12 1864 near Dinwiddie
Bluff Va.*

Book mark:

J. Collins

716 | 2 Cav. | U.S.C.T.

Thomas B. Morris

2 Lt., Co. F, 2 Reg't U. S. Colored Cav.
1 Lt.

Appears on Returns as follows:

Jan 1864 Present
signs returns as
Comdg. Co. 7,

Feb 1864 Present
Date of Commission Dec 14/63

Mar 7 Apr 1864 (1 Lt.)
Present Date of
Commission from
Feb 20, 64

May 1864 Killed
in action near
Drum Bluff Va
May 10, 64

Book mark :

(546)

A. J. Angles

Copyist.

No. 2200 U. S. C. T.

Mr. Thomas S. Harris
1st Lt., Co. 7, 2 Reg't U. S. Col'd Cav.

Appears on Co. Muster-out Roll, dated
Camp Santiago, Texas, Feb. 12, 1866.
Muster-out to date _____, 186 .
Last paid to _____, 186 .

Clothing account:

Last settled _____, 186 ; drawn since \$ _____ 100
Due soldier \$ _____ 100; due U. S. \$ _____ 100
Am't for cloth'g in kind or money adv'd \$ _____ 100

Due U. S. for arms, equipments, &c., \$ _____ 100
Bounty paid \$ _____ 100 due \$ _____ 100

Remarks: Died. named at
original reg. Promoted
from Sgt 3rd N.Y. Cav
killed in action at
Cruz's Ferry on May 12/64

Book mark: _____

J. H. Harris

998

Major George

Co B, 2 U. S. Col'd Cav.

Private Private

CARD NUMBERS.

1	5315418	26
2	5318529	27
3	5318646	28
4	5318764	29
5	5318875	30
6	5316324	31
7	5318990	32
8	5316636	33
9	5319092	34
10	5319195	35
11	5319300	36
12	5319398	37
13	5319495	38
14	5319589	39
15	5319674	40
16	9087187	41
17	40726322	42
18		43
19		44
20		45
21		46
22		47
23		48
24		49
25		50

Book Mark:

See also

NARA 1751

M | 2 Cav. | U.S.C.T.

George Major

, Co. B, 2 Reg't U. S. Col'd Cav.

Appears on
Company Descriptive Book
of the organization named above.

DESCRIPTION.

Age 32 years; height 5 feet 4 inches.

Complexion Dark

Eyes Black; hair Black

Where born Accomack Co, Va.

Occupation Laborer

ENLISTMENT.

When Jan. 20, 1864.

Where Ft Monroe, Va.

By whom Col. Cole; term 3 y'rs.

Remarks: Mustered
Jan. 27/64 by Capt. F.
Martin. Engaged in
action at Suffolk Va
March 9/64. At Drury's
Bluff May 16/64. On
detached service in
Ambulance Train 18" A. G.
from Aug. 6/64 to Jan 1/65.

F. B. Smith
Copyist.

M | 2 Cav. | U.S.C.T.

George Major

Priv., Co., 2 Reg't U. S. Col'd Cav.

Age years.

Appears on a

Detachment Muster-in Roll

of the organization named above. Roll dated

Port Monroe, Va, Jan. 27, 1864.

Muster-in to date Jan. 27, 1864.

Joined for duty and enrolled:

When Jan. 20, 1864.

Where Port Monroe, Va.

Period 3 years.

Valuation of horse, \$ 100

Valuation of horse equipments, \$ 100

Remarks:

Book mark:

Beck

M | **2 Cav.** | **U.S.C.T.**

George Major
Priv., Co. B. 2 Reg't U. S. Col'd Cavalry.

Appears on

Company Muster Roll

for *Dec. 22/63 to Feb. 29, 1864.*

Present or absent *Present*

Stoppage, \$ 100 for

Due Gov't, \$ 100 for

Valuation of horse, \$ 100

Valuation of horse equipments, \$ 100

Remarks :

Book mark :

E. H. Hunter

M | **2 Cav.** | **U.S.C.T.**

George Major
Plt.

Co. B. 2 Reg't U. S. Col'd Cavalry.

Appears on

Company Muster Roll

for *March & April*, 186*4*.

Present or absent *Present*

Stoppage, \$ 100 for

Due Gov't, \$ 100 for

Valuation of horse, \$ 100

Valuation of horse equipments, \$ 100

Remarks :

Book mark :

E. H. Hunter

M | 2 Cav. | U.S.C.T.

George Major
Pvt., Co. B. 2 Reg't U. S. Col'd Cavalry.

Appears on

Company Muster Roll

for May & June, 1864

Present or absent Present

Stoppage, \$ 100 for

Due Gov't, \$ 100 for

Valuation of horse, \$ 100

Valuation of horse equipments, \$ 100

Remarks :

Book mark :

E. H. Hunter

7th | **2 Cav. | U.S.C.T.**

George M. ...

..., Co. B. 2 Reg't U. S. Col'd Cavalry.

Appears on

Company Muster Roll

for ..., 1864.

Present or absent Absent

Stoppage, \$ 100 for

Due Gov't, \$ 100 for

Valuation of horse, \$ 100

Valuation of horse equipments, \$ 100

Remarks: ...

Strikes '52. Discharge in Camp
Amherst Mass. Dec. 24
Admitted to 2nd 3rd Dist. 18th A. G.
Aug. 4, 1864.

Book mark: _____

O. J. Markle,

C. B. 2 bar | **U.S.C.T.**

George Major
C. B. 2 Reg't U. S. Col'd bar

Appears on a

Detachment Muster Roll

of the organization named above

for July & Aug, 1864

Station The field Va

Present or absent Present

Stoppage, \$ 100 for

Due Gov't, \$ 100 for

Valuation of horse, \$ 100

Valuation of horse equipments, \$ 100

Remarks: Due U.S. 60/100 Doll
for Ordnance cost

Book mark:

O. G. Smith

M | **2 Cav.** | **U.S.C.T.**

Georges Major
Private, Co. B. 2 Reg't U. S. Col'd Cavalry.

Appears on

Company Muster Roll

for Sept - Oct, 1864.

Present or absent Absent

Stoppage, \$ 100 for

Due Gov't, \$ 100 for

Valuation of horse, \$ 100

Valuation of horse equipments, \$ 100

Remarks: Col'd in Co. 2nd Ar. Cav.
since June 1864. Col'd
N. 2. 3^d Ar. Cav. Aug. 4, 1864.

Book mark:

O. J. Markle,

MAR 17 1864

M | 2 Cav. | U.S.C.T.

George Major
Privt, Co. B, 2 Reg't U. S. Col'd Cavalry

Appears on a

Detachment Muster Roll

of the organization named above

for Sept 2 Oct, 1864.

Station In the field, Va

Present or absent Present

Stoppage, \$ 100 for

Due Gov't, \$ 100 for

Valuation of horse, \$ 100

Valuation of horse equipments, \$ 100

Remarks: Difference be-
tween white &
Colored soldiers
pay due from Jan.
20/64 to April 30/64

Book mark:

(344)

W. J. Blog

Copyist.

NARA 1700

111 | **2 Cav.** | **U.S.C.T.**

George Miller

Private, Co. B. 2 Reg't U. S. Col'd Cavalry.

Appears on

Company Muster Roll

for *Oct 31, 1864 to Feb 28, 1865.*

Present or absent *present*

Stoppage, \$ 100 for

Due Gov't, \$ 100 for

Valuation of horse, \$ 100

Valuation of horse equipments, \$ 100

Remarks :

Book mark :

O. J. Markle

M. | **2 Cav.** | **U.S.C.T.**

George Major

Private, Co. B. 2 Reg't U. S. Col'd Cavalry.

Appears on

Company Muster Roll

for Mar & Apr, 1865.

Present or absent Present

Stoppage, \$ 100 for

Due Gov't, \$ 100 for

Valuation of horse, \$ 100

Valuation of horse equipments, \$ 100

Remarks :

Book mark : George Major

M. O. Chance

NARA 1762

M. | 2 Cav. | U.S.C.T.

George Major

J., Co. B. 2 Reg't U. S. Col'd Cavalry.

Appears on

Company Muster Roll

for May + June, 1865.

Present or absent Present.

Stoppage, \$ 100 for

Due Gov't, \$ 100 for

Valuation of horse, \$ 100

Valuation of horse equipments, \$ 100

Remarks :

Book mark :

no chance

M. | 2 Cav. | U.S.C.T.

George Major

P. Priv. Co. B. 2 Reg't U. S. Col'd Cavalry.

Appears on

Company Muster Roll

for July & Aug, 1865.

Present or absent Present.

Stoppage, \$ 100 for

Due Gov't, \$ 100 for

Valuation of horse, \$ 100

Valuation of horse equipments, \$ 100

Remarks :

Book mark :

M. Chance

MAR 17 1864

M | **2 Cav.** | **U.S.C.T.**

George Major
pr, Co. B. 2 Reg't U. S. Col'd Cavalry.

Appears on

Company Muster Roll

for *Sept. & Oct*, 186 *5-*

Present or absent *Present*

Stoppage, \$ *100* for

Due Gov't, \$ *100* for

Valuation of horse, \$ *100*

Valuation of horse equipments, \$ *100*

Remarks :

Book mark :

M. Harrison

M | 2 Cav. | U.S.C.T.

George Major

pt, Co. B. 2 Reg't U. S. Col'd Cavalry.

Appears on

Company Muster Roll

for Nov. & Dec, 1865

Present or absent Present

Stoppage, \$ 100 for

Due Gov't, \$ 100 for

Valuation of horse, \$ 100

Valuation of horse equipments, \$ 100

Remarks :

Book mark :

M. Harrison

M | **2 Cav.** | **U.S.C.T.**

George Major
 Pvt, Co. B, 2 Reg't U. S. Colored Cav.

Appears on Returns as follows:

May to June 1864
 On duty in the
 Howitzer Detachment
 Aug 1864 Absent detail
 in Amb Corps
 A. C.
 Sept 1864 Absent in
 Amb Corps as driver
 Oct 1864 Absent detail
 as sharpshooter
 Nov 1864 Absent in
 Ambul Corps as
 driver
 Sept to Nov 1865 On
 duty Co Cook
 Dec 1865 On daily duty
 Jan 1866 On duty
 Co Cook

Book mark :

(546)

A. J. Gouglas
 Copyist.

NARRA 1767

M | **2 Cav. | U.S.C.T.**

George Major

privt, Co. *B*, 2 Reg't U. S. Col'd Cavalry.

Appears on **Co. Muster-out Roll**, dated
Brazos Santiago Tex., Feb. 12, 1866.

Muster-out to date *Feb. 12, 1866.*

Last paid to *June 30, 1865.*

Clothing account:

Last settled....., 186 ; drawn since \$..... $\overline{100}$

Due soldier \$..... $\overline{100}$; due U. S. \$ *2* $\overline{17}$
 $\overline{100}$

Am't for cloth'g in kind or money adv'd \$..... $\overline{100}$

Due U. S. for arms, equipments, &c., \$..... $\overline{100}$

Bounty paid \$..... $\overline{100}$; due \$ *300* $\overline{100}$

Remarks: *Found a Rect.*
Free before April 19
'61.

Book mark :

W. Harrison

(361)

Copyist.

999

Major Henry

Co G, 2 U. S. Col'd Cav.

Private Private

CARD NUMBERS.

1	5324646	26
2	5324719	27
3	5324809	28
4	5324898	29
5	5324989	30
6	5316475	31
7	5325080	32
8	5316588	33
9	5325174	34
10	5325258	35
11	5325351	36
12	5325447	37
13	5325541	38
14	5325624	39
15	5325703	40
16	5325775	41
17	9087694	42
18	40726332	43
19		44
20		45
21		46
22		47
23		48
24		49
25		50

Book Mark:

See also

M | 2 Cav. | U.S.C.T.

Henry Major

, Co. A, 2 Reg't U. S. Col'd Cav.

Appears on

Company Descriptive Book

of the organization named above.

DESCRIPTION.

Age 45 years; height 5 feet 8 inches.

Complexion Dark

Eyes Dark; hair Dark

Where born Camden Co., N. C.

Occupation Sgt.

ENLISTMENT.

When Dec 25, 1863.

Where Norfolk Va.

By whom Col G. W. Cole; term 3 y'rs.

Remarks: Engaged in action at Drury's Bluff Va. May 16-65.

On Det. Service in Sub. Train from Aug. 4-1864 to Jan. 1, 1865.

F. B. Smith

M | **2 Cav.** | **U.S.C.T.**

Henry Mayer
.....
Plt, Co. *G*, 2 Reg,t U. S. Col'd Cavalry.

Age *45* years.

Appears on

Company Muster-in Roll

of the organization named above. Roll dated

At Monroe Va, Jan 8, 186 *4*

Muster-in to date *Jan 8*, 186 *4*

Joined for duty and enrolled:

When *Dec 25*, 186 .

Where *Norfolk, Va.*

Period *3* years.

Valuation of horse, \$.....100

Valuation of horse equipments, \$.....100

Remarks :
.....
.....
.....
.....

Book mark :

J. M. Harmon

MAR 17 1871

M | **2 Cav.** | **U.S.C.T.**

Henry C Major
Cpt., Co. G, 2 Reg't U. S. Col'd Cavalry.

Appears on

Company Muster Roll

for *valid Feb 29*, 186*4*.

Present or absent *Present*

Stoppage, \$ *100* for

Due Gov't, \$ *100* for

Valuation of horse, \$ *100*

Valuation of horse equipments, \$ *100*

Remarks:

Book mark: _____

(358)

A M Harmon

Copyist.

M | **2 Cav.** | **U.S.C.T.**

Henry Major
Pr, Co. G, 2 Reg't U. S. Col'd Cavalry.

Appears on

Company Muster Roll

for *Mar 1864*, 1864

Present or absent *Present*

Stoppage, \$ *100* for

Due Gov't, \$ *100* for

Valuation of horse, \$ *100*

Valuation of horse equipments, \$ *100*

Remarks:

Book mark: _____

J. M. Harmon

M | **2 Cav.** | **U.S.C.T.**

Henry Major
Priv., Co. G, 2 Reg't U. S. Col'd Cavalry.

Appears on

Company Muster Roll

for *May & June*, 1864.

Present or absent *Present*

Stoppage, \$ 100 for

Due Gov't, \$ 1⁹⁴/₁₀₀ for *ordnance*

Valuation of horse, \$ 100

Valuation of horse equipments, \$ 100

Remarks: *Pay amt \$ per mo due since Jan 1*

Book mark:

J. Harmon
(358) Copyist.

M | **2 Cav.** | **U.S.C.T.**

Henry Major

Pri, Co. G, 2 Reg't U. S. Col'd Cavalry.

Appears on

Company Muster Roll

for *July & Aug*, 1864.

Present or absent *absent*

Stoppage, \$ *100* for

Due Gov't, \$ *1 94* for *ordnance*

Valuation of horse, \$ *100*

Valuation of horse equipments, \$ *100*

Remarks: *Detached in Ambulance Corps.*

Book mark:

J. Brown
Copyist.

11 | 2nd Cav. | **U.S.C.T.**

James Mear
Capt., Co. G., 2nd Reg't U.S. Col'd Cav

Appears on a

Detachment Muster Roll

of the organization named above

for July to Aug^r, 1864

Station in the Field Va.

Present or absent Present

Stoppage, \$ 100 for

Due Gov't, \$ 100 for

Valuation of horse, \$ 100

Valuation of horse equipments, \$ 100

Remarks: Due me U.S. for
Expense stopped on
my leave fall 1864.

Book mark:

C. Thompson

M | **2 Cav.** | **U.S.C.T.**

Henry Major

Peri, Co. G, 2 Reg't U. S. Col'd Cavalry.

Appears on

Company Muster Roll

for *Sept & Oct*, 1864.

Present or absent *absent*

Stoppage, \$ 100 for

Due Gov't, \$ 100 for

Valuation of horse, \$ 100

Valuation of horse equipments, \$ 100

Remarks: *Detached in
Arch-Corps 18th Dec*

Book mark:

(358)

J. J. Brown
Copyist.

M. 12" Cav. | **U.S.C.T.**

Henry Major
447, Co. *E*, *2*" Reg't U. S. Col'd *Cav*

Appears on a
Detachment Muster Roll
of the organization named above
for *Sept & Oct.*, 186*A*.
Station *Near Chapins Farm Va*
Present or absent *Present*

Stoppage, \$ 100 for

Due Gov't, \$ 100 for

Valuation of horse, \$ 100

Valuation of horse equipments, \$ 100

Remarks:

Book mark: -----

Sgt Thompson

M

2 Cav. U.S.C.T.

Henry Major

Co. G, 2 Reg't U. S. Col'd Cavalry.

Appears on

Company Muster Roll

for *Nov & Dec*, 1864.

Present or absent *present*

Stoppage, \$ 100 for

Due Gov't, \$ 100 for

Valuation of horse, \$ 100

Valuation of horse equipments, \$ 100

Remarks:

Book mark:

J. Brown
Copyist.

M

2 Cav. U.S.C.T.

Henry Major

Priv, Co. G, 2 Reg't U. S. Col'd Cavalry.

Appears on

Company Muster Roll

for *Jan & Feb*, 1865.

Present or absent *present*

Stoppage, \$ 100 for

Due Gov't, \$ 100 for

Valuation of horse, \$ 100

Valuation of horse equipments, \$ 100

Remarks:

Book mark: _____

J. D. Brown
Copyist.

M | **2 Cav.** | **U.S.C.T.**

Henry Major

Pw, Co. G, 2 Reg't U. S. Col'd Cavalry.

Appears on

Company Muster Roll

for *Men & Gps.*, 186 5.

Present or absent *Present*

Stoppage, \$ 100 for

Due Gov't, \$ 100 for

Valuation of horse, \$ 100

Valuation of horse equipments, \$ 100

Remarks:

Book mark:

J. C. Chapin

M | **2 Cav.** | **U.S.C.T.**

Henry Major
Capt, Co. G, 2 Reg't U.S. Col'd Cavalry.

Appears on

Company Muster Roll

for *May & June*, 186*5*.

Present or absent *Present.*

Stoppage, \$ *100* for

Due Gov't, \$ *100* for

Valuation of horse, \$ *100*

Valuation of horse equipments, \$ *100*

Remarks:

Book mark: -----

Fulton

M | **2 Cav.** | **U.S.C.T.**

Henry Major
Pr, Co. G, 2 Reg't U.S. Col'd Cavalry.

Appears on

Company Muster Roll

for *July & Aug.*, 186*6*

Present or absent *present*

Stoppage, \$ *100* for

Due Gov't, \$ *100* for

Valuation of horse, \$ *100*

Valuation of horse equipments, \$ *100*

Remarks:

Book mark:

E. A. Carter

M | **2 Cav.** | **U.S.C.T.**

Henry Mayzer
Pr, Co. G, 2 Reg't U.S. Col'd Cavalry.

Appears on

Company Muster Roll

for *Sept & Oct*, 186*3*.

Present or absent *Present*

Stoppage, \$ *100* for

Due Gov't, \$ *100* for

Valuation of horse, \$ *100*

Valuation of horse equipments, \$ *100*

Remarks:

Book mark:

C. M. Langley
Copyist.

M | 2 Cav. | U.S.C.T.

Henry Mayer

Private, Co. G, 2 Reg't U.S. Col'd Cavalry.

Appears on

Company Muster Roll

for Nov & Dec, 1865:

Present or absent Present

Stoppage, \$ 100 for

Due Gov't, \$ 100 for

Valuation of horse, \$ 100

Valuation of horse equipments, \$ 100

Remarks:

Book mark:

C. M. Lingle

M | 2 Cav. | U.S.C.T.

Henry Major
Pat., Co. G, 2 Reg't U. S. Colored Cav.

Appears on Returns as follows:

Aug 1864 to Nov 1864
Absent det. in
Ambul Corps
by letter from
Corporal D. L. since
Aug 4, 64

Aug 1865 On duty Co
Cook

Sept 1865 to Jan 1866
On duty Co Cook
since Sept 1, 65

Book mark:

(546)

A. J. G. Copyist.

M | **2 Cav.** | **U.S.C.T.**

Henry Mayor
Pat., Co. G., 2 Reg't U. S. Col'd Cavalry.

Appears on **Co. Muster-out Roll**, dated
Brazos Santiago Tex, Feb 12, 1866.

Muster-out to date Feb 12, 1866.

Last paid to June 20, 1865.

Clothing account:

Last settled....., 186 ; drawn since \$..... 100

Due soldier \$ 9³⁰/₁₀₀; due U. S. \$..... 100

Am't for cloth'g in kind or money adv'd \$..... 100

Due U. S. for arms, equipments, &c., \$..... 100

Bounty paid \$..... 100; due \$..... 100

Remarks: Joined at Oriz.
Oriz.

Book mark: 388 718

C. J. McLaughlin
(361) Copyist.

1000

Major Jim

Co. H, 2 U. S. Col'd Cav.

Private Corporal

CARD NUMBERS.

1	5325885	26
2	5325971	27
3	5326057	28
4	5326145	29
5	5326226	30
6	5326310	31
7	5326347	32
8	5326419	33
9	5326502	34
10	5326583	35
11	5326667	36
12	5326750	37
13	5326824	38
14	5326896	39
15	40726331	40
16		41
17		42
18		43
19		44
20		45
21		46
22		47
23		48
24		49
25		50

Book Mark:

See also

M | 2 Cav. | U.S.C.T.

Jim Major

Private, Co. H, 2 Reg't U. S. Col'd Cav.

Age 22 years.

Appears on

Company Muster-in Roll

of the organization named above. Roll dated

Fentimura Va, Jan 8, 1864.

Muster-in to date Jan 8, 1864.

Joined for duty and enrolled:

When Jan 1, 1864.

Where Pongatigue Va

Period 3 years.

Valuation of horse, \$ 100

Valuation of horse equipments, \$ 100

Remarks:

Book mark:

A. J. Anderson

M | 2 Cav. | U.S.C.T.

Jim Major
Pvt., Co. H, 2 Reg't U. S. Col'd Cavalry.

Appears on

Company Muster Roll

from date of enrollment to Feb 29, 1864.

Present or absent Present

Stoppage, \$ 100 for

Due Gov't, \$ 100 for

Valuation of horse, \$ 100

Valuation of horse equipments, \$ 100

Remarks:

Book mark:

A. J. Anderson

M | **2 Cav.** | **U.S.C.T.**

Jim Major
Capt, Co. H, 2 Reg't U. S. Col'd Cavalry.

Appears on

Company Muster Roll

for *March - April*, 1864.

Present or absent *Present*

Stoppage, \$ *100* for

Due Gov't, \$ *100* for

Valuation of horse, \$ *100*

Valuation of horse equipments, \$ *100*

Remarks:

Book mark: _____

(358)

A. J. Anderson
Copyist.

No | **2 Cav.** | **U.S.C.T.**

Jim Major
Priv, Co. II, 2 Reg't U. S. Col'd Cavalry.

Appears on

Company Muster Roll

for *May "to Sept."*, 1864.

Present or absent *Present*

Stoppage, \$ *100* for

Due Gov't, \$ *100* for

Valuation of horse, \$ *100*

Valuation of horse equipments, \$ *100*

Remarks:

Book mark: _____

W. B. Ferguson
Copyist.

M | **2 Cav.** | **U.S.C.T.**

Jim Meyer
Plt, Co. H, 2 Reg't U. S. Col'd Cavalry.

Appears on

Company Muster Roll

for *May Term*, 1864.

Present or absent *Present*

Stoppage, \$ *100* for

Due Gov't, \$ *100* for

Valuation of horse, \$ *100*

Valuation of horse equipments, \$ *100*

Remarks:

Book mark: _____

(358) *A. J. Anderson* Copyist.

M | **2 Cav.** | **U.S.C.T.**

Lin Major
Priv, Co. H, 2 Reg't U. S. Col'd Cavalry.

Appears on

Company Muster Roll

for *Sept & Oct*, 1864.

Present or absent *Present*

Stoppage, \$ *100* for

Due Gov't, \$ *100* for

Valuation of horse, \$ *100*

Valuation of horse equipments, \$ *100*

Remarks:

Book mark: -----

(358)

W B Ferguson

Copyist.

No | **2 Cav.** | **U.S.C.T.**

John Major
Corpl, Co. H, 2 Reg't U. S. Col'd Cavalry.

Appears on

Company Muster Roll

for *Nov. & Dec.*, 1864.

Present or absent *Present*

Stoppage, \$ *100* for

Due Gov't, \$ *100* for

Valuation of horse, \$ *100*

Valuation of horse equipments, \$ *100*

Remarks: *Appointed Corpl*
Nov. 1st '64

Book mark:

W. J. Ferguson

M | **2 Cav. | U.S.C.T.**

Jim Waper
Capt, Co. H, 2 Reg't U. S. Col'd Cavalry.

Appears on

Company Muster Roll

for *Jan. & Feb.*, 186*0*.

Present or absent *Present*

Stoppage, \$ *100* for

Due Gov't, \$ *100* for

Valuation of horse, \$ *100*

Valuation of horse equipments, \$ *100*

Remarks:
.....
.....
.....
.....
.....
.....
.....
.....
.....
.....

Book mark:
.....
.....

(358)

W. B. Ferguson
Copyist.

M. | **2 Cav.** | **U.S.C.T.**

Jim Major
sergeant, Co. H, 2 Reg't U. S. Col'd Cavalry.

Appears on

Company Muster Roll

for March and April, 1865.

Present or absent Present

Stoppage, \$ 100 for

Due Gov't, \$ 100 for

Valuation of horse, \$ 100

Valuation of horse equipments, \$ 100

Remarks:

Book mark: -----

C. J. Powell

M. | 2 Cav. | U.S.C.T.

John Major
Co. H, Co. H, 2 Reg't U. S. Col'd Cavalry.

Appears on

Company Muster Roll

for *May and June*, 1865.

Present or absent *Present*

Stoppage, \$ *100* for

Due Gov't, \$ *100* for

Valuation of horse, \$ *100*

Valuation of horse equipments, \$ *100*

Remarks:

Book mark:

C. G. Powell

M. | 2 Cav. | U.S.C.T.

John Major
Co. H, Co. H, 2 Reg't U. S. Col'd Cavalry.

Appears on

Company Muster Roll

for *July and Aug.*, 186*5*.

Present or absent *Present*

Stoppage, \$ *100* for

Due Gov't, \$ *100* for

Valuation of horse, \$ *100*

Valuation of horse equipments, \$ *100*

Remarks:

Book mark: -----

C. J. Powell

M | 2 Cav. | U.S.C.T.

Simon Major

Co. H, Co. H, 2 Reg't U. S. Col'd Cavalry.

Appears on

Company Muster Roll

for *Sep & Oct*, 1865.

Present or absent *Present*

Stoppage, \$ 100 for

Due Gov't, \$ 100 for

Valuation of horse, \$ 100

Valuation of horse equipments, \$ 100

Remarks:

Book mark:

W. J. White
Copyist.

M | **2 Cav.** | **U.S.C.T.**

Jim Major
Capt, Co. H, 2 Reg't U. S. Col'd Cavalry.

Appears on

Company Muster Roll

for *Nov & Dec*, 1865.

Present or absent *Present*

Stoppage, \$ 100 for

Due Gov't, \$ 100 for

Valuation of horse, \$ 100

Valuation of horse equipments, \$ 100

Remarks:

Book mark:

Y. D. Hill
Coppist.

M | **2 Cav.** | **U.S.C.T.**

Jim Major
Co. H, 2 Reg't U. S. Colored Cav.

Appears on Returns as follows:

Feb 1864 On daily
duty as Col.
Orderly

Book mark: _____

(546)

A. J. Gault

Copyist.

M. | 2 Cav. | U.S.C.T.

Jim Major
Capt, Co. H, 2 Reg't U. S. Col'd Cavalry.

Appears on **Co. Muster-out Roll**, dated
Brazos Santiago Tex, Feb 12, 1866.
Muster-out to date *Feb 12*, 1866.
Last paid to *June 30*, 1865.

Clothing account:

Last settled....., 186 ; drawn since \$ 100
Due soldier \$ 100; due U. S. \$ *33* ^{*95*}/₁₀₀
Am't for cloth'g in kind or money adv'd \$ 100

Due U. S. for arms, equipments, &c., \$ 100
Bounty paid \$ 100; due \$ *200* 100

Remarks: *joined at orig orgn*
was Private to Aug 1/64
when appt Corp
free before April 19/61

Book mark :

W. H. Hill
Copyist.

1001

Major, Perry

Co. A, 2 U. S. Col'd Cav.

Private Corporal

CARD NUMBERS.

1	5315417	26
2	5325970	27
3	5326055	28
4	5326142	29
5	5326223	30
6	5326308	31
7	5326346	32
8	5326418	33
9	5326500	34
10	5326582	35
11	5326666	36
12	5326749	37
13	5326823	38
14	5326895	39
15	40726333	40
16		41
17		42
18		43
19		44
20		45
21		46
22		47
23		48
24		49
25		50

Book Mark:

See also

M | *2 Cav.* | **U.S.C.T.**

Perry Major
Priv., Co....., *2* Reg't U. S. Col'd *Cav.*

Age years.

Appears on a

Detachment Muster-in Roll

of the organization named above. Roll dated

Fort Monroe, Va. Jan 27, 1864.

Muster-in to date *Jan 27, 1864.*

Joined for duty and enrolled:

When *Jan. 20*....., 1864 .

Where *Fort Monroe, Va.*

Period *3*.....years.

Valuation of horse, \$.....100

Valuation of horse equipments, \$.....100

Remarks:.....

.....

.....

.....

Book mark : *100*

.....

Beck
Copied.

MAR 1865

M | 2 Cav. | U.S.C.T.

Perry Major
Plt, Co. H, 2 Reg't U. S. Col'd Cavalry.

Appears on

Company Muster Roll

for *from date of Enrollment to Feb 29*, 1864.

Present or absent *Present*

Stoppage, \$ *100* for

Due Gov't, \$ *100* for

Valuation of horse, \$ *100*

Valuation of horse equipments, \$ *100*

Remarks:

Book mark:

A. J. Anderson

M | **2 Cav.** | **U.S.C.T.**

Perry Major
Plt, Co. H, 2 Reg't U. S. Col'd Cavalry.

Appears on

Company Muster Roll

for *March & April*, 1864.

Present or absent *Present*

Stoppage, \$ *100* for

Due Gov't, \$ *100* for

Valuation of horse, \$ *100*

Valuation of horse equipments, \$ *100*

Remarks:

Book mark: _____

A. J. Anderson

31 | **2 Cav. U.S.C.T.**

Perry Cooper
Pvt, Co. H, 2 Reg't U. S. Col'd Cavalry.

Appears on

Company Muster Roll

for *May & June*, 1864.

Present or absent *Present*

Stoppage, \$ *100* for

Due Gov't, \$ *100* for

Valuation of horse, \$ *100*

Valuation of horse equipments, \$ *100*

Remarks:

Book mark:

A. J. Anderson

16 | **2 Cav.** | **U.S.C.T.**

Perry Major
Priv, Co. H, 2 Reg't U. S. Col'd Cavalry.

Appears on

Company Muster Roll

for *May "to Sept"*, 1864.

Present or absent *Present*

Stoppage, \$ 100 for

Due Gov't, \$ 100 for

Valuation of horse, \$ 100

Valuation of horse equipments, \$ 100

Remarks:

Book mark:

W B Ferguson

M | **2 Cav. | U.S.C.T.**

Perry Major
Priv, Co. H, 2 Reg't U. S. Col'd Cavalry.

Appears on

Company Muster Roll

for *Sept & Oct*, 1864.

Present or absent *Present*

Stoppage, \$ 100 for

Due Gov't, \$ 100 for

Valuation of horse, \$ 100

Valuation of horse equipments, \$ 100

Remarks:

Book mark:

W. B. Ferguson
Copyist.

16 | 2 Cav. | U.S.C.T.

Perry Major
Coplt, Co. H, 2 Reg't U. S. Col'd Cavalry.

Appears on

Company Muster Roll

for *Nov. & Dec.*, 1864.

Present or absent *Present*

Stoppage, \$ 100 for

Due Gov't, \$ 100 for

Valuation of horse, \$ 100

Valuation of horse equipments, \$ 100

Remarks: *Appointed Coplt*
Nov. 1st/64

Book mark:

A. P. Ferguson
Copyist.

10 | **2 Cav.** | **U.S.C.T.**

Curry Maper

Corpl, Co. H, 2 Reg't U. S. Col'd Cavalry.

Appears on

Company Muster Roll

for *Jan & Feb.*, 186*5*.

Present or absent *Present*

Stoppage, \$ *100* for

Due Gov't, \$ *100* for

Valuation of horse, \$ *100*

Valuation of horse equipments, \$ *100*

Remarks: -----

Book mark: -----

(358) *W B Ferguson* Copyist.

M. | **2 Cav.** | **U.S.C.T.**

Perry Major
Capt., Co. H, 2 Reg't U. S. Col'd Cavalry.

Appears on

Company Muster Roll

for March and April, 1865.

Present or absent Present

Stoppage, \$ 100 for

Due Gov't, \$ 100 for

Valuation of horse, \$ 100

Valuation of horse equipments, \$ 100

Remarks:

Book mark: -----

C. J. Powell

M | 2 Cav. | U.S.C.T.

Perry Major

Corpl, Co. H, 2 Reg't U. S. Col'd Cavalry.

Appears on

Company Muster Roll

for May & June, 1865.

Present or absent Present

Stoppage, \$ 100 for

Due Gov't, \$ 100 for

Valuation of horse, \$ 100

Valuation of horse equipments, \$ 100

Remarks:

Book mark:

(358)

Smart
Army Copyist.

M | **2 Cav.** | **U.S.C.T.**

Perry Major
Co. H, Co. H, 2 Reg't U. S. Col'd Cavalry.

Appears on

Company Muster Roll

for *July and Aug.*, 1865.

Present or absent *Present*

Stoppage, \$ *100* for

Due Gov't, \$ *100* for

Valuation of horse, \$ *100*

Valuation of horse equipments, \$ *100*

Remarks:

Book mark: *22* *1865*

C. J. Powell

M | 2 Cav. | U.S.C.T.

Perry Major
Caspi, Co. H, 2 Reg't U. S. Col'd Cavalry.

Appears on

Company Muster Roll

for *Sep & Oct*, 1865.

Present or absent *Present*

Stoppage, \$ 100 for

Due Gov't, \$ 100 for

Valuation of horse, \$ 100

Valuation of horse equipments, \$ 100

Remarks:

Book mark: -----

W. H. Hill
Copied.

M | **2 Cav.** | **U.S.C.T.**

Perry Major

Copie, Co. H, 2 Reg't U. S. Col'd Cavalry.

Appears on

Company Muster Roll

for *Nov & Dec*, 186*8*.

Present or absent *Present*

Stoppage, \$ 100 for

Due Gov't, \$ 100 for

Valuation of horse, \$ 100

Valuation of horse equipments, \$ 100

Remarks:

Book mark:

J. G. Kelly
Copyist

M | **2 Cav.** | **U.S.C.T.**

Perry Major
Capt. Co. H, 2 Reg't U. S. Colored Cav.

Appears on Returns as follows:

Jan 1865 Absent det
at Hd Qrs 1 Div
25 A.C. Jan 22, 65
Jan 1866 Absent det
as Courier to
Corps Christi
Tex

Book mark :

(546)

A. G. England
Copyist.

M | **2 Cav.** | **U.S.C.T.**

Perry Major
Corpl, Co. *H*, 2 Reg't U. S. Col'd Cavalry.

Appears on **Co. Muster-out Roll**, dated
Brazos Santiago Tex, Feb 12, 186*6*.
 Muster-out to date *Feb 12*, 186*6*.
 Last paid to *June 30*, 186*5*.

Clothing account:

Last settled....., 186 ; drawn since \$..... $\overline{100}$
 Due soldier \$..... $\overline{100}$; due U. S. \$ *31* $\overline{80}$ $\overline{100}$
 Am't for cloth'g in kind or money adv'd \$..... $\overline{100}$

Due U. S. for arms, equipments, &c., \$..... $\overline{40}$ $\overline{100}$
 Bounty paid \$..... $\overline{100}$; due \$ *300* $\overline{100}$

Remarks: *joined a recruit was*
private to July 1/64 when
app'd Corpl. free before
April 19/61 Staff Sergeant
brush wiper

Book mark :

1002

Manchester John H.
Co L, 2 U. S. Col'd Cav.

Private

Private

CARD NUMBERS.

1	26
2	27
3	28
4	29
5	30
6	31
7	32
8	33
9	34
10	35
11	36
12	37
13	38
14	39
15	40
16	41
17	42
18	43
19	44
20	45
21	46
22	47
23	48
24	49
25	50

Book Mark:

See also

1003

Manley, Marcus M.

Co. A + S, 2 U. S. Col'd Cav.

Sergeant Maj. & Surgeon

CARD NUMBERS.

1	5315347	26
2	5317015	27
3	5317027	28
4	5317045	29
5	5317060	30
6	5317075	31
7	5317091	32
8	5317104	33
9	5317115	34
10	5317127	35
11	5317139	36
12	5317151	37
13	5317164	38
14	5317187	39
15	9435820	40
16	40726336	41
17		42
18		43
19		44
20		45
21		46
22		47
23		48
24		49
25		50

Book Mark:

See also

No 1 Cav U.S.C.
Marcus M. Manly,
2d Lt Eng, 1 Reg't U.S. Col'd Cav.

Appears on

Regimental Descriptive Book

(List of Commissioned Officers)

of the regiment named above.

Rank

Date of appointment, 186 .

Remarks: Promoted Surgeon
in 2 U.S.C. Cav, Dec
27/63.

Dayton

M | 2 Cav, | U.S.C.T.

Marcus M. Manley
* Surgeon
Sergeant, Co., 2nd Reg't U. S. Col'd Cavalry

Age 44 years.

Appears on an

Individual Muster-in Roll

of the organization named above. Roll dated

Freshens Moural, Va, Feb. 11, 1864.

Muster-in to date Dec. 27, 1863.

Joined for duty and enrolled:

When Dec 27, 1863.

Where Ft. Moural

Period 3 years.

Valuation of horse, \$ 100

Valuation of horse equipments, \$ 100

Remarks: Mustered in pursuant to authority from War Dept. letter dated Dec. 26th, 63, to fill original vacancy.

Book mark: + corrected by Thos G. Hatch Esq.

C. K. Owen

M | *2 Co* | **U.S.C.T.**

Marcus M. Manly
Rank *Surg*, *2* Reg't U. S. Col'd *Co*

Age.....years.

Appears on

Field and Staff Muster Roll*

for *to Feb 29*, 186*4*.

Joined for duty and enrolled:

When *Dec 27*, 186*3*.

Where *Camp Hamilton Ft Monroe Va*

Period.....years.

Mustered in:

When *Dec 27*, 186*3*.

Where *Ft Monroe Va*

Present or absent *Present*

Stoppage, \$ *100* for.....

Due Gov't, \$ *100* for.....

Valuation of horse, \$ *100*

Valuation of horse equipments, \$ *100*

Remarks :

* First current roll. No muster-in roll of Field and Staff on file.

Book mark :

Breger

M | 2 Car | **U.S.C.T.**

Marcus M. Manly

Rank *Surg.*, *2* Reg't U. S. Col'd *Car*

Appears on

Field and Staff Muster Roll

for *Feb + Apr* 186*4*.

Present or absent *Present*

Stoppage, \$ *100* for

Due Gov't, \$ *100* for

Valuation of horse, \$ *100*

Valuation of horse equipments, \$ *100*

Remarks:

Book mark:-----

Bryson

MAR 18 25

M | I Car | U.S.C.T.

Marcus M. Mandy
Rank *Sgt*, *L* Reg't U. S. Col'd *Car*

Appears on

Field and Staff Muster Roll

for *May 4 June* 186*7*.

Present or absent *Absent*

Stoppage, \$ *100* for

Due Gov't, \$ *100* for

Valuation of horse, \$ *100*

Valuation of horse equipments, \$ *100*

Remarks *Absent with leave Surg -*
cert since May 1st for twenty
days. leave extended thirty
days duty Post Surg Philadel
phia.

Book mark:

Bryer

M | 2 Car | **U.S.C.T.**

Marcus M. Manly

Rank Surg., 2 Reg't U. S. Col'd Car

Appears on

Field and Staff Muster Roll

for July & Aug 1864

Present or absent Present

Stoppage, \$ 100 for

Due Gov't, \$ 100 for

Valuation of horse, \$ 100

Valuation of horse equipments, \$ 100

Remarks: Returned from sick leave July 27, 1864.

Book mark:

Boyer

M | 2 bar | **U.S.C.T.**

Marcus M. Manly

Rank Surg, 2 Reg't U. S. Col'd bar

Appears on

Field and Staff Muster Roll

for Sept & Oct 1864

Present or absent Present

Stoppage, \$ 100 for

Due Gov't, \$ 100 for

Valuation of horse, \$ 100

Valuation of horse equipments, \$ 100

Remarks:

Book mark: -----

Deger

M | 2 Car | **U.S.C.T.**

Marcus M. Manly
Rank Surgeon, 2 Reg't U. S. Col'd Car

Appears on

Field and Staff Muster Roll

for Jan + Dec 1864.

Present or absent Present

Stoppage, \$ 100 for

Due Gov't, \$ 100 for

Valuation of horse, \$ 100

Valuation of horse equipments, \$ 100

Remarks:

Book mark:

Beyer

M | *2* *Cor* | **U.S.C.T.**

Marcus M. Manley

Rank *Surg*, *2* Reg't U. S. Col'd *Cor*

Appears on

Field and Staff Muster Roll

for *Jan & Feb* 1865.

Present or absent *Present*

Stoppage, \$ *100* for

Due Gov't, \$ *100* for

Valuation of horse, \$ *100*

Valuation of horse equipments, \$ *100*

Remarks: *Absent without leave from Jan 31 to Feb 27, 65.*

Book mark:

Bryer

M | 2 Co | **U.S.C.T.**

Marcus M. Mauldy

Rank Surg, 2 Reg't U. S. Col'd War

Appears on

Field and Staff Muster Roll

for Mo - Apl 1865.

Present or absent Present

Stoppage, \$ 100 for

Due Gov't, \$ 100 for

Valuation of horse, \$ 100

Valuation of horse equipments, \$ 100

Remarks:

Book mark:

Boeger

M | *2 Co* | **U.S.C.T.**

Marcus M. Manly

Rank *Surg*, *2* Reg't U. S. Col'd *Co*

Appears on

Field and Staff Muster Roll

for *May 4 June* 1865.

Present or absent *Present*

Stoppage, \$ *100* for

Due Gov't, \$ *100* for

Valuation of horse, \$ *100*

Valuation of horse equipments, \$ *100*

Remarks:

Book mark:

Dreyer

M | 2 Co | **U.S.C.T.**

Marcus M. Manley

Rank Major & Surg., 2 Reg't U. S. Col'd Co

Appears on

Field and Staff Muster Roll

for July & Aug 1865.

Present or absent Present

Stoppage, \$ 100 for

Due Gov't, \$ 100 for

Valuation of horse, \$ 100

Valuation of horse equipments, \$ 100

Remarks:

Book mark: -----

Breyer

M | 2 Co | **U.S.C.T.**

Marcus M Manley
Rank Adj't Surg, 2 Reg't U. S. Col'd Car

Appears on

Field and Staff Muster Roll

for Sept & Oct 1865.

Present or absent Present

Stoppage, \$ 100 for

Due Gov't, \$ 100 for

Valuation of horse, \$ 100

Valuation of horse equipments, \$ 100

Remarks:

Book mark:

J. J. [Signature]

M | 2 Car | **U.S.C.T.**

Marcus M. Mauley
Rank Major, 2 Reg't U. S. Col'd Car

Appears on

Field and Staff Muster Roll

for Nov & Dec 1865.

Present or absent Absent

Stoppage, \$ 100 for

Due Gov't, \$ 100 for

Valuation of horse, \$ 100

Valuation of horse equipments, \$ 100

Remarks: Absent without leave.

Book mark:

Breyer

M | **2 Cav.** | **U.S.C.T.**

Marcus M. Manley
 Surg. Co., 2 Reg't U. S. Colored Cav.

Appears on Returns as follows:

Jan 10 to Apr 1864 Present
 May 1864 Absent in
 Hosp. Ft Monroe
 Va. Wounded
 since May 17, 64

June 1864 Absent with
 out leave since
 June 20, 64 from
 Absent with leave
 on Surge's Certifi-
 cate

July to Dec 1864 Present
 Jan 1865 Absent det'
 at Corps Hd Qrs
 for S. O. 100 Hd Qrs
 18 a. c. Aug 4, 64

Feb to Nov 1865 Present
 Dec 1865 Absent with
 leave

Jan 1866 Disch'd S. O.
 8 Mil Dir Gulf Jan

Book mark:

A. J. ...
 Copyist.

JAN. 18

40726336

1899.

Jan. 7. 44
6750 Kawana
7, Hon. K. S. S. S. S.
Hon. K. S. S. S. S.
S. S. S. S. S. S.
S. S. S. S. S. S.

M | *2 Car* | **U.S.C.T.**

Marcus M. Manley
Rank *Maj's Surg*, *2* Reg't U. S. Col'd *Car*

Appears on a

Field and Staff Muster-out Roll

of the organization named above. Roll dated

Brazos Santiago Tex, Feb 12, 1866

Muster-out to date _____, 186 .

Last paid to _____, 186 .

Clothing account:

Last settled _____, 186 ; drawn since \$ _____ 100

Due soldier \$ _____ 100; due U. S. \$ _____ 100

Am't for cloth'g in kind or money adv'd \$ _____ 100

Due U. S. for arms, equipments, &c., \$ _____ 100

Bounty paid \$ _____ 100; due \$ _____ 100

Remarks *Discharged on resignation*
per S.O. & Hd Qrs Mil Div Gulf
Jan 8/66 at Brazos Santiago
Tex.

Book mark: *1215 Dis May 9/67*

Breger

Manley, M. M.
Surg. Co., 2 Reg't U.S. C. Cav.

21 Enclosures.

Bed Cards	Final Statements
Burial Records	Furloughs or L. of A
Certs. of Dis. for Discharge	Med. Certificates
C. M. Charges	Med. Des. Lists
Descriptive Lists	Orders 4
Discharge Certificates	Pris. of War Record
Enlistment Papers	Resignations

Other papers relating to—

Admission to Hosp'l	Furlough or L. of A 2
Casualty Sheet	Med. Examination 3
Confinement	Misc. Information 6
Contracts	Pay or Clothing 1
Death or Effects	Personal Reports 4
Desertion	Rank
Discharge from Hosp'l	Transfer to Hosp'l
Discharge from Service	Transfer to V. R. C.
Duty	Transportation

MICROFILM PUBLICATION M 1818

COMPILED MILITARY SERVICE RECORDS
OF VOLUNTEER UNION SOLDIERS WHO
SERVED WITH THE USCT (US COLORED TROOPS)
2ND REGIMENT OF CAVALRY

PERSONAL PAPERS' TARGET SHEET

PLEASE NOTE THE CHECKED INFORMATION ABOUT THE PERSONAL PAPERS IN
THIS FILE:

- NO PERSONAL PAPERS WERE FOUND IN THIS FILE WHEN THE
RECORDS WERE ARRANGED FOR MICROFILMING.
- 23 PERSONAL PAPER(S) FOUND IN THIS FILE WHEN THE RECORDS
WERE ARRANGED FOR MICROFILMING.

Headquarters

Military Division of the Gulf

New Orleans, La., January 8th 1866

Special Orders,

761.8.

The following named officers, having tendered their resignation on account of disability, are, upon the recommendation of their superior officers, honorably discharged the service of the United States.

They will receive no final payment until they shall have satisfied the Pay Department of their non-indebtedness to the Government.

Surgeon M. M. Marby, 2nd U. S. Colored Cavalry

By Command of

Major Genl. J. H. Sheridan,

Asst. Adjt. General

Official:

George Lee,

Asst. Adjt. Genl.

C. C. A.
13/12/13.

13337. M.R. 43 of 1865
Medical Certificate

in case of

Surg. M. M. Manly
2^d U. S. C. C.

Gen. S. Brazos Santiago Texas

By
Wm R. Ciska

Asst. Surg. 2^d U. S. C. C.

Dec. 19. 1865.

No. 12 - 3rd U. S. C. C.

Office T. M. O. 25th Dec
Brammerville Tex
December 22/65

Approved

E. P. Morong.
Surgeon U. S. Army
C. M. O. 25th Dec.

Surgeon W. M. Manly 2^d U. S. C. C. having
applied for a Certificate of Disability. I
certify that I have carefully examined this
officer and find him physically unable to
perform military duty, in consequence of a
gunshot wound received May 16th. 1864 in the
battle of Drury's Bluff Va.

A bullet entered the middle of the right thigh
and lodged in the femoral region. The ball
never having been extracted, renders it difficult
and painful for this officer to ride or walk
any great distance.

Dated at Brazos Santiago Texas
this 19th. day of December 1865.

Wm. B. Cisneros
Asst. Surg. 2^d U. S. C. C.

NOV 1940

Wagon 25th Army Corps
In the Field Texas & Okla

M. M. Manley
Surg

Leave of absence

Walter D. D.
Adj. Gen.

Granting leave of absence
for 8 days to Surg Manley
25th Army Corps

R. D. Hood 3rd Div
10th Aug 1940

Headquarters Twenty-fifth Army Corps,
In the field, Texas, ^{5th} Aug 1865.

Special Orders.

No 1972 (Abstract)

Leave of absence to go to New Orleans
is hereby granted to surgeon Wm. W. Mauls
2nd U.S. Cavalry for eight days

By order of Major General Hittjes

D. J. Wheeler

Adjutant

Success Mauls
The Co. 5th

1863
No 393
April 25

A. J. Cas
Camp Smith Amos

Special order
No 1

Ordering Engel
Mansley to proceed
to Norfolk

L. U. S. C. Co.

MAR 1946

Head Quarters, Cav. Brigade 5th Div.
Camp 2, Iloilo Sta. P. I. 1945.

Dear Sir,
No. 101

I am glad to hear that you M. M. Mumbo D.A.C.C.
will proceed to Iloilo in charge of your
troop command and return as soon as practicable.

#

Walter Mansow
1st Lt. U.S.A.
Cav. Brigade
Iloilo Sta. P. I.

By Order of Brig. Gen. ...
Commanding Cav. Brigade
5th Div.

NOV 18 1865

Adj. 2d. 2^d U.S. Col. Cav.
Clarksville Texas
July 31st 1865-

Manly, M. M.
Surg. 2^d U.S.C.

M. M. Manly
Surg. 2^d U.S.C.

Report of Duty-

Recd m. o. 25th a. l. Aug 2/65-

HEAD 1949

Hd. Qrs. 2^d U.S. Col^d Cavalry
Clarksville Texas, July 31st 1865

To Surg. W. Folsom
Act. Med. Director

25th A.C.

I have the honor to report
that I am on duty with 2^d U.S. Col^d Cav.
Stationed at Clarksville Texas

I am, Sir
Very Resp^l
Yours obt^d Servant
M. M. Mayly
Sergeon 2^d U.S.C.

NOV 1865

M. 5. 1. H. G. 1865

H. G. 2^d U.S. Cavalry
Clarksville, Texas July 31st 1865
M 118 - 25 - A

Mauley, W. W.
Surgeon 2^d U.S. Cavalry

Requests Leave of
Absence to visit New -
Orleans to accompany
his sick wife -

So 107 Aug 5



Received by 25th at Aug 6th 65
Recd by 119 31 18

H. G. 2^d U.S. Cavalry
Clarksville Texas Aug 1st 1865

Respectfully forwarded

Approved
J. P. D. [Signature]
Major 2^d U.S. Cavalry
Cavalry Regiment

H. G. Cav Brig 3^d 25th U.S.
Clarksville, Texas Aug 1st 1865

Respectfully forwarded
Approved

[Signature]
Brig. Genl
Cavalry Brigade
3^d U.S. Cavalry

WAR 9056
Adj. Gen 2^d Regt U.S. Cav. Cavalry.
Clarksville, Texas July 31st 1845.

Genl. Col. D. D. Wheeler.

Asst. Adjt. General.

25th Inf. Army Corps.

Sir:

I would respectfully request a Leave of Absence of (8) Eight days for the purpose of accompanying my wife, who is sick, to New Orleans.

Act. Asst. Surgeon W. S. Hamilton is present with the Regiment, who will care for the sick during my absence

Very Respectfully,

Your Obedient Servant

M. M. Manly
Surgeon 2^d U.S. Cavalry

NOV 1851

At. 2nd. U.S. Col. (Cavalry)
Camp near Pa. 1
May 31st 1851

Manley, M. M.
Surg. 2nd U.S. Col.

M. M. Manley
Surg. 2nd U.S. Col.

Wm. P. Cutler

Recd. M. M. Manley's papers

NOV 1852

Ad. Gen. J. W. Miller
Camp Sherman Va. Nov. 31st 1861

Dear Gen. P. Moran
Col. M. A. H. ...
25th Regt.

I have to honor to
put that I am complete
of the 25th Regt. U.S. Colored
Troops

I am, Sir
Very Resp^{tly}
Yours etc. Sincerely
W. W. Manly
Sergeant U.S.C.

Proceedings of a Commission
convened at H^o of 2^d U. S.
C. C. near Norfolk, Va.
February 3, 1855 -
044 (E. 10) 1875,
to the case of Langston
M. v. Mandy 2^o U. S. C. C.

J. G. Mason
ad. J. U. S. C. C.
President

J. L. Cheate
Capt. U. S. C. A. S.
Recorder

Head Quarters Dist. Court Va.
Norfolk, Va. March 21, 1855.
Approved.

G. A. Parker
Diry Seal (officially)

Recd Hd Qrs Dist Ct Va, Mar 21, 1855.

[Faint handwritten notes on the left margin]

1 1

Proceedings of a Commission convened at the
Head Quarters of the 5th U. S. Colored Cavalry near
Norfolk, Va. on the 13th March 1865. by virtue of
the following order, viz:

Head Quarters Dist. of Ea. Va.

Norfolk, Va. 10th March 1865-

Special Order

No. 51

Extract

I. ... A Commission to investigate the
case of Surgeon Wm. W. Manley 2^d U. S. C. Col. who
was overstaid his leave of absence, and to
determine whether or not he was absent
from proper cause, will assemble at the
Head Quarters of the Regiment on Monday the
13th inst at 10 o'clock A. M. or as soon thereafter
as practicable.

Detail for the Board

Col. J. Gerard, 1st U. S. C. Col.

Capt. W. Hoffman, 13th N. Y. Inf.

Capt. T. C. Choate, 3rd U. S. Cav.

The junior member will record the
proceedings of the Board.

By order of Brig. Genl. Geo. H. Moran
(Signed) Wickham Hoffman
A. A. G.

Head Quarters 2nd U.S.C.C.

Fair Greenas near Newford Va
March 13. 1865

The Board met pursuant to the above order
Present. Col. J. Gerrard, 1st U.S.C.C.

Capt. J. C. Choate, 2nd U.S.C.A. & S.

The Board then proceeded to investigate
the case of Surgeon M. W. Manley 2nd U.S.C.C.
who overstays his leave of absence and
find that he was absent from proper
courses.

Capt. Hoffman, having been absent at the meeting
of the Board was afterwards shown the proceedings and
papers connected therewith. and coincides with the
finding of the Board.

The Board having no further business before it
adjourned sine die

J. C. Choate
Capt. 2nd U.S.C.A. & S.
Recorder

Jeptha Garrard
Capt. 1st U.S.C.C.
Presdt. Board

Wickham Hoffman
Capt. 13th N.Y. Artly.

M. M. (E. Va) 1865
Hd. Qu. 2nd U.S. Col. Cav. March 8th 65

Manley M. M.
Surgeon 2nd U.S. C. Cav.

Requests that a Commission
be appointed, to determine
his absence without leave

1865
Hd. Quarters, Patch Defense
Patuxent, Va., March 9/65

Respy forwarded

W. G. A. S.
Pay Genl

S. O. No 51

Rec'd Hqs Dist Crv March 10, 65

Hd. Qu. 2nd U.S. Col. Cavalry
Ft. Mifflin March 8th 1865

Respectfully forwarded

Approved

Deane
Col. Comdg. Regt.

[Signature]

MAR 9 1865

Head Quarters 2nd U.S. Col. Cav.
near Norfolk Va March 8th 1865

Sir

I have the honor to request that a
Commission be appointed, to examine into the
reasons for my absence without leave, in order
that I may be restored to pay

I have the honor to be

Sir

Very Respectfully Your Obedt Servt.

M. M. Mauley

Surgeon 2nd U.S. Col. Cavalry

To

The Asst. Adjt. Genl.
Dept. Eastern Virginia

MAR 1873

Pay Department, U. S. A.,

January 9, 1865

✓ Paymaster of the 2^d Reg't US Col^d Cav

I have this day paid M M Manly Surgeon
Co. _____, \$ 632.82, in full from Sept 1 1864
to Dec^r 31 1864

Geo Ammon Riché
Paymaster U. S. A.

NOV 19 1866

335

In the field before Richmond
Dec 21 1866

M. M. Manly
Surgeon & Surgeon
in service

Monthly Report
of Service

NOV 1864

Headquarters U.S. Army in the field Dec 31 1864

Charles Mc Cormick
Surgeon U.S.A. Med. Director Dept.

I have the honor
to report myself on duty with my
Regt. in the field before Richmond 1st Div 2500
Very Respectfully
Your Obedt Servt
Surgeon 2nd Div 2500

Ms. A. 9. 2. 11
1864
H. A. 3rd U. S. Artillery
Surgeons Office Dec 9, 1864

Surgeon W. M. Mauley 2^d U. S. Artillery having applied to me for a certificate on which to ground an application for leave of absence, I do hereby certify that I have examined this officer, and find that he is suffering from the effects of Intermittent Fever of a serious and persistent type, and that without a change of climate he will in my opinion become permanently disabled; and that he is unfitted thereby for duty in the field; and I further declare my belief that he will not be fit to resume his duties in a less period than thirty days.

Clark Johnston
Surgeon 3rd U. S. Artillery.

1890

M. M. Manley
Aug 2 1890

1864

H. G. M. & C. in the Interest of

Charles McCombe
Surgeon U.S.A. Medical Dept

I have the honor
to report that I was on duty with
my Regt on the 21 of Oct 1864 I regret
that I am unable to furnish a proper
reason for neglect to report at that
time Perhaps the fact that I was at
that time & have been ^{sick} sick in my tent (although
I have constantly held sick call at my head) may
be offered in extenuation for the neglect

As it is the first omission of that duty
in my case I would ask you for
indulgence

I am very Respectfully
M. M. Menely
Surgeon U.S.A.

NOV 1964

M. 1046. MDO Dognob. fld 2nd July 1964

Form of Certificate for Sick Leave, and Absence on account of Sickness.

Surg M. Manley of the 2nd Regiment of U.S. Cav
having applied for a Certificate of absence on account of sickness

I do hereby certify that I have carefully examined this officer, and find that he has a

gun shot wound of the thigh received at Fort Darling

and that in consequence thereof, he is, in my opinion, unfit for duty, and not able to travel.

I further declare my belief that he will not be able to resume his duties in a less period than

Thirty (30) days

Dated at Philadelphia, this 24th day of June, 1864.

Wm. C. Capps
Surgeon
U.S.A. Med. Dir.

Geo. Hensley
Surg of the Post

NOTE.—Regimental Surgeons, or Assistant Surgeons, absent from their commands, and Surgeons of Boards of Enrollment, have no authority to furnish this Certificate. The same rule applies to other medical officers, except they are on duty with troops or in charge of United States hospitals. Certificates of medical officers not in the United States military service, must in all cases be sworn to.

MAR 29 1866

Philadelphia Penn
June 24th '64

Manly W. W.
Surf. 2^d U. S. Exp.

Reports with extension
of leave of absence

MAR 1867

Philadelphia June 24 1864

S. W. Cole
Col 2^d Regt

Sir I have the
honor to forward certificate
of extension of sick leave granted
May 31 1864

Very Respectfully
M. M. McCarty
Surgeon 2^d Regt
Residence 737 Chestnut St
Philadelphia

Dear Col

I am sorry to report that I am
not improving as fast as I had hoped
my wound is still fully discharging &
I am very lame with a dead
heavy feeling in my leg all the time
still I expect to report myself to you
in person at the expiration of this leave
Yr obt Servt
M. M. McCarty

Surg. M. M. Manly
2^d U. S. Col. Cal.

Extension of leave of
absence on Surg.
Certificate

NOV 18 1864

Form of Certificate for Sick Leave, and Absence on account of Sickness.

Surg. M. Mauley of the 2nd Regiment of U. S. Cav.

having applied for a Certificate of absence on account of Accidents

I do hereby certify that I have carefully examined this officer, and find that he has a

Gun shot wound of the thigh, received at Fort Darling.

and that in consequence thereof, he is, in my opinion, unfit for duty and not able to travel.

I further declare my belief that he will not be able to resume his duties in a less period than

Thirty (30) days

Dated at Pulaski, this 24th day of June, 1864.

Approved
Wm C. ...
Surg. U.S.A. Med. Dir.

Wm. Hensley U.S.A.
Surg of the Post.

NOTE.—Regimental Surgeons, or Assistant Surgeons, absent from their commands, and Surgeons of Boards of Enrollment, have no authority to furnish this Certificate. The same rule applies to other medical officers, except they are on duty with troops or in charge of United States hospitals. Certificates of medical officers not in the United States military service, must in all cases be sworn to.

Head Qrs Dept of Va & M.
For's Account the May 31 64

Special Order
No 150

Grants Leave of Absence to
Surgeon Wm. L. Col
Cavalry for 20 days

Head Qrs Dept of Va W.C.
Fort Monroe Va
May 31st 1864

Special Orders }
No 150 } (Extract)

III Leaves of absence to govt of the Dept
are here by granted to the following named officers
Surgn M. Maudy 2nd US Col. Corley for 20 days
on Surgeons Certificate of Disability

By command of Maj Genl Butler
A. J. Schowder
S Col & a. g.

Mr. G. 1864
M. - 95 - 1864

Normand Dist. 160 pl.
Pt. Lookout Md. May 19. 64
Surgeon M. M. Manly
2nd U.S. Cold Cavalry

application for leave of absence

May 29. 64

Respectfully forwarded
Approved.
Surgeon Manly, has been wounded
before Fort Harting, by a gunshot
flesh wound in the thigh, - is able
to bear transportation, and will
not be fit for duty in 20 days.

A. Weyer
Surgeon U.S.A.
in charge Dist. 160 pl.

M.D.C. Dept. Va & N.C.
Fort Monroe Va 30 May 1864

Respectfully forwarded,
Approved

E. M. Hill

Asst. Surg. U.S.A.
Asst. Med. Dir



S.O. 150. Par III S. 1864

Pro M.D.C. Dept Va & N.C. 30 May 1864

W. M. Manly
Surgeon 2. U.S. Cavalry

[Faint handwritten signature]

NOV 19 1864
No. 100 General Hospital -
Point Lookout Md. May 19th 1864.

Surgeon.

I have the honor to respectfully -
apply for a leave of absence of 60. sixty days -
to return to my home in Philadelphia - I was -
wounded in the right thigh May 16th 1864. near -
Port Darling. Va. and will not be fit for duty
sooner than the specified time

Very Respectfully
Your obedient Servant.

M. M. Manly
Surgeon
2nd U. S. Col. Cavalry -

Lo.

Surgeon A. Heger U. S. A.
In charge. General Hospital.

M. M. Hurley
Asst. Surg. 2^d U. S. C. Cav.



Head Quarters Dept. of Virginia and North Carolina,

Fort Monroe, Va. Dec. 27th 1863

SPECIAL ORDERS,

No. 160

V.

EXTRACT.

The following Appointments are hereby made in the 2d Regiment United States Colored Cavalry, subject to the approval of the President of the United States:

Asst. Surgeon Manly 1st U.S. C.C. to be
Surgeon



By Command of Major General BUTLER.

R. P. Davis

Assistant Adjutant General.

To Adjut. Genl.
U.S.A.

NOV 18 1863

Hel. Des Dept. of War
Genl. Monro at Dec 27th 1863

Special Orders
No. 460

Dr. Marcus M. Mansley
to be 2nd. Asst. Surgeon
1st U.S.C.

Head Quarters Dept. of Virginia and North Carolina,

Fort Monroe, Va.

Dec. 27th

1863

SPECIAL ORDERS,

No. 160

III

EXTRACT.

The following Appointments are hereby made in the 1st United States Colored Cavalry subject to the approval of the President of the United States.

So Marcus M. Mauldy to be 2^d Lt. Surgeon

By Command of Major General BUTLER:

P. P. Davis

Assistant Adjutant General.

To Mr Mauldy

M. 303. ✓ 1864.

Philadelphia
June 24. 1864.

Surg. M. M. Manly
U. S. A. C.

Forwarded certificate
of extension of sick
leave granted in
Special Order 130
of May 31. 1864.

One Enclosure

Adas. Dept. V & M. C.
In the field June 29. 64.
Respectfully referred to
Surg. M. M. Manly
Director.

By Command of
Major Butler
St. John
L. P. M. M. Manly

M. D. O. Dept. V & M. C.
In the field 25 July 64

Respectfully returned to Dept. V & M. C.
Surg. Approved
Chas. M. Forman
Surgeon Major
Med. Dir. Dept.

file

Recd. M. D. O. Dept. V & M. C. after 2 July 64

M. M. Manly
Surg. & M. C.



Philadelphia June 24th 1864

Sir I have the honor to
forward herewith certificate
for sick leave or extension of
sick leave granted in Special
Order no 152 of May 31 1864

Very Respectfully

M M Manly
Surgeon ^{USA} 2866

Residence 737 Oxford St
Philadelphia

To Assistant Adjutant General
Dept of Virginia & N.C.

Head Quarters 2^d U.S. Artillery
Brazos Santiago Nov Dec 19th 1865

337 M. 182.
M. 36 U.S.A.

M - 12 - 3rd Div. 25th A.C.
Nancy M
Surgeon 2^d U.S. Artillery

Tender his resignation
in account of disability
pursuant to the Recommen-
dation of Maj Gen Shiras
-des
See Letter to Senator
of Dec 11th 1865 relative
to travelling allowances
and refusing the same.
S.W.A.

Recd 1866 Jan 19 1866
Recd. 2^d U.S. Artillery 2^d Div. 25th A.C.

Head Quarters 3rd U.S. Col. Cav.
Brazos de Santiago, Texas.
December 19th 1865.

Approved, and respectfully
forwarded.

Frank D. Herr
Major
Cohort Regt.

M. 51. 13. 15. 05 1865
Head Quarters 1st Brig. 3rd Div. 25th A.C.
Brazos Santiago, Texas.
December 20th 1865

Respectfully forwarded
approved.

Drank White
Lt Col 2^d U.S. S. Cav.
Commandy Brig
Notice
Def

Head Quarters 3rd Div. 25th A.C.
Brazos Santiago, Texas.
December 1865

Respectfully forwarded
approved

Geo W Cole
Post Surg. Genl.
Army.

Head Quarters 25th Army Corps
Lutherfield Texas Dec 21st
M. 87. 13. 25th A.C.

Respectfully referred to
sup. Army chf. Medical
Officer 25th A.C.

By order of Major Medical
D. Decker
in duty

Offg. Chf. S. O. 25th
Brownsville Tex.
December 22/65

Respectfully returned
"approved"
E. P. Morong.

Surgeon & Gravel
C. S. O. 25th.

Med. Dir. 25th Army Corp
In the field Texas Dec 23/65

Respectfully forwarded
Approved

G. Witzel
Maj Gen
Kearney

111

Head Quarters,
Dist: Rio Grande,
Brownsville, Texas,
Dec 24, 1865.

H. 555.
Respectfully forwarded
Approved

G. Witzel
Maj Gen
Kearney

Head Quarters, Department of Texas
Medical Director's Office
Galveston Texas, January 3rd 1866.

Approved

Allen J. Tolson

Dr. & Colonel & Surgeon U.S.A.
U.S. Medical Director.

MAR 1862

Hd. Qu. report of Texas-
Galveston Jan. 4. 1866
Respectfully forwarded
approved.

by H. G. Wright
Maj. Gen. Comdg
C. B. Smith

Headquarters, Military Division of the Gulf.
New Orleans, La., Jan. 9th 1866.

SPECIAL ORDER,

No. 8 Extract 3rd
date January 8th 1866.

Respectfully forwarded to the Ad-
jutant General of the Army Accepted.
M. D. Sheridan
Major General Commanding.

Reg.
Genl

1863
1864
1865
1866
1867
1868
1869
1870
1871
1872
1873
1874
1875
1876
1877
1878
1879
1880
1881
1882
1883
1884
1885
1886
1887
1888
1889
1890
1891
1892
1893
1894
1895
1896
1897
1898
1899
1900

M^{rs} Genl 2^d W. S. C. C. C. C.
Bradford Santiago Two Dec 19 1865

George S. S. S.
Major Asst Adj^t Genl.
Military Div of the Chief
New Orleans La

Major I have the honor
to tender my resignation as Surgeon 2^d W. S. C. C. C.
on Surgeon's Certificate of Disability pursuant
to the Recommendation of Maj Genl. Sheridan
Endowment Book P. R. B. W. 19 C. B. 205 N^o
Genl. Military Div of the Chief New Orleans La Nov 4 1865
I was last paid by Major Quincy to Sept 30 1865
I am not responsible for any Government property
which I am not ready to turn over or property
account for.

Very Respectfully
Your Obedt Servant
M. M. Maule
Surgeon 2^d W. S. C. C. C.

M. G. (C. 2, 118) 1864
M. G. (C. 2, 118) 1864

Hd. Qu. 2^d U.S.C. Cav. Dec 20th 64
Manly M. M.
Surgeon 2^d U.S.C. Cav.

Requests leave of absence
for thirty days per Surgeon's
Certificate of disability

One 1/2 enclosure

Hd. Qu. 2^d U.S. Cavalry
In the Field Va. Dec. 20th 64

Respectfully forwarded
Approved
Edw. T. Milroy
Capt. 2^d U.S.C. Cav
Comdg. Regt.

E. 13th No 1412 1860
Head Quarters 3rd Div 25th Ab.
In the Field Va. Dec 21st 1864

Respectfully referred to Surg.
Hall Davis, Surgeon in Chief
8th Div 25th Army Corps.

By Order of Brig. Genl. A. G. Dwyer
H. W. Allen
1st Lieut 36th U.S. I. I.
A. A. A. Genl

Approved and respectfully
transmitted
Hall Davis
Surgeon in Chief 3rd Div 25th Ab.

In the Field 2^d U.S. Cav. Dec 21st 64

Hd. Qu. 3^d Div 25th Ab.
In the Field Va. Dec. 22, 1864.

Respectfully forwarded
Approved
A. G. Dwyer
Brig. Gen. Comdg.

Head Quarters 25th Ab.
In the field Va Dec 22 1864
(L A B 86)

Respectfully referred to Surg
J. N. West acting Medical
Director 25th Ab.

By order of Brig Genl. H. H. Henshaw
J. N. West
Acting



Medical Director's Office
25th Army Corps
Smith Field Va. December 25/64
No. 870
Respectfully returned
Approved for twenty (20)
days after personal examination
W. Beest.
Sur. in U.S.A.
Acty in U.S.A. Div. 25th

MO 193 fild (MOO) 1864

Std. In. Dept. Vol. 116
A. J. J. James
Smithfield, Dec. 25/64
Respectfully referred
to the Medical Director
By Command of
Maj. Genl. Ord.
H. B. Scott

At Quantico 25th A.C.
In the field Va Dec 27 1864
L.A.B. 86
Respectfully forwarded
app
O. A. Heisterman
Brig. Genl.

MOO. Dept Va and MO
In the field Va 2nd Jan 1865
Respl. not app.
Ch. Buckley
Sur. Vol
A.M.D.

Jan 2 1865
Recd. MOO. A. of J. Dec. 29 1864



1895

M. M. Manly,
Surgeon 2. U.S. Cav.

Head Quarters U.S. Col. Before Richmond Dec 21 1864

Sir
I have the honor to request a leave of absence for thirty days to visit my home in Philadelphia Pa and recover my health which is now very bad. For the last three months I have for about one third of the time been unable to sit up on account of intermittent fever and debility from miasmatic causes. My system is peculiarly susceptible ^{to} malaria, so that an omission of a large dose of Quinine for a day will be followed by a recurrence of the fever I believe that if I do not have a respite from this climate I shall become permanently disabled. Since the organization of this Regt (except when wounded) I have never been out of camp or neglected a sick call for a day although I have frequently held sick call at my bed when unable to sit up. Hoping my request will meet your approbation

I am Dear Respectfully
M M Mearns
Surgeon 2d USCC

Capt I. R. Dealy
a. a. g.

1004

Markham Edwin C.

Co ~~9~~ ~~CD~~, 2 U. S. Col'd Cav.

2d Lieutenant / Lieutenant

CARD NUMBERS.

1	53 / 5344	26
2	5324669	27
3	5324760	28
4	5324851	29
5	5324940	30
6	5325032	31
7	5325122	32
8	53 / 6676	33
9	5325209	34
10	5325297	35
11	5325395	36
12	5325574	37
13	53 / 6856	38
14	53 / 5345	39
15	5320621	40
16	5320798	41
17	53 / 9444	42
18	53 / 9539	43
19	5320967	44
20	5325803	45
21	53 / 9627	46
22	40726337	47
23		48
24		49
25		50

Book Mark:

See also 3d N. Y. Cav.

M 1960, U.S.C.T.

Edwin C. Markham

2nd Lt., Co., 2nd Reg't U. S. Col'd. Crty.

Age 17 years.

Appears on an

Individual Muster-in Roll

of the organization named above. Roll dated
Fort. Moultrie, Va., Feb. 26, 1864.

Muster-in to date Feb. 20, 1864.

Joined for duty and enrolled:

When Feb. 20, 1864.

Where Fort. Moultrie, Va.

Period 3 years.

Valuation of horse, \$ 100

Valuation of horse equipments, \$ 100

Remarks: Promoted from Surg.
3rd N. Y. Cav. to 2nd Lieut.
2nd Reg't N. Y. Cav. vice
Ensign B. Wood promoted

Book mark:

C. R. Allen

MAR 1899

M | **2 Cav.** | **U.S.C.T.**

Edwin C. Markham

224, Co. G, 2 Reg't U. S. Col'd Cavalry.

Appears on

Company Muster Roll

for dated Feb 29, 1864.

Present or absent Present

Stoppage, \$.....100 for

Due Gov't, \$.....100 for

Valuation of horse, \$.....100

Valuation of horse equipments, \$.....100

Remarks:

Book mark:

J. M. Harmon

M | 2 Cav. | U.S.C.T.

Edwin C Markham
2nd, Co. G, 2 Reg't U.S. Col'd Cavalry.

Appears on

Company Muster Roll

for Mar & Apr, 1864

Present or absent Present

Stoppage, \$ 100 for

Due Gov't, \$ 100 for

Valuation of horse, \$ 100

Valuation of horse equipments, \$ 100

Remarks:

Book mark:

J. W. Harmon

M | 2 Cav. | U.S.C.T.

Edwin O Markham

2 Lt., Co. G, 2 Reg't U. S. Col'd Cavalry.

Appears on

Company Muster Roll

for May & June, 1864

Present or absent Present

Stoppage, \$ 100 for

Due Gov't, \$ 100 for

Valuation of horse, \$ 100

Valuation of horse equipments, \$ 100

Remarks:

Book mark:

J. M. Harmon

W | **2 Cav.** | **U.S.C.T.**

Edwin L. Marsham

2^d Lt., Co. G, 2 Reg't U. S. Col'd Cavalry.

Appears on

Company Muster Roll

for *July + Aug*, 186*4*.

Present or absent *present*

Stoppage, \$ *100* for

Due Gov't, \$ *100* for

Valuation of horse, \$ *100*

Valuation of horse equipments, \$ *100*

Remarks:

Book mark:

(358) *J. P. Brown* Copyist

M

2 Cav. U.S.C.T.

Edwin C. Markham

2^d Lt., Co. G, 2 Reg't U.S. Col'd Cavalry.

Appears on

Company Muster Roll

for *Sept + Oct*, 1864.

Present or absent *present*

Stoppage, \$ *100* for

Due Gov't, \$ *100* for

Valuation of horse, \$ *100*

Valuation of horse equipments, \$ *100*

Remarks: *Temporarily assigned to be to Sept 14/64, by letter from Reg. 16th Dis.*

Book mark:

J. Brown

M

2 Cav.

U.S.C.T.

Edward Markham

L.H., Co. G, 2 Reg't U. S. Col'd Cavalry.

Appears on

Company Muster Roll

for *Nov & Dec*, 1864.

Present or absent *Not stated*

Stoppage, \$ 100 for

Due Gov't, \$ 100 for

Valuation of horse, \$ 100

Valuation of horse equipments, \$ 100

Remarks:

Book mark: *129 64*

J.P. Brown
Copyist.

M | 2 Cav. | U.S.C.T.

Edwin C. Markham

2nd Lt, Co. G, 2 Reg't U. S. Col'd Cavalry

Appears on a

Detachment Muster Roll

of the organization named above

for Nov & Dec, 1864.

Station Field before Richmond Va

Present or absent Present

Stoppage, \$ 100 for

Due Gov't, \$ 100 for

Valuation of horse, \$ 100

Valuation of horse equipments, \$ 100

Remarks:

Book mark:

W. D. L.

M

2 Cav. U.S.C.T.

E. C. Markham

E. S., Co. G, 2 Reg't U. S. Col'd Cavalry.

Appears on

Company Muster Roll

for *Jan'y & Feb'y*, 1865.

Present or absent *present*

Stoppage, \$ 100 for

Due Gov't, \$ 100 for

Valuation of horse, \$ 100

Valuation of horse equipments, \$ 100

Remarks:

Book mark:

J. Brown

i | **2 Cav.** | **U.S.C.T.**

Edwin C. Markham

2^d Lieut., Co. G, 2 Reg't U. S. Col'd Cavalry.

Appears on

Company Muster Roll

for *March + April*, 186*5*.

Present or absent *Absent*

Stoppage, \$ *100* for

Due Gov't, \$ *100* for

Valuation of horse, \$ *100*

Valuation of horse equipments, \$ *100*

Remarks: *With Regt. at Norfolk as per instructions from Reg't Com- mander.*

Book mark: *;*

(358) *J. C. Chapin* Copyist.

M | 2 Cav | US 67

Edwin C Markham
2 H. Co. G 2 Reg US 66

Return

of the Post of Newport News, Va.,

for the month of April, 1865,

dated Apr 30, 1865,

shows the following with regard to the person
named above:

Post or station

Remarks: Absent on detached
duty examining passes on
Indian Pole Bridge as per
instruction from Hdqrs 2
US 66

Book mark:

(600)

W. H. Crosby
Copyist.

M | **2 Cav.** | **U.S.C.T.**

Edwin C. Markham

L L, Co. G, 2 Reg't U. S. Col'd Cavalry.

Appears on

Company Muster Roll

for *May + June*, 186*5*.

Present or absent *present*

Stoppage, \$ *100* for

Due Gov't, \$ *100* for

Valuation of horse, \$ *100*

Valuation of horse equipments, \$ *100*

Remarks:

Book mark: -----

T. T. T. T.

Mr. *I Cav.* U.S.C.T.

Edwin C. Markham

2d, Co., *2* Reg't U. S. Col'd *Cav.*

Appears on an

Individual Muster-out Roll

of the organization named above. Roll dated

Mazos, Sauting, Tex., *July 6*, 186*5*.

Muster-out to date *July 5*, 186*5*.

Last paid to *Apr. 30*, 186*5*.

Clothing account:

Last settled 186 ; drawn since \$..... 100

Due soldier \$..... 100; due U. S. \$..... 100

Am't for cloth'g in kind or money adv'd \$..... 100

Due U. S. for arms, equipments, &c., \$..... 100

Bounty paid \$..... 100 due \$..... 100

Remarks: *Promoted.*

Book mark:

J. J. Smith

M | 2 Cav, | U.S.C.T.

Edwin C Markham

1st Lt., Co., 2nd Reg't U. S. Col'd Cavalry

Age 20 years.

Appears on an

Individual Muster-in Roll

of the organization named above. Roll dated

Bravo Santiago, Tex., July 6th, 1863.

Muster-in to date July 6, 1863.

Joined for duty and enrolled:

When July 6, 1863.

Where Bravo Santiago, Texas, unexpired term

Period the Regt. years.

Valuation of horse, \$ 100

Valuation of horse equipments, \$ 100

Remarks: Promoted from 2nd Lieut-vice Hughes, promoted.

Book mark:

A. Oliver,

MAR 9 1903

M | 2 Cav. | U.S.C.T.

Edwin C. Marsham

2 Lt., Co. G, 2 Reg't U.S. Col'd Cavalry.

Appears on

Company Muster Roll

for July-Aug., 1865.

Present or absent

Stoppage, \$ 100 for

Due Gov't, \$ 100 for

Valuation of horse, \$ 100

Valuation of horse equipments, \$ 100

Remarks: Transferred to Co. C, 2^d U.S. Col'd Cav. by promotion

Book mark:

Trueton

M | **2 Cav.** | **U.S.C.T.**

E. C. Markham

1st Lieut., Co. C, 2 Reg't U. S. Col'd Cavalry.

Appears on

Company Muster Roll

for *July & August*, 1865.

Present or absent *P Absent*

Stoppage, \$ *100* for

Due Gov't, \$ *100* for

Valuation of horse, \$ *100*

Valuation of horse equipments, \$ *100*

Remarks: *Promoted from 2^d Lt. Co. G, per D. O. dated July 10/65. Absent with leave.*

Book mark:

J. L. Harris

MAR 19 1865

M | 2 Cav. | U.S.C.T.

C. B. Markham

1st Lt., Co. B. 2 Reg't U. S. Col'd Cavalry.

Appears on

Company Muster Roll

for Sept & Oct, 1865.

Present or absent Absent

Stoppage, \$ 100 for

Due Gov't, \$ 100 for

Valuation of horse, \$ 100

Valuation of horse equipments, \$ 100

Remarks: Transferred from Co. C. per S. O. No. 67, Hd. Qrs. 2d U. S. C. C. Absent on leave of absence since Aug 15, 1865.

Book mark:

M. Harrison

M | **2 Cav.** | **U.S.C.T.**

E. C. Markham

1 Lt., Co. C, 2 Reg't U. S. Col'd Cavalry.

Appears on

Company Muster Roll

for *Sept & Oct*, 1865.

Present or absent

Stoppage, \$ 100 for

Due Gov't, \$ 100 for

Valuation of horse, \$ 100

Valuation of horse equipments, \$ 100

Remarks: *Transferred to Co. B
2 U.S. Col. per S.O. No. 67.*

Book mark:

G. W. Chase

NOV 19 1867

M | **2 Cav.** | **U.S.C.T.**

E. C. Markham

1st St., Co. B. 2 Reg't U. S. Col'd Cavalry.

Appears on

Company Muster Roll

for *Nov. & Dec*, 186*5*.

Present or absent *Present*

Stoppage, \$ *100* for

Due Gov't, \$ *100* for

Valuation of horse, \$ *100*

Valuation of horse equipments, \$ *100*

Remarks: *Acting Regt
Qtr. Master.*

Book mark:

H. Harrison

M | 2 Cav. | U.S.C.T.

Edwin C Markham

2 Lt, Co. G, 2 Reg't U. S. Colored Cav.
1 Lt, Co. B

Appears on Returns as follows:

Feb to Nov 1864 Present

(Signs returns of Co C for Sept & Oct 1864 as Comdg Co)

Dec 1864 Absent Duty

with Pro Guard

25th Co Hd Qrs

Jan 1865 Present

(Signs Ret Comdg Co)

Feb 1865 Present

Mar 1865 Present on

Spec duty at

Indian Pole Bridge

April 1865 Absent Detchd

as per letter of in-

structions from

Regt Hd Qrs

May 1865 Present

June 1865 Present on

Spec duty Comdg

Co D. Signs

own

Book mark:

(A. J. G. G. G. G. G.)

NOV 1909

JAN. 18

40726337

1899

Return, Co War
Comdg Co)

July 1865 Transf'd
to Co C 2^d U.S.C. for
for S.O. - dated H'd
2^d U.S.C. July 65

July 1865 (1st Co C) Present
Resigned to Co C July
10 by S.O. - from H'd
2^d U.S.C. (Signs
Return Comdg Co)

Aug + Sept 1865 Absent
on leave of absence
for S.O. 384 1863 War Dept

Oct 1865 Loss Oct 14, 65 Transf'd
to Co B 2 U.S.C. for S.O.
67 date Reg'd H'd 2^d U.S.C.

Oct + 1865 (Co B) Absent with
leave since Aug 15, 65

Nov 1865 Present Comdg Co
+ Act Reg'l M. (temporarily)

Dec 1865 + Jan 1866 Pres-
ent on Special duty
as Reg'l 2. M.

M | 2 Cav. | U.S.C.T.

Edwin C. Markham

2) Lieut, Co. G, 2 Reg't U. S. Col'd Cavalry.

Appears on Co. Muster-out Roll, dated

Brazos Santiago Tex, Feb 12, 1866.

Muster-out to date _____, 186 .

Last paid to _____, 186 .

Clothing account:

Last settled _____, 186 ; drawn since \$ _____ 100

Due soldier \$ _____ 100; due U. S. \$ _____ 100

Am't for cloth'g in kind or money adv'd \$ _____ 100

Due U. S. for arms, equipments, &c., \$ _____ 100

Bounty paid \$ _____ 100; due \$ _____ 100

Remarks: Promoted & mustered
as 1st Lieut 1st Co.
2d U.S. Cav., July 6/65

Book mark: _____

C. M. Laughlin

(361)

Copyist.

M | **2 Cav.** | **U.S.C.T.**

Edwin C. Markham
1 Lt., Co. C, 2 Reg't U. S. Col'd Cavalry.

Appears on **Co. Muster-out Roll**, dated
Brazos Santiago, Tex, Feb 12, 1866.

Muster-out to date -----, 186 .

Last paid to -----, 186 .

Clothing account:

Last settled -----, 186 ; drawn since \$ ----- 100

Due soldier \$ ----- 100; due U. S. \$ ----- 100

Am't for cloth'g in kind or money adv'd \$ ----- 100

Due U. S. for arms, equipments, &c., \$ ----- 100

Bounty paid \$ ----- 100; due \$ ----- 100

Remarks: *Was Sgt. 3 N. Y. Cav.*
till Feb. 20/64. Joined and
mustered as 2 Lt. 2 U. S. C. Cav.
Feb. 29/64. Was 2 Lt. till July 6
/65, was assigned to Co. C same
Regt. July 6/65. Transferred
to Co. B same Regt. Oct. 11/65.

Book mark : -----

G. W. Chase

M | **2 Cav.** | **U.S.C.T.**

Edwin C. Markham

1st Lt., Co. *B*, 2 Reg't U. S. Col'd Cavalry.

Appears on **Co. Muster-out Roll**, dated
Brazos Santiago Tex, Feb. 12, 1866.

Muster-out to date *Feb. 12, 1866.*

Last paid to *July 31, 1865.*

Clothing account:

Last settled....., 186 ; drawn since \$.....100

Due soldier \$.....100; due U. S. \$.....100

Am't for cloth'g in kind or money adv'd \$.....100

Due U. S. for arms, equipments, &c., \$.....100

Bounty paid \$.....100; due \$.....100

Remarks: *Originally entered service as private in 3^d N. Y. Cav. at Elmira, N. Y., Aug. 12/61. Disch'd Feb. 20, '64. Promoted 2^d Lieut. in 2^d U. S. Col. and mustered in Feb. 21, '64. Promoted and mus-*

Book mark: *(Over)*

W. Harrison

JAN. - 7

5319627

☆ 1687 ☆

tered in as 1st Lieut July
6 '65. Has filed certifi-
cates of non-indebtedness
and an affidavit that he
has made all returns and
reports required of him.
Discharge with two addi-
tional pay rolls given (to
facilitate payment) with
a view to final payment
without returning to the
State.

Markham, E E
Lt Col 2nd Reg't M. S. C. Cav.
7

Enclosures.

Bed Cards	Final Statements
Burial Records	Furloughs or L. of A. /
Certs. of Dis. for Discharge	Med. Certificates
C. M. Charges	Med. Des. Lists
Descriptive Lists	Orders 3
Discharge Certificates	Pris. of War Record
Enlistment Papers	Resignations

Other papers relating to—

Admission to Hosp'l	Furlough or L. of A. /
Casualty Sheet	Med. Examination
Confinement	Misc. Information
Contracts	Pay or Clothing /
Death or Effects	Personal Reports
Desertion	Rank /
Discharge from Hosp'l	Transfer to Hosp'l
Discharge from Service /	Transfer to V. R. C.
Duty	Transportation

MICROFILM PUBLICATION M 1818

COMPILED MILITARY SERVICE RECORDS
OF VOLUNTEER UNION SOLDIERS WHO
SERVED WITH THE USCT (US COLORED TROOPS)
2ND REGIMENT OF CAVALRY

PERSONAL PAPERS' TARGET SHEET

PLEASE NOTE THE CHECKED INFORMATION ABOUT THE PERSONAL PAPERS IN
THIS FILE:

NO PERSONAL PAPERS WERE FOUND IN THIS FILE WHEN THE
RECORDS WERE ARRANGED FOR MICROFILMING.

9 PERSONAL PAPER(S) FOUND IN THIS FILE WHEN THE RECORDS
WERE ARRANGED FOR MICROFILMING.

C. 240. 3rd Division 18th ab. 1864
C-310 (18th Army Corps) 1864

Hd. Qu. 2nd U.S. Cav. Nov. 27th 1864

Colo George H.

ad Comdg.

Requests the promotion of
2nd Lieut Edwin C. Markham
vice Lieut A. J. Smith promoted
Capt.

2 U.S. Cav.

file

Nov 29 1864

Nov 29 1864



Recd Hd. Qu. 2nd U.S. Cav. Nov 29 1864

Recd Hd. Qu. 3rd Div. 18th ab. Nov 27 1864

"

Head Quarters 3rd Div. 18th a. b.
In the field Va. Nov. 28 1864

Respectfully forwarded

Approved

C. J. Paul
Brig Genl.
Comdg.

Head Quarters 18th Army Corps
In the field Va. Nov 29 1864

Respectfully forwarded

Approved

J. Wetzell
Maj Genl Comdg.

acknowledges herein

Ms. A. 9. 17

Head Quarters 2nd U.S. Cav. Cavalry
In the Field Va Nov. 27th 1864

Sir

I have the honor to request that 2nd Lieut.
Edwin C. Markham may be promoted 1st Lieut vice
1st Lieut A. J. Smith promoted. Capt. Keo is senior 2nd Lieut
and has served honorably since the organization of the regiment

I have the honor to be

Sir

Very Resp^{ly} Your Obedt Servant

Geo. Meade

Col. Comdg. 2nd U.S. Cav.

Capt. J. B. Sealy
A. A. Genl. Dept. Va & N.C.

100 to 200

Order

NARA 929
DAILY TRIBUNE

Railroad, Commercial, and General Printing Office,

*Approved
Reference*
Chicago, July 18 1865

My Dear Sir:

I beg leave to
request a ~~pass~~ leave of
absence for

Lieut E. C. Markham

Co 4. 2^d U. S. Colored Cavalry

25th Army Corps

now at Brownsville, Texas.

Lieut Markham's mother
is sick - not expected to recover
- and she wishes to see her
son again. The request seems
not unreasonable, & if you can
consistently accede to it you
will confer upon me as well
as herself a very great favor.
The distance to Brownsville, Tex-
as is so great that a leave
of absence for Lieut Markham,
to be of any service to him,

should be not less than
60 days from its date, as
more than half of that time
will consume in the trans-
mission of the beam & in his
travelling to & from his home

Very Sincerely
Your friend
Horace White

For Edwin M. Stanton, }
Secretary of War. }

Mem^a
Col Foster -
I have framed
the Mem^a for S. B.,
and the order will
be sent you
July 20 Truly
and

M. 53. 1074 B. 1865

Chicago, Ill.

July 18th 1865.

Thomas White

Requests leave of absence
of sixty days for service
E. E. Markham's 2nd U.S.
Colo. Cav.

Approved by the Secy of War

Note: Order of
no 384 of July
20th 1865 ago

Recd 290 July 21. 1865

NARA 1923

Pay Department, United States Army.

New-Orleans, 21st August 1865.

Paymaster of the 2nd Regiment U. S. C. Cavalry

I have this day paid 1st Lt. C. Markham

Company "C" \$442.12, in full from 1 May 1865,

to 31 July 1865.

O. J. Toney,
Paymaster United States Army.

Northham E. G.
Lt 2. U. S. Colored Cav.

U.S. C. Y.

WAR DEPARTMENT,
ADJUTANT GENERAL'S OFFICE,
Washington, July 20th, 1865.

SPECIAL ORDERS, }
No. 384. }

(Extract.)

* * * * *

1. Leave of absence is hereby granted the following officers:—
Lieutenant *E. C. Markham*, 2d U. S. Colored Cavalry, for sixty days.

* * * * *

By order of the Secretary of War:

E. D. TOWNSEND,
Assistant Adjutant General.

OFFICIAL:

Assistant Adjutant General.

Colonel Vincent G.

NOV 1925

War Department
Adjutant General's Office
Washington July 20/15

E. S. Markham

Lt

Leaves absence

Special Order
no 5884

Granting leave of absence
to Lieut E. S. Markham
for 60 days

War Department
Adjutant General's Office
Washington July 20 1864

Special Order }
No 384 } Extract

1. Leave of absence is hereby granted the following
Officers:—
Lieutenant C. C. Washburn 2^d U. S. Artillery
for sixty days.

By Order of Secretary of War
Signed / C. D. Townsend
Act Adj. Gen.

1841
Capt. J. Smith
went with leave
for No 29 -
left on 20th -
left on 20th -
20 days with
happy to be left
to the command

1841
No 29
to the command

Head Quarters. 2^d U. S. C. Cavalry.
Camp Clark. Texas.
Oct 11th 1865.

Special Orders. }
No 67 }

Extract

IV. 1st Lieut. E. C. Markham Co "C" is hereby
transferred to Co "B", vice 1st Lieut. Edwin Hughes
transferred to Co "M". April 25th 1865.

By Order
Frank J. White.
Lieut. Col. Commdy Regt.

Dan Hitchcock
2^d Lieut. + Act. Adjt.

Fof
C. O.
Co "C" 2^d U. S. C. Cav.

Markham, Ed. L.

Sent, Co., 2 Reg't Wood

Leave of Absence Papers

(File mark: *M. 34* C. T. L. A. B., 186 *5*)

Cannot be found on Leave of Absence File. Investigation shows that the papers were disposed of as indicated below:

Returned

Filed with

E. R. Y. B. M #168

~~Leave of Absence
transferred to
Personal Paper files~~

1005 or William H.

March William F.

Coal, 2 U. S. Col'd Cav.

2 Lieutenant Lieutenant

CARD NUMBERS.

1	5315346	26
2	5321152	27
3	40726338	28
4		29
5		30
6		31
7		32
8		33
9		34
10		35
11		36
12		37
13		38
14		39
15		40
16		41
17		42
18		43
19		44
20		45
21		46
22		47
23		48
24		49
25		50

Book Mark: 16506-a-79.

See also G. M. Mass. Army.

R. L. P. 351595.

07777 > 2 ~~man~~ on

Thos. C. Hatch
Ex.

M 12. Co., U.S.C.T.

William J. Marsh

2nd Lt., Co., 2nd Reg't U. S. Col'd Cavalry,

Age 27 years.

Appears on an

Individual Muster-in Roll

of the organization named above. Roll dated

Ford's Mount, Va., Feb. 17, 1864.

Muster-in to date Feb. 1, 1864.

Joined for duty and enrolled:

When Feb. 1st, 1864.

Where Ft. Monroe, Va.,

Period 3 years.

Valuation of horse, \$ 100

Valuation of horse equipments, \$ 100

Remarks: Mustered in pursuant to authority from War Dept's letter dated Dec. 26th 1863,

Book mark: 16506-a-79.

G. Owen

M | 2 Cav. | U.S.C.T.

William H. Marsh

2nd Lieut., Co. D, 2 Reg't U. S. Col'd Cavalry.

Appears on

Company Muster Roll

for from Enrollment to Feb'y 29, 1864.

Present or absent

Stoppage, \$ 100 for

Due Gov't, \$ 100 for

Valuation of horse, \$ 100

Valuation of horse equipments, \$ 100

Remarks: Deserted Feb'y 21-64
near Fort Monroe Va.
Appointed from Co. G
1st Mass Cavalry.

Not come on muster out roll

Book mark:

Hearst

766 | 2 Cav. | U.S.C.T.

William H. Marsh

2 Lt, Co Q, 2 Reg't U. S. Colored Cav.

Appears on Returns as follows:

Feb 1864 Date of
Commission Feb
1, 64
Deserted at Ft
Monroe Feb 2/64

Book mark :

(546)

A. G. England
Copyist.

Marsh, Wess H.

St., Co. , 2 Reg't U. S. C. Cav

1 Enclosures.

Bed Cards	Final Statements
Burial Records	Furloughs or L. of A.
Certs. of Dis. for Discharge	Med. Certificates
C. M. Charges	Med. Des. Lists
Descriptive Lists	Orders
Discharge Certificates	Pris. of War Record
Enlistment Papers	Resignations

Other papers relating to—

Admission to Hosp'l	Furlough or L. of A.
Casualty Sheet	Med. Examination
Confinement	Misc. Information
Contracts	Pay or Clothing
Death or Effects	Personal Reports
Desertion	Rank
Discharge from Hosp'l	Transfer to Hosp'l
Discharge from Service	Transfer to V. R. C.
Duty	Transportation

Newdgn. Dept D. & M. C.
Fort Monroe Mich. 24/64
Respy. referred to the Col.
Cindy 2^d U. S. Cal Cavalry
By Command of
Maj Genl Butler
A. J. Tupper
Capt & Co

Mr R. G. Marsh enquiring
after his son Lieut W. H. Marsh

Holyoke Mich 21/64
Major Genl B. H. Butler
Dear Sir
I write you to enquire
if you can give me
any information of my
son ~~W~~ Lieutenant William
H. Marsh he is in the
2^d Cavalry Cavalry
under Col Suddow he
left Washington some time
in January last as I under
stand he was appointed a
Lieutenant in the 2^d Cavalry
Regiment under Col Suddow
it is 5 weeks since we have
heard from him as he always
writes us when he can not
feel he must either be taken
Prisoner by the rebels or killed
in some skirmish or

I have not seen by the papers any movement of Col Sedgwick which I have watched very closely
I sent my son Wm H Marsh a Draft on New York for \$75 Dollars Payable to him on his order the Draft was dated New York February 15th 1864 not having from my son since I sent him the draft I take this method to get some information if possible where he is if you do not know his whereabouts I wish you to get his letters they have been directed to ^{sent} Wm H Marsh
I have been Cavalry in the Corps of Col C B Sedgwick Harpers Ferry under this direction you will know where to find the letters as above stated on

by complying with the above request you will confer a favor on me which will be appreciated by one of your Statesmen
If you will give me the earliest information in regard to my enquiries as you can do look after Wm H Marsh's letters and return them to me direct them to R G Marsh New York who I am anxious about his letters is if he is dead or taken prisoner the draft will be taken from the letter and forged on Wm H Marsh indorsement they will get the money as it stands I wish you to do me the favor as requested
Let me hear from you soon
Yours truly R G Marsh

1006

Martin Edward

Co L, 2 U. S. Col'd Cav.

Private Private

CARD NUMBERS.

1	5315421	26
2	5328336	27
3	5328422	28
4	5328509	29
5	5328616	30
6	5316930	31
7	5329438	32
8	9087447	33
9	40726323	34
10		35
11		36
12		37
13		38
14		39
15		40
16		41
17		42
18		43
19		44
20		45
21		46
22		47
23		48
24		49
25		50

Book Mark:

See also

S-2074295-POWELL

242337310

Thos. G. Hatch
ex.

M | **2 Cav.** | **U.S.C.T.**

Edmond Martin

....., Co. *K*, 2 Reg't U. S. Col'd Cav.

Appears on

Company Descriptive Book

of the organization named above.

DESCRIPTION.

Age *32* years; height *5* feet *9* inches.

Complexion *Black*

Eyes *Black*; hair *Black*

Where born *Aecomac, Md*

Occupation *Laborer*

ENLISTMENT.

When *Jan. 20, 1864.*

Where *Fort Monroe*

By whom *Leve Cole*; term *3* y'rs.

Remarks: *Deserted from
cedar Level, Va. Aug.
25th / 1864.*

M | *2 Cav,* | **U.S.C.T.**

Edward Martin

Priv., Co....., *2* Reg't U. S. Col'd *Cav.*

Age years.

Appears on a

Detachment Muster-in Roll

of the organization named above. Roll dated

Fort Monroe, Va., Jan. 27, 1864.

Muster-in to date *Jan. 27,* 1864.

Joined for duty and enrolled:

When *Jan. 20*, 1864.

Where *Fort Monroe, Va.*

Period *3* years.

Valuation of horse, \$.....100

Valuation of horse equipments, \$.....100

Remarks:

Book mark :

M. | **2 Cav.** | **U.S.C.T.**

Edmond Martin

Pvt., Co. K, 2 Reg't U. S. Col'd Cav.

Appears on

Company Muster Roll

for Enrollment to Feb. 29, 1864.

Present or absent Present

Stoppage, \$ 100 for

Due Gov't, \$ 100 for

Valuation of horse, \$ 100

Valuation of horse equipments, \$ 100

Remarks: _____

Book mark: _____

(358)

J. E. Brooks,
Copyist.

M. | **2 Cav.** | **U.S.C.T.**

Edmund Martin
Co. K, 2 Reg't U. S. Col'd Cav.

Appears on

Company Muster Roll

for *Mar & April*, 1864.

Present or absent *Present*

Stoppage, \$.....100 for

Due Gov't, \$.....100 for

Valuation of horse, \$.....100

Valuation of horse equipments, \$.....100

Remarks:

Book mark:

(358)

J. E. Brooks,
Copyist.

M. | 2 Cav. | U.S.C.T.

Edmund Martin
Cvt, Co. K, 2 Reg't U. S. Col'd Cav.

Appears on

Company Muster Roll

for *May + June*, 1864.

Present or absent *Present*

Stoppage, \$ *100* for

Due Gov't, \$ *100* for

Valuation of horse, \$ *100*

Valuation of horse equipments, \$ *100*

Remarks:

Book mark:

(358)

J. E. Brooks
Copyist.

M | **2 Cav.** | **U.S.C.T.**

Edmund Martin
Privt., Co. K, 2 Reg't U. S. Col'd Cav.

Appears on

Company Muster Roll

for *July* & *Aug.*, 186*4*.

Present or absent.....

Stoppage, \$.....¹⁰⁰ for.....

Due Gov't, \$.....¹⁰⁰ for.....

Valuation of horse, \$.....¹⁰⁰

Valuation of horse equipments, \$.....¹⁰⁰

Remarks: *Deserted from Cedar*
Level Aug. 25th bet.
Due U. S. for ordnance
\$ 5. 23.

Muster out next roll on which
name is borne

Book mark:.....

D. M. Kennedy
Copyist.

M | 2. Cav | U.S.C.T.

Edmond Martin
Pvt., Co. K, 2 Reg't U. S. Col'd Cav

Appears on

Descriptive List of Deserters

dated May 29, 1865.

Deserted:

When Aug 25, 1864.
Where Cedar Point

Arrested:

When _____, 186 .
Where _____

Remarks: Due U.S. for Ordnance
\$5.23

Book mark: _____

E. Martin

216 | 2 Cav. | U.S.C.T.

Edmund Martin

Plt., Co. K, 2 Reg't U. S. Colored Cav.

Appears on Returns as follows:

July 1864 (presented)
(activity as Cook)
since Feb 8, 64
Aug 1864 (presented)
(Aug 's Cedar
Lodge)

Book mark :

(546)

A. S. Gagliardi

Copyist.

M *2 Cav* | **U. S. C. T.**

Edmond Martin
Priv, Co K, 2 Reg't U. S. Col'd *Cav*

Appears on **Co. Muster-out Roll**, dated
Brazos Santiago Tex, Feb 12, 1866.

Muster-out to date _____, 186 .

Last paid to *April 30, 1864* .

Clothing account:

Last settled _____, 186 ; drawn since \$ _____ 100

Due soldier \$ _____ 100 ; due U. S. \$ _____ 100

Am't for cloth'g in kind or money adv'd \$ _____ 100

Due U. S. for arms, equipments, &c., \$ _____ 100

Bounty paid \$ _____ 100 due \$ _____ 100

Remarks: *joined a Regt Priv from*
Enrollment Deserted from
Cedar Level Aug 25. 64. Desct.
List given Aug 31. 64

Book mark: _____

S. Armean

1007

Martin James

Co ^L, 2 U. S. Col'd Cav.

Private Private

CARD NUMBERS.

1	5315922	26
2	5329493	27
3	5329588	28
4	5329686	29
5	5329778	30
6	5329863	31
7	5329943	32
8	9088050	33
9	40726340	34
10		35
11		36
12		37
13		38
14		39
15		40
16		41
17		42
18		43
19		44
20		45
21		46
22		47
23		48
24		49
25		50

Book Mark:

See also

NARR 1951

M | 2 Cav. | U.S.C.T.

James Martin
Port, Co. *L*, 2 Reg't U. S. Col'd Cav.

Appears on

Company Descriptive Book

of the organization named above.

DESCRIPTION.

Age *39* years; height *5* feet *10 1/4* inches.

Complexion *Black*

Eyes *Black*; hair *Black*

Where born *Virginia*

Occupation *Far*

ENLISTMENT.

When *Feb. 9*, 1865.

Where *Eason*

By whom *11 Dist Pa.*; term *3* y'rs.

Remarks: *Substitute for*
Geo. A. Weaver San-
-cow Sp Pa 20 Sub
11 levng Dist Pa.

O. B. Smith

MAY 1952

M 2 Cav. U.S.C.T.

James Martin
Appears with rank of *Private* on

Muster and Descriptive Roll of a Detachment of Substitutes forwarded for the *2* Reg't U. S. Col'd *Cav.* Roll dated *Chelton Hills Pa, Nov. 23, 1865.*

Where born *Virginia*

Age *39* y'rs; occupation *Laborer.*

When enlisted _____, 186 .

Where enlisted _____

For what period enlisted *3* years.

Eyes *Blk.*; hair *Blk.*

Complexion *Blk.*; height *5* ft. *10 1/4* in.

When mustered in *Feb. 9*, 186 *5.*

Where mustered in *Easton, 11th Dist, Pa.*

Bounty paid \$ *100*; due \$ *100*

Where credited *Juncos Tp, Pa, 20th Sub Dist, 11th Cong. Dist.*

Company to which assigned _____

Remarks: _____

Book mark: _____

(340b) *T. C. Taylor* Copyist.

M | **2 Cav.** | **U.S.C.T.**

James Martin
Private, Co. F, 2 Reg't U. S. Col'd Cavalry.

Age years.

Appears on

Company Muster Roll*

for Enrollment to Apr 30, 1865.

Joined for duty and enrolled:

When + Substitute, 186 .

Where

Period 3 years.

Mustered in:

When Feb 9, 1865:

Where Easton

Present or absent Present

Stoppage, \$ 100 for

Due Gov't \$ 100 for

Valuation of horse, \$ 100

Valuation of horse equipments, \$ 100

Remarks:

+ Substituted by Thos. E. Hatch Esq.

*First current roll. No muster-in roll of this company on file.

Book mark:

C. S. Rozzelle
(3685) Copyist.

M | 2 Cav. | U.S.C.T.

James Martin
Private, Co. L, 2 Reg't U. S. Col'd Cavalry.

Appears on

Company Muster Roll

for May & June, 1865.

Present or absent Present

Stoppage, \$ 100 for

Due Gov't, \$ 100 for

Valuation of horse, \$ 100

Valuation of horse equipments, \$ 100

Remarks:

Book mark:

(358)

C. S. Rozzell
Copyist.

M | **2 Cav.** | **U.S.C.T.**

James Martin

Private, Co. L, 2 Reg't U.S. Col'd Cavalry.

Appears on

Company Muster Roll

for July + Aug, 1865.

Present or absent Present

Stoppage, \$ 100 for

Due Gov't, \$ 100 for

Valuation of horse, \$ 100

Valuation of horse equipments, \$ 100

Remarks:

Book mark: -----

C. E. Lyzace
(358) Copyist.

M | **2 Cav.** | **U.S.C.T.**

James Martin
Co. L, Co. L, 2 Reg't U. S. Col'd Cavalry.

Appears on

Company Muster Roll

for *Sept + Oct*, 186 *5*.

Present or absent *Present*

Stoppage, \$ *100* for

Due Gov't, \$ *100* for

Valuation of horse, \$ *100*

Valuation of horse equipments, \$ *100*

Remarks: *S. O. at Reg't,*
At. Lrs per S. O. No. 5-5-

Book mark:

F. B. Smith

M | **2 Cav.** | **U.S.C.T.**

James Martin

Priv, Co. L, 2 Reg't U. S. Col'd Cavalry.

Appears on

Company Muster Roll

for *Nov & Dec*, 1865.

Present or absent *Present*

Stoppage, \$ 100 for

Due Gov't, \$ 100 for

Valuation of horse, \$ 100

Valuation of horse equipments, \$ 100

Remarks:

Book mark:

A. B. Smith

(358)

Copyist.

M | **2 Cav.** | **U.S.C.T.**

James Martin
Capt., Co. L, 2 Reg't U. S. Colored Cav.

Appears on Returns as follows:

Sept & Oct 1865 On
duty Regt Hd Qrs
Nov 1865 to Jan 1866
On duty Orderly
Regt Hd Qrs

Book mark:

(548) W. G. Gouglas Copyist.

MAR 19 1866

M | **2 Cav.** | **U.S.C.T.**

James Martin
Coist, Co. L, 2 Reg't U. S. Col'd Cavalry.

Appears on **Co. Muster-out Roll**, dated

Brazos Santiago, Tex. Feb. 12, 1866.

Muster-out to date *Feb. 12*, 1866.

Last paid to *June 30*, 1865.

Clothing account:

Last settled....., 186 ; drawn since \$..... 100

Due soldier \$ *25 26* / 100; due U. S. \$..... 100

Am't for cloth'g in kind or money adv'd \$..... 100

Due U. S. for arms, equipments, &c., \$..... 100

Bounty paid \$..... 100; due \$..... 100

Remarks: *Joined as Recruit*

Book mark: *2920.1878*

J. B. Smith

(361)

Copyist.

MAR 1948

1008

Martin Robert

Co^l, 2 U. S. Col'd Cav.

Private Private

CARD NUMBERS.

1	5329543	26
2	40726341	27
3		28
4		29
5		30
6		31
7		32
8		33
9		34
10		35
11		36
12		37
13		38
14		39
15		40
16		41
17		42
18		43
19		44
20		45
21		46
22		47
23		48
24		49
25		50

Book Mark:

See also

M | 2 Cav. | U.S.C.T.

Robert Martin

Private, Co. L, 2 Reg't U. S. Col'd Cavalry.

Age years.

Appears on

Company Muster Roll*

for Enrollment to Apr 30, 1865.

Joined for duty and enrolled:

+ Substitute

When, 186 .

Where

Period / years.

Mustered in:

When Mch 9, 1865.

Where Philada

Present or absent.....

Stoppage, \$ 100 for.....

Due Gov't \$ 100 for.....

Valuation of horse, \$ 100

Valuation of horse equipments, \$ 100

Remarks: Deserted Apr 10 - 65 -

Due U. S. / Canteen + Mapsack
Not found on muster roll

*First current roll. No muster-in roll of this company on file.

Book mark:.....

* added by Thos G Hatch Esq.

C. S. Rozzell

W | **2 Cav.** | **U.S.C.T.**

Thaddeus W Martin

Priv, Co. C, 2 Reg't U. S. Colored Cav.

Appears on Returns as follows:

Mar 1865 Gain Mar
24 or 29.65 Camp
Norfolk Re. it as
signed to Co C
by order Maj Rob-
ert Dillard 2 U.S.
C.C.

Book mark :

(546) A. Gouglas Copyist.

MICROCOPY

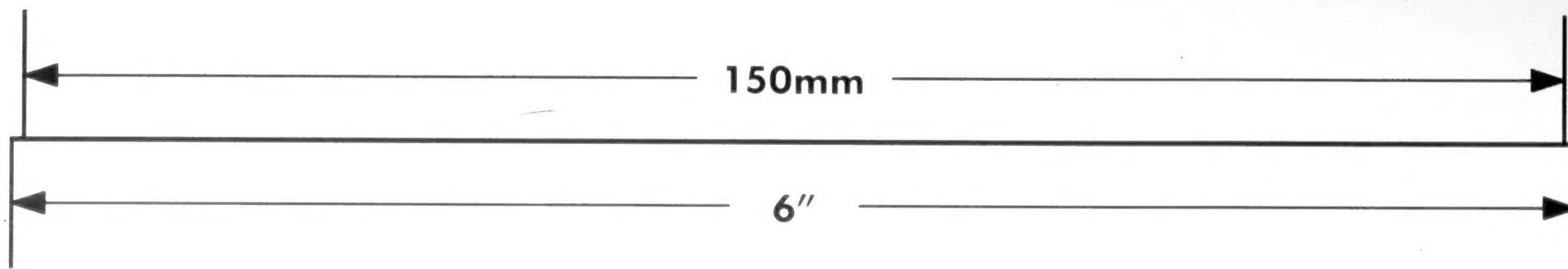
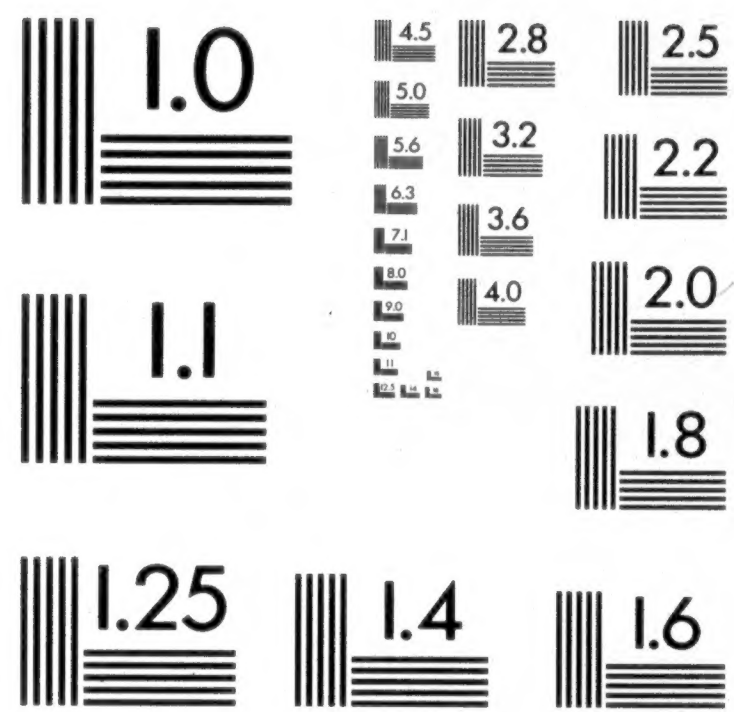
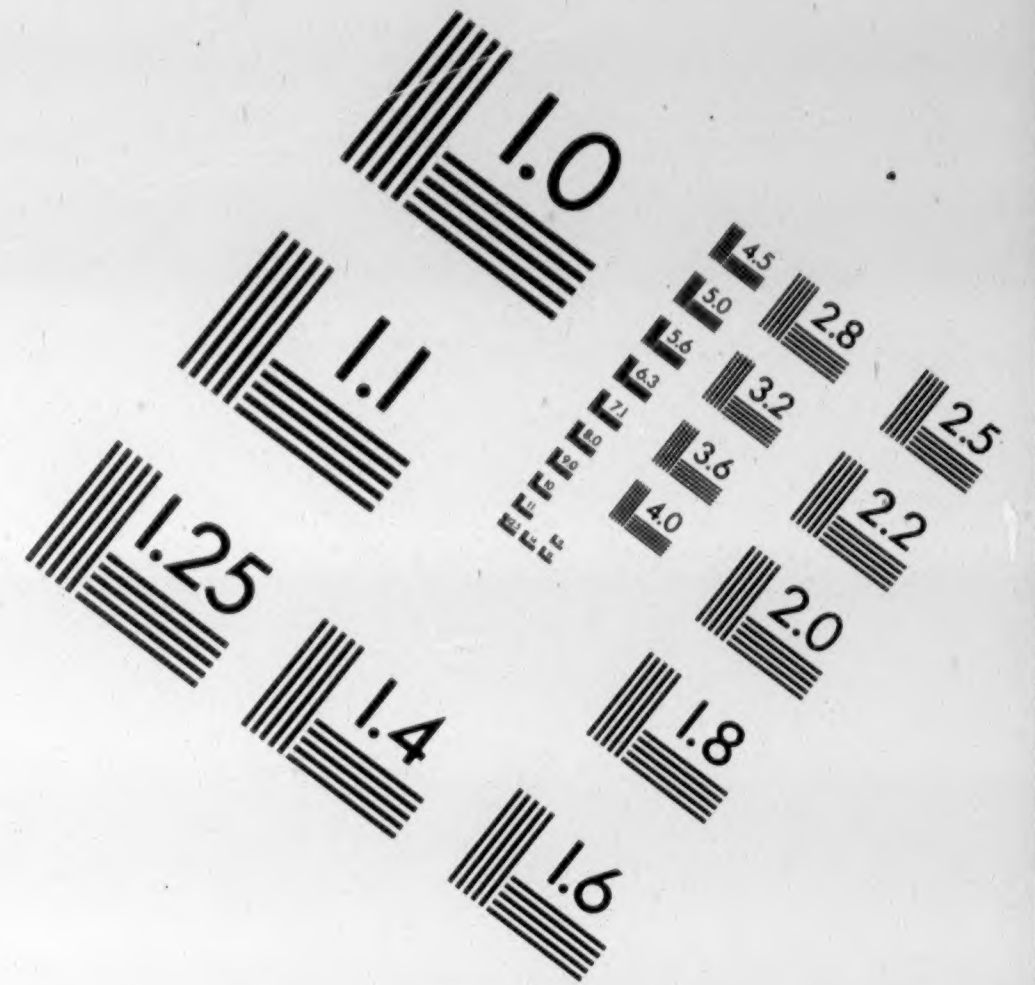
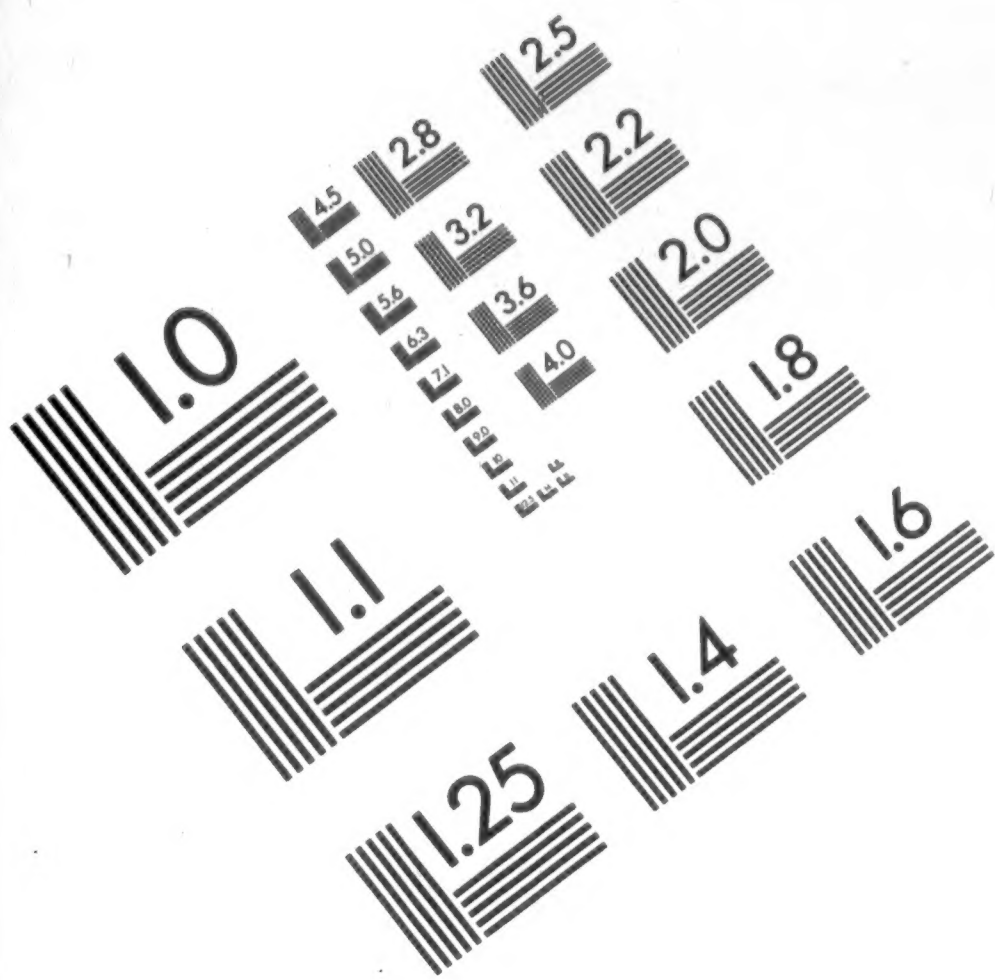
1 8 1 7

ROLL

25

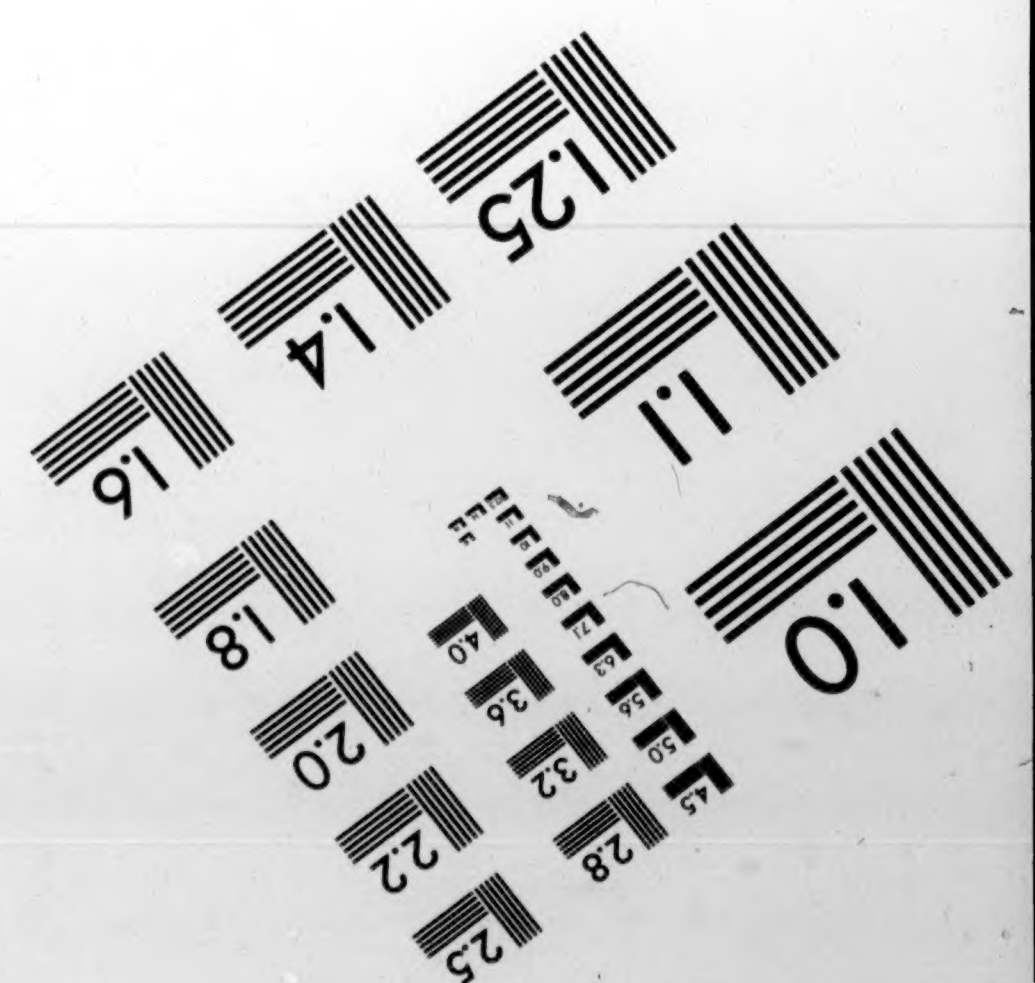
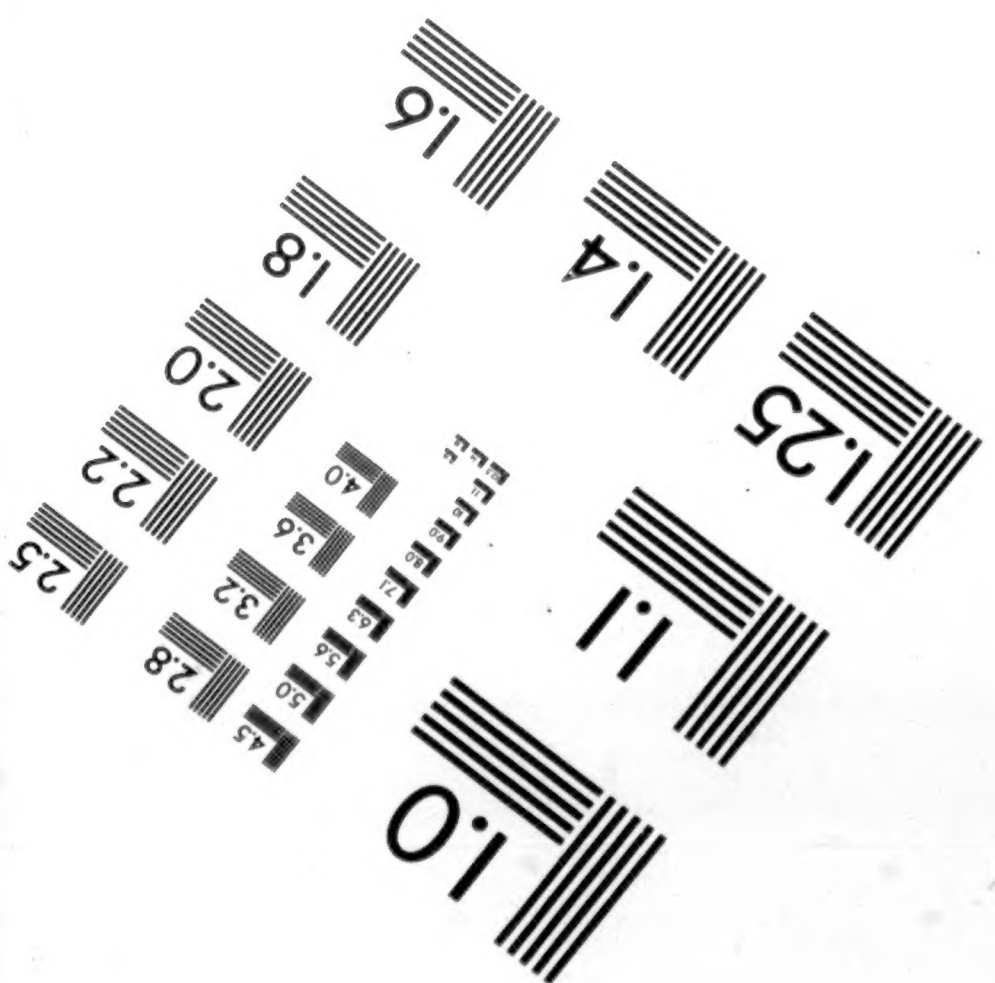


IMAGE EVALUATION TEST TARGET (QA-3)



APPLIED IMAGE, Inc
 1653 East Main Street
 Rochester, NY 14609 USA
 Phone: 716/482-0300
 Fax: 716/288-5989

© 1993, Applied Image, Inc., All Rights Reserved



THE END

PLEASE

REWIND