

**NATIONAL
ARCHIVES
MICROFILM
PUBLICATIONS**

IMAGE EVALUATION TEST TARGET (QA-3)

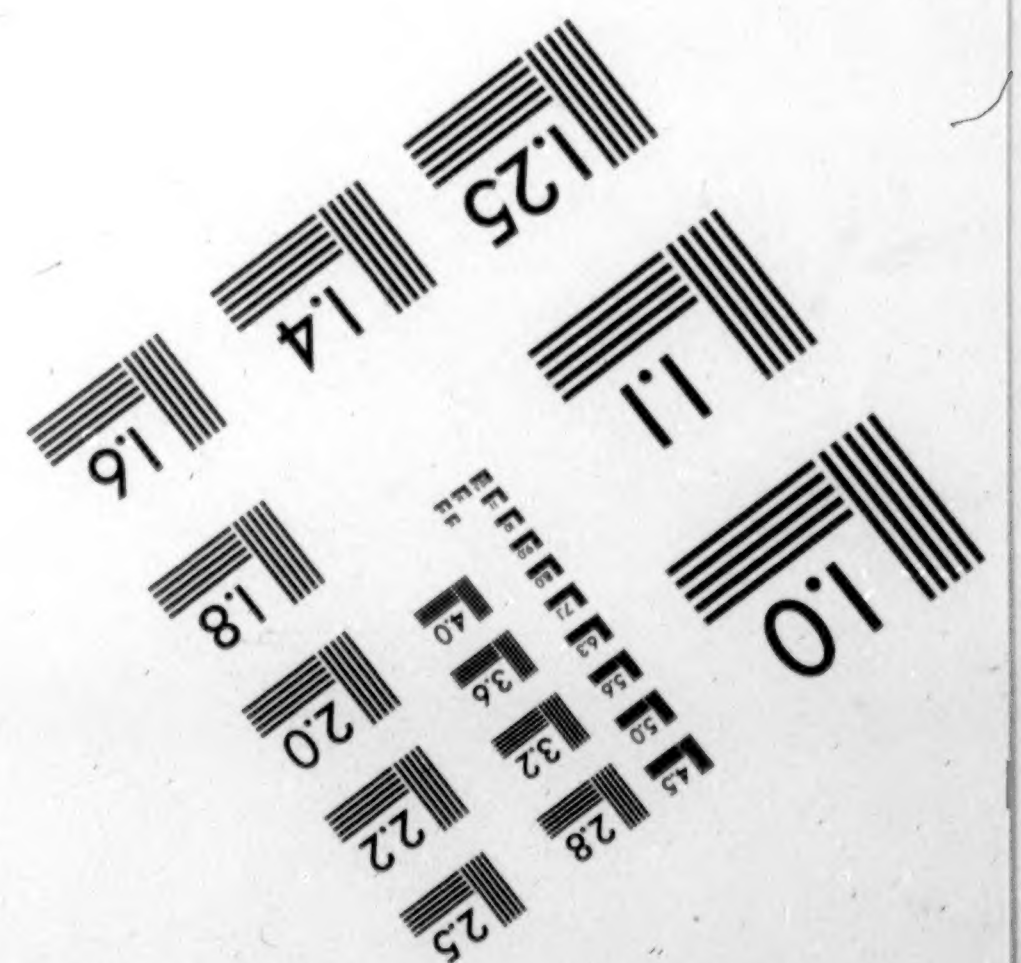
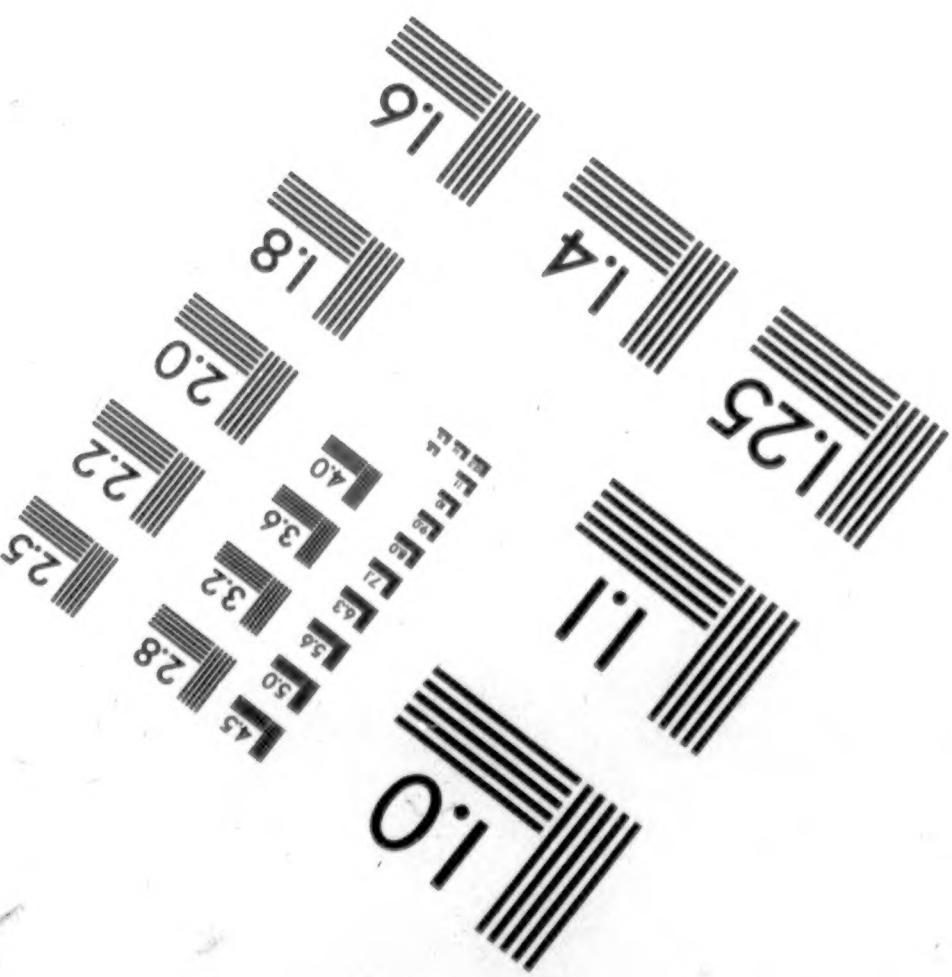
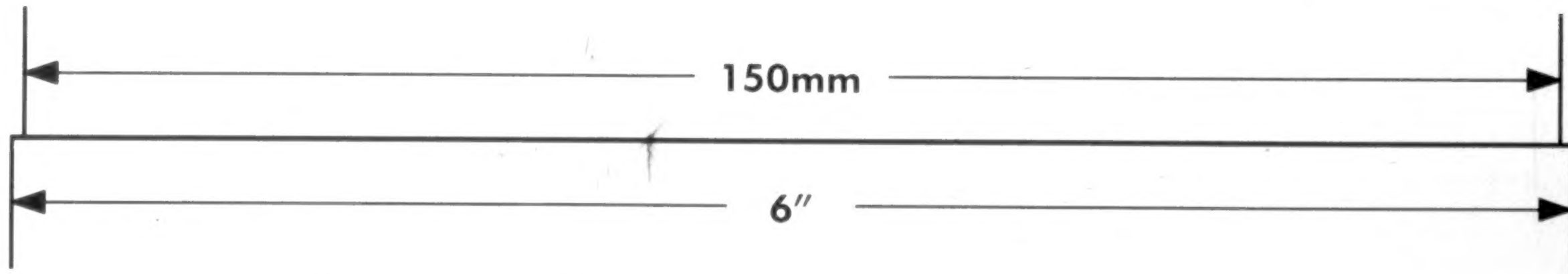
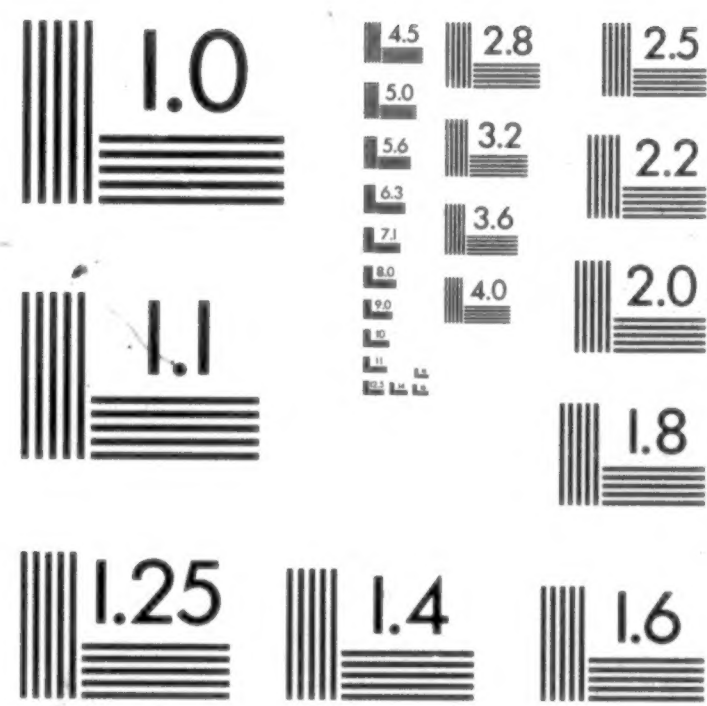
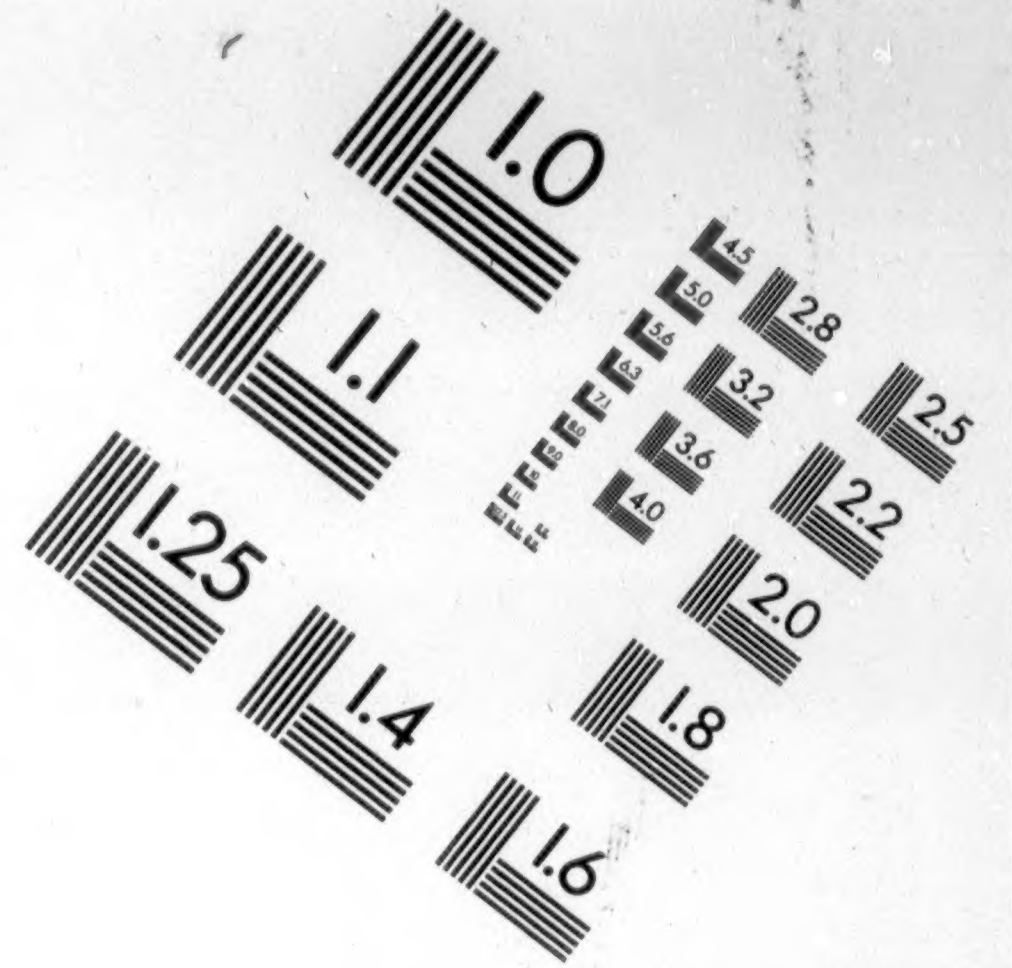
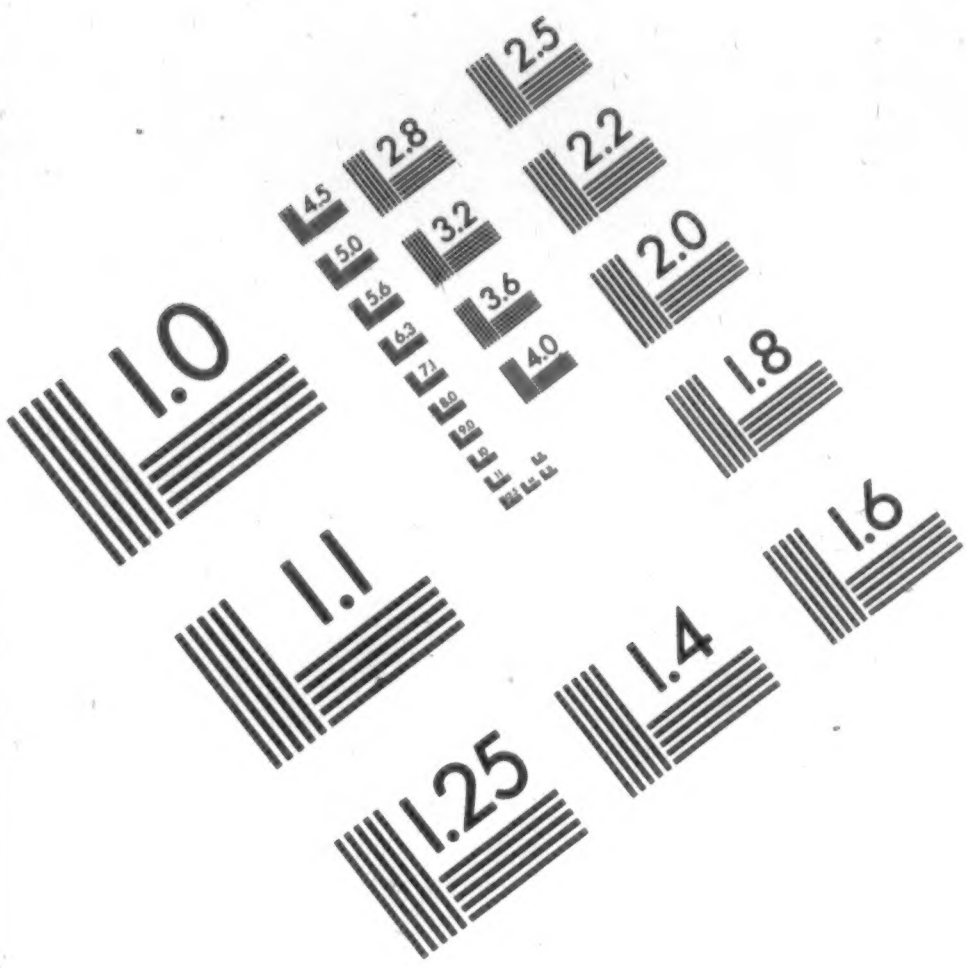

APPLIED IMAGE, Inc
 1653 East Main Street
 Rochester, NY 14609 USA
 Phone: 716/482-0300
 Fax: 716/288-5989

© 1993, Applied Image, Inc., All Rights Reserved

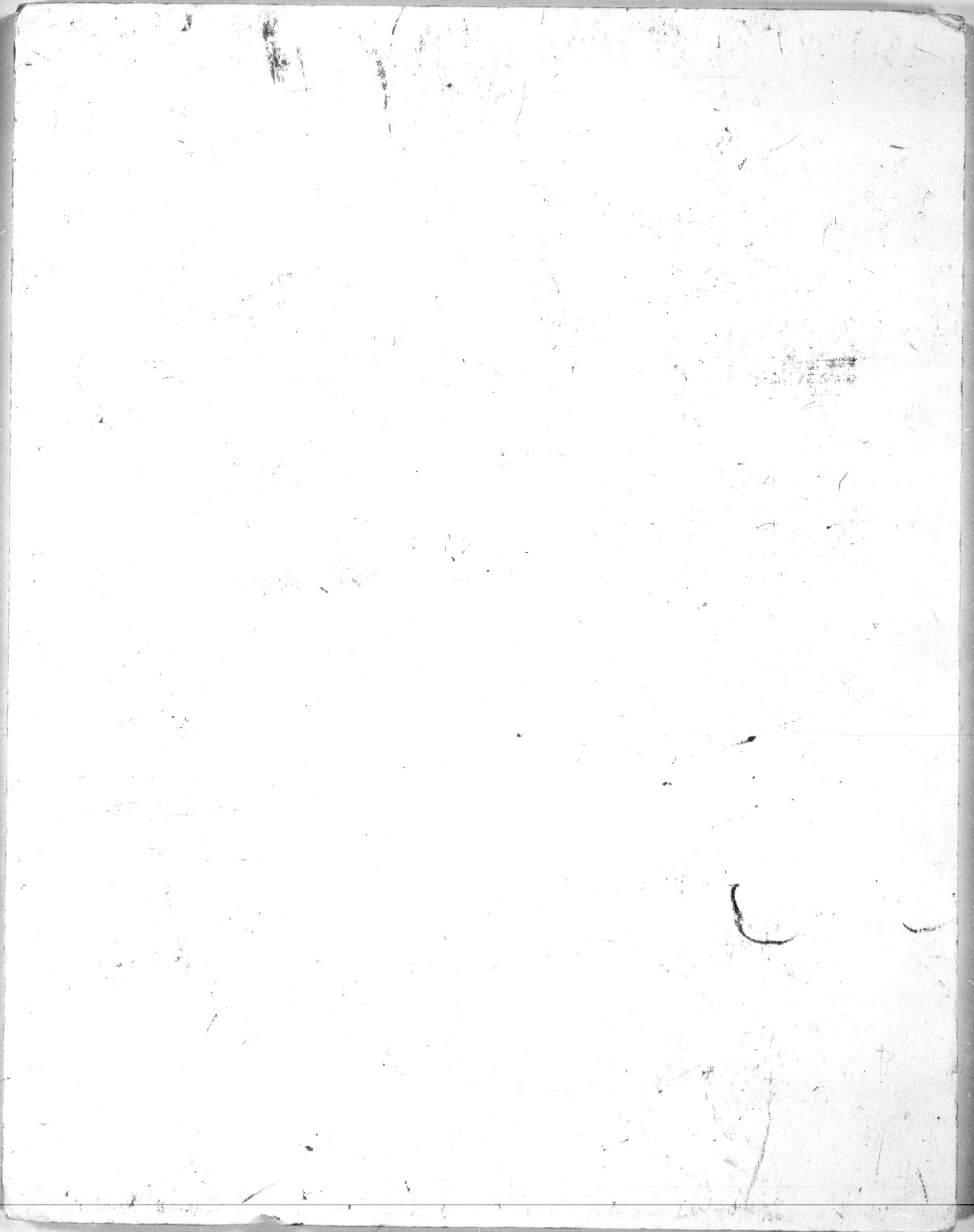

National Archives at College Park



8601 Adelphi Road College Park MD 20740-6001

T. Wilson

OPERATOR

CAMERA

3-29-99

Z-5

DATE FILMED

REDUCTION RATIO

244-0576-014-03 10X

FILM EMULSION NUMBER

1820

32

PROJECT NUMBER

ROLL NUMBER

MICROSCOPY



ROLL



NATIONAL ARCHIVES MICROFILM PUBLICATIONS

M1820

COMPILED MILITARY SERVICE RECORDS OF
VOLUNTEER UNION SOLDIERS WHO SERVED WITH THE
UNITED STATES COLORED TROOPS:
2d Through 7th Colored Infantry, Including
3d Tennessee Volunteers (African Descent)
6th Louisiana Infantry (African Descent)
7th Louisiana Infantry (African Descent)

Introduction written by Budge Weidman, Project Manager

Records prepared for microfilming by volunteers of
the Civil War Conservation Corps

Pat Alfredson	Sue Goward*	Peggy Pratt
Phyllis Altrogge	Bert Greenstein	Ray Puzio
Kenneth Ashton	Anne Greenwood	Sylvia Scott
Sue Barnard*	Jim Harris	Lynn Shearouse
Rex Bowser	Walter Hayden	Charles Spencer
Ann N. Brown	Mary Hayden	Mary Stack-Dunne
Jerry Brown	Pat Ikonen	Ben Stearns
Robert Budway	Dick Ives	Bill Stormer*
Randy Caldwell	Sarah Jaffe	Pat Sullivan
Mary Ann Castellana*	Barbara Kemp	Gorman Tidball*
Mary Lou Cole	Bev Manypenny	John Toole
Giovanni Croce	Frank Masterson	Maryellen Toole
B. H. Custer	Joe Mazur	Dean Warner
Bob Denney	Kathleen McCarthy	Melody Warner
Earl Dunn	Catherine McManus	Milt Weatherhead
Yvette Fallin	Ben Miles	Russ Weidman
Maria Flesher	Dave Murray	Robert Young
Naomi Glass	Mary Poggioli	

Team leaders are indicated by the asterisk.

National Archives and Records Administration
Washington, DC
1999

NATIONAL ARCHIVES MICROFILM PUBLICATIONS

INTRODUCTION

On the 116 rolls of this microfilm publication, M1820, are reproduced the compiled military service records of volunteer Union soldiers belonging to the 2d through the 7th United States Colored Infantry units, including the 3d Tennessee Volunteers (African Descent) and the 6th and 7th Louisiana Infantries (African Descent). These units were part of the United States Colored Troops (USCT). The USCT included 7 numbered cavalry regiments; 13 numbered artillery regiments plus 1 independent battery; 144 numbered infantry regiments; Brigade Bands Nos. 1 & 2 (Corps d'Afrique and US Colored Troops); Powell's Regiment Colored Infantry; Southard's Company Colored Infantry; Quartermaster Detachment; Pioneer Corps, 1st Division, 16th Army Corps; Pioneer Corps, Cavalry Division, 16th Army Corps; Unassigned Company A Colored Infantry; and Unassigned USCT. There are also miscellaneous service cards arranged alphabetically by surname at the end of the unit records. The records reproduced are part of the Records of the Adjutant General's Office, 1780's-1917, Record Group (RG) 94.

Background

United States Colored Troops

Since the time of the American Revolution, African Americans have volunteered to serve their country in time of war. The Civil War was no exception. Official sanction was the difficulty. In the fall of 1862 there were four Union regiments of African Americans raised in New Orleans, LA: the 1st, 2d, and 3d Louisiana Native Guard, and the 1st Louisiana Heavy Artillery (African Descent). The 1st South Carolina Infantry (African Descent) was not officially organized until January 1863; however, three companies of the regiment were on coastal expeditions as early as November 1862. The 1st Kansas Colored Infantry was not mustered into Federal service until January 1863, even though the regiment had already participated in the action at Island Mound, MO, on October 27, 1862. These early unofficial regiments received little Federal support, but they showed the strength of the African American soldier's desire to fight for freedom.

The first official authorization to employ African Americans in Federal service was the Second Confiscation and Militia Act of July 17, 1862. This act allowed President Abraham Lincoln "to receive [African Americans] into the service of the United States, for the purpose of constructing entrenchments, or performing camp service, or any other labor, or any military or naval service for which they may be found competent." The President did not authorize use of African Americans in combat, however, until issuance of the Emancipation Proclamation on January 1, 1863.

In late January 1863 Governor John Andrew of Massachusetts received permission to raise a regiment of African American soldiers. The pace of organizing additional regiments was very slow. In March Secretary of War Edwin M. Stanton sent Gen. Lorenzo Thomas to the lower Mississippi Valley to recruit free and

contraband African Americans. Thomas was given broad authority. He was to explain the administration's policy regarding African American soldiers and recruit volunteers to raise and command them. Stanton wanted all officers of such units to be white, but that policy was softened to allow African American surgeons and chaplains. By the end of the war, in addition to the chaplains and surgeons, there were 87 African American officers. Thomas's endeavor was very successful, and on May 22, 1863, the Bureau of Colored Troops was established to coordinate and organize regiments from all parts of the country. Created under War Department General Order No. 143, the bureau was responsible for handling "all matters relating to the organization of Colored Troops." The bureau was directly under the Adjutant General's Office and its procedures and rules were specific and strict. All African American regiments were now to be designated United States Colored Troops (USCT). At this time there were some African American regiments with state names and a few regiments in the Department of the Gulf designated as Corps d'Afrique. The Corps d'Afrique units ultimately became numbered regiments in the USCT. The 54th and 55th Massachusetts Infantries (Colored), the 5th Massachusetts Cavalry (Colored), the 29th Connecticut Infantry (Colored), the 6th and 7th Louisiana Infantries (African Descent), the 3d Tennessee Volunteers (African Descent), and the 1st South Carolina Volunteers (Colored) retained their number and state designations.

To facilitate recruiting in the states of Maryland, Missouri, Tennessee, and eventually Kentucky, the War Department issued General Order No. 329 on October 3, 1863. Section 6 of the order stated that if any citizen should offer his or her slave for enlistment into the military service, that person would, "if such slave be accepted, receive from the recruiting officer a certificate thereof, and become entitled to compensation for the service or labor of said slave, not exceeding the sum of three hundred dollars, upon filing a valid deed of manumission and of release, and making satisfactory proof of title." For this reason, some records of manumission are contained in the compiled service records reproduced in this publication.

The USCT fought in 39 major engagements and over 400 lesser ones. Sixteen African American soldiers received the Congressional Medal of Honor. As it was in other units, the death toll from disease was very high in the USCT. Deaths from disease and battle totaled 37,000. The last regiment of the USCT was mustered out of Federal service in December 1867.

Important sources for information about African American units in the Civil War are the War Department's *The War of the Rebellion: A Compilation of the Official Records of the Union and Confederate Armies* (Washington, DC: 1880-1901; reprinted Harrisburg, PA, 1971 and 1985) and the Navy Department's *The War of the Rebellion: A Compilation of the Official Records of the Union and Confederate Navies* (Washington, DC: 1874-1922; reprinted Harrisburg, PA, 1971 and 1985). These multivolume works contain reports of operations and other official correspondence.

2d United States Colored Infantry

This regiment was organized at Arlington, VA, from June 23 to November 11, 1863, to serve 3 years. During its existence, the regiment served in New Orleans, LA, and Ship Island, MI. In 1864 the unit moved to Key West and participated in operations on the west coast of Florida. On February 20, 1865, Companies D and I took part in the attack on Fort Myers, FL. Subsequent service took place in the District of Florida until the regiment was mustered out on January 5, 1866.

3d United States Colored Infantry

This regiment was organized at Camp William Penn, Philadelphia, PA, from August 3 to 10, 1863, to serve 3 years. The regiment participated in the siege of Fort Wagner, SC, and operations against Charleston, SC. In 1864 the unit moved to Jacksonville, FL, and maintained duty in the area until being mustered out October 31, 1865.

3d Tennessee Volunteers (African Descent)

This regiment was organized in the spring of 1864 in Memphis, TN, for the defense of that city. Most of the men were transferred to the 7th United States Colored Heavy Artillery, which was redesignated the 11th United States Colored Infantry (New) on January 23, 1865. There are service records pertaining to the officers and men in the 3d Tennessee Volunteers as well as in the 11th United States Colored Infantry (New).

4th United States Colored Infantry

The regiment was organized at Baltimore, MD, July 15 to September 1, 1863, to serve 3 years. The unit participated in actions in Virginia at Bermuda Hundred, Petersburg, Dutch Gap, and Chaffin's Farm. In North Carolina the regiment took part in the battle and capture of Fort Fisher, Sugar Loaf Hill, and the city of Wilmington. In these actions the regiment sustained losses of 355 officers and men wounded, missing, or killed. The regiment was mustered out of service May 6, 1866.

5th United States Colored Infantry

This regiment was organized at Camp Delaware, OH, from August 6, 1863, to January 15, 1864, to serve 3 years. In Virginia the regiment served at Norfolk and Portsmouth and participated in major battles at Petersburg, Chaffin's Farm, and Fair Oaks. The regiment took part in the capture of Fort Fisher and the city of Wilmington in North Carolina. Its remaining service took place in North Carolina until it was mustered out on September 20, 1865.

6th United States Colored Infantry

This regiment was organized at Camp William Penn, Philadelphia, PA, from July 28 to September 12, 1863, to serve 3 years. The unit participated in battles at Chaffin's Farm, Williamsburg, and Petersburg in Virginia and at Sugar Loaf Hill, NC. During these actions the regiment sustained losses of 237 killed, wounded, or missing. The regiment was mustered out September 20, 1865.

6th Louisiana Infantry (African Descent)

This regiment was organized for 60 days in New Orleans, LA, on July 4, 1863. The unit served at New Orleans and was mustered out August 13, 1863.

7th United States Colored Infantry

This regiment was organized at Baltimore, MD, from September 26 to November 12, 1863, to serve 3 years. The unit served in Virginia, Florida, and South Carolina. It was mustered out of service October 13, 1866.

7th Louisiana Infantry (African Descent)

This regiment was organized for 60 days in New Orleans, LA, on July 10, 1863. It served in New Orleans until it was mustered out on August 6, 1863.

Records Description

Compiled service records consist of a jacket-envelope for each soldier, labeled with his name, rank, unit, and card numbers. The compilation of service records of Union soldiers began in 1890 under the direction of Col. Fred C. Ainsworth, head of the Record and Pension Office of the Adjutant General's Office, Department of War. Information from muster rolls, regimental returns, descriptive books, and other records was copied verbatim onto cards. A separate card was prepared each time an individual name appeared on a document. These cards were numbered on the back, and these numbers were entered onto the outside jacket containing the cards. The carded information was verified by a separated operation of comparison; great care was taken to ensure that the cards were accurate.

A typical jacket contains card abstracts of entries found in original records relating to the soldier and original documents relating solely to that soldier. Examples of the latter include enlistment papers, substitute certificates, casualty sheets, death reports, prisoner-of-war memorandums, and correspondence. Unique to the records of the USCT are deeds of manumission, oaths of allegiance, proof of ownership, certificates of monetary award, and bills of sale. These items appear most frequently in units recruited in the border states of Kentucky, Missouri, and Maryland. These states remained in the Union but were slave states. Jackets and cards include a section labeled "bookmark," which was reserved for cross-references to other records relating to the individual or his unit. The service records are

NATIONAL ARCHIVES MICROFILM PUBLICATIONS

arranged by arm of service, thereunder numerically by regiment or independent battalion or company, and thereunder alphabetically by name of the soldier. Records for officers are interfiled alphabetically by name with the records of enlisted men. If an individual served in more than one unit, which was typical for USCT officers, there will be a separate service record for each unit in which he served.

The unjacketed miscellaneous cards were accumulated by the War Department with the expectation that they would be incorporated in individual compiled service records. This expectation was never fulfilled, however, because either insufficient or contradictory information made it impossible to associate the cards or papers with a particular soldier's service records.

Related Records

Among the records of the Adjutant General's Office in the National Archives are many of the original records that were abstracted or "carded" by the Record and Pension Office. These include the individual unit's muster rolls, returns, and descriptive books. Other series in RG 94 that contain information relating to volunteer Union soldiers who served with the USCT include carded records relating to Union staff officers, carded medical records of volunteer Union soldiers, unbound and bound regimental records and "record of events" cards. The regimental records of the 54th Massachusetts Infantry (Colored) have been reproduced as Microfilm Publication M1659, *Records of the Fifty-fourth Massachusetts Infantry Regiment (Colored), 1863-1865*.

The "record of events" cards include information copied from the unit's muster rolls and returns. They show the stations of the field and staff and the companies of the regiment at the time the muster roll or return was prepared and sometimes mention battles, skirmishes, or other activities in which the regiment participated. The cards have been reproduced as Microfilm Publication M594, *Compiled Records Showing Service of Military Units in Volunteer Union Organizations*.

Record Group 94 also includes a card index for the USCT, reproduced as Microfilm Publication M589, *Index to Compiled Military Service Records of Volunteer Union Soldiers Who Served with U.S. Colored Troops*, which may be used to locate the regiment of a USCT soldier. An index card gives the name of the soldier and his rank, as well as the unit in which he served; sometimes there is a cross-reference to his service in other units or organizations. The National Archives is continually producing microfilm publications of volunteer Union compiled military service records. A complete listing of finished publications can be found in the National Archives *Microfilm Resources for Research: A Comprehensive Catalog*, which is available online at <http://www.nara.gov>.

The records of the Colored Troops Division, within RG 94, include division correspondence and records relating to recruiting, the appointment of officers, and the slave or free status of individuals, as well as a compilation of historical extracts

NATIONAL ARCHIVES MICROFILM PUBLICATIONS

and official papers concerning the military service of African Americans from the colonial period through the Civil War entitled *The Negro in the Military Service of the United States, 1639-1886*. This compilation is reproduced as Microfilm Publication M858. The records of the Bounty and Claims Division, also in RG 94, include correspondence of the division and records relating to bounties and claims paid to loyal owners of slaves by the Slave Claims Commissions of Delaware, Kentucky, Maryland, Missouri, Tennessee, and West Virginia.

If a soldier applied for a pension, the pension application case file may be among the Records of the Veterans Administration (RG 15). Indexes to the pension applications have been reproduced as Microfilm Publications T288, *General Index to Pension Files, 1861-1934*, and T289, *Organizational Index to Pension Files of Veterans Who Served Between 1861 and 1900*.

If a soldier or officer was tried before a general court-martial or if an individual or his unit was the subject of a court of inquiry or military commission, transcripts of those proceedings may be among the Records of the Office of the Judge Advocate General (Army) (RG 153). The registers to the proceedings have been reproduced as Microfilm Publication M1105, *Registers of the Records of the Proceedings of the U.S. Army General Courts-Martial, 1809-1890*.

Other record groups having information pertaining to the USCT include Records of the Bureau of Refugees, Freedmen, and Abandoned Lands (RG 105); Records of the Provost Marshal General's Bureau (Civil War) (RG 110); Records of the Accounting Officers of the Department of the Treasury (RG 217); and Records of U.S. Army Continental Commands, 1821-1920 (RG 393).

Holdings of the National Archives relating to the Civil War are outlined in Kenneth W. Munden and Henry Putnam Beers, *Guide to Federal Archives Relating to the Civil War* (Washington, DC: National Archives, 1962) and Henry Putnam Beers, *Guide to the Archives of the Government of the Confederate States of America* (Washington, DC: National Archives, 1968), which were reprinted as *The Union* (1986) and *The Confederacy* (1986).

NATIONAL ARCHIVES MICROFILM PUBLICATIONS

ROLL LIST

Roll Description

2d United States Colored Infantry

1 Abram, Abraham - Bell, Daniel A.
2 Bell, Henry - Brown, Thomas
3 Brown, William - Clark, Moses
4 Clark, Stephen - Downing, Dennis
5 Downs, John - Gavin, Benjamin
6 Gibbs, Paton - Haskins, Iverson
7 Hasler, William - Jenkins, Charles
8 Johnson, Albert - Kratzenberg, Augusta
9 Kratzenberg, Charles - Miller, Thomas
10 Mills, John Q. - Pettis, Alfred
11 Pettis, Frank - Russ, Charles
12 Russell, Charles - Spindle, James E.
13 Sprague, Benedict - Thoroughgood, Miles E.
14 Thomson, Charles H. - West, James
15 West, Nimrod - Woodson, William
16 Woodward, George G. - Young, William A.

2d United States Colored Infantry Miscellaneous Service Cards

16 Ackis, George - Young, Samuel

3d United States Colored Infantry

17 Abbot, Charles S. - Bohlen, John
18 Bond, Charles - Clemens, William
19 Clemmons, Joseph - Fernow, Edward B. F.
20 Fields, Alfred - Harmon, William K.
21 Harris, George - Jackson, Frederick
22 Jackson, George - LaCount, Charles J.
23 Ladson, Thomas - Miller, Henry
24 Miller, John - Preslin, Stephen
25 Preston, Joseph - Shorter, Daniel
26 Shorter, John W. - Thompson, George A.
27 Thompson, John - Williams, Edward
28 Williams, Enoch - Young, William H.

3d United States Colored Infantry Miscellaneous Service Cards

29 Abbott, Chas. - Wright, Lorenzo

3d Tennessee Volunteers (African Descent)

30 Ady, George - Young, Samuel

4th United States Colored Infantry

31 Abney, Richard - Bass, James
 32 Batsom, David - Brown, Stephen R.
 33 Brown Uriah - Cherry, Thomas
 34 Chew, Josiah - Davis, Jeremiah
 35 Davis, John H. J. - Ellis, John J.
 36 Emery, Enoch - Gray, James
 37 Grayson, Noble - Hause, William
 38 Hawkins, Alexander - Jackson, John
 39 Jackson, John Daniel - Jones, John
 40 Jones, John Robert - Linthicum, Dennis C.
 41 Linthicum, George L. - Mercer, Benjamin F.
 42 Mickens, Thomas H. - Novel, Charles
 43 Odiorne George G. - Reynolds, S. Walter
 44 Rezin, George F. - Seymour, George W.
 45 Seymour, Thomas - Stockett, Samuel
 46 Stokes, George E. W. - Veal, Charles
 47 Viney, Richard - Willett, James
 48 Williams, Adam - Zimmons, Charles

4th United States Colored Infantry Miscellaneous Service Cards

49 Adams, James O. - Juricks, Jacob
 50 Kane, Chas. - Zook, Gray

5th United States Colored Infantry

51 Adams, John - Black, Edward
 52 Blackburn, Daniel - Brown, James
 53 Brown, J. R. - Coleman, James
 54 Coleman, Thornton - Duckwilder, Clayburn
 55 Dudley, George - Gilson, James
 56 Glasgow, James - Herse, Jerry
 57 Hervit, John - Johnson, Arthur B.
 58 Johnson, Charles - Lett, William
 59 Levis, Hezekiah - McFarland, Allen
 60 McFarland, John - Page, David
 61 Page, Isaiah - Rider, William H.
 62 Ridgeway, John - Sloan, Samuel
 63 Sly, William - Teeters, Charles
 64 Teeters, Henry W. - Walker, William
 65 Walker, Willis - Winters, James

NATIONAL ARCHIVES MICROFILM PUBLICATIONS

66 Winters, Oscar - Zimmerman, Henry

5th United States Colored Infantry Miscellaneous Service Cards

66 Alexander, Arthur - Kyser, Henry

67 Ladd, Andrew - Young, Thomas

6th United States Colored Infantry

68 Abraham, Jacob - Bolier, Abram

69 Boo, David - Carey, Walter

70 Carr, William - Davis, Peter

71 Davis, Robert - Fiderman, William C.

72 Field, Edward - Gustus, John R.

73 Guy, William - Hopkins, James

74 Hosfield, Lewis M. - Johnson, John Henry

75 Johnson, John W. - Lemon, George

76 Lett, Nelson - Miller, John

77 Miller, Lawson L. - Pierce, Alfred B.

78 Pierce, George - Ruff, Jacob

79 Russell, Lloyd - Smith, William H.

80 Snowden, Henry - Van Clief, Emanuel

81 Van Vrankin, William H. - Wilson, Anthony

82 Wilson, Charles - Young, John

6th United States Colored Infantry Miscellaneous Service Cards

82 Abrams, Jacob - Furgerson, Henry

83 Gadsby, John - Young, Richard

6th Louisiana Infantry (African Descent)

84 Aaron, Koff - Chevarre, Ernest

85 Cheveau, Auguste - Guimiase, Julian

86 Gusman, Thomas - Meyer, Wilson

87 Michael, Louis - Sorza, Antoine

88 Span, Octavus - Zenon, Aristide

7th United States Colored Infantry

89 Abraham, John - Bardy, Joseph

90 Bargus, James J. - Bowyer, Littleton

91 Bowzer, Emory - Bundick, Henry

92 Burden, Daniel - Chase, Henry

93 Chase, Isaac - Crawford, George W.

94 Cray, Charles M. - Drummond, William

NATIONAL ARCHIVES MICROFILM PUBLICATIONS

- 95 Dumpson, George - Gale, Joseph
- 96 Gamby, Charles - Griffin, Charles W.
- 97 Griffin, George E. - Hazelton, William
- 98 Hearn, William E. - Jackson, George H.
- 99 Jackson, Henry - Johnson, Samuel
- 100 Johnson, Stephen - Landsell, William
- 101 Lane, William - Melvin, Sime
- 102 Merrill, Lewis - Nichols, Lloyd
- 103 Noonan, William F. - Purnell, James
- 104 Purnell, John H. - Russell, Thomas
- 105 Russum, Alexander - Smith, James R.
- 106 Smith, James W. - Taylor, Daniel
- 107 Taylor, Levin H. - Vaughn, John H.
- 108 Veasey, Edward - Whitman, Moses P.
- 109 Whittica, James - Wright, John Wesley
- 110 Wright, Joseph - Young, Thomas

7th United States Colored Infantry Miscellaneous Service Cards

- 110 Adams, Gilbert - Kutchumber, Jacob
- 111 Landon, Perry H. - Young, Stephen

7th Louisiana Infantry (African Descent)

- 112 Able, Alfred - Colar, Manuel
- 113 Cole, Arnold - Holland, John C.
- 114 Holland, Jules - Myers, Victor
- 115 Narcisse, James - Swails, George A.
- 116 Sylvester, Joseph - Zoodrick, Dick

7th Louisiana Infantry (African Descent) Miscellaneous Service Cards

- 116 Allen, Charles - Whittey, Hiram C.

NATIONAL ARCHIVES MICROFILM PUBLICATIONS

Microfilm Publication M1820

COMPILED MILITARY SERVICE RECORDS OF VOLUNTEER UNION
SOLDIERS WHO SERVED WITH THE UNITED STATES COLORED TROOPS:
2d Through 7th United States Colored Infantry, Including 3d Tennessee Volunteers
(African Descent), 6th Louisiana Infantry (African Descent), 7th Louisiana Infantry
(African Descent)

Roll 32

4th United States Colored Infantry

Batsom, David - Brown, Stephen R.

NATIONAL ARCHIVES AND RECORDS ADMINISTRATION

87

Batson, David

Co F, 4 U.S. Col'd Inf.

Private | Private

CARD NUMBERS.

1	5560401	26
2	5561071	27
3	5551077	28
4	5560495	29
5	5560588	30
6	5560676	31
7	5560749	32
8	5560813	33
9	5560875	34
10	9062316	35
11	2202-02-1879	36
12		37
13		38
14		39
15		40
16		41
17		42
18		43
19		44
20		45
21		46
22		47
23		48
24		49
25		50

Book Mark: 2202-C.S. 179
 LB. VII P 388

See also

\$ 786487 2nd and.
S-815508-2nd and. Pte.

B | 11 | U.S.C.T.

David Batson

, Co. F, 11 Reg't U.S. Col'd Inf

Appears on

Company Descriptive Book

of the organization named above.

DESCRIPTION.

Age 31 years; height 5 feet 8 inches.

Complexion Black

Eyes Black; hair Black

Where born

Occupation

ENLISTMENT.

When July 3, 1864.

Where Elizabetta Mills Md

By whom Capt. Holland; term 2 y'rs.

Remarks: Drafted from the 5th Regt Dist
Montgomery Co. 5th Regt Dist Md

H. H. Merrill

P | 4 | U.S.C.T.

Daniel Galson

Pvt., Co. F, 4 Reg't U. S. Col'd Infantry.

Appears on

Company Muster Roll

for *March + April*, 1865.

Joined for duty and enrolled:

When....., 186 *.

Where.....*

Period..... years.*

Present or absent..... *Present*

Stoppage, \$.....¹⁰⁰ for.....

Due Gov't \$.....¹⁰⁰ for.....

Remarks: *No papers received*

* See enrollment on card from muster-in roll.

Book mark:.....

(858c)

Linden

Copyist.

9

4

U.S.C.T.

Daniel Golsen

Prvt., Co. F, 4 Reg't U. S. Col'd Infantry.

Appears on

Company Muster Roll

for May & June, 1865

Joined for duty and enrolled:

When....., 186 .*

Where.....*

Period..... years.*

Present or absent Present

Stoppage, \$ 100 for.....

Due Gov't \$ 100 for.....

Remarks No enlistment paper recd

* See enrollment on card from muster-in roll.

Book mark:.....

(858c)

Linden

Copyist.

B | 4 | **U.S.C.T.**

Daniel Galson

Pr., Co. F, 4 Reg't U. S. Col'd Infantry.

Appears on

Company Muster Roll

for July & Aug., 1869.

Joined for duty and enrolled:

When....., 186 .*

Where.....*

Period..... years.*

Present or absent Present

Stoppage, \$..... 100 for.....

Due Gov't \$..... 100 for.....

Remarks: No enlistment papers rec'd

* See enrollment on card from muster-in roll.

Book mark:.....

(858c)

J. J. J. J.
Copyist.

B H U.S.C.T.

Daniel Palsey
Co. A, H Reg't U. S. Col'd Inf.

Appears on

Company Muster Roll

for Sep. + Oct 1865.

Joined for duty and enrolled:

When _____, 186 .*

Where _____ *

Period _____ years.*

Present or absent Absent

Stoppage, \$ 100 for _____

Due Gov't, \$ 100 for _____

Valuation of horse, \$ 100

Valuation of horse equipments, \$ 100

Remarks: Absent sick. No papers received. Pay due from enlistment.

* See enrollment on card from muster-in roll.

Book-mark : _____

Linden

B

4

U.S.C.T.

Daniel Batson

....., Co., 4 Reg't U. S. Col'd Infantry.

Appears on

Descriptive List of Deserters

dated *Nov. 23rd*, 186*5*

Deserted :

When *After draft*, 186*5*

Where

Arrested :

When *March 7*, 186*5*

Where

Remarks : *Drafted and failed to report as ordered. was arrested and turned over to Col John Woolley Pro. Mar 8th Army Corps Baltimore (over)*

Book mark :

Washington

(851)

Copyright.

JAN 19

5551071

1891

*Wd. as a deserter
and the reward allowed
for his apprehension
and delivery \$30.00.*

NARA II

B | 4 | U.S.C.T.

David Paton

Pri, Co. F, 4 Reg't U. S. Col'd Infantry.

Appears on

Company Muster Roll

for Nov & Dec, 1865.

Joined for duty and enrolled:

When July 8, 1864.*

Where Ellacotts Mills Md.*

Period 3 years.*

Present or absent Present

Stoppage, \$ 100 for

Due Gov't \$ 100 for

Remarks: Deserted after Draft
Arrested as deserter Mich 7
1865. Stop \$30.00 as
reward for his apprehension

* See enrollment on card from muster-in roll.

Book mark:

Cummins

B | 4

U.S.C.T.

Daniel Batson

, Co. , 4 Reg't U. S. Col'd Infantry.

Appears on

Descriptive List of Deserters

dated Dec. 20, 1865.

Deserted:

When After Draft, 1865.

Where

Arrested:

When March 7, 1865.

Where

Remarks: Failed to report as ordered was arrested and turned over to Col John Hoolley Co. Mar 8th Army Corps Balt. Md

Book mark: (over)

Washington

(851)

Copyist.

JAN 19

5551077

1891

as a deserter and the
reward allowed for
his apprehension and
delivery \$30.00

B

4

U.S.C.T.

David Balson
Pri, Co. F, 4 Reg't U. S. Col'd Infantry.

Appears on

Company Muster Roll

for Jan & Feb, 1866.

Joined for duty and enrolled:

When July 8, 1864.*

Where Ellicotts Mills Md *

Period 3 years.*

Present or absent Absent

Stoppage, \$ 100 for

Due Gov't \$ 100 for

Remarks: Absent on detached
service authority S.O. No 7
Hed Gns 4 U.S. Co. Jan 5/66

NEXT ROLL ON FILE MUSTER OUT.

* See enrollment on card from muster-in roll.

Book mark:

Currier

P | 4 | U.S.C.T.

David Patson
Pri, Co. F, 4 Reg't U. S. Col'd Infantry.

Appears on Co. Muster-out Roll, dated
Washington D.C., May 4, 1866.

Muster-out to date May 4, 1866.

Last paid to Feb 28, 1866.

Clothing account:

Last settled _____, 1866; drawn since \$ _____ 100

Due soldier \$ 29³⁷/₁₀₀; due U. S. \$ _____ 100

Am't for cloth'g in kind or money adv'd \$ _____ 100

Due U. S. for arms, equipments, &c., \$ _____ 100

Bounty paid \$ _____ 100; due \$ _____ 100

Remarks: Slave on or before Apr 19/61
(age 34. Enrol'd m/m July 8.
by Ellicom's Mill Md. 3/4/61)

Book mark: See list of deserters from
2202 C.T. 79. Ft Mc Henry Md.
over

Currier

(361)

Copyist.

JAN. 15

5560875

1891*

v64 P182.69. SB ¹³/₃₈₈

B | 4" | U. S. C. I.

David Batson

, Co. F, 4th Reg't U. S. C. I.

NOTATION.

Book mark: L. B. 13. 388, with
2202-C-I-1879.

War Department,

Adjutant General's Office,

Washington, July 12, 1880.

Charge of desertion removed
by Special Order #15 of January 19,
1866, Hd. Qrs Dept. of Washington.

W. Allen

(438)

Copyist.

Batson, David

, Co. *F*, *H* Regt *U.S.C.*

1 Enclosures.

Bed Cards	Final Statements
Burial Records	Furloughs
Certs. of Dis. for Discharge	Med. Certificates
C. M. Charges	Med. Des. Lists
Descriptive Lists	Orders
Discharge Certificates	Pris. of War Record

Other papers relating to—

Admission to Hosp'l	Furlough
Casualty Sheet	Med. Examination
Confinement	Misc. Information
Contracts	Pay or Clothing
Death or Effects	Personal Reports
Desertions	Rank
Discharge from Hosp'l	Transfer to Hosp'l
Discharge from Service	Transfer to V. R. C.
Duty	Transportation

David Watson
Co F 4th U.S.C.I.

Sep
S. A. Duncan
Col. 4th U.S.C.I.

Restorations.
Dept, of Wash,
1864-5 & 6.

88 or Reason C.

Genl. Thomas Resin

Co G, 4 U.S. Col'd Inf.

Corporal

Sergeant

CARD NUMBERS

- 1 5560991
- 2 5561090
- 3 5561191
- 4 5561291
- 5 5561390
- 6 5561487
- 7 5561586
- 8 5561678
- 9 5561770
- 10 5561856
- 11 5561945
- 12 5562031
- 13 5562132
- 14 5562230
- 15 5562328
- 16 5562413
- 17 5562488
- 18 5562561
- 19 9062417
- 20
- 21
- 22
- 23
- 24
- 25

- 26
- 27
- 28
- 29
- 30
- 31
- 32
- 33
- 34
- 35
- 36
- 37
- 38
- 39
- 40
- 41
- 42
- 43
- 44
- 45
- 46
- 47
- 48
- 49
- 50

Book Mark: P. 168 VII let. 46

See also

S. 2018878 P. O. m m

13 | 4 | U.S.C.T.

Thomas R. Beak

....., Co. G, 4 Reg't U. S. Col'd Inf.

Appears on
Company Descriptive Book
of the organization named above.

DESCRIPTION.

Age 22 years; height 5 feet 8 3/4 inches.

Complexion Brown

Eyes Black; hair Black

Where born Frederick Md

Occupation Blacksmith

ENLISTMENT.

When Aug 11, 1863

Where Beth Md

By whom Col Birney; term 3 y'rs.

Remarks:

W H Merrill

23 | **4** | **U.S.C.T.**

Thomas Resin Beal
Corp., Co. *G*, 4 Reg't U. S. Col'd Infantry.

Age *27* years.

Appears on

Company Muster-in Roll

of the organization named above. Roll dated
Baltimore Md, Aug 11, 1863.

Muster-in to date *Aug 11, 1863.*

Joined for duty and enrolled:

When *Aug 11*, 186*3*.*

Where *Baltimore City* *

Period *3* years.*

Remarks :

* Muster-in roll shows enrollment and muster-in of this company as of same date and place. See enrollment on subsequent card or cards.

Book mark: _____

Rose

B

4

U.S.C.T.

Thomas Resin Deal
Corp, Co. G, 4 Reg't U. S. Col'd Infantry.

Appears on

Company Muster Roll

for *Aug 11 to 31*, 186*3*

Joined for duty and enrolled:

When *Aug 11*, 186*3**

Where *Baltimore City**

Period *3* years.*

Present or absent *Present*

Stoppage, \$ *100* for

Due Gov't \$ *100* for

Remarks:

* See enrollment on card from muster-in roll.

Book mark: -----

Rose

(358c)

Copyist.

B | 4 | U.S.C.T.

Thomas Resin Beale
Corp, Co. G, 4 Reg't U. S. Col'd Infantry.

Appears on

Company Muster Roll
for Sept & Oct, 1863

Joined for duty and enrolled:

When Aug 11, 1863*

Where Baltimore City*

Period 3 years.*

Present or absent Present

Stoppage, \$ 100 for _____

Due Gov't \$ 100 for _____

Remarks: _____

* See enrollment on card from muster-in roll.

Book mark: _____

(358c) Rose
Copyist.

B | 4 | U.S.C.T.

Thomas Resin Beale
Corp., Co. G, 4 Reg't U. S. Col'd Infantry.

Appears on

Company Muster Roll
for Novth Dec, 1863

Joined for duty and enrolled:

When Aug 11, 1863

Where Baltimore City *

Period 3 years.*

Present or absent Present

Stoppage, \$ 100 for

Due Gov't \$ 190 for

Remarks: Present sick

* See enrollment on card from muster-in roll.

Book mark:

(358c)

Rose
Copyist.

73

4

U.S.C.T.

Thomas Resin Beale
Corp., Co. G, 4 Reg't U. S. Col'd Infantry.

Appears on

Company Muster Roll

for Jan & Feb, 1864.

Joined for duty and enrolled:

When Aug 11, 1863.*

Where Baltimore City *

Period 3 years.*

Present or absent Present

Stoppage, \$ 100 for _____

Due Gov't \$ 100 for _____

Remarks: _____

* See enrollment on card from muster-in roll.

Book mark: _____

(358c)

Rose

Copyist.

B

4

U.S.C.T.

Thomas Resie Beale

Corp., Co. G, 4 Reg't U. S. Col'd Infantry.

Appears on

Company Muster Roll

for Mar & Apr, 1864

Joined for duty and enrolled:

When Aug 11, 1863*

Where Baltimore Md *

Period 3 years.*

Present or absent Present

Stoppage, \$ 100 for

Due Gov't \$ 100 for

Remarks: Stop one canteen
41/100.

* See enrollment on card from muster-in roll.

Book mark:

ET Richardson

(358c)

Copyist.

B

4

U.S.C.T.

Thomas Resin Beale

Corp., Co. G, 4 Reg't U. S. Col'd Infantry.

Appears on

Company Muster Roll

for May & June, 1864.

Joined for duty and enrolled:

When Aug 11, 1863.*

Where Baltimore Md *

Period 3 years.*

Present or absent Present

Stoppage, \$ 100 for

Due Gov't \$ 100 for

Remarks: Stop / Canteen 41/100.

* See enrollment on card from muster-in roll.

Book mark:

E. T. Richardson

(358c)

Copyist.

B | 4 | U.S.C.T.

Thomas R. Beale

Serjt, Co. G, 4 Reg't U. S. Col'd Infantry.

Appears on

Company Muster Roll

for July & Aug, 1864.

Joined for duty and enrolled:

When Aug 11, 1863.*

Where Baltimore City *

Period 3 years.*

Present or absent Present

Stoppage, \$ 100 for

Due Gov't \$ 100 for

Remarks: Free before April 19/64.
 Promoted to Serjt. vice
 Jackson reduced S. O. 34
 Aug. 26/64. Stop 1 canleen 41/100.
 On extra duty at Dutch
 Gap digging Canal since Aug 26/64.

* See enrollment on card from muster-in roll.

Book mark:

C. J. Richardson

B

4

U.S.C.T.

Thomas R. Beale

Serjt, Co. G, 4 Reg't U. S. Col'd Infantry.

Appears on

Company Muster Roll

for Sept + Oct, 1864

Joined for duty and enrolled:

When Aug 11, 1863*

Where Baltimore *

Period 3 years.*

Present or absent Present

Stoppage, \$ 100 for

Due Gov't \$ 100 for

Remarks: Free before April 19/61, Appointed Corporal Aug 11/61, promoted to sergeant from corporal Aug. 26/61.

* See enrollment on card from muster-in roll.

Book mark:

E. Richardson

(358c)

Copyist.

B

4

U.S.C.T.

Thomas R. Beale

Serjt., Co. G, 4 Reg't U. S. Col'd Infantry.

Appears on

Company Muster Roll

for Nov + Dec, 1864

Joined for duty and enrolled:

When Aug 11, 1863.*

Where Baltimore Md *

Period 3 years.*

Present or absent Present

Stoppage, \$ 100 for

Due Gov't \$ 100 for

Remarks: Free before April 19/61, appointed Corporal Aug. 11/63. Promoted to Serjt. Aug 26/64.

* See enrollment on card from muster-in roll.

Book mark:

E. Richardson

(358c)

Copyist.

B

4

U.S.C.T.

Ressin J. Beall

Srpt; Co. G, 4 Reg't U. S. Col'd Infantry.

Appears on

Company Muster Roll

for Dated Feb 28, 1865.

Joined for duty and enrolled:

When Aug 11, 1863.*

Where Balt Md *

Period 3 years.*

Present or absent Present

Stoppage, \$ 100 for

Due Gov't \$ 100 for

Remarks: Free before Apr 19/61
Appointed Corp Aug 11/63
Promoted to Srpt Aug 26/64

* See enrollment on card from muster-in roll.

Book mark:

Ackerman

(358c)

Copyist.

B | 4 | U.S.C.T.

Kevin J. Beall

Serjt, Co. G, 4 Reg't U. S. Col'd Infantry.

Appears on

Company Muster Roll

for *Mar + Apr*, 1865.

Joined for duty and enrolled:

When *Aug 11*, 1863.*

Where *Balto, Md.* *

Period *3* years.*

Present or absent *Present*

Stoppage, \$ *100* for

Due Gov't \$ *100* for

Remarks: *Back Pay due from May 1/64 to date of enlistment. Promoted Serjt Aug 26/64.*

* See enrollment on card from muster-in roll.

Book mark:

Ackerman

(358c)

Copyist.

B

4

U.S.C.T.

Reson T. Beall

Sergt, Co. G, 4 Reg't U. S. Col'd Infantry.

Appears on

Company Muster Roll

for *May & June*, 1865.

Joined for duty and enrolled:

When *Aug 11*, 1863.*

Where *Balt Md* *

Period *3* years.*

Present or absent *Present*

Stoppage, \$ *100* for

Due Gov't \$ *100* for

Remarks: *Appointed Sergt Aug 26/64. Fall before Apr 19/65. Absent with leave.*

* See enrollment on card from muster-in roll.

Book mark:

A. Kerman

(358c)

Copyist.

B | 4 | U.S.C.T.

Reason F Beall
Sergt, Co. G, 4 Reg't U. S. Col'd Infantry.

Appears on

Company Muster Roll

for July + Aug, 1865.

Joined for duty and enrolled:

When Aug 11, 1863.*

Where Balt, Md, *

Period 3 years.*

Present or absent Present

Stoppage, \$ 100 for

Due Gov't \$ 100 for

Remarks: Promoted to Sergt Aug 26/64, Due U.S. for Trans \$5.00

* See enrollment on card from muster-in roll.

Book mark:

A Kerman
(358c) Copyist.

B | 4 | U.S.C.T.

Reason F. Beall
Sergt Co. G, 4 Reg't U. S. Col'd Infantry.

Appears on

Company Muster Roll

for Sept + Oct, 1865.

Joined for duty and enrolled:

When Aug 11, 1863.*

Where Batt. Ind. *

Period 3 years.*

Present or absent Present

Stoppage, \$ 100 for

Due Gov't \$ 100 for

Remarks: Promoted to Sergt Aug
26/64. Due U.S. for Trans,
\$18.00

* See enrollment on card from muster-in roll.

Book mark:

(358c) A Kerman Copyist.

B | 4 | U.S.C.T.

Reason T Beall
Serg., Co. G, 4 Reg't U. S. Col'd Infantry.

Appears on

Company Muster Roll

for Nov & Dec, 1865.

Joined for duty and enrolled:

When Aug 11, 1863.*

Where Baltimore Md *

Period 3 years.*

Present or absent Present

Stoppage, \$ 100 for

Due Gov't \$ 100 for

Remarks: Promoted Sergt
Aug 26/64. On daily
duty as Regtl. S. Sgt
as Blacksmith

* See enrollment on card from muster-in roll.

Book mark:

T. Johnson
(358c) Copyist.

B | 4 | U.S.C.T.

Reason T Deal

Serg., Co. G, 4 Reg't U. S. Col'd Infantry.

Appears on

Company Muster Roll

for Jan + Feb, 1866.

Joined for duty and enrolled:

When Aug 11, 1863.*

Where Baltimore Md *

Period 3 years.*

Present or absent Present

Stoppage, \$ 100 for _____

Due Gov't \$ 100 for _____

Remarks: _____

NEXT ROLL ON FILE MUSTER OUT.

* ~~See~~ See enrollment on card from muster-in roll.

Book mark: 5-20-083

T. Johnson

(358c)

Copyist.

Bj

4

U.S.C.T.

Reason T Beale

Serg, Co. *G*, 4 Reg't U. S. Col'd Infantry.

Appears on **Co. Muster-out Roll**, dated

Washington D.C. May 4, 1866.

Muster-out to date

May 4, 1866.

Last paid to

Feb 28, 1866.

Clothing account:

Last settled _____, 186 ; drawn since \$ _____ 100

Due soldier \$ *41*⁰¹ / 100; due U. S. \$ _____ 100

Am't for cloth'g in kind or money adv'd \$ _____ 100

Due U. S. for arms, equipments, &c., \$ _____ 100

Bounty paid \$ _____ 100; due \$ *100* 100

Remarks: *Free on or before*

Apr 19/61. Appointed Serg

Aug 26/64 Appointed Corp

Aug 11/63 Difference of

pay due from enlistment

to Apr 19/61

Book mark: *B. 168 V. 11 C. J. 76.*

[Signature]

(361)

Copyist.

89

Deard. George

Co C., 4 U.S. Col'd Inf.

Private

Private

CARD NUMBERS.

1	5550489	26
2	5555313	27
3	5555409	28
4	5555503	29
5	5555678	30
6	5556043	31
7	5550860	32
8	9061895	33
9		34
10		35
11		36
12		37
13		38
14		39
15		40
16		41
17		42
18		43
19		44
20		45
21		46
22		47
23		48
24		49
25		50

Book Mark:

See also

S-1742523 PD m
S-1742307 PD aff

B | 4 | U.S.C.T.

George Beard
, Co. E, 4 Reg't U. S. Col'd Inf.

Appears on
Company Descriptive Book
of the organization named above.

DESCRIPTION.

Age 27 years; height 5 feet 10 inches.
Complexion black
Eyes black, hair black
Where born Ross Co. Ohio.
Occupation laborer

ENLISTMENT.

When Sept 3/64, 18i
Where Circleville, O.
By whom Capt. Rehovy; term 1 y'rs.

Remarks: Discharged for dis-
ability June 26/65.

Beard

B

4

U.S.C.T.

Geo. Beard

Appears with rank of *1st Lt* on

Muster and Descriptive Roll of a Detachment of U. S. Vols. forwarded

for the 4 Reg't U. S. Col'd Infantry, Roll dated

Circleville, O., Sept. 3, 1864.

Where born *Rose Co. Ohio*

Age *27* y'rs; occupation *labourer*

When enlisted *Sept. 3*, 1864.

Where enlisted *Circleville*

For what period enlisted *1* years.

Eyes *black*; hair *black*

Complexion *black*; height *5* ft. *10* in.

When mustered in *Sept. 3*, 1864.

Where mustered in *Circleville*

Bounty paid \$ *100*; due \$ *100*

Where credited

Company to which assigned

Remarks: *Credited to Green Tp. Rose Co. Sub. Dist. No. 56 12th Dist. O*

Book mark:

Hattaway

(339)

Copyist.

B

4

U.S.C.T.

George Beard
Pot

Co. C. 4 Reg't U. S. Col'd Infantry.

Appears on

Company Muster Roll

for Nov & Dec, 1864.

Present or absent Present

Stoppage, \$ 100 for

Due Gov't, \$ 100 for

Remarks:

Book mark:

Geo Davis

Copyist.

(858)

B

4

U.S.C.T.

George Beard

Pvt, Co. C. 4 Reg't U. S. Col'd Infantry.

Appears on

Company Muster Roll

for *James T. Feby*, 1865-

Present or absent *Present*

Stoppage, \$ *100* for

Due Gov't, \$ *100* for

Remarks: *Stop wages 20/100
wrench 23/100-*

Book mark:

(858)

Permittor

Copyist.

B

4

U.S.C.T.

George Beard

Pvt, Co. C. 4 Reg't U. S. Col'd Infantry.

Appears on

Company Muster Roll

for *Wch + Aprie*, 1865.

Present or absent *Absent*

Stoppage, \$ 100 for

Due Gov't, \$ 100 for

Remarks: *Sick in Hospital
Stop wages and wages
43/100 -*

Book mark:

Permyington

(858)

Copyist.

B

4

U.S.C.T.

George Beard

Pvt., Co. C. 4 Reg't U.S. Col'd Infantry.

Appears on

Company Muster Roll

for May & June, 1865.

Present or absent

Stoppage, \$ 100 for

Due Gov't, \$ 100 for

Remarks: Mustered out of service at Goldsboro N.C. Under the Provisions of G.O. No. 34, Dated Hd. Qrs. Dept. A.C. May 8th 1865.

Book mark:

Perrington
Copyist.

(358)

B. | 4 | U.S.C.T.

George Beard
Put. *N.C.*, Co. *C*, 4 Reg't U. S. Col'd Infantry.

Appears on Co. Muster-out Roll, dated
Washington, D.C., May 4, 1866.

Muster-out to date _____, 186 .

Last paid to _____, 186 .

Clothing account:

Last settled _____, 186 ; drawn since \$ _____ 100

Due soldier \$ _____ 100; due U. S. \$ _____ 100

Am't for cloth'g in kind or money adv'd \$ _____ 100

Due U. S. for arms, equipments, &c., \$ _____ 100

Bounty paid \$ _____ 100; due \$ _____ 100

Remarks: *Discharged June 26/65, at Goldsboro, N.C. by G.O. No 37. Had Ins Dept N.C. for disability.*

Book mark: *V 225 - P. 240, 76.*

(861)

R. Johnson
Copyist.

73 | 4 | U.S.C.T.

George Beard
Pt. Co. 4 Reg't U. S. Col'd

Appears on a
Detachment Muster-out Roll

of the organization named above. Roll dated
Goldstons NC June 26 1865.

Muster-out to date June 26 1865.

Last paid to
Pay due from Enlistment 1865

Clothing account:
Last settled 186 ; drawn since \$ 100
Due soldier \$ 100; due U. S. \$ 100
Am't for cloth'g in kind or money adv'd \$ 100

Due U. S. for arms, equipments, &c., \$ 100

Bounty paid \$ 100 due \$ 66 ⁶⁶/₁₀₀

Remarks: 1st & 2^d Instalment Bounty, under G.O. 224 series of 64. Cloth ing account never settled. Cloth ing drawn since Enrollment 1864. Due sutler W. L. Cooper 4. U. S. C. T. \$10.00 Patient in over

Book mark:

Jacobson

JAN. 19

5550860

☆ 1891 ☆

Hospital Mustered Out under
G.O. 37, Hd Qrs Dept of N.C.
May 5/65. Transportation
due from place of dis-
charge to place of Enroll-
ment

90
Beard, John
Co 26, 4 U.S. Col'd Inf.

Private | Private

CARD NUMBERS.

1	5550490	26
2	5363557	27
3	5363654	28
4	5563822	29
5	5364316	30
6	9062670	31
7		32
8		33
9		34
10		35
11		36
12		37
13		38
14		39
15		40
16		41
17		42
18		43
19		44
20		45
21		46
22		47
23		48
24		49
25		50

Book Mark: E 12 P 283

See also

B. | 4 | U.S.C.T.

John Beard
 _____, Co. A, 4 Reg't U. S. Col'd Inf.

Appears on
Company Descriptive Book
 of the organization named above.

DESCRIPTION.

Age 34 years; height 5 feet 8 inches.
 Complexion Blk
 Eyes Blk; hair Blk
 Where born Ross Co. O.
 Occupation Laborer

ENLISTMENT.

When Sept 3, 1864.
 Where Circleville, O.
 By whom Capt G M Roby term 1 yrs.

Remarks:
Died at Point of
Rocks Va January 26/65

Selah

B | 4 | U.S.C.T.

John Beard
Private, Co. H, 4 Reg't U. S. Col'd Infantry.

Appears on

Company Muster Roll
for Nov. & Dec., 1864.

Joined for duty and enrolled:

When Sept. 3, 1864.*

Where Circleville, O. *

Period 1 years.*

Present or absent Absent

Stoppage, \$ 100 for

Due Gov't \$ 100 for

Remarks: Absent sick

* See enrollment on card from muster-in roll.

Book mark:

(358c)

C. F. Thompson
Copyist.

B | 4 | U.S.C.T.

John Beard

Pvt., Co. H, 4 Reg't U. S. Col'd Infantry.

Appears on

Company Muster Roll

for *Jan & Feb*, 1865.

Joined for duty and enrolled:

When *Sept 3*, 1864.*

Where *Circleville O* *

Period *1* years.*

Present or absent *Not stated*

Stoppage, \$ *100* for

Due Gov't \$ *100* for

Remarks:

* See enrollment on card from muster-in roll.

Book mark:

Bowman

B | 4 | U.S.C.T.

John Beard

Pvt, Co. H, 4 Reg't U. S. Col'd Infantry.

Appears on

Company Muster Roll

for *Mar & Apr*, 1865.

Joined for duty and enrolled:

When *Sept-3*, 1864.*

Where *Circleville O* *

Period *1* years.*

Present or absent.....

Stoppage, \$ *100* for.....

Due Gov't \$ *100* for.....

Remarks: *Died Jan 16. 1865 at Point of Rocks Va. of disease. Due Sutter \$2.00*

* See enrollment on card from muster-in roll.

Book mark: *Died Jan 23/65 E.B. 12/283*

Bowman

B | 4 | U.S.C.T.

John Beard

Appears with rank of *Pvt* on

Muster and Descriptive Roll of a Detachment of U. S. Vols. forwarded

for the 4 Reg't U. S. Col'd Infantry. Roll dated

Circleville, O., Sept. 3, 1864.

Where born *Ross Co. Ohio*

Age *34* y'rs; occupation *labourer*

When enlisted *Sept. 3*, 1864.

Where enlisted *Circleville*

For what period enlisted *1* years.

Eyes *black*; hair *black*

Complexion *black*; height *5* ft. *8* in.

When mustered in *Sept. 3*, 1864.

Where mustered in *Circleville*

Bounty paid \$ *100*; due \$ *100*

Where credited

Company to which assigned

Remarks: *Credited to Green Tp. Ross Co. Sub Dist. No. 56 12th Dist. O.*

Book mark:

Hathaway

(339)

Copyist.

13. | 4 | U.S.C.T.

John Beard,
Private, Co. H., 4 Reg't U. S. Col'd Infantry.

Appears on **Co. Muster-out Roll**, dated
Washington, D.C. May 4, 1866.

Muster-out to date _____, 186 .

Last paid ~~to~~ *Pay due from enroll't, 186* .

Clothing account:

Last settled _____, 186 ; drawn since \$ _____ 100

Due soldier \$ _____ 100 ; due U. S. \$ _____ 100

Am't for cloth'g in kind or money adv'd \$ _____ 100

Due U. S. for arms, equipments, &c., \$ _____ 100

Bounty paid \$ _____ 100 ; due \$ _____ 100

Remarks: *Died of disease Jan'y*
22, 1865 at Point of Rocks, Va.

Book mark: _____

(861)

R. D. Drummer

Copyist.

Beard, John

, Co. H, 4 Reg't USCG

5 Enclosures.

Bed Cards	Descriptive Lists
Burial Records	Final Statements 1
Certs. of Dis. for Discharge	Furloughs
C. M. Charges	Med. Des. Lists
Med. Certificates	Orders

Other papers relating to—

Admission to Hosp'l	Furlough
Casualty Sheet (Officer's) 1	Med. Examination
Confinement	Misc. Information 1
Contracts	Pay or Clothing
Death or Effects 2	Personal Reports
Desertions	Rank
Discharge from Hosp'l	Transfer to Hosp'l
Discharge from Service	Transfer to V. R. C.
Duty	Transportation

2/20/11 - 2nd Lt. John Beard

CASUALTY SHEET

No. _____

John Beard

of Company

B

4th Regiment of

W.V.A.

State Volunteers.

NATURE OF CASUALTY.

CASUALTY SHEET.

Name: John Beard
 Rank: U.S.A. Company: H Regiment: 4
 Arm: U.S.A. State: Death
 Nature of Casualty: Death

CAUSE OF CASUALTY—(NAME OF DISEASE, &C.)

Dysphoid Fever

DEGREE OF DISABILITY.

BY WHOM CERTIFIED.

H. D. Fowler
Surg 12 N.H. Vols

DATE OF DISCHARGE, DEATH, &C.

Jan. 22, 1865,

PLACE OF DISCHARGE, DEATH, &C.

Coast of Rockport, ^{Hape}

BY WHOM DISCHARGED.

FROM WHAT SOURCE THIS INFORMATION WAS OBTAINED.

Inw. of effects by U.S. ^{Coast} furnished by U.S. ^{Coast} Ansland Womner, 57

REMARKS.

~~Unofficial~~
Inw. of effects sent ^{2d} Aug Oct. 25th
J. B. J.
Clerk.

INVENTORY OF THE EFFECTS

OF

John Beard

Late of Company "H."

4th Reg't of U.S.C.T.

Volunteers, who died at *H of Rock's Hospital*

on the 22nd day of *January* 1865..

Inventory of the effects of John Beard late
a Private of Captain _____ Company "H" of
the 4th Regiment of A. S. C. T. Volunteers, who was enrolled as
a _____ at _____ in the State of _____ on
the _____ day of _____ 186____, and mustered into the service of the United
States as a _____ on the _____ day of _____ 186____, at _____
in Company _____, _____ Regiment of _____ Volunteers, to serve _____
years or during the war; he was born in _____ in the State
of _____: he was _____ years of age, _____ feet _____ inches
high, N complexion, _____ eyes, _____ hair, and by occupation, when enrolled,
a _____; he died in Point of Rocks Hospital, at
Point of Rocks Va on the 22nd day of January 1865, by
reason of "Typhoid Fever"

INVENTORY.					
ARTICLES.	No.	ARTICLES.	No.	ARTICLES.	No.
Hats.....		Pairs trousers.....		Knapsacks.....	/
Caps.....	/	Pairs flannel drawers.....			
Forage Caps.....		Pairs cotton drawers.....	/		
Great coats.....	/	Flannel shirts.....			
Uniform coats.....		Cotton shirts.....			
Uniform jackets.....		Pairs boots.....			
Flannel sack coats.....		Pairs shoes.....			
Blouses.....	/	Pairs socks.....			
Stable frocks.....		Blankets.....			
Fatigue overalls.....		Haversacks.....			
				MONEY.	
				Specie.....	\$
				Notes.....	\$

I CERTIFY, ON HONOR, that the above inventory comprises all the effects of Private
John Beard, deceased, and that the effects are in the hands
of Surg H. B. Fowler at Point of Rocks Hospital Va
to be disposed of by a Council of Administration.

(DUPLICATES.)

STATION: Point of Rocks Va

DATE: January 23rd 1865

[A. G. O. No. 104]

H. B. Fowler
Surg 12th N. H. Vols.
Commanding the Company.
In charge.

Inventory of the effects of
Private John Beard, late of
Co "H" 4th U. S. Colored Troops, who died
at Point of Rocks Hospital Va. on the
22^d day of January 1865.

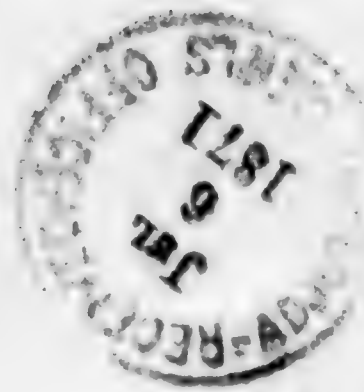

Inventory of the effects of John Beard late a Private of 1st Lieut J. W. Reynolds Co "H" of the 4th U.S. Col. Troops, who was enrolled as a Recruit at Circleville in the State of Ohio, on the 3rd day of September 1864. and mustered into the service of the United States as a Recruit on the 3rd day of September 1864. at Circleville O. in Company "H" 4th U.S. Col. Troops. to One Year; he was born in Ross County State of Ohio, he was 34 years of age, 5 feet 8 inches high Black complexion, Gray eyes, curly hair, and by occupation when enrolled a Laborer; he died in Point of Rocks Hospital Point of Rocks Va. on the 22nd day of January, 1865. by reason of Typhoid Fever.

Inventory

Articles	No	Articles	No
Forage Caps	1	Great Coats	1
Flannel Jack coats	1	Knapsacks	1
Pairs cotton drawers	1		

I certify, on honor, that the above inventory comprises all the effects of Private John Beard deceased, and that the effects are in the hands of Surgeon in Charge of Point of Rocks Hospital Point of Rocks Va to be disposed of by a Council of Administrators -

(Duplicates.)

Station North East Station A. C.
Date March 13th 1865.

J. W. Reynolds
1st Lieut 4th U.S. Col. Troops,
Comdg Company "H"

125
A. S. G. June 15, 1865
Proof of A. S. G. & Co.
recd. for \$1,335 out 2
Auditor

FINAL STATEMENT

OF

Private John Beard
Co. H, 4th Reg't of Colored Troops

~~VOLUNTEERS.~~

Died Jan'y 22^d 1865

NOTE 1.—Two of these certificates (or duplicates) are to be given to each Volunteer Soldier or drafted man who may be discharged previously to the discharge of his company, that he may at once receive from the Paymaster the pay, &c., due him, and the captain or other COMMISSIONED officer commanding the company will certify to the act of the delivery of the duplicate certificates; on these certificates the Soldier is "entitled to" his discharge, and should also present his discharge to the Paymaster to have the payment endorsed on it. The discharge is to be given back to the Soldier by the Paymaster; the latter only retaining as his voucher the duplicate certificates.

NOTE 2.—If the Soldier is entitled to pay for the use of his horse, the Company Commander will certify to that fact on the back of both these final statements, and also to the time he has pay due for having been so mounted on his own horse.

NOTE 3.—When a Soldier is furnished with final statements, his descriptive list, if he has one, should be taken up by the officer who gives the Soldier these statements, and endorsed with a statement to this effect by the officer. This endorsement should exhibit a full statement of the time for which the Soldier was allowed pay on his final statements, the clothing account, and all other charges against him or in his favor, so as to comprise a complete exhibit of his account. It will then be transmitted to the company commander of the Soldier, who will enter all the data necessary to a full understanding of the Soldier's account on the muster roll upon which the Soldier's discharge is reported. The descriptive list will then be destroyed. The object of this is, that the remaining portion of the Soldier's account may be settled upon the receipt of these muster rolls, and the Soldier receive any pay or allowances that may be due him at the time of his discharge, and which may not appear on his final statements from the fact that his descriptive list is incomplete. These accounts for back pay, &c., are settled by the 2d Auditor of the Treasury Department.

NOTE 4.—Charges for loss or injury to ordnance, horse equipments, and other miscellaneous charges, should appear under the heading of "Other Stoppages."

NOTE 5.—Bounty paid by State authorities, and not by the United States, will not be entered on this statement.

NOTE 6.—Amounts due the Sutler and Laundress must be entered on the muster roll on which the discharge, death, desertion, &c., is reported, as well as on the final statement, otherwise the amount cannot be collected from the United States.

NOTE 7.—This blank will be used for deceased volunteers and drafted men, as well as for others.

NOTE 8.—Where a Soldier dies in Hospital or on detached service, his descriptive list, if he has one, should be sent with his final statements, in duplicate, to the Adjutant General, Washington, D. C.

cut on 22 of Aug
DMM
ADJUTANT GENERAL'S OFFICE
WASHINGTON, D. C.

[OFFICE ENDORSEMENT.]

War Department,

ADJUTANT GENERAL'S OFFICE,

March 26th, 1871

The Death of John Beard, Co. H, 4th Reg't U. S. Colored Troops, is reported as follows:

On Company Muster Roll.
For March & April, 1865, January 16, 1865
Company Muster-out Roll.
January 22^d

Company Descriptive Book. 1865

Company Morning Reports. 1865

Soldier's Final Statement. /
January 22^d, 1865

Soldier's Record of Death and Interment. 1865

Soldier's Inventory of Effects. 1865

Soldier's Certificate of Disability for Discharge. 1865

Soldier's Individual Muster-out Roll. 1865

Regimental Return.
For March, 1865, January 22, 1865

Regimental Quarterly Returns. 1865

Regimental Descriptive Book. 1865

By Surgeon General.

() January 22, 1865, is held to be

the correct date, and the Company Muster

Roll will be amended accordingly.

Thomas M. Frewent

Assistant Adjutant General.

Noted 26, 11,

ADJUTANT GENERAL'S OFFICE.

March 22^d 1865

Duplicate with Inventory sent 2d Auditor.

Said John Beard is credited on the quota of New Township. Rec'd by C. Sub. Dist. 56-12th Dist. C.

I certify, on honor, that John Beard a Private of
 #1st Lieut J. W. Reynolds Company (H) of the 4th Regiment of U. S. Colored Troops
VOLUNTEERS, of the State of _____, born in Ross County, State
 of Ohio, aged 34 years; 5 feet 8 inches high; Black complexion,
Black eyes, Black hair, and by occupation a Laborer, having joined the company on
 its original organization at _____, and enrolled in it at the muster into
 the service of the United States at _____, on the _____ day
 of _____, 186____, (or was mustered in service as a recruit, by Captain
S. W. Roby, at Busckville Ohio, on the Third day of September,
 1864, or was drafted and mustered into the service of the United States from the _____
 Enrollment District of the State of _____, at _____,
 on the _____ day of _____, 186____) to serve in the Regiment, for
 the term of One Year; and having served **HONESTLY** and
FAITHFULLY with his Company in the field in Virginia to the present date, is now
 entitled to a **DISCHARGE** by reason of died in Point of Rock Hospital
Point of Rock Va. of Typhoid Fever - January 22^d 1865

The said Private John Beard ^{has never paid.} was last paid by Paymaster
 _____ to include the _____ day of _____, 186____, and has
 pay due him from ^{enlistment} ~~that time to the present date~~; he is entitled to pay and subsistence for
TRAVELING to place of enrollment, and whatever other allowances are authorized to volunteer
 soldiers, drafted men, or militia, so discharged. He has received from the United States **CLOTHING**
 amounting to Thirty-one ⁴⁷/₁₀₀ dollars, since the _____ day of Enlistment,
 186____, when his clothing account was last settled. He has received from the United States
 _____ dollars advanced **BOUNTY**.

There is to be stopped from him, on account of the State of _____, or other
 authorities, for **CLOTHING**, &c., received on entering service, _____ dollars; and
 for other stoppages, viz: _____
 _____ dollars.

He has been furnished with **TRANSPORTATION** in kind from the place of his discharge to
 _____; and he has been **SUBSISTED** for **TRAVELING** to his
 place of enrollment, up to the _____, 186____.

He is indebted to W. C. Cooper 4th Reg. C. T., **SUTLER**, Two ⁰⁰/₁₀₀ dollars.
 He is indebted to _____, **LAUNDRESS**, _____ dollars.

Given in Duplicate, at North East Station N. C., this 13th day
 of March, 1865.

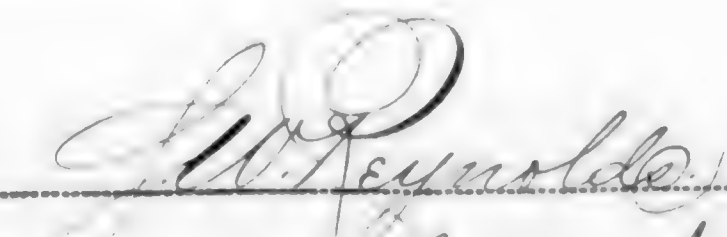

 1st Lieut 4th Reg. C. T.
 Commanding Company "H"

Medical Director Office.
Department of the Army
Richmond Va. Oct 23. 1866

Respectfully returned,
with copy of Inventory
of effects. There are no
data from which final
statements can be furnished.

J. S. ...
Brig. Gen. U. S. Army
Medical Director

7/10/66

4

7/10/66

NARA 69

WAR DEPARTMENT,

ADJUTANT GENERAL'S OFFICE,

WASHINGTON, *Oct. 5*, 1866

SIR:

Final Statements in the cases of deceased soldiers are required to be sent to the Adjutant General's Office in duplicate, with one copy of the Inventory of Effects. The Descriptive List should also be sent to this Office in cases where the soldier was absent from his Company at the time of his death. Where there were no effects, it should be so stated on a blank Inventory, properly signed.

Certificates of Disability should be sent in duplicate. Special care should be taken that the date of discharge and signature of the discharging officer should be affixed.

cho of the Final Statement *or* Inventory, has been received in the case of *John Beard*, of Co. *26*, *4*" Regiment of *U.S.C. 5*, Volunteers, whose papers were forwarded to this Office. You will please forward the missing papers without delay.

I have the honor to be, sir,

Very respectfully,

Your obedient servant,

*Unofficially reported
Buried Point of Rocks. Va*

Edw. Haggard

Assistant Adjutant General.

(110)

~~COMMANDING OFFICER~~

*Medical Director
Dept. of the Potomac*

J.S.

MODEL FOR SET OF PAPERS FOR A DECEASED SOLDIER.

FORM 1.—FINAL STATEMENT.

I CERTIFY, ON HONOR, that *John Smith*, a Private of Captain *J. Brown's* Company, (A.) of the 1st Regiment of Pennsylvania Volunteers, of the State of Pennsylvania, born in *Pittsburg*, State of Pennsylvania, aged *21* years, *5* feet *10* inches high, light complexion, blue eyes, dark hair, and by occupation a *Farmer*, having joined the Company on its original organization at *Pittsburg*, and enrolled in it at the muster into the service of the United States at *Pittsburg*, on the 1st day of *July*, 1861, (or was mustered in service as a recruit, by _____, at _____, on the _____ day of _____, 186—, or was drafted and mustered into the service of the United States from the _____ Enrollment District of the State of _____, at _____, on the _____ day of _____, 186—,) to serve in the Regiment for the term of *Three* Years, and having served *honestly* and *faithfully* with his Company in the field to the present date, is now entitled to a **DISCHARGE** by reason of death. Died in Regimental Hospital, Fort Brown, Texas, December 31, 1863, of typhoid fever.

The said *John Smith* was last paid by Paymaster *Major Morse*, to include the 31st day of *October*, 1863, and has pay due him from that time to the present date. He is entitled to pay and subsistence for *traveling* to place of enrollment, and whatever other allowances are authorized to volunteer soldiers, drafted men, or militia, so discharged. He has received from the United States clothing amounting to *20.00* dollars, since the 31st day of *December*, 1862, when his clothing account was last settled. He has received from the United States *25.00* dollars advanced *bounty*.

There is to be stopped from him on account of the State of _____, or other authorities, for *clothing*, &c., received on entering service, nothing, *1.00* dollars; and for other stoppages, viz: nothing, *1.00* dollars. He has been furnished with no *transportation* in kind from the place of his discharge to _____; and he has not been *subsidized* for *traveling* to his place of enrollment up to the _____, 186—.

He is indebted to _____, *Sutler*, _____ dollars.
 He is indebted to _____, *Laundress*, _____ dollars.

GIVEN, IN DUPLICATE, at Fort Brown, Texas, this 31st day of *December*, 1863.

JAMES BROWN,
Captain Co. A, 1st Penn. Vols.,
Commanding Company.

FORM 2.

INVENTORY of the effects of *John Smith*, late a Private of Captain *J. Brown's* Company, (A.) of the 1st Regiment of Pennsylvania Volunteers, who was enrolled as a Private at *Pittsburg*, in the State of Pennsylvania, on the 1st day of *July*, 1861, and mustered into the service of the United States as a Private on the 1st day of *July*, 1861, at *Pittsburg*, in Company A, 1st Regiment of Pennsylvania Volunteers, to serve three years or during the war. He was born in *Pittsburg*, in the State of Pennsylvania; he was *21* years of age, *5* feet *10* inches high, light complexion, blue eyes, dark hair, and by occupation, when enrolled, a *Farmer*. He died in Regimental Hospital, at Fort Brown, Texas, on the 31st day of *December*, 1863, of typhoid fever.

INVENTORY.			
ARTICLES.	No.	ARTICLES.	No.
Hats.....		Pairs trowsers.....	
Cups.....		Pairs flannel drawers.....	
Forage caps.....		Pairs cotton drawers.....	
Great coats.....	1	Flannel shirts.....	1
Uniform coats.....		Cotton shirts.....	
Uniform jackets.....		Pairs boots.....	
Flannel sack coats.....		Pairs shoes.....	
Blouses.....		Pairs socks.....	
Stable frocks.....		Blankets.....	
Fatigue overalls.....		Haversacks.....	
		MONEY.	
		Specie.....	\$2 00
		Notes.....	\$50 00

I CERTIFY, ON HONOR, that the above inventory comprises all the effects of Private *John Smith*, deceased, and that the effects are in the hands of Captain *J. Brown*, at Fort Brown, Texas, to be disposed of by a Council of Administration, except the money, which has been turned over to Major *Wm. C. Morse*, Paymaster, U. S. Army, whose receipt is hereto annexed.

STATION: Fort Brown, Texas.
 DATE: December 31, 1863.
 (Duplicates.)

JAMES BROWN,
Captain Co. A, 1st Penn. Vols.,
Commanding the Company.

*NOTE.—If the effects have been turned over to relatives of deceased, so state on certificate, instead of "in the hands of Captain," &c., and give the names of the persons, and their relation to the deceased person.

FORM 3.—HEIR'S RECEIPT FOR EFFECTS.

RECEIVED of Captain *John Brown*, Company A, 1st Regiment of Pennsylvania Volunteers, the following effects of Private *John Smith*, late of Company A, 1st Regiment of Pennsylvania Volunteers, now deceased, which I claim as his wife:

1 great coat, 1 flannel shirt, 1 silver watch, fifty dollars in notes, and two dollars in specie.

MARY SMITH.

FORM 4.—PAYMASTER'S RECEIPT FOR MONEY.

RECEIVED, this 31st day of *December*, 1863, at Fort Brown, Texas, of Captain *James Brown*, of Company A, 1st Pennsylvania Volunteers, fifty dollars in Treasury notes and two dollars in specie, the property of the late Private *John Smith*, of Company A, 1st Pennsylvania Volunteers, who died at Fort Brown, Texas, on the 31st day of *December*, 1863.

WM. C. MORSE, Paymaster, U. S. A.

FORM 5.—PROCEEDINGS OF A COUNCIL OF ADMINISTRATION.

Convened at Fort Brown, Texas, pursuant to Orders, No. 1, dated Post Headquarters, Fort Brown, Texas, January 2, 1864—consisting of Captain *James Keith*, Company C, 1st Pennsylvania Volunteers; Captain *John Brown*, Company D, 1st Pennsylvania Volunteers; and Lieutenant *William Roe*, Company E, 1st Pennsylvania Volunteers—for the purpose of disposing of the effects of the late *John Smith*, of Company A, 1st Pennsylvania Volunteers:

The Council found that the effects consisted of the following articles. They were ordered to be sold at auction, which was accordingly done, and the amount set opposite the articles respectively obtained, for which the receipt of the Paymaster is annexed:

AT AUCTION.

1 shirt brought.....	\$1 00
1 great coat ".....	2 50
1 silver watch ".....	25 00
	\$28 50

JAMES KEITH,
Capt. Co. C, 1st Penn. Vols., President.
 WILLIAM ROE,
Lieut. Co. E, 1st Penn. Vols., Recorder.

APPROVED:

JOHN SANDERS,
Colonel 1st Penn. Vols.,
Commanding Post.

FORM 6.—PAYMASTER'S RECEIPT.

RECEIVED from Captain *John Brown*, Company A, 1st Pennsylvania Volunteers, at Fort Brown, Texas, January 10, 1864, twenty-eight dollars and fifty cents, the result of the sale of the effects of the late Private *John Smith*, of Company A, 1st Pennsylvania Volunteers.

WM. C. MORSE, Paymaster U. S. Army.

ARTICLES OF WAR.

ART. 95. When any non-commissioned officer or soldier shall die, or be killed in the service of the United States, the then commanding officer of the troop or company shall, in the presence of two other commissioned officers, take an account of what effects he died possessed of, above his arms and accoutrements, and transmit the same to the office of the Department of War, which said effects are to be accounted for, and paid to the representatives of such deceased non-commissioned officer or soldier. And in case any of the officers, so authorized to take care of the effects of deceased officers and soldiers, should, before they have accounted to their representatives for the same, have occasion to leave the regiment or post, by preference or otherwise, they shall, before they be permitted to quit the same, deposit in the hands of the commanding officer, or of the assistant military agent, all the effects of such deceased non-commissioned officers and soldiers, in order that the same may be secured for, and paid to, their respective representatives.

DIRECTIONS.

NOTE 1.—One copy of the inventories of the effects of deceased non-commissioned officers and soldiers, required by the 95th Article of War, will be forwarded to the Adjutant General, by the commander of the company to which the deceased belonged, and a duplicate of the same to the colonel of the regiment. Final statements of pay, clothing, &c., in duplicate, will be sent to the Adjutant General with one copy of the inventory. Both inventory and final statements should be forwarded, as a general rule, through Regimental Headquarters. When a soldier dies at a post or station absent from his company, it will be the duty of his immediate commander to furnish, direct to the Adjutant General, a report of his death, specifying the date, place, and muster roll of the company to which the man belonged. Each inventory will be endorsed "Inventory of the effects of _____, late of company _____, regiment of _____, who died at _____ the _____ day of _____, 186—." If a legal representative receive the effects, it will be stated in the report. If the soldier leave no effects, the fact will be reported on the blank for inventory.

NOTE 2.—Should the effects of a deceased non-commissioned officer or soldier not be administered upon within a short period after his decease, they shall be disposed of by a Council of Administration under the authority of the commanding officer of the post, and the proceeds deposited with the Paymaster, to the credit of the United States, until they shall be claimed by the legal representatives of the deceased. This should be done according to Forms 5 and 6, and one copy of each sent to the Adjutant General. No copy of the order convening the board is required, the approval of the commanding officer being sufficient.

NOTE 3.—In all such cases of sales by the Council of Administration, a statement in detail, or account of the proceeds duly certified by the Council and commanding officer, (Form 5) accompanied by the Paymaster's receipt of the proceeds, will be forwarded by the commanding officer to the Adjutant General. The statement will be endorsed "Report of the proceeds of the effects of _____, late of company _____, regiment of _____, who died at _____ the _____ day of _____, 186—."

NOTE 4.—The effects in all cases, when called for, should be turned over to the legal representative, without further authority from the Adjutant General. When the effects are turned over to the relatives of the deceased before these inventories are sent to the Adjutant General, their receipts therefor should be attached to the inventories. In all other cases, one copy will be sent with a letter of transmittal direct to the Adjutant General, and a duplicate retained by the officer.

NOTE 5.—Particular care should be taken to take receipts in duplicate from the Paymaster for any funds turned over to him; one copy should be sent direct to the Adjutant General, and one retained by the officer.

NOTE 6.—Where a soldier dies in hospital or on detached service, his descriptive list, if he has one, should be sent with his final statements, in duplicate, to the Adjutant General, Washington, D. C.

NOTE 7.—Form 1 will be forwarded in duplicate to the Adjutant General, through Regimental Headquarters, as soon as possible after the death of the soldier, accompanied by one copy of Forms 2 and 3, or 4, as the case may require. A duplicate of the inventory (Form 2) should be retained until the articles are finally disposed of.

NOTE 8.—The papers for each man should be made SEPARATELY for each man, and, when possible, fastened together. This is especially necessary, and must be done in all cases. The papers cannot be properly disposed of at the Adjutant General's Office unless this is done, and must be returned for correction.

NOTE 9.—Where there are no line officers, as for instance, a general hospital without a line officer to command the guard, the Council of Administration may be made up from other commissioned officers, in the same way as prescribed for line officers.

NOTE 10.—Where a soldier dies away from his company or regiment, and the officer having charge of him cannot furnish Final Statements by reason of not being able to obtain a Descriptive List, he should notify the regimental or company commander, (giving him full particulars as to history and description of the man, as far as possible), whose duty it will then be, in such case, to furnish the necessary papers from the best data he can obtain.

Beard, William H.

Co G, 4 U.S. Col'd Inf.

Private

Private

CARD NUMBERS.

1	55-61004	26
2	55-61103	27
3	55-61204	28
4	55-61304	29
5	55-61403	30
6	55-61501	31
7	55-61599	32
8	55-61692	33
9	55-61779	34
10	55-61867	35
11	55-61958	36
12	55-62047	37
13	55-62147	38
14	55-62242	39
15	55-62339	40
16	55-62427	41
17	55-62552	42
18	55-62685	43
19	9062418	44
20	31633882	45
21	31635088	46
22	31636338	47
23	31636986	48
24	31638719	49
25	40757411	50

Book Mark:

See also:

83181413 Phil
A.S. 201. 114/36 CER.

B

4

U.S.C.T.

William H. Beard

, Co. ^G, 4 Reg't U. S. Col'd Inf.

Appears on

Company Descriptive Book

of the organization named above.

DESCRIPTION.

Age 21 years; height 5 feet 8 inches.

Complexion L. Brown

Eyes Black; hair Black

Where born Balt. Co. Md.

Occupation Farmer

ENLISTMENT.

When May 11, 1863

Where Balt. Md.

By whom Col. Binney; term 3 y'rs.

Remarks: Deserted from Summit House
Hosp. Phila. Penn. Jan 22/65

W. H. Merrill

(383a)

Copyist.

B | 4 | U.S.C.T.

Wm H Beard

Plt, Co. *G*, 4 Reg't U. S. Col'd Infantry.

Age *21* years.

Appears on

Company Muster-in Roll

of the organization named above. Roll dated

Baltimore Md, *Aug 11*, 186*3*

Muster-in to date *Aug 11*, 186*3*

Joined for duty and enrolled:

When *Aug 11*, 186*3*

Where *Baltimore City*

Period *3* years.*

Remarks:

* *45* Muster-in roll shows enrollment and muster-in of this company as of same date and place. See enrollment on subsequent card or cards.

Book mark: _____

Rose

B | 4 | U.S.C.T.

William N Beard

Priv., Co. G, 4 Reg't U. S. Col'd Infantry.

Appears on

Company Muster Roll

for Aug 11 to 31, 1863

Joined for duty and enrolled:

When Aug 11, 1863

Where Baltimore City *

Period 3 years.*

Present or absent Present

Stoppage, \$ 100 for

Due Gov't \$ 100 for

Remarks:

* See enrollment on card from muster-in roll.

Book mark:

Rose

(358c)

Copyist.

23 | 4 | U.S.C.T.

William W Beard
Priv., Co. G, 4 Reg't U. S. Col'd Infantry.

Appears on

Company Muster Roll
for Sept and Oct, 1863.

Joined for duty and enrolled:

When Aug 11, 1863.*

Where Baltimore City *

Period 3 years.*

Present or absent Present

Stoppage, \$ 100 for _____

Due Gov't \$ 100 for _____

Remarks: _____

* See enrollment on card from muster-in roll.

Book mark: _____

(358c)

Rose

Copyist.

B | 4 | U.S.C.T.

William H Beard
Priv, Co. G, 4 Reg't U. S. Col'd Infantry.

Appears on

Company Muster Roll
for *Nov and Dec*, 186*3*.

Joined for duty and enrolled:

When *Aug 11*, 186*3*.*

Where *Baltimore City* *

Period *3* years.*

Present or absent *Present*

Stoppage, \$ *100* for _____

Due Gov't \$ *100* for _____

Remarks: _____

* See enrollment on card from muster-in roll.

Book mark: _____

Rose

B

4

U.S.C.T.

William H Beard
Pat, Co. G, 4 Reg't U. S. Col'd Infantry.

Appears on

Company Muster Roll
for *Jan & Feb*, 186 *4*.

Joined for duty and enrolled:

When *Aug 11*, 186 *3**

Where *Baltimore City* *

Period *3* years.*

Present or absent *Present*

Stoppage, \$ *100* for

Due Gov't \$ *100* for

Remarks:

* See enrollment on card from muster-in roll.

Book mark: _____

Rose

(358c)

Copyist.

B | 4 | U.S.C.T.

William H. Beard
Priv., Co. G, 4 Reg't U. S. Col'd Infantry.

Appears on

Company Muster Roll
for Mar & Apr, 1864.

Joined for duty and enrolled:

When Aug 11, 1863.*

Where Baltimore Md.*

Period 3 years.*

Present or absent Present

Stoppage, \$ 100 for

Due Gov't \$ 100 for

Remarks:

* See enrollment on card from muster-in roll.

Book mark:

E. J. Richardson
(358c) Copyist.

B

4

U.S.C.T.

W^m H. Beard

Priv., Co. G, 4 Reg't U. S. Col'd Infantry.

Appears on

Company Muster Roll

for May June, 1864.

Joined for duty and enrolled:

When Aug 11, 1863.*

Where Baltimore Md *

Period 3 years.*

Present or absent Not stated

Stoppage, \$ 100 for

Due Gov't \$ 100 for

Remarks:

* See enrollment on card from muster-in roll.

Book mark:

E. Richardson

(358c)

Copyist.

B 1 4 MSC

Wm H. Bird

PT, Co. G, 4 Reg't USC

Appears on

Hospital Muster Roll

of Summit House U. S. A. General Hospital,

at Philadelphia, Pa.,

for July & Aug, 1864

Attached to hospital:

When, 186 .

How employed

Last paid by Maj.

to, 186 .

Bounty paid \$ 100; due \$ 100

Present or absent Present

Remarks:

Stand 10

Book mark:

(843)

J. Anderson

Copyist.

B

4

U.S.C.T.

W^m H. Beard

Priv., Co. G, 4 Reg't U. S. Col'd Infantry.

Appears on

Company Muster Roll

for July + Aug, 1864.

Joined for duty and enrolled:

When Aug 11, 1863.*

Where Baltimore City *

Period 3 years.*

Present or absent Absent

Stoppage, \$ 100 for

Due Gov't \$ 100 for

Remarks: Absent sick in Hosp. since July 11/64.

* See enrollment on card from muster-in roll.

Book mark:

E. Richardson

(358c)

Copyist.

B | H | USE

Wm A Beard
Pvt, Co. G, 4 Reg't USE

Appears on

Hospital Muster Roll

of Summit House U. S. A. General Hospital,

at Philadelphia, Pa.,

for Sep & Oct, 1864

Attached to hospital:

When _____, 186 .

How employed _____

Last paid by Maj. _____

to Aug 31, 1864

Bounty paid \$ 100, due \$ 100

Present or absent Present

Remarks: Mustered for
Sep & Oct 1864

Ward 10

Book mark: _____

J M Campbell

B | 4 | U.S.C.T.

William H. Beard

Pvt., Co. G, 4 Reg't U. S. Col'd Infantry.

Appears on

Company Muster Roll

for Sept & Oct, 1864

Joined for duty and enrolled:

When Aug 11, 1863.*

Where Baltimore *

Period 3 years.*

Present or absent Absent

Stoppage, \$ 100 for _____

Due Gov't \$ 100 for _____

Remarks: abs. sick at
U.S. G. H. Philadelphia
since June 11/64

* See enrollment on card from muster-in roll.

Book mark: _____

E. Richardson

(358c)

Copyist.

B | H | U.S.C.
Wm Henry Beard
1st, Co. G, 4 Reg't U.S.C.

Appears on

Hospital Muster Roll

of Summit House U. S. A. General Hospital,

at Philadelphia, Pa.,

for Nov & Dec, 1864.

Attached to hospital:

When Aug 17, 1864.

How employed _____

Last paid by Maj. _____
to Aug 31 1864.

Bounty paid \$ 100; due \$ 100

Present or absent present

Remarks: Mustered in
Sept., Oct., Nov.,
and Dec. 1864.

Ward 10

Book mark: _____

Call

B

4

U.S.C.T.

William H. Beard

Priv., Co. G, 4 Reg't U. S. Col'd Infantry.

Appears on

Company Muster Roll

for Nov & Dec, 1864.

Joined for duty and enrolled:

When Aug 11, 1863.*

Where Baltimore Md.*

Period 3 years.*

Present or absent Absent

Stoppage, \$ 100 for

Due Gov't \$ 100 for

Remarks: Absent sick at U.S.G.H. Philadelphia since June 11/64.

* See enrollment on card from muster-in roll.

Book mark:

E. J. Richardson

(358c)

Copyist.

B | 4 M.S.C.F.

Wm H. Beard

Pvt, Co. G, 4 Reg't U.S.C.

Appears on

Descriptive List of Deserters

from Summit House U. S. A. General Hospital,
Philadelphia, Pa.,

dated Jan. 31, 1865.

Age 22 years; height, feet inches.

Complexion; eyes; hair

Where born Baltimore, Md.

Occupation

When enlisted, 186

Where enlisted

When mustered in, 186

Where mustered in

For what period mustered in

Deserted:

When Jan. 22, 1865.

Where Philada Pa.

Remarks: No Descriptive List
at this Hospital

Book mark:

Humphres

W. H. U.S.G.T.

Wm. H. Beard
Pvt., Co. G, 4th Reg't U.S.G.T.

Appears on

Hospital Muster Roll

of Summit House U. S. A. General Hospital,

at Philadelphia, Pa.,

for Jan. & Feb., 1865.

Attached to hospital:

When Aug. 17., 1864.

How employed _____

Last paid by Maj. _____

to _____, 186 .

Bounty paid \$ 100; due \$ 100

Present or absent _____

Remarks: Deserted Jan. 27/65.

Book mark: _____

Arthur

B | 4 | U.S.C.T.

William A Beard

Priv., Co. G, 4 Reg't U. S. Col'd Inf.

Appears on Returns as follows:

July 1864; Absent sick
 Aug 1864 to May 1865; Absent
 sick at U.S. Genl Hospl
 June 1865; Loss New York Deserted
 July 1865; Absent sick at U.S. Gen
 Hospl
 Aug 1865; Absent sick at Portsmouth
 U.S. Hospl
 Sept + Oct 1865; Absent sick
 Dec 1865; Absent sick

Book mark:

(546)

J. Humsey

Copyist.

B

4

U.S.C.T.

William H. Beard

Pvt, Co. G, 4 Reg't U. S. Col'd Infantry.

Appears on

Company Muster Roll

for Dated Feb 28, 1865.

Joined for duty and enrolled:

When Aug 11, 1863.*

Where Balto Md *

Period 3 years.*

Present or absent Absent

Stoppage, \$ 100 for

Due Gov't \$ 100 for

Remarks: Absent sick in U.S. Genl Hospital since June 11/64

* See enrollment on card from muster-in roll.

Book mark:

Ackerman

(358c)

Copyist.

B | 4 | U.S.C.T.

William H. Beard
Pot, Co. G, 4 Reg't U. S. Col'd Infantry.

Appears on

Company Muster Roll

for Mar + Apr, 1865.

Joined for duty and enrolled:

When Aug 11, 1863.*

Where Balt, Md *

Period 3 years.*

Present or absent Absent

Stoppage, \$ 100 for

Due Gov't \$ 100 for

Remarks: Absent Sick. Back pay from May 1/64 to date of enlistment.

* See enrollment on card from muster-in roll.

Book mark:

Ackerman

(358c)

Copyist.

B | 4 | U.S.C.T.

William H. Beard
Pvt., Co. G, 4 Reg't U. S. Col'd Infantry.

Appears on

Company Muster Roll

for May + June, 1863.

Joined for duty and enrolled:

When Aug 11, 1863.*

Where Balt Md *

Period 3 years.*

Present or absent Absent

Stoppage, \$ 100 for

Due Gov't \$ 100 for

Remarks: Absent sick, back pay due from May 1/64 to date of enlistment.

* See enrollment on card from muster-in roll.

Book mark:

Ackerman

(358c)

Copyist.

13

4

U.S.C.T.

William H. Beard

Plt., Co. G, 4 Reg't U. S. Col'd Infantry.

Appears on

Company Muster Roll

for July + Aug, 1865.

Joined for duty and enrolled:

When Aug 11, 1863.*

Where Balt., Md.*

Period 3 years.*

Present or absent Absent

Stoppage, \$ 100 for

Due Gov't \$ 100 for

Remarks: Absent Sick

* See enrollment on card from muster-in roll.

Book mark:

Ackerman

(358c)

Copyist.

B

4

U.S.C.T.

Wm H Baird

Plt, Co. G, 4 Reg't U. S. Col'd Infantry.

Appears on

Company Muster Roll

for Sept + Oct, 1865.

Joined for duty and enrolled:

When Aug 11, 1863.*

Where Balt Md. *

Period 3 years.*

Present or absent absent

Stoppage, \$ 100 for

Due Gov't \$ 100 for

Remarks: Absent sick

* See enrollment on card from muster-in roll.

Book mark:

A Kerman

(358c)

Copyist.

Bx 4 U.S.C.T.

Wm H Beard
Pot, Co. G, 4 Reg't U. S. Col'd Infantry.

Appears on

Company Muster Roll

for *Nov & Dec*, 186*5*.

Joined for duty and enrolled:

When *Aug 11*, 186*3*.*

Where *Balt Md* *

Period *3* years.*

Present or absent *Absent*

Stoppage, \$ *100* for

Due Gov't \$ *100* for

Remarks: *Absent sick*

* See enrollment on card from muster-in roll.

Book mark:

J. A. Johnson
Copyist.

AB | 4 | U.S.C.T.

Wm A Beard

Cvt, Co. G, 4 Reg't U. S. Col'd Infantry.

Appears on

Company Muster Roll

for Jan & Feb, 1866.

Joined for duty and enrolled:

When Aug 11, 1863.*

Where Baltimore Md *

Period 3 years.*

Present or absent _____

Stoppage, \$ 100 for _____

Due Gov't \$ 100 for _____

Remarks: Deserted at
Summit House
Hoop Child's Perm.
Jan 29/65

NEXT ROLL ON FILE MUSTER OUT.

* See enrollment on card from muster-in roll.

Book mark: 3055022

J A Johnson

B

4

U.S.C.T.

William H. Beard

Co. G, 4 Reg't U. S. Col'd Infantry.

Appears on **Co. Muster-out Roll**, dated *Washington DC, May 4, 1866*.

Muster-out to date _____, 186 .

Last paid to _____, 186 .

Clothing account:

Last settled _____, 186 ; drawn since \$ _____ 100

Due soldier \$ _____ 100; due U. S. \$ _____ 100

Am't for cloth'g in kind or money adv'd \$ _____ 100

Due U. S. for arms, equipments, &c., \$ _____ 100

Bounty paid \$ _____ 100; due \$ _____ 100

Remarks: *Deserted at Summit House Hoepthl Jan 22/65*

Book mark: *V149 P103.73*

J. A. Johnson

(861)

Copyist.

Beard, W. H.

P, Co. G, 4 Reg't USCG

Enclosures.

Bed Cards	Descriptive Lists
Burial Records	Final Statements
Certs. of Dis. for Discharge	Furloughs
C. M. Charges	Med. Des. Lists
Med. Certificates	Orders

Other papers relating to—

Admission to Hosp'l	Furlough
Casualty Sheet (Officer's)	Med. Examination
Confinement	Misc. Information
Contracts	Pay or Clothing
Death or Effects	Personal Reports
Desertions	Rank
Discharge from Hosp'l	Transfer to Hosp'l
Discharge from Service	Transfer to V. R. C.
Duty	Transportation

Hospital Number 3630 48

Name W. H. Beard

Age 29 Nativity Baltimore Md

Married or Single Single

Residence Baltimore Md

Post Office address of wife or nearest relative. Rachel Beard
1014 Baltimore

Rank Priv Co. G Regiment 44367

When admitted Aug. 17. 1864

From what source Manhattan Co.

Diagnosis: (in surgical cases state explicitly seat and character of wound or injury.)
Contusion of Right Hip.

Summit House G. H.
Philadelphia, Pa.

On what occasion wounded before Peterburgh

Date June 15-15 1864

Nature of missile or weapon fragment of tree

TREATMENT.

[HERE NOTE IMPORTANT COMPLICATIONS AND ALL OPERATIONS.]

Cold Water Dressings
 Stimuliréne liniments.

RESULT AND DATE.

Sept 16¹⁸⁶¹ transferred
 to Concord -
 Deserted, Jan. 22, 1863,
 transferred to Capt. E. Gibson
 Great Jon 7/18/63
 O. Stittler
 a. J. M. N. Ch. 10 Ward

Bedford David

Co B, 4 U.S. Col'd Inf.

Private

Private

CARD NUMBERS.

1	5330328	26
2	5333001	27
3	5333101	28
4	5333200	29
5	5333296	30
6	5333388	31
7	5333476	32
8	5333562	33
9	5333642	34
10	5333723	35
11	5333812	36
12	5333906	37
13	5334002	38
14	5334095	39
15	5334225	40
16	5334450	41
17	9061770	42
18		43
19		44
20		45
21		46
22		47
23		48
24		49
25		50

Book Mark:

See also

79

4

U.S.C.T.

David Bedford

Co. "B", 4 Reg't U. S. Col'd Inf.

Appears on

Company Descriptive Book

of the organization named above.

DESCRIPTION.

Age 22 years; height 5 feet 7 inches.

Complexion black

Eyes black; hair black

Where born Charles, Md.

Occupation laborer

ENLISTMENT.

When Aug. 25, 1863.

Where Baltimore

By whom Col. Binney; term 3 yrs.

Remarks: Discharged on Surg. Co. the 1st Sept. 22/65, at Worcester, Mass. by order of Maj. Genl. Joseph Hooker.

Hand

B. | 4 | U.S.C.T.

David Bedford

Co B., 4 Reg't U. S. Col'd Infantry.

Age 22 years.

Appears on a

Detachment Muster-in Roll

of the organization named above. Roll dated

Baltimore Md. Aug. 26, 1863.

Muster-in to date Aug. 26, 1863.

Joined for duty and enrolled:

When Aug. 26, 1863.

Where Baltimore Md.

Period 3 years.

Remarks:

Book mark:

(37)

Hawling

Copyist.

B. | 4 | U.S.C.T.

David Bedford,
Pos, Co. B, 4 Reg't U. S. Col'd Infantry.

Appears on

Company Muster Roll
for July 21 to Aug. 31, 1863

Joined for duty and enrolled:

When August 28, 1863*

Where Baltimore Md*

Period 3 years.*

Present or absent Present

Stoppage, \$ 100 for _____

Due Gov't \$ 100 for _____

Remarks: Premium due \$200

* See enrollment on card from muster-in roll.

Book mark: _____

Ironstall
(358c) _____ Copyist.

B. | 4 | U.S.C.T.

David Bedford,
Priv., Co. B, 4 Reg't U. S. Col'd Infantry.

Appears on

Company Muster Roll

for Sept & Oct, 1863

Joined for duty and enrolled:

When Aug 28, 1863*

Where Baltimore *

Period 31 years.*

Present or absent Present

Stoppage, \$ 100 for

Due Gov't \$ 100 for

Remarks: Confined in Guard House for fighting

* See enrollment on card from muster-in roll.

Book mark:

John Hall
(858c) Copyist.

B. | 4 | U.S.C.T.

David Bedford
Pop., Co. B, 4 Reg't U. S. Col'd Infantry.

Appears on

Company Muster Roll
 for Nov. + Dec., 1863

Joined for duty and enrolled:

When Aug. 25th, 1863*

Where Baltimore*

Period 3 years.*

Present or absent Not stated

Stoppage, \$ 100 for _____

Due Gov't \$ 100 for _____

Remarks: _____

* See enrollment on card from muster-in roll.

Book mark: _____

(358c) John Hall Copyist.

B. | 4 | U.S.C.T.

David Bedford,
Private, Co. B, 4 Reg't U. S. Col'd Infantry.

Appears on

Company Muster Roll
for Jany & Felby, 1864.

Joined for duty and enrolled:

When Aug. 25th, 1863*

Where Baltimore*

Period 3 years.*

Present or absent Present,

Stoppage, \$ 100 for _____

Due Gov't \$ 100 for _____

Remarks: _____

* See enrollment on card from muster-in roll.

Book mark: _____

(358c)

Snowball

Copyist.

B | 4 | U.S.C.T.

David Bedford
Put, Co. B, 4 Reg't U. S. Col'd Infantry.

Appears on

Company Muster Roll

for March + April, 1864.

Joined for duty and enrolled:

When Aug 25th, 1863.*

Where Baltimore, Md*

Period 3 years.*

Present or absent Present.

Stoppage, \$ 100 for _____

Due Gov't \$ 100 for _____

Remarks: _____

* See enrollment on card from muster-in roll.

Book mark: _____

(358c)

S M Clark

Copyist.

B | 4 | U.S.C.T.

David Bedford
Put, Co. B, 4 Reg't U. S. Col'd Infantry.

Appears on

Company Muster Roll

for May & June, 1864.

Joined for duty and enrolled:

When Aug. 25th, 1863.*

Where Baltimore, Md.*

Period 3 years.*

Present or absent Absent.

Stoppage, \$ 100 for

Due Gov't \$ 100 for

Remarks: Absent sick
in Gen'l Hospitals
since May 28, 1864.

* See enrollment on card from muster-in roll.

Book mark:

(358c)

C. H. Clark

Copyist.

B | 4 | U.S.C.T.

David Bedford
Put, Co. B, 4 Reg't U. S. Col'd Infantry.

Appears on

Company Muster Roll

for July & Aug., 1864.

Joined for duty and enrolled:

When Aug. 25th, 1863.*

Where Baltimore, Md.*

Period 3 years.*

Present or absent Present.

Stoppage, \$ 100 for

Due Gov't \$ 100 for

Remarks: Free on or before April 19, 1861.

* See enrollment on card from muster-in roll.

Book mark:

B. M. Clark

B | 4 | U.S.C.T.

David Bedford
Priv, Co. B, 4 Reg't U. S. Col'd Infantry.

Appears on

Company Muster Roll
 for Sept & Oct, 1864.

Joined for duty and enrolled:

When Aug. 25th, 1863.*

Where Baltimore, Md. *

Period 3 years.*

Present or absent Absent

Stoppage, \$ 100 for _____

Due Gov't \$ 100 for _____

Remarks: Free on or before
April 19, 1864. Paid in
hospital for May &
June by Mas Walker.
Due Settler, \$2⁰⁰

* See enrollment on card from muster-in roll.

Book mark: _____

C M Clark
 (358c) Copyist.

B | 4 | U.S.C.T.

David Bedford
 Pvt., Co. B, 4 Reg't U. S. Col'd Infantry.

Appears on

Company Muster Roll

for Nov & Dec, 1864.

Joined for duty and enrolled:

When Aug 25th, 1863.*

Where Baltimore, Md.*

Period 3 years.*

Present or absent Absent.

Stoppage, \$ 100 for

Due Gov't \$ 100 for

Remarks: Free on or before
 April 15, 1861. Paid in
 hospital for May & June by
 Maj. Walter. Absent,
 wounded. Sept. 29th. Due
 W. C. Cooper, Suttler, \$200

* See enrollment on card from muster-in roll.

Book mark:

C. M. Clark

(358c)

Copyist.

B.

4

U.S.C.T.

David Bedford

Pri., Co. B, 4 Reg't U. S. Col'd Infantry.

Appears on

Company Muster Roll

for Jan + Feb., 1865.

Joined for duty and enrolled:

When Aug 25, 1863.*

Where Baltimore, Md *

Period 3 years.*

Present or absent absent

Stoppage, \$ 100 for _____

Due Gov't \$ 100 for _____

Remarks: absent wounded Sep 29,
64 P'd in hosp. for May + June
by Maj: for July + Aug
Maj Green See M. Cooper
Roller 4' U.S.C.T. 200

* Appears on roll.

* See enrollment on card from muster-in roll.

Book mark: Dis. Feb. 20, 66.

(858c)

Barlow

Copyist.

B.

4

U.S.C.T.

David Bedford

Pri, Co. B, 4 Reg't U. S. Col'd Infantry.

Appears on

Company Muster Roll

for *March - April*, 1863.

Joined for duty and enrolled:

When *Aug 25*, 1863.*

Where *Baltimore, Md.* *

Period *3* years.*

Present or absent *Absent*

Stoppage, \$ *100* for

Due Gov't \$ *100* for

Remarks: *cid for may + June
Maj. Walker for Nov. + Dec
maj. Usher absent in hosp.
Due M. Cooper, sutler 4" U.S.
C. T. 2.00*

* See enrollment on card from muster-in roll.

Book mark:

Barton

(358c)

Copyist.

B.

4

U.S.C.T.

David Bedford

Pr, Co. B, 4 Reg't U. S. Col'd Infantry.

Appears on

Company Muster Roll

for *May + June*, 1865.

Joined for duty and enrolled:

When *Aug 25*, 1863.*

Where *Baltimore md* *

Period *3* years.*

Present or absent *Absent*

Stoppage, \$ *100* for

Due Gov't \$ *100* for

Remarks: *P'd in hosp for may + June '64
by Maj. Walker for Nov. + Dec. '64
by Maj. Usher for Jan + Feb. '65 by
Maj. Wood. Absent from wounds.*

* See enrollment on card from muster-in roll.

Book mark: *P.M. Co. Oct 31/65 32.*

(858c)

Barton

Copyist.

B

4

U.S.C.T.

David Bedford

Co. B, 4 Reg't U. S. Col'd Infantry.

Appears on

Company Muster Roll

for July & Aug., 1865.

Joined for duty and enrolled:

When Aug. 25, 1863.*

Where Baltimore Md. *

Period 3 years.*

Present or absent Absent

Stoppage, \$ 100 for

Due Gov't \$ 100 for

Remarks: Adm hosp for May & June '64. Maj. Walker for Nov & Dec. '64. Maj. Usher & Jan & Feb. 65. Maj. Wood. Absent sick.

* See enrollment on card from muster-in roll.

Book mark:

(858c)

Barton

Copyist.

B.

4

U.S.C.T.

David Bedford

Pr., Co. B, 4 Reg't U. S. Col'd Infantry.

Appears on

Company Muster Roll

for *Sept Oct*, 1865.

Joined for duty and enrolled:

When *Aug 25*, 1863.*

Where *Baltimore md.* *

Period *3* years.*

Present or absent

Stoppage, \$ *100* for

Due Gov't \$ *100* for

Remarks: *Disch'd on Surg. Cts. dis
Sep. 22, '65. at Worcester, Mass.
by order Maj' Genl. Hooker*

* See enrollment on card from muster-in roll.

Book mark:

Barton

(358c)

Copyist.

B | 4 U.S.C.T.

David Bedford
Pot., Co. B, 4 Reg't U. S. Col'd Infantry.

Appears on Co. Muster-out Roll, dated
Washington, D.C., May 4, 1866.

Muster-out to date _____, 186 .
Last paid to _____, 186 .

Clothing account:

Last settled _____, 186 ; drawn since \$ _____ 100

Due soldier \$ _____ 100 ; due U. S. \$ _____ 100

Am't for cloth'g in kind or money adv'd \$ _____ 100

Due U. S. for arms, equipments, &c., \$ _____ 100

Bounty paid \$ _____ 100 ; due \$ _____ 100

Remarks: Free on or before April 19/66
Discharged on Surg. Certificate
of disability; Sep. 22/65; at
Worcester, Mass. By order Maj.
Gen. Hooker.

Book mark : _____

(361)

Talbot
Copyist.

Bedford. David

P. B., Co. **4** **U.S.C. Inf.**
Reg't

2 Enclosures.

Bed Cards	Descriptive Lists
Burial Records	Final Statements
Certs. of Dis. for Discharge /	Furloughs
C. M. Charges	Med. Des. Lists
Med. Certificates	Orders

Other papers relating to—

Admission to Hosp'l	Furlough
Casualty Sheet (<i>Pur</i> Officer's) /	Med. Examination
Confinement	Misc. Information
Contracts	Pay or Clothing
Death or Effects	Personal Reports
Desertions	Rank
Discharge from Hosp'l	Transfer to Hosp'l
Discharge from Service	Transfer to V. R. C.
Duty	Transportation

NOTE 1.

The company commander will here add a statement of all the facts known to him concerning the disease or wound, or cause of disability of the soldier; the time, place, manner, and all the circumstances under which the injury occurred, or disease originated or appeared; the duty, or service, or situation of the soldier at the time the injury was received or disease contracted, stating particularly whether the injury was received or the disease contracted in the line of his duty; and whatever other facts may aid a judgment as to the cause, immediate or remote, of the disability, and the circumstances attending it.

When the facts are not known to the company commander, the certificate of any officer or affidavit of other person having such knowledge, will be appended—as the surgeon in charge of a hospital, the officer commanding a detachment of recruits, &c., &c.

NOTE 2.

When a probable case for pension, special care must be taken to state the degree of disability—as $\frac{1}{2}$, $\frac{3}{4}$, &c., &c.; to describe particularly the disability, wound, or disease; the extent of which it deprives him of the use of any limb or faculty, or affects his health, strength, activity, constitution, or capacity to labor or earn his subsistence. The surgeon will add, from his knowledge of the facts and circumstances, and from the evidence in the case, his professional opinion of the cause or origin of the disability. In the case of discharges by Medical Inspectors, the last paragraph will state that the "discharge was given by consent of the soldier, after a personal examination, and for disability, the nature, degree and origin of which are correctly described in the within certificate."

Par. 1260 Regulations, Edit. 1861.

Medical officers, in giving certificates of disability, are to take particular care in all cases that have not been under their charge; and especially in epilepsy, convulsions, chronic rheumatism, derangement of the urinary organs, ophthalmia, ulcers, or any obscure disease liable to be feigned or purposely produced; and in no case shall such certificate be given until after sufficient time and examination to detect any attempt at deception.

DIRECTIONS.

This certificate will be made out in duplicate by the soldier's company commander, or other officer commanding the separate detachment to which he belongs, and sent by him to the surgeon who has charge of the hospital where the soldier is sick. The surgeon will then fill out and sign the surgeon's certificate, and forward these papers to the regimental, detachment, or post commander, who will forward them, with his action endorsed thereon, through the proper channel, to his division commander; or, if the troops are not attached to a division, to his corps, department, or other commander or officer to whom the authority to discharge enlisted men may be specially delegated.

These certificates, after having received the action of the highest authority to which they are required to be sent, will be returned through the same channel to the regimental, post, or detachment commander, who will, if the discharge is authorized by the endorsement of the proper authority, sign the soldier's discharge, and the last certificate on this paper; see that the soldier is furnished with the proper final statements in duplicate, and forward both of these certificates direct to the Adjutant General United States Army, at Washington, D. C.; they will not, under any circumstances, be given into the hands of the soldier.

ADJUTANT GENERAL'S OFFICE

Oct 4. 1865.

Duplicate sent the Pension Office.

✓ B. 30. D. of Dis. 9

CERTIFICATE OF DISABILITY FOR DISCHARGE

IN THE CASE OF

David Bradford
a Private Co. B.
Fourth and Col. Reg't of Heavy Artillery

APPROVED

Wm. Sloan
Surgeon, U. S. A.,
Medical Director Dep't of the East

HEADQUARTERS DEPARTMENT OF THE EAST,

NEW YORK CITY, Sept. 16th, 1865.

To be discharged.

BY COMMAND OF MAJOR GENERAL HOOKER:

J. W. Taylor
Bvt. Maj. and A. D. C., A. A. A. G.

J. W. Taylor

Received (A. G. Office.) , 186

Ent. on R of Cas.

Disability occurred subsequent to enlistment, not eligible for the Veteran Reserve Corps.

J. A. Chamberlain
Surgeon U.S. Army
Leeds Hospital

ARMY OF THE UNITED STATES CERTIFICATE

OF DISABILITY



FOR DISCHARGE

Private David Bradford, of Captain *M. C. Hill* Company, (B. Co.) of the *Fourth* Regiment of the United States *Colored Infantry* was enlisted by *Col Birney* of the *Baltimore Md* Regiment of *Baltimore Md* at *Baltimore Md* on the *Twenty Fifth* day of *August*, 186*3*, to serve *Three* years; he was born in *Charles* in the State of *Maryland*, is *Twenty Two* years of age, *Five* feet *Seven* inches high, *Black* complexion, *Black* eyes, *Black* hair, and by occupation when enlisted a *Leather*. During the last two months said soldier has been unfit for duty *60* days.*

Patent states that he was wounded in action at Shaping Farm, Va. September 29, 1864.

STATION: *Worcester Mass*
DATE: *September 12, 1865*

F. Chamberlain
Surgeon Major
Commanding Company
Hospital

I CERTIFY, that I have carefully examined the said *Private David Bradford* of Captain *M. C. Hill* Company, and find him incapable of performing the duties of a soldier because of *Shot injury of left humerus near head. Wound open. Bones leading to necrosed bone. Impaired motion of shoulder joint. Etc. to be discharged. Disability total.*

F. Chamberlain
Surgeon Major
Commanding *Hospital*

DISCHARGED, this *Twenty Second* day of *September*, 186*5*, at *Fort Mifflin* *General Hospital Worcester Massachusetts*

G. M. Martindale
Asst. Surgeon Major
Commanding *Regt. Hospital*

The Soldier desires to be addressed at

Town *Hagerstown* County *7* State *Maryland*

* See Note 1 on the back of this.

† See Note 2 on the back of this

CASUALTY SHEET

No.

David Bedford

Priv of Company *B*

H Regiment of *W S C T*

State Volunteers.

NATURE OF CASUALTY.

Disch'd Sep 23 1865



CASUALTY SHEET.

Name: David Bedford
 Rank: Priv Company: B Regiment: 4
 Arm: 6 P State: US
 Nature of Casualty: Dischg

CAUSE OF CASUALTY—(NAME OF DISEASE, &c.)

Sing bert

BY WHOM DISCHARGED.

FROM WHAT SOURCE THIS INFORMATION WAS OBTAINED.

Roll 13 Cole Hosp
Mass 1865

DEGREE OF DISABILITY.

BY WHOM CERTIFIED

F E Martindale
Asst Surg USV

DATE OF DISCHARGE, DEATH, &c.

Sep 23 1865

PLACE OF DISCHARGE, DEATH, &c.

Worcester Mass.

REMARKS.

Spencer

Clerk.

asx

93

Geeman, Saml G.

Co B, 4 U.S. Col'd Inf.

1st Lieutenant

CARD NUMBERS.

1	26
2	27
3	28
4	29
5	30
6	31
7	32
8	33
9	34
10	35
11	36
12	37
13	38
14	39
15	40
16	41
17	42
18	43
19	44
20	45
21	46
22	47
23	48
24	49
25	50

Reference Cards

Book Mark:

See also 1st use of

*Bell Charles*⁹⁴

Co *E*, 4 U.S. Col'd Inf.

Corporal

Corporal

CARD NUMBERS.

1	5557739	26
2	5557820	27
3	5558005	28
4	5559315	29
5	9062162	30
6		31
7		32
8		33
9		34
10		35
11		36
12		37
13		38
14		39
15		40
16		41
17		42
18		43
19		44
20		45
21		46
22		47
23		48
24		49
25		50

Book Mark:

See also

B

4

U.S.C.T.

Charles Bell

, Co. E, 4 Reg't U. S. Col'd Inf.

Appears on

Company Descriptive Book

of the organization named above.

DESCRIPTION.

Age 19 years; height 5 feet 8 inches.

Complexion Blue

Eyes Black; hair Curly

Where born Currituck N.C.

Occupation Laborer

ENLISTMENT.

When July 28, 1863.

Where Baltimore

By whom Col. W. Birney; term 3 y'rs.

Remarks: Died at Hospital Baltimore Md. Sept 19 1863 of disease

Final statements sent May 10 /65

N. H. Merrill

Copyist.

(383g)

B | 4 | U.S.C.T.

Charles Bell

Capt. Co. E., 4 Reg't U. S. Col'd Infantry.

Age 19 years.

Appears on

Company Muster-in Roll

of the organization named above. Roll dated

Baltimore Md. July 25, 1863.

Muster-in to date

July 25, 1863.

Joined for duty and enrolled:

When July 25, 1863.*

Where Baltimore Md.*

Period 3 years.*

Remarks:

* Muster-in roll shows enrollment and muster-in of this company as of same date and place. See enrollment on subsequent card or cards.

Book mark:

Haltaway

(356c)

Copyist.

B | 4 | U.S.C.T.

Chas. Bell

....., Co. E, 4 Reg't U. S. Col'd Infantry.

Appears on

Company Muster Roll

for from July 18 to Aug. 31, 1863.

Joined for duty and enrolled:

When July 27, 1863.*

Where Baltimore *

Period 3 years.*

Present or absent Present

Stoppage, \$ 100 for

Due Gov't, \$ 100 for

Remarks:

* See enrollment on card from muster-in roll.

Book mark:

(358c)

Hathaway

Copyist.

B | 4 | U.S.C.T.

Charles Bell
Copt., Co. E, 4 Reg't U. S. Col'd Infantry.

Appears on

Company Muster Roll
for Sept. & Oct., 1863.

Joined for duty and enrolled :

When July 25, 1863.*

Where Balto. Md.*

Period 3 years.*

Present or absent

Stoppage, \$ 100 for

Due Gov't, \$ 100 for

Remarks: Died in Reg't. Hosp.
at Balto. Md. September
6, 1863

* See enrollment on card from muster-in roll.

Book mark :

Hathaway
(358c) Copyist.

B | 4 | U.S.C.T.

Charles Bell.

Corp., Co. E, 4 Reg't U. S. Col'd Infantry.

Appears on **Co. Muster-out Roll**, dated
Washington D.C., May 4, 1866.

Muster-out to date _____, 186 .

Last paid to _____, 186 .

Clothing account:

Last settled _____, 186 ; drawn since \$ _____ 100

Due soldier \$ _____ 100; due U. S. \$ _____ 100

Am't for cloth'g in kind or money adv'd \$ _____ 100

Due U. S. for arms, equipments, &c., \$ _____ 100

Bounty paid \$ _____ 100; due \$ _____ 100

Remarks: *died at Balto Md Sept 6/63 of disease. Final statements forwarded May 10/65.*

Book mark : _____

(361) _____ *Somers* Copyist.

Bell. Charles

Corp. Co. E, **4** ^{Reg't} **U. S. C. Inf.**

4 Enclosures.

Bed Cards	Descriptive Lists
Burial Records	Final Statements <i>2</i>
Certs. of Dis. for Discharge	Furloughs
C. M. Charges	Med. Des. Lists
Med. Certificates	Orders

Other papers relating to—

Admission to Hosp'l	Furlough
Casualty Sheet (<i>Priv</i> Officer's) <i>1</i>	Med. Examination
Confinement	Misc. Information
Contracts	Pay or Clothing
Death or Effects <i>1</i>	Personal Reports
Desertions	Rank
Discharge from Hosp'l	Transfer to Hosp'l
Discharge from Service	Transfer to V. R. C.
Duty	Transportation

CASUALTY SHEET.

No.

Charles Bell

Capt of Company *E*

4th Regiment of *W. S. Calif.*

~~State~~ Volunteers.

NATURE OF CASUALTY.

Died Sept. 6th 1863.

CASUALTY SHEET.

Name: *Charles Bell*
 Rank: *Sergeant* Company: *E.* Regiment: *4*
 Arm: *U.S. Col'd Vol.* State: _____
 Nature of Casualty: *Death*

CAUSE OF CASUALTY—(NAME OF DISEASE, &c.)

Inflammation of Lung

DEGREE OF DISABILITY.

BY WHOM CERTIFIED.

Lieut. C. Holcomb

DATE OF DISCHARGE, DEATH, &c.

Sept. 6, 1863.

PLACE OF DISCHARGE, DEATH, &c.

Nor. Baltimore, Md.

BY WHOM DISCHARGED.

FROM WHAT SOURCE THIS INFORMATION WAS OBTAINED.

*Reg. dis'd Soldiers
 Vol. 1, Duchy Room 1863*

REMARKS.

[Signature]

af Ball

Clerk.

1868

No 1

FINAL STATEMENT

OF
Corporal Chas. Bell
4th Reg't of N. S. I.

~~VOLUNTEERS.~~

NOTE 1.—Two of these certificates (or duplicates) are to be given to each volunteer soldier who may be discharged previously to the discharge of his company, that he may at once receive from the Paymaster the pay, &c., due him, and the captain or other officer commanding the company will certify to the act of the delivery of the duplicate certificates; on these certificates the Soldier is "entitled to" his discharge, and should also present his discharge to the Paymaster to have the payment endorsed on it. The discharge is to be given back to the Soldier by the Paymaster; the latter only retaining as his voucher the duplicate certificates.

NOTE 2.—If the Soldier is entitled to pay for the use of his horse, the Company Commander will certify to that fact, and also to the time he has pay due for having been so mounted on his own horse.

NOTE 3.—Amounts due the Sutler and Laundress must be entered on the Muster Roll on which the death, desertion, &c., is reported, as well as on the final statement, otherwise the amount cannot be collected from the United States.

NOTE 4.—This blank will be used for deceased volunteers as well as others.



I certify, on honor, that Chas. Bell a sergeant of
 Lt Captain Holcombe Company (E) of the 4 Regiment of U.S.C. Troops
VOLUNTEERS, of the State of _____, born in Connecticut, State
 of N Carolina aged 19 years; 5 feet 8 inches high; Dark complexion,
Black eyes, Curly hair, and by occupation a Labourer, having joined the company on
 its original organization at _____, and enrolled in it at the muster into
 the service of the United States at Baltimore, on the 28 day
 of July, 1863, (or was mustered in service as a recruit, by _____
 _____, at _____, on the _____ day of _____,
 186 , to serve in the Regiment,) for the term of Three Years
 and having served **HONESTLY** and **FAITHFULLY** with his Company in MD
 to the present date, is now entitled to a **DISCHARGE** by reason of Death

The said Chas Bell was last paid by Paymaster
 _____ to include the _____ day of _____, 186 , and has
 pay due him from that time to the present date; he is entitled to pay and subsistence for
TRAVELING to place of enrollment and whatever other allowances are authorized to volunteer
 soldiers, or militia, so discharged. He has received _____ dollars,
 advanced by the United States on account of **CLOTHING**.

There is to be stopped from him, on account of the State of U. S., or other
 authorities for **CLOTHING**, &c., received on entering service, 37 83/100 dollars; also,
 for expenses of **SUBSISTENCE** for **TRAVELING** from place of enrollment to the place of rendezvous,
 amounting to _____ dollars: and on account of the United States for **EXTRA**
CLOTHING received in kind from _____ and for other
 stoppages, viz:

_____ amounting to _____ dollars;
 and he has been **SUBSISTED** for **TRAVELING** to his place of enrollment, up to the _____
 _____, 186 .

He is indebted to _____, **SUTLER**, _____ dollars.
 He is indebted to _____, **LAUNDRESS**, _____ dollars.

Given in Duplicate, at Baltimore, this 9 day of Sept, 1863.

Chas. Holcombe
1st Lieutenant
 Commanding Company.

INVENTORY OF THE EFFECTS

OF

Corporal Charles Belle

Late of Company E

4th Reg't of Ill & Indiana Troops

Volunteers, who died at Bull Run, Va.

on the 9th day of September 1863.



Inventory of the effects of George B. [unclear] late
a [unclear] of Captain [unclear] Company E of
the [unclear] Regiment of U. S. Cavalry Volunteers, who was enrolled as
a [unclear] at [unclear] in the State of [unclear] on
the 18 day of [unclear] 1863, and mustered into the service of the United
States as a [unclear] on the 28 day of [unclear] 1863, at [unclear]
in Company [unclear], [unclear] Regiment of U. S. Cavalry Volunteers, to serve [unclear]
years or during the war; he was born in [unclear] in the State
of [unclear]; he was 17 years of age, 5 feet 9 inches
high, [unclear] complexion, [unclear] eyes, [unclear] hair, and by occupation, when enrolled,
a [unclear]; he died in [unclear], at
[unclear] on the [unclear] day of [unclear] 1863, by
reason of [unclear]

INVENTORY.					
ARTICLES.	No.	ARTICLES.	No.	ARTICLES.	No.
Hats.....		Pairs trousers.....		Knapsacks.....	
Caps.....		Pairs flannel drawers.....			
Forage caps.....		Pairs cotton drawers.....			
Great coats.....		Flannel shirts.....			
Uniform coats.....		Cotton shirts.....			
Uniform jackets.....		Pairs boots.....			
Flannel sack coats.....		Pairs shoes.....			
Blouses.....		Pairs socks.....			
Stable frocks.....		Blankets.....			
Fatigue overalls.....		Haversacks.....			
				MONEY.	
				Specie.....	\$
				Notes.....	\$

I CERTIFY, ON HONOR, that the above inventory comprises all the effects of [unclear]
[unclear], deceased, and that the effects are in the hands
of [unclear] at [unclear]
[unclear] to be disposed of by a Council of Administration.

(DUPLICATES.)

STATION: [unclear]

DATE: May 10 1863

[unclear]
Commanding the Company.

FINAL STATEMENT

OF

Company C 13th C. I.

1st Reg't of U. S. Cavalry

VOLUNTEERS.

Co. D 13th C. I.

NOTE 1.—Two of these certificates (or duplicates) are to be given to each Volunteer Soldier or drafted man who may be discharged previously to the discharge of his company, that he may at once receive from the Paymaster the pay, &c., due him, and the captain or other COMMISSIONED officer commanding the company will certify to the act of the delivery of the duplicate certificates; on these certificates the Soldier is "entitled to" his discharge, and should also present his discharge to the Paymaster to have the payment endorsed on it. The discharge is to be given back to the Soldier by the Paymaster; the latter only retaining as his voucher the duplicate certificates.

NOTE 2.—If the Soldier is entitled to pay for the use of his horse, the Company Commander will certify to that fact on the back of both these final statements, and also to the time he has pay due for having been so mounted on his own horse.

NOTE 3.—When a Soldier is furnished with final statements, his descriptive list, if he has one, should be taken up by the officer who gives the Soldier these statements, and endorsed with a statement to this effect by the officer. This endorsement should exhibit a full statement of the time for which the Soldier was allowed pay on his final statements, the clothing account, and all other charges against him or in his favor, so as to comprise a complete exhibit of his account. It will then be transmitted to the company commander of the Soldier, who will enter all the data necessary to a full understanding of the Soldier's account on the muster roll upon which the Soldier's discharge is reported. The descriptive list will then be destroyed. The object of this is, that the remaining portion of the Soldier's account may be settled upon the receipt of these muster rolls, and the Soldier receive any pay or allowances that may be due him at the time of his discharge, and which may not appear on his final statements from the fact that his descriptive list is incomplete. These accounts for back pay, &c., are settled by the 2d Auditor of the Treasury Department.

NOTE 4.—Charges for loss or injury to ordnance, horse equipments, and other miscellaneous charges, should appear under the heading of "Other Stoppages."

NOTE 5.—Bounty paid by State authorities, and not by the United States, will not be entered on this statement.

NOTE 6.—Amounts due the Sutler and Laundress must be entered on the muster roll on which the discharge, death, desertion, &c., is reported, as well as on the final statement, otherwise the amount cannot be collected from the United States.

NOTE 7.—This blank will be used for deceased volunteers and drafted men, as well as for others.

NOTE 8.—Where a Soldier dies in Hospital or on detached service, his descriptive list, if he has one, should be sent with his final statements, in duplicate, to the Adjutant General, Washington, D. C.

ADJUTANT GENERAL'S OFFICE.

June 23. 1865.

Duplicate with Inventory sent 2d Auditor.

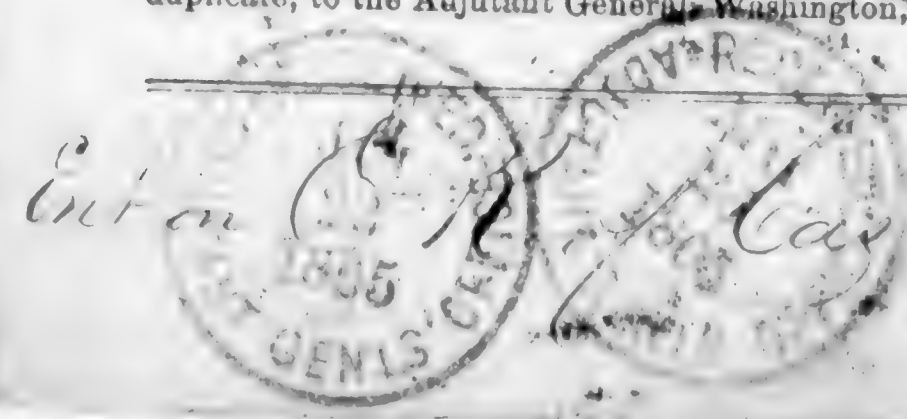

I certify, on honor, that Charles Bell a Company of
 Captain Wm. A. P. ... Company (E) of the 2nd Regiment of Ill. S. Cavalry
VOLUNTEERS, of the State of Illinois, born in Carroll Co., State
 of North Carolina, aged 19 years; 5 feet 8 inches high; Light complexion,
Black eyes, Curly hair, and by occupation a Farmer, having joined the company on
 its original organization at Carroll Co., and enrolled in it at the muster into
 the service of the United States at Carroll Co., on the 10th day
 of July, 1863, (or was mustered in service as a recruit, by ...
..., at ..., on the ... day of ...,
 1863, or was drafted and mustered into the service of the United States from the ...
 Enrollment District of the State of ..., at ...,
 on the ... day of ..., 1863) to serve in the Regiment, for
 the term of Three Years: and having served HONESTLY and
 FAITHFULLY with his Company in ... to the present date, is now
 entitled to a **DISCHARGE** by reason of illness & discharge in
Carroll Co. Ill. 1. 23.

The said Charles Bell was last paid by Paymaster
Wm. A. P. ... to include the 10th day of ..., 1863, and has
 pay due him from that time to the present date; he is entitled to pay and subsistence for
 TRAVELING to place of enrollment, and whatever other allowances are authorized to volunteer
 soldiers, drafted men, or militia, so discharged. He has received from the United States **CLOTHING**
 amounting to ... 470 dollars, since the 29th day of ...,
 1863, when his clothing account was last settled. He has received from the United States
100 dollars advanced **BOUNTY**.

There is to be stopped from him, on account of the State of ..., or other
 authorities, for **CLOTHING**, &c., received on entering service, 100 dollars; and
 for other stoppages, viz: ...

100 dollars.
 He has been furnished with TRANSPORTATION in kind from the place of his discharge to
...; and he has been SUBSISTED for TRAVELING to his
 place of enrollment, up to the ..., 1863.

He is indebted to ..., **SUTLER**, 100 dollars.
 He is indebted to ..., **LAUNDRESS**, 100 dollars.

Given in Duplicate, at Carroll Co. North Carolina, this 10th day
 of July, 1865.

Wm. A. P. ...
...
 Commanding Company

Bell Charles E⁹⁵

Co G, 4 U.S. Col'd Inf.

Private

Private

CARD NUMBERS.

1	5550488	26
2	5561868	27
3	5561954	28
4	5562043	29
5	5562143	30
6	5562240	31
7	5562401	32
8	5562635	33
9	5550881	34
10	9067425	35
11		36
12		37
13		38
14		39
15		40
16		41
17		42
18		43
19		44
20		45
21		46
22		47
23		48
24		49
25		50

Book Mark: EB.V.11 P 233

See also

1037444 - Po age

1896020 P O M M

B

21

U. S. C. T.

Charles E. Bell

Co. E, 4 Reg't U. S. Col'd Inf.

Appears on

Company Descriptive Book

of the organization named above.

DESCRIPTION.

Age 25 years; height 5 feet 7 inches.

Complexion Black

Eyes Black; hair Wavy

Where born Jackson Co. Ohio

Occupation Blacksmith

ENLISTMENT.

When Sept 2, 1864.

Where Cincinnati O

By whom Capt Ross; term 1 y'rs.

Remarks: Mustered out by reason of exp time

Sept 1, 1865 at New Bern N. C.

W. L. May Lt Col 1870.

W. H. Smith

B | 4 | U.S.C.T.

Chas. E. Bell

Appears with rank of *1st Lt.* on

Muster and Descriptive Roll of a Detachment of U. S. Vols. forwarded

for the 4 Reg't U. S. Col'd Infantry. Roll dated

Circleville, O. Sept. 4, 1864.

Where born *Gallia Co. Ohio*

Age *35* y'rs; occupation *Plasterer*

When enlisted *Sept. 2, 1864.*

Where enlisted *Circleville*

For what period enlisted *1* years.

Eyes *Black*; hair *Wool*

Complexion *Black*; height *5* ft. *7* in.

When mustered in *Sept. 2, 1864.*

Where mustered in *Circleville*

Bounty paid \$ *100*; due \$ *100*

Where credited

Company to which assigned

Remarks: *Credited to Walnut Tp. Fairfield Co. Sub Dist. No. 8 18th Dist. O*

Book mark:

Hathaway

B | 4 | U.S.C.T.

Charles E. Bell

Rot, Co. G, 4 Reg't U. S. Col'd Infantry.

Appears on

Company Muster Roll

for Nov & Dec, 1864

Joined for duty and enrolled:

When Sept. 2, 1864*

Where Circleville O. *

Period 1 years.*

Present or absent Present

Stoppage, \$ 100 for

Due Gov't \$ 100 for

Remarks: A recruit assigned to Co G. Nov. 18/64.

* See enrollment on card from muster-in roll.

Book mark:

E. T. Richardson

(358c)

Copyist.

B

4

U.S.C.T.

Charles C. Bell

Priv., Co. G, 4 Reg't U. S. Col'd Infantry.

Appears on

Company Muster Roll

for Dated Feb 28, 1865.

Joined for duty and enrolled:

When Sept 2, 1864.*

Where Circleville, Ohio *

Period 1 years.*

Present or absent Present

Stoppage, \$ 100 for

Due Gov't \$ 100 for

Remarks: Recruit assigned to
Co "G" Nov 18/64.

* See enrollment on card from muster-in roll.

Book mark:

Ackerman

(358c)

Copyist.

B

4

U.S.C.T.

Charles E. Bell

Pvt., Co. G, 4 Reg't U. S. Col'd Infantry.

Appears on

Company Muster Roll

for Mar + Apr, 1865.

Joined for duty and enrolled:

When Sept 2, 1864.*

Where Cerleville Ohio*

Period 3 years.*

Present or absent Present

Stoppage, \$ 100 for

Due Gov't \$ 100 for

Remarks:

* See enrollment on card from muster-in roll.

Book mark:

Ackerman

(358c)

Copyist.

B | 4 | U.S.C.T.

Charles E. Bell

Pvt, Co. G, 4 Reg't U. S. Col'd Infantry.

Appears on

Company Muster Roll

for May + June, 1865.

Joined for duty and enrolled:

When Sept 2, 1864*

Where Circleville, Ohio *

Period 1 years.*

Present or absent Present

Stoppage, \$ 100 for

Due Gov't \$ 100 for

Remarks: Recruit

* See enrollment on card from muster-in roll.

Book mark:

A. Kerman

B

4

U.S.C.T.

Charles E. Bell

Prst, Co. G, 4 Reg't U. S. Col'd Infantry.

Appears on

Company Muster Roll

for July + Aug, 1865.

Joined for duty and enrolled:

When Sept 2, 1865.*

Where Circleville Ohio *

Period 1 years.*

Present or absent Present

Stoppage, \$ 100 for

Due Gov't \$ 100 for

Remarks:

* See enrollment on card from muster-in roll.

Book mark:

Ackerman

(358c)

Copyist.

B

4

U.S.C.T.

Chas, E. Bell

Prst, Co. G, 4 Reg't U. S. Col'd Infantry.

Appears on

Company Muster Roll

for Sept + Oct, 1865.

Joined for duty and enrolled:

When Sept 2, 1864.*

Where Circleville, Ohio *

Period 1 years.*

Present or absent

Stoppage, \$ 100 for

Due Gov't \$ 100 for

Remarks: Mustered out by reason of expiration of term of service.

* See enrollment on card from muster-in roll.

Book mark: Discharged Sept 4/65 over

A. K. Newman

(358e)

Copyist.

JAN 19

5562401

★ 1687 ★

E.B.V. 11.P. 233.

B | 4 U.S.C.T.

Charles E. Bell

Drk, Co. G, 4 Reg't U. S. Col'd Infantry.

Appears on a

Detachment Muster-out Roll

of the organization named above. Roll dated

New Bern N.C. Sep 4, 1865

Muster-out to date Sep 4, 1865

Last paid to June 30 1865

Clothing account:

Last settled Never 186 ; drawn since \$ 100

Due soldier \$ 100; due U. S. \$ 100

Am't for cloth'g in kind or money adv'd \$ 100

Due U. S. for arms, equipments, &c., \$ 100

Bounty paid \$ 100 due \$ 100 ⁰⁰ ₁₀₀

Remarks: Detached as Musician
for Regimental Band Clothing
acct not settled drawn since
Enlistment \$61.⁰³ Mustered out
by reason of expiration of term
of service. Transportation due

Book mark: 335611 over

Jacobson

JAN. 19

5550881

1891

him from place of discharge
to place of Enrichment

B | 4 | U.S.C.T.

Charles E Bell
Sgt, Co. G, 4 Reg't U. S. Col'd Infantry.

Appears on Co. Muster-out Roll, dated
Washington D.C., May 4, 1866.

Muster-out to date _____, 186 .
Last paid to _____, 186 .

Clothing account:

Last settled _____, 186 ; drawn since \$ _____ 100
Due soldier \$ _____ 100 ; due U. S. \$ _____ 100
Am't for cloth'g in kind or money adv'd \$ _____ 100

Due U. S. for arms, equipments, &c., \$ _____ 100
Bounty paid \$ _____ 100 ; due \$ _____ 100

Remarks: Mustered out by
reason of expiration of
term of service Sep 4/65
Newburn N.C. by S. May
S. A. C. M.

Book mark: V 211 B. 208 8. 74
(over)

J. A. Johnson
Copyist.

JAN. 20

5562635

1891

335-011

*(Musters Out Roll
on file)*

Beel, Charles E.

....., Co., Reg't *102d*

3 Enclosures.

Bed Cards.....	Final Statements.....
Burial Records.....	Furloughs or L. of A.....
Certs. of Dis. for Discharge.....	Med. Certificates.....
C. M. Charges.....	Med. Des. Lists.....
Descriptive Lists.....	Orders.....
Discharge Certificates.....	Pris. of War Record.....
Enlistment Papers..... <i>3</i>	Resignations.....

Other papers relating to—

Admission to Hosp'l.....	Furlough or L. of A.....
Casualty Sheet.....	Med. Examination.....
Confinement.....	Misc. Information.....
Contracts.....	Pay or Clothing.....
Death or Effects.....	Personal Reports.....
Desertion.....	Rank.....
Discharge from Hosp'l.....	Transfer to Hosp'l.....
Discharge from Service.....	Transfer to V. R. C.....
Duty.....	Transportation.....

DECLARATION OF RECRUIT.

I, Charles E. Bell, desiring to VOLUNTEER as a Soldier in the Army of the United States, for the term of THREE YEARS, Do Declare, That I am thirty five years and 0 months of age; that I have never been discharged from the United States service on account of disability or by sentence of a court martial, or by order before the expiration of a term of enlistment; and I know of no impediment to my serving honestly and faithfully as a soldier for three years.

GIVEN at Cincinnati Ohio the 20 day of Sept 1864
Witness: S. G. Bunch Charles E. Bell

U. S. C. J.
Charles E. Bell

No.

Volunteered at Cincinnati Ohio
Sept 20 1864
By Capt G. H. Roby, Prov. Mar
12th Dist Regiment of Ohio

enlistment; last served in Company ()

Reg't of

Discharged, 18

To be credited to Walnut Township Fairfield Co. O
Sub Dist No 8
12th Long Dist

Feb. 1896, This paper was formally filed in the Enrollment Act, & 110,

CONSENT IN CASE OF MINOR.

I,, Do certify, That I am; that the of is years of age; and I do hereby freely give my CONSENT to his volunteering as a SOLDIER in the ARMY OF THE UNITED STATES for the period of THREE YEARS.

GIVEN at the day of

Witness:

(A. G. O. No. 74 & 76.)

NOTE 1.—This blank will be used for both enlistments and re-enlistments—enlistment of veterans, &c., &c., in the volunteer service. They will be made out in duplicate in all cases—one to accompany the recruiting return of the superintendent (not the recruiting officer) to the Adjutant General, and one to accompany the accounts of the officer who pays bounty, &c. The Regiment and Company in which the soldier last served should be given on the back.
NOTE 2.—An enlistment holds to service. A muster-in must, in all cases, precede payment of pay, bounty, pension, &c. A muster-in roll must, in all cases, be filed in the Adjutant General's Office as evidence of muster-in. The mustering officer, commissary, or assistant commissary of musters, as the case may be, will countersign both enlistments as having mustered the soldier into the service of the United States before either of them is given to the disbursing officer.

VOLUNTEER ENLISTMENT.

STATE OF

TOWN OF

Ohio

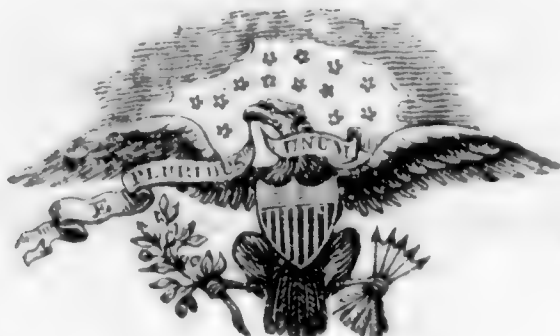

Burlsville

I, *Charles E. Belle*, born in *Galicia Co*
 in the State of *Ohio*, aged ~~thirty five~~ *thirty five* years,
 and by occupation a *Plasterer*, Do HEREBY ACKNOWLEDGE to have
 volunteered this *second* day of *September* 1864,
 to serve as a **Soldier** in the **Army of the United States of America**, for
 the period of ~~THREE YEARS~~ ^{one} *year*, unless sooner discharged by proper authority:
 Do also agree to accept such bounty, pay, rations, and clothing, as are, or may be,
 established by law for volunteers. And I, *Charles E. Belle*, do
 solemnly swear, that I will bear true faith and allegiance to the **United States**
of America, and that I will serve them honestly and faithfully against all
 their enemies or opposers whomsoever; and that I will observe and obey the
 orders of the President of the United States, and the orders of the officers
 appointed over me, according to the Rules and Articles of War.

Sworn and subscribed to, at *Burlsville*
 this *20th* day of *Sept*, 186*4*,
 BEFORE *Geo. H. Roby Capt. 12th Regt. Ohio*
12th Regt. Ohio

I CERTIFY, ON HONOR, That I have carefully examined the above-named Volunteer, agreeably
 to the General Regulations of the Army, and that, in my opinion, he is free from all bodily defects and
 mental infirmity, which would in any way disqualify him from performing the duties of a soldier.

W. J. Jones
Duty Bound Surgeon
 EXAMINING SURGEON.

I CERTIFY, ON HONOR, That I have minutely inspected the Volunteer *Charles E. Belle*
 previously to his enlistment, and that he was entirely sober when enlisted; that, to the best of my
 judgment and belief, he is of lawful age; and that, in accepting him as duly qualified to perform the
 duties of an able-bodied soldier, I have strictly observed the Regulations which govern the recruiting
 service. This soldier has *Blue* eyes, *Wool* hair, *Black* complexion, is *5 ft*
 feet *7* inches high.

Geo. H. Roby Capt. 12th Regt. Ohio
12th Regt. Ohio
 Regiment of *Ohio* Volunteers,
 RECRUITING OFFICER.

(A. G. O. No. 71 & 76.)

Mustered into the service of the United States, for ~~three years~~ ^{one} *year* during the war, from date of enlistment, in Company _____
 Regiment of *U. S. Cal* Volunteers, on the *2nd* day of *Sept*, 186*4*, at *Cincinnati O.*

Geo. H. Roby
Capt. 12th Regt. Ohio
12th Regt. Ohio

DECLARATION OF RECRUIT.

I, Charles E. Bell, desiring to VOLUNTEER as a Soldier in the Army of the United States, for the term of THREE YEARS, Do Declare, That I am thirty five years and months of age; that I have never been discharged from the United States service on account of disability or by sentence of a court martial, or by order before the expiration of a term of enlistment; and I know of no impediment to my serving honestly and faithfully as a soldier for three years.

GIVEN at Cincinnati Ohio the 28th day of Sept 1862

Witness:

U. S. C. J. Charles E. Bell No.

Volunteered at Cincinnati O Sept 2nd 1862 By Capt. Geo. H. Koy, P. M. 12th Regt of Ohio

enlistment; last served in Company () Reg't of Discharged 18

To be credited to Walnut Township Fairfield Co., Sub Dist No 12th Cong Dist

Jan 1868 This paper was filed at the Department of War

CONSENT IN CASE OF MINOR.

I, Do certify, That I am the of years of age; and I do hereby freely give my CONSENT to his volunteering as a SOLDIER in the ARMY OF THE UNITED STATES for the period of THREE YEARS.

GIVEN at the day of

Witness:

(A. G. O. No. 74 & 76.)

NOTE 1.—This blank will be used for both enlistments and re-enlistments—enlistment of veterans, &c., &c., in the volunteer service. They will be made out in duplicate in all cases—one to accompany the recruiting return of the superintendent (not the recruiting officer) to the Adjutant General, and one to accompany the accounts of the officer who pays bounty, &c. The Regiment and Company in which the soldier last served should be given on the back. NOTE 2.—An enlistment holds to service. A muster-in must, in all cases, precede payment of pay, bounty, pension, &c. A muster-in roll must, in all cases, be filed in the Adjutant General's Office as evidence of muster-in. The mustering officer, commissary, or assistant commissary of musters, as the case may be, will countersign both enlistments as having mustered the soldier into the service of the United States before either of them is given to the disbursing officer.

VOLUNTEER ENLISTMENT.

STATE OF

Ohio

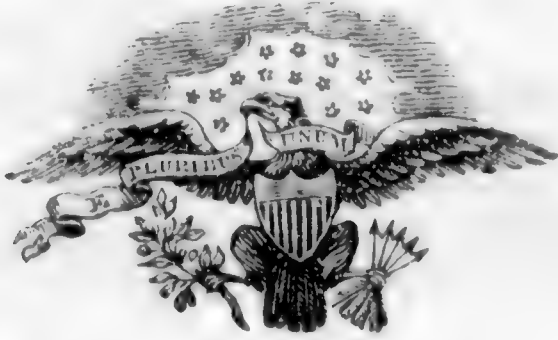

TOWN OF

Circleville.

I, *Charles E Bell*, born in *Gallia Co.*
 in the State of *Ohio*, aged *35* years,
 and by occupation a *Plasterer*, DO HEREBY ACKNOWLEDGE to have
 volunteered this *second* day of *Sept*, 186 *4*
 to serve as a *Soldier* in the **Army of the United States of America**, for
 the period of ~~THREE~~ *one* **YEARS**, unless sooner discharged by proper authority:
 Do also agree to accept such bounty, pay, rations, and clothing, as are, or may be,
 established by law for volunteers. And I, *Charles E Bell*, do
 solemnly swear, that I will bear true faith and allegiance to the **United States**
of America, and that I will serve them honestly and faithfully against all
 their enemies or opposers whomsoever; and that I will observe and obey the
 orders of the President of the United States, and the orders of the officers
 appointed over me, according to the Rules and Articles of War.

Sworn and subscribed to, at *Circleville*
 this *2^d* day of *Sept*, 186 *4* by *Chas. E. Bell*
 BEFORE *Geo. H. Roby Capt. 12th Ind. Inf.*

I CERTIFY, ON HONOR, That I have carefully examined the above-named Volunteer, agreeably
 to the General Regulations of the Army, and that, in my opinion, he is free from all bodily defects and
 mental infirmity, which would in any way disqualify him from performing the duties of a soldier.

W. H. Jones
Surgeon Board of Examiners
 EXAMINING SURGEON.

I CERTIFY, ON HONOR, That I have minutely inspected the Volunteer *Charles E Bell*
 previously to his enlistment, and that he was entirely sober when enlisted; that, to the best of my
 judgment and belief, he is of lawful age; and that, in accepting him as duly qualified to perform the
 duties of an able-bodied soldier, I have strictly observed the Regulations which govern the recruiting
 service. This soldier has *Black* eyes, *Wool* hair, *Black* complexion, is *Five*
 feet *Seven* inches high.

Geo. H. Roby Capt. 12th Ind. Inf.
12th Ind. Inf. Regiment of *Ohio* Volunteers,
 RECRUITING OFFICER.

(A. G. O. No. 74 & 76.)

Mustered into the service of the United States, for *three* years or during the war, from date of enlistment, in Company *.....*
 Regiment of *U. S. Cal* Volunteers, on the *2nd* day of *Sept*, 186 *4*, at *Circleville, O.*
Capt. W. H. Jones
12th Ind. Inf.

DECLARATION OF RECRUIT.

I, Charles E. Bell, desiring to VOLUNTEER as a Soldier in the Army of the United States, for the term of Three YEARS, months Do Declare, That I am Thirty six years and months of age; that I have never been discharged from the United States service on account of disability or by sentence of a court martial, or by order before the expiration of a term of enlistment; and I know of no impediment to my serving honestly and faithfully as a soldier for three years.

GIVEN at Cincinnati Ohio the 29 day of Sept 1864
Witness: Chas. E. Bell

U.S.C. 7

No. Charles E. Bell
Volunteered at Cincinnati
Sept 29, 1864
By Capt G. W. Parry For Major
12th Dist Regiment of Ohio

enlistment; last served in Company ()
Reg't of
Discharged _____, 18 _____

To be credited to Walnut Township Fairfield Co, O Sub Dist No 12th Cong Dist

CONSENT IN CASE OF MINOR.

I, _____, Do certify, That I am _____; that the _____ is _____ years of age; and I do hereby freely give my consent to his volunteering as a SOLDIER in the ARMY OF THE UNITED STATES for the period of THREE YEARS.

GIVEN at _____ the _____ day of _____
Witness: _____

NOTE 1.—This blank will be used for both enlistments and re-enlistments—enlistment of veterans, &c., &c., in the volunteer service. They will be made out in duplicate in all cases—one to accompany the recruiting return of the superintendent (not the recruiting officer) to the Adjutant General, and one to accompany the accounts of the officer who pays bounty, &c. The Regiment and Company in which the soldier last served should be given on the back.
NOTE 2.—An enlistment holds to service. A muster-in must, in all cases, precede payment of pay, bounty, pension, &c. A muster-in roll must, in all cases, be filed in the Adjutant General's Office as evidence of muster-in. The mustering officer, commissary, or assistant commissary of musters, as the case may be, will countersign both enlistments as having mustered the soldier into the service of the United States before either of them is given to the disbursing officer.

VOLUNTEER ENLISTMENT.

STATE OF

Ohio

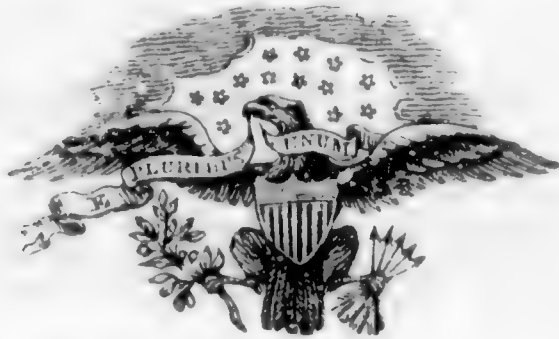

TOWN OF

Circleville

I, *Charles E Bell*, born in *Barren Co.*
 in the State of *Ohio*, aged *thirty five* years,
 and by occupation a *Plasterer*, DO HEREBY ACKNOWLEDGE to have
 volunteered this *second* day of *September*, 1864
 to serve as a **Soldier** in the **Army of the United States of America**, for
 the period of ~~THREE~~ ^{one} **YEARS**, unless sooner discharged by proper authority:
 Do also agree to accept such bounty, pay, rations, and clothing, as are, or may be,
 established by law for volunteers. And I, *Charles E Bell*, do
 solemnly swear, that I will bear true faith and allegiance to the **United States**
of America, and that I will serve them honestly and faithfully against all
 their enemies or opposers whomsoever; and that I will observe and obey the
 orders of the President of the United States, and the orders of the officers
 appointed over me, according to the Rules and Articles of War.

Sworn and subscribed to, at *Circleville*
 this *2^d* day of *Sept*, 1864
 BEFORE *Geo. H. Roky Capt. U.S.A.*
12th Dist of Ohio

I CERTIFY, ON HONOR, That I have carefully examined the above-named Volunteer, agreeably
 to the General Regulations of the Army, and that, in my opinion, he is free from all bodily defects and
 mental infirmity, which would in any way disqualify him from performing the duties of a soldier.

W. H. Jones
Surg. Genl. 12th Dist Ohio
 EXAMINING SURGEON.

I CERTIFY, ON HONOR, That I have minutely inspected the Volunteer *Charles E Bell*
 previously to his enlistment, and that he was entirely sober when enlisted; that, to the best of my
 judgment and belief, he is of lawful age; and that, in accepting him as duly qualified to perform the
 duties of an able-bodied soldier, I have strictly observed the Regulations which govern the recruiting
 service. This soldier has *Blue* eyes, *Wool* hair, *Blue* complexion, is *Five*
 feet *Seven* inches high.

Geo. H. Roky Capt. U.S.A.
12th Dist Ohio
 Regiment of *Ohio* ~~Volunteers~~
 RECRUITING OFFICER.

Mustered into the service of the United States, for ~~three~~ ^{one} years or during the war, from date of enlistment, in Company *D*
 Regiment of *W. S. Cal* Volunteers, on the *2nd* day of *Sept*, 1864, at *Circleville, O.*

Geo. H. Roky
Capt. U.S.A.
12th Dist Ohio

*Bell. Thomas*⁹⁶

Co. *D.*, **4** U.S. Col'd Inf.

Private | *Private*

CARD NUMBERS.

1	5556155	26
2	5556235	27
3	5556334	28
4	5556431	29
5	5556524	30
6	5556612	31
7	5556700	32
8	5556785	33
9	5556867	34
10	5556946	35
11	5557041	36
12	5557132	37
13	5557231	38
14	5557324	39
15	5557414	40
16	5557489	41
17	5557550	42
18	5557611	43
19	9062034	44
20		45
21		46
22		47
23		48
24		49
25		50

Book Mark:

See also

B | 4 | U.S.C.T.

Thomas Bell

Co. 10, 4 Reg't U. S. Col'd Inf.

Appears on

Company Descriptive Book

of the organization named above.

DESCRIPTION.

Age 16 years; height 5 feet 5 3/4 inches.

Complexion Black

Eyes Blue; hair Black

Where born Worcester Co. Ma

Occupation Farmer

ENLISTMENT.

When July 28, 1863

Where Chillicothe O

By whom Lt. J. P. Wilson; term 1 y'rs.

Remarks: Killed Sept 24/64
with company

W. H. Merrill

19

4

U.S.C.T.

Thomas Bell

Pvt., Co. D, 4 Reg't U. S. Col'd Infantry.

Age 16 years.

Appears on

Company Muster-in Roll

of the organization named above. Roll dated

Baltimore Md, July 28 1863.

Muster-in to date July 28, 1863.

Joined for duty and enrolled:

When July 28, 1863.*

Where Baltimore *

Period 3 years.*

Remarks:

* Muster-in roll shows enrollment and muster-in of this company as of same date and place. See enrollment on subsequent card or cards.

Book mark:

Paul Kner

19 | 4 | U.S.C.T.

Thomas Bell

102, Co. D, 4 Reg't U. S. Col'd Infantry.

Appears on

Company Muster Roll

for July 28/63 to Aug 31, 1863.

Joined for duty and enrolled:

When July 28, 1863.*

Where Baltimore Md *

Period 3 years.*

Present or absent present

Stoppage, \$ 100 for

Due Gov't \$ 100 for

Remarks: \$2.00 Premium due

* See enrollment on card from muster-in roll.

Book mark:

Faulkner

R | 4 | U.S.C.T.

Thomas Bell

Pvt., Co. D, 4 Reg't U. S. Col'd Infantry.

Appears on

Company Muster Roll

for Sept & Oct, 1863.

Joined for duty and enrolled:

When July 28, 1863.*

Where Baltimore Md *

Period 3 years.*

Present or absent present

Stoppage, \$ 100 for

Due Gov't \$ 100 for

Remarks:

* See enrollment on card from muster-in roll.

Book mark:

Faulkner

B | 4 | U.S.C.T.

Thomas Bell

Pvt., Co. D, 4 Reg't U. S. Col'd Infantry.

Appears on

Company Muster Roll

for Nov-Dec, 1863.

Joined for duty and enrolled:

When July 28, 1863.*

Where Baltimore Md *

Period 3 years.*

Present or absent present

Stoppage, \$ 100 for

Due Gov't \$ 100 for

Remarks:

* See enrollment on card from muster-in roll.

Book mark:

Faulkner Copyist.

(858c)

19 | 4 | U.S.C.T.

Thomas Bell

Priv., Co. D, 4 Reg't U. S. Col'd Infantry.

Appears on

Company Muster Roll

for Jan & Feb, 1864.

Joined for duty and enrolled:

When July 28, 1863.*

Where Baltimore Md. *

Period 3 years.*

Present or absent present

Stoppage, \$ 100 for

Due Gov't \$ 100 for

Remarks: Stop for 1 cartridge
Box (4.07) Bill (60) Plate (7) = \$ 1.74

* See enrollment on card from muster-in roll.

Book mark:

Faulkner

B | 4 | U.S.C.T.

Thomas Bell

Priv., Co. D, 4 Reg't U. S. Col'd Infantry.

Appears on

Company Muster Roll

for March + Apr, 1864.

Joined for duty and enrolled:

When July 28, 1863.*

Where Baltimore, Md.*

Period 3 years.*

Present or absent Present

Stoppage, \$ 100 for

Due Gov't \$ 100 for

Remarks: Stop for Letter D 14

* See enrollment on card from muster-in roll.

Book mark:

W A Tyler

B | 4 | U.S.C.T.

Thomas Bell

Priv., Co. D, 4 Reg't U. S. Col'd Infantry.

Appears on

Company Muster Roll

for May & June, 1864.

Joined for duty and enrolled:

When July 28, 1863*

Where Baltimore Md*

Period 3 years.*

Present or absent Present

Stoppage, \$ 1/100 for Letter D

Due Gov't \$ 100 for

Remarks: Detailed as Sharpshooter by Lt Col. Rogers, June 23-1864.

* See enrollment on card from muster-in roll.

Book mark:

W A Tyler

(858c)

Copyist.

B | 4 | U.S.C.T.

Thomas Bell

Privt, Co. D, 4 Reg't U. S. Col'd Infantry.

Appears on

Company Muster Roll

for July + Aug, 1864.

Joined for duty and enrolled:

When July 28, 1863.*

Where Baltimore Md.*

Period 3 years.*

Present or absent Present

Stoppage, \$ 1/100 for letter D

Due Gov't \$ 100 for

Remarks: Free on or before Apr 19, 1861. On extra duty at Dutch Gap, Va.

* See enrollment on card from muster-in roll.

Book mark:

W. A. Taylor

D | 4 | U.S.C.T.

Thomas Bell

Priv, Co. D, 4 Reg't U. S. Col'd Infantry.

Appears on

Company Muster Roll

for Sept + Oct, 1864.

Joined for duty and enrolled:

When July 28, 1863*

Where Baltimore Md*

Period 3 years.*

Present or absent Absent

Stoppage, \$ 1/100 for letter D

Due Gov't \$ 100 for _____

Remarks: True and/or before
Apr 29/61. Absent wound-
ed since Sept 29/64
Due Susler \$ 5.00

* ~~See~~ See enrollment on card from muster-in roll.

Book mark: _____

W. S. Tyler

B | 4 | U.S.C.T.

Thomas Bell

Priv., Co. D, 4 Reg't U. S. Col'd Infantry.

Appears on

Company Muster Roll

for Nov + Dec, 1864.

Joined for duty and enrolled:

When July 28, 1863.*

Where Baltimore *

Period 3 years.*

Present or absent Present

Stoppage, \$ 1/100 for letter D

Due Gov't \$ 100 for

Remarks: Free on or before April 19/64. Due letter \$5.00 Rejoined Company Dec. 29/64

* See enrollment on card from muster-in roll.

Book mark:

W. A. Tyler

(858c)

Copyist.

B | 4 | U.S.C.T.

Thomas Bell

Prvt., Co. D, 4 Reg't U. S. Col'd Infantry.

Appears on

Company Muster Roll

for Jan. & Feb., 1865.

Joined for duty and enrolled:

When July 28, 1863.*

Where Baltimore *

Period 3 years.*

Present or absent Present.

Stoppage, \$ 100 for

Due Gov't \$ 100 for

Remarks: Free onlv before Apr. 19/61.
Stop for Letter "D" 19
Due Duties \$ 5.00

* See enrollment on card from muster-in roll.

Book mark:

Castling Copyist.

(858c)

B | 4 | U.S.C.T.

Thomas Bell
Prvt., Co. D, 4 Reg't U. S. Col'd Infantry.

Appears on

Company Muster Roll
for Mar. & Apr., 1863.

Joined for duty and enrolled:

When July 28, 1863.*

Where Baltimore *

Period 3 years.*

Present or absent Present

Stoppage, \$ 100 for

Due Gov't \$ 100 for

Remarks:

* See enrollment on card from muster-in roll.

Book mark:

(858c) Eastling Copyist.

B | 4 | U.S.C.T.

Thomas Bell

Pvt., Co. D, 4 Reg't U. S. Col'd Infantry.

Appears on

Company Muster Roll

for May & June, 1865.

Joined for duty and enrolled:

When July 28, 1863.*

Where Baltimore *

Period 3 years.*

Present or absent Present

Stoppage, \$ 100 for

Due Gov't \$ 100 for

Remarks:

* See enrollment on card from muster-in roll.

Book mark:

(858c)

Castling Copyist.

B | 4 | U.S.C.T.

Thomas Bell

Priv., Co. D, 4 Reg't U. S. Col'd Infantry.

Appears on

Company Muster Roll

for July & Aug., 1865.

Joined for duty and enrolled:

When July 25, 1863.*

Where Balt. Md. *

Period 3 years.*

Present or absent Present.

Stoppage, \$ 100 for

Due Gov't \$ 100 for

Remarks: Stop. for 1 cart. Box
belt & plate 9¢ / cart
box plate 8¢

* See enrollment on card from muster-in roll.

Book mark:

(858c)

Castelberg

Copyist.

B | 4 | U.S.C.T.

Thomas Bell

Cpt., Co. D, 4 Reg't U. S. Col'd Infantry.

Appears on

Company Muster Roll

for Sept. & Oct., 1865.

Joined for duty and enrolled:

When July 28, 1863.*

Where Baltimore *

Period 3 years.*

Present or absent Present

Stoppage, \$ 100 for

Due Gov't \$ 100 for

Remarks: Stop for cap, musket, Letter,
+ Badge 3¢ Great Coat Straps 12¢
Haversack 95¢ Cantus 65¢
= \$1.75

* See enrollment on card from muster-in roll.

Book mark:

(858c)

Castelling

Copyist.

5

B | 4 | U.S.C.T.

Thomas Bell

Pvt., Co. D, 4 Reg't U. S. Col'd Infantry.

Appears on

Company Muster Roll

for Nov & Dec, 1865.

Joined for duty and enrolled:

When July 28, 1863.*

Where Baltimore *

Period 3 years.*

Present or absent Present

Stoppage, \$ 100 for

Due Gov't \$ 100 for

Remarks:

Stop for Haversack 79c
Canteen 65c
shoes 50c
Letter P
17 Number 48 Bangle 2c = 81.98c

* See enrollment on card from muster-in roll.

Book mark:

J. J. J. J.

(858c)

Copyist.

B | 4 | U.S.C.T.

Thomas Bell

Pvt., Co. D, 4 Reg't U. S. Col'd Infantry.

Appears on

Company Muster Roll

for Jan & Feb, 1866.

Joined for duty and enrolled:

When July 28, 1863.*

Where Baltimore *

Period 3 years.*

Present or absent Present

Stoppage, \$ 100 for

Due Gov't \$ 100 for

Remarks: Stop 10 4.03
Ad Gen Dep of Wash
Jan 26/66

NEXT ROLL ON FILE MUSTER OUT.

* See enrollment on card from muster-in roll.

Book mark:

Joiner Copyist.

B. | 4 | U.S.C.T.

Thomas Bell

Pvt, Co. *D*, 4 Reg't U. S. Col'd Infantry.

Appears on Co. Muster-out Roll, dated *Washington D.C. May 4, 1866*.

Muster-out to date *May 4, 1866*.

Last paid to *Feb 28, 1866*.

Clothing account:

Last settled....., 186 ; drawn since \$.....100

Due soldier \$ *15*^{*21*}/₁₀₀; due U. S. \$.....100

Am't for cloth'g in kind or money adv'd \$.....100

Due U. S. for arms, equipments, &c., \$.....100

Bounty paid \$.....100; due \$ *100*/₁₀₀

Remarks: *Free on or before April 19/66*

Book mark:

(361)

J. J. [unclear]
Copyist.

Gell, Thos

P, Co. D, 4 Reg't U.S.C.

2 Enclosures.

Bed Cards	Descriptive Lists
Burial Records	Final Statements
Certs. of Dis. for Discharge	Furloughs
C. M. Charges	Med. Des. Lists
Med. Certificates	Orders

Other papers relating to—

Admission to Hosp'l	Furlough
Casualty Sheet (Officer's)	Med. Examination
Confinement	Misc. Information
Contracts	Pay or Clothing
Death or Effects	Personal Reports
Desertions	Rank
Discharge from Hosp'l	Transfer to Hosp'l
Discharge from Service	Transfer to V. R. C.
Duty	Transportation

Hospital Number 589

Name *Thos. Bell*

Age *19* Nativity *Southern Shore Md*

~~Married~~ Single

Residence *Cambridge Md*

Post Office address of wife or nearest relative. *Mary E Bell
Cambridge Md*

Rank *Priv* Co. *D* Regiment *4th U.S.C.T.*

When admitted *Oct 2nd '11*

From what source *Reg^l Hosp.*

Diagnosis: (in surgical cases state explicitly seat and character of wound or injury.)

Leg

Post Hospital,
New Berne, N.C.

On what occasion wounded

Date

Nature of missile or weapon

TREATMENT.

[HERE NOTE IMPORTANT COMPLICATIONS AND ALL OPERATIONS.]

RESULT and DATE.

Suity act 8
X

D. of D. report

Tried on the charge
 "Drunken and riotous
 conduct found guilty -
 To forfeit to the U.S. \$10.
 and hard labor for 15 days

E. O. E. Defenses of Washington
 (Separate Brigade) Jan 26, 1866.

Bell Thomas
 Co. "H" 4th U.S. Col. Inf.

Pliv. of His. records.

Adjutant General's Office,

COLORED TROOPS BRANCH,

August 4th, 1876

Mr. Ellsbrook
Wanted in the case of Thomas Bell Pvt., Co. "H",
4th Reg't U.S. Col. Inf. copy of order re

Member Roll for Jan'y & July 1866 "Stop \$10.00 of C
3. Hd. Qu. Hq. of Wash. Jan'y 1866 -

Respectfully,

L. A. Woodward
Chief Clerk.
Per J. Halson

Adjutant General's Office,

Division of Discontinued Commands.

Aug. 29th, 1876.

Vol. 17 C. T., 187

Reply in case of Thomas Bell, Co. D,
4th Reg't U.S. Col. Inf.

G.O. No 3 Defences of Washington, (Separate Brigade)
Jan'y 26, 1866 - Charge - Drunken and Riotous
Conduct - Findings - Guilty - Sentence - To
forfeit to the U.S. ten dollars (\$10.00) and to be kept
at hard labor for 15 days - Approved.

See on chap "Personnel & Status of Command - D - found guilty
of forfeiture to the U.S. of \$10.00 and to be kept at hard labor for 15 days by 3 Members
of Washington (Separate Brigade) Jan'y 26, 1866 - see P. 17 & 18 C.T.

97
Bell, William H.

Co H, **4** U.S. Col'd Inf.

Corporal

Corporal

CARD NUMBERS.

1	5562695	26
2	5562495	27
3	5562894	28
4	5562996	29
5	5563092	30
6	5563186	31
7	5563280	32
8	5563368	33
9	5563454	34
10	5563539	35
11	5563637	36
12	5563734	37
13	5563837	38
14	5564009	39
15	5564261	40
16	5580747	41
17	9062658	42
18	623-0-1885	43
19		44
20		45
21		46
22		47
23		48
24		49
25		50

Book Mark: 623-0-1885

See also

113

4

U.S.C.T.

William H. Bell

Co. A, 4 Reg't U. S. Col'd Inf.

Appears on

Company Descriptive Book

of the organization named above.

DESCRIPTION.

Age 36 years ; height 5 feet 7 inches.

Complexion Brown

Eyes Gray ; hair Black

Where born Frederick Co. Md.

Occupation Quarryman

ENLISTMENT.

When Aug 11, 1863.

Where Baltimore Md.

By whom Col. Burney ; term 3 y'rs.

Remarks: Free on or before

Apr 19/64

Discharged for disability
June 28/65, by order
Maj. Genl Schofield

Selah

Copyist.

B | 4 | U.S.C.T.

William H. Bell

Corp., Co. H, 4 Reg't U. S. Col'd Infantry.

Appears on

Company Muster Roll

for *Aug 11 to Aug 31*, 186*3*.

Joined for duty and enrolled:

When *Aug. 11*, 186*3*.*

Where *Baltimore City* *

Period *3* years.*

Present or absent *Present*

Stoppage, \$ *100* for

Due Gov't \$ *100* for

Remarks:

* See enrollment on card from muster-in roll.

Book mark: -----

(858c)

M. A. Michaels

Copyist.

B | 4 | U.S.C.T.

Wm H. Bell

Capt, Co. *H*, 4 Reg't U. S. Col'd Infantry.

Age *36* years.

Appears on

Company Muster-in Roll

of the organization named above. Roll dated

Aug 11, 186*3*.

Muster-in to date

Aug 11, 186*3*.

Joined for duty and enrolled:

When *Aug 11*, 186*3*.*

Where *Baltimore City* *

Period *3* years.*

Remarks:

* Muster-in roll shows enrollment and muster-in of this company as of some date and place. See enrollment on subsequent card or cards.

Book mark: *623-D-1885*

M. A. Michaels

(356r)

Copyist.

B | 4 | U.S.C.T.

William H. Bell

Corpl., Co. H, 4 Reg't U. S. Col'd Infantry.

Appears on

Company Muster Roll

for *Sept & Oct*, 1863.

Joined for duty and enrolled:

When *Aug. 11*, 1863*

Where *Baltimore City**

Period *3* years.*

Present or absent *Present*

Stoppage, \$ *100* for

Due Gov't \$ *100* for

Remarks:

* See enrollment on card from muster-in roll.

Book mark:

M. A. Michaels

(358c)

Copyist.

B | 4 | U.S.C.T.

William H. Bell

Corpl., Co. H, 4 Reg't U. S. Col'd Infantry.

Appears on

Company Muster Roll

for Nov & Dec., 1863.

Joined for duty and enrolled:

When Aug. 11, 1863.*

Where Baltimore City *

Period 3 years.*

Present or absent Present

Stoppage, \$ 100 for

Due Gov't \$ 100 for

Remarks:

* See enrollment on card from muster-in roll.

Book mark:

M. A. Michaels

(358c)

Copyist.

B | 4 | U.S.C.T.

William H Bell
Corp., Co. H, 4 Reg't U. S. Col'd Infantry.

Appears on

Company Muster Roll

for Jan & Febr, 1864.

Joined for duty and enrolled:

When Aug. 11, 1863.*

Where Baltimore City *

Period 3 years.*

Present or absent Present

Stoppage, \$ 100 for

Due Gov't \$ 100 for

Remarks:

* See enrollment on card from muster-in roll.

Book mark:

M. A. Michaels
(858c) Copyist.

B | 4 | U.S.C.T.

William H. Bell
Corpl., Co. H, 4 Reg't U. S. Col'd Infantry.

Appears on

Company Muster Roll

for March 8 April, 1864.

Joined for duty and enrolled:

When Aug. 11, 1863.*

Where Baltimore City *

Period 3 years.*

Present or absent Present.

Stoppage, \$ 100 for

Due Gov't \$ 100 for

Remarks:

* See enrollment on card from muster-in roll.

Book mark:

C. F. Thompson
Copyist.

B

4

U.S.C.T.

William H. Bell,
Corpl, Co. H, 4 Reg't U. S. Col'd Infantry.

Appears on

Company Muster Roll

for *May & June*, 1864.

Joined for duty and enrolled:

When *Aug. 11*, 1863.*

Where *Baltimore City* *

Period *3* years.*

Present or absent *Absent.*

Stoppage, \$ *100* for

Due Gov't \$ *100* for

Remarks: *Absent sick -*
wounded before Peter-
burg Va. June 15th 1864

* See enrollment on card from muster-in roll.

Book mark:

(358c)

C. F. Thompson
 Copyist.

D

4

U.S.C.T.

William H. Bell
Corpl, Co. H, 4 Reg't U. S. Col'd Infantry.

Appears on

Company Muster Roll

for July & Aug., 1864.

Joined for duty and enrolled:

When Aug. 11, 1863.*

Where Baltimore City *

Period 3 years.*

Present or absent Absent

Stoppage, \$ 100 for

Due Gov't \$ 100 for

Remarks: Absent sick -
wounded in action before
Petersburg Va. June 15th
1864

* See enrollment on card from muster-in roll.

Book mark:

(858c)

C. F. Thompson.

Copyist.

B | 4 | U.S.C.T.

William H. Bell,

Corpl., Co. H, 4 Reg't U. S. Col'd Infantry.

Appears on

Company Muster Roll

for *Sept. & Oct.*, 1864.

Joined for duty and enrolled:

When *Aug. 11*, 1863.*

Where *Baltimore, Md.* *

Period *3* years.*

Present or absent *Present*

Stoppage, \$ *100* for

Due Gov't \$ *100* for

Remarks: *Free on or before
Apr. 19/61 - Corporal
since enlistment*

* See enrollment on card from muster-in roll.

Book mark:

(858c)

C. F. Thompson
Copyist.

B | 4 | U.S.C.T.

William H. Bell
Corpl, Co. H, 4 Reg't U. S. Col'd Infantry.

Appears on

Company Muster Roll
for Nov. & Dec., 1864

Joined for duty and enrolled:

When Aug. 11, 1863.*

Where Baltimore *

Period 3 years.*

Present or absent Present

Stoppage, \$ 100 for

Due Gov't \$ 100 for

Remarks: Free on or before
Apr. 19/61

* See enrollment on card from muster-in roll.

Book mark:

(858c) C. F. Thompson, Copyist.

B | 4 | U.S.C.T.

William Bell

Corp, Co. H, 4 Reg't U. S. Col'd Infantry.

Appears on

Company Muster Roll

for Jan + Feb, 1865.

Joined for duty and enrolled:

When Aug 11, 1863.*

Where Baltimore Md *

Period 3 years.*

Present or absent Present

Stoppage, \$ 100 for

Due Gov't \$ 100 for

Remarks: Free on or before April 19, 1861

* See enrollment on card from muster-in roll.

Book mark:

Boroman

B | 4 | U.S.C.T.

William H. Bell

Corp, Co. H, 4 Reg't U. S. Col'd Infantry.

Appears on

Company Muster Roll

for *Mar & Apr*, 1865.

Joined for duty and enrolled:

When *Aug 11*, 1863.*

Where *Baltimore Md* *

Period *3* years.*

Present or absent *Absent*

Stoppage, \$ *100* for

Due Gov't \$ *100* for

Remarks: *Absent sick*

* ~~See~~ See enrollment on card from muster-in roll.

Book mark: -----

Bowman

B

4

U.S.C.T.

William H. Bell

Corp., Co. H, 4 Reg't U. S. Col'd Infantry.

Appears on

Company Muster Roll

for May & June, 1865.

Joined for duty and enrolled:

When Aug 11, 1863.*

Where Baltimore Md *

Period 3 years.*

Present or absent Absent

Stoppage, \$ 100 for

Due Gov't \$ 100 for

Remarks: Absent sick

* See enrollment on card from muster-in roll.

Book mark:

Bowman

B | 4 | U.S.C.T.

William H. Bell

Corp, Co. H, 4 Reg't U. S. Col'd Infantry.

Appears on

Company Muster Roll

for Jul & Aug, 1865.

Joined for duty and enrolled:

When Aug 11, 1863.*

Where Baltimore Md *

Period 3 years.*

Present or absent

Stoppage, \$ 100 for

Due Gov't \$ 100 for

Remarks: Discharged for disability
June 28/65

* See enrollment on card from muster in roll.

Book mark: 119.327.1040.2 and June 7/66

Bowman

13 | 4 | U.S.C.T.

William H. Bell,
Corpl., Co. H., 4 Reg't U. S. Col'd Infantry.

Appears on **Co. Muster-out Roll**, dated
Washington, D. C., May 4, 1866.

Muster-out to date 186 .

Last paid to *Dec. 31, 1864.*

Clothing account:

Last settled....., 186 ; drawn since \$.....100

Due soldier \$.....100; due U. S. \$.....100

Am't for cloth'g in kind or money adv'd \$.....100

Due U. S. for arms, equipments, &c., \$.....100

Bounty paid \$.....100; due \$.....100

Remarks: *Discharged for disability*
June 28, 1865 by order
Maj. Gen. Schofield. Was
Corpl. from enrollment.
Free.

Book mark: *119.327 D. B. V.*

(861)

W. B. Spawmer

Copyist.

B | L | U.S.C.T.

William H Bell

Corpl, Co. . . . , *4* Reg't U. S. Col'd Infantry.

Appears on an

Individual Muster-out Roll

of the organization named above. Roll dated

Wilmington, N. C., June 28, 1865.

Muster-out to date *June 28, 1865.*

Last paid to *Dec. 31, 1864.*

Clothing account:

Last settled, 186 ; drawn since \$ 100

Due soldier \$ 100; due U. S. \$ 100

Am't for cloth'g in kind or money adv'd \$ 100

Due U. S. for arms, equipments, &c., \$ 100

Bounty paid \$ 100; due \$ 100

Remarks: *Patient in Hospital*

Mustered out by authority of G.

O. h. 37. C. S., Hdquarters, Dept N. C.

Clothing acct settled June 30, 1864.

Am't clothing drawn since last

settlement, \$32²⁴ Transportation

(OVER)

Book mark:

C. M. Clark

JAN. 19

5550747

1891*

*due from place of discharge
to place of enrollment.*

B | 4" | C.S.

Wm H. Bell.

, Co. A, 4" Reg't U.S.

NOTATION.

Book mark: 623 D. 1885

Adjutant General's Office,

WAR DEPARTMENT,

Washington, April 8, 1885.

Discharge on file.

(438)

Summy

Copyist.

Bell William H

Corp, Co. H, 4 Reg't U.S.C.I

Enclosures.

Bed Cards	Final Statements
Burial Records	Furloughs or L. of A.
Certs. of Dis. for Discharge	Med. Certificates
C. M. Charges	Med. Des. Lists
Descriptive Lists	Orders
Discharge Certificates	Pris. of War Record
Enlistment Papers	Resignations

Other papers relating to—

Admission to Hosp'l	Furlough or L. of A.
Casualty Sheet	Med. Examination
Confinement	Misc. Information
Contracts	Pay or Clothing
Death or Effects	Personal Reports
Desertion	Rank
Discharge from Hosp'l	Transfer to Hosp'l
Discharge from Service	Transfer to V. R. C.
Duty	Transportation

6 1/2

CASUALTY SHEET
OF WOUNDED.

*Wm H Bell**Corporal* Company *H**4* Regiment of *U.S. (col)*

Volunteers, at the battle of

(see inside)

CASUALTY SHEET.

Name, Wm A Bell
 Rank, Corporal, Company A, Regiment, 4
 Arm, _____, State, U.S. (col?)
 Place of casualty, _____

Nature of casualty, gun shot wound right leg
Arrived July 21 Ward Hospital
 Date of casualty, _____

FROM WHAT SOURCE THIS INFORMATION WAS OBTAINED.

Report of Killed, Wounded, and Missing of the _____ Regiment,
 _____ Brigade, _____ Division, _____ Corps, dated _____
Hospital Register 1st Eng. Sd. Reg. Ariz
Book 4 page 27

W North
April 23 1885 Clerk.

AS

⁹⁸
Bennett, John
Co. D., 4 U.S. Col'd Inf.

Private | Private

CARD NUMBERS.

1	5556154	26
2	5556237	27
3	5566335	28
4	5556433	29
5	5556526	30
6	5556613	31
7	5556701	32
8	5556786	33
9	5556868	34
10	5556947	35
11	5557042	36
12	5557134	37
13	5557232	38
14	5557325	39
15	5557415	40
16	5557490	41
17	5557551	42
18	5557613	43
19	9062035	44
20	S-174-RCI-1867	45
21		46
22		47
23		48
24		49
25		50

Book Mark: B 3. 10864 - B 74. RC I / 67.
S 174 VS. RC I. 1867.

See also

S. 1047489 - 2nd and

B

4

U.S.C.T.

John Bennett

, Co. D, 4 Reg't U. S. Col'd Inf.

Appears on

Company Descriptive Book

of the organization named above.

DESCRIPTION.

Age 25 years; height 5 feet 3/4 inches.

Complexion *Quartette*

Eyes *Black*; hair *Black*

Where born *Cambridge ms*

Occupation *Farmer*

ENLISTMENT.

When *July 28*, 186*2*

Where *Andover O*

By whom *Lt. J. F. Wilson*; term *1* y'rs.

Remarks: *Absent sick since July 15 / 64*
Absent without leave

W. H. Merrill

(388g)

Copyist.

19

4

U.S.C.T.

John Bennett

Co. D, 4 Reg't U. S. Col'd Infantry.

Age 25 years.

Appears on

Company Muster-in Roll

of the organization named above. Roll dated

Baltimore Md, July 28, 1863.

Muster-in to date July 28, 1863.

Joined for duty and enrolled:

When July 28, 1863.*

Where Baltimore *

Period 3 years.*

Remarks:

* Muster-in roll shows enrollment and muster-in of this company as of same date and place. See enrollment on subsequent card or cards.

Book mark:

Faulkner

19 | 4 | **U.S.C.T.**

John Bennett

Cvt., Co. D, 4 Reg't U. S. Col'd Infantry.

Appears on

Company Muster Roll

for July 28th to Aug 31, 1863.

Joined for duty and enrolled:

When July 28, 1863.*

Where Baltimore Md *

Period 3 years.*

Present or absent present

Stoppage, \$ 100 for

Due Gov't \$ 100 for

Remarks: Stop for one quarter
\$2.00 Premium due

* See enrollment on card from muster-in roll.

Book mark:

Faulkner

B | 4 | U.S.C.T.

John Bennett

Pvt., Co. D, 4 Reg't U. S. Col'd Infantry.

Appears on

Company Muster Roll

for Sept & Oct, 1865.

Joined for duty and enrolled:

When July 28, 1863.*

Where Baltimore Md *

Period 3 years.*

Present or absent present

Stoppage, \$ 100 for

Due Gov't \$ 100 for

Remarks:

* See enrollment on card from muster-in roll.

Book mark:

Franklin

18 | 4 | **U.S.C.T.**

John Bennett

Co., Co. D, 4 Reg't U. S. Col'd Infantry.

Appears on

Company Muster Roll

for Nov & Dec, 1863.

Joined for duty and enrolled:

When July 28, 1863.*

Where Baltimore md *

Period 3 years.*

Present or absent present

Stoppage, \$ 100 for

Due Gov't \$ 100 for

Remarks:

* See enrollment on card from muster-in roll.

Book mark: -----

(858c) Faulkner Copyist.

B | 4 | U.S.C.T.

John Bennett

Pvt., Co. D, 4 Reg't U. S. Col'd Infantry.

Appears on

Company Muster Roll

for Jan & Feb, 1864

Joined for duty and enrolled:

When July 28, 1863*

Where Baltimore Md *

Period 3 years.*

Present or absent present

Stoppage, \$ 100 for

Due Gov't \$ 100 for

Remarks: Stop for one knapsack and straps = \$1.85

* See enrollment on card from muster-in roll.

Book mark:

Faulkner

B | 4 | U.S.C.T.

John Bennett
Priv., Co. D, 4 Reg't U. S. Col'd Infantry.

Appears on

Company Muster Roll
for March + Apr, 1864.

Joined for duty and enrolled:

When July 28, 1863.*

Where Baltimore Md.*

Period 3 years.*

Present or absent Present

Stoppage, \$ 100 for

Due Gov't \$ 100 for

Remarks: On daily duty
as Co. Cook Stop
for Letter D 12

* See enrollment on card from muster-in roll.

Book mark:

W A Tyler
(858c) Copyist.

B | 4 | U.S.C.T.

John Bennett
Priv., Co. D, 4 Reg't U. S. Col'd Infantry.

Appears on

Company Muster Roll

for May & June, 1864.

Joined for duty and enrolled:

When July 28, 1863.*

Where Baltimore Md*

Period 3 years.*

Present or absent Present

Stoppage, \$ 1/100 for Letter D

Due Gov't \$ 100 for _____

Remarks: On daily duty as
Company Cook

* See enrollment on card from muster-in roll.

Book mark: _____

W A Tyler

(858c)

Copyist.

B | 4 | U.S.C.T.

John Bennett
Priv, Co. D, 4 Reg't U. S. Col'd Infantry.

Appears on

Company Muster Roll

for July + Aug, 1864.

Joined for duty and enrolled:

When July 28, 1863.*

Where Baltimore Md.*

Period 3 years.*

Present or absent Absent

Stoppage, \$ 1/100 for letter D

Due Gov't \$ 100 for

Remarks: I have on or before
Apr 19, 1861. Absent
sick since July 13, 1864.

* See enrollment on card from muster-in roll.

Book mark:

W. A. Tyler

B | 4 | U.S.C.T.

John Bennett
Priv., Co. D, 4 Reg't U. S. Col'd Infantry.

Appears on

Company Muster Roll

for Sept + Oct, 1864.

Joined for duty and enrolled:

When July 28, 1863.*

Where Baltimore Md.*

Period 3 years.*

Present or absent Absent

Stoppage, \$ 1/100 for letter D

Due Gov't \$ 100 for

Remarks: Status not ascer-
tained. Absent sick
since July 13/64

* See enrollment on card from muster-in roll.

Book mark:

(858c) W. A. Tyler Copyist.

B | 4 | U.S.C.T.

John Bennett
Priv., Co. D, 4 Reg't U. S. Col'd Infantry.

Appears on

Company Muster Roll

for Nov + Dec, 1864.

Joined for duty and enrolled:

When July 28, 1863.*

Where Baltimore *

Period 3 years.*

Present or absent Absent

Stoppage, \$ 1/100 for letter D

Due Gov't \$ 100 for

Remarks: Status not ascer-
tained. Absent sick
since July 13/64

* See enrollment on card from muster-in roll.

Book mark:

W A Tyler
(858c) Copyist.

B | 4 | U.S.C.T.

John Bennett
Pvt., Co. D, 4 Reg't U. S. Col'd Infantry.

Appears on

Company Muster Roll

for Jan. & Feb., 1865.

Joined for duty and enrolled:

When July 28, 1863.*

Where Baltimore *

Period 3 years.*

Present or absent Absent

Stoppage, \$ 100 for

Due Gov't \$ 100 for

Remarks: Status not ascertained,
Absent sick. Stop for
Letter "S" / P.

* See enrollment on card from muster-in roll.

Book mark:

(858c) Pasterling Copyist.

B | 4 | **U.S.C.T.**

John Bennett

Art., Co. D, 4 Reg't U. S. Col'd Infantry.

Appears on

Company Muster Roll

for *Mar. & Apr.*, 186*5*.

Joined for duty and enrolled:

When *July 28*, 186*3*.*

Where *Baltimore*.*

Period *3* years.*

Present or absent *Absent*.

Stoppage, \$ *100* for

Due Gov't \$ *100* for

Remarks: *Status not ascertained.*

Absent without leave.

Stop for Letter D, 18

* See enrollment on card from muster-in roll.

Book mark:

Castling Copyist.

B | 4 | U.S.C.T.

John Bennett

Priv., Co. D, 4 Reg't U. S. Col'd Infantry.

Appears on

Company Muster Roll

for May & June, 1863.

Joined for duty and enrolled:

When July 28, 1863*

Where Baltimore *

Period 3 years.*

Present or absent Absent

Stoppage, \$ 100 for

Due Gov't \$ 100 for

Remarks: Status not ascertained, Absent sick Stop for Letter D, 19

* See enrollment on card from muster-in roll.

Book mark:

Castling Copyist.

B | 4 | U.S.C.T.

John Bennett
Priv., Co. D, 4 Reg't U. S. Col'd Infantry.

Appears on

Company Muster Roll

for July & Aug., 1863.

Joined for duty and enrolled:

When July 28, 1863.*

Where Balt., Md. *

Period 3 years.*

Present or absent Absent

Stoppage, \$ 100 for

Due Gov't \$ 100 for

Remarks: Status not ascertained,
Absent sick

* See enrollment on card from muster-in roll.

Book mark:

(858c)

Castling

Copyist.

B | 4 | U.S.C.T.

John Bennett

Pr., Co. D, 4 Reg't U. S. Col'd Infantry.

Appears on

Company Muster Roll

for *Sept. & Oct.*, 186*5*.

Joined for duty and enrolled:

When *July 28*, 186*3*.*

Where *Baltimore* *

Period *3* years.*

Present or absent *Absent*

Stoppage, \$ *100* for

Due Gov't \$ *100* for

Remarks: *Absent sick since June 14/64. at Point of Rocks Hosp. never since heard from.*

* See enrollment on card from muster-in roll.

Book mark:

Castling
(858c) Copyist.

B | 4 | U.S.C.T.

John Bennett
Private, Co. D, 4 Reg't U. S. Col'd Infantry.

Appears on

Company Muster Roll

for Nov & Dec, 1865.

Joined for duty and enrolled:

When July 28, 1865.*

Where Baltimore *

Period 3 years.*

Present or absent Absent.

Stoppage, \$ 100 for

Due Gov't \$ 100 for

Remarks: Absent sick since June 14/64 at Point of Rock Hosp. Never since heard from

* See enrollment on card from muster-in roll.

Book mark:

(858c) Joiner Copyist.

B. | 4 | U.S.C.T.

John Bennett

Pvt; Co. D, 4 Reg't U. S. Col'd Infantry.

Appears on

Company Muster Roll

for Jan & Feb, 1866.

Joined for duty and enrolled:

When July 28, 1866.*

Where Baltimore *

Period 3 years.*

Present or absent Absent

Stoppage, \$ 100 for

Due Gov't \$ 100 for

Remarks: Absent sick since June 14/64 at Point of Rocks Hosp. Never since heard from.

NEXT ROLL ON FILE MUSTER OUT.

* See enrollment on card from muster-in roll.

Book mark:

Joiner Copyist.

73.1

4

U.S.C.T.

John Bennett.

Pvt., Co. *D.*, 4 Reg't U. S. Col'd Infantry.

Appears on **Co. Muster-out Roll**, dated

Washington D.C. May 4, 1866.

Muster-out to date *May 4*, 1866.

Last paid to *Feb 25*, 1866.

Clothing account:

Last settled....., 186 ; drawn since \$.....100

Due soldier \$.....100; due U. S. \$.....100

Am't for cloth'g in kind or money adv'd \$.....100

Due U. S. for arms, equipments, &c., \$.....100

Bounty paid \$.....100; due \$.....100

Remarks:.....

Book mark: *1639/20 May 21, 131, 112*

B3 Vol 7 c 7693 B74 Vol 5 R6 J67 .V 149. P 58.73

Exchange (over)

Jornin.

Book Mark: ⁹ ⁷
 Died at Balboa Gen
 Hospital Portsmouth Va July
 29, 1864 of remittent fever
 See S. 174 ^U ^{Rec.} ~~Vol~~ 5 ~~Vol~~ 1867

x Corrected by Patton
 &

B | 4" | U. S. C. J.

John Bennett

, Co. D, 4" Reg't U. S. C. J.

NOTATION.

Book mark: B-74-R-C-J-1867 with
S-174-R-C-J-1867.

War Department,

Adjutant General's Office,

Washington, Augt. 24, 1867.

Discharge on file.
Canceled.

M. Allen

Bennett, John

P. O., Co. **4** *Reg't* **U. S. C. Inf.**

2 Enclosures.

Bed Cards	Descriptive Lists
Burial Records	Final Statements
Certs. of Dis. for Discharge	Furloughs
C. M. Charges	Med. Des. Lists
Med. Certificates	Orders

Other papers relating to—

Admission to Hosp'l	Furlough
Casualty Sheet (<i>Prv</i> Officer's)	Med. Examination
Confinement	Misc. Information <i>/</i>
Contracts	Pay or Clothing
Death or Effects	Personal Reports
Desertions	Rank
Discharge from Hosp'l	Transfer to Hosp'l
Discharge from Service	Transfer to V. R. C.
Duty	Transportation

31 1/2

CASUALTY SHEET

Complete

No.

John Bennett

Private of Company D

H Regiment of 4th Troops

State Volunteers.

~~NATURE OF CASUALTY.~~

Died, July 29th 1864.

Noted on Rolls
1864

Enos D. Hoopes

NARA 235

CASUALTY SHEET.

—————

Name: John Bennett

Rank: Private Company: D Regiment: 4th

Arm: U.S. Troops State: _____

Nature of Casualty: Death

CAUSE OF CASUALTY—(NAME OF DISEASE, &c.)

Remittent Fever

BY WHOM DISCHARGED.

DEGREE OF DISABILITY.

FROM WHAT SOURCE THIS INFORMATION WAS OBTAINED.

174. Val. R. 5. 1867.

BY WHOM CERTIFIED.

G. Woodward

REMARKS.

Asst Surg. U.S. Army

DATE OF DISCHARGE, DEATH, &c.

July 29th 1864

PLACE OF DISCHARGE, DEATH, &c.

Balfour General Hospital
Portsmouth, Va.

M. J. G. G. G.
Lowers
Clerk.

Bennett John
"H" 4th Reg. Co. T.S.

Rec^d of His^c. bonds.

mail

Adjutant General's Office,

COLORED TROOPS BRANCH,

August 24th, 1876

Mr. LeBarbrook, 187

Wanted in the case of John Bennett 1st, Co. H,
Hth Regt U.S.C. Is period absent and if in

Member Roll for March & April 1865 "Absent
without leave"

Respectfully,

L. A. Woodward
In J. Halton ^{Chief Clerk.}

Adjutant General's Office,

Division of Discontinued Commands.

Aug^h 29^a, 1876.

Vol. C. T., 187

Reply in case of John Bennett, Co. D,
Hth Regt U.S.C. D

Regt Des DK - Name borne without remark -
Co Des DK - "Absent sick since July 1864 - Absent without
leave" - Mor'g Reports do not cover date

No record of charges, arrest or trial - A letter
sent to the Chief of the Bureau Col^d Troops Jan'y 1866
by Col S.A. Duncan Com'g Regt states that he was
last heard from at Point of Rocks Hospital near
Alexandria - Va, June 14th 65

Note - No record of absence without leave in Apr 1861 under Regt
Records with Regt of P.S. Bonds

This man died in July 1864 see MO Roll - No use stating anything about

the absence without leave from Pt of Rocks

⁹⁹
Bennett John R.

Co. H, 4 U.S. Col'd Inf.

Private Private

CARD NUMBERS.

1	5565995	26
2	5566096	27
3	5566195	28
4	5566293	29
5	5566382	30
6	5566468	31
7	5566554	32
8	5566629	33
9	5566705	34
10	5566796	35
11	5566881	36
12	5566973	37
13	5567059	38
14	5567145	39
15	5567219	40
16	5567278	41
17	5567333	42
18	9067796	43
19	9067924	44
20		45
21		46
22		47
23		48
24		49
25		50

Book Mark:

See also

B | 4 | **U.S.C.T.**

John R. Bennett,

K, Co. *K*, 4 Reg't U. S. Col'd Inf.

Appears on

Company Descriptive Book

of the organization named above.

DESCRIPTION.

Age *22* years; height *5* feet ^{*3/4*} *6* inches.

Complexion *Blk*

Eyes *Blk*; hair *Curly*

Where born *Balbot Co, Md*

Occupation *Farmer*

ENLISTMENT.

When *Sept 2*, 18*63*.

Where *Balto, Md*

By whom *Col Burney*; term *3* y'rs.

Remarks: *Slave*

Selah

(883g)

Copyist.

B | 4 | U.S.C.T.

John A. Bennett

Co. *K*, 4 Reg't U. S. Col'd Inf.

Appears on

Company Descriptive Book

of the organization named above.

DESCRIPTION.

Age *22* years; height *5* feet *6*^{*3*}/_{*4*} inches.

Complexion *Blk*

Eyes *Blk*; hair *Curl*

Where born *Talbot County*

Occupation *Farmer*

ENLISTMENT.

When *Sept 2*, 18*63*.

Where *Balto, Md.*

By whom *Col. Burney*; term *3* y'rs.

Remarks: *Slave*

Selah

P | **4** | **U.S.C.T.**

John R Bennett

P, Co. *K*, 4 Reg't U. S. Col'd Infantry.

Age *22* years.

Appears on

Company Muster-in Roll

of the organization named above. Roll dated

Baltimore Md Sep 1, 1863

Muster-in to date

Sep 1, 1863

Joined for duty and enrolled:

When *Sep 1, 1863**

Where *Baltimore, Md.**

Period *3* years.*

Remarks:

* *48* Muster-in roll shows enrollment and muster-in of this company as of same date and place. See enrollment on subsequent card or cards.

Book mark:

James H. ...

P | 4 | U.S.C.T.

John R Pinnet
.....
....., Co. K, 4 Reg't U. S. Col'd Infantry.

Appears on

Company Muster Roll

for *Sept - Oct*, 186³.

Joined for duty and enrolled :

When *Sept 1*, 186³ .*

Where *Baltimore* *

Period *3* years.*

Present or absent *Present*

Stoppage, \$ *100* for

Due Gov't, \$ *100* for

Remarks:
.....
.....
.....
.....
.....

Book mark:

Wm H. [Signature]

(358c)

Copyist.

J | 4 | U.S.C.T.

John R Bennett
....., Co. K, 4 Reg't U. S. Col'd Infantry.

Appears on

Company Muster Roll
for *Nov & Dec*, 186 *3*.

Joined for duty and enrolled :

When *Sept 1*, 186 *3*.*

Where *Baltimore* *

Period *3* years.*

Present or absent *Present.*

Stoppage, \$ *100* for

Due Gov't, \$ *100* for

Remarks :

.....
.....
.....
.....
.....

* See enrollment on card from muster-in roll.

Book mark :

John Hunter
Copyist.

B | 4 | **U.S.C.T.**

John R. Bennett
 -----, Co. K, 4 Reg't U. S. Col'd Infantry.

Appears on

Company Muster Roll

for *Jan'y & Feb'y*, 186 *3*

Joined for duty and enrolled:

When *Sept 1*, 186 *3**

Where *Baltimore* *

Period *3* years.*

Present or absent *Present*

Stoppage, \$ 100 for

Due Gov't, \$ 100 for

Remarks: -----

* See enrollment on card from muster-in roll.

Book mark: -----

(358c)

Tom H. Gibson

Copyist.

P | 4 | U.S.C.T.

John R. Bennett
Co. K, 4 Reg't U. S. Col'd Infantry.

Appears on

Company Muster Roll

for *March 1861*, 1861

Joined for duty and enrolled :

When *Sept 1*, 1861*

Where *Baltimore**

Period *3* years.*

Present or absent *Present*

Stoppage, \$ *100* for

Due Gov't, \$ *100* for

Remarks:

* See enrollment on card from muster-in roll.

Book mark : _____

Naupfintin

(358c)

Copyist.

B | 4 | U.S.C.T.

John R. Bennet

PL, Co. K, 4 Reg't U. S. Col'd Infantry.

Appears on

Company Muster Roll

for May and June, 1864.

Joined for duty and enrolled :

When Sept. 1, 1863.*

Where Baltimore *

Period 3 years.*

Present or absent Present

Stoppage, \$ 100 for

Due Gov't, \$ 100 for

Remarks:

Book mark:

Bliss

8 | 4 | **U.S.C.T.**

John R. Demuth

PL, Co. K, 4 Reg't U. S. Col'd Infantry.

Appears on

Company Muster Roll

for July and Aug., 1864.

Joined for duty and enrolled :

When Sept. 1, 1863.*

Where Baltimore Md *

Period 3 years.*

Present or absent Present

Stoppage, \$ 100 for

Due Gov't, \$ 100 for

Remarks: Detached as Brigade Pioneer June 28"/1864

Book mark :

Bliss

D | 4 | U.S.C.T.

John R. Bennet
Pl., Co. K, 4 Reg't U. S. Col'd Infantry.

Appears on

Company Muster Roll
 for *Sept. and Oct.*, 1864.

Joined for duty and enrolled:

When *Sept. 1*, 1863.*

Where *Baltimore Md* *

Period *3* years.*

Present or absent *Absent*

Stoppage, \$ *100* for

Due Gov't, \$ *100* for

Remarks: *Detached as Brig
 Pioneer June 28" 1864
 + ~~See N. C. Cooper Letter
 4.10~~*

+ as shown on rolls.

Book mark:

Bliss

B | 4 | U.S.C.T.

John R. Bennet
Pt., Co. K, 4 Reg't U. S. Col'd Infantry.

Appears on

Company Muster Roll

for Nov & Dec, 1864

Joined for duty and enrolled:

When Sept 1, 1863*

Where Baltimore Md. *

Period 3 years.*

Present or absent Present

Stoppage, \$ 100 for

Due Gov't, \$ 100 for

Remarks: Slave

Book mark:

J. Stewart

B | 4 | U.S.C.T.

John R. Bennett

Pt, Co. K, 4 Reg't U. S. Col'd Infantry.

Appears on

Company Muster Roll

for Jan & Feb, 1863.

Joined for duty and enrolled:

When Sept 1, 1863.*

Where Baltimore Md. *

Period 3 years.*

Present or absent Present

Stoppage, \$ 100 for

Due Gov't, \$ 100 for

Remarks: Slave

Book mark:

J. H. Stewart

B. | 4 | U.S.C.T.

John R. Bennett

Pr., Co. K, 4 Reg't U. S. Col'd Infantry.

Appears on

Company Muster Roll

for *Mch. + Apl.*, 1863.

Joined for duty and enrolled :

When *Sept. 1*, 1863.*

Where *Baltimore, Md.* *

Period *3* years.*

Present or absent *Present*

Stoppage, \$ *100* for

Due Gov't, \$ *100* for

Remarks:

* See enrollment on card from muster-in roll.

Book mark:

Philipsen

(858c)

Copyist.

B. | 4 | U.S.C.T.

John R. Bennett
Priv., Co. K, 4 Reg't U. S. Col'd Infantry.

Appears on

Company Muster Roll

for May & June, 1865.

Joined for duty and enrolled:

When Sept. 1, 1863.*

Where Baltimore, Md.*

Period 3 years.*

Present or absent Present

Stoppage, \$ 100 for

Due Gov't, \$ 100 for

Remarks: Slave.

* See enrollment on card from muster-in roll.

Book mark:

(358c)

Philipson
Copyst.

B. | 4 | U.S.C.T.

John R. Bennett
Priv., Co. K, 4 Reg't U. S. Col'd Infantry.

Appears on

Company Muster Roll

for July & Aug., 1863.

Joined for duty and enrolled:

When Sept. 1, 1863.*

Where Baltimore, Md.*

Period 3 years.*

Present or absent Absent.

Stoppage, \$ 100 for

Due Gov't, \$ 100 for

Remarks: On detached service
at Brig. Hd. Qrs.

* See enrollment on card from muster-in roll.

Book mark:

Philipson

(358c)

Copyist.

B. | 4 | U.S.C.T.

John R. Bennet
 Priv., Co. K, 4 Reg't U. S. Col'd Infantry.

Appears on

Company Muster Roll

for *Sept. + Oct.*, 1863.

Joined for duty and enrolled :

When *Sept. 1*, 1863.*

Where *Baltimore* *

Period *3* years.*

Present or absent *Present*

Stoppage, \$ *100* for

Due Gov't, \$ *100* for

Remarks: *Stopped 50 cts.*
for one pair of Metallic
scales.

* See enrollment on card from muster-in roll.

Book mark :

Philipsen

(358c)

Copyist.

4 U.S.C.T.

John R. Bennett
Co. K, 4 Reg't U. S. Col'd Infantry.

Appears on

Company Muster Roll

for Nov + Dec, 1863.

Joined for duty and enrolled:

When September 1, 1863.*

Where Baltimore Md.*

Period 3 years.*

Present or absent Present

Stoppage, \$ 100 for

Due Gov't, \$ 100 for

Remarks: Sick

Book mark:

(858c)

J. M. Vance

Copyist.

J | 4 | U.S.C.T.

John P. Bennett
Co. K, 4 Reg't U. S. Col'd Infantry.

Appears on

Company Muster Roll

for *Jan & Feb*, 186*6*.

Joined for duty and enrolled:

When *September*, 186*5*.*

Where *Baltimore Md*.*

Period *2* years.*

Present or absent *Present*.

Stoppage, \$ *100* for

Due Gov't, \$ *100* for

Remarks:

NEXT ROLL ON FILE MUSTER OUT.

Book mark:

J. McHance

(358c)

Copyist.

P | 4 | U.S.C.T.

John V. Bennett
Co. K, 4 Reg't U. S. Col'd Infantry.

Appears on **Co. Muster-out Roll**, dated
Washburne Mass, 1866.

Muster-out to date July 4, 1866.

Last paid to Feb 28, 1866.

Clothing account:

Last settled....., 186 ; drawn since \$.....100

Due soldier \$.....100; due U. S. \$.....16 ⁹⁵/₁₀₀

Am't for cloth'g in kind or money adv'd \$.....100

Due U. S. for arms, equipments, &c., \$.....100

Bounty paid \$.....100; due \$.....10 ⁰⁰/₁₀₀

Remarks: Transferred to
April 10, 1861. Difference
of pay from Sept. 1, 1863
to April 30, 1866

Book mark: V 186 P 157

J. M. Hance
(861) Copyist.

^{100 or Joshua}
Bennett John T.

Co C, 4 U.S. Col'd Inf.

1st Sergeant | Private

CARD NUMBERS.

1	55545710	26
2	5554610	27
3	5554785	28
4	5556044	29
5	906189H	30
6		31
7		32
8		33
9		34
10		35
11		36
12		37
13		38
14		39
15		40
16		41
17		42
18		43
19		44
20		45
21		46
22		47
23		48
24		49
25		50

Book Mark:

See also

B | 4 | U.S.C.T.

Joshua T. Bennett

, Co. "E", 4 Reg't U. S. Col'd Inf.

Appears on

Company Descriptive Book

of the organization named above.

DESCRIPTION.

Age 23 years; height 5 feet 7 inches.

Complexion Black

Eyes Black; hair curly

Where born Balto, Md.

Occupation waiter

ENLISTMENT.

When July 15, 1863.

Where Balto, Md.

By whom Col. Wm. Birney; term 3 y'rs.

Remarks Discharged for disability

Oct 26/63.

Handwritten signature

D | 4 | U.S.C.T.

Joshua V. Bennett
Sergeant, Co. C, 4 Reg't U. S. Col'd Infantry.

Age *23* years.

Appears on

Company Muster-in Roll

of the organization named above. Roll dated

Patterson Md July 24, 1863.

Muster-in to date

July 24 1863

Joined for duty and enrolled:

When *July 22*, 186

Where *Patterson Md*

Period *3* years.

Remarks:

Book mark:

(356)

Talburt
Copyist.

D

4

U.S.C.T.

Joshua V. Bennett

Priv., Co. C. 4 Reg't U. S. Col'd Infantry.

Appears on

Company Muster Roll

for *July 17th to Aug 31*, 1863.

Present or absent

Present

Stoppage, \$ 100 for

Due Gov't, \$ 100 for

Remarks: *Reduced to the ranks by Regl Order to 26, the 20. August 1863, from Sergeant 1st. Two dollars premium due,*

Book mark:

Talbot

(358)

Copyist,

D | **4** | **U.S.C.T.**

Joshua V. Bennett

....., Co. C. 4 Reg't U. S. Col'd Infantry.

Appears on

Company Muster Roll
for *Sept & Oct*, 186*3*

Present or absent

Stoppage, \$ 100 for

Due Gov't, \$ 100 for

Remarks: *Discharged for disability at Yorktown Va Oct 26, 1863 by order of Maj Gen Porter*

Book mark:

(358)

Talbot
Copyist.

B. | 4 | U.S.C.T.

John J. Bennett
Priv., Co. C, 4 Reg't U. S. Col'd Infantry.

Appears on Co. Muster-out Roll, dated
Washington, D.C., May 4, 1866.

Muster-out to date _____, 186 .

Last paid to _____, 186 .

Clothing account:

Last settled _____, 186 ; drawn since \$ _____ 100

Due soldier \$ _____ 100; due U. S. \$ _____ 100

Am't for cloth'g in kind or money adv'd \$ _____ 100

Due U. S. for arms, equipments, &c., \$ _____ 100

Bounty paid \$ _____ 100; due \$ _____ 100

Remarks: Discharged
Oct 26/63, at York-
town, Va. by order
of Genl Butler for
disability

Book mark : _____

(861)

R. J. Hussey
Copyist.

Bennett, Joshua T.

P. Co. C. 4 Reg. U. S. C. Inf.

1 Enclosures.

Bed Cards	Descriptive Lists
Burial Records	Final Statements
Certs. of Dis. for Discharge /	Furloughs
C. M. Charges	Med. Des. Lists
Med. Certificates	Orders

Other papers relating to—

Admission to Hosp'l	Furlough
Casualty Sheet (Officer's)	Med. Examination
Confinement	Misc. Information
Contracts	Pay or Clothing
Death or Effects	Personal Reports
Desertions	Rank
Discharge from Hosp'l	Transfer to Hosp'l
Discharge from Service	Transfer to V. R. C.
Duty	Transportation

S. 22. R. of Dis 3
1863

CERTIFICATE OF DISABILITY FOR DISCHARGE

IN THE CASE OF

Joshua V. Bennett
Private Co. B
4th Reg't of U. S. C. I.

Approved and Properly
forwarded - Oct 23rd 1863

C. H. Carpenter

Surgeon in Chief
Yorktown Va

Head Quarters Dept of Va & W. C.
Fort Monroe Va 23rd Oct/63

To be discharged.

By Command of
Major Genl Foster
Henry G. Johnson
Lt W. A. A. Genl

Adjutant General's Office
Oct 31 1863
Duplicate sent via Division Office

Received (A. G. Office) (1863) 1863

Ent. on A. R. of Cas. B

[Signature]

NOTE 1.

The company commander will here add a statement of all the facts known to him concerning the disease or wound, or cause of disability of the soldier; the time, place, manner, and all the circumstances under which the injury occurred, or disease originated or appeared; the duty, or service, or situation of the soldier at the time the injury was received or disease contracted, stating particularly whether the injury was received or the disease contracted in the line of his duty; and whatever other facts may aid a judgment as to the cause, immediate or remote, of the disability, and the circumstances attending it.

When the facts are not known to the company commander, the certificate of any officer, or affidavit of other person having such knowledge, will be appended—as the surgeon in charge of a hospital, the officer commanding a detachment of recruits, &c., &c.

NOTE 2.

When a probable case for pension, special care must be taken to state the degree of disability—as $\frac{1}{2}$, $\frac{1}{3}$, &c., &c.; to describe particularly the disability, wound, or disease; the extent to which it deprives him of the use of any limb or faculty, or affects his health, strength, activity, constitution, or capacity to labor or earn his subsistence. The surgeon will add, from his knowledge of the facts and circumstances, and from the evidence in the case, his professional opinion of the cause or origin of the disability. In the case of discharges by Medical Inspectors, the last paragraph will state that the "discharge was given by consent of the soldier, after a personal examination, and for disability, the nature, degree, and origin of which are correctly described in the within certificate."

Par. 1260 Regulations, Edit. 1861.

Medical officers, in giving certificates of disability, are to take particular care in all cases that have not been under their charge; and especially in epilepsy, convulsions, chronic rheumatism, derangement of the urinary organs, ophthalmia, ulcers, or any obscure disease liable to be feigned or purposely produced; and in no case shall such certificate be given until after sufficient time and examination to detect any attempt at deception.

DIRECTIONS.

This certificate will be made out in duplicate by the soldier's company commander, or other officer commanding the separate detachment to which he belongs, and sent by him to the surgeon who has charge of the hospital where the soldier is sick. The surgeon will then fill out and sign the surgeon's certificate, and forward these papers to the regimental, detachment, or post commander, who will forward them, with his action endorsed thereon, through the proper channel, to his division commander; or, if the troops are not attached to a division, to his corps, department, or other commander or officer to whom the authority to discharge enlisted men may be specially delegated.

These certificates, after having received the action of the highest authority to which they are required to be sent, will be returned through the same channel to the regimental, post, or detachment commander, who will, if the discharge is authorized by the endorsement of the proper authority, sign the soldier's discharge, and the last certificate on this paper; see that the soldier is furnished with the proper final statements in duplicate, and forward BOTH of these certificates direct to the Adjutant General United States Army, at Washington, D. C.; they will not, under any circumstances, be given into the hands of the soldier.

ARMY OF THE UNITED STATES
CERTIFICATE
OF DISABILITY FOR DISCHARGE.

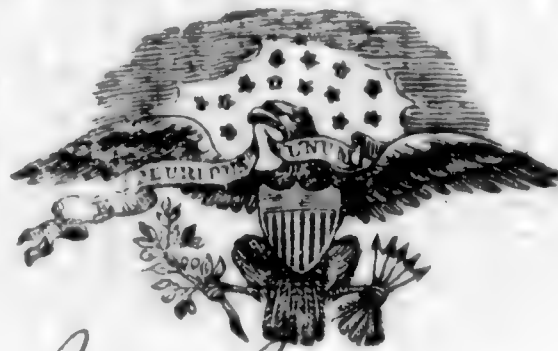

Private Joshua V. Bennett of Captain Adelmino
Mayer Company, (C.) of the Fourth Regiment of United States
Colony Troops was enlisted by Colonel William Binney of
the Second Regiment of U.S. at Baltimore Maryland
on the Fifteenth day of July 1863, to serve Three years; he was born
in Baltimore in the State of Maryland is Twenty Three
years of age, Five feet Seven inches high, Black complexion, Black eyes,
Curly hair, and by occupation when enlisted a Waiter During the last two
months said soldier has been unfit for duty 46 days.*

Complained of his heart troubling
him, was so when he enlisted
I know he has been on the sick
report the most of the time

STATION Camp near Jenkins Va
DATE: Oct 12 1863

Lieut John B. Breckinridge
Commanding Company.

I CERTIFY, that I have carefully examined the said Joshua V. Bennett of
Captain Adelmino Mayer Company, and find him incapable of performing the duties of a soldier
because of † valvular deficiency of heart, and dyspepsia
He was complaining of the same when I took charge
of the Regt. The case is apparently one of long standing
He suffers greatly from pain in the cardiac
region. He is unfit for any manual labor.

J. W. Mitchell
4th U.S.C. Surgeon.

DISCHARGED, this Twenty sixth day of October 1863, at Yorktown
Virginia

Saml A. Simcan
Colonel
Commanding the Reg't.

The soldier desires to be addressed at
Town Baltimore County _____ State Maryland.

* See Note 1 on the back of this. † See Note 2 on the back of this.

101.

Bennett. March

Co F, 4 U.S. Col'd Inf.

Private | Corporal.

CARD NUMBERS.

1	5559372	26
2	5559472	27
3	5559572	28
4	5559672	29
5	5559770	30
6	5559866	31
7	5559960	32
8	5560054	33
9	5560135	34
10	5560212	35
11	5560305	36
12	5560388	37
13	5560482	38
14	5560642	39
15	5560915	40
16	5550748	41
17	9062304	42
18		43
19		44
20		45
21		46
22		47
23		48
24		49
25		50

Book Mark:

See also

14440.63 and W.D.
14163.65.9 and W.D.
161165.9 and W.D.

B | 4 | U.S.C.T.

March Bennett

F, Co. F, 4 Reg't U. S. Col'd Inf.

Appears on

Company Descriptive Book

of the organization named above.

DESCRIPTION.

Age 30 years ; height 5 feet 4 1/2 inches.

Complexion Black

Eyes Black ; hair Black

Where born Marysville Co. Md

Occupation Farmer

ENLISTMENT.

When Aug 4, 1863 .

Where Baltimore Md

By whom Col Wm Paine ; term 3 y'rs.

Remarks: Dis. April 19 1864

Promoted to Corporal Sept 5 1864

Rescription list sent May 24 1865

Mustard out of service by 1st Lt W.B. Wilson

A.C.M. under order of Gen. Har. dated May

3/65 from W. Gen. Hays Ft. Monroe Va.

June 26/65

W H Merrill

(383a)

Copyist.

P. | 4 | **U.S.C.T.**

March Bennett

Pvt., Co. F., 4 Reg't U. S. Col'd Infantry.

Age *30* years.

Appears on

Company Muster-in Roll

of the organization named above. Roll dated

Baltimore Md Aug 4 1863.

Muster-in to date *Aug 4, 1863.*

Joined for duty and enrolled:

When *Aug 4th*, 1863.*

Where *Baltimore Md.*

Period *3* years.*

Remarks:

* ~~See~~ Muster-in roll shows enrollment and muster-in of this company as of same date and place. See enrollment on subsequent card or cards.

Book mark:

Valentine

(356c)

Copyist.

B. 4 U.S.C.T.

March Bennett

Priv., Co. F, 4 Reg't U. S. Col'd Infantry.

Appears on

Company Muster Roll

for Aug 4 to Aug 31, 1863.

Joined for duty and enrolled:

When Aug 4th, 1863.*

Where Baltimore Md. *

Period 3 years.*

Present or absent Present

Stoppage, \$ 100 for

Due Gov't \$ 100 for

Remarks: No dollars premium due

* See enrollment on card from muster-in roll.

Book mark:

Valentine Copyist.

D | 4 | U.S.C.T.

March Bennett

Priv., Co. F, 4 Reg't U. S. Col'd Infantry.

Appears on

Company Muster Roll

for *Sept. & Oct.*, 1863.

Joined for duty and enrolled:

When *August 4th*, 1863.*

Where *Baltimore Md.**

Period *3* years.*

Present or absent *Present*

Stoppage, \$ *100* for

Due Gov't \$ *100* for

Remarks:

* See enrollment on card from muster-in roll.

Book mark: -----

(858c)

Valentine

Copyist.

J | 4 | U.S.C.T.

March Bennett

Priv., Co. F, 4 Reg't U. S. Col'd Infantry.

Appears on

Company Muster Roll

for *Nov. & Dec.*, 1863.

Joined for duty and enrolled:

When *August 4*, 1863.*

Where *Baltimore Md.* *

Period *3* years.*

Present or absent *Present*

Stoppage, \$ *100* for

Due Gov't \$ *100* for

Remarks:

* See enrollment on card from muster-in roll.

Book mark: _____

Valentine
(858c) Copyist.

B | 4 | U.S.C.T.

March Bennett

Priv., Co. F, 4 Reg't U. S. Col'd Infantry.

Appears on

Company Muster Roll

for *Jan. & Feb.*, 1864.

Joined for duty and enrolled:

When *August 4*, 1863.*

Where *Baltimore Md**

Period *3* years.*

Present or absent *Present*

Stoppage, \$ *100* for

Due Gov't \$ *100* for

Remarks:

* See enrollment on card from muster-in roll.

Book mark: -----

Valentine
(858c) Copyist.

B | 4 | **U.S.C.T.**

March Bennett

Jul, Co. F, 4 Reg't U. S. Col'd Infantry.

Appears on

Company Muster Roll

for Rich & April, 1864.

Joined for duty and enrolled:

When Aug 4th, 1864.*

Where Balto Md *

Period 3 years.*

Present or absent present

Stoppage, \$ 100 for

Due Gov't \$ 100 for

Remarks: Stopped for 1 Can
Leav 4/25

* See enrollment on card from muster-in roll.

Book mark: -----

W. M. Brown

B | 4 | U.S.C.T.

Marsh Bennett

Pvt., Co. F, 4 Reg't U. S. Col'd Infantry.

Appears on

Company Muster Roll

for *May & June*, 1864.

Joined for duty and enrolled:

When *Aug 4*, 1863.*

Where *Balto Md* *

Period *3* years.*

Present or absent *present*

Stoppage, \$ *100* for

Due Gov't \$ *100* for

Remarks: *Stoppage one Can-
cen 4/1st*

* See enrollment on card from muster-in roll.

Book mark:

Tandoren

B | 4 | U.S.C.T.

March Bennett

Plt., Co. F, 4 Reg't U. S. Col'd Infantry.

Appears on

Company Muster Roll

for July & Augt, 1864.

Joined for duty and enrolled:

When Augt 4, 1863.*

Where Baltimore Md *

Period 3 years.*

Present or absent Present

Stoppage, \$ 100 for

Due Gov't \$ 100 for

Remarks: Stoppage for 1 Quarter
4/25 - Slave.

* See enrollment on card from muster-in roll.

Book mark

(858c)

Vandoren

Copyist.

B | 4 | **U.S.C.T.**

March Bennett
Capt, Co. F, 4 Reg't U. S. Col'd Infantry.

Appears on

Company Muster Roll

for Sept & Oct, 1864.

Joined for duty and enrolled:

When Aug 4, 1863.*

Where Balto Md *

Period 3 years.*

Present or absent Absent

Stoppage, \$ 100 for

Due Gov't \$ 100 for

Remarks: Slave Absent Sick

* See enrollment on card from muster-in roll.

Book mark:

T. Anderson

B | 4 | U.S.C.T.

March Bennett
Enpl., Co. F, 4 Reg't U. S. Col'd Infantry.

Appears on

Company Muster Roll

for Nov & Dec, 1864.

Joined for duty and enrolled:

When Aug 4, 1863.*

Where Balto Md *

Period 3 years.*

Present or absent Absent

Stoppage, \$ 100 for _____

Due Gov't \$ 100 for _____

Remarks: Slave Absent Sick

* ~~See~~ See enrollment on card from muster-in roll.

Book mark: _____

Tunstren

9 | 4 | **U.S.C.T.**

March Bennett
Spl., Co. F, 4 Reg't U. S. Col'd Infantry.

Appears on

Company Muster Roll

for *Jan'y H. Peby*, 1865.

Joined for duty and enrolled:

When *Aug 4*, 1863.*

Where *Baltimore Md.**

Period *3* years.*

Present or absent *Absent*

Stoppage, \$ *100* for

Due Gov't \$ *100* for

Remarks: *Have Absent Sick. Promoted to Capt Nov. 17 64*

* See enrollment on card from muster-in roll.

Book mark:

Linden
(858c) Copyist.

B | 4 | U.S.C.T.

March Bennett
Cpl, Co. F, 4 Reg't U. S. Col'd Infantry.

Appears on

Company Muster Roll

for March & April, 1865.

Joined for duty and enrolled:

When Aug. 4, 1863.*

Where Baltimore Md*

Period 3 years.*

Present or absent Absent

Stoppage, \$ 100 for

Due Gov't \$ 100 for

Remarks: Promoted Cpl Nov
17, 1864. Paid for Nov &
Dec 1864. Absent sick

* See enrollment on card from muster-in roll.

Book mark:

Linden
Copyist.

(858c)

9

4

U.S.C.T.

March Bennett
Cpl., Co. F, 4 Reg't U. S. Col'd Infantry.

Appears on

Company Muster Roll

for May - June, 1865.

Joined for duty and enrolled:

When Aug. 4, 1865.*

Where Baltimore Md.*

Period 3 years.*

Present or absent Absent

Stoppage, \$ 100 for

Due Gov't \$ 100 for

Remarks: Absent Sick
Promoted to Corporal

* See enrollment on card from muster-in roll.

Book mark:

(858c)

Linden

Copyist.

B | 4 | U.S.C.T.

March Bennett
Spl.; Co. F, 4 Reg't U. S. Col'd Infantry.

Appears on

Company Muster Roll

for *July* *Aug.*, 186*5*.

Joined for duty and enrolled:

When *Aug 4*, 186*5*.*

Where *Galterside Md* *

Period *3* years.*

Present or absent

Stoppage, \$ *100* for

Due Gov't \$ *100* for

Remarks: *Discharged from the service July June 26" 65 by Gen Order dated May 3" from War Dept Washington D.C.*

* See enrollment on card from muster-in roll.

Book mark:

(858c)

J. L. Linder

Copyist.

B | 4 | U.S.C.T.

March Bennett
Capt., Co. A, 4 Reg't U. S. Col'd Infantry.

Appears on an

Individual Muster-out Roll

of the organization named above. Roll dated

Fort Monroe, Va., June 2, 1865.

Muster-out to date

June 2, 1865.

Last paid to

Aug. 31, 1864.

Clothing account:

Last settled *June 30, 1864*; drawn since \$ 100

Due soldier \$ 100; due U. S. \$ 100

Am't for cloth'g in kind or money adv'd \$ *34*⁵⁴/₁₀₀

Due U. S. for arms, equipments, &c., \$ 100

Bounty paid \$ 100; due \$ 100

Remarks: *Paid for the month of Nov. & Dec., 1864. Promoted to Corporal, Sept 6, 1864. Was a slave before April 15, 1861. Mustered out by order of War Dept. dated May 3, 1865. Patient in*

Book mark: _____

C. M. Clark
 Copyist.

JAN 19

5550748

1891 *

*U. S General Hospital, Fort
Monroe, Va.*

B | 4 | U.S.C.T.

March Bennett
Coop, Co. *F*, 4 Reg't U. S. Col'd Infantry.

Appears on **Co. Muster-out Roll**, dated
Washington D.C. Mar 4, 1866.

Muster-out to date _____, 186 .

Last paid to _____, 186 .

Clothing account:

Last settled _____, 186 ; drawn since \$ _____ 100

Due soldier \$ _____ 100; due U. S. \$ _____ 100

Am't for cloth'g in kind or money adv'd \$ _____ 100

Due U. S. for arms, equipments, &c., \$ _____ 100

Bounty paid \$ _____ 100; due \$ _____ 100

Remarks: *Discharged June 26*
1865 by order of Sec of War
Slave on or before Apr 9/61

Book mark : _____

Lunnis

(861)

Copyist.

Bennett, M.

Co. *L*, **4** Regt. **U.S.C. Inf.**

Enclosures.

- | | |
|------------------------------|-------------------|
| Bed Cards | Descriptive Lists |
| Burial Records | Final Statements |
| Certs. of Dis. for Discharge | Furloughs |
| C. M. Charges | Med. Des. Lists |
| Med. Certificates | Orders |

Other papers relating to—

- | | |
|----------------------------|-----------------------------------------------------|
| Admission to Hosp'l | Furlough |
| Casualty Sheet (Officer's) | Med. Examination |
| Confinement | Misc. Information |
| Contracts | Pay or Clothing <input checked="" type="checkbox"/> |
| Death or Effects | Personal Reports |
| Desertions | Rank |
| Discharge from Hosp'l | Transfer to Hosp'l |
| Discharge from Service | Transfer to V. R. C. |
| Duty | Transportation |

U. S. General Hospital,

Fortress Monroe, Va.,

Mar 14, 1865.

Commanding Officer,

C. F., 4 Regt. U. S. I. & T.

Sir:

You are hereby notified that M. Bennett, a
Corpl of your Company, has been paid at this Hospital, for the
 months of November and December, 1864, by Major Howell, U. S. A.

By Order of Surgeon in Charge:

Very Respectfully,

Your Obedient Servant,

Robert Cullen

2D LIEUT. VET. RES. CORPS,
 & MILITARY ASSISTANT.

102

Penson, James C.

Co *H*, *4* U.S. Col'd Inf.

Private

Private

CARD NUMBERS.

1	5565996	26
2	5566097	27
3	5566197	28
4	5566297	29
5	5566383	30
6	5566469	31
7	5566608	32
8	5567420	33
9	9062797	34
10	9062925	35
11		36
12		37
13		38
14		39
15		40
16		41
17		42
18		43
19		44
20		45
21		46
22		47
23		48
24		49
25		50

Book Mark:

See also:

B | 4 | U.S.C.T.

James E. Benson

, Co. K, 4 Reg't U. S. Col'd Inf.

Appears on

Company Descriptive Book

of the organization named above.

DESCRIPTION.

Age 20 years; height 5 feet 6 ¹/₂ inches.

Complexion *Blk*

Eyes *Blk*; hair *Curly*

Where born *Eastern Shore Md*

Occupation *Farmer*

ENLISTMENT.

When *Sept 2*, 18*63*.

Where *Balto, Md*

By whom *Col Burney*; term *3* y'rs.

Remarks: *Died of Typhoid
fever in Genl Hosp at
St Monro Va July 7 '64.
Final statements sent
Aug 29 '64. Slave*

Selah

19 | 4 | U.S.C.T.

James E. Benson
Co. K, 4 Reg't U. S. Col'd Inf.

Appears on
Company Descriptive Book
of the organization named above.

DESCRIPTION.

Age 20 years; height 5 feet 6 1/2 inches.
Complexion Blk
Eyes Blk; hair curly
Where born Eastern Shore Md
Occupation Farmer

ENLISTMENT.

When Sept 21, 1863.
Where Balto. Md
By whom Cal Burney; term 3 y'rs.

Remarks: Slave. Died of Typhoid Fever in Gen'l Hosp'l at Fort Monroe Va July 7/64. Final statements sent Aug 29/64

Selah

(888g)

Copyist.

P

4

U.S.C.T.

James C. Benson

Co. K, 4 Reg't U. S. Col'd Infantry.

Age 20 years.

Appears on

Company Muster-in Roll

of the organization named above. Roll dated

Baltimore Md, Sep 1, 1863.

Muster-in to date Sep 1, 1863.

Joined for duty and enrolled:

When Sep 1, 1863.*

Where Baltimore Md.*

Period 3 years.*

Remarks:

* If Muster-in roll shows enrollment and muster-in of this company as of same date and place. See enrollment on subsequent card or cards.

Book mark:

James Benson

(256c)

Copyist.

P

4

U.S.C.T.

James E. Jensen
Co. K, 4 Reg't U. S. Col'd Infantry.

Appears on

Company Muster Roll

for Sept - Oct, 1863

Joined for duty and enrolled:

When Sept 1, 1863 *

Where Baltimore *

Period 3 years.*

Present or absent Present

Stoppage, \$ 100 for

Due Gov't, \$ 100 for

Remarks:

Book mark:

James E. Jensen

(358c)

Copyist.

P. | 4 | U.S.C.T.

James E. Benson
Pr, Co. K, 4 Reg't U. S. Col'd Infantry.

Appears on

Company Muster Roll

for *Nov & Dec*, 186*3*

Joined for duty and enrolled:

When *Sept*, 186*3**

Where *Baltimore**

Period *3* years.*

Present or absent *Present*

Stoppage, \$ *100* for

Due Gov't, \$ *100* for

Remarks:

* See enrollment on card from muster-in roll.

Book mark: _____

(358c)

Van Hook

Copyist.

P | 4 | U.S.C.T.

James C. Benson.
....., Co. K, 4 Reg't U. S. Col'd Infantry.

Appears on

Company Muster Roll

for *Jan'y 1* *Feb'y*, 186 *4*.

Joined for duty and enrolled :

When *Sept 1*, 186 *3*.*

Where *Baltimore*

Period *3* years.*

Present or absent *Present.*

Stoppage, \$ *100* for

Due Gov't, \$ *100* for

Remarks :

.....
.....
.....
.....
.....

* See enrollment on card from muster-in roll.

Book mark :

D | 4 | U.S.C.T.

James E. Benson
Priv., Co. K, 4 Reg't U. S. Col'd Infantry.

Appears on

Company Muster Roll

for *March & Apr*, 186*4*.

Joined for duty and enrolled:

When *Sept. 1*, 186*3*.*

Where *Baltimore* *

Period *3* years.*

Present or absent *Present*.

Stoppage, \$ 100 for

Due Gov't, \$ 100 for

Remarks:

* See enrollment on card from muster-in roll.

Book mark: -----

Van Hook

B | 4 | U.S.C.T.

James E. Benson
Pvt., Co. K, 4 Reg't U. S. Col'd Infantry.

Appears on

Company Muster Roll
for May and June, 1864.

Joined for duty and enrolled:

When Sept. 1, 1863.*

Where Baltimore *

Period 3 years.*

Present or absent Absent

Stoppage, \$ 100 for

Due Gov't, \$ 100 for

Remarks: Absent sick in
Genl. Hospital Ft. Monroe
City Point June 10. 64

Book mark:

Bliss

D | 4 | U.S.C.T.

James E. Benson
Private, Co. K, 4 Reg't U. S. Col'd Infantry.

Appears on

Company Muster Roll
 for *July until Aug.*, 1864.

Joined for duty and enrolled:

When *Sept. 1*, 1863.*
 Where *Baltimore Md* *
 Period *3* years.*

Present or absent

Stoppage, \$ *100* for

Due Gov't, \$ *100* for

Remarks: *Died of disease*
in Gen. Hospital Ft.
Monroe Va. July 7. 1864
Final statements sent.

Book mark

Bliss

B.

4

U.S.C.T.

James E. Benson
1st Lt., Co. K., 4 Reg't U. S. Col'd Infantry.

Appears on Co. Muster-out Roll, dated
Washington D.C., May 4, 1866.

Muster-out to date _____, 186 .

Last paid to _____, 186 .

Clothing account:

Last settled _____, 186 ; drawn since \$ _____ 100

Due soldier \$ _____ 100 ; due U. S. \$ _____ 100

Am't for cloth'g in kind or money adv'd \$ _____ 100

Due U. S. for arms, equipments, &c., \$ _____ 100

Bounty paid \$ _____ 100 ; due \$ _____ 100

Remarks: Died of Disease,
Hampton Gen. Hospital
July 7 1864

Book mark : _____

(861)

J. M. Hance

Copyist.

Benson, James E.

Co. *K 4*, *Reg't* **U. S. C. Inf.**

2 Enclosures.

Bed Cards <i>/</i>	Descriptive Lists
Burial Records	Final Statements <i>/</i>
Certs. of Dis. for Discharge	Furloughs
C. M. Charges	Med. Des. Lists
Med. Certificates	Orders

Other papers relating to—

Admission to Hosp'l	Furlough
Casualty Sheet (Officer's)	Med. Examination
Confinement	Misc. Information <i>/</i>
Contracts	Pay or Clothing
Death or Effects	Personal Reports
Desertions	Rank
Discharge from Hosp'l	Transfer to Hosp'l
Discharge from Service	Transfer to V. R. C.
Duty	Transportation

MICROFILM PUBLICATION M 1846

COMPILED MILITARY SERVICE RECORDS
OF VOLUNTEER UNION SOLDIERS WHO SERVED WITH
THE UNITED STATES COLORED TROOPS (USCT)
4TH REGIMENT OF INFANTRY

PERSONAL PAPERS' TARGET SHEET

PLEASE NOTE THE CHECKED INFORMATION ABOUT THE PERSONAL PAPERS IN
THIS FILE:

- NO PERSONAL PAPERS WERE FOUND IN THIS FILE WHEN THE
RECORDS WERE ARRANGED FOR MICROFILMING.
- 10 PERSONAL PAPER(S) FOUND IN THIS FILE WHEN THE RECORDS
WERE ARRANGED FOR MICROFILMING.

1353 83.

A.G.O. Oct 31st 68.
 I certify that the name
 of James E. Benson is borne
 on the Muster-in Roll of Co.
 "H" 4th U.S.C. on file in this
 Office. It is stated that he
 was Enrolled in Baltimore
 Md.

Wm. Hayward

A. A. Gen. Vol.

A.A.G.

Ad. Q. 4th U.S. Colored Troops
 Baltimore Md Sept. 8, 1863

This certifies that James E. Benson (colored)
 20 yrs of age, 5 feet, 6 1/2 inches high, is an
 enlisted private in Co. "K" of the
 above Regiment.

William Birney,
 Colonel Comd. 4th U.S.C.T.
 and Mustering Officer.

To
 Samuel Chamblaine
 Talbot Co. Md

~~This~~ The State of Maryland
 not yet revised by Board of Claims Nov. 17, 1864
 H. H. Johnson
 City

C. No. 83. P. 1/2
C. No. 58. P. 1/2
No. 133~~3~~ 133~~3~~

APPLICATION OF

Sam Chamblain

OF

Talbot County

For Compensation for Service of Slave,

James E. Benson

Enlisted in 1st 1/2th Regiment

U. S. Colored Troops, Co. K.

Received, April 9th 1864.

COMPENSATION AWARDED,

October 16th 1865

Three Hundred Dollars.

Thos. Finmore

Presid. Bd. Claim

James Benson

Recd. J. G. J. Oct 14. 1865.

EVIDENCE OF TITLE.

I, Samuel Chamberlaine, of Talbot
 County, Md., do solemnly swear that James E Benson
 who has been enlisted in the fourth Regiment, U. S. Colored Troops,
 Co. K; is my slave for life ~~(a term of service expiring on~~
~~_____ day of _____ 1865)~~ and that
 I became possessed of him by inheritance, in the month
 of August, eighteen hundred and seventy three. And I
 do further swear that I have not purchased said slave from any person or persons disloyal
 to the Government of the United States, with the object of obtaining compensation for
 the same; and furthermore, that I have no agency for obtaining compensation for any per-
 son or persons but such as, to my knowledge, are loyal citizens of the United States.

Samuel Chamberlaine

March 16th 1864.

STATE OF MARYLAND,

Talbot County, to wit:

On this *16th* day of *March* in the year 1864, before me, the subscriber, a Justice of the Peace of the State and County aforesaid, personally appeared *Samuel Chambelaine*, and took, signed, and acknowledged the oaths preceding; and further made oath, in due form of law, that all the statements made in this application are, to the best of *his* knowledge and belief, strictly true.

Also personally appeared before me *Levin H Delahay* and *John F Mullikin*, loyal citizens of the United States, residents of *Talbot County*, well acquainted with the said *Samuel Chambelaine*, and in no manner interested in the prosecution of this claim, and made oath, in due form of law, that the said *Samuel Chambelaine* is the owner of the slave *James O Benson*, as a fact of public notoriety; that they believe all the statements herein made by *him*, in reference thereto, are correct, and that *he* is unquestionably loyal to the Government of the United States. Witness their signatures:

L H Delahay
John F Mullikin

Josiah Higgins Justice of the Peace.



STATE OF MARYLAND,

Talbot County, to wit:

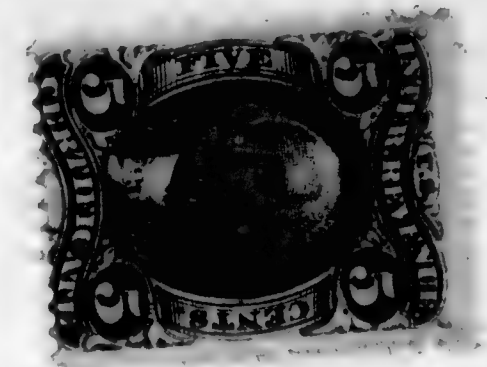

I, *Samuel J Hopkins*, Clerk of the Circuit Court for *Talbot* County, do hereby certify that *Josiah Higgins Esq* before whom the foregoing affidavits were made, was, at the time of signing the same, a Justice of the Peace for the County and State aforesaid, duly commissioned and sworn; and that his signature thereto is genuine, and that full faith and credit should be given to his official acts.

Witness my hand and the seal of said Court, this *16th* day of *March*, A. D. 1864.

Samuel J Hopkins CLERK.

Samuel Chamblaine
to
James Benson

Copy Manuscript

E.

DEED OF MANUMISSION AND RELEASE OF SERVICE.

WHEREAS, my slave *James E. Benson* has enlisted in the service of the United States: now in consideration thereof, I, *Saml. Chambelaine* of Talbot county, State of Maryland, do hereby, in consideration of said enlistment, manumit, set free, and release the above-named *James E. Benson* from all service due me; his freedom to commence from the *10th September Eighteen hundred and sixty three* the date of his enlistment as aforesaid in the *4th* Regiment of Colored Troops, in the service of the United States. *book*

Witness my hand and seal, this *29th* day of *March* 1864.

Samuel Chambelaine {SEAL}

WITNESS:

W. S. Shepard
H. H. Goldborough
J. H. McNeal

TALBOT COUNTY, STATE OF MARYLAND, *March 29* 1864.

Before me appeared this day *Samuel Chambelaine* and acknowledged the above Deed of Manumission and Release of Service to be his free act and deed.

W. S. Shepard J.P.

STATE OF MARYLAND, TALBOT COUNTY, S^cr:

I hereby certify that the foregoing is truly taken and copied from the original Manumission this day filed for record in the office of Clerk of Circuit Court for Talbot County.

In Testimony whereof I hereto set my hand and affix the seal of the said Court this *31st* day of *March* A. D. 1864.

Saml. J. Hopkins Clerk
 Circuit Court for Talbot County.



A.

No. 1333

CLAIMANT'S CERTIFICATE.

I, Samuel Chamberlain, a loyal citizen, and a resident of Indian Creek Creek, County of Balto, State of Maryland, hereby claim compensation, under the provisions of General Orders, No. 329, 1863, for my slave James E Benson enlisted September 1st 1863, at Baltimore Md by Col Wm Burney in the ~~Fourth~~ Regiment U. S. Colored Troops, Co. R; certificate of ~~which~~ enlistment, and a descriptive list, as required, accompany this application.

In proof of my loyalty to the Constitution and Government of the United States, I present the accompanying oath, which I have taken, signed, and acknowledged, to be filed with this application, in accordance with requirement of said General Orders.

Samuel Chamberlain

March 16th 1864

B.

OATH OF ALLEGIANCE.

I, Samuel Chambelaine, do solemnly swear that I have never joined, or been concerned in, any insurrection or rebellion; that I have never borne arms against the United States; that I have never given any aid, countenance, counsel, or encouragement to any person or persons engaged, or whom I had reason to believe were about to engage, in insurrection, rebellion, or armed hostility against the United States; that I have neither sought, nor accepted, nor attempted to exercise the functions of any office, civil or military, nor to perform any service whatever, under any authority or pretended authority in hostility to the United States; that I have not yielded a voluntary support to any insurrection, rebellion, or pretended government, authority, power, or constitution within the United States hostile thereto. And I do further swear that, to the best of my knowledge and ability, I have supported and defended, and will continue to support and defend, the United States against all enemies, foreign and domestic; and that I have supported, defended, and obeyed, and will continue to support, defend, and obey, the Constitution and laws of the United States; that I will bear true faith and allegiance to the same; and that I take this oath freely, without any mental reservation or purpose of evasion: So help me God.

Samuel Chambelaine

Sworn to and subscribed before me, at Trappan Ind
this 16th day of March 1864

Edw. H. Higgins
Justice of the peace

I present herewith evidence of my title to the slave James E Benson
enlisted as aforesaid, and in consideration of the sum of _____
by me received, I hereby covenant and agree with the United States, that I, my heirs, executors, or assigns, shall never hereafter make or enforce any claim to the labor or services of said slave; and pledge myself to execute a valid Deed of Manumission and Release of all my claims to service forever of said James E Benson to be filed with the Board of Claims now in session at Maitland Ind

Samuel Chambelaine

March 16th, 1864.

Presented for pay 3 months 15.
4' 118.

FINAL STATEMENT

OF

Private James E. Benson
Co. K.
4th Reg't of He S Colored Troops

VOLUNTEERS.

Acid July 7th 1864

NOTE 1.—Two of these certificates (or duplicates) are to be given to each Volunteer Soldier or drafted man who may be discharged previously to the discharge of his company, that he may at once receive from the Paymaster the pay, &c., due him, and the captain or other COMMISSIONED officer commanding the company will certify to the act of the delivery of the duplicate certificates; on these certificates the Soldier is "entitled to" his discharge, and should also present his discharge to the Paymaster to have the payment endorsed on it. The discharge is to be given back to the Soldier by the Paymaster; the latter only retaining as his voucher the duplicate certificates.

NOTE 2.—If the Soldier is entitled to pay for the use of his horse, the Company Commander will certify to that fact on the back of both these final statements, and also to the time he has pay due for having been so mounted on his own horse.

NOTE 3.—When a Soldier is furnished with final statements, his descriptive list, if he has one, should be taken up by the officer who gives the Soldier these statements, and endorsed with a statement to this effect by the officer. This endorsement should exhibit a full statement of the time for which the Soldier was allowed pay on his final statements, the clothing account, and all other charges against him or in his favor, so as to comprise a complete exhibit of his account. It will then be transmitted to the company commander of the Soldier, who will enter all the data necessary to a full understanding of the Soldier's account on the muster roll upon which the Soldier's discharge is reported. The descriptive list will then be destroyed. The object of this is, that the remaining portion of the Soldier's account may be settled upon the receipt of these muster rolls, and the Soldier receive any pay or allowances that may be due him at the time of his discharge, and which may not appear on his final statements from the fact that his descriptive list is incomplete. These accounts for back pay, &c., are settled by the 2d Auditor of the Treasury Department.

NOTE 4.—Charges for loss or injury to ordnance, horse equipments, and other miscellaneous charges, should appear under the heading of "Other Stoppages."

NOTE 5.—Bounty paid by State authorities, and not by the United States, will not be entered on this statement.

NOTE 6.—Amounts due the Sutler and Laundress must be entered on the muster roll on which the discharge, dea b. desertion, &c., is reported, as well as on the final statement, otherwise the amount cannot be collected from the United States.

NOTE 7.—This blank will be used for deceased volunteers and drafted men, as well as for others.

NOTE 8.—Where a Soldier dies in Hospital or on detached service, his descriptive list, if he has one, should be sent with his final statements, in duplicate, to the Adjutant General, Washington, D. C.

ADJUTANT GENERAL'S OFFICE.
Sept 9th 1864
Duplicate with Inventory sent 2d Auditor.

Enter on roll
RECEIVED
AUG 31
1864
Lumber

I certify, on honor, that James E Benson a Private of
 Captain W. P. Haskell's Company (K) of the 4th Regiment of U.S. Colored Troops
VOLUNTEERS, of the State of _____, born in Eastern Shore, State
 of Maryland, aged 20 years; 5 feet 6^h inches high; Black complexion,
Black eyes, Black hair, and by occupation a Farmer, having joined the company on
 its original organization at Baltimore Md, and enrolled in it at the muster into
 the service of the United States at Baltimore Md, on the first day
 of September, 1863, (or was mustered in service as a recruit, by _____
 _____, at _____, on the _____ day of _____,
 186 , or was drafted and mustered into the service of the United States from the _____
 Enrollment District of the State of _____, at _____,
 on the _____ day of _____, 186 .) to serve in the Regiment, for
 the term of three years; and having served **HONESTLY** and
FAITHFULLY with his Company in Virginia to the present date, is now
 entitled to a **DISCHARGE** by reason of Death by disease in Gen Hospital
at Ft Monroe Va July 7th 1864

The said private James E Benson was last paid by Paymaster
Maj Keelme to include the 29th day of February, 1864, and has
 pay due him from that time to the ^{date of death} ~~present date~~; he is entitled to pay and subsistence for
TRAVELING to place of enrollment, and whatever other allowances are authorized to volunteer
 soldiers, drafted men, or militia, so discharged. He has received from the United States **CLOTHING**
 amounting to Sixty Eight ¹¹/₁₀₀ dollars, since the _____ day of enlistment,
 1863, ~~when~~ his clothing account was ~~last~~ ^{never} settled. He has received from the United States
 _____ ¹⁰⁰/₁₀₀ dollars advanced **BOUNTY**.

There is to be stopped from him, on account of the State of _____, or other
 authorities, for **CLOTHING**, &c., received on entering service, _____ ¹⁰⁰/₁₀₀ dollars; and
 for other stoppages, viz: _____

_____ ¹⁰⁰/₁₀₀ dollars.
 He has been furnished with **TRANSPORTATION** in kind from the place of his discharge to
 _____; and he has been **SUBSISTED** for **TRAVELING** to his
 place of enrollment, up to the _____, 186 .

He is indebted to _____, **SUTLER**, _____ ¹⁰⁰/₁₀₀ dollars.
 He is indebted to _____, **LAUNDRESS**, _____ ¹⁰⁰/₁₀₀ dollars.

Given in Duplicate, at Dutch Gap Va, this 29th day
 of August, 1864.

W P Haskell Capt.
4th Reg U.S. Colored Troops
 Commanding Company K

F.

CERTIFICATE OF AWARD OF THE BOARD OF CLAIMS.

No. 1049

Office of the Board of Claims
For Slaves Enlisted in the Service of the United States,

Baltimore Md.,

October 18th, 1865.

\$300-

We hereby certify, that Samuel Chamblaine, of Talbot county, State of Maryland, having proved, under oath, his loyalty to the Constitution and Government of the United States, and established his title as to the ownership of James E. Benson, a slave enlisted at Baltimore Md., on the 1st day of September, 1863, by Col. Wm. Birney, in the service of the United States, in the 4th Regiment of Colored Troops, Co. K, and having filed a valid Deed of Manumission and Release of Service of said slave, is entitled to the sum of Three hundred dollars, which has been awarded to him by this Board as a remuneration for all claim to the future labor or service of said slave, under the provision of General Orders, War Department, No. 329, 1863.

Thos. Simmons, President of the Board.

Edmund Rogers, Member of the Board.

Wm. W. Goff, Member of the Board.

To Col. C. W. Foster,

Chief of the Bureau for the
Organization of Colored Troops, Washington, D. C.

C. No. 58 R. V.

No. .

ABSTRACT OF DISBURSEMENTS.

....., 186 .

Chamberlaine, Samuel

Dollars *300* 100.

Paid , 186 .

The United States,

To Samuel Chamberlaine Dr.

1865.		DOLLARS.	CENTS.
Oct 18 th	For amount awarded him by the Board of Claims, in consideration of the enlistment of <i>James E. Benson</i> in the <i>4th Regt. U.S. Col. Troops</i>	300	00
<i>Total \$</i>		300	00

I CERTIFY that the above account is correct and just; that the name of *James E. Benson* is borne on the muster-in rolls of the *4th Regt. U.S. Col. Troops*; and that the above amount was awarded by the Board of which *Thos. Simmons Esq.* is President, said award being in accordance with section 24 of the act entitled "An act to amend an act entitled 'An act for enrolling and calling out the national forces, and for other purposes,'" approved Feb. 24, 1864.

Assistant Adjutant General.

RECEIVED

, 186 , of *Major A.F. Rockwell A.A.G.* dollars and cents, in full of the above account.

Samuel Chamberlaine,
Trappe, Talbot Co. Maryland.

(SIGNED DUPLICATES.)

The United States,

To Samuel Chamberlaine Dr.

1865.		DOLLARS.	CENTS.
Oct 18 th	For amount awarded him by the Board of Claims, in consideration of the enlistment of <i>James E. Benson</i> in the <i>4th Regt. U.S. Col. Troops</i>	300	00
<i>Total \$</i>		300	00

I CERTIFY that the above account is correct and just; that the name of *James E. Benson* is borne on the muster-in rolls of the *4th Regt. U.S. Col. Troops*; and that the above amount was awarded by the Board of which *Thos. Simmons Esq.* is President, said award being in accordance with section 24 of the act entitled "An act to amend an act entitled 'An act for enrolling and calling out the national forces, and for other purposes,'" approved Feb. 24, 1864.

Assistant Adjutant General.

RECEIVED

, 186 , of *Major A.F. Rockwell A.A.G.* dollars and cents, in full of the above account.

Samuel Chamberlaine,
Trappe, Talbot Co. Maryland.

(SIGNED DUPLICATES.)

C. No. 58. P. V.

No. .

ABSTRACT OF DISBURSEMENTS.

....., 186 .

Chamberlaine, Samuel

Dollars *300* .
100.

Paid , 186 .

C. No. 57. R. V.

No. .

ABSTRACT OF DISBURSEMENTS.

....., 186 .

Chamberlain, Samuel

Dollars *300* 100.

Paid , 186 .

The United States,

To Samuel Chamberlaine Dr.

1865.		DOLLARS.	CENTS.
Oct 18 th	For amount awarded him by the Board of Claims, in consideration of the enlistment of <u>Murray Chamberlaine</u> in the <u>2nd Regt U.S. Col. Troops</u>	300	00
<u>Total</u>		\$ 300	00

I CERTIFY that the above account is correct and just; that the name of Murray Chamberlaine is borne on the muster-in rolls of the 2nd Regt U.S. Col. Troops; and that the above amount was awarded by the Board of which Thos. Munroe Esq is President, said award being in accordance with section 24 of the act entitled "An act to amend an act entitled 'An act for enrolling and calling out the national forces, and for other purposes,'" approved Feb. 24, 1864.

Assistant Adjutant General.

RECEIVED

, 186 , of Major A. F. Rockwell A. G. Vols dollars and _____ cents, in full of the above account.

Samuel Chamberlaine,
Trappe, Talbot Co. Maryland.

(SIGNED DUPLICATES.)

C. No. 57. R. 1.

No. .

ABSTRACT OF DISBURSEMENTS.

....., 186 .

Chamberlaine, Samuel

Dollars *300* 100.

Paid , 186 .

The United States,

To Samuel Chamberlain Dr.

		DOLLARS.	CENTS.
1865.	For amount awarded him by the Board of Claims, in consideration		
Oct 18 th	of the enlistment of <i>Murray Hambleton</i>		
	in the <i>2nd Regt. U.S. Col. Troop</i>	300	00
<i>Total</i>		300	00

I CERTIFY that the above account is correct and just; that the name of *Murray Hambleton* is borne on the muster-in rolls of the *2nd Regt. U.S. Col. Troop*; and that the above amount was awarded by the Board of which *Thos. Simmons Esq.* is President, said award being in accordance with section 24 of the act entitled "An act to amend an act entitled 'An act for enrolling and calling out the national forces, and for other purposes,'" approved Feb. 24, 1864.

RECEIVED

, 186 , of *Murray Hambleton*
dollars and _____ cents, in full of the above account.

Samuel Chamberlain.
Trappe, Talbot Co. Maryland.

(SIGNED DUPLICATES.)

Assistant Adjutant General.

of Major A. J. Rockwell a. a. g. ad.

¹⁰³
Bentley, Samuel

Co H, 4 U.S. Col'd Inf.

Private

Private

CARD NUMBERS.

1	55-65-997	26
2	55-66-098	27
3	55-66-198	28
4	55-66-295	29
5	55-66-385	30
6	55-66-470	31
7	55-66-555	32
8	55-66-632	33
9	55-66-706	34
10	55-66-800	35
11	55-66-887	36
12	55-66-978	37
13	55-67-063	38
14	55-67-148	39
15	55-67-221	40
16	55-67-317	41
17	55-67-449	42
18	9062798	43
19	9062926	44
20		45
21		46
22		47
23		48
24		49
25		50

Book Mark:

See also

B | **4** | **U.S.C.T.**

Samuel Bentley
 _____, Co. *K*, 4 Reg't U. S. Col'd Inf.

Appears on
Company Descriptive Book
 of the organization named above.

DESCRIPTION.

Age *23* years; height *5* feet *7* inches.

Complexion *Blk*

Eyes *Blk*; hair *Curly*

Where born *Clear Spring Md*

Occupation *Farmen*

ENLISTMENT.

When *Aug 28*, 18*63*.

Where *Balto Md*

By whom *Sgt Barney*; term *3* y'rs.

Remarks: *Greer Deserted*
Jan 16/65, from Genl
Hosp Fort Monroe,
Wounded at Newmarket
Va Sept 29, 64

Selah

(388g)

Copyist.

B | 4 | U.S.C.T.

Samuel Bentley

, Co K, 4 Reg't U. S. Col'd Inf.

Appears on

Company Descriptive Book

of the organization named above.

DESCRIPTION.

Age 23 years; height 5 feet 7 inches.

Complexion Blk

Eyes Blk; hair Curly

Where born Clear Springs Md

Occupation Farmer

ENLISTMENT.

When Aug. 28, 1863.

Where Baltimore

By whom Col Burney; term 3 y'rs.

Remarks: Now Deserted
Jan 16/65, from US
Genl Hosp at Monro

Selak

P

4

U.S.C.T.

Samuel S. Soutby

A, Co *K*, 4 Reg't U. S. Col'd Infantry.

Age *23* years.

Appears on

Company Muster-in Roll

of the organization named above. Roll dated

Baltimore Md, Sep 1, 1863

Muster-in to date *Sep 1, 1863*

Joined for duty and enrolled:

When *Sep 1, 1863**

Where *Baltimore Md**

Period *3* years.*

Remarks:

* *no* Muster-in roll shows enrollment and muster-in of this company as of same date and place. See enrollment on subsequent card or cards.

Book mark:

W. S. Soutby

(356c)

Copyist.

P | 4 | U.S.C.T.

Samuel Penty

P, Co. K, 4 Reg't U. S. Col'd Infantry.

Appears on

Company Muster Roll

for *Sept + Oct*, 186^{*3*}

Joined for duty and enrolled :

When *Sept 1*, 186^{*3*} .*

Where *Baltimore* *

Period *3* years.*

Present or absent *Present*

Stoppage, \$ *100* for

Due Gov't, \$ *100* for

Remarks :

Book mark :

John H. ...

P | 4 | U.S.C.T.

Samuel Bentley
P, Co. K, 4 Reg't U. S. Col'd Infantry.

Appears on

Company Muster Roll

for Nov & Dec, 1863

Joined for duty and enrolled:

When Sept 1, 1863*

Where Baltimore *

Period 3 years.*

Present or absent Present

Stoppage, \$ 100 for

Due Gov't, \$ 100 for

Remarks:

* See enrollment on card from muster-in roll.

Book mark:

Taus Hunter
Copyst.

P | 4 | U.S.C.T.

Samuel Penly
....., Co. K, 4 Reg't U. S. Col'd Infantry.

Appears on

Company Muster Roll

for *Jan'y & Feby*, 186*4*.

Joined for duty and enrolled:

When *Sept 1*, 186*3*.*

Where *Baltimore* *

Period *3* years.*

Present or absent *Present*.

Stoppage, \$ *100* for

Due Gov't, \$ *100* for

Remarks:

* See enrollment on card from muster-in roll.

Book mark:

(358c)

Van Herten
.....
Copyist.

J | 4 | U.S.C.T.

Samuel Bentley
Pvt., Co. K, 4 Reg't U. S. Col'd Infantry.

Appears on

Company Muster Roll

for *March & Apr*, 186 ^{*4*}.

Joined for duty and enrolled :

When *Sept 1*, 186 ^{*3*}.*

Where *Baltimore* *

Period *3* years.*

Present or absent *Present*.

Stoppage, \$ *100* for

Due Gov't, \$ *100* for

Remarks :

* See enrollment on card from muster-in roll.

Book mark : -----

Samuel Bentley

D | 4 | U.S.C.T.

Samuel Dently
Pr, Co. K, 4 Reg't U. S. Col'd Infantry.

Appears on

Company Muster Roll

for *May and June*, 186*4*.

Joined for duty and enrolled :

When *Sept. 1*, 186*3*.*

Where *Baltimore* *

Period *3* years.*

Present or absent *Absent*

Stoppage, \$ *100* for

Due Gov't, \$ *100* for

Remarks: *Absent sick in Genl. Hospital June 27. 1864.*

Book mark :

Bliss

D

4

U.S.C.T.

Samuel Denty

PL

, Co. K, 4 Reg't U. S. Col'd Infantry.

Appears on

Company Muster Roll

for July and Aug., 1864.

Joined for duty and enrolled :

When Sept. 1, 1863.*

Where Baltimore Md.*

Period 3 years.*

Present or absent Present

Stoppage, \$ 100 for

Due Gov't, \$ 100 for

Remarks: Free Apr. 19. 1864

Book mark :

Bliss

D | 4 | U.S.C.T.

Samuel Bentley
Pvt., Co. K, 4 Reg't U. S. Col'd Infantry.

Appears on

Company Muster Roll
for Sept. and Oct., 1864.

Joined for duty and enrolled:

When Sept. 1, 1863.*

Where Baltimore Md. *

Period 3 years.*

Present or absent Absent

Stoppage, \$ 100 for

Due Gov't, \$ 100 for

Remarks: Free Apr. 19. 1861
Wounded in action
Sept. 29. 1864. In Genl
Hospit. due W. C. Cooper
Letter 3.00

Book mark:

Bliss

B | 4 | U.S.C.T.

Samuel Bentley
Pt, Co. K, 4 Reg't U. S. Col'd Infantry.

Appears on

Company Muster Roll

for Nov & Dec, 1864.

Joined for duty and enrolled :

When Sept 1, 1863.*

Where Baltimore Md.*

Period 3 years.*

Present or absent Absent

Stoppage, \$ 100 for

Due Gov't, \$ 100 for

Remarks: Free Apl 19, 1864
Wounded Sept 29th G.H.
Due W. C. Cooper
sutler 3.00

Book mark :

J. H. Stewart

B | 4 | U.S.C.T.

Samuel Bentley
 Pt., Co. K, 4 Reg't U. S. Col'd Infantry.

Appears on

Company Muster Roll
 for Jan & Feb, 1865.

Joined for duty and enrolled:

When Sept 1, 1863.*

Where Baltimore Md. *

Period 3 years.*

Present or absent Absent

Stoppage, \$ 100 for

Due Gov't, \$ 100 for

Remarks: Free on or before
 Apr 19, 61 Wounded
 Sept 29, 64 in Hosp.
 Due sutles 3.00

Book mark:

JH Stewart

13. | 4 | U.S.C.T.

Samuel Bentley

Priv., Co. K, 4 Reg't U. S. Col'd Infantry.

Appears on

Company Muster Roll

for *Mch. + Apl.*, 1865.

Joined for duty and enrolled :

When *Sept. 1*, 1863.*

Where *Baltimore, Md.* *

Period *3* years.*

Present or absent *Absent.*

Stoppage, \$ *100* for

Due Gov't, \$ *100* for

Remarks: *Free on or before April 19/61. Back pay due from date of enlistment to May 1/64. Due H.C. Cooper \$3.00. Absent in hospt.*

* See enrollment on card from muster-in roll.

Book mark :

Philipsen

B. | 4 | U.S.C.T.

Samuel Bentley

Priv., Co. K, 4 Reg't U. S. Col'd Infantry.

Appears on

Company Muster Roll

for *May + June*, 1865.

Joined for duty and enrolled :

When *Sept. 1*, 1863.*

Where *Baltimore, Md.* *

Period *3* years.*

Present or absent *Absent.*

Stoppage, \$ *100* for

Due Gov't, \$ *100* for

Remarks: *Back pay due from enlistment to May 1st/64. Absent in hosp't. Due W.C. Cooper, Amt. \$300. Free.*

* See enrollment on card from muster-in roll.

Book mark :

Philipson

(358c)

Copyist.

B. | 4 | U.S.C.T.

Samuel Bentley

Priv., Co. K, 4 Reg't U. S. Col'd Infantry.

Appears on

Company Muster Roll

for July & Aug., 1865.

Joined for duty and enrolled:

When Sept. 1, 1863.*

Where Baltimore, Md.*

Period 3 years.*

Present or absent Absent

Stoppage, \$ 100 for

Due Gov't, \$ 100 for

Remarks: Free on or before April 19/61. Back pay due from enlistment to May 1/64. Due W.C. Cooper \$300. Absent Sick in hosp't

* See enrollment on card from muster-in roll.

Book mark:

Philippen

B. | 4 | U.S.C.T.

Samuel Bentley

Priv., Co. K, 4 Reg't U. S. Col'd Infantry.

Appears on

Company Muster Roll

for *Sept. + Oct.*, 1865.

Joined for duty and enrolled :

When *Sept. 1*, 1865.*

Where *Baltimore* *

Period *3* years.*

Present or absent *Absent*

Stoppage, \$ *100* for

Due Gov't, \$ *100* for

Remarks: *Free on or before
April 19/64. Back pay
due from enlistment to
May 1/64. Sick
in hospital.*

* See enrollment on card from muster-in roll.

Book mark :

Philipson

B | 4 | U.S.C.T.

Samuel Benney

Priv, Co. K, 4 Reg't U. S. Col'd Infantry.

Appears on

Company Muster Roll

for Nov + Dec, 1865.

Joined for duty and enrolled:

When September 1, 1863.*

Where Baltimore Md.*

Period 3 years.*

Present or absent Absent

Stoppage, \$ 100 for

Due Gov't, \$ 100 for

Remarks: Free on or before April 19, 1861 Difference of pay due from enlistment to date of last payment Absent sick in hospital

Book mark:

J. McHance

J | 4 | U.S.C.T.

Samuel Bentley
Prvt, Co. K, 4 Reg't U. S. Col'd Infantry.

Appears on

Company Muster Roll

for *Jan + Feb*, 1866.

Joined for duty and enrolled :

When _____, 186 .*

Where _____ *

Period *3* years.*

Present or on file **NEXT ROLL ON FILE MUSTER OUT.**

Stoppage, \$ *100* for _____

Due Gov't, \$ *100* for _____

Remarks: *Free on or before April 19, 1861*
Difference of pay due from enlist-
ment to date of last payment
Deserted about Jan 16, 1865
from Hampton Genl Hospital

Book mark: *159.442 PV 1 Pg 3. U*

(358c)

J. M. Vance

Copyist.

B | of U.S.C.T.

Samuel Bentley
 1st, Co. H, 4th Reg't U. S. Col'd Infy

Appears on Co. Muster-out Roll, dated
 Washington D.C., May 4, 1866.

Muster-out to date _____, 1866 .

Last paid to _____, 1866 .

Clothing account:

Last settled _____, 1866 ; drawn since \$ _____ 100

Due soldier \$ _____ 100; due U. S. \$ _____ 100

Am't for cloth'g in kind or money adv'd \$ _____ 100

Due U. S. for arms, equipments, &c., \$ _____ 100

Bounty paid \$ _____ 100; due \$ _____ 100

Remarks: *Free Wounded 10 for*

*29, 1864. Ordered to Regt from Hamp-
 ton Gen. Hoops Jan 16, 1865
 Never reported to Regt*

Book mark: *See Des List on file*

159 442 PVIP 93.68

(361)

J. M. Vance

Copyist.

¹⁰⁴
Bentley, William J.

Co H, 4 U.S. Col'd Inf.

Private

Private

CARD NUMBERS.

1	5565998	26
2	5566099	27
3	5566199	28
4	5566296	29
5	5566384	30
6	5566441	31
7	5566552	32
8	5566633	33
9	5566707	34
10	5566797	35
11	5566883	36
12	5566974	37
13	5567060	38
14	5567149	39
15	5567222	40
16	5567281	41
17	5567337	42
18	9062927	43
19	9062799	44
20		45
21		46
22		47
23		48
24		49
25		50

Book Mark: 119. 109 29 Oct 72

See also

Sift 5258 PJ man

B | 4 | U.S.C.T.

William J. Bentley
....., Co. A, 4 Reg't U. S. Col'd Inf.

Appears on
Company Descriptive Book
of the organization named above.

DESCRIPTION.

Age 22 years; height 5 feet 6 1/4 inches.
Complexion Blk
Eyes Blk; hair Curly
Where born Eastern Shore Md
Occupation Farmer

ENLISTMENT.

When Sept 21, 1863.
Where,
By whom,; termy'rs.

Remarks: None
.....
.....
.....
.....
.....
.....
.....
.....

.....
Selah
.....
(888g) Copyist.

B | 4 | U.S.C.T.

William J. Bentley

Co. K, 4 Reg't U. S. Col'd Inf.

Appears on

Company Descriptive Book

of the organization named above.

DESCRIPTION.

Age 20 years; height 5 feet 6 1/4 inches.

Complexion Blk

Eyes Blk; hair curly

Where born Eastern Shore Md

Occupation Farmer

ENLISTMENT.

When Sept 21, 1863.

Where Balto Md

By whom Col Burney; term 2 y'rs.

Remarks: Wounded near Petersburg Va June 15/64

Selah

S | **4** | **U.S.C.T.**

William T. Smith
Co. *K*, 4 Reg't U. S. Col'd Infantry.

Age *22* years.

Appears on

Company Muster-in Roll

of the organization named above. Roll dated

Baltimore Md, Sep 1, 1863.

Muster-in to date *Sep 1, 1863.*

Joined for duty and enrolled:

When *Sep 1, 1863.**

Where *Baltimore Md.**

Period *3* years.*

Remarks:

* If Muster-in roll shows enrollment and muster-in of this company as of same date and place. See enrollment on subsequent card or cards.

Book mark:

Wm Smith

P

4

U.S.C.T.

William Bently

Pr, Co. K, 4 Reg't U. S. Col'd Infantry.

Appears on

Company Muster Roll

for *Sept & Oct*, 186 ³

Joined for duty and enrolled :

When *Sept 1*, 186 *

Where *Baltimore* *

Period *3* years.*

Present or absent *Present*

Stoppage, \$ *100* for

Due Gov't, \$ *100* for

Remarks:

Book mark:

10000000

Wm Bently

3 | 4 | U.S.C.T.

William Bentley
of _____, Co. K, 4 Reg't U. S. Col'd Infantry.

Appears on

Company Muster Roll

for Nov & Dec, 1863.

Joined for duty and enrolled:

When Sept 1, 1863.*

Where Baltimore *

Period 3 years.*

Present or absent Present.

Stoppage, \$ 100 for _____

Due Gov't, \$ 100 for _____

Remarks: _____

* See enrollment on card from muster-in roll.

Book mark: 3215100

Wm Bentley

P | 4 | U.S.C.T.

William T. Penly
Penly, Co. K, 4 Reg't U. S. Col'd Infantry.

Appears on

Company Muster Roll

for Jan'y & Feb'y, 1864

Joined for duty and enrolled:

When Sept 1, 1863.*

Where Baltimore *

Period 3 years.*

Present or absent Present

Stoppage, \$ 100 for

Due Gov't, \$ 100 for

Remarks Stopped for one letter

* See enrollment on card from muster-in roll.

Book mark :

Wm H. Penly

P

4

U.S.C.T.

William Penning
Priv., Co. K, 4 Reg't U. S. Col'd Infantry.

Appears on

Company Muster Roll

for *March 1864*, 186 *4*

Joined for duty and enrolled :

When *Sept 1*, 186 *3**

Where *Baltimore* *

Period *3* years.*

Present or absent *Present*

Stoppage, \$ *100* for

Due Gov't, \$ *100* for

Remarks:

* See enrollment on card from muster-in roll.

Book mark:

Van Hooker

D | 4 | U.S.C.T.

William T. Bruty
Plt, Co. K, 4 Reg't U. S. Col'd Infantry.

Appears on

Company Muster Roll

for May and June, 1864.

Joined for duty and enrolled:

When Sept. 1, 1863.*

Where Baltimore *

Period 3 years.*

Present or absent Absent

Stoppage, \$ 100 for

Due Gov't, \$ 100 for

Remarks: Wounded near Peters-
burg Va. June 15th 1864
Absent in Gen. Hosp'tl.

Book mark:

Bliss

B | 4 | U.S.C.T.

William T. Bently
PL, Co. K, 4 Reg't U. S. Col'd Infantry.

Appears on

Company Muster Roll

for *July and Aug.*, 1864.

Joined for duty and enrolled:

When *Sept. 1*, 186*3*.*

Where *Baltimore Md.* *

Period *3* years.*

Present or absent *absent*

Stoppage, \$ *100* for

Due Gov't, \$ *100* for

Remarks: *Wounded near Petersburg June 15. 1864 In Gen. Hosp't.*

Book mark:

Bliss

B | 4 | U.S.C.T.

William T. Dentey
Pvt., Co. K, 4 Reg't U. S. Col'd Infantry.

Appears on

Company Muster Roll

for Sept. 1st Oct., 1864.

Joined for duty and enrolled:

When Sept. 1, 1863.*

Where Baltimore Md *

Period 3 years.*

Present or absent Present

Stoppage, \$ 100 for

Due Gov't, \$ 100 for

Remarks: Free Apr. 19. 1861
Paid for months of May
& June by Maj. Walker
in Hospital amt. \$32.00

Book mark: 20000

Bliss

B | 4 | U.S.C.T.

William J. Bentley
Pt, Co. K, 4 Reg't U. S. Col'd Infantry.

Appears on

Company Muster Roll

for Nov & Dec, 1864.

Joined for duty and enrolled:

When Sept 1, 1863.*

Where Baltimore Md *

Period 3 years.*

Present or absent Absent

Stoppage, \$ 100 for

Due Gov't, \$ 100 for

Remarks: Free April 19, 1861
Paid for May & June
at Hosp'l p Maj
Walker Absent
wounded

Book mark:

W. Stewart
Copyst.

13

4

U.S.C.T.

William T. Bentley
Pt., Co. K, 4 Reg't U. S. Col'd Infantry.

Appears on

Company Muster Roll

for Jan & Feb, 1865.

Joined for duty and enrolled:

When Sept 1, 1863*

Where Baltimore Md. *

Period 3 years.*

Present or absent Present

Stoppage, \$ 100 for

Due Gov't, \$ 100 for

Remarks: Free on or before
Apr 19/61 paid in
Hosp. for months
May and June by
Maj. Walker

Book mark:

JH Stewart

B | 4 | U.S.C.T.

William J. Bentley

Prv., Co. K, 4 Reg't U. S. Col'd Infantry.

Appears on

Company Muster Roll

for *Mch. & apri*, 1863.

Joined for duty and enrolled:

When *Sept. 1*, 1863.*

Where *Baltimore, Md.**

Period *3* years.*

Present or absent *Absent*

Stoppage, \$ *100* for

Due Gov't, \$ *100* for

Remarks: *Free on or before April 19, 61. Paid in hospt. for the months of May & June by Maj. Walker. Back pay due from date of enlistment to May 1/1864. Absent in hospt.*

* See enrollment on card from muster-in roll.

Book mark:

Philipson

(358c)

Copyist.

B. | 4 | U.S.C.T.

William T. Bentley

Prov., Co. K, 4 Reg't U. S. Col'd Infantry.

Appears on

Company Muster Roll

for *May + June*, 1865.

Joined for duty and enrolled :

When *Sept. 1*, 1863.*

Where *Baltimore, Md.**

Period *3* years.*

Present or absent *Absent*.

Stoppage, \$ *100* for

Due Gov't, \$ *100* for

Remarks: *Paid in hoapt. for June + May by Maj. Walker. Pay due from enlistment to May 1st/64. Absent in hoapt. Free.*

* See enrollment on card from muster-in roll.

Book mark :

Philipson

P. | 4 | U.S.C.T.

William T. Bentley

Priv., Co. K, 4 Reg't U. S. Col'd Infantry.

Appears on

Company Muster Roll

for *July & Aug.*, 1865.

Joined for duty and enrolled:

When *Sept. 1*, 1863.*

Where *Baltimore, Md.* *

Period *3* years.*

Present or absent *Present.*

Stoppage, \$ *100* for

Due Gov't, \$ *100* for

Remarks:

* See enrollment on card from muster-in roll.

Book mark:

Philipsen

B. | 4 | U.S.C.T.

William T. Bentley

Priv., Co. K, 4 Reg't U. S. Col'd Infantry.

Appears on

Company Muster Roll

for *Sept. + Oct.*, 1863.

Joined for duty and enrolled :

When *Sept. 1*, 1863.*

Where *Baltimore* *

Period *3* years.*

Present or absent *Present.*

Stoppage, \$ *100* for

Due Gov't, \$ *100* for

Remarks:

* See enrollment on card from muster-in roll.

Book mark:

Philipson

B | 4 | U.S.C.T.

William P. Bentley
Co. K, 4 Reg't U. S. Col'd Infantry.

Appears on

Company Muster Roll

for Nov. & Dec., 1863.

Joined for duty and enrolled:

When September 1, 1863.*

Where Baltimore, Md. *

Period 3 years.*

Present or absent Present

Stoppage, \$ 100 for

Due Gov't, \$ 100 for

Remarks:

Book mark:

J. M. Hance

P

4

U.S.C.T.

William T. Bentley
Pvt., Co. K, 4 Reg't U. S. Col'd Infantry.

Appears on

Company Muster Roll

for *Jan. & Feb.*, 186*6*.

Joined for duty and enrolled :

When *September 1*, 186*6*.*

Where *Baltimore Md* *

Period *3* years.*

Present or absent *Present*

Stoppage, \$ *100* for

Due Gov't, \$ *100* for

Remarks :

NEXT ROLL ON FILE MUSTER OUT.

Book mark :

J. M. Hance

B. | 4 | U.S.C.T.

William G. Bentley
 Pvt., Co. K., 4 Reg't U. S. Col'd Infantry.

Appears on Co. Muster-out Roll, dated
 Washington D.C., May 4, 1866.
 Muster-out to date May 4, 1866.
 Last paid to Feb 28, 1866.

Clothing account:

Last settled....., 186 ; drawn since \$.....100
 Due soldier \$ 2 ²³/₁₀₀; due U. S. \$.....100
 Am't for cloth'g in kind or money adv'd \$.....100

Due U. S. for arms, equipments, &c., \$ 6 ⁰⁰/₁₀₀
 Bounty paid \$.....100; due \$ 100 ⁰⁰/₁₀₀

Remarks: Wounded Sept. 29, 1864
 Prisoner or before April 19, 1865
 Difference of pay due Sept. 1, 1863
 to April 30, 1864

Book mark: 270.058 B 109 V9 C 172

(861) J. M. Hance Copyist.

105 Loup or Lewis
Brimley, William

Co G, 4 U.S. Col'd Inf.

Private

Private

CARD NUMBERS.

1	26
2	27
3	28
4	29
5	30
6	31
7	32
8	33
9	34
10	35
11	36
12	37
13	38
14	39
15	40
16	41
17	42
18	43
19	44
20	45
21	46
22	47
23	48
24	49
25	50

See Brimley Lewis

Book Mark:

See also

106

Drummond Henry

Coa., 4 U.S. Col'd Inf.

Private

Private

CARD NUMBERS.

1	555-0314	26
2	555-1396	27
8	555-1492	28
4	555-1584	29
5	555-1686	30
6	555-1780	31
7	555-1872	32
8	555-1953	33
9	555-2022	34
10	555-2094	35
11	555-2184	36
12	555-2271	37
13	555-2366	38
14	555-2463	39
15	555-2554	40
16	555-2634	41
17	555-2701	42
18	555-2760	43
19	<i>Cards withdrawn and filed</i>	
20	<i>in envelope Drummond,</i>	
21	<i>Henry where it belongs</i>	
22	<i>Sept 24/91 MCH</i>	
23		48
24		49
25		50

Book Mark:

See also

¹⁰⁷
Priv. Stephen H.

Co a. , 4 U.S. Col'd Inf.

Private

Private

CARD NUMBERS.

1	✓✓✓✓1305	26
2	✓✓✓✓1393	27
3	✓✓✓✓1495	28
4	✓✓✓✓1594	29
5	✓✓✓✓1692	30
6	✓✓✓✓1786	31
7	✓✓✓✓1876	32
8	✓✓✓✓1958	33
9	✓✓✓✓2030	34
10	✓✓✓✓2104	35
11	✓✓✓✓2195	36
12	✓✓✓✓2284	37
13	✓✓✓✓2378	38
14	✓✓✓✓2476	39
15	✓✓✓✓2565	40
16	✓✓✓✓2644	41
17	✓✓✓✓2700	42
18	✓✓✓✓2759	43
19	9061619	44
20		45
21		46
22		47
23		48
24		49
25		50

Book Mark:

See also

S-745-131- P. 6. M. & M.

B | 4 | U.S.C.T.

Stephen H. Bias

....., Co. *"A"*, 4 Reg't U. S. Col'd Inf.

Appears on

Company Descriptive Book

of the organization named above.

DESCRIPTION.

Age *19* years; height *5* feet *5 3/8* inches.

Complexion *black*

Eyes *dark*; hair *curly*

Where born *Baltimore, Md.*

Occupation *laborer*

ENLISTMENT.

When *July 15*, 186*3*.

Where *Baltimore*

By whom *Col. W. Birney*; term *3* y'rs.

Remarks:

.....

read

B | 4 | U.S.C.T.

Stephen H. Bias
 Priv., Co. A, 4 Reg't U. S. Col'd Infantry.
 Age 19 years.

Appears on

Company Muster-in Roll

of the organization named above. Roll dated

Baltimore Md July 15, 1863.

Muster-in to date July 15, 1863

Joined for duty and enrolled:

When July 15, 1863.*

Where Baltimore *

Period 3 years.*

Remarks:

* Muster-in roll shows enrollment and muster-in of this company as of same date and place. See enrollment on subsequent card or cards.

Book mark: 2001203

(356c)

Laueb
 Copyist.

B | 4 | U.S.C.T.

Stephen H. Bias
 Priv., Co. A, 4 Reg't U. S. Col'd Infantry.

Appears on

Company Muster Roll

for July 15th to Aug 31, 1863.

Joined for duty and enrolled:

When July 15th, 1863*

Where Baltimore Md *

Period 3 years.*

Present or absent Present

Stoppage, \$ 100 for

Due Gov't \$ 100 for

Remarks: Arrears due \$ 2,

* See enrollment on card from muster-in roll.

Book mark:

(358c)

Lamb
 Copyist.

B

4

U.S.C.T.

Stephen H. Bias
Priv., Co. A, 4 Reg't U. S. Col'd Infantry.

Appears on

Company Muster Roll

for Sept & Octo, 1863.

Joined for duty and enrolled:

When July 15th, 1863.*

Where Baltimore Md *

Period 3 years.*

Present or absent Present

Stoppage, \$ 100 for

Due Gov't \$ 100 for

Remarks:

* See enrollment on card from muster-in roll.

Book mark:

Lamb

(358c)

Copyist.

B | 4 | U.S.C.T.

Stephen H. Bias
Priv., Co. A, 4 Reg't U. S. Col'd Infantry.

Appears on

Company Muster Roll

for Nov & Dec, 1863.

Joined for duty and enrolled:

When July 10, 1863*

Where Baltimore Md *

Period 3 years.*

Present or absent Present

Stoppage, \$ 100 for

Due Gov't \$ 100 for

Remarks:

* See enrollment on card from muster-in roll.

Book mark:

Lamb

B

4

U.S.C.T.

Stephen H. Bias
Priv., Co. A, 4 Reg't U. S. Col'd Infantry.

Appears on

Company Muster Roll

for Jones & Feby, 1864.

Joined for duty and enrolled:

When July 15th, 1863.*

Where Baltimore Md*

Period 3 years.*

Present or absent Present

Stoppage, \$ 100 for

Due Gov't \$ 100 for

Remarks: On daily duty at small pox hospital

* See enrollment on card from muster-in roll.

Book mark:

Laubs

B

4

U.S.C.T.

Stephen H. Bras

Priv., Co. A, 4 Reg't U. S. Col'd Infantry.

Appears on

Company Muster Roll

for Mch. & Apr., 1864.

Joined for duty and enrolled:

When July 15., 1863.*

Where Baltimore, Md.*

Period 2 years.*

Present or absent Absent

Stoppage, \$ 100 for

Due Gov't \$ 100 for

Remarks: On detached service at Small Pox Hospital near Yorktown, Va.

* See enrollment on card from muster-in roll.

Book mark:

R. E. Wiles

(358c)

Copyist.

B

4

U.S.C.T.

Stephen H. Bias

Priv., Co. A, 4 Reg't U. S. Col'd Infantry.

Appears on

Company Muster Roll

for *May & June*, 1864.

Joined for duty and enrolled:

When *July 15*, 1863.*

Where *Baltimore, Md.* *

Period *3* years.*

Present or absent *Absent*

Stoppage, \$ *100* for _____

Due Gov't \$ *100* for _____

Remarks: *On detached service at small pov hospital Yorktown, Va.*

* See enrollment on card from muster-in roll.

Book mark: _____

R. E. Wilson

(358c)

Copyist.

C

4

U.S.C.T.

Stephen N. Bias
Priv., Co. A, 4 Reg't U. S. Col'd Infantry.

Appears on

Company Muster Roll

for *July & Aug.*, 1864

Joined for duty and enrolled:

When *July 15*, 1863.*

Where *Baltimore, Md.* *

Period *3* years.*

Present or absent *present*

Stoppage, \$ *100* for

Due Gov't \$ *100* for

Remarks: *On extra duty at ca-
 mal - Free on or before
 Apr. 19. 1864.*

* See enrollment on card from muster-in roll.

Book mark:

R. E. Wilson

B

4

U.S.C.T.

Stephen H. Bear

Priv., Co. A, 4 Reg't U. S. Col'd Infantry.

Appears on

Company Muster Roll

for *Sept. & Oct.*, 186*4*.

Joined for duty and enrolled:

When *Aug. 20*, 186*3*.*

Where *Baltimore, Md.* *

Period *3* years.*

Present or absent *present*

Stoppage, \$ *100* for

Due Gov't \$ *100* for

Remarks: *Free on or before
Apr. 19. 1864. Due sutler 5.00*

* See enrollment on card from muster-in roll.

Book mark:

R. E. Wilson

B

4

U.S.C.T.

Stephen H. Bias

Priv., Co. A, 4 Reg't U. S. Col'd Infantry.

Appears on

Company Muster Roll

for *Nov. & Dec.*, 186*4*.

Joined for duty and enrolled:

When *July 15*, 186*3*.*

Where *Baltimore, Md.* *

Period *3* years.*

Present or absent *present*

Stoppage, \$ *100* for

Due Gov't \$ *100* for

Remarks: *Free before Apr. 19, 1864*
Not paid for Jan. & Feb. as
stated on rolls.

* See enrollment on card from muster-in roll.

Book mark: _____

R. E. Wilson

B | 4 | U.S.C.T.

Stephen H Bias
Priv, Co. A, 4 Reg't U. S. Col'd Infantry.

Appears on

Company Muster Roll

for Jan + Feb, 1865.

Joined for duty and enrolled:

When July 15, 1863*

Where Balk. Md.*

Period 3 years.*

Present or absent present

Stoppage, \$ 100 for 2 G. Coat straps

Due Gov't \$ 100 for

Remarks: Free on or before
Apr 19, 1861.

* See enrollment on card from muster-in roll.

Book mark:

Saxton

B | 4 | U.S.C.T.

Stephen H. Bias
Priv., Co. A, 4 Reg't U. S. Col'd Infantry.

Appears on

Company Muster Roll
for March & Apr, 1865.

Joined for duty and enrolled:

When July 15, 1863.*

Where Balt. Md. *

Period 3 years.*

Present or absent absent

Stoppage, \$ 11/100 for 2 G. coat straps

Due Gov't \$ 100 for _____

Remarks: Absent sick.
Free or slave not stated.

* See enrollment on card from muster-in roll.

Book mark: _____

Sutton

B | 4 | U.S.C.T.

Stephen H. Bias
Sgt., Co. A, 4 Reg't U. S. Col'd Infantry.

Appears on

Company Muster Roll
for May & June, 1865.

Joined for duty and enrolled:

When July 15, 1863.*

Where Balt. Md. *

Period 3 years.*

Present or absent absent

Stoppage, \$ 100 for _____

Due Gov't \$ 100 for _____

Remarks: Absent sick.
Free on or before
Apr. 19, 1861.

* See enrollment on card from muster-in roll.

Book mark: _____

Daxton

B | 4 | U.S.C.T.

Stephen H. Bias
Priv, Co. A, 4 Reg't U. S. Col'd Infantry.

Appears on

Company Muster Roll

for July & Aug, 1865.

Joined for duty and enrolled:

When July 15, 1863.*

Where Balt. Md *

Period 3 years.*

Present or absent present

Stoppage, \$ 100 for _____

Due Gov't \$ 100 for _____

Remarks: _____

* See enrollment on card from muster-in roll.

Book mark: _____

Daxton

B | 4 | U.S.C.T.

Stephen H. Bias
Pot, Co. A, 4 Reg't U. S. Col'd Infantry.

Appears on

Company Muster Roll
for Sept + Oct, 1865

Joined for duty and enrolled:

When July 15, 1863*

Where Baltimore, Md. *

Period 3 years.*

Present or absent present

Stoppage, \$ 100 for

Due Gov't \$ 100 for

Remarks:

* See enrollment on card from muster-in roll.

Book mark:

Jaxton

Bz

4

U.S.C.T.

Stephen H. Bias
Cor, Co. A, 4 Reg't U. S. Col'd Infantry.

Appears on

Company Muster Roll

for Nov. & Dec, 1865.

Joined for duty and enrolled:

When July 15, 1863.*

Where Balt. Md. *

Period 3 years.*

Present or absent Present

Stoppage, \$ 100 for

Due Gov't \$ 100 for

Remarks: Not paid for
Jan & Feb, as
stated on Roll,

* See enrollment on card from muster-in roll.

Book mark:

(358c)

Hammer
Copyist.

Bz | 4 | U.S.C.T.

Stephen H. Bias
Co, Co. A, 4 Reg't U. S. Col'd Infantry.

Appears on

Company Muster Roll

for *Jan 1 Feb*, 186*6*.

Joined for duty and enrolled:

When *July 15*, 186*3*.*

Where *Balt. Md*, *

Period *3* years.*

Present or absent *Present*

Stoppage, \$ *100* for _____

Due Gov't \$ *100* for _____

Remarks: _____

NEXT ROLL ON FILE MUSTER OUT.

* See enrollment on card from muster-in roll.

Book mark: _____

(358e)

Heavenly
Copyist.

Bz

4

U.S.C.T.

Stephen H. Beas

Cor, Co. A, 4 Reg't U. S. Col'd Infantry.

Appears on Co. Muster-out Roll, dated Washington DC, May 4, 1866.

Muster-out to date May 4, 1866.

Last paid to Feb 28, 1866.

Clothing account:

Last settled....., 186 ; drawn since \$.....100

Due soldier \$.....⁴⁸100; due U. S. \$.....100

Am't for cloth'g in kind or money adv'd \$.....100

Due U. S. for arms, equipments, &c., \$.....100

Bounty paid \$.....100; due \$.....¹⁰⁰100

Remarks: Free on or before Apr 14, 61

Book mark:

Manning Copyist.

108 *William Lewis or
Gimney Lewis*

Co. G, 4 U.S. Col'd Inf.

Private | *Private*

CARD NUMBERS.

1	5550519	26
2	5561869	27
3	5561955	28
4	5562044	29
5	5562144	30
6	5562241	31
7	5562402	32
8	5562636	33
9	5550880	34
10	9062427	35
11		36
12		37
13		38
14		39
15		40
16		41
17		42
18		43
19		44
20		45
21		46
22		47
23		48
24		49
25		50

Book Mark:

See also

B

4

U.S.C.T.

Louis Birney

, Co. *G*, 4 Reg't U. S. Col'd Inf.

Appears on

Company Descriptive Book

of the organization named above.

DESCRIPTION.

Age *42* years; height *5* feet *7 1/2* inches.

Complexion *Black*

Eyes *Black*; hair *Black*

Where born *Robinson Co. Tenn.*

Occupation *Laborer*

ENLISTMENT.

When *Sept 1*, 18*62*.

Where *New York*

By whom *Capt Mills*; term *1* y'rs.

Remarks: *Mustered out by reason of expiration term of service Sept 2 1865 at New Bern N.C. by Lt. G. A. May A.C.M.*

W. H. Merrill

(8837)

Copyist.

B

4

U.S.C.T.

Lewis Binney

Appears with rank of *Priv.* on

Muster and Descriptive Roll of a Detachment of U. S. Vols. forwarded

for the 4 Reg't U. S. Col'd Infantry. Roll dated

Dayton, Ohio, Sept. 6, 1864.

Where born *Robison's Ferry, Tenn.*

Age *42* y'rs; occupation *laborer*

When enlisted *Sept. 1, 1864.*

Where enlisted *Dayton, O.*

For what period enlisted _____ years.

Eyes *black*; hair *black*

Complexion *black*; height *5* ft. *7* in.

When mustered in *Sept. 1, 1864.*

Where mustered in *Dayton, O.*

Bounty paid \$ *100*; due \$ *100*

Where credited _____

Company to which assigned _____

Remarks: *Credited to Third Ward Hamilton
Butler Co. Sub District 23, 8th District
Ohio. Forwarded to Camp
Delaware September 6/64*

Book mark: _____

Hathaway
(339) *Hathaway* Copyist.

B

4

U.S.C.T.

Lewis Binney

Priv., Co. G, 4 Reg't U. S. Col'd Infantry.

Appears on

Company Muster Roll

for Nov & Dec, 1864

Joined for duty and enrolled:

When Sept 1, 1864

Where Dayton O.

Period 1 years.*

Present or absent Present

Stoppage, \$ 100 for

Due Gov't \$ 100 for

Remarks: A recruit assigned to Co. G. Nov. 18/64.

* See enrollment on card from muster-in roll.

Book mark:

C. Richardson

(358c)

Copyist.

B

4

U.S.C.T.

William Berney

Pvt, Co. G, 4 Reg't U. S. Col'd Infantry.

Appears on

Company Muster Roll

for Dated Feb 28, 1865.

Joined for duty and enrolled:

When Sept 1, 1864.*

Where Dayton Ohio *

Period 1 years.*

Present or absent Present

Stoppage, \$ 100 for

Due Gov't \$ 100 for

Remarks: Recruit assigned to Co G Apr 18/64

* See enrollment on card from muster-in roll.

Book mark:

Ackerman

(358c)

Copyist.

43

4

U.S.C.T.

William Birney

Pot, Co. G, 4 Reg't U. S. Col'd Infantry.

Appears on

Company Muster Roll

for *Mar + Apr*, 1865.

Joined for duty and enrolled:

When *Sept 1*, 1864.*

Where *Dayton Ohio* *

Period *3* years.*

Present or absent *Present*

Stoppage, \$ *100* for _____

Due Gov't \$ *100* for _____

Remarks: _____

* See enrollment on card from muster-in roll.

Book mark: _____

Ackerman
(358c) Copyist.

B

4

U.S.C.T.

William Purney

Pvt, Co. G, 4 Reg't U. S. Col'd Infantry.

Appears on

Company Muster Roll

for *May + June*, 1865.

Joined for duty and enrolled:

When *Sept 1*, 1864*

Where *Dayton Ohio**

Period *1* years.*

Present or absent *Present*

Stoppage, \$ *100* for

Due Gov't \$ *100* for

Remarks: *Recruit*

* See enrollment on card from muster-in roll.

Book mark:

Ackerman

(358c)

Copyist.

B

4

U.S.C.T.

William Berry

Pvt., Co. G, 4 Reg't U. S. Col'd Infantry.

Appears on

Company Muster Roll

for July + Aug, 1865.

Joined for duty and enrolled:

When Sept 1, 1864*

Where Dayton Ohio *

Period 1 years.*

Present or absent Present

Stoppage, \$ 100 for

Due Gov't \$ 100 for

Remarks:

* See enrollment on card from muster-in roll.

Book mark:

Ackerman

(358c)

Copyist.

B

4

U.S.C.T.

Louis Berney

Pvt, Co. G, 4 Reg't U. S. Col'd Infantry.

Appears on

Company Muster Roll

for Sept + Oct, 1865.

Joined for duty and enrolled:

When Sept 1, 1864.*

Where Dayton Ohio, *

Period 1 years.*

Present or absent

Stoppage, \$ 100 for

Due Gov't \$ 100 for

Remarks: Mustered out by reason of expiration of term of service.

* See enrollment on card from muster-in roll.

Book mark:

A. Kerman

(358c)

Copyist.

B | 4 U.S.C.T.

Lewis Birney
Co G, 4 Reg't U. S. Col'd Infantry.

Appears on a

Detachment Muster-out Roll

of the organization named above. Roll dated

New Berne N.C., Sept 4, 1865.

Muster-out to date Sept 4, 1865.

Last paid to June 30, 1865

Clothing account:

Last settled Never, 1865 ; drawn since \$ 100

Due soldier \$ 100 ; due U. S. \$ 100

Am't for cloth'g in kind or money adv'd \$ 100

Due U. S. for arms, equipments, &c., \$ 100

Bounty paid \$ 100 due \$ 100 ⁰⁰/₁₀₀

Remarks: Clothing drawn since
Enlistment of \$42.04 Mustered
out by reason of expiration of
term of service Transportation
due him from place of discharge
over

Book mark:

Jacobson

JAN 19

5550880

1891

to place of Enrichment

B | 4 | U.S.C.T.

Lewis Birney

Co. G, 4 Reg't U. S. Col'd Infantry.

Appears on **Co. Muster-out Roll**, dated
Washington DC May 4, 1866.

Muster-out to date _____, 186 .

Last paid to _____, 186 .

Clothing account:

Last settled _____, 186 ; drawn since \$ _____ 100

Due soldier \$ _____ 100; due U. S. \$ _____ 100

Am't for cloth'g in kind or money adv'd \$ _____ 100

Due U. S. for arms, equipments, &c., \$ _____ 100

Bounty paid \$ _____ 100; due \$ _____ 100

Remarks: *Mustered out by*
reason of expiration
of term of service
Sep 4/65 Newburn NC
by L. Wags A. C. W.

Book mark: *Muster Out Roll on file*

T. A. Johnson

(861)

Copyist.

109

Bishop. Abraham.

Co. *D*, **4** U.S. Col'd Inf.

Private

Private

CARD NUMBERS.

1	5564377	26
2	5564478	27
3	5564578	28
4	5564758	29
5	5565942	30
6	9862552	31
7		32
8		33
9		34
10		35
11		36
12		37
13		38
14		39
15		40
16		41
17		42
18		43
19		44
20		45
21		46
22		47
23		48
24		49
25		50

Book Mark:

See also

B. | 4 | U.S.C.T.

Abraham Bishop

, Co. I., 4 Reg't U. S. Col'd Inf.

Appears on

Company Descriptive Book

of the organization named above.

DESCRIPTION.

Age 23 years ; height 5 feet 6 inches.

Complexion Bek

Eyes Bk ; hair Bek

Where born Dorchester md

Occupation Farmer

ENLISTMENT.

When Aug 11, 1863.

Where Baltimore md

By whom Col M. Burney ; term 3 y'rs.

Remarks: Free apl 19/61

Selah

(383g)

Copyist.

B 4 U.S.C.T.

Abraham Bishop

Co. I, 4 Reg't U. S. Col'd Infantry.

Age *23* years.

Appears on

Company Muster-in Roll

of the organization named above. Roll dated

Baltimore Md August, 186*3*.

Muster-in to date

August, 186*3*.

Joined for duty and enrolled:

When

August 11, 186*3*.*

Where

Baltimore Md

Period

3 years.*

Remarks:

* ~~42~~ Muster-in roll shows enrollment and muster-in of this company as of same date and place. See enrollment on subsequent card or cards.

Book mark:

G. F. J.

B | 4 | U.S.C.T.

Abram Bishop
Cvt., Co. I, 4 Reg't U. S. Col'd Infantry.

Appears on

Company Muster Roll

for *Aug. 11 to 31*, 186*3*

Joined for duty and enrolled :

When *Aug. 11*, 186*3*.*

Where *Baltimore Md.**

Period *3* years.*

Present or absent *Present*

Stoppage, \$ *100* for

Due Gov't, \$ *100* for

Remarks: *Stoppage for
one catch. Two
dollars premium
due*

* See enrollment on card from muster-in roll.

Book mark :

G. For

B | 4 | U.S.C.T.

Abraham Bishop
Cmt, Co. I, 4 Reg't U. S. Col'd Infantry.

Appears on

Company Muster Roll

for Sept & Oct., 1863.

Joined for duty and enrolled:

When Aug 11, 1863*

Where Baltimore Md.

Period 3 years.*

Present or absent Present

Stoppage, \$ 100 for

Due Gov't, \$ 100 for

Remarks:

* See enrollment on card from muster-in roll.

Book mark:

B | 4 | U.S.C.T.

Abraham Bishop
Pvt., Co. I, 4 Reg't U. S. Col'd Infantry.

Appears on

Company Muster Roll

for *Nov. & Dec.*, 186*3*.

Joined for duty and enrolled:

When *Aug. 11*, 186*3*.*

Where *Baltimore Md.**

Period *3* years.*

Present or absent

Stoppage, \$ *100* for

Due Gov't, \$ *100* for

Remarks: *Died in Hosp^l*
Near Williamsburg
Va., Dec. 21 1863. (Disease
Typhoid Fever)

* See enrollment on card from muster-in roll.

Book mark: *Dead. 98523*

Geo. W. Fox
 Copyist.

B | 4 | U.S.C.T.

Abraham Bishop
Pvt, Co. D, 4 Reg't U. S. Col'd Infantry.

Appears on Co. Muster-out Roll, dated
Washington, D.C. May 4, 1866.

Muster-out to date _____, 186 .
Last paid to _____, 186 .

Clothing account:

Last settled _____, 186 ; drawn since \$ _____ 100
Due soldier \$ _____ 100; due U. S. \$ _____ 100
Am't for cloth'g in kind or money adv'd \$ _____ 100

Due U. S. for arms, equipments, &c., \$ _____ 100
Bounty paid \$ _____ 100; due \$ _____ 100

Remarks: Died Dec 21, 63

Book mark: 98,523 H.B.V.

(861) Ballade Copyist.

Bishop, Abraham

P, Co. *I*, **4** Regt. **U. S. C. Inf.**

3 Enclosures.

Bed Cards	Descriptive Lists
Burial Records	Final Statements /
Certs. of Dis. for Discharge	Furloughs
C. M. Charges	Med. Des. Lists
Med. Certificates	Orders

Other papers relating to—

Admission to Hosp'l	Furlough
Casualty Sheet (Officer's)	Med. Examination
Confinement	Misc. Information
Contracts	Pay or Clothing
Death or Effects 2	Personal Reports
Desertions	Rank
Discharge from Hosp'l	Transfer to Hosp'l
Discharge from Service	Transfer to V. R. C.
Duty	Transportation

ag. C. July 21, 1861
Disc List sent 2d Aud.
Mi.

[Faint handwritten notes and a checkmark]

FINAL STATEMENT

OF

Abraham Bishop
4th Reg't of U.S.C. 7

~~VOLUNTEER~~

Dis'd December 21 1863

NOTE 1.—Two of these certificates (or duplicates) are to be given to each volunteer soldier who may be discharged previously to the discharge of his company, that he may at once receive from the Paymaster the pay, &c., due him, and the captain or other officer commanding the company will certify to the act of the delivery of the duplicate certificates; on these certificates the Soldier is "entitled to" his discharge, and should also present his discharge to the Paymaster to have the payment endorsed on it. The discharge is to be given back to the Soldier by the Paymaster; the latter only retaining as his voucher the duplicate certificates.

NOTE 2.—If the Soldier is entitled to pay for the use of his horse, the Company Commander will certify to that fact, and also to the time he has pay due for having been so mounted on his own horse.

NOTE 3.—Amounts due the Sutler and Laundress must be entered on the Muster Roll on which the death, desertion, &c., is reported, as well as on the final statement, otherwise the amount cannot be collected from the United States.

NOTE 4.—This blank will be used for deceased volunteers as well as others.

QUARTERMASTER GENERAL'S OFFICE

April 26th 1864

Duplicate with Inventory sent 2d Auditor.

Ent. on R. of C.

I certify, on honor, that Abraham Bishop a private of
 Captain Mansell Company (2) of the 4 Regiment of U.S.C.V.
~~VOLUNTEERS~~, of the State of Maryland, born in Dorchester, State
 of Maryland, aged 21 years; 5 feet 6 inches high; W complexion,
Blue eyes, Blk hair, and by occupation a farmer having joined the company on
 its original organization at Baltimore Md, and enrolled in it at the muster into
 the service of the United States at Baltimore Md, on the 11th day
 of Aug, 186 3 (or was mustered in service as a recruit, by _____
 _____, at _____, on the _____ day of _____,
 186 , to serve in the Regiment,) for the term of _____:
 and having served HONESTLY and FAITHFULLY with his Company in _____
 to the present date, is now entitled to a **DISCHARGE** by reason of _____
Wound at Williamsburg Va
Dec 9 1863 - of exploded mine

The said Abraham Bishop was last paid by Paymaster
May Henry to include the 31 day of Oct, 186 3, and has
 pay due him from that time to the present date; ~~he is entitled to pay and subsistence for~~
~~TRAVELING~~ to place of enrollment and whatever other allowances are authorized to volunteer
~~soldiers, or militia, so discharged.~~ He has received Thirty Six ⁶⁶/₁₀₀ dollars,
 advanced by the United States on account of **CLOTHING**.

~~There is to be stopped from him, on account of the State of _____, or other~~
~~authorities for CLOTHING, &c., received on entering service, _____ dollars; also,~~
~~for expenses of SUBSISTENCE for TRAVELING from place of enrollment to the place of rendezvous,~~
~~amounting to _____ dollars: and on account of the United States for EXTRA~~
~~CLOTHING received in kind from _____ and for other~~
~~stoppages, viz:~~

_____ amounting to _____ dollars;
 and he has been SUBSISTED for TRAVELING to his place of enrollment, up to the _____
 _____, 186 .

He is indebted to _____ SUTLER, _____ dollars.
 He is indebted to _____ LAUNDRESS, _____ dollars.

Given in Duplicate, at Williamsburg, this 26 day of Dec, 186 3

J. J. Mansell
Capt
 Commanding Company.

Inventory of the effects
of Abraham Bishop
late of Co I, 4 Reg. of
U.S.C. who died
near Williamsburg Va
21st day of December
1863

Inventory of the effects
of Abraham Bishop
private Co I, 4 Reg. U.S.C.
70th Reg. 1st Reg. Sash
1 Shirt -
1 pair Stockings
1 Dress Coat

Stephens
Capt Co I, 4 Reg. U.S.C.

1863

F. G. on file No 2
INVENTORY OF THE EFFECTS

OF
Abraham B. Bishop
~~*Joseph H. Houghton*~~

Late of Company *I*

4 Regt of *U. S. C. 7*

Volunteers, who died at *Williamsburg Va*
~~*Jackson*~~

on the *21* day of *October* 1863



Inventory of the effects of Abraham Bishop late
a private of Captain S. J. Mendell Company I of
the 4th Regiment of U. S. C. V. Volunteers, who was enrolled as
a Soldier at Baltimore in the State of Maryland on
the 11th day of August 1863, and mustered into the service of the United
States as a Soldier on the 11 day of Aug 1863, at Baltimore Md
in Company I 4th Regiment of U. S. C. V. Volunteers, to serve 3 years
years or during the war; he was born in Douchester in the State
of Maryland; he was 23 years of age, 5 feet 6 inches
high, Black complexion, Blue eyes, Black hair, and by occupation, when enrolled,
a farmer; he died in Williamsburg Va at
Hospital on the 21 day of Dec 1863 by
reason of Typhoid fever

INVENTORY.					
ARTICLES.	No.	ARTICLES.	No.	ARTICLES.	No.
Hats.....		Pairs trousers.....	2	Knapsacks.....	1
Caps.....		Pairs flannel drawers.....			
Forage caps.....		Pairs cotton drawers.....			
Great coats.....	1	Flannel shirts.....	1		
Uniform coats.....	1	Cotton shirts.....			
Uniform jackets.....		Pairs boots.....			
Flannel sack coats.....		Pairs shoes.....			
Blouses.....		Pairs socks.....	1		
Stable frocks.....		Blankets.....	1		
Fatigue overalls.....		Haversacks.....			
				MONEY.	
				Specie.....	\$
				Notes.....	\$

I CERTIFY, ON HONOR, that the above inventory comprises all the effects of private
Abraham Bishop deceased, and that the effects are in the hands
of Capt S. J. Mendell at Williamsburg Va
Va to be disposed of by a Council of Administration.

(DUPLICATES.)

STATION: Williamsburg Va

DATE: Dec 26 1863

S. J. Mendell
Capt
 Commanding the Company.

110

Black. Alford

Co. D., 4 U.S. Col'd Inf.

Private Private

CARD NUMBERS.

1	5557661	26
2	55570925	27
3	5556948	28
4	55571043	29
5	5557133	30
6	5557234	31
7	5557326	32
8	5557460	33
9	90691041	34
10	B210-05-1876	35
11		36
12		37
13		38
14		39
15		40
16		41
17		42
18		43
19		44
20		45
21		46
22		47
23		48
24		49
25		50

Book Mark: B210-05-1876

See also

B | 4 | U.S.C.T.

Alfonso Black

Co. *A*, 4 Reg't U. S. Col'd Inf.

Appears on

Company Descriptive Book

of the organization named above.

DESCRIPTION.

Age *30* years; height *5* feet *7* inches.

Complexion *Dark*

Eyes *Black*; hair *Black*

Where born *Carters Gap Ky*

Occupation *Farmer*

ENLISTMENT.

When *1861 Aug*, 1864.

Where *Irreston O.*

By whom *Let Booth*; term *1* y'rs.

Remarks: *Mustered into service Aug 18/64*
Irreston O. by Capt Cory 11 Comp Dist
O. Lawrence Ky upper Tp.
Mustered out by reason of expiration of
term of service Sept 4/65 at New Rome n.c.

H. H. Merrill

B | 4 | U.S.C.T.

Alford Black
Opt., Co. D, 4 Reg't U. S. Col'd Infantry.

Appears on
Company Muster Roll
for Sept. & Oct., 1865.

Joined for duty and enrolled:
When Aug. 18, 1864.*
Where Ironton, O. *
Period 1 years.*

Present or absent
Stoppage, \$ 100 for
Due Gov't \$ 100 for

Remarks: Mustered out of
service at New Berne
N.C. by Lt. Way.

* See enrollment on card from muster-in roll.

Book mark: Discharged Sept. 4/65. CB.
V. 12, P. 165 + B. 210, V. 11, C. 7, 76.

(858c) Castling Copyist.

B | 4 | U.S.C.T.

Alford Black
Priv, Co. D, 4 Reg't U. S. Col'd Infantry.

Appears on

Company Muster Roll

for *Nov + Dec*, 1864.

Joined for duty and enrolled:

When *Aug 18*, 1864.*

Where *Simsion, O.* *

Period *1* years.*

Present or absent *Present*

Stoppage, \$ *100* for

Due Gov't \$ *100* for

Remarks: *joined company*
Dec. 7/64. No pay
since enlistment.

* See enrollment on card from muster-in roll.

Book mark:

W A Tyler
(858c) Copyist.

B | 4 | U.S.C.T.

Alford Black
Cvt., Co. D, 4 Reg't U. S. Col'd Infantry.

Appears on

Company Muster Roll

for Jan. & Feb., 1865.

Joined for duty and enrolled:

When Aug. 18, 1864.*

Where Ironton O. *

Period 1 years.*

Present or absent Present.

Stoppage, \$ 100 for

Due Gov't \$ 100 for

Remarks: Joined Company
Dec. 7/64. No pay since
enlistment.

* See enrollment on card from muster-in roll.

Book mark:

Easterling
Copyist.

(868c)

B | 4 | U.S.C.T.

Alfred Black

Prvt., Co. D, 4 Reg't U. S. Col'd Infantry.

Appears on

Company Muster Roll

for *Mar. & Apr.*, 1865.

Joined for duty and enrolled:

When *Aug. 18*, 1864.*

Where *Ironton, O.* *

Period *1* years.*

Present or absent *Present*

Stoppage, \$ *100* for

Due Gov't \$ *100* for

Remarks: *Joined Co. Dec. 7/64,
no pay since enlistment.*

* See enrollment on card from muster-in roll.

Book mark:

(858c)

Easterbury

Copyist.

B | **4** | **U.S.C.T.**

Alford Black

Priv., Co. D, 4 Reg't U. S. Col'd Infantry.

Appears on

Company Muster Roll

for *May & June*, 1865.

Joined for duty and enrolled:

When *Aug. 18*, 1864.*

Where *Ironton, O.* *

Period *1* years.*

Present or absent *Present*,

Stoppage, \$ *100* for

Due Gov't \$ *100* for

Remarks: *Joined Co. Dec. 7/64,
no pay since enlistment.*

* See enrollment on card from muster-in roll.

Book mark:

(858c)

Castling

Copyist.

B | 4 | U.S.C.T.

Alfred Black

Pvt., Co. D, 4 Reg't U. S. Col'd Infantry.

Appears on

Company Muster Roll

for July & Aug, 1865.

Joined for duty and enrolled:

When Aug, 18, 1864.*

Where Houston, O. *

Period 1 years.*

Present or absent Present,

Stoppage, \$ 100 for

Due Gov't \$ 100 for

Remarks:

* See enrollment on card from muster-in roll.

Book mark:

(858c)

Easterling

Copyist.

B | 4 U.S.C.T.

Alfred Black
 Co D, 4 Reg't U. S. Col'd Infantry.

Appears on a

Detachment Muster-out Roll

of the organization named above. Roll dated

New Bern NC, Sept 4, 1865.

Muster-out to date Sept 4, 1865.

Last paid to June 30, 1865

Clothing account:

Last settled 186 ; drawn since \$None 100

Due soldier \$ 100 ; due U. S. \$ 100

Am't for cloth'g in kind or money adv'd \$ 100

Due U. S. for arms, equipments, &c., \$ 6 100

Bounty paid \$None 100 due \$ 100 100

Remarks: Stop 1 year & set account
 account retained, Mustered
 out by reason of expiration of
 term of service Transportation
 due from place of discharge to place
 of enrollment

Book mark:

Jacobson

B. | 4 | U.S.C.T.

Alford Black
Sgt, Co. D, 4 Reg't U. S. Col'd Infantry.

Appears on Co, Muster-out Roll, dated
Washington D.C. May 4, 1866.

Muster-out to date _____, 1866 .

Last paid to _____, 1866 .

Clothing account:

Last settled _____, 1866 ; drawn since \$ _____ 100

Due soldier \$ _____ 100 ; due U. S. \$ _____ 100

Am't for cloth'g in kind or money adv'd \$ _____ 100

Due U. S. for arms, equipments, &c., \$ _____ 100

Bounty paid \$ _____ 100 ; due \$ _____ 100

Remarks: is discharged
April 4/65

Enrol'd in Aug 18/64 Proctor
Ohio 1 year age 30

Book mark: B. 210. VII. C. T. 76. Discharged
Sep 4 65 E.B. V12 P165

(861)

J. J. Jowers
Copyist.

B. 1 4" U.S. 6.J

Alfred Black

, Co. D, 4" Reg't U.S. 6.J.

NOTATION.

EB 12/165 B. 210. 6.J. 1876.
Book mark:

War Department,

Adjutant General's Office,

Washington, Oct 27, 1876.

Discharged Sept 4th, 1865.

E. P. Conrazier.

111

Shaker Allen

Co *E*, **4** U.S. Col'd Inf.

Private

Private

CARD NUMBERS.

1	5550428	26
2	5561870	27
3	5561956	28
4	5562045	29
5	5562145	30
6	5562810	31
7	5562663	32
8	4062424	33
9		34
10		35
11		36
12		37
13		38
14		39
15		40
16		41
17		42
18		43
19		44
20		45
21		46
22		47
23		48
24		49
25		50

Book Mark:

See also

B

4

U.S.C.T.

Allen Blake

, Co. G, 4 Reg't U.S. Col'd Inf

Appears on

Company Descriptive Book

of the organization named above.

DESCRIPTION.

Age 23 years; height 5 feet 7 inches.

Complexion Black

Eyes Black; hair Black

Where born Ohio

Occupation Laborer

ENLISTMENT.

When Sept 5, 1864.

Where Circleville O

By whom Rec. Agent Dougherty, term 1 y'rs.

Remarks: Died in the US Gen. Hosp't
Wilmington N.C. April 29/65
of pneumonia

N. H. Merrill

B | 4 | U.S.C.T.

Allen Blake

Appears with rank of Pvt. on

Muster and Descriptive Roll of a Detachment of U. S. Vols. forwarded

for the 4 Reg't U. S Col'd Infantry. Roll dated

Circleville, Ohio, Sept. 5, 1864.

Where born Ohio

Age 23 yrs; occupation laborer

When enlisted Sept. 5, 1864

Where enlisted Circleville

For what period enlisted 1 years.

Eyes black; hair black

Complexion black; height 5 ft. 7 in.

When mustered in Sept. 5, 1864.

Where mustered in Circleville

Bounty paid \$ 100; due \$ 100

Where credited

Company to which assigned

Remarks: Credited to Franklin T. Tuscarawas Co. Sub. Dist. 16.

Book mark:

Hathaway

(339)

Copyist.

B | 4 | U.S.C.T.

Allen Blake

Priv., Co. G, 4 Reg't U. S. Col'd Infantry.

Appears on

Company Muster Roll

for Nov & Dec, 1864

Joined for duty and enrolled:

When Sept. 5, 1864

Where Circleville O

Period 1 years.

Present or absent Present

Stoppage, \$ 100 for

Due Gov't \$ 100 for

Remarks: A recruit assigned to Co. G. Nov. 18/64.

* See enrollment on card from muster-in roll.

Book mark:

E. J. Richardson

(358c)

Copyist.

B

4

U.S.C.T.

Allen Blake

Pvt., Co. G, 4 Reg't U. S. Col'd Infantry.

Appears on

Company Muster Roll

for Dated Feb 28, 1865.

Joined for duty and enrolled:

When Sept 5, 1864*

Where Circleville Ohio *

Period 1 years.*

Present or absent Present

Stoppage, \$ 100 for

Due Gov't \$ 100 for

Remarks: Recruit assigned to Co. G. Nov 18/64

* See enrollment on card from muster-in roll.

Book mark:

A. Kerman

(358c)

Copyist.

B

4

U.S.C.T.

Allen Blake

Pvt., Co. G, 4 Reg't U. S. Col'd Infantry.

Appears on

Company Muster Roll

for *Mar + Apr*, 1865.

Joined for duty and enrolled:

When *Sept 5*, 1864.*

Where *Curdeville Ohio* *

Period *3* years.*

Present or absent *absent*

Stoppage, \$ *100* for

Due Gov't \$ *100* for

Remarks: *Absent sick Stop 1
Musket.*

* See enrollment on card from muster-in roll.

Book mark:

Ackerman

B

4

U.S.C.T.

Allen Blakke

Plt, Co. G, 4 Reg't U. S. Col'd Infantry.

Appears on

Company Muster Roll

for May & June, 1865.

Joined for duty and enrolled:

When Sept 5, 1864*

Where Circleville Ohio *

Period 1 years.*

Present or absent Absent

Stoppage, \$ 100 for

Due Gov't \$ 100 for

Remarks: Absent Sick * Stop one month

* So on Roll

* See enrollment on card from muster-in roll.

Book mark:

Ackerman

B

4

U.S.C.T.

Allen Blake

Pvt, Co. G, 4 Reg't U. S. Col'd Infantry.

Appears on

Company Muster Roll

for July + Aug, 1865.

Joined for duty and enrolled:

When Sept 5, 1864*

Where Circleville O.*

Period 1 years.*

Present or absent _____

Stoppage, \$ 100 for _____

Due Gov't \$ 100 for _____

Remarks: Died at U.S. Gen Hospital
Wilmington N.C., Apr 29
Pneumonia

* See enrollment on card from muster-in roll.

Book mark: _____

A. Kerman

(358c)

Copyist.

B | 4 | U.S.C.T.

Allen Blake

Pvt, Co. *G*, 4 Reg't U. S. Col'd Infantry.

Appears on **Co. Muster-out Roll**, dated *Washington D.C. May 4*, 186*6*.

Muster-out to date _____, 186 .

Last paid to _____, 186 .

Clothing account:

Last settled _____, 186 ; drawn since \$ _____ 100

Due soldier \$ _____ 100; due U. S. \$ _____ 100

Am't for cloth'g in kind or money adv'd \$ _____ 100

Due U. S. for arms, equipments, &c., \$ _____ 100

Bounty paid \$ _____ 100; due \$ _____ 100

Remarks: *Died at US GA*
Mil N.C

Book mark: *A.G.C. Died Apr 29/65*

(over)

(361)

T. Johnson

Copyist.

JAN. 20

5562663

* 1891 *

Des List on file

Blake, Allen

P. Co. G, 4 Regt U.S.C. Inf.

2 Enclosures.

Bed Cards	Descriptive Lists
Burial Records	Final Statements
Certs. of Dis. for Discharge	Furloughs
C. M. Charges	Med. Des. Lists
Med. Certificates	Orders

Other papers relating to—

Admission to Hosp'l	Furlough
Casualty Sheet (Officer's)	Med. Examination
Confinement	Misc. Information
Contracts	Pay or Clothing
Death or Effects	Personal Reports
Desertions	Rank
Discharge from Hosp'l	Transfer to Hosp'l
Discharge from Service	Transfer to V. R. C.
Duty	Transportation

No. 3
 Recd from Sec. of Discontinued
 (Command); Filed June 10/75

INVENTORY

OF THE EFFECTS OF

Allen Blake

Late of Company "C", 4th Regiment

U.S. Cavalry, who died
 at Fort C. & G. General

Hospital April 29th,
 1865.

Inventory of Effects
 and Personal Statements
 forwarded to A.G.O.
 Sept. 9, 1865.



Inventory of the effects of Allen Bolake
 Company F, 4th Regiment U.S. C. Troops
 who died in the U.S. C. T. General Hospital
April 29th, 1865.

CAPS	BLANKETS
DRESS COATS	KNAPSACKS
OVERCOATS	CANTEENS
JACKETS	HAVERSACKS
TROUSERS	MUSKETS
SHIRTS	BAYONETS
DRAWERS	CARTRIDGE BOX
BOOTS, pairs	BELT
SHOES, pairs	MONEY
STOCKINGS	

Colt Troops U. S. Army General Hospital,
Wilmington N. C. June 24 1863.

Commanding Officer, "C" Company,
4th Regiment Mass. Co. Troops

I have to inform you
that Allen Blake of your Company died in this
Hospital on April 29th of
Pneumonia

I enclose his Descriptive List, with Pay and Clothing Account,
and Inventory of his effects.

Very respectfully, yours, &c.,

Wm. B. Bealer
Act. Asst. Surgeon U. S. Army
In charge of General Hospital

Extract from Act of Congress.

SEC. 12. *And be it further enacted,* That the fees of agents and attorneys for making out and causing to be executed the papers necessary to establish a claim for a pension, bounty, and other allowance before the Pension Office, under this act, shall not exceed the following rates: For making out and causing to be duly executed a declaration by the applicant, with the necessary affidavits, and forwarding the same to the Pension Office, with the requisite correspondence, ten dollars; which sum shall be received by such agent or attorney in full for all services in obtaining such pension, and shall not be demanded or received, in whole or in part, until such pension shall be obtained; and the sixth and seventh sections of an act entitled "An act to grant pensions," approved July [fourteenth,] eighteen hundred and sixty-two, are hereby repealed.

SEC. 13. *And be it further enacted,* That any agent or attorney who shall, directly or indirectly, demand or receive any greater compensation for his services under this act than is prescribed in the preceding section of this act, or who shall contract or agree to prosecute any claim for a pension, bounty, or other allowance under this act, on the condition that he shall receive a per centum upon any portion of the amount of such claim, or who shall wrongfully withhold from a pensioner or other claimant the whole or any part of the pension or claim allowed and due to such pensioner or claimant, shall be deemed guilty of a high misdemeanor, and, upon conviction thereof, shall, for every such offense, be fined not exceeding three hundred dollars, or imprisoned at hard labor not exceeding two years, or both, according to the circumstances and aggravations of the offense.

Approved July 4, 1864.

NOTE. 10.—If any soldier is charged a higher fee than that allowed by the above act, he should report the fact and the name of the agent to the Adjutant General, in order that steps may be taken to have the same refunded.

ADJUTANT GENERAL'S OFFICE
 Sept 16 1865
 Duplicate with Inventory sent 2d Auditor.

FINAL STATEMENT.

OF
Pvt. Allen Brock Co. G.
4th Reg't of U.S. Col'd Troops.

VOLUNTEERS.
Disch April 29 1865

NOTE 1.—Two of these certificates (or duplicates) are to be given to each Volunteer Soldier or drafted man who may be discharged without being mustered out (Final Statements are never given to men mustered out of service) that he may at once receive from the Paymaster the pay, &c., due to him, and the captain or other COMMISSIONED officer commanding the company will certify to the act of the delivery of the duplicate certificates; with these certificates the Soldier is "entitled to" his discharge, and should also present his discharge to the Paymaster to have the payment endorsed on it. The discharge is to be given back to the Soldier by the Paymaster; the latter only retaining as his vouchers the duplicate certificates.

NOTE 2.—If the Soldier is entitled to pay for the use of his horse, the Company Commander will certify to that fact on the back of both these final statements, and also to the time he has pay due for having been so mounted on his own horse.

NOTE 3.—When a Soldier is furnished with final statements, his descriptive list, if he has one, should be taken up by the officer who gives the Soldier these statements, and endorsed with a statement to this effect by the officer. The endorsement should exhibit a full statement of the time for which the Soldier was allowed pay on his final statements, the clothing account, and all other charges against him or in his favor, so as to comprise a complete exhibit of his account. It will then be transmitted to the Company Commander of the Soldier, who will enter all the data necessary to a full understanding of the Soldier's account on the muster roll upon which the Soldier's discharge is reported. The descriptive list will then be destroyed. The object of this is, that the remaining portion of the Soldier's account may be settled upon the receipt of these muster rolls, and the Soldier receive any pay or allowances that may be due him at the time of his discharge, and which may not appear on his last final statements from the fact that his descriptive list is incomplete. These accounts for back pay, &c., are settled by the 2d Auditor of the Treasury Department.

NOTE 4.—Charges for loss or injury to ordnance, horse equipments, and other miscellaneous charges, should appear under the heading of "Other Stoppages."

NOTE 5.—Bounty paid by State authorities, and not by the United States, will not be entered on this statement.

NOTE 6.—Amounts due the Sutler and Landdress must be entered on the muster roll on which the discharge, death, desertion, &c., is reported, as well as on the final statement, otherwise the amount cannot be collected from the United States.

NOTE 7.—This blank will be used for deceased volunteers and drafted men, as well as for others.

NOTE 8.—Where a Soldier dies in Hospital or on detached service, his descriptive list, if he has one, should be sent with his final statements, in duplicate, to the Adjutant General, Washington, D. C.

NOTE 9.—If the soldier is a drafted man or substitute, the space for time, &c., of enrolled, should contain only the word *drafted* or *substitute*, as the case may be. If the Soldier is a "VETERAN," (or RECRUIT,) the words *as a veteran*, (or *recruit*.) as the case may be, should be interlined after the words *mustered into the service of the U. S.* A statement of all the installments of *Veteran* or *Recruit Bounty* RECEIVED by the Soldier must be made on the back of each final statement.

Cent. & H. Reg't
 ADJUTANT GENERAL'S OFFICE

I certify, on honor, that Allen Blake, a Private of
 Captain Jos. N. Wick Company (9) of the 4th Regiment of U.S.C. Troops
Volunteers, of the State of _____, born in _____ State
 of Ohio, aged 22 years; 5 feet 7 inches high; Black complexion,
Black eyes, Black hair, and by occupation a Labourer, who joined for service
 and was enrolled (see Note 9) on the 3rd day of Sept, 1864, at Cincinnati Ohio
 by Sarge. J. P. Doherty, for the period of One years, and mustered into
 the service of the United States, on the 3rd day of September, 1864, at
Cincinnati Ohio, by Capt. J. W. Forbes; and having served
HONESTLY and **FAITHFULLY** with his Company to the present date, is now entitled to a
DISCHARGE by reason of Death

The said Priv. Allen Blake was last paid by Paymaster
Wm. M. Rainey, to include the 31st day of December, 1864, and
 has pay due him from that time to the present date; he is entitled to pay and subsistence for
TRAVELING to place of enrollment, and whatever other allowances are authorized to volunteer
 soldiers, drafted men, or militia, so discharged. He has received from the United States **CLOTHING**
 amounting to Twenty (20) 41 dollars, since the his enlistment day of _____,
 1864, when his clothing account was last settled. He has received from the United States
 _____ dollars advanced **BOUNTY**.

There is to be stopped from him, on account of the State of _____, or other
 authorities, for **CLOTHING**, &c., received on entering service, _____ dollars; and
 for other stoppages, viz: _____

_____ dollars.
 He has been furnished with **TRANSPORTATION** in kind from the place of his discharge to
 _____; and he has been **Subsisted** for **Traveling** to his
 place of enrollment, up to the _____, 1864.

He is indebted to W. C. Cooper, Sutler, Six (6) 00 dollars.
 He is indebted to _____ Laundress, _____ dollars.

Given in Duplicate, at New Bern N.C., this 11th day
 of September 1864.

Jos. H. McCullough
2nd Lieutenant

 Commanding Company.

Paid April 29 1865

¹¹²
Plat. John W.

Co. 4, U.S. Col'd Inf.

Private Private

CARD NUMBERS.

1	5550364	26
2	5556236	27
3	5556336	28
4	5556434	29
5	5556527	30
6	5556614	31
7	5556463	32
8	5559700	33
9	9062036	34
10	72-CJ-1878	35
11		36
12		37
13		38
14		39
15		40
16		41
17		42
18		43
19		44
20		45
21		46
22		47
23		48
24		49
25		50

Book Mark: 72-CJ-1878

See also

B

4

U.S.C.T.

John W Blake

, Co. *10*, 4 Reg't U. S. Col'd Inf.

Appears on

Company Descriptive Book

of the organization named above.

DESCRIPTION.

Age *41* years; height *5* feet *5 1/4* inches.

Complexion *Black*

Eyes *Black*; hair *Black*

Where born *Washington Co. Md*

Occupation *-*

ENLISTMENT.

When *May 26*, 1863 .

Where *Chillicothe O*

By whom *Lt. J. F. Wilson*; term *1* y'rs.

Remarks: *Died in Gen. Hospital*

City Point Va. Sunstroke

H. H. Merrill

(388g)

Copyist.

B. | 4 | U.S.C.T.

John W. Blake
Prvt., Co. D, 4 Reg't U. S. Col'd Infantry.

Age *21* years.

Appears on a

Detachment Muster-in Roll

of the organization named above. Roll dated

Baltimore Md., Aug. 26, 1863.

Muster-in to date *Aug. 26, 1863.*

Joined for duty and enrolled:

When *Aug. 26, 1863.*

Where *Baltimore Md.*

Period *3* years.

Remarks:

Book mark: *72-07-1878*

(337)

Hawling Copyist.

R | 4 | U.S.C.T.

John M. Blake

Co., Co. D, 4 Reg't U. S. Col'd Infantry.

Appears on

Company Muster Roll

for July 28, 63 to Aug 31, 1863.

Joined for duty and enrolled:

When July 28, 1863.*

Where Baltimore Md.*

Period 3 years.*

Present or absent present

Stoppage, \$ 100 for

Due Gov't \$ 100 for

Remarks: joined as recruit Aug. 28, 1863. \$2.00 Pre-mission due.

* See enrollment on card from muster-in roll.

Book mark:

Faulkner

B

4

U.S.C.T.

John M. Blakes

Priv., Co. D, 4 Reg't U. S. Col'd Infantry.

Appears on

Company Muster Roll

for Sept & Oct, 1863.

Joined for duty and enrolled:

When Aug 28, 1863.*

Where Baltimore Md *

Period 3 years.*

Present or absent present

Stoppage, \$ 100 for

Due Gov't \$ 100 for

Remarks:

* See enrollment on card from muster-in roll.

Book mark:

Faulkner

B | **4** | **U.S.C.T.**

John M. Blake

Priv, Co. D, 4 Reg't U. S. Col'd Infantry.

Appears on

Company Muster Roll

for *Nov & Dec*, 186 ⁶.

Joined for duty and enrolled:

When *Aug 28*, 186 ³.*

Where *Baltimore Md* *

Period *3* years.*

Present or absent *present*

Stoppage, \$ *100* for

Due Gov't \$ *100* for

Remarks:

* See enrollment on card from muster-in roll.

Book mark:

Frankner

(868c)

Copyist.

B | 4 | U.S.C.T.

John W. Blaker

Priv., Co. D, 4 Reg't U. S. Col'd Infantry.

Appears on

Company Muster Roll

for Jan & Feby, 1864.

Joined for duty and enrolled:

When Aug 28, 1863.*

Where Baltimore Md. *

Period 3 years.*

Present or absent present

Stoppage, \$ 100 for

Due Gov't \$ 100 for

Remarks: On daily duty as Bugler. Stop for one pair shoulder straps &c

* See enrollment on card from muster-in roll.

Book mark:

Franklin

(858c)

Copyist.

B | 4 | U.S.C.T.

John W Blake

Priv't, Co. D, 4 Reg't U. S. Col'd Infantry.

Appears on

Company Muster Roll

for March + April, 1864.

Joined for duty and enrolled:

When Aug. 28, 1863.*

Where Baltimore, Md.*

Period 3 years.*

Present or absent Present

Stoppage, \$ 100 for

Due Gov't \$ 100 for

Remarks: On daily duty as Bugler

* See enrollment on card from muster-in roll.

Book mark:

W. A. S. S. S.

B | 4 | U.S.C.T.

John W. Blake
Priv, Co. D, 4 Reg't U. S. Col'd Infantry.

Appears on

Company Muster Roll

for *May, June*, 1864.

Joined for duty and enrolled:

When *Aug 28*, 1863.*

Where *Baltimore Md* *

Period *3* years.*

Present or absent _____

Stoppage, \$ *100* for _____

Due Gov't \$ *100* for _____

Remarks: *Died May 18, 1864*
in Hospital at City
Point, Va.

* See enrollment on card from muster-in roll.

Book mark: *Died May 17/64 E.B. 482*

(858c)

W. S. Tyler

Copyist.

73. | 4 | U.S.C.T.

John W. Blake

Pvt., Co. *2*, 4 Reg't U. S. Col'd Infantry.

Appears on **Co. Muster-out Roll**, dated *Washington D.C. May 4*, 1866 .

Muster-out to date 186 .

Last paid to 186 .

Clothing account:

Last settled 186 ; drawn since \$ 100

Due soldier \$ 100 ; due U. S. \$ 100

Am't for cloth'g in kind or money adv'd \$ 100

Due U. S. for arms, equipments, &c., \$ 100

Bounty paid \$ 100 ; due \$ 100

Remarks: *Died of Disease*
May 27/63

Book mark: *also Died March 27 1864*
See F.S. on file.

J. W. Blake

(861)

Copyist.

P. H. *1895*
John H. Blake
, Co. D, 4th Reg't U.S.C.

NOTATION.

Book mark: *72. 25. 1878.*

War Department,

Adjutant General's Office,

Washington, *Jan'y 7th*, 1878.

Call from _____

returned with report.

The above book mark was noted on rolls in order to
preserve results of search in this case.

(475)

J. L. Robinson

Copyist.

Blake, John W.

P. D., 4 U. S. C. Inf.

2 Enclosures.

Bed Cards	Descriptive Lists
Burial Records	Final Statements ✓
Certs. of Dis. for Discharge	Furloughs
C. M. Charges	Med. Des. Lists
Med. Certificates	Orders

Other papers relating to—

Admission to Hosp'l	Furlough
Casualty Sheet (Officer's)	Med. Examination
Confinement	Misc. Information
Contracts	Pay or Clothing
Death or Effects ✓	Personal Reports
Desertions	Rank
Discharge from Hosp'l	Transfer to Hosp'l
Discharge from Service	Transfer to V. R. C.
Duty	Transportation

Recd from Div. of discontinued ^{No 16}
Commands; Filed June 9/75
INVENTORY OF THE EFFECTS

^{OF}
John W. Blake

Late of Company D

4th Reg't of U. S. C. I.

Volunteers, who died at City Point

on the 17 day of March 1864.



Inventory of the effects of John W. Blake late
a private of Captain John J. Eberhardt's Company A of
the 4th Regiment of U.S. Colored Troops Volunteers, who was enrolled as
a private at Baltimore in the State of Maryland on
the 28 day of August 1863, and mustered into the service of the United
States as a private on the 28 day of August 1863, at Baltimore
in Company D, 4th Regiment of U.S.C.T. Volunteers, to serve 3
years or during the war; he was born in Washington County in the State
of Maryland; he was 21 years of age, 5 feet 5 1/4 inches
high, Black complexion, Black eyes, Black hair, and by occupation, when enrolled,
a Laborer; he died in Post Hospital, at
City Point on the 17 day of Mar 1864, by
reason of Brain stroke

INVENTORY.					
ARTICLES.	No.	ARTICLES.	No.	ARTICLES.	No.
Hats.....		Pairs trousers.....		Knapsacks.....	1
Caps.....	1	Pairs flannel drawers.....		<u>Pocket Book</u>	1
Forage caps.....		Pairs cotton drawers.....			
Great coats.....		Flannel shirts.....	1		
Uniform coats.....		Cotton shirts.....			
<u>Uniform jackets</u>	1	Pairs boots.....			
Flannel sack coats.....		Pairs shoes.....	2		
Blouses.....		Pairs socks.....	1		
Stable frocks.....		Blankets.....		MONEY.	
Fatigue overalls.....		Haversacks.....	1	Specie.....	\$
				Notes.....	\$ 5

I CERTIFY, ON HONOR, that the above inventory comprises all the effects of John W. Blake, deceased, and that the effects are in the hands of Capt John J. Eberhardt at Spring Hill 7th to be disposed of by a Council of Administration.

(DUPLICATES.)

STATION: Spring Hill 7th
DATE: Mar 18th 1864

Capt John J. Eberhardt
4th U.S.C.T.
Commanding the Company.

[OFFICE ENDORSEMENT.]

War Department,

ADJUTANT GENERAL'S OFFICE,

January 14, 1878.

The death of John W. Blake
Private, Co. "D", 4th Reg't U.S.

Colored Troops, is reported as follows:

- Of Company Muster Roll. For May & June, 1864, May 15, 1864
- Company Muster-out Roll. May 23, 1863
- Company Descriptive Book. 1863
- Company Morning Reports. 1863
- Soldier's Final Statement. May 17, 1864
- Soldier's Record of Death and Interment. 1866
- Soldier's Inventory of Effects. May 17, 1864
- Soldier's Certificate of Disability for Discharge. 1866
- Soldier's Individual Muster-out Roll. 1866
- Regimental Return. For May, 1864, May 15, 1864
- Regimental Quarterly Returns. 1866
- Regimental Descriptive Book. 1866
- By Surgeon General. November, 1864, is held to be the correct date, and the Company Muster Roll will be amended accordingly.

John Puch

Assistant Adjutant General.

CPB 12/482

Noted

Present - An claim duty or longer - March 9, April 1864 - See letters to...

FINAL STATEMENT

OF

John W. Blake
4th Reg't of U. S. C. T.

VOLUNTEERS.

Sud May 17 1864

NOTE 1.—Two of these certificates (or duplicates) are to be given to each Volunteer Soldier or drafted man who may be discharged previously to the discharge of his company, that he may at once receive from the Paymaster the pay, &c., due him, and the captain or other COMMISSIONED officer commanding the company will certify to the act of the delivery of the duplicate certificates; on these certificates the Soldier is "entitled to" his discharge, and should also present his discharge to the Paymaster to have the payment endorsed on it. The discharge is to be given back to the Soldier by the Paymaster; the latter only retaining as his voucher the duplicate certificates.

NOTE 2.—If the Soldier is entitled to pay for the use of his horse, the Company Commander will certify to that fact on the back of both these final statements, and also to the time he has pay due for having been so mounted on his own horse.

NOTE 3.—When a Soldier is furnished with final statements, his descriptive list, if he has one, should be taken up by the officer who gives the Soldier these statements, and endorsed with a statement to this effect by the officer. This endorsement should exhibit a full statement of the time for which the Soldier was allowed pay on his final statements, the clothing account, and all other charges against him or in his favor, so as to comprise a complete exhibit of his account. It will then be transmitted to the company commander of the Soldier, who will enter all the data necessary to a full understanding of the Soldier's account on the muster roll upon which the Soldier's discharge is reported. The descriptive list will then be destroyed. The object of this is, that the remaining portion of the Soldier's account may be settled upon the receipt of these muster rolls, and the Soldier receive any pay or allowances that may be due him at the time of his discharge, and which may not appear on his final statements from the fact that his descriptive list is incomplete. These accounts for back pay, &c., are settled by the 2d Auditor of the Treasury Department.

NOTE 4.—Charges for loss or injury to ordnance, horse equipments, and other miscellaneous charges, should appear under the heading of "Other Stoppages."

NOTE 5.—Bounty paid by State authorities, and not by the United States, will not be entered on this statement.

NOTE 6.—Amounts due the Sutler and Laundress must be entered on the muster roll on which the discharge, death, desertion, &c., is reported, as well as on the final statement, otherwise the amount cannot be collected from the United States.

NOTE 7.—This blank will be used for deceased volunteers and drafted men, as well as for others.

NOTE 8.—Where a Soldier dies in Hospital or on detached service, his descriptive list, if he has one, should be sent with his final statements, in duplicate, to the Adjutant General, Washington, D. C.

John W. Blake

I certify, on honor, that John W. Blake a private of
 Captain John J. Eckhardt's Company (A) of the 4th Regiment of U.S. Col. Troops
~~VOLUNTEERS~~, of the State of _____, born in Washington County, State
 of Maryland, aged 21 years; 5 feet 5 1/4 inches high; Black complexion,
Black eyes, Black hair, and by occupation a Laborer, having joined the company on
 its original organization at Baltimore Md, and enrolled in it at the muster into
 the service of the United States at Baltimore Md, on the 28th day
 of August, 1863, (or was mustered in service as a recruit, by Col. J. W.
Bisney, at Baltimore, on the 28th day of August,
 1863, or was drafted and mustered into the service of the United States from the _____
 Enrollment District of the State of _____, at _____,
 on the _____ day of _____, 186) to serve in the Regiment, for
 the term of Three Years: and having served HONESTLY and
 FAITHFULLY with his Company in the 4th U.S.C.T. to the present date, is now
 entitled to a **DISCHARGE** by reason of Discharge 17th 1864 see

The said John W. Blake was last paid by Paymaster
Major Holmes to include the 29th day of February, 1864, and has
 pay due him from that time to the present date; he is entitled to pay and subsistence for
TRAVELING to place of enrollment, and whatever other allowances are authorized to volunteer
 soldiers, drafted men, or militia, so discharged. He has received from the United States **CLOTHING**
 amounting to Fifty seven⁸¹/₁₀₀ dollars, since the 28 day of August,
 1863, when his clothing account was last settled. He has received from the United States
 _____¹⁰⁰ dollars advanced **BOUNTY**.

There is to be stopped from him, on account of the State of _____, or other
 authorities, for **CLOTHING**, &c., received on entering service, _____¹⁰⁰ dollars; and
 for other stoppages, viz: 1 Hat cost 49c 1 Cap cost 41c 1 Waist Belt 31c

_____ ²¹/₁₀₀ dollars.
 He has been furnished with **TRANSPORTATION** in kind from the place of his discharge to
 _____; and he has been **SUBSISTED** for **TRAVELING** to his
 place of enrollment, up to the _____, 186 .

He is indebted to _____, **SUTLER**, _____¹⁰⁰ dollars.
 He is indebted to _____, **LAUNDRESS**, _____¹⁰⁰ dollars.

Given in Duplicate, at Spring Hill Virginia, this 18th day
 of May, 1864.

Capt John J. Eckhardt
4th U.S.C.T.
 Commanding Company.

113

Blake Joshua

Co a., 4 U.S. Col'd Inf.

Private Private

CARD NUMBERS.

1	5551304	26
2	5551391	27
3	5551494	28
4	5551592	29
5	5551691	30
6	5551849	31
7	5552851	32
8	9061628	33
9		34
10		35
11		36
12		37
13		38
14		39
15		40
16		41
17		42
18		43
19		44
20		45
21		46
22		47
23		48
24		49
25		50

Book Mark:

See also

73 | 4 | U.S.C.T.

Joshua Blake
....., Co. *"A"*, 4 Reg't U. S. Col'd Inf.

Appears on
Company Descriptive Book
of the organization named above.

DESCRIPTION.

Age *21* years ; height.....feet.....inches.

Complexion

Eyes..... ; hair.....

Where born

Occupation

ENLISTMENT.

When *July 15*....., 186*3*.

Where *Baltimore*.....

By whom *Ed. W. Birney* ; term *3* y'rs.

Remarks: *Transferred to naval
service, April 26/64
Point Lookout, Md.*

(383g)

Ward

Copyist.

B

4

U.S.C.T.

Joshua Blake
Private, Co. A, 4 Reg't U. S. Col'd Infantry.

Appears on

Company Muster Roll

for July 15th to Aug 31, 1863

Joined for duty and enrolled:

When July 15, 1863*

Where Baltimore Md *

Period 3 years.*

Present or absent Not stated

Stoppage, \$ 100 for

Due Gov't \$ 100 for

Remarks: Premium due \$2,

* See enrollment on card from muster-in roll.

Book mark:

(358c)

Laub

Copyist.

B

4

U.S.C.T.

Joshua Blake
Priv, Co. A, 4 Reg't U. S. Col'd Infantry.

Appears on

Company Muster Roll

for *Sept & Oct*, 186 *3*

Joined for duty and enrolled:

When *July 10¹*, 186 *3*.*

Where *Baltimore Md*.*

Period *3* years.*

Present or absent *Present*

Stoppage, \$ *100* for

Due Gov't \$ *100* for

Remarks: *Under arrest*

* See enrollment on card from muster-in roll.

Book mark:

Lamb

B | 4 | U.S.C.T.

Joshua Blake
Priv, Co. A, 4 Reg't U. S. Col'd Infantry.

Appears on

Company Muster Roll

for *Nov & Dec*, 1863

Joined for duty and enrolled:

When *July 15*, 1863.*

Where *Baltimore Md**

Period *3* years.*

Present or absent *Absent*

Stoppage, \$ *100* for

Due Gov't \$ *100* for

Remarks: *Absent at York town
 was in confinement un-
 dergoing sentence.
 Stop pay on Haversack 16¢
 one canteen (44) one gun
 sling (16)*

* See enrollment on card from muster-in roll.

Book mark:

Lamb
 (358c) Copyist.

B | 4 | U.S.C.T.

Joshua Blake
Priv, Co. A, 4 Reg't U. S. Col'd Infantry.

Appears on

Company Muster Roll

for *Jany & Feby*, 1864.

Joined for duty and enrolled:

When *July 10th*, 1863.*

Where *Baltimore Md*

Period *3* years.*

Present or absent *Present*

Stoppage, \$ *100* for

Due Gov't \$ *100* for

Remarks:

* See enrollment on card from muster-in roll.

Book mark:

Lamb

B

4

U.S.C.T.

Joshua Blake
Priv., Co. A, 4 Reg't U. S. Col'd Infantry.

Appears on

Company Muster Roll

for *Mch. & Apr.*, 186*4*!

Joined for duty and enrolled:

When *July 15*, 186*3*.*

Where *Baltimore, Md.* *

Period *3* years.*

Present or absent.....

Stoppage, \$ *100* for.....

Due Gov't \$ *100* for.....

Remarks: *Transferred to naval service by enlistment per Gen. order No. 91. War Dept. Mch. 14. 1864. A. G. O. April 23. 1864.*

* See enrollment on card from muster-in roll.

Book mark: *2d and Nov. 28. '65-*

R. E. Wilson

(358c)

Copyist.

B

4

U.S.C.T.

Joshua Blake

Pr, Co. *A*, 4 Reg't U. S. Col'd Infantry.

Appears on **Co. Muster-out Roll**, dated

Washington, D.C., May 4, 1864.

Muster-out to date _____, 186 .

Last paid to _____, 186 .

Clothing account:

Last settled _____, 186 ; drawn since \$ _____ 100

Due soldier \$ _____ 100; due U. S. \$ _____ 100

Am't for cloth'g in kind or money adv'd \$ _____ 100

Due U. S. for arms, equipments, &c., \$ _____ 100

Bounty paid \$ _____ 100; due \$ _____ 100

Remarks: *Transferred to Army*
Apr. 23. 64 per G.O.
Mar Sept 1864

Book mark: _____

Hanning
Copyist.

(361)

B | 4 | U.S.C.T.

Joshua Blake
Co. A, 4 Reg't U. S. Col'd Infantry.

Age *21* years.

Appears on

Company Muster-in Roll

of the organization named above. Roll dated

Baltimore Md, July 15, 1863.

Muster-in to date *July 15*, 1863.

Joined for duty and enrolled:

When *July 15*, 1863.*

Where *Baltimore* *

Period *3* years.*

Remarks:

* ~~4~~ Muster-in roll shows enrollment and muster-in of this company as of same date and place. See enrollment on subsequent card or cards.

Book mark:

Laub

Blake Joshua

P., Co. A, 4 Reg't U.S. 6 I

Enclosures.

Bed Cards	Final Statements
Burial Records	Furloughs or L. of A
Certs. of Dis. for Discharge	Med. Certificates
C. M. Charges	Med. Des. Lists
Descriptive Lists	Orders
Discharge Certificates	Pris. of War Record
Enlistment Papers	Resignations

Other papers relating to—

Admission to Hosp'l	Furlough or L. of A
Casualty Sheet	Med. Examination
Confinement	Misc. Information
Contracts	Pay or Clothing
Death or Effects	Personal Reports
Desertion	Rank
Discharge from Hosp'l	Transfer to Hosp'l
Discharge from Service	Transfer to V. R. C.
Duty	Transportation

Joshua Blake
 Privt. Co. A. 4th C. I.

W. of A. Co. reports
 find in Blake's case
 charge 1 W. of O. Charge 2
 Conduct prejudicial &c.
 Found guilty. To be confined
 at Yorktown Va. for 60 days
 &c. L. O. by Ad. Gen. Dept. Va.
 M. Co. Nov 24 1863.

and chain weighing twenty pounds. attached
to one of his legs. the whole of the time.

“ “ “ “ “ “
Approved and confirmed.

“ “ “ “ “ “
By command of Maj. Genl. B. F. Butler.

June 20th 1863

Adjutant General's Office,

COLORED TROOPS BRANCH,

Mr Ellersbrook

June 13, 1876

Vol. C. T., 187

Wanted in the case of Joshua Blake Pvt, Co. "A",
4 Reg't U.S. Troops. cause of arrest and
Sentence.

Muste Roll for Sept. & Oct. 1863 reports him "Under
arrest", Nov & Dec. 1863 "Absent at Yorktown Va
in confinement, undergoing sentence."

Respectfully,

L. A. Woodward,

Chief Clerk.

Per J. H. Heston

Adjutant General's Office,

Trans by of bill on Chgs 1st & 2nd Chgs & Conduct on some guilty
to be confined at Ft Yorktown Va for 60 days as per ltr of 1876
of the Adjutant

Vol. C. T., 187

Reply in case of Joshua Blake
4 Reg't U. S. Troops

Company and regtl records furnish no
further information. Nor reports of
and regtl. prior to 1865 not on file.

Ord 2nd Dept Va J. H. C. Fort Monroe Va November 24 1863
G. O. No 37. 14. Pvt. Joshua Blake Co. A. 4 U.S.C.T.

Charge 1st Disobedience of orders. " " "
Charge 2nd Conduct prejudicial to good order and
military discipline. " " "

Findings Guilty. Sentence. " " " to be
confined at Fort Yorktown Va at hard labor for
the term of sixty days, with an iron ball (over)

114
Shaker Lewis

CoF., 4 U.S. Col'd Inf.

Private

Private

CARD NUMBERS.

1	5559371	26
2	5559471	27
3	5559573	28
4	5559749	29
5	5560954	30
6	9062311	31
7		32
8		33
9		34
10		35
11		36
12		37
13		38
14		39
15		40
16		41
17		42
18		43
19		44
20		45
21		46
22		47
23		48
24		49
25		50

Book Mark:

See also

B | 4 | U.S.C.T.

Lewis Blake

, Co. F, 4 Reg't U. S. Col'd Inf.

Appears on

Company Descriptive Book

of the organization named above.

DESCRIPTION.

Age 18 years ; height 5 feet 6 inches.

Complexion Black

Eyes Black ; hair Black

Where born Westminster Co. Md

Occupation Farmer

ENLISTMENT.

When , 186 .

Where

By whom ; term y'rs.

Remarks: Died Dec 16 1863 at Yorktown Va.
of Pertussis (Whooping Cough)

W H Merrill

B. | 4 | U.S.C.T.

Lewis Blake

Priv, Co. F, 4 Reg't U. S. Col'd Infantry.

Appears on

Company Muster Roll

for *Sept. & Oct.*, 1863.

Joined for duty and enrolled:

When *August 4th*, 1863.*

Where *Baltimore Md.**

Period *3* years.*

Present or absent *Present*

Stoppage, \$ *100* for

Due Gov't \$ *100* for

Remarks: *Present, sick*

* See enrollment on card from muster-in roll.

Book mark:

Valentine

B.

4

U.S.C.T.

Lewis Blake

Priv., Co. F, 4 Reg't U. S. Col'd Infantry.

Appears on

Company Muster Roll

for Aug 4 to Aug 31, 1863.

Joined for duty and enrolled:

When Aug 4th, 1863.*

Where Baltimore Md.*

Period 3 years.*

Present or absent Present

Stoppage, \$ 100 for

Due Gov't \$ 100 for

Remarks:

No dollars premium due.

* See enrollment on card from muster-in roll.

Book mark:

Valentine

A. | 4 | U.S.C.T.

Lewis Blake

Priv, Co. F, 4 Reg't U. S. Col'd Infantry.

Appears on

Company Muster Roll

for Nov. & Dec., 1863.

Joined for duty and enrolled:

When August 4, 1863.*

Where Baltimore Md *

Period 3 years.*

Present or absent

Stoppage, \$ 100 for

Due Gov't \$ 100 for

Remarks:

Died Dec. 16, 1863 at
Post Hospital Yorktown
Va.

* See enrollment on card from muster-in roll.

Book mark:

Valentine

B | 4 | U.S.C.T.

Lewis Blake

Pi, Co., 4 Reg't U. S. Col'd Infantry.

Appears on Co. Muster-out Roll, dated Washington Dc, May 4, 1866.

Muster-out to date, 186 .

Last paid to, 186 .

Clothing account:

Last settled, 186 ; drawn since \$ 100

Due soldier \$ 100; due U. S. \$ 100

Am't for cloth'g in kind or money adv'd \$ 100

Due U. S. for arms, equipments, &c., \$ 100

Bounty paid \$ 100; due \$ 100

Remarks: Died Dec 16 1863 of disease

Book mark: V 225 P 235, 76

Sumner

(361)

Copyist.

B

4

U.S.C.T.

Lewis Blake

Pvt, Co. F, 4 Reg't U. S. Col'd Infantry.

Age 18 years.

Appears on

Company Muster-in Roll

of the organization named above. Roll dated

Baltimore Md, Aug 4, 1863.

Muster-in to date Aug 4, 1863.

Joined for duty and enrolled:

When Aug 4, 1863.*

Where Baltimore Md.*

Period 3 years.*

Remarks:

* Muster-in roll shows enrollment and muster-in of this company as of same date and place. See enrollment on subsequent card or cards.

Book mark:

Valentine

Blake, Lewis

P, Co. F., 4 U.S.C. Inf.

3 Enclosures.

Bed Cards	Descriptive Lists
Burial Records	Final Statements /
Certs. of Dis. for Discharge	Furloughs
C. M. Charges	Med. Des. Lists
Med. Certificates	Orders

Other papers relating to—

Admission to Hosp'l	Furlough
Casualty Sheet (Officer's)	Med. Examination
Confinement	Misc. Information /
Contracts	Pay or Clothing
Death or Effects /	Personal Reports
Desertions	Rank
Discharge from Hosp'l	Transfer to Hosp'l
Discharge from Service	Transfer to V. R. C.
Duty	Transportation

MICROFILM PUBLICATION M 1846

COMPILED MILITARY SERVICE RECORDS
OF VOLUNTEER UNION SOLDIERS WHO SERVED WITH
THE UNITED STATES COLORED TROOPS (USCT)
4TH REGIMENT OF INFANTRY

PERSONAL PAPERS' TARGET SHEET

PLEASE NOTE THE CHECKED INFORMATION ABOUT THE PERSONAL PAPERS IN
THIS FILE:

- NO PERSONAL PAPERS WERE FOUND IN THIS FILE WHEN THE
RECORDS WERE ARRANGED FOR MICROFILMING.
- 10 PERSONAL PAPER(S) FOUND IN THIS FILE WHEN THE RECORDS
WERE ARRANGED FOR MICROFILMING.

689.

A.G.O. Dec 10, 1864

I certify that the name Lewis Blake
is borne on the Muster in Roll of Company
of 4th Regt U. S. C. I. on file in this Office
It is stated on said Roll that he was
enrolled at Baltimore Md.

W.S.

E. W. Faggard
A. S. General

Head Quarters 4th U. S. Col. Troops
Sept. 16. 1863

I hereby certify that Lewis Blake, 18 years of age, height 5 ft. 6 inches, complexion, black, eyes, black, hair, black, born at Westminster, Md, was mustered into the service of the U. States by me on the 4th day of August 1863, and is a private in Co. "F", 4th Regt U. S. Colored Troops

William Birney
Col. 2nd Regt. U. S. Col. Troops
& Mustering Officer

Dec 29/64
Examined & found correct
Th. H.

J. No. 30. O. C. T. 1864.

No. 684 No. 3.

APPLICATION OF

Elizabeth Ovington

OF

Wilmington Carriage Co

For Compensation for Service of Slave,

Lewis Blake

Enlisted in 70th Regiment

U. S. Colored Troops Co. F.

Received, March 1st 1864.

COMPENSATION AWARDED,

November 23rd 1864.

Three Hundred Dollars.

Thos. Simmons
President Board of Claims

By J. G. H.
Wm. J. Reifensider
Wilmington

Dec. 1st. G. C. December 4. 1864.

Received March 30/67

STATE OF MARYLAND,

Carroll County, to wit:

On this *Sixth* day of *February* in the year 1864,
 before me, the subscriber, a Justice of the Peace of the State and County aforesaid, personally appeared *Elizabeth Owings*, and took, signed, and acknowledged the oaths preceding; and further made oath, in due form of law, that all the statements made in this application are, to the best of *her* knowledge and belief, strictly true. Also personally appeared before me *Joshua Smith* and *George W. Cook*, loyal citizens of the United States, residents of *Westminster Carroll Co. Md.*, well acquainted with the said *Elizabeth Owings*, and in no manner interested in the prosecution of this claim, and made oath, in due form of law, that the said *Elizabeth Owings* is the owner of the slave *Lewis Blake*, as a fact of public notoriety; that they believe all the statements herein made by *her*, in reference thereto, are correct, and that *she* is unquestionably loyal to the Government of the United States. Witness their signature



Joshua Smith
George W. Cook

Wm J. Mitten

Justice of the Peace.

STATE OF MARYLAND,

Carroll County, to wit:

I, *W. A. McPhillip*, Clerk of the Circuit Court for *Carroll* County, do hereby certify that *Wm J. Mitten*, before whom the foregoing affidavits were made, was, at the time of signing the same, a Justice of the Peace for the County and State aforesaid, duly commissioned and sworn; and that his signature thereto is genuine, and that full faith and credit should be given to his official acts.

Witness my hand and the seal of said Court, this *twenty fifth* day of *February*, A. D. 1864.



Wm A. McPhillip

CLERK.

EVIDENCE OF TITLE.

I, *Elizabeth Owings*, of *Carroll*
 County, Md., do solemnly swear that *Lewis Blake*
 who has been enlisted in the *fourth* Regiment, U. S. Colored Troops,
 Co. *7*; is my slave for *life*; (his term of service expiring on
 the *_____* day of *_____* 186*2*) and that
 I became possessed of him by *law (his mother being a slave & owned by me)*, in the month
 of *June*, eighteen hundred and *forty five*. And I
 do further swear that I have not purchased said slave from any person or persons disloyal
 to the Government of the United States, with the object of obtaining compensation for
 the same; and furthermore, that I have no agency for obtaining compensation for any per-
 son or persons but such as, to my knowledge, are loyal citizens of the United States.

Elizabeth Owings
 February 6th 1864.

Elizabeth Ovingo
Deed of
Manumission
to
Lewis Blake
Copy

J. E. Smith

B. C.

State of Maryland Carroll County Sec.
I hereby certify that the above is a true and correct copy of a deed of
Manumission as recorded in Liber. W.A. Mch. N^o 6. folio 328c one of
the Chattel Record Books of Carroll County.

In Testimony whereof I hereunto set my hand and
affix the seal of the Circuit Court for Carroll
County this 25th day of May A. D. 1864.

Wm. A. McNeillip
Clerk of the Circuit Court for Carroll County



E.

DEED OF MANUMISSION AND RELEASE OF SERVICE.

Whereas my slave Lewis Blake has enlisted in the service of the United States: now, in consideration thereof, I, Elizabeth Owings, of Carroll county, State of Maryland, do hereby, in consideration of said enlistment, manumit, set free, and release the above-named Lewis Blake from all service due me; his freedom to commence from the 4th day of August 1863, the date of his enlistment as aforesaid in the 4th Regiment of Colored Troops, in the service of the United States.

Witness my hand and seal, this 16th day of May, 1864.

Elizabeth Owings



Witness:

Joshua Smith
Charles F. Smith
Jos. C. Smith

Carroll County,

State of Maryland, 1864.

Before me appeared this day Elizabeth Owings and acknowledged the above Deed of Manumission and Release of Service to be his free act and deed.

Wm. J. Witten J. P.

Recd. to be recorded May 25th 1864 &
 Same day recorded and examined per Wm. A. McKellip CLK

Annapolis May 27, 64

Dear Sir,

I enclose you
a certified copy of deed of
Manumission from Elizabeth
Owings. You her slave Lewis
Blake. I certify to the loyalty
of the Applicant. You will
please notify me when the
certificate is ready or oblige

Yours Respectfully

Geo. E. Smith

3.

No. .

ABSTRACT OF DISBURSEMENTS.

....., 186 .

Elizabeth Cwirings

Dollars *300* ^{*00*}/_{*100*}.

Paid, 186 .

The United States,

To Elizabeth Owings Dr.

		DOLLARS.	CENTS.
1864	For amount awarded him by the Board of Claims, in consideration		
December 3 rd	of the enlistment of Lewis Blake		
	in the 4 th Regt. U.S. Col. Troops	300	00
Total. \$		300	00

I CERTIFY that the above account is correct and just; that the name of Lewis Blake is borne on the muster-in rolls of the 4th Regt. U.S. Col. Troops; and that the above amount was awarded by the Board of which Hon. Emmons Esqr. is President, said award being in accordance with section 24 of the act entitled "An act to amend an act entitled 'An act for enrolling and calling out the national forces, and for other purposes,'" approved Feb. 24, 1864.

Assistant Adjutant General.

RECEIVED _____, 186 , of Cap. A. F. Rickwell A.A.G. dollars and _____ cents, in full of the above account.

Elizabeth Owings & Co.

(SIGNED DUPLICATES.)

Elizth Owings
3.

No. .

ABSTRACT OF DISBURSEMENTS.

....., 186 .

Elizabeth Owings

Dollars *300* ^{*00*}/_{*100*}

Paid, 186 .

The United States,

To Elizabeth Owings Dr.

1864

December 30

For amount awarded him by the Board of Claims, in consideration

of the enlistment of Lewis Blake

in the 4th Reg't U. S. Col'd Troops

DOLLARS.	CENTS.
300	00
Total \$	
300	00

I CERTIFY that the above account is correct and just; that the name of Lewis Blake is borne on the muster-in rolls of the 4th Reg't U. S. Col'd Troops; and that the above amount was awarded by the Board of which Thos. Simmons Esq is President, said award being in accordance with section 24 of the act entitled "An act to amend an act entitled 'An act for enrolling and calling out the national forces, and for other purposes,'" approved Feb. 24, 1864.

Assistant Adjutant General.

RECEIVED

, 186 , of Capt. H. Rockwell, A. A. G., Col
dollars and cents, in full of the above account.

Elizabeth Owings E. O.

(SIGNED DUPLICATES.)

No. 689

CLAIMANT'S CERTIFICATE.

I, Elizabeth Oving a loyal citizen, and a resident
of Westminster District, County of Carroll, State of
Maryland, hereby claim compensation, under the provisions of
General Orders, No. 329, 1863, for my slave Lewis Blake,
enlisted August 4th 1863, at Baltimore
by Col. William Biney in the Fourth
Regiment U. S. Colored Troops, Co. 7; certificate of which enlistment, and a
descriptive list, as required, accompany this application.

In proof of my loyalty to the Constitution and Government of the United States, I
present the accompanying oath, which I have taken, signed, and acknowledged, to be filed
with this application, in accordance with requirement of said General Orders.

Elizabeth Oving

February 6th 1864.

B.

OATH OF ALLEGIANCE.

I, Elizabeth Owings, do solemnly swear that I have never joined, or been concerned in, any insurrection or rebellion; that I have never borne arms against the United States; that I have never given any aid, countenance, counsel, or encouragement to any person or persons engaged, or whom I had reason to believe were about to engage, in insurrection, rebellion, or armed hostility against the United States; that I have neither sought, nor accepted, nor attempted to exercise the functions of any office, civil or military, nor to perform any service whatever, under any authority or pretended authority in hostility to the United States; that I have not yielded a voluntary support to any insurrection, rebellion, or pretended government, authority, power, or constitution within the United States hostile thereto. And I do further swear that, to the best of my knowledge and ability, I have supported and defended, and will continue to support and defend, the United States against all enemies, foreign and domestic; and that I have supported, defended, and obeyed, and will continue to support, defend, and obey, the Constitution and laws of the United States; that I will bear true faith and allegiance to the same; and that I take this oath freely, without any mental reservation or purpose of evasion: So help me God.

Elizabeth Owings

Sworn to and subscribed before me, at Wilmington
 this 6th day of February 1864.

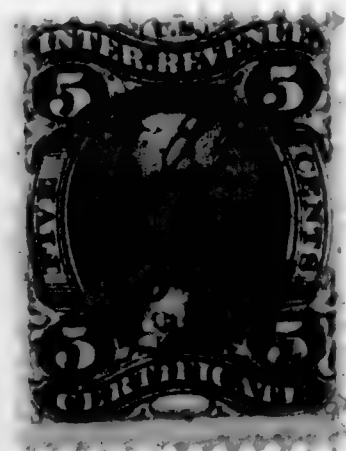

Wm J. Minton
 Justice of the Peace

C.

I present herewith evidence of my title to the slave Lewis Blake enlisted as aforesaid, and in consideration of the sum of _____ by me received, I hereby covenant and agree with the United States, that I, my heirs, executors, or assigns, shall never hereafter make or enforce any claim to the labor or services of said slave; and pledge myself to execute a valid Deed of Manumission and Release of all my claims to service forever of said Lewis Blake to be filed with the Board of Claims now in session at Baltimore

Elizabeth Owings

February, 1864.

Recd from Div. of Discontinued
 Commands, dated June 8/71,
 INVENTORY OF THE EFFECTS

1903

OF

Private Lewis Blake

Late of Company F

4th Reg't of U.S. Col. Troops

Volunteers, who died at Fort Klouanpa

on the 16th day of December 1863



Inventory of the effects of Lewis Blake late
a Private of Captain J. H. Dillenback's Company F of
the Fourth Regiment of U. S. Colored Troop Volunteers, who was enrolled as
a Soldier at Baltimore in the State of Maryland on
the fourth day of August 1863, and mustered into the service of the United
States as a Soldier on the 4th day of August 1863, at Baltimore
in Company F, 4th Regiment of U. S. Col. Troop Volunteers, to serve Three
years or during the war; he was born in Westminster Co. in the State
of Maryland; he was 18 years of age, 5 feet 6 inches
high, Black complexion, Black eyes, Black hair, and by occupation, when enrolled,
a Farmer; he died in Regimental Hospital, at
Yorktown Va on the 16th day of December 1863, by
reason of Pertussis (Whooping Cough)

INVENTORY.					
ARTICLES.	No.	ARTICLES.	No.	ARTICLES.	No.
Hats		Pairs trousers		Knapsacks	1
Caps	1	Pairs flannel drawers			
Forage caps		Pairs cotton drawers	1		
Great coats	1	Flannel shirts	1		
Uniform coats		Cotton shirts			
Uniform jackets		Pairs boots			
Flannel sack coats		Pairs shoes			
Blouses	1	Pairs socks	1		
Stable frocks		Blankets	1		
Fatigue overalls		Haversacks	1		
				MONEY.	
				Specie	\$ 0
				Notes	\$ 0

I CERTIFY, ON HONOR, that the above inventory comprises all the effects of Private
Lewis Blake, deceased, and that the effects are in the hands
of Regimental Surgeon at Yorktown Va.
to be disposed of by a Council of Administration.

(DUPLICATES.)

STATION: Yorktown

DATE: Dec. 28 1863

J. H. Dillenback
Captain
Commanding the Company.

✓

3

FINAL STATEMENT

OF

Cornel - Lewis Blake

4th Reg't of N. S. C. Troop

VOLUNTEERS.

Died Dec 16-63

NOTE 1.—Two of these certificates (or duplicates) are to be given to each volunteer soldier who may be discharged previously to the discharge of his company, that he may at once receive from the Paymaster the pay, &c., due him, and the captain or other officer commanding the company will certify to the act of the delivery of the duplicate certificates; on these certificates the Soldier is "entitled to" his discharge, and should also present his discharge to the Paymaster to have the payment endorsed on it. The discharge is to be given back to the Soldier by the Paymaster; the latter only retaining as his voucher the duplicate certificates.

NOTE 2.—If the Soldier is entitled to pay for the use of his horse, the Company Commander will certify to that fact, and also to the time he has pay due for having been so mounted on his own horse.

NOTE 3.—Amounts due the Sutler and Laundress must be entered on the Muster Roll on which the death, desertion, &c., is reported, as well as on the final statement, otherwise the amount cannot be collected from the United States.

NOTE 4.—This blank will be used for deceased volunteers as well as others.

ADJUTANT GENERAL'S OFFICE,

Floy 11th 1864

Duplicate, with Inventory, sent 2d

Auditor.

Ent on O. R. of Coy

I certify, on honor, that Private Lewis Blake a Member of
 Captain John Dilleubuck's Company (F) of the Fourth Regiment of U.S. Col. Troops
VOLUNTEERS, of the State of Maryland, born in Westminster Co. State
 of Maryland, aged 18 years; 5 feet 6 inches high; Black complexion,
Black eyes, Black hair, and by occupation a Farmer, having joined the company on
 its original organization at Baltimore, and enrolled in it at the muster into
 the service of the United States at Baltimore, on the Fourth day
 of August, 1863, (or was mustered in service as a recruit, by Col. William
Pinney, at Baltimore, on the Fourth day of August,
 1863, to serve in the Regiment,) for the term of Three Years;
 and having served **HONESTLY** and **FAITHFULLY** with his Company in 4th Reg. U.S. Col.
 to the present date, is now entitled to a **DISCHARGE** by reason of Death.

The said Private Lewis Blake was last paid by Paymaster
Major King to include the 30th day of November, 1863, and has
 pay due him from that time to the present date; he is entitled to pay and subsistence for
TRAVELING to place of enrollment and whatever other allowances are authorized to volunteer
 soldiers, or militia, so discharged. He has received Thirty Seven $\frac{50}{100}$ dollars,
 advanced by the United States on account of **CLOTHING**.

There is to be stopped from him, on account of the State of _____, or other
 authorities for **CLOTHING, &c.**, received on entering service, _____ $\frac{100}{100}$ dollars; also,
 for expenses of **SUBSISTENCE** for **TRAVELING** from place of enrollment to the place of rendezvous,
 amounting to _____ $\frac{100}{100}$ dollars: and on account of the United States for **EXTRA**
CLOTHING received in kind from _____ and for other
 stoppages, viz: _____

_____ amounting to _____ $\frac{100}{100}$ dollars;
 and he has been **SUBSISTED** for **TRAVELING** to his place of enrollment, up to the _____
 _____, 1863.

He is indebted to _____, **SUTLER**, _____ $\frac{100}{100}$ dollars.
 He is indebted to _____, **LAUNDRESS**, _____ $\frac{100}{100}$ dollars.

Given in Duplicate, at Johns River, this 28th day of Dec., 1863.

John Dilleubuck
Captain
 Commanding Company.

F.

CERTIFICATE OF AWARD OF THE BOARD OF CLAIMS.

Office of the Board of Claims
For Slaves Enlisted in the Service of the United States,

Baltimore Md.

December 3rd 1864

No 398
\$ 300

We hereby certify, that *Elizabeth Owings*, of *Carroll* county, State of *Maryland*, having proved, under oath, *her* loyalty to the Constitution and Government of the United States, and established *her* title as to the ownership of *Lewis Blake*, a slave enlisted at *Baltimore Md.*, on the *4th* day of *August*, *1863*, by *Col. Wm. Birney*, in the service of the United States, in the *4th* Regiment of Colored Troops, *Co. F.*, and having filed a valid Deed of Manumission and Release of Service of said slave, is entitled to the sum of *Three Hundred* dollars, which has been awarded to *her* by this Board as a remuneration for all claim to the future labor or service of said slave, under the provision of General Orders, War Department, No. 329, 1863.

Thos. Ammons, President of the Board.

S. C. Strangher, Member of the Board.

Wm. T. Jones, Member of the Board.

To *Col. C. W. Foster*,

Chief of the Bureau for the
Organization of Colored Troops, Washington, D. C.

115

Blake, William

Co/E, 4 U.S. Col'd Inf.

Private

Private

CARD NUMBERS.

1	5565999	26
2	5566100	27
3	5566200	28
4	5566297	29
5	5566386	30
6	5566528	31
7	5567421	32
8	9662928	33
9	9662800	34
10		35
11		36
12		37
13		38
14		39
15		40
16		41
17		42
18		43
19		44
20		45
21		46
22		47
23		48
24		49
25		50

Book Mark:

See also

B | 4 | U.S.C.T.

William Blake

Co. K, 4 Reg't U. S. Col'd Inf.

Appears on

Company Descriptive Book

of the organization named above.

DESCRIPTION.

Age 18 years; height 5 feet 5 1/4 inches.

Complexion Blk

Eyes Blk; hair Curly

Where born Williamsport Md

Occupation Farmer

ENLISTMENT.

When Aug 28, 1863.

Where Balto, Md

By whom Col Burney; term 3 y'rs.

Remarks: Killed in action near Petersburg Va June 15/64. Personal statements sent Aug 13/64

Delah

(888g)

Copyist.

B | 4 | U.S.C.T.

William Blake

, Co. K, 4 Reg't U. S. Col'd Inf.

Appears on

Company Descriptive Book

of the organization named above.

DESCRIPTION.

Age 18 years; height 5 feet 5 1/4 inches.

Complexion Blk

Eyes Blk; hair Curly

Where born Williamsport Md

Occupation Farmer

ENLISTMENT.

When Aug 28, 1863.

Where

By whom; term y'rs.

Remarks: Killed in action near Petersburg Va June 15/64. Final state ments sent Aug 15/64

Selah

S

4

U.S.C.T.

William Spoke

A, Co. K, 4 Reg't U. S. Col'd Infantry.

Age 15 years.

Appears on

Company Muster-in Roll

of the organization named above. Roll dated

Baltimore Md, Sep 1, 1863.

Muster-in to date

Sep 1, 1863.

Joined for duty and enrolled:

When Sep 1, 1863.*

Where Baltimore Md.*

Period 3 years.*

Remarks:

* Muster-in roll shows enrollment and muster-in of this company as of same date and place. See enrollment on subsequent card or cards.

Book mark:

Jan. 1863

P | **4** | **U.S.C.T.**

William Blake

Pr....., Co. K, 4 Reg't U. S. Col'd Infantry.

Appears on

Company Muster Roll

for *Sept & Oct*....., 186 *3*

Joined for duty and enrolled:

When *Sept 1*....., 186 .*

Where *Baltimore*.....*

Period *3*..... years.*

Present or absent *Present*.....

Stoppage, \$..... *100* for.....

Due Gov't, \$..... *100* for.....

Remarks:

Book mark:

(358c)

Wm. H. ...

Copyist.

P | 4 | U.S.C.T.

William Blake

Pt., Co. K, 4 Reg't U. S. Col'd Infantry.

Appears on

Company Muster Roll

for *Nov & Dec*, 186³.

Joined for duty and enrolled :

When *Sept 1*, 186³.*

Where *Baltimore* *

Period *3* years.*

Present or absent *Present*

Stoppage, \$ *100* for

Due Gov't, \$ *100* for

Remarks :

* ~~See~~ See enrollment on card from muster-in roll.

Book mark :

210103

James L. ...

P | 4 | U.S.C.T.

William Baker

W, Co. K, 4 Reg't U. S. Col'd Infantry.

Appears on

Company Muster Roll

for *Jan'y & Feb'y*, 186*4*.

Joined for duty and enrolled :

When *Sept 1*, 186*3*.*

Where *Baltimore* *

Period *3* years.*

Present or absent *Present*

Stoppage, \$ *100* for

Due Gov't, \$ *100* for

Remarks: *Stopped for one
Haversack & 1 Canteen.*

* See enrollment on card from muster-in roll.

Book mark :

Vau H. ...

S | 4 | U.S.C.T.

William Blake.
74, Co. K, 4 Reg't U. S. Col'd Infantry.

Appears on

Company Muster Roll

for *Mch 1861*, 186 ^{*1*}.

Joined for duty and enrolled :

When *Sept 1*, 186 ^{*3*}.*

Where *Baltimore*.*

Period *3* years.*

Present or absent *Present*.

Stoppage, \$ *100* for

Due Gov't, \$ *100* for

Remarks: _____

* See enrollment on card from muster-in roll.

Book mark: _____

Vautour

B | 4 | U.S.C.T.

William Blake
Pr, Co. K, 4 Reg't U. S. Col'd Infantry.

Appears on

Company Muster Roll

for May and June, 1864.

Joined for duty and enrolled :

When Sept. 1, 1864 .*

Where Baltimore *

Period 3 years.*

Present or absent _____

Stoppage, \$ 100 for _____

Due Gov't, \$ 100 for _____

Remarks: Killed in action
near Petersburg Va. June
15th 1864.

Book mark: No. 84.205-Mch/15-1865

Bliss

(858c)

Copyist.

B | 4 | U.S.C.T.

William Blake

Priv., Co. K, 4 Reg't U. S. Col'd Infantry.

Appears on Co. Muster-out Roll, dated Washington D.C., May 4, 1866.

Muster-out to date _____, 1866 .

Last paid to _____, 1866 .

Clothing account:

Last settled _____, 1866 ; drawn since \$ _____ 100

Due soldier \$ _____ 100; due U. S. \$ _____ 100

Am't for cloth'g in kind or money adv'd \$ _____ 100

Due U. S. for arms, equipments, &c., \$ _____ 100

Bounty paid \$ _____ 100; due \$ _____ 100

Remarks: Killed in Action Sept. 29, 1864

Book mark: Sgt. 205 H13V.

Died June 15, 1864 EAS 313

(861)

J. M. Hance

Copyist.

Blake, William

P. K., Co. H., 4 Regt. U.S.C. Inf.

2 Enclosures.

Bed Cards	Descriptive Lists
Burial Records	Final Statements /
Certs. of Dis. for Discharge	Furloughs
C. M. Charges	Med. Des. Lists
Med. Certificates	Orders

Other papers relating to—

Admission to Hosp'l	Furlough
Casualty Sheet (Officer's)	Med. Examination
Confinement	Misc. Information
Contracts	Pay or Clothing
Death or Effects /	Personal Reports
Desertions	Rank
Discharge from Hosp'l	Transfer to Hosp'l
Discharge from Service	Transfer to V. R. C.
Duty	Transportation

1864

No 17

F. G. on file

INVENTORY OF THE EFFECTS

OF

Private William Blake

Late of Company K

4th Reg't of Meade Troops

Volunteers, who died near Petersburg Va

on the 15th day of June 1864.



Inventory of the effects of William Blake late
a private of Captain A. P. Haskell's Company K of
the 4th Regiment of U.S. Co. Troops Volunteers, who was enrolled as
a private at Baltimore in the State of Maryland on
the 1st day of September 1863, and mustered into the service of the United
States as a private on the 1st day of September 1863, at Baltimore Md
in Company K, 4th Regiment of U.S. Co. Troops Volunteers, to serve three
years or during the war; he was born in Williamsport in the State
of Maryland; he was 18 years of age, 5 feet 5 1/4 inches
high, Black complexion, Black eyes, Black hair, and by occupation, when enrolled,
a farmer; he died in action near
Petersburg Va on the 15th day of June 1864, by
reason of gun shot

INVENTORY.							
ARTICLES.	No.	ARTICLES.	No.	ARTICLES.	No.		
Hats.....	None	Pairs trousers.....	None	Knapsacks.....	None		
Caps.....		Pairs flannel drawers.....					
Forage caps.....		Pairs cotton drawers.....					
Great coats.....		Flannel shirts.....					
Uniform coats.....		Cotton shirts.....					
Uniform jackets.....		Pairs boots.....					
Flannel sack coats.....		Pairs shoes.....					
Blouses.....		Pairs socks.....		MONEY.			
Stable frocks.....		Blankets.....				Specie.....	\$
Fatigue overalls.....		Haversacks.....				Notes.....	\$

I CERTIFY, ON HONOR, that the above inventory comprises all the effects of private
William Blake, deceased, and that the effects are in the hands
of _____ at _____
_____ to be disposed of by a Council of Administration.

(DUPLICATES.)

A. P. Haskell Capt.
4th Regt. U.S. Co. Troops

STATION: San Bernardino Arsenal Va Commanding the Company.

DATE: Aug 1864

FINAL STATEMENT

OF

1st
1st Private William Blake
1st Reg't of West. Co.

VOLUNTEERS.

1st
Discharged June 15, 1864

NOTE 1.—Two of these certificates (or duplicates) are to be given to each Volunteer Soldier or drafted man who may be discharged previously to the discharge of his company, that he may at once receive from the Paymaster the pay, &c., due him, and the captain or other COMMISSIONED officer commanding the company will certify to the act of the delivery of the duplicate certificates; on these certificates the Soldier is "entitled to" his discharge, and should also present his discharge to the Paymaster to have the payment endorsed on it. The discharge is to be given back to the Soldier by the Paymaster; the latter only retaining as his voucher the duplicate certificates.

NOTE 2.—If the Soldier is entitled to pay for the use of his horse, the Company Commander will certify to that fact on the back of both these final statements, and also to the time he has pay due for having been so mounted on his own horse.

NOTE 3.—When a Soldier is furnished with final statements, his descriptive list, if he has one, should be taken up by the officer who gives the Soldier these statements, and endorsed with a statement to this effect by the officer. This endorsement should exhibit a full statement of the time for which the Soldier was allowed pay on his final statements, the clothing account, and all other charges against him or in his favor, so as to comprise a complete exhibit of his account. It will then be transmitted to the company commander of the Soldier, who will enter all the data necessary to a full understanding of the Soldier's account on the muster roll upon which the Soldier's discharge is reported. The descriptive list will then be destroyed. The object of this is, that the remaining portion of the Soldier's account may be settled upon the receipt of these muster rolls, and the Soldier receive any pay or allowances that may be due him at the time of his discharge, and which may not appear on his final statements from the fact that his descriptive list is incomplete. These accounts for back pay, &c., are settled by the 2d Auditor of the Treasury Department.

NOTE 4.—Charges for loss or injury to ordnance, horse equipments, and other miscellaneous charges, should appear under the heading of "Other Stoppages."

NOTE 5.—Bounty paid by State authorities, and not by the United States, will not be entered on this statement.

NOTE 6.—Amounts due the Sutler and Laundress must be entered on the muster roll on which the discharge, death, desertion, &c., is reported, as well as on the final statement, otherwise the amount cannot be collected from the United States.

NOTE 7.—This blank will be used for deceased volunteers and drafted men, as well as for others.

NOTE 8.—Where a Soldier dies in Hospital or on detached service, his descriptive list, if he has one, should be sent with his final statements, in duplicate, to the Adjutant General, Washington, D. C.

1st
1st Private William Blake
1st Reg't of West. Co.
1st
1st Private William Blake
1st Reg't of West. Co.

[OFFICE ENDORSEMENT.]

War Department,

ADJUTANT GENERAL'S OFFICE,

May 31st, 1871

The Death of William Blake,
Co. K, 4th Reg't U.S.
Colored Troops, is reported as follows:

- On Company Muster Roll, *1864*
- For *May 15th*, 1864, *June 15th*, 1864
- Company Muster-out Roll, *1864*
- September 29th*, 1864
- Company Descriptive Book, *1864*
- Company Morning Reports, *1864*
- Soldier's Final Statement, *1864*
- June 15th*, 1864
- Soldier's Record of Death and Interment, *1864*
- Soldier's Inventory of Effects, *1864*
- Soldier's Certificate of Disability for Discharge, *1864*
- Soldier's Individual Muster-out Roll, *1864*
- Regimental Return, *1864*
- For *June 15th*, 1864, *June 15th*, 1864
- Regimental Quarterly Returns, *1864*
- Regimental Descriptive Book, *1864*

By Surgeon General,
June 15th, 1864, is held to be
the correct date, and the Company Muster-out
Roll will be amended accordingly,

Thomas M. Smeant
Assistant Adjutant General.
1864

ADJUTANT GENERAL'S OFFICE.

Aug 17th 1864

Duplicates with Inventory sent 2d Auditor.



I certify, on honor, that William Blake a Private of
 Captain W. Haskell Company (K) of the 4th Regiment of West Island Troop
VOLUNTEERS, of the State of _____, born in Milliansport, State
 of Maryland, aged 18 years; 5 feet 5 1/4 inches high; Black complexion,
Black eyes, Black hair, and by occupation a Farmer, having joined the company on
 its original organization at Baltimore Md, and enrolled in it at the muster into
 the service of the United States at Baltimore, on the first day
 of September, 1863, (or was mustered in service as a recruit, by _____
 _____, at _____, on the _____ day of _____,
 1863, or was drafted and mustered into the service of the United States from the _____
 Enrollment District of the State of _____, at _____,
 on the _____ day of _____, 1863.) to serve in the Regiment, for
 the term of three years: and having served **HONESTLY** and
FAITHFULLY with his Company in Virginia to the present date, is now
 entitled to a **DISCHARGE** by reason of death being killed in action
near Petersburg Va June 13th 1864

The said Private William Blake was last paid by Paymaster
Wm Haskell to include the 24th day of February, 1864, and has
 pay due him from that time to the date of death present date; he is entitled to pay and subsistence for
TRAVELING to place of enrollment, and whatever other allowances are authorized to volunteer
 soldiers, drafted men, or militia, so discharged. He has received from the United States **CLOTHING**
 amounting to forty seven 69 dollars, since the _____ day of enlistment,
 1863, when his clothing account was last settled. He has received from the United States
 _____ 100 dollars advanced **BOUNTY**.

There is to be stopped from him, on account of the State of _____, or other
 authorities, for **CLOTHING**, &c., received on entering service, _____ 100 dollars; and
 for other stoppages, viz: _____

_____ 100 dollars.

He has been furnished with **TRANSPORTATION** in kind from the place of his discharge to
 _____; and he has been **SUBSISTED** for **TRAVELING** to his
 place of enrollment, up to the _____, 1864.

He is indebted to _____, **SUTLER**, _____ 100 dollars.

He is indebted to _____, **LAUNDRESS**, _____ 100 dollars.

Given in Duplicate, at Inchfield near Petersburg Va, this 5th day
 of August, 1864.

W. P. Haskell Capt.
4th Reg West Island Troop
 Commanding Company. 78

116

Bordley William F.

Co B, 4 U.S. Col'd Inf.

Private

Private

CARD NUMBERS.

1	26
2	27
3	28
4	29
5	30
6	31
7	32
8	33
9	34
10	35
11	36
12	37
13	38
14	39
15	40
16	41
17	42
18	43
19	44
20	45
21	46
22	47
23	48
24	49
25	50

Book Mark:

See also

Goemstein, Augustus J.

Coa - *F* 4 U.S. Col'd Inf.

Captain

Lieut. Colonel

CARD NUMBERS.

1	5551371	26	36.56-67-1863
2	5551572	27	
3	5552798	28	
4	5550242	29	
5	5551098	30	
6	5551110	31	
7	5551123	32	
8	5551136	33	
9	5551149	34	
10	5551162	35	
11	5551175	36	
12	5551188	37	
13	5551201	38	
14	5551213	39	
15	5551254	40	
16	5550749	41	
17	5550243	42	
18	5551226	43	
19	5551086	44	
20	5551239	45	
21	5551257	46	
22	5551283	47	
23	9428500	48	
24	9428511	49	
25	9428501	50	

Book Mark: 36.56-67-1863

See also

РР416612

Р.Р. 669857

Р.Р. 671776.

АХ 201(7-2-29) 013.

Рер 416612

Р.Р. 669857

Р.Р. 671776.

А № 201(7-2-29) 013.

B | 4" | U.S.C.T.

Aug J. Bornstein

Captain, Co....., *4*" Reg't U. S. Col'd Inf.

Appears on

Regimental Descriptive Book

(List of Commissioned Officers)

of the regiment named above.

Rank *captain*

Date of appointment *July 20*" 1863..

Remarks: *Reported for duty*

July 23. 63 assigned to the
command of Co A I.C., 4"

U.S.C. July 23. 63 promoted Major

4" U.S.C. Aug 28. 63

Spiller

B | 4" | U.S.C.T.

Augustus S. Bonstein

Major, Co., 4th Reg't U. S. Col'd Inf.

Appears on

Regimental Descriptive Book

(List of Commissioned Officers)

of the regiment named above.

Rank Major

Date of appointment Aug 28 1863.

Remarks: Promoted Major from
Captain 4th U.S. Col'd Inf.
from 4th U.S. Col'd Inf.
8. 63

[Signature]

B | 4 | U.S.C.T.

Aug. S. Borstein

Lieut. Col., *4th* Reg't U. S. Col'd Inf.

Appears on

Regimental Descriptive Book

(List of Commissioned Officers)

of the regiment named above.

Rank *Lieut. Col.*

Date of appointment *July 5th* 1865.

Remarks: *Promoted from Major
4th U.S.C. dismissed the service
of the 9th by sentence of a General
Court Martial G.O. 161 Dept
of Washington Dec 1, 1865*

Mills

B | *4* | U.S.C.T.

Augustus S. Boernstein
 Major, Co. *4*, Reg't U. S. Col'd Infantry.
 Age *32* years.

Appears on an

Individual Muster-in Roll

of the organization named above. Roll dated
Yorktown, Va. Nov. 24, 1863.
 Muster-in to date *Sep 2, 1863.*

Joined for duty and enrolled:

When *Sep 2*, 1863.

Where *Baltimore*

Period *3* years.

Remarks: *By authority dated*
War Dept's Sep 28/63.

Book mark :

(336)

Lacey

Copist.

B

4

U.S.C.T.

Augustus S. Boorenstein
 Capt., Co. A, 4 Reg't U. S. Col'd Infantry.

Appears on

Company Muster Roll

for July 15th to Aug 31, 1863.

Joined for duty and enrolled:

When....., 186 .*

Where.....*

Period..... years.*

Present or absent *Not stated*

Stoppage, \$..... 100 for.....

Due Gov't \$..... 100 for.....

Remarks: *Appointed by the President Captain in 4th Reg't U.S.C.T. July 20/63 Accepted July 20/63 reported for duty July 22nd 1862*

* See enrollment on card from muster-in roll.

Book mark: *H 56 - C. T. - 1863.*

Lamb

(358c)

Copyist.

B

4

U.S.C.T.

Aug. L. Boerstein
Lupt, Co. A, 4 Reg't U. S. Col'd Infantry.

Appears on

Company Muster Roll

for *Sept & Octo*, 1863.

Joined for duty and enrolled:

When *Aug 28*, 1863.*

Where _____ *

Period _____ years.*

Present or absent _____

Stoppage, \$ _____ 100 for _____

Due Gov't \$ _____ 100 for _____

Remarks: *Promoted to*
Major by appointment
of the President Aug 2^o / 63
accepted appointment
Sep 2 1863

* See enrollment on card from muster-in roll.

Book mark: _____

Lamb

B. | 4 U.S.C.T.

Augustus L. Boemstein

Rank Major, 4 Reg't U. S. Col'd Infantry.

Appears on

Field and Staff Muster Roll

for Nov & Dec., 1863.

Present or absent Present.

Stoppage, \$ 100 for

Due Gov't, \$ 100 for

Valuation of horse, \$ 100

Valuation of horse equipments, \$ 100

Remarks: Pay due as
Major from Sep 2nd
1863.

Book mark:

Jornier

P. | 4 | U.S.C.T.

Augustus S. Boemstein

Rank *Major*, 4 Reg't U. S. Col'd Infantry.

Appears on

Field and Staff Muster Roll

for *Jan & Feb*, 1864.

Present or absent *Present*

Stoppage, \$ 100 for

Due Gov't, \$ 100 for

Valuation of horse, \$ 100

Valuation of horse equipments, \$ 100

Remarks:

Book mark:

Joiner

P | 4

U.S.C.T.

Augustus S. Bremstein

Rank Major, 4 Reg't U. S. Col'd Infantry.

Appears on

Field and Staff Muster Roll

for May & Apr., 1864.

Present or absent Present

Stoppage, \$ 100 for

Due Gov't, \$ 100 for

Valuation of horse, \$ 100

Valuation of horse equipments, \$ 100

Remarks:

[Empty lines for remarks]

Book mark:

J. J. J. J.

W.B. 1 4

U.S.C.T.

Augustus S. Boemstein

Rank *Major*, *4* Reg't U. S. Col'd Infantry.

Appears on

Field and Staff Muster Roll

for *May & June*, 186*4*.

Present or absent *Present*

Stoppage, \$ *100* for

Due Gov't, \$ *100* for

Valuation of horse, \$ *100*

Valuation of horse equipments, \$ *100*

Remarks:

Book mark:

(357)

Jornier

Copyist

B | 4

U.S.C.T.

Augustus H Bernstein

Rank *Major*, *4* Reg't U. S. Col'd Infantry.

Appears on

Field and Staff Muster Roll

for *July & Aug*, 186*4*.

Present or absent *Present*

Stoppage, \$ *100* for

Due Gov't, \$ *100* for

Valuation of horse, \$ *100*

Valuation of horse equipments, \$ *100*

Remarks:

Book mark:

(357)

Jornier

Copied

B. | 4

U.S.C.T.

Augustus S. Boemstein

Rank *Major*, *4* Reg't U. S. Col'd Infantry.

Appears on

Field and Staff Muster Roll

for *Sept & Oct*, 186*4*.

Present or absent *Present*

Stoppage, \$ 100 for

Due Gov't, \$ 100 for

Valuation of horse, \$ 100

Valuation of horse equipments, \$ 100

Remarks:

Book mark:

Jones

B | *4* | **U.S.C.T.**

Augustus S. Premstein

Rank *Major*, *4* Reg't U. S. Col'd Infantry.

Appears on

Field and Staff Muster Roll

for *Nov & Dec*, 186*4*.

Present or absent *Present*

Stoppage, \$ *100* for

Due Gov't, \$ *100* for

Valuation of horse, \$ *100*

Valuation of horse equipments, \$ *100*

Remarks:

Book mark:-----

Josner

B. | 4

U.S.C.T.

Augustus S. Boemstein

Rank Major, 4 Reg't U. S. Col'd Infantry.

Appears on

Field and Staff Muster Roll

for Jan & Feb, 1865.

Present or absent Present

Stoppage, \$ 100 for

Due Gov't, \$ 100 for

Valuation of horse, \$ 100

Valuation of horse equipments, \$ 100

Remarks:

Book mark:

J. J. J. J.

B. | 4

U.S.C.T.

Augustus S Boernstein

Rank *Major*; *4* Reg't U. S. Col'd Infantry.

Appears on

Field and Staff Muster Roll

for *May, & Apr.*, 1865.

Present or absent *Present.*

Stoppage, \$ *100* for

Due Gov't, \$ *100* for

Valuation of horse, \$ *100*

Valuation of horse equipments, \$ *100*

Remarks :

Book mark : _____

Josieu.

P. 4

U.S.C.T.

Augustus S. Boemstein

Rank *Major*, *4* Reg't U. S. Col'd Infantry.

Appears on

Field and Staff Muster Roll

for *May + June*, 186*4*.

Present or absent *Present*

Stoppage, \$ 100 for

Due Gov't, \$ 100 for

Valuation of horse, \$ 100

Valuation of horse equipments, \$ 100

Remarks:

Book mark:

Jornen

B | 4 | U.S.C.T.

Augustus S. Boernsterin
 Lt. Col., Co. 4 Reg't U. S. Col'd Infantry.

Age 33 years.

Appears on an

Individual Muster-in Roll

of the organization named above. Roll dated
 New Bern, N.C., July 17, 1865.

Muster-in to date July 19, 1865.

Joined for duty and enrolled:

When July 17, 1865.

Where New Bern, N.C.

Period unexpired term.

Remarks: Promoted from Major
 to Lt. Col. same Regt (vice
 Lt. Col. J. Rogers resigned)
 Appointment received
 from the President, dated
 July 8th/65. Dat of this muster
 July 19, 1865.

Book mark :

Lowry

B. | 4

U.S.C.T.

Augustus S. Remstein

Rank Lt. Col., 4 Reg't U. S. Col'd Infantry.

Appears on

Field and Staff Muster Roll

for July + Aug., 1865.

Present or absent Present.

Stoppage, \$ 100 for

Due Gov't, \$ 100 for

Valuation of horse, \$ 100

Valuation of horse equipments, \$ 100

Remarks: Provost Marshall
New Bern N.C.

Book mark:

Jones

B | 4 | U.S.C.T.

Augustus S. Boemster

Rank Major, 4 Reg't U. S. Col'd Infantry.

Appears on

Field and Staff Muster Roll

for Sep & Oct, 1865.

Present or absent Present

Stoppage, \$ 100 for

Due Gov't, \$ 100 for

Valuation of horse, \$ 100

Valuation of horse equipments, \$ 100

Remarks: Promoted Major
4th U.S.C.T Aug 28/63
Promoted Sep 2/63
Paid as Capt 4th U.S.C.T
to Aug 31/63

Book mark:

Joiner

W.B. | 7

U.S.C.T.

Augustus S Bernstein

Rank *2d Col.*, 4 Reg't U. S. Col'd Infantry.

Appears on

Field and Staff Muster Roll

for *Sept & Oct*, 1865.

Present or absent *Present*

Stoppage, \$ 100 for

Due Gov't, \$ 100 for

Valuation of horse, \$ 100

Valuation of horse equipments, \$ 100

Remarks:

Book mark:

Joiner

P. 17

U.S.C.T.

Augustus S Boemstein

Rank Lt Col., 4 Reg't U. S. Col'd Infantry.

Appears on

Field and Staff Muster Roll

for Nov + Dec, 1865.

Present or absent

Stoppage, \$ 100 for

Due Gov't, \$ 100 for

Valuation of horse, \$ 100

Valuation of horse equipments, \$ 100

Remarks: Dismissed by
sentence of G. C. W. G. O.
161 Dept of Washington
Dec 1st 1865

Book mark: 8646 P.M. Feb 28/65
a.g.o.

(857)

Boemstein

COPY

B | 4 | U.S.C.T.

Augustus S. Bernstein
Capt., Co. B, 4 Reg't U. S. Col'd Infantry.

Appears on Co. Muster-out Roll, dated
Washington D.C., May 4, 1866.

Muster-out to date 186 .

Last paid to 186 .

Clothing account:

Last settled 186 ; drawn since \$ 100

Due soldier \$ 100; due U. S. \$ 100

Am't for cloth'g in kind or money adv'd \$ 100

Due U. S. for arms, equipments, &c., \$ 100

Bounty paid \$ 100; due \$ 100

Remarks: Transferred
Promoted May 4 1866
Aug 28, 63

Book mark:

(361)

Stamm
Copyist.

B. | 4 | U.S.C.T.

Augustus S. Boernstein

Rank *Major*, *4* Reg't U. S. Col'd Inf.

Appears on

Field and Staff Muster-out Roll

of the organization named above. Roll dated

Washington D.C. May 4, 1866 .

Muster-out to date _____, 186 .

Last paid to _____, 186 .

Clothing account:

Last settled _____, 186 ; drawn since \$ _____ 100

Due soldier \$ _____ 100; due U. S. \$ _____ 100

Am't for cloth'g in kind or money adv'd \$ _____ 100

Due U. S. for arms, equipments, &c., \$ _____ 100

Bounty paid \$ _____ 100; due \$ _____ 100

Remarks: *Promoted to be*

2d Col. 4th W.S.C.I July

8th 1865

Book mark: _____

James
Copyist.

B | 4 | U.S.C.T.

Augustus S Boernstein
 Major, Co....., 4 Reg't U. S. Col'd Infantry.

Appears on an

Individual Muster-out Roll

of the organization named above. Roll dated

New Berne, N.C., July 19, 1865.

Muster-out to date

July 18, 1865.

Last paid to

May 31, 1865.

Clothing account:

Last settled....., 186 ; drawn since \$..... 100

Due soldier \$..... 100; due U. S. \$..... 100

Am't for cloth'g in kind or money adv'd \$..... 100

Due U. S. for arms, equipments, &c., \$..... 100

Bounty paid \$..... 100; due \$..... 100

Remarks:

Mustered out for promotion to Lieut Col, same Regt. (vice Lt. Col. Rogers) resigned) Appointment received from the President, dated July 8, 1865. Date of this muster, July 16, 1865.

Book mark:

C. M. Clark

S. | *4* | **U.S.C.T.**

Augustus S. Beaman

Rank *4th Col.*, *4* Reg't U. S. Col'd Inf.

Appears on

Field and Staff Muster-out Roll

of the organization named above. Roll dated

Washington D.C. May 4, 186*6*.

Muster-out to date _____, 186 .

Last paid to _____, 186 .

Clothing account:

Last settled _____, 186 ; drawn since \$ _____ 100

Due soldier \$ _____ 100; due U. S. \$ _____ 100

Am't for cloth'g in kind or money adv'd \$ _____ 100

Due U. S. for arms, equipments, &c., \$ _____ 100

Bounty paid \$ _____ 100; due \$ _____ 100

Remarks: *Dismissed by Sentence*
of G. C. M., G. O. 161 Dept. of
Washington Dec 1st. 1865

Book mark: *8646 P.M.G Feb 22/68*

J. J. J.

B | 4 | U. S. C. Inf

Augustus S. Bernstein
Lt Col., Co. —, 4 Reg't W. S. C. Inf

NOTATION.

Book mark: H 56 C. I. 1863

Record and Pension Office,

WAR DEPARTMENT,

Washington, Jan'y 21, 1895.

Under the provisions of the act of Congress, approved June 3, 1884, and the acts amendatory thereof, this officer is considered by this Department as commissioned to the grade of ~~Major~~

Lieut. Colonel
Co. —, 4 Reg't W. S. C. Inf

to take effect from July 8, 1865,
vice Ly. Rogers discharged

Keely
(442) * Corrected Dec 13/01. Comptrol

Boernstein Augustus S.
1st Reg't U.S.C.
Med. Co.

5 Enclosures.

Bed Cards	Final Statements
Burial Records	Furloughs or L. of A
Certs. of Dis. for Discharge	Med. Certificates
C. M. Charges /	Med. Des. Lists
Descriptive Lists	Orders
Discharge Certificates	Pris. of War Record
Enlistment Papers	Resignations

Other papers relating to—

Admission to Hosp'l	Furlough or L. of A /
Casualty Sheet	Med. Examination
Confinement <i>2</i>	Misc. Information /
Contracts	Pay or Clothing
Death or Effects	Personal Reports
Desertion	Rank
Discharge from Hosp'l	Transfer to Hosp'l
Discharge from Service	Transfer to V. R. C.
Duty	Transportation

Adm Wm W. ...
... Nov 26/63

Respectfully forwarded
approved
Wm W. ...

Yorktown Va - Nov. 26/63
B 171 ✓ '83

Boernstein, A. S. Major
4th U. S. Col. Troops -

Asks leave of absence for
ten days to go to Baltimore
Md. on important business

234 ... Baltimore C 1863

Officers present for duty.	26
" " sick	5
" " in arrest	1
" absent detach service	5
" " on leave	1
" " sick	1
	<u>39</u>

Nov. 26/63

~~Head Qrs. 4th U.S. Col.~~
Nov. 26, 1863

Ad Ltr 4th U.S.C. 7.
Nov. 26th 1863

Approved & respectfully
forwarded.

Ad Ltr Dept Va ...
Nov 27, 1863
Col. ...

Yorktown Va.

Nov. 26. 1863

Major R. S. Davis
Apt. Adjt. Genl. Fort Monroe Va.

Sir,

I have the honor to request that leave of absence for ten days be granted me, to go to Baltimore Md. on important business -

Very respectfully

your obt. servant
Augustus S. Boernstein
Major 4th U.S. Col. Troops -

B. 1591 Q. 4. 1865

Head Quarters Dep. of Washington
Washington D.C. Oct. 25. 1865

James A. K. 1st. Lieut
4th. Regt. U.S. Col'd Troop

Report in accordance to
verbal instructions in the
case of Lieut Colonel
Boernstein.

4 11 3 1

Filed

HEADQUARTERS, WASHINGTON.
ARMY CORPS.
OCT 28 1865

E.M.P. 52-141

Hd. Quarters of Washington
Washington D.C. Oct. 26th 1865

Report of Lt. Barnes A.D.C.
Respectfully forwarded

J. A. Easton
B. Gen. 10th
Comd'g

I would further inform
you that Lt. Col. Boernstein
was arrested yesterday
as directed and is now
in arrest.

J. A. Easton
B. Gen. 10th
Comd'g

File
J.H.

Headquarters Defences of Washington,
 Washington, D. C., Oct^r 25th 1865.

General:-

In obedience to verbal instructions requiring me to investigate and report upon certain complaints entered against Lt. Col. N. S. Boernstein, 4th U. S. Col. Inf^y, I have the honor to submit the following:

On the 15th inst., while a detachment of the 4th U. S. C. I., under command of Lt. Col. Boernstein, on their way from the "Soldiers' Rest" to Fort Slocum, halted for a few moments at the terminus of the street railway on 7th street, a colored citizen fell upon and injured one of the brass instruments belonging to the Band, and immediately after ran away, pursued by the owner of the instrument. Upon being caught, a policeman arrested both citizen and soldier, and proceeded with them towards the station house, before reaching which, Lt. Allen, Adj^t 4th U. S. C. I., requested the policeman to deliver the soldier to him, which was refused. Lt. Allen replied that a soldier in the presence of the Regiment should not be arrested by a policeman without an application to and consent of the commanding officer. The policeman still refused to deliver the soldier, when the Adj^t forced the soldier from him. Lt. Col. Boernstein then coming up, told the policemen that a

soldier of his Regt should not be arrested by them, but that if guilty of any offence, upon proper application he should be dealt with as the occasion required. Upon the statement of the Sergt of Police that the soldier was wanted merely as a witness against the person who broke his instrument, the Lt Col caused the man to be brought up for that purpose. The examination eliciting the fact that the injury to the instrument was purely accidental, the matter was dismissed. No improper conduct was indulged in by Lt Col Boernstein, or any officer or soldier on this occasion. The facts of this statement are vouched for by myself, being a witness of the entire affair.

In reference to the complaint entered by Surgeon General Barnes, of disorderly conduct on the part of Lt Col Boernstein, on the 23rd inst, from the best evidence I can procure, I think the following are the facts in the case:-

Lt Col Boernstein had been visiting the city on business and was returning to his Head Quarters at Fort Slocum; - while near the "Soldiers' Home" his horse, on which he had never before been mounted, became very restless, and while punishing him with spurs, dashed rapidly along the road; - arriving at a curve, he came suddenly upon three carriages, leaving but a small space on the side of the road for him to pass, and as he could not stop, attempted to get through, but, owing to the horse being blind in

one eye, (which fact the Lt Col says he did not then know) ran against a tree, which threw the Lt Col to the ground. Dismounting the horse, he dashed on towards the Fort, meeting one carriage on the way. This carriage was probably one of those at the curve, where the Lt Col was thrown, now returning to the city. Lt Col Boernstein states that he is entirely ignorant as to who were the occupants of the carriage - cannot state whether there was but one, or two - whether citizens or officers - so busily was he engaged in controlling his horse, and he entirely disclaims any intention to molest or injure any person.

Respectfully Submitted,

J. P. Barnes
1st Lt 4th U.S. C. I. & A. I. C.

Brig. Gen. J. A. Haswell
Com^{dr} Defense of Washington

B. 1613. O. H. 1865

Hqrs. 4th U.S.C. Fort. Slocum
November 2^d 1865.

Boernstein, Aug. 1.
Lieut. Col. Comd. 4th U.S.C.

Announces his release from arrest
by virtue of provisions contained
in Sect. 11. of an Act of Congress
approved July 17th 1862.

E. M. P 35-149
Adj. Gns. Offices of Washington
Washington "D.C." Nov. 3^d /65

Respectfully forwarded

J. A. Easton
Brig. Genl. Comd'g

File
7117

Filed

pt. Washington.
22^d ARMY CORPS.
NOV 7 1865

Headquarters 4th U. S. Col. S. Inf.
 Fort Monroe, D. C.
 November 2^d 1865.

By
 To

D. W. Van Horn
 Capt. & Adjt. G.
 Def. of. Washington

Sir:

I have the honor
 to inform you, that by provisions of Section 11.
 of an Act of Congress, approved July 17th 1862 and
 incorporated in Rev. Army Regulations (on page 53),
 my Arrest has ceased (this day) at 10'clock P. M.,
 having been put under arrest on the 25th day of Oct.
 1865 & at 10'clock P. M. by yourself.

I have the honor to remain

Your most obedient servant
 Augustus S. Boernstein
 S. Col. Comd'g. 4th U. S. C. I.

Head Quarters Dept of Washington
Washington D.C. Dec 10, 1865

General Orders

No 161

- Extract -

1st Lt Col Augustus S Bornstein
4th U.S.C. Troops

Charge 1st; Drunkenness, to the prejudice
of good order and military discipline

Charge 2^d; conduct unbecoming an Officer
and a gentleman;

Charge 3^d; conduct to the prejudice of good
order and military discipline;

Charge 4th; Violation of the 32^d Article
of War.

Charge 5th; Using contemptuous and dis-
respectful words against the President of
the United States.

Finding. Of the 1st, 2^d, 3^d & 5th Charges
- Guilty -
Of the 4th Charge, not guilty.

Sentence, x x x x to be dismissed the
service of the U.S.

At a June 13/76

Approved + Confirmed -

Augustus J. Bonafino
Lt. Col. 4th Inf. C. I.

Div of His Comds

Adjutant General's Office,

COLORED TROOPS BRANCH,

June 6, 1876

Mr Ellersbrook Vol. C. T., 187

Wanted in the case of Augustus S. Boerstein, Lt. Col.,
4 Reg't Col. Troops Copy of Court Martial
order dismissing him.

He is reported "Dismissed by sentence of
G. C. M., G. O. 161 Dept. of Washington Dec 18
1865"

Respectfully,

A. Woodward
Chief Clerk.

In J. H. Haldon

Adjutant General's Office,

, 187

Vol. C. T., 187

Reply in case of _____, Co. _____,

Reg't _____

Note - Tried by G. C. M. on Chgs 1st Disrespectful conduct
unbecoming an officer & gentleman, 3rd Contumacious to the Republic
of good order & military discipline 4th Violation of
Art 32nd which of War 5th Army Contumacious &
disrespectful words against the President of the
United States, finding 1st 2nd & 5th Chgs guilty 4th
Chgs - Not guilty - Sentence - To be dismissed on the
order of the G. C. M. No 161, Hd. Qu. Dept. of
Washington December 10 1865

1E7a

Bowley Lynam

Co. E, 4 U. S. Col'd Inf.

CARD NUMBERS.

1		26
2		27
3		28
4		29
5	<i>See</i>	30
6		31
7	<i>Bowley, Lynam.</i>	32
8		33
9		34
10		35
11		36
12		37
13		38
14		39
15		40
16		41
17		42
18		43
19		44
20		45
21		46
22		47
23		48
24		49
25		50

Number of personal papers herein.....

Book Mark: _____

See also _____

18
Gibby, Jeremiah

Co. *D*, **4** U.S. Col'd Inf.

Private | *Private*

CARD NUMBERS.

1	5556 155	26
2	5556 238	27
3	5556 337	28
4	5556 435	29
5	5556 528	30
6	5556 615	31
7	5556 702	32
8	5556 787	33
9	5556 869	34
10	5556 949	35
11	5557 045	36
12	5557 135	37
13	5557 233	38
14	5557 327	39
15	5557 416	40
16	5557 491	41
17	5557 552	42
18	5557 660	43
19	9062037	44
20		45
21		46
22		47
23		48
24		49
25		50

Book Mark:

See also

B

4

U.S.C.T.

Jeremiah Boley

, Co. *D*, 4 Reg't U. S. Col'd Inf.

Appears on

Company Descriptive Book

of the organization named above.

DESCRIPTION.

Age *35* years; height *5* feet *5* inches.

Complexion *Black*

Eyes *Black*; hair *Black*

Where born *Haverhill Co. Md.*

Occupation *Farmer*

ENLISTMENT.

When *July 28*, 1863.

Where *Phillips Co.*

By whom *Chas. F. Wilson*; term *1* y'rs.

Remarks: *On detached service as teamster
in Wash. Froze hands & in Hospital
permanently disabled*

*Discharged the service U.S. for disability
of Maj. Gen. August 30 1866 at
Post Hospital Fort Detrick Washington 1866*

W. H. Merrill

B

4

U.S.C.T.

Jeremiah Poley

B Co. D, 4 Reg't U. S. Col'd Infantry.

Age *25* years.

Appears on

Company Muster-in Roll

of the organization named above. Roll dated

Baltimore Md, July 28, 1863.

Muster-in to date *July 28, 1863.*

Joined for duty and enrolled:

When *July 28*, 1863.*

Where *Baltimore* *

Period *3* years.*

Remarks:

* Muster-in roll shows enrollment and muster-in of this company as of same date and place. See enrollment on subsequent card or cards.

Book mark:

Faulkner

B | 4 | U.S.C.T.

Jeremiah Poley

Priv., Co. D, 4 Reg't U. S. Col'd Infantry.

Appears on

Company Muster Roll

for July 28/63 to Aug 31, 1863.

Joined for duty and enrolled:

When July 28, 1863.*

Where Baltimore Md.*

Period 3 years.*

Present or absent present

Stoppage, \$ 100 for

Due Gov't \$ 100 for

Remarks: \$2.00 Premium due

* See enrollment on card from muster-in roll.

Book mark: -----

Faulkner

(858c) Copyist.

B | 4 | U.S.C.T.

Jeremiah Poley

Priv, Co. D, 4 Reg't U. S. Col'd Infantry.

Appears on

Company Muster Roll

for Sept & Oct, 1863.

Joined for duty and enrolled:

When July 28, 1863.*

Where Baltimore Md. *

Period 3 years.*

Present or absent present

Stoppage, \$ 100 for _____

Due Gov't \$ 100 for _____

Remarks: _____

* See enrollment on card from muster-in roll.

Book mark: _____

Faulkner

B | 4 | U.S.C.T.

Jeremiah Boley
Priv., Co. D, 4 Reg't U. S. Col'd Infantry.

Appears on

Company Muster Roll

for Nov & Dec, 1863.

Joined for duty and enrolled:

When July 28, 1863.*

Where Baltimore Md) *

Period 3 years.*

Present or absent present

Stoppage, \$ 100 for

Due Gov't \$ 100 for

Remarks:

* See enrollment on card from muster-in roll.

Book mark:

Franklin

B | 4 | **U.S.C.T.**

Jeremiah Foley

Foley, Co. D, 4 Reg't U. S. Col'd Infantry.

Appears on

Company Muster Roll

for *Jan & Feb*, 1864.

Joined for duty and enrolled:

When *July 28*, 1863.*

Where *Baltimore Md*.*

Period *3* years.*

Present or absent *present*

Stoppage, \$ *100* for

Due Gov't \$ *100* for

Remarks: *Sick in Quarters*

* See enrollment on card from muster-in roll.

Book mark: -----

Faulkner
(858c) Copyist.

B

4

U.S.C.T.

Jeremiah Boley

Pvt, Co. D, 4 Reg't U. S. Col'd Infantry.

Appears on

Company Muster Roll

for *March + Apr*, 1864.

Joined for duty and enrolled:

When *July 28*, 1863.*

Where *Baltimore Md**

Period *3* years.*

Present or absent *Present*

Stoppage, \$ *100* for

Due Gov't \$ *100* for

Remarks:

* See enrollment on card from muster-in roll.

Book mark: -----

W. A. Tyler

B | 4 | U.S.C.T.

Jeremiah Boley
Priv., Co. D, 4 Reg't U. S. Col'd Infantry.

Appears on

Company Muster Roll

for *May/June*, 1864.

Joined for duty and enrolled:

When *July 28*, 1863.*

Where *Baltimore Md* *

Period *3* years.*

Present or absent *Present*

Stoppage, \$ *100* for

Due Gov't \$ *100* for

Remarks:

* See enrollment on card from muster-in roll.

Book mark:

(858c)

W A Tyler

Copyist.

3

4

U.S.C.T.

Jeremiah Boley

Priv, Co. D, 4 Reg't U. S. Col'd Infantry.

Appears on

Company Muster Roll

for *July & Aug*, 1864.

Joined for duty and enrolled:

When *July 28*, 1863.*

Where *Baltimore Md**

Period *3* years.*

Present or absent *Present*

Stoppage, \$ *100* for

Due Gov't \$ *100* for

Remarks: *Free on or before
Apr 19, 1861.*

* See enrollment on card from muster-in roll.

Book mark:

W. A. Tyler

B | 4 | U.S.C.T.

Jeremiah Boley
Priv., Co. D, 4 Reg't U. S. Col'd Infantry.

Appears on

Company Muster Roll

for Sept + Oct, 1864.

Joined for duty and enrolled:

When July 28, 1863.*

Where Baltimore Md.*

Period 3 years.*

Present or absent Present

Stoppage, \$ 100 for

Due Gov't \$ 100 for

Remarks: free on board before
Apr 19, 1861

* See enrollment on card from muster-in roll.

Book mark:

W. S. Taylor Copyist.
(858c)

B | 4 | U.S.C.T.

Jeremiah Boley

Priv., Co. D, 4 Reg't U. S. Col'd Infantry.

Appears on

Company Muster Roll

for *Nov + Dec*, 1864.

Joined for duty and enrolled:

When *July 25*, 1863.*

Where *Baltimore* *

Period *3* years.*

Present or absent *Present*

Stoppage, \$ *100* for _____

Due Gov't \$ *100* for _____

Remarks: *Free on war before Apr 19/61*

* See enrollment on card from muster-in roll.

Book mark: _____

W. A. Tyler

B | 4 | U.S.C.T.

Jeremiah Boley
Pvt., Co. D, 4 Reg't U. S. Col'd Infantry.

Appears on

Company Muster Roll

for *Jan. & Feb.*, 1865.

Joined for duty and enrolled:

When *July 28*, 1863.*

Where *Baltimore* *

Period *3* years.*

Present or absent *Present*

Stoppage, \$ *100* for

Due Gov't \$ *100* for

Remarks: *Free on or before Apr. 19/64.*
Stop, for shoulder scales 509,

* See enrollment on card from muster-in roll.

Book mark:

Boyle
(858c) Copyist.

B | 4 | U.S.C.T.

Jeremiah Boley
Pvt., Co. D, 4 Reg't U. S. Col'd Infantry.

Appears on

Company Muster Roll

for Mar & Apr, 1865.

Joined for duty and enrolled:

When July 28, 1863.*

Where Baltimore *

Period 3 years.*

Present or absent Present,

Stoppage, \$ 100 for

Due Gov't \$ 100 for

Remarks: Free on leave Apr. 19/64
Back pay due from
Mar. 1/64 to date of muster
in.

* See enrollment on card from muster-in roll.

Book mark:

(858c)

Castellino Copyist.

B | 4 | U.S.C.T.

Jeremiah Boley
Pvt., Co. D, 4 Reg't U. S. Col'd Infantry.

Appears on

Company Muster Roll
 for May & June, 1863.

Joined for duty and enrolled:

When July 28, 1863.*

Where Baltimore *

Period 3 years.*

Present or absent Present

Stoppage, \$ 100 for

Due Gov't \$ 100 for

Remarks: Back pay due
from date of muster
in to May 1/64.
Free Apr. 19/61.

* See enrollment on card from muster-in roll.

Book mark:

(858c)

Easterling Copyist.

B

4

U.S.C.T.

Jeremiah Boley

Pvt., Co. D, 4 Reg't U. S. Col'd Infantry.

Appears on

Company Muster Roll

for *July & Aug.*, 1865.

Joined for duty and enrolled:

When *July 26*, 1863.*

Where *Balt, Md.* *

Period *3* years.*

Present or absent *Present*

Stoppage, \$ *100* for

Due Gov't \$ *100* for

Remarks: *Stop for 1 cart boy
belt plate 9¢ + 1 cart
boy plate 8¢*

* See enrollment on card from muster-in roll.

Book mark:

(858c)

Castling

Copyist.

B | 4 | U.S.C.T.

Jeremiah Boley

Pvt., Co. D, 4 Reg't U. S. Col'd Infantry.

Appears on

Company Muster Roll

for *Sept. & Oct.*, 186*5*.

Joined for duty and enrolled:

When *July 25*, 186*3*.*

Where *Baltimore* *

Period *3* years.*

Present or absent *Present*

Stoppage, \$ *100* for

Due Gov't \$ *100* for

Remarks: *Stop. for Cap Number,
Letters & Badge 3⁰⁰, G. Coat
Straps 12⁰⁰, Haversack 95⁰⁰,
Canteen 65⁰⁰ = \$1.75⁰⁰*

* See enrollment on card from muster-in roll.

Book mark:

(858c)

Castling Copyist.

B. | 4 | U.S.C.T.

Jeremiah Boley
Pt., Co. D, 4 Reg't U. S. Col'd Infantry.

Appears on

Company Muster Roll

for Nov & Dec, 1865.

Joined for duty and enrolled:

When July 28, 1863.*

Where Baltimore *

Period 3 years.*

Present or absent Present

Stoppage, \$ 100 for

Due Gov't \$ 100 for

Remarks: Stop letters 1st number
1st = 2nd

* See enrollment on card from muster-in roll.

Book mark:

Joiner.
(858c) Copyist.

B. | 4 | U.S.C.T.

Jeremiah Boley

Pvt., Co. D, 4 Reg't U. S. Col'd Infantry.

Appears on

Company Muster Roll

for *Jan & Feb*, 1866.

Joined for duty and enrolled:

When *July 28*, 1863.*

Where *Baltimore* *

Period *3* years.*

Present or absent *Present*

Stoppage, \$ *100* for

Due Gov't \$ *100* for

Remarks: *Sick at Regt
Hosp.*

NEXT ROLL ON FILE MUSTER OUT.

* See enrollment on card from muster-in roll.

Book mark:

J. J. J. J.

B. 1 4 U.S.C.T.

Jeremiah Bley
Sgt., Co. D, 4 Reg't U. S. Col'd Infantry.

Appears on Co. Muster-out Roll, dated
Washington D.C., May 4, 1866.

Muster-out to date _____, 1866.

Last paid to _____, 1866.

Clothing account:

Last settled _____, 1866; drawn since \$ _____ 100

Due soldier \$ _____ 100; due U. S. \$ _____ 100

Am't for cloth'g in kind or money adv'd \$ _____ 100

Due U. S. for arms, equipments, &c., \$ _____ 100

Bounty paid \$ _____ 100; due \$ _____ 100

Remarks: Discharged April

20/66

Book mark: V. 121 P. 496. 71. Dis. 926. Nov. 12/66

V. 122 P. 242. 76. X. 122. P. 496. 71.

J. J. J. J.

Poley, Jeremiah

P. O. 4 **U. S. C. Inf.**

2 Enclosures.

Bed Cards.....	<i>1</i>	Descriptive Lists.....
Burial Records.....		Final Statements.....
Certs. of Dis. for Discharge.....	<i>/</i>	Furloughs.....
C. M. Charges.....		Med. Des. Lists.....
Med. Certificates.....		Orders.....

Other papers relating to—

Admission to Hosp'l.....	Furlough.....
Casualty Sheet (Officer's).....	Med. Examination.....
Confinement.....	Misc. Information.....
Contracts.....	Pay or Clothing.....
Death or Effects.....	Personal Reports.....
Desertions.....	Rank.....
Discharge from Hosp'l.....	Transfer to Hosp'l.....
Discharge from Service.....	Transfer to V. R. C.....
Duty.....	Transportation.....

Hospital Number 604

Name Jerry Boley

Age 36 Natcity Maryland

Married or Single Single

Residence Church Creek Md

Post Office address of wife or nearest relative } Nell Cornish
as above

Rank Private Co. D Regiment 1st Md. Inf.

When admitted Oct 1

From what source War

Diagnosis: (in surgical cases state explicitly seat and character of wound or injury.)

Jerry Boley

Post Hospital,
New Berne, N. C.

On what occasion wounded

Date

Nature of missile or weapon

TREATMENT.

[HERE NOTE IMPORTANT COMPLICATIONS AND ALL OPERATIONS.]

RESULT and DATE.

Col 20 Aug 1914
Aug. Col 20
1865.

NOTE 1.

The company commander will here add a statement of all the facts known to him concerning the disease or wound, or cause of disability of the soldier; the time, place, manner, and all the circumstances under which the injury occurred, or disease originated or appeared; the duty, or service, or situation of the soldier at the time the injury was received or disease contracted, stating particularly whether the injury was received or the disease contracted in the line of his duty; and whatever other facts may aid a judgment as to the cause, immediate or remote, of the disability, and the circumstances attending it.

When the facts are not known to the company commander, the certificate of any officer, or affidavit of other person having such knowledge, will be appended—as the surgeon in charge of a hospital, the officer commanding a detachment of recruits, &c., &c.

NOTE 2.

When a probable case for pension, special care must be taken to state the degree of disability—as $\frac{1}{2}$, $\frac{3}{4}$, &c., &c.; to describe particularly the disability, wound, or disease, the extent of which it deprives him of the use of any limb or faculty, or affects his health, strength, activity, constitution, or capacity to labor or earn his subsistence. The surgeon will add, from his knowledge of the facts and circumstances, and from the evidence in the case, his professional opinion of the cause or origin of the disability. In the case of discharges by Medical Inspectors, the last paragraph will state that the "discharge was given by consent of the soldier, after a personal examination, and for disability, the nature, degree, and origin of which are correctly described in the within certificate."

Par. 1260 Regulations, Edit. 1861.

Medical officers, in giving certificates of disability, are to take particular care in all cases that have not been under their charge; and especially in epilepsy, convulsions, chronic rheumatism, derangement of the urinary organs, ophthalmia, ulcers, or any obscure disease liable to be feigned or purposely produced; and in no case shall such certificate be given until after sufficient time and examination to detect any attempt at deception.

DIRECTIONS.

This certificate will be made out in duplicate by the soldier's company commander, or other officer commanding the separate detachment to which he belongs, and sent by him to the surgeon who has charge of the hospital where the soldier is sick. The surgeon will then fill out and sign the surgeon's certificate, and forward these papers to the regimental, detachment, or post commander, who will forward them, with his action endorsed thereon, through the proper channel, to his division commander; or, if the troops are not attached to a division, to his corps, department, or other commander or officer to whom the authority to discharge enlisted men may be specially delegated.

These certificates, after having received the action of the highest authority to which they are required to be sent, will be returned through the same channel to the regimental, post, or detachment commander, who will, if the discharge is authorized by the endorsement of the proper authority, sign the soldier's discharge, and the last certificate on this paper; see that the soldier is furnished with the proper final statements in duplicate, and forward BOTH of these certificates to the Adjutant General United States Army at Washington, D. C.; they will not, under any circumstances, be given to the hands of the soldiers.

ADJUTANT GENERAL'S OFFICE

May 19 1866

Duplicate sent the Post Office

CERTIFICATE OF DISABILITY FOR DISCHARGE

1866, 7
B19 "S.P. 1866"
S. 33, W. of D.C.
IN THE CASE OF
Jermiah Foley
a Private Co. D's
4th Reg't of U.S.C.F.

Approved
J. W. ...
aft ...

HEAD OF ARTILLERY,
DEPARTMENT OF THE ARMY,
220 ARMY ...

March, 7 1866

TO BE DISCHARGED.

BY COMMAND OF

MAJ. GEN'L E. C. AUGUR.

W. J. ...



Received

Anton ...

ARMY OF THE UNITED STATES. CERTIFICATE OF DISABILITY FOR DISCHARGE.



Jeremiah Coley of Captain J. J. Shephard's Company, (D) of the 12th Regiment of the United States... was enlisted by Capt. Wm. Birney... on the 28th day of July, 1863, to serve three years; he was born in... in the State of... is thirty five years of age, five feet... inches high, Black complexion, Black eyes, Black hair, and by occupation when enlisted a... During the last two months said soldier has been unfit for duty 45 days* This man froze his fingers whilst in the line of his duty as Private in Washington City, which has left him permanently unable to perform the duty of a Soldier.

STATION: Fort Lincoln, D.C. DATE: February 20th 1866

John Shephard, Captain, Commanding Company.

I CERTIFY, that I have carefully examined the said Jeremiah Coley of Captain J. J. Shephard's Company and find him incapable of performing the duties of a soldier because of the loss of the entire first, and a part of the second phalanges of all his fingers, and also the first phalanx of the right thumb. Disability complete. Disability incurred in service while in line of his duty as a soldier.

J. W. Mitchell, Surgeon.

DISCHARGED, this twentieth day of April, 1866, at Fort Lincoln Dist. of Columbia

Paul A. Duncan, Commanding the Reg't

The Soldier desires to be addressed at Town Church Creek County Eastern Shore State Maryland

* See Note 1 on the back of this. † See Note 2 on the back of this.

119
Goley Joseph

Co. *D*, **4** U.S. Col'd Inf.

Private

Private

CARD NUMBERS.

1	5556 156	26
2	5556-259	27
3	5556 411	28
4	5557 699	29
5	9062038	30
6		31
7		32
8		33
9		34
10		35
11		36
12		37
13		38
14		39
15		40
16		41
17		42
18		43
19		44
20		45
21		46
22		47
23		48
24		49
25		50

Book Mark:

See also

B | 4 | U.S.C.T.

Joseph Boley

Co. K, 4 Reg't U. S. Col'd Inf.

Appears on
Company Descriptive Book
of the organization named above.

DESCRIPTION.

Age 25 years; height 5 feet 2 inches.

Complexion Ruddy

Eyes Blue; hair Black

Where born Winchester Co. Md.

Occupation Farmer

ENLISTMENT.

When July 25, 1862

Where Chillicothe O

By whom Lt J. F. Wilson; term 1 y'rs.

Remarks: Died on Typhoid pneumonia
Sept 23 1863 Yorktown Va.

W H Merrill

B

4

U.S.C.T.

Joseph Boley

Pos, Co. D, 4 Reg't U. S. Col'd Infantry.

Age 23 years.

Appears on

Company Muster-in Roll

of the organization named above. Roll dated

Baltimore, Md, July 28, 1863.

Muster-in to date

July 28, 1863.

Joined for duty and enrolled:

When July 28, 1863.*

Where Baltimore *

Period 3 years.*

Remarks:

* Muster-in roll shows enrollment and muster-in of this company as of same date and place. See enrollment on subsequent card or cards.

Book mark:

Frank Kne

B | 4 | U.S.C.T.

Joseph Boley

Priv., Co. D, 4 Reg't U. S. Col'd Infantry.

Appears on

Company Muster Roll

for July 28/67 to Aug 31, 1867.

Joined for duty and enrolled:

When July 28, 1867.*

Where Baltimore Md.*

Period 3 years.*

Present or absent present

Stoppage, \$ 100 for

Due Gov't \$ 100 for

Remarks: Stop for one quarter.
\$2.00 Premium due

* See enrollment on card from muster-in roll.

Book mark:

Faulkner

78

4

U.S.C.T.

Joseph Foley

Private, Co. D, 4 Reg't U. S. Col'd Infantry.

Appears on

Company Muster Roll

for Sept & Oct, 1863.

Joined for duty and enrolled:

When July 28, 1863.*

Where Baltimore Md.*

Period 3 years.*

Present or absent

Stoppage, \$100 for

Due Gov't \$100 for

Remarks: Died in Regt. Hospital Oct. 23, 1863 of Typhoid Pneumonia.

* See enrollment on card from muster-in roll.

Book mark:

Faulkner

P. | 4 | U.S.C.T.

Joseph Boley
Pvt., Co. *D.*, 4 Reg't U. S. Col'd Infantry.

Appears on **Co. Muster-out Roll**, dated
Washington P. C. May 4, 1865.

Muster-out to date 186 .
Last paid to 186 .

Clothing account:

Last settled....., 186 ; drawn since \$.....100
Due soldier \$.....100; due U. S. \$.....100
Am't for cloth'g in kind or money adv'd \$.....100

Due U. S. for arms, equipments, &c., \$.....100
Bounty paid \$.....100; due \$.....100

Remarks: *Died of disease*
 Oct 29/63

Book mark :

(861) *Jornier* Copyist.

Poley, Joseph

P. D., Co. **4** **U. S. C. Inf.**

2 Enclosures.

Bed Cards	Descriptive Lists
Burial Records	Final Statements
Certs. of Dis. for Discharge	Furloughs
C. M. Charges	Med. Des. Lists
Med. Certificates	Orders

Other papers relating to—

Admission to Hosp'l	Furlough
Casualty Sheet (Officer's)	Med. Examination
Confinement	Misc. Information
Contracts	Pay or Clothing
Death or Effects	Personal Reports
Desertions	Rank
Discharge from Hosp'l	Transfer to Hosp'l
Discharge from Service	Transfer to V. R. C.
Duty	Transportation

Recd from Sir, of the contents of A
(continued) Since June 8 / '75
INVENTORY OF THE EFFECTS

OF
Joseph Boley

Late of Company D

4th Reg't of U. S. Colored Troops

Volunteers, who died at Camp near Yorktown

on the 23rd day of October 1863.



Inventory of the effects of Joseph Boley late
 a Private of Captain John J. Eberhardt's Company 11 of
 the 14th Regiment of U.S.C.T. Volunteers, who was enrolled as
 a private at Baltimore in the State of Maryland on
 the 28th day of July 1863, and mustered into the service of the United
 States as a private on the 28th day of July 1863, at Baltimore
 in Company 11, 14th Regiment of U.S.C.T. Volunteers, to serve three
 years or during the war; he was born in Dorchester County in the State
 of Maryland; he was 23 years of age, 5 feet 3 inches
 high, Black complexion, Blue eyes, Black hair, and by occupation, when enrolled,
 a Farmer; he died in Hospital, at
Camp near Yorktown Va on the 23rd day of October 1863, by
 reason of Typhoid Pneumonia

INVENTORY.					
ARTICLES.	No.	ARTICLES.	No.	ARTICLES.	No.
Hats		Pairs trousers		Knapsacks	1
Caps	1	Pairs flannel drawers	1	Canteen	1
Forage caps		Pairs cotton drawers		Packet Book	1
Great coats	1	Flannel shirts	2	Memorandum	1
Uniform coats		Cotton shirts			
Uniform jackets		Pairs boots			
Flannel sack coats	1	Pairs shoes	1		
Blouses		Pairs socks	1		
Stable frocks		Blankets	1		
Fatigue overalls		Haversacks			
				MONEY.	
				Specie	\$
				Notes	\$

I CERTIFY, ON HONOR, that the above inventory comprises all the effects of Private
Joseph Boley, deceased, and that the effects are in the hands
 of Captain John J. Eberhardt at Camp near Yorktown
 to be disposed of by a Council of Administration.

(DUPLICATES.)

STATION: Camp near Yorktown

DATE: October 26th 1863

[A. G. O. No. 104.]

Captain John J. Eberhardt
14th Regt U.S.C.T.
 Commanding the Company.

4

✓

FINAL STATEMENT

OF

Joseph Boley

4th Reg't of U. S. C. T.

VOLUNTEERS.

Due Oct 23/63

NOTE 1.—Two of these certificates (or duplicates) are to be given to each volunteer soldier who may be discharged previously to the discharge of his company, that he may at once receive from the Paymaster the pay, &c., due him, and the captain or other officer commanding the company will certify to the act of the delivery of the duplicate certificates; on these certificates the Soldier is "entitled to" his discharge, and should also present his discharge to the Paymaster to have the payment endorsed on it. The discharge is to be given back to the Soldier by the Paymaster; the latter only retaining as his voucher the duplicate certificates.

NOTE 2.—If the Soldier is entitled to pay for the use of his horse, the Company Commander will certify to that fact, and also to the time he has pay due for having been so mounted on his own horse.

NOTE 3.—Amounts due the Sutler and Laundress must be entered on the Muster Roll on which the death, desertion, &c., is reported, as well as on the final statement, otherwise the amount cannot be collected from the United States.

NOTE 4.— This blank will be used for deceased volunteers as well as others.

ADJUTANT GENERAL'S OFFICE,

May 11th 1864

Duplicate, with Inventory, sent 2d Auditor.

Wm. C. R. Cas...

I certify, on honor, that Joseph Boley a private of
 Captain John J. Eberhardt Company (D) of the 4th Regiment of U. S. C. V.
VOLUNTEERS, of the State of _____, born in Dorchester County, State
 of Maryland, aged 23 years; 5 feet 3 inches high; Black complexion,
Black eyes, Black hair, and by occupation a Farmer, having joined the company on
 its original organization at Baltimore Md., and enrolled in it at the muster into
 the service of the United States at Baltimore Md., on the 28th day
 of July, 1863, (or was mustered in service as a recruit, by Colonel Wm
Birney, at Baltimore, on the 28th day of July,
 1863, to serve in the Regiment,) for the term of Three years:
 and having served **HONESTLY** and **FAITHFULLY** with his Company in the 4th Regt U. S. C. V.
 to the present date, is now entitled to a **DISCHARGE** by reason of Death

The said Joseph Boley was last paid by Paymaster
Major Mopper to include the 31st day of August, 1863, and has
 pay due him from that time to the present date; he is entitled to pay and subsistence for
TRAVELING to place of enrollment and whatever other allowances are authorized to volunteer
 soldiers, or militia, so discharged. He has received Thirty four $\frac{33}{100}$ dollars,
 advanced by the United States on account of **CLOTHING**.

There is to be stopped from him, on account of the State of _____, or other
 authorities for **CLOTHING, &c.**, received on entering service, _____ $\frac{100}{100}$ dollars; also,
 for expenses of **SUBSISTENCE** for **TRAVELING** from place of enrollment to the place of rendezvous,
 amounting to _____ $\frac{100}{100}$ dollars: and on account of the United States for **EXTRA**
CLOTHING received in kind from _____ and for other
 stoppages, viz:

One Cartridge Box, Belt & Plate, one Waist Belt & Plate,
one Haversack amounting to Two $\frac{59}{100}$ dollars;
 and he has been **SUBSISTED** for **TRAVELING** to his place of enrollment, up to the _____
 _____, 1863.

He is indebted to _____, **SUTLER**, _____ $\frac{100}{100}$ dollars.
 He is indebted to _____, **LAUNDRESS**, _____ $\frac{100}{100}$ dollars.

Given in Duplicate, at Camp near Fort Monro, this 26th day of October, 1863.

John J. Eberhardt
4th Regt U. S. C. V.
 Commanding Company.

120

Jonaharte Jerome

Co C., 4 U.S. Col'd Inf.

Private | *Corporal*

CARD NUMBERS.

1	5554517	26
2	5554601	27
3	5554703	28
4	5554805	29
5	5554899	30
6	5554990	31
7	5555080	32
8	5555161	33
9	5555235	34
10	5555304	35
11	5555400	36
12	5555494	37
13	5555677	38
14	5556039	39
15	5550861	40
16	9061898	41
17		42
18		43
19		44
20		45
21		46
22		47
23		48
24		49
25		50

Book Mark:

See also

B | 4 | U.S.C.T.

Jerome Bonaparte
 , Co. "C", 4 Reg't U. S. Col'd Inf.

Appears on
Company Descriptive Book
 of the organization named above.

DESCRIPTION.

Age *22* years; height *5* feet *10* inches.
 Complexion *Black*
 Eyes *Black*; hair *Black*
 Where born *Balto. Md.*
 Occupation *waiter.*

ENLISTMENT.

When *July 15*, 18*63*.
 Where *Balto. Md.*
 By whom *Col. Wm. Binney*; term *3* y'rs.
 Remarks: *Discharged for dis-*
ability June 26/65.

J. A. M.

D

4

U.S.C.T.

Jerome Bonaparte

Corp, Co. C, 4 Reg't U. S. Col'd Infantry.

Age *22* years.

Appears on

Company Muster-in Roll

of the organization named above. Roll dated

Baltimore Md. July 24 186*3*

Muster-in to date *July 24, 1863*.

Joined for duty and enrolled:

When *July 15*, 186*3*

Where *Baltimore Md*

Period *3* years.

Remarks:

Book mark:

(356)

Talbott
Copyist.

D

4

U.S.C.T.

Jerome Guaparte Corp, Co. C. 4 Reg't U. S. Col'd Infantry.

Appears on

Company Muster Roll

for *July 12 to Aug 31*, 186*3*

Present or absent *Present*

Stoppage, \$ *100* for

Due Gov't, \$ *100* for

Remarks: *Two dollars pre-
mium due*

Book mark:

(358)

Talburt

Copyist.

D

4

U.S.C.T.

Jerome Bonaparte
Corp, Co. C. 4 Reg't U. S. Col'd Infantry.

Appears on

Company Muster Roll

for *Sept & Oct*, 186*3*.

Present or absent *Present*

Stoppage, \$ *100* for

Due Gov't, \$ *100* for

Remarks:

Book mark:

Talborth
Copyist.

(358)

D

4

U.S.C.T.

Jerome Bonaparte
Corp, Co. C. 4 Reg't U. S. Col'd Infantry.

Appears on

Company Muster Roll

for *Nov & Dec*, 186*3*

Present or absent *Present*

Stoppage, \$ *100* for

Due Gov't, \$ *100* for

Remarks:

Book mark:

Talbot

(358)

Copyist.

D

4

U.S.C.T.

Jerome Bonaparte
Corp, Co. C. 4 Reg't U. S. Col'd Infantry.

Appears on

Company Muster Roll

for *Jacques & Heby*, 1864.

Present or absent *Present*

Stoppage, \$ *100* for

Due Gov't, \$ *100* for

Remarks: *Stoppage for loss of ordnance \$0.22*

Book mark:

Talbot

(358)

Copyist.

B

4

U.S.C.T.

Jerome Bonapart
Corpl, Co. C. 4 Reg't U. S. Col'd Infantry.

Appears on

Company Muster Roll

for *March & April* 1864.

Present or absent *Present*

Stoppage, \$ *100* for

Due Gov't, \$ *100* for

Remarks:

Book mark:

J. Davis

B

4

U.S.C.T.

Jerome Bonaparte

Cospl, Co. C. 4 Reg't U. S. Col'd Infantry.

Appears on

Company Muster Roll

for *May & June*, 1864.

Present or absent *Absent*

Stoppage, \$ *100* for

Due Gov't, \$ *100* for

Remarks: *Absent sick,
wounded near Petersburg
Va, June 15th 1864*

Book mark:

(858)

G. Davis

Copyist.

B | 4 | U.S.C.T.

Jerome Bonaparte
Corpl, Co. C. 4 Reg't U. S. Col'd Infantry.

Appears on

Company Muster Roll

for *July + Aug*, 186*4*.

Present or absent *Absent*

Stoppage, \$ *100* for

Due Gov't, \$ *100* for

Remarks: *Status not ascertained*
Absent since June 15th
1864.

Book mark:

(358)

J. S. Davis
Copyist.

B

4

U.S.C.T.

Jerome Bonaparte
Corpl, Co. C. 4 Reg't U. S. Col'd Infantry.

Appears on

Company Muster Roll

for *Sept + Oct*, 186 *4*.

Present or absent *Present*

Stoppage, \$ *100* for

Due Gov't, \$ *100* for

Remarks: *Slavv Paid in Hosp by*
Mag Walker for may + June
\$36.00

Book mark:

(358)

Godavis

Copyist.

B 4 U.S.C.T.

Jerome Bonaparte
Corpl, Co. C. 4 Reg't U. S. Col'd Infantry.

Appears on

Company Muster Roll

for Nov + Dec, 1864

Present or absent Present

Stoppage, \$ 100 for

Due Gov't, \$ 100 for

Remarks: Slavr: Paid in Hosp. by
Maj' Walker for May + June
\$36.00. Present sick

Book mark:

(358)

Godwin

Copyist.

B

4

U.S.C.T.

Jerome Bonaparte
 Corp'l, Co. C. 4 Reg't U. S. Col'd Infantry.

Appears on

Company Muster Roll

for *Jan'y & Feby*, 1865.

Present or absent *Present*

Stoppage, \$ 100 for

Due Gov't, \$ 100 for

Remarks: *Slave Paid in Hosp't by Maj Walker for May & June \$36.00 Stop wages 20/100*

Book mark:

Permyington

(858)

Copyist.

B

4

U.S.C.T.

Jerome Bonaparte
Corpl. Co. C. 4 Reg't U. S. Col'd Infantry.

Appears on

Company Muster Roll

for *March & April*, 1865.

Present or absent *Absent*

Stoppage, \$ *100* for

Due Gov't, \$ *100* for

Remarks: *Absent sick*
Promoted to Corpl.
July 15/63. Paid in
stoppt. for May & June
\$32.00 by Maj. Walker
stop wipes 20/100

Book mark: *C*

Perrington
Copyist

B

4

U.S.C.T.

Jerome Bonaparte
Corpl, Co. C. 4 Reg't U. S. Col'd Infantry.

Appears on

Company Muster Roll

for *May & June*, 1865.

Present or absent

Stoppage, \$ 100 for

Due Gov't, \$ 100 for

Remarks: *Mustered out of*
Service at Goldsboro N.C.
Under the Provisions of
G. O. No. 37, Dated Hd. Qrs.
Dept. N.C. May 8" 1865.

Book mark: *16107*
Dis } *April 24/68 JFM.*
Discharged June 26/65. see M.O.R.

Permyington

(358)

Copyist.

73 | 4 | **U.S.C.T.**

Jerome Bonapart
Capt, Co. 4, Reg't U. S. Col'd Infantry.

Appears on a

Detachment Muster-out Roll

of the organization named above. Roll dated

Goldboro NC June 26, 1865.

Muster-out to date

June 26, 1865.

Last paid to

Feb 29, 1864

Clothing account:

Last settled 186 ; drawn since \$ 100

Due soldier \$ 100 ; due U. S. \$ 100

Am't for cloth'g in kind or money adv'd \$ 100

Due U. S. for arms, equipments, &c., \$ 100

Bounty paid \$ 100 due \$ 100

Remarks: Clothing account never
settled clothing drawn since
Enlistment stop ⁴⁸ 20
no pay May + June 1865. received
while in Hospital stop 20th for
wiper lost. Back pay due this
over

Book mark :

Jacobson

JAN. 19

5550861

1891

Soldier from Enrollment
to July 29/64 at rate of \$6⁰⁰
per month Corporal from date
of Muster In, Free Apr 19/61
Duo W. S. Cooper letter 4.26.61
C. T. \$11⁰⁰ wounded in action
June 15, 1864. Patient in
Hospital Mustered out under
G.O. No 37. Hd Qrs Dept Mc
May 5, 1865 Transportation
due from place of discharge
to place of Enrollment

B | 4 | U.S.C.T.

Jerome Bonaparte
Capt, Co. C, 4 Reg't U. S. Col'd Infantry.

Appears on Co. Muster-out Roll, dated
Washington, DC May 4, 1866.

Muster-out to date _____, 186 .

Last paid to _____, 186 .

Clothing account:

Last settled _____, 186 ; drawn since \$ _____ 100

Due soldier \$ _____ 100; due U. S. \$ _____ 100

Am't for cloth'g in kind or money adv'd \$ _____ 100

Due U. S. for arms, equipments, &c., \$ _____ 100

Bounty paid \$ _____ 100; due \$ _____ 100

Remarks: *Discharged*
Jan 26/65 at Golds-
borough, N.C., by
GO No 37 HD Ins
Sept N.C. for disability

Book mark: *1610 Dis Apl 24/64*
V 225. P 237. 76

(861)

R Johnson
Copyist.

Bonapart, Jerome

P. B. 4 **U.S.C. Inf.**
 , Co. *B. 4* , Reg't

Enclosures.

Bed Cards	Descriptive Lists
Burial Records	Final Statements
Certs. of Dis. for Discharge	Furloughs
C. M. Charges	Med. Des. Lists
Med. Certificates	Orders

Other papers relating to—

Admission to Hosp'l	Furlough
Casualty Sheet (Officer's)	Med. Examination
Confinement	Misc. Information <i>/</i>
Contracts	Pay or Clothing
Death or Effects	Personal Reports
Desertions	Rank
Discharge from Hosp'l	Transfer to Hosp'l
Discharge from Service	Transfer to V. R. C.
Duty	Transportation

MICROFILM PUBLICATION M 1846

COMPILED MILITARY SERVICE RECORDS
OF VOLUNTEER UNION SOLDIERS WHO SERVED WITH
THE UNITED STATES COLORED TROOPS (USCT)
4TH REGIMENT OF INFANTRY

PERSONAL PAPERS' TARGET SHEET

PLEASE NOTE THE CHECKED INFORMATION ABOUT THE PERSONAL PAPERS IN
THIS FILE:

- NO PERSONAL PAPERS WERE FOUND IN THIS FILE WHEN THE
RECORDS WERE ARRANGED FOR MICROFILMING.
- 7 PERSONAL PAPER(S) FOUND IN THIS FILE WHEN THE RECORDS
WERE ARRANGED FOR MICROFILMING.

Baltimore, Sept. 24, '63.

I hereby certify that Jerome Bonaparte,
aged 22 years, was by me duly mus-
tered into the service of the United
States for three years unless sooner
discharged, as Corporal of Co. G,
4th Regiment U.S. Colored Troops.

William Birney,
Colonel Comd^g U.S.C.T.,
Mustering Officer.

24

A.D. May 9. 1864

I certify that the name of
Jerome Bonaparte is borne on the
muster in Roll of Company 30th
Art Regt U S Cavalry on
file in this office

MA

J. W. Faggan
Act Adj't Genl

No 2
Eliz Stevens
for
Jerome Bonaparte

A.

No. 2

CLAIMANT'S CERTIFICATE.

I, Elizabeth Stephens a loyal citizen, and a resident
of Baltimore City, County of _____, State of
Maryland, hereby claim compensation, under the provisions of
General Orders, No. 329, 1863, for my slave Lerome Bonaparte
enlisted April 1863, at Baltimore
by Col W. D. Barney in the H 3
Regiment U. S. Colored Troops, Co. B; certificate of which enlistment, and a
descriptive list, as required, accompany this application.

In proof of my loyalty to the Constitution and Government of the United States, I
present the accompanying oath, which I have taken, signed, and acknowledged, to be filed
with this application, in accordance with requirement of said General Orders.

Elizabeth Stephens

Baltimore City, Jan'y 23 1864

B.

OATH OF ALLEGIANCE.

I, Elizabeth Stephens, do solemnly swear that I have never joined, or been concerned in, any insurrection or rebellion; that I have never borne arms against the United States; that I have never given any aid, countenance, counsel, or encouragement to any person or persons engaged, or whom I had reason to believe were about to engage, in insurrection, rebellion, or armed hostility against the United States; that I have neither sought, nor accepted, nor attempted to exercise the functions of any office, civil or military, nor to perform any service whatever, under any authority or pretended authority in hostility to the United States; that I have not yielded a voluntary support to any insurrection, rebellion, or pretended government, authority, power, or constitution within the United States hostile thereto. And I do further swear that, to the best of my knowledge and ability, I have supported and defended, and will continue to support and defend, the United States against all enemies, foreign and domestic; and that I have supported, defended, and obeyed, and will continue to support, defend, and obey, the Constitution and laws of the United States; that I will bear true faith and allegiance to the same; and that I take this oath freely, without any mental reservation or purpose of evasion: So help me God.

Elizabeth Stephens

Sworn to and subscribed before me, at

this 23 day of January 1864

Daltman
W. B. Daltman
Daltman



C.

I present herewith evidence of my title to the slave Lerome Bonaparte enlisted as aforesaid, and in consideration of the sum of _____ by me received, I hereby covenant and agree with the United States, that I, my heirs, executors, or assigns, shall never hereafter make or enforce any claim to the labor or services of said slave; and pledge myself to execute a valid Deed of Manumission and Release of all my claims to service forever of said Lerome Bonaparte to be filed with the Board of Claims now in session at Daltman

Daltman Jan 23 1864

Elizabeth Stephens

A.

No. 2

CLAIMANT'S CERTIFICATE.

I, Elizabeth Stephens a loyal citizen, and a resident
of Baltimore City, County of _____, State of
Maryland, hereby claim compensation, under the provisions of
General Orders, No. 329, 1863, for my slave Lerome Bonaparte
enlisted March 1863, at Baltimore
by Col W. D. Barney in the H 3
Regiment U. S. Colored Troops, Co. B; certificate of which enlistment, and a
descriptive list, as required, accompany this application.

In proof of my loyalty to the Constitution and Government of the United States, I
present the accompanying oath, which I have taken, signed, and acknowledged, to be filed
with this application, in accordance with requirement of said General Orders.

Elizabeth Stephens

Baltimore City Jan'y 23 1864

231. South Street
S. No. 21. D. C. No. 1864.

No. 2 No. 45.

APPLICATION OF

Mrs. Elizabeth Stephens

OF

Baltimore

For Compensation for Service of Slave,

Jerome Bonaparte

Enlisted in Fourth Regiment

U. S. Colored Troops, Co. B.

Received, January 23d, 1864.

COMPENSATION AWARDED,

May 3rd 1864.

Three Hundred Dollars.

J. F. Streetes.

Presdt Bd of Claims.

J. H. Hill

Recd. A. G. O. May 8. 1864.

War Department.

A. G. O. Washington D. C.

June 2. 1864.

Respectfully returned for evidence
that the bounty due the recruit from
the State of Maryland has been paid.

By order:

R. G. Denwick,
Capt. 1st Regt. U. S. Col. Troops,
U. S. Army.

Recd back A. G. O. Sept. 13. 1864

Received from Mrs. Stephens

EVIDENCE OF TITLE.

I, *Elizabeth Stevens*, of *Patterson*
 County, Md., do solemnly swear that *Jerome Bonaparte*
 who has been enlisted in the *4th* Regiment, U. S. Colored Troops,
 Co. *C*; is my slave for *life*; (~~his term of service expiring on~~
~~the~~ ~~day of~~ *186*;) and that
 I became possessed of him by *Inheritance*, in the month
 of _____, eighteen hundred and *forty*. And I
 do further swear that I have not purchased said slave from any person or persons disloyal
 to the Government of the United States, with the object of obtaining compensation for
 the same; and furthermore, that I have no agency for obtaining compensation for any per-
 son or persons but such as, to my knowledge, are loyal citizens of the United States.

Patterson May 23.

Elizabeth Stevens
1864

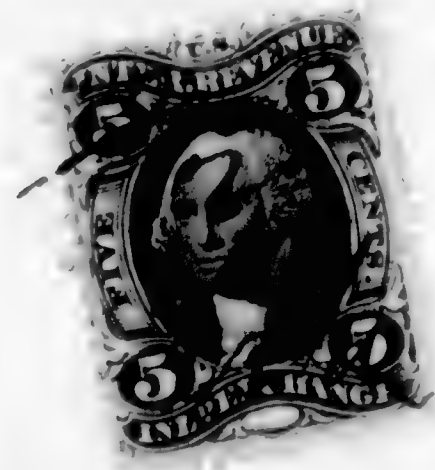

STATE OF MARYLAND.

Baltimore City County, to wit:

On this *23* day of *January* in the year 1864,

before me, the subscriber, a Justice of the Peace of the State and County aforesaid, personally appeared *Elizabeth Stephens*, and took, signed, and acknowledged the oaths preceding; and further made oath, in due form of law, that all the statements made in this application are, to the best of *her* knowledge and belief, strictly true. Also personally appeared before me *Edwin C. Kirkwood* and *Miah Minnick*, loyal citizens of the United States, residents of *Baltimore City*, well acquainted with the said *Elizabeth Stephens*, and in no manner interested in the prosecution of this claim, and made oath, in due form of law, that the said *Elizabeth Stephens* is the owner of the slave *Lerome Bonaparte* as a fact of public notoriety; that they believe all the statements herein made by *her*, in reference thereto, are correct, and that *she* is unquestionably loyal to the Government of the United States. Witness their signatures:

Edwin C. Kirkwood
Miah Minnick
Justice of the Peace.



Wm. Hayward

STATE OF MARYLAND,

Baltimore City County, to wit:

I, *Alford Mace*, Clerk of the ^{*Superior*} ~~Circuit~~ Court for *Baltimore City*, do hereby certify that *William H. Hayward*

before whom the foregoing affidavits were made, was, at the time of signing the same, a Justice of the Peace for the ~~County~~ ^{*City*} and State aforesaid, duly commissioned and sworn; and that his signature thereto is genuine, and that full faith and credit should be given to his official acts.

Witness my hand and the seal of said Court, this *28th* day of *April*, A. D. 1864.



Alford Mace CLERK.

*Alford Mace Clerk
Superior Court*

E.

Deed of Manumission and Release of Service.

WHEREAS my slave Jerome Bonaparte has enlisted in the service of the United States: now, in consideration thereof, I, Elizabeth Stephens, of Baltimore City county, State of Maryland, do hereby, in consideration of said enlistment, manumit, set free, and release the above-named Jerome Bonaparte from all service due me; his freedom to commence from the July 1863, the date of his enlistment as aforesaid in the A Regiment of Colored Troops, in the service of the United States.

Witness my hand and seal, this 27th day of April, 1864.

Elizabeth Stephens 

WITNESS:

Thos B Gaither
John W Peale
W W Carter

Baltimore City County,
State of Maryland, 1864.

Before me appeared this day Elizabeth Stephens and acknowledged the above Deed of Manumission and Release of Service to be ^{her} ~~his~~ free act and deed.

Alford Mace *clerk*

Received for record 27th April 1864; same day recorded and examined,

Per Alford Mace
Clerk of the Superior Court of Baltimore City.

In Testimony that the foregoing is a true copy taken from the Original, I herunto subscribe my name and affix the seal of the Superior Court of Baltimore City, this 27th day of April A. D. 1864.

Alford Mace
Clerk of the Superior Court of Baltimore City.

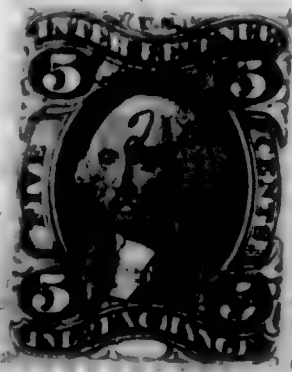

F.

CERTIFICATE OF AWARD OF THE BOARD OF CLAIMS.

Office of the Board of Claims

For Slaves Enlisted in the Service of the United States,

Baltimore Md

May 3^d 1866

No 72

\$300-

We hereby certify, that Elizabeth Stephens, of Baltimore City, ~~county~~, State of Maryland, having proved, under oath, her loyalty to the Constitution and Government of the United States, and established her title as to the ownership of Jerome Bonaparte, a slave enlisted at Baltimore Md on the 15th day of July, 1863, by Col Wm. Birney, in the service of the United States, in the Fourth Regiment of Colored Troops, Co. C, and having filed a valid Deed of Manumission and Release of Service of said slave, is entitled to the sum of Three Hundred dollars, which has been awarded to her by this Board as a remuneration for all claim to the future labor or service of said slave, under the provision of General Orders, War Department, No. 329, 1863.

J. F. Steller

President of the Board.

Wm. F. Simmon

Member of the Board.

L. E. Staughn

Member of the Board.

To Maj C. W. Foster

Chief of the Bureau for the

Organization of Colored Troops, Washington, D. C.

Stephens
45.

No. .

ABSTRACT OF DISBURSEMENTS.

....., 186 .

Mrs Elizabeth Stephens.

Dollars *300* $\frac{00}{100}$

Paid , 186 .

The United States,

To Elizabeth Stephens Dr.

186 .		DOLLARS.	CENTS.
	For amount awarded him by the Board of Claims, in consideration of the enlistment of <i>Jerome Bonaparte</i> in the <i>4th Regt U. S. Colored Troops</i>	300	00
	<i>Total \$</i>	<i>300</i>	<i>00</i>

I CERTIFY that the above account is correct and just; that the name of *Jerome Bonaparte* is borne on the muster-in rolls of the *4th Regt U. S. Colored Troops*; and that the above amount was awarded by the Board of which *S. F. Street* Esq is President, said award being in accordance with section 24 of the act entitled "An act to amend an act entitled 'An act for enrolling and calling out the national forces, and for other purposes,'" approved Feb. 24, 1864.

Assistant Adjutant General.

RECEIVED
Three Hundred , 186 , of *Capt S. G. Benedict, Asst. Adj. Gen.* dollars and _____ cents, in full of the above account.

Elizabeth Stephens

(SIGNED DUPLICATES.)

45.

No. .

ABSTRACT OF DISBURSEMENTS.

....., 186 .

Mrs. Elizabeth Stearns

Dollars *317* ^{*00*}/₁₀₀

Paid, 186 .

The United States,

To Elizabeth Stephens Dr.

186 .		DOLLARS.	CENTS.
	For amount awarded him by the Board of Claims, in consideration of the enlistment of <i>Jerome Bonaparte</i> in the <i>4th Regt U.S. Colored Troop</i>	<i>300</i>	<i>00</i>
	<i>Total \$</i>	<i>300</i>	<i>00</i>

I CERTIFY that the above account is correct and just; that the name of *Jerome Bonaparte* is borne on the muster-in rolls of the *4th Regt U.S. Colored Troop*; and that the above amount was awarded by the Board of which *S. F. Street* Esq. is President, said award being in accordance with section 24 of the act entitled "An act to amend an act entitled 'An act for enrolling and calling out the national forces, and for other purposes,'" approved Feb. 24, 1864.

Assistant Adjutant General.

RECEIVED _____, 186 , of *Capt S. F. Benedict, A. A. G., Col.*
Three Hundred dollars and _____ cents, in full of the above account.

Elizabeth Stephens

(SIGNED DUPLICATES.)

121

Pond, George

Co C, 4 U.S. Col'd Inf.

Private | *Captain*

CARD NUMBERS.

1	5554528	26
2	5554614	27
3	5554714	28
4	5554817	29
5	5554910	30
6	5555002	31
7	5555090	32
8	5555167	33
9	5555240	34
10	5555309	35
11	5555405	36
12	5555497	37
13	5555684	38
14	5556038	39
15	9061889	40
16		41
17		42
18		43
19		44
20		45
21		46
22		47
23		48
24		49
25		50

Book Mark:

See also

J-949173-PO, MxM

B | **4** | **U.S.C.T.**

George Bond
 , Co. *"E"*, 4 Reg't U. S. Col'd Inf.

Appears on

Company Descriptive Book

of the organization named above.

DESCRIPTION.

Age *24* years; height *5* feet *10* inches.

Complexion *black*

Eyes *black*; hair *black*

Where born *Balto. Md.*

Occupation *laborer*

ENLISTMENT.

When *July 15*, 18*63*.

Where *Balto. Md.*

By whom *Col. Wm. Birney*; term *3* y'rs.

Remarks: *Discharged June 7/65*
at U. S. A. Gen. Hopt.
Bristol Bucks Co. Pa.

Hand

9

4

U.S.C.T.

George Bond
Priv., Co. C, 4 Reg't U. S. Col'd Infantry.

Age 24 years.

Appears on

Company Muster-in Roll

of the organization named above. Roll dated

Baltimore Md July 24 1863.

Muster-in to date

July 24, 1863.

Joined for duty and enrolled:

When July 15, 186

Where Baltimore Md

Period 3 years.

Remarks:

Book mark:

(356)

Talbot
Copyist.

D

4

U.S.C.T.

George Bond

Priv, Co. C. 4 Reg't U. S. Col'd Infantry.

Appears on

Company Muster Roll

for *July 12 To Aug 31*, 1863.

Present or absent *Present*

Stoppage, \$ *100* for

Due Gov't, \$ *100* for

Remarks: *Two dollars pre-
mium due.*

Book mark:

Talbott

(358)

Copyist.

D

4

U.S.C.T.

George Bondy

Priv., Co. C. 4 Reg't U. S. Col'd Infantry.

Appears on

Company Muster Roll

for Sept & Oct, 1863.

Present or absent Present

Stoppage, \$ 100 for

Due Gov't, \$ 100 for

Remarks:

Book mark:

Talborth

(358)

Copyist.

D

4

U.S.C.T.

George Bond

Priv, Co. C. 4 Reg't U. S. Col'd Infantry.

Appears on

Company Muster Roll

for *Nov & Dec*, 186*8*.

Present or absent *Present*

Stoppage, \$ *100* for

Due Gov't, \$ *100* for

Remarks:

Book mark:

Talbot

D

4

U.S.C.T.

George Bond
Priv, Co. C. 4 Reg't U. S. Col'd Infantry.

Appears on

Company Muster Roll

for *Jacoby & Peby*, 1864.

Present or absent *Present*

Stoppage, \$ 100 for

Due Gov't, \$ 100 for

Remarks:

Book mark:

(858)

Talbot
Copyist.

B | 4 | U.S.C.T.

George Bond
Pvt., Co. C. 4 Reg't U. S. Col'd Infantry.

Appears on

Company Muster Roll

for *March + Apr*, 186 *4*.

Present or absent *Present*

Stoppage, \$ *100* for

Due Gov't, \$ *100* for

Remarks:

Book mark:

(858)

Geo Davis

Copyist.

B

4

U.S.C.T.

George Bond
Pvt., Co. C. 4 Reg't U. S. Col'd Infantry.

Appears on

Company Muster Roll
for May & June, 1864

Present or absent Present

Stoppage, \$ 100 for

Due Gov't, \$ 100 for

Remarks:

Book mark:

(358)

J. W. Davis

Copyist.

B 4 U.S.C.T.

George Bond
Corpl

Co. C. 4 Reg't U. S. Col'd Infantry.

Appears on

Company Muster Roll

for July & Aug, 1864.

Present or absent Present

Stoppage, \$ 100 for

Due Gov't, \$ 100 for

Remarks: Slave, Appointed
Corpl Aug 1st by S. O.
No. 34.

Book mark:

JWS Davis

D | **4** | **U.S.C.T.**

George Bond
Corpl, Co. C. 4 Reg't U. S. Col'd Infantry.

Appears on

Company Muster Roll
for *Sept & Oct*, 186*4*.

Present or absent *Absent*

Stoppage, \$ *100* for

Due Gov't, \$ *100* for

Remarks: *Slav. Appointed*
Corpl Aug 1st/64 S.O.No.
(34) ab. wounded

Book mark: _____

(358)

J. W. Davis

Copyist.

B | 4 | U.S.C.T.

George Bond
Corpl, Co. C. 4 Reg't U. S. Col'd Infantry.

Appears on

Company Muster Roll
for *Nov & Dec*, 1864.

Present or absent *Absent*

Stoppage, \$ *100* for

Due Gov't, \$ *100* for

Remarks: *slav. Appointed*
Corpl Aug/64 S.O. No. 134

Book mark:

(358)

Geo Davis

Copyist.

B

4

U.S.C.T.

George Bond

Corpl, Co. C. 4 Reg't U. S. Col'd Infantry.

Appears on

Company Muster Roll

for *Jany & Feby*, 1865.

Present or absent *Present*

Stoppage, \$ *100* for

Due Gov't, \$ *100* for

Remarks: *Slave,*

Book mark:

Pennington

(358)

Copyist.

B

4

U.S.C.T.

George Bond

Cos. C. 4 Reg't U. S. Col'd Infantry.

Appears on

Company Muster Roll

for *March & April*, 1865.

Present or absent *Absent*

Stoppage, \$ *100* for

Due Gov't, \$ *100* for

Remarks: *Absent sick -*

*Promoted to
Cospl. Aug. 6/64.*

Book mark:

(358)

Pennings

Copyist.

B

4

U.S.C.T.

George Bond

Corpl, Co. C. 4 Reg't U. S. Col'd Infantry.

Appears on

Company Muster Roll

for *May & June*, 1865.

Present or absent

Stoppage, \$ 100 for

Due Gov't, \$ 100 for

Remarks:

Mustered out of service at U.S. G. Hoapt. Bristol Pa. June 7th 1865. on Surgeons certificate of disability.

Book mark:

Perrington

(358)

Copyist.

B | 4 | U.S.C.T.

George Bond
Capt. Co. C, 4 Reg't U. S. Col'd Infantry.

Appears on Co. Muster-out Roll, dated
Washington D.C., May 4, 1866.

Muster-out to date _____, 186 .

Last paid to _____, 186 .

Clothing account:

Last settled _____, 186 ; drawn since \$ _____ 100

Due soldier \$ _____ 100; due U. S. \$ _____ 100

Am't for cloth'g in kind or money adv'd \$ _____ 100

Due U. S. for arms, equipments, &c., \$ _____ 100

Bounty paid \$ _____ 100; due \$ _____ 100

Remarks: Discharged
Jan 7, 1868 at U.S.
Genl Hospital
Bristol Pa on Surg
Cert.

Book mark: V 166 P 22, - 73

(861)

R Johnson
Copyist.

Bond, George

Al, Co. C, 4 Reg't U.S.C.I.

3 Enclosures.

Red Cards	/	Descriptive Lists
Burial Records		Final Statements
Certs. of Dis. for Discharge	/	Furloughs
C. M. Charges		Med. Des. Lists
Med. Certificates		Orders

Other papers relating to—

Admission to Hosp'l	Furlough
Casualty Sheet (Officer's)	Med. Examination
Confinement	Misc. Information
Contracts	Pay or Clothing
Death or Effects	Personal Reports
Desertions	Rank
Discharge from Hosp'l	Transfer to Hosp'l /
Discharge from Service	Transfer to V. R. C.
Duty	Transportation

368
Hospital Number 4641.30 262

Name George Bond Sgt

Age 26 Nativity Md

Married or Single Married

Residence Baltimore

Post Office address of wife or nearest relative. No. 2, Saratoga St
A. R. Bond Wife

Bank Corp Co. 6 Regiment 4 USG

When admitted Oct 1864

From what source Hampton Hosp

Diagnosis: (in surgical cases state explicitly seat and character of wound or injury.)

Gsw of R. Hip
Ash

Summit House G. H.
Philadelphia, Pa.

On what occasion wounded Sep Bottom

Date Sept 29/64

Nature of missile or weapon M Ball

TREATMENT.

[HERE NOTE IMPORTANT COMPLICATIONS AND ALL OPERATIONS.]

Cold Water Dressing
Permaning, Potas. Iod.

RESULT AND DATE.

Trans to Wood Dec. 3-44

J. A. Buchanan

Transferred to ^{Asper} 4th Ward

Feb. 8-55 Le. Dr. Robinson

Transferred to 1st Ward

M.S.A. Gen. Hospital

March 29 1864
J. A. Buchanan

B 1301-800-64
Baltimore Md
Oct 20 64
Mrs Rebecca Bond
For transfer of Corp Geo
Bond 4 West to
Baltimore
Rd to Transfer to H
Summit House Pa

MEDICAL DIRECTOR'S OFFICE,
DEPT. OF THE SUSQUEHANNA,
PHILA., PA. Oct 23 1864.

Respectfully referred to the Surgeon in Charge
of Summit House Hospital for
report and
recommendation

To be returned with report.
BY ORDER OF THE MEDICAL DIRECTOR.

Wm. H. Green
Asst. Surgeon U. S. Army.

Md. Genl. Hospital
Summit House, Phila.
October 24 1864.

Respectfully returned, with
the report, that the within
named man is too severely
wounded, to bear transpor-
tation with safety in a less
period of time than twenty
(20) days.

A. Taylor
Surgeon U.S.A.
in charge

L. H. E. B
Aug 19.

Respectfully returned
to the Surgeon Gen-
-eral U.S.A. whose atten-
tion is invited to the
Endorsement of Surg.
Taylor U.S.A. in charge
Summit House, Genl
Hospital.

John Campbell
Surgeon U.S.A.
Med. Dir.
M.H.
Oct 25 1864

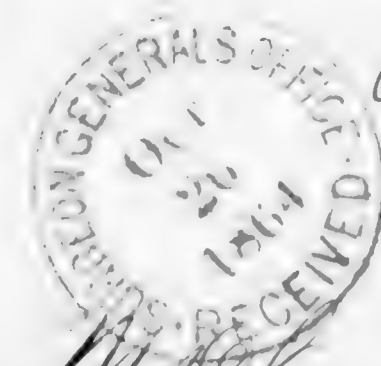

Respectfully referred to Medical
Director *Campbell* for
report and recommendation.

By order of the Surgeon General:
S. G. O. } *L. A. Crane*
Oct 22 1864. } Surgeon, U. S. A.



Baltimore Oct. 21st 1844

Brig. Genl. I. H. Tamm
 Surgeon, Genl. U. S. A.
 Washington D. C.

Dear Sir,

Will you have the kindness to
 transmit my husband, George Bond Junr Co. "C" 4th U. S.
 Cavalry Regt, who is now a Patient at Summit ^{House} U. S. Genl.
 Hospital at or near Philadelphia Pa. to the same U. S.
 Genl Hospital in this city.

My husband was wounded at the Battle of Gettysburg
 a few weeks since and was so taken up by his wounds for several
 months, my circumstances & duties will not permit me to
 visit him at that City.

In granting the above application you will
 confer on the Sir in much business.

Very Respectfully

Ann. Rebecca Bond

NOTE 1.

The company commander will here add a statement of all the facts known to him concerning the disease or wound, or cause of disability of the soldier; the time, place, manner, and all the circumstances under which the injury occurred, or disease originated or appeared; the duty, or service, or situation of the soldier at the time the injury was received or disease contracted, stating particularly whether the injury was received or the disease contracted in the line of his duty; and whatever other facts may aid a judgment as to the cause, immediate or remote, of the disability, and the circumstances attending it.

When the facts are not known to the company commander, the certificate of any officer, or affidavit of other person having such knowledge, will be appended—as the surgeon in charge of a hospital, the officer commanding a detachment of recruits, &c., &c.

NOTE 2.

When a probable case for pension, special care must be taken to state the degree of disability—as 1, 2, &c., &c.; to describe particularly the disability, wound, or disease; the extent of which it deprives him of the use of any limb or faculty, or affects his health, strength, activity; constitution, or capacity to labor or earn his subsistence. The surgeon will add, from his knowledge of the facts and circumstances, and from the evidence in the case, his professional opinion of the cause or origin of the disability. In the case of discharges by Medical Inspectors, the last paragraph will state that the "discharge was given by consent of the soldier, after a personal examination, and for disability, the nature, degree, and origin of which are correctly described in the within certificate."

Par. 1260, Regulations, Edit. 1861.

Medical officers, in giving certificates of disability, are to take particular care in all cases that have not been under their charge; and especially in epilepsy, convulsions, chronic rheumatism, derangement of the urinary organs, ophthalmia, ulcers, or any obscure disease liable to be feigned or purposely produced; and in no case shall such certificate be given until after sufficient time and examination to detect any attempt at deception.

DIRECTIONS.

This certificate will be made out in duplicate by the soldier's company commander, or other officer commanding the separate detachment to which he belongs, and sent by him to the surgeon who has charge of the hospital where the soldier is sick. The surgeon will then fill out and sign the surgeon's certificate, and forward these papers to the regimental, detachment, or post commander, who will forward them, with his action endorsed thereon, through the proper channel, to his division commander; or, if the troops are not attached to a division, to his corps, department, or other commander or officer to whom the authority to discharge enlisted men may be specially delegated.

These certificates, after having received the action of the highest authority to which they are required to be sent, will be returned through the same channel to the regimental, post, or detachment commander, who will, if the discharge is authorized by the endorsement of the proper authority, sign the soldier's discharge, and the last certificate on this paper; see that the soldier is furnished with the proper final statements in duplicate, and forward BOTH of these certificates direct to the Adjutant General United States Army, at Washington, D.C., they will not, under any circumstances, be given into the hands of the soldier.

ADJUTANT GENERAL'S OFFICE

REC'D
MAY 31 1865
DEPT. OF PENN.

June 13 1865
sent the Pension Office.

CERTIFICATE OF DISABILITY FOR DISCHARGE

IN THE CASE OF

B. 25. H. of Dis. 4
1865
George Bonch
a *Coopers & Co. "B"*
4th Reg't of *W. Colored*

APPROVED
John C. Pen
COLONEL, U.S.A.,
MEDICAL DIRECTOR,
DEPT. OF PENNSYLVANIA.

Received (A. G. Office) 186

Edw. H. Hooper
ADJUTANT GENERAL'S OFFICE

HEAD QUARTERS
DEPT OF PENNSYLVANIA
PHILADELPHIA PA.

JUN. 2 1865

TO BE DISCHARGED THE
UNITED STATES SERVICE

BY COMMAND OF
MAJ. GEN. CADWALADER.

J. E. Montgomery
ASST ADJT GENL.

IV
SB.
202

ARMY OF THE UNITED STATES
CERTIFICATE
OF DISABILITY FOR DISCHARGE.

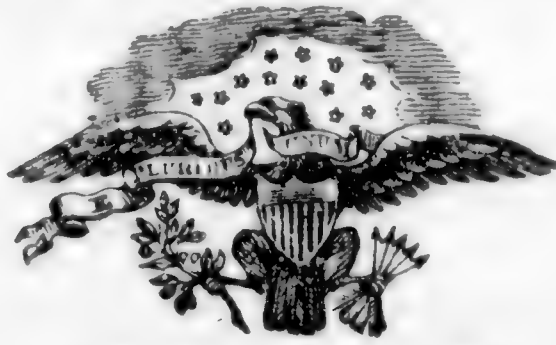

George Bond a Corporal of Captain St. H. Mubler
Company, (B) of the 4th US Colored Regiment of the United States
Volunteers was enlisted by Col. Wm. Ganney and mustered into
the Service Regiment of the US at Baltimore MD
on the Fifteenth day of July 1863, to serve three years; he was born
in Baltimore State of Maryland, is Twentyfour
years of age Five inches high, Black complexion, Blue eyes,
Black hair, and no tattoo when enlisted a Laborer. During the last two
months said soldier has been unfit for duty days. was admitted to this
Hospital May 12th/65 with Gun shot wound of right
hip recd. in battle at Dept Bottom Va Sept 29th 1864

STATION: White Hall Md Hospital
DATE: May 30th 1865

W. W. Wood
Commanding Company

I CERTIFY, that I have carefully examined the said George Bond
of Captain St. H. Mubler's Company, and find him incapable of performing the duties of a
soldier because of injury to formation to formation
of right hip from gun shot wound
recd in battle Dept Bottom Va Sept
29th 64 Disability 3/4.

W. W. Wood
Assistant Surgeon. U.S.A.

DISCHARGED, this seventh day of June, 1865, at White Hall
MD Hospital Near Bristol Va

W. W. Wood
Commanding the Hospital

The Soldier desires to be addressed at
Town _____ County _____ State _____

* See Note 1 on the back of this. † See Note 2 on the back of this.

122

Pond, Thomas W.

Co *H.*, **4** U.S. Col'd Inf.

Corporal | *Sergeant*

CARD NUMBERS.

1	5562699	26
2	5562799	27
3	5562899	28
4	5562992	29
5	5563088	30
6	5563182	31
7	5563275	32
8	5563363	33
9	5563521	34
10	5564312	35
11	9062659	36
12		37
13		38
14		39
15		40
16		41
17		42
18		43
19		44
20		45
21		46
22		47
23		48
24		49
25		50

Book Mark:

See also

B. | 4 | U.S.C.T.

Thomas W. Bond
 , Co. H, 4 Reg't U. S. Col'd Inf.

Appears on
Company Descriptive Book
 of the organization named above.

DESCRIPTION.

Age 21 years; height 5 feet 7 inches.
 Complexion Brown
 Eyes Bl'k; hair Bl'k
 Where born Harford Co, Md.
 Occupation Farmer

ENLISTMENT.

When Aug 11, 1863.
 Where Baltimore Md.
 By whom Col. Burney; term 3 y'rs.

Remarks: Free or before
April 19/61
Died July 7/64 near
City Point Va.

Selah

B

4

U.S.C.T.

Thomas W Bond

Corpl., Co. G, 4 Reg't U. S. Col'd Infantry.

Age 21 years.

Appears on

Company Muster-in Roll

of the organization named above. Roll dated

Aug 11, 1863.

Muster-in to date

Aug 11, 1863.

Joined for duty and enrolled:

When Aug 11, 1863.*

Where Baltimore City *

Period 3 years.*

Remarks:

* Muster-in roll shows enrollment and muster-in of this company as of same date and place. See enrollment on subsequent card or cards.

Book mark:

M. A. Michaels

D | 4 | U.S.C.T.

Thomas W. Bond

Capt., Co. H, 4 Reg't U. S. Col'd Infantry.

Appears on

Company Muster Roll

for *Aug. 11 to Aug. 31, 1863.*

Joined for duty and enrolled:

When *Aug. 11*, 186*3*.*

Where *Baltimore City* *

Period *3* years.*

Present or absent *Present.*

Stoppage, \$ *100* for _____

Due Gov't \$ *100* for _____

Remarks: _____

* ~~See~~ See enrollment on card from muster-in roll.

Book mark: _____

M. A. Michaels

B | 4 | U.S.C.T.

Thomas W. Bond

Corpl., Co. H, 4 Reg't U. S. Col'd Infantry.

Appears on

Company Muster Roll

for Sept & Oct., 1863.

Joined for duty and enrolled:

When Aug. 11, 1863.*

Where Baltimore City *

Period 3 years.*

Present or absent Present

Stoppage, \$ 100 for

Due Gov't \$ 100 for

Remarks:

* See enrollment on card from muster-in roll.

Book mark:

M. A. Michaels

D | 4 | U.S.C.T.

Thomas W. Bond

Sergt.; Co. H, 4 Reg't U. S. Col'd Infantry.

Appears on

Company Muster Roll

for *Nov & Dec.*, 1863.

Joined for duty and enrolled:

When *Aug 11*, 1863.*

Where *Baltimore City* *

Period *3* years.*

Present or absent *Present*

Stoppage, \$ *100* for

Due Gov't \$ *100* for

Remarks: *Corpl promoted to Sergeant Dec. 2nd per Regt. order No 55.*

* See enrollment on card from muster-in roll.

Book mark:

M. A. Michaels

D | 4 | U.S.C.T.

Thomas W. Bond

Serjt, Co. H, 4 Reg't U. S. Col'd Infantry.

Appears on

Company Muster Roll

for Jan & Febr, 1864.

Joined for duty and enrolled:

When Aug. 11, 1863.*

Where Baltimore City *

Period 3 years.*

Present or absent Present

Stoppage, \$ 100 for

Due Gov't \$ 100 for

Remarks:

* See enrollment on card from muster-in roll.

Book mark:

M. A. Michaels

B | 4 | U.S.C.T.

Thomas W. Bond
Serg't, Co. H, 4 Reg't U. S. Col'd Infantry.

Appears on

Company Muster Roll

for *Co. H, 4 Reg't*, 1864.

Joined for duty and enrolled:

When *Aug. 11*, 1863.*

Where *Baltimore City**

Period *3* years.*

Present or absent *Present*

Stoppage, \$ *100* for

Due Gov't \$ *100* for

Remarks:

* See enrollment on card from muster-in roll.

Book mark:

C. F. Thompson
Copyist.

B | 4 | U.S.C.T.

Thomas W. Bond.

Sergt., Co. H, 4 Reg't U. S. Col'd Infantry.

Appears on

Company Muster Roll

for May & June, 1864.

Joined for duty and enrolled:

When Aug. 11, 1863.*

Where Baltimore City.*

Period 3 years.*

Present or absent Present.

Stoppage, \$ 100 for

Due Gov't \$ 100 for

Remarks:

* See enrollment on card from muster-in roll.

Book mark:

C. F. Thompson.

(858c)

Copyist.

10 | 4 | U.S.C.T.

Thomas W. Bond.
Sergeant, Co. H, 4 Reg't U. S. Col'd Infantry.

Appears on

Company Muster Roll

for July & Aug., 1864.

Joined for duty and enrolled:

When Aug. 11, 1863.*

Where Baltimore City.*

Period 3 years.*

Present or absent Absent.

Stoppage, \$ 100 for

Due Gov't \$ 100 for

Remarks: Sick in Genl. Hospital.

* See enrollment on card from muster-in roll.

Book mark:

(858c) C. F. Thompson Copyist.

B

4

U.S.C.T.

Thomas W. Bond

Serjt, Co. H, 4 Reg't U. S. Col'd Infantry.

Appears on

Company Muster Roll

for Sept. & Oct., 1864.

Joined for duty and enrolled:

When Aug. 11, 1863.*

Where Baltimore Md. *

Period 3 years.*

Present or absent

Stoppage, \$ 100 for

Due Gov't \$ 100 for

Remarks: Died of disease at City Point Va. July 7th 1864

* See enrollment on card from muster-in roll.

Book mark: 106, 703

(358c)

C. F. Thompson
Copyist.

B. | 4 | U.S.C.T.

Thomas W. Bond,
Serjt., Co. H., 4 Reg't U. S. Col'd Infantry.

Appears on **Co. Muster-out Roll**, dated
(Washington, D.C., May 4, 1866 .

Muster-out to date _____, 186 .

Last paid to *July 29 1864.*

Clothing account:

Last settled _____, 186 ; drawn since \$ _____ 100

Due soldier \$ _____ 100 ; due U. S. \$ _____ 100

Am't for cloth'g in kind or money adv'd \$ _____ 100

Due U. S. for arms, equipments, &c., \$ _____ 100

Bounty paid \$ _____ 100 ; due \$ *100.* 100

Remarks: *Died of disease July 7, 1864 near City Point, Va. (Was Corporal from enrollment to Dec. 5, 1863, then Ser- quant. Free.*

Book mark: *106. 703 S. B. V. 46 21. 1880.*

(861) *W. S. Grauner.* Copyist.

Bond, Thomas W.

Sgt, Co. H 4 U.S.C. Inf.

3 Enclosures.

Bed Cards	Descriptive Lists
Burial Records	Final Statements
Certs. of Dis. for Discharge	Furloughs
C. M. Charges	Med. Des. Lists
Med. Certificates	Orders

Other papers relating to—

Admission to Hosp'l	Furlough
Casualty Sheet (Sgt Officer's)	Med. Examination
Confinement	Misc. Information
Contracts	Pay or Clothing
Death or Effects	Personal Reports
Desertions	Rank
Discharge from Hosp'l	Transfer to Hosp'l
Discharge from Service	Transfer to V. R. C.
Duty	Transportation

FINAL STATEMENT

OF

Sergt. Thomas M. Bond

2nd Reg't of W. S. Cold, Troop

VOLUNTEERS.

Must July 4th 1864

NOTE 1.—Two of these certificates (or duplicates) are to be given to each Volunteer Soldier or drafted man who may be discharged previously to the discharge of his company, that he may at once receive from the Paymaster the pay, &c., due him, and the captain or other COMMISSIONED officer commanding the company will certify to the act of the delivery of the duplicate certificates; on these certificates the Soldier is "entitled to" his discharge, and should also present his discharge to the Paymaster to have the payment endorsed on it. The discharge is to be given back to the Soldier by the Paymaster; the latter only retaining as his voucher the duplicate certificates.

NOTE 2.—If the Soldier is entitled to pay for the use of his horse, the Company Commander will certify to that fact on the back of both these final statements, and also to the time he has pay due for having been so mounted on his own horse.

NOTE 3.—When a Soldier is furnished with final statements, his descriptive list, if he has one, should be taken up by the officer who gives the Soldier these statements, and endorsed with a statement to this effect by the officer. This endorsement should exhibit a full statement of the time for which the Soldier was allowed pay on his final statements, the clothing account, and all other charges against him or in his favor, so as to comprise a complete exhibit of his account. It will then be transmitted to the company commander of the Soldier, who will enter all the data necessary to a full understanding of the Soldier's account on the muster roll upon which the Soldier's discharge is reported. The descriptive list will then be destroyed. The object of this is, that the remaining portion of the Soldier's account may be settled upon the receipt of these muster rolls, and the Soldier receive any pay or allowances that may be due him at the time of his discharge, and which may not appear on his final statements from the fact that his descriptive list is incomplete. These accounts for back pay, &c., are settled by the 2d Auditor of the Treasury Department.

NOTE 4.—Charges for loss or injury to ordnance, horse equipments, and other miscellaneous charges, should appear under the heading of "Other Stoppages."

NOTE 5.—Bounty paid by State authorities, and not by the United States, will not be entered on this statement.

NOTE 6.—Amounts due the Sutler and Laundress must be entered on the muster roll on which the discharge, death, desertion, &c., is reported, as well as on the final statement, otherwise the amount cannot be collected from the United States.

NOTE 7.—This blank will be used for deceased volunteers and drafted men, as well as for others.

NOTE 8.—Where a Soldier dies in Hospital or on detached service, his descriptive list, if he has one, should be sent with his final statements, in duplicate, to the Adjutant General, Washington, D. C.

ADJUTANT GENERAL'S OFFICE.
Sept 21st 1864
Duplicate with Inventory sent 2d Auditor.

Thomas M. Bond
RECEIVED
21
ADJUTANT GENERAL'S OFFICE
Leuby

I certify, on honor, that Thomas W. Bond a Sergeant of
 Captain A. G. Crawford's Company ("16") of the Fourth Regiment of U. S. Col'd Troops
VOLUNTEERS, of the State of _____, born in Carford County, State
 of Maryland, aged 21 years; 5 feet 9 inches high; Brown complexion,
Black eyes, Black hair, and by occupation a Farmer, having joined the company on
 its original organization at Baltimore City, and enrolled in it at the muster into
 the service of the United States at Baltimore City, on the 11th day
 of August, 1863, (or was mustered in service as a recruit, by _____
 _____, at _____, on the _____ day of _____,
 186 , or was drafted and mustered into the service of the United States from the _____
 Enrollment District of the State of _____, at _____,
 on the _____ day of _____, 186 .) to serve in the Regiment, for
 the term of Three Years: and having served **HONESTLY** and
FAITHFULLY with his Company in The Field to the present date, is now
 entitled to a **DISCHARGE** by reason of Death - he died of Typhoid
Fever July 7th 1864

The said Thomas W. Bond was last paid by Paymaster
Wm. H. Adams to include the 29th day of February, 1864, and has
 pay due him from that time to the July 7th 1864 present date; he is entitled to pay and subsistence for
TRAVELING to place of enrollment, and whatever other allowances are authorized to volunteer
 soldiers, drafted men, or militia, so discharged. He has received from the United States **CLOTHING**
 amounting to 64 77⁰ dollars, since the _____ day of Enlistment,
 186 , when his clothing account was last settled. He has received from the United States
 00 dollars advanced **BOUNTY**.

There is to be stopped from him, on account of the State of _____, or other
 authorities, for **CLOTHING**, &c., received on entering service, _____ dollars; and
 for other stoppages, viz: _____
 _____ dollars.

He has been furnished with **TRANSPORTATION** in kind from the place of his discharge to
 _____; and he has been **SUBSISTED** for **TRAVELING** to his
 place of enrollment, up to the _____, 186 .

He is indebted to _____, **SUTLER**, _____ dollars.

He is indebted to _____, **LAUNDRESS**, _____ dollars.

Given in Duplicate, at Dutch Gap, Va., this 19th day
 of September, 1864.

William H. Appleton

1st Lieut. - 1st U.S.C.T.

Commanding Company He.

Recd from Div. of Discontinued
Commands, Filed June 9/75

INVENTORY OF THE EFFECTS

OF

Sergt Thomas W Bond

Late of Company "K"

11th Reg't of U. S. Col'd. Troops

Volunteers, who died at Near City Point Va

on the 7th day of July 1864.



Inventory of the effects of Thomas W. Bond late
a Sergeant of Captain Albert G. Saunders Company "H" of
the Fourth Regiment of U. S. Cold Troops Volunteers, who was enrolled as
a Private at Baltimore City in the State of Maryland on
the 11th day of August 1863, and mustered into the service of the United
States as a Private on the 11th day of August 1863, at Baltimore City
in Company "H", Fourth Regiment of U. S. Cold Troops Volunteers, to serve 3 years
or during the war; he was born in Harford County in the State
of Maryland; he was 21 years of age, 5 feet 9 inches
high, Brown complexion, Black eyes, Black hair, and by occupation, when enrolled,
a Farmer; he died in U. S. Genl Hospital for Cold Troops, at
Near City Point Va on the 7th day of July 1864, by
reason of Dysphoid Fever

INVENTORY.							
ARTICLES.	No.	ARTICLES.	No.	ARTICLES.	No.		
Hats.....	No Effects	Pairs trousers.....	No Effects	Knapsacks.....	No Effects		
Caps.....		Pairs flannel drawers.....					
Forage caps.....		Pairs cotton drawers.....					
Great coats.....		Flannel shirts.....					
Uniform coats.....		Cotton shirts.....					
Uniform jackets.....		Pairs boots.....					
Flannel sack coats.....		Pairs shoes.....					
Blouses.....		Pairs socks.....					
Stable frocks.....		Blankets.....		MONEY.		Specie.....	\$ 00
Fatigue overalls.....		Haversacks.....				Notes.....	\$ 00

I CERTIFY, ON HONOR, that the above inventory comprises all the effects of Sergeant
Thomas W. Bond, deceased, and that the effects are in the hands
of _____ at _____
_____ to be disposed of by a Council of Administration.

(DUPLICATES.)

STATION: Dutch Gap Va.
DATE: September 19th 1864

William H. Shelton
1st Lieut. U. S. Cold Troops
Commanding the Company. "H"

CASUALTY SHEET

No. _____

Thos W Bond

of Company *N.*

14" Regiment of *U.S.*

State Volunteers.

NATURE OF CASUALTY.

CASUALTY SHEET.

Name: Thos. M. Bond

Rank: _____ Company: 36 Regiment: 43

Arm: USCT State: _____

Nature of Casualty: Death.

CAUSE OF CASUALTY—(NAME OF DISEASE, &c.)

BY WHOM DISCHARGED.

DEGREE OF DISABILITY.

FROM WHAT SOURCE THIS INFORMATION WAS OBTAINED.

BY WHOM CERTIFIED.

Records furnished by U.S. Christian Commission Pg 82,

REMARKS.

DATE OF DISCHARGE, DEATH, &c.

Non Official,

PLACE OF DISCHARGE, DEATH, &c.

D. A. Hospital
City of Paris 2nd
P

J.

Clerk.

123

Pondurant Isaac

Co ~~A~~, 4 U.S. Col'd Inf.

Private

Private

CARD NUMBERS.

1	5552108	26
2	5552199	27
3	5552288	28
4	5552452	29
5	5552867	30
6	9061616	31
7		32
8		33
9		34
10		35
11		36
12		37
13		38
14		39
15		40
16		41
17		42
18		43
19		44
20		45
21		46
22		47
23		48
24		49
25		50

Book Mark:

See also

B

4

U.S.C.T.

Isaac H. Bondurant

Co. ⁴A, 4 Reg't U. S. Col'd Inf.

Appears on

Company Descriptive Book

of the organization named above.

DESCRIPTION.

Age 18 years; height 5 feet 3 inches.

Complexion dark

Eyes black; hair black

Where born Bath Co. Kentucky

Occupation carmer

ENLISTMENT.

When Aug 20, 1864.

Where Pikeston, O.

By whom Lt. W. S. Bennett; term 1 y'rs.

Remarks: Charged with one can-
teen .65. No charge of
sutlers. Final statements
& inventory of effects sent to
Wash. D. C. Aug. 22/65.

Bond

B | 4 | U.S.C.T.

Isaac Bondurant
Priv., Co. A, 4 Reg't U. S. Col'd Infantry.

Appears on

Company Muster Roll

for Nov. & Dec., 186 4

Joined for duty and enrolled:

When Aug. 30, 186 4*

Where Pibston, O. *

Period 1 years.*

Present or absent present

Stoppage, \$ 100 for _____

Due Gov't \$ 100 for _____

Remarks: Free before Apr. 19. 1861.

* See enrollment on card from muster-in roll.

Book mark: _____

R. E. Wilson

B

4

U.S.C.T.

Isaac Bondurant

Ant, Co. A, 4 Reg't U. S. Col'd Infantry.

Appears on

Company Muster Roll

for *Jan + Feb*, 1865.

Joined for duty and enrolled:

When *Aug. 30*, 1864.*

Where *Pibeton, O* *

Period *1* year.*

Present or absent *present*

Stoppage, \$ *100* for _____

Due Gov't \$ *100* for _____

Remarks: *Free on or before
Apr. 19, 1861.*

* See enrollment on card from muster-in roll.

Book mark: _____

Saxton

B | 4 | U.S.C.T.

Isaac Bondurant
Priv, Co. A, 4 Reg't U. S. Col'd Infantry.

Appears on

Company Muster Roll

for March & Apr, 1865.

Joined for duty and enrolled:

When Aug. 30, 1864.*

Where Pike-ton, O.*

Period 1 year.*

Present or absent present

Stoppage, \$ 100 for _____

Due Gov't \$ 100 for _____

Remarks: Free or slave
not stated.

* See enrollment on card from muster-in roll.

Book mark: _____

(858c)

Daxton
Copyist.

B

4

U.S.C.T.

Isaac Pondurant

Private, Co. A, 4 Reg't U. S. Col'd Infantry.

Appears on

Company Muster Roll

for May + June, 1865.

Joined for duty and enrolled:

When Aug 30, 1864.*

Where Pikeston, O *

Period 1 years.*

Present or absent

Stoppage, \$ 100 for

Due Gov't \$ 100 for

Remarks: Died of Inter-
mittent Fever, Golds-
boro, N.C. June 21?
1865.

* See enrollment on card from muster-in roll.

Book mark: 554, 2nd Aud. Mar 28,
1866

Saxton

(358c)

Copyist.

B | 4 | U.S.C.T.

Isaac Bordenant
Pvt, Co. *A*, 4 Reg't U. S. Col'd Infantry.

Appears on **Co. Muster-out Roll**, dated
Washington, D.C. May 4, 1864.

Muster-out to date 186 .

Last paid to 186 .

Clothing account:

Last settled 186 ; drawn since \$ 100

Due soldier \$ 100 ; due U. S. \$ 100

Am't for cloth'g in kind or money adv'd \$ 100

Due U. S. for arms, equipments, &c., \$ 100

Bounty paid \$ 100 ; due \$ 100

Remarks: *Died of disease*
in Hosp't Goldstoad
N.C. June 2, 65
(Enrol. Aug 30/64 Pickens Co
W.Va. Sept. 1. 64 Circleville Oh
1 Year - age 18.)

Book mark: *276, 304*

(361)

Manning Copyist.

Bondurant, Isaac

P, Co. A 4

Reg't U.S.C. Inf.

1 Enclosures.

Bed Cards	Descriptive Lists
Burial Records	Final Statements
Certs. of Dis. for Discharge	Furloughs
C. M. Charges	Med. Des. Lists
Med. Certificates	Orders

Other papers relating to—

Admission to Hosp'l	Furlough
Casualty Sheet (Officer's)	Med. Examination
Confinement	Misc. Information
Contracts	Pay or Clothing
Death or Effects	Personal Reports
Desertions	Rank
Discharge from Hosp'l	Transfer to Hosp'l
Discharge from Service	Transfer to V. R. C.
Duty	Transportation

FINAL STATEMENT *H.*

OF

Isaac Bondurant

4 Reg't of *USEC*

VOLUNTEERS.

Recd June 9 1865

NOTE 1.—Two of these certificates (or duplicates) are to be given to each Volunteer Soldier or drafted man who may be discharged previously to the discharge of his company, that he may at once receive from the Paymaster the pay, &c., due him, and the captain or other COMMISSIONED officer commanding the company will certify to the act of the delivery of the duplicate certificates; on these certificates the Soldier is "entitled to" his discharge, and should also present his discharge to the Paymaster to have the payment endorsed on it. The discharge is to be given back to the Soldier by the Paymaster; the latter only retaining as his voucher the duplicate certificates.

NOTE 2.—If the Soldier is entitled to pay for the use of his horse, the Company Commander will certify to that fact on the back of both these final statements, and also to the time he has pay due for having been so mounted on his own horse.

NOTE 3.—When a Soldier is furnished with final statements, his descriptive list, if he has one, should be taken up by the officer who gives the Soldier these statements, and endorsed with a statement to this effect by the officer. This endorsement should exhibit a full statement of the time for which the Soldier was allowed pay on his final statements, the clothing account, and all other charges against him or in his favor, so as to comprise a complete exhibit of his account. It will then be transmitted to the company commander of the Soldier, who will enter all the data necessary to a full understanding of the Soldier's account on the muster roll upon which the Soldier's discharge is reported. The descriptive list will then be destroyed. The object of this is, that the remaining portion of the Soldier's account may be settled upon the receipt of these muster rolls, and the Soldier receive any pay or allowances that may be due him at the time of his discharge, and which may not appear on his final statements from the fact that his descriptive list is incomplete. These accounts for back pay, &c., are settled by the 2d Auditor of the Treasury Department.

NOTE 4.—Charges for loss or injury to ordnance, horse equipments, and other miscellaneous charges, should appear under the heading of "Other Stoppages."

NOTE 5.—Bounty paid by State authorities, and not by the United States, will not be entered on this statement.

NOTE 6.—Amounts due the Sutler and Laundress must be entered on the muster roll on which the discharge, death, desertion, &c., is reported, as well as on the final statement, otherwise the amount cannot be collected from the United States.

NOTE 7.—This blank will be used for deceased volunteers and drafted men, as well as for others.

NOTE 8.—Where a Soldier dies in Hospital or on detached service, his descriptive list, if he has one, should be sent with his final statements, in duplicate, to the Adjutant General, Washington, D. C.

D. H. ...
Cent on ...

ADJUTANT GENERAL'S OFFICE.
July 29 1865
Duplicate with Inventory sent 2d Auditor.

I certify, on honor, that Isaac Bondurant a private of
 Captain J. W. Parmyter Company (N) of the 4 Regiment of USCS
VOLUNTEERS of the State of _____, born in Kath, State
 of Kentucky aged 18 years; 5 feet 3 inches high; dark complexion,
black eyes, dark hair, and by occupation a farmer, having joined the company on
 its original organization at _____, and enrolled in it at the muster into
 the service of the United States at _____, on the _____ day
 of _____, 1864, (or was mustered in service as a recruit, by Capt G. W. Rott
P. Ketchum O., at P. Ketchum O., on the 20 day of Aug,
 1864, or was drafted and mustered into the service of the United States from the
 Enrollment District of the State of _____, at _____,
 on the _____ day of _____, 1864,) to serve in the Regiment, for
 the term of One (1) year: and having served **HONESTLY** and
FAITHFULLY with his Company in No 4 USCS to the present date, is now
 entitled to a **DISCHARGE** by reason of Death due to disease at
Post Hospital Goldsboro N.C. June 2^d 1865

The said Isaac Bondurant was last paid by Paymaster
M. Kerney to include the 31st day of Dec, 1864 and has
 pay due him from that time to the present date; he is entitled to pay and subsistence for
TRAVELING to place of enrollment, and whatever other allowances are authorized to volunteer
 soldiers, drafted men, or militia, so discharged. He has received from the United States **CLOTHING**
 amounting to Sept 14 1864 $\frac{6}{100}$ dollars, since the _____ day of enlistment,
 1864, when his clothing account was last settled. He has received from the United States
No $\frac{100}{100}$ dollars advanced **BOUNTY**.

There is to be stopped from him, on account of the State of _____, or other
 authorities, for **CLOTHING**, &c., received on entering service, _____ dollars; and
 for other stoppages, viz: One Centine 65 Was for April
19.61
 _____ dollars.

He has been furnished with **TRANSPORTATION** in kind from the place of his discharge to
 _____; and he has been **SUBSISTED** for **TRAVELING** to his
 place of enrollment, up to the _____, 1864.

He is indebted to _____, **SUTLER**, _____ dollars.
 He is indebted to _____, **LAUNDRESS**, _____ dollars.

Given in Duplicate, at Newbern N.C., this 22 day
 of August, 1865.

J. W. Parmyter
Capt 4th USCS
 Commanding Company.

124

Gouem. Kelly

Co F, 4 U.S. Col'd Inf.

Private

Private

CARD NUMBERS.

1	5550550	26	/
2	5560400	27	
3	5560494	28	/
4	5560651	29	
5	5560980	30	
6	9062314	31	
7		32	
8		33	
9		34	
10		35	
11		36	
12		37	
13		38	
14		39	
15		40	
16		41	
17		42	
18		43	
19		44	
20		45	
21		46	
22		47	
23		48	
24		49	
25		50	

Book Mark:

See also

B | 4 | U.S.C.T.

Kelley Bonem

Co. *F*, 4 Reg't U. S. Col'd Inf.

Appears on

Company Descriptive Book

of the organization named above.

DESCRIPTION.

Age *19* years ; height *5* feet *7 1/4* inches.

Complexion *Black*

Eyes *Black* ; hair *Black*

Where born *Mecklen Co. N. C.*

Occupation *Stoker*

ENLISTMENT.

When *March 1*, 1865 .

Where *Wilmington*

By whom *Det. J. Allen* ; term *3* y'rs.

Remarks: *Pay due from enrollment*

300 Dollars due

Mustered by Det. E. Hughes

H. H. Merrill

B | 4 | U.S.C.T.

Kelly Bonny

Appears with rank of Pvt. on

Muster and Descriptive Roll of a Detachment of U. S. Vols. forwarded

for the 4 Reg't U. S. Col'd Infantry. Roll dated

N.E. Station W.M.R.R. N.C., Mar. 13, 1865.

Where born Harnett Co. North Carolina

Age 19 y'rs; occupation Stoker

When enlisted Mar. 1, 1865.

Where enlisted Wilmington N.C.

For what period enlisted 3 years.

Eyes black; hair black

Complexion black; height 5 ft. 7/4 in.

When mustered in Mar. 13, 1865.

Where mustered in N.E. Station W.M.R.R. N.C.

Bounty paid \$ 100; due \$ 300 ¹⁰⁰

Where credited _____

Company to which assigned _____

Remarks: _____

Book mark: _____

Hathaway

P | 4 | U.S.C.T.

Kelly Jones
Prk, Co. F, 4 Reg't U. S. Col'd Infantry.

Appears on

Company Muster Roll

for March 1865, 1865.

Joined for duty and enrolled:

When March 1, 1865.*

Where Wilmington N.C.*

Period 3 years.*

Present or absent Present

Stoppage, \$ 100 for

Due Gov't \$ 100 for

Remarks: On detached Service
as Division Pioneer
No pay received since
enlistment \$100.00 bounty
due 1" installment

* See enrollment on card from muster-in roll.

Book mark:

Grider
(858c) Copyist.

P | 4 | U.S.C.T.

Kelley Bowen
Pr., Co. F, 4 Reg't U. S. Col'd Infantry.

Appears on

Company Muster Roll

for *May - June*, 1865.

Joined for duty and enrolled:

When *March 1*, 1865.*

Where *Wilmington* *

Period *3* years.*

Present or absent *Absent*

Stoppage, \$ *100* for

Due Gov't \$ *100* for

Remarks: *Absent without leave. Pay due from enlistment # 106 County due 1" installment*

* See enrollment on card from muster-in roll.

Book mark:

Linden
(858c) Copyist.

P

4

U.S.C.T.

Kelly Jones

Pr, Co. F, 4 Reg't U. S. Col'd Infantry.

Appears on

Company Muster Roll

for *July & Aug*, 1865.

Joined for duty and enrolled:

When *March*, 1865.*

Where *Wilmington N.C.**

Period *3* years.*

Present or absent

Stoppage, \$ *100* for

Due Gov't \$ *100* for

Remarks: *Deserted at
Goldsboro N.C.
May 31" 65*

* See enrollment on card from muster-in roll.

Book mark:

Jorden

B | **4** | **U.S.C.T.**

Kelly Bowen
Pri, Co. *F*, 4 Reg't U. S. Col'd Infantry.

Appears on **Co. Muster-out Roll**, dated
Washington D. C. May 4, 186 *6*.

Muster-out to date _____, 186 .
 Last paid to _____, 186 .

Clothing account:

Last settled _____, 186 ; drawn since \$ _____ 100

Due soldier \$ _____ 100 ; due U. S. \$ _____ 100

Am't for cloth'g in kind or money adv'd \$ _____ 100

Due U. S. for arms, equipments, &c., \$ _____ 100

Bounty paid \$ _____ 100 ; due \$ _____ 100

Remarks: *Deserted May 31, 1865*

Book mark : _____

(861)

Currier
 Copyist.

Donem Kelly

, Co. *F*, *4* Reg't *U.S.C.I*

Enclosures.

Bed Cards	Final Statements
Burial Records	Furloughs or L. of A
Certs. of Dis. for Discharge	Med. Certificates
C. M. Charges	Med. Des. Lists
Descriptive Lists	Orders
Discharge Certificates	Pris. of War Record
Enlistment Papers	Resignations

Other papers relating to—

Admission to Hosp'l	Furlough or L. of A
Casualty Sheet	Med. Examination
Confinement	Misc. Information
Contracts	Pay or Clothing
Death or Effects	Personal Reports
Desertion	Rank
Discharge from Hosp'l	Transfer to Hosp'l
Discharge from Service	Transfer to V. R. C.
Duty	Transportation

5

Kelly Bonner

Co. "F"

1st U.S.C.

Adjutant General's Office,

COLORED TROOPS BRANCH,

Mr Ellubrook, Dec. 4, 1876

Vol. C. T., 187

Wanted in the case of Kelly Bonem, Co. F,

4 Reg't U.S.C. Troops - Period of absence and if tried.

He is reported on M.R. May & June 1865: "Absent without leave"

Respectfully,

I. A. Woodward,
Chief Clerk.
Iu JH

Adjutant General's Office,

Division of Discontinued Commands.

Dec 8, 1876.

Vol. C. T., 187

Reply in case of Kelly Bonem, Co. F,

4 "Reg't U.S.C. T.

Reg't Dec BK reports him Mustered-out - Codes BK reports his name without remarks as to desertion - Register of Deserters reports him "Deserted May 31, '65 at Goldsboro' N.C." - Comsig Repts do not cover date - No evidence of return -

W. B. K.

125

Gonham. Arches

Co., 4 U.S.C. Id Inf.

Private

CARD NUMBERS.

1	5550526	26	1
2		27	
3		28	
4		29	
5		30	
6		31	
7		32	
8		33	
9		34	
10		35	
11		36	
12		37	
13		38	
14		39	
15		40	
16		41	
17		42	
18		43	
19		44	
20		45	
21		46	
22		47	
23		48	
24		49	
25		50	

Book Mark:

See also

B

4

U.S.C.T.

Archy Compton

Appears with rank of *1st* on

Muster and Descriptive Roll of a Detachment of U. S. Vols. forwarded

for the 4 Reg't U. S. Col'd Infantry. Roll dated

Indianapolis, Oct. 20, 1864.

Where born *Fultonville, Alabama.*

Age *19* y'rs; occupation *farmer*

When enlisted *Oct. 20, 1864.*

Where enlisted *Indianapolis Ind.*

For what period enlisted *1* years.

Eyes *dark*; hair *dark*

Complexion *dark*; height *5 ft. 3 1/2 in.*

When mustered in _____, 186 .

Where mustered in _____

Bounty paid \$ *33 1/2* 100; due \$ *66 1/2* 100

Where credited _____

Company to which assigned _____

Remarks: _____

Not taken upon M.R. of Regt

Book mark: _____

Hathaway

(339)

Copyist.

Bourhan Archie

....., Co., ⁴ Reg't ^{USC}

² Enclosures.

Bed Cards.....	Final Statements.....
Burial Records.....	Furloughs or L. of A.....
Certs. of Dis. for Discharge.....	Med. Certificates.....
C. M. Charges.....	Med. Des. Lists.....
Descriptive Lists.....	Orders.....
Discharge Certificates.....	Pris. of War Record.....
Enlistment Papers..... ²	Resignations.....

Other papers relating to—

Admission to Hosp'l.....	Furlough or L. of A.....
Casualty Sheet.....	Med. Examination.....
Confinement.....	Misc. Information.....
Contracts.....	Pay or Clothing.....
Death or Effects.....	Personal Reports.....
Desertion.....	Rank.....
Discharge from Hosp'l.....	Transfer to Hosp'l.....
Discharge from Service.....	Transfer to V. R. C.....
Duty.....	Transportation.....
.....

DECLARATION OF RECRUIT.

I, Archey Bonham, desiring to VOLUNTEER as a Soldier in the Army of the United States, for the term one YEAR and 19 months of age; that I have never been discharged from the United States service on account of disability, or by sentence of a court martial, or by order before the expiration of a term of enlistment; and I know of no impediment to my serving honestly and faithfully as a soldier for one year

GIVEN at Indianapolis, Ind., the 20th day of October 1864

Witness: J. B. Becher As chptn Bonham

No. 1000

Volunteered at Indianapolis, Ind.,

19th day October 1864

By Asst Johnson

Regiment of Indiana Volunteers.

Light Artillery

enlistment; last served in Company

Reg't of

Discharged 186

Received from Second Auditor August 30th, 1892.

Resides in

Township,

County,

Congressional District, Indiana.

CONSENT IN CASE OF MINOR.

I, _____, Do CERTIFY, that I am _____ of _____; that the said _____ is _____ years of age; and I do hereby freely give my CONSENT to his volunteering as a SOLDIER in the ARMY OF THE UNITED STATES, for the period of _____ YEAR

GIVEN at _____, Indiana, the _____ day of _____, 186

Witness:

NOTE 1.—This blank will be used for both enlistments and re-enlistments—enlistment of veterans, &c., &c., in the volunteer service. They will be made out in duplicate in all cases—one to accompany the recruiting return of the superintendent (not the recruiting officer) to the Adjutant General, and one to accompany the accounts of the officer who pays bounty, &c. The Regiment and Company in which the soldier last served should be given on the back.
NOTE 2.—An enlistment holds to service. A muster-in must, in all cases, precede payment of pay, bounty, pension, &c. A muster-in roll must, in all cases, be filed in the Adjutant General's Office as evidence of muster-in. The mustering officer, commissary, or assistant commissary of musters, as the case may be, will countersign both enlistments as having mustered the soldier into the service of the United States before either of them is given to the disbursing officer.

Entitled to Bounty

VOLUNTEER ENLISTMENT.

STATE OF INDIANA.



TOWN OF

Indianapolis

I, Ashey Bonham, born in Huntsville, in the State of Alabama, aged 19 years, and by occupation a Farmer, Do HEREBY ACKNOWLEDGE to have volunteered this 20th day of October, 1864, to serve as a **Soldier** in the **Army of the United States of America**, for the period of one YEAR unless sooner discharged by proper authority: Do also agree to accept such bounty, pay, rations, and clothing, as are, or may be, established by law for volunteers. And I, Ashey Bonham, do solemnly swear, that I will bear true faith and allegiance to the United States of America, and that I will serve them honestly and faithfully against all their enemies or opposers whomsoever; and that I will observe and obey the orders of the President of the United States, and the orders of the officers appointed over me, according to the Rules and Articles of War.

Sworn and subscribed to, at Indianapolis Ind., this 20th day of October 1864, Ashey X Bonham BEFORE B. J. Johnson 1st Lieut 4th Bat mark

I CERTIFY, ON HONOR, That I have carefully examined the above named Volunteer, agreeably to the General Regulations of the Army, and that, in my opinion, he is free from all bodily defects and mental infirmity, which would in any way disqualify him from performing the duties of a soldier.

[Signature]
EXAMINING SURGEON.

I CERTIFY, ON HONOR, That I have minutely inspected the Volunteer, previously to his enlistment, and that he was entirely sober when enlisted; that, to the best of my judgment and belief, he is of lawful age; and that, in accepting him as duly qualified to perform the duties of an able-bodied soldier, I have strictly observed the Regulations which govern the recruiting service.

This soldier has dark eyes, dark hair, clear complexion, is 6- feet 3 inches high.

B. J. Johnson 1st Lieut

Regiment of Indiana Volunteers,
RECRUITING OFFICER.

Mustered into the service of the United States, for his year from date of enlistment, in Company N. S. Lewis Regiment of Indiana Volunteers, on the 20th day of October 1864, at Indianapolis Ind.

[Signature]
[Signature]
[Signature]
[Signature]

126

Booker George
Co C, 4 U.S. Col'd Inf.

Private | *Private*

CARD NUMBERS.

1	✓✓✓✓✓27	26
2	✓✓✓✓613	27
3	✓✓✓✓713	28
4	✓✓✓✓816	29
5	✓✓✓✓909	30
6	✓✓✓✓001	31
7	✓✓✓✓089	32
8	✓✓✓✓171	33
9	✓✓✓✓246	34
10	✓✓✓✓317	35
11	✓✓✓✓413	36
12	✓✓✓✓506	37
13	✓✓✓✓604	38
14	✓✓✓✓709	39
15	✓✓✓✓795	40
16	✓✓✓✓874	41
17	✓✓✓✓938	42
18	✓✓✓✓996	43
19	9061890	44
20		45
21		46
22		47
23		48
24		49
25		50

Book Mark:

See also

79 | 4 | U.S.C.T.

George Booker
Co. "B", 4 Reg't U. S. Col'd Inf.

Appears on

Company Descriptive Book

of the organization named above.

DESCRIPTION.

Age 24 years; height 5 feet 7 inches.

Complexion Black

Eyes Black; hair curly

Where born Balto. Md.

Occupation sailor

ENLISTMENT.

When July 15, 1863.

Where Balto. Md.

By whom Col. Wm. Birney; term 3 y'rs.

Remarks:

[Empty lines for remarks]

Frank

D

4

U.S.C.T.

George Dooper

Priv, Co. C, 4 Reg't U. S. Col'd Infantry.

Age *24* years.

Appears on

Company Muster-in Roll

of the organization named above. Roll dated

Baltimore Md July 24, 1863

Muster-in to date

July 24, 1863

Joined for duty and enrolled:

When *July 15,* 186

Where *Baltimore Md*

Period *3* years.

Remarks:

Book mark:

(356)

Talworth
Copyist.

D

4

U.S.C.T.

George Bookes

Priv, Co. C. 4 Reg't U. S. Col'd Infantry.

Appears on

Company Muster Roll

for *July 17 To Aug 31*, 186*3*.

Present or absent *Present*

Stoppage, \$ *100* for

Due Gov't, \$ *100* for

Remarks: *Two dollars pre-
mium due,*

Book mark:

Talbot

(358)

Copyist.

D

4

U.S.C.T.

George Booker

Priv, Co. C. 4 Reg't U. S. Col'd Infantry.

Appears on

Company Muster Roll

for *Sept & Oct*, 186*3*

Present or absent *Present*

Stoppage, \$ *100* for

Due Gov't, \$ *100* for

Remarks:

Book mark:

(358)

Talbot
Copyist.

D

4

U.S.C.T.

George Booker

Priv, Co. C. 4 Reg't U. S. Col'd Infantry.

Appears on

Company Muster Roll

for *Nov & Dec*, 186*3*

Present or absent *Present*

Stoppage, \$ *100* for

Due Gov't, \$ *100* for

Remarks:

Book mark:

Talbott

(358)

Copyist.

D

4

U.S.C.T.

George Booker

Priv, Co. C. 4 Reg't U. S. Col'd Infantry.

Appears on

Company Muster Roll

for James & Feby, 1864.

Present or absent Present

Stoppage, \$ 100 for

Due Gov't, \$ 100 for

Remarks:

Book mark:

Talbot Copyist.

B

4

U.S.C.T.

George Booker
Pvt, Co. C. 4 Reg't U. S. Col'd Infantry.

Appears on

Company Muster Roll

for *March & Apr*, 1864.

Present or absent *Present*

Stoppage, \$ *100* for

Due Gov't, \$ *100* for

Remarks: *Present sick*

Book mark:

J. W. Davis

(858)

Copyist.

B

4

U.S.C.T.

George Booker
Pr

Co. C. 4 Reg't U. S. Col'd Infantry.

Appears on

Company Muster Roll

for *May & June*, 186 *4*

Present or absent *Present*

Stoppage, \$ *100* for

Due Gov't, \$ *100* for

Remarks:

Book mark:

J. Davis

(358)

Copyist.

B

4

U.S.C.T.

George Dooker
Priv

Co. C. 4 Reg't U. S. Col'd Infantry.

Appears on

Company Muster Roll

for *July & Aug*, 186 *4*

Present or absent *Present*

Stoppage, \$ *100* for

Due Gov't, \$ *100* for

Remarks: *Free on or before*
Apr 19. 1861. Extra duty
on Canal at Dutch Gap.

Book mark:

JW Davis

B

4

U.S.C.T.

George Booker
Priv, Co. C. 4 Reg't U. S. Col'd Infantry.

Appears on

Company Muster Roll

for *Sept & Oct*, 186 *4*.

Present or absent *Present*

Stoppage, \$ *100* for

Due Gov't, \$ *100* for

Remarks: *Free on or before*
April 19/61

Book mark:

J. D. Davis

B

4

U.S.C.T.

George Booker
Priv

Co. C. 4 Reg't U. S. Col'd Infantry.

Appears on

Company Muster Roll

for Nov & Dec, 1864

Present or absent Present

Stoppage, \$ 100 for

Due Gov't, \$ 100 for

Remarks: Free on or before
April 19/61

Book mark:

J. Davis

(358)

Copyist.

B

4

U.S.C.T.

George Booker

Pvt, Co. C. 4 Reg't U. S. Col'd Infantry.

Appears on

Company Muster Roll

for James Feby, 1865.

Present or absent Present

Stoppage, \$ 100 for

Due Gov't, \$ 100 for

Remarks: Free on or before April 19-61.

Book mark:

Pennington

(858)

Copyist.

B

4

U.S.C.T.

George Booker

Pvt, Co. C. 4 Reg't U. S. Col'd Infantry.

Appears on

Company Muster Roll

for *March & April*, 1865.

Present or absent *Present*

Stoppage, \$ *100* for

Due Gov't, \$ *100* for

Remarks: *Free before April 19/61. Back pay due from enlistment to May 1/64.*

Book mark: *37-117*

Pennington

(358)

Copyist.

B

4

U.S.C.T.

George Booker
Pvt, Co. C. 4 Reg't U. S. Col'd Infantry.

Appears on

Company Muster Roll

for May & June, 1865.

Present or absent Present

Stoppage, \$ 100 for

Due Gov't, \$ 100 for

Remarks: Free on or before
April 19th 1861 - Difference
in pay due from
enlistment - to May
1st 64.

Book mark:

1861

Permyington

(358)

Copyist.

B

4

U.S.C.T.

George Booker

Pvt, Co. C. 4 Reg't U. S. Col'd Infantry.

Appears on

Company Muster Roll

for July & Aug, 1865.

Present or absent Absent

Stoppage, \$ 100 for

Due Gov't, \$ 100 for

Remarks: On detached duty

Book mark: 18

(358)

Pennington Copyist.

B

4

U.S.C.T.

George Booker

Priv., Co. C. 4 Reg't U. S. Col'd Infantry.

Appears on

Company Muster Roll

for Sept & Oct, 1865.

Present or absent Absent

Stoppage, \$ 100 for

Due Gov't, \$ 100 for

Remarks: On detached duty

Book mark:

Pennington

(358)

Copist.

B.

4

U.S.C.T.

George Booker
Priv, Co. C. 4 Reg't U. S. Col'd Infantry.

Appears on

Company Muster Roll

for *Nov and Dec*, 1865.

Present or absent *Present.*

Stoppage, \$ *100* for

Due Gov't, \$ *100* for

Remarks: *Free on or before April 19, 1861. Difference in pay due from enlistment to May 1, 1864.*

Book mark: _____

(858)

R. Johnson
Copyist.

B. | 4 | U.S.C.T.

George Bowen
Put, Co. C. 4 Reg't U. S. Col'd Infantry.

Appears on

Company Muster Roll

for Jan'y & Feby, 1866.

Present or absent Present

Stoppage, \$ 100 for

Due Gov't, \$ 100 for

Remarks:

NEXT ROLL ON FILE MUSTER OUT.

Book mark:

R. Johnson

(858)

Copyist.

B. | 4 | U.S.C.T.

George Booker

Priv., Co. *C*, 4 Reg't U. S. Col'd Infantry.

Appears on **Co. Muster-out Roll**, dated
Washington DC, May 4, 186*6*.
Muster-out to date *May 4*, 186*6*.
Last paid to *Dec 31*, 186*5*.

Clothing account:

Last settled _____, 186 ; drawn since \$ _____¹⁰⁰
Due soldier \$ _____¹⁰⁰; due U. S. \$ *6*²⁵/₁₀₀
Am't for cloth'g in kind or money adv'd \$ _____¹⁰⁰

Due U. S. for arms, equipments, &c., \$ *6*⁰⁰/₁₀₀

Bounty paid \$ _____¹⁰⁰; due \$ *100*⁰⁰/₁₀₀

Remarks: *Free on April*
19/61

Book mark : _____

(861)

R. Johnson

Copyist.

127
Hooker, Peter

Co. 2, 4 U.S. Col'd Inf.

Corporal. Private

CARD NUMBERS.

1	5556148	26
2	5556230	27
3	5556338	28
4	5556436	29
5	5556529	30
6	5556617	31
7	5556703	32
8	5556788	33
9	5556870	34
10	5556950	35
11	5557044	36
12	5557136	37
13	5557235	38
14	5557328	39
15	5557417	40
16	5557492	41
17	5557553	42
18	5557614	43
19	9062039	44
20		45
21		46
22		47
23		48
24		49
25		50

Book Mark:

See also

R 1 1 | **U.S.C.T.**

..... Peter Bosker

....., Co. A, 11 Reg't U.S. Col'd Inf

Appears on

Company Descriptive Book

of the organization named above.

DESCRIPTION.

Age 21 years; height 5 feet 6 3/4 inches.

Complexion Road

Eyes Dark; hair Black

Where born Carson Co. Md

Occupation Priv. Soldier

ENLISTMENT.

When July 28, 1863 .

Where Baltimore

By whom Col. W. Binney; term 3 y'rs.

Remarks: Detained to 1 month hard labor
and to be reduced to ranks Gen order no -
thousand Abstract from Oct 28/63 to Nov 28
63 Rejoined Co. on this day
Paid for July and Aug 1864 by Maj. Jones
at Bulger Hospital Va Oct 1/64 # 32⁰⁰

W. H. Merrill

B | 4 | U.S.C.T.

Peter Booker

Corp, Co. *D*, 4 Reg't U. S. Col'd Infantry.

Age *21* years.

Appears on

Company Muster-in Roll

of the organization named above. Roll dated
Baltimore Md, *July 28*, 186*3*.

Muster-in to date *July 28*, 186*3*.

Joined for duty and enrolled:

When *July 28*, 186*3*.*

Where *Baltimore* *

Period *3* years.*

Remarks:

* If Muster-in roll shows enrollment and muster-in of this company as of same date and place. See enrollment on subsequent card or cards.

Book mark:

Faulkner

(356c)

Copyist.

R | 4 | **U.S.C.T.**

Oster Booker

Corpl, Co. D, 4 Reg't U. S. Col'd Infantry.

Appears on

Company Muster Roll

for July 28/63 to Aug 31, 1863.

Joined for duty and enrolled:

When July 28, 1863.*

Where Baltimore Md *

Period 3 years.*

Present or absent present

Stoppage, \$ 100 for _____

Due Gov't \$ 100 for _____

Remarks: \$2.00 Premiums due

* See enrollment on card from muster-in roll.

Book mark: _____

Faulkner

B | 4 | **U.S.C.T.**

Peter Booker

Priv, Co. D, 4 Reg't U. S. Col'd Infantry.

Appears on

Company Muster Roll

for Sept & Oct, 1863.

Joined for duty and enrolled:

When July 26, 1863.*

Where Baltimore Md.*

Period 3 years.*

Present or absent absent

Stoppage, \$ 100 for _____

Due Gov't \$ 100 for _____

Remarks: Reduced from corporal to ranks. Due on account of U. S. one month's pay by S.O. no 110 Hd. Qrs. U. S. force Yorktown Va. Oct. 27/63
Absent by S.O. no 110 toen,

* See enrollment on card from muster-in roll.

Book mark: _____

Faulkner
 (858c) Copyist.

18 | 4 | U.S.C.T.

Peter Booker

Co. D, 4 Reg't U. S. Col'd Infantry.

Appears on

Company Muster Roll

for Nov & Dec, 1863.

Joined for duty and enrolled:

When July 28, 1863.*

Where Baltimore Md *

Period 3 years.*

Present or absent present

Stoppage, \$ 100 for

Due Gov't \$ 100 for

Remarks: Sick in Hospital

* See enrollment on card from muster-in roll.

Book mark:

Faulkner

B | 4 | U.S.C.T.

Peter Booker

Pvt., Co. D, 4 Reg't U. S. Col'd Infantry.

Appears on

Company Muster Roll

for Sept & Oct, 1863.

Joined for duty and enrolled:

When July 26, 1863.*

Where Baltimore Md.*

Period 3 years.*

Present or absent absent

Stoppage, \$ 100 for

Due Gov't \$ 100 for

Remarks: Reduced from corporal to ranks. Absent on account of U. S. one month's pay by S.O. no. 110 1st. 2nd. U. S. force Yorktown Va. Oct. 27/63 Absent by S.O. no. 110 1000,

* See enrollment on card from muster-in roll.

Book mark:

Faulkner

NARA 719

JAN. 19

5556338

★ 1891 ★

Hd. Qr. U.S. force
Yorktown Va. Oct. 27/63

18 | 4 | **U.S.C.T.**

Peter Booker

Pvt, Co. D, 4 Reg't U. S. Col'd Infantry.

Appears on

Company Muster Roll

for Jan & Feby, 1864.

Joined for duty and enrolled:

When July 28, 1864 .*

Where Baltimore md .*

Period 9 years.*

Present or absent present

Stoppage, \$ 100 for

Due Gov't \$ 100 for

Remarks:

* See enrollment on card from muster-in roll.

Book mark: _____

Pauline

(858c) Copyist.

B | 4 | U.S.C.T.

Peter Booker

Priv., Co. D, 4 Reg't U. S. Col'd Infantry.

Appears on

Company Muster Roll

for March + April, 1864.

Joined for duty and enrolled:

When July 28, 1863.*

Where Baltimore Md*

Period 3 years.*

Present or absent Present

Stoppage, \$ 100 for

Due Gov't \$ 100 for

Remarks: Stop for Letter
D 1c, Knapsack +
straps \$1.83 - Gaversack
49c Centen 41c
Corp Chevron 20c = \$2.96

* See enrollment on card from muster-in roll.

Book mark:

(858c)

W. A. Tyler

Copyist.

B | 4 | U.S.C.T.

Peter Booker

Priv., Co. D, 4 Reg't U. S. Col'd Infantry.

Appears on

Company Muster Roll

for May & June, 1864

Joined for duty and enrolled:

When July 28, 1864.*

Where Baltimore Md.*

Period 3 years.*

Present or absent Absent

Stoppage, \$ 100 for _____

Due Gov't \$ 100 for _____

Remarks: Absent sick
Stop for kit & 1c
Knapsack & straps
#1.85 - Haversack 49c
Canteen 41c Cofl
Chevron 20c = \$ 2.96

* See enrollment on card from muster-in roll.

Book mark: _____

W A Tyler

B | 4 | U.S.C.T.

Peter Booker

Priv., Co. D, 4 Reg't U. S. Col'd Infantry.

Appears on

Company Muster Roll

for July & Aug, 1864.

Joined for duty and enrolled:

When July 28, 1863.*

Where Baltimore Md*

Period 3 years.*

Present or absent Absent

Stoppage, \$ 100 for

Due Gov't \$ 100 for

Remarks: Free on or before
Apr 19, 1861. Absent sick
since June 14/64. Stoppage
letter D 1^c Knapsack stops 1.85
Haversack 49c Canteen 41c
Cup & Cheverons 20c = \$2.96

* See enrollment on card from muster-in roll.

Book mark:

W. A. Tyler

B | 4 | U.S.C.T.

Peter Booker

Privt, Co. D, 4 Reg't U. S. Col'd Infantry.

Appears on

Company Muster Roll

for *Sept + Oct*, 1864.

Joined for duty and enrolled:

When *July 28*, 1863.*

Where *Baltimore Md**

Period *3* years.*

Present or absent *Present*

Stoppage, \$ *100* for

Due Gov't \$ *100* for

Remarks: *Free on or before*
Apr. 19/61. Stop for Letter
D 1^c Knapsack + Staps
\$1.85 - Haversack 49^c Car-
pen 41^c Corporal's Chevrons
20^c = \$ 2.96

* See enrollment on card from muster-in roll.

Book mark:

W. A. Tyler

(858c)

Copyist.

B | 4 | U.S.C.T.

Peter Booker

Priv., Co. D, 4 Reg't U. S. Col'd Infantry.

Appears on

Company Muster Roll

for Nov + Dec, 1864.

Joined for duty and enrolled:

When July 28, 1863.*

Where Baltimore *

Period 3 years.*

Present or absent Present

Stoppage, \$ 100 for

Due Gov't \$ 100 for

Remarks: Free on or before Apr 19, 61. Stop for list of 1st Knapsack & straps \$1.50 - Haversack 47c - Canteen 41st Corporal Chevrons 20th - \$2.96 Stop \$32.00 paid by Mgr.

* See enrollment on card from muster-in roll.

Book mark:

W A Tyler

(858c)

Copyist.

B | 4 | U.S.C.T.

Peter Booker

Prvt., Co. D, 4 Reg't U. S. Col'd Infantry.

Appears on

Company Muster Roll

for Jan. & Feb., 1865.

Joined for duty and enrolled:

When July 28, 1863.*

Where Baltimore *

Period 3 years.*

Present or absent Present

Stoppage, \$ 100 for

Due Gov't \$ 100 for

Remarks Given on before Apr. 19/61. Stop for Letter 'D' 1st Knapsack & Straps \$1.50, Haversack 49¢, Canteen 41¢, 1 Corporal, Chevrons 20¢ Stop \$32.00 paid by Major Green = \$34.96

* See enrollment on card from muster-in roll.

Book mark:

Castelberg

B | 4 | U.S.C.T.

Peter Booker

Art., Co. D, 4 Reg't U. S. Col'd Infantry.

Appears on

Company Muster Roll

for Mar. & Apr., 1865-

Joined for duty and enrolled:

When July 28, 1863.*

Where Baltimore *

Period 3 years.*

Present or absent Present

Stoppage, \$ 100 for

Due Gov't \$ 100 for

Remarks: Due on or before Apr. 19/61. Back pay due from Mar. 1/64 & date of muster in. Stop for Letter D. 1st Knapsack \$1.85; Haversack 49¢ Canteen 71¢ Corps Chevrons 20¢ Stop \$32.⁰⁰ paid by Major Green = \$34.96.

* See enrollment on card from muster-in roll.

Book mark:

(858c) Eastwing Copyist.

B | 4 | U.S.C.T.

Peter Booker

Prx, Co. D, 4 Reg't U. S. Col'd Infantry.

Appears on

Company Muster Roll

for May & June, 1865.

Joined for duty and enrolled:

When July 28, 1863.*

Where Baltimore *

Period 3 years.*

Present or absent Present,

Stoppage, \$ 100 for

Due Gov't \$ 100 for

Remarks: From Apr. 19/61. Back pay due from date of muster in to May 1/64. Stop. for Letter D. 1st Knapsack \$185⁰⁰ Chevrons 20⁰⁰ Stop. \$32⁰⁰ paid by Major Gunn = \$34.96⁰⁰

* See enrollment on card from muster-in roll.

Book mark:

(858c)

Cartwright Copyist.

B | 4 | U.S.C.T.

Peter Booker

Pvt., Co. D, 4 Reg't U. S. Col'd Infantry.

Appears on

Company Muster Roll

for July & Aug., 1863.

Joined for duty and enrolled:

When July 28, 1863.*

Where Balt. Md. *

Period 3 years.*

Present or absent Present

Stoppage, \$ 100 for

Due Gov't \$ 100 for

Remarks: Stop. for 1 cast box
belt plate 9¢ & 1 cast
box plate 8¢, 1 wrench
20¢, 1 screwdriver 23¢

* See enrollment on card from muster-in roll.

Book mark:

(858c)

Castling

Copyist.

B | 4 | U.S.C.T.

Peter Booker

Prt., Co. D, 4 Reg't U. S. Col'd Infantry.

Appears on

Company Muster Roll

for Sept. & Oct., 1865.

Joined for duty and enrolled:

When July 28, 1863.*

Where Baltimore *

Period 3 years.*

Present or absent Present.

Stoppage, \$ 100 for

Due Gov't \$ 100 for

Remarks: Stop for cart. box belt
plate 9¢ Cart. box plate 8¢
Wipers 20¢ screw driver 23¢
Hammock 95¢ Canvas 65¢
= \$ 2.10.

* See enrollment on card from muster-in roll.

Book mark:

(858c)

Eustelling

Copyist.

B. | 4 | U.S.C.T.

Peter Booker

Pvt., Co. D, 4 Reg't U. S. Col'd Infantry.

Appears on

Company Muster Roll

for Nov + Dec, 1863.

Joined for duty and enrolled:

When July 25, 1863.*

Where Baltimore *

Period 3 years.*

Present or absent Present.

Stoppage, \$ 100 for

Due Gov't \$ 100 for

Remarks: Stop for letter D
1st Number 1^c = 2

* See enrollment on card from muster-in roll.

Book mark:

(858c)

James

Copyist.

B. | 4 | U.S.C.T.

Peter Baker
 Pvt., Co. D, 4 Reg't U. S. Col'd Infantry.

Appears on

Company Muster Roll
 for Jan & Feb, 1866.

Joined for duty and enrolled:

When July 28, 1866.*
 Where Baltimore *
 Period 3 years.*

Present or absent Present

Stoppage, \$ 100 for

Due Gov't \$ 100 for

Remarks: Stop \$10 in G.O.
 3 Hd Qrs Dep of Wash
 Jan'y 26/66

NEXT ROLL ON FILE MUSTER OUT.

* See enrollment on card from muster-in roll.

Book mark:

(858c) *James* Copyist.

74 | **4** | **U.S.C.T.**

Peter Booker
Pvt., Co. *D*, 4 Reg't U. S. Col'd Infantry.

Appears on **Co. Muster-out Roll**, dated
Washington D.C. May 4, 1866 .

Muster-out to date *May 4*, 1866 .

Last paid to *Feb 28*, 1866 .

Clothing account:

Last settled....., 186 ; drawn since \$.....100

Due soldier \$ *48*^{*13*}100; due U. S. \$.....100

Am't for cloth'g in kind or money adv'd \$.....100

Due U. S. for arms, equipments, &c., \$.....100

Bounty paid \$.....100; due \$ *100*100

Remarks: *Free on or before*
April 19/61

Book mark: *V 69 P. 148 69*

(861) *J. J. J. J.* Copyist.

Boaker Peter

P, Co. D, 4 Reg't U. S. C. I

2 Enclosures.

Bed Cards	Final Statements
Burial Records	Furloughs or L. of A
Certs. of Dis. for Discharge	Med. Certificates
C. M. Charges	Med. Des. Lists
Descriptive Lists	Orders
Discharge Certificates	Pris. of War Record
Enlistment Papers	Resignations

Other papers relating to—

Admission to Hosp'l	Furlough or L. of A
Casualty Sheet	Med. Examination
Confinement	Misc. Information 2
Contracts	Pay or Clothing
Death or Effects	Personal Reports
Desertion	Rank
Discharge from Hosp'l	Transfer to Hosp'l
Discharge from Service	Transfer to V. R. C.
Duty	Transportation

Peter Booker

Co. D. 14th Cal.

Order required not
read in A.C.C.

Adjutant General's Office,

COLORED TROOPS BRANCH,

Mr Thian

Sept 13th, 1876

Vol. _____ C. T., 187

Wanted in the case of Peter Booker, Co. D,

4 Reg't U.S. Troops Copy of Special Order
110 Hd. Qs. U.S. Forces Yorktown Oct 27, 1863

Respectfully,

E. A. Woodward
Chief Clerk.
F. J. [Signature]

Adjutant General's Office,

_____, 187

Vol. _____ C. T., 187

Reply in case of _____, Co. _____,

Reg't _____

Have not got it from the source above named.
F. J. [Signature]
J. Allen

C. J. P., A. G. O.

Oct. 26, 1876.

Respectfully returned to Mr. Ellubrock for date and cause of reduction from Capt to ranks, also any information regarding the one months pay due as per U. S. R. Sept 10, 1863.

Respy.

E. A. Woodward
In J. Haddon

Booker T. W. Peter
Co. "H" 4th Reg. U. S. I.

Sir of His Comd

No record. The claim requested to furnish order.

"Returns to ranks for Special Order No 109 June 11. D. Forces Yorktown Va, Oct 27. '63." - Company Regts Oct 25/63. "Absent in must" you 5.0.110 M. S. Forces Yorktown Va, & to return to the ranks. There is no copy of above mentioned order on file with Regie & Co Records, and the foregoing is all the information obtainable in this case therefrom -
A. R. K. E
10739763

Adjutant General's Office,

COLORED TROOPS BRANCH,

August 14th, 1876

Mr. E. Loderhook, 187

Wanted in the case of Peter Booker, Pvt., Co. "H",
4th Reg't U.S.C. Copy of order re. cause of
reduction in
Member Roll for Sept & Oct. 1863 reports him
"Reduced from Corp to rank, due on account
of 1 months pay of 110 Hd Qr. Wm Jones, Yorktown
Oct. 27, 1863"

Respectfully,

R. A. Woodward
Chief Clerk.
J. H. Halson

Adjutant General's Office,

Division of Discontinued Commands.
Aug 29th, 1876.

Vol. C. T., 187

Reply in case of Peter Booker, Co. D,
4th Reg't U. S. C. I -

D.O., U.S. Forces Yorktown, Va, prior to '64 are
not on file in this office, nor is there a copy
of the order above mentioned on file with Regal
Co Records

Co D Co BK reports him - "Sentenced to one
months hard labor & to be reduced to rank
G.O. No - therefore absent from Oct 28/63
to Nov 28/63 - rejoined Co this day -" On Register
of Non Com^d Officers. Name born as Corp with remark

Handwritten note:
I am not sure if the Co. D. is the same as the Co. D. in the
1863 records. I am not sure if the Co. D. is the same as the
Co. D. in the 1863 records. I am not sure if the Co. D. is the
same as the Co. D. in the 1863 records.

Booth¹²⁸ James
Col. , 4 U.S. Col'd Inf.

Private | Private

CARD NUMBERS.

1	✓✓✓2915	26
2	✓✓✓2996	27
3	✓✓✓2096	28
4	✓✓✓3194	29
5	✓✓✓3291	30
6	✓✓✓3382	31
7	✓✓✓3469	32
8	✓✓✓3556	33
9	✓✓✓3637	34
10	✓✓✓3718	35
11	✓✓✓3805	36
12	✓✓✓3900	37
13	✓✓✓3996	38
14	✓✓✓4091	39
15	✓✓✓4179	40
16	✓✓✓4258	41
17	✓✓✓4368	42
18	✓✓✓4482	43
19	9061761	44
20		45
21		46
22		47
23		48
24		49
25		50

Book Mark:

See also

B | 4 | U.S.C.T.
James Booth
Co. "B", 4 Reg't U. S. Col'd Inf.

Appears on
Company Descriptive Book
of the organization named above.

DESCRIPTION. *Not given*

Age 24 years; height _____ feet _____ inches.

Complexion _____

Eyes _____; hair _____

Where born _____

Occupation _____

ENLISTMENT.

When July 21, 1863.

Where Baltimore

By whom Col. Birney; term 3 y'rs.

Remarks: Died in Hospt. at
Wilmington, N.C. Mch 30/65.
No official notice of death rec'd
from Hospt. Name ordered to be
dropped from rolls by Genl. Sumner
and final statements forwarded with
affidavit in regard to death etc.

Ward

B. | 4 | U.S.C.T.

James Booth
Pvt., Co. B., 4 Reg't U. S. Col'd Infantry.
 Age 24 years.

Appears on

Company Muster-in Roll

of the organization named above. Roll dated
Baltimore, Md., July 21, 1863.
 Muster-in to date July 21, 1863.

Joined for duty and enrolled:

When July 21st, 1863*
 Where Baltimore, Md.
 Period 3 years.*

Remarks:

* Muster-in roll shows enrollment and muster-in of this company as of same date and place. See enrollment on subsequent card or cards.

Book mark: _____

Mo. W. Wall
 Copyist.

B. | 4 | U.S.C.T.

James Booth
Priv., Co. B, 4 Reg't U. S. Col'd Infantry.

Appears on

Company Muster Roll

for July 21 to Aug. 31, 1863.

Joined for duty and enrolled:

When July 21, 1863.*

Where Baltimore *

Period 3 years.*

Present or absent Present

Stoppage, \$ 100 for

Due Gov't \$ 100 for

Remarks: Premium due \$2.00

* See enrollment on card from muster-in roll.

Book mark:

Wm Hall

B, | 4 | U.S.C.T.

James Booth
Private, Co. B, 4 Reg't U. S. Col'd Infantry.

Appears on

Company Muster Roll

for Sept & Oct, 1863.

Joined for duty and enrolled:

When July 21st, 1863*

Where Baltimore *

Period 3 1/2 years.*

Present or absent Present

Stoppage, \$ 100 for

Due Gov't \$ 100 for

Remarks:

* See enrollment on card from muster-in roll.

Book mark:

(358c)

John Hall Copyist.

B. | 4 | U.S.C.T.

James Booth
Pr., Co. B, 4 Reg't U. S. Col'd Infantry.

Appears on

Company Muster Roll
for Nov. & Dec., 1863

Joined for duty and enrolled:

When July 21st, 1863*

Where Baltimore *

Period 3 years.*

Present or absent Not stated

Stoppage, \$ 100 for

Due Gov't \$ 100 for

Remarks:

* See enrollment on card from muster-in roll.

Book mark:

Iron Hall

B. | 4 | U.S.C.T.

James Booth

Priv., Co. B, 4 Reg't U. S. Col'd Infantry.

Appears on

Company Muster Roll
for Jan'y + Feby, 1864

Joined for duty and enrolled:

When July 21st, 1863.*

Where Baltimore *

Period 3 years.*

Present or absent Present.

Stoppage, \$ 100 for _____

Due Gov't \$ 100 for _____

Remarks: To be stopped, 1
Navysack ⁴⁹ - 1 lantern ⁴¹

* See enrollment on card from muster-in roll.

Book mark: _____

John Hall

Copyist.

B | 4 | U.S.C.T.

James Booth
Pat, Co. B, 4 Reg't U. S. Col'd Infantry.

Appears on

Company Muster Roll
for March & April, 1864.

Joined for duty and enrolled:

When July 21st, 1863.*

Where Baltimore, Md*

Period 3 years.*

Present or absent Present

Stoppage, \$ 100 for _____

Due Gov't \$ 100 for _____

Remarks: _____

* See enrollment on card from muster-in roll.

Book mark: _____

C. U. Clark

B

4

U.S.C.T.

James Booth
Plat., Co. B, 4 Reg't U. S. Col'd Infantry.

Appears on

Company Muster Roll

for May + June, 1864.

Joined for duty and enrolled:

When July 21st, 1863.*

Where Baltimore, Md *

Period 3 years.*

Present or absent Present

Stoppage, \$ 100 for _____

Due Gov't \$ 100 for _____

Remarks: _____

Book mark: _____

C M Clark

(358c)

Copyist.

B | 4 | U.S.C.T.

James Booth
Out, Co. B, 4 Reg't U. S. Col'd Infantry.

Appears on

Company Muster Roll

for July + Aug, 1864.

Joined for duty and enrolled:

When July 21st, 1863.*

Where Baltimore, Md.*

Period 3 years.*

Present or absent Present

Stoppage, \$ 100 for _____

Due Gov't \$ 100 for _____

Remarks: Free on or
before April 19, 1861.

* See enrollment on card from muster-in roll.

Book mark: _____

C M Clark
 (358c) Copyist.

B | 4 | U.S.C.T.

James Booth
Put, Co. B, 4 Reg't U. S. Col'd Infantry.

Appears on

Company Muster Roll
for Sept & Oct, 1864.

Joined for duty and enrolled:

When July 21st, 1863.*

Where Baltimore, Md.*

Period 3 years.*

Present or absent Present

Stoppage, \$ 100 for

Due Gov't \$ 100 for

Remarks: Free on or
before April 19, 1864.

* See enrollment on card from muster-in roll.

Book mark:

(358c)

C M Clark
Copyist.

B | 4 | **U.S.C.T.**

James Boothe
Put, Co. B, 4 Reg't U. S. Col'd Infantry.

Appears on

Company Muster Roll
 for Nov + Dec, 1864.

Joined for duty and enrolled:

When July 21st, 1863.*

Where Baltimore, Md *

Period 3 years.*

Present or absent Absent

Stoppage, \$ 100 for _____

Due Gov't \$ 100 for _____

Remarks: Free on or before
April 19, 1861. Absent
sick since Dec 20, 1864.

* ~~See~~ See enrollment on card from muster-in roll.

Book mark: _____

C M Clark
 (358c) Copyist.

B

4

U.S.C.T.

James Boothe

Pr, Co. B, 4 Reg't U. S. Col'd Infantry.

Appears on

Company Muster Roll

for *Jan & Feb*, 1865.

Joined for duty and enrolled:

When *July 21*, 1863.*

Where *Baltimore, Md* *

Period *3* years.*

Present or absent *absent*

Stoppage, \$ *100* for

Due Gov't \$ *100* for

Remarks: *Absent sick since Dec. 20, '64. Free on or before April 19, 1865.*

* See enrollment on card from muster-in roll.

Book mark:

Barton

13. | 4 | **U.S.C.T.**

James Booth
Pr, Co. B, 4 Reg't U. S. Col'd Infantry.

Appears on

Company Muster Roll

for March & April, 1865.

Joined for duty and enrolled:

When July 21, 1863.*

Where Baltimore, Md *

Period 3 years.*

Present or absent absent

Stoppage, \$ 100 for

Due Gov't \$ 100 for

Remarks: Free on or before April 19, '61.
pay due from enlistment to May
1, '64. 1 ea. got coat strap¹²
absent sick.

* See enrollment on card from muster-in roll.

Book mark: _____

Barlow
 (358c) Copyist.

B.

4

U.S.C.T.

James Booth

Pr, Co. B, 4 Reg't U. S. Col'd Infantry.

Appears on

Company Muster Roll

for *May 1 June, 1863*

Joined for duty and enrolled:

When *July 21, 1863*.*

Where *Baltimore Md.* *

Period *3* years.*

Present or absent *absent*

Stoppage, \$ *100* for

Due Gov't \$ *100* for

Remarks: *Def. of pay due from date of enlistment to May 1 '64. Stop 1 pr. of Coat Straps² Absent sick Free on or before Apr. 19, 1861.*

* See enrollment on card from muster-in roll.

Book mark:

Barlow

B. | 4 | **U.S.C.T.**

James Booth
Pr....., Co. B, 4 Reg't U. S. Col'd Infantry.

Appears on

Company Muster Roll

for July & Aug....., 1865.

Joined for duty and enrolled:

When July 21....., 1863.*

Where Baltimore.....*

Period 3 years.*

Present or absent Absent.....

Stoppage, \$ 100 for.....

Due Gov't \$ 100 for.....

Remarks: Dif. of pay due from
enlistment to May 1, '64.
Stop 1 pr. grt. cook straps¹²
Absent sick. Free

* ~~See~~ See enrollment on card from muster-in roll.

Book mark:

(358c) Barton Copyist.

B.

4

U.S.C.T.

James Booth

Pri, Co. B, 4 Reg't U. S. Col'd Infantry.

Appears on

Company Muster Roll

for *Sep & Oct*, 186*5*.

Joined for duty and enrolled:

When *July 21*, 186*3*.*

Where *Baltimore Md*.*

Period *3* years.*

Present or absent *absent*

Stoppage, \$ *100* for

Due Gov't \$ *100* for

Remarks: *Dif. of pay due from date of enlistment to May 1st '64. Stop 1 pr. gvt. court stroke. Absent sick. Free.*

* See enrollment on card from muster-in roll.

Book mark:

Barton

(358c)

Copyist.

B | 4 | U.S.C.T.

James Booth
Pvt., Co. B, 4 Reg't U. S. Col'd Infantry.

Appears on

Company Muster Roll

for Nov. & Dec., 1865.

Joined for duty and enrolled:

When July 21, 1865.*

Where Baltimore, Md. *

Period 3 years.*

Present or absent absent

Stoppage, \$ 100 for _____

Due Gov't \$ 100 for _____

Remarks: Difference of pay due
from enlistment to May 1/64,
Stop 1 pr. Lt. Coat straps 12¢.
absent sick - Free on or before
abt. 19/61.

* See enrollment on card from muster-in roll.

Book mark: _____

(358c)

Fabler

Copyist.

B

4

U.S.C.T.

James Booth

Priv., Co. B, 4 Reg't U. S. Col'd Infantry.

Appears on

Company Muster Roll

for *Jan'y & Feby*, 1866.

Joined for duty and enrolled:

When *July 21*, 1863.*

Where *Baltimore, Md.* *

Period *3* years.*

Present or absent

Stoppage, \$ *100* for

Due Gov't \$ *100* for

Remarks: *Died in Hospital at
Wilmington, N.C. Mch. 30/65.
Final Statements forwarded.*

NEXT ROLL ON FILE MUSTER OUT.

* See enrollment on card from muster-in roll.

Book mark: *A.G.O. - Died march
over*

Tabler

(858c)

Copyist.

JAN 19

5554368

1891

30, 1864. See F. S. on file.

B | 4 U.S.C.T.

James Booth
Sgt., Co. B, 4 Reg't U. S. Col'd Infantry.

Appears on Co. Muster-out Roll, dated
Washington, D.C., May 4, 1866.

Muster-out to date _____, 186 .
Last paid to _____, 186 .

Clothing account:

Last settled _____, 186 ; drawn since \$ _____ 100
Due soldier \$ _____ 100 ; due U. S. \$ _____ 100
Am't for cloth'g in kind or money adv'd \$ _____ 100

Due U. S. for arms, equipments, &c., \$ _____ 100
Bounty paid \$ _____ 100 ; due \$ _____ 100

Remarks: *Free on or before April 19/61.
Died mch. 30/65, of disease
at Wilmington, N.C.*

Book mark: *V. 245, P. 229, 77*
over

(261)

Fabler
Copyist.

JAN. 19

5554482

1891

V. 122, P. 303-71

V. 149, P. 83-73.

Als. O. sua mch. 31/6 H.

P. S. on file.

Booth, James.
 P, Co. B, 4 Regt. U. S. C. Inf.

3 Enclosures.

Bed Cards	Descriptive Lists
Burial Records	Final Statements /
Certs. of Dis. for Discharge	Furloughs
C. M. Charges	Med. Des. Lists
Med. Certificates	Orders

Other papers relating to—

Admission to Hosp'l	Furlough
Casualty Sheet (Officer's)	Med. Examination
Confinement	Misc. Information /
Contracts	Pay or Clothing
Death or Effects /	Personal Reports
Desertions	Rank
Discharge from Hosp'l	Transfer to Hosp'l
Discharge from Service	Transfer to V. R. C.
Duty	Transportation

MICROFILM PUBLICATION M 1846

COMPILED MILITARY SERVICE RECORDS
OF VOLUNTEER UNION SOLDIERS WHO SERVED WITH
THE UNITED STATES COLORED TROOPS (USCT)
4TH REGIMENT OF INFANTRY

PERSONAL PAPERS' TARGET SHEET

PLEASE NOTE THE CHECKED INFORMATION ABOUT THE PERSONAL PAPERS IN
THIS FILE:

- NO PERSONAL PAPERS WERE FOUND IN THIS FILE WHEN THE
RECORDS WERE ARRANGED FOR MICROFILMING.
- 4 PERSONAL PAPER(S) FOUND IN THIS FILE WHEN THE RECORDS
WERE ARRANGED FOR MICROFILMING.

Drove on or before April 19th 1861. Difference of pay and subsistence - to May 1st 1864

I certify, on honor, that James Booth, a Powhatan of
 Captain S Gillingham's Company ('B') of the 4th Regiment of U. S. C. I
Volunteers, of the State of _____, born in Calbot Co State
 of Virginia, aged 24 years; 5 feet 1 1/2 inches high; Black complexion,
Black eyes, Black hair, and by occupation a Laborer, who joined for service
 and was enrolled (see Note 9) on the 21st day of July, 1863, at Baltimore, Md.
 by Co. Wm Birney, for the period of Three years, and mustered into
 the service of the United States on the 21st day of July, 1863, at
Baltimore, Md., by Co. Wm Birney; and having served
HONESTLY and **FAITHFULLY** with his Company to the present date, is now entitled to a
DISCHARGE by reason of death. - Died in Post Hosp. at
Wilmington - N. C. on the 30th day of March 1864 of disease

The said James Booth was last paid by Paymaster
Wm Birney, to include the 31st day of August, 1864, and
 has pay due him from that time to the present date; he is entitled to pay and subsistence for
TRAVELING to place of enrollment, and whatever other allowances are authorized to volunteer
 soldiers, drafted men, or militia, so discharged. He has received from the United States **CLOTHING**
 amounting to 31 ⁸⁷/₁₀₀ dollars, since the 30th day of June,
 1864, when his clothing account was last settled. He has received from the United States
 _____ dollars advanced **BOUNTY**.

There is to be stopped from him, on account of the State of _____, or other
 authorities, for **CLOTHING**, &c., received on entering service, _____ dollars; and
 for other stoppages, viz: _____

_____ dollars.
 He has been furnished with **TRANSPORTATION** in kind from the place of his discharge to
 _____; and he has been **Subsisted** for **Traveling** to his
 place of enrollment, up to the _____, 186 .

He is indebted to _____, **Sutler**, _____ dollars.
 He is indebted to _____, **Laundress**, _____ dollars.

Given in Duplicate, at Fort Stevens I. C., this 17th day
 of March 1866.

Saml. Gillingham
Co. 4th Regt. U. S. C. I
 Commanding Company.

Regimental and Company Descriptive Book report James Booth, Pr. Co. B. 4th U.S. C.T. "Died at Hospital, Wilmington, N. C., March 30, 1865." The Company Descriptive Book adds: No official notice of Death received from Hospital: Name ordered to be dropped from rolls by Genl Duncan, and final statements forwarded with regard to death, etc. - Cons. Morning Report Book is not on file. Co. B. Morning Report Book is not on file covering date. -

Record Room

5th April 71. E. G. H.

P. 169. vol 9. C. 5. 1871.

November 20, 1871.

James Booth,
late Capt Co "B" 1st U.S.C.T.

Surgeon General returns
letter of April 8, 1871, from
A. S. O. of, with report
enclosed.

(One Enclosed)

112 ✓
27



Rec'd A. S. O. Nov 21, 1871.

Surgeon General's Office,
Record and Pension Division,

Washington, D. C., Nov 21, 1871.

Respectfully returned to the Adjutant
General, U. S. Army, with report enclosed.

BY ORDER OF THE SURGEON GENERAL:

J. J. [Signature]

Bvt. Lt. Col. and Asst. Surgeon, U. S. A.
(80)

(One Enclosed)

War Department,

Adjutant General's Office,

Washington, D. C.; April 8th 1871.

Surgeon General

U. S. Army,

Washington, D. C.

General:

I have to request that this office be advised of the date of death of Private James Booth, Company "B" 4th U. S. Colored Troops, which occurred in General Hospital at Wilmington, N. C., - date not shown by the records of this office.

Very Respectfully,
Your Obedient Servant,
Samuel M. Durant
Assistant Adjutant General.

(14.122.P.303.71)

Recd

WAR DEPARTMENT,
Surgeon General's Office,

RECORD AND PENSION DIVISION,

Washington, D. C., *Nov 20th*, 1871.

[TRANSCRIPT FROM RECORDS.]

It appears from the records filed in this Office, that *James Booth or*
Booze Private Co *B*, *4th* Reg't *U.S. T.* Vol.....

was admitted to *Geer General* Hospital, *Wilmington N.C.*

March 13th, 1865, from for treatment for

Pneumonia and died of that disease *March*
29th 1865.

Date of death also appears as *March 30th* 1865.

~~.....~~

By order of the Surgeon General:

H. J. Woodward

Assistant Surgeon, U. S. Army.

(109)

Vol. *27*
No. *1187*

(NOTE.—This transcript should not be detached from the accompanying papers. If additional information is desired relative to the case, this paper should accompany the application therefor.)

1

B169 vol 9. C. J. 1841.

(First Endmt)

129

Bordley, Daniel C.

Co C, 4 U.S. Col'd Inf.

Private | Private

CARD NUMBERS.

1	5554529	26
2	5554615	27
3	5554715	28
4	5554818	29
5	5554912	30
6	5555003	31
7	5555091	32
8	5555173	33
9	5555247	34
10	5555318	35
11	5555414	36
12	5555507	37
13	5555605	38
14	5555710	39
15	5555797	40
16	5555878	41
17	5555939	42
18	5555997	43
19	906189A 17	44
20		45
21		46
22		47
23		48
24		49
25		50

Book Mark: .

See also

B 1

4

U.S.C.T.

Daniel Bodley

Co. "E", 4 Reg't U. S. Col'd Inf.

Appears on

Company Descriptive Book

of the organization named above.

DESCRIPTION.

Age 22 years ; height 5 feet 11 inches.

Complexion black

Eyes black ; hair black

Where born Balto. Md.

Occupation hod carrier

ENLISTMENT.

When July 15, 1863.

Where Balto. Md.

By whom Col. Wm. Biney ; term 3 y'rs.

Remarks:

[Empty lines for remarks]

[Handwritten signature]

9

4

U.S.C.T.

Samuel C. Dordley
Priv, Co. C, 4 Reg't U. S. Col'd Infantry.

Age *22* years.

Appears on

Company Muster-in Roll

of the organization named above. Roll dated

Baltimore Md July 24 1863

Muster-in to date *July 24, 1863*

Joined for duty and enrolled:

When *July 15, 1863*

Where *Baltimore Md*

Period *3* years.

Remarks:

Book mark:

(356)

Talbot
Copyist.

D

4

U.S.C.T.

Daniel C. Gordley
Priv, Co. C. 4 Reg't U. S. Col'd Infantry.

Appears on

Company Muster Roll

for *July 12 To Aug 31*, 186*3*.

Present or absent *Present*

Stoppage, \$ *100* for

Due Gov't, \$ *100* for

Remarks: *Two dollars pre-*
mium due,

Book mark:

Talborth

(358)

Copyist.

D

4

U.S.C.T.

Daniel C. ^VBordley ~~Bradley~~

Priv, Co. C. 4 Reg't U. S. Col'd Infantry.

Appears on

Company Muster Roll

for *Sept & Oct*, 18*63*.

Present or absent *Present*

Stoppage, \$ *100* for

Due Gov't, \$ *100* for

Remarks: *Present sick*

Correctly Pattern of

Book mark:

Talbott

(358)

Copyist.

D

4

U.S.C.T.

Wm C. Goddley
Priv, Co. C. 4 Reg't U. S. Col'd Infantry.

Appears on

Company Muster Roll

for *Nov & Dec*, 1863

Present or absent *Present*

Stoppage, \$ *100* for

Due Gov't, \$ *100* for

Remarks: *Present sick*

Book mark:

Talbot

D | 4 | U.S.C.T.

Daniel C. Bodley
Priv, Co. C. 4 Reg't U. S. Col'd Infantry.

Appears on

Company Muster Roll

for *Jay & Selby*, 1864.

Present or absent *Present*

Stoppage, \$ 100 for

Due Gov't, \$ 100 for

Remarks:

Book mark:

Talburt

(358)

Copyist.

B

4

U.S.C.T.

Samuel C. Bordley

Pvt, Co. C. 4 Reg't U. S. Col'd Infantry.

Appears on

Company Muster Roll

for *March & April*, 1864.

Present or absent *Present*

Stoppage, \$ *100* for

Due Gov't, \$ *100* for

Remarks: *Stop loss of equipage
49 cts*

Book mark:

J. W. Davis

(358)

Copyist.

B

4

U.S.C.T.

Samuel C. Bordley
Pvt

, Co. C. 4 Reg't U. S. Col'd Infantry.

Appears on

Company Muster Roll

for May & June, 1864.

Present or absent Present

Stoppage, \$ 100 for

Due Gov't, \$ 100 for

Remarks:

Book mark:

J. W. Davis

B

4

U.S.C.T.

Samuel C. Bordley

Pvt., Co. C. 4 Reg't U. S. Col'd Infantry.

Appears on

Company Muster Roll

for July & Aug, 1864

Present or absent Present

Stoppage, \$ 100 for

Due Gov't, \$ 100 for

Remarks: Free on or before
Apr 19, 1861. Extra duty on
Canal at Dutch Gap.

Book mark:

JWS avis

(858)

Copyist.

B

4

U.S.C.T.

Samuel C. Bordly
Post, Co. C. 4 Reg't U. S. Col'd Infantry.

Appears on

Company Muster Roll

for *Sept & Oct*, 186 *4*

Present or absent *Absent*

Stoppage, \$ *100* for

Due Gov't, \$ *100* for

Remarks: *Free on or before*
April 19/61. Due Reg't
Sutler \$7.00 Absent wounded

Book mark:

W. Davis

(358)

Copyist.

B

4

U.S.C.T.

Daniel Bordley
Pvt, Co. C. 4 Reg't U. S. Col'd Infantry.

Appears on

Company Muster Roll

for Nov & Dec, 1864.

Present or absent Absent

Stoppage, \$ 100 for

Due Gov't, \$ 100 for

Remarks: Free on or before
April 19/61. Due Sutter \$7.00
ab. wounded

Book mark:

(358)

JW Davis

Copyst.

B

4

U.S.C.T.

Daniel G. Bordley
Pvt, Co. C. 4 Reg't U. S. Col'd Infantry.

Appears on

Company Muster Roll

for *Jany & Feby*, 1865-

Present or absent *Present*

Stoppage, \$ 100 for

Due Gov't, \$ 100 for

Remarks: *Free on or
before April 19'61
Due H. C. Cooper
utter 4" U.S.C.T.
\$ 7.00.*

Book mark:

Perrington

(858)

Copyist.

B

4

U.S.C.T.

Daniel C. Bordley

Priv, Co. C. 4 Reg't U. S. Col'd Infantry.

Appears on

Company Muster Roll

for *March & April*, 1865.

Present or absent *Absent*

Stoppage, \$ *100* for

Due Gov't, \$ *100* for

Remarks: *Free before April 19/61 - Back pay due from enlistment - to May 1/64 - Due sutler H. C. Cooper \$7.00 - Absent - sick -*

Book mark:

Perrington
Copyist.

B

4

U.S.C.T.

Daniel C. Bordley

Priv, Co. C. 4 Reg't U. S. Col'd Infantry.

Appears on

Company Muster Roll

for May & June, 1865

Present or absent Absent

Stoppage, \$ 100 for

Due Gov't, \$ 100 for

Remarks: Absent - sick

Book mark:

Perrington

(358)

Copyist.

B

4

U.S.C.T.

Daniel C. Bordley

Pvt, Co. C. 4 Reg't U. S. Col'd Infantry.

Appears on

Company Muster Roll

for July & Aug, 1865.

Present or absent Present

Stoppage, \$ 100 for

Due Gov't, \$ 100 for

Remarks:

Book mark:

(858)

Pennington

Copyist.

B

4

U.S.C.T.

Daniel G. Bordley

Priv., Co. C. 4 Reg't U. S. Col'd Infantry.

Appears on

Company Muster Roll

for Sept & Oct, 1863.

Present or absent Present

Stoppage, \$ 100 for

Due Gov't, \$ 100 for

Remarks: Free on or before April 19-1861. Back pay due from date of enlistment to May 1/64.

Book mark:

Pennington

(358)

Copyist.

B 1 4 MS. C. J.

Daniel C. Cordley
Pvt., Co. C, 4 Reg't, MS. Cold. Inf.

Appears on

Company Muster Roll

for Nov + Dec, 1865.

Present or absent Present

Stoppage, \$ 100 for

Due Gov't, \$ 100 for

Valuation of horse, \$ 100

Valuation of horse equipments, \$ 100

Remarks:

Book mark:

J. Hammond

B

4

U.S.C.T.

Daniel C. Cordley
Put, Co. C. 4 Reg't U. S. Col'd Infantry.

Appears on

Company Muster Roll

for *Jan'y & Feby*, 186 *6*

Present or absent *Present*

Stoppage, \$ *100* for

Due Gov't, \$ *100* for

Remarks:

NEXT ROLL ON FILE MUSTER OUT.

Book mark:

R. Johnson
Copyist.

B | 4 | U.S.C.T.

Daniel C. Bradley
Put., Co. C, 4 Reg't U. S. Col'd Infantry.

Appears on **Co. Muster-out Roll**, dated
Washington, D.C. May 4, 1866.

Muster-out to date May 4, 1866.

Last paid to Feb 28, 1866.

Clothing account:

Last settled....., 186 ; drawn since \$.....100

Due soldier \$ 34 40 / 100; due U. S. \$.....100

Am't for cloth'g in kind or money adv'd \$.....100

Due U. S. for arms, equipments, &c., \$ 600 / 100

Bounty paid \$.....100; due \$ 100 / 100

Remarks: Free on April 19
61.

Correctly Put in

Book mark: PV 17 - P. 3. 71
V 120 P 176 73.

R. Johnson
Copyist.

130

Gordley, William F.

Co B., 4 U.S. Col'd Inf.

Private

Private

CARD NUMBERS.

1	5553916	26
2	5553997	27
3	5553097	28
4	5553195	29
5	5553290	30
6	5553384	31
7	5553471	32
8	5557557	33
9	5553638	34
10	5553719	35
11	5553806	36
12	5553901	37
13	5553997	38
14	5554092	39
15	5554178	40
16	5554257	41
17	5554325	42
18	5554389	43
19	9061763	44
20		45
21		46
22		47
23		48
24		49
25		50

Book Mark:

See also

B | 4 | U.S.C.T.

William F. Bodley

....., Co. B, 4 Reg't U. S. Col'd Inf.

Appears on

Company Descriptive Book

of the organization named above.

DESCRIPTION.

Age 18 years; height 5 feet 8 inches.

Complexion black

Eyes black; hair black

Where born Talbot Co. Md.

Occupation laborer

ENLISTMENT.

When July 21, 1863.

Where Baltimore

By whom Col. Birney; term 3 y'rs.

Remarks:

.....
.....
.....
.....
.....
.....
.....
.....
.....
.....

Hand

B. | **4** | **U.S.C.T.**

William F. Bordley,

Priv., Co. *B*, 4 Reg't U. S. Col'd Infantry.

Age *18* years.

Appears on

Company Muster-in Roll

of the organization named above. Roll dated

Baltimore Md July 21, 186 *3*

Muster-in to date

July 21, 186 *3*

Joined for duty and enrolled:

When *July 21*st, 186 *3**

Where *Baltimore, Md* *

Period *3* years.*

Remarks:

* ~~Use~~ Muster-in roll shows enrollment and muster-in of this company as of same date and place. See enrollment on subsequent card or cards.

Book mark:

Mo. W. Hall

B. | 4 | U.S.C.T.

William F. Bradley
Priv., Co. B, 4 Reg't U. S. Col'd Infantry.

Appears on

Company Muster Roll
for *July 31 to Aug. 31*, 186 *3*

Joined for duty and enrolled:

When *July 31*, 186 *3**

Where *Baltimore**

Period *3* years.*

Present or absent *Present*

Stoppage, \$ *100* for

Due Gov't \$ *100* for

Remarks: *Premium due \$200*

Corrected by Patton &

* See enrollment on card from muster-in roll.

Book mark:

John Hall
Copyist.

B | 4 | U.S.C.T.

William J. Bradley
William J. Bradley
Pvt., Co. B, 4 Reg't U. S. Col'd Infantry.

Appears on

Company Muster Roll

for *Sept & Oct*, 186*3*.

Joined for duty and enrolled:

When *July 21st*, 186*3**

Where *Baltimore* *

Period *3* years.*

Present or absent *Present*

Stoppage, \$ *100* for _____

Due Gov't \$ *100* for _____

Remarks: _____

Corrected by Patton &

* See enrollment on card from muster-in roll.

Book mark: _____

(358c)

Wm Hall

Copyist.

B. | 4 | U.S.C.T.

William J. Bondley
Pot., Co. B, 4 Reg't U. S. Col'd Infantry.

Appears on

Company Muster Roll
for Nov. & Dec, 1863

Joined for duty and enrolled:

When July 21st, 1863*

Where Baltimore *

Period 3 years.*

Present or absent NOT stated

Stoppage, \$ 100 for

Due Gov't \$ 100 for

Remarks:

* Corrected by Pottinger

* See enrollment on card from muster-in roll.

Book mark:

(358c) J. M. Wall Copyist.

B. | 4 | U.S.C.T.

^{* Bradley}
William F. ~~Bradley~~
Priv., Co. B, 4 Reg't U. S. Col'd Infantry.

Appears on

Company Muster Roll
for Jan'y & Feb'y, 1864.

Joined for duty and enrolled:

When July 21st, 1864^{*}

Where Baltimore *

Period 3 years.*

Present or absent Present.

Stoppage, \$ 100 for _____

Due Gov't \$ 100 for _____

Remarks: To be stopped 1 Miper²⁰
1 Wrench²³, 1 Canteen⁴¹
1 Messpack⁴⁹, 1 Knapsack⁸⁵

* Corrected by Patton

* See enrollment on card from muster-in roll.

Book mark: _____

Small

B | 4 | U.S.C.T.

William Bordley
Put, Co. B, 4 Reg't U. S. Col'd Infantry.

Appears on

Company Muster Roll
for March & April, 1864.

Joined for duty and enrolled:

When July 21st, 1863.*

Where Baltimore, Md.*

Period 3 years.*

Present or absent Present

Stoppage, \$ 100 for

Due Gov't \$ 100 for

Remarks:

* See enrollment on card from muster-in roll.

Book mark:

C. M. Clark
Copyist.

B | 4 | U.S.C.T.

William P. Bordley
Private, Co. B, 4 Reg't U. S. Col'd Infantry.

Appears on

Company Muster Roll

for May & June, 1864.

Joined for duty and enrolled:

When July 21st, 1863.*

Where Baltimore, Md.*

Period 3 years.*

Present or absent Present.

Stoppage, \$ 100 for

Due Gov't \$ 100 for

Remarks:

* See enrollment on card from muster-in roll.

Book mark:

(358c)

C. M. Clark

Copyist.

B | 4 | U.S.C.T.

William F Bordly
Pat, Co. B, 4 Reg't U. S. Col'd Infantry.

Appears on

Company Muster Roll
for July & Aug, 1864.

Joined for duty and enrolled:

When July 21, 1863.*

Where Baltimore, Md *

Period 3 years.*

Present or absent Present

Stoppage, \$ 100 for _____

Due Gov't \$ 100 for _____

Remarks: Free on or
before April 19, 1861.

* See enrollment on card from muster-in roll.

Book mark: _____

C M Clark
(358c) Copyist.

B | 4 | U.S.C.T.

William F Bardley
Put, Co. B, 4 Reg't U. S. Col'd Infantry.

Appears on

Company Muster Roll

for Sept. & Oct., 1864.

Joined for duty and enrolled:

When July 21st, 1863.*

Where Baltimore, Md.*

Period 3 years.*

Present or absent Absent.

Stoppage, \$ 100 for

Due Gov't \$ 100 for

Remarks: Free on or
before April 19, 1861.
Absent wounded
Due Sutter, \$6.00

* See enrollment on card from muster-in roll.

Book mark:

C M Clark

B | 4 | U.S.C.T.

William F Bondley
Pvt., Co. B, 4 Reg't U. S. Col'd Infantry.

Appears on

Company Muster Roll

for Nov. & Dec., 1864.

Joined for duty and enrolled:

When July 21st, 1863.*

Where Baltimore, Md.*

Period 3 years.*

Present or absent Present.

Stoppage, \$ 100 for

Due Gov't \$ 100 for

Remarks: Free on or
before April 19, 1861.
Due W. C. Cooper, Supt.,
\$6.00.

* See enrollment on card from muster-in roll.

Book mark:

C. H. Clark

(358c)

Copyist.

B.

4

U.S.C.T.

William F. Bordley

cri, Co. B, 4 Reg't U. S. Col'd Infantry.

Appears on

Company Muster Roll

for *Jan & Feb.*, 1865.

Joined for duty and enrolled:

When *July 21*, 1863.*

Where *Baltimore, Md.* *

Period *3* years.*

Present or absent *Absent*

Stoppage, \$ *100* for

Due Gov't \$ *100* for

Remarks: *Absent sick since*

Dec. 8, '64. Freemon

before Apl. 19, 1865.

Due W. Cooper letter 4'

U. S. C. T. 600

* See enrollment on card from muster-in roll.

Book mark:

(358c)

Barton

Copyist.

B. | 4 | **U.S.C.T.**

William F. Bordley
Pri, Co. B, 4 Reg't U. S. Col'd Infantry.

Appears on

Company Muster Roll

for *Mch & Apr*, 1865.

Joined for duty and enrolled:

When *July 21*, 1863.*

Where *Baltimore Md.* *

Period *3* years.*

Present or absent *Present*

Stoppage, \$ *100* for

Due Gov't \$ *100* for

Remarks: *Stop 1 pr. Govt. coat
staps .12*

* See enrollment on card from muster-in roll.

Book mark:

(358c)

Burton

Copyist.

B. | 4 | U.S.C.T.

Wm F. Bondley

Pri, Co. B, 4 Reg't U. S. Col'd Infantry.

Appears on

Company Muster Roll

for *May + June*, 1865.

Joined for duty and enrolled:

When *July 2, 1863*.*

Where *Baltimore md* *

Period *3* years.*

Present or absent *Present*

Stoppage, \$ *100* for

Due Gov't \$ *100* for

Remarks: *Stop 1 pr. gvt. Coat strips²*
See W. C. Cooper, Sullivan, 4th U. S.
C. T. \$500 Free War before
Apr. 1916.

* See enrollment on card from muster-in roll.

Book mark: _____

Burton

B.

4

U.S.C.T.

William F Bordley

Pr....., Co. B, 4 Reg't U. S. Col'd Infantry.

Appears on

Company Muster Roll

for *July + Aug*....., 186*5*.

Joined for duty and enrolled:

When *July 21*....., 186*3*.*

Where *Baltimore Md.*.....*

Period *3* years.*

Present or absent *absent*

Stoppage, \$ *100* for

Due Gov't \$ *100* for

Remarks: *Absent on Det. Serv.*

* See enrollment on card from muster-in roll.

Book mark:

(358c)

Barton

Copyist.

7

B. | 4 | **U.S.C.T.**

Wm. F. Bordley
Private, Co. B, 4 Reg't U. S. Col'd Infantry.

Appears on

Company Muster Roll

for Sep. & Oct., 1865.

Joined for duty and enrolled:

When July 21, 1863.*

Where Baltimore Md.*

Period 3 years.*

Present or absent Present

Stoppage, \$ 100 for _____

Due Gov't \$ 100 for _____

Remarks: _____

* See enrollment on card from muster-in roll.

Book mark: _____

(358c) Barton Copyist.

B | 4 | U.S.C.T.

Wm F. Bradley
Priv., Co. B, 4 Reg't U. S. Col'd Infantry.

Appears on

Company Muster Roll

for Nov. & Dec., 1865.

Joined for duty and enrolled:

When July 21, 1865.*

Where Baltimore, Md. *

Period 3 years.*

Present or absent Present

Stoppage, \$ 100 for _____

Due Gov't \$ 100 for _____

Remarks: _____

* See enrollment on card from muster-in roll.

Book mark: _____

(858c)

Teller

Copyist.

B

4

U.S.C.T.

William F. Bordley

Pat., Co. B, 4 Reg't U. S. Col'd Infantry.

Appears on

Company Muster Roll

for *Jan'y & Feby*, 1866.

Joined for duty and enrolled:

When *July 21*, 1863.*

Where *Baltimore, Md.**

Period *3* years.*

Present or absent *Present*

Stoppage, \$ *100* for

Due Gov't \$ *100* for

Remarks:

NEXT ROLL ON FILE MUSTER OUT.

* See enrollment on card from muster-in roll.

Book mark:

(358c)

Jabler

Copyist.

B

4

U.S.C.T.

William F. Bordley
Co. B, 4 Reg't U. S. Col'd Infantry.

Appears on **Co. Muster-out Roll**, dated
Washington, D.C. May 4, 1866.

Muster-out to date *May 4, 1866.*

Last paid to *Feb. 28 1866.*

Clothing account:

Last settled....., 186 ; drawn since \$.....100

Due soldier \$ *16*^{*49*}100; due U. S. \$.....100

Am't for cloth'g in kind or money adv'd \$.....100

Due U. S. for arms, equipments, &c., \$ *6*100

Bounty paid \$.....100; due \$ *100*100

Remarks *Discharged about April 19/61*

Book mark: *284 823*

Fabler

(861)

Copyist.

Bordley Wm J

_____, Co. _____, _____ Reg't *USCJ*

Enclosures.

Bed Cards	Final Statements
Burial Records	Furloughs or L. of A.
Certs. of Dis. for Discharge	Med. Certificates
C. M. Charges	Med. Des. Lists
Descriptive Lists	Orders
Discharge Certificates	Pris. of War Record
Enlistment Papers	Resignations

Other papers relating to—

Admission to Hosp'l	Furlough or L. of A.
Casualty Sheet	Med. Examination
Confinement	Misc. Information <i>/</i>
Contracts	Pay or Clothing
Death or Effects	Personal Reports
Desertion	Rank
Discharge from Hosp'l	Transfer to Hosp'l
Discharge from Service	Transfer to V. R. C.
Duty	Transportation

B. 632. 1863

Baltimore Sept. 4th 1863

Briny Col. Stm

In answer to Mrs Gregory's
inquiry as regards a Col'd boy
in her charge, reported to have
enlisted in 4th Col'd Troops. Says
there is a private in Co. B. answer-
ing to the description.

W. F. Bondley
H. W. C. S.

Adj. Ins. 4th U. S. Colored Troops
 Baltimore Md. Sept 4, 1863

Mrs. Ann R. Gregory

Madam

In
 answer to your inquiry respecting one
 William F. Bordley, who was apprenticed to
 your husband Amos Gregory until he should
 arrive at twenty one years of age; I have
 to state that a man answering to that
 name and your description, is a private
 in Co. "B." of the above Regt

Very Respectfully
 Yours. &c

Col Wm Birney

per St. Sykes, Clerk

131

Fosterick Henry W. M.

Co F, 4 U.S. Col'd Inf

Private

Sergeant

CARD NUMBERS.

1	55-59 378	26
2	55-59 478	27
3	55-59 578	28
4	55-59 677	29
5	55-59 775	30
6	55-59 871	31
7	55-59 966	32
8	55-60 057	33
9	55-60 142	34
10	55-60 219	35
11	55-60 307	36
12	55-60 389	37
13	55-60 484	38
14	55-60 575	39
15	55-60 664	40
16	55-60 735	41
17	55-60 800	42
18	55-60 862	43
19	9062 303	44
20		45
21		46
22		47
23		48
24		49
25		50

Book Mark:

See also

S. 136196 P.O. Off.

~~S. 1747700 P.O. Off.~~

S. 175-6247 P.O. Off.

S-1756357- P.O. Off

B

4

U.S.C.T.

Henry M. M. Boetricks

, Co. F, 4 Reg't U. S. Col'd Inf.

Appears on

Company Descriptive Book

of the organization named above.

DESCRIPTION.

Age 22 years; height 5 feet 7 1/2 inches.

Complexion *Quadrum*

Eyes *Black*; hair *Black*

Where born *Frederick Co. Md*

Occupation *Farmer*

ENLISTMENT.

When *Aug 4, 1863*

Where *Baltimore Md*

By whom *Col. W. Birney*; term *3* y'rs.

Remarks: *Absent from wounds recd in
actions before Petersburg Va. June 15/64
Returned to duty Sept 5/64*

W. H. Merrill

B

4

U.S.C.T.

Henry W. M. Postnick

Priv, Co. G, 4 Reg't U. S. Col'd Infantry.

Age *22* years.

Appears on

Company Muster-in Roll

of the organization named above. Roll dated

Baltimore Md, Aug 4, 1863.

Muster-in to date *Aug 4, 1863.*

Joined for duty and enrolled:

When *Aug 4th, 1863.**

Where *Baltimore Md.**

Period *3* years.*

Remarks:

* ~~Ed~~ Muster-in roll shows enrollment and muster-in of this company as of same date and place. See enrollment on subsequent card or cards.

Book mark:

Valentine

4 U.S.C.T.

Henry N. M. Bestnick
Priv. Co. F, 4 Reg't U. S. Col'd Infantry.

Appears on

Company Muster Roll

for *Aug 4 to Aug 31*, 1863.

Joined for duty and enrolled:

When *August 4th*, 1863.*

Where *Baltimore Md.**

Period *3* years.*

Present or absent *Present*

Stoppage, \$ *100* for

Due Gov't \$ *100* for

Remarks:
No dollars premium due.

* See enrollment on card from muster-in roll.

Book mark:

Valentine

B. | 4 | U.S.C.T.

Henry W. M. Pastricks
Priv. Co. F, 4 Reg't U. S. Col'd Infantry.

Appears on

Company Muster Roll

for *Sept. & Oct.*, 1863.

Joined for duty and enrolled:

When *August 4th*, 1863.*

Where *Baltimore Md.**

Period *3* years.*

Present or absent *Present*

Stoppage, \$ *100* for _____

Due Gov't \$ *100* for _____

Remarks: _____

* See enrollment on card from muster-in roll.

Book mark: _____

(858c)

Valentine
 Copyist.

B | 4 | U.S.C.T.

Henry W. M. Bestnick

Priv Co. F, 4 Reg't U. S. Col'd Infantry.

Appears on

Company Muster Roll

for *Nov. & Dec.*, 1863.

Joined for duty and enrolled:

When *August 4.*, 1863.*

Where *Baltimore Md**

Period *3* years.*

Present or absent *Present*

Stoppage, \$ *100* for

Due Gov't \$ *100* for

Remarks:

* See enrollment on card from muster-in roll.

Book mark:

Valentine

B. | 4 | **U.S.C.T.**

Henry W. M. Pastnicks
Pvt., Co. F, 4 Reg't U. S. Col'd Infantry.

Appears on

Company Muster Roll

for *Jan & Feb.*, 1864.

Joined for duty and enrolled:

When *August 4.*, 1863.*

Where *Baltimore Md.* *

Period *3* years.*

Present or absent *Present*,

Stoppage, \$ 100 for

Due Gov't \$ 100 for

Remarks:

* See enrollment on card from muster-in roll.

Book mark: -----

Talentine

B | 4 | U.S.C.T.

H. W. M. Postwicks

Pvt, Co. F, 4 Reg't U. S. Col'd Infantry.

Appears on

Company Muster Roll

for *Mich & Apl*, 1864.

Joined for duty and enrolled:

When *Augt 4*, 1863.*

Where *Balto Md* *

Period *3* years.*

Present or absent *Present*

Stoppage, \$ *100* for

Due Gov't \$ *100* for

Remarks:

* See enrollment on card from muster-in roll.

Book mark: -----

J. M. Storer

B | 4 | U.S.C.T.

A. M. M. Portwicks

Det, Co. F, 4 Reg't U. S. Col'd Infantry.

Appears on

Company Muster Roll

for *May & June*, 1864.

Joined for duty and enrolled:

When *Aug 4*, 1863.*

Where *Balto Md* *

Period *3* years.*

Present or absent *Absent*

Stoppage, \$ *100* for

Due Gov't \$ *100* for

Remarks: *Absent sick Wound-
ed in action before Peter-
burg Va June 15/64.*

* See enrollment on card from muster-in roll.

Book mark:

VauSoren

19 | 4 | U.S.C.T.

N. W. M. Postwick

Priv, Co. F, 4 Reg't U. S. Col'd Infantry.

Appears on

Company Muster Roll

for *July & Augt*, 1864.

Joined for duty and enrolled:

When *Augt 4*, 1863.*

Where *Baltimore Md* *

Period *3* years.*

Present or absent *Absent*

Stoppage, \$ *100* for

Due Gov't \$ *100* for

Remarks: *Absent sick on ac-
count of wound rec'd. be-
fore Petersburg Va. June 15/64.*

* See enrollment on card from muster-in roll.

Book mark:

Fauson
(858c) Copyist.

79 | 4 | U.S.C.T.

H. W. M. Postwick
priv, Co. F, 4 Reg't U. S. Col'd Infantry.

Appears on

Company Muster Roll

for *Sept 10th*, 1864.

Joined for duty and enrolled:

When *Aug 4*, 1863.*

Where *Baltimore Md* *

Period *3* years.*

Present or absent *present*

Stoppage, \$ *100* for

Due Gov't \$ *100* for

Remarks: *Paid by Maj Walker*
for the months of May & June
due W. C. Cooper ^{\$} 200

* See enrollment on card from muster-in roll.

Book mark:

Wm. Soren

B | 4 | U.S.C.T.

A. W. M. Postwicks
Capt., Co. F, 4 Reg't U. S. Col'd Infantry.

Appears on

Company Muster Roll
 for *Nov + Dec*, 1864.

Joined for duty and enrolled:

When *Aug - 4*, 1863.*

Where *Balto Md* *

Period *3* years.*

Present or absent *Present*

Stoppage, \$ *100* for

Due Gov't \$ *100* for

Remarks: *Free before April 19*
1861. Paid for May &
June - Promoted Capt
Nov 17/64. - Due U.S.
Cooper Sutter \$2,00

* See enrollment on card from muster-in roll.

Book mark:

J. W. Soren
 (858c) Copyist.

P | 4 | U.S.C.T.

H. W. M. Postwicks
Spl., Co. F, 4 Reg't U. S. Col'd Infantry.

Appears on

Company Muster Roll

for *Jan'y & Feby*, 1865.

Joined for duty and enrolled:

When *Aug. 4*, 1865.*

Where *Baltimore Md.**

Period *3* years.*

Present or absent *Present*

Stoppage, \$ *100* for

Due Gov't \$ *100* for

Remarks: *Free on or before*
Apr. 19, 61. Paid by
Maj. Walker for May
& June.
Due W. C. Cooper
Sutler # U.S.C.T. 2.00

* See enrollment on card from muster-in roll.

Book mark:

Linden

9

4

U.S.C.T.

H. W. M. Postwicks

Spl., Co. F, 4 Reg't U. S. Col'd Infantry.

Appears on

Company Muster Roll

for *March* *1865*, 1865.

Joined for duty and enrolled:

When *Aug. 4*, 186³.*

Where *Baltimore Md.**

Period *3* years.*

Present or absent *Present*

Stoppage, \$ *100* for

Due Gov't \$ *100* for

Remarks:

* See enrollment on card from muster-in roll.

Book mark:

Linden

9

4

U.S.C.T.

Henry W. M. Postwick
Sgt. Co. F, 4 Reg't U. S. Col'd Infantry.

Appears on

Company Muster Roll

for May & June, 1865.

Joined for duty and enrolled:

When Aug. 4, 1865.*

Where Baltimore Md. *

Period 3 years.*

Present or absent Present

Stoppage, \$ 100 for _____

Due Gov't \$ 100 for _____

Remarks: _____

* See enrollment on card from muster-in roll.

Book mark: _____

(858c)

Linden

Copyist.

P

4

U.S.C.T.

Henry W. M. Pastwick
Cpl., Co. F, 4 Reg't U. S. Col'd Infantry.

Appears on

Company Muster Roll

for *July* & *Aug*, 1865.

Joined for duty and enrolled:

When *Aug. 4, 1865*.*

Where *Baltimore Md.**

Period *3* years.*

Present or absent *Present*

Stoppage, \$ *100* for

Due Gov't \$ *100* for

Remarks:

* See enrollment on card from muster-in roll.

Book mark:

Linden
Copyist.

B | *H* | U.S.C.T.

Henry W M Postwick
Cpl Co, *H* Reg't U. S. Col'd *Inf*

Appears on

Company Muster Roll

for *Sep* + *Oct* 1865.

Joined for duty and enrolled:

When *Aug 4*, 186 *3**

Where *Baltimore Md* *

Period *3* years.*

Present or absent *Present*

Stoppage, \$ *100* for

Due Gov't, \$ *100* for

Valuation of horse, \$ *100*

Valuation of horse equipments, \$ *100*

Remarks: *Stop for 1 pr me-*
talic scales 5 Vets.

* See enrollment on card from muster-in roll.

Book-mark :

Linden

B | 4 | U.S.C.T.

Henry W. M. Postwicks

Corp., Co. F, 4 Reg't U. S. Col'd Infantry.

Appears on

Company Muster Roll

for Nov & Dec, 1865.

Joined for duty and enrolled:

When Aug 4, 1863.*

Where Baltimore Md. *

Period 3 years.*

Present or absent Present

Stoppage, \$ 100 for

Due Gov't \$ 100 for

Remarks:

* See enrollment on card from muster-in roll.

Book mark:

Cumms

B

4

U.S.C.T.

Henry H. M. Postwicks
Sergt, Co. F, 4 Reg't U. S. Col'd Infantry.

Appears on

Company Muster Roll

for Jan to Feb, 1866.

Joined for duty and enrolled:

When Aug 4, 1863.*

Where Baltimore Md *

Period 3 years.*

Present or absent Present.

Stoppage, \$ 100 for

Due Gov't \$ 100 for

Remarks: Promoted Sergeant from
Corp. Feb 6/66 by S.O. No 19
from Reg'tl Med Gns.

NEXT ROLL ON FILE MUSTER OUT.

* See enrollment on card from muster-in roll.

Book mark:

Cumms

B | 4 | U.S.C.T.

Henry H. M. Bostwicks
 Sergt, Co. F, 4 Reg't U. S. Col'd Infantry.

Appears on Co. Muster-out Roll, dated
 Washington D. C., May 4, 1866.
 Muster-out to date May 4, 1866.
 Last paid to Feb 28, 1866.

Clothing account:

Last settled....., 186 ; drawn since \$.....¹⁰⁰
 Due soldier \$.....¹⁰⁰; due U. S. \$ 3 ⁰⁶/₁₀₀
 Am't for cloth'g in kind or money adv'd \$.....¹⁰⁰

Due U. S. for arms, equipments, &c., \$.....¹⁰⁰

Bounty paid \$.....¹⁰⁰; due \$.....¹⁰⁰

Remarks: Private to Nov 17/64
 Corp. to Feb 6/66
 Stop \$6.00 for Spring field
 Rifle & accoutrements
 retained. Free on or before
 Apr 19/61

Book mark: Pr 17. P 63. 73

Levens

132

Gowdell, James L.
 Co. B, 4 U.S. Col'd Inf.

Private Private

CARD NUMBERS.

1	5552918	26
2	5553000	27
3	5553099	28
4	5553201	29
5	5553297	30
6	5553389	31
7	5553478	32
8	5553563	33
9	5553643	34
10	5553724	35
11	5553807	36
12	5553902	37
13	5553998	38
14	5554093	39
15	5554180	40
16	5554259	41
17	5554367	42
18	5554452	43
19	9661764	44
20		45
21		46
22		47
23		48
24		49
25		50

Book Mark:

See also

B | 4 | U.S.C.T.

James L. Bowdell
 _____, Co. B, 4 Reg't U. S. Col'd Inf.

Appears on
Company Descriptive Book
 of the organization named above.

DESCRIPTION.

Age 45 years; height 5 feet 6 inches.

Complexion black

Eyes black; hair black

Where born Talbot Co. Md.

Occupation laborer

ENLISTMENT.

When July 21, 1863.

Where Baltimore

By whom Col. Binney; term 3 y'rs.

Remarks: Discharged on Surg.
Off. Dis. 2 Aug 17/66, at
Baltimore, Md.

Ward

B. | 4 | U.S.C.T.

James L. Bowdell
 Pvt., Co. B., 4 Reg't U. S. Col'd Infantry.

Age 48 years.

Appears on

Company Muster-in Roll

of the organization named above. Roll dated

Baltimore Md, July 21, 1863.

Muster-in to date July 21, 1863.

Joined for duty and enrolled:

When July 21, 1863*

Where Baltimore, Md, *

Period 2 years.*

Remarks:

* Muster-in roll shows enrollment and muster-in of this company as of same date and place. See enrollment on subsequent card or cards.

Book mark:

Geo. W. Hall
 Copyist.

B. | 4 | U.S.C.T.

James L. Bowdell

Private, Co. B, 4 Reg't U. S. Col'd Infantry.

Appears on

Company Muster Roll

for *July 21 to Aug. 31*, 186*3*

Joined for duty and enrolled:

When *July 21*, 186*3**

Where *Baltimore**

Period *3* years.*

Present or absent *Present*

Stoppage, \$ *100* for

Due Gov't \$ *100* for

Remarks: *Detailed as Company Cook since July 21/63 Premium due \$200*

* See enrollment on card from muster-in roll.

Book mark:

Geo N. Hall

(358c)

Copyist.

B. | 4 | U.S.C.T.

James L. Bondell

Pvt., Co. B, 4 Reg't U. S. Col'd Infantry.

Appears on

Company Muster Roll

for Sept 1 Oct, 1863

Joined for duty and enrolled:

When July 21st, 1863*

Where Baltimore *

Period 3 years.*

Present or absent Present,

Stoppage, \$ 100 for

Due Gov't \$ 100 for

Remarks: Detailed as Cook since July 1st 1863,

* See enrollment on card from muster-in roll.

Book mark: _____

(358c)

Tom Hall Copyist.

B. | 4 | U.S.C.T.

James L. Bowdell
Pvt., Co. B, 4 Reg't U. S. Col'd Infantry.

Appears on

Company Muster Roll
for Nov. & Dec., 1863

Joined for duty and enrolled:

When July 21st, 1863*

Where Baltimore *

Period 3 years.*

Present or absent Not stated

Stoppage, \$ 100 for

Due Gov't \$ 100 for

Remarks:

* See enrollment on card from muster-in roll.

Book mark:

John Hall
Copyist.

B. | 4 | U.S.C.T.

James L. Bowdell
Priv., Co. B, 4 Reg't U. S. Col'd Infantry.

Appears on

Company Muster Roll
for Jan'y & Feby, 1864.

Joined for duty and enrolled:

When July 21st, 1863.*

Where Baltimore *

Period 3 years.*

Present or absent Present

Stoppage, \$ 100 for

Due Gov't \$ 100 for

Remarks: Job charged,
1 cauteen,

* See enrollment on card from muster-in roll.

Book mark:

Malon Hall
(858c) Copyist.

B | 4 | U.S.C.T.

James L. Bndell

Pat, Co. B, 4 Reg't U. S. Col'd Infantry.

Appears on

Company Muster Roll

for March & April, 1864.

Joined for duty and enrolled:

When July 21st, 1863.*

Where Baltimore, Md.*

Period 3 years.*

Present or absent Present.

Stoppage, \$ 100 for

Due Gov't \$ 100 for

Remarks:

[Empty lines for remarks]

* See enrollment on card from muster-in roll.

Book mark:

C. M. Clark

(358c)

Copyist.

B | 4 | U.S.C.T.

James L. Bowdell
Priv., Co. B, 4 Reg't U. S. Col'd Infantry.

Appears on

Company Muster Roll

for May & June, 1864.

Joined for duty and enrolled:

When July 21st, 1863.*

Where Baltimore, Md.*

Period 3 years.*

Present or absent Present.

Stoppage, \$ 100 for _____

Due Gov't \$ 100 for _____

Remarks: _____

* See enrollment on card from muster-in roll.

Book mark: _____

(358c) C. M. Clark
Copyist.

B | 4 | U.S.C.T.

James L. Bowdell
Pvt., Co. B, 4 Reg't U. S. Col'd Infantry.

Appears on

Company Muster Roll

for July & Aug., 1864.

Joined for duty and enrolled:

When July 21st, 1863.*

Where Baltimore, Md.*

Period 3 years.*

Present or absent Absent.

Stoppage, \$ 100 for

Due Gov't \$ 100 for

Remarks: Status not known. Absent sick in Gen'l hospital.

* See enrollment on card from muster-in roll.

Book mark:

C. M. Clark

(358c)

Copyist.

B

4

U.S.C.T.

James L. Bowdell

Pat, Co. B, 4 Reg't U. S. Col'd Infantry.

Appears on

Company Muster Roll

for Sept + Oct, 1864.

Joined for duty and enrolled:

When July 21st, 1863.*

Where Baltimore, Md.*

Period 3 years.*

Present or absent Absent

Stoppage, \$ 100 for

Due Gov't \$ 100 for

Remarks: Free on or before April 19, 1861. Absent sick since Oct. 24, 1864. Due Suttles, \$600.

* See enrollment on card from muster-in roll.

Book mark:

C M Clark

(358c)

Copyist.

B | 4 | U.S.C.T.

James L. Bindell
Pat, Co. B, 4 Reg't U. S. Col'd Infantry.

Appears on

Company Muster Roll

for Nov + Dec, 1864.

Joined for duty and enrolled:

When July 21st, 1863.*

Where Baltimore, Md *

Period 3 years.*

Present or absent Absent.

Stoppage, \$ 100 for _____

Due Gov't \$ 100 for _____

Remarks: Free on or before
April 19, 1864. Absent
sick since Oct 24 ch.
Due W B Cooper, Suttles, \$6⁰⁰

* See enrollment on card from muster-in roll.

Book mark: _____

(358c)

C. M. Clark

Copyist.

B.

4

U.S.C.T.

James L. Bowdell

Pri., Co. B, 4 Reg't U. S. Col'd Infantry.

Appears on

Company Muster Roll

for Jan + Feb., 1865.

Joined for duty and enrolled:

When July 21, 1863.*

Where Baltimore, Md. *

Period 3 years.*

Present or absent Absent

Stoppage, \$ 100 for

Due Gov't \$ 100 for

Remarks: Absent sick since Oct. 24, '64. Free on or before Apr. 19, 1865. Due Mc Cooper sutler 4th M.S.C. \$ 600

* See enrollment on card from muster-in roll.

Book mark:

(358c)

Boston

Copyist.

B. | 4 | **U.S.C.T.**

James L Bondell
Pri, Co. B, 4 Reg't U. S. Col'd Infantry.

Appears on

Company Muster Roll

for mech + apri, 1865.

Joined for duty and enrolled:

When July 21, 1863.*

Where Baltimore Md. *

Period 3 years.*

Present or absent absent

Stoppage, \$ 100 for

Due Gov't \$ 100 for

Remarks: Free on or before apri, 19, '61.
Back pay due from enlistment
to may, 1, '64. P'd for nov. & Dec
May. 1861 absent sick
See Mr. Cooper, letter 4th W.S.
C.T. 600

* See enrollment on card from muster-in roll.

Book mark: 1-3-10

(358c) Barton Copyist.

B.

4

U.S.C.T.

James Bondell

Pri, Co. B, 4 Reg't U. S. Col'd Infantry.

Appears on

Company Muster Roll

for *May 1 June 1*, 1865.

Joined for duty and enrolled:

When *July 21*, 1863.*

Where *Baltimore Md.* *

Period *3* years.*

Present or absent *absent*

Stoppage, \$ *100* for

Due Gov't \$ *100* for

Remarks: *Dis. of pay due from*

date of enlistment to May

1st 64. C'd in hosp. for Nov. & Dec

1864. by Maj. Powell. Absent sick.

Free on or before Apr. 19/61.

* See enrollment on card from muster-in roll.

Book mark:

Barton

(258c)

Copyist.

B.

4

U.S.C.T.

James L. Bowdell

Pri., Co. B, 4 Reg't U. S. Col'd Infantry.

Appears on

Company Muster Roll

for July & Aug., 1865.

Joined for duty and enrolled:

When July 21, 1863.*

Where Baltimore Md.*

Period 3 years.*

Present or absent Absent

Stoppage, \$ 100 for

Due Gov't \$ 100 for

Remarks: Dif. of pay due from enlistment to May 1, '64. R'd in hosp for Nov & Dec '64. Maj. Howell. Absent sick. Free

* See enrollment on card from muster-in roll.

Book mark:

(358c)

Bartoul

Copyist.

B. | 4 | U.S.C.T.

James L. Bowdell
Pri., Co. B, 4 Reg't U. S. Col'd Infantry.

Appears on

Company Muster Roll

for *Sep + Oct*, 186*5*.

Joined for duty and enrolled:

When *July 21*, 186*3*.*

Where *Baltimore md.* *

Period *3* years.*

Present or absent *absent*

Stoppage, \$ *100* for _____

Due Gov't \$ *100* for _____

Remarks: *Absent sick. Dif. of*
pay due from enlistment to
May 1, '64. R'd in hosp for
Nov. + Dec. '64 by Maj. Howell
Free

* See enrollment on card from muster-in roll.

Book mark: _____

Barton
 (358c) Copyist.

B

4

U.S.C.T.

James L. Bowdell

Sgt., Co. B, 4 Reg't U. S. Col'd Infantry.

Appears on

Company Muster Roll

for Nov. & Dec., 1863.

Joined for duty and enrolled:

When July 21, 1863.*

Where Baltimore, Md. *

Period 3 years.*

Present or absent absent

Stoppage, \$ 100 for _____

Due Gov't \$ 100 for _____

Remarks: Difference of pay due
from enlistment to May 1/64.
Said in hosp. for May & June '64.
Maj. Nowell - Absent sick.
Free on or before April 19/61.

* See enrollment on card from muster-in roll.

Book mark: _____

(358c)

Tobler

Copyist.

73

4

U.S.C.T.

James L. Bowdell
Priv., Co. B, 4 Reg't U. S. Col'd Infantry.

Appears on

Company Muster Roll

for Jan'y & Feby, 1866.

Joined for duty and enrolled:

When July 21, 1863.*

Where Baltimore, Md.*

Period 3 years.*

NEXT ROLL ON FILE MUSTER OUT.
Present or absent

Stoppage, \$ 100 for

Due Gov't \$ 100 for

Remarks: Discharged the service
Jan'y 17, 1866, at Baltimore,
Md., on Surgeon's Certificate
of Disability

* See enrollment on card from muster-in roll.

Book mark:

(358c)

Tabler

Copyist.

B | 4 | U.S.C.T.

James L. Bowdell
Priv, Co. B, 4 Reg't U. S. Col'd Infantry.

Appears on Co. Muster-out Roll, dated
Washington, D.C., May 4, 1866.

Muster-out to date _____, 186 .

Last paid to _____, 186 .

Clothing account:

Last settled _____, 186 ; drawn since \$ _____ 100

Due soldier \$ _____ 100 ; due U. S. \$ _____ 100

Am't for cloth'g in kind or money adv'd \$ _____ 100

Due U. S. for arms, equipments, &c., \$ _____ 100

Bounty paid \$ _____ 100 ; due \$ _____ 100

Remarks: Free on or before April 19/61
Discharged on Surg. Certificate
of Disability June 17/64 at
Baltimore, Md. by order Maj.
Gen. Hooker.

Book mark: 296, 227
over

(861)

Tabler
Copyist.

Bowdell, Jas L
P, Co. D, 4 Reg't U.S.C.A.

2 Enclosures.

Bed Cards <i>/</i>	Descriptive Lists
Burial Records	Final Statements
Certs. of Dis. for Discharge <i>/</i>	Furloughs
C. M. Charges	Med. Des. Lists
Med. Certificates	Orders

Other papers relating to—

Admission to Hosp'l	Furlough
Casualty Sheet (Officer's)	Med. Examination
Confinement	Misc. Information
Contracts	Pay or Clothing
Death or Effects	Personal Reports
Desertions	Rank
Discharge from Hosp'l	Transfer to Hosp'l
Discharge from Service	Transfer to V. R. C.
Duty	Transportation

Hospital Number 1428-¹⁷/₁₂

Name James L. Bowdell

Age 53 Activity _____

Married or Single m

Residence Baltimore Md.

Post Office address of J. L. Bowdell
wife or nearest relative. } Baltimore Md.

Rank Priv Co. 4 Regiment USC

When admitted Apr 3rd 65

From what source Genl Hosp. Fort. Sumner.

Diagnosis: (In surgical cases, state explicitly
seat and character of wound or injury.)

Chronic Rheumatism

Hicks G.H.
Baltimore, Md.

On what occasion wounded _____

Date _____

Nature of missile or weapon _____

TREATMENT.

(HERE NOTE IMPORTANT COMPLICATIONS AND ALL OPERATIONS.)

RESULT AND DATE.

Discharged Jan. 18th 1866

[OFFICE ENDORSEMENT.]

War Department,

ADJUTANT GENERAL'S OFFICE,

Aug 16, 1876

The Discharge of James L. Bondell, Co. B, 4th Reg't U. S. Colored Troops, is reported as follows:

- On Company Muster Roll. For Jan. 1, 1866, Jan. 17, 1866
- Company Muster-out Roll. Jan. 17, 1864
- Company Descriptive Book. 186
- Company Morning Reports. 186
- Soldier's Final Statement. 186
- Soldier's Record of Death and Interment. 186
- Soldier's Inventory of Effects. 186
- Soldier's Certificate of Disability for Discharge. Jan. 17, 1866
- Soldier's Individual Muster out Roll. 186
- Regimental Return. For Jan. 1, 1866, Jan. 17, 1866
- Regimental Quarterly Returns. 186
- Regimental Descriptive Book. 186
- By Surgeon General. 186

Jan. 17, 1866 is held to be the correct date and the Company Muster-out Roll will be amended accordingly.

Thomas M. Sweet, Assistant Adjutant General, Sept. 27, 1876

Duplicate sent the Pension Office

B. 34, P. of Dix

CERTIFICATE OF DISABILITY FOR DISCHARGE

IN THE CASE OF

James L. Bondell a Private Co. "B" 4th Reg't of U.S.C.T.

MEDICAL DIRECTOR'S OFFICE

MIDDLE MILITARY DEPT.

Baltimore, Md. Jan. 13, 1866.

APPROVED.

W. Simpson, Det. Col. and Surg. U. S. A. Medical Director.

HEAD-QUARTERS MIDDLE MILITARY DEPARTMENT

Baltimore, Md., Jan. 13, 1866.

To be discharged

BY COMMAND OF MAJOR GENERAL HANCOCK.

Abner C. Young, Asst. Adj. Genl.

Extract furnished 20th 1866

Received (A. G. Office.) 1866

Entiret, Roflas.

ARMY OF THE UNITED STATES
CERTIFICATE

OF DISABILITY



FOR DISCHARGE

Private James S. Bondell, of Captain W. C. Hills Company, (B.) of the 4th Regiment of the United States Cal. Vols. was enlisted by Col. Birney of the Baltimore Md. Regiment of the 2nd day of July, 1863, to serve 3 years; he was born in Talbot Co. in the State of Maryland, is 47 years of age, five feet inches high, fair complexion, black eyes, black hair, and by occupation when enlisted a Laborer. During the last two months said soldier has been unfit for duty 49 days.*

STATION: Hicks Co. Hopt. Balto Md
DATE: Jan 12 '65

Thos. S. S. S. S. S.
Surgeon U. S. A. Hopt. C.
Commanding Company

I CERTIFY, that I have carefully examined the said James S. Bondell of Captain Hills Company, and find him incapable of performing the duties of a soldier because of Chronic Rheumatism contracted Sept 1864 at Deep Bottom Va, in consequence of exposure in line of duty

Disability one fourth (1/4)

Thos. S. S. S. S. S.
Surgeon

DISCHARGED, this 17th day of January, 1865, at Hicks Co. Hopt. Balto Md

Thos. S. S. S. S. S.
Surgeon U. S. A.
Commanding the Regt.

The Soldier desires to be addressed at
Town Balto County Balto State Md

* See Note 1 on the back of this. † See Note 2 on the back of this
[A. G. O., No. 100 & 101-First.] [DUPLICATES.]

133

Bowden, Henry

Co H, 4 U.S. Col'd Inf.

Private | Private

CARD NUMBERS.

1	5550524	26
2	5563555	27
3	5563655	28
4	5563752	29
5	5563854	30
6	5563945	31
7	5564079	32
8	5564264	33
9	5550987	34
10	90626717	35
11		36
12		37
13		38
14		39
15		40
16		41
17		42
18		43
19		44
20		45
21		46
22		47
23		48
24		49
25		50

Book Mark:

See also

S 1188079 Po. m. m

S 1190197 Po aff

3-2654157 - Port

J. 2884228 Port.

B | 4 | U.S.C.T.

Henry Bowden

Co. H, 4 Reg't U. S. Col'd Inf.

Appears on

Company Descriptive Book

of the organization named above.

DESCRIPTION.

Age *30* years; height *5* feet *8* inches.

Complexion *Blk*

Eyes *Blk*; hair *Blk*

Where born *Richmond Co Va*

Occupation *Farmer*

ENLISTMENT.

When *Sept 1*, 186*4*.

Where *Dayton, O*

By whom *Capt Miller, P.M.*, term *1* y'rs.

Remarks:

*Mustered out at
expiration of service
Sept 5, 1863,*

Selah

B

4

U.S.C.T.

Henry Bowdler

Appears with rank of *Pvt.* on

Muster and Descriptive Roll of a Detachment of U. S. Vols. forwarded

for the 4 Reg't U. S. Col'd Infantry. Roll dated

Dayton Ohio, Sept. 6, 1864.

Where born *Richmond Co. North Carolina.*

Age *30* y'rs; occupation *farmer*

When enlisted *Sept. 1, 1864.*

Where enlisted *Dayton O.*

For what period enlisted _____ years.

Eyes *black*; hair *black*

Complexion *black*; height *5* ft. *8* in.

When mustered in *Sept. 1, 1864.*

Where mustered in *Dayton O.*

Bounty paid \$ *100*; due \$ *100*

Where credited _____

Company to which assigned _____

Remarks: *Credited to Third Ward, Hamilton Butter Co. Sub-District 23, 3^d District Ohio. Forwarded to Camp Delaware September 6/64.*

Book mark: _____

Hathaway

B | 4 | U.S.C.T.

Henry Bowden
Pvt., Co. H, 4 Reg't U. S. Col'd Infantry.

Appears on

Company Muster Roll

for Nov. & Dec., 1864.

Joined for duty and enrolled:

When Sept. 1, 1864.*

Where Dayton, O. *

Period 1 years.*

Present or absent Present.

Stoppage, \$ 100 for

Due Gov't \$ 100 for

Remarks:

* See enrollment on card from muster-in roll.

Book mark:

C. F. Thompson.

B | 4 | U.S.C.T.

Henry Bowden

Private, Co. H, 4 Reg't U. S. Col'd Infantry.

Appears on

Company Muster Roll

for Jan & Feb, 1865.

Joined for duty and enrolled:

When Sept 1, 1864.*

Where Dayton O *

Period 1 years.*

Present or absent Present

Stoppage, \$ 100 for

Due Gov't \$ 100 for

Remarks:

[Empty lines for remarks]

* See enrollment on card from muster-in roll.

Book mark:

Bowman

B | 4 | U.S.C.T.

Henry Bowden

Priv, Co. H, 4 Reg't U. S. Col'd Infantry.

Appears on

Company Muster Roll

for *Mar & Apr*, 1865.

Joined for duty and enrolled:

When *Sept 1*, 1864.*

Where *Dayton Ohio* *

Period *1* years.*

Present or absent *Present*

Stoppage, \$ *100* for

Due Gov't \$ *100* for

Remarks: *Stop for one Knapsack
& Straps thrown away on march*

* See enrollment on card from muster-in roll.

Book mark: *256*

Bowman
(858c) Copyist.

B

4

U.S.C.T.

Henry Bowden

Pvt., Co. H, 4 Reg't U. S. Col'd Infantry.

Appears on

Company Muster Roll

for May & June, 1865.

Joined for duty and enrolled:

When Sept 1, 1864.*

Where Dayton Ohio *

Period 1 years.*

Present or absent Present

Stoppage, \$ 100 for

Due Gov't \$ 100 for

Remarks: Stop for one knapsack & straps thrown away on march

* See enrollment on card from muster-in roll.

Book mark:

Bowman

(858c)

Copyist.

B | 4 | U.S.C.T.

Henry Bowden

Priv., Co. H, 4 Reg't U. S. Col'd Infantry.

Appears on

Company Muster Roll

for Jul & Aug, 1865.

Joined for duty and enrolled:

When Sept 1, 1864.*

Where Dayton O *

Period 1 years.*

Present or absent Present

Stoppage, \$ 100 for

Due Gov't \$ 100 for

Remarks:

[Empty lines for remarks]

* See enrollment on card from muster-in roll.

Book mark:

(858c) Bowman Copyist.

79 | 4 | U.S.C.T.

Henry Bowden
Pvt, Co N, 4 Reg't U. S. Col'd Infantry.

Appears on a

Detachment Muster-out Roll

of the organization named above. Roll dated

New Bern N.C., Sept 5, 1865.

Muster-out to date Sept 5, 1865.

Last paid to June 30, 1865

Clothing account:

Last settled June 30, 1865; drawn since None

Due soldier \$ 100; due U. S. \$ 100

Am't for cloth'g in kind or money adv'd \$ 100

Due U. S. for arms, equipments, &c., \$ 6 100

Bounty paid \$ 100 due \$ 100, 100

Remarks: Muster + accoutrements

retained. Mustered out by reason
of expiration of term of service
Transportation due from place
of discharge to place of en-
listment

Book mark:

Jacobson

B | 4 | U.S.C.T.

Henry Bowden

Pvt, Co. H, 4 Reg't U. S. Col'd Infantry.

Appears on

Company Muster Roll

for *Sept & Oct*, 1865.

Joined for duty and enrolled:

When *Sept 1*, 1864.*

Where *Circleville O.* *

Period *1* years.*

Present or absent _____

Stoppage, \$ *100* for _____

Due Gov't \$ *100* for _____

Remarks: *Mustered out by reason of expiration of term of service at New Berne N.C. Sept 3/65*

* See enrollment on card from muster-in roll.

Book mark: _____

Bowman

13. | **4** | **U.S.C.T.**

Odney Spudens,
Priv., Co. H., 4 Reg't U. S. Col'd Infantry.

Appears on **Co. Muster-out Roll**, dated
Washington, D.C., May 7, 1866.

Muster-out to date _____, 186 .

Last paid to *June 30, 1865.*

Clothing account:

Last settled _____, 186 ; drawn since \$ _____ 100

Due soldier \$ _____ 100; due U. S. \$ _____ 100

Am't for cloth'g in kind or money adv'd \$ _____ 100

Due U. S. for arms, equipments, &c., \$ _____ 100

Bounty paid \$ *100.* 100; due \$ _____ 100

Remarks: *Discharged for expiration of enlistment Sept. 5, 1865.*

Book mark: *1725. 1883.*
V. 226. P. 32. 76.

(861)

R. B. Primmer
 Copyist.

Henry Bowden

, Co. *H*, 4 Reg't *CT*.

2 Inclosures.

Bed Cards	Final Statements
Burial Records	Furloughs or L. of A.
Certs. of Dis. for Discharge	Med. Certificates
C. M. Charges	Med. Des. Lists
Descriptive Lists	Orders
Discharge Certificates	Pris. of War Record
Enlistment Papers <u>2</u>	Resignations

Other papers relating to—

Admission to Hosp'l	Furlough or L. of A.
Casualty Sheet	Med. Examination
Confinement	Misc. Information
Contracts	Pay or Clothing
Death or Effects	Personal Reports
Desertion	Rank
Discharge from Hosp'l	Transfer to Hosp'l
Discharge from Service	Transfer to V. R. C.
Duty	Transportation

DECLARATION OF RECRUIT.

I, Henry Bowden, desiring to VOLUNTEER as a Soldier in the Army of the United States, for the term of THREE YEARS, months Do Declare, That I am years and months of age; that I have never been discharged from the United States service on account of disability or by sentence of a court martial, or by order before the expiration of a term of enlistment; and I know of no impediment to my serving honestly and faithfully as a soldier for three years.

GIVEN at Dayton, Ohio the 1 day of September 1864. Witness: Charles E. Taylor, Henry Bowden

Condition to Sub Mit 7023 - 3rd Dist 3rd Mass Cavalry Co

No. 100 Henry Bowden Volunteered at Dayton Ohio September 1, 1864 By Capt John Mads Co 4th Regiment of Mass 4th Colored Inf enlistment; last served in Company () Reg't of Discharged , 18

1 year 5 months Enlistment

Jan. 1896. This paper was formerly filed in the Enrollment Div. R. & P. O.

NOTE 1.—This blank will be used for both enlistments and re-enlistments—enlistment of veterans, &c., &c., in the volunteer service. They will be made out in duplicate in all cases—one to accompany the recruiting return of the superintendent (not the recruiting officer) to the Adjutant General, and one to accompany the accounts of the officer who pays bounty, &c. The Regiment and Company in which the soldier last served should be given on the back. NOTE 2.—An enlistment holds to service. A muster-in must, in all cases, precede payment of pay, bounty, pension, &c. A muster-in roll must, in all cases, be filed in the Adjutant General's Office as evidence of muster-in. The mustering officer, commissary, or assistant commissary of musters, as the case may be, will countersign both enlistments as having mustered the soldier into the service of the United States before either of them is given to the disbursing officer.

CONSENT IN CASE OF MINOR.

I, Do CERTIFY, That I am of years of age; and I do hereby freely give my CONSENT to his volunteering as a SOLDIER in the ARMY OF THE UNITED STATES for the period of THREE YEARS.

GIVEN at the day of Witness:

VOLUNTEER ENLISTMENT.

STATE OF

TOWN OF

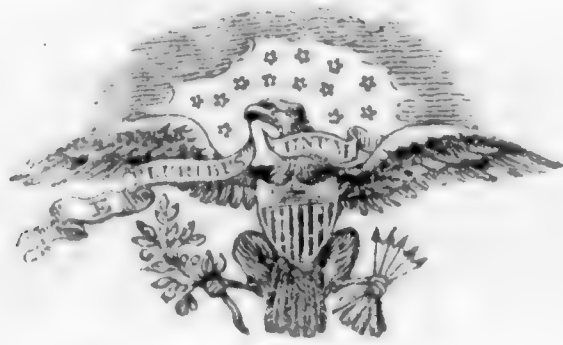

Ohio

Duynin

I, *Henry Bowden*, born in *Richmond Lee*
 in the State of *North Carolina*, aged *Thirty* years,
 and by occupation a *Farmer*. DO HEREBY ACKNOWLEDGE to have
 volunteered this *Ten* day of *September*, 1864,
 to serve as a **Soldier** in the **Army of the United States of America**, for
 the period of ~~THREE YEARS~~, unless sooner discharged by proper authority:
 Do also agree to accept such bounty, pay, rations, and clothing, as are, or may be,
 established by law for volunteers. And I, _____, do
 solemnly swear, that I will bear true faith and allegiance to the **United States**
of America, and that I will serve them honestly and faithfully against all
 their enemies or opposers whomsoever; and that I will observe and obey the
 orders of the President of the United States, and the orders of the officers
 appointed over me, according to the Rules and Articles of War.

Sworn and subscribed to, at *Duynin, Ohio*
 this *1* day of *September*, 1864, by *Henry Bowden*
 BEFORE *John Smith* mark
32nd Dist

I CERTIFY, ON HONOR, That I have carefully examined the above-named Volunteer, agreeably
 to the General Regulations of the Army, and that, in my opinion, he is free from all bodily defects and
 mental infirmity, which would in any way disqualify him from performing the duties of a soldier.

John Smith
 32nd Dist
 EXAMINING SURGEON.

I CERTIFY, ON HONOR, That I have minutely inspected the Volunteer *Henry Bowden*
 previously to his enlistment, and that he was entirely sober when enlisted; that, to the best of my
 judgment and belief, he is of lawful age; and that, in accepting him as duly qualified to perform the
 duties of an able-bodied soldier, I have strictly observed the Regulations which govern the recruiting
 service. This soldier has *Black* eyes, *Black* hair, *Black* complexion, is *Five*
 feet *8* inches high.

John Smith
 Captain 3rd Regiment of *Mounted* Volunteers.
 3rd District *Ohio* RECRUITING OFFICER.

(A. G. O. No. 74 & 75.)

Mustered into the service of the United States, for three years or during the war, from date of enlistment, in Company
 _____ Regiment of *32nd Dist* Volunteers, on the *1* day of *September*, 1864, at *Duynin, Ohio*

John Smith
 32nd Dist
 Captain 3rd Regiment of *Mounted* Volunteers.

DECLARATION OF RECRUIT.

I, Henry Bowden, desiring to VOLUNTEER as a soldier in the Army of the United States, for the term of THREE YEARS, Do Declare, That I am years and months of age; that I have never been discharged from the United States service on account of disability or by sentence of a court martial, or by order before the expiration of a term of enlistment; and I know of no impediment to my serving honestly and faithfully as a soldier for three years.

GIVEN at Dayton, Ohio the 1 day of September 1861. Witness: Charles Snyder, Henry Bowden

Credited to 3rd Dist 3023. 3rd Dist 3rd Ward Hamilton. 19th Co.

No. Henry Bowden Volunteered at Dayton Ohio September 1st, 1861 By Cap John Mills 1st Regiment of 2nd District 4th US Colonel Inf

enlistment; last served in Company () Reg't of Discharged 18

1 year enlistment

CONSENT IN CASE OF MINOR.

I, Do certify, That I am the of ; that the said is years of age; and I do hereby freely give my CONSENT to his volunteering as a SOLDIER in the ARMY OF THE UNITED STATES for the period of THREE YEARS.

GIVEN at the day of Witness:

NOTE 1.—This blank will be used for both enlistments and re-enlistments—enlistment of veterans, &c., &c., in the volunteer service. They will be made out in duplicate in all cases—one to accompany the recruiting return of the superintendent (not the recruiting officer) to the Adjutant General, and one to accompany the accounts of the officer who pays bounty, &c. The Regiment and Company in which the soldier last served should be given on the back. NOTE 2.—An enlistment holds to service. A muster-in must, in all cases, precede payment of pay, bounty, pension, &c. A muster-in roll must, in all cases, be filed in the Adjutant General's Office as evidence of muster-in. The mustering officer, commissary, or assistant commissary of musters, as the case may be, will countersign both enlistments as having mustered the soldier into the service of the United States before either of them is given to the disbursing officer.

VOLUNTEER ENLISTMENT.

STATE OF

TOWN OF

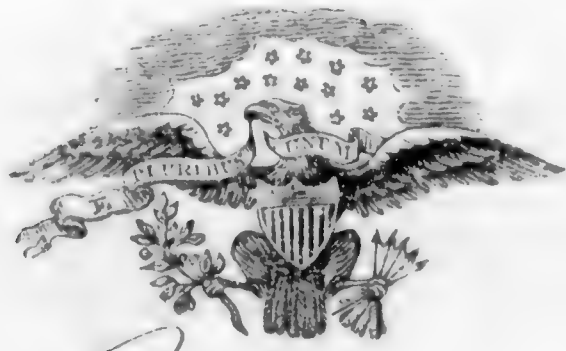

I, Henry Borden, born in Dayton, North Carolina, aged 27 years, and by occupation a Farmer, DO HEREBY ACKNOWLEDGE to have volunteered this 1st day of September, 1864

to serve as a Soldier in the Army of the United States of America, for the period of THREE YEARS, unless sooner discharged by proper authority: Do also agree to accept such bounty, pay, rations, and clothing, as etc. or may be, established by law for volunteers. And I, Henry Borden, do solemnly swear, that I will bear true faith and allegiance to the United States of America, and that I will serve them honestly and faithfully against all their enemies or opposers whomsoever; and that I will observe and obey the orders of the President of the United States, and the orders of the officers appointed over me, according to the Rules and Articles of War.

Sworn and subscribed to, at Dayton, O. this 1st day of September, 1864, before James M. ... Capt. J. M. ...

I CERTIFY, ON HONOR, That I have carefully examined the above-named Volunteer, agreeably to the General Regulations of the Army, and that, in my opinion, he is free from all bodily defects and mental infirmity, which would in any way disqualify him from performing the duties of a soldier.

Board of Examiners, 32nd Dist. O. EXAMINING SURGEON.

I CERTIFY, ON HONOR, That I have minutely inspected the Volunteer Henry Borden previously to his enlistment, and that he was entirely sober when enlisted; that, to the best of my judgment and belief, he is of lawful age; and that, in accepting him as duly qualified to perform the duties of an able-bodied soldier, I have strictly observed the Regulations which govern the recruiting service. This soldier has black eyes, black hair, black complexion, is 5 feet 8 inches high.

James M. ... Capt. J. M. ... Regiment of ... Volunteers, 32nd District O. RECRUITING OFFICER.

(A. G. O. No. 74 & 75.)

Mustered into the service of the United States, for three years or during the war, from date of enlistment, in Company ... Regiment of ... Volunteers, on the 1st day of September, 1864, at Dayton, O.

Handwritten notes and signatures on the right margin, including names like 'James M. ...' and 'Capt. J. M. ...'

134

Bowen, John

Co E, 4 U.S. Col'd Inf.

Private | Private

CARD NUMBERS.

1	5557057	26
2	5558748	27
3	5558844	28
4	5558935	29
5	5559025	30
6	5559100	31
7	5559169	32
8	5559230	33
9	9062159	34
10	2202-03-1879	35
11	B 19 Ret-1868.	36
12	4075-7526	37
13	34477740	38
14		39
15		40
16		41
17		42
18		43
19		44
20		45
21		46
22		47
23		48
24		49
25		50

Book Mark: 2202-10349. B19. V5. AC218
LB. V13 p. 388

See also

D. 3101356 and. N.W.

B | 4 | U.S.C.T.

John Bowen

, Co. *E*, 4 Reg't U. S. Col'd Inf.

Appears on

Company Descriptive Book

of the organization named above.

DESCRIPTION.

Age *35* years; height *5* feet *4 1/2* inches.

Complexion *Brown*

Eyes *Black*; hair *Black*

Where born

Occupation

ENLISTMENT.

When *Nov. 17*, 186*4*.

Where *Elliotts Mills Md*

By whom *Capt. F. Holland*; term *1* y'rs.

Remarks: *Drafted and failed to report as ordered, was arrested and turned over to Capt. John Morley Prov. Marshal 8th A.C. Baltimore Md. as a deserter and the reward allowed for his apprehension and delivery \$50. The above charge removed per D.O. No 15 Hd. Qrs Dept Washington Jun 19/64 Signed Robert Gathout Capt and Prov. Mar. 2nd Cony Dist Md. & act P.M. 1st 2nd & 5th Dist Md.*

No H Monell

Copyist.

200. E.
D | *+* | *6. 7.*

John Bowen

Appears with rank of _____ on _____

Muster and Descriptive Roll

of drafted men, deserters, released from confinement and forwarded for the 1 U. S. C. T. Roll dated

St. Michaels, Md., 1865.

Where born _____

Age *35* years; occupation _____

When enlisted *Nov. 17*, 1864.

Where enlisted *St. Michaels, Md.*

For what period enlisted *1* years.

Eyes *Blue*; hair *Blue*

Complexion *Brown*; height *5* ft. *9 1/2* in.

When mustered in _____, 186 .

Where mustered in _____

Bounty paid \$*None* ¹⁰⁰; due \$*None* ¹⁰⁰

Clothing account:

Last settled _____, 186 ; drawn since \$ *27* ³² ₁₀₀

Date of first muster _____

Regiment to which assigned _____

Remarks: *Reward paid \$30.*
14th Dist. Montgomery
Co. Md.

Book mark: _____

(356m)

[Signature]
Copyist.

23 | 4 | U.S.C.T.

John Bowen
Priv., Co. E, 4 Reg't U. S. Col'd Infantry.

Appears on

Company Muster Roll
for March & April, 1865.

Joined for duty and enrolled :

When _____, 186 .*

Where _____ *

Period 3 years.*

Present or absent present

Stoppage, \$ 100 for _____

Due Gov't, \$ 100 for _____

Remarks: Assigned to Co. as recruit March 11/65.

No papers rec'd respecting date of enlistment &c.

* See enrollment on card from muster-in roll.

Book mark : _____

(358c)

Long
Copyist.

B | 4 | U.S.C.T.

John Bowen

Put, Co. E, 4 Reg't U. S. Col'd Infantry.

Appears on

Company Muster Roll

for May June, 1865.

Joined for duty and enrolled:

When, 186 .*

Where *

Period years.*

Present or absent Absent

Stoppage, \$ 100 for

Due Gov't, \$ 100 for

Remarks: Assigned to Co as a recruit Apl. 11/65.

No enlistment papers rec'd. Absent sick.

* See enrollment on card from muster-in roll.

Book mark:

Long

(858c)

Copyist.

B | 4 | U.S.C.T.

John Bowen
Pvt., Co. E, 4 Reg't U. S. Col'd Infantry.

Appears on

Company Muster Roll

for *July + Aug.*, 1865.

Joined for duty and enrolled:

When _____, 186 .*

Where _____ *

Period _____ years.*

Present or absent *absent*

Stoppage, \$ 100 for _____

Due Gov't, \$ 100 for _____

Remarks: *Absent sick.*

*Assigned to Co. as a recruit
April 11/65. No papers rec'd.*

* See enrollment on card from muster-in roll.

Book mark: _____

(358c)

Long
Cypriat.

B | 4 | U.S.C.T.

John Bowen
Pat., Co. E, 4 Reg't U. S. Col'd Infantry.

Appears on

Company Muster Roll

for *Sept - Oct.*, 1865.

Joined for duty and enrolled :

When _____, 186 .*

Where _____ *

Period _____ years.*

Present or absent *absent*

Stoppage, \$ _____ 100 for _____

Due Gov't, \$ _____ 100 for _____

Remarks: *Absent sick*
Assigned to Co. Meh. 11/65
No papers rec'd.

* See enrollment on card from muster-in roll.

Book mark : _____

Long

B | 4 | U.S.C.T.

John Brown Col

Co. *4* Reg't U. S. Col'd Infantry.

Appears on

Descriptive List of Deserters

dated *Oct. 30*, 186*5*.

Deserted:

When *After Draft-*, 186*5*.

Where

Arrested:

When *Dec. 27*, 186*4*.

Where *Montgomery Co. Md*

Remarks: *Drafted and failed to report as ordered was arrested and turned over to Col John Woolley Pro Mar 8th Army Corps Baltimore Md as (over)*

Book mark:

Washington

JAN. 19

5551057

1891

a deserter and the
reward allowed for his
apprehension and
delivery \$30.00

B | 4 | U.S.C.T.

John Bowen
priv., Co. E, 4 Reg't U. S. Col'd Infantry.

Appears on

Company Muster Roll

for *Nov & Dec*, 1865.

Joined for duty and enrolled :

When _____, 186 .*

Where _____ *

Period *1* years.*

Present or absent *Absent*

Stoppage, \$ *100* for _____

Due Gov't, \$ *100* for _____

Remarks: *Drafted. Mustered in*
Nov 17/64 at Edlicotts Mills
Md. Absent sick. Arrested as a
deserter from draft Dec 27/64 &
\$30. paid for apprehension and de-
livery.

* See enrollment on card from muster-in roll.

Book mark : _____

Somers

B | 4 | U.S.C.T.

John Bowen^x
Priv. Co. E, 4 Reg't U. S. Col'd Inf.

Appears on Returns as follows:

May to July 1865: Absent sick
or wounded
Aug 1865: Absent sick or wounded
Sept to Nov 1865: Absent sick
or wounded
Dec 1865 to Mar 1866: Absent sick

*name appears also as Brown

Book mark:

(546)

J. Hursey Copyist.

B

4

U.S.C.T.

John Bowen
~~Brown~~

priv., Co. *E*, 4 Reg't U. S. Col'd Infantry.

Appears on **Co. Muster-out Roll**, dated
Washington D.C., May 4, 186*6*.

Muster-out to date _____, 186 .

Last paid to _____, 186 .

Clothing account:

Last settled _____, 186 ; drawn since \$ _____ 100

Due soldier \$ *31* ^{*90*} 100; due U. S. \$ _____ 100

Am't for cloth'g in kind or money adv'd \$ _____ 100

Due U. S. for arms, equipments, &c., \$ _____ 100

Bounty paid \$ _____ 100; due \$ _____ 100

Remarks: *no dis furnished*
about sick

Book mark: *V. 220. P. 110, 75; P. 34. P. 9, 75.*
2202 C.T./79 B19.V.5.R.C.T./68. L.B. 13/388

Somers

(361)

Copyist.

B H W.C.P.

John Bowen.

, Co. E., H. Reg't W.C.P.

NOTATION.

Book mark: B. 19. R. I. 1868

Record and Pension Office,

WAR DEPARTMENT.

This book mark refers only to a report from the medical records, made by the Surgeon General to the Adjutant General, relative to the above-named man. As the medical records have since been carded, no transcript of this report is made hereon.

Multiple horizontal lines for additional notes or signatures.

A. M. Muzzey.

B | 4th | U.S.C.S.

John Bowen

, Co. E, 4th Reg't U.S.C.S.

NOTATION. L.B. 13.388.

LB 13/388

Book mark: 2202-C-S-1879.

War Department,

Adjutant General's Office,

Washington, July 12, 1880.

Charge of desertion removed
by Special Order #15 of January
19, 1866, Hd. Qrs. Dept. of Washington.

W. Allen

B | 4 | U.S.C.T.

John Bowen

priv., Co. E, 4 Reg't U. S. Col'd Infantry.

Appears on

Company Muster Roll

for *Jan & Feb.*, 1866.

Joined for duty and enrolled :

When _____, 186 .*

Where _____ *

Period *1* years.*

NEXT ROLL ON FILE MUSTER OUT.

Present or absent *Absent*

Stoppage, \$ *100* for _____

Due Gov't, \$ *100* for _____

Remarks: *Absent sick,*

Goldboro N.C.

*Drafted & mustered in
Nov 17/64 at Edlicotts Mills
Md.*

* See enrollment on card from muster-in roll.

Book mark : _____

Loren

135

Bowie, John

Co K., 4 U.S. Col'd Inf.

Private

Private

CARD NUMBERS.

1	5566000	26
2	5566101	27
3	5566201	28
4	5566298	29
5	5566388	30
6	5566472	31
7	5566556	32
8	5566634	33
9	5566708	34
10	5566799	35
11	5566885	36
12	5566976	37
13	5567062	38
14	5567147	39
15	5567226	40
16	5567280	41
17	5567335	42
18	90621801	43
19	9062929	44
20		45
21		46
22		47
23		48
24		49
25		50

Book Mark:

See also

R. P 559488

A 1823.829 P.O. m+ny

P. 1813-489 Arnold

B | 4 | U.S.C.T.

John Bonie

Co. K, 4 Reg't U. S. Col'd Inf.

Appears on

Company Descriptive Book

of the organization named above.

DESCRIPTION.

Age 18 years; height 5 feet 6 3/4 inches.

Complexion Blk

Eyes Blk; hair Curly

Where born Frederick, Md

Occupation In store

ENLISTMENT.

When Aug 31, 1863.

Where Balto Md

By whom Col Berney; term 3 y'rs.

Remarks: Slave wounded at Newmarket Va Sept 29, 64

Selah

Copyist.

B | **4** | **U.S.C.T.**

John Bowie
 , Co. *K*, 4 Reg't U. S. Col'd Inf.

Appears on
Company Descriptive Book
 of the organization named above.

DESCRIPTION.

Age *18* years ; height *5* feet *6 3/4* inches.
 Complexion *Blk*
 Eyes *Blk* ; hair *Curl*
 Where born *Frederick Co. Md*
 Occupation *In store*

ENLISTMENT.

When *Aug 31* , 18*63* .
 Where *Balto Md*
 By whom *W. M. Burney* ; term *3* y'rs.
 Remarks: *Slave*

(388g)

Selah
 Copyist.

S

4

U.S.C.T.

John Lewis
A. K., Co. 4 Reg't U. S. Col'd Infantry.

Age *18* years.

Appears on

Company Muster-in Roll

of the organization named above. Roll dated

Baltimore Md Sep 1, 1863

Muster-in to date

Sep 1, 1863

Joined for duty and enrolled:

When

*Sep 1, 1863**

Where

*Baltimore, Md.**

Period

3 years.*

Remarks:

* *cc* - Muster-in roll shows enrollment and muster-in of this company as of same date and place. See enrollment on subsequent card or cards.

Book mark:

Van Hook

P | 4 | U.S.C.T.

John Bowie
....., Co. K, 4 Reg't U. S. Col'd Infantry.

Appears on

Company Muster Roll

for *Sept - Oct*, 186*3*.

Joined for duty and enrolled :

When *Sept 1*, 186*3* .*

Where *Baltimore* *

Period *3* years.*

Present or absent *Present*.

Stoppage, \$ *100* for

Due Gov't, \$ *100* for

Remarks:

.....
.....
.....
.....
.....

Book mark:

Van Hook

P

4

U.S.C.T.

John Powell
P, Co. K, 4 Reg't U. S. Col'd Infantry.

Appears on

Company Muster Roll

for *Nov + Dec*, 186 *3*.

Joined for duty and enrolled :

When *Sept 1*, 186 *3*.*

Where *Baltimore* *

Period *3* years.*

Present or absent *Present.*

Stoppage, \$ *14*/₁₀₀ for *2 Great Coat Straps*

Due Gov't, \$ *100* for

Remarks:

* See enrollment on card from muster-in roll.

Book mark:

Van Hook

P

4

U.S.C.T.

John Bowie
Co. K, 4 Reg't U. S. Col'd Infantry.

Appears on

Company Muster Roll

for Jan'y & Feb'y, 1864

Joined for duty and enrolled:

When Sept 1, 1863*

Where Baltimore *

Period 3 years.*

Present or absent Present

Stoppage, \$ 100 for

Due Gov't, \$ 100 for

Remarks Stopped for one letter

* See enrollment on card from muster-in roll.

Book mark:

James H. ...

S

4

U.S.C.T.

John Bowie
Pr, Co. K, 4 Reg't U. S. Col'd Infantry.

Appears on

Company Muster Roll

for *Men & Ap*, 186 *4*

Joined for duty and enrolled:

When *Sept 1*, 186 *3*.*

Where *Baltimore*.*

Period *3* years.*

Present or absent *Present*

Stoppage, \$ *100* for

Due Gov't, \$ *100* for

Remarks:

* See enrollment on card from muster-in roll.

Book mark:

Vautour

B | 4 | U.S.C.T.

John Bowie

PL, Co. K, 4 Reg't U. S. Col'd Infantry.

Appears on

Company Muster Roll

for May to June, 1864.

Joined for duty and enrolled:

When Sept. 1, 1863.*

Where Baltimore *

Period 3 years.*

Present or absent Present

Stoppage, \$ 100 for

Due Gov't, \$ 100 for

Remarks:

Book mark:

Bliss

D

4

U.S.C.T.

John Bowie

Private, Co. K, 4 Reg't U. S. Col'd Infantry.

Appears on

Company Muster Roll

for July and Aug, 1864.

Joined for duty and enrolled:

When Sept. 1, 1863.*

Where Baltimore Md *

Period 3 years.*

Present or absent Present

Stoppage, \$ 100 for

Due Gov't, \$ 100 for

Remarks: Slave on extra duty at Canal Aug. 26 1864

Book mark:

Bliss

(358c)

Copyist.

D | 4 | U.S.C.T.

John Bowie
Plt, Co. K, 4 Reg't U. S. Col'd Infantry.

Appears on
Company Muster Roll
for *Sept. and Oct.*, 1864.

Joined for duty and enrolled:
When *Sept. 1*, 1863.*
Where *Baltimore Md* *
Period *3* years.*

Present or absent *Absent*

Stoppage, \$ *100* for

Due Gov't, \$ *100* for

Remarks: *Slav. Wounded*
in action Sept. 29. 1864
In Gen. Hospital. Due
W. G. Cooper's sister 8.00

Book mark:

Bliss
Copyright.

B | 4 | U.S.C.T.

John Bowie
Pt, Co. K, 4 Reg't U. S. Col'd Infantry.

Appears on

Company Muster Roll

for Nov & Dec, 1864

Joined for duty and enrolled:

When Sept 1, 1863.*

Where Baltimore Md.*

Period 3 years.*

Present or absent Present

Stoppage, \$ 100 for

Due Gov't, \$ 100 for

Remarks: Slave Due
W.C. Cooper Sutter
800

Book mark:

J. H. Stewart

B | 4 | U.S.C.T.

John Bowey
Pt., Co. K, 4 Reg't U. S. Col'd Infantry.

Appears on

Company Muster Roll

for Jan & Feb, 1865.

Joined for duty and enrolled :

When Sept 1, 1863*

Where Baltimore Md. *

Period 3 years.*

Present or absent Present

Stoppage, \$ 100 for

Due Gov't, \$ 100 for

Remarks: Slave
Due sutler \$8.00

Book mark :

J. H. Stewart

B. | 4 | U.S.C.T.

John Bowie
Pr., Co. K, 4 Reg't U. S. Col'd Infantry.

Appears on

Company Muster Roll
for *Mch. + Apl.*, 1865.

Joined for duty and enrolled :

When *Sept. 1*, 1863.*

Where *Baltimore, Md.* *

Period *3* years.*

Present or absent *Present*

Stoppage, \$ *100* for

Due Gov't, \$ *100* for

Remarks: *Stop one canteen
65 cts.*

* See enrollment on card from muster-in roll.

Book mark :

Philipson

B. | 4 | U.S.C.T.

John Bowie
Co. K, 4 Reg't U. S. Col'd Infantry.

Appears on

Company Muster Roll

for *May + June*, 1863.

Joined for duty and enrolled :

When *Sept. 1*, 1863.*

Where *Baltimore, Md.* *

Period *3* years.*

Present or absent *Present*

Stoppage, \$ *100* for

Due Gov't, \$ *100* for

Remarks: *Stopped one
canteen 65 cts. Slave.*

* See enrollment on card from muster-in roll.

Book mark :

Philipson
Copyist.

B. | 4 | U.S.C.T.

John Bowie

Priv., Co. K, 4 Reg't U. S. Col'd Infantry.

Appears on

Company Muster Roll

for *July & Aug.*, 1865.

Joined for duty and enrolled :

When *Sept. 1*, 1863.*

Where *Baltimore, Md.* *

Period *3* years.*

Present or absent *Present*

Stoppage, \$ *100* for

Due Gov't, \$ *100* for

Remarks:

* See enrollment on card from muster-in roll.

Book mark :

Philipsen

(358c)

Copyist.

B. | 4 | U.S.C.T.

John Bowie

Priv., Co. K, 4 Reg't U. S. Col'd Infantry.

Appears on

Company Muster Roll

for *Sept. & Oct.*, 1865.

Joined for duty and enrolled :

When *Sept. 1*, 1863.*

Where *Baltimore* *

Period *3* years.*

Present or absent *Present*

Stoppage, \$ *100* for

Due Gov't, \$ *100* for

Remarks: _____

* See enrollment on card from muster-in roll.

Book mark : _____

Philipson

B

4

U.S.C.T.

John Bowie

Priv, Co. K, 4 Reg't U. S. Col'd Infantry.

Appears on

Company Muster Roll

for *Nov. & Dec*, 186*5*.

Joined for duty and enrolled:

When *September 1*, 186*3*.*

Where *Baltimore Md*.*

Period *3* years.*

Present or absent *Present*

Stoppage, \$ *100* for

Due Gov't, \$ *100* for

Remarks: *In Confinement*

Book mark:

J. McHance

(358c)

Copyist.

D. | **4** | **U.S.C.T.**

John Bowie
....., Co. K, 4 Reg't U. S. Col'd Infantry.

Appears on

Company Muster Roll

for *Jan + Feb*, 186*6*.

Joined for duty and enrolled:

When *September 1*, 186*3*.*

Where *Baltimore Md**

Period *3* years.*

Present or absent *Absent*

Stoppage, \$ *100* for

Due Gov't, \$ *100* for

Remarks: *On detached Service*

NEXT ROLL ON FILE MUSTER OUT.

Book mark:

J. Medance
(358c) Copyist.

B | 4 | **U.S.C.T.**

John Bonie

Plt, Co. K, 4 Reg't U. S. Col'd Infantry.

Appears on **Co. Muster-out Roll**, dated Washington D.C., May 4, 1866.

Muster-out to date May 4, 1866.

Last paid to July 28, 1866.

Clothing account:

Last settled....., 186 ; drawn since \$.....¹⁰⁰

Due soldier \$.....¹⁰⁰; due U. S. \$.....^{11 28}/₁₀₀

Am't for cloth'g in kind or money adv'd \$.....¹⁰⁰

Due U. S. for arms, equipments, &c., \$.....^{6 00}/₁₀₀

Bounty paid \$.....¹⁰⁰; due \$.....^{100 00}/₁₀₀

Remarks: Wounded Sept 29, 1864

Spies on or before April 19, 1861

Difference of pay due Sept 1,
1863 to April 30, 1864

Book mark: V120.P.15.70 V222P125.75

(861)

J M Stance

Copyist.

Boy, Jno A.

, Co. K, 4 Reg't U.S. Col'd

1 Enclosures.

Bed Cards	1	Descriptive Lists
Burial Records		Final Statements
Certs. of Dis. for Discharge		Furloughs
C. M. Charges		Med. Des. Lists
Med. Certificates		Orders

Other papers relating to—

Admission to Hosp'l	Furlough
Casualty Sheet (Officer's)	Med. Examination
Confinement	Misc. Information
Contracts	Pay or Clothing
Death or Effects	Personal Reports
Desertions	Rank
Discharge from Hosp'l	Transfer to Hosp'l
Discharge from Service	Transfer to V. R. C.
Duty	Transportation

Hospital Number 4621 59 B.

Name Sohn H. Boy

Age 19 Nativity Maryland

Married or Single Single

Residence Fredrick Co

Post Office address of } Mother
wife or nearest relative. }

Rank private Co. K Regiment 4th U.S. Cal

When admitted Oct 18/64

From what source Fort Monroe.

Diagnosis: (in surgical cases state explicitly seat and character of wound or injury.)

*Contusion of
Back from a
Shell*

Summit House G. H.
Philadelphia, Pa.

On what occasion wounded Chapin's farm

Date Oct 19/64

Nature of missile or weapon Shell,

TREATMENT.

[HERE NOTE IMPORTANT COMPLICATIONS AND ALL OPERATIONS.]

No Treatment,

RESULT AND DATE.

*Returned to Duty
Nov 21st 1864 By
order examining Board**Wm. Shapley
Capt. U.S.A.*

¹³⁶
Bowley Cyrus

Co E, **4** U.S. Col'd Inf.

4th Sergeant | *Sergeant*
CARD NUMBERS.

1	5557735	26
2	5557816	27
3	5557917	28
4	5558017	29
5	5558111	30
6	5558204	31
7	5558297	32
8	5558388	33
9	5558546	34
10	5559317	35
11	9068164	36
12		37
13		38
14		39
15		40
16		41
17		42
18		43
19		44
20		45
21		46
22		47
23		48
24		49
25		50

Book Mark:

See also

8818109-2 land owner

B

4

U.S.C.T.

Cyrus Baley

, Co. E, 4 Reg't U. S. Col'd Inf.

Appears on

Company Descriptive Book

of the organization named above.

DESCRIPTION.

Age 27 years; height 5 feet 10 1/4 inches.

Complexion Black

Eyes Black; hair Curly

Where born Dorchester Co. Md

Occupation Laborer

ENLISTMENT.

When July 28, 1863

Where Baltimore

By whom Col. W. Barney; term ? y'rs.

Remarks: Killed in action New Market

Height Va. Sept 29/64

Final statements sent Nov. 3/64

W. H. Merrill

B

4

U.S.C.T.

Cyrus Bowley

4 Sgt. Co. E, 4 Reg't U. S. Col'd Infantry.

Age 27 years.

Appears on

Company Muster-in Roll

of the organization named above. Roll dated

Baltimore Md., July 25, 1863.

Muster-in to date

July 25, 1863.

Joined for duty and enrolled:

When July 25, 1863.*

Where Baltimore Md.*

Period 3 years.*

Remarks:

* If Muster-in roll shows enrollment and muster-in of this company as of same date and place: See enrollment on subsequent card or cards.

Book mark:

Hathaway

(356e)

Copyist.

B

4

U.S.C.T.

Cyrus Boley

....., Co. E, 4 Reg't U. S. Col'd Infantry.

Appears on

Company Muster Roll

for *from Feb. 15 to Aug. 31*, 186*3*.

Joined for duty and enrolled:

When *July 2*, 186*3* *

Where *Baltimore* *

Period *3* years.*

Present or absent *Present*

Stoppage, \$ *100* for

Due Gov't, \$ *100* for

Remarks:

* See enrollment on card from muster-in roll.

Book mark:

Hathaway

(358c)

Copyist.

B | 4 | U.S.C.T.

Cyrus Cole

Sgt., Co. E, 4 Reg't U. S. Col'd Infantry.

Appears on

Company Muster Roll

for *Sept. & Oct.*, 186*3*.

Joined for duty and enrolled:

When *July 27*, 186*3*.*

Where *Balt. Md*.*

Period *0* years.*

Present or absent *Present*

Stoppage, \$ *100* for

Due Gov't, \$ *100* for

Remarks:

* See enrollment on card from muster-in roll.

Book mark:

(358c)

H. H. H. H.
Copyist.

B | 4 | U.S.C.T.

Cyprien Boleu

Sgt, Co. E, 4 Reg't U. S. Col'd Infantry.

Appears on

Company Muster Roll

for *Nov. Dec.*, 186*3*.

Joined for duty and enrolled:

When *July 28*, 186*3*.*

Where *Baltimore* *

Period *3* years.*

Present or absent *Present*

Stoppage, \$ *100* for

Due Gov't, \$ *100* for

Remarks:

* See enrollment on card from muster-in roll.

Book mark:

Hathaway
Copyist.

B | 4 | U.S.C.T.

Cyrus Boley
Sgt.; Co. E, 4 Reg't U. S. Col'd Infantry.

Appears on

Company Muster Roll
for Jan. & Feb., 1864.

Joined for duty and enrolled:

When July 25, 1863.*

Where Baltimore Md.*

Period 9 years.*

Present or absent Present

Stoppage, \$ 100 for

Due Gov't, \$ 100 for

Remarks:

* See enrollment on card from muster-in roll.

Book mark:

Wattaway

B | 4 | **U.S.C.T.**

Cyrus Boley

Sgt., Co. E, 4 Reg't U. S. Col'd Infantry.

Appears on

Company Muster Roll

for Mar & Apr, 1864.

Joined for duty and enrolled :

When July 28, 1863.*

Where Baltimore Md.*

Period 3 years.*

Present or absent Present

Stoppage, \$ 100 for

Due Gov't, \$ 100 for

Remarks :

* See enrollment on card from muster-in roll.

Book mark :

Murray

B | 4 | U.S.C.T.

Cyrus Baley
Sgt., Co. E, 4 Reg't U. S. Col'd Infantry.

Appears on

Company Muster Roll

for May & June, 1864.

Joined for duty and enrolled :

When July 28, 1863.*

Where Baltimore *

Period 3 years.*

Present or absent Present

Stoppage, \$ 100 for

Due Gov't, \$ 100 for

Remarks:

* See enrollment on card from muster-in roll.

Book mark:

Murray

3

4

U.S.C.T.

Cyrus Boley

Sgt, Co. E, 4 Reg't U. S. Col'd Infantry.

Appears on

Company Muster Roll

for *July & Aug*, 1864.

Joined for duty and enrolled :

When *July 28*, 1863.*

Where *Baltimore City* *

Period *3* years.*

Present or absent *absent*

Stoppage, \$ *100* for

Due Gov't, \$ *100* for

Remarks: *Absent sick*

* See enrollment on card from muster-in roll.

Book mark :

Murray

B | 4 | U.S.C.T.

Cyrus Boley

Serjt., Co. E, 4 Reg't U. S. Col'd Infantry.

Appears on

Company Muster Roll

for *Sept Oct*, 186*3*.

Joined for duty and enrolled :

When *July 28, 1863*.*

Where *Baltimore Md*.*

Period *3* years.*

Present or absent

Stoppage, \$ *100* for

Due Gov't, \$ *100* for

Remarks: *Killed in action at
New Market Heights Va.
Sept 29 64*

* See enrollment on card from muster-in roll.

Book mark :

Murray

B

4

U.S.C.T.

Cyrus Baly

Sgt., Co. *E*, 4 Reg't U. S. Col'd Infantry.

Appears on **Co. Muster-out Roll**, dated
Washington D.C., May 4, 1866.

Muster-out to date _____, 186 .

Last paid to _____, 186 .

Clothing account:

Last settled _____, 186 ; drawn since \$ _____ 100

Due soldier \$ _____ 100; due U. S. \$ _____ 100

Am't for cloth'g in kind or money adv'd \$ _____ 100

Due U. S. for arms, equipments, &c., \$ _____ 100

Bounty paid \$ _____ 100; due \$ _____ 100

Remarks: *Killed in action*
at New Market Heights Va.
Sept 29, '64. Final statement
given Nov 3/64.

Book mark: *2369/80*

Somers

(361)

Copyist.

Poley, Cyrus

Sgt., Co. *C*, **4** *Reg't* **U. S. C. Inf.**

2 Enclosures.

Bed Cards	Descriptive Lists
Burial Records	Final Statements <i>/</i>
Certs. of Dis. for Discharge	Furloughs
C. M. Charges	Med. Des. Lists
Med. Certificates	Orders

Other papers relating to—

Admission to Hosp'l	Furlough
Casualty Sheet (Officer's)	Med. Examination
Confinement	Misc. Information
Contracts	Pay or Clothing
Death or Effects <i>/</i>	Personal Reports
Desertions	Rank
Discharge from Hosp'l	Transfer to Hosp'l
Discharge from Service	Transfer to V. R. C.
Duty	Transportation

1864 J. P. 509 file No. 18
Inventory of the effects
of
Sergeant Cyrus Coley.
Late of Company "E."
4th Regt of U. S. C. Troops,
who was killed at New Market Heights Va
on the 29th day of September 1864.



Inventory of the effects of Cyrus Boley, late a Sergeant of
 Lieut Thomas H. Price's Company "E" of the 4th Regiment of U. S. Cold
 Troops, who was enrolled as a Sergeant at Baltimore in the State of
 Maryland on the 28th day of July 1863, and mustered into the service of the
 United States as a Sergeant on the 28th day of July 1864, at Baltimore Md.
 in Company "E" 4th Regiment of U. S. C. Troops, to serve Three years; he
 was born in Dorchester County in the State of Maryland; he was 27
 years of age, 5 feet, 10 $\frac{1}{4}$ inches high, Black complexion, Black eyes,
 curly hair, and his occupation, when enrolled, a Laborer; he was killed
 in action at New Market Heights Va, on the 29th day of September 1864,
 by reason of being struck by a musket ball.

No effects have been found.

I certify, ~~in~~ honor, that the above inventory comprises all the effects
 of Sergeant Cyrus Boley deceased.

(Duplicat^{es}.)

J. H. Reynolds

Lieut 4th U. S. C. T.

Commanding the Company.

Station: Near Antietam, Va

Date: November 3rd 1864.

FINAL STATEMENT

OF

Sergeant Cyrus Polay
1st Reg't of U.S. Troops

VOLUNTEERS.

Rec'd Dept 29" 1864

NOTE 1.—Two of these certificates (or duplicates) are to be given to each Volunteer Soldier or drafted man who may be discharged previously to the discharge of his company, that he may at once receive from the Paymaster the pay, &c., due him, and the captain or other COMMISSIONED officer commanding the company will certify to the act of the delivery of the duplicate certificates; on these certificates the Soldier is "entitled to" his discharge, and should also present his discharge to the Paymaster to have the payment endorsed on it. The discharge is to be given back to the Soldier by the Paymaster; the latter only retaining as his voucher the duplicate certificates.

NOTE 2.—If the Soldier is entitled to pay for the use of his horse, the Company Commander will certify to that fact on the back of both these final statements, and also to the time he has pay due for having been so mounted on his own horse.

NOTE 3.—When a Soldier is furnished with final statements, his descriptive list, if he has one, should be taken up by the officer who gives the Soldier these statements, and endorsed with a statement to this effect by the officer. This endorsement should exhibit a full statement of the time for which the Soldier was allowed pay on his final statements, the clothing account, and all other charges against him or in his favor, so as to comprise a complete exhibit of his account. It will then be transmitted to the company commander of the Soldier, who will enter all the data necessary to a full understanding of the Soldier's account on the muster roll upon which the Soldier's discharge is reported. The descriptive list will then be destroyed. The object of this is, that the remaining portion of the Soldier's account may be settled upon the receipt of these muster rolls, and the Soldier receive any pay or allowances that may be due him at the time of his discharge, and which may not appear on his final statements from the fact that his descriptive list is incomplete. These accounts for back pay, &c., are settled by the 2d Auditor of the Treasury Department.

NOTE 4.—Charges for loss or injury to ordnance, horse equipments, and other miscellaneous charges, should appear under the heading of "Other Stoppages."

NOTE 5.—Bounty paid by State authorities, and not by the United States, will not be entered on this statement.

NOTE 6.—Amounts due the Sutler and Laundress must be entered on the muster roll on which the discharge, den b. desertion, &c., is reported, as well as on the final statement, otherwise the amount cannot be collected from the United States.

NOTE 7.—This blank will be used for deceased volunteers and drafted men, as well as for others.

NOTE 8.—Where a Soldier dies in Hospital or on detached service, his descriptive list, if he has one, should be sent with his final statements, in duplicate, to the Adjutant General, Washington.

E. C. H. [Signature]



ADJUTANT GENERAL'S OFFICE.

Nov 21" 1864

Duplicate with Inventory sent 2d Auditor.

I certify, on honor, that Cyrus Boley a Sergeant of
Captain Thos H. Price's Company (E) of the 1st Regiment of 2^d Ill. Trooper
VOLUNTEERS, of the State of _____, born in Dorchester Co, State
 of Maryland, aged 27 years; 5 feet 10 1/4 inches high; Black complexion,
Black eyes, Curly hair, and by occupation a Laborer, having joined the company on
 its original organization at Baltimore Md., and enrolled in it at the muster into
 the service of the United States at Baltimore Md., on the 25th day
 of July, 1863, (or was mustered in service as a recruit, by _____
 _____, at _____, on the _____ day of _____,
 186 , or was drafted and mustered into the service of the United States from the _____
 Enrollment District of the State of _____, at _____,
 on the _____ day of _____, 186), to serve in the Regiment, for
 the term of Three Years: and having served **HONESTLY** and
FAITHFULLY with his Company in _____ to the present date, is now

entitled to a **DISCHARGE** by reason of Discharged on the 29th Sept 1864
Heighten Va on the 29th Sept 1864

The said Sergeant Cyrus Boley was last paid by Paymaster
Mal Holmes to include the 29th day of February, 1864, and has
 pay due him from that time to the present date; he is entitled to pay and subsistence for
TRAVELING to place of enrollment, and whatever other allowances are authorized to volunteer
 soldiers, drafted men, or militia, so discharged. He has received from the United States **CLOTHING**
 amounting to Sixty-three & 64/100 dollars, since the _____ day of Enlistment,
 186 , when his clothing account was last settled. He has received from the United States
_____ dollars advanced **BOUNTY**.

There is to be stopped from him, on account of the State of _____, or other
 authorities, for **CLOTHING**, &c., received on entering service, _____ dollars; and
 for other stoppages, viz: _____

_____ dollars.
 He has been furnished with **TRANSPORTATION** in kind from the place of his discharge to
 _____; and he has been **SUBSISTED** for **TRAVELING** to his
 place of enrollment, up to the _____, 186 .

He is indebted to Malcolm 4th U.S.C.T., **SUTLER**, Nine 00/100 dollars.
 He is indebted to _____, **LAUNDRESS**, _____ 100/100 dollars.

Given in Duplicate, at Camp near Dutch Gap Va, this 3rd day
 of November, 1864.

[Signature]
Malcolm 4th U.S.C.T.
 Commanding Company. 6

137

Powyer, Samuel

Co H, 4 U.S. Col'd Inf.

Private

Private

CARD NUMBERS.

1	5562712	26
2	5562811	27
3	5562911	28
4	5563013	29
5	5563110	30
6	5563203	31
7	5563292	32
8	5563383	33
9	5563467	34
10	5563552	35
11	5563643	36
12	5563743	37
13	5563842	38
14	5563936	39
15	5564031	40
16	5564119	41
17	5564209	42
18	5564262	43
19	9062665	44
20		45
21		46
22		47
23		48
24		49
25		50

Book Mark: E.B. Vio. P. 497

See also

03094915 Arch WA

B | **4** | **U.S.C.T.**

Daniel Boyer

, Co. *H*, 4 Reg't U. S. Col'd Inf.

Appears on

Company Descriptive Book

of the organization named above.

DESCRIPTION.

Age *45* years; height *5* feet *7* inches.

Complexion *Blk*

Eyes *Blk*; hair *Gray*

Where born *Frederick Co, Md*

Occupation *Laborer*

ENLISTMENT.

When *Aug. 11*, 18*63*.

Where *Baltimore, Md.*

By whom *Col Birney*, term *3* y'rs.

Remarks:

Enlisted on or before April 19, 1861

Discharged for Disability Jan'y 18, 1866, at Baltimore, Md.

Delah

B | **4** | **U.S.C.T.**

Daniel Boyer

Private, Co. *H*, 4 Reg't U. S. Col'd Infantry.

Age *45* years.

Appears on

Company Muster-in Roll

of the organization named above. Roll dated

Aug 11, 1863.

Muster-in to date

Aug 11, 1863.

Joined for duty and enrolled:

When *Aug 11*, 1863.*

Where *Baltimore City*.*

Period *3* years.*

Remarks:

* Muster-in roll shows enrollment and muster-in of this company as of same date and place. See enrollment on subsequent card or cards.

Book mark:

M. A. Michaels

B | 4 | U.S.C.T.

Daniel Boyer

Civ., Co. H, 4 Reg't U. S. Col'd Infantry.

Appears on

Company Muster Roll

for Aug 11 to Aug 31, 1863.

Joined for duty and enrolled:

When Aug. 11, 1863.*

Where Baltimore City *

Period 3 years.*

Present or absent Present

Stoppage, \$ 100 for

Due Gov't \$ 100 for

Remarks:

* See enrollment on card from muster-in roll.

Book mark:

(858c)

M. A. Michaels Copyist.

B | 4 | U.S.C.T.

Daniel Boyer
Priv., Co. H, 4 Reg't U. S. Col'd Infantry.

Appears on

Company Muster Roll

for Sept & Oct, 1863.

Joined for duty and enrolled:

When Aug. 11, 1863.*

Where Baltimore City *

Period 3 years.*

Present or absent Present

Stoppage, \$ 100 for

Due Gov't \$ 100 for

Remarks: Detailed as Company Cook

* See enrollment on card from muster-in roll.

Book mark: 245676

M. A. Michaels

(858c)

Copyist.

B | 4 | U.S.C.T.

Daniel Bowyer
Civ., Co. H, 4 Reg't U. S. Col'd Infantry.

Appears on

Company Muster Roll
for *Nov & Dec.*, 186*3*.

Joined for duty and enrolled:

When *Aug. 11*, 186*3*.*

Where *Baltimore City* *

Period *3* years.*

Present or absent *Present*

Stoppage, \$ *100* for

Due Gov't \$ *100* for

Remarks: *On daily duty as
Company Cook.*

* See enrollment on card from muster-in roll.

Book mark:

M. A. Michaels
(858c) Copyist.

B | 4 | U.S.C.T.

Daniel Bouyer
Priv., Co. H, 4 Reg't U. S. Col'd Infantry.

Appears on

Company Muster Roll
for Jan + Febr, 1864.

Joined for duty and enrolled:

When Aug. 11, 1863.*

Where Baltimore City *

Period 3 years.*

Present or absent Present

Stoppage, \$ 100 for

Due Gov't \$ 100 for

Remarks: Detailed as Co. Cook

* See enrollment on card from muster-in roll.

Book mark:

M. A. Michaels
(358c) Copyist.

B | 4 | U.S.C.T.

Daniel Boyer
Priv., Co. H, 4 Reg't U. S. Col'd Infantry.

Appears on

Company Muster Roll

for March 8 Apr., 1864.

Joined for duty and enrolled:

When Aug. 11, 1863.*

Where Baltimore City*

Period 8 years.*

Present or absent Present

Stoppage, \$ 100 for

Due Gov't \$ 100 for

Remarks: Detailed as Co. Cook.

* See enrollment on card from muster-in roll.

Book mark:

(858c)

C. F. Thompson.
Copyist.

B | 4 | U.S.C.T.

Daniel Boyer
 Pvt., Co. H, 4 Reg't U. S. Col'd Infantry.

Appears on

Company Muster Roll

for May & June, 1864.

Joined for duty and enrolled:

When Aug. 11, 1863.*

Where Baltimore city*

Period 3 years.*

Present or absent Absent

Stoppage, \$ 100 for _____

Due Gov't \$ 100 for _____

Remarks: Detailed as Co. cook. Sick in Div. Hosp.

* See enrollment on card from muster-in-roll.

Book mark: _____

(358c)

C. F. Thompson
 Copyist.

10 | 4 | U.S.C.T.

Daniel Sawyer
Priv., Co. H, 4 Reg't U. S. Col'd Infantry.

Appears on

Company Muster Roll

for *July & Aug.*, 186*4*.

Joined for duty and enrolled:

When *Aug. 11*, 186*3*.*

Where *Baltimore City**

Period *3* years.*

Present or absent *Present.*

Stoppage, \$ *100* for

Due Gov't \$ *100* for

Remarks: *On daily duty
 as Company Cook,
 Free on or before Apr.
 19/61*

* See enrollment on card from muster-in roll.

Book mark:

C. F. Thompson
 Copyist.

B | 4 | U.S.C.T.

Daniel Boyer

pt., Co. H, 4 Reg't U. S. Col'd Infantry.

Appears on

Company Muster Roll

for Sept. & Oct., 1864.

Joined for duty and enrolled:

When Aug. 11, 1863.*

Where Baltimore, Md. *

Period 3 years.*

Present or absent Present.

Stoppage, \$ 100 for

Due Gov't \$ 100 for

Remarks: Free on or before Apr. 19/61

* See enrollment on card from muster-in roll.

Book mark:

C. F. Thompson.

(858c)

Copyist.

B | 4 | U.S.C.T.

Daniel Boyer
privat, Co. H, 4 Reg't U. S. Col'd Infantry.

Appears on

Company Muster Roll
 for *Nov. & Dec.*, 1864.

Joined for duty and enrolled:

When *Aug. 11*, 1863.*

Where *B Altmore* *

Period *3* years.*

Present or absent *Absent*

Stoppage, \$ *100* for

Due Gov't \$ *100* for

Remarks: *Absent sick*

* ~~See~~ See enrollment on card from muster-in roll.

Book mark: -----

C. F. Thompson
 (858c) Copyist.

B | 4 | U.S.C.T.

Daniel Boyer

Private, Co. H, 4 Reg't U. S. Col'd Infantry.

Appears on

Company Muster Roll

for Jan & Feb, 1865.

Joined for duty and enrolled:

When Aug 11, 1863.*

Where Baltimore Md *

Period 3 years.*

Present or absent Absent

Stoppage, \$ 100 for

Due Gov't \$ 100 for

Remarks: Absent sick

* See enrollment on card from muster-in roll.

Book mark:

Bowman

B | 4 | U.S.C.T.

Daniel Bowyer

Pvt., Co. H, 4 Reg't U. S. Col'd Infantry.

Appears on

Company Muster Roll

for *Mar & Apr*, 1865.

Joined for duty and enrolled:

When *Aug 11*, 1863.*

Where *Baltimore Md* *

Period *3* years.*

Present or absent *Absent*

Stoppage, \$ *100* for

Due Gov't \$ *100* for

Remarks: *Free on or before April 19 1861. Back Pay due from May 1.64 to muster into service. Absent sick*

* See enrollment on card from muster-in roll.

Book mark:

Bowman

B | 4 | U.S.C.T.

Daniel Bowyer

Pvt., Co. H, 4 Reg't U. S. Col'd Infantry.

Appears on

Company Muster Roll

for *May + June*, 1865.

Joined for duty and enrolled:

When *Aug 11*, 1863.*

Where *Baltimore Md* *

Period *3* years.*

Present or absent *Absent*

Stoppage, \$ *100* for

Due Gov't \$ *100* for

Remarks: *Back pay due from enlistment to May 1.64*
Absent sick

* See enrollment on card from muster-in roll.

Book mark:

Bowman

B

4

U.S.C.T.

Daniel Bouyer

Pvt, Co. H, 4 Reg't U. S. Col'd Infantry.

Appears on

Company Muster Roll

for Jul & Aug, 1865.

Joined for duty and enrolled:

When Aug 11, 1863.*

Where Baltimore Md *

Period 3 years.*

Present or absent. Absent

Stoppage, \$ 100 for

Due Gov't \$ 100 for

Remarks: Absent sick.

Back pay due from enlistment to May 1/64.

Free before April 19/61

* See enrollment on card from muster-in roll.

Book mark:

Bowman

B | 4 | U.S.C.T.

Daniel Bouyer

Priv., Co. H, 4 Reg't U. S. Col'd Infantry.

Appears on

Company Muster Roll

for Sept + Oct, 1865.

Joined for duty and enrolled:

When Aug 11, 1863.*

Where Baltimore Md *

Period 3 years.*

Present or absent Absent

Stoppage, \$ 100 for

Due Gov't \$ 100 for

Remarks: Absent sick

Back pay due from enlistment to May 1/64.

Free before April 19/61

* See enrollment on card from muster-in roll.

Book mark:

Bowman

B. | 4 | U.S.C.T.

Daniel Boyer,
Spir., Co. H, 4 Reg't U. S. Col'd Infantry.

Appears on

Company Muster Roll
for Novbr 4th Decbr, 1865.

Joined for duty and enrolled:

When August 11, 1863.*

Where Baltimore, Md.*

Period 3 years.*

Present or absent Absent.

Stoppage, \$ 100 for

Due Gov't \$ 100 for

Remarks: Absent sick. Difference
of pay due from enlistment
to May 1, 1864. - Free before
April 19/61. Paid in stop for
May 4th June 1865 by Maj. Put-
sifer.

* See enrollment on card from muster-in roll.

Book mark:

(358c) R. B. Primmer Copyist.

18. | 4 | U.S.C.T.

Daniel Sawyer,
Priv., Co. H, 4 Reg't U. S. Col'd Infantry.

Appears on

Company Muster Roll

for *Jan'y⁴ Feb'y*, 186*6*.

Joined for duty and enrolled:

When *August 11*, 186*3*.*

Where *Baltimore, Md.* *

Period *3* years.*

Present or absent.....

Stoppage, \$ *100* for.....

Due Gov't \$ *100* for.....

Remarks: *Discharged for dis-*
ability at Sick U.S. A.
Gen. Hosp. Baltimore, Md.,
Jan'y 18, 1866.

NEXT ROLL ON FILE MUSTER OUT.

* See enrollment on card from muster-in roll.

Book mark *Discharged Jan. 17/66.*
E. B. V. 10. P. 497.

M. D. Sawyer

13

4

U.S.C.T.

Daniel Sawyer,
Private, Co. A., 4 Reg't U. S. Col'd Infantry.

Appears on Co. Muster-out Roll, dated
Washington, D.C. May 4, 1866 .

Muster-out to date _____, 186 .

Last paid to *Aug. 31,* 1864 .

Clothing account:

Last settled _____, 186 ; drawn since \$ _____¹⁰⁰

Due soldier \$ _____¹⁰⁰; due U. S. \$ _____¹⁰⁰

Am't for cloth'g in kind or money adv'd \$ _____¹⁰⁰

Due U. S. for arms, equipments, &c., \$ _____¹⁰⁰

Bounty paid \$ _____¹⁰⁰; due \$ _____¹⁰⁰

Remarks: *Discharged for disability*
Jan. 18, 1866 at Baltimore,
Mar Free.

Book mark: *PV 28. P. 180. 73.*

R. S. Brauner

(861)

Copyist.

Boyer, Daniel

P. Co. H, 4 Reg't U.S.A.

2 Enclosures.

Red Cards	1	Descriptive Lists
Burial Records		Final Statements
Certs. of Dis. for Discharge	1	Furloughs
C. M. Charges		Med. Des. Lists
Med. Certificates		Orders

Other papers relating to—

Admission to Hosp'l	Furlough
Casualty Sheet (Officer's)	Med. Examination
Confinement	Misc. Information
Contracts	Pay or Clothing
Death or Effects	Personal Reports
Desertions	Rank
Discharge from Hosp'l	Transfer to Hosp'l
Discharge from Service	Transfer to V. R. C.
Duty	Transportation

NOTE 1.

The company commander will here add a statement of all the facts known to him concerning the disease or wound, or cause of disability of the soldier; the time, place, manner, and all the circumstances under which the injury occurred, or disease originated or appeared; the duty, or service, or situation of the soldier at the time the injury was received or disease contracted, stating particularly whether the injury was received or the disease contracted in the line of his duty; and whatever other facts may aid a judgment as to the cause, immediate or remote, of the disability, and the circumstances attending it.

When the facts are not known to the company commander, the certificate of any officer, or affidavit of other person having such knowledge, will be appended—as the surgeon in charge of a hospital, the officer commanding a detachment of recruits, &c., &c.

NOTE 2.

When a probable case for pension, special care must be taken to state the degree of disability—as 1/2, 1/3, &c., &c.; to describe particularly the disability, wound, or disease; the extent of which it deprives him of the use of any limb or faculty, or affects his health, strength, activity, constitution, or capacity to labor or earn his subsistence. The surgeon will add, from his knowledge of the facts and circumstances, and from the evidence in the case, his professional opinion of the cause or origin of the disability. In the case of discharges by Medical Inspectors, the last paragraph will state that the "discharge was given by consent of the soldier, after a personal examination, and for disability, the nature, degree, and origin of which are correctly described in the within certificate."

Par. 1260 Regulations, Edit. 1861.

Medical officers, in giving certificates of disability, are to take particular care in all cases that have not been under their charge; and especially in epilepsy, convulsions, chronic rheumatism, derangement of the urinary organs, ophthalmia, ulcers, or any obscure disease liable to be feigned or purposely produced; and in no case shall such certificate be given until after sufficient time and examination to detect any attempt at deception.

DIRECTIONS.

This certificate will be made out in duplicate by the soldier's company commander, or other officer commanding the separate detachment to which he belongs, and sent by him to the surgeon who has charge of the hospital where the soldier is sick. The surgeon will then fill out and sign the surgeon's certificate, and forward these papers to the regimental, detachment, or post commander, who will forward them, with his action endorsed thereon, through the proper channel, to his division commander; or, if the troops are not attached to a division, to his corps, department, or other commander or officer to whom the authority to discharge enlisted men may be specially delegated.

These certificates, after having received the action of the highest authority to which they are required to be sent, will be returned through the same channel to the regimental, post, or detachment commander, who will, if the discharge is authorized by the endorsement of the proper authority, sign the soldier's discharge, and the last certificate on this paper; see that the soldier is furnished with the proper final statements in duplicate, and forward BOTH of these certificates direct to the Adjutant General United States Army, at Washington, D. C., they will not, under any circumstances, be given into the hands of the soldier.

ADJUTANT GENERAL'S OFFICE

Jan 21 1866

Duplicate sent the Pension Office.

B. & J. R. G. O. S.

CERTIFICATE OF DISABILITY FOR DISCHARGE

IN THE CASE OF

Samuel Bayer
Private Co. A
4th Reg't of *Cy. C. T.*

Medical Director Office
Dept of W Oct. 26 '65

Approved

J. S. S. S.
Chief of W. Army
Head Office

Extract furnished 2^d
Auditor. June 9 '68,

Received (A. G. Office) 1866

Eaton, R. & Co.

Head Quarters Department of Virginia,

RICHMOND, VA., Oct 27 1865.

To be Discharged by reason of _____

Disability

By command of Major General TERRY:

Edw Smith
Assistant Adjutant General.

War Department
Adjutant General's Office,
Washington D.C. Oct. 25, 1873.
The Muster Out Roll of Co "H" 4th
U.S.C., also the Co. Muster Roll for
Jan'y and Feb'y 1866, reports Private
Samuel Bayer discharged Jan'y 18,
1866.

The Surgeon's Cert. of Disability
for discharge indicates that he was
discharged Jan'y 17, 1866.

The latter date (Jan'y 17, 1866) is held
to be correct and the Co Muster and
Muster Out Rolls will be amended
accordingly.

Thoma M. S. S.
E. B. 10 of W. Adj't General,
1497

Noted
S. S.

See letter to 2^d and
Nov. 21 1873

ARMY OF THE UNITED STATES
CERTIFICATE
OF DISABILITY FOR DISCHARGE.



Daniel Boyer, *Private*, of Captain _____
Company, (*H*) of the *Fourth* Regiment of the United States
Col. Birney was enlisted by _____ of
the _____ Regiment of _____ at *Balto Md*
on the *11th* day of *August*, 186*3*, to serve *3* years; he was born
in *Uniontown* in the State of *Maryland*, is *sixty one*
years of age, *five* feet *three* inches high, *Dark* complexion, *Black* eyes,
Black hair, and by occupation when enlisted a *Gasfitter*. During the last two
months said soldier has been unfit for duty _____ days. * *This soldier is unfit
for duty in U.S.A. He claims that he is sixty
one (61) years of age*

STATION: *Fortress Monroe Va.*
DATE: *Oct. 23rd 1865*

J. H. Grant
Asst Surg. U.S.A.
Commanding ~~Company~~ *Hospital*
Daniel Boyer Private

I CERTIFY, that I have carefully examined the said _____
of Captain _____ Company, and find him incapable of performing the duties of a
soldier because of *Chronic Rheumatism & General
debility resulting from old age.*

J. H. Grant
Assistant Surgeon, U.S.A.
Hicks

DISCHARGED, this *17th* day of *Jan'y*, 186*6*, at *U.S. Gen. Hospital
Fortress Monroe, Va. Balto Md*

Thos. Sim
Asst Surg. U.S.A.
Commanding the ~~Reg't~~ *Hospital*

The Soldier desires to be addressed at
Town *Unionville* County *Frederick* State *Md*

* See Note 1 on the back of this. † See Note 2 on the back of this.

34 Hospital Number 1429 14

Name Samuel Boyer

Age 60 Activity American

Married or Single Married

Residence Unionville, Md.

Post Office address of } Mrs. D. Boyer
 wife or nearest relative. }

Rank Pvt Co. 4 Regiment U.S.

When admitted Nov 3 65

From what source _____

Diagnosis: (*In surgical cases, state explicitly seat and character of wound or injury.*)

Chronic Rheumatism

Hicks G. H.
Baltimore, Md.

On what occasion wounded _____

Date _____

Nature of missile or weapon _____

100
Fowyer, John W.
Co B, 4 U.S. Col'd Inf.

Sergeant. Private
CARD NUMBERS.

1 5552902
2 5552984
3 5553084
4 5553182
5 5553278
6 5553369
7 5553477
8 5553564
9 5553644
10 5553725
11 5553802
12 5553898
13 5553994
14 5554157
15 5554481
16 9061768
17
18
19
20
21
22
23
24
25

26
27
28
29
30
31
32
33
34
35
36
37
38
39
40
41
42
43
44
45
46
47
48
49
50

Book Mark:

See also

73

4

U.S.C.T.

John H. Boyer
 , Co. "B", 4 Reg't U. S. Col'd Inf.

Appears on

Company Descriptive Book

of the organization named above.

DESCRIPTION.

Age 26 years; height 5 feet 6 1/2 inches.

Complexion black

Eyes black; hair black

Where born Baltimore, Md

Occupation druggist

ENLISTMENT.

When July 21, 1863.

Where Baltimore

By whom Col. Birney; term 3 y'rs.

Remarks: Died April 16/65, at
 Wilmington N. C. of
 Chronic diarrhoea.

Ward

B. | 4 | U.S.C.T.

John N. Bowyer

Serjt, Co. B, 4 Reg't U. S. Col'd Infantry.

Age 27 years.

Appears on

Company Muster-in Roll

of the organization named above. Roll dated

Baltimore Md July 21, 1863

Muster-in to date

July 21, 1863

Joined for duty and enrolled:

When July 21st, 1863*

Where Baltimore Md.

Period 3 years.*

Remarks:

* Muster-in roll shows enrollment and muster-in of this company as of same date and place. See enrollment on subsequent card or cards.

Book mark:

John W. Naab

B. | 4 | U.S.C.T.

John W. Bowyer
Sergt., Co. B, 4 Reg't U. S. Col'd Infantry.

Appears on

Company Muster Roll

for *from July 21 to Aug 31*, 186 *3*

Joined for duty and enrolled:

When *July 21*, 186 *3*.*

Where *Baltimore* *

Period *3* years.*

Present or absent *Present*

Stoppage, \$ *100* for _____

Due Gov't \$ *100* for _____

Remarks: *Premium due \$2.00*

* See enrollment on card from muster-in roll.

Book mark: _____

(358c)

Monro Hall

Copyist.

B. | 4 | U.S.C.T.

John W. Boyer,
Sergt., Co. B, 4 Reg't U. S. Col'd Infantry.

Appears on

Company Muster Roll

for Sept & Oct, 1863

Joined for duty and enrolled:

When July 21", 1863*

Where Baltimore *

Period 31 years.*

Present or absent Present

Stoppage, \$ 100 for

Due Gov't \$ 100 for

Remarks:

* See enrollment on card from muster-in roll.

Book mark:

John Hall

(358c)

Copyist.

B.

4

U.S.C.T.

John W. Boyer
Sergt., Co. B, 4 Reg't U. S. Col'd Infantry.

Appears on

Company Muster Roll

for Nov. & Dec., 1863

Joined for duty and enrolled:

When July 21st, 1863*

Where Baltimore *

Period 3 years.*

Present or absent Not stated,

Stoppage, \$ 100 for

Due Gov't \$ 100 for

Remarks:

* See enrollment on card from muster-in roll.

Book mark:

Geo W Hall

B. | 4 | U.S.C.T.

John W. Boyer
Serjt, Co. B, 4 Reg't U. S. Col'd Infantry.

Appears on

Company Muster Roll
for *Jan. + Feb.*, 1864

Joined for duty and enrolled:

When *July 21st*, 1863.*

Where *Baltimore* *

Period *3* years.*

Present or absent *Present*

Stoppage, \$ *100* for _____

Due Gov't \$ *100* for _____

Remarks: *Job stopped, /*
Knapsack 1.85

* See enrollment on card from muster-in roll.

Book mark: _____

John Hall
(358c) Copyist.

B | 4 | U.S.C.T.

John W Bouyer
Serjt, Co. B, 4 Reg't U. S. Col'd Infantry.

Appears on

Company Muster Roll
for March & April, 1864.

Joined for duty and enrolled:

When July 21st, 1863.*

Where Baltimore, Md.*

Period 3 years.*

Present or absent Present

Stoppage, \$ 100 for _____

Due Gov't \$ 100 for _____

Remarks: _____

* ~~See~~ See enrollment on card from muster-in roll.

Book mark: _____

S M Clark
(358c) Copyist.

B | 4 | U.S.C.T.

John W Bowyer
Priv, Co. B, 4 Reg't U. S. Col'd Infantry.

Appears on

Company Muster Roll

for May & June, 1864.

Joined for duty and enrolled:

When July 21st, 1863.*

Where Baltimore Md.*

Period 3 years.*

Present or absent Present

Stoppage, \$ 100 for _____

Due Gov't \$ 100 for _____

Remarks: Reduced to the rank from Sergeant, June 25, 1864.

* See enrollment on card from muster-in roll.

Book mark: _____

(358c)

C M Clark

Copyist.

B | . 4 | **U.S.C.T.**

John W Bouyer
Put, Co. B, 4 Reg't U. S. Col'd Infantry.

Appears on

Company Muster Roll
 for July + Aug., 1864.

Joined for duty and enrolled:

When July 21st, 1863.
 Where Baltimore, Md *
 Period 3 years.*

Present or absent Present.

Stoppage, \$ 100 for _____

Due Gov't \$ 100 for _____

Remarks: Free on or
before April 19, 1861.

* See enrollment on card from muster-in roll.

Book mark: _____

G M Clark

(358c)

Copyist.

B | 4 | U.S.C.T.

John W Boyer
Priv, Co. B, 4 Reg't U. S. Col'd Infantry.

Appears on

Company Muster Roll
for Sept & Oct, 1864.

Joined for duty and enrolled:

When July 21st, 1863.*

Where Baltimore, Md.*

Period 3 years.*

Present or absent + Present

Stoppage, \$ 100 for

Due Gov't \$ 100 for

Remarks: Free on or before
April 19, 1861.

* Name appears in Present column
as "John W Boyer"

* See enrollment on card from muster-in roll.

Book mark:

(358c) B M Clark Copyist.

B

4

U.S.C.T.

John W. Bouyer
Plt, Co. B, 4 Reg't U. S. Col'd Infantry.

Appears on

Company Muster Roll

for *Nov & Dec*, 1864.

Joined for duty and enrolled:

When *July 21st*, 1863.*

Where *Baltimore, Md* *

Period *3* years.*

Present or absent *Present*.

Stoppage, \$ *100* for

Due Gov't \$ *100* for

Remarks: *Free on or before April 19, 1861.*

* See enrollment on card from muster-in roll.

Book mark:

B M Clark

(358c)

Copyist.

B. | 4 | U.S.C.T.

John Bouyer
Pri....., Co. B, 4 Reg't U. S. Col'd Infantry.

Appears on

Company Muster Roll

for *Jan + Feb*....., 186*5*.

Joined for duty and enrolled:

When *July 21*....., 186*3*.*

Where *Baltimore, Md*.....*

Period *3* years.*

Present or absent *absent*

Stoppage, \$ *100* for.....

Due Gov't \$ *100* for.....

Remarks: *Absent sick since*
Feb. 1st 65.

Free on or before Apr. 19, 1861

* See enrollment on card from muster-in roll.

Book mark:

Barlow
 Copyist.

B. | 4 | **U.S.C.T.**

John W. Bouyer
Pri, Co. B, 4 Reg't U. S. Col'd Infantry.

Appears on

Company Muster Roll

for March & April, 1865.

Joined for duty and enrolled:

When July 21, 1863.*

Where Baltimore Md *

Period 3 years.*

Present or absent Absent

Stoppage, \$ 100 for

Due Gov't \$ 100 for

Remarks: Free on or before April 19, '61
Back pay due from enlistment
to May 1, '64. Stop 1 pr. Cost
coat stop¹² Absent sick

* See enrollment on card from muster-in roll.

Book mark:

Barton
 (358c) Copyist.

13.

4

U.S.C.T.

John W. Bouyer

Pri, Co. B, 4 Reg't U. S. Col'd Infantry.

Appears on

Company Muster Roll

for May + June, 1865.

Joined for duty and enrolled:

When July 21, 1863.*

Where Baltimore Md. *

Period 3 years.*

Present or absent absent

Stoppage, \$ 100 for

Due Gov't \$ 100 for

Remarks: Def. of pay due from
date of enlistment to May 1
'64 Stop 1 pr. get coat straps
absent sick. Free on or before
Apr. 19/61.

* See enrollment on card from muster-in roll.

Book mark:

Barton

B.

4

U.S.C.T.

John W. Bouyer

Pri, Co. B, 4 Reg't U. S. Col'd Infantry.

Appears on

Company Muster Roll

for *July + Aug*, 1865.

Joined for duty and enrolled:

When *July 21*, 1863.*

Where *Baltimore* *

Period *3* years.*

Present or absent _____

Stoppage, \$ *100* for _____

Due Gov't \$ *100* for _____

Remarks: *Died at Wilmington N.C. Apr. 16, 1865. from chronic diarrhoea final statements + inventory of effects for July 7/65*

* See enrollment on card from muster-in roll.

Book mark: _____

(858c)

Barton

Copyist.

B | 4 | U.S.C.T.

John W. Sawyer
 Co. B, 4 Reg't U. S. Col'd Infantry.

Appears on **Co. Muster-out Roll**, dated
Washington, D.C., May 4, 1866.

Muster-out to date _____, 186 .
 Last paid to _____, 186 .

Clothing account:

Last settled _____, 186 ; drawn since \$ _____ 100
 Due soldier \$ _____ 100; due U. S. \$ _____ 100
 Am't for cloth'g in kind or money adv'd \$ _____ 100

Due U. S. for arms, equipments, &c., \$ _____ 100

Bounty paid \$ _____ 100; due \$ _____ 100

Remarks: *Free on on before April 19/61.
 Died April 16/65, of disease at
 Wilmington, N. C. was furloughed
 from enrollment to July 23/63.
 then sergt. to June 20/64.*

Book mark: *P. V. H. P. 234, 68.*

(361)

Tabler
 Copyist.

Bowyer, John W.

P, Co. B, 4 U.S.C. Inf.

1 Enclosures.

Bed Cards	Descriptive Lists
Burial Records	Final Statements /
Certs. of Dis. for Discharge	Furloughs
C. M. Charges	Med. Des. Lists
Med. Certificates	Orders

Other papers relating to—

Admission to Hosp'l	Furlough
Casualty Sheet (Officer's)	Med. Examination
Confinement	Misc. Information
Contracts	Pay or Clothing
Death or Effects	Personal Reports
Desertions	Rank
Discharge from Hosp'l	Transfer to Hosp'l
Discharge from Service	Transfer to V. R. C.
Duty	Transportation

Extract from Act of Congress.

SEC. 12. *And be it further enacted,* That the fees of agents and attorneys for making out and causing to be executed the papers necessary to establish a claim for a pension, bounty, and other allowance before the Pension Office, under this act, shall not exceed the following rates: For making out and causing to be duly executed a declaration by the applicant, with the necessary affidavits, and forwarding the same to the Pension Office, with the requisite correspondence, ten dollars: which sum shall be received by such agent or attorney in full for all services in obtaining such pension, and shall not be demanded or received, in whole or in part, until such pension shall be obtained; and the sixth and seventh sections of an act entitled "An act to grant pensions," approved July [fourteenth,] eighteen hundred and sixty-two, are hereby repealed.

SEC. 13. *And be it further enacted,* That any agent or attorney who shall, directly or indirectly, demand or receive any greater compensation for his services under this act than is prescribed in the preceding section of this act, or who shall contract or agree to prosecute any claim for a pension, bounty, or other allowance under this act, on the condition that he shall receive a per centum upon any portion of the amount of such claim, or who shall wrongfully withhold from a pensioner or other claimant the whole or any part of the pension or claim allowed and due to such pensioner or claimant, shall be deemed guilty of a high misdemeanor, and, upon conviction thereof, shall, for every such offense, be fined not exceeding three hundred dollars, or imprisoned at hard labor not exceeding two years, or both, according to the circumstances and aggravations of the offense.

Approved July 4, 1864.

NOTE. 10.—If any soldier is charged a higher fee than that allowed by the above act, he should report the fact and the name of the agent to the Adjutant General, in order that steps may be taken to have the same refunded.

ADJUTANT GENERAL'S OFFICE.
July 11. 1865
 Duplicate with Inventory sent 2d Auditor.

FINAL STATEMENT. 5

OF

Private John W. Sawyer
4th Regt of U.S. Colored Infantry
 VOLUNTEERS.
1st Div. 16th Corps

NOTE 1.—Two of these certificates (or duplicates) are to be given to each Volunteer Soldier or drafted man who may be discharged without being mustered out (Final Statements are never given to men mustered out of service,) that he may at once receive from the Paymaster the pay, &c., due to him, and the captain or other commissioned officer commanding the company will certify to the act of the delivery of the duplicate certificates; with these certificates the Soldier is "entitled to" his discharge, and should also present his discharge to the Paymaster to have the payment endorsed on it. The discharge is to be given back to the Soldier by the Paymaster; the latter only retaining as his vouchers the duplicate certificates.

NOTE 2.—If the Soldier is entitled to pay for the use of his horse, the Company Commander will certify to that fact on the back of both these final statements, and also to the time he has pay due for having been so mounted on his own horse.

NOTE 3.—When a Soldier is furnished with final statements, his descriptive list, if he has one, should be taken up by the officer who gives the Soldier these statements, and endorsed with a statement to this effect by the officer. The endorsement should exhibit a full statement of the time for which the Soldier was allowed pay on his final statements, the clothing account, and all other charges against him or in his favor, so as to comprise a complete exhibit of his account. It will then be transmitted to the Company Commander of the Soldier, who will enter all the data necessary to a full understanding of the Soldier's account on the muster roll upon which the Soldier's discharge is reported. The descriptive list will then be destroyed. The object of this is, that the remaining portion of the Soldier's account may be settled upon the receipt of these muster rolls, and the Soldier receive any pay or allowances that may be due him at the time of his discharge, and which may not appear on his last final statements from the fact that his descriptive list is incomplete. These accounts for back pay, &c., are settled by the 2d Auditor of the Treasury Department.

NOTE 4.—Charges for loss or injury to ordnance, horse equipments, and other miscellaneous charges, should appear under the heading of "Other Stoppages."

NOTE 5.—Bounty paid by State authorities, and not by the United States, will not be entered on this statement.

NOTE 6.—Amounts due the Sutler and Laundress must be entered on the muster roll on which the discharge, death, desertion, &c., is reported, as well as on the final statement, otherwise the amount cannot be collected from the United States.

NOTE 7.—This blank will be used for deceased volunteers and drafted men, as well as for others.

NOTE 8.—Where a Soldier dies in Hospital or on detached service, his descriptive list, if he has one, should be sent with his final statements, in duplicate, to the Adjutant General, Washington, D. C.

NOTE 9.—If the soldier is a drafted man or substitute, the space for time, &c., of enrolled, should contain only the word *drafted* or *substitute*, as the case may be. If the Soldier is a "VETERAN," (or RECRUIT,) the words *as a veteran*, (or *recruit*,) as the case may be, should be interlined after the words *mustered into the service of the U. S.* A statement of all the installments of *Veteran or Recruit Bounty RECEIVED* by the Soldier must be made on the back of each final statement.

(C. H. R. of C.)

I certify, on honor, that John W. Bomber, a Private of
 Captain McNeill Company (13) of the 4th Regiment of U.S. Colored Infantry
Volunteers, of the State of Maryland, born in Baltimore State
 of Maryland, aged 26 years; 5 feet 6 1/2 inches high; Black complexion,
Black eyes, Black hair, and by occupation a Druggist, who joined for service
 and was enrolled (see Note 9) on the 21st day of July, 1869, at Baltimore Md
 by Colonel Wm Barry, for the period of Three years, and mustered into
 the service of the United States on the 21st day of July, 1869, at
Baltimore Md, by Colonel Wm Barry; and having served

HONESTLY and **FAITHFULLY** with his Company to the present date, is now entitled to a
DISCHARGE by reason of Death having died at the U.S. General Hospital
for Colored Troops Baltimore Md on the 16th day of April 1862 of
Chronic Diarrhoea

The said Private John W. Bomber was last paid by Paymaster
Major Barry, to include the 31st day of July, 1869, and
 has pay due him from that time to the present date; he is entitled to pay and subsistence for
TRAVELING to place of enrollment, and whatever other allowances are authorized to volunteer
 soldiers, drafted men, or militia, so discharged. He has received from the United States **CLOTHING**
 amounting to 9 42 dollars, since the 30th day of June,
 1864, when his clothing account was last settled. He has received from the United States
No dollars advanced **BOUNTY**.

There is to be stopped from him, on account of the State of _____, or other
 authorities, for **CLOTHING**, &c., received on entering service, _____ dollars; and
 for other stoppages, viz: 1 Pr. Col. Coat Strap 13^{ts}
This Soldier was Free on or before April 14th 1861. Difference of pay due from
delt. of Enrollment to May 1st 1861 as Long _____ dollars.
 He has been furnished with **TRANSPORTATION** in kind from the place of his discharge to
 _____; and he has been **Subsisted** for **Traveling** to his
 place of enrollment, up to the _____, 186 .

He is indebted to McCooper, **Sutler**, 4 60 dollars.
 He is indebted to _____ **Laundress**, _____ dollars.

Given in Duplicate, at New Bern N.C., this 7th day
 of July, 1869.

Wareham C. Hill
Officer to B⁴ U.S. I
 Commanding Company.

139

Bradford Caesar N

Co C, 4 U.S. Col'd Inf.

Private

Private

CARD NUMBERS.

1	5554525	26
2	5554611	27
3	5554712	28
4	5554814	29
5	5554907	30
6	5554998	31
7	5555087	32
8	5555170	33
9	5555244	34
10	5555315	35
11	5555412	36
12	5555500	37
13	5555600	38
14	5555704	39
15	5555791	40
16	5555872	41
17	5555937	42
18	5555995	43
19	9061887	44
20		45
21		46
22		47
23		48
24		49
25		50

Book Mark: 532 109. 75

See also

A 2261321 Po. Rek

B | 4 | U.S.C.T.

Caesar H. Bradford

Co. "E", 4 Reg't U. S. Col'd Inf.

Appears on

Company Descriptive Book

of the organization named above.

DESCRIPTION.

Age 18 years; height 5 feet 7 inches.

Complexion black

Eyes black; hair curly

Where born Hamsville, Md.

Occupation farmer

ENLISTMENT.

When July 15, 1863.

Where Balt. Md.

By whom Col. Wm. Biney; term 3 y'rs.

Remarks:

[Empty lines for remarks]

[Signature]

D

4

U.S.C.T.

Cesar H. Bradford

Priv, Co. C, 4 Reg't U. S. Col'd Infantry.

Age *18* years.

Appears on

Company Muster-in Roll

of the organization named above. Roll dated

Baltimore Md July 24, 186*3*.

Muster-in to date

July 24, 186*3*.

Joined for duty and enrolled:

When *July 15*, 186 .

Where *Baltimore Md*

Period *3* years.

Remarks :

Book mark :

Talworth

(356)

Copyist.

D

4

U.S.C.T.

Caesar H. Bradford

Priv, Co. C. 4 Reg't U. S. Col'd Infantry.

Appears on

Company Muster Roll

for *July 17 To Aug 31*, 186*3*.

Present or absent *Present*

Stoppage, \$ _____ *100* for _____

Due Gov't, \$ _____ *100* for _____

Remarks: *Two dollars pre-
mium due,*

Book mark: _____

Talbrioth

(358)

Copyist.

D

4

U.S.C.T.

Caesar H. Bradford

Priv, Co. C. 4 Reg't U. S. Col'd Infantry.

Appears on

Company Muster Roll

for *Sept & Oct*, 186*3*

Present or absent

Present

Stoppage, \$ *100* for

Due Gov't, \$ *100* for

Remarks:

Book mark:

Dalburt

(358)

Copyist.

P

4

U.S.C.T.

Caesar H. Bradford

Priv, Co. C. 4 Reg't U. S. Col'd Infantry.

Appears on

Company Muster Roll

for *Nov & Dec*, 186*3*

Present or absent *Present*

Stoppage, \$ *100* for

Due Gov't, \$ *100* for

Remarks:

Book mark:

Talburt

(358)

Copyist.

D

4

U.S.C.T.

Caesar H. Bradford

Priv, Co. C. 4 Reg't U. S. Col'd Infantry.

Appears on

Company Muster Roll

for *Jany & Feb*, 1864.

Present or absent *Present*

Stoppage, \$ 100 for

Due Gov't, \$ 100 for

Remarks: *Stoppage for lack of ordnance for 22.*

Book mark:

Talbot
Copyist.

(858)

B

4

U.S.C.T.

Ceasar H. Bradford

Pvt, Co. C. 4 Reg't U. S. Col'd Infantry.

Appears on

Company Muster Roll

for March & April, 1864.

Present or absent Present

Stoppage, \$ 100 for

Due Gov't, \$ 100 for

Remarks:

Book mark:

J. W. Davis

B

4

U.S.C.T.

Caesar H. Bradford
Pot, Co. C. 4 Reg't U. S. Col'd Infantry.

Appears on

Company Muster Roll

for May & June, 1864.

Present or absent Present

Stoppage, \$ 100 for

Due Gov't, \$ 100 for

Remarks:

Book mark:

J. W. Davis

B

4

U.S.C.T.

Caesar H. Bradford

Plt, Co. C. 4 Reg't U. S. Col'd Infantry.

Appears on

Company Muster Roll

for July & Aug, 1864

Present or absent Present

Stoppage, \$ 100 for

Due Gov't, \$ 100 for

Remarks: Free on or before Apl. 19. 1861. Extra duty on Pausal at Dutch Gap.

Book mark:

J. W. Davis

B

4

U.S.C.T.

Caesar H. Bradford

Pvt, Co. C. 4 Reg't U.S. Col'd Infantry.

Appears on

Company Muster Roll

for Sept & Oct, 1864.

Present or absent Present

Stoppage, \$ 100 for

Due Gov't, \$ 100 for

Remarks: Free on or before April 19/61

Book mark: 183 183

J. W. Davis

(858)

Copyist.

B

4

U.S.C.T.

Caesar H. Bradford

Pvt

, Co. C. 4 Reg't U. S. Col'd Infantry.

Appears on

Company Muster Roll

for Nov & Dec, 1864

Present or absent Present

Stoppage, \$ 100 for

Due Gov't, \$ 100 for

Remarks: Free on or before
April 19/61

Book mark:

J. W. Davis

(858)

Copyist.

B | 4 | **U.S.C.T.**

Caesar H. Bradford
Pvt, Co. C. 4 Reg't U. S. Col'd Infantry.

Appears on

Company Muster Roll

for Jan'y & Feby, 1865.

Present or absent Present

Stoppage, \$ 100 for

Due Gov't, \$ 100 for

Remarks: Free on or before
April 19-61. Stop
wrench 23/100
wiper 20/100.

Book mark: _____

(858)

Permittor Copyist.

B

4

U.S.C.T.

Caesar H. Bradford

Corpl, Co. C. 4 Reg't U. S. Col'd Infantry.

Appears on

Company Muster Roll

for *March & April*, 1865.

Present or absent *Present*

Stoppage, \$ *100* for

Due Gov't, \$ *100* for

Remarks: *Promoted to*
Corpl. April 9/65. Back
pay due from enlist-
ment to May 1/64.
Fracture or before April
19' 61. Stop wrench & wiper
4 3/100 -

Book mark:

Pennington

(358)

Copyist.

B

4

U.S.C.T.

Caesar H. Bradford

Corpl, Co. C. 4 Reg't U. S. Col'd Infantry.

Appears on

Company Muster Roll

for May & June, 1865.

Present or absent Present

Stoppage, \$ 100 for

Due Gov't, \$ 100 for

Remarks: Promoted to
Corpl, April 9, '65.
Stop for wrench &
wiper 43/100-

Book mark:

Pennington

(358)

Copyist.

B

4

U.S.C.T.

Caesar H. Bradford
Corpl, Co. C. 4 Reg't U. S. Col'd Infantry.

Appears on

Company Muster Roll

for July & Aug, 1865.

Present or absent Present-

Stoppage, \$ 100 for

Due Gov't, \$ 100 for

Remarks: Stop for trans-
portation while on
furlough \$13.25.
Pay due for commutation of
rations while on furlough
from July 31" to August 29,"
1865.

Book mark:

Perrington

(358)

Copyist.

B

4

U.S.C.T.

Caesar H. Bradford

Corpl, Co. C. 4 Reg't U. S. Col'd Infantry.

Appears on

Company Muster Roll

for Sept & Oct, 1865.

Present or absent Present

Stoppage, \$ 100 for

Due Gov't, \$ 100 for

Remarks: Stop for Trans-
portation while on
furlough \$ 13.75.
Free on or before
April 19/61. Back pay
due from enlistment
to May 1/64.

Book mark:

Permyington
Copyist.

(358)

B.

4

U.S.C.T.

Caesar H Bradford
Capt, Co. C. 4 Reg't U. S. Col'd Infantry.

Appears on

Company Muster Roll

for *Nov and Dec*, 1865.

Present or absent *Present*

Stoppage, \$ *100* for

Due Gov't, \$ *100* for

Remarks:

Book mark:

(858)

R. J. Luom
Copyist.

B

4

U.S.C.T.

Caesar H Bradford

Put, Co. C. 4 Reg't U. S. Col'd Infantry.

Appears on

Company Muster Roll

for Jan'y & Feby, 1866.

Present or absent Present

Stoppage, \$ 100 for

Due Gov't, \$ 100 for

Remarks: Reduced from Corp's Feby 6, 66.

NEXT ROLL ON FILE MUSTER OUT.

Book mark:

R Johnson

(358)

Copyist.

B | 4 | U.S.C.T.

Caesar H. Bradford
 Pvt., Co. C, 4 Reg't U. S. Col'd Infantry.

Appears on Co. Muster-out Roll, dated
Washington, DC, May 4, 1866.

Muster-out to date *May 4, 1866.*

Last paid to *July 28, 1866.*

Clothing account:

Last settled....., 186 ; drawn since \$.....100

Due soldier \$ *33 89*/100; due U. S. \$.....100

Am't for cloth'g in kind or money adv'd \$.....100

Due U. S. for arms, equipments, &c., \$ *6 00*/100

Bounty paid \$.....100; due \$ *100 00*/100

Remarks: *Was Priv from enrollment to April 19/65. Corporal to Feb'y 6/66. Free on April 19/66.*

Book mark: *532 - C.T. 75*

(861)

R. Johnson
 Copyist.

Bradford. Isaac A.

Co. ; 4 U.S. Col'd Inf.

Private

Private

CARD NUMBERS.

5554526	26
5554612	27
5554711	28
5554815	29
5554908	30
5555000	31
5555088	32
5555172	33
5555240	34
5555316	35
5555411	36
5555505	37
5555603	38
5555708	39
5555796	40
5555876	41
5555936	42
5555994	43
7061888	44
	45
	46
	47
	48
	49
	50

Mark:

also

S. 052846 - P. 6. 1901

B

4

U.S.C.T.

Isaac A. Bradford

Co. "B", 4 Reg't U. S. Col'd Inf.

Appears on

Company Descriptive Book

of the organization named above.

DESCRIPTION.

Age 25 years; height 5 feet 8 inches.

Complexion black

Eyes black; hair curly

Where born Cecil, Md.

Occupation farmer

ENLISTMENT.

When July 20, 1863.

Where Baltol., Md.

By whom Col. Wm. Binney; term 3 y'rs.

Remarks:

[Empty lines for remarks]

[Signature]

D

4

U.S.C.T.

Isaac A. Bradford
Priv, Co. C, 4 Reg't U. S. Col'd Infantry.

Age *35* years.

Appears on

Company Muster-in Roll

of the organization named above. Roll dated

Baltimore Md July 24 186*3*.

Muster-in to date

July 24, 186*3*.

Joined for duty and enrolled:

When *July 20*, 186

Where *Baltimore Md*

Period *3* years.

Remarks:

Book mark:

Talbot
Copyist.

D

4

U.S.C.T.

Isaac A. Bradford

Priv, Co. C. 4 Reg't U. S. Col'd Infantry.

Appears on

Company Muster Roll

for *July 17 to Aug 31*, 186*3*.

Present or absent *Present*

Stoppage, \$ *100* for

Due Gov't, \$ *100* for

Remarks: *Two dollars pre-
sumed due,*

Book mark: _____

(358)

Talbot
Copyist.

D

4

U.S.C.T.

Isaac A. Bradford

Priv, Co. C. 4 Reg't U. S. Col'd Infantry.

Appears on

Company Muster Roll

for *Sept & Oct*, 186*3*

Present or absent *Present*

Stoppage, \$ *100* for

Due Gov't, \$ *100* for

Remarks:

Book mark:

Palvurtz
Copyist.

(358)

D

4

U.S.C.T.

Isaac W. Bradford
Priv., Co. C. 4 Reg't U. S. Col'd Infantry.

Appears on

Company Muster Roll

for *Jany & Feby*, 1864

Present or absent *Present*

Stoppage, \$ 100 for

Due Gov't, \$ 100 for

Remarks:

Book mark:

Talbot
Copyist.

(358)

B

4

U.S.C.T.

Isaac A. Bradford

Co. C. 4 Reg't U. S. Col'd Infantry.

Appears on

Company Muster Roll

for *March & Apr*, 1864.

Present or absent *Present*

Stoppage, \$ *100* for

Due Gov't, \$ *100* for

Remarks:

Book mark:

J. Davis

B

4

U.S.C.T.

Isaac A. Bradford
Pvt, Co. C. 4 Reg't U. S. Col'd Infantry.

Appears on

Company Muster Roll

for May & June, 1864.

Present or absent Absent

Stoppage, \$ 100 for

Due Gov't, \$ 100 for

Remarks: Absent sick,
wounded near Petersburg
Va. June 15th 1864

Book mark:

J. W. Davis

(358)

Copyist.

B

4

U.S.C.T.

Isaac A. Bradford

Pvt., Co. C. 4 Reg't U. S. Col'd Infantry.

Appears on

Company Muster Roll

for July & Aug, 1864.

Present or absent Absent

Stoppage, \$ 100 for

Due Gov't, \$ 100 for

Remarks: Status not ascertained
Absent wounded since
June 15. 1864.

Book mark:

JW Davis

B

4

U.S.C.T.

Isaac A. Bradford

Capt., Co. C. 4 Reg't U. S. Col'd Infantry.

Appears on

Company Muster Roll

for Sept & Oct, 1864

Present or absent Absent

Stoppage, \$ 100 for

Due Gov't, \$ 100 for

Remarks: Absent wounded
Paid in Hosp. by Maj
Walker for May & June
\$32.00. Due Regt Duties \$20.00

Book mark:

J. W. Davis

B

4

U.S.C.T.

Isaac Bradford

Post, Co. C. 4 Reg't U. S. Col'd Infantry.

Appears on

Company Muster Roll

for Nov & Dec, 1864

Present or absent Absent

Stoppage, \$ 100 for

Due Gov't, \$ 100 for

Remarks: Paid in Hosp by maj Walker for May & June \$32.00 Due Sutter \$2.00. Ab. wounded

Book mark:

J. W. Davis

(858)

Copyist.

B

4

U.S.C.T.

Isaac Bradford

Pvt, Co. C. 4 Reg't U. S. Col'd Infantry.

Appears on

Company Muster Roll

for Jany & Feby, 1865-

Present or absent Absent

Stoppage, \$ 100 for

Due Gov't, \$ 100 for

Remarks: Paid in Hospit. by Maj. Walker for May & June \$ 32.00. Absent sick - Due H.C. Cooper, Quarter 4" U.S.C.T. \$ 2.00.

Book mark:

Permyngton

(358)

Copyist.

B | 4 | U.S.C.T.

Isaac Bradford
Pvt, Co. C. 4 Reg't U. S. Col'd Infantry.

Appears on

Company Muster Roll

for March & April, 1865.

Present or absent Present

Stoppage, \$ 100 for

Due Gov't, \$ 100 for

Remarks: Paid in Hospital
by Maj Walker for
May and June \$2.00
Due cutter \$ 2.00-

Book mark: _____

(358)

Permittor
Copyist.

B

4

U.S.C.T.

Isaac Bradford

Pvt, Co. C. 4 Reg't U. S. Col'd Infantry.

Appears on

Company Muster Roll

for May & June, 1865.

Present or absent Present

Stoppage, \$ 100 for

Due Gov't, \$ 100 for

Remarks: Paid in Hospt. by Maj. Walker for May & June 64 (32.00)

Book mark:

Perriington Copyist.

B

4

U.S.C.T.

Isaac Bradford

Priv, Co. C. 4 Reg't U. S. Col'd Infantry.

Appears on

Company Muster Roll

for July & Aug, 1865

Present or absent Absent

Stoppage, \$ 100 for

Due Gov't, \$ 100 for

Remarks: On detached duty

Book mark:

Perrington

(358)

Copyist.

B

4

U.S.C.T.

Isaac Bradford

Priv., Co. C. 4 Reg't U. S. Col'd Infantry.

Appears on

Company Muster Roll

for Sept - 7 Oct, 1865

Present or absent Present

Stoppage, \$ 100 for

Due Gov't, \$ 100 for

Remarks: Free on or before April 19/61 - Back pay due from May 1/64 to date of enlistment.

Book mark:

Permitt
Copyist.

B.

4

U.S.C.T.

Isaac Bradford

Priv, Co. C. 4 Reg't U.S. Col'd Infantry.

Appears on

Company Muster Roll

for *Nov and Dec.*, 1865.

Present or absent *Present.*

Stoppage, \$ *100* for

Due Gov't, \$ *100* for

Remarks:

Book mark:

R. Johnson

B. | 4 | **U.S.C.T.**

Isaac Bradford
Priv., Co. C. 4 Reg't U. S. Col'd Infantry.

Appears on

Company Muster Roll

for Jan'y & Feby., 186 6.

Present or absent Present

Stoppage, \$ 100 for

Due Gov't, \$ 100 for

Remarks:

NEXT ROLL ON FILE MUSTER OUT.

Book mark:

(358)

R. Johnson
Copyist.

B | 4 | U.S.C.T.

Isaac A. Bradford
Pvt, Co. C, 4 Reg't U. S. Col'd Infantry.

Appears on **Co. Muster-out Roll**, dated
Washington D.C., May 4, 1866.

Muster-out to date May 4, 1866.

Last paid to July 28, 1866.

Clothing account:

Last settled....., 186 ; drawn since \$.....100

Due soldier \$.....100; due U. S. \$.....842100

Am't for cloth'g in kind or money adv'd \$.....100

Due U. S. for arms, equipments, &c., \$ 6⁰⁰/₁₀₀

Bounty paid \$.....100; due \$ 100⁰⁰/₁₀₀

Remarks: Free on April
19, 61

Book mark :

(361)

R. Johnson
Copyist.

141

Bradley James M.

COC. G. 4 U.S. Col'd Inf.

1st Lieutenant 1st Lieutenant
 CARD NUMBERS.

1	5 5 5 0 2 4 4	26
2	5 5 5 4 7 9 6	27
3	5 5 5 4 8 9 1	28
4	5 5 5 4 9 8 3	29
5	5 5 5 5 0 7 3	30
6	5 5 5 0 6 3 2	31
7	5 5 5 5 1 5 3	32
8	5 5 5 5 2 2 7	33
9	5 5 5 5 2 9 8	34
10	5 5 5 5 3 9 3	35
11	5 5 5 6 0 3 2	36
12	5 5 6 1 9 3 9	37
13	5 5 6 2 0 2 6	38
14	5 5 6 2 1 2 6	39
15	5 5 6 2 2 2 4	40
16	5 5 6 2 3 2 4	41
17	5 5 6 2 4 0 9	42
18	5 5 6 2 4 8 5	43
19	5 5 6 2 5 5 8	44
20	9 4 2 8 5 4 1	45
21	B 334 - C.T. - 1863	46
22	4 3 2 2 5 3 7 7	47
23	4 3 2 2 3 3 9 5	48
24		49
25		50

Book Mark: B 334 - C.T. - 1863

See also 2 Com Hq 273

NARA 1022

D. 3214573 POKET.

B | 4[#] | U.S.C.T.

James M Bradley
 1[#] Lt Co., 4[#] Reg't U. S. Col'd Inf.

Appears on

Regimental Descriptive Book

(List of Commissioned Officers)

of the regiment named above.

Rank 1[#] Lt

Date of appointment Oct 30th 1863.

Remarks: Reported for duty
 Nov 19th '63 and assigned
 to company "C" by Par 2.
 SO. 53 4[#] U.S.C.T. Nov 19. 63.
 Was chief Ambulance Officer
 of the 3rd Div 18th A.C. 3rd Div -
 25th A.C. of both expeditions
 against Ft Fisher N.C. of the
 10th A.C. and Dept of N.C.
 Transferred to company G. by
 SO. 1. 4[#] U.S.C.T. Jan - 18. 65.
 Rejoined the Regt for duty Nov
 18. 65 Promoted Captain & Major
 U.S. Vol for distinguished Gallantry
 to date Mar 25. 1865

M. J. [Signature]

B | 4 | U.S.C.T.

James M. Bradley
 2nd Lt, Co., 4 Reg't U. S. Col'd Infantry.

Age 25 years.

Appears on an

Individual Muster-in Roll

of the organization named above. Roll dated
 Yorktown, Va., Nov. 24, 1863.

Muster-in to date Nov. 19, 1863.

Joined for duty and enrolled:

When Nov. 19, 1863.

Where Yorktown, Va.

Period 2 years.

Remarks: By authority dated
 War Dept's Sept 28/63

Book mark:

(336)

Lowry

Copist.

D

4

U.S.C.T.

James M. Bradley
1st Lt, Co. C. 4 Reg't U. S. Col'd Infantry.

Appears on

Company Muster Roll

for *Nov & Dec*, 186*3*

Present or absent *Present*

Stoppage, \$ *100* for

Due Gov't, \$ *100* for

Remarks:

Book mark:

Talbot
Copyist.

D

4

U.S.C.T.

James M. Bradley
1st Lt, Co. C. 4 Reg't U. S. Col'd Infantry.

Appears on

Company Muster Roll

for *Jany & Feb*, 1864.

Present or absent *Present*

Stoppage, \$ *100* for

Due Gov't, \$ *100* for

Remarks: *Pay due from Nov*
19. To Nov 24. 1863,

Book mark:

Galveston

(858)

Copyist

B

4

U.S.C.T.

James M. Bradley
1st Lt, Co. C. 4 Reg't U. S. Col'd Infantry.

Appears on

Company Muster Roll

for *March & Apr*, 1864.

Present or absent *Present*

Stoppage, \$ *100* for

Due Gov't, \$ *100* for

Remarks:

Book mark: *20-2005*

(858)

J. Davis

Copyist.

B

4

U.S.C.T.

James M. Bradley

1st St., Co. C. 4 Reg't U. S. Col'd Infantry.

Appears on

Company Muster Roll

for May & June, 1864

Present or absent Absent

Stoppage, \$ 100 for

Due Gov't, \$ 100 for

Remarks: Detached as Aid-de-Camp to Gen Hinks, pursuant to Special order No.

Book mark:

J. W. Davis

B

4

U.S.C.T.

James M Bradley
1st, Co. C, 4 Reg't U. S. Col'd Infantry.

Appears on a

Detachment Muster Roll

of the organization named above

for May & June, 1864.

Station in the Field Va (near Petersburg)

Present or absent Present

Stoppage, \$ 100 for

Due Gov't, \$ 100 for

Remarks: Detailed for A. C.
No. 122 1st. Ins. Dept.
Va & N. C. Fort Monroe
Va. May 2/64.

Book mark:

Vaus... ..

B

4

U.S.C.T.

James M. Bradley
1st Lt, Co. C. 4 Reg't U. S. Col'd Infantry.

Appears on

Company Muster Roll

for July & Aug, 1864.

Present or absent Absent

Stoppage, \$ 100 for

Due Gov't, \$ 100 for

Remarks: Detached service in
Ambulance Corps (Div)

Book mark:

J. Davis

B

4

U.S.C.T.

James M. Bradley
1st Lieut., Co. C. 4 Reg't U. S. Col'd Infantry.

Appears on

Company Muster Roll

for Sept & Oct, 1864

Present or absent Absent

Stoppage, \$ 100 for

Due Gov't, \$ 100 for

Remarks: Detached Service
Division Ambulance Corps

Book mark:

J. W. Davis

B

4

U.S.C.T.

James M. Bradley

1st Lieut., Co. C. 4 Reg't U. S. Col'd Infantry.

Appears on

Company Muster Roll

for *Nov & Dec*, 1864.

Present or absent *Absent*

Stoppage, \$ *100* for

Due Gov't, \$ *100* for

Remarks: *Detached Service
Div. Ambulance Corps*

Book mark: _____

(358)

J. W. Davis

Copyist.

B

4

U.S.C.T.

James M. Bradley

1st Lieut, Co. C. 4 Reg't U. S. Col'd Infantry.

Appears on

Company Muster Roll

for *Jany & Feby*, 1865.

Present or absent

Stoppage, \$ 100 for

Due Gov't, \$ 100 for

Remarks: *Transferred to Co. "G" by special order No (1) dated Jany 1st 1865.*

Book mark:

(858)

Permitt
Copyist.

B

4

U.S.C.T.

J. M. Bradley

1 Lt, Co. G, 4 Reg't U. S. Col'd Infantry.

Appears on

Company Muster Roll

for *Dated Feb 28*, 1865.

Joined for duty and enrolled:

When _____, 186 .*

Where _____ *

Period _____ years.*

Present or absent *Absent*

Stoppage, \$ 100 for _____

Due Gov't \$ 100 for _____

Remarks: *Appointed by the President Oct 30/63*
Assigned to Co "G" by S. O. Ho
1 Hd Qrs 4 U. S. C. T. Detached
with Amb Corps at Div Hd
Qrs

* ~~See~~ See enrollment on card from muster-in roll.

Book mark: _____

Ackerman

43

4

U.S.C.T.

J. M. Bradley

Lt., Co. G, 4 Reg't U. S. Col'd Infantry.

Appears on

Company Muster Roll

for *Mar + Apr*, 1865.

Joined for duty and enrolled:

When _____, 186 .*

Where _____ *

Period _____ years.*

Present or absent *Absent*

Stoppage, \$ _____ 100 for _____

Due Gov't \$ _____ 100 for _____

Remarks: *Appointed by the President Oct 30/63.*

Detached with Amb Corps

* See enrollment on card from muster-in roll.

Book mark: _____

A. Kerman

B

4

U.S.C.T.

J. M. Bradley

1 Lt., Co. G, 4 Reg't U. S. Col'd Infantry.

Appears on

Company Muster Roll

for May + June, 1865.

Joined for duty and enrolled:

When, 186 .*

Where *

Period years.*

Present or absent Absent

Stoppage, \$ 100 for

Due Gov't \$ 100 for

Remarks: Appointed by the President Oct 30/63, Detached with Ambulance Corps.

* See enrollment on card from muster-in roll.

Book mark:

A. Kerman

(358c)

Copyist.

B

4

U.S.C.T.

J. M. Bradley
i. G., Co. G, 4 Reg't U. S. Col'd Infantry.

Appears on

Company Muster Roll

for July & Aug, 1865.

Joined for duty and enrolled:

When, 186 .*

Where *

Period years.*

Present or absent absent

Stoppage, \$ 100 for

Due Gov't \$ 100 for

Remarks: Appointed by the
President Oct 30 1863,
Detached with Ambulance
Corps.

* See enrollment on card from muster-in roll.

Book mark:

A. Kerman

B

4

U.S.C.T.

J. M. Bradley

1st Lt., Co. G, 4 Reg't U. S. Col'd Infantry.

Appears on

Company Muster Roll

for *Sept + Oct*, 1865.

Joined for duty and enrolled:

When....., 186 .*

Where*

Period years.*

Present or absent *Absent*

Stoppage, \$ *100* for.....

Due Gov't \$ *100* for.....

Remarks: *Appointed by the President Oct 30/63, Detached with Ambulance Corps,*

* See enrollment on card from muster-in roll.

Book mark:

A. Kernan

(358c)

Copyist.

B | 4 | U.S.C.T.

J. M. Bradley
1st, Co. G, 4 Reg't U. S. Col'd Infantry.

Appears on

Company Muster Roll

for Nov & Dec, 1865.

Joined for duty and enrolled:

When _____, 1865 .*

Where _____ *

Period 3 years.*

Present or absent Present

Stoppage, \$ 100 for _____

Due Gov't \$ 100 for _____

Remarks: Appointed by the
President Oct 30/63
Mustered into the service
for 3 yrs Nov 19/63.
Appointed Brevet Major
Mar 13/65

* See enrollment on card from muster-in roll.

Book mark: _____

T. Johnson
(358c) Copyist.

B

4

U.S.C.T.

James M Bradley

Co. G, 4 Reg't U. S. Col'd Infantry.

But. Maj.
Appears on

Company Muster Roll

for Jan & Feb, 1866.

Joined for duty and enrolled:

When Oct 3, 1863.*

Where Yorktown Va.*

Period 3 years.*

Present or absent Absent

Stoppage, \$ 100 for

Due Gov't \$ 100 for

Remarks: Absent under orders
at Raleigh N.C.

NEXT ROLL WILL MUSTER OUT.

* See enrollment on card from muster-in roll.

Book mark:

T. Johnson

(358c)

Copyist.

B | **4** | **U.S.C.T.**

James M Bradley
St. G., 4 Reg't U. S. Col'd Infantry.

Appears on **Co. Muster-out Roll**, dated
Washington DC, May 4, 1866
 Muster-out to date *May 4, 1866*
 Last paid to *Feb 28, 1866*.

Clothing account:

Last settled....., 186 ; drawn since \$.....100
 Due soldier \$.....100; due U. S. \$.....100
 Am't for cloth'g in kind or money adv'd \$.....100
 Due U. S. for arms, equipments, &c., \$.....100
 Bounty paid \$.....100; due \$.....100

Remarks: *First mustered into U.S*
service at Litchfield Conn
App'd 1st Lt. Oct 3/63
App'd Brig. Maj Mch 13/65
Travel pay & subsistence due
to Litchfield Conn 3 months

Book mark: *187200 R. J 1880*

J. A. Johnson
 Copyist.

JAN. 20

5562558

1961

pay proper due on
Discharge per Act Mch 3/60
Pay due for Condy Co
for Jan, Mch, & Apt, /66.
In continual service
since Aug 4/62

B. | 4 | U.S.C.T.

James M Bradley
P.H., Co. *C*, 4 Reg't U. S. Col'd Infantry.

Appears on Co. Muster-out Roll, dated
Washington, D.C., May 4, 186*6*.

Muster-out to date _____, 186 .

Last paid to _____, 186 .

Clothing account:

Last settled _____, 186 ; drawn since \$ _____ 100

Due soldier \$ _____ 100; due U. S. \$ _____ 100

Am't for cloth'g in kind or money adv'd \$ _____ 100

Due U. S. for arms, equipments, &c., \$ _____ 100

Bounty paid \$ _____ 100; due \$ _____ 100

Remarks: *Transferred to*
Co "G" 4th MSB &
June 1, 65.

Book mark : _____

(861)

R Johnson
Copyist.

B | 4 | U.S.C.T

James M Bradley

1 Lt 4 Regt U.S. Col'd Troops

Appears on

General Order

No. 65, dated War Department, Adjutant General's Office, June 22, 1867.

Appointed to be

Captain

BY BREVET

in the Volunteer Force, Army of the United States, for gallant and meritorious services

To date from March 13, 1865.

(400)

J. A. Johnson

Copyist.

B. | 4. | U.S.C.T.

James M. Bradley
1 Lieut. 4 Regt. U.S. Col. d. T.

Appears on

General Order

No. 65, dated War Department, Adjutant Gen-
eral's Office, June 22, 1867.

Appointed to be

Major

BY BREVET

in the Volunteer Force, Army of the United
States, for gallant and
meritorious services

To date from Mch. 13, 1865.

L. Herrera

(400)

Copyist.

B | 4" | U. S. C. I.

James M. Bradley

, Co. , 4th Reg't U. S. C. I.

NOTATION.

Book mark: { 1529 - C. I. - 1880.
B-334 - C. I. - 1863.

War Department,

Adjutant General's Office,

Washington, April 8, 1880.

See also Co. I. 19th Conn, vols
(2nd Reg. Arty).

M. Allen

Bradley James M
1st Lt., Co., *H* Reg't *USC I*

6 Enclosures.

Bed Cards	Final Statements
Burial Records	Furloughs or L. of A
Certs. of Dis. for Discharge	Med. Certificates
C. M. Charges	Med. Des. Lists
Descriptive Lists	Orders
Discharge Certificates	Pris. of War Record
Enlistment Papers	Resignations

Other papers relating to—

Admission to Hosp'l	Furlough or L. of A 3
Casualty Sheet	Med. Examination
Confinement	Misc. Information 2
Contracts	Pay or Clothing
Death or Effects	Personal Reports
Desertion	Rank
Discharge from Hosp'l	Transfer to Hosp'l
Discharge from Service	Transfer to V. R. C.
Duty /	Transportation

Ad. Quarters 4th U. S. C. Troops
Yorktown Va. Nov. 24. 1863

I hereby certify that 1st Lt. James M. Bradley reported
for duty with this Regt. on the 19th Nov. 1863

Saml. A. Duncan
Col. Comdg.

Sworn & subscribed to }
Before me }
W. L. Horton Lt. Col.

Bizot's ... 1863

Yorktown Va. Decr 26/63
B 227 ✓ 1863

J. M. Bradley. 1st Lieut
4th U.S. Col. Troops -

Requests leave of absence for
three days to visit Baltimore
Md. on important business

Coman ^d Officers present for duty	24
" " on special duty	3
" " present sick	2
" " " in arrest	1
" " detach ^d service	6
" " absent with leave	3
	39

Hd. Qrs 4th U.S.C. Troops
Decr. 27/63

Approved and respectfully
forwarded -

Hd. Quarters Va. 28 Dec 1863
Genl. A. Duncan
Lieut. Col. Comd^g
4th U.S. Col. Troops

Hd. Qu. U.S. Troops,
Yorktown, Va., Dec. 27th 1863
Respectfully forwarded
Approved J. M. Bradley
B.S.

Approved

S.O. 161 (4)

Yorktown Va.

Dec 26, 1863

Major R. S. Davis
Capt. Adj. Genl., Ft. Monroe Va.

Sir,

I have the honor to request leave of absence
for three days to visit Baltimore, Md. on important
business.

Very respectfully
your obedient servant

J. M. R. A. Eley
1st Lieut. 4th Regt. U. S.

Colored Troops.

B 54 3^d Div. 18th A. C. 1864

Hd. Qrs. Amer. Corps

P. O. V. 3^d Div. 18th A. C. 1864
Aug. 5th 1864

Bradley, James M.,
Lt. & Chf. of Amb.

Makes application for
twenty (20) days leave of
absence to go out of the Dept.



Hd. Qrs. 3^d Div. 18th A. C. Aug. 5th 1864

H. Q. 3^d Div. 18th Corps

Near Petersburg Aug. 5. 1864

Respectfully forwarded

Approved, ~~Edwards~~

Chas. J. Paine

Brig Genl. Comdg

Hd Qrs 18th A. C.

Aug. 6. 1864

Respectfully forwarded

Approved,

Edwards

M. G. S.

Comdg

S. O. No. 214 - 1 - 1864

James M. Bradley
Lt. 4th U. S. A.
Chief of Amb.

Head (Quarters) Amb. Corps.
3^d Div. 18th. A.C.
Aug. 5th. 1864

Major R. J. Davis
Capt. Adj. Genl.
Dept. Va. 3^d Div. A.C.

Major.

I have the honor to make application for twenty days leave of absence to go out of the Dept. in consideration of the following circumstances.

Not having had a leave of absence since my entrance into the service, nearly two years ago, and as my wife and child are now lying at the point of death, I feel that in view of these facts I am justified in making this request at this time.

I am Major

Very Respectfully - over -

Your Obedt. Servt
James M. Bralley
Mr. Lt. Col. A. S. C. P.
Chf. of Amtr. 31 Wm. 1830 A.C.

B. 137 3rd Div. 10th A.C. 1865
B. 88 = 2nd B. 3rd Div. 10th A.C. 1865.

Head Quarters 4th U.S. Inf.
Goldboro N.C.
May 29th 1865.

Head Quarters 2nd Div., 3rd Div., 10th A.C.,
Goldboro, N.C.; May 31st / 65

Boernstein, Aug. F.
Major Comdg Regt.

Respectfully forwarded.
I and I mean
Brig Gen. Landry

Report of the absence of
James M. Bradley
1st Lieut 4th U.S. Inf.

Head Quarters 3rd Div. 10th A.C.
Goldboro N.C. June 3 1865

Respectfully forwarded

G. J. Parne
Brig Gen. Landry
Head Qrs 10th A.C.
Raleigh. June 15th / 65

Respy forwarded.

Alms.
Bot Maj Gen C

Recd Hd. Qrs. 3rd Div. 10th A.C. May 31st 1865
Hd Qrs. 2nd B. 3rd Div. 10th A.C. May 30th 1865.

Report of absent Officers of 4th U. S. Colored Troops.
 as required by Par I. G.O. 59. Ad. Div. Dept. of North Carolina.

Names.	Rank.	Station.	Remarks.
James M. Bradley.	1st Lieut.	Raleigh N.C.	Chief Ambulance Officer 10th Army Corps. by virtue of Par II. G.O. 122. Ad. Div. Dept. of War N.C. May 2nd 1864.

I certify that the above report is a correct transcript from the records of the
 4th U. S. Colored Troops.

Aug. S. Baerstein
 Major 4th U. S. Colored Troops.
 60nd Regiment.

Goldboro N.C.
 May 29th 1865.

Hd Qtrs Dept 761
Raleigh 761 Sept 13 1855

B 416 v 2 DUC
Bradley James Lieut and
Acting Chief of ambulance

Requests leave of absence
with permission of an
extension of 10 on application
at Mexico Atlantic

James M. Bradley
Lt. 4. U. S. C. Inf

James Bradley
Lieut.

S/O 182. Par. 2.

318

Headquarters Department of North Carolina,

Raleigh, N. C., Sept 13th 1865.

Col C. A. Cilly

Asst Adgt Gen. Dept N. C.
Sic.

I have the honor to request a leave of absence for 20 days to go to New Haven Conn. to attend to important private business with the privilege of extension 10 days at Head Quarters Dept of the East.

I have the honor to be
Very Respectfully
James W. Bradley
Acty Chf of Ambulance
Dept N. C.

Bq 20. 1866, Carroll, D.C.
January 24 1866

Burdley James M.
1st Lieut. & Post Major
of 1st Col Regt

Enclosed & returned from a
Military Commission now in
session at Raleigh N.C. and
respectfully requests inclusion

Some special orders
under this office
to comply with
this subpoena without
delay & send copy
to Judge Brewer

Home Office, Dept. of War
Washington D.C. July 24 66

Respectfully forwarded

C. A. Mastin
Adj. General
Commanding

Fort Carroll D.C. Jan 27/66

Col. Taylor
Asst. Adjt. Genl., Dept. Washington D.C.

Sir

I have the honor to
enclose a report from a Military Commission
now in session at Raleigh N.C. I would
respectfully request instructions.

Very Respectfully
Yours
James M. Bradley
Adj. Genl. Dept. Army
4th U.S.C.T.

142

Gray, James

Co B, 4 U.S. Col'd Inf.

Private

CARD NUMBERS.

1	5553727	26
2	5553813	27
3	5553907	28
4	5554003	29
5	5554097	30
6	5554227	31
7	5554447	32
8	5550938	33
9	9161771	34
10		35
11		36
12		37
13		38
14		39
15		40
16		41
17		42
18		43
19		44
20		45
21		46
22		47
23		48
24		49
25		50

Book Mark:

See also

Ø1942336. P.O. m. m

B

4

U.S.C.T.

James Bray

Co. "B", 4 Regt U. S. Col'd Inf.

Appears on

Company Descriptive Book

of the organization named above.

DESCRIPTION.

Age 30 years; height 5 feet 6 inches.

Complexion black

Eyes black; hair black

Where born Chinton Co. O.

Occupation farmer

ENLISTMENT.

When Sept. 6, 1864.

Where Hillsboro, O.

By whom Capt. Marley; term 1 y'rs.

Remarks: Discharged Sept 5/65.
Exp. term of service at New Bern
N.C. S. L. Way 1st Lt. and
A. C. M. Paines Div.

Read

B | 4 | U.S.C.T.

James Bray
Pat, Co. B, 4 Reg't U. S. Col'd Infantry.

Appears on

Company Muster Roll

for Nov. + Dec, 1864.

Joined for duty and enrolled:

When Sept 2nd, 1864.*

Where Hillsboro, O. *

Period 1 years.*

Present or absent Present

Stoppage, \$ 100 for

Due Gov't \$ 100 for

Remarks: No pay received since enlistment.

* See enrollment on card from muster-in roll.

Book mark: _____

C. M. Clark

(358c)

Copyist.

B

4

U.S.C.T.

James Bray

Pri, Co. B, 4 Reg't U. S. Col'd Infantry.

Appears on

Company Muster Roll

for *Jan + Feb*, 1865.

Joined for duty and enrolled:

When *Sep 2*, 1864.*

Where *Hillsboro, Ohio**

Period *1* years.*

Present or absent *Present*

Stoppage, \$ *100* for

Due Gov't \$ *100* for

Remarks: *No pay rec'd since enlistment.*

* See enrollment on card from muster-in roll.

Book mark:

Barton

B. | 4 | U.S.C.T.

James Bray
Pri., Co. B, 4 Reg't U. S. Col'd Infantry.

Appears on

Company Muster Roll

for mch + apr , 186 57

Joined for duty and enrolled:

When Sep 2 , 186 4.*

Where Hillsboro 0 *

Period 1 years.*

Present or absent Present

Stoppage, \$ 100 for _____

Due Gov't \$ 100 for _____

Remarks: _____

* See enrollment on card from muster-in roll.

Book mark: _____

(358c) Barton Copyist.

B. | 4 | U.S.C.T.

James Bray
Pr, Co. B, 4 Reg't U. S. Col'd Infantry.

Appears on

Company Muster Roll

for *May + June*, 1865.

Joined for duty and enrolled:

When *Sep. 2*, 1864.*

Where *Hillsboro, O.**

Period *1* years.*

Present or absent *Present*

Stoppage, \$ *100* for _____

Due Gov't \$ *100* for _____

Remarks: *See W.C. Cooper Ruller, 4"*
W. S. C. T. # 8.

* See enrollment on card from muster-in roll.

Book mark: _____

Barton
 (858c) Copyist.

B

4

U.S.C.T.

James Bray

Pr....., Co. B, 4 Reg't U. S. Col'd Infantry.

Appears on

Company Muster Roll

for *July & Aug*....., 1865.

Joined for duty and enrolled:

When *Sep 2*"....., 1864.*

Where *Hillsboro O.*.....*

Period *1*..... years.*

Present or absent *Present*

Stoppage, \$ *100* for.....

Due Gov't \$ *100* for.....

Remarks:.....

* See enrollment on card from muster-in roll.

Book mark:.....

Barton

B. | 4 | U.S.C.T.

James Bray
B....., Co. B, 4 Reg't U. S. Col'd Infantry.

Appears on

Company Muster Roll

for *Sep & Oct*....., 1865.

Joined for duty and enrolled:

When *Sep. 2*"....., 1864.*

Where *Hillsboro*.....*

Period *1* years.*

Present or absent.....

Stoppage, \$ *100* for.....

Due Gov't \$ *100* for.....

Remarks: *mustered out N. S. Serv.*
Sep. 5, '65. Exp. time at New
Bern, N. C. D. L. May, A. C. M.

* See enrollment on card from muster-in roll.

Book mark:.....

Barton

B *4* U.S.C.T.

James Bray
Co. B, 4 Reg't U. S. Col'd Infantry.

Appears on a

Detachment Muster-out Roll

of the organization named above. Roll dated
New Berne N.C. Sept 5, 1865.

Muster-out to date *Sept 5, 1865.*

Last paid to *June 30, 1865*

Clothing account:

Last settled *June 30, 1865*; drawn since *None* 100

Due soldier \$ 100; due U. S. \$ 100

Am't for cloth'g in kind or money adv'd \$ 100

Due U. S. for arms, equipments, &c., \$ *6* 00 / 100

Bounty paid *None* 100 due \$ *100*, 100

Remarks: *Muster and complete set of accoutrements retained mustered out by reason of expiration of term of service transportation due from place of discharge to place of*

Book mark: *490,300*

Carroll

B | 4 U.S.C.T.

James Bray
Park, Col'd, 4 Reg't U. S. Col'd Infantry.

Appears on **Co. Muster-out Roll**, dated
Washington, DC, May 4, 1866.

Muster-out to date _____, 186 .
 Last paid to _____, 186 .

Clothing account:

Last settled _____, 186 ; drawn since \$ _____ 100

Due soldier \$ _____ 100 ; due U. S. \$ _____ 100

Am't for cloth'g in kind or money adv'd \$ _____ 100

Due U. S. for arms, equipments, &c., \$ _____ 100

Bounty paid \$ _____ 100 ; due \$ _____ 100

Remarks: *Discharged by reason*
of expiration term of service
Sept. 5/60 by Lt. D. L. May,
ac m.

(Age 30 Enrolled Sept 2 1864
at Hillsboro O. 1 Year)

Book mark: *Muster out Roll on file.*
over

Tabler

Dray *James*
P, Co. — *4* Reg't *USCT*

Enclosures.

Bed Cards	Final Statements
Burial Records	Furloughs or L. of A.
Certs. of Dis. for Discharge	Med. Certificates
C. M. Charges	Med. Des. Lists
Descriptive Lists	Orders
Discharge Certificates	Pris. of War Record
Enlistment Papers <i>1</i>	Resignations

Other papers relating to—

Admission to Hosp'l	Furlough or L. of A.
Casualty Sheet	Med. Examination
Confinement	Misc. Information
Contracts	Pay or Clothing
Death or Effects	Personal Reports
Desertion	Rank
Discharge from Hosp'l	Transfer to Hosp'l
Discharge from Service	Transfer to V. R. C.
Duty	Transportation

E. P. Hiler 5/21/02
MSB

DECLARATION OF RECRUIT.

I, James Bray, desiring to VOLUNTEER as a Soldier in the Army of the United States, for the term of THREE YEARS, Do Declare, That I am single years and 24 months of age; that I have never been discharged from the United States service on account of disability or by sentence of a court martial, or by order before the expiration of a term of enlistment; and I know of no impediment to my serving honestly and faithfully as a soldier for three years.

GIVEN at Hillsboro O. the 2^d day of September 1864
Witness: O. B. Gaden James M. Bray mark

B/64
Co. Massignee

No. _____

James Bray
Volunteered at Hillsboro O.

September 2^d, 1864

By Capt Jas K. Marley
Pro Major 6th Dist O.

_____ enlistment; last served in Company ()

_____ Reg't of _____

Discharged _____, 18 _____

58th Ind. Dist
Union Sp
Clinton Co
6th Dist O

CONSENT IN CASE OF MINOR.

I, _____, Do CERTIFY, That I am _____ of _____; that the said _____ is _____ years of age; and I do hereby freely give my CONSENT to his volunteering as a SOLDIER in the ARMY OF THE UNITED STATES for the period of THREE YEARS.

GIVEN at _____ the _____ day of _____

Witness: _____

NOTE 1.—This blank will be used for both enlistments and re-enlistments—enlistment of veterans, &c., &c., in the volunteer service. They will be made out in duplicate in all cases—one to accompany the recruiting return of the superintendent (not the recruiting officer) to the Adjutant General, and one to accompany the accounts of the officer who pays bounty, &c. The Regiment and Company in which the soldier last served should be given on the back.
NOTE 2.—An enlistment holds to service. A muster-in must, in all cases, precede payment of pay, bounty, pension, &c. A muster-in roll must, in all cases, be filed in the Adjutant General's Office as evidence of muster-in. The mustering officer, commissary, or assistant commissary of musters, as the case may be, will counter-sign both enlistments as having mustered the soldier into the service of the United States before either of them is given to the disbursing officer.

VOLUNTEER ENLISTMENT.

STATE OF

TOWN OF

Ohio

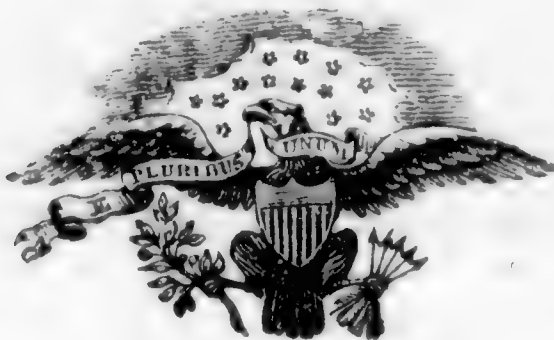

Hillsboro

I, *James Bray*, born in *Clinton Co*
 in the State of *Ohio*, aged *Thirty* years,
 and by occupation a *Farmer*, Do HEREBY ACKNOWLEDGE to have
 volunteered this *Second* day of *September*, 186*4*,
 to serve as a **Soldier** in the **Army of the United States of America**, for
 the period of ~~THREE YEARS~~, unless sooner discharged by proper authority:
 Do also agree to accept such bounty, pay, rations, and clothing, as are, or may be,
 established by law for volunteers. And I, *James Bray*, do
 solemnly swear, that I will bear true faith and allegiance to the **United States**
of America, and that I will serve them honestly and faithfully against all
 their enemies or opposers whomsoever; and that I will observe and obey the
 orders of the President of the United States, and the orders of the officers
 appointed over me, according to the Rules and Articles of War.

Sworn and subscribed to, at *Hillsboro* his
 this *2* day of *September* 186*4*, *James & Bray*
 BEFORE *John Marley* mark
Capt. Pro. Mar. 6th Dist.

I CERTIFY, ON HONOR, That I have carefully examined the above-named Volunteer, agreeably
 to the General Regulations of the Army, and that, in my opinion, he is free from all bodily defects and
 mental infirmity, which would in any way disqualify him from performing the duties of a soldier.

David Holt
Surgeon Board of Examiners
6th Dist. O. EXAMINING SURGEON.

I CERTIFY, ON HONOR, That I have minutely inspected the Volunteer *James Bray*
 previously to his enlistment, and that he was entirely sober when enlisted, that, to the best of my
 judgment and belief, he is of lawful age; and that, in accepting him as duly qualified to perform the
 duties of an able-bodied soldier, I have strictly observed the Regulations which govern the recruiting
 service. This soldier has *Black* eyes, *Black* hair, *Black* complexion, is *3-*
 feet *6* inches high.

John Marley
Capt. Pro. Mar. 6th Dist. Volunteers, O.
 RECRUITING OFFICER.

(A. G. O. No. 74 & 76.)

Mustered into the service of the United States, for ~~three~~ ^{one} years or during the war, from date of enlistment, in Company
 Regiment of _____ Volunteers, on the *2* day of *September*, 186*4*, at *Hillsboro O.*

John Marley
Capt. Pro. Mar. 6th Dist.
Mustering Officer

143

Breckenridge, John C.

Co C., 4 U.S. Col'd Inf.

2" Lieutenant. | 2" Lieutenant.

CARD NUMBERS.

1	5550245	26
2	5554593	27
3	5534695	28
4	5554797	29
5	5534980	30
6	5556029	31
7	9428560	32
8		33
9		34
10		35
11		36
12		37
13		38
14		39
15		40
16		41
17		42
18		43
19		44
20		45
21		46
22		47
23		48
24		49
25		50

Book Mark:

See also

B | 4[#] | U.S.C.T.

John C Bucknidge
2^d *Lieut*, Co., 4th Reg't U. S. Col'd Inf.

Appears on

Regimental Descriptive Book

(List of Commissioned Officers)

of the regiment named above.

Rank *2^d Lieut*

Date of appointment *Aug 7th* 1863.

Remarks: *Accepted his appointment*
as 2^d Lt. 4th U.S.C.I.
Aug 11. 63 Assigned to Co. C
Mustered out of service on
account of permanent
Physical disability Par
8. S.O. 50 Dept War N.C.
Approved by Par 28 Do 90.
War Dept a. 90 Feb 24. '64

J. J. [Signature]

B | 4 | U.S.C.T.

John C. Breckenridge

2d Lt, Co. 4 Reg't U. S. Col'd Infantry.

Age *23* years.

Appears on an

Individual Muster-in Roll

of the organization named above. Roll dated

Yorktown, Va., Nov. 24, 1863.

Muster-in to date *Aug 11, 1863.*

Joined for duty and enrolled:

When *Aug. 11*, 1863.

Where *Baltimore*

Period years.

Remarks: *By authority dated War Dept. Sep. 28/63.*

Book mark :

(336)

Lowry

Copyist.

②

4

U.S.C.T.

John C. Beckenridge
2^d Lieut, Co. C. 4 Reg't U. S. Col'd Infantry.

Appears on

Company Muster Roll

for July 12, to Aug 31, 1863.

Present or absent Present

Stoppage, \$ 100 for

Due Gov't, \$ 100 for

Remarks: Appointed by the President of the United States 2^d Lieut in the 4th Reg't U.S. Col Troops Aug 7, 1863, accepted Aug 11th, reported for duty Aug 11,

Book mark:

Talbot

(358)

Copyist.

D

4

U.S.C.T.

John C. Beckenridge

2^d Lieut, Co. C. 4 Reg't U. S. Col'd Infantry.

Appears on

Company Muster Roll

for Sept & Oct, 1863

Present or absent Present

Stoppage, \$ 100 for

Due Gov't, \$ 100 for

Remarks: Appointed 2^d Lieut in the 4th Reg't U.S. Colored Troop Aug 7, 1863, by the President of the United States. Accepted the appointment August 11, 1863, has been in command of Co. C, from September 14th, 1863,

Book mark:

Talbott

(358)

Copyist.

D

4

U.S.C.T.

J. C. Breckinridge
2d St, Co. C. 4 Reg't U. S. Col'd Infantry.

Appears on

Company Muster Roll

for *Nov & Dec*, 186*3*.

Present or absent *Present*

Stoppage, \$ *100* for

Due Gov't, \$ *100* for

Remarks: *Present sick*

Book mark:

Falvorth

(358)

Copyist.

D

4

U.S.C.T.

John C. Peckemridge
2^d Lt, Co. C, 4 Reg't U.S. Col'd Inf.

Appears on

Company Muster Roll

for *Jany & Feby*, 1864

Present or absent

Stoppage, \$ 100 for

Due Gov't, \$ 100 for

Remarks: *Mustered out for permanent disability by order of Maj Gen Butler Feb 19, 1864. Pay due from Oct 31, to Nov 24, 1863.*

Book mark:

Dalburt

(358)

Copyist

19 | 4 | **U.S.C.T.**

John C Breckenridge
2^d Lt. Co. C, 4 Reg't U. S. Col'd Infantry.

Appears on **Co. Muster-out Roll**, dated
Washington, DC, May 4, 1866.

Muster-out to date _____, 186 .

Last paid to _____, 186 .

Clothing account:

Last settled _____, 186 ; drawn since \$ _____ 100

Due soldier \$ _____ 100; due U. S. \$ _____ 100

Am't for cloth'g in kind or money adv'd \$ _____ 100

Due U. S. for arms, equipments, &c., \$ _____ 100

Bounty paid \$ _____ 100; due \$ _____ 100

Remarks: *Discharged*
Mustered out of service
by order of Genl Butler
July 19/64, at Yorktown,
W. Va., for disability.

Book mark: _____

(861)

R Johnson
Copyist.

Breckenridge, J. C.
 2^d Lt, Co. C, 4 U.S.C. Inf.

4 Enclosures.

Bed Cards	Descriptive Lists
Burial Records	Final Statements
Certs. of Dis. for Discharge	Furloughs
C. M. Charges	Med. Des. Lists
Med. Certificates	Orders 3 2

Other papers relating to—

Admission to Hosp'l	Furlough <i>orig. a 1</i>
Casualty Sheet (Officer's)	Med. Examination
Confinement	Misc. Information
Contracts	Pay or Clothing
Death or Effects	Personal Reports
Desertions	Rank
Discharge from Hosp'l	Transfer to Hosp'l
Discharge from Service	Transfer to V. R. C.
Duty /	Transportation

MICROFILM PUBLICATION M 1846

COMPILED MILITARY SERVICE RECORDS
OF VOLUNTEER UNION SOLDIERS WHO SERVED WITH
THE UNITED STATES COLORED TROOPS (USCT)
4TH REGIMENT OF INFANTRY

PERSONAL PAPERS' TARGET SHEET

PLEASE NOTE THE CHECKED INFORMATION ABOUT THE PERSONAL PAPERS IN
THIS FILE:

- NO PERSONAL PAPERS WERE FOUND IN THIS FILE WHEN THE
RECORDS WERE ARRANGED FOR MICROFILMING.
- 6 PERSONAL PAPER(S) FOUND IN THIS FILE WHEN THE RECORDS
WERE ARRANGED FOR MICROFILMING.

8

SPECIAL ORDERS, } WAR DEPARTMENT,
No. 90. } ADJUTANT GENERAL'S OFFICE,
Washington, February 24th, 1864.

(Extract.)

* * * * *
28. So much of Special Orders, No. 50, Paragraph 8, Headquarters
Department of Virginia and North Carolina, as musters out of service
Lieutenant *John C. Breckenridge*, 4th Regiment U. S. Colored Troops,
on account of ~~permanent physical disability existing prior~~ to his ap-
pointment, is hereby approved.

* * * * *
By order of the Secretary of War:

E. D. TOWNSEND,
Assistant Adjutant General.

OFFICIAL :

Assistant Adjutant General.

John C. Breckenridge

SPECIAL ORDERS, } WAR DEPARTMENT,
No. 90. } ADJUTANT GENERAL'S OFFICE.
Washington, February 24th, 1864.

(Extract.)

Recd

* * * * *
28. So much of Special Orders, No. 50, Paragraph 8, Headquarters,
Department of Virginia and North Carolina, as musters out of service
Lieutenant *John C. Breckenridge*, 4th Regiment U. S. Colored Troops,
on account of permanent physical disability, existing prior to his ap-
pointment, is hereby approved.
* * * * *

By order of the Secretary of War:

E. D. TOWNSEND,

Assistant Adjutant General.

OFFICIAL :

E. D. Townsend

Assistant Adjutant General.

Pay to the order of
24

Breckenridge John Co.

Let. 4th U.S. Co. T.

SPECIAL ORDERS, } WAR DEPARTMENT.
No. 90. } ADJUTANT GENERAL'S OFFICE.
Washington, February 24th, 1864.

(Extract.)

* * * * *
23. So much of Special Orders, No. 50, Paragraph 8, Headquarters Department of Virginia and North Carolina, as musters out of service Lieutenant *John C. Breckenridge*, 4th Regiment U. S. Colored Troops, on account of permanent physical disability, existing prior to his appointment, is hereby approved.
* * * * *

By order of the Secretary of War:

E. D. TOWNSEND,
Assistant Adjutant General.

OFFICIAL:

Assistant Adjutant General.

Respectfully

5
J. C. Breckinridge

4th US Cold Troops

pl. Keep this

B

SPECIAL ORDERS, } WAR DEPARTMENT,
No. 90. } ADJUTANT GENERAL'S OFFICE,
Washington, February 24th, 1864.

(Extract.)

✓ 28. So much of Special Orders, No. 50, Paragraph 8, Headquarters, Department of Virginia and North Carolina, as musters out of service Lieutenant *John C. Breckenridge*, 4th Regiment U. S. Colored Troops, on account of permanent physical disability, existing prior to his appointment, is hereby approved.

* * * * *

By order of the Secretary of War:

E. D. TOWNSEND,

Assistant Adjutant General.

OFFICIAL:

Assistant Adjutant General.

81

John C. Breckenridge

Ad. Quarters 4th U. S. C. Troops
Yorktown Va. Nov. 24, 1863

I hereby certify that 2^d Lt. J. C. Breckenridge reported
in duty with this Regt. on the 11th Aug. 1863.

Prova Submitted to }
Reference }
M. Norton Lt. Genl. }

Saml. A. Duncan
Col Comdg.

Camp General, Va. 1864

Major P. S. Davis
Capt. Co. 1st Regt.

I have the
pleasure to solicit a loan of a horse
for three days to go to Richmond with
Lieutenant McCall. My application is
based on the enclosed Surgeon's certificate.

Very Respectfully,
John C. Breckinridge
Major, 1st Regt. Va. Cavalry

B

32

1864

Mo. Dept. War. b.
 Ft Monroe July 17 64

Respectfully referred to
 Medical Director

By command of
 Maj Gen Butler

P. P. Davis

Acty.

Mo. Dept. War. b.
 Ft Monroe 18 Feb 64

Respectfully returned
 with the suggestions
 of Surg. Otis & Gen -
 Director approved.

Charles McNeill
 M.D. Dir.

Recd M.D. Dir. War. b. Feb. 17. 64.

Adm Gen Vukturn
Feb 9. 1864

Respectfully forwarded
disapproval with refer-
-ence to endorsement of
Surgen Otis. Surgen in
Chief - from which it appears
that those officers should
not have entered the
Service with a permanent
disqualification for service
at the time of his muster.

Being in he should be
mustered out -

J. M. Stewart
B. S.

J. M. Stewart

144

Grent. Philip Lewis

Co K, 4 U.S. Col'd Inf.

Private

Private

CARD NUMBERS.

1	5566001	26
2	5566102	27
3	5566202	28
4	5566299	29
5	5566387	30
6	5566473	31
7	5566558	32
8	5566635	33
9	5566709	34
10	5566798	35
11	5566884	36
12	5566975	37
13	5567061	38
14	5567146	39
15	5567221	40
16	5567279	41
17	5567334	42
18	9062802	43
19	9062930	44
20		45
21		46
22		47
23		48
24		49
25		50

Book Mark:

See also

J. 1109252 P.O. Rev.
Q. 1230702 P.O. M.M.
A-1636710 And. W.D.

B | 4 | U.S.C.T.

Phillip Lewis Brent,

Co. K, 4 Reg't U. S. Col'd Inf.

Appears on

Company Descriptive Book

of the organization named above.

DESCRIPTION.

Age 25 years; height 5 feet 5 inches.

Complexion *Blk*

Eyes *Blk*; hair *Curly*

Where born *Clark Co. Va*

Occupation *Farmer*

ENLISTMENT.

When *Aug 31*, 18*63*.

Where *Balto, Md*

By whom *Col W. Berney*; term *3* y'rs.

Remarks: *Free*

Salah

(388g)

Copyist.

B | 4 | U.S.C.T.

Phillip Lewis Brent

....., Co. K, 4 Reg't U. S. Col'd Inf.

Appears on

Company Descriptive Book

of the organization named above.

DESCRIPTION.

Age 25 years ; height 5 feet 5 inches.

Complexion Blk

Eyes Blk ; hair Curly

Where born Clark Co Va

Occupation Harmer

ENLISTMENT.

When Aug. 31 , 1863.

Where Balto, md

By whom Col Burney ; term 3 y'rs.

Remarks:

Free

Selah

P

4

U.S.C.T.

Philip Lewis Brent

A. R., Co. *R*, 4 Reg't U. S. Col'd Infantry.

Age *25* years.

Appears on

Company Muster-in Roll

of the organization named above. Roll dated

Baltimore Md, Sep 1, 1863.

Muster-in to date *Sep 1, 1863.*

Joined for duty and enrolled:

When *Sep 1, 1863.**

Where *Baltimore Md.**

Period *3* years.*

Remarks :

* *U.S.* Muster-in roll shows enrollment and muster-in of this company as of same date and place. See enrollment on subsequent card or cards.

Book mark :

Philip Lewis Brent

B | 4 | U.S.C.T.

Phillip Lewis Brent
Co. K, 4 Reg't U. S. Col'd Infantry.

Appears on

Company Muster Roll

for Sept - Oct, 1863

Joined for duty and enrolled:

When Sept 1, 1863*

Where Baltimore *

Period 3 years.*

Present or absent Present.

Stoppage, \$ 100 for

Due Gov't, \$ 100 for

Remarks:

Book mark:

Tom H. ...

P | 4 | U.S.C.T.

Phillip L. Brent
P, Co. K, 4 Reg't U. S. Col'd Infantry.

Appears on
Company Muster Roll
for *Nov + Dec*, 186*3*.

Joined for duty and enrolled :
When *Sept 1*, 186*3*.
Where *Baltimore* *
Period *3* years.*

Present or absent *Present*
Stoppage, \$ *70* for *[+ 11 Haversack]*
100 for *21 Great Coat stop*
Due Gov't, \$ *100* for

Remarks :

* See enrollment on card from muster-in roll.

Book mark :

Jan Hunter
(358c) Copyist.

P | 4 | U.S.C.T.

Phillip L. Trent
Pl, Co. K, 4 Reg't U. S. Col'd Infantry.

Appears on

Company Muster Roll

for Jan'y & Feb'y, 1864.

Joined for duty and enrolled:

When Sept 1, 1863.*

Where Baltimore.*

Period 3 years.*

Present or absent Present.

Stoppage, \$ 100 for

Due Gov't, \$ 100 for

Remarks Stopped for one letter

* See enrollment on card from muster-in roll.

Book mark:

Van Houten

B

4

U.S.C.T.

Philip S. Brent
Priv, Co. K, 4 Reg't U. S. Col'd Infantry.

Appears on

Company Muster Roll

for *March & Apr*, 186 *4*

Joined for duty and enrolled :

When *Sept 1*, 186 *3* *

Where *Baltimore* *

Period *3* years.*

Present or absent *Present*

Stoppage, \$ *100* for

Due Gov't, \$ *100* for

Remarks:

* See enrollment on card from muster-in roll.

Book mark:

Van Houten

D | 4 | U.S.C.T.

Phillip L. Brent
Pvt, Co. K, 4 Reg't U. S. Col'd Infantry.

Appears on

Company Muster Roll

for May and June, 1864.

Joined for duty and enrolled:

When Sept. 1, 1863.*

Where Baltimore.*

Period 3 years.*

Present or absent Present

Stoppage, \$ 100 for

Due Gov't, \$ 100 for

Remarks: _____

Book mark: _____

Bliss

D | 4 | U.S.C.T.

Phillip L. Brent

Pr., Co. K, 4 Reg't U. S. Col'd Infantry.

Appears on

Company Muster Roll

for July ~~and~~ Aug., 1864.

Joined for duty and enrolled:

When Sept. 1, 1863.*

Where Baltimore Md *

Period 3 years.*

Present or absent Present

Stoppage, \$ 100 for

Due Gov't, \$ 100 for

Remarks: Free Apr. 19. 1861
On extra duty at Canal
Aug. 9. 1864

Book mark:

Bliss

D

4

U.S.C.T.

Phillips L. Drench

Pvt, Co. K, 4 Reg't U. S. Col'd Infantry.

Appears on

Company Muster Roll

for Sept and Oct, 1864

Joined for duty and enrolled:

When Sept. 1, 1863*

Where Baltimore Md *

Period 3 years.*

Present or absent Present

Stoppage, \$ 100 for

Due Gov't, \$ 100 for

Remarks: Free April 19. 1861

Book mark:

Diase

B | 4 | U.S.C.T.

Phillip L. Brent
Pt, Co. K, 4 Reg't U. S. Col'd Infantry.

Appears on

Company Muster Roll

for Nov & Dec, 1864.

Joined for duty and enrolled :

When Sept 1, 1863*

Where Baltimore Md.*

Period 3 years.*

Present or absent Present

Stoppage, \$ 100 for

Due Gov't, \$ 100 for

Remarks: Free April 19, 1861

Book mark :

J. H. Stewart

B | 4 | U.S.C.T.

Philip Brent
 Pt, Co. K, 4 Reg't U. S. Col'd Infantry.

Appears on

Company Muster Roll
 for Jan & Feb, 1865.

Joined for duty and enrolled:

When Sept 1, 1863.*
 Where Baltimore Md. *
 Period 3 years.*

Present or absent Present

Stoppage, \$ 100 for

Due Gov't, \$ 100 for

Remarks: Free on or before
 Apr 19. 61

Book mark:

J. H. Stewart

B. | 4 | U.S.C.T.

Philip S. Brent.

Prv., Co. K, 4 Reg't U. S. Col'd Infantry.

Appears on

Company Muster Roll

for *Mch. & Apl.*, 1865.

Joined for duty and enrolled :

When *Sept. 1*, 1863.*

Where *Baltimore, Md.**

Period *3* years.*

Present or absent *Present*

Stoppage, \$ *100* for

Due Gov't, \$ *100* for

Remarks: *Free on or before April 19, 61. Back pay due from date of enlistment to May 1/1864.*

* See enrollment on card from muster-in roll.

Book mark :

Philipson

B. | 4 | U.S.C.T.

Philip Brent

Priv., Co. K, 4 Reg't U. S. Col'd Infantry.

Appears on

Company Muster Roll

for *May + June*, 1863.

Joined for duty and enrolled:

When *Sept. 1*, 1863.*

Where *Baltimore, Md.**

Period *3* years.*

Present or absent *Present*

Stoppage, \$ *100* for

Due Gov't, \$ *100* for

Remarks: *Back pay due from enlistment to May 1st/64. Free.*

* See enrollment on card from muster-in roll.

Book mark:

Phillipsen

B. | 4 | U.S.C.T.

Philip Brent

Pr., Co. K, 4 Reg't U. S. Col'd Infantry.

Appears on

Company Muster Roll

for July & Aug., 1865.

Joined for duty and enrolled :

When Sept. 1, 1863.*

Where Baltimore, Md.*

Period 3 years.*

Present or absent Present

Stoppage, \$ 100 for

Due Gov't, \$ 100 for

Remarks:

* See enrollment on card from muster-in roll.

Book mark:

Philipsen

B | 4 | U.S.C.T.

Philip L. Boant

Prv., Co. K, 4 Reg't U. S. Col'd Infantry.

Appears on

Company Muster Roll

for *Sept. + Oct.*, 186*5*.

Joined for duty and enrolled :

When *Sept. 1*, 186*3*.*

Where *Baltimore* *

Period *3* years.*

Present or absent *Present.*

Stoppage, \$ *100* for

Due Gov't, \$ *100* for

Remarks: _____

* See enrollment on card from muster-in roll.

Book mark: _____

Philipson

(358c)

Copyist.

E. | **4** | **U.S.C.T.**

Phillip L Brent

Priv, Co. K, 4 Reg't U. S. Col'd Infantry.

Appears on

Company Muster Roll

for *Nov. & Dec*, 1865.

Joined for duty and enrolled :

When *September 1*, 186*3*.*

Where *Baltimore Md.* *

Period *3* years.*

Present or absent *Present*

Stoppage, \$ *100* for

Due Gov't, \$ *100* for

Remarks:

Book mark:

J. M. Vance

J. | **4** | **U.S.C.T.**

Phillip L. Perry
.....
Pat., Co. K, 4 Reg't U. S. Col'd Infantry.

Appears on

Company Muster Roll

for *Jan & Feb.*, 186*6*.

Joined for duty and enrolled:

When *September 1*, 186*3*.*

Where *Waltham Mass*.*

Period *3* years.*

Present or absent *Present*

Stoppage, \$ *100* for

Due Gov't, \$ *100* for

Remarks:

NEXT ROLL ON FILE MUSTER OUT.

Book mark:

J. D. Haines

L | 4 | U.S.C.T.

Philip J. Grant
Sgt., Co. *K*, 4 Reg't U. S. Col'd Infantry.

Appears on Co. Muster-out Roll, dated
Washington D.C. May 4, 1866 .
Muster-out to date *May 4*, 1866 .
Last paid to *Feb 28*, 1866 .

Clothing account:

Last settled....., 186 ; drawn since \$.....¹⁰⁰
Due soldier \$.....¹⁰⁰; due U. S. \$ *14* ^{*47*}/_{*100*}
Am't for cloth'g in kind or money adv'd \$.....¹⁰⁰

Due U. S. for arms, equipments, &c., \$.....¹⁰⁰
Bounty paid \$.....¹⁰⁰; due \$.....¹⁰⁰ ^{*00*}/_{*100*}

Remarks: *Free on us before Apr*
19, 1861

Book mark: *305. 278*

(861) *J. H. Stance* Copyist.

145

Grewington, John H.

Coal, 4 U.S. Col'd Inf.

Private | Private

CARD NUMBERS.

1	5564376	26
2	5564476	27
3	5564576	28
4	5564679	29
5	5564775	30
6	5564945	31
7	5565950	32
8	9062551	33
9	Bq-05-1870	34
10		35
11		36
12		37
13		38
14		39
15		40
16		41
17		42
18		43
19		44
20		45
21		46
22		47
23		48
24		49
25		50

Book Mark: Bq-05-1870

See also Navy

B. | 4 | U.S.C.T.

John H Brewington
Co. A, 4 Reg't U. S. Col'd Inf.

Appears on

Company Descriptive Book

of the organization named above.

DESCRIPTION.

Age 19 years; height 6 feet 6 1/2 inches.

Complexion Blk

Eyes Blk; hair Blk

Where born Dorchester Md

Occupation Harmer

ENLISTMENT.

When Aug 11, 1863.

Where Baltimore Md

By whom Sgt W Burney; term 3 yrs.

Remarks:

Free Apr 19/61

Selah

B | 4 | U.S.C.T.

John A. Brewington
Cvt., Co. I, 4 Reg't U. S. Col'd Infantry.

Age 19 years.

Appears on

Company Muster-in Roll

of the organization named above. Roll dated

Baltimore Md Aug 11, 1863

Muster-in to date *Aug 11, 1863*

Joined for duty and enrolled:

When *August 11, 1863*

Where *Baltimore Md*

Period 3 years.*

Remarks:

* ~~See~~ Muster-in roll shows enrollment and muster-in of this company as of same date and place. See enrollment on subsequent card or cards.

Book mark: *3563*

G. Fox
Coryist.

B | 4 | U.S.C.T.

John F. Brewington
Cpt., Co. I, 4 Reg't U. S. Col'd Infantry.

Appears on

Company Muster Roll

for *Sept. & Oct.*, 186 *3*

Joined for duty and enrolled :

When *Aug. 11'*, 186 *3**

Where *Baltimore Md.**

Period *3* years.*

Present or absent *Present*

Stoppage, \$ *100* for

Due Gov't, \$ *100* for

Remarks :

.....
.....
.....
.....
.....

* See enrollment on card from muster-in roll.

Book mark :

.....

G. Fox
Copyist.

B | 4 | U.S.C.T.

John Brewington
Cvt., Co. I, 4 Reg't U. S. Col'd Infantry.

Appears on

Company Muster Roll

for Aug 11 to 31, 1863.

Joined for duty and enrolled :

When Aug. 11, 1863.*

Where Baltimore Md.*

Period 3 years.*

Present or absent Present

Stoppage, \$ 100 for

Due Gov't, \$ 100 for

Remarks: Stoppage for
one quarter. Two
dollars premium
due.

* See enrollment on card from muster-in roll.

Book mark :

G. Fox

B | 4 | U.S.C.T.

John H. Brewington
Cpt., Co. I, 4 Reg't U. S. Col'd Infantry.

Appears on

Company Muster Roll

for *Nov: 4 Dec.*, 186*3*.

Joined for duty and enrolled :

When *Aug: 11*, 186*3**

Where *Baltimore Md**

Period *3* years.*

Present or absent *Present*

Stoppage, \$ *100* for

Due Gov't, \$ *100* for

Remarks :

* See enrollment on card from muster-in roll.

Book mark :

G. F. N.
1
Copyst.

B | 4 | U.S.C.T.

John A. Brewington
Cvt., Co. I, 4 Reg't U. S. Col'd Infantry.

Appears on

Company Muster Roll

for *Jan. & Feb.*, 1864.

Joined for duty and enrolled:

When *Aug. 11th*, 1863.*

Where *Baltimore Md**

Period *3* years.*

Present or absent *Present*

Stoppage, \$ *100* for

Due Gov't, \$ *100* for

Remarks:

* See enrollment on card from muster-in roll.

Book mark: _____

G. F. J.
Copyist.

B | **4** | **U.S.C.T.**

John W. Brewington
Pr, Co. I, 4 Reg't U. S. Col'd Infantry.

Appears on

Company Muster Roll

for *Nov 9*, 186*1*.

Joined for duty and enrolled :

When *Aug 11*, 186*3*.*

Where *Baltimore Md* *

Period *3* years.*

Present or absent

Stoppage, \$ *100* for

Due Gov't, \$ *100* for

Remarks: *Transferred to the Army*
by General Order No 91
War Department at Point
LeFort. Oct 25th 1864

* See enrollment on card from muster-in roll.

Book mark :

W. J. ...

B. 1 4" U.S. b. J.

John H. Brewington,
Co. D, 4" Reg't U.S. b. J.

NOTATION.

Book mark: B. 9. b. J. 1870.

War Department,
Adjutant General's Office,

Washington, Jan'y. 14", 1870.

Transferred to the Navy
April 25, 1864.

E. P. Conrazier.

B | 4 | U.S.C.T.

John H. Brewerton
Pvt, Co. D, 4 Reg't U. S. Col'd Infantry.

Appears on Co. Muster-out Roll, dated
Washington DC, May 4, 1866.

Muster-out to date _____, 186 .

Last paid to _____, 186 .

Clothing account:

Last settled _____, 186 ; drawn since \$ _____ 100

Due soldier \$ _____ 100 ; due U. S. \$ _____ 100

Am't for cloth'g in kind or money adv'd \$ _____ 100

Due U. S. for arms, equipments, &c., \$ _____ 100

Bounty paid \$ _____ 100 ; due \$ _____ 100

Remarks: Transferred to U.S.M.
April 29, 1864

Book mark: V100:P237 by (over)

(861) Dallade Copyist.

JAN. 20

5565930

1891 *

*Transferred April 25, by
B. G. Vol. 8, C. T. 70.*

146

Brigham, Alfred M.

Co K, 4 U.S. Col'd Inf.

2nd Lieutenant | 2nd Lieutenant

CARD NUMBERS.

1	5550246	26
2	5566076	27
3	5566177	28
4	5566278	29
5	5566362	30
6	5566526	31
7	5567877	32
8	9428565	33
9		34
10		35
11		36
12		37
13		38
14		39
15		40
16		41
17		42
18		43
19		44
20		45
21		46
22		47
23		48
24		49
25		50

Book Mark:

See also

and. no. 1.
S 15-40248 ~~same~~
S 1688464 and. no. 1.
PSP 539838

B | 4 # | U.S.C.T.

Alfred M. Brigham
2^d Lieut, Co., 4th Reg't U. S. Col'd Inf.

Appears on

Regimental Descriptive Book

(List of Commissioned Officers)

of the regiment named above.

Rank 2^d Lieut

Date of appointment Aug 12th 1863.

Remarks: Reported for duty
assigned to Co K Par 3 80
24. 4th U.S.C.I. Sept 4. 63
killed in action before
Petersburg Va June 15. 64

J. J. [Signature]

D | 4 | U.S.C.T.

Alfred M. Brigham
 2^d Lt., Co., 4 Reg't U. S. Col'd Infantry.

Age 34 years.

Appears on an

Individual Muster-in Roll

of the organization named above. Roll dated
 Fort Monroe, Va., Nov. 17, 1863.

Muster-in to date Sep 3, 1863.

Joined for duty and enrolled:

When Sep 3, 1863.

Where Baltimore, Md.

Period 3 years.

Remarks: Mustered in according to War Office authority dated Sep 28/63 & signed C. M. Foster M. G.

Book mark :

(336)

Lowry

Copist.

S | 4 | U.S.C.T.

Alfred M. Brighton
7th, Co. K, 4 Reg't U. S. Col'd Infantry.

Appears on

Company Muster Roll

for *Sept & Oct*, 186 ³.

Joined for duty and enrolled:

When *Aug 12*, 186 ³.*

Where *Washington* *

Period *3* years.*

Present or absent *Absent*

Stoppage, \$ *100* for

Due Gov't, \$ *100* for

Remarks: *Reported for duty*
Sept. 4, acci-
dentally wounded
Oct. 10. Absent in
Gen Hospital at Ft.
Monroe.

Book mark:

P

4

U.S.C.T.

Alfred M. Brigham

2 Lt., Co. K, 4 Reg't U. S. Col'd Infantry.

Appears on

Company Muster Roll

for *Nov & Dec*, 186*3*.

Joined for duty and enrolled:

When *Sept 3*, 186*3*.*

Where *Washington* *

Period *3* years.*

Present or absent *Present*

Stoppage, \$ *100* for

Due Gov't, \$ *100* for

Remarks:

* See enrollment on card from muster-in roll.

Book mark:

John A. ...

P

4

U.S.C.T.

Alfred M. Brigham
2nd Lt, Co. K, 4 Reg't U. S. Col'd Infantry.

Appears on

Company Muster Roll

for *Jan'y & Feby*, 186*4*.

Joined for duty and enrolled :

When *Sept 3*, 186*3*.*

Where *Washington* *

Period years.*

Present or absent *Present*

Stoppage, \$ *100* for

Due Gov't, \$ *100* for

Remarks: *Due \$35.25*

*Amount due Hampton
 G.M. Hosp't. which a-
 mount had been paid
 by being taken out of pay
 due for Oct. & Nov. by (over)*

* See enrollment on card from muster-in roll.

Book mark :

Jan Hunter

P | 4 | **U.S.C.T.**

Alfred M. Brigham
2nd Lt., Co. K, 4 Reg't U. S. Col'd Infantry.

Appears on

Company Muster Roll

for *March & April*, 186*4*.

Joined for duty and enrolled :

When *Sept 3*, 186*3*.*

Where *Washington*.*

Period years.*

Present or absent *Present.*

Stoppage, \$ 100 for

Due Gov't, \$ 100 for

Remarks :
.....
.....
.....
.....
.....

* See enrollment on card from muster-in roll.

Book mark :
.....

Jan Newton
Copyist.

B

4

U.S.C.T.

Alfred M. Brigham
 2^d Lieut., Co. K, 4 Reg't U. S. Cold Infantry.

Appears on

Company Muster Roll

for May and June, 1864.

Joined for duty and enrolled:

When Sept. 2, 1864.*

Where Washington.*

Period 3 years.*

Present or absent

Stoppage, \$ 100 for

Due Gov't, \$ 100 for

Remarks; Detached as Act^y
Adjutant June 10" Killed
in action June 15. 1864
near Petersburg.

Book mark: No. 64. 749 Nov. 23. 1864

Bliss

B | 4 | U.S.C.T.

Alfred M Brigham
2^d Lieut, Co K, 4 Reg't U. S. Col'd Infantry.

Appears on Co. Muster-out Roll, dated
Washington D.C., May 14, 1866 .
Muster-out to date _____, 1866 .
Last paid to _____, 1866 .

Clothing account:

Last settled _____, 1866 ; drawn since \$ _____ 100
Due soldier \$ _____ 100 ; due U. S. \$ _____ 100
Am't for cloth'g in kind or money adv'd \$ _____ 100

Due U. S. for arms, equipments, &c., \$ _____ 100
Bounty paid \$ _____ 100 ; due \$ _____ 100

Remarks: Killed in action
June 15, 1864 Baylor's
Farm Va. while acting
Adj't of Reg't.

Book mark: 64.729

(861) J. M. Hance Copyist.

Brigham, Alfred M.

Lt, Co. K, 4 U.S.C. Inf.

5 Enclosures.

Bed Cards	Descriptive Lists
Burial Records	Final Statements
Certs. of Dis. for Discharge	Furloughs
C. M. Charges	Med. Des. Lists
Med. Certificates	Orders B A

Other papers relating to—

Admission to Hosp'l	Furlough
Casualty Sheet (Officer's)	Med. Examination
Confinement	Misc. Information 2
Contracts	Pay or Clothing
Death or Effects	Personal Reports
Desertions	Rank
Discharge from Hosp'l	Transfer to Hosp'l
Discharge from Service	Transfer to V. R. C.
Duty	Transportation

Head Qrs Middle Dept. 8th Army Corps
 Baltimore Md. Sept. 3^d. 1863 -

Special Orders }
 no. 237 }

1. Lieut. A. M. Brigham appointed to the 4th Regt.
 U. S. Col. Troops, having reported for duty at these Head-
 Quarters in accordance with instructions from the
 Secretary of War, will report to Col. Wm Bimney for duty.

By command of
 Maj. General Schenck

(Signed) W. H. Chesbrough
 Aft. Aft. General

Official:
 Marcus Daily
 Lt & Adjutant 4th U. S. C. Troops

Head Quarters 4th U. S. Col. Troops
 Birney Barracks, Sept. 4. 1863

Regimental Orders }
 no 24 }

III. Lieut. Alfred M. Brigham, appointed
 by the President 2nd Lieut. 4th Regt. U. S. Col. Troops, to
 rank as such from 12th August, having reported for
 duty on the 3rd inst., is hereby assigned to Co. "K."

By order of Wm Birney
 Colonel Commanding
 Marshall D. Pike
 Lieut. & Adjutant

Official:

Marshall D. Pike
 Lieut. & Adjutant.

27
A. M. Brigham
~~Lt. 4th U. S. C. Inf~~



Head Quarters Dept. of Virginia and North Carolina,

Fort Monroe, Va. Dec. 1 6th 1863.

SPECIAL ORDERS,

No. 149.

2^d Lt. A. M. Brigham. 4th U.S. Colored Infy. is hereby ordered to report to the commanding Officer of his regiment for duty without delay.

By Command of Major General BUTLER.

A. S. Davis

Assistant Adjutant General.

To Adjt. Genl.
USA.

U.S. Genl. Hospital, Hampton Va.
 M 208 ✓ Dec. 16th 1863

E. W. Sillan. Asst. Surgeon U.S. Army

Letter asking that Lieut. A. M. Brigham
 Co. K - 4th U.S. Col. Infy may be ordered
 to report at Hd. Quarters of his Regt.

Order

S. O. 1149/5-

Hd Qrs Dept Va & M. C Dec 16 1863

U. S. General Hospital
 Hampton Va.
 Dec. 16th 1863.

Major
 I have the honor to ask that the following
 named officer may be ordered to report at the head
 quarters of his Regiment, he being able to perform
 duty.

2nd Lt. A. M. Bighams. Co K. 2th U. S. Col. Regt.

Very respectfully
 Your obedient servant
 E M Williams
 Asst. Surgeon
 U. S. A.

Major R. L. Davis.
 Asst. Adj. General
 Dept. Va. & North Carolina.

In the Field Co.
Oct. 24th. 1864

Patterson, M.
Sr. 2^d U. S. C. T.
Judge Advocate

Notifies 2^d Lt. A. M. Brigham
U. S. C. T. to appear
before a Court Martial
convened at Hd. Qrs. 3^d Div.
18th A. C.

Hd. Qrs. 4th U. S. C. T.
In the Field Co. Oct. 24th 64

Respectfully returned to Sr.
M. Patterson 2^d U. S. C. T. Judge
Advocate, with the information
that 2^d Lt. A. M. Brigham of this
Regt. was killed in action
June 15th 1864 -

Wm. J. Hensley
Major Company

60
North Field, Va.
Oct. 24th / 864.

Sir,

You are hereby notified
to appear as a witness at 10 o'clock
A.M. this day, before a General
Court Martial, convened by Special
Orders No. 285. Hd. Qrs. Dept. Va. and N.C.
at Hd. Qrs 3rd Div. 18th A.C.

By Order of the Court
Marion Patterson
1st Lt. 22nd M.I.C.F.

2^d Lieut. J. M. Brigham
4th M.I.C.F.

Judge Advocate.

Thro. C. O. 4th M.I.C.F.

147

Bright Astbury

CoG, 4 U.S. Col'd Inf

Private | Private

CARD NUMBERS.

1	5561005	26
2	5561104	27
3	5561205	28
4	5561305	29
5	5561404	30
6	5561573	31
7	5562629	32
8	9062419	33
9		34
10		35
11		36
12		37
13		38
14		39
15		40
16		41
17		42
18		43
19		44
20		45
21		46
22		47
23		48
24		49
25		50

Book Mark:

See also *Navy*

B | 4 | U.S.C.T.

Asbury Bright

, Co. G, 4 Reg't U. S. Col'd Inf.

Appears on
Company Descriptive Book
of the organization named above.

DESCRIPTION.

Age 18 years; height 5 feet 5/4 inches.

Complexion Brown

Eyes Blue; hair Black

Where born Caroline Co. Md.

Occupation Farmer

ENLISTMENT.

When Aug 11, 1865.

Where Balt Md

By whom Col. Birney; term 3 y'rs.

Remarks: Transferred to Navy Apr 23/64
in accordance with G.O. no 91 dated
Nov Sept. 27/60. March 4/61

N. H. Merrill

Copyist.

B | 4 | U.S.C.T.

Asbury Bright

Put, Co. *G*, 4 Reg't U. S. Col'd Infantry.

Age *18* years.

Appears on

Company Muster-in Roll

of the organization named above. Roll dated

Baltimore Md, Aug 11, 1863.

Muster-in to date

Aug 11, 1863.

Joined for duty and enrolled:

When *Aug 11, 1863.*

Where *Baltimore City.*

Period *3* years.*

Remarks:

* If Muster-in roll shows enrollment and muster-in of this company as of same date and place. See enrollment on subsequent card or cards.

Book mark:

Rose

B | 4 | U.S.C.T.

Asbury Bright
Pat, Co. G, 4 Reg't U. S. Col'd Infantry.

Appears on

Company Muster Roll
for *Aug 11 to 31*, 186*3*

Joined for duty and enrolled:

When *Aug 11*, 186*3*

Where *Baltimore City* *

Period *3* years.*

Present or absent *Present*

Stoppage, \$ *100* for

Due Gov't \$ *100* for

Remarks:

* See enrollment on card from muster-in roll.

Book mark:

Rose

B | 4 | U.S.C.T.

Asbury Bright
Pat, Co. *G*, 4 Reg't U. S. Col'd Infantry.

Appears on

Company Muster Roll
for *Sept and Oct*, 186*3*

Joined for duty and enrolled:

When *Aug 11*, 186*3*.*

Where *Baltimore City* *

Period *3* years.*

Present or absent *Present*

Stoppage, \$ *100* for _____

Due Gov't \$ *100* for _____

Remarks: _____

* See enrollment on card from muster-in roll.

Book mark: _____

Rose

(358c)

Copyist.

B | 4 | U.S.C.T.

Asbury Bright
Priv., Co. G, 4 Reg't U. S. Col'd Infantry.

Appears on

Company Muster Roll
for Nov and Dec, 1863.

Joined for duty and enrolled:

When Aug 11, 1863*

Where Baltimore City *

Period 3 years.*

Present or absent Present

Stoppage, \$ 100 for

Due Gov't \$ 100 for

Remarks: Stop one cross belt
plate 7/100 one wiper 20/100
one screw driver 20/100 one
pair of shoulder scales 30/100
In confinement

* See enrollment on card from muster-in roll.

Book mark:

Ruse

B | 4 | U.S.C.T.

Asbury Bright
Pat, Co. G, 4 Reg't U. S. Col'd Infantry.

Appears on

Company Muster Roll
for *Jan Feb*, 186 *4*.

Joined for duty and enrolled:

When *Aug 11*, 186 *3*.*

Where *Baltimore City* *

Period *3* years.*

Present or absent *Present*

Stoppage, \$ *100* for

Due Gov't \$ *100* for

Remarks: *Not Paid since*
Oct 31, 1863 been under
arrest at date of last
Muster.

* See enrollment on card from muster-in roll.

Book mark:

Rose

B

4

U.S.C.T.

Asbury Bright

Priv., Co. G, 4 Reg't U. S. Col'd Infantry.

Appears on

Company Muster Roll

for Mar + Apr, 1864.

Joined for duty and enrolled:

When Aug 11, 1863.*

Where Baltimore Md *

Period 3 years.*

Present or absent.....

Stoppage, \$ 100 for.....

Due Gov't \$ 100 for.....

Remarks: Transferred by
enlistment into Naval
Service by Virtue of
G.O. No. 91 War Dept.
March 4/64.

* See enrollment on card from muster-in roll.

Book mark: 158.019.

10.621 2^{da} May 28/68.

E J Richardson

(358c)

Copyist.

151 4 U.S.C.T.

Asbury Bright
Priv, Co. G, 4 Reg't U. S. Col'd Infantry.

Appears on Co. Muster-out Roll, dated
Washington D.C. May 4, 1866 .

Muster-out to date _____, 186 .

Last paid to _____, 186 .

Clothing account:

Last settled _____, 186 ; drawn since \$ _____ 100

Due soldier \$ _____ 100; due U. S. \$ _____ 100

Am't for cloth'g in kind or money adv'd \$ _____ 100

Due U. S. for arms, equipments, &c., \$ _____ 100

Bounty paid \$ _____ 100; due \$ _____ 100

Remarks: Transferred to U.S.
W. Apr 29/64 G. Oct 19
War Dept AGO Mich 1/64

Book mark: 158019.106212 And May 28/68

(361)

(over)
T. H. Johnson
Copyist.

148

Bright. Miles

Co D., 4 U.S. Col'd Inf.

Private | Private

CARD NUMBERS.

1	5-5-5-6-1-5-7-	26
2	5-5-5-6-2-4-0	27
3	5-5-5-6-3-3-9	28
4	5-5-5-6-4-3-7	29
5	5-5-5-6-5-3-0	30
6	5-5-5-6-6-1-6	31
7	5-5-5-6-7-0-5	32
8	5-5-5-6-7-8-9	33
9	5-5-5-6-8-7-1	34
10	5-5-5-6-9-5-7	35
11	5-5-5-7-0-4-6	36
12	5-5-5-7-1-3-7	37
13	5-5-5-7-2-3-6	38
14	5-5-5-7-3-2-9	39
15	5-5-5-7-4-1-8	40
16	5-5-5-7-4-9-3	41
17	5-5-5-7-5-3-4	42
18	5-5-5-7-6-1-5	43
19	9065040	44
20		45
21		46
22		47
23		48
24		49
25		50

Book Mark:

See also

B

4

U.S.C.T.

Miles Bright

, Co. 10, 4 Reg't U. S. Col'd Inf.

Appears on

Company Descriptive Book

of the organization named above.

DESCRIPTION.

Age 18 years ; height 5 feet 4 inches.

Complexion Black

Eyes Dark ; hair Black

Where born Norfolk Va

Occupation Waiter

ENLISTMENT.

When July 28, 1863

Where Baltimore

By whom Col M. Barry ; term 3 y'rs.

Remarks: At Washington May 15 1865

joined Regt. May 24/65

On duty duty as Bugler

H. H. Merrill

B

4

U.S.C.T.

Miles Bright

Regt., Co. *D*, 4 Reg't U. S. Col'd Infantry.

Age *18* years.

Appears on

Company Muster-in Roll

of the organization named above. Roll dated

Baltimore, Md., July 28, 1863.

Muster-in to date

July 28, 1863.

Joined for duty and enrolled:

When *July 28*, 1863.*

Where *Baltimore* *

Period *3* years.*

Remarks:

* Muster-in roll shows enrollment and muster-in of this company as of same date and place. See enrollment on subsequent card or cards.

Book mark:

Franklin

18 | 4 | U.S.C.T.

Miles Bright
Co. D, 4 Reg't U. S. Col'd Infantry.

Appears on
Company Muster Roll
for July 28/63 to Aug 31, 1863.

Joined for duty and enrolled:
When July 28, 1863.*
Where Baltimore Md.*
Period 3 years.*

Present or absent present
Stoppage, \$ 100 for
Due Gov't \$ 100 for

Remarks: Stop for one canteen
\$2.00 Premium due.

* See enrollment on card from muster-in roll.

Book mark:

Faulkner
(358c) Copyist.

19 | 4 | **U.S.C.T.**

Miles Bright

Pvt, Co. D, 4 Reg't U. S. Col'd Infantry.

Appears on

Company Muster Roll

for Sept & Oct, 1863.

Joined for duty and enrolled:

When July 28, 1863.*

Where Baltimore Md *

Period 3 years.*

Present or absent present

Stoppage, \$ 100 for

Due Gov't \$ 100 for

Remarks:

* See enrollment on card from muster-in roll.

Book mark: -----

Gaultner
(858c) Copyist.

B | 4 | **U.S.C.T.**

Miles Bright

Co. D, Co. D, 4 Reg't U. S. Col'd Infantry.

Appears on

Company Muster Roll

for Nov & Dec, 1867.

Joined for duty and enrolled:

When July 28, 1867.*

Where Baltimore Md *

Period 3 years.*

Present or absent present

Stoppage, \$ 100 for _____

Due Gov't \$ 100 for _____

Remarks: _____

Faulkner

* See enrollment on card from muster-in roll.

B | 4 | U.S.C.T.

Miles Bright

Co., Co. D, 4 Reg't U. S. Col'd Infantry.

Appears on

Company Muster Roll

for Jan & Feby, 1864.

Joined for duty and enrolled:

When July 28, 1863.*

Where Baltimore Md)*

Period 3 years.*

Present or absent present

Stoppage, \$ 100 for

Due Gov't \$ 100 for

Remarks:

[Empty lines for remarks]

* See enrollment on card from muster-in roll.

Book mark:

Faulkner

B | *4* | **U.S.C.T.**

Miles Bright
Priv., Co. D, 4 Reg't U. S. Col'd Infantry.

Appears on

Company Muster Roll
 for *March + April*, 1864.

Joined for duty and enrolled:

When *July 28*, 1863.*

Where *Baltimore Md* *

Period *3* years.*

Present or absent *Present*

Stoppage, \$ *100* for _____

Due Gov't \$ *100* for _____

Remarks: _____

* See enrollment on card from muster-in roll.

Book mark: _____

W A Syler

B

4

U.S.C.T.

Miles Bright

Priv, Co. D, 4 Reg't U. S. Col'd Infantry.

Appears on

Company Muster Roll

for *May + June*, 1864.

Joined for duty and enrolled:

When *July 28*, 1863.*

Where *Baltimore Md**

Period *3* years.*

Present or absent *Present*

Stoppage, \$ *100* for

Due Gov't \$ *100* for

Remarks:

* See enrollment on card from muster-in roll.

Book mark:

W A Tyler

(858c)

Copyist.

B | 4 | U.S.C.T.

Miles Bright

Privt, Co. D, 4 Reg't U. S. Col'd Infantry.

Appears on

Company Muster Roll

for July & Aug, 1864.

Joined for duty and enrolled:

When July 28, 1863.*

Where Baltimore Md *

Period 3 years.*

Present or absent Present

Stoppage, \$ 100 for

Due Gov't \$ 100 for

Remarks: True on or before Apr 19, 1861

* See enrollment on card from muster-in roll.

Book mark:

W A Tyler

B | 4 | U.S.C.T.

Miles Bright
Priv., Co. D, 4 Reg't U. S. Col'd Infantry.

Appears on

Company Muster Roll
for Sept + Oct, 1864.

Joined for duty and enrolled:

When July 28, 1863.*

Where Baltimore Md.*

Period 3 years.*

Present or absent Present

Stoppage, \$ 100 for

Due Gov't \$ 100 for

Remarks: True on or before
Apr 19, 1864.

* See enrollment on card from muster-in roll.

Book mark:

W. S. Tyler
(858c) Copyist.

B | 4 | U.S.C.T.

Miles Bright

Priv., Co. D, 4 Reg't U. S. Col'd Infantry.

Appears on

Company Muster Roll

for Nov & Dec, 1864.

Joined for duty and enrolled:

When July 28, 1863.*

Where Baltimore *

Period 3 years.*

Present or absent Present

Stoppage, \$ 100 for

Due Gov't \$ 100 for

Remarks: True on or before Apr 19/61

* See enrollment on card from muster-in roll.

Book mark:

W A Tyler

B | 4 | U.S.C.T.

Miles Bright

Opt., Co. D, 4 Reg't U. S. Col'd Infantry.

Appears on

Company Muster Roll

for Jan. & Feb., 1863.

Joined for duty and enrolled:

When July 28, 1863.*

Where Baltimore *

Period 3 years.*

Present or absent Present,

Stoppage, \$ 100 for

Due Gov't \$ 100 for

Remarks: Free on or before Apr. 19/64,
As daily duty as Bugler
Stop for Shoulder Seals 50¢

* See enrollment on card from muster-in roll.

Book mark:

(858c) Eastaling Copyist.

B | 4 | U.S.C.T.

Miles Bright

Prvt, Co. D, 4 Reg't U. S. Col'd Infantry.

Appears on

Company Muster Roll

for Mar. & Apr., 1865.

Joined for duty and enrolled:

When July 28, 1863.*

Where Baltimore.*

Period 3 years.*

Present or absent Absent.

Stoppage, \$ 100 for

Due Gov't \$ 100 for

Remarks: Greou vs before Apr. 19/65.
Back pay due from Mar 1/64
& date of Muster-in. Absent
Sick Stop. for 2 calis 50¢.

* See enrollment on card from muster-in roll.

Book mark:

(858c)

Bestulring

Copyist.

B | 4 | U.S.C.T.

Miles Bright

Cpt, Co. D, 4 Reg't U. S. Col'd Infantry.

Appears on

Company Muster Roll

for May & June, 1865.

Joined for duty and enrolled:

When July 28, 1863.*

Where Baltimore *

Period 3 years.*

Present or absent Present

Stoppage, \$ 100 for _____

Due Gov't \$ 100 for _____

Remarks: Free Apr. 19/61. On daily
duty as Bugler. Stop for
Scale 50¢ Back pay
due from date of
muster in to May/64.

* See enrollment on card from muster-in roll.

Book mark: _____

(858c)

Castling

Copyist.

B | 4 | U.S.C.T.

Miles Bright
Cpt., Co. D, 4 Reg't U. S. Col'd Infantry.

Appears on

Company Muster Roll

for July & Aug., 1863.

Joined for duty and enrolled:

When July 28, 1863.*

Where Balt., Md. *

Period 3 years.*

Present or absent Present.

Stoppage, \$ 100 for

Due Gov't \$ 100 for

Remarks: Stop for 1 cart box
belt plate 9¢ & 1 cart
box plate 8¢

* See enrollment on card from muster-in roll.

Book mark:

(858c) Eastwing Copyist.

B | 4 | U.S.C.T.

Miles Bright

Priv., Co. D, 4 Reg't U. S. Col'd Infantry.

Appears on

Company Muster Roll

for Sept, & Oct,, 1865.

Joined for duty and enrolled:

When July 28, 1863.*

Where Baltimore *

Period 3 years.*

Present or absent Present

Stoppage, \$ 100 for _____

Due Gov't \$ 100 for _____

Remarks: Stop for Cap Number,
Letter & badge 3¢, Coat
Straps 12¢ Haversack 95¢
Canteen 65¢ = \$1.75.
On daily duty as Bugler

* See enrollment on card from muster-in roll.

Book mark: _____

Erstling

43 | 4 | U.S.C.T.

Miles Bright
Pot., Co. D, 4 Reg't U. S. Col'd Infantry.

Appears on

Company Muster Roll
for Nov & Dec, 1865.

Joined for duty and enrolled:

When July 28, 1863.*

Where Baltimore *

Period 3 years.*

Present or absent Present.

Stoppage, \$ 100 for

Due Gov't \$ 100 for

Remarks: Stop for hardware 79¢
canteen 65¢ scales 50¢ \$1.94

* See enrollment on card from muster-in roll.

Book mark:

Joiner

B | 4 | U.S.C.T.

Wiles Bright
Pt., Co. D, 4 Reg't U. S. Col'd Infantry.

Appears on

Company Muster Roll

for *Jan & Feb*, 1866.

Joined for duty and enrolled:

When *July 28*, 1863.*

Where *Baltimore* *

Period *9* years.*

Present or absent *Present*

Stoppage, \$ *100* for

Due Gov't \$ *100* for

Remarks: *In daily duty
as Bugler*

NEXT ROLL ON FILE MUSTER OUT.

* See enrollment on card from muster-in roll.

Book mark:

J. J. J. J.

(858c)

Copyist.

B. 1 4 U.S.C.T.

Miles Bright
Co., 4 Reg't U. S. Col'd Infantry.

Appears on Co. Muster-out Roll, dated
Washington DC, May 4, 1866.

Muster-out to date May 4, 1866.

Last paid to Feb 28, 1866.

Clothing account:

Last settled, 186 ; drawn since \$ 100

Due soldier \$ 6 ⁷² / 100; due U. S. \$ 100

Am't for cloth'g in kind or money adv'd \$ 100

Due U. S. for arms, equipments, &c., \$ 100

Bounty paid \$ 100; due \$ 100 / 100

Remarks: Free on or before
April 19, 61

Book mark: 160 1881

(861)

J. J. J. J.

Copyist.

149

Prisco. John

Co F, 4 U.S. Col'd Inf.

Private | Corporal.

CARD NUMBERS.

1	5559573	26
2	5559474	27
3	5559574	28
4	5559673	29
5	5559771	30
6	5559867	31
7	5559962	32
8	5560056	33
9	5560140	34
10	5560226	35
11	5560312	36
12	5560397	37
13	5560491	38
14	5560585	39
15	5560673	40
16	5560746	41
17	5560808	42
18	5560869	43
19	9062305	44
20		45
21		46
22		47
23		48
24		49
25		50

Book Mark:

See also

D. 2557276 pointer

2 Mrs. Holston 11/3/32

USVA 12/1/32 CRP

B

4

U.S.C.T.

John Briscoe

, Co. F, 4 Reg't U. S. Col'd Inf.

Appears on

Company Descriptive Book

of the organization named above.

DESCRIPTION.

Age 18 years ; height 5 feet 1 inches.

Complexion Black

Eyes Black ; hair Black

Where born Prince George Co. Md.

Occupation Farmer

ENLISTMENT.

When Aug 4, 1863 .

Where Baltimore Md.

By whom Col. Wm. Biney ; term 3 y'rs.

Remarks: Free on or before April 19/64

Absent from service and before Petersburg Va. June 15/64

Returned to duty Aug 30/64

W. H. Merrill

B | **4** | **U.S.C.T.**

John Arisco

Priv. Co. F, 4 Reg't U. S. Col'd Infantry.

Age *18* years.

Appears on

Company Muster-in Roll

of the organization named above. Roll dated

Baltimore Md, Aug 4, 1863.

Muster-in to date *Aug 4*, 1863.

Joined for duty and enrolled:

When *Aug 4th*, 1863.*

Where *Baltimore Md*.*

Period *3* years.*

Remarks:

* ~~See~~ Muster-in roll shows enrollment and muster-in of this company as of same date and place. See enrollment on subsequent card or cards.

Book mark: _____

Valentine

B

4

U.S.C.T.

John Brisco

Priv, Co. F, 4 Reg't U. S. Col'd Infantry.

Appears on

Company Muster Roll

for *Aug 4 to Aug 31*, 1863.

Joined for duty and enrolled:

When *Aug 4th*, 1863.*

Where *Baltimore Md.**

Period *3* years.*

Present or absent *Present*

Stoppage, \$ *100* for

Due Gov't \$ *100* for

Remarks:

No dollars premium due

* See enrollment on card from muster-in roll.

Book mark:

Valentine

P | 4 | U.S.C.T.

John Priscoe
Priv, Co. F, 4 Reg't U. S. Col'd Infantry.

Appears on

Company Muster Roll

for Sept. & Oct., 1863.

Joined for duty and enrolled:

When August 4th, 1863.*

Where Baltimore Md.*

Period 3 years.*

Present or absent Present.

Stoppage, \$ 100 for _____

Due Gov't \$ 100 for _____

Remarks: _____

* See enrollment on card from muster-in roll.

Book mark: _____

(858c)

Valentine

Copyist.

B. | 4 | U.S.C.T.

John Brisco

Priv, Co. F, 4 Reg't U. S. Col'd Infantry.

Appears on

Company Muster Roll

for *Nov & Dec*, 1863.

Joined for duty and enrolled:

When *August 4*, 1863.*

Where *Baltimore Md*,*

Period *3* years.*

Present or absent *Present*

Stoppage, \$ *100* for

Due Gov't \$ *100* for

Remarks:

* See enrollment on card from muster-in roll.

Book mark:

Valentine

B. | 4 | U.S.C.T.

John Briscoe
Pvt., Co. F, 4 Reg't U. S. Col'd Infantry.

Appears on

Company Muster Roll

for Jan. & Feb., 1864.

Joined for duty and enrolled:

When August 4., 1863.*

Where Baltimore Md.*

Period 3 years.*

Present or absent Present

Stoppage, \$ 100 for

Due Gov't \$ 100 for

Remarks:

* See enrollment on card from muster-in roll.

Book mark:

Valentine

B

4

U.S.C.T.

John Briscoe

Priv, Co. F, 4 Reg't U. S. Col'd Infantry.

Appears on

Company Muster Roll

for *Arch & Ap'l*, 1864.

Joined for duty and enrolled:

When *Aug 4*, 1863.*

Where *Balto Md* *

Period *3* years.*

Present or absent *present*

Stoppage, \$ *100* for

Due Gov't \$ *100* for

Remarks:-----

* See enrollment on card from muster-in roll.

Book mark:-----

VanSoren

(858e) Copyist.

B | 4 | **U.S.C.T.**

John Brisco
Prvt, Co. F, 4 Reg't U. S. Col'd Infantry.

Appears on

Company Muster Roll

for May & June, 1864.

Joined for duty and enrolled:

When Aug 4, 1863.*

Where Balto Md *

Period 3 years.*

Present or absent Absent

Stoppage, \$ 100 for _____

Due Gov't \$ 100 for _____

Remarks: Absent sick wound-
ed in action before Peters-
burg Va June 15/64.

* ~~See~~ See enrollment on card from muster-in roll.

Book mark: _____

Wustoren

B | 4 | U.S.C.T.

John Brisco
Col, Co. F, 4 Reg't U. S. Col'd Infantry.

Appears on

Company Muster Roll

for *July & Augt*, 1864.

Joined for duty and enrolled:

When *Augt 4*, 1863.*

Where *Baltimore Md.* *

Period *3* years.*

Present or absent *present*

Stoppage, \$ *100* for

Due Gov't \$ *100* for

Remarks: *Free on or before Apr 19/61.*

* See enrollment on card from muster-in roll.

Book mark:

Van Doren
(858c) Copyist.

B

4

U.S.C.T.

John Price

Plt, Co. F, 4 Reg't U. S. Col'd Infantry.

Appears on

Company Muster Roll

for *Sept 1864*, 1864.

Joined for duty and enrolled:

When *Aug 4*, 1863.*

Where *Balto Md* *

Period *3* years.*

Present or absent *Present*

Stoppage, \$ *100* for

Due Gov't \$ *100* for

Remarks: *Free at or before
Apr 19/67 - Due Co. G
Cooper Sutter \$200*

* See enrollment on card from muster-in roll.

Book mark:

Vandoren

B

4

U.S.C.T.

John Prisco
priv, Co. F, 4 Reg't U. S. Col'd Infantry.

Appears on

Company Muster Roll

for *Nov 1 Dec*, 1864.

Joined for duty and enrolled:

When *Aug 4*, 1863.*

Where *Balto, Md* *

Period *3* years.*

Present or absent *Present*

Stoppage, \$ *100* for

Due Gov't \$ *100* for

Remarks: *Free before Apr*
19/61 - Due W.C. Cooper
Butler \$200

* See enrollment on card from muster-in roll.

Book mark:

Paul Soren

P | 4 | U.S.C.T.

John Prisco
Pvt., Co. F, 4 Reg't U. S. Col'd Infantry.

Appears on

Company Muster Roll

for *Jan'y 1865*, 1865.

Joined for duty and enrolled:

When *Aug 4*, 186³.*

Where *Baltimore Md.* *

Period *3* years.*

Present or absent *Present*

Stoppage, \$ *100* for

Due Gov't \$ *100* for

Remarks *Free before Apl 14 1861*

*Due W. C. Cooper
Sutler 4" reg. Co. 2.00*

* See enrollment on card from muster-in roll.

Book mark:

Linden
(858c) Copyist.

B | 4 | U.S.C.T.

John Pusey
Co., Co. F, 4 Reg't U. S. Col'd Infantry.

Appears on

Company Muster Roll

for *March & April*, 1865.

Joined for duty and enrolled:

When *Aug 4*, 186*3*.*

Where *Baltimore Md*.*

Period *3* years.*

Present or absent *Present*

Stoppage, \$ *100* for

Due Gov't \$ *100* for

Remarks: *Free before April 19th 1861. Back pay due from May 1st 61 to enrollment*

* ~~See~~ See enrollment on card from muster-in roll.

Book mark:

Juden

B | 4 | U.S.C.T.

John Priscoe
Pr., Co. F, 4 Reg't U. S. Col'd Infantry.

Appears on

Company Muster Roll

for May & June, 1865.

Joined for duty and enrolled:

When Aug 4, 1863.*

Where Baltimore Md.*

Period 3 years.*

Present or absent Present

Stoppage, \$ 100 for

Due Gov't \$ 100 for

Remarks:

* See enrollment on card from muster-in roll.

Book mark:

(858c)

Linden

Copyist.

~

P

4

U.S.C.T.

John Prisco
Cpt., Co. F, 4 Reg't U. S. Col'd Infantry.

Appears on

Company Muster Roll

for *July & Aug*, 1865.

Joined for duty and enrolled:

When *Aug 4*, 1865.*

Where *Baltimore Md.**

Period *3* years.*

Present or absent *Present*

Stoppage, \$ *100* for

Due Gov't \$ *100* for

Remarks:

* See enrollment on card from muster-in roll.

Book mark:

(868c)

Linden

Copyist.

D | *H* | U.S.C.T.

John *Prusey*
Prh, Co. A, 4 Reg't U. S. Col'd Inf.

Appears on

Company Muster Roll

for *Sep. + Oct* 1865.

Joined for duty and enrolled:

When *Aug. 4, 1865**

Where *Baltimore Md.**

Period *3* years.*

Present or absent *Absent*

Stoppage, \$ *100* for

Due Gov't, \$ *100* for

Valuation of horse, \$ *100*

Valuation of horse equipments, \$ *100*

Remarks: *Absent Sick*

* See enrollment on card from muster-in roll.

Book-mark :

Linden
Copyist.

B | 4 | U.S.C.T.

John Busico
Pri, Co. F, 4 Reg't U. S. Col'd Infantry.

Appears on

Company Muster Roll
for *Nov & Dec*, 1865.

Joined for duty and enrolled:

When *Aug 4*, 1863.*

Where *Baltimore Md* *

Period *3* years.*

Present or absent *Present*

Stoppage, \$ *100* for

Due Gov't \$ *100* for

Remarks:

* See enrollment on card from muster-in roll.

Book mark: _____

Busico
(858c) Copyist.

P | **4** | **U.S.C.T.**

John Prisco
Corp, Co. F, 4 Reg't U. S. Col'd Infantry.

Appears on

Company Muster Roll

for *Jan & Feb*, 186*6*.

Joined for duty and enrolled:

When *Aug 4*, 186*6*.*

Where *Baltimore Md* *

Period *3* years.*

Present or absent *Present*

Stoppage, \$ *100* for

Due Gov't \$ *100* for

Remarks: *Promoted Corp. from
Pri. Feb 6/66 by S. O. no
19 from Regt. Med Drs.*

NEXT ROLL ON FILE MUSTER OUT.

* See enrollment on card from muster-in roll.

Book mark:

Currier
(858c) Copyist.

J | 4 | U.S.C.T.

John Prisco
Corp., Co. F, 4 Reg't U. S. Col'd Infantry.

Appears on Co. Muster-out Roll, dated
Washington D. C., May 4, 1866.
Muster-out to date May 4, 1866.
Last paid to Feb 28, 1866.

Clothing account:

Last settled _____, 186 ; drawn since \$ _____ 100
Due soldier \$ 8 21 / 100; due U. S. \$ _____ 100
Am't for cloth'g in kind or money adv'd \$ _____ 100

Due U. S. for arms, equipments, &c., \$ _____ 100

Bounty paid \$ _____ 100; due \$ 100 / 100

Remarks: Private to Feb 6, 1866
Stop for Springfield Rifle
Musket & accoutrements retained.
Free on or before Apr 19/61

Book mark: V 69 P 146. 69
PV 18 P 53. 71

Currier

Briseo, John

Co. G, 4 Reg't 75th Div

Enclosures.

Bed Cards	Final Statements
Burial Records	Furloughs or L. of A.
Certs. of Dis. for Discharge	Med. Certificates
C. M. Charges	Med. Des. Lists
Descriptive Lists	Orders
Discharge Certificates	Pris. of War Record
Enlistment Papers	Resignations

Other papers relating to—

Admission to Hosp'l	Furlough or L. of A. ✓
Casualty Sheet	Med. Examination
Confinement	Misc. Information
Contracts	Pay or Clothing
Death or Effects	Personal Reports
Desertion	Rank
Discharge from Hosp'l	Transfer to Hosp'l
Discharge from Service	Transfer to V. R. C.
Duty	Transportation

Front Station D.C.
March 13th 1866

S. Dillenbach J. W.
Capt. 4th U.S.C.I.
Comdy. Co. "F"

Ask that a furlough
of fifteen (15) days
be granted Corporal
John Brisco of his
Company.

app.
M.D.

W. Q. H. M. U.S. Infantry
Fort Lincoln D.C. Mar. 14th 66

Respectfully forwarded
Attn

No. of men present	44
Absent on furlough	0
Applications pending	0

W. Hill
Major Comd.

P.O. 256-110.
Head Qrs: Defense of Wash.
Washington D.C. Mar 14. 1866.
Respectfully forwarded.
Approved.

J. A. Easton
Dir: General Comd.

RECEIVED
ARMY CORPS
MAR 15 1866

Fort Stanton D.C.

March 13th 1866

Lieut. George Allen
Adjutant 4th U.S.C.I.

Sir -

I have the honor
to request that a furlough of fifteen
(15) days be granted to Corporal
John Briscoe of my Company.
This man's faithfulness as a Soldier
fully entitles him to the indulgence
asked for -

Very Respectfully
Yr. Obedt. Servant
John W. Dillenbach
Capt. Co. 7th 4th U.S.C.I.

150 Allison
Brooks. ~~Address~~

Co C., 4 U.S. Col'd Inf.

Private

CARD NUMBERS.

1	55555-10	26
2	5555688	27
3	5556102	28
4	9061898	29
5		30
6		31
7		32
8		33
9		34
10		35
11		36
12		37
13		38
14	/	39
15		40
16		41
17		42
18		43
19		44
20		45
21		46
22		47
23		48
24		49
25		50

Book Mark:

See also

B1

4

U.S.C.T.

Allison Brooks

....., Co....., 4 Reg't U. S. Col'd Inf.

Appears on

Company Descriptive Book

of the organization named above.

DESCRIPTION. *Not given*

Age..... years ; height..... feet..... inches.

Complexion

Eyes..... ; hair.....

Where born

Occupation

ENLISTMENT.

When....., 18; .

Where

By whom.....; term..... y'rs.

Remarks: *No enlistment papers
ever rec'd. Died June 24/65.*

Ward

B

4

U.S.C.T.

Allison Brooks

Priv, Co. C. 4 Reg't U. S. Col'd Infantry.

Appears on

Company Muster Roll

for *March & April*, 1865.

Present or absent *not stated*

Stoppage, \$ 100 for

Due Gov't, \$ 100 for

Remarks: *No enlistment papers rec'd.*

Book mark: *708*

Perrin
Copyist

(858)

B

4

U.S.C.T.

Allison Brooks

Pvt, Co. C. 4 Reg't U. S. Col'd Infantry.

Appears on

Company Muster Roll

for May & June, 1865.

Present or absent

Stoppage, \$ 100 for

Due Gov't, \$ 100 for

Remarks: No enlistment - Papers
Rec'd. Died in Reg't.
Hospt. Newbern N.C.
June 24-65.

Book mark:

Perrington

(358)

Copyist.

P. | 4 | U.S.C.T.

* *Pattison*
Gettysburg Brocks
Put, Co. *B*, 4 Reg't U. S. Col'd Infantry.

Appears on Co. Muster-out Roll, dated
Washington DC, May 4, 1866.

Muster-out to date _____, 186 .

Last paid to _____, 186 .

Clothing account:

Last settled _____, 186 ; drawn since \$ _____ 100

Due soldier \$ _____ 100; due U. S. \$ _____ 100

Am't for cloth'g in kind or money adv'd \$ _____ 100

Due U. S. for arms, equipments, &c., \$ _____ 100

Bounty paid \$ _____ 100; due \$ _____ 100

Remarks: *Died June 24*
65 New Berne, Nc
of disease
No. enrollmunt
ever recd.

* *Corrected by*
Book mark: *See list of*
(over)

R. Johnson
Copyist.

JAN. 19

5556102

1891 *

deserters from Fort
McHenry Md.
P.O. 35 P 165, 76

Brooks Allison

P, Co. C, 4 Reg't U. S. C. I

2 Enclosures.

Bed Cards	Final Statements
Burial Records	Furloughs or L. of A
Certs. of Dis. for Discharge	Med. Certificates
C. M. Charges	Med. Des. Lists
Descriptive Lists	Orders
Discharge Certificates	Pris. of War Record
Enlistment Papers	Resignations

Other papers relating to—

Admission to Hosp'l	Furlough or L. of A
Casualty Sheet	Med. Examination
Confinement	Misc. Information
Contracts	Pay or Clothing
Death or Effects	Personal Reports
Desertion	Rank
Discharge from Hosp'l	Transfer to Hosp'l
Discharge from Service	Transfer to V. R. C.
Duty	Transportation

Extract from Act of Congress.

SEC. 12. *And be it further enacted,* That the fees of agents and attorneys for making out and causing to be executed the papers necessary to establish a claim for a pension, bounty, and other allowance before the Pension Office, under this act, shall not exceed the following rates: For making out and causing to be duly executed a declaration by the applicant, with the necessary affidavits, and forwarding the same to the Pension Office, with the requisite correspondence, ten dollars; which sum shall be received by such agent or attorney in full for all services in obtaining such pension, and shall not be demanded or received, in whole or in part, until such pension shall be obtained, and the sixth and seventh sections of an act entitled "An act to grant pensions," approved July [fourteenth,] eighteen hundred and sixty-two, are hereby repealed.

SEC. 13. *And be it further enacted,* That any agent or attorney who shall, directly or indirectly, demand or receive any greater compensation for his services under this act than is prescribed in the preceding section of this act, or who shall contract or agree to prosecute any claim for a pension, bounty, or other allowance under this act, on the condition that he shall receive a per centum upon any portion of the amount of such claim, or who shall wrongfully withhold from a pensioner or other claimant the whole or any part of the pension or claim allowed and due to such pensioner or claimant, shall be deemed guilty of a high misdemeanor, and, upon conviction thereof, shall, for every such offense, be fined not exceeding three hundred dollars, or imprisoned at hard labor not exceeding two years, or both, according to the circumstances and aggravations of the offense.

Approved July 4, 1864.

NOTE 10.—If any soldier is charged a higher fee than that allowed by the above act, he should report the fact and the name of the agent to the Adjutant General, in order that steps may be taken to have the same refunded.

ADJUTANT GENERAL'S OFFICE
Nov 1. 1865.
 Duplicate with Inventory sent 2d Auditor.

FINAL STATEMENT. *9.*

OF

Allison Brooks
4th Reg't of U.S.C. Inf.

VOLUNTEERS.

Paid June 24. 1865.

NOTE 1.—Two of these certificates (or duplicates) are to be given to each Volunteer Soldier or drafted man who may be discharged without being mustered out (Final Statements are never given to men mustered out of service) that he may at once receive from the Paymaster the pay, &c., due to him, and the captain or other COMMISSIONED officer commanding the company will certify to the act of the delivery of the duplicate certificates; with these certificates the Soldier is "entitled to" his discharge, and should also present his discharge to the Paymaster to have the payment endorsed on it. The discharge is to be given back to the Soldier by the Paymaster; the latter only retaining as his vouchers the duplicate certificates.

NOTE 2.—If the Soldier is entitled to pay for the use of his horse, the Company Commander will certify to that fact on the back of both these final statements, and also to the time he has pay due for having been so mounted on his own horse.

NOTE 3.—When a Soldier is furnished with final statements, his descriptive list, if he has one, should be taken up by the officer who gives the Soldier these statements, and endorsed with a statement to this effect by the officer. The endorsement should exhibit a full statement of the time for which the Soldier was allowed pay on his final statements, the clothing account, and all other charges against him or in his favor, so as to comprise a complete exhibit of his account. It will then be transmitted to the Company Commander of the Soldier, who will enter all the data necessary to a full understanding of the Soldier's account on the muster roll upon which the Soldier's discharge is reported. The descriptive list will then be destroyed. The object of this is, that the remaining portion of the Soldier's account may be settled upon the receipt of these muster rolls, and the Soldier receive any pay or allowances that may be due him at the time of his discharge, and which may not appear on his last final statements from the fact that his descriptive list is incomplete. These accounts for back pay, &c., are settled by the 2d Auditor of the Treasury Department.

NOTE 4.—Charges for loss or injury to ordnance, horse equipments, and other miscellaneous charges, should appear under the heading of "Other Stoppages."

NOTE 5.—Bounty paid by State authorities, and not by the United States, will not be entered on this statement.

NOTE 6.—Amounts due the Sutler and Laundry must be entered on the muster roll on which the discharge, death, desertion, &c., is reported, as well as on the final statement, otherwise the amount cannot be collected from the United States.

NOTE 7.—This blank will be used for deceased volunteers and drafted men, as well as for others.

NOTE 8.—Where a Soldier dies in Hospital or on detached service, his descriptive list, if he has one, should be sent with his final statements, in duplicate, to the Adjutant General, Washington, D. C.

NOTE 9.—If the soldier is a drafted man or substitute, the space for time, &c., of enrolled, should contain only the word *drafted* or *substitute*, as the case may be. If the Soldier is a "VETERAN," (OR RECRUIT,) the words *as a veteran*, (or *recruit*,) as the case may be, should be interlined after the words *mustered into the service of the U. S.* A statement of all the installments of *Veteran* or *Recruit* Bounty RECEIVED by the Soldier must be made on the back of each final statement.

Out on O.R. 1865.

This man was assigned to this company as a recruit on the 10th day of April 1861. No enlistment papers have been received in regard to him. Application has been made to the A. G. O. for them - and the application was returned with the endorsement that his name did not appear on the files in the office as ever having been sent to this regiment.

I certify, on honor, that Allison Brooks, a Private of
Captain A. M. Houge's Company (6) of the 4th Regiment of M. S. C. Inf
Volunteers, of the State of _____, born in _____ State
of _____, aged _____ years; _____ feet _____ inches high; _____ complexion,
_____ eyes, _____ hair, and by occupation a _____, who joined for service
and was enrolled (see Note 9) on the _____ day of _____, 186 _____, at _____
by _____, for the period of _____ years, and mustered into
the service of the United States on the _____ day of _____, 186 _____, at _____,
by _____; and having served

HONESTLY and **FAITHFULLY** with his Company to the present date, is now entitled to a
DISCHARGE by reason of Death Died of disease
in Regt Hospital New Bern N.C. June 24th 1864

The said Allison Brooks was last paid by Paymaster
No payment was made while with the regiment
_____ to include the _____ day of _____, 186 _____, and
has pay due him from that time to the present date; he is entitled to pay and subsistence for
TRAVELING to place of enrollment, and whatever other allowances are authorized to volunteer
soldiers, drafted men, or militia, so discharged. He has received from the United States **CLOTHING**
amounting to Unknown dollars, since the _____ day of _____,
186 _____, when his clothing account was last settled. He has received from the United States
Unknown dollars advanced **BOUNTY**.

There is to be stopped from him, on account of the State of _____, or other
authorities, for **CLOTHING**, &c., received on entering service, Unknown dollars; and
for other stoppages, viz: Nothing while with his company.

_____ dollars.
He has been furnished with **TRANSPORTATION** in kind from the place of his discharge to _____;
and he has been **Subsisted** for **Traveling** to his
place of enrollment, up to the _____, 186 _____.

He is indebted to _____, **Sutler**, _____ dollars.
He is indebted to _____, **Laundress**, _____ dollars.

Given in Duplicate, at Washington DC, this 27th day
of October 1864.

Sam Gillingham
Plt Squad 4th M S C I
Commanding Company. "C"

[A. G. O. No. 95—First.]

Enlistments are not in that application to make out his final papers in this manner.

Albion Brooks
Co. C. 40th Regt.

D. F. D. C. report your
record of ~~service~~
absence.

Adjutant General's Office,

COLORED TROOPS BRANCH,

Mr Ellertson

Sept 8, 1876

Vol. _____ C. T., 187

Wanted in the case of *Allison Brooks*, Co. *"G"*,
4th Reg't *U. S. C. T.* Cause of Absence _____

*He is reported on Muster Roll for about
April 1865 - absent (cause not stated)*

Respectfully,

E. A. Mendenhall

Chief Clerk.

per J. T.

Adjutant General's Office,

_____, 187

Vol. _____ C. T., 187

Reply in case of *Allison Brooks*, Co. *"G"*,
4th Reg't *U. S. C. T.*

*Name appears upon M. Book of Company
with remark. No enlistment paper ever
recd. Died June 24th 65.*

*Mor. reports cov. March apr. May
& June 65. not on file.*

Rept. 12-76. P.

1515

Brooks, Daniel

Co G , 4 U.S. Col'd Inf.

Private

Private

CARD NUMBERS.

1	5550517	26
2	5561871	27
3	5561957	28
4	5562046	29
5	5562146	30
6	5562243	31
7	5562400	32
8	5562634	33
9	5550750	34
10	9062426	35
11	B56-01-1873	36
12		37
13		38
14		39
15		40
16		41
17		42
18		43
19		44
20		45
21		46
22		47
23		48
24		49
25		50

Book Mark: B. 56 710 01.43

See also

NARRA 1211

81874902 P.O. m.m.
P2074878P. O. aff.

B

4

U.S.C.T.

Daniel Brooks

, Co. *G*, 4 Reg't U. S. Col'd Inf.

Appears on

Company Descriptive Book

of the organization named above.

DESCRIPTION.

Age years ; height *5* feet *7* inches.

Complexion *Black*

Eyes *Black* ; hair *Black*

Where born *Landon Co. Va.*

Occupation *Laborer*

ENLISTMENT.

When *Aug. 30*, 18*64*.

Where *Hayter Co.*

By whom *Capt Miller* ; term *1* y'rs.

Remarks: *Mustered out in obedience to G.O. No. — dated War Dept. Aug. May 2/65 at Fort Monroe Va. June 9th /65*

H. H. Mill

(3837)

Copyist.

B | 4 | U.S.C.T.

Daniel Brooks

Appears with rank of *Private* on

Muster and Descriptive Roll of a Detachment of U. S. Vols. forwarded

for the 4 Reg't U. S. Co'd Infantry. Roll dated

Dayton Ohio Sept 6, 1864.

Where born *London Co. Virginia*

Age *28* y'rs; occupation *laborer*

When enlisted *Aug. 30, 1864.*

Where enlisted *Dayton O.*

For what period enlisted _____ years.

Eyes *black*; hair *black*

Complexion *black*; height *5* ft. *7* in.

When mustered in *Aug. 30, 1864.*

Where mustered in *Dayton O.*

Bounty paid \$ *100*; due \$ *100*

Where credited _____

Company to which assigned _____

Remarks: *Credited to Third Ward Hamilton*

Butler Co. Sub District 23, 3^d District

Ohio. Forwarded to Camp

Delaware September 6/64

Book mark: _____

H. H. Hawley
(839) Copyst.

B | 4 | U.S.C.T.

Daniel Brooks
Rt, Co. G, 4 Reg't U. S. Col'd Infantry.

Appears on

Company Muster Roll

for Nov + Dec, 1864

Joined for duty and enrolled:

When Aug 30, 1864*

Where Dayton O. *

Period 1 years.*

Present or absent Not stated

Stoppage, \$ 100 for

Due Gov't \$ 100 for

Remarks: A recruit
assigned to Co. G.
Nov. 18/64.

* See enrollment on card from muster-in roll.

Book mark:

E. Richardson

(358c)

Copyist.

B

4

U.S.C.T.

Daniel Brooks

Prvt, Co. G, 4 Reg't U. S. Col'd Infantry.

Appears on

Company Muster Roll

for Dated Feb 28, 1865.

Joined for duty and enrolled:

When Aug 30, 1864.*

Where Dayton Ohio *

Period 1 years.*

Present or absent Absent

Stoppage, \$ 100 for

Due Gov't \$ 100 for

Remarks: Recruit assigned to Co. G Nov 18/64 Absent sick.

* See enrollment on card from muster-in roll.

Book mark:

Ackerman

B

4

U.S.C.T.

Daniel Brooks

Pvt, Co. G, 4 Reg't U. S. Col'd Infantry.

Appears on

Company Muster Roll

for Mar + Apr, 1865.

Joined for duty and enrolled:

When Aug 30, 1864.*

Where Dayton Ohio *

Period 3 years.*

Present or absent Absent

Stoppage, \$ 100 for

Due Gov't \$ 100 for

Remarks: Recruit assigned to Co. G, Nov 18/64. Absent sick

* See enrollment on card from muster-in roll.

Book mark:

Ackerman

B | 4 | U.S.C.T.

Daniel Brooks

Pvt, Co. G, 4 Reg't U. S. Col'd Infantry.

Appears on

Company Muster Roll

for May + June, 1865.

Joined for duty and enrolled:

When Aug 30, 1864.*

Where Dayton Ohio *

Period 1 years.*

Present or absent Absent

Stoppage, \$ 100 for _____

Due Gov't \$ 100 for _____

Remarks: Recruit assigned to
Co G Nov 18/64, absent sick.

* See enrollment on card from muster-in roll.

Book mark: _____

Ackerman

B

4

U.S.C.T.

Daniel Brooks

Pvt., Co. G, 4 Reg't U. S. Col'd Infantry.

Appears on

Company Muster Roll

for July + Aug, 1865.

Joined for duty and enrolled:

When Aug 30, 1864*

Where Dayton, O.*

Period 1 years.*

Present or absent Absent

Stoppage, \$ 100 for _____

Due Gov't \$ 100 for _____

Remarks: Back pay due from
enlistment to May 1/64, ab-
sent sick

* See enrollment on card from muster-in roll.

Book mark: _____

Ackerman

(358c)

Copyist.

B | 4 | U.S.C.T.

Daniel Brooks

Pat, Co. G, 4 Reg't U. S. Col'd Infantry.

Appears on

Company Muster Roll

for Sept + Oct, 1865.

Joined for duty and enrolled:

When Aug 30, 1864.*

Where Daton Ohio *

Period 1 years.*

Present or absent _____

Stoppage, \$ 100 for _____

Due Gov't \$ 100 for _____

Remarks: Mustered out of Ser-
vice by Order of War Dept
dated May 3/65 Patron
U.S. Hosp Ft Monroe Va.

* ~~See~~ See enrollment on card from muster-in roll.

Book mark: Discharged June 9/65

A. Kerman

(358c)

Copyist.

NARA 1228

JAN. 19

5562400

1891 *

B 56. 8. 10. 6. J. 73.

B | 4 | U.S.C.T.

Daniel Brooks
Pvt., Co. *G*, 4 Reg't U. S. Col'd Infantry.

Appears on **Co. Muster-out Roll**, dated
Washington D.C. May 4, 1866

Muster-out to date _____, 186 .
Last paid to _____, 186 .

Clothing account:

Last settled _____, 186 ; drawn since \$ _____ 100
Due soldier \$ _____ 100 ; due U. S. \$ _____ 100
Am't for cloth'g in kind or money adv'd \$ _____ 100

Due U. S. for arms, equipments, &c., \$ _____ 100
Bounty paid \$ _____ 100 ; due \$ _____ 100

Remarks: *Mustered out of*
service in obedience
to G. O. War Dept
A. G. O. May 3/65 Ft.
Monroe Va June 7/65

Book mark: *Discharged June 9/65*
(over)

J. A. Johnson
Copyist.

JAN. 20

5562634

* 1891 *

B. 56 V. 10. C. J. 73.

P. V 27. P. 7. 73

*Master Cut Roll
on file*

B | 4 | U.S.C.T.

Daniel Broake
Pat, Co. *G*, *4* Reg't U. S. Col'd *Inf.*

Appears on an

Individual Muster-out Roll

of the organization named above. Roll dated

Fort Monroe, Va., June, 186*5*.

Muster-out to date *June 9*, 186*5*.

Last paid to *Dec. 31*, 186*4*.

Clothing account:

Last settled *Never*, 186; drawn since \$ *100*

Due soldier \$ *100*; due U. S. \$ *100*

Am't for cloth'g in kind or money adv'd \$ *26* ^{*50*} *100*

Due U. S. for arms, equipments, &c., \$ *100*

Bounty paid \$ *100* due \$ *100*

Remarks: *Mustered out by order of War Dept, dated May 3, 1865. Patient in U.S. Genl. Hospital, Fort Monroe, Va.*

Book mark: _____

(348)

Fitz
 Copyist
Compr.

B 1 4 U.S.A.

Daniel Brooks

, Co. 2, 4 Reg't U.S.A.

SB 10
523

NOTATION.

Book mark: B. 56. 6. 7. 1873

War Department,

Adjutant General's Office,

Washington April 21, 1873.

Discharged June 9, 1865.

C. C. Coen
Copyist.

¹⁵²
Brooks, George H.

Co H, 4 U.S. Col'd Inf.

Private

Private

CARD NUMBERS.

1	5562707	26
2	5562807	27
3	5562906	28
4	5563008	29
5	5563103	30
6	5563196	31
7	5563290	32
8	5563378	33
9	5563462	34
10	5563546	35
11	5563648	36
12	5563748	37
13	5563850	38
14	5563941	39
15	5564035	40
16	5564122	41
17	5564180	42
18	5564233	43
19	9062660	44
20		45
21		46
22		47
23		48
24		49
25		50

Book Mark:

See also

S- 1030255 }
1030256 } *Small*
D2760667 *POR.*

B. | 4 | U.S.C.T.

George W Brooks

, Co. N, 4 Reg't U. S. Col'd Inf.

Appears on

Company Descriptive Book

of the organization named above.

DESCRIPTION.

Age 22 years ; height 5 feet 9 1/4 inches.

Complexion Blk

Eyes Dark ; hair Curly

Where born Carolina Co, Md

Occupation Laborer

ENLISTMENT.

When Aug 11, 1863 .

Where Baltimore Md

By whom Col Burney ; term 3 y'rs.

Remarks: Free on or before
Apr 19/61

Mustered out May 4/66
by order of Secy of War

Selah

B

4

U.S.C.T.

George W. Brooks

Private Co H, 4 Reg't U. S. Col'd Infantry.

Age *22* years.

Appears on

Company Muster-in Roll

of the organization named above. Roll dated

Aug 11, 1863.

Muster-in to date

Aug 11, 1863.

Joined for duty and enrolled:

When *Aug 11*, 1863.*

Where *Baltimore City* *

Period *3* years.*

Remarks:

* Muster-in roll shows enrollment and muster-in of this company as of same date and place. See enrollment on subsequent card or cards.

Book mark:

M. A. Michaels

(356c)

Copyist.

3 | 4 | U.S.C.T.

George W. Brooks
Priv., Co. H, 4 Reg't U. S. Col'd Infantry.

Appears on

Company Muster Roll

for Aug 11 to Aug 31, 1863.

Joined for duty and enrolled:

When Aug. 11, 1863.*

Where Baltimore City *

Period 9 years.*

Present or absent Present

Stoppage, \$ 100 for

Due Gov't \$ 100 for

Remarks:

* See enrollment on card from muster-in roll.

Book mark:

(858c)

M. A. Michaels
Copyist.

B | 4 | U.S.C.T.

George W. Brooks
Priv., Co. H, 4 Reg't U. S. Col'd Infantry.

Appears on

Company Muster Roll

for *Sept & Oct*, 1863.

Joined for duty and enrolled:

When *Aug. 11*, 1863.*

Where *Baltimore City* *

Period *3* years.*

Present or absent *Present*

Stoppage, \$ *100* for

Due Gov't \$ *100* for

Remarks:

* See enrollment on card from muster-in roll.

Book mark:

M. A. Michaels

(858c)

Copyist.

B | 4 | U.S.C.T.

George W. Brooks
Priv., Co. H, 4 Reg't U. S. Col'd Infantry.

Appears on

Company Muster Roll

for Nov & Dec, 1863.

Joined for duty and enrolled:

When Aug. 11, 1863.*

Where Baltimore City *

Period 3 years.*

Present or absent Present.

Stoppage, \$ 100 for

Due Gov't \$ 100 for

Remarks:

* See enrollment on card from muster-in roll.

Book mark:

M. A. Michaels

(358c)

Copyist.

B | 4 | U.S.C.T.

George W. Brooks
Priv., Co. H, 4 Reg't U. S. Col'd Infantry.

Appears on

Company Muster Roll

for Jan + Febr, 1864.

Joined for duty and enrolled:

When Aug. 11, 1863.*

Where Baltimore City *

Period 3 years.*

Present or absent Present

Stoppage, \$ 100 for

Due Gov't \$ 100 for

Remarks:

* See enrollment on card from muster-in roll.

Book mark:

M. A. Michaels
Copyist:

B | 4 | U.S.C.T.

George W. Brooks,
Pvt., Co. H, 4 Reg't U. S. Col'd Infantry.

Appears on

Company Muster Roll
for Mich. & Apr., 1864.

Joined for duty and enrolled:

When Aug 11, 1863.*

Where Baltimore City*

Period 3 years.*

Present or absent Present

Stoppage, \$ 100 for

Due Gov't \$ 100 for

Remarks:

* See enrollment on card from muster-in roll.

Book mark: _____

(358c) C. F. Thompson Copyist.

B

4

U.S.C.T.

George W. Brooks
Private, Co. H, 4 Reg't U. S. Col'd Infantry.

Appears on

Company Muster Roll

for *May & June*, 1864.

Joined for duty and enrolled:

When *Aug. 11*, 1863.*

Where *Baltimore City*.*

Period *3* years.*

Present or absent *Absent*.

Stoppage, \$ *100* for _____

Due Gov't \$ *100* for _____

Remarks: *Sick in Gen. Hosp.*

* See enrollment on card from muster-in roll.

Book mark: _____

(858c)

C. F. Thompson

Copyist.

B | 4 | U.S.C.T.

George W. Brooks
Priv., Co. H, 4 Reg't U. S. Col'd Infantry.

Appears on

Company Muster Roll

for *July & Aug.*, 1864.

Joined for duty and enrolled:

When *Aug. 11*, 1863.*

Where *Baltimore City**

Period *3* years.*

Present or absent *Absent*

Stoppage, \$ *100* for

Due Gov't \$ *100* for

Remarks: *Sick in General Hospital*

* See enrollment on card from muster-in roll.

Book mark:

C. F. Thompson
 Copyist.

B | 4 | U.S.C.T.

George Brooks
Out, Co. H, 4 Reg't U. S. Col'd Infantry.

Appears on

Company Muster Roll
 for *Sept & Oct*, 1864.

Joined for duty and enrolled:

When *Aug. 11*, 1863.*
 Where *Baltimore, Md.**
 Period *3* years.*

Present or absent *Absent*

Stoppage, \$ *100* for

Due Gov't \$ *100* for

Remarks: *Sick in Gen. Hosp.*

* See enrollment on card from muster-in roll.

Book mark:

C. F. Thompson
 Copyist.

B | 4 | U.S.C.T.

George W. Brooks
Priv., Co. H, 4 Reg't U. S. Col'd Infantry.

Appears on

Company Muster Roll

for *Nov. & Dec.*, 186*4*.

Joined for duty and enrolled:

When *Aug. 11*, 186*4*.*

Where *Baltimore* *

Period *3* years.*

Present or absent *Absent*

Stoppage, \$ *100* for

Due Gov't \$ *100* for

Remarks: *Absent sick.*

* See enrollment on card from muster-in roll.

Book mark:

C. F. Hooper

B | 4 | U.S.C.T.

George W. Brooks

Private, Co. H, 4 Reg't U. S. Col'd Infantry.

Appears on

Company Muster Roll

for Jan & Feb, 1865.

Joined for duty and enrolled:

When Aug 11, 1863.*

Where Baltimore Md *

Period 3 years.*

Present or absent Absent

Stoppage, \$ 100 for

Due Gov't \$ 100 for

Remarks: Absent sick

* See enrollment on card from muster-in roll.

Book mark: -----

Bowman

B | 4 | U.S.C.T.

George W. Brooks

Priv, Co. H, 4 Reg't U. S. Col'd Infantry.

Appears on

Company Muster Roll

for *Mar & Apr*, 1865.

Joined for duty and enrolled:

When *Aug 11*, 1863.*

Where *Baltimore Md**

Period *3* years.*

Present or absent *Present*

Stoppage, \$ *100* for

Due Gov't \$ *100* for

Remarks: *Free on or before April 19th 1861. Back Pay due from May 1. 1864 to date of muster into service*

* See enrollment on card from muster-in roll.

Book mark:

Bowman

B | 4 | U.S.C.T.

George W. Brooks

Priv....., Co. H, 4 Reg't U. S. Col'd Infantry.

Appears on

Company Muster Roll

for *May & June*....., 1865.

Joined for duty and enrolled:

When *Aug 11*....., 1863.*

Where *Baltimore Md*.....*

Period *3* years.*

Present or absent *Absent*

Stoppage, \$.....100 for.....

Due Gov't \$.....100 for.....

Remarks: *Back pay due from enlistment to May 1.64*
Absent sick

* See enrollment on card from muster-in roll.

Book mark:.....

Bowman

B | 4 | U.S.C.T.

George W. Brooks

Pvt., Co. H, 4 Reg't U. S. Col'd Infantry.

Appears on

Company Muster Roll

for Jul & Aug, 1865.

Joined for duty and enrolled:

When Aug 11, 1865.*

Where Baltimore Md *

Period 3 years.*

Present or absent Present

Stoppage, \$ 100 for

Due Gov't \$ 100 for

Remarks:

[Empty lines for remarks]

* See enrollment on card from muster-in roll.

Book mark:

(858c) Bowman Copyist.

B | 4 | U.S.C.T.

George W. Brooks

Priv, Co. H, 4 Reg't U. S. Col'd Infantry.

Appears on

Company Muster Roll

for *Sept & Oct*, 1865.

Joined for duty and enrolled:

When *Aug 11*, 1863.*

Where *Baltimore Md* *

Period *3* years.*

Present or absent *Present*

Stoppage, \$ *100* for

Due Gov't \$ *100* for

Remarks: *Back pay due from enlistment to May 1/64*
Free before April 19/61

* See enrollment on card from muster-in roll.

Book mark:

Bowman

13. | 4 | U.S.C.T.

George W. Brooks,
Priv., Co. H, 4 Reg't U. S. Col'd Infantry.

Appears on

Company Muster Roll

for *Novr. 4th Decbr.*, 186*3*.

Joined for duty and enrolled:

When *August 11*, 186*3*.*

Where *Baltimore, Md.* *

Period *3* years.*

Present or absent *Present.*

Stoppage, \$ *100* for

Due Gov't \$ *100* for

Remarks:

* See enrollment on card from muster-in roll.

Book mark:

E. J. Grammer

10. | **4** | **U.S.C.T.**

George W. Brooks,
Priv., Co. H, 4 Reg't U. S. Col'd Infantry.

Appears on

Company Muster Roll

for *Jamieson Feby*, 186*6*.

Joined for duty and enrolled:

When *August 11*, 186*3**

Where *Baltimore, Md.*

Period *3* years.*

Present or absent *Present*

Stoppage, \$ *100* for

Due Gov't \$ *100* for

Remarks:

~~NEXT ROLL ON FILE MUSTER OUT~~

* See enrollment on card from muster-in roll.

Book mark:

(858c)

E. W. Grauner

Copyist.

13. | 4 | U.S.C.T.

George W. Brooks,
Priv., Co. H., 4 Reg't U. S. Col'd Infantry.

Appears on **Co. Muster-out Roll**, dated
Washington, D. C. May 4, 1866.

Muster-out to date *May 4, 1866.*

Last paid to *Feb'y. 28, 1866.*

Clothing account:

Last settled....., 186 ; drawn since \$..... 100

Due soldier \$ *17.⁵⁰* 100; due U. S. \$..... 100

Am't for cloth'g in kind or money adv'd \$..... 100

Due U. S. for arms, equipments, &c., \$..... 100

Bounty paid \$..... 100; due \$ *100.* 100

Remarks: *Free.*

Book mark :

(861)

R. S. Spruener

Copyist.

Brooks, George
 P, Co. 4 Reg't U.S.C.

2 Enclosures.

Bed Cards	2	Descriptive Lists
Burial Records		Final Statements
Certs. of Dis. for Discharge		Furloughs
C. M. Charges		Med. Des. Lists
Med. Certificates		Orders

Other papers relating to—

Admission to Hosp'l	Furlough
Casualty Sheet (Officer's)	Med. Examination
Confinement	Misc. Information
Contracts	Pay or Clothing
Death or Effects	Personal Reports
Desertions	Rank
Discharge from Hosp'l	Transfer to Hosp'l
Discharge from Service	Transfer to V. R. C.
Duty	Transportation

Hospital Number 3679. B
 Name George Brooks
 Age 23 Nativity America
 Married or Single Single
 Residence Eastern Shore
 Post Office address of wife or nearest relative. } Emeline Brooks
 } Eastern Shore Md.
 Rank Private Co. H Regiment 4th U.S.C.
 When admitted Aug 17 85
 From what source McClellan's Army
~~at Fort Sumner~~
 Diagnosis: (in surgical cases state explicitly seat and character of wound or injury.)
Contusion
from kick of a
horse
 Summit House G. H.
 On what occasion wounded Philadelphia, Pa.
 Date Aug 17 85
 Nature of missile or weapon ...

Hospital Number 127
 Name George Brooks
 Age 35 Nativity Md.
 Married or Single ...
 Residence Md.
 Post Office address of wife or nearest relative. } Emeline Brooks
 } Centerville Md.
 Rank Priv Co. H Regiment 4 U.S.C.
 When admitted June 29 85
 From what source Field
 Diagnosis: (in surgical cases state explicitly seat and character of wound or injury.)
Remittent Fever!
 Post Hospital,
 New Berne, N. C.
 On what occasion wounded ...
 Date ...
 Nature of missile or weapon ...

TREATMENT.

[HERE NOTE IMPORTANT COMPLICATIONS AND ALL OPERATIONS.]

Sinamoni & Tonic

RESULT AND DATE.

*Transferred to junk
Oct-21/64*

*Returned to Duty
2. 6. /65
94
H.C.*

TREATMENT.

[HERE NOTE IMPORTANT COMPLICATIONS AND ALL OPERATIONS.]

RESULT and DATE.

*Returned to duty
7 July 29th*

¹⁵³
Brooks, Horace

Co 26, 4 U.S. Col'd Inf.

Pruitt | Private

CARD NUMBERS.

1	5563548	26
2	5563653	27
3	5563750	28
4	5563852	29
5	5563943	30
6	5564078	31
7	5564263	32
8	5560988	33
9	9062669	34
10		35
11		36
12		37
13		38
14		39
15		40
16		41
17		42
18		43
19		44
20		45
21		46
22		47
23		48
24		49
25		50

Book Mark:

See also

S-841697-P.O. aff-

51241594 Draft

A 1247528 Draft

S-2230428 P.O. in m

B | 4 | U.S.C.T.

Horace Brooks
Co. H, 4 Reg't U. S. Col'd Inf.

Appears on
Company Descriptive Book
of the organization named above.

DESCRIPTION.

Age 27 years ; height 5 feet 7 inches.
Complexion *Blk*
Eyes *Brown* ; hair *Blk*
Where born *Mason Co, Ky*
Occupation *Farmer*

ENLISTMENT.

When *Sept 2*, 1861 .
Where *Hillsboro, O*
By whom *Capt J. Marley*; term *1* y'rs.

Remarks: *Mustered out of
service Sept 3/65. Expira
tion of enlistment*

Selah
Copyist.

B | 4 | U.S.C.T.

Horace Brooks

Priv., Co. H, 4 Reg't U. S. Col'd Infantry.

Appears on

Company Muster Roll

for Nov. & Dec., 1864.

Joined for duty and enrolled:

When Sept. 2, 1864.*

Where Hillsboro, O. *

Period 1 years.*

Present or absent Present

Stoppage, \$ 100 for _____

Due Gov't \$ 100 for _____

Remarks: _____

* ~~See~~ See enrollment on card from muster-in roll.

Book mark: _____

(358c)

C. F. Thompson

Copyist.

B

4

U.S.C.T.

Horace Brooks

Pvt, Co. H, 4 Reg't U. S. Col'd Infantry.

Appears on

Company Muster Roll

for *Jan & Feb*, 1865.

Joined for duty and enrolled:

When *Sept 2*, 1864.*

Where *Hillsboro O* *

Period *1* years.*

Present or absent *Present*

Stoppage, \$ *100* for

Due Gov't \$ *100* for

Remarks:

* See enrollment on card from muster-in roll.

Book mark: -----

(858c)

Bowman

Copyist.

B | 4 | U.S.C.T.

Horace Brooks

Pvt., Co. H, 4 Reg't U. S. Col'd Infantry.

Appears on

Company Muster Roll

for Mar & Apr, 1865.

Joined for duty and enrolled:

When Sept 2, 1864.*

Where Hillsboro O. *

Period 1 years.*

Present or absent Present

Stoppage, \$ 100 for

Due Gov't \$ 100 for

Remarks:

[Empty lines for remarks]

* See enrollment on card from muster-in roll.

Book mark:

Bowman

B

4

U.S.C.T.

Horace Brooks

Pvt, Co. H, 4 Reg't U. S. Col'd Infantry.

Appears on

Company Muster Roll

for May + June, 1865.

Joined for duty and enrolled:

When Sept- 2, 1864.*

Where Hillsboro O *

Period 1 years.*

Present or absent Present

Stoppage, \$ 100 for

Due Gov't \$ 100 for

Remarks:

* See enrollment on card from muster-in roll.

Book mark:

Bowman

B

4

U.S.C.T.

Horace Brooks

Priv, Co. H, 4 Reg't U. S. Col'd Infantry.

Appears on

Company Muster Roll

for *Jul & Aug*, 1865.

Joined for duty and enrolled:

When *Sept-2*, 1864.*

Where *Hillsboro O.* *

Period *1* years.*

Present or absent *Present*

Stoppage, \$ *100* for

Due Gov't \$ *100* for

Remarks:

* See enrollment on card from muster-in roll.

Book mark:

Bowman

B | 4 | U.S.C.T.

Horace Brooks

Pvt, Co. H, 4 Reg't U. S. Col'd Infantry.

Appears on

Company Muster Roll

for *Sept & Oct*, 1865.

Joined for duty and enrolled:

When *Sept 2*, 1864.*

Where *Hillsboro O.* *

Period *1* years.*

Present or absent _____

Stoppage, \$ *100* for _____

Due Gov't \$ *100* for _____

Remarks: *Mustered out by reason of expiration of term of service at New Bern N.C. Sept 5/65*

* See enrollment on card from muster-in roll.

Book mark: _____

Bowman

13. | 4 | U.S.C.T.

Horace Brooks,
Private, Co. H., 4 Reg't U. S. Col'd Infantry.

Appears on **Co. Muster-out Roll**, dated
Washington, D.C., May 4, 1866.

Muster-out to date _____, 186 .

Last paid to *June 30, 1865.*

Clothing account:

Last settled _____, 186 ; drawn since \$ _____ 100

Due soldier \$ _____ 100; due U. S. \$ _____ 100

Am't for cloth'g in kind or money adv'd \$ _____ 100

Due U. S. for arms, equipments, &c., \$ _____ 100

Bounty paid \$ *100*; due \$ _____ 100

Remarks: *Discharged for expi-*
ration of enlistment Sept.
5, 1865.

(age 24, Enrol'd mfm Sept 9/61
at Hillsboro O. 1 year)

Book mark: *1355. 1879.*

(861)

R. S. Greener
 Copyist.

79 | 4 U.S.C.T.

Abrae Brooks
Ork, N, 4 Reg't U. S. Col'd Infantry.

Appears on a

Detachment Muster-out Roll

of the organization named above. Roll dated

New Bern, NC, Sept 5, 1865.

Muster-out to date

Sept 5, 1865.

Last paid to

June 30, 1865

Clothing account:

Last settled June 30, 1865; drawn since None $\frac{00}{100}$

Due soldier \$ $\frac{100}{100}$; due U. S. \$ $\frac{100}{100}$

Am't for cloth'g in kind or money adv'd \$ $\frac{100}{100}$

Due U. S. for arms, equipments, &c., \$ $\frac{6}{100}$

Bounty paid \$ $\frac{100}{100}$ due \$ $\frac{100}{100}$

Remarks Muster + accountments
retained Mustered out by reason
of Expiration of term of Service
transportation due from place
of Discharge to place of Co
achment

Book mark:

Jacobson

Brooks, Horace

Co. _____,

Reg't _____

U.S.A.

Enclosures.

Bed Cards	Final Statements
Burial Records	Furloughs or L. of A.
Certs. of Dis. for Discharge	Med. Certificates
C. M. Charges	Med. Des. Lists
Descriptive Lists	Orders
Discharge Certificates	Pris. of War Record
Enlistment Papers	Resignations

Other papers relating to—

Admission to Hosp'l	Furlough or L. of A.
Casualty Sheet	Med. Examination
Confinement	Misc. Information
Contracts	Pay or Clothing
Death or Effects	Personal Reports
Desertion	Rank
Discharge from Hosp'l	Transfer to Hosp'l
Discharge from Service	Transfer to V. R. C.
Duty	Transportation

DECLARATION OF RECRUIT.

I, Horace Brooks, desiring to VOLUNTEER as a Soldier in the Army of the United States, for the term of 3 YEARS months Do Declare, That I am Twenty Seven years of age; that I have never been discharged from the United States service on account of disability or by sentence of a court martial, or by order before the expiration of a term of enlistment; and I know of no impediment to my serving honestly and faithfully as a soldier for 3 years

GIVEN at Willsboro Ch the 2 day of September 1864
Witness: Horace Brooks
Mark

27
Colored Unassigned
B/64 No.
Horace Brooks
Volunteered at Willsboro Ch
September 2, 1864,
By Cap J. S. ...
6th Regt of 6th Ill Ch

..... enlistment; last served in Company ()

Reg't of

Discharged, 18

18" Drill dress
Uniform of
Brown Co
6" dress D

CONSENT IN CASE OF MINOR.

I,, Do CERTIFY, That I am, that the, years of age; and I do hereby freely give my CONSENT to his volunteering as a SOLDIER in the ARMY OF THE UNITED STATES for the period of THREE YEARS.

GIVEN at, the, day of

Witness:

NOTE 1.—This blank will be used for both enlistments and re-enlistments—enlistment of veterans, &c., &c., in the volunteer service. They will be made out in duplicate in all cases—one to accompany the recruiting return of the superintendent (not the recruiting officer) to the Adjutant General, and one to accompany the accounts of the officer who pays bounty, &c. The Regiment and Company in which the soldier last served should be given on the back.
NOTE 2.—An enlistment holds to service. A muster-in must, in all cases, precede payment of pay, bounty, pension, &c. A muster-in roll must, in all cases, be filed in the Adjutant General's Office as evidence of muster-in. The mustering officer, commissary, or assistant commissary of musters, as the case may be, will countersign both enlistments as having mustered the soldier into the service of the United States before either of them is given to the disbursing officer.

VOLUNTEER ENLISTMENT.

STATE OF

TOWN OF

Ohio

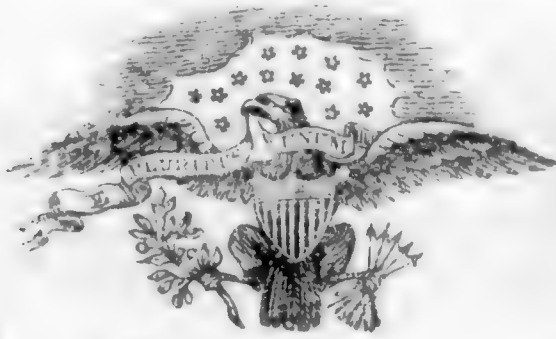

Millersburg

I, *Horace Brooks*, born in *Mason Co* in the State of *Kentucky*, aged *Twenty seven* years, and by occupation a *Farmer*, Do HEREBY ACKNOWLEDGE to have volunteered this *second* day of *September*, 1864, to serve as a **Soldier** in the **Army of the United States of America**, for the period of ~~THREE~~ **YEARS**, unless sooner discharged by proper authority: Do also agree to accept such bounty, pay, rations, and clothing, as are, or may be, established by law for volunteers. And I, *Horace Brooks*, do solemnly swear, that I will bear true faith and allegiance to the **United States of America**, and that I will serve them honestly and faithfully against all their enemies or opposers whomsoever; and that I will observe and obey the orders of the President of the United States, and the orders of the officers appointed over me, according to the Rules and Articles of War.

Sworn and subscribed to, at *Millersburg* this *2^d* day of *Sept*, 1864, BEFORE *Jos Mearley* *Horace Brooks* *mark*
Capt P. Mearley *6th Ohio*

I CERTIFY, ON HONOR, That I have carefully examined the above-named Volunteer, agreeably to the General Regulations of the Army, and that, in my opinion, he is free from all bodily defects and mental infirmity, which would in any way disqualify him from performing the duties of a soldier.

David Noble
Surgeon Board of Enlistment
C^o Dist O
EXAMINING SURGEON.

I CERTIFY, ON HONOR, That I have minutely inspected the Volunteer *Horace Brooks* previously to his enlistment, and that he was entirely sober when enlisted; that, to the best of my judgment and belief, he is of lawful age; and that, in accepting him as duly qualified to perform the duties of an able-bodied soldier, I have strictly observed the Regulations which govern the recruiting service. This soldier has *Brown* eyes, *Black* hair, *Black* complexion, is *Five* feet *Seven* inches high.

Jos Mearley
Capt P. Mearley *6th Ohio* *Volunteers,*
RECRUITING OFFICER.

(A. G. O. No. 74 & 76.)

Mustered into the service of the United States, for ~~the~~ *one* year or during the war, from date of enlistment, in Company *Millersburg* Regiment of *Volunteers*, on the *2^d* day of *September*, 1864, at *Millersburg Ohio*

Jos Mearley
Capt P. Mearley
6th Ohio

154

Brooks, Lloyd

Co B, 4 U.S. Col'd Inf.

Private | *Corporal*

CARD NUMBERS.

1	5550350	26
2	5553004	27
3	5553103	28
4	5553199	29
5	5553295	30
6	5553387	31
7	5553470	32
8	5553560	33
9	5553641	34
10	5553722	35
11	5553810	36
12	5553890	37
13	5553987	38
14	5554079	39
15	5554166	40
16	5554247	41
17	5554314	42
18	5554380	43
19	9061769	44
20		45
21		46
22		47
23		48
24		49
25		50

Book Mark:

See also

A107H15-1 P.O. man
S-2184235 P.O. Rita

B | 4 | U.S.C.T.
Lloyd Brooks
....., Co. "B", 4 Reg't U. S. Col'd Inf.

Appears on
Company Descriptive Book
of the organization named above.

DESCRIPTION.

Age 19 years; height 5 feet 5 1/2 inches.
Complexion black
Eyes black; hair black
Where born Washington, Md.
Occupation sailor

ENLISTMENT.

When Aug. 25, 1863.
Where Baltimore
By whom Col. Birney; term 3 y'rs.

Remarks:

Ward

B. | 4

U.S.C.T.

Lloyd Brooks

Co. B., 4 Reg't U. S. Col'd Infantry.

Age 19 years.

Appears on a

Detachment Muster-in Roll

of the organization named above. Roll dated

Baltimore Md. Aug. 26, 1863.

Muster-in to date Aug. 26, 1863.

Joined for duty and enrolled:

When Aug. 26, 1863.

Where Baltimore Md.

Period 3 years.

Remarks:

Book mark:

(337)

Hawling

Copyist.

B. | 4 | U.S.C.T.

Lloyd Brooks,
Pvt., Co. B, 4 Reg't U. S. Col'd Infantry.

Appears on

Company Muster Roll
for July 21 to Aug. 31, 1863

Joined for duty and enrolled:

When August 28th, 1863*

Where Baltimore *

Period 3 years.*

Present or absent Present

Stoppage, \$ 100 for

Due Gov't \$ 100 for

Remarks: Premium due \$200

* See enrollment on card from muster-in roll.

Book mark:

Ironstaal Copyist.

B. | 4 | U.S.C.T.

Lloyd Brooks,
Priv., Co. B, 4 Reg't U. S. Col'd Infantry.

Appears on

Company Muster Roll

for Sept & Oct, 1863

Joined for duty and enrolled:

When August 28th, 1863*

Where Baltimore *

Period 3 years.*

Present or absent Present

Stoppage, \$ 100 for

Due Gov't \$ 100 for

Remarks:

* See enrollment on card from muster-in roll.

Book mark:

J. M. Hall

B. | 4 | U.S.C.T.

Lloyd Brooks,
Priv., Co. B, 4 Reg't U. S. Col'd Infantry.

Appears on

Company Muster Roll
for Nov. & Dec., 1863

Joined for duty and enrolled:

When Aug 25, 1863

Where Baltimore *

Period 3 years.*

Present or absent Not stated

Stoppage, \$ 100 for

Due Gov't \$ 100 for

Remarks:

* See enrollment on card from muster-in roll.

Book mark:

John Wall
(358c) Copyist.

B. | 4 | U.S.C.T.

Lloyd Brooks,
Pvt., Co. B, 4 Reg't U. S. Col'd Infantry.

Appears on

Company Muster Roll
for Jan'y & Feb'y, 186 3

Joined for duty and enrolled:

When Aug 25, 186 3*

Where Baltimore*

Period 3 years.*

Present or absent Present

Stoppage, \$ 100 for

Due Gov't \$ 100 for

Remarks: Jobn charged 41
Wiper²⁰, 1 cauteen

* See enrollment on card from muster-in roll.

Book mark:

Mowhall

B

4

U.S.C.T.

Lloyd Brooks

Private, Co. B, 4 Reg't U. S. Col'd Infantry.

Appears on

Company Muster Roll

for March + April, 1864.

Joined for duty and enrolled:

When Aug. 25th, 1863.*

Where Baltimore, Md.*

Period 3 years.*

Present or absent Present.

Stoppage, \$ 100 for

Due Gov't \$ 100 for

Remarks:

* See enrollment on card from muster-in roll.

Book mark:

S M Clark

B | 4 | U.S.C.T.

Lloyd Brooks
Private, Co. B, 4 Reg't U. S. Col'd Infantry.

Appears on

Company Muster Roll

for May & June, 1864.

Joined for duty and enrolled:

When Aug 25th, 1863.*

Where Baltimore, Md.*

Period 3 years.*

Present or absent Present

Stoppage, \$ 100 for

Due Gov't \$ 100 for

Remarks:

* See enrollment on card from muster-in roll.

Book mark:

C. M. Clark
Copyist.

B | 4 | U.S.C.T.

Lloyd Brooks
Pat, Co. B, 4 Reg't U. S. Col'd Infantry.

Appears on

Company Muster Roll

for July & Aug., 1864.

Joined for duty and enrolled:

When Aug. 25th, 1863.*

Where Baltimore, Md *

Period 3 years.*

Present or absent Present.

Stoppage, \$ 100 for _____

Due Gov't \$ 100 for _____

Remarks: Slave

* See enrollment on card from muster-in roll.

Book mark: _____

C. M. Clark
 (358c) Copyist.

B | 4 | U.S.C.T.

Lloyd Brooks
Priv., Co. B, 4 Reg't U. S. Col'd Infantry.

Appears on

Company Muster Roll

for Sept + Oct, 1864.

Joined for duty and enrolled:

When Aug 25th, 1863.*

Where Baltimore, Md.*

Period 3 years.*

Present or absent Present

Stoppage, \$ 100 for

Due Gov't \$ 100 for

Remarks: Slave.

* See enrollment on card from muster-in roll.

Book mark: -----

(358c) C M Clark Copyist.

B | 4 | U.S.C.T.

Lloyd Brock
Private, Co. B, 4 Reg't U. S. Col'd Infantry.

Appears on

Company Muster Roll

for Nov + Dec, 1864.

Joined for duty and enrolled:

When Aug 25th, 1863.*

Where Baltimore Md.*

Period 3 years.*

Present or absent Present

Stoppage, \$ 100 for

Due Gov't \$ 100 for

Remarks: Free on or before
April 19, 1863.

* See enrollment on card from muster-in roll.

Book mark:

B M Clark

(358c)

Copyist.

B. | 4 | U.S.C.T.

Lloyd Brooks
Pr, Co. B, 4 Reg't U. S. Col'd Infantry.

Appears on

Company Muster Roll

for Jan & Feb., 1865.

Joined for duty and enrolled:

When Aug 25, 1863. *

Where Baltimore, Md. *

Period 3 years. *

Present or absent Present

Stoppage, \$ 100 for _____

Due Gov't \$ 100 for _____

Remarks: Slave prior before
Apr. 19, 1861.

* See enrollment on card from muster-in roll.

Book mark: _____

(358c) Burton Copyist.

B.

4

U.S.C.T.

Lloyd Brooks

Capt., Co. B, 4 Reg't U. S. Col'd Infantry.

Appears on

Company Muster Roll

for *March 1865*, 1865.

Joined for duty and enrolled:

When *Aug 25*, 1863.*

Where *Baltimore Md.* *

Period *3* years.*

Present or absent *Present*

Stoppage, \$ *100* for

Due Gov't \$ *100* for

Remarks: *Promoted to Capt. S. O. No. 14 dated April 9, '65 Md. Drs. 4" U.S.C.T. Stop, caution '65 1 pr. get. cash strap '12 77 '65.*

* See enrollment on card from muster-in roll.

Book mark:

Burton

B.

4

U.S.C.T.

Lloyd Brown

Co. B, 4 Reg't U. S. Col'd Infantry.

Appears on

Company Muster Roll

for May + June, 1865.

Joined for duty and enrolled:

When Aug 25, 1863.*

Where Baltimore, Md.*

Period 3 years.*

Present or absent Present

Stoppage, \$ 100 for

Due Gov't \$ 100 for

Remarks: No. 1 cauteen. 1 prgt cook

Stripes. Promoted to co. pl S. O.

No. 14 Apl. 9 '65 .77

Due W.C. Cooper Butler, 4th U.S. Ct.

\$10. Slave on or before Apl. 19/61

* See enrollment on card from muster-in roll.

Book mark:

Barton

(358c)

Copyist.

3. | 4 | U.S.C.T.

Lloyd Brooks
Capt., Co. B, 4 Reg't U. S. Col'd Infantry.

Appears on

Company Muster Roll

for *July & Aug.*, 1863.

Joined for duty and enrolled:

When *Aug. 25*, 1863.*

Where *Baltimore md* *

Period *3* years.*

Present or absent *Present*

Stoppage, \$ *100* for _____

Due Gov't \$ *100* for _____

Remarks: _____

* See enrollment on card from muster-in roll.

Book mark: _____

(358c) *Barton* Copyist.

B.

4

U.S.C.T.

Lloyd Brooks

Capt., Co. B, 4 Reg't U. S. Col'd Infantry.

Appears on

Company Muster Roll

for *Sep & Oct.*, 1865.

Joined for duty and enrolled:

When *Aug 25*, 1863.*

Where *Baltimore Md.* *

Period *3* years.*

Present or absent *Present*

Stoppage, \$ *100* for

Due Gov't \$ *100* for

Remarks:

* See enrollment on card from muster-in roll.

Book mark: -----

Barton

73

4

U.S.C.T.

Lloyd Brooks

Corpl., Co. B, 4 Reg't U. S. Col'd Infantry.

Appears on

Company Muster Roll

for Nov. & Dec., 1865

Joined for duty and enrolled:

When Aug. 25, 1863.*

Where Baltimore, Md. *

Period 3 years.*

Present or absent Present

Stoppage, \$ 100 for

Due Gov't \$ 100 for

Remarks:

* See enrollment on card from muster-in roll.

Book mark:

(858c)

Fabler

Copyist.

B

4

U.S.C.T.

Lloyd Brooks

Cerpl., Co. B, 4 Reg't U. S. Col'd Infantry.

Appears on

Company Muster Roll

for *Janij & Febij*, 1866.

Joined for duty and enrolled:

When *Aug 25*, 1863.*

Where *Baltimore, Md.* *

Period *3* years.*

Present or absent *Present.*

Stoppage, \$ *100* for

Due Gov't \$ *100* for

Remarks: *Stop for 1 cerus driver 23 cts
& 1 wiper 20 cts.*

NEXT ROLL ON FILE MUSTER OUT.

* See enrollment on card from muster-in roll.

Book mark:

Sabler

(358c)

Copyist.

B

4

U.S.C.T.

Lloyd Brooks

Capt, Co. *B*, 4 Reg't U. S. Col'd Infantry.

Appears on **Co. Muster-out Roll**, dated *Washington, DC, May 4, 1866*.

Muster-out to date *May 4, 1866*.

Last paid to *Feb. 28, 1866*.

Clothing account:

Last settled....., 186 ; drawn since \$.....100

Due soldier \$ *3*^{*31*}.....100; due U. S. \$.....100

Am't for cloth'g in kind or money adv'd \$.....100

Due U. S. for arms, equipments, &c., \$.....100

Bounty paid \$.....100; due \$.....100

Remarks *Slave on or about apr. 19/61. Was private arm enrollment. to april 9, 1865.*

Book mark : *L. 322. Mil.*

Tabler

(361)

Copyist.

Brooks, Lloyd

P, Co. B, 4

Reg't U. S. C. Inf.

Enclosures.

Bed Cards	Descriptive Lists
Burial Records	Final Statements
Certs. of Dis. for Discharge	Furloughs
C. M. Charges	Med. Des. Lists
Med. Certificates	Orders

Other papers relating to—

Admission to Hosp'l	Furlough
Casualty Sheet (Officer's)	Med. Examination
Confinement	Misc. Information
Contracts	Pay or Clothing
Death or Effects	Personal Reports
Desertions	Rank
Discharge from Hosp'l	Transfer to Hosp'l
Discharge from Service	Transfer to V. R. C.
Duty	Transportation

Endorsement.

No. 322

APPLICATION OF

Simon Long

OF

Washington County

for compensation for service of slave,

Lloyd Brooks

enlisted..... 1863

in "B" Co. 41st Regiment U. S.

Colored Troops.

Received *Mar 8* 1863

Compensation awarded,

..... 186

..... Dollars.

President Board of Claims.

P. O. Address and Claimant:

Downsville Md

*Johnd. Sears
att'y for claimant*

War Department,

ADJUTANT GENERAL'S OFFICE,

Washington, May 9th 1867.

Respectfully returned to the
Commission for the State of
Md. with the informa-

tion that *Lloyd Brooks*

was enlisted at *Baltimore Md.*

Aug 26th 1863. and was

mustered in as *Priv. in Co. "B"*

4th U. S. C. T. Aug 26/63.

L. 322. Md.

J. W. Hazard

Asst. Adj't General.

CERTIFICATE OF AWARD OF THE BOARD OF CLAIMS.

OFFICE OF THE BOARD OF CLAIMS,

For Slaves Enlisted or Drafted in the Service of the United States,

.....
.....186

that.....of.....

County, State of.....having proved, under oath,.....

and Government of the United States, and established.....title to the ownership of

....., a slave enlisted or drafted (as the case may be) and

....., on the.....day of

....., 186 , by.....

in the service of the United States, in the.....Regiment of Colored Troops, Co....., the sum

of.....dollars has been awarded to.....by this Board,

subject to the approval of the Secretary of War, as a compensation for the said slave, under the provisions of Section 24,

Act approved February 24, 1864, and Section 2, Act approved July 28, 1866.

....., President of the Board.

....., Member of the Board.

....., Member of the Board.

To.....

Chief of the Bureau for the

Organization of Colored Troops, Washington, D. C.

Endorsement.

No. 322

APPLICATION OF

Simon Long

OF

Washington County

for compensation for service of slave,

Lloyd Brooks

enlisted....., 1863

"B" Co. 4th Regiment U. S. Colored Troops.

Received Mch 8 1863

Compensation awarded,

....., 186

..... Dollars.

President Board of Claims.

P. O. Address and Claimant:

Donneville Md

Johnd. Sears
atty for client

CERTIFICATE OF AWARD OF THE BOARD OF CLAIMS.

OFFICE OF THE BOARD OF CLAIMS,

For Slaves Enlisted or Drafted in the Service of the United States,

.....

.....186

We hereby certify that.....of.....
.....County, State of....., having proved, under oath,.....
loyalty to the Constitution and Government of the United States, and established.....title to the ownership of
....., a slave enlisted or drafted (as the case may be) and
mustered at....., on the.....day of
....., 186 , by.....
in the service of the United States, in the.....Regiment of Colored Troops, Co....., the sum
of.....dollars has been awarded to.....by this Board,
subject to the approval of the Secretary of War, as a compensation for the said slave, under the provisions of Section 24,
Act approved February 24, 1864, and Section 2, Act approved July 28, 1865.

....., President of the Board.

....., Member of the Board.

....., Member of the Board.

To.....

Chief of the Bureau for the
Organization of Colored Troops, Washington, D. C.

EVIDENCE OF TITLE.

I, Simon Long, of Washington County, Maryland, do solemnly swear that Lloyd Brooks, who has been enlisted in the 4th Regiment, U. S. Colored Troops, Co. B; was my Slave for a term ending Feb 5th 1876, at the time of said enlistment; and that I became possessed of him by purchase in the month of February, eighteen hundred and fifty five (1855) And I do further swear that I have not purchased said Slave from any person or persons disloyal to the Government of the United States, with the object of obtaining compensation for the same: and furthermore, that I have no agency for obtaining compensation for any person or persons but such as to my knowledge are loyal citizens of the United States.

Sworn and subscribed before

Simon Long
J. RHOADES J.P.
Justice of the Peace.

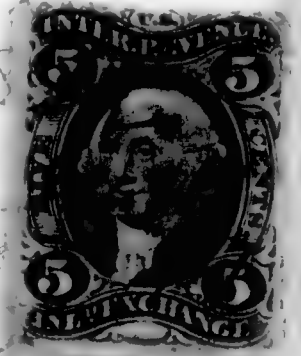

STATE OF MARYLAND, Washington County, to wit:

On this twenty sixth day of January in the year 1867 before me, the subscriber, a Justice of the Peace of the State and County aforesaid, personally appeared E. G. M. Stake, and William H. Thomas, loyal citizens of the United States, residents of Washington County, Maryland, and in no manner interested in the prosecution of this claim, and made oath in due form of law, that the said Simon Long was the owner of the Slave Lloyd Brooks as a fact of public notoriety; that they believe all the statements made by him in reference to said Slave are correct.

Witness their Signatures,

E. G. M. Stake
William H. Thomas
J. RHOADES J.P.
Justice of the Peace.



Sworn and subscribed before

And I Hereby do Certify, That the said E. G. M. Stake and William H. Thomas are citizens of Washington County, in good repute, and that their statements, under oath, are entitled to full faith and credit.

J. RHOADES J.P.
Justice of the Peace.

EVIDENCE OF LOYALTY.

STATE OF MARYLAND, Washington County, to wit:

On this twenty sixth day of January in the year 1867 before me, the subscriber, a Justice of the Peace of the State and County aforesaid, personally appeared Robert Kimble, a resident of Washington County, State of Maryland, and John A. Fleming, a resident of Washington County, State of Maryland, having first been duly sworn, upon their oaths declare that they reside respectively in Washington County, State of Maryland, and Washington County, State of Maryland; that they are personally acquainted with Simon Long, claimant for compensation for his Slave Lloyd Brooks under the Acts of Congress of February 24, 1864, and July 28, 1866, and that they know that said claimant hath firmly and faithfully maintained his allegiance and adherence to the Government of the United States, by defending its cause against the Government of the so-called Confederate States of America, in all suitable and practicable ways, and according to his ability and opportunity; they also swear that they have themselves maintained a like adherence and allegiance to the Government of the United States, and that they have no interest in said claim.

Sworn and Subscribed before

R. Kimble
John A. Fleming
J. RHOADES J.P.
Justice of the Peace.



STATE OF MARYLAND, Washington County, to wit:

I, Lewis R. Symon, Clerk of the Circuit Court for Washington County, do hereby certify that J. R. Rhoades, Esq. before whom the foregoing affidavits were made, was, at the time of signing the same, a Justice of the Peace for the County and State aforesaid, duly commissioned and sworn; and that his signature thereto is genuine, and that full faith and credit should be given to his official acts.

WITNESS my hand and the Seal of said Court, this 30th day of January A. D. 1867 Lewis R. Symon Clerk.



CLAIM FOR COMPENSATION FOR ENLISTED SLAVE.

No.

I, Simon Long a loyal citizen, and a resident
of Dorchester County of Maryland State of
Maryland, hereby claim compensation, under the provisions of Section 24, Act
approved February 24, 1864, and Section 2, Act approved July 28, 1866, for my slave Rayd Brooks
enlisted 1863,
at Baltimore Md by Col Wm. B. Perry
in the 4th Regiment U. S. Colored Troops, Co. B; certificate of which enlistment and a
descriptive list, as required, accompany this application.

In proof of my loyalty to the Constitution and Government of the United States, I present the accompanying oath,
which I have taken, signed and acknowledged; to be filed with this application, in accordance with requirement of Gen-
eral Orders, No. 329, 1863, War Department, Adjutant General's Office.

January 26th 1867.
Simon Long S. L.

OATH OF ALLEGIANCE.

I, Simon Long, the owner and claimant, do solemnly swear
that the foregoing claim is a just and true claim due to me as master and owner of the said slave, and that the facts
alleged in said claim in respect to the draft or enlistment (as the case may be) of said slave into the military service of the
United States are true. And I do further swear that I have never joined, or been concerned in, any insurrection or
rebellion; that I have never borne arms against the United States; that I have never given any aid, countenance, counsel
or encouragement to any person or persons engaged, or whom I had reason to believe were about to engage, in insurrec-
tion, rebellion or armed hostility against the United States; that I have neither sought, nor accepted, nor attempted to
exercise the functions of any office, civil or military, nor to perform any service whatever, under any authority or pre-
tended authority in hostility to the United States; that I have not yielded a voluntary support to any insurrection, rebel-
lion or pretended government, authority, power or constitution within the United States hostile thereto. And I do further
swear that to the best of my knowledge and ability, I have supported and defended, and will continue to support and
defend, the United States against all enemies, foreign and domestic; and that I have supported, defended and obeyed,
and will continue to support, defend and obey, the Constitution and laws of the United States: that I will bear true faith
and allegiance to the same; and that I take this oath freely, without any mental reservation or purpose of evasion: So
help me God.

Simon Long S. L.

Sworn to and subscribed before me, at Williams port }
this 26 day of January, 1867. }

J. R. HOSE
Justice of the Peace



Books. Nathaniel

Co. B., 4 U.S. Col'd Inf

Private | *Private*

CARD NUMBERS.

5550329	26
5553002	27
5555102	28
5553198	29
5553294	30
5553386	31
5553474	32
5553561	33
5553640	34
5553721	35
5554154	36
5553811	37
5553905	38
5554001	39
5554444	40
9061765	41
	42
	43
	44
	45
	46
	47
	48
	49
	50

Book Mark: *EB.V.12. P.12*

See also

S. 722 5:36 2 "aud.
Q 2821351 00mil

B

4

U.S.C.T.

Nathaniel Brooks

, Co. "B", 4 Reg't U. S. Col'd Inf.

Appears on

Company Descriptive Book

of the organization named above.

DESCRIPTION.

Age 17 years; height 5 feet 3 1/2 inches.

Complexion black

Eyes black; hair black

Where born Cumberland, Va.

Occupation laborer

ENLISTMENT.

When Aug. 25, 1863.

Where Baltimore

By whom Al. Birney; term 3 y'rs.

Remarks: Discharged on Surg.
Offe. Dis. June 24/65,
N. Y. harbor, by order
Maj. Genl. Bliss.

N. and

B. | 4 | U.S.C.T.

Nathanial Brooks

Pl., Co *B.*, *4* Reg't U. S. Col'd Infantry.

Age *18* years.

Appears on a

Detachment Muster-in Roll

of the organization named above. Roll dated

Baltimore Md. Aug. 26, 1863.

Muster-in to date

Aug. 26 1863.

Joined for duty and enrolled:

When

Aug. 26, 1863.

Where

Baltimore Md.

Period

3 years.

Remarks :

Book mark :

Heawling

B | 4 | U.S.C.T.

Nathaniel Brooks.

Priv., Co. B, 4 Reg't U. S. Col'd Infantry.

Appears on

Company Muster Roll

for July 21 to Aug. 31, 1863

Joined for duty and enrolled:

When August 28th, 1863*

Where Baltimore *

Period 3 years.*

Present or absent Present

Stoppage, \$ 100 for

Due Gov't \$ 100 for

Remarks: Premium due \$200

* See enrollment on card from muster-in roll.

Book mark:

Montal

B. | 4 | U.S.C.T.

Nathaniel Brooks.

Pvt., Co. B, 4 Reg't U. S. Col'd Infantry.

Appears on

Company Muster Roll

for Sept + Oct, 1863

Joined for duty and enrolled:

When August 28, 1863*

Where Baltimore *

Period 3 years.*

Present or absent Present

Stoppage, \$ 100 for

Due Gov't \$ 100 for

Remarks:

* See enrollment on card from muster-in roll.

Book mark:

W. M. Stall

(358c)

Copyist.

B. | 4 | U.S.C.T.

Nathaniel Brooks
Priv., Co. B, 4 Reg't U. S. Col'd Infantry.

Appears on

Company Muster Roll

for Nov. & Dec., 1863

Joined for duty and enrolled:

When Aug 25, 1863*

Where Baltimore *

Period 3 1/2 years.*

Present or absent Not stated,

Stoppage, \$ 100 for

Due Gov't \$ 100 for

Remarks:

* See enrollment on card from muster-in roll.

Book mark:

(358c)

James Hall

Copist.

B. | 4 | U.S.C.T.

Nathaniel Brooks

Pvt, Co. B, 4 Reg't U. S. Col'd Infantry.

Appears on

Company Muster Roll

for Jan'y to Feby, 1864.

Joined for duty and enrolled:

When August 25, 1863*

Where Baltimore*

Period 3 years.*

Present or absent Present

Stoppage, \$ 100 for

Due Gov't \$ 100 for

Remarks: Job charged, 1
Wiper²⁰, 1rench²³, 1bau-
teen⁴¹, 1Navvise⁴⁹, 1
Kuapsae¹⁸⁵, 1 Cartridge
Case¹⁰⁹, 1 Cartridge box
Whe⁵⁵ + plate⁰⁷, 1 pu sculis⁵⁰,

* See enrollment on card from muster-in roll.

Book mark:

Howell

B | 4 | U.S.C.T.

Nathaniel Brooks
Pat., Co. B, 4 Reg't U. S. Col'd Infantry.

Appears on

Company Muster Roll

for March & April, 1864.

Joined for duty and enrolled:

When Aug 25th, 1863.*

Where Baltimore, Md *

Period 3 years.*

Present or absent

Stoppage, \$ 100 for

Due Gov't \$ 100 for

Remarks: Stop one wife
20 cts.

* See enrollment on card from muster-in roll.

Book mark:

(358c)

C. H. Clark
Copyist.

B | 4 | U.S.C.T.

Nathaniel Brooks
Priv., Co. B, 4 Reg't U. S. Col'd Infantry.

Appears on

Company Muster Roll

for May & June, 1864.

Joined for duty and enrolled:

When Aug. 25th, 1863.*

Where Baltimore, Md.*

Period 3 years.*

Present or absent Present.

Stoppage, \$ 100 for _____

Due Gov't \$ 100 for _____

Remarks: Stop for one
wife, 20 cts.

* See enrollment on card from muster-in roll.

Book mark: _____

(358c)

C M Clark

Copyist.

B | 4 | U.S.C.T.

Nathaniel Brooks
Pat, Co. B, 4 Reg't U. S. Col'd Infantry.

Appears on

Company Muster Roll
for July & Aug, 1864.

Joined for duty and enrolled:

When Aug 25th, 1863.*

Where Baltimore, Md*

Period 3 years.*

Present or absent Present.

Stoppage, \$ 100 for _____

Due Gov't \$ 100 for _____

Remarks: Free on or
before April 19, 1861.

* See enrollment on card from muster-in roll.

Book mark: _____

C. M. Clark
Copyist.

(358c)

B | 4 | U.S.C.T.

Nathaniel Brooks

Pat, Co. B, 4 Reg't U. S. Col'd Infantry.

Appears on

Company Muster Roll

for Sept. & Oct., 1864.

Joined for duty and enrolled:

When Aug. 25th, 1863.*

Where Baltimore, Md.*

Period 3 years.*

Present or absent Absent.

Stoppage, \$ 100 for _____

Due Gov't \$ 100 for _____

Remarks: Free on or before
April 19, 1861. Absent,
wounded. Due sutles,
\$8⁰⁰

* See enrollment on card from muster-in roll.

Book mark: _____

C M Clark
(358c) Copyist.

B | 4 | U.S.C.T.

Nathaniel Brooks
 Pat, Co. B, 4 Reg't U. S. Col'd Infantry.

Appears on

Company Muster Roll
 for Nov. + Dec, 1864.

Joined for duty and enrolled:

When Aug. 25th, 1863.*

Where Baltimore, Md.*

Period 3 years.*

Present or absent Absent

Stoppage, \$ 100 for

Due Gov't \$ 100 for

Remarks: Free on or before
 April 19, 1861. Absent
 from wounds received
 Sept. 29, 1864. Died W.C.
 Cooper, Sutter, \$800

* See enrollment on card from muster-in roll.

Book mark: Disease 81022

S. M. Clark
 Copyist.

(358c)

B. | 4 | U.S.C.T.

Nathaniel Brooks
 Pri., Co. B, 4 Reg't U. S. Col'd Infantry.

Appears on

Company Muster Roll

for Jan & Feb., 1865.

Joined for duty and enrolled:

When Aug 25, 1863.*

Where Baltimore, Md.*

Period 3 years.*

Present or absent Absent

Stoppage, \$ 100 for

Due Gov't \$ 100 for

Remarks: Absent wounded
 Sep. 29, '64. Free on or before
 Apr. 19, 1861. Due M. Cooper
 under 4th U. S. C. T. 800

* See enrollment on card from muster-in roll.

Book mark:

(358c) Boston Copyist.

B. | 4 | U.S.C.T.

Nathaniel Brooks

Pr, Co. B, 4 Reg't U. S. Col'd Infantry.

Appears on

Company Muster Roll

for March + April, 1863.

Joined for duty and enrolled:

When Aug 25, 1863.*

Where Baltimore, Md.*

Period 3 years.*

Present or absent Absent

Stoppage, \$ 100 for

Due Gov't \$ 100 for

Remarks: Absent wounded since Sep. 29, 1864 Stop 1 pr. Gt. Coat strap
12

* See enrollment on card from muster-in roll.

Book mark: _____

B

4

U.S.C.T.

Nathaniel Brooks

Bri, Co. B, 4 Reg't U. S. Col'd Infantry.

Appears on

Company Muster Roll

for May 1 June, 1865.

Joined for duty and enrolled:

When Aug 25, 1863.*

Where Baltimore Md.*

Period 3 years.*

Present or absent Absent

Stoppage, \$ 100 for

Due Gov't \$ 100 for

Remarks: Stop 1 pr. grt. coat stripes
Absent wounded since Sep.
29, 86 T. 12

* See enrollment on card from muster-in roll.

Book mark:

(358c)

Barton

Copyist.

B. | 4 | U.S.C.T.

Nathaniel Brooks

Pri, Co. B, 4 Reg't U. S. Col'd Infantry.

Appears on

Company Muster Roll

for *July & Aug*, 1865.

Joined for duty and enrolled:

When *Aug. 25*, 1863.*

Where *Baltimore Md.* *

Period *3* years.*

Present or absent

Stoppage, \$ *100* for

Due Gov't \$ *100* for

Remarks: *Disch'd at U.S. Gen. hosp. N.Y. on Surg. Certif. by ord. of Maj. Genl. Dix.*

* See enrollment on card from muster-in roll.

Book mark: *Disch'd June 24/65 - E. B. U. 12 P. 724 This '1' does appear crossed.*

(358c)

Barton

Copyist.

73

4

U.S.C.T.

Catharine Brooks
Priv., Co. B, 4 Reg't U. S. Col'd Infantry.

Appears on **Co. Muster-out Roll**, dated
Washington, D.C., May 4, 1866.

Muster-out to date _____, 186 .

Last paid to _____, 186 .

Clothing account:

Last settled _____, 186 ; drawn since \$ _____ 100

Due soldier \$ _____ 100 ; due U. S. \$ _____ 100

Am't for cloth'g in kind or money adv'd \$ _____ 100

Due U. S. for arms, equipments, &c., \$ _____ 100

Bounty paid \$ _____ 100 ; due \$ _____ 100

Remarks: *Fra on or before April 19/66*

*Discharged on Surg. Certificate
of disability June 21/65 by
by order Maj. Gen. Dix, at New
York Harbor,*

Book mark: *E. B. V. 12, p. 12, June 24/65-*

(361)

Tabler

Copyist.

Brooks, Nathaniel

P, Co. B

4

U.S.C. Int.

2 Enclosures.

Bed Cards	Descriptive Lists
Burial Records	Final Statements
Certs. of Dis. for Discharge /	Furloughs
C. M. Charges	Med. Des. Lists
Med. Certificates	Orders

Other papers relating to—

Admission to Hosp'l	Furlough
Casualty Sheet (Officer's) /	Med. Examination
Confinement	Misc. Information
Contracts	Pay or Clothing
Death or Effects	Personal Reports
Desertions	Rank
Discharge from Hosp'l	Transfer to Hosp'l
Discharge from Service	Transfer to V. R. C.
Duty	Transportation

CASUALTY SHEET

No.

Mathaniel Brooks

Dr of Company *73*

4 Regiment of *W.C.T. Inf*

State Volunteers.

NATURE OF CASUALTY.

Dischg June 24-65

CASUALTY SHEET.

Name: *Nathaniel Brooks*

Rank: *Pr* Company: *B* Regiment: *4*

Arm: *Inf* State: *U.S.C.T*

Nature of Casualty: *Disch*

CAUSE OF CASUALTY—(NAME OF DISEASE, &c.)

BY WHOM DISCHARGED.

DEGREE OF DISABILITY.

FROM WHAT SOURCE THIS INFORMATION WAS OBTAINED.

BY WHOM CERTIFIED.

*Roll 25-15 Gen Hosp
Central RR NY C*

REMARKS.

DATE OF DISCHARGE, DEATH, &c.

June 24 15

PLACE OF DISCHARGE, DEATH, &c.

New York City

T. Brook

Clerk.

[Circular stamp]

[OFFICE ENDORSEMENT.]

War Department,

ADJUTANT GENERAL'S OFFICE,

Aug. 16, 1876

The Discharge of Nathaniel Brooks, Co. B, 4th Reg't U. S. Colored Troops, is reported as follows:

- On Company Muster Roll. For July, Aug., 1865, No date, 186
- Company Muster-out Roll. June 21st, 1865
- Company Descriptive Book. 186
- Company Morning Reports. 186
- Soldier's Final Statement. 186
- Soldier's Record of Death and Interment. 186
- Soldier's Inventory of Effects. 186
- Soldier's Certificate of Disability for Discharge. June 24, 1865
- Soldier's Individual Muster-out Roll. 186
- Regimental Return. For July, 1865, date not given, 186
- Regimental Quarterly Returns. 186
- Regimental Descriptive Book. 186
- By Surgeon General. 186

(June 24, 1865, is held to be the correct date, and the Company Muster Roll will be amended accordingly.)

Thomas M. Vincent, Assistant Adjutant General.

Sept 25 1876

B. 28, R. of Dis, 7

CERTIFICATE OF DISABILITY FOR DISCHARGE

IN THE CASE OF

Nathaniel Brooks

a private Co. B.

4th Reg't of U.S.C.T.

Vols

APPROVED

[Signature]

Surgeon U. S. A.

HEADQUARTERS DEPARTMENT OF THE EAST,

NEW YORK CITY, June 21st, 1865.

To be discharged.

BY COMMAND OF MAJOR GENERAL DEW:

[Signature]

Capt. and A. D. C., A. A. A. G.

Received (A. G. Office) 186

Cut, on, R. of Cas

NR 1311

ARMY OF THE UNITED STATES
CERTIFICATE
OF DISABILITY FOR DISCHARGE.

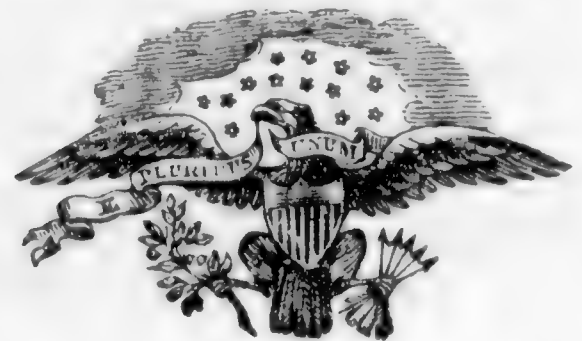

Priv Nathaniel Brooks, of Captain Hill's
B Company, (B) of the 4th U.S. C.S. Regiment of the United States
Volunteers was enlisted by Col Binney of
the 4th U.S. C.S. Regiment of U.S. C.S. at Baltimore, Maryland,
on the 25th day of August, 1863, to serve 3 years; he was born
in Cumby Mills Co. in the State of Maryland, is seventeen
years of age, 5 feet 3 1/2 inches high, black complexion, black eyes,
black hair, and by occupation when enlisted a Laborer. During the last two
months said soldier has been unfit for duty 60 days.*

States that his left forearm was amputated in consequence
of a gunshot wound received in the line of his duty at New
Market Heights Va. Sept. 29. 1864. Descriptive states that he
was severely wounded at time & place specified.

STATION: Wash Genl Hospital Central Park N.Y.
DATE: June 14th 1865

John D. Milman
Brig. St. Col & Surg. U.S.A.
Commanding Company
Hopel

I CERTIFY, that I have carefully examined the said Nathaniel Brooks
of Captain Hill's Company, and find him incapable of performing the duties of a
soldier because of †

Amputation of left forearm result of a gunshot
wound. Fit for V. A. C. elects to be discharged.

Degree of Disability Total

John D. Milman
Brig. St. Col & Surgeon. U.S.A.
In charge

DISCHARGED, this 24 day of June, 1865, at Central
Park Hospital. N.Y. City

John D. Milman
Brig. St. Col & Surgeon
Commanding the Regt
Hopel

The Soldier desires to be addressed at
Town Williamsport County Washington State Maryland

* See Note 1 on the back of this. † See Note 2 on the back of this.

1867.
Brooks, William H.

Co H, 4 U.S. Col'd Inf.

Private | Corporal

CARD NUMBERS.

1	5 5 6 2 7 0 9	26
2	5 5 6 2 8 0 8	27
3	5 5 6 2 9 0 7	28
4	5 5 6 3 0 0 9	29
5	5 5 6 3 1 0 5	30
6	5 5 6 3 1 9 8	31
7	5 5 6 3 2 9 1	32
8	5 5 6 3 3 7 9	33
9	5 5 6 3 4 6 3	34
10	5 5 6 3 5 4 7	35
11	5 5 6 3 6 4 9	36
12	5 5 6 3 7 4 9	37
13	5 5 6 3 8 5 7	38
14	5 5 6 3 9 4 2	39
15	5 5 6 4 0 3 6	40
16	5 5 6 4 1 1 4	41
17	5 5 6 4 1 7 3	42
18	5 5 6 4 2 2 5	43
19	9062 661	44
20		45
21		46
22		47
23		48
24		49
25		50

Book Mark:

See also

S. 2746226 and wd
S. 2819302 permit

B | **4** | **U.S.C.T.**

William H Brooks

Co. H, 4 Reg't U. S. Col'd Inf.

Appears on

Company Descriptive Book

of the organization named above.

DESCRIPTION.

Age *19* years; height *5 feet 10 1/2* inches.

Complexion *Bl'k*

Eyes *Dark*; hair *Curley*

Where born *Talbot Co, Md*

Occupation *Laborer*

ENLISTMENT.

When *Aug 11*, 18*63*.

Where *Baltimore Md*

By whom *Col M Burney*; term *3* y'rs.

Remarks: *One or more before*
Apr 19/61

Mustered out May 4
1866 by order of Sec'y
of War

Selah

B | 4 | U.S.C.T.

Wm H. Brooks

Private, Co. *H*, 4 Reg't U. S. Col'd Infantry.

Age *19* years.

Appears on

Company Muster-in Roll

of the organization named above. Roll dated

Aug 11, 1863.

Muster-in to date

Aug 11, 1863.

Joined for duty and enrolled:

When *Aug 11*, 1863.*

Where *Baltimore City*.*

Period *3* years.*

Remarks:

* Muster-in roll shows enrollment and muster-in of this company as of same date and place. See enrollment on subsequent card or cards.

Book mark:

M. A. Michaels

(356c)

Copyist.

B | 4 | U.S.C.T.

William H. Brooks
Priv., Co. H, 4 Reg't U. S. Col'd Infantry.

Appears on

Company Muster Roll

for Aug 11 to Aug 31, 1863.

Joined for duty and enrolled:

When Aug. 11, 1863.*

Where Baltimore City *

Period 3 years.*

Present or absent Present.

Stoppage, \$ 100 for

Due Gov't \$ 100 for

Remarks:

* See enrollment on card from muster-in roll.

Book mark:

M. A. Michaels

(358c)

Copyist.

B | 4 | U.S.C.T.

William H. Brooks

Priv., Co. H, 4 Reg't U. S. Col'd Infantry.

Appears on

Company Muster Roll

for *Sept & Oct.*, 186*3*.

Joined for duty and enrolled:

When *Aug. 11*, 186*3*.*

Where *Baltimore City* *

Period *3* years.*

Present or absent *Present*.

Stoppage, \$ *100* for _____

Due Gov't \$ *100* for _____

Remarks: _____

* See enrollment on card from muster in roll.

Book mark: _____

M. A. Michaels

(858c)

Copyist.

B | 4 | U.S.C.T.

William H. Brooks

Priv., Co. H, 4 Reg't U. S. Col'd Infantry.

Appears on

Company Muster Roll

for *Nov + Dec.*, 1863.

Joined for duty and enrolled:

When *Aug. 11*, 1863.*

Where *Baltimore City**

Period *3* years.*

Present or absent *Present*

Stoppage, \$ *100* for

Due Gov't \$ *100* for

Remarks:

* See enrollment on card from muster-in roll.

Book mark:

M. A. Michaels

D | 4 | U.S.C.T.

William G. Brooks

Priv., Co. H, 4 Reg't U. S. Col'd Infantry.

Appears on

Company Muster Roll

for *Jan + Febr*, 186*4*.

Joined for duty and enrolled:

When *Aug. 11*, 186*3**

Where *Baltimore City* *

Period *3* years.*

Present or absent *Present*

Stoppage, \$ *100* for

Due Gov't \$ *100* for

Remarks:

* ~~See~~ See enrollment on card from muster-in roll.

Book mark: _____

M. A. Michaels
Copyist.

B | 4 | **U.S.C.T.**

William H. Brooks,
Pvt., Co. H, 4 Reg't U. S. Col'd Infantry.

Appears on

Company Muster Roll

for March 8 Apr., 1864

Joined for duty and enrolled:

When Aug. 11, 1863.*

Where Baltimore City*

Period 3 years.*

Present or absent Present.

Stoppage, \$ 100 for _____

Due Gov't \$ 100 for _____

Remarks: _____

* ~~See~~ See enrollment on card from muster-in roll.

Book mark: _____

C. F. Thompson.
 Copyist.

B | 4 | U.S.C.T.

William H. Brooks

Pvt., Co. H, 4 Reg't U. S. Col'd Infantry.

Appears on

Company Muster Roll

for May & June, 1864.

Joined for duty and enrolled:

When Aug 11, 1863.*

Where Baltimore City *

Period 3 years.*

Present or absent Present

Stoppage, \$ 100 for

Due Gov't \$ 100 for

Remarks:

* See enrollment on card from muster-in roll.

Book mark:

(858c)

C. F. Thompson

Copyist.

B

4

U.S.C.T.

William H. Brooks
Pvt., Co. H, 4 Reg't U. S. Col'd Infantry.

Appears on

Company Muster Roll

for July & Aug., 1864.

Joined for duty and enrolled:

When Aug. 11, 1863.*

Where Baltimore City.*

Period 3 years.*

Present or absent Present

Stoppage, \$ 100 for

Due Gov't \$ 100 for

Remarks: Free on or before
Apr. 19/61

* See enrollment on card from muster-in roll.

Book mark:

C. F. Thompson

B | 4 | U.S.C.T.

William Brooks,

Priv., Co. H, 4 Reg't U. S. Col'd Infantry.

Appears on

Company Muster Roll

for Sept. & Oct, 1864.

Joined for duty and enrolled:

When Aug. 11, 1863.*

Where Baltimore, Md. *

Period 3 years.*

Present or absent Present.

Stoppage, \$ 100 for

Due Gov't \$ 100 for

Remarks: Free on or before Apr. 19/61

* See enrollment on card from muster-in roll.

Book mark:

(358c)

C. F. Thompson.

Copyist.

B | 4 | U.S.C.T.

William H. Brooks,
Priv., Co. H, 4 Reg't U. S. Col'd Infantry.

Appears on

Company Muster Roll
for Nov. & Dec., 1864.

Joined for duty and enrolled:

When Aug. 11, 1863.*

Where Baltimore *

Period 3 years.*

Present or absent Present

Stoppage, \$ 100 for

Due Gov't \$ 100 for

Remarks:

* See enrollment on card from muster-in roll.

Book mark:

C. F. Thompson,
Copyist.

B | 4 | U.S.C.T.

William Brooks

Pvt, Co. H, 4 Reg't U. S. Col'd Infantry.

Appears on

Company Muster Roll

for Jan & Feb, 1865.

Joined for duty and enrolled:

When Aug 11, 1863.*

Where Baltimore Md *

Period 3 years.*

Present or absent Present

Stoppage, \$ 100 for

Due Gov't \$ 100 for

Remarks:

* See enrollment on card from muster-in roll.

Book mark:

Bowman

B | 4 | U.S.C.T.

William H. Brooks

Priv, Co. H, 4 Reg't U. S. Col'd Infantry.

Appears on

Company Muster Roll

for *Mar & Apr*, 1865.

Joined for duty and enrolled:

When *Aug 11*, 1863.*

Where *Baltimore Md* *

Period *3* years.*

Present or absent *Present*

Stoppage, \$ *100* for

Due Gov't \$ *100* for

Remarks:

* See enrollment on card from muster-in roll.

Book mark: -----

Bowman

B | 4 | U.S.C.T.

William H. Brooks

Pvt, Co. H, 4 Reg't U. S. Col'd Infantry.

Appears on

Company Muster Roll

for *May & June*, 1865.

Joined for duty and enrolled:

When *Aug 11*, 1863.*

Where *Baltimore Md* *

Period *3* years.*

Present or absent *Present*

Stoppage, \$ *100* for

Due Gov't \$ *100* for

Remarks: *Back pay due from enlistment to May 1, 64*

* See enrollment on card from muster-in roll.

Book mark:

Bowman

B

4

U.S.C.T.

William H. Brooks

Pvt, Co. H, 4 Reg't U. S. Col'd Infantry.

Appears on

Company Muster Roll

for *Jul & Aug*, 1865.

Joined for duty and enrolled:

When *Aug 11*, 1863.*

Where *Baltimore Md* *

Period *3* years.*

Present or absent *Present*

Stoppage, \$ *100* for

Due Gov't \$ *100* for

Remarks:

* See enrollment on card from muster-in roll.

Book mark:

Bowman

(858c)

Copyist.

B | 4 | U.S.C.T.

William H. Brooks

Priv, Co. H, 4 Reg't U. S. Col'd Infantry.

Appears on

Company Muster Roll

for *Sept & Oct*, 1865.

Joined for duty and enrolled:

When *Aug 11*, 1863.*

Where *Baltimore Md* *

Period *3* years.*

Present or absent *Present*

Stoppage, \$ *100* for

Due Gov't \$ *100* for

Remarks:

* See enrollment on card from muster-in roll.

Book mark:

Bowman

13. | 4 | U.S.C.T.

William H. Brooke,
Corpl., Co. H, 4 Reg't U. S. Col'd Infantry.

Appears on

Company Muster Roll

for *Novbr⁴ Decbr*, 1865.

Joined for duty and enrolled:

When *August 11*, 1863.*

Where *Baltimore, Md.* *

Period *3* years.*

Present or absent *Present.*

Stoppage, \$ *100* for

Due Gov't \$ *100* for

Remarks: *Promoted Corporal*
Nov. 9/65 per S. O. No. 105
dated Ad. No. 4 U. S. C. T.
Nov. 9, 1865.

* See enrollment on card from muster-in roll.

Book mark:

R. S. Trauner

13. | 4 | U.S.C.T.

William T. Brooke,
Corpl., Co. H, 4 Reg't U. S. Col'd Infantry.

Appears on

Company Muster Roll

for *Jan'y 4th Feby*, 186*6*.

Joined for duty and enrolled:

When *August 11*, 186*3*.*

Where *Baltimore, Md.* *

Period *3* years.*

Present or absent *Present.*

Stoppage, \$ *100* for

Due Gov't \$ *100* for

Remarks:

NEXT ROLL ON FILE MUSTER OUT.

* See enrollment on card from muster-in roll.

Book mark:

R. Sprenger
 Copyist.

13.

4

U.S.C.T.

William H. Brooke,
Capt., Co. H., 4 Reg't U. S. Col'd Infantry.

Appears on **Co. Muster-out Roll**, dated

Washington, D. C., May 4, 1866.

Muster-out to date *May 4, 1866.*

Last paid to *July 28, 1866.*

Clothing account:

Last settled....., 186 ; drawn since \$.....100

Due soldier \$ *7.87* / 100; due U. S. \$.....100

Am't for cloth'g in kind or money adv'd \$.....100

Due U. S. for arms, equipments, &c., \$.....100

Bounty paid \$.....100; due \$ *100.00* / 100

Remarks: *Was Private from*
enrollment to Nov. 9, 1865.
Free.

Book mark :

(361)

M. Drauer

Copyist.



NARR 1334

A/933334 P. o. m. + m.
02248014 06 aff

A/1933334 P. o. m. n.

02048074 P. o. aff

B

4

U.S.C.T.

Alexander Brown

Co. E, 4 Reg't U. S. Col'd Inf.

Appears on

Company Descriptive Book

of the organization named above.

DESCRIPTION.

Age 22 years; height 5 feet 10 1/2 inches.

Complexion Black

Eyes Black; hair Curly

Where born Baltimore Md

Occupation Farmer

ENLISTMENT.

When May 20, 1863

Where Baltimore

By whom Col. W. Berny; term 3 y'rs.

Remarks:

N. H. Merrill

Copyist.

D. | *4* | **U.S.C.T.**

Alexander W. Brown
Pn., Co *E*, *4* Reg't U. S. Col'd Infantry.

Age *22* years.

Appears on a

Detachment Muster-in Roll

of the organization named above. Roll dated

Baltimore Md. Aug. 20, 1863.

Muster-in to date *Aug. 20, 1863.*

Joined for duty and enrolled:

When *Aug. 20, 1863.*

Where *Baltimore Md.*

Period *3* years.

Remarks :

Book mark :

Hawling

B | 4 | U.S.C.T.

Alex Brown

Co. E, 4 Reg't U. S. Col'd Infantry.

Appears on

Company Muster Roll

for from Jul. 15 to Aug. 31, 1863.

Joined for duty and enrolled :

When Aug. 20, 186 .*

Where Baltimore *

Period 3 years.*

Present or absent Present

Stoppage, \$ 100 for

Due Gov't, \$ 100 for

Remarks:

* See enrollment on card from muster-in roll.

Book mark:

Hathaway

B

4

U.S.C.T.

Alexander Brown

Pvt., Co. E, 4 Reg't U. S. Col'd Infantry.

Appears on

Company Muster Roll

for Sept. & Oct., 1863.

Joined for duty and enrolled:

When July 20, 1863.*

Where Balt. Md.*

Period 3 years.*

Present or absent Present

Stoppage, \$ 100 for

Due Gov't, \$ 100 for

Remarks:

* See enrollment on card from muster-in roll.

Book mark:

W. H. ...

B | 4 | U.S.C.T.

Alexander Brown
Sgt., Co. E, 4 Reg't U. S. Col'd Infantry.

Appears on

Company Muster Roll
for Nov. & Dec., 1863.

Joined for duty and enrolled :

When Aug. 20, 1863.*

Where Baltimore.*

Period 9 years.*

Present or absent Present

Stoppage, \$ 100 for

Due Gov't, \$ 100 for

Remarks: Stop one waist
belt and one waist
belt plate and one
Bayonet

* See enrollment on card from muster-in roll.

Book mark :

(358c)

Hathaway
Copyist.

B | 4 | U.S.C.T.

Alexander Brown
Pt., Co. E, 4 Reg't U. S. Col'd Infantry.

Appears on

Company Muster Roll
for Jan & Feb., 1864.

Joined for duty and enrolled :

When Aug. 20, 1863.*

Where Baltimore Md.*

Period 9 years.*

Present or absent Present

Stoppage, \$ 100 for

Due Gov't, \$ 100 for

Remarks:

* See enrollment on card from muster-in roll.

Book mark :

(358c)

Hathaway

Copyist.

B

4

U.S.C.T.

Alexander Brown

Priv., Co. E, 4 Reg't U. S. Col'd Infantry.

Appears on

Company Muster Roll

for Mar 1864, 1864.

Joined for duty and enrolled:

When Aug 20, 1863*

Where Baltimore Md.*

Period 8 years.*

Present or absent Present

Stoppage, \$ 100 for

Due Gov't, \$ 100 for

Remarks:

* See enrollment on card from muster-in roll.

Book mark:

Murray

B

4

U.S.C.T.

Alexander Brown

Put, Co. E, 4 Reg't U. S. Col'd Infantry.

Appears on

Company Muster Roll

for *May & June*, 1864.

Joined for duty and enrolled:

When *Aug - 20*, 1863.*

Where *Baltimore*.*

Period *3* years.*

Present or absent *Present*

Stoppage, \$ *100* for

Due Gov't, \$ *100* for

Remarks:

* See enrollment on card from muster-in roll.

Book mark:

Murray

Q

4

U.S.C.T.

Alexander Brown

Priv., Co. E, 4 Reg't U. S. Col'd Infantry.

Appears on

Company Muster Roll

for July-Aug., 1864.

Joined for duty and enrolled:

When Aug. 2, 1863.*

Where Baltimore City.*

Period 3 years.*

Present or absent Present

Stoppage, \$ 100 for

Due Gov't, \$ 100 for

Remarks: Free on or before
April 19. 61 Extra duty
dutch Gap Va.

* See enrollment on card from muster-in roll.

Book mark:

Murray

3 | 4 | U.S.C.T.

Alexander Brown
Priv., Co. E, 4 Reg't U. S. Col'd Infantry.

Appears on
Company Muster Roll
for Sept & Oct, 1864.

Joined for duty and enrolled :
When Aug. 20, 1863*
Where Baltimore Md.*
Period 3 years.*

Present or absent absent

Stoppage, \$ 100 for

Due Gov't, \$ 100 for

Remarks: absent sick in
Hospital. Free on or
before Apr. 19. 61

* See enrollment on card from muster-in roll.

Book mark :

Murray

② | 4 | U.S.C.T.

Alexander Brown

Quat., Co. E, 4 Reg't U. S. Col'd Infantry.

Appears on

Company Muster Roll

for Nov. & Dec., 1864

Joined for duty and enrolled:

When Aug. 20, 1863.*

Where Baltimore, Md.*

Period 3 years.*

Present or absent Present

Stoppage, \$ 100 for

Due Gov't, \$ 100 for

Remarks: Free on Sep. 19, 61

* See enrollment on card from muster-in roll.

Book mark:

Murray

B | 4 | U.S.C.T.

Alexander Brown
Capt., Co. E, 4 Reg't U. S. Col'd Infantry.

Appears on

Company Muster Roll

for Jan + Feb, 1865.

Joined for duty and enrolled :

When Aug 20, 1863.*

Where Baltimore, Md. *

Period 3 years.*

Present or absent present

Stoppage, \$ 100 for

Due Gov't, \$ 100 for

Remarks: Free man or before
April 19/65.

* See enrollment on card from muster-in roll.

Book mark :

B | 4 | U.S.C.T.

Alexander Brown
Pvt., Co. E, 4 Reg't U. S. Col'd Infantry.

Appears on

Company Muster Roll

for *March 1st*, 1865.

Joined for duty and enrolled:

When *Aug. 20*, 1863.*

Where *Baltimore, Md.* *

Period *3* years.*

Present or absent *present*

Stoppage, \$ *100* for

Due Gov't, \$ *100* for

Remarks: *Free on or before Apr. '61.
Back pay due from enlistment
to May 1/64.*

* See enrollment on card from muster-in roll.

Book mark:

Long

B | 4 | **U.S.C.T.**

Alexander Brown
Priv, Co. E, 4 Reg't U. S. Col'd Infantry.

Appears on

Company Muster Roll

for *May - June*, 1865.

Joined for duty and enrolled :

When *Aug. 20*, 186*3*.*

Where *Baltimore, Md.* *

Period *3* years.*

Present or absent *present*

Stoppage, \$ *100* for

Due Gov't, \$ *100* for

Remarks: *Due sutles W.C. Cooper \$3.00*
Free on or before Apl. '61.

* See enrollment on card from muster-in roll.

Book mark :

Long

B | 4 | U.S.C.T.

Alexander Brown

Private, Co. E, 4 Reg't U. S. Col'd Infantry.

Appears on

Company Muster Roll

for July & Aug., 1865.

Joined for duty and enrolled :

When Aug. 20, 1863*

Where Baltimore *

Period 3 years.*

Present or absent absent

Stoppage, \$ 100 for

Due Gov't, \$ 100 for

Remarks: Detached service
Brig. Hd. Qrs.
Free on or before
Apr. 19/61

* See enrollment on card from muster-in roll.

Book mark :

Long

B | 4 | U.S.C.T.

Alexander Brown
Pvt, Co. E, 4 Reg't U. S. Col'd Infantry.

Appears on

Company Muster Roll

for Sept & Oct., 1865.

Joined for duty and enrolled :

When Aug. 20, 1863.*

Where Baltimore *

Period 3 years.*

Present or absent present

Stoppage, \$ 100 for

Due Gov't, \$ 100 for

Remarks: Free on or before
Apr. 19/61.

* See enrollment on card from muster-in roll.

Book mark :

Long

B

4

U.S.C.T.

Alexander Brown

priv., Co. E, 4 Reg't U. S. Col'd Infantry.

Appears on

Company Muster Roll

for *Nov & Dec*, 186*9*.

Joined for duty and enrolled :

When *Aug 20*, 186*9*.*

Where *Baltimore Md*, *

Period *3* years.*

Present or absent *present*

Stoppage, \$ *100* for

Due Gov't, \$ *100* for

Remarks: *Free on ar before
apr 19/61, difference of
pay due from enlistment
to May 1/64.*

* See enrollment on card from muster-in roll.

Book mark :

Somers

B

4

U.S.C.T.

Alexander Brown

priv., Co. E, 4 Reg't U. S. Col'd Infantry.

Appears on

Company Muster Roll

for *Jan & Feb.*, 1866.

Joined for duty and enrolled :

When *Aug 20*, 186*7*.*

Where *Baltimore Md.* *

Period *2* years.*

Present or absent *present*

Stoppage, \$ *100* for

Due Gov't, \$ *100* for

Remarks :

NEXT ROLL ON FILE MUSTER OUT.

* See enrollment on card from muster-in roll.

Book mark :

Somers

3

4

U.S.C.T.

Alexander Brown
priv., Co. *C*, 4 Reg't U. S. Col'd Infantry.

Appears on **Co. Muster-out Roll**, dated
Washington D.C., May 4, 1866.

Muster-out to date *May 4, 1866*.
Last paid to *Feb 28, 1866*.

Clothing account:

Last settled....., 186 ; drawn since \$.....100
Due soldier \$ *.73* ^{*33*} / 100; due U. S. \$.....100
Am't for cloth'g in kind or money adv'd \$.....100

Due U. S. for arms, equipments, &c., \$.....100
Bounty paid \$.....100; due \$ *100* / 100

Remarks: *Free on or before*
Apr 19 / 61

Book mark :

Somers

(361)

Copist.

Iron Charles A.

Co D., 4 U.S. Col'd Inf.

2" Lieutenant 2" Lieutenant

CARD NUMBERS.

5550247
 5556218
 5556319
 5556417
 5556508
 5556678
 5557648
 9428556

26
 27
 28
 29
 30
 31
 32
 33
 34
 35
 36
 37
 38
 39
 40
 41
 42
 43
 44
 45
 46
 47
 48
 49
 50

Book Mark:

See also

B | 4[#] | U.S.C.T.

Charles A. Brown

2^d Lieut, Co., 4[#] Reg't U. S. Col'd Inf.

Appears on

Regimental Descriptive Book

(List of Commissioned Officers)

of the regiment named above.

Rank 2^d Lieut

Date of appointment July 22 1863

Remarks: Reported for duty
and assigned to Co. D.

S.O. 9 4th U.S.C.I. July 29 '63

Dismissed Par 4. S.O. 82.

Dept Va & NC Mar 23. 64

Order of dismissal revoked by

Par 3. S.O. 137 Mar Dept a.g.o

Apr 4th by and ordered to

be discharged

James

B | 4 | U.S.C.T.

C. A. Brown
 2^d Lt., Co., 4 Reg't U. S. Col'd Infantry.

Age 28 years.

Appears on an

Individual Muster-in Roll

of the organization named above. Roll dated
 Yorktown, Va., Nov. 24, 1863.

Muster-in to date July 29, 1863.

Joined for duty and enrolled:

When July 29, 1863.

Where Baltimore

Period 9 years.

Remarks: By authority dated
 War Dept. Sept 28/63.

Book mark :

(336) Lowry Copyist.

B | **4** | **U.S.C.T.**

Charles A. Brown

2d Lieut., Co. D, 4 Reg't U. S. Col'd Infantry.

Appears on

Company Muster Roll

for *July 28/63 to Aug 31*, 186*3*.

Joined for duty and enrolled:

When *July 22*, 186*3*.*

Where _____*

Period _____ years.*

Present or absent *present*

Stoppage, \$ 100 for _____

Due Gov't \$ 100 for _____

Remarks: *Appointed 2d Lieut. by the President of the U. S. July 22/63. Accepted July 27/63. Reported for duty July 29/63.*

* See enrollment on card from muster-in roll.

Book mark: _____

Faulkner

B | 4 | U.S.C.T.

Charles A. Brown

2d Lieut, Co. D, 4 Reg't U. S. Col'd Infantry.

Appears on

Company Muster Roll

for Sept & Oct, 1863.

Joined for duty and enrolled:

When....., 186 .*

Where*

Period..... years.*

Present or absent *present*

Stoppage, \$.....¹⁰⁰ for.....

Due Gov't \$.....¹⁰⁰ for.....

Remarks: *Appointed 2d Lieut by the President of the U. S. July 22/63 accepted July 27.*

Reported for duty July 29, 1863

Back pay due as commandant of co from July 29/63 to Aug 15/63

* See enrollment on card from muster-in roll.

Book mark:

Faulkner

(858c)

Copyist.

B

4

U.S.C.T.

Charles A. Brown

2d Lieut., Co. D, 4 Reg't U. S. Col'd Infantry.

Appears on

Company Muster Roll

for Nov & Dec, 1865.

Joined for duty and enrolled:

When, 1865.*

Where.*

Period, years.*

Present or absent present

Stoppage, \$100 for

Due Gov't \$100 for

Remarks: Appointed, 2d Lieut. by the President of the U.S. July 23, 1865. Accepted July 27, 1865. Reported for duty July 29, 1865.

* See enrollment on card from muster-in roll.

Book mark:

Faulkner

B | 4 | **U.S.C.T.**

Charles A. Brown

2 Lieut, Co. D, 4 Reg't U. S. Col'd Infantry.

Appears on

Company Muster Roll

for Jan & Feby, 1864.

Joined for duty and enrolled:

When July 29, 1863.*

Where Baltimore md *

Period 3 years.*

Present or absent present

Stoppage, \$ 100 for

Due Gov't \$ 100 for

Remarks:

* See enrollment on card from muster-in roll.

Book mark: _____

Faulkner
(858c) Copyist.

B |

4

U.S.C.T.

Charles A. Brown

2nd Lieut, Co. D, 4 Reg't U. S. Col'd Infantry.

Appears on

Company Muster Roll

for March + Apr, 1864.

Joined for duty and enrolled:

When July 29, 1863.*

Where Baltimore Md*

Period 3 years.*

Present or absent _____

Stoppage, \$ 100 for _____

Due Gov't \$ 100 for _____

Remarks: Discharged the
service U.S. subject
to the approval of
the President, Order
no. 1537 Hd Qrs. Dept. Va
+ M.C. March 23, 1864

* See enrollment on card from muster-in roll.

Book mark: _____

W A Tyler

(858c)

Copyist.

731 | 4 | U.S.C.T.

Charles A Brown

22d., Co. *D*, 4 Reg't U. S. Col'd Infantry.

Appears on **Co. Muster-out Roll**, dated *Washington DC May 4*, 1866 .

Muster-out to date 186 .

Last paid to 186 .

Clothing account:

Last settled....., 186 ; drawn since \$.....100

Due soldier \$.....100; due U. S. \$.....100

Am't for cloth'g in kind or money adv'd \$.....100

Due U. S. for arms, equipments, &c., \$..... 100

Bounty paid \$.....100; due \$..... 100

Remarks: *Dismissed from the service U.S. March 23/64*

Book mark :

(861)

Journier

Copyist.

Brown, C. A.

2^d Lt., Co.

4

Reg't U. S. C. Inf.

7 1/2 Enclosures.

Bed Cards	Descriptive Lists
Burial Records	Final Statements
Certs. of Dis. for Discharge	Furloughs
C. M. Charges	Med. Des. Lists
Med. Certificates	Orders ✓
	Resignations ✓

Other papers relating to—

Admission to Hosp'l	Furlough <i>or L.A.</i> 2
Casualty Sheet (Officer's)	Med. Examination
Confinement	Misc. Information /
Contracts	Pay or Clothing
Death or Effects	Personal Reports
Desertions	Rank
Discharge from Hosp'l	Transfer to Hosp'l
Discharge from Service	Transfer to V. R. C.
Duty /	Transportation

Head Quarters 4th U. S. C. Troops
Yorktown Va. Nov. 24, 1863.

I hereby certify that 2^d Lt. C. A. Brown reported
for duty with this Regt. on the 29th July 1863

Sworn & subscribed to
before me

W. L. Horton Lt. Col.

Saml. A. Duncan
Col. Comdg.

District of Columbia D 143

Yorktown, Va.
11 Oct. 19th 1863

Charles A Brown

2nd Lieut Co. D. 4th U.S. Col.

Request Leave of Absence
of ten days to visit
Woodsport N.Y. on
important private
business.

Approved and respectfully
forwarded.

Paul A. Duncan
Col. 4th U.S. Col.

Lieut. Chas. A. Brown has
leave to carry this document
forward in person

Paul A. Duncan
1st Lieut Dept of War. Co. D. 4th U.S. Col.

Oct. 19. 1863 -

Co. A.	3	com. offrs. for duty
Co. B.	2	" " " " 1 absent sick
" C.	1	" " " " 1 detached Union
" D.	3	" " " "
" E.	3	" " " "
" F.	3	" " " "
" G.	-	Gloucester Point - 3 offrs
" H.	3	com. offrs for duty
" I.		Gloucester Point 3 offrs
" K.		Gloucester Point 2 offrs

in daily
list of 2.50.2-

Ad In Yorktown
Oct 19. 1863

Approved respectfully
forwarded
J. M. [Signature]
B.S.

S. C. 116/7.

Co. A. Capt. J. W. Farrington
1st Lt. A. P. Burney } present
2nd Lt. Geo. Frazer } present

Co. B. Capt. Wolfe } present
1st Lieut. Marshall } present

Co. C. 3 com. offrs present
Co. B. 2 "

Camp of the 4th Regt U.S.C.T.
Yaktown Va Oct 19th 1863

Marcellas Bailey
Adj 4th Regt U.S.C.T.

Sir
I have the honor to
ask a Leave of absence for ten (10) days
to go to Woodport Cayuga County New York
on important private business, my wife
being dangerously ill, and in the opinion
of her physician beyond the hope of
recovery
I am

Your most Obedient Servant
Charles A. Brown
2^d Lieut Co. "D" 4th Regt U.S.C.T.

Get Office address while absent
Woodport, Cayuga, Co. N.Y.

1120. Ad. No. Ft. Yorktown A 1103

Hd Qrs 4th Regt. U.S.C.T.
 Yorktown Va.; Nov. 4th /63

H. P. Fullerton
 Nov. 5th /63.

Saml. A. Duncan
 Col. 4th U.S.C.T.

Approved respectfully
 forwarded
 J. M. [Signature]
 B.S.

Suggests that so much
 of Special Orders No. 106.
 from Hd Qrs Dept. Va. & N.C.
 as grants a Leave of Ab-
 sence to Chas. A. Brown,
2nd Lieut. "D" Co. 4th U.S.C.T.,
 be revoked, for the reasons
 within set forth.

filed 12-6-93

Reviewed by
 S. C. 109/4

Hd Qrs Dept Va & N.C Nov 6 1863
 Recd Ad. No. Ft. Yorktown Nov 5 1863

Adj. Dir. 4th Regt. U.S. Col. Troops,
Yorktown, Va.; Nov. 4th 1863.

Lt. Col. Southard Hoffman, A.A.,
Colonel;

I have the honor to represent that the reasons which led me to approve an application for leave of absence from Capt. A. Brown, 2nd Lieut. Co. "D", 4th Regt. U.S.C.T., which application was granted at Department Head quarters on the 3^d inst. have changed so materially as to render it, in my opinion, inadvisable that he should be allowed an absence from the regt.

Other reasons influence me in making this representation; among them the following. —

I The Captain & the 1st Lieut. of Co. "D" are both unfitted for duty by reason of sickness, with a prospect of the disability continuing.

II The morale of the regt. would be seriously affected, as an impression is current among the officers that Lieut. Brown did not fairly represent his case when he filed his application.

I would respectfully suggest that Special Order No. 106, granting Lt. Brown a leave of absence, be revoked. Until an answer be received, I take the liberty to hold his leave in abeyance.

Respectfully, Your Obedt. Serv.

Saml. A. Duncan
Col. 4th U.S.C.T.

B. 17. Hd. Qu. Brigades U.S. C. T. 1864

B. 16. B. Hd. Qu. Yorktown Va 1864

Yorktown - Va
March 15th / 64

Bno 7 B. G. C. T. R. B. 1864

Charles A. Brown
2nd Lt. 4th U. S. C. T.

Yorktown Va 1864

Under his resignation
Hd. Qu. Yorktown March 15th 1864

Hd. Qu. Brigades U.S. C. T. March 15th

Yorktown - Va -
March 15th / 1864

Approved and respectfully
forwarded - This officer
is one of the three whom the
commanding officer of this reg-
-ment recently requested to have
cited before a Board of Examination
to determine the questions of their
efficiency and conduct as
officers - Every effort has
been made to arouse - excite -
and call up some exhibition
of soldierly bearing and
conduct on the part of Lt.
- Rec. A. G. Brown - but he has uniformly
failed to realize any hopes that
may have been entertained of him -

Want of energy - resolutions - and
judgment - renders him unsafe
in camp - and - in the field -
dangerous alone to the
cause he hopes to serve -
Geo. Eger
Lt Col Comdg

Hd. Qu. Brigades U.S. C. T.
Yorktown, Va.; March 16th / 64

Approved & respectfully
forwarded. Lieut. Brown, altho
meaning well, has none of the
qualifications requisite for
a military officer. He is
lacking in authority & is exceedingly
inefficient - He has evidently
mistaken his calling -

This resignation is doubtless
offered in preference to
appearing before a Board of
Examination -
Saml. A. Duncan
Col. Comdg

Hd. Qu. U. S. Army, Yorktown Va.,
March 19th 1864

Although this resignation
is not in accordance with
Rev. Reg. it is respectfully
forwarded, as perhaps the
best mode of getting rid of
an officer incompetent
but not criminal -

J. M. M. No
B. S.

O.R. 118 - 104
 Head Quarters, Dept. of War
 Fort Monroe, Mich. 22, 1864

Approved and most
 respectfully forwarded,
 for information, to the
 Bureau of Colored Troops.
 The endorsement and ^{the} conduct
 of the Officer are a practi-
 cal commentary of the Ex-
 amination of the Board
 which passed him. The
 resignation amounts to a
 request to be dismissed the
 Service, and the officer is
 dismissed.

Wm. F. Smith
 Major General
 1864

S.O. no 82-4

War Dept A. G. Office

March 31. 1864.

Respectfully submitted to Major General
 H. H. Halleck Chief of Staff, with
 the recommendation that so much of
 Special Orders No 82. C. S. from Head
 Quarters Department of Virginia and
 North Carolina, as dismisses this
 officer from the Service, may be revoked,
 and that he be discharged to date from
 the date of said order of dismissal

L. W. Foster
 Asst Adjt Genl.

E. D. Vol. 0. Page 668
 Above occurred in
 April 2/64

H. H. Halleck
 W. C. C. P. S. O. 137

Note - See par. 36. S. O. 137. 1864

file

Rec'd at G. O. Army April 2^d 64.

Headquarters Dept. of Va. & N. Carolina
 Fort Monroe, Va. Mar. 23, 1864

Special Order }
 No. 82 }

IV. The following named Officers, having
 tendered their resignation, are hereby dismissed from the
 service of the United States, subject to the
 approval of the President. —

2nd Lieut. Chas. A. Brown 4th U. S. C. ¹⁴ Regt

(By command of Maj. Gen. Butler
 (Signed) U. S. Davis

A. A. G.

Adj. Gen. Lee's Office }
 March 30, 1864 }

Official

~~Gen. Foster~~

Asst. Adj. G.

Lt. Charles A. Brown
4th A.C.T.

137

SPECIAL ORDERS, } WAR DEPARTMENT,
No. 137. } ADJUTANT GENERAL'S OFFICE.
Washington, April 4th, 1864.

(Extract.)

* * * * *

36. So much of Special Orders, No. 82, Headquarters, Department of Virginia and North Carolina, March 23d, 1864, as dismisses from the service of the United States, subject to the approval of the President, the following named officers, is revoked, and they are hereby discharged the service, to take effect March 23d, 1864:—

2d Lieutenant *Charles A. Brown*, 4th U. S. Colored Troops.

* * * * *

By order of the Secretary of War :

E. D. TOWNSEND,

Assistant Adjutant General.

OFFICIAL :

Assistant Adjutant General.

3

Handwritten signature and date

Jan. 9 1865—

Chas A. Prower
Vernon Springs
Howard Co.
4286 Inf

Claims to have
served two years
in present war,
& wants to enlist
in Hancock's
Corps.

Feb. 1905, This paper was formerly
part of the records of the Provost
Marshal's Office, 3rd District of Iowa, in the
case of [unclear]

Vernon Springs, Howard Co
 January, 9th 1863
 Michael P. Adams
 P. M. 3^d Dis Iowa)

Sir

I have the honor
 to request you to inform me
 if I will be accepted as a
 recruit in the Veteran Corps
 now being organized at
 Washington D. C.

I have been
 in the U. S. Service since the
 war commenced twenty-two
 months nearly, and am able
 to show the same by papers
 in my possession, as follows
 First two months and seven
 days in the 15th N. Y. Volunteers
 and next in the 9th N. Y. Artillery
 from Aug 12th 62 to July 22^d 1863

I was then discharged to accept
 an appointment as 2^d Lieut
 4th U.S. Colored Troops I served
 with the last named Regt until
 March 23^d 1864 when ~~my~~
 resignation was accepted

I am now
 desirous of entering the service
 as a Private and should like
 to enter the British Corps

You will confer a great favor
 on me by giving the information
 asked for

I am Sir most Resptly
 Your Obedt Servant
 Charles A. Brown

D.C. address

Bermon Springs
 Howard Co
 Iowa

From Cyrus

No. 2, 4 U.S. Col'd Inf.

Private | *Private*

CARD NUMBERS.

1	5556158	26
2	5556241	27
3	5556340	28
4	5556438	29
5	5556531	30
6	5556618	31
7	5556704	32
8	5556791	33
9	5556872	34
10	5556952	35
11	5557047	36
12	5557210	37
13	5557701	38
14	90621042	39
15		40
16		41
17		42
18		43
19		44
20		45
21		46
22		47
23		48
24		49
25		50

Book Mark: *EP-712-P487-72 CP 78*

See also

Wm. G. G. G.

Co. D., 4 U.S. Col'd Inf.

Private | *Private*

CARD NUMBERS.

1	5556158	26
2	5556241	27
3	5556340	28
4	5556438	29
5	5556531	30
6	5556618	31
7	5556704	32
8	5556791	33
9	5556872	34
10	5556952	35
11	5557047	36
12	5557210	37
13	5557701	38
14	90621042	39
15		40
16		41
17		42
18		43
19		44
20		45
21		46
22		47
23		48
24		49
25		50

Book Mark: *EB-712-P487-72 CG 78*

See also

B | 4 | U.S.C.T.

Cyrus Brown

, Co. *W*, 4 Reg't U. S. Col'd Inf.

Appears on

Company Descriptive Book

of the organization named above.

DESCRIPTION.

Age *23* years ; height *5* feet *3 1/2* inches.

Complexion *Black*

Eyes *Black* ; hair *Black*

Where born *Suffolk Va.*

Occupation *Farmer*

ENLISTMENT.

When *July 20*, 1863 .

Where *Baltimore*

By whom *Col. W. Binney* ; term *3* y'rs.

Remarks: *Wied Feb. 22 /65 on Vascular
dilatation at USA Gen Hospital
Baltimore. Was wounded Feb 11 /65 at
Sugar Loaf Battery Federal Point M.C.*

W. H. Merrill

B

4

U.S.C.T.

Cyrus Brown

Priv., Co. D, 4 Reg't U. S. Col'd Infantry.

Age 23 years.

Appears on

Company Muster-in Roll

of the organization named above. Roll dated

Baltimore Md., July 28, 1863.

Muster-in to date July 28, 1863.

Joined for duty and enrolled:

When July 28, 1863.*

Where Baltimore *

Period 3 years.*

Remarks:

* Muster-in roll shows enrollment and muster-in of this company of same date and place. See enrollment on subsequent card or cards.

Book mark:

Faulkner

(356e)

Copyist.

17 | 4 | U.S.C.T.

Cyrus Brown
Pvt., Co. D, 4 Reg't U. S. Col'd Infantry.

Appears on

Company Muster Roll

for July 28/63 to Aug 31, 1863.

Joined for duty and enrolled:

When July 28, 1863.*

Where Baltimore Md.*

Period 3 years.*

Present or absent present

Stoppage, \$ 100 for

Due Gov't \$ 100 for

Remarks: \$2.00 Premium due.

* See enrollment on card from muster-in roll.

Book mark: -----

Gault
(858c) Copyist.

B | 4 | U.S.C.T.

Cyrus Brown
Pvt., Co. D, 4 Reg't U. S. Col'd Infantry.

Appears on
Company Muster Roll
for Sept & Oct, 1863.

Joined for duty and enrolled:
When July 28, 1863. *
Where Baltimore Md *
Period 3 years.*

Present or absent present
Stoppage, \$ 100 for _____
Due Gov't \$ 100 for _____

Remarks: _____

* See enrollment on card from muster-in roll.

Book mark: _____

Faulkner
(858c) Copyist.

B

4

U.S.C.T.

Cyrus Brown
Private, Co. D, 4 Reg't U. S. Col'd Infantry.

Appears on

Company Muster Roll

for Nov & Dec, 1863.

Joined for duty and enrolled:

When July 28, 1863.*

Where Baltimore Md) *

Period 3 years.*

Present or absent Present

Stoppage, \$ 100 for

Due Gov't \$ 100 for

Remarks:

* See enrollment on card from muster-in roll.

Book mark: -----

Franklin
Copyist.

B | 4 | **U.S.C.T.**

Cyrus Brown

Priv., Co. D, 4 Reg't U. S. Col'd Infantry.

Appears on

Company Muster Roll

for Jan & Feb, 1864.

Joined for duty and enrolled:

When July 28, 1867.*

Where Baltimore Md *

Period 3 years.*

Present or absent present

Stoppage, \$ 100 for _____

Due Gov't \$ 100 for _____

Remarks: _____

* ~~See~~ See enrollment on card from muster-in roll.

Book mark: _____

(358c)

Haultner

Copyist.

B | 4 | U.S.C.T.

Cyrus Brown

Priv, Co. D, 4 Reg't U. S. Col'd Infantry.

Appears on

Company Muster Roll

for *March + Apr*, 1864.

Joined for duty and enrolled:

When *July 28*, 1863.*

Where *Baltimore Md* *

Period *3* years.*

Present or absent *Present*

Stoppage, \$ *100* for

Due Gov't \$ *100* for

Remarks: *Stop for Letter*
D 10 glovesack 49c
= 50¢

* See enrollment on card from muster-in roll.

Book mark:

(858c)

W A Tyler

Copyist.

B | 4 | U.S.C.T.

Cyrus Brown
Priv., Co. D, 4 Reg't U. S. Col'd Infantry.

Appears on

Company Muster Roll

for May & June, 1864.

Joined for duty and enrolled:

When July 28, 1863.*

Where Baltimore Md.*

Period 3 years.*

Present or absent Present

Stoppage, \$ 100 for

Due Gov't \$ 100 for

Remarks: Stop for letter
D 1st Haversack 49c
= \$0.50

* See enrollment on card from muster-in roll.

Book mark:

W A Tyler
(858c) Copyist.

B | 4 | U.S.C.T.

Cyrus Brown

Priv, Co. D, 4 Reg't U. S. Col'd Infantry.

Appears on

Company Muster Roll

for *July + Aug*, 1864.

Joined for duty and enrolled:

When *July 28*, 186 3.*

Where *Baltimore Md* *

Period *3* years.*

Present or absent *Present*

Stoppage, \$ *100* for

Due Gov't \$ *100* for

Remarks: *In arrears on before
Apr 19, 1861, Stop for
letter D 1c Haversack
49c = \$0.50*

* See enrollment on card from muster-in roll.

Book mark:

W A Tyler

B | 4 | U.S.C.T.

Cyrus Brown
Priv., Co. D, 4 Reg't U. S. Col'd Infantry.

Appears on

Company Muster Roll
for Sept + Oct, 1864.

Joined for duty and enrolled:

When July 28, 1863.*

Where Baltimore Md *

Period 3 years.*

Present or absent Present

Stoppage, \$ 100 for

Due Gov't \$ 100 for

Remarks: Freed on or before
Apr 19/61

* See enrollment on card from muster-in roll.

Book mark:

W. A. Tyler

(858c)

Copyist.

B | 4 | U.S.C.T.

Cyrus Brown
Priv., Co. D, 4 Reg't U. S. Col'd Infantry.

Appears on

Company Muster Roll

for Nov & Dec, 1864.

Joined for duty and enrolled:

When July 27, 1863.*

Where Baltimore *

Period 3 years.*

Present or absent Present

Stoppage, \$ 100 for

Due Gov't \$ 100 for

Remarks: Free on or before
Apr 19, 1861

* See enrollment on card from muster-in roll.

Book mark:

W. A. Tyler

B | 4 | U.S.C.T.

Cyrus Brown
Pvt., Co. D, 4 Reg't U. S. Col'd Infantry.

Appears on

Company Muster Roll

for Jan. & Feb., 1865.

Joined for duty and enrolled:

When July 28, 1863.*

Where Baltimore, *

Period 3 years.*

Present or absent Absent.

Stoppage, \$ 100 for

Due Gov't \$ 100 for

Remarks Free on or before April 19/65,
Absent wounded,

* See enrollment on card from muster-in roll.

Book mark:

(858c) *Castling* Copyist.

B | 4 | U.S.C.T.

Cyrus Brown

Pvt., Co. D, 4 Reg't U. S. Col'd Infantry.

Appears on

Company Muster Roll

for Mar. & Apr., 1865.

Joined for duty and enrolled:

When July 28, 1863.*

Where Baltimore *

Period 3 years.*

Present or absent

Stoppage, \$ 100 for

Due Gov't \$ 100 for

Remarks: Free on or before Apr. 19/64,
Quid of Mlme Sospeticum
at U.S. Gen. Hoop's Baltimore
Feb. 22/65.

* See enrollment on card from muster-in roll.

Book mark:

Pasterling

(858c)

Copyist.

W.B. | 4 | U.S.C.T.

Cyrus Brown
Pvt., Co. D, 4 Reg't U. S. Col'd Infantry.

Appears on **Co. Muster-out Roll**, dated
Washington D.C. May 4, 1866.

Muster-out to date _____, 186 .
Last paid to _____, 186 .

Clothing account:

Last settled _____, 186 ; drawn since \$ _____ 100

Due soldier \$ _____ 100; due U. S. \$ _____ 100

Am't for cloth'g in kind or money adv'd \$ _____ 100

Due U. S. for arms, equipments, &c., \$ _____ 100

Bounty paid \$ _____ 100; due \$ _____ 100

Remarks: Died of Disease
Feb 22 / 65

Book mark: P.V. 18. P. 165. 71 Died May 17/64
EB 12 . 72 C.T. 78
482

(861)

James

Copyist.

Brown, Cyrus

P, Co. D, 4

Reg't U. S. C. Inf.

43 Enclosures.

Bed Cards	Descriptive Lists
Burial Records	Final Statements
Certs. of Dis. for Discharge	Furloughs
C. M. Charges	Med. Des. Lists
Med. Certificates	Orders

Other papers relating to—

Admission to Hosp'l	Furlough
Casualty Sheet (Officers) 2	Med. Examination
Confinement	Misc. Information
Contracts	Pay or Clothing
Death or Effects /	Personal Reports
Desertions	Rank
Discharge from Hosp'l	Transfer to Hosp'l
Discharge from Service	Transfer to V. R. C.
Duty	Transportation

6

CASUALTY SHEET
OF WOUNDED.

Syrus Brown

Private Company *D*

H Regiment of *USCZ*

Volunteers at the battle of *near Port**Pishes N. C.*

Febry 11. 1865

See Syrus Brown loc 13

CASUALTY SHEET.

Name, Cyrus Beaman
 Rank, private, Company D., Regiment, 4
 Arm, USCT, State, _____
 Place of casualty, Near Port Fisher N.C.
 Nature of casualty, Fr. shaft R. humerus.
 Date of casualty, Feby. 11. 1865

FROM WHAT SOURCE THIS INFORMATION WAS OBTAINED.

Report of ~~Killed, Wounded, and Missing of the~~ _____ Regiment,
 Casualties in Gen Terry's Command
 Brigade. _____ Division, _____ Corps, dated near Port
Fisher N.C. Feby 11. 1865 - not signed

Index 57 B No 24.

R. B. Jones

Clerk.

Index

17

CASUALTY SHEET
OF WOUNDED.

Asias Brown

Private Company "B"

4th Regiment of U.S.C.F.

Volunteers at the battle of _____

See Cyrus Brown Co "D"

CASUALTY SHEET.

Name, Siras Brown
 Rank, Private, Company "B", Regiment, 4^{*}
 Arm, U.S.C.T., State, _____
 Place of casualty, Not stated
 Nature of casualty, Cir. Amp. Arm. - Fore shaft
R. humerus.
 Date of casualty, Not stated

FROM WHAT SOURCE THIS INFORMATION WAS OBTAINED.

Report of Killed, Wounded, and Missing of the _____ Regiment,
Gen. Stryker's Command
 Brigade Taine's Division, _____ Corps, dated Near Fort
Fisher, N.C., February 11th, 1865. Not signed.

(Index 57 B No. 24)

M. Burke

Clerk.

FINAL STATEMENT ^{6.}

OF

Cyrus Brown

4th Reg't of W. S. Co. Troops

~~VOLUNTEERS~~ ^{10.}

NOTE 1.—Two of these certificates (or duplicates) are to be given to each Volunteer Soldier or drafted man who may be discharged previously to the discharge of his company, that he may at once receive from the Paymaster the pay, &c., due him, and the captain or other COMMISSIONED officer commanding the company will certify to the act of the delivery of the duplicate certificates; on these certificates the Soldier is "entitled to" his discharge, and should also present his discharge to the Paymaster to have the payment endorsed on it. The discharge is to be given back to the Soldier by the Paymaster; the latter only retaining as his voucher the duplicate certificates.

NOTE 2.—If the Soldier is entitled to pay for the use of his horse, the Company Commander will certify to that fact on the back of both these final statements, and also to the time he has pay due for having been so mounted on his own horse.

NOTE 3.—When a Soldier is furnished with final statements, his descriptive list, if he has one, should be taken up by the officer who gives the Soldier these statements, and endorsed with a statement to this effect by the officer. This endorsement should exhibit a full statement of the time for which the Soldier was allowed pay on his final statements, the clothing account, and all other charges against him or in his favor, so as to comprise a complete exhibit of his account. It will then be transmitted to the company commander of the Soldier, who will enter all the data necessary to a full understanding of the Soldier's account on the muster roll upon which the Soldier's discharge is reported. The descriptive list will then be destroyed. The object of this is, that the remaining portion of the Soldier's account may be settled upon the receipt of these muster rolls, and the Soldier receive any pay or allowances that may be due him at the time of his discharge, and which may not appear on his final statements from the fact that his descriptive list is incomplete. These accounts for back pay, &c., are settled by the 2d Auditor of the Treasury Department.

NOTE 4.—Charges for loss or injury to ordnance, horse equipments, and other miscellaneous charges, should appear under the heading of "Other Stoppages."

NOTE 5.—Bounty paid by State authorities, and not by the United States, will not be entered on this statement.

NOTE 6.—Amounts due the Sutler and Laundress must be entered on the muster roll on which the discharge, *de la* desertion, &c., is reported, as well as on the final statement, otherwise the amount cannot be collected from the United States.

NOTE 7.—This blank will be used for deceased volunteers and drafted men, as well as for others.

NOTE 8.—Where a Soldier dies in Hospital or on detached service, his descriptive list, if he has one, should be sent with his final statements, in duplicate, to the Adjutant General, Washington, D. C.

ADJUTANT GENERAL'S OFFICE.

April 4th 1865

Duplicate with Inventory sent 2d Auditor.

W. S. Co. Troops
1865

I certify, on honor, that Cyrus Brown a private of
 Captain John J. Richard's Company (D) of the 4th Regiment of U.S.C. Troops
VOLUNTEERS, of the State of _____, born in Suffolk, State
 of Virginia, aged 29 years; 5 feet 3 1/2 inches high; Black complexion,
Black eyes, Black hair, and by occupation a farmer, having joined the company on
 its original organization at Baltimore Md, and enrolled in it at the muster into
 the service of the United States at Baltimore Md, on the 28th day
 of July, 1862, (or was mustered in service as a recruit, by Col Wm
Birney, at Baltimore, on the 28th day of July,
 1862, or was drafted and mustered into the service of the United States from the
 Enrollment District of the State of _____, at _____,
 on the _____ day of _____, 186) to serve in the Regiment, for
 the term of three years: and having served HONESTLY and
 FAITHFULLY with his Company in the 4th U.S.C.T. to the present date, is now
 entitled to a **DISCHARGE** by reason of Death. Died of Yulmus
Sclopeticum at U.S. Genl Hospital Baltimore Feb 29/65.

The said Cyrus Brown was last paid by Paymaster
Major Birney to include the 31st day of August, 1864, and has
 pay due him from that time to the present date; he is entitled to pay and subsistence for
 TRAVELING to place of enrollment, and whatever other allowances are authorized to volunteer
 soldiers, drafted men, or militia, so discharged. He has received from the United States **CLOTHING**
 amounting to Sixteen 100 dollars, since the 20th day of June,
 1864, when his clothing account was last settled. He has received from the United States
100 dollars advanced **BOUNTY**.

There is to be stopped from him, on account of the State of _____, or other
 authorities, for **CLOTHING**, &c., received on entering service, _____ 100 dollars; and
 for other stoppages, viz: _____

 _____ 100 dollars.

He has been furnished with **TRANSPORTATION** in kind from the place of his discharge to
 _____; and he has been **SUBSISTED** for **TRAVELING** to his
 place of enrollment, up to the _____, 186 .

He is indebted to _____, **SUTLER**, _____ 100 dollars.
 He is indebted to _____, **LAUNDRESS**, _____ 100 dollars.

Given in Duplicate, at Faison Station N. C., this 28th day
 of March, 1865.

John J. Richard
Capt 4th U.S.C.T.
 Commanding Company.

1865-
F. G. on file, No. 6.
INVENTORY OF THE EFFECTS

OF
Cyrus Brown

Late of Company D

4th Reg't of W. S. Cal. Troops

Volunteers, who died at Baltimore

on the 22nd day of February 1865.



160
Brown, David

Co. H, 4 U.S. Col'd Inf.

Private | Corporal

CARD NUMBERS.

1	5562708	26
2	5562809	27
3	5562908	28
4	5563010	29
5	5563106	30
6	5563199	31
7	5563292	32
8	5563380	33
9	5563465	34
10	5563549	35
11	5563644	36
12	5563744	37
13	5563846	38
14	5563937	39
15	5564032	40
16	5564120	41
17	5564175	42
18	5564230	43
19	9067662	44
20		45
21		46
22		47
23		48
24		49
25		50

Book Mark:

See also

NARA 1483

S-1024815. *Almond*

13. | 4 | U.S.C.T.

David A. Brown

Co. H., 4 Reg't U. S. Col'd Inf.

Appears on

Company Descriptive Book

of the organization named above.

DESCRIPTION.

Age 34 years; height 5 feet 8 inches.

Complexion Brown

Eyes Blue; hair Curly

Where born Carroll Co, Md

Occupation Laborer

ENLISTMENT.

When Aug. 11, 1863.

Where Baltimore, Md

By whom Col. W. Birney; term 3 y'rs.

Remarks:

Free on or before

Apr. 19/64.

Mustered out May 4/66
by order of Sec'y of War

Selah

Copyist.

B

4

U.S.C.T.

David N. Brown

Private, Co. H, 4 Reg't U. S. Col'd Infantry.

Age 34 years.

Appears on

Company Muster-in Roll

of the organization named above. Roll dated

_____, Aug 11, 1863.

Muster-in to date

Aug 11, 1863.

Joined for duty and enrolled:

When Aug 11, 1863.*

Where Baltimore City *

Period 3 years.*

Remarks:

* Muster-in roll shows enrollment and muster-in of this company of same date and place. See enrollment on subsequent card or cards.

Book mark:

M. A. Michaels

B | 4 | U.S.C.T.

David N. Brown

Priv., Co. H, 4 Reg't U. S. Col'd Infantry.

Appears on

Company Muster Roll

for Aug 11 to Aug 31, 1863.

Joined for duty and enrolled:

When Aug. 11, 1863.*

Where Baltimore City *

Period 3 years.*

Present or absent Present

Stoppage, \$ 100 for

Due Gov't \$ 100 for

Remarks:

* See enrollment on card from muster-in roll.

Book mark:

M. A. Michaels

(858c)

Copyist.

D | 4 | U.S.C.T.

David N. Brown

Priv., Co. H, 4 Reg't U. S. Col'd Infantry.

Appears on

Company Muster Roll

for *Sept & Oct.*, 1863.

Joined for duty and enrolled:

When *Aug. 11*, 186 *3**

Where *Baltimore City* *

Period *3* years.*

Present or absent *Present*

Stoppage, \$ *100* for

Due Gov't \$ *100* for

Remarks: *Sick in Quarters*

* See enrollment on card from muster-in roll.

Book mark:

M. A. Michaels

B | 4 | U.S.C.T.

David N. Brown

Civ., Co. H, 4 Reg't U. S. Col'd Infantry.

Appears on

Company Muster Roll

for Nov & Dec, 1863.

Joined for duty and enrolled:

When Aug. 11, 1863.*

Where Baltimore City *

Period 3 years.*

Present or absent Present

Stoppage, \$ 100 for

Due Gov't \$ 100 for

Remarks: Detailed as Pioneer

* See enrollment on card from muster-in roll.

Book mark:

(858c)

M. A. Michael
Copyst.

B | 4 | U.S.C.T.

David W. Brown

Pvt., Co. H, 4 Reg't U. S. Col'd Infantry.

Appears on

Company Muster Roll

for Jan & Feb, 1864.

Joined for duty and enrolled:

When Aug. 11, 1863.*

Where Baltimore City *

Period 3 years.*

Present or absent Present

Stoppage, \$ 100 for

Due Gov't \$ 100 for

Remarks: Detailed in Pioneer Corps.

* See enrollment on card from muster-in roll.

Book mark: 5039172

M. A. Michaels

(858c)

Copyist.

B

4

U.S.C.T.

David N. Brown

Private, Co. H, 4 Reg't U. S. Col'd Infantry.

Appears on

Company Muster Roll

for March 8 April, 1864.

Joined for duty and enrolled:

When Aug. 11, 1863.*

Where Baltimore City.*

Period 3 years.*

Present or absent Present

Stoppage, \$ 100 for

Due Gov't \$ 100 for

Remarks: detailed as Pioneer at Brigade Hd. Qrs.

* See enrollment on card from muster-in roll.

Book mark:

C. F. Thompson

(858c)

Copyist.

B

4

U.S.C.T.

David N. Brown

Priv., Co. H, 4 Reg't U. S. Col'd Infantry.

Appears on

Company Muster Roll

for May & June, 1864.

Joined for duty and enrolled:

When Aug. 11, 1863.*

Where Baltimore City *

Period 3 years.*

Present or absent Present

Stoppage, \$ 100 for

Due Gov't \$ 100 for

Remarks: detailed as Pioneer at Brig Hd 2'rs.

* See enrollment on card from muster-in roll.

Book mark:

C. F. Thompson

(858c)

Copyist.

B | 4 | U.S.C.T.

David N. Brown
 Pvt., Co. H, 4 Reg't U. S. Col'd Infantry.

Appears on

Company Muster Roll

for July & Aug., 1864.

Joined for duty and enrolled:

When Aug. 11, 1863.*

Where Baltimore City*

Period 3 years.*

Present or absent Present

Stoppage, \$ 100 for

Due Gov't \$ 100 for

Remarks: Detached as
 Pioneer at Brig. Hd.
 2'rs.

* See enrollment on card from muster-in roll.

Book mark:

(858c) C. F. Thompson. Copyist.

B | 4 | U.S.C.T.

David N. Brown.

Priv., Co. H, 4 Reg't U. S. Col'd Infantry.

Appears on

Company Muster Roll

for Sept. & Oct., 1864.

Joined for duty and enrolled:

When Aug. 11, 1863.*

Where Baltimore, Md. *

Period 3 years.*

Present or absent Present.

Stoppage, \$ 100 for _____

Due Gov't \$ 100 for _____

Remarks: Free on or before
Apr. 19/61. On detached
duty as Pioneer at
Brig Hd 2nd.

* See enrollment on card from muster-in roll.

Book mark: _____

C. F. Thompson.

B | 4 | U.S.C.T.

David W. Brown
Plt, Co. H, 4 Reg't U. S. Col'd Infantry.

Appears on

Company Muster Roll
 for *Nov. & Dec.*, 1864.

Joined for duty and enrolled:

When *Aug. 11*, 186*3*.*

Where *Baltimore* *

Period *3* years.*

Present or absent *Present*

Stoppage, \$ *100* for _____

Due Gov't \$ *100* for _____

Remarks: _____

* See enrollment on card from muster-in roll.

Book mark: _____

C. F. Thompson,
 Copyist.

B | 4 | U.S.C.T.

David A. Brown

Pvt, Co. H, 4 Reg't U. S. Col'd Infantry.

Appears on

Company Muster Roll

for Jan & Feb, 1865.

Joined for duty and enrolled:

When Aug 11, 1863.*

Where Baltimore Md.*

Period 3 years.*

Present or absent Present

Stoppage, \$ 100 for

Due Gov't \$ 100 for

Remarks:

* See enrollment on card from muster-in roll.

Book mark:

Bowman

B | 4 | U.S.C.T.

David N. Brown

Pvt., Co. H, 4 Reg't U. S. Col'd Infantry.

Appears on

Company Muster Roll

for Mar & Apr, 1865.

Joined for duty and enrolled:

When Aug 11, 1863.*

Where Baltimore Md *

Period 3 years.*

Present or absent Absent

Stoppage, \$ 100 for

Due Gov't \$ 100 for

Remarks: Free on or before April 19th 1861 Back Pay due from May 1, 1864 to muster into service Detached Service as Brigade Pioneer

* See enrollment on card from muster-in roll.

Book mark:

Bowman

B

4

U.S.C.T.

David N. Brown

Pvt., Co. H, 4 Reg't U. S. Col'd Infantry.

Appears on

Company Muster Roll

for May & June, 1865.

Joined for duty and enrolled:

When Aug 11, 1863.*

Where Baltimore Md *

Period 3 years.*

Present or absent Present

Stoppage, \$ 100 for

Due Gov't \$ 100 for

Remarks: Back pay due from enlistment to May 1. 64

* See enrollment on card from muster-in roll.

Book mark:

Bowman

B | 4 | U.S.C.T.

David N. Brown

Pvt, Co. H, 4 Reg't U. S. Col'd Infantry.

Appears on

Company Muster Roll

for Jul & Aug, 1865.

Joined for duty and enrolled:

When Aug 11, 1863.*

Where Baltimore Md *

Period 3 years.*

Present or absent Absent

Stoppage, \$ 100 for

Due Gov't \$ 100 for

Remarks: Detached Service as
Brig Pioneer. Stop \$300 for
transportation

* See enrollment on card from muster-in roll.

Book mark:

Brown

B | 4 | U.S.C.T.

David N. Brown

Pvt., Co. H, 4 Reg't U. S. Col'd Infantry.

Appears on

Company Muster Roll

for Sept & Oct, 1865.

Joined for duty and enrolled:

When Aug 11, 1863.*

Where Baltimore Md *

Period 3 years.*

Present or absent Absent

Stoppage, \$ 100 for

Due Gov't \$ 100 for

Remarks: Detached Service News
Berne N.C. Stop for Transporta
tion \$17.750. Due Commutation
for Rations while absent
with leave \$9.00

* See enrollment on card from muster-in roll.

Book mark: _____

Bowman

13. | 4 | U.S.C.T.

David M. Brown,
Priv., Co. H, 4 Reg't U. S. Col'd Infantry.

Appears on

Company Muster Roll

for Novth Dec^r, 1865.

Joined for duty and enrolled:

When August 11, 1863.*

Where Baltimore, Md.*

Period 3 years.*

Present or absent Present.

Stoppage, \$ 100 for

Due Gov't \$ 100 for

Remarks:

* See enrollment on card from muster-in roll.

Book mark:

R. S. Brauner
Copyist.

13 | 4 | U.S.C.T.

David M. Sproul,
Corpl., Co. H, 4 Reg't U. S. Col'd Infantry.

Appears on

Company Muster Roll

for *Jan'y^{4th} Feby*, 186*6*.

Joined for duty and enrolled:

When *August 11*, 186*3*.*

Where *Baltimore, Md.* *

Period *3* years.*

Present or absent *Present.*

Stoppage, \$ *100* for

Due Gov't \$ *100* for

Remarks: *Promoted Corporal Feby.*
2, 1866 per S. C. No. 18 Sta.
Ans. 4 U.S. C. T. Feby. 2/66.

NEXT ROLL ON FILE MUSTER OUT.

* See enrollment on card from muster-in roll.

Book mark:

(858c) *D. M. Sproul* Copyist.

B. | 4 | U.S.C.T.

David N. Brown,
Corpl, Co H, 4 Reg't U. S. Col'd Infantry.

Appears on **Co. Muster-out Roll**, dated
Washington, D. C., May 4, 1866.
 Muster-out to date *May 4, 1866.*
 Last paid to *Feb'y 28, 1866.*

Clothing account:

Last settled....., 186 ; drawn since \$.....100

Due soldier \$ *22.38* 100; due U. S. \$.....100

Am't for cloth'g in kind or money adv'd \$.....100

Due U. S. for arms, equipments, &c., \$ *0.*100

Bounty paid \$.....100; due \$ *100.*100

Remarks: *Was Private from en-*
rollment to Feb. 2, 1866.

Free.

Book mark :

D. Brauner

(361)

Copyist.

101
Brown. Isaac

Co G, 4 U.S. Col'd Inf.

Private Private

CARD NUMBERS.

1	5561006	26
2	5561105	27
3	5561206	28
4	5561306	29
5	5561405	30
6	5561502	31
7	5561600	32
8	5561693	33
9	5561780	34
10	5561872	35
11	5562024	36
12	5562662	37
13	9062420	38
14		39
15		40
16		41
17		42
18		43
19		44
20		45
21		46
22		47
23		48
24		49
25		50

Book Mark: L. B. V. 14. P. 890

See also

B | 4 | U.S.C.T.

Isaac Brown
 Co. G, 4 Reg't U. S. Col'd Inf.

Appears on
Company Descriptive Book
 of the organization named above.

DESCRIPTION.

Age 20 years; height 5 feet 7 1/2 inches.
 Complexion Brown
 Eyes Black; hair Black
 Where born Fredericksville
 Occupation Farmer

ENLISTMENT.

When Aug 11, 1863
 Where Saltville
 By whom Col. Ripley; term 3 y'rs.
 Remarks: Killed in action Feb. 22/65
 near Wilmington N.C.

W. H. Merrill

B | 4 | U.S.C.T.

Isaac Brown
Pt. Co. G, 4 Reg't U. S. Col'd Infantry.

Age 20 years.

Appears on

Company Muster-in Roll

of the organization named above. Roll dated

Baltimore Md, Aug 11, 1863

Muster-in to date

Aug 11, 1863

Joined for duty and enrolled:

When

Aug 11, 1863

Where

Baltimore City

Period

3 years.*

Remarks:

* Muster-in roll shows enrollment and muster-in of this company as of same date and place. See enrollment on subsequent card or cards.

Book mark:

Rose

73

4

U.S.C.T.

Isaac Brown
Pvt., Co. G, 4 Reg't U. S. Col'd Infantry.

Appears on

Company Muster Roll
for Aug 11 to 31, 1863

Joined for duty and enrolled:

When Aug 11, 1863

Where Baltimore City *

Period 3 years.*

Present or absent Present

Stoppage, \$ 100 for

Due Gov't \$ 100 for

Remarks:

* See enrollment on card from muster-in roll.

Book mark:

Rose

(358c)

Copyist.

IB

4

U.S.C.T.

Isaac Brown

Priv, Co. G, 4 Reg't U. S. Col'd Infantry.

Appears on

Company Muster Roll

for *Sept and Oct*, 186*3*

Joined for duty and enrolled:

When *Aug 11*, 186*3**

Where *Baltimore City* *

Period *3* years.*

Present or absent *Present*

Stoppage, \$ *100* for _____

Due Gov't \$ *100* for _____

Remarks: _____

* See enrollment on card from muster-in roll.

Book mark: _____

Rose

73

4

U.S.C.T.

Isaac Brown

Sgt., Co. G, 4 Reg't U. S. Col'd Infantry.

Appears on

Company Muster Roll

for Nov and Dec, 1863

Joined for duty and enrolled:

When Aug 11, 1863*

Where Baltimore City *

Period 3 years.*

Present or absent Present

Stoppage, \$ 100 for

Due Gov't \$ 100 for

Remarks: Detailed as Company cook

* See enrollment on card from muster-in roll.

Book mark:

Rose

73 | **4** | **U.S.C.T.**

Isaac Brown
Priv, Co. G, 4 Reg't U. S. Col'd Infantry.

Appears on

Company Muster Roll
for *Jan & Feb*, 186*4*.

Joined for duty and enrolled:

When *Aug 11*, 186*3*.*

Where *Baltimore City* *

Period *3* years.*

Present or absent *Present*

Stoppage, \$ *100* for

Due Gov't \$ *100* for

Remarks: *Stop one knapsack*
\$185/100

* See enrollment on card from muster-in roll.

Book mark:

Rose

B | 4 | U.S.C.T.

Isaac Brown

Priv., Co. G, 4 Reg't U. S. Col'd Infantry.

Appears on

Company Muster Roll

for Mar & Apr, 1864.

Joined for duty and enrolled:

When Aug 11, 1863.*

Where Baltimore Md *

Period 3 years.*

Present or absent Present

Stoppage, \$ 100 for _____

Due Gov't \$ 100 for _____

Remarks: Stop one Canteen
41/100 2 Gt Coat Straps
11/100.

* See enrollment on card from muster-in roll.

Book mark: _____

C. Richardson

(358c)

Copyist.

B

4

U.S.C.T.

Isaac Brown

Priv., Co. G, 4 Reg't U. S. Col'd Infantry.

Appears on

Company Muster Roll

for May June, 1864

Joined for duty and enrolled:

When Aug 11, 1863.*

Where Baltimore Md.*

Period 3 years.*

Present or absent Absent

Stoppage, \$ 100 for

Due Gov't \$ 100 for

Remarks: Absent in Genl. Hospital at City Point 1/2 Stop one canteen + two g't coat straps 5 1/2 00.

* See enrollment on card from muster-in roll.

Book mark:

E. J. Richardson

B | 4 | U.S.C.T.

Isaac Brown

Priv., Co. G, 4 Reg't U. S. Col'd Infantry.

Appears on

Company Muster Roll

for July & Aug, 1864.

Joined for duty and enrolled:

When Aug 11, 1863.*

Where Baltimore City *

Period 3 years.*

Present or absent Present

Stoppage, \$ 1.00 for

Due Gov't \$ 1.00 for

Remarks: Slave when enlisted.

Stop 1 Canteen 2 g't coat

Shops 52/100. Extra duty

Comp Cook.

Absent sick in Hospital

from June 15 to Aug. 5/64.

* See enrollment on card from muster-in roll.

Book mark:

C. T. Richardson

B

4

U.S.C.T.

Isaac Brown

Priv., Co. G, 4 Reg't U. S. Col'd Infantry.

Appears on

Company Muster Roll

for Sept + Oct, 1864.

Joined for duty and enrolled:

When Aug 11, 1863.*

Where Baltimore *

Period 3 years.*

Present or absent Present

Stoppage, \$ 100 for _____

Due Gov't \$ 100 for _____

Remarks: Slave when enlisted.
On daily duty as company
cook.

* ~~See~~ See enrollment on card from muster-in roll.

Book mark: _____

E. J. Richardson

(358c)

Copyist.

B | 4 | U.S.C.T.

Isaac Brown
 Pvt., Co. G, 4 Reg't U. S. Col'd Infantry.

Appears on

Company Muster Roll

for Nov + Dec, 186 4

Joined for duty and enrolled:

When Aug 11, 186 3.*

Where Baltimore Md*

Period 3 years.*

Present or absent Present

Stoppage, \$ 100 for _____

Due Gov't \$ 100 for _____

Remarks: Slave when enlisted.

* See enrollment on card from muster-in roll.

Book mark: _____

(358c) E. Richardson Copyist.

B

4

U.S.C.T.

Isaac Brown

Pvt., Co. G, 4 Reg't U. S. Col'd Infantry.

Appears on

Company Muster Roll

for *Dated Feb 28*, 1865.

Joined for duty and enrolled:

When *Aug 11*, 1863.*

Where *Balt-Md* *

Period *3* years.*

Present or absent

Stoppage, \$ *100* for

Due Gov't \$ *100* for

Remarks: *Slave when enlisted
Killed in action Feb 22/64
near Wilmington, N.C.*

* See enrollment on card from muster-in roll.

Book mark *Disd Feb 22/65 L.B. 14/890*

Ackerman

(358c)

Copyist.

B | **4** | **U.S.C.T.**

Isaac Brown
Priv, Co. *G*, 4 Reg't U. S. Col'd Infantry.

Appears on **Co. Muster-out Roll**, dated
Washington D.C. May 4, 186*6*.

Muster-out to date _____, 186 .

Last paid to _____, 186 .

Clothing account:

Last settled _____, 186 ; drawn since \$ _____ 100

Due soldier \$ _____ 100; due U. S. \$ _____ 100

Am't for cloth'g in kind or money adv'd \$ _____ 100

Due U. S. for arms, equipments, &c., \$ _____ 100

Bounty paid \$ _____ 100; due \$ _____ 100

Remarks: *Slave Killed*
in action Feb 22/65

Book mark: *1495.1880.766.810*

(861)

W. Johnson
Copyist.

Brown, Isaac

P, Co. G, 4 U.S.C. Inf.

4 Enclosures.

Bed Cards	Descriptive Lists
Burial Records	Final Statements
Certs. of Dis. for Discharge	Furloughs
C. M. Charges	Med. Des. Lists
Med. Certificates	Orders

Other papers relating to—

Admission to Hosp'l	Furlough
Casualty Sheet (^{Priv} Officer's)	Med. Examination
Confinement	Misc. Information
Contracts	Pay or Clothing
Death or Effects	Personal Reports
Desertions	Rank
Discharge from Hosp'l	Transfer to Hosp'l
Discharge from Service	Transfer to V. R. C.
Duty	Transportation

MICROFILM PUBLICATION M 1846

COMPILED MILITARY SERVICE RECORDS
OF VOLUNTEER UNION SOLDIERS WHO SERVED WITH
THE UNITED STATES COLORED TROOPS (USCT)
4TH REGIMENT OF INFANTRY

PERSONAL PAPERS' TARGET SHEET

PLEASE NOTE THE CHECKED INFORMATION ABOUT THE PERSONAL PAPERS IN
THIS FILE:

- NO PERSONAL PAPERS WERE FOUND IN THIS FILE WHEN THE
RECORDS WERE ARRANGED FOR MICROFILMING.
- 11 PERSONAL PAPER(S) FOUND IN THIS FILE WHEN THE RECORDS
WERE ARRANGED FOR MICROFILMING.

Loyalty of
John Norris
+
Wesley Norris

[Faint handwritten text, possibly bleed-through from the reverse side]

[Faint handwritten text, possibly bleed-through from the reverse side]

Frederick Md Dec 2nd 1864
 To the Board of Censors, Bal:

We hereby certify that
 Messrs John Norris and William Lee Norris
 are gentlemen well known to us and that
 their reputation is that of being loyal citizens
 very usfy
 Chas. E. Traie

John A. Steiner Sherrif
 of Frederick County Md

T. L. McLean

Messrs. Traie, Senator Elect from this county, John A. Steiner,
 Sheriff, and Thomas L. McLean, who give the foregoing
 certificate, are undoubted Union men and prominent
 and respectable citizens of Frederick County.

Frederick Schley,
 Editor of The Examiner,
 Dec. 2nd 1864.

433.

A. S. O., July 12. 1865

I certify that the name of Isaac Brown
is borne on the Muster-in Roll of Company
"G" 4th Regt. U.S.C. Troops, on file in this
Office. It is stated on said Roll
that he was enrolled at Balltown Md.
Md.

Wm. Taggart
A. S. General

VOLUNTEER DESCRIPTIVE LIST and Account of Pay and Clothing of

State of Maryland, Andraick County, Set: Personally appeared before me, the Subscribed, a Justice of the Peace of the State of Maryland, in and for Andraick County aforesaid, John Norris, a resident of "Hoodsborough District," in the County and State aforesaid, and made oath in due form of law, that Isaac Brown: about five feet eight or nine inches high black eyes and complexion and about eighteen years of age, a Man of Office or Rank, and Subject in Company E, Fourth U.S. Regiment of Colored and Troops from Maryland Commanded by Col. Denking; The aforesaid Isaac Brown, being his Slave for a term of years, to wit for the term of twenty three years, one month and five days from the tenth day of August last, the time of his Tutelment; and that the said Isaac Brown, is his Slave for the term of years aforesaid under the laws of the State of Maryland, and that he purchased the aforesaid Isaac Brown from John Norris, a resident of the County & State aforesaid on the 29th day of October A.D. 1860.

I, John Norris, do hereby certify before me at Andraick County Maryland, this twenty fifth day of January, A.D. 1864. John Norris Justice of the Peace

[A. G. O. No. 93.]

1. A receipt of the amount of the pay and clothing of the volunteer must be made, in duplicate, by the commanding officer, and one copy of the receipt must be retained by the commanding officer. It must be made in duplicate, and one copy of the receipt must be retained by the commanding officer. It must be made in duplicate, and one copy of the receipt must be retained by the commanding officer.

Maryland, Frederick County, Set:

I hereby Certify, That James M. Harding, Esquire, before whom the foregoing Affidavit was made and who has thereto subscribed his name, was at the time of so doing, a Justice of the Peace of the State of Maryland, in and for Frederick County, duly elected, commissioned and sworn.

In Testimony Whereof, I have subscribed my name and affix the seal of the Circuit Court for Frederick County, this fifteenth day of February, A.D. 1864. J. M. Hardy Clerk of the Circuit Court for Frederick County.

STATION: Mount Airy DATE: February 10 1864

Proprietor of the Mount Airy Penitentiary

Signature of James M. Harding

to James M. Harding

14th Nov 64

REMARKS

Sample



Correct.

J. H.

J. 1st District Md

No. 438 No. H. 30

APPLICATION OF

John Norris

Woodborough P.O., OF

Fredricks County

For Compensation for Service of Slave,

Isaac Brown

Enlisted in Smith Regiment

U. S. Colored Troops, Co. G.

Received, Feb 26th 1864.

COMPENSATION AWARDED,

January 6th 1864.

Three Hundred Dollars.

Thos. Simmons

President Board of Claims

Woodborough P.O.

Md

Ma

Slave for more than 2 years

Recd. 1st District Jan 3. 1864

EVIDENCE OF TITLE.

I, John Norris, of Frederick County, Md., do solemnly swear that Isaac Brown who has been enlisted in the Fourth Regiment, U. S. Colored Troops, Co. G; is my slave for a term of years; (his term of service expiring on the eighth day of September, 1886, 1886;) and that I became possessed of him by purchase, in the month of October, eighteen hundred and sixty. And I do further swear that I have not purchased said slave from any person or persons disloyal to the Government of the United States, with the object of obtaining compensation for the same; and furthermore, that I have no agency for obtaining compensation for any person or persons but such as, to my knowledge, are loyal citizens of the United States.

John Norris

February 19th 1864



Sworn before, J. M. Harvey, a Justice of the Peace of the State of Maryland and for Frederick County.

STATE OF MARYLAND,

Frederick County, to wit:

On this *Seventeenth* day of *February* in the year 1864, before me, the subscriber, a Justice of the Peace of the State and County aforesaid, personally appeared *John Norris*, and took, signed, and acknowledged the oaths preceding; and further made oath, in due form of law, that all the statements made in this application are, to the best of *his* knowledge and belief, strictly true.

John Norris

Also personally appeared before me ~~*Thomas S. Fulton*~~ and *Otto Norris*, loyal citizens of the United States, residents of *Frederick County*, well acquainted with the said *John Norris*, and in no manner interested in the prosecution of this claim, and made oath, in due form of law, that the said *John Norris* is the owner of the slave *Isaac Brown*, as a fact of public notoriety; that they believe all the statements herein made by *him*, in reference thereto, are correct, and that *he* is unquestionably loyal to the Government of the United States. Witness their signatures:

John Fulton
Otto Norris

J. M. Harding Justice of the Peace.



5cts Stamp

STATE OF MARYLAND,

Frederick County, to wit:

I, *Joseph W. S. Carby*, Clerk of the Circuit Court for *Frederick* County, do hereby certify that *James McHarding*, before whom the foregoing affidavits were made, was, at the time of signing the same, a Justice of the Peace for the County and State aforesaid, duly commissioned and sworn; and that his signature thereto is genuine, and that full faith and credit should be given to his official acts.

Witness my hand and the seal of said Court, this *Seventeenth* day of *February*, A. D. 1864.



Stamp

J. W. S. Carby CLERK.

EVIDENCE OF TITLE.

I, John Norris, of Fredrick
 County, Md., do solemnly swear that Isaac Brown
 who has been enlisted in the Fourth Regiment, U. S. Colored Troops,
 Co. G; is my slave for a term of years; (his term of service expiring on
 the eighth day of September, 1886, 1886;) and that
 I became possessed of him by purchase, in the month
 of October, eighteen hundred and sixty. And I
 do further swear that I have not purchased said slave from any person or persons disloyal
 to the Government of the United States, with the object of obtaining compensation for
 the same; and furthermore, that I have no agency for obtaining compensation for any per-
 son or persons but such as, to my knowledge, are loyal citizens of the United States.

John Norris

February 19th 1864



Sworn before, J. M. Harvey, a Justice of the
Peace of the State of Maryland and for
Ind. of the County,

A.

No. 433

CLAIMANT'S CERTIFICATE.

I, John Norris a loyal citizen, and a resident of Woodsborough District, County of Fredricks, State of Maryland, hereby claim compensation, under the provisions of General Orders, No. 329, 1863, for my slave Isaac Brown enlisted August 11th 1863, at Baltimore City by Col. Wm. Birney in the Fourth Regiment U. S. Colored Troops, Co. G; certificate of which enlistment, and a descriptive list, as required, accompany this application.

In proof of my loyalty to the Constitution and Government of the United States, I present the accompanying oath, which I have taken, signed, and acknowledged, to be filed with this application, in accordance with requirement of said General Orders.

John Norris J. N.

February 17th 1864

B.

OATH OF ALLEGIANCE.

I, John Norris, do solemnly swear that I have never joined, or been concerned in, any insurrection or rebellion; that I have never borne arms against the United States; that I have never given any aid, countenance, counsel, or encouragement to any person or persons engaged, or whom I had reason to believe were about to engage, in insurrection, rebellion, or armed hostility against the United States; that I have neither sought, nor accepted, nor attempted to exercise the functions of any office, civil or military, nor to perform any service whatever, under any authority or pretended authority in hostility to the United States; that I have not yielded a voluntary support to any insurrection, rebellion, or pretended government, authority, power, or constitution within the United States hostile thereto. And I do further swear that, to the best of my knowledge and ability, I have supported and defended, and will continue to support and defend, the United States against all enemies, foreign and domestic; and that I have supported, defended, and obeyed, and will continue to support, defend, and obey, the Constitution and laws of the United States; that I will bear true faith and allegiance to the same; and that I take this oath freely, without any mental reservation or purpose of evasion: So help me God.

John Norris J.N.

Sworn to and subscribed before me, at Frederick
 this 19th day of February, 1864

5 ct Stamp



*W. Harding a Justice of the Peace
 of the State of Maryland in and for
 Frederick County*

C.

I present herewith evidence of my title to the slave Isaac Brown enlisted as aforesaid, and in consideration of the sum of _____ by me received, I hereby covenant and agree with the United States, that I, my heirs, executors, or assigns, shall never hereafter make or enforce any claim to the labor or services of said slave; and pledge myself to execute a valid Deed of Manumission and Release of all my claims to service forever of said Isaac Brown to be filed with the Board of Claims now in session at Baltimore Md

John Norris J.N.

February 17th, 1864

5 ct Stamp



State of Maryland, Frederick County, to wit:
I hereby certify that the within is a true copy of the Original Manumission
as recorded in Liber J. W. L. C. No. 1 one of the Land Records of Frederick
County.

In testimony whereof I hereunto subscribe my name & affix
the seal of the Circuit Court for Frederick County, this
Seventeenth day of February, Eighteen hundred & sixty four
Jos. W. L. Carty Clerk



F.

CERTIFICATE OF AWARD OF THE BOARD OF CLAIMS.

Office of the Board of Claims
For Slaves Enlisted in the Service of the United States,

Baltimore Md

January 7th 1865

\$300

We hereby certify, that *John Norris*, of *Fredrick* county, State of *Maryland*, having proved, under oath, *his* loyalty to the Constitution and Government of the United States, and established *his* title as to the ownership of *Isaac Brown*, a slave enlisted at *Baltimore Md*, on the *11th* day of *August*, *1863*, by *Col. Wm. Birney*, in the service of the United States, in the *4th* Regiment of Colored Troops, *Co. G*, and having filed a valid Deed of Manumission and Release of Service of said slave, is entitled to the sum of *Three hundred* dollars, which has been awarded to *him* by this Board as a remuneration for all claim to the future labor or service of said slave, under the provision of General Orders, War Department, No. 329, *1863*.

Thos. Simmons, President of the Board.

L. E. Staughen, Member of the Board.

Wm. T. Jones, Member of the Board.

To *Col. C. W. Foster*,

Chief of the Bureau for the
Organization of Colored Troops, Washington, D. C.

P. J. M. Norake 10

No. .

ABSTRACT OF DISBURSEMENTS.

....., 186 .

John Norris

Dollars *300* ⁰⁰/₁₀₀

Paid , 186 .

The United States,

To *John Norris* Dr.

		DOLLARS.	CENTS.
1865. <i>January 7th</i>	For amount awarded him by the Board of Claims, in consideration of the enlistment of <i>Isaac Brown</i> in the <i>4th Regt. W. S. Col'd. Troop</i>	<i>300</i>	<i>00</i>
	<i>Total \$</i>		<i>300</i>

I CERTIFY that the above account is correct and just; that the name of *Isaac Brown* is borne on the muster-in rolls of the *4th Regt. W. S. Col'd. Troop*; and that the above amount was awarded by the Board of which *Thomas Simmons Esq.* is President, said award being in accordance with section 24 of the act entitled "An act to amend an act entitled 'An act for enrolling and calling out the national forces, and for other purposes,'" approved Feb. 24, 1864.

Assistant Adjutant General.

RECEIVED _____, 186 _____, of *Capt. A. F. Rockwell, U.S.G., Vol.* dollars and _____ cents, in full of the above account.

John Norris

(SIGNED DUPLICATES.)

R. V. A. No. 10.

No. .

ABSTRACT OF DISBURSEMENTS.

....., 186 .

John Harris

Dollars *500* $\frac{10}{100}$

Paid , 186 .

The United States,

To *John Norris* Dr.

186 3.
July 7th

	DOLLARS.	CENTS.
For amount awarded him by the Board of Claims, in consideration of the enlistment of <i>Isaac Brown</i> in the <i>4th Regt U.S. Col'd Troops</i>	<i>300</i>	<i>00</i>
<i>Total</i> \$	<i>300</i>	<i>00</i>

I CERTIFY that the above account is correct and just; that the name of *Isaac Brown* is borne on the muster-in rolls of the *4th Regt U.S. Col'd Troops*; and that the above amount was awarded by the Board of which *Thomas Timmons Esq* is President, said award being in accordance with section 24 of the act entitled "An act to amend an act entitled 'An act for enrolling and calling out the national forces, and for other purposes,'" approved Feb. 24, 1864.

Assistant Adjutant General.

RECEIVED _____, 186 _____, of *Capt. J. Rockwell, A.A.G.*,
dollars and _____ cents, in full of the above account.

John Norris

(SIGNED DUPLICATES.)

1865-
F.S. on file No. 7

INVENTORY OF THE EFFECTS

OF

Private Isaac Brown

Late of Company "G"

4th Reg't of U.S. Cold. Troops

Volunteers, who died ^{was killed} at N. C. Station Wm. R. R. C.

on the 22^d day of February 1865.



Inventory of the effects of Isaac Brown late
a Private of Captain James H. Wickes Company G of
the Fourth Regiment of U.S. Col. Troops Volunteers, who was enrolled as
a Private at Baltimore in the State of Maryland on
the 11th day of August 1863, and mustered into the service of the United
States as a Private on the 11th day of August 1863, at Balt. Md.
in Company G, Fourth Regiment of U.S. Col. Troops Volunteers, to serve Three
years or during the war; he was born in Fredricks in the State
of Maryland; he was 20 years of age, 5 feet 7¹/₄ inches
high, Brown complexion, Black eyes, Black hair, and by occupation, when enrolled,
a Farmer; he died in was killed in action, at
Fort Fisher on the 22nd day of February 1865, by
reason of was shot through.

INVENTORY.					
ARTICLES.	No.	ARTICLES.	No.	ARTICLES.	No.
Hats		Pairs trousers		Knapsacks	
Caps		Pairs flannel drawers		<div style="text-align: center;"> <p><i>Effects</i></p> </div>	
Forage caps		Pairs cotton drawers			
Great coats		Flannel shirts			
Uniform coats		Cotton shirts			
Uniform jackets		Pairs boots			
Flannel sack coats		Pairs shoes			
Blouses		Pairs socks			
Stable frocks		Blankets			
Fatigue overalls		Haversacks			
					MONEY.
				Specie	\$
				Notes	\$

I CERTIFY, ON HONOR, that the above inventory comprises all the effects of Private
Isaac Brown, deceased, and that the effects are in the hands
of _____ at _____
_____ to be disposed of by a Council of Administration.

(DUPLICATES.)

STATION: Frederick Station 10x10 C. & P. N. E.

DATE: April 5, 1865

John G. Gullough
2nd Lieutenant
Commanding the Company.

4

CASUALTY SHEET

No.

Isaac Brown

Private of Company G

4 Regiment of USCA

State Volunteers.

NATURE OF CASUALTY

Killed

CASUALTY SHEET.

Name: Isaac Brown

Rank: Private Company: B Regiment: 4

Arm: U.S.A. State: _____

Nature of Casualty: Killed - Head musket ball

CAUSE OF CASUALTY—(NAME OF DISEASE, &C)	BY WHOM DISCHARGED.
DEGREE OF DISABILITY.	FROM WHAT SOURCE THIS INFORMATION WAS OBTAINED.
BY WHOM CERTIFIED.	REMARKS.
DATE OF DISCHARGE, DEATH, &C.	
PLACE OF DISCHARGE, DEATH, &C.	

Norman S. Barnes

Surgeon U.S.A. Medical Director

Feb 22nd 1865

Near Wilmington N.C.

Tabulated report of Casualties
Occurring in Maj Genl
Derry Command near
Wilmington N.C. Feb 19 22
1865

Died 51 No 46

W.F. Thompson

Clerk.

[OFFICE ENDORSEMENT.]

War Department,
ADJUTANT GENERAL'S OFFICE,

Nov 17th, 1862.

The death of Isaac Brown, Pvt, Co G, 4th Reg't U. S. Colored Troops, is reported as follows:

- On Company Muster Roll. For Jan + Feb 1865, Feb 22nd, 1864
- Company Muster-out Roll. Feb 22nd, 1865
- Company Descriptive Book. Feb 22nd, 186
- Company Morning Reports. Feb 22nd, 186
- Soldier's Final Statement. February 22nd, 1865
- Soldier's Record of Death and Interment. Feb 22nd, 186
- Soldier's Inventory of Effects. Feb 22nd, 186
- Soldier's Certificate of Disability for Discharge. Feb 22nd, 186
- Soldier's Individual Muster-out Roll. Feb 22nd, 186
- Regimental Return. Feb 22nd, 186
- Regimental Quarterly Returns. Feb 22nd, 186
- Regimental Descriptive Book. Feb 22nd, 186

By Surgeon General. Feb 22nd, 1865, is held to be the correct date, and the Company Muster Roll will be amended accordingly.

L.B. 14/890

M. Parker
Assistant Adjutant General.

DWS

Noted

FINAL STATEMENT

OF

Private Isaac Brown

4th Reg't of U.S. Colored Troops

VOLUNTEERS.

NOTE 1.—Two of these certificates (or duplicates) are to be given to each Volunteer Soldier or drafted man who may be discharged previously to the discharge of his company, that he may at once receive from the Paymaster the pay, &c., due him, and the captain or other COMMISSIONED officer commanding the company will certify to the act of the delivery of the duplicate certificates; on these certificates the Soldier is "entitled to" his discharge, and should also present his discharge to the Paymaster to have the payment endorsed on it. The discharge is to be given back to the Soldier by the Paymaster; the latter only retaining as his voucher the duplicate certificates.

NOTE 2.—If the Soldier is entitled to pay for the use of his horse, the Company Commander will certify to that fact on the back of both these final statements, and also to the time he has pay due for having been so mounted on his own horse.

NOTE 3.—When a Soldier is furnished with final statements, his descriptive list, if he has one, should be taken up by the officer who gives the Soldier these statements, and endorsed with a statement to this effect by the officer. This endorsement should exhibit a full statement of the time for which the Soldier was allowed pay on his final statements, the clothing account, and all other charges against him or in his favor, so as to comprise a complete exhibit of his account. It will then be transmitted to the company commander of the Soldier, who will enter all the data necessary to a full understanding of the Soldier's account on the muster roll upon which the Soldier's discharge is reported. The descriptive list will then be destroyed. The object of this is, that the remaining portion of the Soldier's account may be settled upon the receipt of these muster rolls, and the Soldier receive any pay or allowances that may be due him at the time of his discharge, and which may not appear on his final statements from the fact that his descriptive list is incomplete. These accounts for back pay, &c., are settled by the 2d Auditor of the Treasury Department.

NOTE 4.—Charges for loss or injury to ordnance, horse equipments, and other miscellaneous charges, should appear under the heading of "Other Stoppages."

NOTE 5.—Bounty paid by State authorities, and not by the United States, will not be entered on this statement.

NOTE 6.—Amounts due the Sutler and Laundress must be entered on the muster roll on which the discharge, death, desertion, &c., is reported, as well as on the final statement, otherwise the amount cannot be collected from the United States.

NOTE 7.—This blank will be used for deceased volunteers and drafted men, as well as for others.

NOTE 8.—Where a Soldier dies in Hospital or on detached service, his descriptive list, if he has one, should be sent with his final statements, in duplicate, to the Adjutant General, Washington, D. C.

Isaac Brown

I certify, on honor, that Isaac Brown a Private of
 Captain James H. Wells Company (4th) of the Fourth Regiment of M.D. Col. Troops
VOLUNTEERS, of the State of Maryland, born in Frederick, State
 of Maryland, aged 20 years; 5 feet 7 1/4 inches high; Brown complexion,
Black eyes, Black hair, and by occupation a Farmer, having joined the company on
 its original organization at Baltimore Md, and enrolled in it at the muster into
 the service of the United States at Baltimore Md, on the Eleventh day
 of August, 1863, (or was mustered in service as a recruit, by
 _____, at _____, on the _____ day of _____,
 186 , or was drafted and mustered into the service of the United States from the _____
 Enrollment District of the State of _____, at _____,
 on the _____ day of _____, 186) to serve in the Regiment, for
 the term of Three Years: and having served HONESTLY and
 FAITHFULLY with his Company in The Field to the present date, is now
 entitled to a **DISCHARGE** by reason of being killed in action at N.C.
Station W.F.W. at N.C. July 20 1865

The said Private Isaac Brown was last paid by Paymaster
Major Bunn to include the 31st day of August, 1864, and has
 pay due him from that time to the present date; he is entitled to pay and subsistence for
 TRAVELING to place of enrollment, and whatever other allowances are authorized to volunteer
 soldiers, drafted men, or militia, so discharged. He has received from the United States **CLOTHING**
 amounting to Twenty-nine 29 28 dollars, since the 30th day of June,
 1864, when his clothing account was last settled. He has received from the United States
 _____ dollars advanced **BOUNTY**.

There is to be stopped from him, on account of the State of _____, or other
 authorities, for **CLOTHING**, &c., received on entering service, _____ dollars; and
 for other stoppages, viz: _____

_____ dollars.
 He has been furnished with **TRANSPORTATION** in kind from the place of his discharge to
 _____; and he has been **SUBSISTED** for **TRAVELING** to his
 place of enrollment, up to the _____, 186 .

He is indebted to W. C. Cooper, **SUTLER**, Two 2 dollars.
 He is indebted to _____, **LAUNDRESS**, _____ dollars.

Given in Duplicate, at Thurmont Md, this 5th day
 of April, 1865.

James H. Wells
2

 Commanding Company

102

Brown, James G.

Co. B., 4 U.S. Col'd Inf.

Private

Private

CARD NUMBERS.

5554392	26
5550751	27
9061882	28
B-192-CJ-1816	29
	30
	31
	32
	33
	34
	35
	36
	37
	38
	39
	40
	41
	42
	43
	44
	45
	46
	47
	48
	49
	50

Book Mark: *B 192 U.S. 46 - B.9. AC 76 - EB. V12 P 1107*

See also

S 1100813 - Pom. m
A-1209625 P.O. Rad.
01438251. and NWA

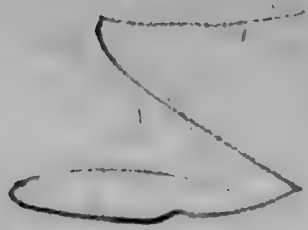

B | 4 | U.S.C.T.

James G. Brown
Co. "B", 4 Reg't U. S. Col'd Inf.

Appears on

Company Descriptive Book

of the organization named above.

DESCRIPTION.

Age 34 years; height 5 feet 7 1/2 inches.

Complexion mulatto

Eyes black; hair black

Where born Morgan Co. Ohio.

Occupation farmer

ENLISTMENT.

When Sept. 3, 1864.

Where Newark, O.

By whom Capt. J. A. Simut; term 1 y'rs.

Remarks:

[Handwritten signature]

B | 4 | U.S.C.T.

James G. Brown
 Pvt., Co., 4 Reg't U. S. Col'd Infantry.

Appears on an

Individual Muster-out Roll

of the organization named above. Roll dated

Fort Monroe, Va., Oct. 14, 1865.

Muster-out to date Oct. 14, 1865.

Last paid to Pd. for months of May & June 1865 by Maj. Pulifer 1865.

Clothing account:

Last settled, 186 ; drawn since \$ 100

Due soldier \$ 100; due U. S. \$ 100

Am't for cloth'g in kind or money adv'd \$ 11 87 ^{in hospital} / 100

Due U. S. for arms, equipments, &c., \$ 100

Bounty paid \$ 100; due \$ 100

Remarks: This man was assigned to the 4th U.S.C.T. in Sept. 1864, at Dutch Gap as a Recruit, before being assigned to a company he was sent to the U. S. hospital at Point of Rocks as a Patient. He has never reported to the regiment since. No notice (OVER)

Book mark: Dis. list on file with H 373 Vol. 2 R. 6. 1/65. Filed in Mis Box, A. G. C.

C. M. Clark

JAN. 19

5550751

1891 *

of his having received payments
or clothing has been received. The
money value of clothing charged
to him at the date of his enlist-
ment is not stated on his enlist-
ment papers. Patient in U. S.
Gen'l Hospital, Fort Monroe,
Va., Mustered out by reason
of expiration of term of
service

73

4

U.S.C.T.

James G. Brown
Priv., Co. B, 4 Reg't U. S. Col'd Infantry.

Appears on **Co. Muster-out Roll**, dated
Washington, D.C., May 4, 1866.

Muster-out to date 186 .

Last paid to 186 .

Clothing account:

Last settled 186 ; drawn since \$ 100

Due soldier \$ 100 ; due U. S. \$ 100

Am't for cloth'g in kind or money adv'd \$ 100

Due U. S. for arms, equipments, &c., \$ 100

Bounty paid \$ 100 ; due \$ *100* 100

Remarks: *Assigned to Canham*
Ohio, 1866 - absent sick,
No discharge given.
(Enrol. & mfm Sept 3/64 Newark
Ohio 1 year age 37)

Book mark: *See B. 192, U. S. G. I. 76*
over

Tabler

(861)

Copyist.

NARRA1469

JAN. 19

5554392

1891

*B. 9, Vol. 5, R. C. T., 1865,
Discharged Oct. 14/65.
E. 93. V. 12, P. 167.*

B. 1 4" M.S. 6. J

James G. Brown
Co. B, 4" Reg't U.S. 6. J.

B9RC3 **NOTATION**
1868 with
Book mark: B. 192 6. J. 1876.

War Department,

Adjutant General's Office,

Washington, Sept. 23, 1896.

Call from _____

returned with report.

The above book mark was noted on rolls in order to
preserve results of search in this case.

(475)

E. P. Conrazier

Copyist.

Brown, James G.
 P, Co. B, 4 Reg't S. C. Inf.

2 Enclosures.

Bed Cards	Descriptive Lists
Burial Records	Final Statements
Certs. of Dis. for Discharge	Furloughs
C. M. Charges	Med. Des. Lists
Med. Certificates	Orders

Other papers relating to—

Admission to Hosp'l	Furlough /
Casualty Sheet (Officer's)	Med. Examination
Confinement	Misc. Information
Contracts	Pay or Clothing
Death or Effects	Personal Reports
Desertions	Rank
Discharge from Hosp'l	Transfer to Hosp'l
Discharge from Service /	Transfer to V. R. C.
Duty	Transportation

Record and Pension Office,

WAR DEPARTMENT.

The slip hereto attached is a stub from
a "Pass Book", Headquarters Department
of Washington.

No. 735-

Name, James Brown

Reg't, 4th Reg. Colored

Co. Army of the

Recommended by Farlow

Date, July 27 1864.

Expires, 1864.

This man is only borne on Muster out Roll of Co. Not borne on any other Roll of Regt.

War Department,

ADJUTANT GENERAL'S OFFICE,

November 2nd, 1876

The Discharge of James L. Brown, Co. B, 4th Reg't U. S. Colored Troops, is reported as follows:

On Company Muster Roll.

For _____, 186 _____, 186

Company Muster-out Roll.

Assigned to Co. April 16/66. Absent sick. No discharge given

Company Descriptive Book.

Name borne without remark, 186

Company Morning Reports.

No information kept for Apr & May, not on file, 186

Soldier's Final Statement.

_____, 186

Soldier's Record of Death and Interment.

_____, 186

Soldier's Inventory of Effects.

_____, 186

Soldier's Certificate of Disability for Discharge.

_____, 186

Soldier's Individual Muster-out Roll.

Oct 14, 1865

Regimental Return.

For _____, 186 _____, 186

Regimental Quarterly Returns.

_____, 186

Regimental Descriptive Book.

Name borne without remark, 186

By Surgeon General.

(Oct 7 4), 1865, is held to be

the correct date, and the Company Muster out Roll will be amended accordingly.

From M. Lucien
See letter to 2d Auditor
Assistant Adjutant General.

W. H. B. 147
107

~~For pleasure~~
Please
furnish such
information in
that case - as
to assignment
station and
service - as you
records may
afford.

Rufy
Wardlaw
Oct-30-76

163

Brown, John D.

Co H, 4 U.S. Col'd Inf.

Private Private

CARD NUMBERS.

1 5563553
 2 5563645
 3 5563747
 4 5563849
 5 5563939
 6 5564077
 7 5564262
 8 55650986
 9 9062672

26
 27
 28
 29
 30
 31
 32
 33
 34
 35
 36
 37
 38
 39
 40
 41
 42
 43
 44
 45
 46
 47
 48
 49
 50

Book Mark:

See also

10 208 35 PD. M M

B | 4 | U.S.C.T.

John D. Brown

H, Co. H, 4 Reg't U. S. Col'd Inf.

Appears on

Company Descriptive Book

of the organization named above.

DESCRIPTION.

Age 34 years; height 5 feet 8 inches.

Complexion Blk

Eyes Blk; hair Blk

Where born Charles City Co., Va.

Occupation Farmer

ENLISTMENT.

When Sept 2, 1864.

Where Harrison, O.

By whom Capt. I. Barber; term 1 y'rs.

Remarks:

Mustered out ex-
piration of service Sept
5/65.

Selah

3

4

U.S.C.T.

John D. Brown
Aut., Co. H, 4 Reg't U. S. Col'd Infantry.

Appears on

Company Muster Roll

for *Nov. & Dec.*, 1864.

Joined for duty and enrolled:

When *Sept. 2*, 1864.*

Where *Harris Co.* *

Period *1* years.*

Present or absent *Present*

Stoppage, \$ *100* for _____

Due Gov't \$ *100* for _____

Remarks: _____

* See enrollment on card from muster-in roll.

Book mark: _____

(858c)

C. F. Thompson
 Copyist.

B | 4 | U.S.C.T.

John D. Brown

Pvt, Co. H, 4 Reg't U. S. Col'd Infantry.

Appears on

Company Muster Roll

for Jan & Feb, 1865.

Joined for duty and enrolled:

When Sept 2, 1864.*

Where Union O. *

Period 1 years.*

Present or absent Present

Stoppage, \$ 100 for

Due Gov't \$ 100 for

Remarks:

[Empty lines for remarks]

* See enrollment on card from muster-in roll.

Book mark:

Bowman

B | 4 | U.S.C.T.

John D. Brown

Pvt, Co. H, 4 Reg't U. S. Col'd Infantry.

Appears on

Company Muster Roll

for *Mar + Apr*, 1865.

Joined for duty and enrolled:

When *Sept 2*, 1864.*

Where *Union O.**

Period *1* years.*

Present or absent *Present*

Stoppage, \$ *100* for

Due Gov't \$ *100* for

Remarks:

* See enrollment on card from muster-in roll.

Book mark: *100*

Boroman

B | 4 | **U.S.C.T.**

John D. Brown
Pvt, Co. H, 4 Reg't U. S. Col'd Infantry.

Appears on

Company Muster Roll

for May & June, 1865.

Joined for duty and enrolled:

When Sept 2, 1864.*

Where Union O. *

Period 1 years.*

Present or absent Present

Stoppage, \$ 100 for _____

Due Gov't \$ 100 for _____

Remarks: _____

* ~~See~~ See enrollment on card from muster-in roll.

Book mark: _____

Bowman
 (858c) Copyist.

B

4

U.S.C.T.

John D. Brown

Private, Co. H, 4 Reg't U. S. Col'd Infantry.

Appears on

Company Muster Roll

for Jul & Aug, 1865.

Joined for duty and enrolled:

When Sept 2, 1864.*

Where Union O. *

Period 1 years.*

Present or absent Present

Stoppage, \$ 100 for

Due Gov't \$ 100 for

Remarks:

* See enrollment on card from muster-in roll.

Book mark:

Bowman

B | 4 | U.S.C.T.

John D. Brown

Pvt., Co. H, 4 Reg't U. S. Col'd Infantry.

Appears on

Company Muster Roll

for Sept & Oct, 1865.

Joined for duty and enrolled:

When Sept 2, 1864.*

Where Union Co. *

Period 1 years.*

Present or absent

Stoppage, \$ 100 for

Due Gov't \$ 100 for

Remarks: Mustered out by reason of expiration of term of service at New Bern N.C. Sept 7/65

* See enrollment on card from muster-in roll.

Book mark:

Bowman

B | 4 U.S.C.T.

John D Brown
Co B, Co H, 4 Reg't U. S. Col'd Infantry.

Appears on a

Detachment Muster-out Roll

of the organization named above. Roll dated

New Berne NC, Sept 5, 1865.

Muster-out to date Sept 5, 1865.

Last paid to June 30, 1865

Clothing account:

Last settled June 30 1865; drawn since None $\frac{00}{100}$

Due soldier \$ $\frac{100}{100}$; due U. S. \$ $\frac{100}{100}$

Am't for cloth'g in kind or money adv'd \$ $\frac{100}{100}$

Due U. S. for arms, equipments, &c., \$ $\frac{600}{100}$

Bounty paid \$ $\frac{100}{100}$ due \$ $\frac{10000}{100}$

Remarks: Muster and account books retained. Mustered out by reason of expiration of term of service. Travel for station due from place of Dis charge to place of Enlistment

Book mark : _____

Jacobson

AD. | 4 | U.S.C.T.

John D. Brown,
Priv., Co. H., 4 Reg't U. S. Col'd Infantry.

Appears on **Co. Muster-out Roll**, dated
Washington, D. C., May 4, 1866.

Muster-out to date _____, 186 .

Last paid to *June 30, 1865.*

Clothing account:

Last settled _____, 186 ; drawn since \$ _____ 100

Due soldier \$ _____ 100; due U. S. \$ _____ 100

Am't for cloth'g in kind or money adv'd \$ _____ 100

Due U. S. for arms, equipments, &c., \$ _____ 100

Bounty paid \$ *100.* 100; due \$ _____ 100

Remarks: *Discharged for expiration of enlistment Sept 5/65.*

*(Enrol'd m/p: Sept 2/64 Harrison
 O: 1 Year age 34)*

Book mark : _____

(861)

R. D. Spawmer
 Copyist.

164

Brown John H

Co H, 4 U.S. Col'd Inf.

Private Private

CARD NUMBERS.

1	5562710
2	5562810
3	5562909
4	5563011
5	5563107
6	5563200
7	5563293
8	5563381
9	5563464
10	5563550
11	5563646
12	5563745
13	5563847
14	5563938
15	5564033
16	5564121
17	5564179
18	5564230
19	9062663
20	
21	
22	
23	
24	
25	

26
27
28
29
30
31
32
33
34
35
36
37
38
39
40
41
42
43
44
45
46
47
48
49
50

Book Mark:

See also



NARA 1487

S1792972 - P.O. memo

B | 4 | U.S.C.T.

John H. Brown

, Co. K, 4 Reg't U. S. Col'd Inf.

Appears on

Company Descriptive Book

of the organization named above.

DESCRIPTION.

Age 21 years; height 5 feet 7 inches.

Complexion *Blk*

Eyes *Blk*; hair *Curly*

Where born *Baltimore, Md*

Occupation *Laborer*

ENLISTMENT.

When *Aug. 11*, 1863.

Where *Baltimore Md*

By whom *Col M Birney*; term *3* y'rs.

Remarks: *Present or before*

April 19/61
Mustered out May 4/66
by order of Sec'y of War

Selah

B

4

U.S.C.T.

John H. Brown

Private, Co. H., 4 Reg't U. S. Col'd Infantry.

Age *21* years.

Appears on

Company Muster-in Roll

of the organization named above. Roll dated

Aug 11, 1863.

Muster-in to date

Aug 11, 1863.

Joined for duty and enrolled:

When *Aug 11, 1863.**

Where *Baltimore City.**

Period *3* years.*

Remarks:

* Muster-in roll shows enrollment and muster-in of this company as of same date and place. See enrollment on subsequent card or cards.

Book mark:

M. A. Michaels

(3567)

Copyist.

B | 4 | U.S.C.T.

John H. Brown

Priv., Co. H, 4 Reg't U. S. Col'd Infantry.

Appears on

Company Muster Roll

for Aug 11 to Aug 31, 1863.

Joined for duty and enrolled:

When Aug. 11, 1863.*

Where Baltimore City *

Period 3 years.*

Present or absent Present

Stoppage, \$ 100 for

Due Gov't \$ 100 for

Remarks:

* See enrollment on card from muster-in roll.

Book mark:

(858c)

M. A. Michaels

Copyist.

B | 4 | U.S.C.T.

John H. Brown

Priv., Co. H, 4 Reg't U. S. Col'd Infantry.

Appears on

Company Muster Roll

for *Sept & Oct*, 1863.

Joined for duty and enrolled:

When *Aug. 11*, 1863.*

Where *Baltimore City**

Period *3* years.*

Present or absent *Present*

Stoppage, \$ *100* for

Due Gov't \$ *100* for

Remarks:

* See enrollment on card from muster-in roll.

Book mark: -----

M. A. Michaels
 (358c) Copyist

B | 4 | U.S.C.T.

John H. Brown
Priv., Co. H, 4 Reg't U. S. Col'd Infantry.

Appears on

Company Muster Roll
for Nov & Dec, 1863.

Joined for duty and enrolled:

When Aug. 11, 1863.*

Where Baltimore City *

Period 3 years.*

Present or absent Present

Stoppage, \$ 100 for

Due Gov't \$ 100 for

Remarks:

* See enrollment on card from muster-in roll.

Book mark: 11

(858c)

M. A. Michaels

Copyist.

B | 4 | U.S.C.T.

John H. Brown
Priv., Co. H, 4 Reg't U. S. Col'd Infantry.

Appears on

Company Muster Roll

for Jan & Feb, 1864.

Joined for duty and enrolled:

When Aug. 11, 1863.*

Where Baltimore City *

Period 3 years.*

Present or absent Present

Stoppage, \$ 100 for

Due Gov't \$ 100 for

Remarks:

* See enrollment on card from muster-in roll.

Book mark:

M. A. Michaels
Copyist.

(858c)

B | 4 | U.S.C.T.

John H. Brown,
Pvt., Co. H, 4 Reg't U. S. Col'd Infantry.

Appears on

Company Muster Roll
for Mich. & Apr., 1864.

Joined for duty and enrolled:

When Aug 11, 1863.*

Where Baltimore City.*

Period 3 years.*

Present or absent Present

Stoppage, \$ 100 for

Due Gov't \$ 100 for

Remarks:

* See enrollment on card from muster-in roll.

Book mark: _____

(858c) C. F. Thompson
Copyist.

B | 4 | U.S.C.T.

John H. Brown.
Priv., Co. H, 4 Reg't U. S. Col'd Infantry.

Appears on

Company Muster Roll

for May & June, 1864.

Joined for duty and enrolled:

When August, 1863.*

Where Baltimore City *

Period 3 years.*

Present or absent Present.

Stoppage, \$ 100 for

Due Gov't \$ 100 for

Remarks:

* See enrollment on card from muster-in roll.

Book mark:

(358c)

C. F. Thompson
Copyist.

13

4

U.S.C.T.

John H. Brown
 Pvt., Co. H, 4 Reg't U. S. Col'd Infantry.

Appears on

Company Muster Roll

for July & Aug., 1864.

Joined for duty and enrolled:

When Aug. 11, 1863.*

Where Baltimore City*

Period 3 years.*

Present or absent Present

Stoppage, \$ 100 for

Due Gov't \$ 100 for

Remarks: On extra duty
digging Canal at
Dutch Gap Va. since
Aug. 9/64. Free on or
before Apr. 19/61

* See enrollment on card from muster-in roll.

Book mark:

(358c)

C. F. Thompson
 Copyist.

B

4

U.S.C.T.

John H. Brown
Out, Co. H, 4 Reg't U. S. Col'd Infantry.

Appears on

Company Muster Roll

for *Sept. & Oct.*, 1864.

Joined for duty and enrolled:

When *Aug. 11*, 1863.*

Where *Baltimore, Md.* *

Period *3* years.*

Present or absent *Present*

Stoppage, \$ *100* for

Due Gov't \$ *100* for

Remarks: *Free on or before*
Apr. 19/64

* See enrollment on card from muster-in roll.

Book mark:

(358c)

C. F. Thompson
 Copyist.

B | 4 | U.S.C.T.

John H. Brown
Private, Co. H, 4 Reg't U. S. Col'd Infantry.

Appears on

Company Muster Roll
for Nov. & Dec., 1864.

Joined for duty and enrolled:

When Aug. 11, 1864.*

Where Baltimore.*

Period 3 years.*

Present or absent Present.

Stoppage, \$ 100 for

Due Gov't \$ 100 for

Remarks:

* See enrollment on card from muster-in roll.

Book mark:

(858c)

C. F. Thompson

Copyist.

B

4

U.S.C.T.

John H. Brown

Private, Co. H, 4 Reg't U. S. Col'd Infantry.

Appears on

Company Muster Roll

for Jan & Feb, 1865.

Joined for duty and enrolled:

When Aug 11, 1863.*

Where Baltimore Md *

Period 3 years.*

Present or absent Present

Stoppage, \$ 100 for

Due Gov't \$ 100 for

Remarks:

* See enrollment on card from muster-in roll.

Book mark:

Bowman

(358c)

Copyist.

B

4

U.S.C.T.

John H. Brown

Pot., Co. H, 4 Reg't U. S. Col'd Infantry.

Appears on

Company Muster Roll

for Mar & Apr, 1865.

Joined for duty and enrolled:

When Aug 11, 1863.*

Where Baltimore Md *

Period 3 years.*

Present or absent Absent

Stoppage, \$ 100 for

Due Gov't \$ 100 for

Remarks: Free on or before
 April 19th 1861. Back Pay due from
 May 1, 1864 to muster into service
 Detached service as Brigade
 Wagon Master

* See enrollment on card from muster-in roll.

Book mark:

Bowman

(858c)

Copyist.

B | 4 | U.S.C.T.

John H. Brown

Pr....., Co. H, 4 Reg't U. S. Col'd Infantry.

Appears on

Company Muster Roll

for *May & June*....., 1865.

Joined for duty and enrolled:

When *Aug 11*....., 1863.*

Where *Baltimore Md*.....*

Period *3* years.*

Present or absent *Absent*

Stoppage, \$.....100 for.....

Due Gov't \$.....100 for.....

Remarks: *Back pay due from enlistment to May 1.64*
Absent sick

* See enrollment on card from muster-in roll.

Book mark:.....

Bowman

B | 4 | U.S.C.T.

John H. Brown

Priv, Co. H, 4 Reg't U. S. Col'd Infantry.

Appears on

Company Muster Roll

for *Jul & Aug*, 1865.

Joined for duty and enrolled:

When *Aug 11*, 1863.*

Where *Baltimore Md* *

Period *3* years.*

Present or absent *Absent*

Stoppage, \$ *100* for

Due Gov't \$ *100* for

Remarks: *Detached Service as
Division Teamster*

* See enrollment on card from muster-in roll.

Book mark:

Bowman

B

4

U.S.C.T.

John H. Brown

Priv, Co. H, 4 Reg't U. S. Col'd Infantry.

Appears on

Company Muster Roll

for *Sept & Oct*, 1865.

Joined for duty and enrolled:

When *Aug 11*, 1863.*

Where *Baltimore Md* *

Period *3* years.*

Present or absent *Present*

Stoppage, \$ *100* for

• Due Gov't \$ *100* for

Remarks:

* See enrollment on card from muster-in roll.

Book mark:

Bowman

13. | 4 | U.S.C.T.

John H. Brown,
Priv., Co. H, 4 Reg't U. S. Col'd Infantry.

Appears on

Company Muster Roll

for Novbr. 4th Decbr., 1865.

Joined for duty and enrolled:

When August 11, 1863.*

Where Baltimore, Md. *

Period 3 years.*

Present or absent Present.

Stoppage, \$ 100 for _____

Due Gov't \$ 100 for _____

Remarks: _____

* ~~See~~ See enrollment on card from muster-in roll.

Book mark: _____

R. A. Brauner
Copyist.

18.

4

U.S.C.T.

John H. Brown,
Priv., Co. H, 4 Reg't U. S. Col'd Infantry.

Appears on

Company Muster Roll

for *Jan'y⁴ Febr'y*, 186*6*.

Joined for duty and enrolled:

When *August 11*, 186*3*.*

Where *Baltimore, Md.* *

Period *3* years.*

Present or absent *Present.*

Stoppage, \$ *100* for

Due Gov't \$ *100* for

Remarks:

NEXT ROLL ON FILE MUSTER OUT.

* See enrollment on card from muster-in roll.

Book mark:

(858c)

R. S. Spencer

Copyist.

18

4

U.S.C.T.

John H. Brown,
Priv., Co. H., 4 Reg't U. S. Col'd Infantry.

Appears on **Co. Muster-out Roll**, dated
Washington, D.C., May 4, 1866.

Muster-out to date *May 4, 1866.*

Last paid to *July 28, 1866.*

Clothing account:

Last settled....., 186 ; drawn since \$.....100

Due soldier \$ *34¹⁴*.....100; due U. S. \$.....100

Am't for cloth'g in kind or money adv'd \$.....100

Due U. S. for arms, equipments, &c., \$.....100

Bounty paid \$.....100; due \$ *100.*.....100

Remarks: *Free.*

Book mark :

(861)

J. H. Examiner

Copyist.

Wm. John Henry

No. 4 U.S. Col'd Inf.

Private | Corporal

CARD NUMBERS.

56 2 7 1 1
 56 2 8 1 2
 56 2 9 1 0
 56 3 0 1 2
 56 3 1 0 8
 56 3 2 0 1
 56 3 2 9 4
 56 3 3 8 2
 56 3 4 6 6
 56 3 5 5 1
 56 3 6 4 7
 56 3 7 4 6
 56 3 8 4 8
 56 3 9 4 0
 56 4 0 3 4
 56 4 1 1 5
 56 4 1 7 4
 56 4 2 2 6
 62 6 6 4

26
 27
 28
 29
 30
 31
 32
 33
 34
 35
 36
 37
 38
 39
 40
 41
 42
 43
 44
 45
 46
 47
 48
 49
 50

rk:

SO

1292972 - P.O. Mem

B | 4 | U.S.C.T.

John Henry Brown
 Co. A, 4 Reg't U. S. Col'd Inf.

Appears on

Company Descriptive Book

of the organization named above.

DESCRIPTION.

Age 25 years; height 5 feet 10 ^{3/4} inches.

Complexion *Blk*

Eyes *Blk*; hair *Curly*

Where born *Fredrick Co, Md*

Occupation *Laborer*

ENLISTMENT.

When *Aug 11*, 1863.

Where *Baltimore, Md*

By whom *Col M Burney*; term *3* y'rs.

Remarks:

*Free or before
 Apr 19/61*

*Mustered out May 4/66
 by order of Secy of War*

Selah
 Copyist.

B | **4** | **U.S.C.T.**

John Henry Brown
Private, Co. *H.*, 4 Reg't U. S. Col'd Infantry.

Age *25* years.

Appears on

Company Muster-in Roll

of the organization named above. Roll dated

....., *Aug 11*, 186*3*.

Muster-in to date *Aug 11*, 186*3*.

Joined for duty and enrolled:

When *Aug. 11*, 186*3*.*

Where *Baltimore City* *

Period *3* years.*

Remarks:

* ~~The~~ Muster-in roll shows enrollment and muster-in of this company as of same date and place. See enrollment on subsequent card or cards.

Book mark: *10*

M. A. Michael

(356e)

Copyist.

B | 4 | U.S.C.T.

John Henry Brown

Priv., Co. H, 4 Reg't U. S. Col'd Infantry.

Appears on

Company Muster Roll

for *Aug 11 to Aug 31*, 186*3*.

Joined for duty and enrolled:

When *Aug. 11*, 186*3*.*

Where *Baltimore City* *

Period *3* years.*

Present or absent *Present*

Stoppage, \$ *100* for

Due Gov't \$ *100* for

Remarks: *Stoppage for one
Canteen*

* ~~45~~ See enrollment on card from muster-in roll.

Book mark:

M. A. Michaels

B | 4 | U.S.C.T.

John Henry Brown
Priv., Co. H, 4 Reg't U. S. Col'd Infantry.

Appears on

Company Muster Roll

for *Sept & Oct*, 1863.

Joined for duty and enrolled:

When *Aug 11*, 1863.*

Where *Baltimore City* *

Period *3* years.*

Present or absent *Present*

Stoppage, \$ *100* for

Due Gov't \$ *100* for

Remarks:

* See enrollment on card from muster-in roll.

Book mark:

M. A. Michaels
Copyst.

B | 4 | U.S.C.T.

John Henry Brown
Priv., Co. H, 4 Reg't U. S. Col'd Infantry.

Appears on

Company Muster Roll

for Nov. & Dec, 1863.

Joined for duty and enrolled:

When Aug. 11, 1863.*

Where Baltimore City *

Period 3 years.*

Present or absent Present.

Stoppage, \$ 100 for

Due Gov't \$ 100 for

Remarks: Sick in Quarters

* See enrollment on card from muster-in roll.

Book mark:

M. A. Michaels
(358c) Copyist.

B | 4 | U.S.C.T.

John Henry Brown
Priv., Co. H, 4 Reg't U. S. Col'd Infantry.

Appears on

Company Muster Roll

for *Jan & Febr*, 1864.

Joined for duty and enrolled:

When *Aug. 11*, 1863.*

Where *Baltimore City**

Period *3* years.*

Present or absent *Present*

Stoppage, \$ *100* for

Due Gov't \$ *100* for

Remarks: *Sick in Hospital*

* See enrollment on card from muster-in roll.

Book mark:

(358c)

M. A. Michaels

Copyist.

B | 4 | U.S.C.T.

John Henry Brown.
Priv., Co. H, 4 Reg't U. S. Col'd Infantry.

Appears on

Company Muster Roll
for *March 8 Apr.*, 1864.

Joined for duty and enrolled:

When *Aug. 11*, 1863.*

Where *Baltimore City*.*

Period *3* years.*

Present or absent *Present*.

Stoppage, \$ *100* for _____

Due Gov't \$ *100* for _____

Remarks: _____

* ~~See~~ See enrollment on card from muster-in roll.

Book mark: _____

C. F. Thompson
(358c) Copyist.

B | 4 | U.S.C.T.

John Henry Brown
Rgt, Co. H, 4 Reg't U. S. Col'd Infantry.

Appears on

Company Muster Roll

for May & June, 1864

Joined for duty and enrolled:

When Aug. 11, 1863.*

Where Baltimore City *

Period 3 years.*

Present or absent Present

Stoppage, \$ 100 for

Due Gov't \$ 100 for

Remarks:

* See enrollment on card from muster-in roll.

Book mark:

(858c)

C. F. Thompson
Copyist.

B | 4 | U.S.C.T.

John Henry Brown
Priv., Co. H, 4 Reg't U. S. Col'd Infantry.

Appears on

Company Muster Roll

for July & Aug., 1864.

Joined for duty and enrolled:

When Aug. 11, 1863.*

Where Baltimore City.*

Period 3 years.*

Present or absent absent

Stoppage, \$ 100 for

Due Gov't \$ 100 for

Remarks: Sick in General Hospital.

* See enrollment on card from muster-in roll.

Book mark:

C. F. Thompson.

B

4

U.S.C.T.

John Henry Brown

Priv., Co. H, 4 Reg't U. S. Col'd Infantry.

Appears on

Company Muster Roll

for Sept. & Oct., 1864.

Joined for duty and enrolled:

When Aug. 11, 1863.*

Where Baltimore, Md. *

Period 3 years.*

Present or absent Present

Stoppage, \$ 100 for

Due Gov't \$ 100 for

Remarks: Free on or before Apr. 19/61.

* See enrollment on card from muster-in roll.

Book mark:

C. F. Thompson

(858c)

Copyist.

B

4

U.S.C.T.

John Henry Brown
Pvt., Co. H, 4 Reg't U. S. Col'd Infantry.

Appears on

Company Muster Roll

for Nov. 8 Dec., 1864.

Joined for duty and enrolled:

When Aug. 11, 1863.*

Where Baltimore *

Period 3 years.*

Present or absent Present.

Stoppage, \$ 100 for

Due Gov't \$ 100 for

Remarks: Free on or before
Apr. 19/65

* See enrollment on card from muster-in roll.

Book mark:

(358c)

C. F. Thompson.
Copyist.

B

4

U.S.C.T.

John Henry Brown

Pvt, Co. H, 4 Reg't U. S. Col'd Infantry.

Appears on

Company Muster Roll

for *Jan & Feb*, 1865.

Joined for duty and enrolled:

When *Aug 11*, 1863.*

Where *Baltimore Md* *

Period *3* years.*

Present or absent *Present*

Stoppage, \$ *100* for

Due Gov't \$ *100* for

Remarks: *Free on or before
April 19, 1861*

* See enrollment on card from muster-in roll.

Book mark:

Bowman

B | 4 | U.S.C.T.

John Henry Brown

Pvt., Co. H, 4 Reg't U. S. Col'd Infantry.

Appears on

Company Muster Roll

for Mar & Apr, 1865.

Joined for duty and enrolled:

When Aug 11, 1863.*

Where Baltimore Md *

Period 3 years.*

Present or absent Present

Stoppage, \$ 100 for

Due Gov't \$ 100 for

Remarks:

* See enrollment on card from muster-in roll.

Book mark:

Bowman

(858c)

Copyist.

B | 4 | U.S.C.T.

John Henry Brown
Pvt, Co. H, 4 Reg't U. S. Col'd Infantry.

Appears on

Company Muster Roll

for *May & June*, 1865.

Joined for duty and enrolled:

When *Aug 11*, 1863.*

Where *Baltimore Md* *

Period *3* years.*

Present or absent *Present*

Stoppage, \$ *100* for

Due Gov't \$ *100* for

Remarks:

* See enrollment on card from muster-in roll.

Book mark:

Bowman

B

4

U.S.C.T.

John Henry Brown

Priv, Co. H, 4 Reg't U. S. Col'd Infantry.

Appears on

Company Muster Roll

for *Jul & Aug*, 1865.

Joined for duty and enrolled:

When *Aug 11*, 1863.*

Where *Baltimore Md* *

Period *3* years.*

Present or absent *Present*

Stoppage, \$ *100* for

Due Gov't \$ *100* for

Remarks:

* See enrollment on card from muster-in roll.

Book mark:

Bowman

B | 4 | U.S.C.T.

John Henry Brown

Prst, Co. H, 4 Reg't U. S. Col'd Infantry.

Appears on

Company Muster Roll

for *Sept & Oct*, 1865.

Joined for duty and enrolled:

When *Aug 11*, 1863.*

Where *Baltimore Md* *

Period *3* years.*

Present or absent *Present*

Stoppage, \$ *100* for

Due Gov't \$ *100* for

Remarks:

* ~~See~~ See enrollment on card from muster-in roll.

Book mark: *557*

Bowman

18. | **4** | **U.S.C.T.**

John Henry Brown,
Corpl., Co. H, 4 Reg't U. S. Col'd Infantry.

Appears on

Company Muster Roll

for *North 2^d Dist.*, 186*5*.

Joined for duty and enrolled:

When *August 11*, 186*3*.*

Where *Baltimore, Md.* *

Period *3* years.*

Present or absent *Present.*

Stoppage, \$ *100* for

Due Gov't \$ *100* for

Remarks: *Promoted Corporal Nov.*
9, 1865 per S.O. No. 105 dated
Ad. Drs. 4 U.S.C.T. Nov. 9,
1865.

* See enrollment on card from muster-in roll.

Book mark: _____

(858c)

R. S. Granger.

Copyist.

18. | **4** | **U.S.C.T.**

John Henry Brown,
Capt., Co. H, 4 Reg't U. S. Col'd Infantry.

Appears on

Company Muster Roll

for *Jan'y⁴ Febr'y*, 186*6*.

Joined for duty and enrolled:

When *August 11*, 186*3*.*

Where *Baltimore, Md.* *

Period *3* years.*

Present or absent *Present.*

Stoppage, \$ *100* for

Due Gov't \$ *100* for

Remarks:

NEXT ROLL ON FILE MUSTER OUT.

* See enrollment on card from muster-in roll.

Book mark:

(358c)

R. Spunner

Copyist.

Ed. | 4 | U.S.C.T.

John Henry Brown,
Capt., Co. *H.*, 4 Reg't U. S. Col'd Infantry.

Appears on **Co. Muster-out Roll**, dated

Washington, D.C., May 4, 1866.

Muster-out to date *May 4, 1866.*

Last paid to *Feb. 28 1866.*

Clothing account:

Last settled....., 186 ; drawn since \$.....¹⁰⁰

Due soldier \$ *9.13*¹⁰⁰; due U. S. \$.....¹⁰⁰

Am't for cloth'g in kind or money adv'd \$.....¹⁰⁰

Due U. S. for arms, equipments, &c., \$ *6.*⁰⁰/₁₀₀

Bounty paid \$.....¹⁰⁰; due \$ *100.*¹⁰⁰

Remarks: *Was Private from*
enrollment to Nov. 9, 1865.
Free.

Book mark: *V. 177. P. 82. 73.*

(261)

M. Grauer.

Copyist.

166

Brown. Moses

Co I, 4 U.S. Col'd Inf.

Private

Private

CARD NUMBERS.

1	5564378	26
2	5564477	27
3	5564579	28
4	5564680	29
5	5564779	30
6	5564876	31
7	5564972	32
8	5565061	33
9	5565200	34
10	5565944	35
11	90625153	36
12		37
13		38
14		39
15		40
16		41
17		42
18		43
19		44
20		45
21		46
22		47
23		48
24		49
25		50

Book Mark:

See also

B | 4 | U.S.C.T.

Moses Brown

, Co. D., 4 Reg't U. S. Col'd Inf.

Appears on

Company Descriptive Book

of the organization named above.

DESCRIPTION.

Age 23 years; height 5 feet 2 inches.

Complexion *Blk*

Eyes *Blk*; hair *Blk*

Where born *Baltimore Md*

Occupation *Stamper*

ENLISTMENT.

When *Aug 11*, 18*63*.

Where *Baltimore Md*

By whom *Col M Barney*; term *3* y'rs.

Remarks:

Free apl 19/61

Selah

B | *4* | **U.S.C.T.**

Moses Brown
Cvt, Co. *I*, 4 Reg't U. S. Col'd Infantry.

Age *33* years.

Appears on

Company Muster-in Roll

of the organization named above. Roll dated
Baltimore Md August, 186 *3*.

Muster-in to date *Aug 11*, 186 *3*.

Joined for duty and enrolled:

When *August 11*, 186 *3**

Where *Baltimore Md**

Period *3* years.*

Remarks: _____

* *23* Muster-in roll shows enrollment and muster-in of this company as of same date and place. See enrollment on subsequent card or cards.

Book mark: _____

(356c)

G. F. J.
 Copyist.

B | 4 | U.S.C.T.

Moses Brown
Cvt, Co. I, 4 Reg't U. S. Col'd Infantry.

Appears on

Company Muster Roll

for Aug. 11 to 31, 1863.

Joined for duty and enrolled:

When Aug. 11, 1863.*

Where Baltimore Md.*

Period 3 years.*

Present or absent Present

Stoppage, \$ 100 for

Due Gov't, \$ 100 for

Remarks: Two dollars
premium due.

* See enrollment on card from muster-in roll.

Book mark:

G. Fox

3 | 4 | **U.S.C.T.**

Moses Brown
Capt, Co. I, 4 Reg't U. S. Col'd Infantry.

Appears on

Company Muster Roll

for Sept. & Oct., 1863

Joined for duty and enrolled:

When Aug. 11, 1863*

Where Baltimore Md*

Period 3 years.*

Present or absent Present

Stoppage, \$ 100 for

Due Gov't, \$ 100 for

Remarks: _____

* See enrollment on card from muster-in roll.

Book mark: _____

G. Fox

B | 4 | U.S.C.T.

Mrs Brown
Cmt, Co. I, 4 Reg't U. S. Col'd Infantry.

Appears on

Company Muster Roll
for *Nov: & Dec.*, 1863.

Joined for duty and enrolled:

When *Aug. 11*, 1863*

Where *Baltimore Md.**

Period *3* years.*

Present or absent *Present*

Stoppage, \$ *100* for

Due Gov't, \$ *100* for

Remarks: _____

* See enrollment on card from muster-in roll.

Book mark: _____

G. F. M.
Copyist.

B | 4 | **U.S.C.T.**

Moses Brown
Cvt, Co. I, 4 Reg't U. S. Col'd Infantry.

Appears on

Company Muster Roll

for Jan. 9 Feb., 1864.

Joined for duty and enrolled :

When Aug. 11th, 1863.

Where Baltimore Md

Period 3 years.*

Present or absent Present

Stoppage, \$ 100 for

Due Gov't, \$ 100 for

Remarks :

* See enrollment on card from muster-in roll.

Book mark :

G. M.
Copyst.

B | 4 | U.S.C.T.

Moses Brown
Priv, Co. I, 4 Reg't U. S. Col'd Infantry.

Appears on

Company Muster Roll

for *Mos & Co*, 1864.

Joined for duty and enrolled :

When *Aug 11*, 1863.*

Where *Baltimore Md* *

Period *3* years.*

Present or absent *Present*

Stoppage, \$ *100* for

Due Gov't, \$ *100* for

Remarks: _____

* See enrollment on card from muster-in roll.

Book mark : _____

efferman

B | 4 | U.S.C.T.

Moses Brown
Rt, Co. I, 4 Reg't U. S. Col'd Infantry.

Appears on

Company Muster Roll

for *May + June*, 1864.

Joined for duty and enrolled :

When *Aug 11*, 1863.*

Where *Baltimore Md* *

Period *3* years.*

Present or absent *Present*

Stoppage, \$ *100* for

Due Gov't, \$ *100* for

Remarks :

* See enrollment on card from muster-in roll.

Book mark :

W. J. ...

B | *4* | **U.S.C.T.**

Moses Brown

Plt, Co. I, 4 Reg't U. S. Col'd Infantry.

Appears on

Company Muster Roll

for *July & Aug*, 1864.

Joined for duty and enrolled:

When *Aug 11*, 1863.*

Where *Gallatin* *Mo* *

Period *3* years.*

Present or absent *Present*

Stoppage, \$ *100* for

Due Gov't, \$ *100* for

Remarks: *On Extra duty at D. C.*
Free and before April 19. 1861

* See enrollment on card from muster-in roll.

Book mark:

Uffelman
Copyist.

B | 4 U.S.C.T.

Moses Brown
Prst, Co. I, 4 Reg't U. S. Col'd Infantry.

Appears on

Company Muster Roll

for *Sep + Oct*, 1864.

Joined for duty and enrolled :

When *Aug 11*, 1863.*

Where *Baltimore Md* *

Period *3* years.*

Present or absent

Stoppage, \$ *100* for

Due Gov't, \$ *100* for

Remarks: *Killed at Dutch Gap
 Va By Shell Sept 14th 1864.
 Face not before April 19th 1861*

* See enrollment on card from muster-in roll.

Book mark: *154634* *M 80, 600, Vol 8, 60*

W. Freeman

B | **4** | **U.S.C.T.**

Moses Brown
Put, Co. D, 4 Reg't U. S. Col'd Infantry.

Appears on **Co. Muster-out Roll**, dated
Washington, D.C., May 4, 1866.

Muster-out to date _____, 186 .

Last paid to _____, 186 .

Clothing account:

Last settled _____, 186 ; drawn since \$ _____ ¹⁰⁰

Due soldier \$ _____ ¹⁰⁰; due U. S. \$ _____ ¹⁰⁰

Am't for cloth'g in kind or money adv'd \$ _____ ¹⁰⁰

Due U. S. for arms, equipments, &c., \$ _____ ¹⁰⁰

Bounty paid \$ _____ ¹⁰⁰; due \$ _____ ¹⁰⁰

Remarks: *Died Sept. 14/66*

Book mark: *80610. H.B.V. 154.531*

(861) *Ballade* Copyist.

Brown, Moses -

P, Co. I, 4 Regt U.S.C. Inf.

3 Enclosures.

Bed Cards	Descriptive Lists
Burial Records	Final Statements
Certs. of Dis. for Discharge	Furloughs
C. M. Charges	Med. Des. Lists
Med. Certificates	Orders

Other papers relating to—

Admission to Hosp'l	Furlough
Casualty Sheet (Officer's)	Med. Examination
Confinement	Misc. Information
Contracts	Pay or Clothing
Death or Effects	Personal Reports
Desertions	Rank
Discharge from Hosp'l	Transfer to Hosp'l
Discharge from Service	Transfer to V. R. C.
Duty	Transportation

MICROFILM PUBLICATION M 1846

COMPILED MILITARY SERVICE RECORDS
OF VOLUNTEER UNION SOLDIERS WHO SERVED WITH
THE UNITED STATES COLORED TROOPS (USCT)
4TH REGIMENT OF INFANTRY

PERSONAL PAPERS' TARGET SHEET

PLEASE NOTE THE CHECKED INFORMATION ABOUT THE PERSONAL PAPERS IN
THIS FILE:

- NO PERSONAL PAPERS WERE FOUND IN THIS FILE WHEN THE
RECORDS WERE ARRANGED FOR MICROFILMING.
- 4 PERSONAL PAPER(S) FOUND IN THIS FILE WHEN THE RECORDS
WERE ARRANGED FOR MICROFILMING.

1864 J.G. on file No 24

INVENTORY OF THE EFFECTS

OF

Moses Brown

Late of Company I

4 Reg't of M B C

Volunteers, who died at Dutch Gap

on the 14 day of Sept 1864



FINAL STATEMENT

OF

Moses Brown
4th Reg't of U. S. Col. Troops

VOLUNTEERS.

Sept 21st 1864

NOTE 1.—Two of these certificates (or duplicates) are to be given to each Volunteer Soldier or drafted man who may be discharged previously to the discharge of his company, that he may at once receive from the Paymaster the pay, &c., due him, and the captain or other COMMISSIONED officer commanding the company will certify to the act of the delivery of the duplicate certificates; on these certificates the Soldier is "entitled to" his discharge, and should also present his discharge to the Paymaster to have the payment endorsed on it. The discharge is to be given back to the Soldier by the Paymaster; the latter only retaining as his voucher the duplicate certificates.

NOTE 2.—If the Soldier is entitled to pay for the use of his horse, the Company Commander will certify to that fact on the back of both these final statements, and also to the time he has pay due for having been so mounted on his own horse.

NOTE 3.—When a Soldier is furnished with final statements, his descriptive list, if he has one, should be taken up by the officer who gives the Soldier these statements, and endorsed with a statement to this effect by the officer. This endorsement should exhibit a full statement of the time for which the Soldier was allowed pay on his final statements, the clothing account, and all other charges against him or in his favor, so as to comprise a complete exhibit of his account. It will then be transmitted to the company commander of the Soldier, who will enter all the data necessary to a full understanding of the Soldier's account on the muster roll upon which the Soldier's discharge is reported. The descriptive list will then be destroyed. The object of this is, that the remaining portion of the Soldier's account may be settled upon the receipt of these muster rolls, and the Soldier receive any pay or allowances that may be due him at the time of his discharge, and which may not appear on his final statements from the fact that his descriptive list is incomplete. These accounts for back pay, &c., are settled by the 2d Auditor of the Treasury Department.

NOTE 4.—Charges for loss or injury to ordnance, horse equipments, and other miscellaneous charges, should appear under the heading of "Other Stoppages."

NOTE 5.—Bounty paid by State authorities, and not by the United States, will not be entered on this statement.

NOTE 6.—Amounts due the Sutler and Landress must be entered on the muster roll on which the discharge, death, desertion, &c., is reported, as well as on the final statement, otherwise the amount cannot be collected from the United States.

NOTE 7.—This blank will be used for deceased volunteers and drafted men, as well as for others.

NOTE 8.—Where a Soldier dies in Hospital or on detached service, his descriptive list, if he has one, should be sent with his final statements, in duplicate, to the Second Auditor, Washington, D. C.

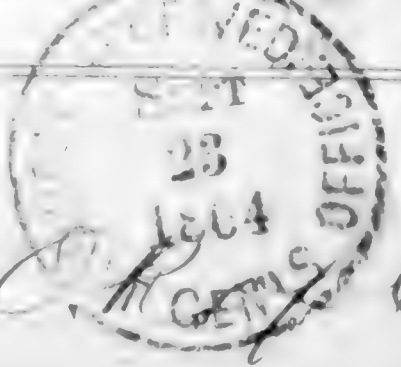

Entered by [Signature]

ADJUTANT GENERAL'S OFFICE.

Sept 21st 1864

Duplicate with Inventory sent 2d Auditor.

I certify, on honor, that Moses Brown a Private of
 Captain Mendell Company (A) of the 4th Regiment of United States Colored
VOLUNTEERS, of the State of Maryland, born in Baltimore, State
 of Maryland, aged 23 years; 5 feet 2 inches high; Black complexion,
Black eyes, Black hair, and by occupation a Blacksmith having joined the company on
 its original organization at Baltimore Maryland and enrolled in it at the muster into
 the service of the United States at Baltimore Maryland on the 11th day
 of August, 1863, (or was mustered in service as a recruit, by
 _____, at _____, on the _____ day of _____
 186____, or was drafted and mustered into the service of the United States from the
 Enrollment District of the State of _____, at _____,
 on the _____ day of _____, 186____,) to serve in the Regiment, for
 the term of three Years: and having served HONESTLY and
 FAITHFULLY with his Company in the Field to the present date, ~~is~~
 entitled to a ~~DISCHARGE~~, by reason of was killed at - Queth Gap
on September the 14th 1864 by a Rebel shell

The said Moses Brown was last paid by Paymaster
Major Holmes to include the 29th day of February, 1864, and has
 pay due him from that time to the present date; he is entitled to pay and subsistence for
 TRAVELING to place of enrollment, and whatever other allowances are authorized to volunteer
 soldiers, drafted men, or militia, so discharged. He has received from the United States **CLOTHING**
 amounting to seventy seven ⁰⁸/₁₀₀ dollars, since the 11th day of August,
 1863, ~~when his clothing account was last settled.~~ He has received from the United States
 _____ ⁰⁰/₁₀₀ dollars advanced **BOUNTY.** (Money)

There is to be stopped from him, on account of the State of _____, or other
 authorities, for **CLOTHING**, &c, received on entering service, _____ ⁰⁰/₁₀₀ dollars; and
 for other stoppages, viz. _____

_____ ⁰⁰/₁₀₀ dollars.

He has been furnished with **TRANSPORTATION** in kind from the place of his discharge to
 _____; and he has been **SUBSISTED** for **TRAVELING** to his
 place of enrollment, up to the _____, 186____.

He is indebted to Wm C. Cooper, **SUTLER**, Six ⁰⁰/₁₀₀ dollars.
 He is indebted to _____, **LAUNDRESS**, _____ ⁰⁰/₁₀₀ dollars.

Given in Duplicate, at Queth Gap Va, this 20th day
 of Sept, 1864.

S J Mendell
Capt Co (D) 4 Reg USCT
 Commanding Company

EB. Lts. 9-10

Surgeon General's Office,
Record and Pension Bureau,

May 1 1865.

Respectfully referred to the Medical
Director Army of the
Potomac

These papers to be returned with
report.

BY ORDER OF THE SURGEON GENERAL:

Assistant Surgeon, U. S. A.

M.D.C. Dept of Virginia
Richmond Va 25th May 1865
Respectfully referred
to Medical Director
Dept of N.C. where this
right is supposed to
be serving
Lieut Col W. G. ...
Act Med Director

W. M. ...

80610,
C.M.

10.1.c.

S - 256.

a of c.

(No. 14.)

Department of the Interior,
PENSION OFFICE,

Feb 6 13, 1864

Sir:

You are respectfully requested to furnish official evidence of the
Service, date and cause of death of Moses Brown who
was a Private in Co. "I", of 4 Regiment
of U.S. Colored Troops Volunteers, who is reported to have
died at Lynch Gap, Va on the 14 day of
September, 1864, of wounds

Please attach this Circular to your report, and return the same
to this Office

Respectfully, &c.,

80610

Joseph M. Barnett

Commissioner.

Surgeon

A. J. C. Gen'l U. S. A.

C. M. U.

167

Erwin Peter

Co B, 4 U.S. Col'd Inf.

Private | *Private*

CARD NUMBERS.

1	5552917	26
2	5552998	27
3	5553098	28
4	5553196	29
5	5553292	30
6	5553383	31
7	5553472	32
8	5553568	33
9	5553695	34
10	5554480	35
11	9061162	36
12		37
13		38
14		39
15		40
16		41
17		42
18		43
19		44
20		45
21		46
22		47
23		48
24		49
25		50

Book Mark:

See also

B | **4** | **U.S.C.T.**

Peter Brown

....., Co. *"B"*, 4 Reg't U. S. Col'd Inf.

Appears on

Company Descriptive Book

of the organization named above.

DESCRIPTION.

Age *19* years ; height feet inches.

Complexion *black*

Eyes *black* ; hair *black*

Where born *Baltimore, Md.*

Occupation *laborer*

ENLISTMENT.

When *July 21* , 18*63*.

Where *Baltimore*

By whom *Col. Binney* ; term *3* y'rs.

Remarks: *Died of disease, Oct 23/64 at Phil^a Pa.*

.....

Ward

B | *4* | **U.S.C.T.**

Peter Brown

Priv, Co. *B*, 4 Reg't U. S. Col'd Infantry.

Age *19* years.

Appears on

Company Muster-in Roll

of the organization named above. Roll dated

Baltimore Md July 21, 186 *3*

Muster-in to date *July 21*, 186 *3*

Joined for duty and enrolled:

When *July 21*, 186 *3**

Where *Baltimore, Md*

Period *3* years.*

Remarks:

* ~~See~~ Muster-in roll shows enrollment and muster-in of this company as of same date and place. See enrollment on subsequent card or cards.

Book mark:

Ma W Hall

B. | 4 | U.S.C.T.

Peter Brown
Priv, Co. B, 4 Reg't U. S. Col'd Infantry.

Appears on

Company Muster Roll
 for *July 21 to Aug 31*, 186 *3*

Joined for duty and enrolled:

When *July 21st*, 186 *3*.*

Where *Baltimore* *

Period *3* years.*

Present or absent *Present*

Stoppage, \$ *100* for _____

Due Gov't \$ *100* for _____

Remarks: *Premium due \$200*

* See enrollment on card from muster-in roll.

Book mark: _____

Ironhall

B. | 4 | U.S.C.T.

Peter Brown,
Priv., Co. B, 4 Reg't U. S. Col'd Infantry.

Appears on

Company Muster Roll

for Sept & Oct, 1863

Joined for duty and enrolled:

When July 21st, 1863

Where Baltimore *

Period 3 years.*

Present or absent Present

Stoppage, \$ 100 for

Due Gov't \$ 100 for

Remarks:

* See enrollment on card from muster-in roll.

Book mark:

(858c)

J. M. Hall

Copyist.

B. | 4 | U.S.C.T.

Peter Brown,
Priv., Co. B, 4 Reg't U. S. Col'd Infantry.

Appears on

Company Muster Roll

for Nov. & Dec., 1863

Joined for duty and enrolled:

When July 21st, 1863*

Where Baltimore *

Period 3 years.*

Present or absent Not stated

Stoppage, \$ 100 for

Due Gov't \$ 100 for

Remarks:

* See enrollment on card from muster-in roll.

Book mark:

(858c)

John Hall
Copyist.

B. | 4 | U.S.C.T.

Peter Brown,

Priv., Co. B, 4 Reg't U. S. Col'd Infantry.

Appears on

Company Muster Roll

for Jan'y & Feby, 1864

Joined for duty and enrolled:

When July 21st, 1863*

Where Baltimore *

Period 3 years.*

Present or absent Present

Stoppage, \$ 100 for _____

Due Gov't \$ 100 for _____

Remarks: Job stopped 1st Mep^{ch} 20
1st Mep^{ch} 23, 2nd Canteens, 82
1st Mep^{ch} 49, 1st Mep^{ch} 183

* See enrollment on card from muster-in roll.

Book mark: _____

(358c)

John Hall

Copyist.

B | 4 | U.S.C.T.

Peter Brown

Priv, Co. B, 4 Reg't U. S. Col'd Infantry.

Appears on

Company Muster Roll

for March & April, 1864.

Joined for duty and enrolled:

When July 21st, 1863.*

Where Baltimore, Md.*

Period 3 years.*

Present or absent Present

Stoppage, \$ 100 for _____

Due Gov't \$ 100 for _____

Remarks: _____

* See enrollment on card from muster-in roll.

Book mark: _____

C. M. Clark

(358c)

Copyist.

B | 4 | U.S.C.T.

Peter Brown
Pat, Co. B, 4 Reg't U. S. Col'd Infantry.

Appears on

Company Muster Roll

for May + June, 1864.

Joined for duty and enrolled:

When July 21st, 1863.*

Where Baltimore, Md.*

Period 3 years.*

Present or absent Present.

Stoppage, \$ 100 for _____

Due Gov't \$ 100 for _____

Remarks: _____

* See enrollment on card from muster-in roll.

Book mark: _____

C. M. Clark
(358c) Copyist.

B | 4 | U.S.C.T.

Peter Brown
Plt, Co. B, 4 Reg't U. S. Col'd Infantry.

Appears on

Company Muster Roll

for July & Aug, 1864.

Joined for duty and enrolled:

When July 21st, 1863.*

Where Baltimore, Md*

Period 3 years.*

Present or absent Present

Stoppage, \$ 100 for _____

Due Gov't \$ 100 for _____

Remarks: Free on or before
April 19, 1861.

* See enrollment on card from muster-in roll.

Book mark: _____

E M Clark
 (358c) Copyist.

B | 4 | U.S.C.T.

Peter Brown

Pat, Co. B, 4 Reg't U. S. Col'd Infantry.

Appears on

Company Muster Roll

for Sept. + Oct, 1864.

Joined for duty and enrolled:

When July 21st, 1863.*

Where Baltimore, Md.*

Period 3 years.*

Present or absent _____

Stoppage, \$ 100 for _____

Due Gov't \$ 100 for _____

Remarks: Died of Phthisis
Pulmonalis, Oct. 23rd, 1864,
at Summit House Hospital,
Philadelphia, Pa. Due Suttles,
\$800

* See enrollment on card from muster-in roll.

Book mark: _____

C. M. Clark

(358c)

Copyist.

B | 4 | U.S.C.T.

Peter Brown

Det; Co. B, 4 Reg't U. S. Col'd Infantry.

Appears on **Co. Muster-out Roll**, dated
Washington D.C., May 4, 1866.

Muster-out to date 186 .

Last paid to 186 .

Clothing account:

Last settled....., 186 ; drawn since \$.....100

Due soldier \$.....100; due U. S. \$.....100

Am't for cloth'g in kind or money adv'd \$.....100

Due U. S. for arms, equipments, &c., \$.....100

Bounty paid \$.....100; due \$.....100

Remarks *Free on or before April 19/61.*

Died Oct 23/64 of disease.

Book mark :

(261)

Tabler

Copyist.

Brown, Peter

I, Co. B, 4 Reg't U.S.C.P.

6 Enclosures.

Bed Cards	/	Descriptive Lists	
Burial Records	/	Final Statements	2
Certs. of Dis. for Discharge		Furloughs	
C. M. Charges		Med. Des. Lists	
Med. Certificates		Orders	

Other papers relating to—

Admission to Hosp'l		Furlough	
Casualty Sheet (Officer's)		Med. Examination	
Confinement		Misc. Information	/
Contracts		Pay or Clothing	
Death or Effects	/	Personal Reports	
Desertions		Rank	
Discharge from Hosp'l		Transfer to Hosp'l	
Discharge from Service		Transfer to V. R. C.	
Duty		Transportation	

MICROFILM PUBLICATION M 1846

COMPILED MILITARY SERVICE RECORDS
OF VOLUNTEER UNION SOLDIERS WHO SERVED WITH
THE UNITED STATES COLORED TROOPS (USCT)
4TH REGIMENT OF INFANTRY

PERSONAL PAPERS' TARGET SHEET

PLEASE NOTE THE CHECKED INFORMATION ABOUT THE PERSONAL PAPERS IN
THIS FILE:

- NO PERSONAL PAPERS WERE FOUND IN THIS FILE WHEN THE
RECORDS WERE ARRANGED FOR MICROFILMING.
- 13 PERSONAL PAPER(S) FOUND IN THIS FILE WHEN THE RECORDS
WERE ARRANGED FOR MICROFILMING.

A. O. May 3. 1864
I certify that the name of
Peter Brown is borne on the Muster-rolls
Roll of Comp'y "B" 4th Regt U. S.
C Troops. on file in this Office
W. A.

F. W. Tappan
Act. Adj't - Genl.

Baltimore, Sept. 24, 1863.
I hereby certify that Peter Brown,
aged 19 years, was by me duly mus-
tered into the service of the United
States for three years, as private of
Co. B, 4th U.S. Colored Troops.

William Birney
Colonel (Inf. 4th U.S. C.)
& Mustering Officer.

NARA 1565

Mr. Elias Stevens
for
Peter Brown
No 3

A.

No. 3

CLAIMANT'S CERTIFICATE.

I, Elizabeth Stephens a loyal citizen, and a resident
of Baltimore, County of _____, State of
Maryland, hereby claim compensation, under the provisions of
General Orders, No. 329, 1863, for my slave Peter Brown
enlisted July 1863 at Baltimore
by Col M W Vinney in the _____
Regiment U. S. Colored Troops, Co. B, certificate of which enlistment, and a
descriptive list, as required, accompany this application.

In proof of my loyalty to the Constitution and Government of the United States, I
present the accompanying oath, which I have taken, signed, and acknowledged, to be filed
with this application, in accordance with requirement of said General Orders.

Baltimore July 23 1864

Elizabeth Stephens



B.

OATH OF ALLEGIANCE.

I, Elizabeth Shepher, do solemnly swear that I have never joined, or been concerned in, any insurrection or rebellion; that I have never borne arms against the United States; that I have never given any aid, countenance, counsel, or encouragement to any person or persons engaged, or whom I had reason to believe were about to engage, in insurrection, rebellion, or armed hostility against the United States; that I have neither sought, nor accepted, nor attempted to exercise the functions of any office, civil or military, nor to perform any service whatever, under any authority or pretended authority in hostility to the United States; that I have not yielded a voluntary support to any insurrection, rebellion, or pretended government, authority, power, or constitution within the United States hostile thereto. And I do further swear that, to the best of my knowledge and ability, I have supported and defended, and will continue to support and defend, the United States against all enemies, foreign and domestic; and that I have supported, defended, and obeyed, and will continue to support, defend, and obey, the Constitution and laws of the United States; that I will bear true faith and allegiance to the same; and that I take this oath freely, without any mental reservation or purpose of evasion: So help me God.

Elizabeth Shepher

Sworn to and subscribed before me, at

Baltimore

this

23

day of

January

1864

W. G. Hayward
Justice of the Peace



C.

I present herewith evidence of my title to the slave Peter Brown enlisted as aforesaid, and in consideration of the sum of _____ by me received, I hereby covenant and agree with the United States, that I, my heirs, executors, or assigns, shall never hereafter make or enforce any claim to the labor or services of said slave; and pledge myself to execute a valid Deed of Manumission and Release of all my claims to service forever of said Peter Brown to be filed with the Board of Claims now in session at Baltimore

Baltimore Jan 23 1864

Elizabeth Shepher

Balt^o Sep^r 25th 1863

We do hereby certify that we are well acquainted with Mrs Elizabeth Stephens, a life long resident of this city. and that we know her to be perfectly loyal in her sentiments towards the United States Government.

— Thos. H. Evans

From the evidence presented to me by two of our most loyal Citizens I am convinced that Mrs Elizabeth Stephens is a loyal person

John See Chapman

Mayor

Chas. C. Keyser

EVIDENCE OF TITLE.

I, *Elizabeth Stephas*, of *Baltimore City*
 County, Md., do solemnly swear that *Peter Brown*
 who has been enlisted in the _____ Regiment, U. S. Colored Troops,
 Co. *B* ; is my slave for *life* ; (~~his term of service expiring on~~
 the _____ day of _____ 186 _____;) and that
 I became possessed of him by *Inheritance*, in the month
 of _____, eighteen hundred and *forty four*. And I
 do further swear that I have not purchased said slave from any person or persons disloyal
 to the Government of the United States, with the object of obtaining compensation for
 the same; and furthermore, that I have no agency for obtaining compensation for any per-
 son or persons but such as, to my knowledge, are loyal citizens of the United States.

Mrs. Wm. Howard *Elizabeth Stephas*
Baltimore City Jan 23 1864



STATE OF MARYLAND.

Baltimore City County, to wit:

On this *23rd* day of *January* in the year 1864,

before me, the subscriber, a Justice of the Peace of the State and County aforesaid, personally appeared *Elizabeth Stephens* and took, signed, and acknowledged the oaths preceding: and further made oath, in due form of law, that all the statements made in this application are, to the best of *her* knowledge and belief, strictly true. Also personally appeared before me *Edwin Kirkwood* and *Wm Minnick*, loyal citizens of the United States, residents of *Baltimore City*, well acquainted with the said *Elizabeth Stephens*, and in no manner interested in the prosecution of this claim, and made oath, in due form of law, that the said *Elizabeth Stephens* is the owner of the slave *Peter Brown*, as a fact of public notoriety: that they believe all the statements herein made by *her*, in reference thereto, are correct, and that *she* is unquestionably loyal to the Government of the United States. Witness their signatures:

Edwin Kirkwood
Wm Minnick
Justice of the Peace.



STATE OF MARYLAND,

Baltimore City County, to wit:

I, *Alford Mace*, Clerk of the ^{*Superior*} ~~Circuit~~ Court for *Baltimore City*, do hereby certify that *William H. Hayward*

before whom the foregoing affidavits were made, was, at the time of signing the same, a Justice of the Peace for the ~~County~~ ^{*City*} and State aforesaid, duly commissioned and sworn; and that his signature thereto is genuine, and that full faith and credit should be given to his official acts.

Witness my hand and the seal of said Court, this *28th* day of

April, A. D. 1864.

Alford Mace CLERK.

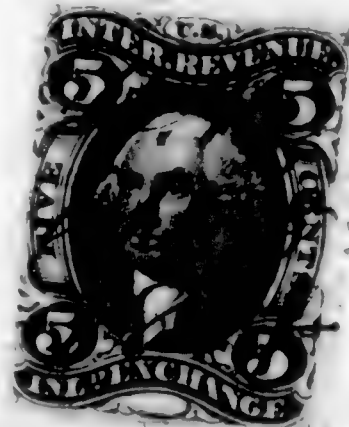

F.

CERTIFICATE OF AWARD OF THE BOARD OF CLAIMS.

Office of the Board of Claims
For Slaves Enlisted in the Service of the United States,

No 58

Baltimore Md

April 26th, 1864

\$300

We hereby certify, that Elizabeth Stephens, of Baltimore City ~~county~~, State of Maryland, having proved, under oath, her loyalty to the Constitution and Government of the United States, and established her title as to the ownership of Peter Brown, a slave enlisted at Baltimore Md, on the 21st day of July, 1863, by Col. Wm. Birney, in the service of the United States, in the Fourth Regiment of Colored Troops, Co. B, and having filed a valid Deed of Manumission and Release of Service of said slave, is entitled to the sum of Three Hundred dollars, which has been awarded to her by this Board as a remuneration for all claim to the future labor or service of said slave, under the provision of General Orders, War Department, No. 329, 1863.

L. F. Sheller, President of the Board.

Thos. Simmons, Member of the Board.

L. C. Stauffer, Member of the Board.

To Maj. C. W. Foster,

Chief of the Bureau for the
Organization of Colored Troops, Washington, D. C.

E.

Deed of Manumission and Release of Service.

WHEREAS my slave Peter Brown has enlisted in the service of the United States: now, in consideration thereof, I, Elizabeth Stephens of Baltimore City county, State of Maryland, do hereby, in consideration of said enlistment, manumit, set free, and release the above-named Peter Brown from all service due me; his freedom to commence from the July 1863, the date of his enlistment as aforesaid in the 4th Regiment of Colored Troops, in the service of the United States.

Witness my hand and seal, this 27th day of April, 1864.

Elizabeth Stephens 

WITNESS:

Thos B Gutter
John W Seate
W W Carter

Baltimore City County,
 State of Maryland, 1864.

Before me appeared this day Elizabeth Stephens and acknowledged the above Deed of Manumission and Release of Service to be his free act and deed.

Alford Mace

Received for record 27th April 1864; same day recorded and examined,

Per Alford Mace
 Clerk of the Superior Court of Baltimore City.

In Testimony that the foregoing is a true copy taken from the Original, I hercunto subscribe my name and affix the seal of the Superior Court of Baltimore City, this 27th day of April A. D. 1864.

Alford Mace
 Clerk of the Superior Court of Baltimore City.



Hospital Number 4557 31

Name Peter Brown

Age 20 Nativity American

Married or Single Single

Residence Baltimore city Md

Post Office address of Wife Emily Chase
 wife or nearest relative. 132 South St Baltimore city

Rank Private Co. B Regiment 4 U.S. Col

When admitted October 19th 1864

From what source Hampton Hospital, Fort Mifflin

Diagnosis: (in surgical cases state explicitly seat and character of wound or injury.)

Acute Bronchitis

Summit House G. H.
 Philadelphia, Pa.

On what occasion wounded.....

Date.....

Nature of missile or weapon.....

TREATMENT.

[HERE NOTE IMPORTANT COMPLICATIONS AND ALL OPERATIONS.]

*Stim Expectorants
& Counter Irritation*

RESULT AND DATE.

*Dead Oct 23 of
Phthisis Pulmonalis*

*A. Hanson
Act off Surg Mfg
First Capt*

HOSPITAL RECORD,

SUBJECT TO THE

ORDER OF THE SURGEON GENERAL

UNITED STATES ARMY.

Peter Brown
Proc^o 13th 4th Regt. I. S.
Oct 23. 1864
Sumner House Phila

Quill's Expt.

No. 1.

RECORD OF DEATH AND INTERMENT.

Name and number of person interred.	<i>Peter Brown</i>	<i>199</i>
Number and locality of the grave . . .	<i>239 Lebanon Cemetery.</i>	
Hospital number of the deceased . . .	<i>4657</i>	
Regiment, rank, and company . . .	<i>4th U.S.C.T. Private Co. B.</i>	
Residence before enlistment . . .		
Conjugal condition, (and if married, the residence of the widow) . . .	<i>Single</i>	
Cause of death	<i>Phthisis Pulmonalis</i>	
Age of the deceased	<i>Twenty years.</i>	
Nativity	<i>America.</i>	
<i>P.O. Address of a relative</i> References and remarks	<i>Emily Chase 132, South Stamp St. Baltimore Md.</i>	
Date of death and burial	<i>Died Oct. 23 Buried Oct. 24th</i>	<i>1864.</i>

Duplicates sent to the Adjutant General of the United States Army, and to the Sexton of the Cemetery.

Memoranda:

Inventory of the effects of *Private Peter Brown*
Company B 4th Regiment U.S.C.T.
 who died in the *U.S. Army General Hospital Summit House*
Phila. October 23 1864.

CAPS.....	1	BLANKETS	
DRESS COATS.....		KNAPSACKS.....	
OVERCOATS.....		CANTEENS.....	
JACKETS.....	1	HAYERSACKS.....	
TROUSERS.....	1	MUSKETS.....	
SHIRTS.....		BAYONETS.....	
DRAWERS.....		CARTRIDGE BOX.....	
BOOTS, prs.....		BELT.....	
SHOES, prs.....	1	MONEY.....	\$7.32
STOCKINGS.....	2		

1864 No 25-

F.S. on file
 Inventory
 of the effects of *Private*
Peter Brown
 late of *Co. B 4th Regiment*
U.S.C.T. who died
 at *Summit House General*
Hospital Phila. Oct. 23
 1864



Summit-House U. S. Army General Hospital,
Phila. Oct. 23rd 1864

Commanding Officer *B.* Company,
4th Regt U. S. C. I.

I have to inform you
that *Peter Brown (Private)* of your Company, died
in this hospital on the 23rd of October 1864,
of *Phthisis Pulmonalis*.

I inclose his ~~descriptive list, with pay and clothing account,~~
~~and~~ inventory of his effects.

Very respectfully yours, &c.,

W. H. Taylor
Surgeon U. S. Army

In charge of General Hospital.

25

FINAL STATEMENT

OF

Samuel Peter Brown

4th Reg't of A S Colored Troops

VOLUNTEERS.

2d Co of 25th Reg't

NOTE 1.—Two of these certificates (or duplicates) are to be given to each Volunteer Soldier or drafted man who may be discharged previously to the discharge of his company, that he may at once receive from the Paymaster the pay, &c., due him, and the captain or other COMMISSIONED officer commanding the company will certify to the act of the delivery of the duplicate certificates; on these certificates the Soldier is "entitled to" his discharge, and should also present his discharge to the Paymaster to have the payment endorsed on it. The discharge is to be given back to the Soldier by the Paymaster; the latter only retaining as his voucher the duplicate certificates.

NOTE 2.—If the Soldier is entitled to pay for the use of his horse, the Company Commander will certify to that fact on the back of both these final statements, and also to the time he has pay due for having been so mounted on his own horse.

NOTE 3.—When a Soldier is furnished with final statements, his descriptive list, if he has one, should be taken up by the officer who gives the Soldier these statements, and endorsed with a statement to this effect by the officer. This endorsement should exhibit a full statement of the time for which the Soldier was allowed pay on his final statements, the clothing account, and all other charges against him or in his favor, so as to comprise a complete exhibit of his account. It will then be transmitted to the company commander of the Soldier, who will enter all the data necessary to a full understanding of the Soldier's account on the muster roll upon which the Soldier's discharge is reported. The descriptive list will then be destroyed. The object of this is, that the remaining portion of the Soldier's account may be settled upon the receipt of these muster rolls, and the Soldier receive any pay or allowances that may be due him at the time of his discharge, and which may not appear on his final statements from the fact that his descriptive list is incomplete. These accounts for back pay, &c., are settled by the 2d Auditor of the Treasury Department.

NOTE 4.—Charges for loss or injury to ordnance, horse equipments, and other miscellaneous charges, should appear under the heading of "Other Stoppages."

NOTE 5.—Bounty paid by State authorities, and not by the United States, will not be entered on this statement.

NOTE 6.—Amounts due the Soldier and Laundress must be entered on the muster roll on which the discharge, death, desertion, &c., is reported, as well as on the final statement, otherwise the amount cannot be collected from the United States.

NOTE 7.—This blank will be used for deceased volunteers and drafted men, as well as for others.

NOTE 8.—Where a Soldier dies in Hospital or on detached service, his descriptive list, if he has one, should be sent with his final statements, in duplicate, to the Adjutant General, Washington, D. C.

ADJUTANT GENERAL'S OFFICE.
Nov. 2nd 1865
Duplicate with Inventory sent 2d Auditor.

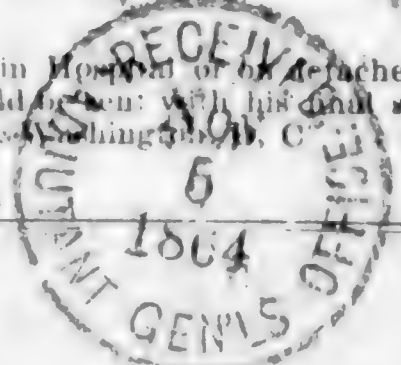

dup

I certify, on honor, that Peter Brown a Private of
 Captain Nathan C Hill Company (B) of the Fourth Regiment of U.S. Colored Troops
VOLUNTEERS, of the State of Maryland, born in Baltimore, State
 of Maryland, aged 19 years; _____ feet _____ inches high; Black complexion,
Black eyes, Black hair, and by occupation a Labourer, having joined the company on
 its original organization at Baltimore Md, and enrolled in it at the muster into
 the service of the United States at Baltimore Md, on the Twenty first day
 of July, 1863, (or was mustered in service as a recruit, by Capt William
Brimley, at Baltimore, on the Twenty first day of July,
 1863, or was drafted and mustered into the service of the United States from the _____
 Enrollment District of the State of _____, at _____,
 on the _____ day of _____, 186) to serve in the Regiment, for
 the term of Three Years: and having served HONESTLY and
 FAITHFULLY with his Company in Smart Res - U.S. Camp to the present date, is now
 entitled to a **DISCHARGE** by reason of Death from Typhoid Pulmonitis
Died in U.S. Genl. Hospital Phila Pa Oct 23rd 1864

The said Private Peter Brown was last paid by Paymaster
Major Brimley to include the Thirty first day of August, 1864, and has
 pay due him from that time to the present date; he is entitled to pay and subsistence for
 TRAVELING to place of enrollment, and whatever other allowances are authorized to volunteer
 soldiers, drafted men, or militia, so discharged. He has received from the United States **CLOTHING**
 amounting to Thirteen ⁶⁶/₁₀₀ dollars, since the first day of June,
 1864, when his clothing account was last settled. He has received from the United States
 _____ ¹⁰⁰/₁₀₀ dollars advanced **BOUNTY**.

There is to be stopped from him, on account of the State of _____, or other
 authorities, for **CLOTHING**, &c., received on entering service, _____ ¹⁰⁰/₁₀₀ dollars; and
 for other stoppages, viz: _____

_____ ¹⁰⁰/₁₀₀ dollars.

He has been furnished with TRANSPORTATION in kind from the place of his discharge to
 _____; and he has been SUBSISTED for TRAVELING to his
 place of enrollment, up to the _____, 186 .

He is indebted to N C Leiper, SUTLER, Eight ¹⁰⁰/₁₀₀ dollars.

He is indebted to _____, LAUNDRESS, _____ ¹⁰⁰/₁₀₀ dollars.

Given in Duplicate, at Mar Dist Genl Va, this 2nd day
 of November, 1864.

From an original of this 1871/100

Nathan C Hill
Capt Co B 4th U.S.C.T.

Commanding Company.

Extract from Act of Congress.

SEC. 12. And be it further enacted, That the fees of agents and attorneys for making out and causing to be executed the papers necessary to establish a claim for a pension, bounty, and other allowance before the Pension Office, under this act, shall not exceed the following rates: For making out and causing to be duly executed a declaration by the applicant, with the necessary affidavits, and forwarding the same to the Pension Office, with the requisite correspondence, ten dollars; which sum shall be received by such agent or attorney in full for all services in obtaining such pension, and shall not be demanded or received, in whole or in part, until such pension shall be obtained; and the sixth and seventh sections of an act entitled "An act to grant pensions," approved July [fourteenth,] eighteen hundred and sixty-two, are hereby repealed.

SEC. 13. And be it further enacted, That any agent or attorney who shall, directly or indirectly, demand or receive any greater compensation for his services under this act than is prescribed in the preceding section of this act, or who shall contract or agree to prosecute any claim for a pension, bounty, or other allowance under this act, on the condition that he shall receive a per centum upon any portion of the amount of such claim, or who shall wrongfully withhold from a pensioner or other claimant the whole or any part of the pension or claim allowed and due to such pensioner or claimant, shall be deemed guilty of a high misdemeanor, and, upon conviction thereof, shall, for every such offense, be fined not exceeding three hundred dollars, or imprisoned at hard labor not exceeding two years, or both, according to the circumstances and aggravations of the offense.

Approved July 4, 1864.

NOTE 10.—If any soldier is charged a higher fee than that allowed by the above act, he should report the fact and the name of the agent to the Adjutant General, in order that steps may be taken to have the same refunded.

Handwritten notes:
2964
see list of items sent
for expenses sent 2nd Aug
H.

ADJUTANT GENERAL'S OFFICE.
Rec 29th 1864
Duplicate with Inventory sent 2d Auditor.

U. S. A. Genl Hospital
FINAL STATEMENT 25
Summit House Phila

Peter Brown
14th Reg't of U. S. Colored

VOLUNTEERS.
And Oct 13th 1864

NOTE 1.—Two of these certificates (or duplicates) are to be given to each Volunteer Soldier or drafted man who may be discharged without being mustered out. (Final Statements are never given to men mustered out of service) that he may at once receive from the Paymaster the pay, &c., due him, and the captain or other COMMISSIONED officer commanding the company will certify to the act of the delivery of the duplicate certificates; with these certificates the Soldier is "entitled to" his discharge, and should also present his discharge to the Paymaster to have the payment endorsed on it. The discharge is to be given back to the Soldier by the Paymaster; the latter only retaining as his vouchers the duplicate certificates.

NOTE 2.—If the Soldier is entitled to pay for the use of his horse, the Company Commander will certify to that fact on the back of both these final statements, and also to the time he has pay due for having been so mounted on his own horse.

NOTE 3.—When a Soldier is furnished with final statements, his descriptive list, if he has one, should be taken up by the officer who gives the Soldier these statements, and endorsed with a statement to this effect by the officer. The endorsement should exhibit a full statement of the time for which the Soldier was allowed pay on his final statements, the clothing account, and all other charges against him or in his favor, so as to comprise a complete exhibit of his account. It will then be transmitted to the Company Commander of the Soldier, who will enter all the data necessary to a full understanding of the Soldier's account on the muster roll upon which the Soldier's discharge is reported. The descriptive list will then be destroyed. The object of this is, that the remaining portion of the Soldier's account may be settled upon the receipt of these muster rolls, and the Soldier receive any pay or allowances that may be due him at the time of his discharge, and which may not appear on his last final statements from the fact that his descriptive list is incomplete. These accounts for back pay, &c., are settled by the 2d Auditor of the Treasury Department.

NOTE 4.—Charges for loss or injury to ordnance, horse equipments, and other miscellaneous charges, should appear under the heading of "Other Stoppages."

NOTE 5.—Bounty paid by State authorities, and not by the United States, will not be entered on this statement.

NOTE 6.—Amounts due the Sutler and Laundress must be entered on the muster roll on which the discharge, death, desertion, &c., is reported, as well as on the final statement, otherwise the amount cannot be collected from the United States.

NOTE 7.—This blank will be used for deceased volunteers and drafted men, as well as for others.

NOTE 8.—Where a Soldier dies in Hospital or on detached service, his descriptive list, if he has one, should be sent with his final statements, in duplicate, to the Adjutant General, Washington, D. C.

NOTE 9.—If the soldier is a drafted man or substitute, the space for time, &c., of enrolled, should contain only the word *drafted* or *substitute*, as the case may be. If the Soldier is a "VETERAN," (or RECRUIT,) the words *as a veteran*, (or *recruit*,) as the case may be, should be interlined after the words *mustered into the service of the U. S.* A statement of all the installments of *Veteran* or *Recruit* Bounty RECEIVED by the Soldier must be made on the back of each final statement.

Green L. H. ...



I certify, on honor, that Peter Brown, a Private of
 Captain Hill's Company (B.) of the 4th Regiment of U.S. Colored
VOLUNTEERS, of the State of _____, born in Baltimore, State
 of Maryland, aged 19 years; 4 feet 11 inches high; Black complexion,
Black eyes, Black hair, and by occupation a Laborer, who joined for service
 and was enrolled (see Note 9) on the 21st day of July, 1863, at Baltimore
 by Col. Binny, for the period of Three years, and mustered into
 the service of the United States on the 21st day of July, 1863, at
Baltimore Md., by Col. Binny; and having served
 HONESTLY and FAITHFULLY with his Company to the present date, is now entitled to a
DISCHARGE by reason of Death at U. S. A. Genl. Hospital
Summit House on the 23^d Oct. 1864 from Phthisis Pulmonalis

The said Peter Brown was last paid by Paymaster
Binny, to include the 31st day of August, 1864, and
 has pay due him from that time to the present date; he is entitled to pay and subsistence for
TRAVELING to place of enrollment, and whatever other allowances are authorized to volunteer
 soldiers, drafted men, or militia, so discharged. He has received from the United States **CLOTHING**
 amounting to Thirty $\frac{10}{100}$ dollars, since the 2nd day of June,
 1864, when his clothing account was last settled. He has received from the United States
No $\frac{00}{100}$ dollars advanced **BOUNTY**.

There is to be stopped from him, on account of the State of _____, or other
 authorities, for **CLOTHING**, &c., received on entering service, _____ $\frac{00}{100}$ dollars; and
 for other stoppages, viz: _____
 _____ $\frac{00}{100}$ dollars.
 He has been furnished with **TRANSPORTATION** in kind from the place of his discharge to
 _____; and he has been **SUBSISTED** for **TRAVELING** to his
 place of enrollment, up to the _____, 1864.

He is indebted to _____, **BUTLER**, _____ $\frac{00}{100}$ dollars.
 He is indebted to _____, **LAUNDRESS**, _____ $\frac{00}{100}$ dollars.

Given in Duplicate, at Philadelphia, this 20th day
 of December, 1864.

A. Taylor
 Surgeon U.S.A.
 Commanding Company
 Genl Hospital

44

No. .

ABSTRACT OF DISBURSEMENTS.

....., 186 .

Elizabeth Sturges

Dollars *300* ^{*00*}/_{*100*}

Paid , 186 .

The United States,

To Elizabeth Stephens Dr.

186	For amount awarded him by the Board of Claims, in consideration of the enlistment of <i>Peter Brown</i> in the <i>4th Regt U. S. Colored Troops</i>	DOLLARS.	CENTS.
		300	00
	<i>Total \$</i>	300.	00

I CERTIFY that the above account is correct and just; that the name of *Peter Brown* is borne on the muster-in rolls of the *4th Regt U. S. Colored Troops*; and that the above amount was awarded by the Board of which *S. F. Streete Esq* is President, said award being in accordance with section 24 of the act entitled "An act to amend an act entitled 'An act for enrolling and calling out the national forces, and for other purposes,'" approved Feb. 24, 1864.

Assistant Adjutant General.

RECEIVED _____, 186 , of *Capt S. G. Benedict, A. A. G. Col*
Three Hundred dollars and _____ cents, in full of the above account.

Elizabeth Stephens

(SIGNED DUPLICATES.)

E. Stephens
H.B.

No. .

ABSTRACT OF DISBURSEMENTS.

....., 186 .

Elizabeth Stephens.....

Dollars *311* $\frac{00}{100}$

Paid, 186 .

The United States,

To Elizabeth Stephens Dr.

186 .		DOLLARS.	CENTS.
	For amount awarded him by the Board of Claims, in consideration of the enlistment of <i>Peter Brown</i> in the <i>4th Regt U. S. Colored Troops</i>	300.	00
	<i>Total \$</i>	300	00

I CERTIFY that the above account is correct and just; that the name of *Peter Brown* is borne on the muster-in rolls of the *4th Regt U. S. Colored Troops*; and that the above amount was awarded by the Board of which *S. F. Steeter Esq* is President, said award being in accordance with section 24 of the act entitled "An act to amend an act entitled 'An act for enrolling and calling out the national forces, and for other purposes,'" approved Feb. 24, 1864.

Assistant Adjutant General.

RECEIVED , 186 , of *Capt L. G. Benedict, A. A. G. Vol*
Three Hundred dollars and _____ cents, in full of the above account.

Elizabeth Stephens

(SIGNED DUPLICATES.)

Wm. Philip
 Co. D., 4 U.S. Col'd Inf.

Prewatt | *Private*

CARD NUMBERS.

1	5557138	26
2	5557237	27
3	5557337	28
4	5557419	29
5	5557494	30
6	5557555	31
7	5557616	32
8	9062104	33
9	2202-05-1879	34
10	B-5-RCJ-1868	35
11		36
12		37
13		38
14		39
15		40
16		41
17		42
18		43
19		44
20		45
21		46
22		47
23		48
24		49
25		50

Book Mark: *2202 05 79*
B 5- RCJ 1868

See also

B | 4 | U.S.C.T.

Philip Brown
 _____, Co. 10, 4 Reg't U. S. Col'd Inf.

Appears on
Company Descriptive Book
 of the organization named above.

DESCRIPTION.

Age 20 years; height 5 feet 5 1/2 inches.
 Complexion Black
 Eyes Black; hair Black
 Where born _____
 Occupation _____

ENLISTMENT.

When _____, 186 ____
 Where _____
 By whom _____; term _____ y'rs.

Remarks: Drafted Nov. 19/64 at
 Ellicott's Mills by Capt. J. C. Williams
 for 1 year 3rd Dist. Charles Co. Clothing \$27.92
 Deserted after draft arrested Jan 21/65
 Charles County sent to Col. Wiley
 24p #30. arrest as deserter. Atient sick at
 Wilmington Last heard from Apr. 22/65

W. H. Merrill
 _____ Copyist.
 (383g)

B | 4 | U.S.C.T.

Philip Brown

Pvt., Co. D, 4 Reg't U. S. Col'd Infantry.

Appears on

Company Muster Roll

for Mar. & Apr., 1867.

Joined for duty and enrolled:

When _____, 186 .*

Where _____ *

Period _____ years.*

Present or absent Absent,

Stoppage, \$ 100 for _____

Due Gov't \$ 100 for _____

Remarks: Absent sick.
Recruit. No papers
forwarded.

* See enrollment on card from muster-in roll.

Book mark: _____

(858c)

Easterling

Copyist.

B | 4 | **U.S.C.T.**

Philip Brown
Pr^x, Co. D, 4 Reg't U. S. Col'd Infantry.

Appears on

Company Muster Roll

for *May & June*, 1865.

Joined for duty and enrolled:

When....., 186 .*

Where.....*

Period..... years.*

Present or absent. *Absent*

Stoppage, \$ 100 for.....

Due Gov't \$ 100 for.....

Remarks: *Recruit No papers forwarded, Absent sick.*

.....

* ~~See~~ See enrollment on card from muster-in roll.

Book mark:.....

Easterling
 (358c) Copyist.

B | 4 | **U.S.C.T.**

Philip Brown
Prvt, Co. D, 4 Reg't U. S. Col'd Infantry.

Appears on

Company Muster Roll

for *July & Aug*, 186*5*.

Joined for duty and enrolled:

When *Nov 14*, 186*4*.*

Where *Ellicott's Mills, Md.**

Period *1* year.*

Present or absent *Absent*.

Stoppage, \$ *100* for

Due Gov't \$ *100* for

Remarks: *Absent sick,*
Pay due from
enlistment.

* See enrollment on card from muster-in roll.

Book mark:

(858c)

Castuliny Copyist.

B

4

U.S.C.T.

Philip Brown

Pvt., Co. D, 4 Reg't U. S. Col'd Infantry.

Appears on

Company Muster Roll

for Sept. & Oct., 1865.

Joined for duty and enrolled:

When Nov. 14, 1863.*

Where Ellicott's Mills *

Period 1 years.*

Present or absent absent.

Stoppage, \$ 100 for

Due Gov't \$ 100 for

Remarks: Stop. for Cap. Number, Letter & Badge 3¢. Coat Strap 12¢. Canteen 65¢. Drafted. Stop \$30. for his arrest as a deserter = \$30.79¢. Absent sick.

* See enrollment on card from muster-in roll.

Book mark:

Castling

(858c)

Copyist.

B | 4 | U.S.C.T.

Philip Brown
Pvt., Co. D, 4 Reg't U. S. Col'd Infantry.

Appears on

Company Muster Roll

for Nov & Dec, 1865.

Joined for duty and enrolled:

When Jan 21, 1865.*

Where *

Period 1 years.*

Present or absent Absent

Stoppage, \$ 100 for

Due Gov't \$ 100 for

Remarks: Deserted after draft. Ar-
rested Jan 21/65. Joined company
April 19/65. charge of desertion
removed & to serve his time
from date of arrest S.O. 289
Hd Qrs Dept of Wash. Nov 29/65
(over)

* See enrollment on card from muster-in roll.

Book mark:

J. J. Jones

JAN. 19

5557494

1891

Remark.: Stop \$30 paid
for his arrest. Letter and
number 2^c, coat straps
12^c canteen 65^c = \$30.79^c

Absent sick at Raleigh
since April 1st 65. Never
since heard from

B. | 4 | U.S.C.T.

Philip Brown
Pt., Co. D, 4 Reg't U. S. Col'd Infantry.

Appears on

Company Muster Roll
for Jan & Feb, 1866.

Joined for duty and enrolled:

When Jan 21, 1865.*

Where _____*

Period 1 years.*

NEXT ROLL ON FILE MUSTER OUT.
Present or absent _____

Stoppage, \$ 100 for _____

Due Gov't \$ 100 for _____

Remarks: Absent sick at
Raleigh since April
21/65. Never since heard
from
Drafted. Mustered into
service Nov 19/64 at Ellicotts Mills.

* See enrollment on card from muster-in roll.

Book mark: _____

J. J. J. J. J.
(858c) Copyist.

B. | 4 | U.S.C.T.

Philip Brown
Plt, Co. *D*, 4 Reg't U. S. Col'd Infantry.

Appears on **Co. Muster-out Roll**, dated
Washington DC, May 4, 1866.

Muster-out to date *May 4, 1866.*

Last paid to *to pay since Draft, 1866.*

Clothing account:

Last settled....., 186 ; drawn since \$.....100

Due soldier \$.....100; due U. S. \$.....100

Am't for cloth'g in kind or money adv'd \$.....100

Due U. S. for arms, equipments, &c., \$.....100

Bounty paid \$.....100; due \$.....100

Remarks: *absent sick no
discharges furnished.*

*Drafted + m/in Dec 19 64 at
Elliott. Mills Md. 14 yr*

Book mark: *Deserters from V 122 P.
974, 220 79. Ft. McHenry Md.
(over)*

(361)

J. J. J.
Copyist.

Book ST ~~455~~ 57616 ^{*T681*}
 V 149 ~~40~~ 134. 73 S.O. 289
 D.M. Dow. 23/65
 B 5 Vol. 5. R.C.T 1868.

B | 4" | U. S. C. I.

Phillip Brown

, Co. D, 4th Reg't U. S. C. I.

NOTATION.

Book mark: *L. B. 13-388. with*
2202. C. I. - 1879.

War Department,

Adjutant General's Office,

Washington, *July 12*, 1880.

*Charge of desertion removed
 by Special Order #15. of January
 19. 1866. Hd. Qrs. Dept. of Washington.*

M. Allen

B. H. W. S.

Philip Brown

, Co. A., H. Reg't W. Troops

NOTATION.

Book mark: B. 5 R. C. I. 1868

Record and Pension Office,

WAR DEPARTMENT.

This book mark refers only to a report from the medical records, made by the Surgeon General to the Adjutant General, relative to the above-named man. As the medical records have since been carded, no transcript of this report is made hereon.

A. M. Muzzey Copyist.

Brown, Philip

P. D. 4

Reg. U. S. C. Inf.

Enclosures.

- | | |
|------------------------------|-------------------|
| Bed Cards | Descriptive Lists |
| Burial Records | Final Statements |
| Certs. of Dis. for Discharge | Furloughs |
| C. M. Charges | Med. Des. Lists |
| Med. Certificates | Orders |

Other papers relating to—

- | | |
|----------------------------|----------------------|
| Admission to Hosp'l | Furlough |
| Casualty Sheet (Officer's) | Med. Examination |
| Confinement | Misc. Information |
| Contracts | Pay or Clothing |
| Death or Effects | Personal Reports |
| Desertions | Rank |
| Discharge from Hosp'l | Transfer to Hosp'l |
| Discharge from Service | Transfer to V. R. C. |
| Duty | Transportation |

Philip Brown
Col. 4th U.S.C.I.

See
J. A. Duncan
Col. 4th U.S.C.I.

Restorations.
Dept; of Wash,
1864-5 & 6.

169

John W. Primm

Co *K*, 4 U.S. Col'd Inf.

Private

Private

CARD NUMBERS.

1	5566002	26
2	5566103	27
3	5566203	28
4	5566301	29
5	5566389	30
6	5566474	31
7	5566559	32
8	5566636	33
9	5566710	34
10	5566794	35
11	5566880	36
12	5566971	37
13	5567058	38
14	5556627	39
15	5567144	40
16	5567218	41
17	5567277	42
18	5567332	43
19	9062803	44
20	9062931	45
21		46
22		47
23		48
24		49
25		50

Book Mark:

See also

D. 2860866 Pomil

P 2904737 unova

B | 4 | U.S.C.T.

Primus Brown

, Co. K, 4 Reg't U. S. Col'd Inf.

Appears on

Company Descriptive Book

of the organization named above.

DESCRIPTION.

Age *20* years; height *5* feet *4 1/2* inches.

Complexion *Blk*

Eyes *Blk*; hair *Curly*

Where born *Savannah Ga*

Occupation *Servant*

ENLISTMENT.

When *Aug. 28*, 18*63*.

Where *Balto Mds*

By whom *Cal Burney*; term *3* y'rs.

Remarks:

Free

Selah

B | 4 | U.S.C.T.

Primes Brown

Co. K., 4 Reg't U. S. Col'd Inf.

Appears on

Company Descriptive Book

of the organization named above.

DESCRIPTION.

Age 20 years; height 5 feet 4 inches.

Complexion Blk

Eyes Blk; hair Curly

Where born Savannah Ga

Occupation Servant

ENLISTMENT.

When Aug 28, 1863.

Where Balto, Md

By whom C. H. Binney; term 3 y'rs.

Remarks: Good

Selah

Copyist.

J | 4 | U.S.C.T.

James Brown

J, Co. *K*, 4 Reg't U. S. Col'd Infantry.

Age *20* years.

Appears on

Company Muster-in Roll

of the organization named above. Roll dated

Baltimore Md Sept, 186*3*.

Muster-in to date *Sept*, 186*3*.

Joined for duty and enrolled:

When *Sept*, 186*3*.*

Where *Baltimore Md*, *

Period *3* years.*

Remarks :

* ~~40~~ Muster-in roll shows enrollment and muster-in of this company as of same date and place. See enrollment on subsequent card or cards.

Book mark: _____

James Brown

B | 4 | U.S.C.T.

James Brown

Pr, Co. K, 4 Reg't U. S. Col'd Infantry.

Appears on

Company Muster Roll

for *Sept & Oct*, 186².

Joined for duty and enrolled:

When *Sept 1*, 186².*

Where *Baltimore* *

Period *3* years.*

Present or absent *Present*.

Stoppage, \$ *100* for

Due Gov't, \$ *100* for

Remarks:

Book mark:

Jan Amten

P | 4 | U.S.C.T.

James Brown
Pt, Co. K, 4 Reg't U. S. Col'd Infantry.

Appears on

Company Muster Roll

for *Nov & Dec*, 186³.

Joined for duty and enrolled :

When *Sept 1*, 186³.*

Where *Baltimore* *

Period *3* years.*

Present or absent *Present*.

Stoppage, \$ $\frac{56}{100}$ for *1 Haversack*

Due Gov't, \$ $\frac{100}{100}$ for

Remarks: _____

* See enrollment on card from muster-in roll.

Book mark: _____

Wm. H. ...

P | 4 | U.S.C.T.

James Brown

....., Co. K, 4 Reg't U. S. Col'd Infantry.

Appears on

Company Muster Roll

for *Jan'y & Feb'y*, 186*4*.

Joined for duty and enrolled :

When *Sept 1*, 186*3*.*

Where *Baltimore*

Period *3* years.*

Present or absent *Present.*

Stoppage, \$ *100* for

Due Gov't, \$ *100* for

Remarks: *Stopped for one letter*

* See enrollment on card from muster-in roll.

Book mark :

Van Houten

P

4

U.S.C.T.

James Brown
....., Co. K, 4 Reg't U. S. Col'd Infantry.

Appears on

Company Muster Roll

for *March & Apr.*, 186 *7* ✓

Joined for duty and enrolled :

When *Sept. 1*, 186 *7*.*

Where *Baltimore,*

Period *3* years.*

Present or absent *Present*

Stoppage, \$ *100* for

Due Gov't, \$ *100* for

Remarks:

.....
.....
.....
.....
.....

* See enrollment on card from muster-in roll.

Book mark:

.....

Vau Herten,

B | 4 | U.S.C.T.

Primas Brown
Pvt., Co. K, 4 Reg't U. S. Col'd Infantry.

Appears on

Company Muster Roll
 for *May to June*, 186*4*.

Joined for duty and enrolled:

When *Sept. 1*, 186*3*.*

Where *Baltimore*.*

Period *3* years.*

Present or absent *Absent*

Stoppage, \$ *100* for

Due Gov't, \$ *100* for

Remarks: *Absent sick in*
Genl. Hosp th. June 27.
1864

Book mark:

Oliss

D

4

U.S.C.T.

Primas Brown

Pl, Co. K, 4 Reg't U. S. Col'd Infantry.

Appears on

Company Muster Roll

for July and Aug., 1864.

Joined for duty and enrolled :

When Sept. 1., 1863.*

Where Baltimore *

Period 3 years.*

Present or absent Present

Stoppage, \$ 100 for

Due Gov't, \$ 100 for

Remarks: Free Apr. 19, 1861

Book mark :

Bliss

D | 4 | U.S.C.T.

Primas Brown

Pvt., Co. K, 4 Reg't U. S. Col'd Infantry.

Appears on

Company Muster Roll

for Sept. and Oct., 1864

Joined for duty and enrolled :

When Sept. 1, 1863.*

Where Baltimore Md *

Period 3 years.*

Present or absent Present

Stoppage, \$ 100 for

Due Gov't, \$ 100 for

Remarks: Free April 19, 1861

Book mark :

Bless

B | 4 | U.S.C.T.

* Primas Brown
Pt., Co. K, 4 Reg't U. S. Col'd Infantry.

Appears on

Company Muster Roll

for Nov & Dec, 1864.

Joined for duty and enrolled:

When Sept 1, 1863.*

Where Baltimore Md.*

Period 3 years.*

Present or absent Present

Stoppage, \$ 100 for

Due Gov't, \$ 100 for

Remarks: Free apl 19, 1861

* In Col. Pres. name appears
as "Primas Brown"

Book mark:

J. H. Stewart

B | 4 | U.S.C.T.

Primus Brown

Pt., Co. K, 4 Reg't U. S. Col'd Infantry.

Appears on

Company Muster Roll

for Jan & Feb, 1865.

Joined for duty and enrolled :

When Sept 1, 1863.*

Where Baltimore Md. *

Period 3 years.*

Present or absent Present

Stoppage, \$ 100 for

Due Gov't, \$ 100 for

Remarks: Free on or before
apl 19. 61

Book mark :

J. Stewart

B. | 4 | U.S.C.T.

Primis Brown

Priv., Co. K, 4 Reg't U. S. Col'd Infantry.

Appears on

Company Muster Roll

for *March + April*, 1865.

Joined for duty and enrolled :

When *Sept. 1*, 1863.*

Where *Baltimore, Md.* *

Period *3* years.*

Present or absent *Present*

Stoppage, \$ *100* for

Due Gov't, \$ *100* for

Remarks: *Free on or before April the 19, 61. Back pay due from enlistment to May 1/64.*

* See enrollment on card from muster-in roll.

Book mark :

Philipsen

B | 4 | U.S.C.T.

Primis Brown

Priv., Co. K, 4 Reg't U. S. Col'd Infantry.

Appears on

Company Muster Roll

for *May & June*, 1865.

Joined for duty and enrolled:

When *Sept. 1*, 1863.*

Where *Baltimore, Md.**

Period *3* years.*

Present or absent *Present.*

Stoppage, \$ *100* for

Due Gov't, \$ *100* for

Remarks: *Back pay due from enlistment to May 1st/64. Free.*

* See enrollment on card from muster-in roll.

Book mark:

Philipson

B | 4 | U.S.C.T.

Primmis Brown

Prv., Co. K, 4 Reg't U. S. Col'd Infantry.

Appears on

Company Muster Roll

for *July + Aug.*, 1865.

Joined for duty and enrolled :

When *Sept. 1*, 1863.*

Where *Baltimore, Md.* *

Period *3* years.*

Present or absent *Present*

Stoppage, \$ *100* for

Due Gov't, \$ *100* for

Remarks :

* ~~45~~ See enrollment on card from muster-in roll.

Book mark :

Philipson

(358c) Copyist.

B. | 4 | **U.S.C.T.**

Prinus Brown

Co., *Co. K*, *4* Reg't U. S. Col'd Inf.

Appears on **Hospital Muster Roll**

of *A* Reg't U. S. Col'd Infantry

for *July & Aug.* 186 *5*

When attached to Hosp. _____, 186 .

How employed _____

Present or absent *Present.*

Remarks *No Descriptive list.*

Book mark : _____

(343) *Hawling* Copyist.

B. | 4 | U.S.C.T.

Primis Brown

Priv., Co. K, 4 Reg't U. S. Col'd Infantry.

Appears on

Company Muster Roll

for *Sept. & Oct.*, 1865.

Joined for duty and enrolled :

When *Sept. 1*, 1863.*

Where *Baltimore* *

Period *3* years.*

Present or absent *Present*

Stoppage, \$ *100* for

Due Gov't, \$ *100* for

Remarks: *Stopped 50cts
for one pair of Metallic
scales.*

* See enrollment on card from muster-in roll.

Book mark :

Philipson

B.I.

4

U.S.C.T.

Primus Brown

Priv, Co. K, 4 Reg't U. S. Col'd Infantry.

Appears on

Company Muster Roll

for *Nov & Dec*, 1865.

Joined for duty and enrolled :

When *September 1*, 1863.*

Where *Baltimore Md* *

Period *3* years.*

Present or absent *Present*

Stoppage, \$ *100* for

Due Gov't, \$ *100* for

Remarks:

Book mark:

J. M. Vance

S. | 4 | U.S.C.T.

Primus Jones

Priv., Co. K, 4 Reg't U. S. Col'd Infantry.

Appears on

Company Muster Roll

for *Jan. & Feb.*, 186*6*.

Joined for duty and enrolled:

When *September 1*, 186*3*.*

Where *Baltimore Md*.*

Period *3* years.*

Present or absent *Present*

Stoppage, \$ *100* for

Due Gov't, \$ *100* for

Remarks:

NEXT ROLL ON FILE MUSTER OUT.

Book mark:

(858c)

J. M. Jones

Copyist.

F | **4** | **U.S.C.T.**

James Brown

Feb, Co. *A*, 4 Reg't U. S. Col'd Infantry.

Appears on **Co. Muster-out Roll**, dated *Washington D.C.*, *May 4*, 186*6*.

Muster-out to date *May 4*, 186*6*.

Last paid to *Feb 28*, 186*6*.

Clothing account:

Last settled....., 186 ; drawn since \$.....¹⁰⁰

Due soldier \$.....¹⁰⁰; due U. S. \$.....^{14 97}/₁₀₀

Am't for cloth'g in kind or money adv'd \$.....¹⁰⁰

Due U. S. for arms, equipments, &c., \$.....¹⁰⁰

Bounty paid \$.....¹⁰⁰; due \$.....^{100 00}/₁₀₀

Remarks: *Free on or before*
April 19, 1866

Book mark :

(861)

J. M. Hance

Copyist.

170

Brown, Stephen R.
 Co F, 4 U.S. Col'd Inf.

Private | Private

CARD NUMBERS.

1	5559374	26
2	5559473	27
3	5559650	28
4	5566953	29
5	9062306	30
6		31
7		32
8		33
9		34
10		35
11		36
12		37
13		38
14		39
15		40
16		41
17		42
18		43
19		44
20		45
21		46
22		47
23		48
24		49
25		50

Book Mark:

See also

B | 4 | U.S.C.T.

Stephen P. Brown

, Co. F, 4 Reg't U. S. Col'd Inf.

Appears on

Company Descriptive Book

of the organization named above.

DESCRIPTION.

Age 29 years; height 5 feet 2 inches.

Complexion Brown

Eyes Black; hair Black

Where born Carroll Co. Md

Occupation Leatherer

ENLISTMENT.

When May 11, 1863

Where Baltimore Md

By whom Col Wm Finny; term 3 y'rs.

Remarks: Died Sept 3 1863 at Yorktown Va of Pneumonia

W H Merrill

A | 4 | U.S.C.T.

Stephen R. Brown

Priv, Co. *F*, 4 Reg't U. S. Col'd Infantry.

Age *29* years.

Appears on

Company Muster-in Roll

of the organization named above. Roll dated

Baltimore Md Aug 4, 1863.

Muster-in to date *Aug 4*, 1863.

Joined for duty and enrolled:

When *Aug 4th*, 1863.*

Where *Baltimore Md*.*

Period *3* years.*

Remarks :

* ~~4~~ Muster-in roll shows enrollment and muster-in of this company as of same date and place. See enrollment on subsequent card or cards.

Book mark: _____

Valentine

B.

4

U.S.C.T.

Stephen P. Brown

Priv., Co. F, 4 Reg't U. S. Col'd Infantry.

Appears on

Company Muster Roll

for Aug 4 to Aug 31, 1863.

Joined for duty and enrolled:

When Aug 4th, 1863.*

Where Baltimore Md.*

Period 3 years.*

Present or absent Present.

Stoppage, \$ 100 for

Due Gov't \$ 100 for

Remarks:

No dollars premium due

* See enrollment on card from muster-in roll.

Book mark:

Valentine

B. | 4 | U.S.C.T.

Stephen R. Brown

Priv, Co. F, 4 Reg't U. S. Col'd Infantry.

Appears on

Company Muster Roll

for Sept. & Oct., 1863.

Joined for duty and enrolled:

When August 4., 1863.*

Where Baltimore Md.*

Period 3 years.*

Present or absent _____

Stoppage, \$ 100 for _____

Due Gov't \$ 100 for _____

Remarks: _____

Disced Oct. 3. 1863-
final statements
given

* See enrollment on card from muster-in roll.

Book mark: _____

Valentine

B | 4 | U.S.C.T.

Stephen Brown
Tri, Co. *F*, 4 Reg't U. S. Col'd Infantry.

Appears on **Co. Muster-out Roll**, dated
Washington D C, May 4, 1866

Muster-out to date _____, 186 .

Last paid to _____, 186 .

Clothing account:

Last settled _____, 186 ; drawn since \$ _____ 100

Due soldier \$ _____ 100; due U. S. \$ _____ 100

Am't for cloth'g in kind or money adv'd \$ _____ 100

Due U. S. for arms, equipments, &c., \$ _____ 100

Bounty paid \$ _____ 100; due \$ _____ 100

Remarks: *Died Sept 3 1863*
of disease

Book mark: _____

(261)

Cummins

Copyist.

Brown, Stephen R.

P. F., Co.

4

Reg't. U. S. C. Inf.

2 Enclosures.

Bed Cards	Descriptive Lists
Burial Records	Final Statements
Certs. of Dis. for Discharge	Furloughs
C. M. Charges	Med. Des. Lists
Med. Certificates	Orders

Other papers relating to—

Admission to Hosp'l	Furlough
Casualty Sheet (Officer's)	Med. Examination
Confinement	Misc. Information
Contracts	Pay or Clothing
Death or Effects	Personal Reports
Desertions	Rank
Discharge from Hosp'l	Transfer to Hosp'l
Discharge from Service	Transfer to V. R. C.
Duty	Transportation

✓

6

FINAL STATEMENT

OF

Private - Stephen R Brown
Fourth Reg't of United States
Colonel Troops
VOLUNTEERS.
Died Sept 3/63

NOTE 1.—Two of these certificates (or duplicates) are to be given to each volunteer soldier who may be discharged previously to the discharge of his company, that he may at once receive from the Paymaster the pay, &c., due him, and the captain or other officer commanding the company will certify to the act of the delivery of the duplicate certificates; on these certificates the Soldier is "entitled to" his *discharge*, and should also present his discharge to the Paymaster to have the payment endorsed on it. The discharge is to be given back to the Soldier by the Paymaster; the latter only retaining as his voucher the duplicate certificates.

NOTE 2.—If the Soldier is entitled to pay for the use of his horse, the Company Commander will certify to that fact, and also to the time he has pay due for having been so mounted on his own horse.

NOTE 3.—Amounts due the Sutler and Laundress must be entered on the Muster Roll on which the death, desertion, &c., is reported, as well as on the final statement, otherwise the amount cannot be collected from the United States.

NOTE 4.—This blank will be used for deceased volunteers as well as others.

ADJUTANT GENERAL'S OFFICE,

May 11th 1864

Duplicates, with Inventory, sent 2d Auditor.

Ent. on O.R. & C.

I certify, on honor, that Private - Stephen R Brown a Member of
 Captain J. M. Dillenback's Company (7) of the 4th Regiment of United States Colored
Volunteers, of the State of Maryland, born in Carroll County, State
 of Maryland, aged 29 years; five feet two inches high; Brown complexion,
Black eyes, Black hair, and by occupation a Severer, having joined the company on
 its original organization at Baltimore, and enrolled in it at the muster into
 the service of the United States at Baltimore, on the Fourth day
 of August, 1863, (or was mustered in service as a recruit, by Col. Wm
Birney, at Baltimore, on the Fourth day of August,
 1863, to serve in the Regiment,) for the term of Three Years:
 and having served **HONESTLY** and **FAITHFULLY** with his Company in the Regiment
 to the present date, is now entitled to a **DISCHARGE** by reason of Death.

The said Private - Stephen R Brown was last paid by Paymaster
Major E. H. Hooper to include the 31st day of August, 1863, and has
 pay due him from that time to the present date; he is entitled to pay and subsistence for
TRAVELING to place of enrollment and whatever other allowances are authorized to volunteer
 soldiers, or militia, so discharged. He has received Thirty Six $\frac{46}{100}$ dollars,
 advanced by the United States on account of **CLOTHING**.

There is to be stopped from him, on account of the State of _____, or other
 authorities for **CLOTHING, &c.**, received on entering service, _____ dollars; also,
 for expenses of **SUBSISTENCE** for **TRAVELING** from place of enrollment to the place of rendezvous,
 amounting to _____ dollars: and on account of the United States for **EXTRA**
CLOTHING received in kind from _____ and for other
 stoppages, viz:

_____ amounting to _____ dollars;
 and he has been **SUBSISTED** for **TRAVELING** to his place of enrollment, up to the _____
 _____, 186 .

He is indebted to _____ **SUTLER**, _____ dollars.
 He is indebted to _____ **LAUNDRESS**, _____ dollars.

Given in Duplicate, at Baltimore Va, this 3^d day of September, 1863.

J. M. Dillenback
Captain
 Commanding Company.

Rec'd from Dir, of discontinued ¹⁵⁰⁵
Commands Filed June 8/75
INVENTORY OF THE EFFECTS

OF

Private - Stephen R. Brown

Late of Company F

4th Reg't of United States Col.

Troops
Volunteers, who died at Yorktown Va.

on the 3^d day of September 1863.



Inventory of the effects of Private - Stephen R. Brown late a Member of Captain J. W. Dillenback's Company F of the Fourth Regiment of United States Colored ^{troops} Volunteers, who was enrolled as a Private at Baltimore in the State of Maryland on the Fourth day of August 1863, and mustered into the service of the United States as a Private on the Fourth day of August 1863, at Baltimore in Company F, 4th Regiment of United States Colored ^{troops} Volunteers, to serve Three years or during the war; he was born in Carroll County in the State of Maryland; he was 29 years of age, Five feet Two inches high, Brown complexion, Black eyes, Black hair, and by occupation, when enrolled, a Seaman; he died in Hospital at Jorktown Va on the 11th day of September 1863, reason of Pneumonia

INVENTORY.					
ARTICLES.	No.	ARTICLES.	No.	ARTICLES.	No.
Hats		Pairs trousers		Knapsacks	/
Caps		Pairs flannel drawers			
Forage caps		Pairs cotton drawers	/		
Great coats	/	Flannel shirts	/		
Uniform coats		Cotton shirts			
Uniform jackets		Pairs boots			
Flannel sack coats		Pairs shoes			
Blouses	/	Pairs socks			
Stable frocks		Blankets	/		
Fatigue overalls		Haversacks	/		
				MONEY.	
				Specie	\$
				Notes	\$20.00

I CERTIFY, ON HONOR, that the above inventory comprises all the effects of Private - Stephen R. Brown, deceased, and that the effects are in the hands of Captain J. W. Dillenback at Jorktown Va to be disposed of by a Council of Administration.

(DUPLICATES.)

STATION: Jorktown Va

DATE: September 3rd 1863

[A. G. O. No. 104.]

J. W. Dillenback
Captain
 Commanding the Company.



IMAGE EVALUATION TEST TARGET (QA-3)

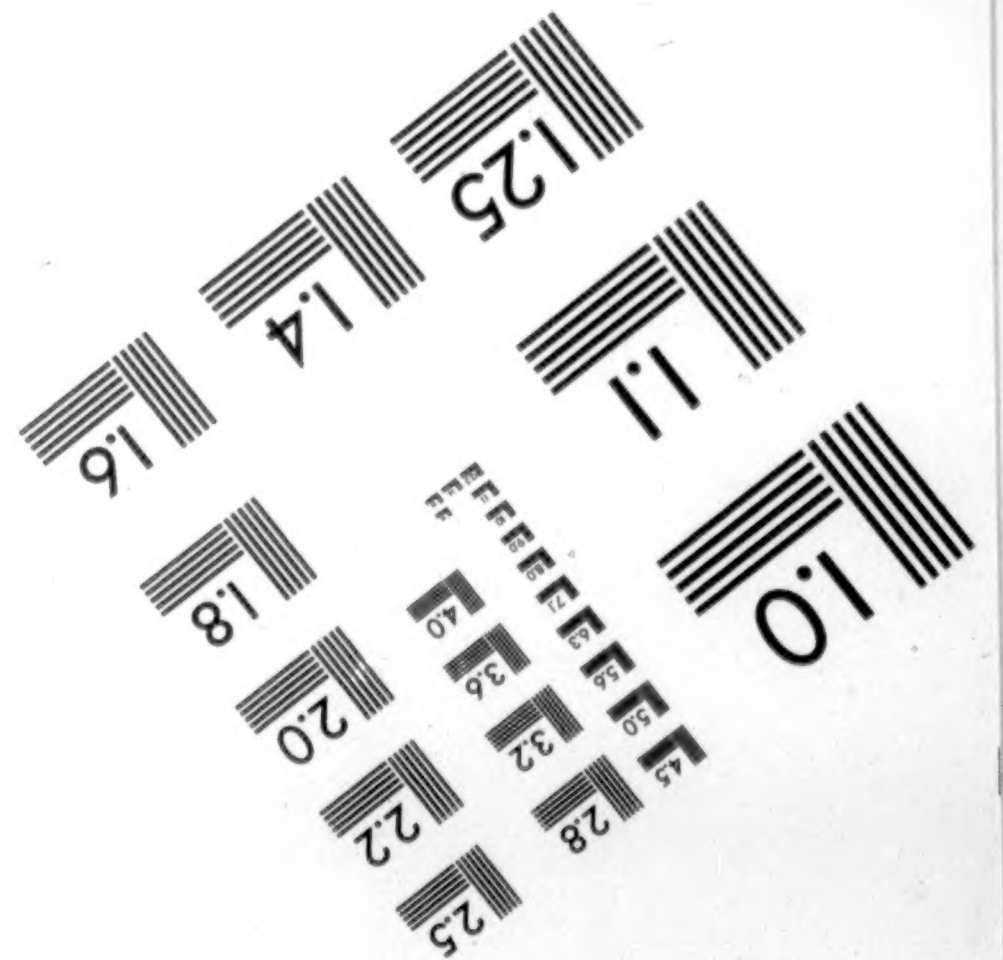
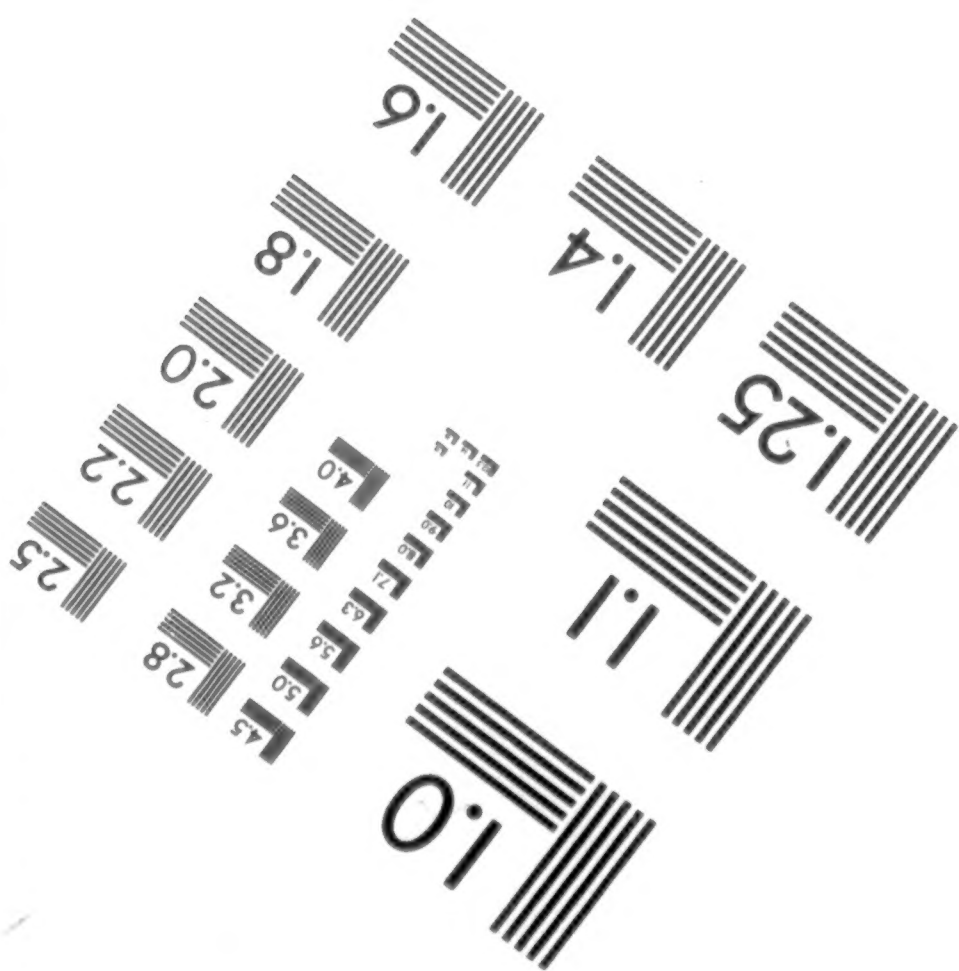
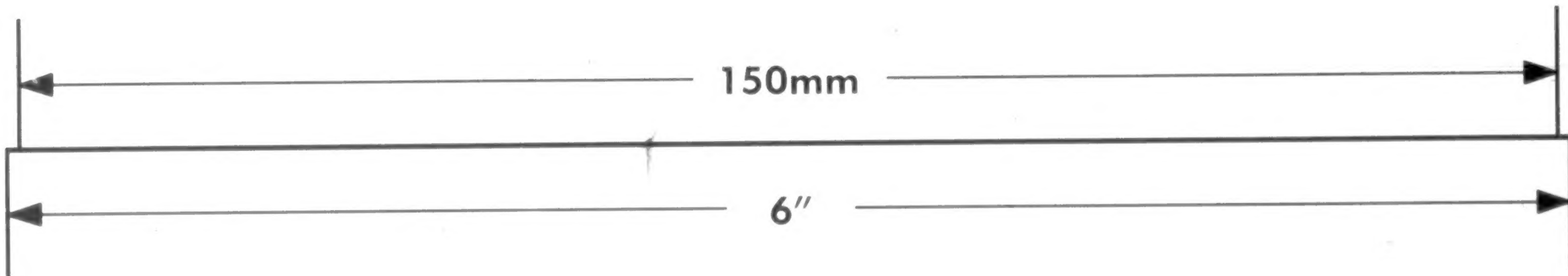
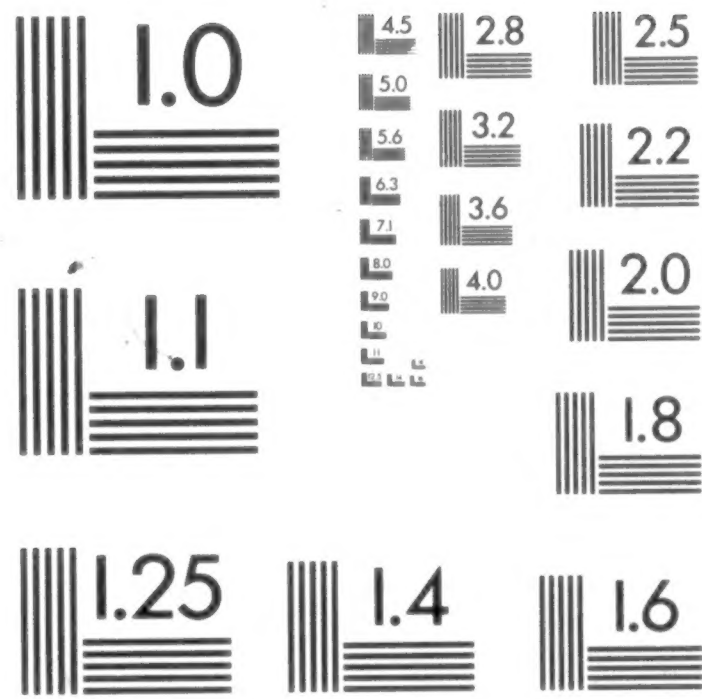
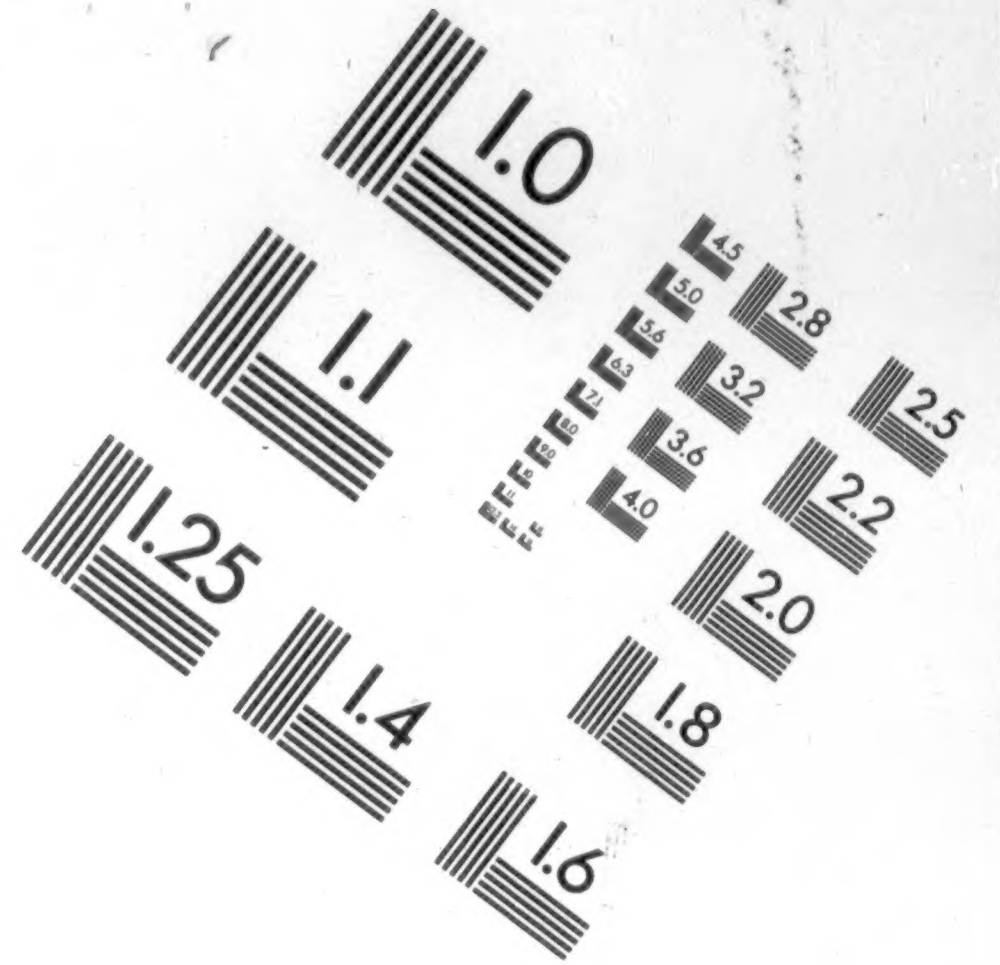
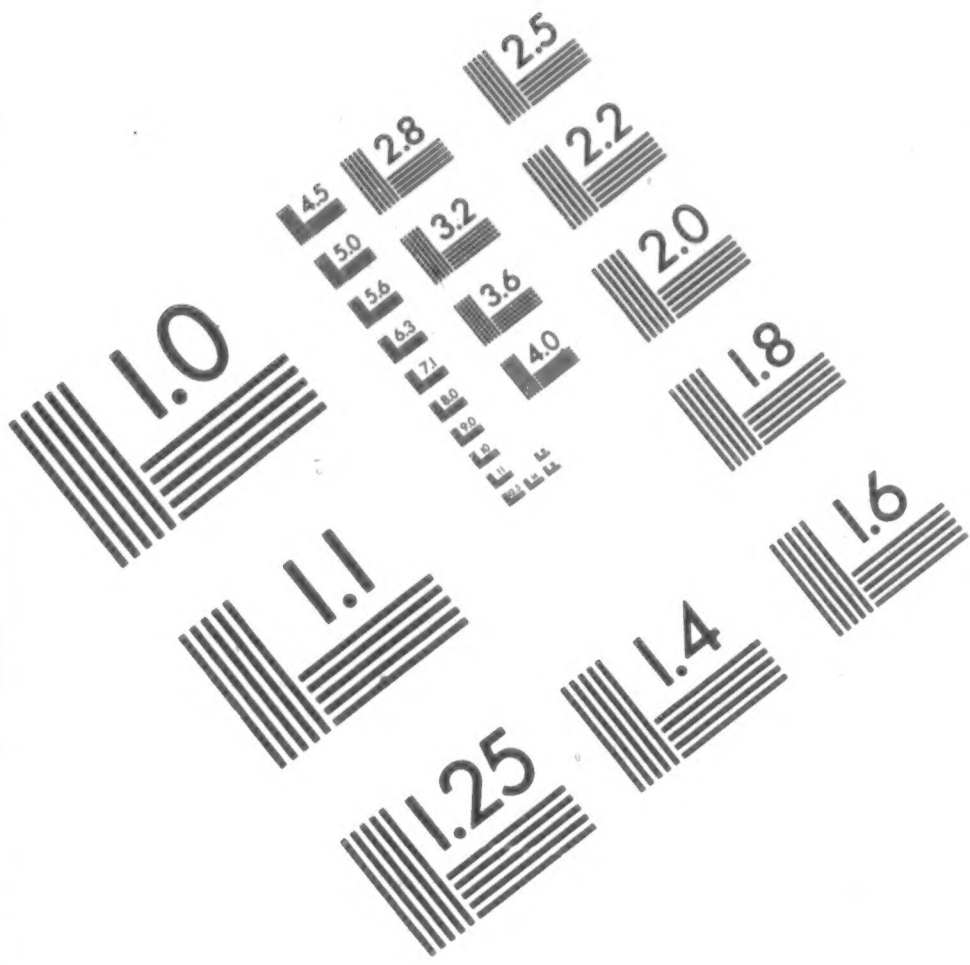

APPLIED IMAGE, Inc
 1653 East Main Street
 Rochester, NY 14609 USA
 Phone: 716/482-0300
 Fax: 716/288-5989

© 1993, Applied Image, Inc., All Rights Reserved

THE END

PLEASE

REWIND

