

**NATIONAL
ARCHIVES
MICROFILM
PUBLICATIONS**

IMAGE EVALUATION TEST TARGET (QA-3)

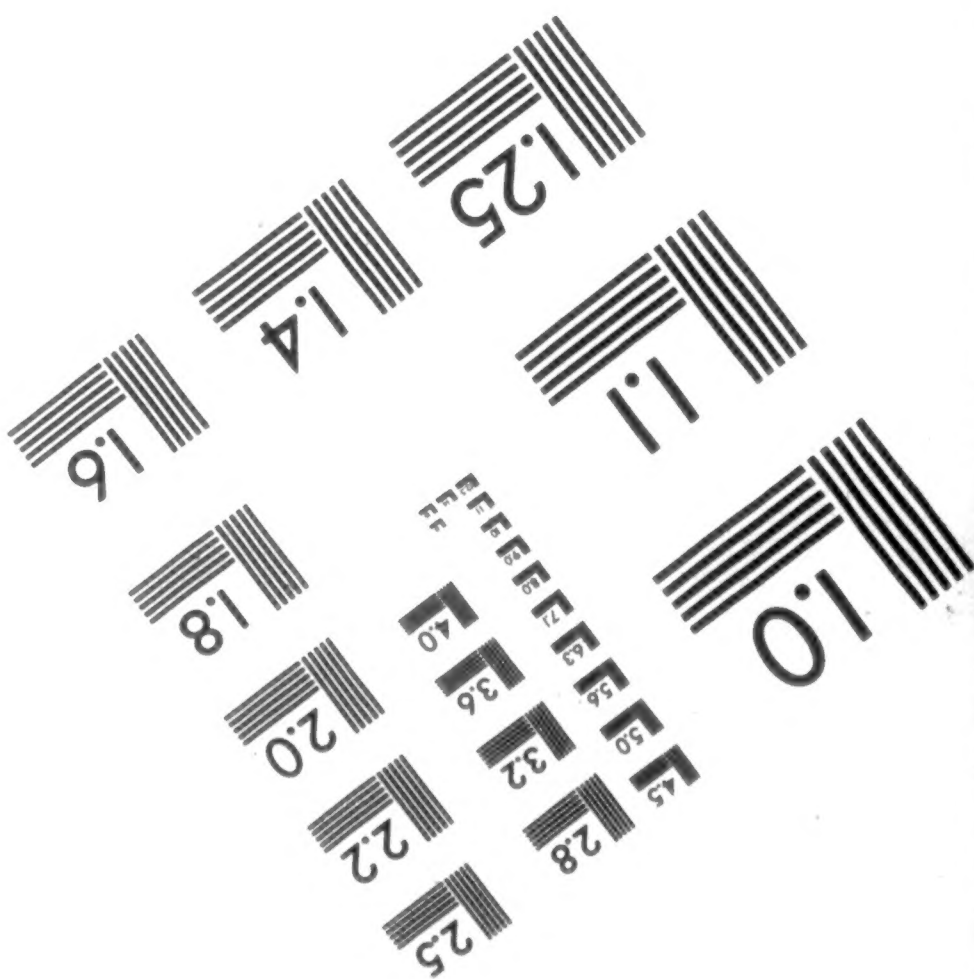
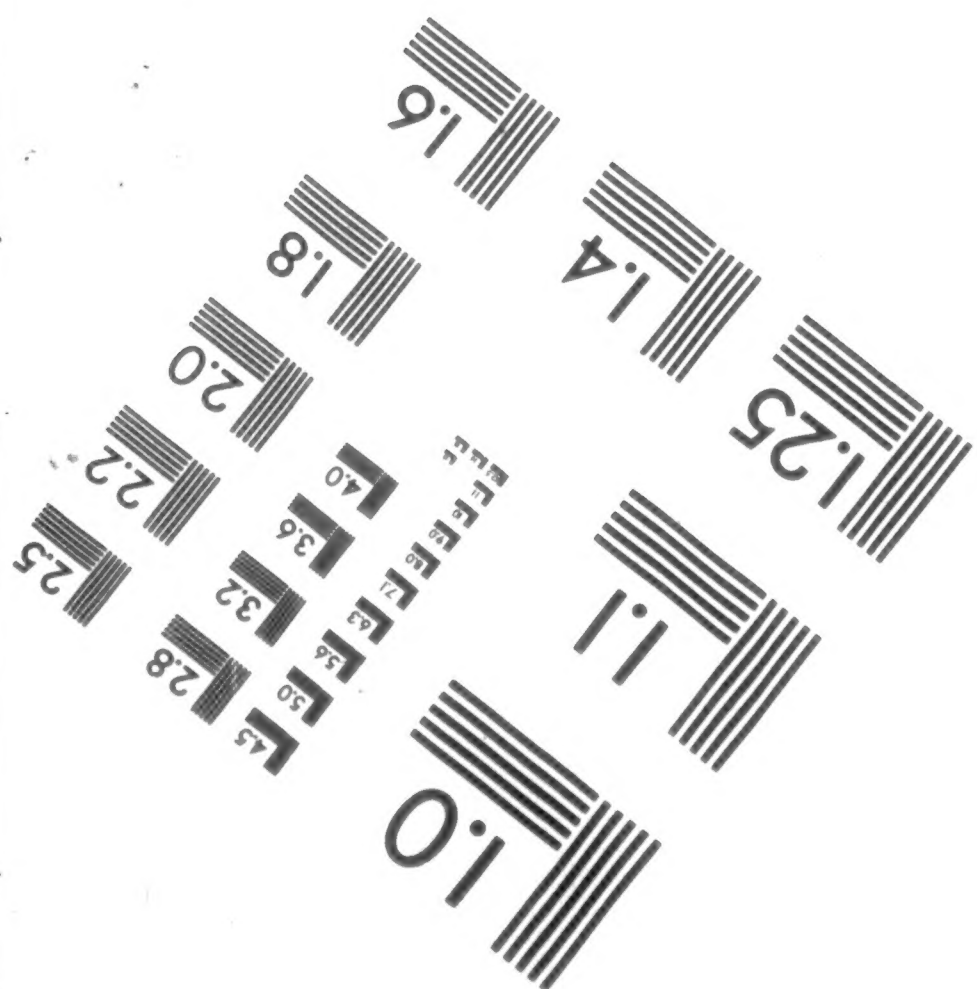
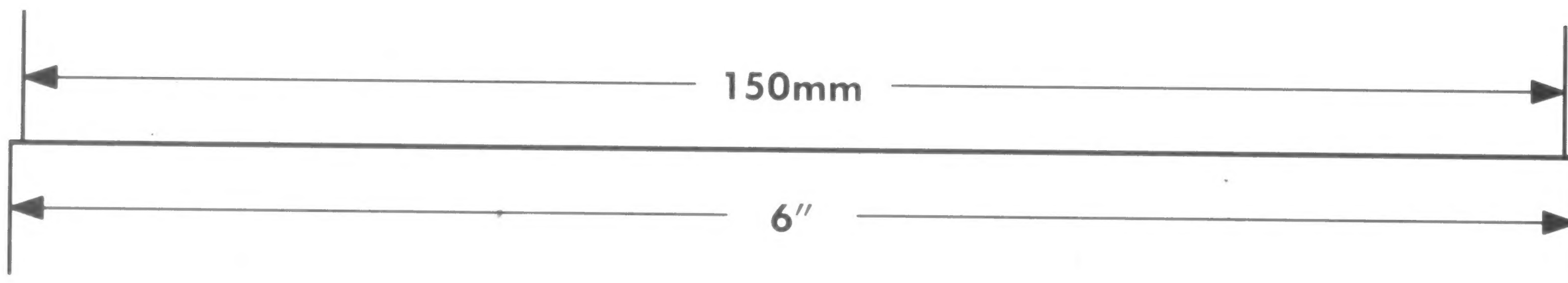
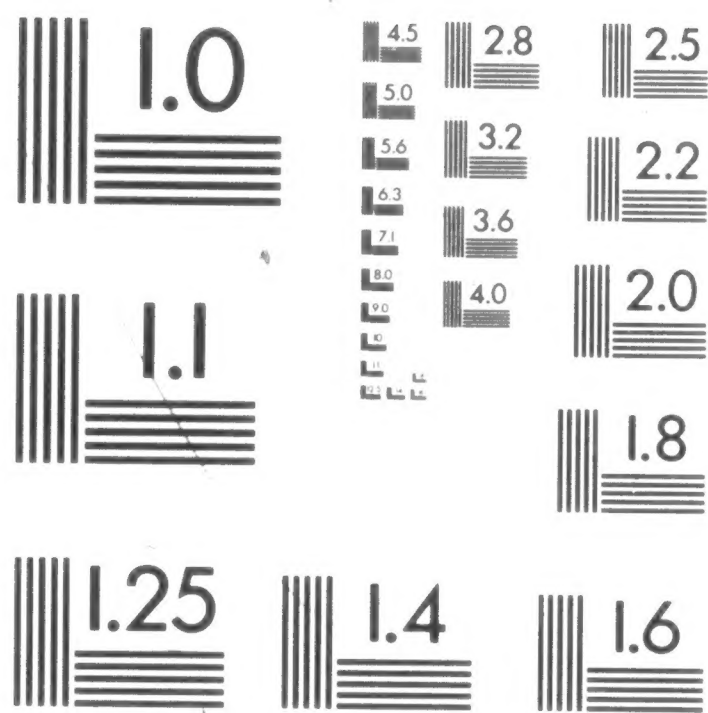
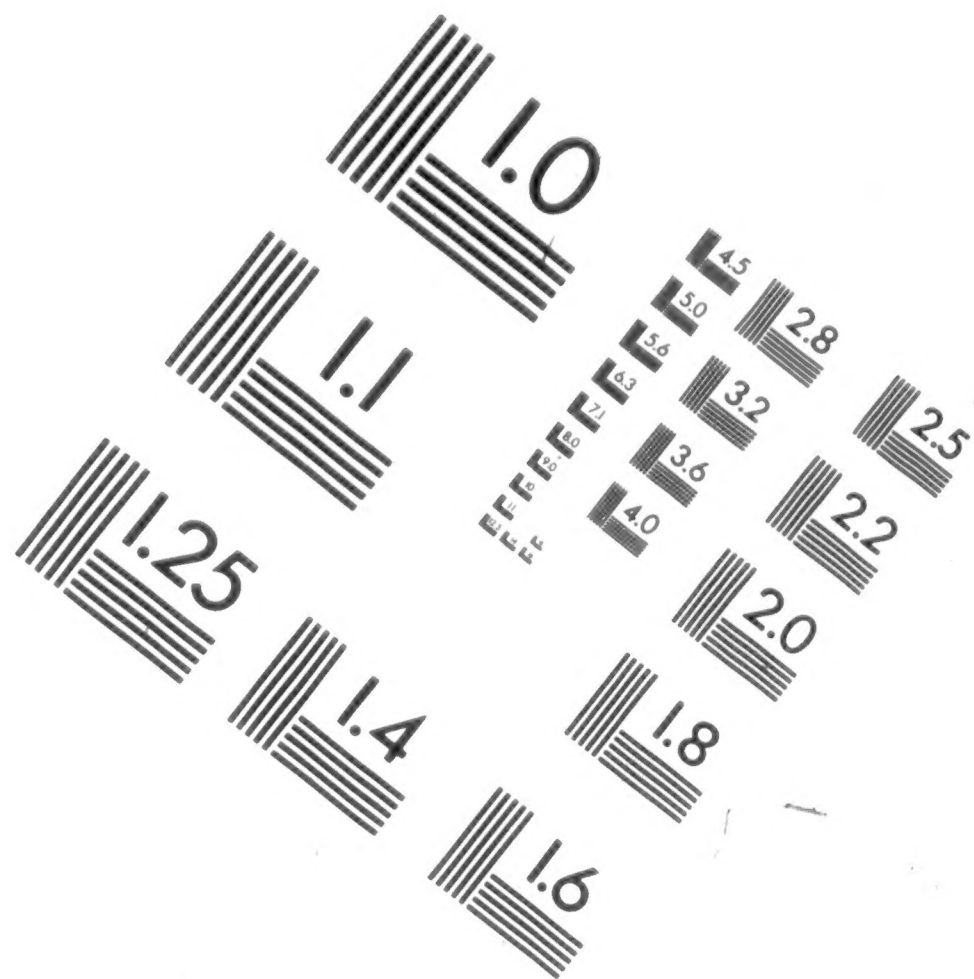
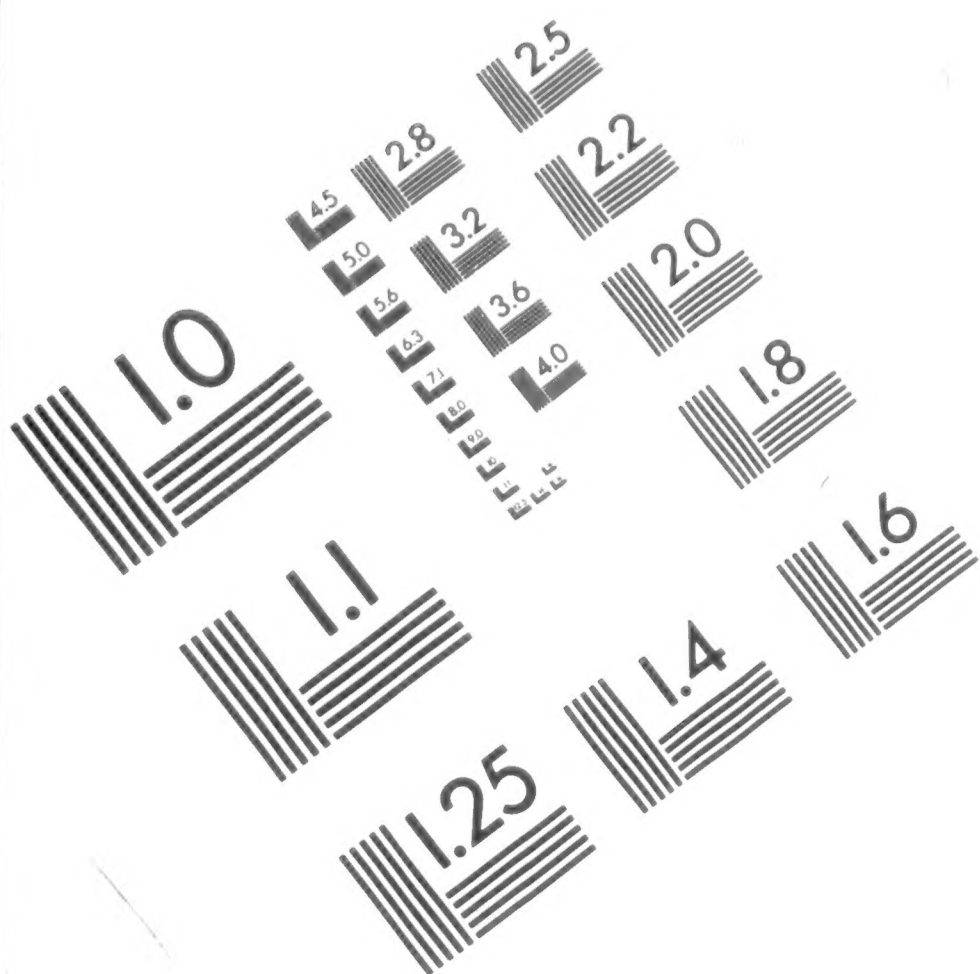

APPLIED IMAGE, Inc
 1653 East Main Street
 Rochester, NY 14609 USA
 Phone: 716/482-0300
 Fax: 716/288-5989

© 1993, Applied Image, Inc., All Rights Reserved

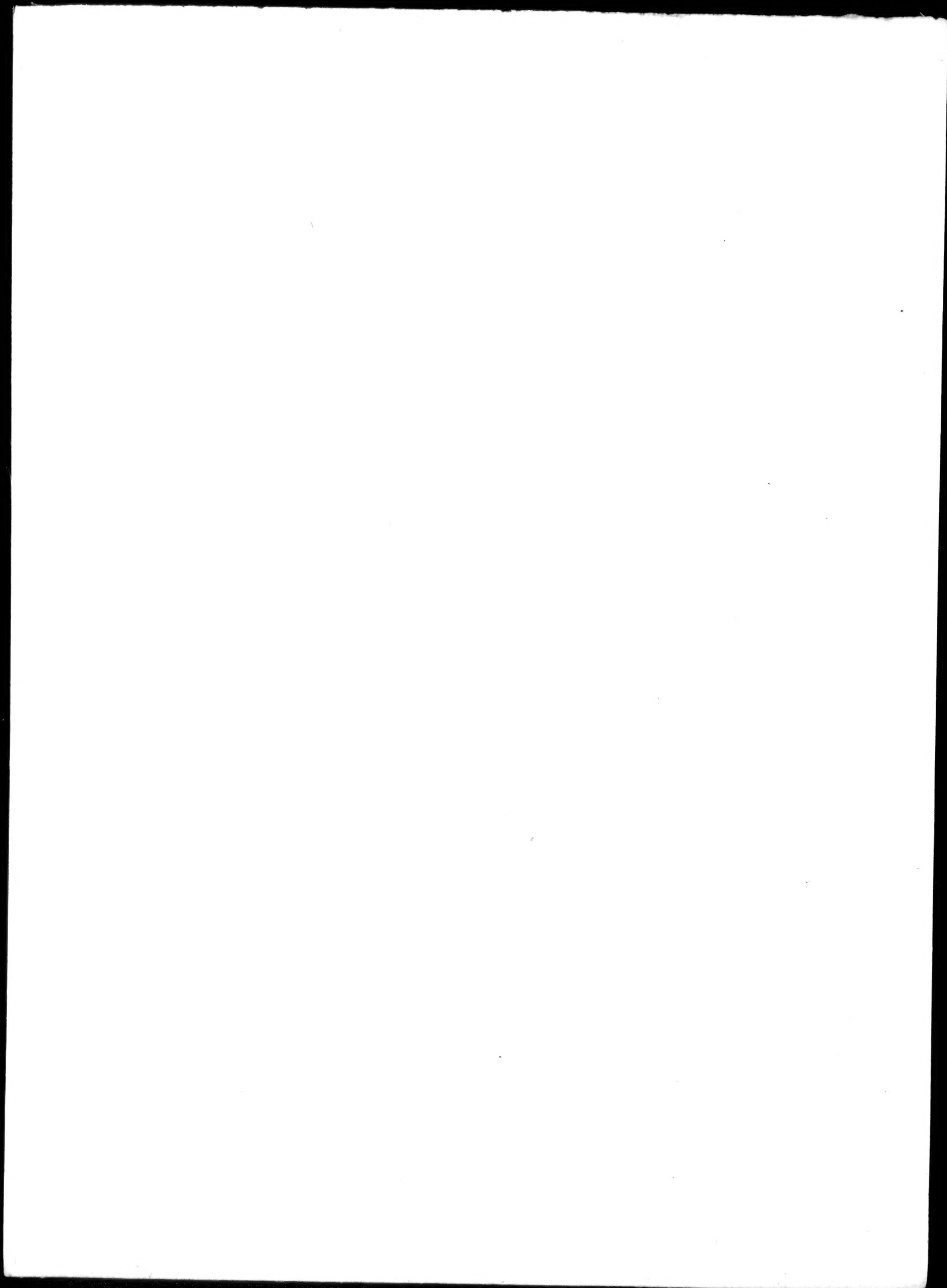

National Archives at College Park



8601 Adelphi Road College Park MD 20740-6001

Rebecca Sullivan 23

OPERATOR

CAMERA

August 15, 1997 10

DATE FILMED

REDUCTION RATIO

23510107

FILM EMULSION NUMBER

M-1817 39

PROJECT NUMBER

ROLL NUMBER

MICROCOPY

1 8 1 7

ROLL

3 9

M1817

COMPILED MILITARY SERVICE RECORDS OF
VOLUNTEER UNION SOLDIERS WHO SERVED WITH THE
UNITED STATES COLORED TROOPS:
1st Through 5th United States Colored Cavalry
5th Massachusetts Cavalry (Colored)
6th United States Colored Cavalry

Introduction by Michael E. Pilgrim

Records prepared for microfilming by members of
the Civil War Conservation Corps

Budge Weidman, Project Director

Pat Alfredson	Naomi Glass	Dave Murray
Phyllis Altrogge	Sue Goward*	Ray Puzio
Kenneth Ashton	Bert Greenstein	Bill Schneider
Sue Barnard*	Anne Greenwood	Sylvia Scott
Dee Benson	Jim Harris	Lynn Shearouse
Ann N. Brown	Walter Hayden	Mary Stack-Dunne
Robert Budway	Mary Hayden	Ben Stearns
MaryAnn Castellana*	Pat Ikonen	Bill Stormer*
Mary Lou Cole	Dick Ives	Pat Sullivan
Marjory Cooper	Sarah Jaffe	Gorman Tidball*
Giovanni Croce	Barbara Kemp	Cathy Tinston
B. H. Custer	Bev Manypenny	John Toole
Bob Denney	Frank Masterson	Maryellen Toole
Richard Dow	Joe Mazur	Milt Weatherhead
Yvette Fallin	Sarah McDougall	C. Lois Young
	Ben Miles	

Team leaders are indicated by the asterisk.

National Archives and Records Administration
1997

INTRODUCTION

On the 107 rolls of this microfilm publication, M1817, are reproduced the compiled military service records of volunteer Union soldiers belonging to the 1st through 5th United States Colored Cavalry, the 5th Massachusetts Cavalry (Colored), and the 6th United States Colored Cavalry. While the 5th Massachusetts did retain its state designation, these units were all part of the United States Colored Troops (USCT). The USCT included 7 numbered cavalry regiments; 14 numbered artillery regiments; 144 numbered infantry regiments; plus Brigade Bands Nos. 1 & 2 (Corps d'Afrique and US Colored Troops); Powell's Regiment Colored Infantry; Southard's Company Colored Infantry; Quartermaster Detachment; Pioneer Corps, 1st Division, 16th Army Corps; Unassigned Company A Colored Infantry and Unassigned USCT. The records reproduced are part of the Records of the Adjutant General's Office, 1780's-1917, Record Group (RG) 94.

Background

United States Colored Troops

Since the time of the American Revolution, African Americans have volunteered to serve their country in time of war. The Civil War was no exception. Official sanction was the difficulty. In the fall of 1862 there were four Union regiments of African Americans raised in New Orleans, LA: the 1st, 2d, and 3d Louisiana Native Guard, and the 1st Louisiana Heavy Artillery (African Descent). The 1st South Carolina Infantry (African Descent) was not officially organized until January 1863; however, three companies of the regiment were on coastal expeditions as early as November 1862. Similarly, the 1st Kansas Colored Infantry was not mustered into Federal service until January 1863, even though the regiment had already participated in the action at Island Mound, MO, on October 27, 1862. These early unofficial regiments received little Federal support, but they showed the strength of the African American soldier's desire to fight for freedom.

The first official authorization to employ African Americans in Federal service was the Second Confiscation and Militia Act of July 17, 1862. This act allowed President Abraham Lincoln to receive into the military or naval service persons of African descent and gave him permission to use them for any purpose "he may judge best for the public welfare." However, the President did not authorize use of African Americans until issuance of the Emancipation Proclamation on January 1, 1863.

In late January 1863, Gov. John Andrew of Massachusetts received permission to raise a regiment of African American soldiers. The pace of organizing additional regiments was very slow. In March Secretary of War Edwin M. Stanton sent Gen. Lorenzo Thomas to the lower Mississippi Valley to recruit

free and contraband African Americans. Thomas was given broad authority. He was to explain the administration's policy regarding African American soldiers and recruit volunteers to raise and command them. Stanton wanted all officers of such units to be white, but that policy was softened to allow African American surgeons and chaplains. By the end of the war, in addition to the chaplains and surgeons, there were some 87 African-American officers. Thomas's endeavor was very successful, and on May 22, 1863, the Bureau of Colored Troops was established to coordinate and organize regiments from all parts of the country. Created under War Department General Order No. 143, the bureau was responsible for handling "all matters relating to the organization of Colored Troops." The bureau was directly under the Adjutant General's Office and its procedures and rules were specific and strict. All African American regiments were now to be designated United States Colored Troops (USCT). At this time there were some African American regiments with state names and a few regiments in the Department of the Gulf designated as Corps d'Afrique. All these were ultimately assimilated into the USCT, even though some of the regiments, such as the 5th Massachusetts, retained their state designations.

To facilitate recruiting in the states of Maryland, Missouri, Tennessee, and eventually Kentucky, the War Department issued General Order No. 329 on October 3, 1863. Section 6 of the order stated that if any citizen should offer his or her slave for enlistment into the military service, that person would, "if such slave be accepted, receive from the recruiting officer a certificate thereof, and become entitled to compensation for the service or labor of said slave, not exceeding the sum of three hundred dollars, upon filing a valid deed of manumission and of release, and making satisfactory proof of title." For this reason, some records of manumission are contained in the compiled service records reproduced in this publication.

The USCT fought in 39 major engagements and over 400 lesser ones. Sixteen African American soldiers received Medals of Honor. As it was in other units, the death toll from disease was very high in the USCT. Deaths from disease and battle totaled 37,000. The last regiment of the USCT was mustered out of Federal service in December 1867.

Important sources for information about African American units in the Civil War are the War Department's *The War of the Rebellion: A Compilation of the Official Records of the Union and Confederate Armies* (Washington, DC: 1880-1901; reprinted Harrisburg, 1971 and 1985) and the Navy Department's *The War of the Rebellion; A Compilation of the Official Records of the Union and Confederate Navies* (Washington, DC: 1874-1922; reprinted Harrisburg, 1971 and 1985). These multivolume works contains reports of operations and other official correspondence.

1st United States Colored Cavalry

This regiment was organized at Camp Hamilton, VA, on December 22, 1863, and assigned to duty in the Department of Virginia and North Carolina. The 1st participated in Gen. Benjamin F. Butler's operations on the south side of the James River and against Petersburg and Richmond, May 4-28, 1864. These included the capture of Bermuda Hundred and City Point, VA, on May 5, and events leading up to and including the siege of Petersburg. In August 1864 it was transferred to the defenses of Portsmouth, District of Eastern Virginia. On June 10, 1865, the 1st sailed from City Point, VA, to Texas where it was assigned duty on the Rio Grande and various other areas of the state. The unit was mustered out on February 4, 1866. Compiled casualty figures are not available.

2d United States Colored Cavalry

This regiment was organized at Fort Monroe, VA, on December 22, 1863, and assigned to duty in the Department of Virginia and North Carolina. The 2d participated in Gen. Benjamin F. Butler's operations on the south side of the James River and against Petersburg and Richmond, May 4-28, 1864. These included the capture of Bermuda Hundred and City Point, VA, on May 5, and events leading up to and including the siege of Petersburg. In February 1865 it was transferred to Norfolk, District of Eastern Virginia. On June 10, 1865, the 2d sailed from City Point, VA, to Texas where it was assigned duty on the Rio Grande and various other areas of the state. The unit was mustered out on February 12, 1866. Losses included 19 killed in action and 161 dead from disease and other causes.

3d United States Colored Cavalry

Organized at Vicksburg, MS, on October 9, 1863, as the 1st Mississippi Cavalry (African Descent), this regiment was redesignated the 3d U.S. Colored Cavalry on March 11, 1864. From its organization until March 1864, the unit was attached to the District of Northeast Louisiana and from January to March 1864 participated in operations up the Yazoo River and the occupation of Yazoo City. The regiment was then transferred to the District of Vicksburg, Department of Tennessee, where it remained until December 1864. That month the unit moved to Memphis, TN, and from December 21, 1864, to January 5, 1865, participated in Gen. Benjamin Grierson's raid to destroy the Mobile & Ohio Railroad. The 3d remained on duty in Memphis and the District of West Tennessee and took part in the expedition from Memphis to Brownsville, MS, April 23-26, 1865. On April 29 the regiment returned to Vicksburg and operated around Natchez in search of fugitive Confederate President Jefferson Davis. The unit remained in the District of West Tennessee and Department of Mississippi until January 26, 1866, when it was mustered out. Losses included 37 killed in action and 367 dead from disease and other causes.

4th United States Colored Cavalry

Organized on September 12, 1863, as the 1st Corps d'Afrique Cavalry, this regiment was redesignated the 4th United States Colored Cavalry on April 4, 1864. From its organization until August 1864, it was attached to the Defenses of New Orleans, Department of the Gulf. On August 8, 1864, the 4th was ordered to Baton Rouge, LA, District of Port Hudson, and remained on duty at that post until July 1865 when it was transferred to the Department of Mississippi. It performed duties at various points in that department until it was mustered out on March 20, 1866. Compiled casualty figures are not available.

5th United States Colored Cavalry

This regiment was organized at Camp Nelson, KY, on October 24, 1864, and attached to the 1st Division, District of Kentucky, Department of Ohio. December 10-29, 1864, it participated in Stoneman's Raid into southwestern Virginia, including the capture of Saltville and the destruction of saltworks on December 20-21. In February 1865 the regiment was transferred to the Military District and Department of Kentucky until December of that year when it was ordered to the Department of Arkansas. During the latter period the unit performed mostly garrison duty. The regiment was mustered out March 20, 1866. Losses included 35 killed in action and 152 dead from disease and other causes.

5th Massachusetts Cavalry (Colored)

This regiment was organized at Camp Meigs, Reedville, MA, in the spring of 1864, and sent to Washington, DC, in May of that year. On May 13 the regiment moved to City Point, VA, where it was attached to the 18th Army Corps. Until June 16 it functioned as an infantry unit and participated in the siege of Petersburg. On June 30 it was moved to Point Lookout, MD, to guard prisoners of war. In July 1864 the regiment, still at Point Lookout, became part of the 22d Army Corps. It was transferred to the 25th Army Corps in March 1865 and ordered to the field near Richmond and Petersburg. In June the regiment was ordered to the Department of Texas where it was assigned duty at Clarksville until October 31, 1865, when it was mustered out. Losses included 7 men killed in action and 116 dead from disease and other causes.

6th United States Colored Cavalry

This regiment was organized at Camp Nelson, KY, on October 24, 1864, and attached to the 1st Division, District of Kentucky, Department of Ohio. December 10-29, 1864, it participated in Stoneman's Raid, including the destruction of the lead mines in southwestern Virginia. At the end of December the regiment returned to Camp Nelson and in February 1865 was transferred to the Military District and Department of Kentucky. It remained there until December

1865 when it was ordered to the Department of Arkansas. The unit was mustered out on April 15, 1866. Compiled casualty figures are not available.

Records Description

Compiled service records consist of a jacket-envelope for each soldier, labeled with his name, rank, unit, and card numbers. The compilation of service records of Union soldiers began in 1890 under the direction of Col. Fred C. Ainsworth, head of the Record and Pension Office of the Adjutant General's Office, Department of War. Information from muster rolls, regimental returns, descriptive books, and other records was copied verbatim onto cards. A separate card was prepared each time an individual name appeared on a document. These cards were numbered on the back, and these numbers were entered onto the outside jacket containing the cards. The carded information was verified by a separated operation of comparison; great care was taken to ensure that the cards were accurate.

A typical jacket contains card abstracts of entries found in original records relating to the soldier and original documents relating solely to that soldier. Examples of the latter include enlistment papers, substitute certificates, casualty sheets, death reports, prisoner-of-war memorandums, and correspondence. Unique to the records of the USCT are deeds of manumission, oaths of allegiance, proof of ownership, certificates of monetary award, and bills of sale. These items appear most frequently in units recruited in the border states of Kentucky, Missouri, and Maryland. These states remained in the Union but were slave states. Jackets and cards include a section labeled "bookmark" which was reserved for cross-references to other records relating to the individual or his unit. The service records are arranged by arm of service, thereunder numerically by regiment or independent battalion or company and thereunder alphabetically by name of the soldier. Records for officers are interfiled alphabetically by name with the records of enlisted men. If an individual served in more than one unit, which was typical for USCT officers, there will be a separate service record for each unit in which he served.

Related Records

Among the records of the Adjutant General's Office in the National Archives are many of the original records that were abstracted or "carded" by the Record and Pension Office. These include the individual unit's muster rolls, returns and descriptive books. Other series in RG 94 that contain information relating to volunteer Union soldiers who served with the USCT include carded records relating to Union staff officers, carded medical records of volunteer Union soldiers, unbound and bound regimental records and "record of events" cards. The regimental records of the 54th Massachusetts Infantry (Colored) have been

NATIONAL ARCHIVES MICROFILM PUBLICATIONS

reproduced as Microfilm Publication M1659, *Records of the Fifty-fourth Massachusetts Infantry Regiment (Colored), 1863-1865*.

The "record of events" cards include information copied from the unit's muster rolls and returns. They show the stations of the field and staff and those of the various companies of the regiment at the time the muster roll or return was prepared and sometimes mention battles, skirmishes, or other activities in which the regiment participated. The cards have been reproduced as Microfilm Publication M594 *Compiled Records Showing Service of Military Units in Volunteer Union Organizations*.

Record Group 94 also includes a card index for the USCT, reproduced as Microfilm Publication M589, *Index to Compiled Military Service Records of Volunteer Union Soldiers Who Served with U.S. Colored Troops*, which may be used to locate the regiment of USCT personnel. An index card gives the name of the soldier and his rank, as well as the unit in which he served; sometimes there is a cross-reference to his service in other units or organizations. The National Archives is continually producing microfilm publications of volunteer Union compiled military service records. A complete listing of finished publications can be found in the National Archives' *Microfilm Resources for Research: A Comprehensive Catalog* which is available online at <http://www.nara.gov>.

The Records of the Colored Troops Division, within RG 94, include division correspondence and records relating to recruiting, the appointment of officers, and the slave or free status of individuals; and a compilation of historical extracts and official papers concerning the military service of African Americans from the colonial period through the Civil War entitled *The Negro in the Military Service of the United States 1639-1886*. This compilation is reproduced as Microfilm Publication M858. The Records of the Bounty and Claims Division, also in RG 94, include correspondence of the division and records relating to bounties and claims paid to loyal owners of slaves by the Slave Claims Commissions of Delaware, Kentucky, Maryland, Missouri, Tennessee and West Virginia.

If an application for a pension was made, the pension application case file may be among the Records of the Veterans Administration (RG 15). Indexes to the pension applications have been reproduced as Microfilm Publication T288, *General Index to Pension Files, 1861-1934*, and T289, *Organizational Index to Pension Files of Veterans Who Served Between 1861 and 1900*.

If a soldier or officer was tried before a general court-martial or if an individual or his unit was the subject of a court of inquiry or military commission, transcripts of the proceedings may be among the Records of the Office of the Judge Advocate General (Army) (RG 153). The registers to the proceedings have been reproduced as Microfilm Publication M1105, *Registers of the Records of the Proceedings of the U.S. Army General Courts-Martial, 1809-1890*.

NATIONAL ARCHIVES MICROFILM PUBLICATIONS

Other record groups having information pertaining to the USCT include Records of the Bureau of Refugees, Freedmen, and Abandoned Lands (RG 105); Records of the Provost Marshal General's Bureau (Civil War) (RG 110); Records of the Accounting Officers of the Department of the Treasury (RG 217); and Records of U.S. Army Continental Commands, 1821-1920 (RG 393).

ROLL LIST

Roll Description

1st United States Colored Cavalry

- 1 Akess, Alexander - Bom, John H.
- 2 Bomer, James - Cartwright, John
- 3 Casey, Thomas - Davenport, John J.
- 4 Davis, Augustus - Floyd, George
- 5 Fly, Benjamin - Griffin, Oliver
- 6 Griffin, Quinton - Holstead, Peter
- 7 Holt, George - Jones, Herbert
- 8 Jones, Howell - Macoy, Peter
- 9 Madry, Andrew - Mosley, Jacob
- 10 Moss, James - Polk, James
- 11 Pollard, Sipio - Sales, William
- 12 Sample, Abram (Abraham) - Smith, Ives
- 13 Smith, James - Times, Nelson
- 14 Tines, Archer - Wheldon, Charles M.
- 15 Whitby, Joseph - Wilson, Isaac
- 16 Wilson, James - Zoe (no first name)

2d United States Colored Cavalry

- 17 Abbot, John - Bell, Charles
- 18 Bell, Henry - Burns, Richard
- 19 Burroughs, George L. - Cotton, Samuel
- 20 Coues, Alexander - Duncan, Levi
- 21 Dunkins, Ezikiah James - Gardner, Richard
- 22 Garris, Henry - Harrison, Thomas
- 23 Harrison, William - Humphries, David
- 24 Hunter, Francis - Jones, Robert
- 25 Jones, Robert F. - Martin, Robert (Martin)
- 26 Martin, Thaddeus or Martin, Thaddeus W. - Osborne, Henry S.
- 27 Oulden, Jacob - Prior, Edward or Edmund
- 28 Proctor, David - Sawyer, Wilson
- 29 Scabber, Charles - Stanley, William
- 30 Stanley, Wright or Right - Upshear, Neverson
- 31 Upshear, Samuel - Whites, Joe
- 32 Whites, Silas - Zodrick, Isaiah A. or Isaiah

3d United States Colored Cavalry

- 33 Aaron, John - Black, David
- 34 Black, Richard - Cameron, Wyatt

NATIONAL ARCHIVES MICROFILM PUBLICATIONS

<u>Roll</u>	<u>Description</u>
35	Cammel, Austin - Cooper, Stephen
36	Coran, Joseph - Erving, Tilson
37	Erwin, Anderson - Gool, George
38	Gordon, Alfred - Haskins, Jasper
39	Hawkins, Frank - Jackson, Harvey
40	Jackson, Henry - Kembro, Abraham
41	Kenedy, Lemuel - Lott, Judge
42	Lott, Matton - Mitchell, Berry
43	Mitchell, George - Pettis, Edmond
44	Pettis, George - Roberson, Jefferson
45	Roberson, Wallace - Simpson, Levi
46	Sims, Anderson - Taylor, Phillip
47	Taylor, Richard - Washington, Isaac
48	Washington, Oscar - Williams, Mitchel
49	Williams, Moses - Young, Mathew

4th United States Colored Cavalry

50	Abraham, Randall - Blanchan, William
51	Blanchard, Moses - Clark, Moses
52	Clark, Theodore - Ellars, James
53	Ellars, John - Heath, Culbert
54	Henderson, George - Johnson, Henderson
55	Johnson, Henry - Mayberry, Nelson
56	Macomory, John - Oliver, Celestine
57	Olsten, Alexander - Robinson, William
58	Robinson, William E. - Thomas, Stephen
59	Thomas, William - Williams, Horace
60	Williams, Isaac - Zulia, Francois

5th United States Colored Cavalry

61	Abel, Fletcher - Biggs, Randall
62	Birch, Benjamin - Burly, Frank
63	Burly, James - Coffman, James D.
64	Coke, Samuel - Dudley, John
65	Duke, John - Givens, Peter
66	Glen, John - Harriden, Edmund
67	Harrigan, Harden - Hughes, Thomas
68	Hulse, James - Keller, Ephraim
69	Kelley, Franklin - Matthews, Benjamin
70	Maupin, Preston - Murry, Ned
71	Murtney, Morton - Ray, John
72	Ray, Thomas - Sherrod, Willliam

NATIONAL ARCHIVES MICROFILM PUBLICATIONS

<u>Roll</u>	<u>Description</u>
73	Shrewsbury, Joseph - Stone, John
74	Stone, Lewis - Trye, Benjamin
75	Trueheart, Samuel - Williams, James
76	Williams, Jerry - Yowell, Joseph

5th Massachusetts Cavalry (Colored)

77	Abbey, David - Biers, William
78	Billings, Jeremiah - Burgess, Williams
79	Burnett, Lewis - Cook, Joseph T.
80	Cooper, Isaac - Dunmore, William
81	Durbin, Stephen - Furman, Seneca A.
82	Gadson, James - Gurley, Joseph L.
83	Guy, James - Hill, John W.
84	Hill, Richard - Johns, Thomas H.
85	Johnson, Aaron - Lambert, William
86	Lancaster, James - Mason, John
87	Mason, John H. - Nelson, Philip
88	Nelson, Preston - Preston, Thomas
89	Price, Adam - Sampson, George P.
90	Sanborn, Madison - Stringer, William
91	Strother, Frank - Vance, William H.
92	Van Hoesen, Charles - Wilkinson, Simon
93	Williams, Abram H. - Young, Thomas

6th United States Colored Cavalry

94	Abbot, John - Birch, James
95	Bivins, Gabriel - Buckner, George
96	Buckner, Henderson - Compton, James
97	Cook, Benjamin - Ellis, William
98	Ellis, Wyatt - Godley, Isaac
99	Gooch, Alexander - Herston, Abraham
100	Heywood, John R. - Johnson, Jackson
101	Johnson, James M. - Marshall, Lyman
102	Marshall, William - Neihardt, Isaac D.
103	Nelson, Joseph - Redd, Tiney
104	Redway, Hamilton K. - Sebree, Bob Woodcock
105	Sebree, Crittenden - Sumpter, John
106	Sutherland, Williams - Washington, Charles
107	Washington, George - Wren (no first name)

NATIONAL ARCHIVES MICROFILM PUBLICATIONS

Microfilm Publication M1817

COMPILED MILITARY SERVICE RECORDS OF VOLUNTEER UNION
SOLDIERS WHO SERVED WITH THE UNITED STATES COLORED
TROOPS: 1st Through 5th United States Colored Cavalry, 5th Massachusetts
Cavalry (Colored), 6th United States Colored Cavalry

Roll 39

3d United States Colored Cavalry

Hawkins, Frank - Jackson, Harvey

NATIONAL ARCHIVES AND RECORDS ADMINISTRATION

619
Hawkins Frank

Co D, 3 U. S. Col'd Cav.

Private Private

CARD NUMBERS.

1	5342522	26
2	5342618	27
3	5342704	28
4	5342792	29
5	5342873	30
6	5342948	31
7	5343032	32
8	5343141	33
9	5343240	34
10	5343327	35
11	5343416	36
12	5343491	37
13	5343565	38
14	9089333	39
15	40727505	40
16		41
17		42
18		43
19		44
20		45
21		46
22		47
23		48
24		49
25		50

Book Mark: 11

See also

0.1213036 P. G. M. T. M.

A. M. Sherman
C.

W | **3 Cav. | U.S.C.T.**

Frank Hopkins
....., Co. *C*....., 3 Reg't U. S. Col'd Cav.

Appears on

Company Descriptive Book
of the organization named above.

DESCRIPTION.

Age *22* years; height *5* feet *4* inches.

Complexion *Blk*

Eyes *Blk*; hair *Blk*

Where born *Haines Trip*

Occupation *Field Hand*

ENLISTMENT.

When *Feb 24*, 186*4*.

Where *Haines Bluff*

By whom *Capt Brainard*; term *3* y'rs.

Remarks:

.....
.....
.....
.....
.....
.....

Hinton

A | **3 Cav.** | **U.S.C.T.**

Frank Hawkins

Pvt., Co. *D*, 1 Reg't Miss. Cav., Corps d'Afrique.*

Age 22 yrs
Appears on

Company Muster-in Roll

of the organization named above. Roll dated

Haines Bluffs Miss Feb 26, 1864.

Muster-in to date *Feb 24*, 1864.

Joined for duty and enrolled:

When *Feb 24*, 1864.

Where *Haines Bluffs Miss.*

Period *3* years.

Valuation of horse, \$ 100

Valuation of horse equipments, \$ 100

Remarks: _____

*This organization subsequently became Co *D*, 3 Reg't U. S. Colored Cavalry.

Book mark: _____

Bradshaw

A | **3 Cav.** | **U.S.C.T.**

Frank Hawkins

Pvt, Co. I, 3 Reg't U. S. Col'd Cavalry.

Appears on

Company Muster Roll

for *Feb 24 to Apr 30*, 186*4*

Present or absent *present*

Stoppage, \$.....*100* for

Due Gov't, \$.....*100* for

Valuation of horse, \$.....*100*

Valuation of horse equipments, \$.....*100*

Remarks:

Book mark:

Bradshaw

A | **3 Cav. | U.S.C.T.**

Frank Hawkins

Pvt, Co. I, 3 Reg't U. S. Col'd Cavalry.

Appears on

Company Muster Roll

for *May & June*, 1864.

Present or absent *present*

Stoppage, \$ *100* for

Due Gov't, \$ *100* for

Valuation of horse, \$ *100*

Valuation of horse equipments, \$ *100*

Remarks: *Stop for me
pr. Spurs and
Straps \$0.60.*

Book mark:

Bradshaw

N | **3 Cav.** | **U.S.C.T.**

Frank Hawkins

Priv, Co. I, 3 Reg't U. S. Col'd Cavalry.

Appears on

Company Muster Roll

for *July 4 Aug*, 186*4*.

Present or absent *present*

Stoppage, \$ *100* for

Due Gov't, \$ *100* for

Valuation of horse, \$ *100*

Valuation of horse equipments, \$ *100*

Remarks: *Stop for me
for Spurs & Straps, me
Halter \$2.00.*

Book mark:

Bradshaw

A | **3 Cav.** | **U.S.C.T.**

Frank Hawkins

Prof, Co. I, 3 Reg't U. S. Col'd Cavalry.

Appears on

Company Muster Roll

for *Sept & Oct*, 186*1*

Present or absent *present*

Stoppage, \$ *100* for

Due Gov't, \$ *100* for

Valuation of horse, \$ *100*

Valuation of horse equipments, \$ *100*

Remarks: *Stop for one Horse Brush, one Cartridge Box & Belts, One Cap Box one Halter \$1.44; one Haversack 40 cts.*

Book mark:

Bradshaw

(358)

Copyist.

H | **3 Cav.** | **U.S.C.T.**

Frank Hawkins

Pvt., Co. I, 3 Reg't U. S. Col'd Cavalry.

Appears on

Company Muster Roll

for Nov. & Dec., 1864.

Present or absent Absent

Stoppage, \$ 100 for

Due Gov't, \$ 100 for

Valuation of horse, \$ 100

Valuation of horse equipments, \$ 100

Remarks: Absent on scout
since Dec 21/64

Book mark: _____

Lucas

H | **3 Cav.** | **U.S.C.T.**

Frank Hawkins

Plt-, Co. I, 3 Reg't U. S. Col'd Cavalry.

Appears on

Company Muster Roll

for June & July, 1865.

Present or absent Present

Stoppage, \$ 100 for

Due Gov't, \$ 100 for

Valuation of horse, \$ 100

Valuation of horse equipments, \$ 100

Remarks: Stop for one pr Spurs
and Straps etc

Book mark: Lucas

H | **3 Cav.** | **U.S.C.T.**

Frank Hawkins

Sgt, Co. I, 3 Reg't U. S. Col'd Cavalry.

Appears on

Company Muster Roll

for *March + April*, 186*7*.

Present or absent *Present*

Stoppage, \$ *100* for

Due Gov't, \$ *100* for

Valuation of horse, \$ *100*

Valuation of horse equipments, \$ *100*

Remarks: *Stop for one canteen
one haversack 1.00.*

Book mark:

Lucas

A | **3 Cav.** | **U.S.C.T.**

Frank Hawkins

Pvt, Co. I, 3 Reg't U. S. Col'd Cavalry.

Appears on

Company Muster Roll

for *May June*, 1865.

Present or absent *Present*

Stoppage, \$ *60* / *100* for *6 + 5. E.*

Transf'd. from last muster roll

Due Gov't, \$ *100* for

Valuation of horse, \$ *100*

Valuation of horse equipments, \$ *100*

Remarks:

Book mark:

(358)

J. Underwood

Copyist.

A | **3 Cav.** | **U.S.C.T.**

Frank Hawkins

Priv, Co. I, 3 Reg't U. S. Col'd Cavalry.

Appears on

Company Muster Roll

for July & Aug, 1865.

Present or absent Present

Stoppage, \$ 100 for

Due Gov't, \$ 100 for

Valuation of horse, \$ 100

Valuation of horse equipments, \$ 100

Remarks:

Book mark:

Snow

H | **3 Cav.** | **U.S.C.T.**

Frank Hawkins

Priv., Co. I, 3 Reg't U. S. Col'd Cavalry.

Appears on

Company Muster Roll

for Sept - Oct, 1865

Present or absent Present

Stoppage, \$ 100 for

Due Gov't, \$ 100 for

Valuation of horse, \$ 100

Valuation of horse equipments, \$ 100

Remarks:

Book mark:

(358)

Edmondson

Copyist.

H | **3 Cav. | U.S.C.T.**

Frank Hawkins

Priv., Co. I, 3 Reg't U. S. Col'd Cavalry.

Appears on

Company Muster Roll

for *Nov + Dec*, 1865.

Present or absent *Present*

Stoppage, \$ *100* for

Due Gov't, \$ *100* for

Valuation of horse, \$ *100*

Valuation of horse equipments, \$ *100*

Remarks:

Book mark:

Edmondson

H. | 3 Cav. | U.S.C.T.

Frank Hawkins
Pvt., Co. I, 3 Reg't U. S. Colored Cav.

Appears on Returns as follows:

Apr. 1864, Absent sick in Pest
Hosp.

Book mark :

(546)

J. B. Sittler

Copyist.

1177 10
H | 3 Cav. | U.S.C.T.

Frank Hawkins

Priv., Co. I, 3 Reg't U. S. Col'd Cavalry.

Appears on Co. Muster-out Roll, dated

Memphis Tenn Jan 26, 1866.

Muster-out to date Jan 26, 1866.

Last paid to June 30, 1865.

Clothing account:

Last settled _____, 186 ; drawn since \$ _____ 100

Due soldier \$ ⁶/₁₀₀ 100; due U. S. \$ _____ 100

Am't for cloth'g in kind or money adv'd \$ _____ 100

Due U. S. for arms, equipments, &c., \$ _____ 100

Bounty paid \$ _____ 100; due \$ _____ 100

Remarks: _____

Book mark: 7109 P 93. 70

(861)

[Signature]
Copyist.

⁶²⁰
Hawkins Henry

Co D, 3 U. S. Col'd Cav.

Private | Private

CARD NUMBERS.

1	5342523	26
2	5342619	27
3	5342705	28
4	5342793	29
5	5342874	30
6	5342949	31
7	5343033	32
8	5343140	33
9	5343239	34
10	5343326	35
11	5343415	36
12	5343492	37
13	5343566	38
14	9089334	39
15	40727506	40
16		41
17		42
18		43
19		44
20		45
21		46
22		47
23		48
24		49
25		50

Book Mark: V 122 P 470-71
86 886 R 89

See also

S. 1946183 Pownm
alg. 2274571

3 | **3 Cav. | U.S.C.T.**

Henry Hawkins
....., Co. *D*, 3 Reg't U. S. Col'd Cav.

Appears on
Company Descriptive Book
of the organization named above.

DESCRIPTION.

Age *17* years; height *5* feet *4* inches.

Complexion *Blk*

Eyes *Blk*; hair *Blk*

Where born *Holmes Miss*

Occupation *field hand*

ENLISTMENT.

When *Feb 24*, 1864.

Where *Haines Bluff*

By whom *Capt Brainard*; term *3* y'rs.

Remarks:
.....
.....
.....
.....
.....
.....
.....

Hillman

H | **3 Cav. | U.S.C.T.**

Henry Hawkins

Priv., Co. *J*, 1 Reg't Miss. Cav., Corps d'Afrique.*
Age 18 yrs
Appears on

Company Muster-in Roll

of the organization named above. Roll dated

Haines Bluffs Miss Feb 26, 1864.

Muster-in to date *Feb 24*, 1864.

Joined for duty and enrolled:

When *Feb 24*, 1864.

Where *Haines Bluffs Miss*

Period *3* years.

Valuation of horse, \$ 100

Valuation of horse equipments, \$ 100

Remarks: _____

*This organization subsequently became Co. *J*, 3 Reg't U. S. Colored Cavalry.

Book mark: *See 86886. R.V.P. Div. 89*
(over)

Bradshaw

(356)

Copyist.

JAN. - 8

5342523

"1891"

W.B. Dec 17/89.

H | **3 Cav.** | **U.S.C.T.**

Henry Hawkins
Pvt, Co. I, 3 Reg't U. S. Col'd Cavalry.

Appears on

Company Muster Roll

for *Feb 24 to Apr 30*, 186*4*.

Present or absent *present*

Stoppage, \$ *100* for

Due Gov't, \$ *100* for

Valuation of horse, \$ *100*

Valuation of horse equipments, \$ *100*

Remarks:

Book mark:

(358)

Bradshaw

Copyist.

A | **3 Cav. | U.S.C.T.**

Henry Hawkins
Pvt, Co. I, 3 Reg't U. S. Col'd Cavalry.

Appears on

Company Muster Roll

for *May & June*, 186*4*.

Present or absent *Present.*

Stoppage, \$ *100* for

Due Gov't, \$ *100* for

Valuation of horse, \$ *100*

Valuation of horse equipments, \$ *100*

Remarks:

Book mark:

Bradshaw

A. | **3 Cav.** | **U.S.C.T.**

Henry Hawkins
Priv, Co. I, 3 Reg't U. S. Col'd Cavalry.

Appears on

Company Muster Roll

for July & Aug, 1864

Present or absent present

Stoppage, \$ 100 for

Due Gov't, \$ 100 for

Valuation of horse, \$ 100

Valuation of horse equipments, \$ 100

Remarks: Stop for one
Carriage one Haversack
\$100

Book mark: _____

Bradshaw

A | **3 Cav.** | **U.S.C.T.**

Henry A. Jenkins
Priv., Co. I, 3 Reg't U. S. Col'd Cavalry.

Appears on

Company Muster Roll

for *Sept & Oct*, 186*1*.

Present or absent *present*.

Stoppage, \$ *100* for

Due Gov't, \$ *100* for

Valuation of horse, \$ *100*

Valuation of horse equipments, \$ *100*

Remarks: *Stop for one Garrison
Gamb and Brush one
Saw circle one Sabre
and Belts one Cart
rudge Box one Haver-
sack one Gun Pouch
Nulter one Horse
Wrench \$13.37.*

Book mark:

Bradshaw

A | **3 Cav.** | **U.S.C.T.**

Henry Hawkins
Sgt., Co. I, 3 Reg't U. S. Col'd Cavalry.

Appears on

Company Muster Roll

for Nov & Dec, 1864.

Present or absent Absent

Stoppage, \$ 100 for

Due Gov't, \$ 100 for

Valuation of horse, \$ 100

Valuation of horse equipments, \$ 100

Remarks: Absent on account
since Dec 21/64

Book mark:

Lucas

H | **3 Cav.** | **U.S.C.T.**

Henry Hawkins

Plt, Co. I, 3 Reg't U. S. Col'd Cavalry.

Appears on

Company Muster Roll

for Jan & Feb, 1865.

Present or absent Present

Stoppage, \$ 100 for

Due Gov't, \$ 100 for

Valuation of horse, \$ 100

Valuation of horse equipments, \$ 100

Remarks: Stop for one curry
comb. one horse brush
1.01

Book mark: _____

Lucas

H

3 Cav. U.S.C.T.

Henry Hawkins

Pvt., Co. I, 3 Reg't U. S. Col'd Cavalry.

Appears on

Company Muster Roll

for *Mch & Apl*, 1865

Present or absent *Present*

Stoppage, \$ *100* for

Due Gov't, \$ *100* for

Valuation of horse, \$ *100*

Valuation of horse equipments, \$ *100*

Remarks: *Stop for one canteen
one haversack 1.00*

Book mark:

Lucas

A | **3 Cav.** | **U.S.C.T.**

Henry Harknis
Prvt, Co. I, 3 Reg't U. S. Col'd Cavalry.

Appears on

Company Muster Roll

for May & June, 1865.

Present or absent Present

Stoppage, \$ 1/100 for 6 + G. E.

Transfr from last muster roll

Due Gov't, \$ 100 for _____

Valuation of horse, \$ _____ 100

Valuation of horse equipments, \$ _____ 100

Remarks: _____

Book mark: _____

(358)

J. H. Anderson
Copyist.

H | **3 Cav. U.S.C.T.**

Henry Hawkins

Plt, Co. I, 3 Reg't U. S. Col'd Cavalry.

Appears on

Company Muster Roll

for July & Aug, 1865:

Present or absent Present

Stoppage, \$ 100 for

Due Gov't, \$ 100 for

Valuation of horse, \$ 100

Valuation of horse equipments, \$ 100

Remarks:

Book mark: _____

Lucas

JK | **3 Cav.** | **U.S.C.T.**

Henry Hawkins

Private, Co. I, 3 Reg't U. S. Col'd Cavalry.

Appears on

Company Muster Roll

for Sept & Oct, 1865.

Present or absent Present

Stoppage, \$ 100 for

Due Gov't, \$ 100 for

Valuation of horse, \$ 100

Valuation of horse equipments, \$ 100

Remarks:

Book mark:

Commander

JK | **3 Cav.** | **U.S.C.T.**

Hewitt Perkins
Priv., Co. I, 3 Reg't U. S. Col'd Cavalry.

Appears on

Company Muster Roll

for Nov & Dec, 1865.

Present or absent Present

Stoppage, \$ 100 for

Due Gov't, \$ 100 for

Valuation of horse, \$ 100

Valuation of horse equipments, \$ 100

Remarks: _____

Book mark: _____

(358) Perkins Copyist.

H. | 3 Cav. | U.S.C.T.

Henry Hawkins
Pvt., Co. I, 3 Reg't U. S. Colored Cav.

Appears on Returns as follows:

Apr. 1864, Absent sick in Pest
Hosp.

July 1864, On duty, Nurse in Regtl Hosp.
Aug. 1864, On duty, Batt. Hosp.
Nurse

Sept. 1864, Sept. 10 Goodrich's
Ldg. Returned to Co. by
order Maj. Chapin.

Book mark :

(546)

J. B. Dittler

Copyist.

A | 3 Cav. | U.S.C.T.

Henry Hawkins

Griss, Co. D, 3 Reg't U. S. Col'd Cavalry.

Appears on Co. Muster-out Roll, dated

Memphis Tenn Jan 26, 1866.

Muster-out to date June 26, 1866.

Last paid to June 30, 1865.

Clothing account:

Last settled 186 ; drawn since \$ 100

Due soldier \$ 100; due U. S. \$ 100

Am't for cloth'g in kind or money adv'd \$ 100

Due U. S. for arms, equipments, &c., \$ 100

Bounty paid \$ 100; due \$ 100

Remarks:

Book mark: 1922 P. H. 70. 71 (over)

Edwards

(361)

Copyist.

JAN. - 8

5343566

1891

86886 QTP Dec 89

621

Hawkins James

Co No, 3 U. S. Col'd Cav.

Private | Private

CARD NUMBERS.

1	5346010	26
2	5346105	27
3	5346189	28
4	5346278	29
5	5346377	30
6	5346455	31
7	5346557	32
8	5346660	33
9	5346755	34
10	5346853	35
11	5346938	36
12	5347019	37
13	5347098	38
14	9089760	39
15	9089885	40
16	140727508	41
17	31691536	42
18		43
19		44
20		45
21		46
22		47
23		48
24		49
25		50

Book Mark:

See also

A 1754630 P.O. 211721

J M Shammur
En

H | **3 Cav. | U.S.C.T.**

James Hawkins
....., Co *M*, 3 Reg't U. S. Col'd Cav.

Appears on

Company Descriptive Book
of the organization named above.

DESCRIPTION.

Age *22* years; height *5* feet *9* inches.

Complexion *Black*

Eyes *Black*; hair *Black*

Where born *St Louis, Mo.*

Occupation *Farmer*

ENLISTMENT.

When *Feb 24, 1864.*

Where *Mississippi*

By whom *East Highland*; term *3* y'rs.

Remarks:

.....
.....
.....
.....
.....
.....
.....
.....

A. B. Smith

9 | 3 Cav. | U.S.C.T.

James Hawkins
Co. M, 3 Reg't U. S. Col'd Cav.

Appears on

Company Descriptive Book

of the organization named above.

DESCRIPTION.

Age 22 years; height 5 feet 6 inches.

Complexion Black

Eyes Black; hair Black

Where born St Louis Mo.

Occupation Farmer

ENLISTMENT.

When Feb 24, 1864.

Where Mississippi

By whom Wm Hyland; term 3 y'rs.

Remarks:

.....
.....
.....
.....
.....
.....

F. B. Smith

26

3 Cav. U.S.C.T.

James Hawkins
Priv, Co. M, 3 Reg't U. S. Col'd Cavalry.

Appears on

Company Muster-in and Descriptive Roll

of the organization named above. Roll dated

Waines Bluffs Miss, Uch 1, 1864.

Where born St Louis Missouri

Age 22 y'rs; occupation Farmer

When enlisted July 24, 1864

Where enlisted Mississippi

For what period enlisted 3 years.

Eyes Black; hair Black

Complexion Black; height 5 ft. 6 in.

When mustered in _____, 186 .

Where mustered in _____

Bounty paid \$ 100; due \$ 100

Where credited _____

Company to which assigned _____

Remarks : _____

Book mark : _____

(356d)

P. S. Richardson

Copyist.

76 | 3 Cav. | U.S.C.T.

James Howkins
Pri, Co. M, 3 Reg't U. S. Col'd Cavalry.

Appears on

Company Muster Roll

for Apr 30 to Aug 31, 1864

Present or absent Present

Stoppage, \$ 100 for

Due Gov't, \$ 100 for

Valuation of horse, \$ 100

Valuation of horse equipments, \$ 100

Remarks :

Book mark :

R. Richardson

(358)

Copyist.

710 | 3 Cav. | U.S.C.T.

James Hawkins
Pon, Co. M, 3 Reg't U. S. Col'd Cavalry.

Appears on

Company Muster Roll

for *March + April*, 1864.

Present or absent *Present*

Stoppage, \$ *100* for

Due Gov't, \$ *100* for

Valuation of horse, \$ *100*

Valuation of horse equipments, \$ *100*

Remarks:

*On march 16 64 at
Haynes Bluff Miss*

Book mark:

R. Richardson

No | **3 Cav.** | **U.S.C.T.**

James Hawkins
.....
Priv, Co. M, 3 Reg't U. S. Col'd Cavalry.

Appears on

Company Muster Roll

for *May & June*, 1864.

Present or absent *Present*

Stoppage, \$.....100 for.....

Due Gov't, \$.....¹/100 for.....

Valuation of horse, \$.....100

Valuation of horse equipments, \$.....100

Remarks :.....
.....
.....
.....
.....
.....
.....
.....
.....
.....
.....

Book mark :.....

R. Richardson

(358)

Copyist.

No | **3 Cav.** | **U.S.C.T.**

James Hawkins
Prin, Co. M, 3 Reg't U. S. Col'd Cavalry.

Appears on

Company Muster Roll

for *Sept + Oct*, 186 *4*.

Present or absent *Present*

Stoppage, \$ *100* for

Due Gov't, \$ *100* for

Valuation of horse, \$ *100*

Valuation of horse equipments, \$ *100*

Remarks :

Book mark :

(358)

R. Richardson
Copyist.

36 | 3 Cav. | U.S.C.T.

James Hawkins
Sgt., Co. M, 3 Reg't U. S. Col'd Cavalry.
Appears on

Company Muster Roll

for Nov + Dec, 1864.

Present or absent present

Stoppage, \$ 3.72 for one Jim Swivel
+ sling / Horse Brush Sursingle

Due Gov't, \$ 1.00 for

Valuation of horse, \$ 1.00

Valuation of horse equipments, \$ 1.00

Remarks:

Book mark:

Wm L Allen

W. | **3 Cav.** | **U.S.C.T.**

James H. Lawrence
1st Lt., Co. M, 3 Reg't U. S. Col'd Cavalry.

Appears on

Company Muster Roll

for *Jan & Feb*, 186*5*.

Present or absent *present*

Stoppage, \$ *100* for

Due Gov't, \$ *100* for

Valuation of horse, \$ *100*

Valuation of horse equipments, \$ *100*

Remarks: *in Genl Hospital*

Book mark:

Wm L Allen

H I 3 Cav USCT

James Hawkins
Pvt, Co. M, 3 Reg't USCT Cav

Appears on

Hospital Muster Roll

of Webster U. S. A. General Hospital,

at Memphis, Tenn.,

for Jan & Feb, 1865.

Attached to hospital:

When Feb 23, 1865.

How employed Sick

Last paid by Maj. _____

to _____, 1865.

Bounty paid \$ 100; due \$ 100

Present or absent Present

Remarks: _____

Book mark: _____

(848) J Underwood Copyist.

R. | **3 Cav. | U.S.C.T.**

James Hamilton
Sgt, Co. M, 3 Reg't U. S. Col'd Cavalry.

Appears on

Company Muster Roll
for *Mar & Apr*, 1867.

Present or absent *present*

Stoppage, \$ *100* for

Due Gov't, \$ *100* for

Valuation of horse, \$ *100*

Valuation of horse equipments, \$ *100*

Remarks :

Book mark :

Am. Allen
Copyist.

H. | **3 Cav.** | **U.S.C.T.**

James Hawkins
Sgt., Co. M, 3 Reg't U. S. Col'd Cavalry.

Appears on

Company Muster Roll

for May + June, 1865.

Present or absent present

Stoppage, \$ 40 for ordnance

lost + destroyed

Due Gov't, \$ 100 for

Valuation of horse, \$ 100

Valuation of horse equipments, \$ 100

Remarks:

Book mark:

Wm. Allen

H. | **3 Cav. | U.S.C.T.**

James Hawkins
....., Co. M, 3 Reg't U. S. Col'd Cavalry.

Appears on

Company Muster Roll

for *July & Aug*, 1865.

Present or absent *Present*

Stoppage, \$ *70* / *100* for *insurance*

lost & destroyed

Due Gov't, \$ *100* for

Valuation of horse, \$ *100*

Valuation of horse equipments, \$ *100*

Remarks:

Book mark:

Am. Allen

4 | **3 Cav. | U.S.C.T.**

James Hawkins
Prvt., Co. M, 3 Reg't U. S. Col'd Cavalry.

Appears on

Company Muster Roll

for *Sept. & Oct.*, 1865.

Present or absent *Present*

Stoppage, \$ *100* for

Due Gov't, \$ *100* for

Valuation of horse, \$ *100*

Valuation of horse equipments, \$ *100*

Remarks :
.....
.....
.....
.....
.....
.....
.....
.....
.....
.....

Book mark :
.....

Terrill
Copyist.

A | **3 Cav. | U.S.C.T.**

James Hawkins
2nd, Co. M, 3 Reg't U. S. Col'd Cavalry.

Appears on

Company Muster Roll

for Nov. & Dec., 1865.

Present or absent Present

Stoppage, \$ 100 for

Due Gov't, \$ 100 for

Valuation of horse, \$ 100

Valuation of horse equipments, \$ 100

Remarks:

Book mark:

(358)

L. L. Loring

Copyist.

H. | **3 Cav.** | **U.S.C.T.**

James Hawkins
Pvt., Co. M, 3 Reg't U. S. Colored Cav.

Appears on **Returns** as follows:

Feb. 1865, Absent sick in Web-
ster G.H. Memphis, Tenn.
Feb. 23"

Book mark : _____

(548)

J. B. Dittler

Copyist.

3 Cav. U.S.C.T.

James Harrison
Co. M., 3 Reg't U. S. Col'd Cavalry.

Appears on Co. Muster-out Roll, dated
Memphis Tenn, Jan. 26, 1866.

Muster-out to date Jan. 26, 1866.

Last paid to June 30, 1867.

Clothing account:

Last settled _____, 186 ; drawn since \$ _____ 100

Due soldier \$ _____ 100; due U. S. \$ _____ 100

Am't for cloth'g in kind or money adv'd \$ _____ 100

Due U. S. for arms, equipments, &c., \$ _____ 5 ²⁴/₁₀₀

Bounty paid \$ _____ 100; due \$ _____ 100

Remarks: Mustered out under O.C.
16th Mil. Div. of Tenn.

Book mark:

_____ 100
_____ Copyist.

672

Haynes Andrew J.

Co. K, 3 U. S. Col'd Cav.

Captain

Captain

CARD NUMBERS.

1	5343658	26
2	5343745	27
3	5343836	28
4	5343915	29
5	5343991	30
6	5344078	31
7	5344165	32
8	5344271	33
9	5344372	34
10	5344463	35
11	5344545	36
12	5344622	37
13	5344696	38
14	9435906	39
15	40727507	40
16		41
17		42
18		43
19		44
20		45
21		46
22		47
23		48
24		49
25		50

Book Mark:

See also

4 Ill leary

N 13 bar | **U.S.C.T.**

Andrew J. Haynes
Capt, Co. 3 Reg't U. S. Col'd bar,

Appears on

Regimental Descriptive Book
(List of Commissioned Officers)

of the regiment named above.

Rank Captain

Date of appointment Oct 15 1863.

Remarks: Appointed from

F. B. Smith

H | **3 Cav.** | **U.S.C.T.**

Andrew J. Haynes
Capt, Co. K, 3 Reg't U. S. Col'd Cavalry.

Appears on

Company Muster Roll
for *July 24 to Sept 30*, 186 *4*

Present or absent *Present*

Stoppage, \$ *100* for

Due Gov't, \$ *100* for

Valuation of horse, \$ *100*

Valuation of horse equipments, \$ *100*

Remarks: *Appointed from*
Sergeant Co. C. 4th Regt Cavalry
Vol to Capt, Co. K, 3d
Regt Cavalry (Colored)

Mustered in Feb 24. 64
at Harris Bluff

Book mark:

Beach

H 3 Cav | **U.S.C.T.**

Andrew J Haynes
Capt, Co. M., 3 Reg't U. S. Col'd Cav

Appears on

Company Muster-in and Descriptive Roll
of the organization named above. Roll dated

Haines Bluff Miss, Mch 1, 1864.

Where born Kane Co Illinois

Age 25 y'rs; occupation Farmer

When enlisted Feb 24, 1864.

Where enlisted Haines Bluff Miss

For what period enlisted 3 years.

Eyes Blue; hair Brown

Complexion Dark; height 6 ft. — in.

When mustered in _____, 186 .

Where mustered in _____

Bounty paid \$ 100; due \$ 100

Where credited _____

Company to which assigned _____

Remarks: Appointed from 2^d Sargt Co C.

All Cav. to be capt 1st Miss Cav A. & Muster
to date from.

× Became Co K. 3 Regt USC Cav.

Book mark: _____

Beach

H

3 Cav. U.S.C.T.

Andrew J Hayes

Capt, Co. K, 3 Reg't U. S. Col'd Cavalry.

Appears on

Company Muster Roll

for May & June, 1864

Present or absent Present

Stoppage, \$ 100 for

Due Gov't, \$ 100 for

Valuation of horse, \$ 100

Valuation of horse equipments, \$ 100

Remarks:

Book mark:

Beach

H | **3 Cav.** | **U.S.C.T.**

Andrew J. Haynes
Capt, Co. K, 3 Reg't U. S. Col'd Cavalry.

Appears on

Company Muster Roll

for *July & Aug*, 186*4*

Present or absent *Present*

Stoppage, \$ *100* for

Due Gov't, \$ *100* for

Valuation of horse, \$ *100*

Valuation of horse equipments, \$ *100*

Remarks:

Book mark:

Boach

H | **3 Cav.** | **U.S.C.T.**

Andrew J. Haynes

Captain, Co. K, 3 Reg't U. S. Col'd Cavalry.

Appears on

Company Muster Roll

for *Sept & Oct* -----, 186 *4*.

Present or absent *Present* -----

Stoppage, \$ ----- *100* for -----

Due Gov't, \$ ----- *100* for -----

Valuation of horse, \$ ----- *100*

Valuation of horse equipments, \$ ----- *100*

Remarks: -----

Book mark: -----

Beach

A | **3 Cav. | U.S.C.T.**

Andrew J. Haynes
Capt., Co. K, 3 Reg't U. S. Col'd Cavalry.

Appears on

Company Muster Roll

for *Nov. & Dec.*, 1864.

Present or absent *Present*

Stoppage, \$ *100* for

Due Gov't, \$ *100* for

Valuation of horse, \$ *100*

Valuation of horse equipments, \$ *100*

Remarks:

Absent on Scout since
Dec. 21st 1864

Book mark:

Valentine

H | **3 Cav.** | **U.S.C.T.**

Andrew J. Haynes.
Capt., Co. K, 3 Reg't U. S. Col'd Cavalry.

Appears on

Company Muster Roll

for *Jan & Feb.*, 1865.

Present or absent *Present*

Stoppage, \$ *100* for

Due Gov't, \$ *100* for

Valuation of horse, \$ *100*

Valuation of horse equipments, \$ *100*

Remarks:

Book mark:

Valentine

(358)

Copyist.

A | **3 Cav.** | **U.S.C.T.**

Andrew J. Staynes
Capt., Co. *K*, 3 Reg't U. S. Col'd Cavalry.

Appears on

Company Muster Roll

for *March & April*, 1865.

Present or absent *Present*.

Stoppage, \$.....100 for

Due Gov't, \$.....100 for

Valuation of horse, \$.....100

Valuation of horse equipments, \$.....100

Remarks:

Book mark:

Valentine

(358)

Copyist.

H | **3 Cav.** | **U.S.C.T.**

A. J. Haynes.

Capt., Co. K, 3 Reg't U. S. Col'd Cavalry.

Appears on

Company Muster Roll

for *May & June*, 1865.

Present or absent *Present*

Stoppage, \$ *100* for

Due Gov't, \$ *100* for

Valuation of horse, \$ *100*

Valuation of horse equipments, \$ *100*

Remarks:

Book mark:

(358)

Valentine

Copyist.

A | **3 Cav.** | **U.S.C.T.**

Andrew J. Haynes
Capt., Co. K, 3 Reg't U. S. Col'd Cavalry.

Appears on

Company Muster Roll

for *July & Aug*, 1865.

Present or absent *Absent*

Stoppage, \$ *100* for

Due Gov't, \$ *100* for

Valuation of horse, \$ *100*

Valuation of horse equipments, \$ *100*

Remarks:

*Absent with leave
since Aug. 22^d 1865*

Book mark:

Talentine

H | **3 Cav. | U.S.C.T.**

Andrew J. Haynes
Capt., Co. K, 3 Reg't U. S. Col'd Cavalry.

Appears on

Company Muster Roll

for *Sept and Oct.*, 1865.

Present or absent *Present.*

Stoppage, \$ *100* for

Due Gov't, \$ *100* for

Valuation of horse, \$ *100*

Valuation of horse equipments, \$ *100*

Remarks: *Paid on Leave*
of absence by Maj.
M. G. G. to include
April 30, 1865

Book mark: *...*

(358)

Howard,
Copyist.

H | **3 Cav.** | **U.S.C.T.**

Andrew J. Hayes
Capt., Co. K, 3 Reg't U. S. Col'd Cavalry.

Appears on

Company Muster Roll

for *Nov and Dec.*, 1865.

Present or absent *Present.*

Stoppage, \$ *100* for

Due Gov't, \$ *100* for

Valuation of horse, \$ *100*

Valuation of horse equipments, \$ *100*

Remarks: *Paid on leave of ab-*
sence for March and April,
1865 inclusive by Maj.
W. Smith

Book mark:

Hayes

H. | 3 Cav. | U.S.C.T.

Andrew J. Haynes
Capt., Co. K, 3 Reg't U. S. Colored Cav.

Appears on Returns as follows:

Feb. 1864. (1 Miss Cav. A, 20.) Present
mustered on Feb. 24/64 by
Lt. Calian.

Mar. 1864 to July 1865, (3 U. S. C. C.)
Present,

Aug. 1865, Absent with leave
since Aug. 22, '65

Sept. 1865, Absent without
leave since Sept. 13/65

Oct. to Dec. 1865, Present for duty,

Book mark :

(546)

J. B. Dittler

Copyist.

H | **3 Cav. | U.S.C.T.**

Andrew J. Haynes
Capt., Co. *H*, 3 Reg't U. S. Col'd Cavalry.

Appears on **Co. Muster-out Roll**, dated
Memphis, Tenn., Jan. 26, 1866.

Muster-out to date *Jan. 26, 1866.*

Last paid to *Apr. 30, 1865.*

Clothing account:

Last settled _____, 186 ; drawn since \$ _____ 100

Due soldier \$ _____ 100; due U. S. \$ _____ 100

Am't for cloth'g in kind or money adv'd \$ _____ 100

Due U. S. for arms, equipments, &c., \$ _____ 100

Bounty paid \$ _____ 100; due \$ _____ 100

Remarks: *Enlisted in Co. "H"*

Ills. Cav. Sept. 1, '61 at

Cresgo, Kendall Co., Ills. App-

ointed Capt. 3 U.S. Col. Cav.

Feb. 26, '64.

Book mark: _____

Howard
Copyist.

Haynes A. J.
Capt. K., **3** Reg **U.S.C. Cav**

2 Enclosures.

Bed Cards	Descriptive Lists
Burial Records	Final Statements
Certs. of Dis. for Discharge	Furloughs
C. M. Charges	Med. Des. Lists
Med. Certificates <i>2</i>	Orders

Other papers relating to—

Admission to Hosp'l	Furlough <i>+ S.A.</i> <i>2</i>
Casualty Sheet (Officer's)	Med. Examination
Confinement	Misc. Information
Contracts	Pay or Clothing
Death or Effects	Personal Reports
Desertions	Rank
Discharge from Hosp'l	Transfer to Hosp'l
Discharge from Service	Transfer to V. R. C.
Duty	Transportation

MICROFILM PUBLICATION M.1819

COMPILED MILITARY SERVICE RECORDS
OF VOLUNTEER UNION SOLDIERS WHO
SERVED WITH THE USCT (US COLORED TROOPS)
3RD REGIMENT OF CAVALRY

PERSONAL PAPERS' TARGET SHEET

PLEASE NOTE THE CHECKED INFORMATION ABOUT THE PERSONAL PAPERS IN
THIS FILE:

- NO PERSONAL PAPERS WERE FOUND IN THIS FILE WHEN THE
RECORDS WERE ARRANGED FOR MICROFILMING.
- 5 PERSONAL PAPER(S) FOUND IN THIS FILE WHEN THE RECORDS
WERE ARRANGED FOR MICROFILMING.

H. A. 96. C. B. 2. W. T. 1865.

H^d Q^r 3^d Reg U.S. Cav
Memphis Tenn
July 24th 1865

205th Reg U.S. Cav
H^d Q^r

A. J.

Capt Co "K" 3^d U.S. Cav
Applies for a Leave of
Absence for Twenty Days

Head Q^r 3^d Reg U.S. Cav
Memphis Tenn July 25th 1865

50.30 dr

Respectfully forwarded
Approved

J. B. Cook

Head 3^d Reg U.S. Cav
Comd of the Regiment

H. A. 96
Head-Quarters 1st Cav Brigade
Dist West Tenn.
La Grange Tenn. July 27. 1865.

Respectfully forwarded.
Approved.

John E. Phelps
Col. 2^d Art. Cav Vol
Brig. Genl

HEAD-QUARTERS, DIST. WEST TENN.

MEMPHIS, TENN. July 28th 1865.

Respectfully forwarded. Approved.

A. L. Chittam

Brevet Major General,

Rec'd Hd. Q^r 3^d U.S. Cav July 28th 1865.

HEAD QRS CO "K" 3^d U.S. C. CAL
Memphis Tenn July 24th 1865

Brig Gen W. A. Morgan
A. A. Gen Dist West Tenn

General

I have the honor of applying herewith for a Leave of Absence for Twenty days for the purpose of visiting my home in Oswego Ills. I have been in the service of the United States since September 1861, during which time I have not had the benefit of a Leave of Absence. First Lieut C. M. Parks and Second Lieut J. H. Griswold are both serving in the company to which I belong and my services can readily be spared for the period desired.

I am General very Respectfully
your Obedt Servant

A. J. Hayes
Capt 3^d U.S. Cal Cal

Washed

10.53.19. L. a. P. 1865

and transmitted by
our committee of
C. L. Hill

One Encl
W. C. C. C.

Recd 290 Sept 21. 15

Morris Pennycuik Esq
Dec 12th 1865

Dear Major Genl Sherman
Dear Genl Wood

General

I have the honor to acknowledge
the receipt of your kind letter
of the 9th inst. in relation to
the 1st Regt of Col. Sherman's
Regt of Cavalry 1865

I am General of the
our old Regiment

Yours truly
R. H. Lee
Major Genl

State of Missouri
County of Grund
morris Apr 12th 1865

Concerning A. J. Hoarner, Cap
of Co K, 3rd W. S. Col Cavalry
Sick

I hereby certify that the officer above
described is on the sick list & is a patient
under medical treatment in my charge
just convalescing from an attack of
Pulmonary Intermittent fever, & that in
my opinion his condition is such that
he cannot on the true attempt to return his
regiment without risk to his life, & further
that a period of not less than ^{twenty} ~~ten~~ days
will expire before he can safely repair himself
~~to his~~ to his Regiment

I therefore recommend that he be
expensed for continued absence till the
2nd day of October 1865

A. J. Hoarner M.D.

Permanently
Grund Co. Ill

MS. A. 9. 2. 10

James B. Thomas
966



Washington, D.C. 15 05
I have been very much
pleased to hear from you
and hope you are well.
I am well at present and
hope these few lines will
find you the same.
I have not much news to
write at present.
I am, dear friend,
very truly yours,
James B. Thomas





State of Illinois
 County of Cook
 I, James B Thomas
 Clerk of the County Court in and for said
 County, hereby certify that one A. J. Bond
 whose name is subscribed to the within
 written instrument is a respectable
 practicing Physician in said County
 and that he this day personally appeared
 before me and made affidavit to said
 instrument.

Witness my hand and
 official seal this 12th day of
 September A.D. 1865

James B Thomas
 Clerk



[Faint handwritten notes and scribbles on the left side of the page]

~~H. 579. Vol 5. 1865.~~
H. 579. Vol 5. 1865.
H. 579. Vol 5. 1865.
Morris Illinois

Oct 3d 1865

Captain

A. J. Hayne
Ball Blk.

Surgeons Certificate

Rescued Oct. 10. 1865

Adjutant Genl, Office
Washington D C
Oct 4th 1865

Respo. referred to letter
to W. Foster. Asst. Adjt.
General.

Chas. F. Smith

Asst. Adjt. Genl

91.
10- 65
D. E. H.

H. G. J. C. J. S. M. B. 1865

State of Illinois
County of [unclear]

I Samuel B Thomas clerk
of the county court in and for said
county hereby certify that Dr J. P. France
whose name is subscribed to the
foregoing certificate is a respectable
practising Physician in said county, and
that he this day personally appeared
before me and made affidavit to the
matter and things therein set forth.

Witness my hand & official
seal this 2d day of October 1865

Samuel B Thomas
clerk



State of Illinois
County of Grundy

Oct 27 1865 John of Morris

In the case of Capt A. J. Hayes
3rd US, Col of Cavalry, sick

I hereby certify that the above
named party is a
patient under treatment in my charge
suffering from acute Rheumatism & also
a weak curvilinear from intermittent
fever of reason of which he is at the
time unfit for active service of any kind
and in my opinion cannot safely travel
to or from his Regiment in a safe period
than twenty days from the date

I therefore recommend that he
be excused from further service of war
till the 25th day of October 1865

A. H. [Signature]

Physician in Charge
Grundy Co Ill

623
Haynes Lorenzo

Co K, 3 U. S. Col'd Cav.

Sergeant | Sergeant

CARD NUMBERS.

1	5343660	26
2	5343748	27
3	5343839	28
4	5343918	29
5	5343994	30
6	5344081	31
7	5344266	32
8	5330749	33
9	5335452	34
10	5335559	35
11	5335659	36
12	5335755	37
13	5335844	38
14	5335929	39
15	5336012	40
16	5344769	41
17	9089471	42
18	9435940	43
19	40727571	44
20		45
21		46
22		47
23		48
24		49
25		50

Book Mark:

See also

72 Ill. Vols

A | **3 Cav. | U.S.C.T.**

Lawrence Haynes
....., Co. *K* 3 Reg't U. S. Col'd Cav.

Appears on

Company Descriptive Book

of the organization named above.

DESCRIPTION.

Age *21* years; height *5* feet *8* inches.

Complexion *Fair*

Eyes *Grey*; hair *Brown*

Where born *Kendall Co. Ill.*

Occupation *Soldier*

ENLISTMENT.

When *Feb. 24, 1864.*

Where *James Bluff, Miss.*

By whom *Adj't Genl. Thomas*, term *3* y'rs.

Remarks: *Appointed from*
Corporal Co "D" 72^d Ills.
Inftry. to be 1st sergt.
1st Miss. Cav. A. D. (Per
S. O. No. 4 A. G. O. Phil-
-adelphia, Pa, Jan'y 22
1864) Reported for
duty Feb. 24/64. (over)

F. B. Smith

MAY. 12

9089471

1891

Discharged at
Memphis Tenn. Jan'y.
24th 1865 To receive
promotion as 2^d Lieut.
3^d U. S. C. Cav. By Order
of the Secretary of War
Final statements given

A | 3 bar | **U.S.C.T.**

Lomza Haynes

....., Co., 3 Reg't U. S. Col'd bar

Appears on

Regimental Descriptive Book

(List of Commissioned Officers)

of the regiment named above.

Rank

Date of appointment 186.....

Remarks:

.....

.....

.....

.....

.....

.....

.....

.....

.....

.....

.....

.....

.....

.....

.....

.....

.....

.....

.....

.....

.....

.....

.....

.....

F. B. Smith
Copyist.

H | *3* *Law* | **U.S.C.T.**

Lorenzo Kaynes
Sergh, Co. *M*, *3* Reg't U. S. Col'd *Car.*

Appears on

Company Muster-in and Descriptive Roll
of the organization named above. Roll dated

Waines Bluff Miss, *Mich*, 186 *4*.

Where born *Kendall Co Illinois*

Age *21* y'rs; occupation *Farmer*

When enlisted *Febr* *24*, 186 *4*.

Where enlisted *Waines Bluff Miss*

For what period enlisted *3* years.

Eyes *Grey*; hair *Brown*

Complexion *Fair*; height *5* ft. *8* in.

When mustered in _____, 186 .

Where mustered in _____

Bounty paid \$ _____ *100*; due \$ _____ *100*

Where credited _____

Company to which assigned _____

Remarks *Appointed from*
Corpsral Co D 42 Ills Vol
Duty to be 1st Sergh Miss Car A, D.

Book mark: _____

over

Beach

JAN. - 8

5343660

☆ 1891 ☆

*Must be to date form.
x Became com 3a Regt 23C Cav*

K | **3 Cav.** | **U.S.C.T.**

Lorenzo Haynes

Serq, Co. K, 3 Reg't U. S. Col'd Cavalry.

Appears on

J **Company Muster Roll**
for *Feb 24*, to *Apr 30*, 186*4*

Present or absent *Present*

Stoppage, \$ *100* for

Due Gov't, \$ *100* for

Valuation of horse, \$ *100*

Valuation of horse equipments, \$ *100*

Remarks. *Appointed from*
corporal Co D 2^d July
Dep Vol to 1st Serq Co
K 3^d U.S. Cav (Colored)
(Mustered in Feb 26. 64
at Harpers Bluff)

Book mark:

Beach

H | **3 Cav.** | **U.S.C.T.**

Lorenzo Kaynes

Serget, Co. K, 3 Reg't U. S. Col'd Cavalry.

Appears on

Company Muster Roll

for *May & June*, 186*4*

Present or absent *Present*

Stoppage, \$.....*100* for

Due Gov't, \$.....*100* for

Valuation of horse, \$.....*100*

Valuation of horse equipments, \$.....*100*

Remarks:

Book mark:

Deach

10 | **3 Cav.** | **U.S.C.T.**

Lorenzo Haynes
1st Sergt, Co. K, 3 Reg't U. S. Col'd Cavalry.

Appears on

Company Muster Roll

for *July & Aug*, 186*4*

Present or absent *Present*

Stoppage, \$.....100 for.....

Due Gov't, \$.....100 for.....

Valuation of horse, \$.....100

Valuation of horse equipments, \$.....100

Remarks:.....
.....
.....
.....
.....
.....
.....
.....

Book mark:.....

Beach

B. | **3 Cav.** | **U.S.C.T.**

Lorenzo Kaynes

1st Reg't, Co. K, 3 Reg't U. S. Col'd Cavalry.

Appears on

Company Muster Roll

for *Sept & Oct*, 186 *4*

Present or absent. *Present*

Stoppage, \$ *100* for

Due Gov't, \$ *100* for

Valuation of horse, \$ *100*

Valuation of horse equipments, \$ *100*

Remarks:

Book mark:

Beach

A | **3 Cav.** | **U.S.C.T.**

Lorenzo Hayes
1st Sergt., Co. K, 3 Reg't U. S. Col'd Cavalry.

Appears on

Company Muster Roll

for *Nov & Dec.*, 1864.

Present or absent *Present*

Stoppage, \$ 100 for

Due Gov't, \$ 100 for

Valuation of horse, \$ 100

Valuation of horse equipments, \$ 100

Remarks:

*Absent on scout since
Dec. 21st 1864*

Book mark:

Valentine

A | **3 Cav.** | **U.S.C.T.**

Lorenzo Haynes
1st Sergt, Co. K, 3 Reg't U. S. Col'd Cavalry.

Appears on

Company Muster Roll

for *Jan & Feb*, 1865.

Present or absent

Stoppage, \$ 100 for

Due Gov't, \$ 100 for

Valuation of horse, \$ 100

Valuation of horse equipments, \$ 100

Remarks:

*Promoted from 1st Sergt
to 2d Lieut 3d U. S. Col.
Cav. Dec 25th 1864
Discharged*

Book mark:

(358)

Valentine

Copyist.

H. & P. Coy | **U.S.C.T.**

Lorenzo Haynes

2^d Co., *3* Reg't U. S. Col'd *Coy*

Age *21* years.

Appears on an

Individual Muster-in Roll

of the organization named above. Roll dated

Memphis, Tenn., Jan'y 25, 186*5.*

Muster-in to date *Jan'y 25,* 186*5.*

Joined for duty and enrolled :

When *Jan'y 25,* 186*5.*

Where *Memphis, Tenn.*

Period years.

Valuation of horse, \$ 100

Valuation of horse equipments, \$ 100

Remarks : *Appointed from 1st Sgt*
Co. "K", 5th U.S. Col. Coy to be 2^d
Sgt. in the same Regiment.
Muster in to date from Jan'y 25,
1865

Book mark :

W. Sewell

No | **3 Cav.** | **U.S.C.T.**

Lorenzo Haynes
2^d Lt, Co. C, 3 Reg't U. S. Col'd Cavalry.

Appears on

Company Muster Roll

for *Jan'y & Feb'y*, 1865

Present or absent *Present*

Stoppage, \$.....100 for

Due Gov't, \$.....100 for

Valuation of horse, \$.....100

Valuation of horse equipments, \$.....100

Remarks: *appointed from 1st Sgt Co. K. Jan 25, 1865,*

Book mark:

(358)

Talbot
Copyist.

26 | **3 Cav.** | **U.S.C.T.**

Lorenzo Haynes
2^d Lieut., Co. C, 3 Reg't U. S. Col'd Cavalry.

Appears on

Company Muster Roll

for March & April, 1865.

Present or absent Present

Stoppage, \$ 100 for

Due Gov't, \$ 100 for

Valuation of horse, \$ 100

Valuation of horse equipments, \$ 100

Remarks:

Book mark:

Jalworth
Copyist.

76 | 3 Cav. | U.S.C.T.

Lorenzo Haynes
2^d Lt, Co. C, 3 Reg't U. S. Col'd Cavalry.

Appears on

Company Muster Roll

for *May & June*, 1865.

Present or absent *Present*

Stoppage, \$ 100 for

Due Gov't, \$ 100 for

Valuation of horse, \$ 100

Valuation of horse equipments, \$ 100

Remarks:

Book mark:

Talburt

76 | 3 Cav. | U.S.C.T.

Lorenzo Hayner
2^d Lieut., Co. C, 3 Reg't U. S. Col'd Cavalry.

Appears on

Company Muster Roll

for July & Aug, 1865.

Present or absent Present

Stoppage, \$ 100 for

Due Gov't, \$ 100 for

Valuation of horse, \$ 100

Valuation of horse equipments, \$ 100

Remarks:

Book mark:

(358)

Galvorth
Copyist.

N | **3 Cav.** | **U.S.C.T.**

Lornz Haynes
2^d Lt, Co. C, 3 Reg't U. S. Col'd Cavalry.

Appears on

Company Muster Roll

for *Sept & Oct*, 1865.

Present or absent *+*

Stoppage, \$ *100* for

Due Gov't, \$ *100* for

Valuation of horse, \$ *100*

Valuation of horse equipments, \$ *100*

Remarks: *Det. R. D. M. for*
S. O. N. 80. No. 2 in 3^d
U. S. Col'd Cavalry.

In column of Names Present
Name cancelled

Book mark:

H | **3 Cav.** | **U.S.C.T.**

Lorenzo Haynes
257, Co. C, 3 Reg't U. S. Col'd Cavalry.

Appears on

Company Muster Roll

for *Nov & Dec*, 1865.

Present or absent *present*

Stoppage, \$ 100 for

Due Gov't, \$ 100 for

Valuation of horse, \$ 100

Valuation of horse equipments, \$ 100

Remarks: *Act R 25M*

Book mark:

H | **3 Cav. U.S.C.T.**

Longobaynes
241, Co. *C*, 3 Reg't U. S. Col'd Cavalry.

Appears on **Co. Muster-out Roll**, dated
Memphis Tenn Jan'y 26, 1866.
Muster-out to date *Jan'y 26, 1866*.
Last paid to *June 30, 1865*.

Clothing account:

Last settled....., 186 ; drawn since \$.....100
Due soldier \$.....100; due U. S. \$.....100
Am't for cloth'g in kind or money adv'd \$.....100

Due U. S. for arms, equipments, &c., \$.....100
Bounty paid \$.....100; due \$.....100

Remarks: *Enlisted at Chicago, Ills*
in the 72d Ill's Inftry Aug 7, 62,
Promoted to 1st Sergt, 3d U.S. Col'd
Cavalry, Feb, 24, 64, at Vicks
burg, Miss,

Book mark: *PMG, 8432*

W. M. M.
Copyist.

Ho, | 3 Cav. | U.S.C.T.

Lorenzo Haynes

1 Sergt, Co. K, 3 Reg't U. S. Colored Cav.
2^d Lt, " C,

Appears on Returns as follows:

Jan. 1865. Loss Jan. 25/65 - Mem-
phis, Tenn. appointed 2 Lt.
3 U. S. C. C. by order of Sec,
of War + signed L. Thomas
Adjt. Genl.

(2^d Lt.) Present. (Co. C.)

Feb. 1865. Present for duty.

Mar. 1865. Present.

Apr. 1865. Present. (Signs Return
Comdg Co.)

May 1865. Present sick.

June to Aug. 1865. Present.

Sept. + Oct. 1865. Present, acting
R. Q. M. since Sept. 15/65
per S. O. No. 80 Hd. Qrs.
U. S. C. Cav. Sept. 13/65.

Nov. 1865. Present, special duty
A. Q. M.

Dec. 1865. Present, Act. R. Q. M.

Book mark :

(546)

J. B. Sittler

Copyist.

H | 3 Cav. | U.S.C.T.

Lorenzo Haynes
1st Sgt., Co. K, 3 Reg't U. S. Col'd Cavalry.

Appears on Co. Muster-out Roll, dated
Memphis, Tenn., Jan. 26, 1866.

Muster-out to date _____, 186 .

Last paid to Aug. 31, 1864.

Clothing account:

Last settled _____, 186 ; drawn since \$ _____ 100

Due soldier \$ _____ 100; due U. S. \$ _____ 100

Am't for cloth'g in kind or money adv'd \$ _____ 100

Due U. S. for arms, equipments, &c., \$ _____ 100

Bounty paid \$ _____ 100; due \$ _____ 100

Remarks: Appointed 2nd Lieut
Co. C, 3rd U.S. C. Jan 23,
1865

(Discharged)

Book mark: _____

(361)

Howard
Copyist.

Haynes Lorenzo
Cap, Co. K, 3 Reg't *U.S. Cavalry*

..... 1 **Enclosures.**

- | | |
|------------------------------------|----------------------------|
| Bed Cards | Final Statements |
| Burial Records | Furloughs or L. of A. |
| Certs. of Dis. for Discharge | Med. Certificates |
| C. M. Charges | Med. Des. Lists |
| Descriptive Lists | Orders |
| Discharge Certificates | Pris. of War Record |
| Enlistment Papers | Resignations |

Other papers relating to—

- | | |
|------------------------------|---------------------------|
| Admission to Hosp'l | Furlough or L. of A. |
| Casualty Sheet | Med. Examination |
| Confinement | Misc. Information |
| Contracts | Pay or Clothing |
| Death or Effects | Personal Reports |
| Desertion | Rank |
| Discharge from Hosp'l | Transfer to Hosp'l |
| Discharge from Service | Transfer to V. R. C. |
| Duty | Transportation |

MICROFILM PUBLICATION M 1819

COMPILED MILITARY SERVICE RECORDS
OF VOLUNTEER UNION SOLDIERS WHO
SERVED WITH THE USCT (US COLORED TROOPS)
3RD REGIMENT OF CAVALRY

PERSONAL PAPERS' TARGET SHEET

PLEASE NOTE THE CHECKED INFORMATION ABOUT THE PERSONAL PAPERS IN
THIS FILE:

- NO PERSONAL PAPERS WERE FOUND IN THIS FILE WHEN THE
RECORDS WERE ARRANGED FOR MICROFILMING.
- 2 PERSONAL PAPER(S) FOUND IN THIS FILE WHEN THE RECORDS
WERE ARRANGED FOR MICROFILMING.

FINAL STATEMENT

OF

Lorenzo Hynes
3^d Reg't of U.S. Cold Cav.

VOLUNTEERS.

NOTE 1.—Two of these certificates (or duplicates) are to be given to each Volunteer Soldier or drafted man who may be discharged without being mustered out (Final Statements are never given to men mustered out of service.) that he may at once receive from the Paymaster the pay, &c., due him, and the captain or other COMMISSIONED officer commanding the company will certify to the act of the delivery of the duplicate certificates; with these certificates the Soldier is "entitled to" his discharge, and should also present his discharge to the Paymaster to have the payment endorsed on it. The discharge is to be given back to the Soldier by the Paymaster; the latter only retaining as his vouchers the duplicate certificates.

NOTE 2.—If the Soldier is entitled to pay for the use of his horse, the Company Commander will certify to that fact on the back of both these final statements, and also to the time he has pay due for having been so mounted on his own horse.

NOTE 3.—When a Soldier is furnished with final statements, his descriptive list, if he has one, should be taken up by the officer who gives the Soldier these statements, and endorsed with a statement to that effect by the officer. The endorsement should exhibit a full statement of the time for which the Soldier was allowed pay on his final statements, the clothing account, and all other charges against him or in his favor, so as to comprise a complete exhibit of his account. It will then be transmitted to the Company Commander of the Soldier, who will enter all the data necessary to a full understanding of the Soldier's account on the muster roll upon which the Soldier's discharge is reported. The descriptive list will then be destroyed. The object of this is, that the remaining portion of the Soldier's account may be settled upon the receipt of these muster rolls, and the Soldier receive any pay or allowances that may be due him at the time of his discharge, and which may not appear on his last final statements from the fact that his descriptive list is incomplete. These accounts for back pay, &c., are settled by the 24 Auditor of the Treasury Department.

NOTE 4.—Charges for loss or injury to allowance, horse equipments, and other miscellaneous charges, should appear under the heading of "Other Stoppages."

NOTE 5.—Bounty paid by State authorities, and not by the United States, will not be entered on this statement.

NOTE 6.—Amounts due the Sutler and Laundress must be entered on the muster roll on which the discharge, death, desertion, &c., is reported, as well as on the final statement, otherwise the amount cannot be collected from the United States.

NOTE 7.—This blank will be used for deceased volunteers and drafted men, as well as for others.

NOTE 8.—Where a Soldier dies in Hospital or on detached service, his descriptive list, if he has one, should be sent with his final statements, in duplicate, to the Adjutant General, Washington, D. C.

NOTE 9.—If the soldier is a drafted man or substitute, the space for time, &c., of enrolled, should contain only the word *drafted*, or *substitute*, as the case may be. If the Soldier is a "VETERAN" (or RECRUIT,) the words *as a veteran* (or *recruit*) as the case may be, should be interlined after the words *mustered into the service of the U. S.* A statement of all the installments of *Veteran* or *Recruit* Bounty RECEIVED by the Soldier must be made on the back of each final statement.

1865-10-10

I certify, on honor, that Lorenzo Hughes, a 2^d Sergt. of
 Captain A. J. Hayes Company (K) of the 3^d Regiment of U.S. Col. Regt.
VOLUNTEERS, of the State of _____, born in Kendall Co., State
 of Illinois, aged 21 years; 5 feet 9 inches high; Fair complexion,
Grey eyes, Brown hair, and by occupation a Soldier, who joined for service
 and was enrolled (see Note 9) on the 24th day of February, 1864, at Hughesbluff
 by Adj. Genl. Thomas, for the period of Three years, and mustered into
 the service of the United States on the 26th day of February, 1864, at
Hughesbluff Miss. by Lieut. Callinan; and having served
 HONESTLY and FAITHFULLY with his Company to the present date, is now entitled to a
DISCHARGE by reason of Promotion as 2^d Lieut. 3^d U.S. Co.
Mustered in to date Jan. 25th 1865.

The said Lorenzo Hughes was last paid by Paymaster
Maj. Candee, to include the 31st day of August, 1864, and
 has pay due him from that time to the present date; he is entitled to pay and subsistence for
TRAVELING to place of enrollment, and whatever other allowances are authorized to volunteer
 soldiers, drafted men, or militia, so discharged. He has received from the United States **CLOTHING**
 amounting to None 100 dollars, since the 31st day of August,
 1864, when his clothing account was last settled. He has received from the United States
_____ 100 dollars advanced **BOUNTY**.

There is to be stopped from him, on account of the State of _____, or other
 authorities, for **CLOTHING**, &c., received on entering service, _____ 100 dollars; and
 for other stoppages, viz: There is due him 100 One Hundred
Dollars Bounty for over two years continued service
the 25 Advance bounty having been deducted _____ 100 dollars.
 He has been furnished with **TRANSPORTATION** in kind from the place of his discharge to
 _____; and he has been **SUBSISTED** for **TRAVELING** to his
 place of enrollment, up to the _____, 186 .

He is indebted to _____, **SUTLER**, _____ 100 dollars.

He is indebted to _____, **LAUNDRESS**, _____ 100 dollars.

Given in Duplicate, at Memphis Tenn., this 25th day
 of January, 1865.

A. J. Hayes Capt
Co. K 3^d U.S. Co.

Commanding Company.

H^e L^{ieut} Gen^l of W. T.
Memphis Tenn Jan 25/64

respectfully referred
to Capt Campbell A. M.
attention called to with
in request

Lt Hayes will not
be mustered out until
further order

Geo E Smith
Bot Reg^t Gen^l

3 MS C Cav

Jan. 1906, This paper was formerly
filed with the records of the Chief
Mustering Officer Dept of the Cumberland
in the Archives Div. M. S. O.

Head Quarters, 1st West Tenn
Office Sgt Quartermaster
Memphis Tenn. Jan 25. 1862

Br Major Genl R. Smith
Comdg 1st West Tenn
General

I have the honor very respectfully
to recommend that the muster out and payment of Sicut
G. Hayes, A. R. I. A. 3rd U. S. Cal. be suspended until he
has transpired all his duty, for which he is accountable to
the United States.

Yours, General
Very Respectfully,
Your Obedt Servant
W. C. W. Brown
Capt. A. I. A.

624

Hoays Henry

Co G, 3 U. S. Col'd Cav.

Private

Private

CARD NUMBERS.

1	5338882	26
2	5338969	27
3	5339057	28
4	5339131	29
5	5339203	30
6	5339278	31
7	5339363	32
8	5339454	33
9	5339560	34
10	5339655	35
11	5339745	36
12	5339832	37
13	5339914	38
14	5339993	39
15	9088949	40
16		41
17		42
18		43
19		44
20		45
21		46
22		47
23		48
24		49
25		50

Book Mark: 188 P45, '69

See also

D1745-205 P.O. 201424

A. M. Shannon
E.

A | **3 Cav.** | **U.S.C.T.**

Henry Stays

Priv, Co. F, 1 Reg't Miss. Cav., Corps d'Afrique.*

age 19 yrs
Appears on

Company Muster-in Roll

of the organization named above. Roll dated

Vicksburg Miss, Jan 26, 1864.

Muster-in to date Dec 10, 1863.

Joined for duty and enrolled:

When Dec 10, 1863.

Where Skipwiths Miss.

Period 3 years.

Valuation of horse, \$ 100

Valuation of horse equipments, \$ 100

Remarks: _____

*This organization subsequently became Co. F, 3 Reg't U. S. Colored Cavalry.

Book mark: _____

E. F. Richardson

(356)

Copyist.

H | **3 Cav. | U.S.C.T.**

Henry Hays
.....
Pvt, Co. *F*, 1 Reg't Miss. Cav., Corps d'Afrique.*

Appears on

Company Muster Roll

for *Dec 6/63 to Feb 29*, 1864.

Present or absent *Present*

Stoppage, \$..... *100* for

Due Gov't, \$..... *100* for

Valuation of horse, \$..... *100*

Valuation of horse equipments, \$..... *100*

Remarks:.....
.....
.....
.....
.....
.....
.....
.....

*This organization subsequently became Co. *F*, 3 Reg't U. S. Colored Cavalry.

Book mark:.....

E. S. Richardson
.....
(358) Copyist.

H | **3 Cav.** | **U.S.C.T.**

Henry Stays
Plt, Co. F, 3 Reg't U. S. Col'd Cavalry.

Appears on

Company Muster Roll

for Mar & Apr, 1864.

Present or absent Present

Stoppage, \$ 100 for

Due Gov't, \$ 100 for

Valuation of horse, \$ 100

Valuation of horse equipments, \$ 100

Remarks:

Book mark:

E. Richardson

(358)

Copyist.

14 | 3 Cav. | U.S.C.T.

Henry Stays

Priv., Co. F, 3 Reg't U. S. Col'd Cavalry.

Appears on

Company Muster Roll

for May & June, 1864.

Present or absent Present

Stoppage, \$ 100 for

Due Gov't, \$ 100 for

Valuation of horse, \$ 100

Valuation of horse equipments, \$ 100

Remarks:

Book mark:

E. Richardson

(358)

Copyist.

14 | **3 Cav.** | **U.S.C.T.**

Henry Stays
Priv, Co. F, 3 Reg't U.S. Col'd Cavalry.

Appears on

Company Muster Roll

for July & Aug, 1864.

Present or absent Present

Stoppage, \$ 100 for

Due Gov't, \$ 100 for

Valuation of horse, \$ 100

Valuation of horse equipments, \$ 100

Remarks:
.....
.....
.....
.....
.....
.....
.....
.....
.....

Book mark:

(358)

E. Richardson
Copyist.

A | **3 Cav.** | **U.S.C.T.**

Henry Stays

Priv, Co. F, 3 Reg't U. S. Col'd Cavalry.

Appears on

Company Muster Roll

for Sept + Oct, 1864.

Present or absent Present

Stoppage, \$ 100 for _____

Due Gov't, \$ 100 for _____

Valuation of horse, \$ 100

Valuation of horse equipments, \$ 100

Remarks: _____

Book mark: _____

C. Richardson

M | **3 Cav.** | **U.S.C.T.**

Murray Hoays
Pvt, Co. F, 3 Reg't U. S. Col'd Cavalry.

Appears on

Company Muster Roll

for *Nov & Dec*, 1864.

Present or absent *Absent*

Stoppage, \$ *1* ^{*no*}/_{*100*} for *66 & 75*

Due Gov't, \$ *1* ^{*no*}/_{*100*} for

Valuation of horse, \$ *1* ^{*no*}/_{*100*}

Valuation of horse equipments, \$ *1* ^{*no*}/_{*100*}

Remarks: *Absent on scout since Dec 21 1864 Stoppage for ordnance 25-41*

Book mark: _____

Mead

No | **3 Cav.** | **U.S.C.T.**

Henry Hoag
1st, Co. F, 3 Reg't U. S. Col'd Cavalry.

Appears on

Company Muster Roll

for *Jan & Feb*, 1865.

Present or absent *present*

Stoppage, \$ 100 for

Due Gov't, \$ 100 for

Valuation of horse, \$ 100

Valuation of horse equipments, \$ 100

Remarks:

Book mark:

No | **3 Cav.** | **U.S.C.T.**

Henry Hoays
pt, Co. F, 3 Reg't U. S. Col'd Cavalry.

Appears on

Company Muster Roll

for March & April, 1865.

Present or absent Absent

Stoppage, \$ 100 for

Due Gov't, \$ 100 for

Valuation of horse, \$ 100

Valuation of horse equipments, \$ 100

Remarks: Absent on
service since Apr 27,
65

Book mark: _____

Mead
Copyist.

M. | **3 Cav.** | **U.S.C.T.**

Henry Wags
Rt I, Co. F, 3 Reg't U. S. Col'd Cavalry.

Appears on

Company Muster Roll

for May & June, 1865.

Present or absent present

Stoppage, \$.....100 for

Due Gov't, \$.....100 for

Valuation of horse, \$.....100

Valuation of horse equipments, \$.....100

Remarks:

Book mark:

(358)

Mead
Copyist.

Mo | **3 Cav.** | **U.S.C.T.**

Henry Mays
Part, Co. F, 3 Reg't U. S. Col'd Cavalry.

Appears on

Company Muster Roll

for July & Aug, 1865.

Present or absent present

Stoppage, \$.....100 for

Due Gov't, \$.....100 for

Valuation of horse, \$.....100

Valuation of horse equipments, \$.....100

Remarks:

Book mark:

A | **3 Cav.** | **U.S.C.T.**

Henry S. Samps
Or, Co. F, 3 Reg't U. S. Col'd Cavalry.

Appears on

Company Muster Roll
for *Sept 7th 1863*, 186³.

Present or absent *Present*

Stoppage, \$ 100 for

Due Gov't, \$ 100 for

Valuation of horse, \$ 100

Valuation of horse equipments, \$ 100

Remarks:

Book mark: -----

Or

A | **3 Cav. | U.S.C.T.**

James J. ...

..., Co. F, 3 Reg't U. S. Col'd Cavalry.

Appears on

Company Muster Roll

for *...*, 186*3*.

Present or absent *Present*

Stoppage, \$ *100* for *...*

Due Gov't, \$ *100* for *...*

Valuation of horse, \$ *100*

Valuation of horse equipments, \$ *100*

Remarks: *...*

Book mark: *...*

...

A | **3 Cav.** | **U.S.C.T.**

Henry Jones
....., Co. *G*, 3 Reg't U. S. Col'd Cavalry.

Appears on **Co. Muster-out Roll**, dated
Jan 20, 186*6*.
Muster-out to date *Jan 20*, 186*6*.
Last paid to *Jan 20*, 186*6*.

Clothing account:

Last settled, 186 ; drawn since \$ 100
Due soldier \$ 100; due U. S. \$ 100
Am't for cloth'g in kind or money adv'd \$ 100

Due U. S. for arms, equipments, &c., \$ 100

Bounty paid \$ 100; due \$ 100

Remarks:

Book mark: *188 J 12 69*

[Signature]
.....
Copyist.

A | **3 Cav. | U.S.C.T.**

Henry Hays

....., Co. *F*, 3 Reg't U. S. Col'd Cav.

Appears on

Company Descriptive Book
of the organization named above.

DESCRIPTION.

Age *19* years; height *5* feet *0* inches.

Complexion *Black*

Eyes *Black*; hair *Black*

Where born *Lagrang, Tennessee*

Occupation *Farmer*

ENLISTMENT.

When *Dec 10*, 1863.

Where *Skippwith*

By whom *C.C. Spaid*; term *3* y'rs.

Remarks:

.....
.....
.....
.....
.....
.....
.....
.....

E. Weston

625

Helbron, Arnold

Co G, 3 U. S. Col'd Cav.

Private

Corporal

CARD NUMBERS.

1	5340118	26
2	5340210	27
3	5340287	28
4	5340365	29
5	5340429	30
6	5340501	31
7	5340588	32
8	5340686	33
9	5340792	34
10	5340888	35
11	5340972	36
12	5341029	37
13	5341104	38
14	5341179	39
15	9089098	40
16	40727509	41
17		42
18		43
19		44
20		45
21		46
22		47
23		48
24		49
25		50

Book Mark:

See also

N | **3 Cav. | U.S.C.T.**

Arnold Hebrew

....., Co. *G*., 3 Reg't U. S. Col'd Cav.

Appears on

Company Descriptive Book

of the organization named above.

DESCRIPTION.

Age *18* years; height *5* feet *7*/₈ inches.

Complexion *Black*

Eyes *Black*; hair *Black*

Where born *Warren Co Miss*

Occupation *field hand*

ENLISTMENT.

When *Dec 3*, 1863.

Where *Wicksburg*

By whom *Capt Geo. C. Lundell*, term *3* y'rs.

Remarks: *Promoted to Capt Oct 11 1865*

Wittne

H | 3 Cav. | U.S.C.T.

Arnold Hebron

Co. G, 1 Reg't Miss. Cav., Corps d'Afrique.*
age 18 yrs
Appears on

Company Muster-in Roll

of the organization named above. Roll dated

Vicksburg miss Jan 27, 1864.

Muster-in to date Dec 3, 1863.

Joined for duty and enrolled:

When Dec 3, 1863.

Where Vicksburg miss

Period 3 years.

Valuation of horse, \$ 100

Valuation of horse equipments, \$ 100

Remarks:

*This organization subsequently became Co. G, 3 Reg't U. S. Colored Cavalry.

Book mark:

(356)

Posey

Copyist.

H | 3 Cav. | U.S.C.T.

Arnold Helbron
Pot. Co. G, 1 Reg't Miss. Cav., Corps d'Afrique.*

Appears on

Company Muster Roll

for Dec 24/63 to Feb 29, 1864.

Present or absent Present

Stoppage, \$ 100 for

Due Gov't, \$ 100 for

Valuation of horse, \$ 100

Valuation of horse equipments, \$ 100

Remarks:

*This organization subsequently became Co. G, 3 Reg't U. S. Colored Cavalry.

Book mark:

(358)

Posey

Copyist.

26 | 3 Cav. | U.S.C.T.

Arnold Hebron
Pet, Co. G, 3 Reg't U. S. Col'd Cavalry.

Appears on

Company Muster Roll

for Michxape, 1864

Present or absent Present

Stoppage, \$ 100 for

Due Gov't, \$ 100 for

Valuation of horse, \$ 100

Valuation of horse equipments, \$ 100

Remarks:

Book mark:

(358)

P. S. Sely
Copyist.

H | 3 Cav. | U.S.C.T.

Arnold Hebron

Pat, Co. G, 3 Reg't U. S. Col'd Cavalry.

Appears on

Company Muster Roll

for May + June, 1864

Present or absent Present

Stoppage, \$ 100 for

Due Gov't, \$ 100 for

Valuation of horse, \$ 100

Valuation of horse equipments, \$ 100

Remarks:

Book mark:

(358)

Vosey

Copyist.

H | **3 Cav.** | **U.S.C.T.**

Ronald Hebron

Put, Co. G, 3 Reg't U. S. Col'd Cavalry.

Appears on

Company Muster Roll

for July & Aug, 1864.

Present or absent Present

Stoppage, \$ 100 for

Due Gov't, \$ 100 for

Valuation of horse, \$ 100

Valuation of horse equipments, \$ 100

Remarks:

Book mark:

M. Audin

14 | **3 Cav. | U.S.C.T.**

- Donald H. Brown
Put, Co. G, 3 Reg't U. S. Col'd Cavalry.

Appears on

Company Muster Roll

for *Sept + Oct*, 186*4*.

Present or absent *Present*

Stoppage, \$ *100* for

Due Gov't, \$ *100* for

Valuation of horse, \$ *100*

Valuation of horse equipments, \$ *100*

Remarks:

Book mark:

M. Anderson

(358)

Copyist.

1177 139
146 | **3 Cav.** | **U.S.C.T.**

Arnold Hebrew

Priv, Co. G, 3 Reg't U. S. Col'd Cavalry.

Appears on

Company Muster Roll

for Nov + Dec, 18611.

Present or absent Present

Stoppage, \$ 100 for

Due Gov't, \$ 100 for

Valuation of horse, \$ 100

Valuation of horse equipments, \$ 100

Remarks:

Book mark:

J. Davis
Copyist.

16 | **3 Cav. | U.S.C.T.**

Arnold Hebron

Private, Co. G, 3 Reg't U. S. Col'd Cavalry.

Appears on

Company Muster Roll

for *Dated Feb 28*, 186*5*.

Present or absent *Present*

Stoppage, \$ *100* for

Due Gov't, \$ *100* for

Valuation of horse, \$ *100*

Valuation of horse equipments, \$ *100*

Remarks:

Book mark:

Jurris
Copyist.

46 | 3 Cav. | U.S.C.T.

Arnold Hebron

Pvt., Co. G, 3 Reg't U. S. Col'd Cavalry.

Appears on

Company Muster Roll

for *March & April*, 1865.

Present or absent *Absent*

Stoppage, \$ 100 for

Due Gov't, \$ 100 for

Valuation of horse, \$ 100

Valuation of horse equipments, \$ 100

Remarks: *Absent on expedition since
April 29*

Book mark:

(358)

J. J. Jarvis
Copyist.

W | **3 Cav.** | **U.S.C.T.**

Arnold Gibson

Prvt, Co. G, 3 Reg't U. S. Col'd Cavalry.

Appears on

Company Muster Roll

for *May & June*, 186*5*.

Present or absent *Present*

Stoppage, \$ *100* for

Due Gov't, \$ *100* for

Valuation of horse, \$ *100*

Valuation of horse equipments, \$ *100*

Remarks:

Book mark: -----

Jarvis

26

3 Cav. | U.S.C.T.

Arnold Nelson

Rt 1, Co. G, 3 Reg't U. S. Col'd Cavalry.

Appears on

Company Muster Roll

for *Sibley & Co.*, 1865.

Present or absent *Present*

Stoppage, \$ 100 for

Due Gov't, \$ 100 for

Valuation of horse, \$ 100

Valuation of horse equipments, \$ 100

Remarks:

Book mark:

(358)

Jarvis
Copyist.

A | **3 Cav.** | **U.S.C.T.**

Arnald Hebron

Capt, Co. G, 3 Reg't U. S. Col'd Cavalry.

Appears on

Company Muster Roll

for Sept & Oct, 1865.

Present or absent Present

Stoppage, \$/ 27 for ord lost
100

Due Gov't, \$ 100 for

Valuation of horse, \$ 100

Valuation of horse equipments, \$ 100

Remarks: 1 H Brush⁷⁵ Spurs & Staps⁵²
Stoppage for lost ordnance carried
from July & Aug Balls \$1.27

Book mark:

Burnham

H | **3 Cav.** | **U.S.C.T.**

Arnold Hebron

Capt, Co. G, 3 Reg't U. S. Col'd Cavalry.

Appears on

Company Muster Roll

for Nov & Dec, 1865.

Present or absent Present

Stoppage, \$ 1 $\frac{27}{100}$ for wd lost

Due Gov't, \$ 100 for

Valuation of horse, \$ 100

Valuation of horse equipments, \$ 100

Remarks: Promoted to Capt Oct 1/65

Book mark:

Bainham

H. | 3 Cav. | U.S.C.T.

Arnold Hebron

Priv., Co. G, 3 Reg't U. S. Colored Cav.

Appears on Returns as follows:

Oct. 1864 to May 1865, On daily duty as Orderly at Regt Hd. Qrs.

Aug. & Sept. 1865, On daily duty, as Orderly at Regt Hd. Qrs.

Book mark :

J. B. Sittler

(546)

Copyist.

4 | 3 Cav. | U.S.C.T.

Arnold Hebron

Capt., Co. G, 3 Reg't U. S. Col'd Cavalry.

Appears on Co. Muster-out Roll, dated
Memphis Tenn, Jan 26, 1866.

Muster-out to date Jan 26, 1866.

Last paid to June 30, 1865.

Clothing account:

Last settled _____, 186 ; drawn since \$ 100

Due soldier \$ 3 75; due U. S. \$ 100

Am't for cloth'g in kind or money adv'd \$ 100

Due U. S. for arms, equipments, &c., \$ 100

Bounty paid \$ 100; due \$ 100

Remarks: Promoted from Capt Oct 1
165 by order of Lt Col Cook Comdg
Regt Totell Steppage for lost
commander \$127

Book mark:

Burnham

626
Hebron, David

Co G, 3 U. S. Col'd Cav.

Private | Corporal

CARD NUMBERS.

1	5340119	26
2	5340211	27
3	5340288	28
4	5340366	29
5	5340430	30
6	5340502	31
7	5340589	32
8	5340687	33
9	5340793	34
10	5340889	35
11	5340943	36
12	5341027	37
13	5341102	38
14	5341177	39
15	9089099	40
16	40727572	41
17		42
18		43
19		44
20		45
21		46
22		47
23		48
24		49
25		50

Book Mark:

See also

D. 2019621 P.O. m.m.
S. Coy. Sec. for Mrs. J. J. ...
12/26/20
S.S., 203.
2-24-21

A. M. Shannon
Co.

W | **3 Cav. | U.S.C.T.**

David Wilson

....., Co. *G*., 3 Reg't U. S. Col'd Cav.

Appears on

Company Descriptive Book

of the organization named above.

DESCRIPTION.

Age *18* years; height *5* feet *2 3/4* inches.

Complexion *Black*

Eyes *Black*; hair *black*

Where born *Warren Co Miss*

Occupation *S. Hand*

ENLISTMENT.

When *Dec 1*, 186*3*.

Where *Wicksburg Miss*

By whom *Capt Geo Caykendall* term *3* y'rs.

Remarks: *promoted to Corporal
July 1st 1865*

Wilson

H | **3 Cav.** | **U.S.C.T.**

David Hebron

Pat., Co. *G*, 1 Reg't Miss. Cav., Corps d'Afrique.*
age 18 yrs
Appears on

Company Muster-in Roll

of the organization named above. Roll dated

Wicksburg miss Jan 27, 1864.

Muster-in to date *Dec 1*, 1863.

Joined for duty and enrolled:

When *Dec 1*, 1863.

Where *Wicksburg miss*

Period *3* years.

Valuation of horse, \$ 100

Valuation of horse equipments, \$ 100

Remarks:

*This organization subsequently became Co. *G*, 3 Reg't U. S. Colored Cavalry.

Book mark:

(356)

Posey

Copyist.

H | **3 Cav.** | **U.S.C.T.**

David Hebron

Det, Co. G, 1 Reg't Miss. Cav., Corps d'Afrique.*

Appears on

Company Muster Roll

for *Dec 24/63 to Jan 79*, 1864.

Present or absent *Present*

Stoppage, \$ *100* for

Due Gov't, \$ *100* for

Valuation of horse, \$ *100*

Valuation of horse equipments, \$ *100*

Remarks:

*This organization subsequently became Co. *G*, 3 Reg't U. S. Colored Cavalry.

Book mark:

Vosey

H | **3 Cav.** | **U.S.C.T.**

David Hebron
Pat, Co. G, 3 Reg't U. S. Col'd Cavalry.

Appears on

Company Muster Roll

for *Michyaple*, 186*4*

Present or absent *Present*

Stoppage, \$ 100 for

Due Gov't, \$ 100 for

Valuation of horse, \$ 100

Valuation of horse equipments, \$ 100

Remarks:

Book mark:

Posey

H | **3 Cav.** | **U.S.C.T.**

David Hebron

Pat, Co. G, 3 Reg't U. S. Col'd Cavalry.

Appears on

Company Muster Roll

for *May + June*, 186*4*

Present or absent *Present*

Stoppage, \$ *100* for

Due Gov't, \$ *100* for

Valuation of horse, \$ *100*

Valuation of horse equipments, \$ *100*

Remarks:

Book mark:

Josey

(358)

Copyist.

A | **3 Cav.** | **U.S.C.T.**

David Hebron

Priv, Co. G, 3 Reg't U. S. Col'd Cavalry.

Appears on

Company Muster Roll

for *July 7 Aug*, 1864.

Present or absent *Present*

Stoppage, \$ *100* for

Due Gov't, \$ *100* for

Valuation of horse, \$ *100*

Valuation of horse equipments, \$ *100*

Remarks:

Book mark: -----

M. J. Anderson

4 | **3 Cav. | U.S.C.T.**

Alfred Hebrant
Put, Co. G, 3 Reg't U. S. Col'd Cavalry.

Appears on

Company Muster Roll

for Sept & Oct, 1864.

Present or absent Present

Stoppage, \$ 100 for

Due Gov't, \$ 100 for

Valuation of horse, \$ 100

Valuation of horse equipments, \$ 100

Remarks:

Book mark:

W. S. Andrews

(358)

Copyist.

46 | **3 Cav.** | **U.S.C.T.**

David Hebron

Dr, Co. G, 3 Reg't U. S. Col'd Cavalry.

Appears on

Company Muster Roll

for *Nov & Dec*, 186*4*.

Present or absent *Present*

Stoppage, \$ *100* for

Due Gov't, \$ *100* for

Valuation of horse, \$ *100*

Valuation of horse equipments, \$ *100*

Remarks:

Book mark: _____

Jarris
Copyist.

46 | **3 Cav. | U.S.C.T.**

David Webber

Priv, Co. G, 3 Reg't U. S. Col'd Cavalry.

Appears on

Company Muster Roll

for *Dated Feby 28*, 186*5*.

Present or absent *Present*

Stoppage, \$ *100* for

Due Gov't, \$ *100* for

Valuation of horse, \$ *100*

Valuation of horse equipments, \$ *100*

Remarks:
.....
.....
.....
.....
.....
.....
.....
.....
.....
.....

Book mark:

.....
J. J. Harris
.....
Copyist.

46 | **3 Cav. | U.S.C.T.**

David Hebron

Pr, Co. G, 3 Reg't U.S. Col'd Cavalry.

Appears on

Company Muster Roll

for *March + April*, 1865.

Present or absent *Absent*

Stoppage, \$ *100* for

Due Gov't, \$ *100* for

Valuation of horse, \$ *100*

Valuation of horse equipments, \$ *100*

Remarks:

Absent on expedition since Apr 29

Book mark:

(358)

Jarvis
Copyist.

W | **3 Cav. | U.S.C.T.**

David Hobson

Priv, Co. G, 3 Reg't U.S. Col'd Cavalry.

Appears on

Company Muster Roll

for *May & June*, 186*5*.

Present or absent *Present*

Stoppage, \$ 100 for

Due Gov't, \$ 100 for

Valuation of horse, \$ 100

Valuation of horse equipments, \$ 100

Remarks:
.....
.....
.....
.....
.....
.....
.....
.....
.....
.....

Book mark:

Jarvis
Copyist.

W | **3 Cav.** | **U.S.C.T.**

David Hebron
Capt, Co. G, 3 Reg't U. S. Col'd Cavalry.

Appears on

Company Muster Roll

for *July & Aug*, 1865.

Present or absent *Present*

Stoppage, \$ *100* for

Due Gov't, \$ *100* for

Valuation of horse, \$ *100*

Valuation of horse equipments, \$ *100*

Remarks: *to be stopped for one horse
worth 75^c. Promoted July 4/65*

Book mark:

[Signature]
Copyist.

A | **3 Cav.** | **U.S.C.T.**

David Hebron

Capt., Co. G, 3 Reg't U.S. Col'd Cavalry.

Appears on

Company Muster Roll

for Sept & Oct, 1865.

Present or absent Present

Stoppage, \$ $\frac{75}{100}$ for Ord Cost

Due Gov't, \$ 100 for

Valuation of horse, \$ 100

Valuation of horse equipments, \$ 100

Remarks: Promoted to Capt from
private July 1/65

Book mark:

Burnham

H | **3 Cav.** | **U.S.C.T.**

David Hebron

Capt, Co. G, 3 Reg't U.S. Col'd Cavalry.

Appears on

Company Muster Roll

for *Nov & Dec*, 1865.

Present or absent *Present*

Stoppage, \$ $\frac{75}{100}$ for *ard last*

Due Gov't, \$ $\frac{100}{100}$ for

Valuation of horse, \$ $\frac{100}{100}$

Valuation of horse equipments, \$ $\frac{100}{100}$

Remarks *Promoted to Capt July 1/65*

Book mark:

Burnham

H. | **3 Cav.** | **U.S.C.T.**

David Helbron
Priv., Co. G, 3 Reg't U. S. Colored Cav.

Appears on **Returns** as follows:

Feb. 1864, (1 Miss. Cav. a. D.)
Cook for Co.

Mar. to May 1864, (3 U. S. C. C.)
Co. & Cook.

* July 1864, On daily duty as
Co. cook

Aug. 1864 to Mar. 1865, On duty
Orderly at Regt. Hd.
Qrs.

* Entire entry cancelled.

Book mark :

(546)

J. B. Sittler

Copyist.

A | **3 Cav.** | **U.S.C.T.**

David Hebron

Capt., Co. E, 3 Reg't U. S. Col'd Cavalry.

Appears on **Co. Muster-out Roll**, dated

Memphis Tenn Jan 26, 1866.

Muster-out to date Jan 26, 1866.

Last paid to June 30, 1865.

Clothing account:

Last settled _____, 186 ; drawn since \$ _____ 100

Due soldier \$ 20 ⁸³/₁₀₀; due U. S. \$ _____ 100

Am't for cloth'g in kind or money adv'd \$ _____ 100

Due U. S. for arms, equipments, &c., \$ _____ 100

Bounty paid \$ _____ 100; due \$ _____ 100

Remarks: Total steppage for lost advances
75^c Promoted from Private July 1/65
by order of Lt Col Cook Comdg Regt

Book mark: _____

Burnham

(361)

Copyist.

627

Hebron, Esquire
Co. G, 3 U. S. Col'd Cav.

Private | 1st Sergeant

CARD NUMBERS.

1	5340120	26
2	5340180	27
3	5340264	28
4	5340344	29
5	5340404	30
6	5340470	31
7	5340555	32
8	5340639	33
9	5340748	34
10	5340847	35
11	5340934	36
12	5341018	37
13	5341093	38
14	5341168	39
15	9089100	40
16		41
17		42
18		43
19		44
20		45
21		46
22		47
23		48
24		49
25		50

Book Mark:

See also

S. 752937 R.O. Aff.
S. 1123652 R.O. M. M. M.

A. M. Shannon
Co.

N | **3 Cav. U.S.C.T.**

Esquim Wilson

G, Co. *G*, 3 Reg't U. S. Col'd Cav.

Appears on

Company Descriptive Book

of the organization named above.

DESCRIPTION.

Age *21* years; height *5* feet *6* inches.

Complexion *Black*

Eyes *Black*; hair *black*

Where born *Winn Co Miss*

Occupation *Carpenter*

ENLISTMENT.

When *Dec 1*, 186*3*.

Where *Vicksburg Miss*

By whom *Capt Geo. Cockfield, term 3* y'rs.

Remarks: *Serget from Muster in
of Company,*

Wilson

H | 3 Cav. | U.S.C.T.

Esquire Hebron

Co. G, 1 Reg't Miss. Cav., Corps d'Afrique.*

Age 21 yrs
Appears on

Company Muster-in Roll

of the organization named above. Roll dated

Vicksburg Miss Jan 27, 1864.

Muster-in to date Dec 1, 1863.

Joined for duty and enrolled:

When Dec 1, 1863.

Where Vicksburg Miss

Period 3 years.

Valuation of horse, \$ 100

Valuation of horse equipments, \$ 100

Remarks:

*This organization subsequently became Co. G, 3 Reg't U. S. Colored Cavalry.

Book mark:

(356)

J. J. Osley

Copyist.

H | 3 Cav. | U.S.C.T.

Esquire Holbron
Sgt., Co. G, 1 Reg't Miss. Cav., Corps d'Afrique.*

Appears on

Company Muster Roll

for Dec 24/63 to Dec 29, 1864

Present or absent. Present

Stoppage, \$ 100 for

Due Gov't, \$ 100 for

Valuation of horse, \$ 100

Valuation of horse equipments, \$ 100

Remarks:

*This organization subsequently became Co. G, 3 Reg't U. S. Colored Cavalry.

Book mark:

(358)

P. S. L.

Copyist.

H | **3 Cav.** | **U.S.C.T.**

Esquire Hebron
Sgt, Co. G, 3 Reg't U. S. Col'd Cavalry.

Appears on

Company Muster Roll

for *Mchapl*, 1864

Present or absent *Present*

Stoppage, \$ 100 for

Due Gov't, \$ 100 for

Valuation of horse, \$ 100

Valuation of horse equipments, \$ 100

Remarks:

Book mark:

Wosey

H | **3 Cav.** | **U.S.C.T.**

Esquire Hebron

Sgt, Co. G, 3 Reg't U. S. Col'd Cavalry.

Appears on

Company Muster Roll

for *May & June*, 1864.

Present or absent *Present*

Stoppage, \$.....100 for

Due Gov't, \$.....100 for

Valuation of horse, \$.....100

Valuation of horse equipments, \$.....100

Remarks:.....

Book mark:.....

(358)

Josely

Copyist.

A | **3 Cav.** | **U.S.C.T.**

Esquire Hebron
Sgt, Co. G, 3 Reg't U. S. Col'd Cavalry.

Appears on

Company Muster Roll

for *July 4*, 1864.

Present or absent *Present.*

Stoppage, \$ *100* for

Due Gov't, \$ *100* for

Valuation of horse, \$ *100*

Valuation of horse equipments, \$ *100*

Remarks: *Appointed Sgt*
Jan 27, 1864

Book mark:

(358)

Posey

Copyist.

4 | 3 Cav. | U.S.C.T.

Esquire Hebron

Serjeant, Co. G, 3 Reg't U. S. Col'd Cavalry.

Appears on

Company Muster Roll

for Sept 7 Oct, 1864.

Present or absent Present

Stoppage, \$ 100 for

Due Gov't, \$ 100 for

Valuation of horse, \$ 100

Valuation of horse equipments, \$ 100

Remarks:

Book mark:

M. Anderson

4 | **3 Cav.** | **U.S.C.T.**

Osquire Hebrew

297, Co. G, 3 Reg't U. S. Col'd Cavalry.

Appears on

Company Muster Roll

for Nov + Dec, 1864

Present or absent Present

Stoppage, \$ 100 for

Due Gov't, \$ 100 for

Valuation of horse, \$ 100

Valuation of horse equipments, \$ 100

Remarks:

Book mark: _____

Osquire

Copyist.

W | **3 Cav.** | **U.S.C.T.**

Esquire Hebrew

Sgt, Co. G, 3 Reg't U. S. Col'd Cavalry.

Appears on

Company Muster Roll

for *Dated Feb 28*, 186*5*.

Present or absent *Present*

Stoppage, \$ *100* for

Due Gov't, \$ *100* for

Valuation of horse, \$ *100*

Valuation of horse equipments, \$ *100*

Remarks:

Book mark:

(358)

J. J. Lewis
Copyist.

46 | **3 Cav. | U.S.C.T.**

Esquire Hebron

Sgt, Co. G, 3 Reg't U.S. Col'd Cavalry.

Appears on

Company Muster Roll

for *March & April*, 1865.

Present or absent *Absent*

Stoppage, \$ *100* for

Due Gov't, \$ *100* for

Valuation of horse, \$ *100*

Valuation of horse equipments, \$ *100*

Remarks: *Absent on expedition since April 29.*

Book mark:

J. J. Harris
Copyist.

A | **3 Cav.** | **U.S.C.T.**

Esquire Hebron

Sergeant, Co. G, 3 Reg't U.S. Col'd Cavalry.

Appears on

Company Muster Roll

for *May + June*, 1865.

Present or absent *present*

Stoppage, \$ *100* for

Due Gov't, \$ *100* for

Valuation of horse, \$ *100*

Valuation of horse equipments, \$ *100*

Remarks:

Book mark:

(358)

J. Davis

Copyist.

H | **3 Cav.** | **U.S.C.T.**

Esquire Hebron

Sgt, Co. G, 3 Reg't U.S. Col'd Cavalry.

Appears on

Company Muster Roll

for *July + Aug*, 1865.

Present or absent *Present*

Stoppage, \$ 100 for

Due Gov't, \$ 100 for

Valuation of horse, \$ 100

Valuation of horse equipments, \$ 100

Remarks: *He has stopped for 1 pr Spurs & Traps 52^{cs} Due Army Account 26^{cs}*

Book mark:

(358)

Jarvis
Copyist.

A | **3 Cav.** | **U.S.C.T.**

Esquire Hebron
Sergt, Co. G, 3 Reg't U. S. Col'd Cavalry.

Appears on

Company Muster Roll

for *Sept & Oct*, 1865.

Present or absent *Present*

Stoppage, \$ $\frac{28}{100}$ for *Ordn Cost*

Due Gov't, \$ $\frac{100}{100}$ for

Valuation of horse, \$ $\frac{100}{100}$

Valuation of horse equipments, \$ $\frac{100}{100}$

Remarks:

Book mark:

(358)

Bunham

Copyist.

| 3 Cav. | U.S.C.T.

Esquire Hebron
1st Supt, Co. G, 3 Reg't U. S. Col'd Cavalry.

Appears on

Company Muster Roll

for *Nov & Dec*, 1865.

Present or absent *Present*

Stoppage, \$ *28* for *ord lost*
100

Due Gov't, \$ *100* for

Valuation of horse, \$ *100*

Valuation of horse equipments, \$ *100*

Remarks *Reinstated to 1st Supt to date*
from Nov. 1/65 by order of Lt Col
Cook Comdg Regt

Book mark :

H | **3 Cav.** | **U.S.C.T.**

Esquire Hebron

1st Supt., Co. G, 3 Reg't U. S. Col'd Cavalry.

Appears on **Co. Muster-out Roll**, dated
Memphis Tenn, Jan 26, 1866.

Muster-out to date Jan 26, 1866.

Last paid to June 30, 1865.

Clothing account:

Last settled 186 ; drawn since \$ 100

Due soldier \$ 100; due U. S. \$ 3 ²¹/₁₀₀

Am't for cloth'g in kind or money adv'd \$ 100

Due U. S. for arms, equipments, &c., \$ 100

Bounty paid \$ 100; due \$ 100

Remarks: Det'd stoppage for lost ordnance &
Promoted from Sergeant Nov 1/65 order
of Lt Col Cook Comdg Regiment

Book mark :

Burham

(361)

Copyist.

628

Hebron, Henry
Co G, 3 U. S. Col'd Cav.

Private | Private

CARD NUMBERS.

1	26
2	27
3	28
4	29
5	30
6	31
7	32
8	33
9	34
10	35
11	36
12	37
13	38
14	39
15	40
16	41
17	42
18	43
19	44
20	45
21	46
22	47
23	48
24	49
25	50

See Hebron, Henry

Book Mark:

See also

629

Hellen Tagewell

Co E, 3 U. S. Col'd Cav.

Private Private

CARD NUMBERS.

1	5331322	26
2	5338109	27
3	5338203	28
4	5338313	29
5	5338412	30
6	5338496	31
7	5338586	32
8	5338660	33
9	5338726	34
10	9088866	35
11	46727512	36
12	31691526	37
12		38
14		39
15		40
16		41
17		42
18		43
19		44
20		45
21		46
22		47
23		48
24		49
25		50

Book Mark:

See also

S-884369 Clement
A. 2385811 POKA
A 2400761 PO aff

W. M. Shannon
Es

7 | 3 Cav. | U.S.C.T.

Helon J. G. Well

....., Co. *E*, 3 Reg't U. S. Col'd Cav.

Appears on

Company Descriptive Book

of the organization named above.

DESCRIPTION.

Age *24* years; height *5* feet *5* inches.

Complexion *Black*,

Eyes *Black*; hair *Black*,

Where born *Mississippi*,

Occupation *Farmer*,

ENLISTMENT.

When *Nov 1*, 186 *4*.

Where *Vicksburg Miss*

By whom *E. C. Kensley*; term *3* y'rs.

Remarks:

E. Weston

H. | **3 Cav.** | **U.S.C.T.**

Taswell Helms

Appears with rank of *Priv.* on

Muster and Descriptive Roll of a Detachment of U. S. Vols. forwarded

for the 3 Reg't U. S. Col'd Cavalry. Roll dated

Vicksburg Miss Nov 2, 1864.

Where born *Washington Co, Miss*

Age *20* y'rs; occupation *Farmer*

When enlisted *Nov 1*, 1864.

Where enlisted *V. Burg Miss.*

For what period enlisted *3* years.

Eyes *Black*; hair *Black*

Complexion *Redd*; height *5 ft. 5 in.*

When mustered in *Nov 2*, 1864.

Where mustered in *V. Burg Miss.*

Bounty paid \$ *100*^{*00*}/_{*100*}; due \$ *200*^{*00*}/_{*100*}

Where credited *State of Mass*

Company to which assigned

Remarks:

** Inserted by comparer.*

Book mark:

Joiner.
Copyist.

11. | **3 Cav.** | **U.S.C.T.**

Maxwell Adams

1st, Co. E, 3 Reg't U. S. Col'd Cavalry.

Appears on

Company Muster Roll

for April, 1st, 1861.

Present or absent Present

Stoppage, \$ 2.40 for Armed
5.00 S. C. & G. 18

Due Gov't, \$ 1.00 for

Valuation of horse, \$ 100

Valuation of horse equipments, \$ 100

Remarks: Armed and equipped
with arms and accoutrements
and provisions and the usual

Book mark:

C. F. Hoff

(358)

Copyist.

W. | **3 Cav.** | **U.S.C.T.**

Payroll
.....
....., Co. E, 3 Reg't U. S. Col'd Cavalry.

Appears on

Company Muster Roll

for *Jan. & Dec.*, 1867.

Present or absent *absent*

Stoppage, \$ *100* for

Due Gov't, \$ *100* for

Valuation of horse, \$ *100*

Valuation of horse equipments, \$ *100*

Remarks: *absent sick in
hospital at Memphis
Tenn. since Dec. 10, 1867*

Book mark:

(358)

W. H. Hoff
Copyist.

H 1 3 car 1005

Taswell Helm
Priv., Co. E, 3 Reg't U.S.C. Cav

Appears on

Hospital Muster Roll

of Webster U. S. A. General Hospital,

at Memphis, Tenn,

for Jan & Feb, 1865.

Attached to hospital:

When Feb 2, 1865.

How employed Sick

Last paid by Maj.

to _____, 186 .

Bounty paid \$ 100 ; due \$ 100

Present or absent Present

Remarks

Book mark:

(848)

J. Anderson

Copyst.

11 | **3 Cav.** | **U.S.C.T.**

Page 22 of 100
11, Co. E, 3 Reg't U. S. Col'd Cavalry.

Appears on

Company Muster Roll

for March & April, 1867.

Present or absent Present

Stoppage, \$ 2/100 for Manance
\$1.00 for h. h. & G. B.

Due Gov't, \$ 100 for

Valuation of horse, \$ 100

Valuation of horse equipments, \$ 100

Remarks: Must be found last
(muster for Manance) \$1.00
for h. h. & G. B. 1.00

Book mark:

(358)

[Signature]
Copyist.

04. | **3 Cav. | U.S.C.T.**

Payroll) Helms

25., Co. E, 3 Reg't U. S. Col'd Cavalry.

Appears on

Company Muster Roll

for *July & Aug.*, 186 *5.*

Present or absent *Present*

Stoppage, \$ 100 for

Due Gov't, \$ 100 for

Valuation of horse, \$ 100

Valuation of horse equipments, \$ 100

Remarks:

Book mark:

(358)

C. P. Helms
Copyist.

46 | **3 Cav. | U.S.C.T.**

Sagwell Holman

Pvt., Co. E, 3 Reg't U.S. Col'd Cavalry.

Appears on

Company Muster Roll

for *Sept. & Oct.*, 1865.

Present or absent *Present*

Stoppage, \$ *100* for

Due Gov't, \$ *100* for

Valuation of horse, \$ *100*

Valuation of horse equipments, \$ *100*

Remarks: *Stop for two Haversacks.
Stop for 1 bone wrench for
Carbine 35.*

Book mark:

(358)

Lewis
Copyist.

76 | **3 Cav.** | **U.S.C.T.**

Lazewell Helen

Priv., Co. E, 3 Reg't U.S. Col'd Cavalry.

Appears on

Company Muster Roll

for Nov. & Dec., 1865.

Present or absent Present.

Stoppage, \$ 100 for

Due Gov't, \$ 100 for

Valuation of horse, \$ 100

Valuation of horse equipments, \$ 100

Remarks: _____

Book mark: _____

Lewis
Copyist.

Ho. | 3 Cav. | U.S.C.T.

Taswell Helem

Priv., Co. E, 3 Reg't U. S. Colored Cav.

Appears on Returns as follows:

Nov. 1864. Gained Nov. 1 Vicksburg - Recruit.

Feb. & Mar. 1865. Absent sick in Gen. Hosp. Memphis, Tenn. since Feb. 1/65.

Book mark :

(548)

J. B. Dittler

Copyist.

1777 121
H | 3 Cav. | U.S.C.T.

Lazewell Hellem

Pvt., Co. E., 3 Reg't U. S. Col'd Cavalry.

Appears on Co. Muster-out Roll, dated

Memphis, Tenn. Jan. 26., 1866 .

Muster-out to date Jan. 26., 1866 .

Last paid to June 30., 1865 .

Clothing account:

Last settled _____, 186 ; drawn since \$ _____ 100

Due soldier \$ 32 ⁵⁰/₁₀₀; due U. S. \$ _____ 100

Am't for cloth'g in kind or money adv'd \$ _____ 100

Due U. S. for arms, equipments, &c., \$ / ³⁵/₁₀₀

Bounty paid \$ _____ 100; due \$ _____ 100

Remarks: Bounty due 1st installment

\$ 100. none paid.

Book mark:

(361)

Lewis
Copyist.

Helm Gaswell

Pr., Co.

3

Reg't

McCarr

2 Enclosures.

ed Cards	Final Statements
urial Records	Furloughs or L. of A.
erts. of Dis. for Discharge	Med. Certificates
M. Charges	Med. Des. Lists
escriptive Lists	Orders
ischarge Certificates	Pris. of War Record
enlistment Papers 2	Resignations

Other papers relating to—

admission to Hosp'l	Furlough or L. of A.
asualty Sheet	Med. Examination
onfinement	Misc. Information
ontracts	Pay or Clothing
death or Effects	Personal Reports
esertion	Rank
ischarge from Hosp'l	Transfer to Hosp'l
ischarge from Service	Transfer to V. R. C.
uty	Transportation

Helm Caswell

Pr, Co. ; *3* Reg't *1st Cav*

2 Enclosures.

Bed Cards	Final Statements
Burial Records	Furloughs or L. of A.
Certs. of Dis. for Discharge	Med. Certificates
C. M. Charges	Med. Des. Lists
Descriptive Lists	Orders
Discharge Certificates	Pris. of War Record
Enlistment Papers <i>2</i>	Resignations

Other papers relating to—

Admission to Hosp'l	Furlough or L. of A.
Casualty Sheet	Med. Examination
Confinement	Misc. Information
Contracts	Pay or Clothing
Death or Effects	Personal Reports
Desertion	Rank
Discharge from Hosp'l	Transfer to Hosp'l
Discharge from Service	Transfer to V. R. C.
Duty	Transportation

NOTE 1.—This blank will be used for both enlistments and reenlistments... NOTE 2.—An enlistment... in the Adjutant General's Office as evidence of enlistment... enlistment as having transferred the soldier into the service...

DECLARATION OF RECRUIT.

I, Taswell Helm, desiring to VOLUNTEER as a Soldier in the Army of the United States, for the term of THREE YEARS, Do Declare, That I am twenty six years and _____ months of age; that I have never been discharged from the United States service on account of disability or by sentence of a court martial, or by order before the expiration of a term of enlistment; and I know of no impediment to my serving honestly and faithfully as a soldier for three years.

GIVEN at Ficksburg, Miss the 1st day of November 1864

Witness: P. F. Stevens

Taswell Helm mark

Enlistment: last served in Company ()
Reg't of _____
Discharged _____ 18__

No. _____
Taswell Helm
Volunteered at Ficksburg, Miss
1st November 1864
By Chas. C. Amodeo, Capt
Regiment of _____

CONSENT IN CASE OF MINOR.

I, _____, Do CERTIFY, That I am the _____ of _____; that the said _____ is _____ years of age; and I do hereby freely give my CONSENT to his volunteering as a SOLDIER in the ARMY OF THE UNITED STATES for the period of THREE YEARS.

GIVEN at _____ the _____ day of _____

Witness: _____

VOLUNTEER ENLISTMENT.

STATE OF

TOWN OF

Mississippi

Vicksburg



I, Taswell Helm, born in Washington Co
 in the State of Mississippi, aged twenty six years,
 and by occupation a Farmer. Do HEREBY ACKNOWLEDGE to have
 volunteered this First day of November, 1864,
 to serve as a **Soldier** in the **Army** of the **United States of America**, for
 the period of **THREE YEARS**, unless sooner discharged by proper authority:
 Do also agree to accept such bounty, pay, rations, and clothing as are, or may be,
 established by law for volunteers. And I, Taswell Helm, do
 solemnly swear, that I will bear true faith and allegiance to the **United States**
of America, and that I will serve them honestly and faithfully against all
 their enemies or opposers whomsoever; and that I will observe and obey the
 orders of the President of the United States, and the orders of the officers
 appointed over me, according to the Rules and Articles of War.

Single

Mustered into the service of the United States, for three years or during the war, from date of enlistment, in Company
 of 3rd Regiment of MS Cavalry Volunteers, on the 2 day of Nov, 1864, at Meridian Miss

Sworn and subscribed to, at Vicksburg
 this 1st day of Novem, 1864.
 Before E. C. Kusely Witness P. F. Stevens
Adj. Gen. & Marshal

I CERTIFY, ON HONOR, That I have carefully examined the above-named Volunteer, agreeably
 to the General Regulations of the Army, and that, in my opinion, he is free from all bodily defects and
 mental infirmity, which would in any way disqualify him from performing the duties of a soldier.

H. B. Huntsman
Surgeon U.S.A.
 EXAMINING SURGEON.

I CERTIFY, ON HONOR, That I have minutely inspected the Volunteer Taswell Helm
 previously to his enlistment, and that he was entirely sober when enlisted; that, to the best of my
 judgment and belief, he is of lawful age; and that, in accepting him as duly qualified to perform the
 duties of an able-bodied soldier, I have strictly observed the Regulations which govern the recruiting
 service. This soldier has Blk eyes, Blk hair, Cold complexion, is five
 feet five inches high.

Adj. Gen. & Marshal
Dist of Miss and RECRUITING OFFICER.

(A. G. O. No. 74 & 76.)

Entitled to Bounty

Adj. Gen. & Marshal
MS Cavalry

VOLUNTEER ENLISTMENT.

STATE OF

Mississippi

TOWN OF

Vicksburg

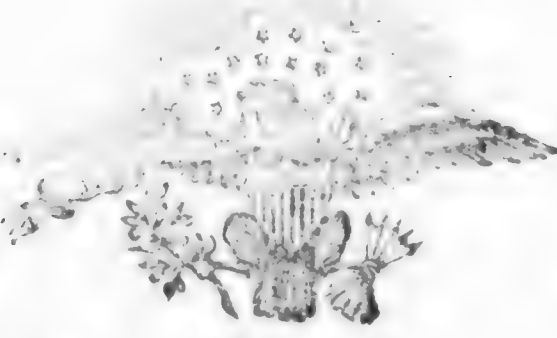

I, Taswell Helm, born in Washington Co in the State of Mississippi, aged Twenty Six years, and by occupation a Farmer, Do HEREBY ACKNOWLEDGE to have volunteered this First day of November, 1864, to serve as a **Soldier** in the Army of the United States of America, for the period of **THREE YEARS**, unless sooner discharged by proper authority: Do also agree to accept such bounty, pay, rations, and clothing, as are, or may be, established by law for volunteers. And I, Taswell Helm, do solemnly swear, that I will bear true faith and allegiance to the **United States of America**, and that I will serve them honestly and faithfully against all their enemies or opposers whomsoever; and that I will observe and obey the orders of the President of the United States, and the orders of the officers appointed over me, according to the Rules and Articles of War.

Belisle

Mustered into the service of the United States, for three years or during the war, from date of enlistment, in Company 3 Regiment of Mississippi Volunteers, on the 2 day of Nov, 1864, at Stamps Miss

Sworn and subscribed to, at

this 1st day of November

Vicksburg

Taswell Helm his mark

Before:

Eli C. Kusely
Major
Adj. Genl. of Mass

Witness J. F. Stevens

A CLERK IN CHIEF OF HONOR, That I have carefully examined the above-named Volunteer, agreeably to the General Regulations of the Army, and that, in my opinion, he is free from all bodily defects and mental infirmity, which would in any way disqualify him from performing the duties of a soldier.

H. C. Huntington
Surgeon
EXAMINING SURGEON.

I CERTIFY, ON HONOR, That I have minutely inspected the Volunteer Taswell Helm previously to his enlistment, and that he was entirely sober when enlisted; that, to the best of my judgment and belief, he is of lawful age; and that, in accepting him as duly qualified to perform the duties of an able-bodied soldier, I have strictly observed the Regulations which govern the recruiting service. This soldier has Blue eyes, Blue hair, Cold complexion, is Five feet Five inches high.

Lt. Col Eli C. Kusely
Adj. Genl. of Mass
Regiment of Mississippi Volunteers,
Dist of Miss and RECRUITING OFFICER.

(A. G. O. No. 74 & 76.)

Entitled to Bounty

Stamps Miss
Nov 2 1864
Company 3

630

Helm, Henry
Co H, 3 U. S. Col'd Cav.

Private

Private

CARD NUMBERS.

1	5341348	26
2	5341445	27
3	5341530	28
4	5341618	29
5	5341704	30
6	5341793	31
7	5341897	32
8	5341995	33
9	5342091	34
10	5342180	35
11	5342296	36
12	5342464	37
13	9089211	38
14	40727511	39
15		40
16		41
17		42
18		43
19		44
20		45
21		46
22		47
23		48
24		49
25		50

Book Mark:

EB 8-11 P 47

See also

D-6-2-17-50

A. M. Shannon
Esq.

N | **3 Cav. | U.S.C.T.**

Henry Nelson

....., Co. *M*, 3 Reg't U. S. Col'd Cav.

Appears on

Company Descriptive Book

of the organization named above.

DESCRIPTION.

Age *25* years; height *5* feet *4 1/2* inches.

Complexion *Blk*

Eyes *blk*; hair *blk*

Where born *Franklin Co Va*

Occupation *field hand*

ENLISTMENT.

When *Feb 15*....., 186*4*.

Where *Near Bluff Miss*

By whom *Capt W. H. White*; term *3* y'rs.

Remarks: *Died in Regt Hospital*
Sept 11 1865 at Memphis Tenn
final statements forwarded Sept 15
1865

Nittner

H | **3 Cav. | U.S.C.T.**

Henry Helm

Pvt, Co. H, 1 Reg't Miss. Cav. A. D.*

Age *25* years.

Appears on

Company Muster-in Roll

of the organization named above. Roll dated

James Bluff Miss, Feb 23, 1864.

Muster-in to date *Feb 15, 1864.*

Joined for duty and enrolled:

When *Feb 15, 1864.*

Where *James Bluff Miss*

Period *3* years.

Valuation of horse, \$ *100*

Valuation of horse equipments, *100*

Remarks:

* This organization subsequently became Company H, 3 Reg't U. S. Colored Cavalry.

Book mark:

W. H. Scott

H | **3 Cav. | U.S.C.T.**

Henry Hehn
1st, Co. H, 3 Reg't U. S. Col'd Cavalry.

Appears on

Company Muster Roll

for *from Feb 23 to Apr 30*, 186*4*.

Present or absent *Present*

Stoppage, \$ *100* for

Due Gov't, \$ *100* for

Valuation of horse, \$ *100*

Valuation of horse equipments, \$ *100*

Remarks:
.....
.....
.....
.....
.....
.....
.....
.....
.....

Book mark:

(358)

Wilson Scott

Copyist.

A | **3 Cav.** | **U.S.C.T.**

Henry Helm
Priv, Co. H, 3 Reg't U. S. Col'd Cavalry.

Appears on

Company Muster Roll

for *May & June*, 1864

Present or absent *Present*

Stoppage, \$ *100* for

Due Gov't, \$ *100* for

Valuation of horse, \$ *100*

Valuation of horse equipments, \$ *100*

Remarks:

Book mark:

Mrs. M. M. Mays
(358) *Mays* Copyist.

A | **3 Cav.** | **U.S.C.T.**

Henry Helm
Pvt, Co. H, 3 Reg't U. S. Col'd Cavalry.

Appears on

Company Muster Roll
for July & Aug, 1864.
Present or absent Present

Stoppage, \$.....100 for

Due Gov't, \$.....100 for

Valuation of horse, \$.....100

Valuation of horse equipments, \$.....100

Remarks:

Book mark:

(358)

W. W. Payne
Copyist.

H | 3 Cav. | U.S.C.T.

Henry Helm
Prvt, Co. H, 3 Reg't U. S. Col'd Cavalry.

Appears on

Company Muster Roll

for Sept 1864, 1864.

Present or absent Present

Stoppage, \$ 100 for

Due Gov't, \$ 100 for

Valuation of horse, \$ 100

Valuation of horse equipments, \$ 100

Remarks:

Book mark:

M. Rayne
(358) Copyist.

H | 3 Cav. | U.S.C.T.

Henry Helm
Pvt, Co. H, 3 Reg't U. S. Col'd Cavalry.

Appears on

Company Muster Roll

for Nov & Dec, 1864.

Present or absent Present

Stoppage, \$ 100 for

Due Gov't, \$ 100 for

Valuation of horse, \$ 100

Valuation of horse equipments, \$ 100

Remarks:

Book mark:

W. Dayre

(358)

Copyist.

A | **3 Cav.** | **U.S.C.T.**

Henry Helms

priv., Co. H, 3 Reg't U. S. Col'd Cavalry.

Appears on

Company Muster Roll

for Jan & Feb., 1865.

Present or absent present

Stoppage, \$ 100 for

Due Gov't, \$ 100 for

Valuation of horse, \$ 100

Valuation of horse equipments, \$ 100

Remarks:

Book mark:

James
Copyist.

A | **3 Cav.** | **U.S.C.T.**

Henry Helm
priv., Co. H, 3 Reg't U. S. Col'd Cavalry.

Appears on

Company Muster Roll

for March & April, 1863.

Present or absent Absent

Stoppage, \$ 100 for

Due Gov't, \$ 100 for

Valuation of horse, \$ 100

Valuation of horse equipments, \$ 100

Remarks: Absent on account
since Apr 29/63

Book mark: _____

Forre

A | **3 Cav. | U.S.C.T.**

Henry Helm

priv., Co. H, 3 Reg't U. S. Col'd Cavalry.

Appears on

Company Muster Roll

for May & June, 1865.

Present or absent present

Stoppage, \$ 100 for

Due Gov't, \$ 100 for

Valuation of horse, \$ 100

Valuation of horse equipments, \$ 100

Remarks: Stop for one Remington Revolver on
curry comb \$20 & c.

Book mark: _____

(358)

Sumner

Copyist.

A | **3 Cav.** | **U.S.C.T.**

Henry Helm
priv., Co. H, 3 Reg't U. S. Col'd Cavalry.

Appears on

Company Muster Roll

for July & Aug., 1869.

Present or absent present

Stoppage, \$ 100 for

Due Gov't, \$ 12 ²⁶/₁₀₀ for Ordinance
from last muster

Valuation of horse, \$ 100

Valuation of horse equipments, \$ 100

Remarks:

Book mark:

(358)

Loren

Copyist.

A | **3 Cav.** | **U.S.C.T.**

Henry Helm

priv., Co. H, 3 Reg't U. S. Col'd Cavalry.

Appears on

Company Muster Roll

for *Sept & Oct*, 186*5*.

Present or absent

Stoppage, \$ *100* for

Due Gov't, \$ *100* for

Valuation of horse, \$ *100*

Valuation of horse equipments, \$ *100*

Remarks: *Wid in Reg't. Hospital
at Sept. 15/65. at Memphis
Tenn.*

Book mark: *Wid Sept 14/65. E.B.N. 11.P.47.
120. 239. Sec. ER.*

Lourens

(358)

Copyist.

76 | **3 Cav.** | **U.S.C.T.**

Henry Helm
Priv., Co. H, 3 Reg't U. S. Colored Cav.

Appears on **Returns** as follows:

Sept. 1865, Lose Sept. 14/65 -
Memphis, Tenn. - Died
of disease.

Book mark :

(546)

J. B. Sittler

Copyist.

N. | **3 Cav.** | **U.S.C.T.**

Henry Nelson
Privt, Co. H, 3 Reg't U. S. Col'd Cavalry.

Appears on **Co, Muster-out Roll**, dated
Memphis Tenn. Jan 26, 1866 .

Muster-out to date _____, 186 .

Last paid to June 20, 1865 .

Clothing account:

Last settled _____, 186 ; drawn since \$ _____ 100

Due soldier \$ _____ 100; due U. S. \$ _____ 100

Am't for cloth'g in kind or money adv'd \$ _____ 100

Due U. S. for arms, equipments, &c., \$ _____ 100

Bounty paid \$ _____ 100; due \$ _____ 100

Remarks: Died in Regt
Hospit at Memphis
Tenn. Sept 14th 64.
Final statements
forwarded Sept 15th 65

Book mark: 120,239 HBV

died Sept 14/65. EBV 11 P 47.

Joiner.

1919

--	--	--

Helm, Henry
B, Co. H, **3** **U.S.C. Cav.**
..... **Reg't**.....

Enclosures.

Bed Cards	Descriptive Lists
Burial Records	Final Statements
Certs. of Dis. for Discharge	Furloughs
C. M. Charges	Med. Des. Lists
Med. Certificates	Orders

Other papers relating to—

Admission to Hosp'l	Furlough
Casualty Sheet (Officer's)	Med. Examination
Confinement	Misc. Information
Contracts	Pay or Clothing
Death or Effects	Personal Reports
Desertions	Rank
Discharge from Hosp'l	Transfer to Hosp'l
Discharge from Service	Transfer to V. R. C.
Duty	Transportation

[OFFICE INDORSEMENT.]

War Department,

ADJUTANT GENERAL'S OFFICE,

May 11, 1871

The Death of *Capt. Henry*
W. H. ..., Co. *H*, 3rd Reg't U. S.

Colored *... is reported as follows:*

- On Company Muster Roll.
For *Sept 11, 1864*, *Sept 11, 1864*
- Company Muster-out Roll.
Sept 11, 1864
- Company Descriptive Book. *1864*
- Company Morning Reports. *1864*
- Soldier's Final Statement. *1864*
- Soldier's Record of Death and Interment. *1864*
- Soldier's Inventory of Effects. *1864*
- Soldier's Certificate of Disability for Discharge. *1864*
- Soldier's Individual Muster-out Roll. *1864*
- Regimental Return.
For *Sept 11, 1864*, *Sept 11, 1864*
- Regimental Quarterly Returns. *1864*
- Regimental Descriptive Book. *1864*
- By Surgeon General. *1864*

Sept 14, 1864, is held to be

the correct date, and the Company Muster Roll will be amended accordingly.

See *Page 2nd Aug* *Clay 19th 71.*
Anna M. ...

E. B. ...

Assistant Adjutant General.

Noted J. M.

FINAL STATEMENT

OF

Henry ...
3rd Reg't of ...

VOLUNTEERS.

NOTE 1.—Two of these certificates (or duplicates) are to be given to each Volunteer Soldier or drafted man who may be discharged without being mustered out (Final Statements are never given to men mustered out of service) that he may at once receive from the Paymaster the pay, &c., due him, and the original or other COMMISSIONED OFFICER commanding the company will certify to the fact of the delivery of the duplicate certificates; with these certificates the Soldier is "credited to" his discharge, and should also present himself to the Paymaster to have the payment endorsed upon it. The discharge is to be given back to the Soldier by the Paymaster; the latter only retaining as his vouchers the duplicate certificates.

NOTE 2.—If the Soldier is entitled to pay for the use of his horse, the Company Commander will certify to that fact on the back of both these final statements, and also to the time he has pay due for having been so mounted on his own horse.

NOTE 3.—When a Soldier is furnished with final statements, his descriptive list, if he has one, should be taken up by the officer who gives the Soldier these statements, and endorsed with a statement to that effect by the officer. The endorsement should exhibit a full statement of the time for which the Soldier was allowed pay on his final statements, the clothing account, and all other charges made for him on his account, so as to comprise a complete exhibit of his account. It will then be transmitted to the Company Commander of the Soldier, who will enter all the data necessary to a full discharge of the Soldier's account on the muster roll upon which the Soldier's discharge is reported. The descriptive list will then be destroyed. The entry of these data on the muster roll and the Soldier's account may be set out upon the receipt of these final statements from the Soldier, and which may not appear on his last final statements from the fact that his discharge is incomplete. These accounts for back pay, &c., are settled by the 2d Auditor of the Treasury Department.

NOTE 4.—Charges for loss or injury to clothing, horse equipments, and other miscellaneous charges, should appear under the heading of "Other Stoppages."

NOTE 5.—Bounty paid by State authorities, and not by the United States, will not be entered on this statement.

NOTE 6.—Amounts due the Sutler and Laundress must be entered on the muster roll on which the discharge, death, desertion, &c., is reported, as well as on the final statement, otherwise the amount cannot be collected from the United States.

NOTE 7.—This blank will be used for deceased volunteers and drafted men, as well as for others.

NOTE 8.—Where a Soldier dies in Hospital or on detached service, his descriptive list, if he has one, should be sent with his final statements, in duplicate, to the Adjutant General, Washington, D. C.

NOTE 9.—If the soldier is a drafted man or substitute, the space for time, &c., if enrolled, should contain only the word *drafted* or *substitute*, as the case may be. If the Soldier is a *RECRUIT* (or RECRUIT) the words *as a recruit*, (or *recruit*) as the case may be, should be interlined after the words *mustered into the service of the U. S.* statement of all the instalments of *Veteran* or *Recruit* *Bounty* *REMOVED* by the Soldier must be made on the back of each final statement.

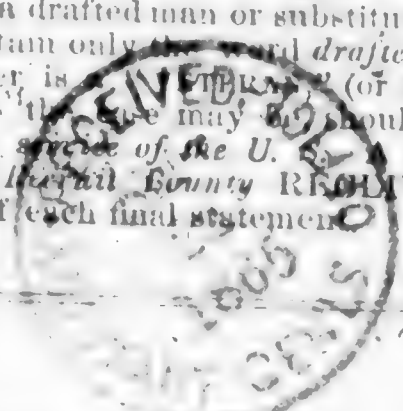

[OFFICE INDORSEMENT.]

War Department,

ADJUTANT GENERAL'S OFFICE,

March 1, 1871

The Death of *Capt. Henry
Hobbs*, Co. *H*, 3^d Reg't U. S.

Colored *Georgias* reported as follows:

On Company Muster Roll.	
For <i>Sept 1864</i> , <i>Sept 1864</i> , 1864	
Company Muster-out Roll.	
<i>Sept 1864</i> , 1864	
Company Descriptive Book.	186
Company Morning Reports.	186
Soldier's Final Statement.	186
<i>Sept 1864</i> , 1864	
Soldier's Record of Death and Interment.	186
Soldier's Inventory of Effects.	186
Soldier's Certificate of Disability for Discharge.	186

FINAL STATEMENT

OF

Henry Hobbs
3^d Reg't of *H. S. Co.*

VOLUNTEERS.

NOTE 1.—Two of these certificates (or duplicates) are to be given: each Volunteer Soldier or drafted man who may be discharged without being mustered out (Final Statements are never given to such instances out of service) that he may at once receive from the Paymaster the pay, &c. due him, and the captain or other COMMISSIONED OFFICER commanding the company will certify to the act of the delivery of the duplicate certificates; with these certificates the Soldier is "entitled to" his discharge, and should also present his discharge to the Paymaster to have the payment endorsed on it. The discharge is to be given back to the Soldier by the Paymaster; the latter only retaining as his vouchers the duplicate certificates.

NOTE 2.—If the Soldier is entitled to pay for the use of his horse, the Company Commander will certify to that fact on the back of both these final statements, and also to the time he has pay due for having been so mounted on his own horse.

NOTE 3.—When a Soldier is furnished with final statements, his descriptive list, if he has one, should be taken up by the officer who gives the Soldier these statements, and endorsed with a statement to that effect by the officer. The endorsement should exhibit a full statement of the time for which the Soldier was allowed pay on his final statements, the clothing account, and all other accounts against him or in his favor, so as to comprise a complete exhibit of his account. It will then be transmitted to the Company Commander of the Soldier, who will enter all the data necessary to a full understanding of the Soldier's account on the muster roll upon which the Soldier's discharge is reported. The descriptive list will then be destroyed. The object of this is, that the remaining portion of the Soldier's account may be settled upon the receipt of these muster rolls and the Soldier receive any pay or advances that may be due him at the time of his discharge, and which may not appear on his last final statements from the fact that his descriptive list is complete. These accounts for back pay, &c., are settled by the 2d Auditor of the Treasury Department.

NOTE 4.—Charges for loss or injury to ordnance, horse equipments, and other miscellaneous charges, should appear under the heading of "Other Stoppages."

NOTE 5.—Bounty paid by State authorities, and not by the United States, will not be entered on this statement.

NOTE 6.—Amounts due the Sutler and Landress must be entered on the muster roll on which the discharge, death, desertion, &c., is reported, as well as on the final statement, otherwise the amount cannot be collected from the United States.

NOTE 7.—This blank will be used for deceased volunteers and drafted men, as well as for others.

NOTE 8.—Where a Soldier dies in Hospital or on detached service, his descriptive list, if he has one, should be sent with his final statements, in duplicate, to the Adjutant General, Washington, D. C.

NOTE 9.—If the soldier is a drafted man or substitute, the space for time, &c., enrolled, should contain only the word *drafted* or *substitute*, as the case may be. If the Soldier is a *recruit* (or *RECRUIT*) the words *as a veteran*, (or *recruit*.) as the case may be, should be interlined after the words *mustered into the service of the U. S.* statement of all the installments of *Veteran* or *Recruit* Bounty RECEIVED by the Soldier must be made on the back of each final statement.

ADJUTANT GENERAL'S OFFICE.

Sept 25. 1865.

Duplicate with Inventory sent 2d Auditor.

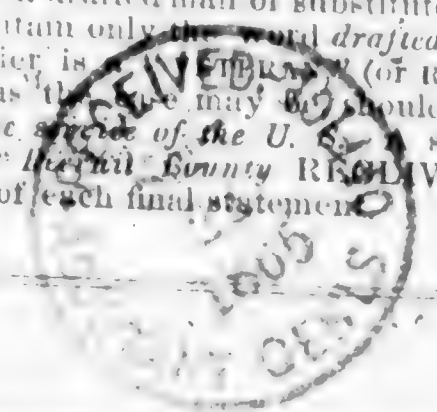

I certify, on honor, that Henry Helm, a Trooper of
 Captain H. White Company No 3 of the 3rd Regiment of Missouri
VOLUNTEERS, of the State of _____, born in Franklin Co State
 of Virginia, aged 25 years; 5 feet 4 1/2 inches high; Blk complexion,
Blk eyes, Blk hair, and by occupation a Trice Hand, who joined for service
 and was enrolled (see Note 9) on the 15th day of Feb, 1864, at Haines Bluff
 by Capt White, for the period of 3 years, and mustered into
 the service of the United States on the 23rd day of February, 1864, at
Haines Bluff, by Reut Callinan; and having served
 HONESTLY and FAITHFULLY with his Company to the present date, is now entitled to a
DISCHARGE by reason of Death, died in Regtl Hospital
at Memphis Tenn, Sept 14th 1865 of Typhoid Fever

The said Henry Helm was last paid by Paymaster
Maj Emerson, to include the 30th day of June, 1865, and
 has pay due him from that time to the present date; he is entitled to pay and subsistence for
TRAVELING to place of enrollment, and whatever other allowances are authorized to volunteer
 soldiers, drafted men, or militia, so discharged. He has received from the United States **CLOTHING**
 amounting to Sixty One⁴⁹/₁₀₀ dollars, since the 31st day of August,
 1864, when his clothing account was last settled. He has received from the United States
 _____₁₀₀ dollars advanced **BOUNTY**.

There is to be stopped from him, on account of the State of _____, or other
 authorities, for **CLOTHING**, &c., received on entering service, _____₁₀₀ dollars; and
 for other stoppages, viz: _____

_____₁₀₀ dollars.
 He has been furnished with **TRANSPORTATION** in kind from the place of his discharge to
 _____; and he has been **SUBSISTED** for **TRAVELING** to his
 place of enrollment, up to the _____, 186 .

He is indebted to _____, **SUTLER**, _____₁₀₀ dollars.
 He is indebted to _____, **LAUNDRESS**, _____₁₀₀ dollars.

Given in Duplicate at Memphis Tenn, this 13th day
 of Sept, 1865.

Harrison White
Capt 3rd US Cavalry
 Commanding Company.

631
Helm Jazewell

Co E, 3 U. S. Col'd Cav.

Private

CARD NUMBERS.

1	26
2	27
3	28
4	29
5	30
6	31
7	32
8	33
9	34
10	35
11	36
12	37
13	38
14	39
15	40
16	41
17	42
18	43
19	44
20	45
21	46
22	47
23	48
24	49
25	50

See Hellem Jazewell

Book Mark:

See also

632

Hemway, Robert
Co I, 3 U. S. Col'd Cav.

Private | *Private*

CARD NUMBERS.

1	3 3 4 2 5 2 6	26
2	5 3 4 2 6 2 1	27
3	5 3 4 2 7 0 7	28
4	5 3 4 2 7 9 4	29
5	8 3 4 2 9 0 7	30
6	5 3 4 3 6 1 7	31
7	9 0 8 9 3 3 4	32
8	4 0 7 2 7 5 1 3	33
9		34
10		35
11		36
12		37
13		38
14		39
15		40
16		41
17		42
18		43
19		44
20		45
21		46
22		47
23		48
24		49
25		50

Book Mark:

See also

W | **3 Cav. | U.S.C.T.**

Robert Hamway
Co. _____, 3 Reg't U. S. Col'd Cav.

Appears on
Company Descriptive Book
of the organization named above.

DESCRIPTION.

Age *40* years; height *5* feet *9* inches.
Complexion *Blk*
Eyes *blk*; hair *blk*
Where born *Petersburg Va*
Occupation *field hand*

ENLISTMENT.

When *Feb 24*, 186*4*.
Where *Maine Bluff*
By whom *Capt Brainard*; term *3* y'rs.
Remarks: *Died of disease Oct 12/64*
at Gedrick Edge Va

Hutton

A | **3 Cav.** | **U.S.C.T.**

Robert Hemmway
Part, Co. *I*, 1 Reg't Miss. Cav., Corps d'Afrique.*
age 40 yrs
Appears on

Company Muster-in Roll

of the organization named above. Roll dated

Haines Bluffs Miss, Feb 26, 1864.

Muster-in to date *Feb 26, 1864.*

Joined for duty and enrolled:

When *Feb 24*, 186*4*

Where *Haines Bluffs Miss*

Period *3* years.

Valuation of horse, \$ 100

Valuation of horse equipments, \$ 100

Remarks:

*This organization subsequently became Co. *D*, 3 Reg't U. S. Colored Cavalry.

Book mark:

(356)

Bradshaw

Copyist.

A | **3 Cav.** | **U.S.C.T.**

Robert Hemway
Prot, Co. I, 3 Reg't U. S. Col'd Cavalry.

Appears on

Company Muster Roll

for *Feb 24 to Apr 30*, 1864.

Present or absent *present*

Stoppage, \$ *100* for

Due Gov't, \$ *100* for

Valuation of horse, \$ *100*

Valuation of horse equipments, \$ *100*

Remarks:

Book mark:

(358)

Bradshaw
Copyist.

A | **3 Cav.** | **U.S.C.T.**

Robert Hemway
Pvt, Co. I, 3 Reg't U. S. Col'd Cavalry.

Appears on

Company Muster Roll

for *May & June*, 186*4*.

Present or absent *present*.

Stoppage, \$ *100* for

Due Gov't, \$ *100* for

Valuation of horse, \$ *100*

Valuation of horse equipments, \$ *100*

Remarks: *Stop for one pr
Spurs & Straps 60 cents.*

Book mark:

Bradshaw

A | **3 Cav. | U.S.C.T.**

Robert Newway
Priv., Co. I, 3 Reg't U. S. Col'd Cavalry.

Appears on

Company Muster Roll

for July & Aug, 186

Present or absent Present

Stoppage, \$ 100 for

Due Gov't, \$ 100 for

Valuation of horse, \$ 100

Valuation of horse equipments, \$ 100

Remarks: Stop for one
for Spurs and Straps
and Burching to \$1.64

Book mark: _____

(358)

Bradshaw
Copyist.

A | **3 Cav. | U.S.C.T.**

Robert Hemway
Pvt, Co. I, 3 Reg't U. S. Col'd Cavalry.

Appears on

Company Muster Roll

for *Sept & Oct*, 186*4*.

Present or absent.....

Stoppage, \$..... 100 for.....

Due Gov't, \$..... 100 for.....

Valuation of horse, \$..... 100

Valuation of horse equipments, \$..... 100

Remarks: *Died at Vicksburg,*
Miss Oct 12/64. I
stop for one canteen
one Haversack \$1.00
one pr. Spurs and
Straps 60 cts.

Book mark:.....

V. Bradshaw

(358)

Copyist.

76, | 3 Cav. | U.S.C.T.

Robt Hemway
Pvt, Co. I, 3 Reg't U. S. Colored Cav.

Appears on Returns as follows:

Oct. 1864. Lost Oct. 12/64 Vicksburg - Died.

Book mark :

J. B. Dittler

(546)

Copyist.

H | 3 Cav. | U.S.C.T.

Robert Henway

Priv., Co. D, 3 Reg't U. S. Col'd Cavalry.

Appears on Co. Muster-out Roll, dated
Memphis Tenn Jan 26, 1866.

Muster-out to date _____, 1866 .

Last paid to Apr 30, 1864 .

Clothing account:

Last settled _____, 1866 ; drawn since \$ _____ 100

Due soldier \$ _____ 100; due U. S. \$ _____ 100

Am't for cloth'g in kind or money adv'd \$ _____ 100

Due U. S. for arms, equipments, &c., \$ _____ 100

Bounty paid \$ _____ 100; due \$ _____ 100

Remarks: Died of Disease
at Vicksburg, Miss Oct 12
1864. Final statements for-
warded.

Book mark: _____

(861)

Copyist.

Hemway, Robert

A, Co.

3

Reg't **U.S.C. Cav.**

5 Enclosures.

Bed Cards	Descriptive Lists
Burial Records	Final Statements <i>LL</i>
Certs. of Dis. for Discharge	Furloughs
C. M. Charges	Med. Des. Lists
Med. Certificates	Orders

Other papers relating to—

Admission to Hosp'l	Furlough
Casualty Sheet (Officer's)	Med. Examination
Confinement	Misc. Information
Contracts	Pay or Clothing
Death or Effects <i>/</i>	Personal Reports
Desertions	Rank
Discharge from Hosp'l	Transfer to Hosp'l
Discharge from Service	Transfer to V. R. C.
Duty	Transportation

FINAL STATEMENT

OF

Robert Hemway
3^d Reg't of U.S. Col'd Cavalry

~~VOUCHERS.~~

Robert Hemway

NOTE 1.—Two of these certificates (or duplicates) are to be given to each Volunteer Soldier or drafted man who may be discharged previously to the discharge of his company, that he may at once receive from the Paymaster the pay, &c., due him, and the captain or other COMMISSIONED officer commanding the company will certify to the act of the delivery of the duplicate certificates; on these certificates the Soldier is "entitled to" his discharge, and should also present his discharge to the Paymaster to have the payment endorsed on it. The discharge is to be given back to the Soldier by the Paymaster; the latter only retaining as his voucher the duplicate certificates.

NOTE 2.—If the Soldier is entitled to pay for the use of his horse, the Company Commander will certify to that fact on the back of both these final statements, and also to the time he has pay due for having been so mounted on his own horse.

NOTE 3.—When a Soldier is furnished with final statements, his descriptive list, if he has one, should be taken up by the officer who gives the Soldier these statements, and endorsed with a statement to this effect by the officer. This endorsement should exhibit a full statement of the time for which the Soldier was allowed pay on his final statements, the clothing account, and all other charges against him or in his favor, so as to comprise a complete exhibit of his account. It will then be transmitted to the company commander of the Soldier, who will enter all the data necessary to a full understanding of the Soldier's account on the muster roll upon which the Soldier's discharge is reported. The descriptive list will then be destroyed. The object of this is, that the remaining portion of the Soldier's account may be settled upon the receipt of these muster rolls, and the Soldier receive any pay or allowances that may be due him at the time of his discharge, and which may not appear on his final statements from the fact that his descriptive list is incomplete. These accounts for back pay, &c., are settled by the 2d Auditor of the Treasury Department.

NOTE 4.—Charges for loss or injury to ordnance, horse equipments, and other miscellaneous charges, should appear under the heading of "Other Stoppages."

NOTE 5.—Bounty paid by State authorities, and not by the United States, will not be entered on this statement.

NOTE 6.—Amounts due the Sutler and Laundress must be entered on the muster roll on which the discharge, death, desertion, &c., is reported, as well as on the final statement, otherwise the amount cannot be collected from the United States.

NOTE 7.—This blank will be used for deceased volunteers and drafted men, as well as for others.

NOTE 8.—Where a Soldier dies in Hospital or on detached service, his descriptive list, if he has one, should be sent with his final statements, in duplicate, to the Adjutant General, Washington, D. C.

ADJUTANT GENERAL'S OFFICE.

Nov 21 1864

Duplicate with Inventory sent 2d Auditor.



I certify, on honor, that Robert Kemway a Private of
Captain J. Brannards Company (I) of the 2^d Regiment of Colored Cavalry
~~VOLUNTEERS~~ of the State of _____, born in Petersburg, State
of Virginia, aged 40 years; 5 feet 9 inches high; Black complexion,
Black eyes, Black hair, and by occupation a Field Hand, having joined the company on
its original organization at Hains Bluffs Miss, and enrolled in it at the muster into
the service of the United States at Hains Bluffs, on the 24th day
of February, 1864, (or was mustered in service as a recruit, by _____
_____, at _____, on the _____ day of _____,
1864, or was drafted and mustered into the service of the United States from the
Enrollment District of the State of _____, at _____,
on the _____ day of _____, 1864,) to serve in the Regiment, for
the term of Three Years: and having served **HONESTLY** and
FAITHFULLY with his Company in The Field to the present date, is now
entitled to a **DISCHARGE** by reason of Death Died at Vicksburg Miss
Oct 12th 1864

The said Robert Kemway was last paid by Paymaster
Ma^r Martin to include the 30th day of April, 1864, and has
pay due him from that time to the present date; he is entitled to pay and subsistence for
TRAVELING to place of enrollment, and whatever other allowances are authorized to volunteer
soldiers, drafted men, or militia, so discharged. He has received from the United States **CLOTHING**
amounting to Forty Five $\frac{55}{100}$ dollars, since the 24 day of February,
1864, when his clothing account was last settled. He has received from the United States
100 dollars advanced **BOUNTY**.

There is to be stopped from him, on account of the State of _____, or other
authorities, for **CLOTHING**, &c., received on entering service, _____ $\frac{100}{100}$ dollars; and
for other stoppages, viz: One Centen one Hair comb One
pr Spurs and Straps
One $\frac{50}{100}$ dollars.

He has been furnished with **TRANSPORTATION** in kind from the place of his discharge to
_____; and he has been **SUBSISTED** for **TRAVELING** to his
place of enrollment, up to the _____, 1864.

He is indebted to _____, **SUTLER**, _____ $\frac{100}{100}$ dollars.

He is indebted to _____, **LAUNDRESS**, _____ $\frac{100}{100}$ dollars.

Given in Duplicate, at Vicksburg Miss, this 20th day
of October, 1864.

Howard Cook
2^d Lieut

FINAL STATEMENT

OF

Robert Fenwick

3^d Reg't of U.S. Col'd. Cavalry

VOLUNTEERS.

NOTE 1.—Two of these certificates (or duplicates) are to be given to each Volunteer Soldier or drafted man who may be discharged previously to the discharge of his company, that he may at once receive from the Paymaster the pay, &c., due him, and the captain or other COMMISSIONED officer commanding the company will certify to the act of the delivery of the duplicate certificates; on these certificates the Soldier is "entitled to" his discharge, and should also present his discharge to the Paymaster to have the payment enforced on it. The discharge is to be given back to the Soldier by the Paymaster; the latter only retaining as his voucher the duplicate certificates.

NOTE 2.—If the Soldier is entitled to pay for the use of his horse, the Company Commander will certify to that fact on the back of both these final statements, and also to the time he has pay due for having been so mounted on his own horse.

NOTE 3.—When a Soldier is furnished with final statements, his descriptive list, if he has one, should be taken up by the officer who gives the Soldier these statements, and endorsed with a statement to this effect by the officer. This endorsement should exhibit a full statement of the time for which the Soldier was allowed pay on his final statements, the clothing account, and all other charges against him or in his favor, so as to comprise a complete exhibit of his account. It will then be transmitted to the company commander of the Soldier, who will enter all the data necessary to a full understanding of the Soldier's account on the muster roll upon which the Soldier's discharge is reported. The descriptive list will then be destroyed. The object of this is, that the remaining portion of the Soldier's account may be settled upon the receipt of these muster rolls, and the Soldier receive any pay or allowances that may be due him at the time of his discharge, and which may not appear on his final statements from the fact that his descriptive list is incomplete. These accounts for back pay, &c., are settled by the 2d Auditor of the Treasury Department.

NOTE 4.—Charges for loss or injury to ordnance, horse equipments, and other miscellaneous charges, should appear under the heading of "Other Stoppages."

NOTE 5.—Bounty paid by State authorities, and not by the United States, will not be entered on this statement.

NOTE 6.—Amounts due the Sutler and Laundress must be entered on the muster roll on which the discharge, death, desertion, &c., is reported, as well as on the final statement, otherwise the amount cannot be collected from the United States.

NOTE 7.—This blank will be used for deceased volunteers and drafted men, as well as for others.

NOTE 8.—Where a Soldier dies in Hospital or on detached service, his descriptive list, if he has one, should be sent with his final statements, in duplicate, to the Second Auditor, Washington, D. C.

1864



MARR 23

I certify, on honor, that Robert Hemway a Private of
Captain J. Brainard Company (E) of the 5th Regiment of A. S. Cavalry
~~VOLUNTEERS~~ of the State of _____, born in Petersburg, State
of Virginia, aged 40 years; 5 feet 9 inches high; Black complexion.
Black eyes, Black hair, and by occupation a Field Hand, having joined the company on
its original organization at Blains Bluff Miss, and enrolled in it at the muster into
the service of the United States at Blains Bluff, on the 24 day
of February, 1864, (or was mustered in service as a recruit, by _____
at _____, on the _____ day of _____,
186 , or was drafted and mustered into the service of the United States from the _____
Enrollment District of the State of _____, at _____
on the _____ day of _____, 186 ,) to serve in the Regiment, for
the term of Three Years: and having served **HONESTLY** and
FAITHFULLY with his Company in The Field to the present date, is now
entitled to a **DISCHARGE** by reason of Death Died at Vicksburg Miss
Oct. 12th 1864

The said Robert Hemway was last paid by Paymaster
Wm. Martin to include the 30th day of April, 1864, and has
pay due him from that time to the present date; he is entitled to pay and subsistence for
TRAVELING to place of enrollment, and whatever other allowances are authorized to volunteer
soldiers, drafted men, or militia, so discharged. He has received from the United States **CLOTHING**
amounting to Forty Four $\frac{52}{100}$ dollars, since the 24th day of February
1864, when his clothing account was last settled. He has received from the United States
_____ $\frac{100}{100}$ dollars advanced **BOUNTY**.

There is to be stopped from him, on account of the State of _____, or other
authorities, for **CLOTHING**, &c, received on entering service, _____ $\frac{100}{100}$ dollars; and
for other stoppages, viz: One Canteen One Haversack One
pr Spur and Straps
One $\frac{50}{100}$ dollars.

He has been furnished with **TRANSPORTATION** in kind from the place of his discharge to
_____; and he has been **SUBSISTED** for **TRAVELING** to his
place of enrollment, up to the _____, 186 .

He is indebted to _____, **SUTLER**, _____ $\frac{100}{100}$ dollars.

He is indebted to _____, **LAUNDRESS**, _____ $\frac{100}{100}$ dollars.

Given in Duplicate, at Vicksburg Miss, this 20th day
of October, 1864.

Howard Cook

2^d Lieut

Commanding Company

14

FINAL STATEMENT

OF

Robert Henryway

3^d Reg't of U.S. Col'd. Cavalry

VOLUNTEERS.

NOTE 1.—Two of these certificates (or duplicates) are to be given to each Volunteer Soldier or drafted man who may be discharged previously to the discharge of his company, that he may at once receive from the Paymaster the pay, &c., due him, and the captain or other COMMISSIONED officer commanding the company will certify to the act of the delivery of the duplicate certificates; on these certificates the Soldier is "entitled to" his discharge, and should also present his discharge to the Paymaster to have the payment endorsed on it. The discharge is to be given back to the Soldier by the Paymaster; the latter only retaining as his voucher the duplicate certificates.

NOTE 2.—If the Soldier is entitled to pay for the use of his horse, the Company Commander will certify to that fact on the back of both these final statements, and also to the time he has pay due for having been so mounted on his own horse.

NOTE 3.—When a Soldier is furnished with final statements, his descriptive list, if he has one, should be taken up by the officer who gives the Soldier these statements, and endorsed with a statement to this effect by the officer. This endorsement should exhibit a full statement of the time for which the Soldier was allowed pay on his final statements, the clothing account, and all other charges against him or in his favor, so as to comprise a complete exhibit of his account. It will then be transmitted to the company commander of the Soldier, who will enter all the data necessary to a full understanding of the Soldier's account on the muster roll upon which the Soldier's discharge is reported. The descriptive list will then be destroyed. The object of this is, that the remaining portion of the Soldier's account may be settled upon the receipt of these muster rolls, and the Soldier receive any pay or allowances that may be due him at the time of his discharge, and which may not appear on his final statements from the fact that his descriptive list is incomplete. These accounts for back pay, &c., are settled by the 2d Auditor of the Treasury Department.

NOTE 4.—Charges for loss or injury to ordnance, horse equipments, and other miscellaneous charges, should appear under the heading of "Other Stoppages."

NOTE 5.—Bounty paid by State authorities, and not by the United States, will not be entered on this statement.

NOTE 6.—Amounts due the Sutler and Laundress must be entered on the muster roll on which the discharge, death, desertion, &c., is reported, as well as on the final statement, otherwise the amount cannot be collected from the United States.

NOTE 7.—This blank will be used for deceased volunteers and drafted men, as well as for others.

NOTE 8.—Where a Soldier dies in Hospital or on detached service, his descriptive list, if he has one, should be sent with his final statements, in duplicate, to the Adjutant General, Washington, D. C.

1864 JUN 21 1871
ADJUTANT GEN'L

I certify, on honor, that Robert F. Hemway a Private of
 Captain J. B. Rainards Company (L) of the 8th Regiment of U. S. Colored Cavalry
~~VOLUNTEERS~~, of the State of _____, born in Petersburg, State
 of Virginia, aged 40 years; 5 feet 9 inches high; Black complexion,
Black eyes, Black hair, and by occupation a Field Hand, having joined the company on
 its original organization at Hains Bluffs, and enrolled in it at the muster into
 the service of the United States at Hains Bluffs, on the 24th day
 of February, 1864, (or was mustered in service as a recruit, by _____
 _____, at _____, on the _____ day of _____,
 186 , or was drafted and mustered into the service of the United States from the _____
 Enrollment District of the State of _____, at _____,
 on the _____ day of _____, 186 ,) to serve in the Regiment, for
 the term of Three Years: and having served HONESTLY and
 FAITHFULLY with his Company in The Field to the present date, is now
 entitled to a **DISCHARGE** by reason of Death Died at Vicksburg Miss
Oct. 12th 1864

The said Robert F. Hemway was last paid by Paymaster
Major Martin to include the 30th day of April, 1864, and has
 pay due him from that time to the present date; he is entitled to pay and subsistence for
 TRAVELING to place of enrollment, and whatever other allowances are authorized to volunteer
 soldiers, drafted men, or militia, so discharged. He has received from the United States **CLOTHING**
 amounting to Twenty Four $\frac{52}{100}$ dollars, since the 24 day of February,
 1864, when his clothing account was last settled. He has received from the United States
 _____ $\frac{100}{100}$ dollars advanced **BOUNTY**.

There is to be stopped from him, on account of the State of _____, or other
 authorities, for **CLOTHING**, &c., received on entering service, _____ $\frac{100}{100}$ dollars; and
 for other stoppages, viz: One Canteen One Haversack One
per Spurs and Straps
 _____ $\frac{50}{100}$ dollars.

He has been furnished with **TRANSPORTATION** in kind from the place of his discharge to
 _____; and he has been **SUBSISTED** for **TRAVELING** to his
 place of enrollment, up to the _____, 186 .

He is indebted to _____, **SUTLER**, _____ $\frac{100}{100}$ dollars.

He is indebted to _____, **LAUNDRESS**, _____ $\frac{100}{100}$ dollars.

Given in Duplicate, at Vicksburg Miss, this 20th day
 of October, 1864.

Howard Cook
2 Lieut

Commanding Company.

14

ARTICLES OF WAR.

ART. 95. When any non-commissioned officer or soldier shall die, or be killed in the service of the United States, the then commanding officer of the troop or company shall, in the presence of two other commissioned officers, take an account of what effects he died possessed of, above his arms and accoutrements, and transmit the same to the office of the Department of War, which said effects are to be accounted for, and paid to the representatives of such deceased non-commissioned officer or soldier. And in case any of the officers, so authorized to take care of the effects of deceased officers and soldiers, should, before they have accounted to their representatives for the same, have occasion to leave the regiment or post, by preferment or otherwise, they shall, before they be permitted to quit the same, deposit in the hands of the commanding officer, or of the assistant military agent, all the effects of such deceased non-commissioned officers and soldiers, in order that the same may be secured for, and paid to, their respective representatives.

ARMY REGULATIONS—EDITION OF 1861.

DECEASED SOLDIERS.

Par. 152. Inventories of the effects of deceased non-commissioned officers and soldiers, required by the 95th Article of War, will be forwarded to the Adjutant General, by the commander of the company to which the deceased belonged, and a duplicate of the same to the colonel of the regiment. Final statements of pay, clothing, &c., will be sent with the inventories. When a soldier dies at a post or station absent from his company, it will be the duty of his immediate commander to furnish the required inventory, and, at the same time, to forward to the commanding officer of the company to which the soldier belonged, a report of his death, specifying the date, place, and cause; to what time he was last paid, and the money or other effects in his possession at the time of his decease; which report will be noted on the next muster roll of the company to which the man belonged. Each inventory will be endorsed, "Inventory of the effects of _____, late of company (—) _____ regiment of _____, who died at _____, the _____ day of _____, 186—." If a legal representative receive the effects, it will be stated in the report. If the soldier leave no effects, the fact will be reported.

Par. 153. Should the effects of a deceased non-commissioned officer or soldier not be administered upon within a short period after his decease, they shall be disposed of by a Council of Administration, under the authority of the commanding officer of the post, and the proceeds deposited with the Paymaster, to the credit of the United States, until they shall be claimed by the legal representatives of the deceased.

Par. 154. In all such cases of sales by the Council of Administration, a statement in detail, or account of the proceeds, duly certified by the Council and commanding officer, accompanied by the Paymaster's receipt for the proceeds, will be forwarded by the commanding officer to the Adjutant General. The statement will be endorsed, "Report of the proceeds of the effects of _____, late of company (—) _____ regiment of _____, who died at _____, the _____ day of _____, 186—."

NOTE 1.—The effects in all cases, when called for, should be turned over to the legal representative, without further authority from the Adjutant General. When the effects are turned over to the relatives of the deceased before these inventories are sent to the Adjutant General, their receipts therefor should be attached to the inventories. In all other cases, one copy will be sent with a letter of transmittal direct to the Adjutant General, and a duplicate retained by the officer.

NOTE 2.—Particular care should be taken to take receipts in duplicate from the Paymaster for any funds turned over to him; one copy should be sent direct to the Adjutant General and one retained by the officer.

INVENTORY OF THE EFFECTS

OF

Robert Hemmway

Late of Company *E*

E Reg't of U.S. Calnd Cavalry

Volunteers, who died at *Richmond Ky*

on the *12* day of *October* 186*4*



Inventory of the effects of Robert Sherman late
a Private of Captain J. Rainards Company A of
the 3^d Regiment of U.S. Colored Cavalry ~~Volunteers~~, who was enrolled as
a Private at Harris Bluffs in the State of Mississippi on
the 24 day of February 1864, and mustered into the service of the United
States as a Private on the 26 day of February 1864, at Harris Bluffs
in Company A, 3^d Regiment of U.S. Colored Cavalry Volunteers, to serve 6
years or during the war; he was born in Petersburg in the State
of Virginia; he was 40 years of age, 5 feet 9 inches
high, Dark complexion, Black eyes, Black hair, and by occupation, when enrolled,
a Field Hand; he died in Hospital, at
Vicksburg Miss. on the 12 day of October 1864, by
reason of Disease.

INVENTORY.					
ARTICLES.	No.	ARTICLES.	No.	ARTICLES.	No.
Hats.....		Pairs trousers.....		Knapsacks.....	
Caps.....		Pairs flannel drawers.....			
Forage caps.....		Pairs cotton drawers.....			
Great coats.....		Flannel shirts.....			
Uniform coats.....		Cotton shirts.....			
Uniform jackets.....		Pairs boots.....			
Flannel sack coats.....		Pairs shoes.....			
Blouses.....		Pairs socks.....			
Stable frocks.....		Blankets.....			
Fatigue overalls.....		Haversacks.....			
				MONEY.	
					Specie.....
				Notes.....	\$

I CERTIFY, ON HONOR, that ~~the above inventory comprises~~ all the effects of Robert Sherman, deceased, and that ~~the effects are in the hands~~ of were ~~barred with~~ at him to be disposed of by a Council of Administration.

(DUPLICATES.)

Howard Cook
2 Lieut
Commanding the Company.

STATION: Vicksburg Miss.
DATE: October 20 1864

ARTICLES OF WAR.

ART. 95. When any non-commissioned officer or soldier shall die, or be killed in the service of the United States, the then commanding officer of the troop or company shall, in the presence of two other commissioned officers, take an account of what effects he died possessed of, above his arms and accoutrements, and transmit the same to the office of the Department of War, which said effects are to be accounted for, and paid to the representatives of such deceased non-commissioned officer or soldier. And in case any of the officers, so authorized to take care of the effects of deceased officers and soldiers, should, before they have accounted to their representatives for the same, have occasion to leave the regiment or post, by preferment or otherwise, they shall, before they be permitted to quit the same, deposit in the hands of the commanding officer, or of the assistant military agent, all the effects of such deceased non-commissioned officers and soldiers, in order that the same may be secured for, and paid to, their respective representatives.

ARMY REGULATIONS—EDITION OF 1861.

DECEASED SOLDIERS.

Par. 152. Inventories of the effects of deceased non-commissioned officers and soldiers, required by the 95th Article of War, will be forwarded to the Adjutant General, by the commander of the company to which the deceased belonged, and a duplicate of the same to the colonel of the regiment. Final statements of pay, clothing, &c., will be sent with the inventories. When a soldier dies at a post or station absent from his company, it will be the duty of his immediate commander to furnish the required inventory, and, at the same time, to forward to the commanding officer of the company to which the soldier belonged, a report of his death, specifying the date, place, and cause; to what time he was last paid, and the money or other effects in his possession at the time of his decease: which report will be noted on the next muster roll of the company to which the man belonged. Each inventory will be endorsed, "Inventory of the effects of _____, late of company (—) _____ regiment of _____, who died at _____, the _____ day of _____, 186—." If a legal representative receive the effects, it will be stated in the report. If the soldier leave no effects, the fact will be reported.

Par. 153. Should the effects of a deceased non-commissioned officer or soldier not be administered upon within a short period after his decease, they shall be disposed of by a Council of Administration, under the authority of the commanding officer of the post, and the proceeds deposited with the Paymaster, to the credit of the United States, until they shall be claimed by the legal representatives of the deceased.

Par. 154. In all such cases of sales by the Council of Administration, a statement in detail, or account of the proceeds, duly certified by the Council and commanding officer, accompanied by the Paymaster's receipt for the proceeds, will be forwarded by the commanding officer to the Adjutant General. The statement will be endorsed, "Report of the proceeds of the effects of _____, late of company (—) _____ regiment of _____, who died at _____, the _____ day of _____, 186—."

NOTE 1.—The effects in all cases, when called for, should be turned over to the legal representative, without further authority from the Adjutant General. When the effects are turned over to the relatives of the deceased before these inventories are sent to the Adjutant General, their receipts therefor should be attached to the inventories. In all other cases, one copy will be sent with a letter of transmittal direct to the Adjutant General, and a duplicate retained by the officer.

NOTE 2.—Particular care should be taken to take receipts in duplicate from the Paymaster for any funds turned over to him; one copy should be sent direct to the Adjutant General and one retained by the officer.

INVENTORY OF THE EFFECTS

OF

Robert Hemmway

Late of Company "G"

3^d Reg't of U.S. Colored Cavalry

Volunteers, who died at *Padwick's bridge*

on the *12th* day of *October* 186*4*



Inventory of the effects of Robert Hemway late
a Private of Captain J. Brammards Company "D" of
the 3^d Regiment of U.S. Colored Cavalry Volunteers, who was enrolled as
a Private at Haines Bluffs in the State of Mississippi on
the 24 day of February 1864, and mustered into the service of the United
States as a Private on the 26th day of February 1864, at Haines Bluffs
in Company "D", 3^d Regiment of U.S. Colored Cavalry Volunteers, to serve 3
years or during the war; he was born in Petersburg in the State
of Virginia; he was 40 years of age, 5 feet 7 inches
high, Black complexion, Black eyes, Black hair, and by occupation, when enrolled,
a Field Hand; he died in Hospital, at
Petersburg Miss on the 12th day of October 1864, by
reason of Disease

INVENTORY.					
ARTICLES.	No.	ARTICLES.	No.	ARTICLES.	No.
Hats.....		Pairs trousers.....		Knapsacks.....	
Caps.....		Pairs flannel drawers.....			
Forage caps.....		Pairs cotton drawers.....			
Great coats.....		Flannel shirts.....			
Uniform coats.....		Cotton shirts.....			
Uniform jackets.....		Pairs boots.....			
Flannel sack coats.....		Pairs shoes.....			
Blouses.....		Pairs socks.....			
Stable frocks.....		Blankets.....			
Fatigue overalls.....		Haversacks.....			
				MONEY.	
				Specie.....	\$
				Notes.....	\$

I CERTIFY, ON HONOR, that the ~~above inventory comprises~~ all the effects of Robert Hemway, deceased, and that the effects are in the hands ~~of~~ were buried with him to be disposed of by a Council of Administration.

(DUPLICATES.)

Howard Cook
2^d Lieut
Commanding the Company.

STATION: Petersburg Miss
DATE: October 30th 1864

655
Henderson, Alfred

Co H, 3 U. S. Col'd Cav.

2^o Lieut.

1^o Lieut.

CARD NUMBERS.

1	5341326	26
2	5330874	27
3	5341413	28
4	5341501	29
5	5341586	30
6	5341670	31
7	5341761	32
8	5341853	33
9	5341957	34
10	5342055	35
11	5342143	36
12	5331594	37
13	5330750	38
14	5342223	39
15	5342300	40
16	5342374	41
17	9435937	42
18	H-215-CJ-1864	43
19	40727514	44
20		45
21		46
22		47
23		48
24		49
25		50

Book Mark: 1557 let. 80
H-215-CJ-1864

See also J. H. H. H. H.

41669993 20 21111

02988451 actual

P.M. & M. Co. 998455-12-18-15 P.F.C.

A. M. Shannon
E. H.

H6 | 3 Cav. | U.S.C.T.

Alfred S Henderson
2nd Lt., Co. H, 1 Reg't Miss. Cav. A. D.*

Age 21 years.

Appears on

Company Muster-in Roll

of the organization named above. Roll dated

Haines Bluff Miss, Feb 20, 1864.

Muster-in to date _____, 186 .

Joined for duty and enrolled:

When _____, 186 .

Where _____

Period 3 years.

Valuation of horse, \$ 100

Valuation of horse equipments, 100

Remarks: Not mustered a -
waiting appointment

*This organization subsequently became Company H, 3 Reg't U. S. Colored Cavalry.

Book mark: H-215-07-1864

Wheat Scott

(356)

Copyist.

76. | 3 Cav. | U.S.C.T.

Alfred S. Henderson.
2^d Lt., Co. , 3 Reg't U. S. Col'd Cav.

Age 21 years.

Appears on a

Detachment Muster-in Roll

of the organization named above. Roll dated
Vicksburg, Miss, Mar 22, 1864.

Muster-in to date Mar. 22, 1864.

Joined for duty and enrolled:

When March 22, 1864.

Where Haines Bluff.

Period 3 years.

Valuation of horse, \$ 100

Valuation of horse equipments, \$ 100

Remarks: Appointed from
Private Co. "K" 8th Mis-
consin Inf. Vol. to be
2^d Lieut 3^d U. S. Cav.
(Col'd)

Book mark :

Sitter.

H

3 Cav. U.S.C.T.

Alfred S. Henderson
2nd Lt, Co. H, 3 Reg't U. S. Col'd Cavalry.

Appears on

Company Muster Roll

for *from Feb 23 to Apr 30*, 186*4*.

Present or absent *Present*

Stoppage, \$ *100* for

Due Gov't, \$ *100* for

Valuation of horse, \$ *100*

Valuation of horse equipments, \$ *100*

Remarks: *Appointed from 1st Lt*
Co. H, 8th Wisemian
Vol Infantry to be 2nd
Lieut 3rd U.S. Cav.
Muster in to date from
Feb 25, 1864.

Book mark:

W. H. Scott

H | 3 Cav. | U.S.C.T.

Alfred S. Henderson
2^d Lieut, Co. H, 3 Reg't U. S. Col'd Cavalry.

Appears on

Company Muster Roll

for May & June, 1864.

Present or absent Present

Stoppage, \$ 100 for

Due Gov't, \$ 100 for

Valuation of horse, \$ 100

Valuation of horse equipments, \$ 100

Remarks:

Book mark:

W. W. Payne
Copyist.

77 | **3 Cav.** | **U.S.C.T.**

Alfred S Henderson
2 Lieut, Co. H, 3 Reg't U. S. Col'd Cavalry.

Appears on

Company Muster Roll

for July & Aug, 1864

Present or absent Present

Stoppage, \$ 100 for

Due Gov't, \$ 100 for

Valuation of horse, \$ 100

Valuation of horse equipments, \$ 100

Remarks: _____

Book mark: _____

W. W. Mayre

H | **3 Cav.** | **U.S.C.T.**

Alfred S. Henderson
2^d Lieut, Co. H, 3 Reg't U. S. Col'd Cavalry.

Appears on

Company Muster Roll
for Sept & Oct, 1864
Present or absent Present

Stoppage, \$.....100 for

Due Gov't, \$.....100 for

Valuation of horse, \$.....100

Valuation of horse equipments, \$.....100

Remarks:.....
.....
.....
.....
.....
.....
.....
.....
.....

Book mark:.....

W. Mayne
(358) Copyist.

A | **3 Cav.** | **U.S.C.T.**

Alfred S. Henderson
2 Lieut, Co. H, 3 Reg't U. S. Col'd Cavalry.

Appears on

Company Muster Roll

for *Nov & Dec*, 186*4*.

Present or absent *Present*

Stoppage, \$ *100* for

Due Gov't, \$ *100* for

Valuation of horse, \$ *100*

Valuation of horse equipments, \$ *100*

Remarks: _____

Book mark: _____

(358)

M. Dayre

Copyist.

A | **3 Cav.** | **U.S.C.T.**

Alfred S. Henderson

2- 4th, Co. H, 3 Reg't U. S. Col'd Cavalry.

Appears on

Company Muster Roll

for Jan & Feb., 1867.

Present or absent present

Stoppage, \$ 100 for

Due Gov't, \$ 100 for

Valuation of horse, \$ 100

Valuation of horse equipments, \$ 100

Remarks:

Book mark:

F. D. [Signature]

1867 204

A | **3 Cav.** | **U.S.C.T.**

Alfred S. Henderson

2 Lt., Co. H, 3 Reg't U. S. Col'd Cavalry.

Appears on

Company Muster Roll

for month report, 1867.

Present or absent absent

Stoppage, \$ 100 for

Due Gov't, \$ 100 for

Valuation of horse, \$ 100

Valuation of horse equipments, \$ 100

Remarks: absent on account
since Apr 29, 67

Book mark: _____

Forner

H | **3 Cav.** | **U.S.C.T.**

Alfred S. Henderson

2-44, Co. H, 3 Reg't U. S. Col'd Cavalry.

Appears on

Company Muster Roll

for May & June, 1865.

Present or absent present

Stoppage, \$ 100 for

Due Gov't, \$ 100 for

Valuation of horse, \$ 100

Valuation of horse equipments, \$ 100

Remarks:

Book mark:

Lomen

A | **3 Cav.** | **U.S.C.T.**

Alfred S. Henderson

2- Lt., Co. H, 3 Reg't U. S. Col'd Cavalry.

Appears on

Company Muster Roll

for July & Aug, 1861.

Present or absent Absent

Stoppage, \$ 100 for

Due Gov't, \$ 100 for

Valuation of horse, \$ 100

Valuation of horse equipments, \$ 100

Remarks: Absent with leave
since Aug 21/63

Book mark: _____

Lewis
Copyist.

H. V. War | U.S.C.T.

Alfred S. Henderson
2^d Sq., Co. H., 3^d Reg't U. S. Col'd Cav.

Appears on an

Individual Muster-out Roll

of the organization named above. Roll dated

Memphis Tenn., Sept. 19, 1863.

Muster-out to date Sept 18, 1863.

Last paid to Feb. 28, 1863.

Clothing account:

Last settled 186 ; drawn since \$ 100

Due soldier \$ 100; due U. S. \$ 100

Am't for cloth'g in kind or money adv'd \$ 100

Due U. S. for arms, equipments, &c., \$ 100

Bounty paid \$ 100 due \$ 100

Remarks: Mustered out as 1st Lt. by virtue of receiving an appointment as 1st Lt. from Secretary of War. Muster out to date from Sept 18/63.

Book mark:

(348)

A. S. Thompson

Copyist.

H | 3 Cav. | **U.S.C.T.**

Alfred S. Henderson

Co., 3 Reg't U. S. Col'd Cav.

Age 22 years.

Appears on an

Individual Muster-in Roll

of the organization named above. Roll dated

Memphis Tenn, Sept. 19, 1865.

Muster-in to date Sept. 19, 1865.

Joined for duty and enrolled:

When Sept. 19, 1865.

Where Memphis Tenn.

Period 1 years.

Valuation of horse, \$ 100

Valuation of horse equipments, \$ 100

Remarks: Appointed from 2d Lt. 1st U.S. Col. Cav. to 1st Lt. 3d U.S. Col. Cav. via Moore's charge. Muster-in to date

Book mark: Sept. 19/1865

Ward

A | **3 Cav. | U.S.C.T.**

Alfred S. Hudson
1. Lt., Co. H, 3 Reg't U. S. Col'd Cavalry.

Appears on

Company Muster Roll

for Sept & Oct, 1863.

Present or absent present

Stoppage, \$ 100 for

Due Gov't, \$ 100 for

Valuation of horse, \$ 100

Valuation of horse equipments, \$ 100

Remarks:

Book mark: -----

Somer

H. | **3 Cav.** | **U.S.C.T.**

Alfred Henderson

1st Lieut., Co. H, 3 Reg't U. S. Col'd Cavalry.

Appears on

Company Muster Roll

for Nov and Dec, 186 5.

Present or absent Present

Stoppage, \$ 100 for

Due Gov't, \$ 100 for

Valuation of horse, \$ 100

Valuation of horse equipments, \$ 100

Remarks:

Book mark:

(358)

Forner

Copyist.

H. | **3 Cav.** | **U.S.C.T.**

Wm Fred S Henderson
1st Lieut, Co. H, 3 Reg't U. S. Col'd Cavalry.

Appears on **Co. Muster-out Roll**, dated
Memphis Tenn, Jan 26, 1866.
Muster-out to date *Jan 26*, 1866.
Last paid to *Pay due from muster*, 1866.

Clothing account:

Last settled....., 1866 ; drawn since \$.....100

Due soldier \$.....100; due U. S. \$.....100

Am't for cloth'g in kind or money adv'd \$.....100

Due U. S. for arms, equipments, &c., \$.....100

Bounty paid \$.....100; due \$.....100

Remarks: *Enlisted as private*
in Co. H. 8th Wis. Infantry
Sept 5th 61 at Racine
Wis. Was mustered as
2^d Lieut 3^d U.S. C Cav. Feb 15/64
Promoted to 1st Lieut. Sep 14th 1865

Book mark: *1551 ct 80*

(861)

Joiner.
Copyist.

N | 3 bars | **U.S.C.T.**

A. S. Henderson

....., Co., 3 Reg't U. S. Col'd bars

Appears on

Regimental Descriptive Book

(List of Commissioned Officers)

of the regiment named above.

Rank.....

Date of appointment..... 186....

Remarks:.....

.....

.....

.....

.....

.....

.....

.....

.....

.....

.....

.....

.....

.....

.....

.....

F. B. Smith
Copyist.

No. 1 3rd Cav. U.S.C.

Alfred S. Henderson,
Co. , 3rd Reg't U.S.C.

NOTATION.

Book mark: 1551-03-1880 with
No. 215. C. J. 1864.

War Department,

Adjutant General's Office,

Washington, April 17, 1880.

See also Co. 32nd 8th Wis. Inf.

E. P. Conner.

H. | 3 Cav. | U.S.C.T.

Alfred S. Henderson

2^d Lt., Co. H, 3 Reg't U. S. Colored Cav.
1st Lt.

Appears on Returns as follows:

Mar. 1864, Present, appointed
Feb. 20/64, joined for
duty and mustered to
date Feb. 15/64.

Apr. 1864 to July 1865, Present.

Aug. 1865, Absent on leave since
Aug. 21/65 per S. O. No. 25
Hd. Qrs. Dept. of Tenn.
Knoxville, Tenn. Aug. 4/65

Sept. 1865, Present for duty.
Returned from absence
with leave Sept. 12/65
(1 Lt)

Oct. to Dec. 1865, Present for duty

Book mark :

(546)

J. B. Sittler

Copyist.

Linderson A.C.
.....
2A, Co....., *3* Reg't *Wisc.*

Resignation Papers

(File mark *2665* C. T. R. B., 1865.)

Cannot be found on Resignation File. Investigation shows that the papers were disposed of as indicated below:

Returned

Filed with

Vide 9/13, vol 3, p 354
Work done

~~Resignation papers
transferred to
Personal Paper files~~

Henderson A.S.
 2^d Lt. Co. H, 3 Reg't U.S. Cavalry
 4 Enclosures.

Bed Cards	Final Statements
Burial Records	Furloughs or L. of A.
Certs. of Dis. for Discharge	Med. Certificates
C. M. Charges	Med. Des. Lists
Descriptive Lists	Orders
Discharge Certificates	Pris. of War Record
Enlistment Papers	Resignations

Other papers relating to—

Admission to Hosp'l	Furlough or L. of A. /
Casualty Sheet	Med. Examination
Confinement	Misc. Information
Contracts	Pay or Clothing
Death or Effects	Personal Reports
Desertion	Rank
Discharge from Hosp'l	Transfer to Hosp'l
Discharge from Service .. /	Transfer to V. R. C.
Duty	Transportation

MAR 25 1967
MICROFILM PUBLICATION M 1819

COMPILED MILITARY SERVICE RECORDS
OF VOLUNTEER UNION SOLDIERS WHO
SERVED WITH THE USCT (US COLORED TROOPS)
3RD REGIMENT OF CAVALRY

PERSONAL PAPERS' TARGET SHEET

PLEASE NOTE THE CHECKED INFORMATION ABOUT THE PERSONAL PAPERS IN
THIS FILE:

- NO PERSONAL PAPERS WERE FOUND IN THIS FILE WHEN THE
RECORDS WERE ARRANGED FOR MICROFILMING.

- 1 PERSONAL PAPER(S) FOUND IN THIS FILE WHEN THE RECORDS
WERE ARRANGED FOR MICROFILMING.

H. A. 89. C. B. D. W. T. 1865.
Head Qrs Co. 3rd U. S. C. C.
Memphis Tenn July 18 1865

Henderson A. S.
2nd Lieut - 3rd U. S. C. C.

Asks for a leave of absence
from the Regt for 20 days
States that Capt. White is
present with the company
for duty and his services
can readily be spared
also states that he entered
the service in Sept 1861
and has not received any
leave of absence during
that time

Henderson U. S.
2nd Lieut - 3rd U. S. C. C.

Forwards application for
leave of absence for (20)
Twenty days.

Approved and respectfully
forwarded to Head Qrs 3rd
U. S. Colored Cavalry.

Harrison White
Capt - 3rd U. S. C. C.
Comdy Co "H".

Head Qrs 3rd U. S. Colored Cavalry
Memphis Tenn July 19 1865
Respectfully forwarded
Approved
O. M. Main
Major Comdy 3rd U. S. C. C.

Headquarters 1st Cav. Brig. Dist. West Tenn.
Logansport Tenn July 20 1865
Approved and respectfully forwarded

John S. Phelps
Col 1st Cav. Brig. Dist. West Tenn.

Recd H. Q. C. B. D. W. T. July 21 1865.
Recd H. Q. C. B. D. W. T. July 20 1865.

HEAD-QUARTERS, DIST. WEST TENN.
MEMPHIS, TENN. July 21 1865.

Respectfully forwarded, approved.

W. L. Smith
Brevet Major General.

NO. 222, Co. "H" 3^d U. S. C. Co.

Memphis Tenn. July 18th 1863

Brevet Brig. Gen. W. H. Morgan
A. C. G. Dept. West. Tennessee

Genl

I have the honor to request a
leave of absence for 20, twenty days for the purpose of
visiting my friends in Mc Henry County Illinois

I have not received a furlough or leave of absence
since my enlistment - which was on the 5th Fifth day
of Sept 1861

Captain White is serving with the company
to which I am attached and my services can readily
be spared for the period desired

I am General

Very Respectfully Yours Obedt. Servt.

Alfred S. Henderson

2^d Lieut. Co. "H" 3^d U. S. C. Co.

634

Henderson, Andrew

Co C, 3 U. S. Col'd Cav.

Private

Captain

CARD NUMBERS.

1	5334812	26
2	5334905	27
3	5334993	28
4	5335078	29
5	5335160	30
6	5335239	31
7	5335318	32
8	5335402	33
9	5335485	34
10	5335592	35
11	5335670	36
12	5335764	37
13	5335856	38
14	5335940	39
15	5336023	40
16	7088070	41
17		42
18		43
19		44
20		45
21		46
22		47
23		48
24		49
25		50

Book Mark:

See also

A1056645 P. O. M. W. M.
D2019301 00 off
A2532396 a. c. R. W. D.

J. M. Shannon
Esq

H | **3 Cav. | U.S.C.T.**

Andrew Henderson

....., Co. C, 3 Reg't U. S. Col'd Cav.

Appears on

Company Descriptive Book
of the organization named above.

DESCRIPTION.

Age 23 years; height 5 feet 5½ inches.

Complexion Black

Eyes Black; hair Black

Where born Warren Co. Miss.

Occupation H. Servant

ENLISTMENT.

When Nov. 1, 1863

Where Vicksburg. Miss.

By whom B. Wing; term 3 y'rs.

Remarks: Promoted to
Corpl. by S.O. No. 47
dated Ad. G.O. 3d.
Col'd Cav. Memphis-
Tenn. June - 16 - 1865.

F. A. Wright

H **3 Cav. U.S.C.T.**

Andrew Henderson
Pat. *C*, Co. *C*, 1 Reg't Miss. Cav., A. D.†
Age *23* years.

Appears on

Company Muster-in Roll

of the organization named above. Roll dated
Vicksburg, Miss, Nov 1, 1863.

Muster-in to date *Nov 1, 1863*

Joined for duty and enrolled:

When *Nov 1*, 1863.*

Where *Vicksburg, Miss.*

Period *3* years.*

Valuation of horse, \$ 100

Valuation of horse equipments, \$ 100

Remarks:

† This organization subsequently became Co. *C*, 3 Reg't U.S. Colored Cavalry.

* * * Muster-in roll shows enrollment and muster-in of this company as of same date. See enrollment on subsequent card or cards.

Book mark:

R Johnson
Copyright

(8562)

26 | 3 Cav. | U.S.C.T.

Andrew Henderson
Pvt, Co. C, 1 Reg't Miss. Cav., A. D.†

Appears on

Company Muster Roll
for Nov and Dec, 1863

Joined for duty and enrolled:

When Nov 1, 1863.*

Where Vicksburg *

Period 3 years.*

Present or absent Not stated

Stoppage, \$ 100 for

Due Gov't \$ 100 for

Valuation of horse, \$ 100

Valuation of horse equipments, 100

Remarks:

† This organization subsequently became Co. C, 3 Reg't U. S. Colored Cavalry.

* See enrollment on card from muster-in roll.

Book mark:

A. Henderson
Copyist.

H | **3 Cav. | U.S.C.T.**

Andrew Henderson
Pvt., Co. *C*, 1 Reg't Miss. Cav., Corps d'Afrique.*

Appears on

Company Muster Roll

for *Jan'y & Feby*, 186*X*

Present or absent *Present*

Stoppage, \$ *100* for

Due Gov't, \$ *100* for

Valuation of horse, \$ *100*

Valuation of horse equipments, \$ *100*

Remarks: *stop 1 hour
and a trap 30 X*

*This organization subsequently became Co. *C*, 3 Reg't U. S. Colored Cavalry.

Book mark: _____

(358)

R. Johnson
Copyist.

H | **3 Cav. | U.S.C.T.**

Andrew Henderson
Priv., Co. C, 3 Reg't U. S. Col'd Cavalry.

Appears on

Company Muster Roll
for *March & April*, 1864.

Present or absent *Present*

Stoppage, \$ 100 for

Due Gov't, \$ 100 for

Valuation of horse, \$ 100

Valuation of horse equipments, \$ 100

Remarks:

Book mark:

R. Johnson
Copyst.

H | **3 Cav.** | **U.S.C.T.**

Andrew Henderson
Put, Co. C, 3 Reg't U. S. Col'd Cavalry.

Appears on

Company Muster Roll

for *May and June*, 186 *4*

Present or absent *Present*

Stoppage, \$ *100* for

Due Gov't, \$ *100* for

Valuation of horse, \$ *100*

Valuation of horse equipments, \$ *100*

Remarks:

Book mark:

R. Johnson

H | **3 Cav.** | **U.S.C.T.**

Andrew Henderson
Prs, Co. C, 3 Reg't U. S. Col'd Cavalry.

Appears on

Company Muster Roll
for July & Aug., 1864.
Present or absent Present

Stoppage, \$.....100 for

Due Gov't, \$.....100 for

Valuation of horse, \$.....100

Valuation of horse equipments, \$.....100

Remarks:

Book mark:

(358)

R. Johnson
Copyist.

He | **3 Cav.** | **U.S.C.T.**

Andrew Henderson
Priv, Co. C, 3 Reg't U. S. Col'd Cavalry.

Appears on

Company Muster Roll

for *Sept & Oct*, 186*4*

Present or absent *Present*

Stoppage, \$ 100 for

Due Gov't, \$ 100 for

Valuation of horse, \$ 100

Valuation of horse equipments, \$ 100

Remarks:

Book mark:

Talbott
Copyist.

HC | **3 Cav.** | **U.S.C.T.**

Andrew Henderson
Ser, Co. C, 3 Reg't U. S. Col'd Cavalry.

Appears on

Company Muster Roll
for *Nov & Dec*, 186 *7*

Present or absent *Absent*

Stoppage, \$.....100 for

Due Gov't, \$.....100 for

Valuation of horse, \$.....100

Valuation of horse equipments, \$.....100

Remarks: *on scout*

Book mark:

(358)

Galvorth
Copyist.

76 | **3 Cav.** | **U.S.C.T.**

Andrew Henderson
Priv, Co. C, 3 Reg't U. S. Col'd Cavalry.

Appears on

Company Muster Roll

for Jany & Kelly, 1865.

Present or absent Present

Stoppage, \$ 100 for

Due Gov't, \$ 100 for

Valuation of horse, \$ 100

Valuation of horse equipments, \$ 100

Remarks:

Book mark:

(358)

Talburt
Copyist.

H | **3 Cav.** | **U.S.C.T.**

Andrew Henderson
Priv, Co. C, 3 Reg't U. S. Col'd Cavalry.

Appears on

Company Muster Roll

for *March & April*, 186*5*.

Present or absent *Absent*

Stoppage, \$ *100* for

Due Gov't, \$ *100* for

Valuation of horse, \$ *100*

Valuation of horse equipments, \$ *100*

Remarks: *On expedition*
since Apr 29, 65

Book mark: _____

Talbot

HC | **3 Cav.** | **U.S.C.T.**

Andrew Henderson
Corp, Co. C, 3 Reg't U. S. Col'd Cavalry.

Appears on

Company Muster Roll

for *May & June*, 1865.

Present or absent *Present*

Stoppage, \$.....100 for

Due Gov't, \$.....100 for

Valuation of horse, \$.....100

Valuation of horse equipments, \$.....100

Remarks: *Promoted from Priv-*
ate June 16. 65. By order
of Maj. Main Comdg Regt
Staff for 1. Cav wrench
37. 4

Book mark:

(358)

Talworth
Copyist.

76 | **3 Cav. | U.S.C.T.**

Andrew Henderson
Corp, Co. C, 3 Reg't U. S. Col'd Cavalry.

Appears on

Company Muster Roll

for *July & Aug*, 186*5*

Present or absent *Present*

Stoppage, \$ 100 for

Due Gov't, \$ 100 for

Valuation of horse, \$ 100

Valuation of horse equipments, \$ 100

Remarks:

Book mark:

Talbot
Copyist.

A | **3 Cav.** | **U.S.C.T.**

Andrew Anderson
Capt, Co. C, 3 Reg't U. S. Col'd Cavalry.

Appears on

Company Muster Roll

for *Sept Oct*, 1865.

Present or absent *Present*

Stoppage, \$ 100 for

Due Gov't, \$ 100 for

Valuation of horse, \$ 100

Valuation of horse equipments, \$ 100

Remarks:

Book mark:

A | **3 Cav.** | **U.S.C.T.**

Andrew Henderson

Appl, Co. C, 3 Reg't U. S. Col'd Cavalry.

Appears on

Company Muster Roll

for *Nov & Dec*, 1865.

Present or absent *present*

Stoppage, \$ 100 for

Due Gov't, \$ 100 for

Valuation of horse, \$ 100

Valuation of horse equipments, \$ 100

Remarks:

Book mark:

[Signature]
Copyist.

A | **3 Cav. | U.S.C.T.**

Andrew Hinderfon
Copt. C, 3 Reg't U. S. Col'd Cavalry.

Appears on **Co. Muster-out Roll**, dated
Memphis, Tenn July 26, 186*6*.
Muster-out to date *July 26*, 186*6*.
Last paid to *June 30* 186*5*.

Clothing account:

Last settled....., 186 ; drawn since \$.....100

Due soldier \$ *26 43*/100; due U. S. \$.....100

Am't for cloth'g in kind or money adv'd \$.....100

Due U. S. for arms, equipments, &c., \$.....100

Bounty paid \$.....100; due \$.....100

Remarks:.....
.....
.....
.....
.....

Book mark: *V. 143, P. 162-72.*

(861)

Wm
Coptist.

635

Henderson, Cain

Co E, 3 U. S. Col'd Cav.

Private

Saddler

CARD NUMBERS.

1	5337614	26
2	5337673	27
3	5337752	28
4	5337828	29
5	5337907	30
6	5337972	31
7	5338036	32
8	5338107	33
9	5338174	34
10	5338290	35
11	5338390	36
12	5338480	37
13	5338618	38
14	5331849	39
15	5338820	40
16	9088985	41
17	25-CJ-1884	42
18	40727516	43
19		44
20		45
21		46
22		47
23		48
24		49
25		50

Book Mark: 25 G. I. 84, LB 16/501

See also

1858431 P.O. aff

\$, 1833770 P.M.M.M.

Mr. Sidney Henderson, 2404 Forest
St., St. Louis, Mo. 9-17-53 abm

A. McShannon
Exr

A | **3 Cav. | U.S.C.T.**

Cain Henderson

....., Co. *E*, 3 Reg't U. S. Col'd Cav.

Appears on

Company Descriptive Book

of the organization named above.

DESCRIPTION.

Age *24* years; height *5* feet *6* inches.

Complexion *Black*

Eyes *Black*; hair *Black*

Where born *Mississippi*

Occupation *Farmer*

ENLISTMENT.

When *Nov 20*, 1863.

Where *Stipwith Lodge*

By whom *Capt Cook*; term *3* y'rs.

Remarks: *Deserted at Memphis,*
Tenn., Sept 26, 1865.

.....
.....
.....
.....
.....

E. Arsten

H | **3 Cav.** | **U.S.C.T.**

Cain Henderson
Alison Reef X

Por, Co. *E*, 1 Reg't Miss. Cav., Corps d'Afrique.*

Age *25*
Appears on

Company Muster-in Roll

of the organization named above, Roll dated

Sept 10 *Edg* *Mus*, *Reg*, 186*3*

Muster-in to date *Nov 25*, 186*3*.

Joined for duty and enrolled:

When *Nov 25*, 186*3*.

Where *Sept 10 Edg Mus*

Period *3* years.

Valuation of horse, \$.....*100*

Valuation of horse equipments, \$.....*100*

Remarks:

X. Do appear on roll.

*This organization subsequently became Co. *E* 3 Reg't U. S. Colored Cavalry.

Book mark:

Brader

H | **3 Cav.** | **U.S.C.T.**

Paris Henderson

Co. E, 1 Reg't Miss. Cav., Corps d'Afrique.*

Appears on

Company Muster Roll

for *Dates Dec 31*, 186*3*

Present or absent *Present*

Stoppage, \$.....*100* for

Due Gov't, \$.....*100* for

Valuation of horse, \$.....*100*

Valuation of horse equipments, \$.....*100*

Remarks:

*This organization subsequently became Co. *E*, 3 Reg't U. S. Colored Cavalry.

Book mark:

Priddy

H | **3 Cav.** | **U.S.C.T.**

Carr Henderson

Co. E, 1 Reg't Miss. Cav., Corps d'Afrique.*

Appears on

Company Muster Roll

for *June & July*, 186*4*

Present or absent *Present*

Stoppage, \$.....*100* for

Due Gov't, \$.....*100* for

Valuation of horse, \$.....*100*

Valuation of horse equipments, \$.....*100*

Remarks:.....

.....
.....
.....
.....
.....
.....

*This organization subsequently became Co. *E*, 3 Reg't U. S. Colored Cavalry.

Book mark:.....

Biddle

H | **3 Cav.** | **U.S.C.T.**

Carr Henderson
Pos, Co. E, 3 Reg't U.S. Col'd Cavalry.

Appears on

Company Muster Roll

for *Mur Hape*, 186 *4*

Present or absent *Present*

Stoppage, \$ *100* for

Due Gov't, \$ *100* for

Valuation of horse, \$ *100*

Valuation of horse equipments, \$ *100*

Remarks:

Book mark: _____

Budd

76 | 3 Cav. | U.S.C.T.

Pain Henderson

Pr, Co. E, 3 Reg't U. S. Col'd Cavalry.

Appears on

Company Muster Roll

for *May June*, 1864.

Present or absent *Present*

Stoppage, \$ 100 for

Due Gov't, \$ 100 for

Valuation of horse, \$ 100

Valuation of horse equipments, \$ 100

Remarks:

Book mark:

Pr

76 | 3 Cav. | U.S.C.T.

Quin Henderson

Pvt, Co. E, 3 Reg't U. S. Col'd Cavalry.

Appears on

Company Muster Roll

for July Aug, 1864

Present or absent Present

Stoppage, \$ 5.46 for Bridle + Halters

Due Gov't, \$ 1.00 for

Valuation of horse, \$ 1.00

Valuation of horse equipments, \$ 1.00

Remarks:

Book mark:

Bridle

3 Cav. U.S.C.T.

Wain [unclear]

Co. E, 3 Reg't U. S. Col'd Cavalry.

Appears on

Company Muster Roll

for [unclear], 1864.

Present or absent [unclear]

Stoppage, \$ $\frac{40}{100}$ for [unclear]

Due Gov't, \$ $\frac{100}{100}$ for [unclear]

Valuation of horse, \$ $\frac{100}{100}$

Valuation of horse equipments, \$ $\frac{100}{100}$

Remarks: [unclear]

Book mark: [unclear]

[Handwritten signature]

(358)

Copyist.

M. | **3 Cav.** | **U.S.C.T.**

William Henderson

W., Co. E, 3 Reg't U.S. Col'd Cavalry.

Appears on

Company Muster Roll

for *Nov. 4 1861*, 1861.

Present or absent *Present*

Stoppage, \$ $\frac{10}{100}$ for *W. H. & G. P.*

Due Gov't, \$ $\frac{100}{100}$ for

Valuation of horse, \$ $\frac{100}{100}$

Valuation of horse equipments, \$ $\frac{100}{100}$

Remarks: *Wm. Henderson Co. E, 3rd Regt U.S. Col'd Cavalry*

Book mark:

W. H. Henderson

Ch. | **3 Cav.** | **U.S.C.T.**

William H. ...

..., Co. E, 3 Reg't U. S. Col'd Cavalry.

Appears on

Company Muster Roll

for *...*, 186*5*.

Present or absent *Present*

Stoppage, \$ 100 for

Due Gov't, \$ 100 for

Valuation of horse, \$ 100

Valuation of horse equipments, \$ 100

Remarks:

Book mark:

111 | **3 Cav. | U.S.C.T.**

William Anderson
Saddler, Co. E, 3 Reg't U. S. Col'd Cavalry.

Appears on

Company Muster Roll
for March & April, 1864.

Present or absent Present

Stoppage, \$ 100 for

Due Gov't, \$ 100 for

Valuation of horse, \$ 100

Valuation of horse equipments, \$ 100

Remarks:

Book mark:

(358)

W. A. [Signature]
Copyist.

No. 3 Cav. U.S.C.T.

Wain Henderson
Saddler, Co. E, 3 Reg't U. S. Col'd Cavalry.

Appears on

Company Muster Roll

for May & June, 1865.

Present or absent Present

Stoppage, \$ 7 ³⁷/₁₀₀ for Wainance,

Due Gov't, \$ 100 for

Valuation of horse, \$ 100

Valuation of horse equipments, \$ 100

Remarks: Col's for 1 Bivouac, 1
Co. Camp, 1 Walked 1 H. Brush

Book mark:

(358)

[Signature]
Copyist.

Ch. 3 Cav. U.S.C.T.

Carroll Henderson

Yadalu, Co. E, 3 Reg't U. S. Col'd Cavalry.

Appears on

Company Muster Roll

for July & Aug., 1865.

Present or absent Present

Stoppage, \$ 100 for

Due Gov't, \$ 100 for

Valuation of horse, \$ 100

Valuation of horse equipments, \$ 100

Remarks:

Book mark:

(358)

Copyist.

358
H | 3 Cav. | U.S.C.T.

Cain Henderson

Saddler, Co. E, 3 Reg't U. S. Col'd Cavalry.

Appears on

Company Muster Roll

for Sept. & Oct., 1865.

Present or absent

Stoppage, \$ 100 for

Due Gov't, \$ 100 for

Valuation of horse, \$ 100

Valuation of horse equipments, \$ 100

Remarks: Deserted at Memphis Tenn.

Sept. 26. 65.

Stop for 1 Co. Army Revolver.

Book mark:

(358)

Lewis

Copyist.

H | 3 cav | **U.S.C.T.**

Cain Henderson
Saddler, Co. E, 3 Reg't U. S. Col'd Cav

Appears on

Descriptive List of Deserters

dated Memphis Tenn Oct 3, 1865.

Deserted:

When Sep 20, 1865.

Where Memphis Tenn

Arrested:

When _____, 186 .

Where _____

Remarks: Stoppage for Ordnance
\$19.31

Book mark: _____

(351)

H S Miller

Copyist.

H. | 3 Cav. | U.S.C.T.

Cain Henderson

Priv., Co. E, 3 Reg't U. S. Colored Cav.
Artif
Sad.

Appears on Returns as follows:

Feb. 1864. (1 Miss Cav. A. D.) On duty, Regt. saddler.

Mar. 1864. (3 U. S. C. C.) Co. saddler.

Apr. to June 1864. On duty, saddler for 1st Batt^m

July to Sept. 1864. Co. saddler.

Mar. to Aug. 1865. (Artif.) Co. Saddler.

Sept. 1865. (Sad.) Loss Sept. 20 Memphis - Deserted.

Book mark :

J. B. Sittler

(546)

Copyist.

H | **3 Cav.** | **U.S.C.T.**

Cain Henderson

Saddler, Co. E., 3 Reg't U. S. Col'd Cavalry.

Appears on **Co. Muster-out Roll**, dated
Memphis, Tenn. Jan. 26, 1866 .

Muster-out to date _____, 186 .

Last paid to June 30, 1865 .

Clothing account:

Last settled _____, 186 ; drawn since \$ _____ 100

Due soldier \$ _____ 100; due U. S. \$ _____ 100

Am't for cloth'g in kind or money adv'd \$ _____ 100

Due U. S. for arms, equipments, &c., \$ _____ 100

Bounty paid \$ _____ 100; due \$ _____ 100

Remarks Deserted at Memphis, Tenn.

Sept. 26, 65.

Book mark: 25- C. R. - 84. LB 16 / 505

Discharged Sep 26 / 65.

(361)

Lewis
Copyist.

No. 3rd Cav. U.S. C.

Gain Henderson

, Co. E, 3rd Reg't U.S. C.

SP NOTATION
167501 with

Book mark: 25 - 6.3.1884.

War Department,

Adjutant General's Office,

Washington, July 29th 1884.

The charge

of desertion of Sept.
26th, 1865,

is removed and he is discharged

to date Sept. 26th, 1865, under the pro-

visions of the act of Congress, approved July 5, 1884.

Discharge certificate furnished by Adjutant General's

Office _____ 18

Discharge certificate sent
to Atty. Aug. 2, 1884.

636

Henderson, Hardee

Co C, 3 U. S. Col'd Cav.

Private

Private

CARD NUMBERS.

1	5334811	26
2	5334904	27
3	5334992	28
4	5335077	29
5	5335159	30
6	5335238	31
7	5335317	32
8	5335401	33
9	5335484	34
10	5335591	35
11	5335690	36
12	5335784	37
13	5335876	38
14	5335958	39
15	5336041	40
16	9088509	41
17		42
18		43
19		44
20		45
21		46
22		47
23		48
24		49
25		50

Book Mark:

See also

010 49857 10 m m
D. 2865793 Ant. N. 2,

A. M. Shannon
Esq

A | **3 Cav. | U.S.C.T.**

Hardee Henderson

....., Co. *C*, 3 Reg't U. S. Col'd Cav.

Appears on

Company Descriptive Book

of the organization named above.

DESCRIPTION.

Age *25* years; height *5* feet *6* inches.

Complexion *Black*

Eyes *Black*; hair *Black*

Where born *Tennessee*

Occupation *Farmer*

ENLISTMENT.

When *Nov. 1*, 186 *3*

Where *Vicksburg, Miss -*

By whom *B. S. King*; term *3* y'rs.

Remarks:

.....
.....
.....
.....
.....
.....
.....
.....

F. A. Wright

H | **3 Cav. | U.S.C.T.**

Hardee Henderson
Priv., Co. *C*, 1 Reg't Miss. Cav., A. D.†
Age *25* years.

Appears on

Company Muster-in Roll

of the organization named above. Roll dated
Vicksburg, Miss. Nov 1, 1863.
Muster-in to date *Nov 1, 1863.*

Joined for duty and enrolled:

When *Nov 1*, 1863.*

Where *Vicksburg, Miss.**

Period *3* years.*

Valuation of horse, \$ 100

Valuation of horse equipments, \$ 100

Remarks:

† This organization subsequently became Co. *C*, 3 Reg't U.S. Colored Cavalry.

* Muster-in roll shows enrollment and muster-in of this company as of same date. See enrollment on subsequent card or cards.

Book mark:

(3566)

R. Johnson
Copyright.

76 | **3 Cav.** | **U.S.C.T.**

Hardee Henderson
Put, Co. *C*, 1 Reg't Miss. Cav., A. D.†

Appears on

Company Muster Roll
for *Nov and Dec*, 186*3*

Joined for duty and enrolled:

When *Nov 1*, 186*3*.*

Where *Vicksburg* *

Period *3* years.*

Present or absent *Not stated*

Stoppage, \$ *100* for

Due Gov't \$ *100* for

Valuation of horse, \$ *100*

Valuation of horse equipments, *100*

Remarks:

† This organization subsequently became Co. *C*, 3 Reg't U. S. Colored Cavalry.

* See enrollment on card from muster-in roll.

Book mark:

(358d)

R. Johnson
Copyist.

H.C. | **3 Cav.** | **U.S.C.T.**

Hardee Henderson
Pvt, Co. *C*, 1 Reg't Miss. Cav., Corps d'Afrique.*

Appears on

Company Muster Roll

for *Jan'y & Feby*, 186*7*.

Present or absent *Present*

Stoppage, \$.....*100* for

Due Gov't, \$.....*100* for

Valuation of horse, \$.....*100*

Valuation of horse equipments, \$.....*100*

Remarks: *Stop & Harrocks*
H.C.

*This organization subsequently became Co. *C*, 3 Reg't U. S. Colored Cavalry.

Book mark :

P. Johnson
Copied.

H | **3 Cav.** | **U.S.C.T.**

Hardee Henderson

Pvt, Co. C, 3 Reg't U. S. Col'd Cavalry.

Appears on

Company Muster Roll
for *March & April*, 186*0*

Present or absent *Present*

Stoppage, \$ *100* for

Due Gov't, \$ *100* for

Valuation of horse, \$ *100*

Valuation of horse equipments, \$ *100*

Remarks:
.....
.....
.....
.....
.....
.....
.....
.....
.....
.....

Book mark:

R. Johnson
Copyist.

76 | 3 Cav. | U.S.C.T.

Hardey Henderson
Priv., Co. C, 3 Reg't U. S. Col'd Cavalry.

Appears on

Company Muster Roll

for May and June, 1864

Present or absent Present

Stoppage, \$ 100 for

Due Gov't, \$ 100 for

Valuation of horse, \$ 100

Valuation of horse equipments, \$ 100

Remarks: Saddle Blanket
Curry comb. Horse
Brush Wrench
Brush & Horns, Cartridge
Box Cap Pouch & Pick
7/19

Book mark:

Johnson
Copyist.

76 | **3 Cav.** | **U.S.C.T.**

Hardee Henderson
Private, Co. C, 3 Reg't U. S. Col'd Cavalry.

Appears on

Company Muster Roll

for July & Aug, 1864.

Present or absent Present

Stoppage, \$ 100 for

Due Gov't, \$ 100 for

Valuation of horse, \$ 100

Valuation of horse equipments, \$ 100

Remarks: None M. R. for
Ordinance from last
Muster Rolls \$7.19

Book mark:

R. Johnson
Copyist.

Ho | 3 Cav. | U.S.C.T.

Hardee Henderson
Priv, Co. C, 3 Reg't U. S. Col'd Cavalry.

Appears on

Company Muster Roll

for *Sept & Oct*, 1864.

Present or absent *Present*

Stoppage, \$ 100 for

Due Gov't, \$ 100 for

Valuation of horse, \$ 100

Valuation of horse equipments, \$ 100

Remarks: *Stop for 1 pr spurs
& Straps, cone wrench
Brush & Thong \$1.29,*

Book mark:

Talburt
Copyist.

76 | 3 Cav. | U.S.C.T.

Harold Henderson

Priv, Co. C, 3 Reg't U. S. Col'd Cavalry.

Appears on

Company Muster Roll

for Nov & Dec, 1864.

Present or absent Present

Stoppage, \$ 100 for

Due Gov't, \$ 100 for

Valuation of horse, \$ 100

Valuation of horse equipments, \$ 100

Remarks: Due U.S. for Ordnance
for last muster Roll 1.29
Stopped for 1 Curry Comb
1 Horse Brush, 7230

Book mark:

Talbot

H | **3 Cav.** | **U.S.C.T.**

Hardee Henderson
Hiv, Co. C, 3 Reg't U. S. Col'd Cavalry.

Appears on

Company Muster Roll

for *Jany & Alby*, 186 *5*

Present or absent *Present*

Stoppage, \$ *100* for

Due Gov't, \$ *100* for

Valuation of horse, \$ *100*

Valuation of horse equipments, \$ *100*

Remarks:

Book mark:

(358)

Talbot
Copyist.

H6 | **3 Cav.** | **U.S.C.T.**

Hardee Henderson

Priv, Co. C, 3 Reg't U. S. Col'd Cavalry.

Appears on

Company Muster Roll

for March & April, 1865.

Present or absent Present

Stoppage, \$ 100 for

Due Gov't, \$ 100 for

Valuation of horse, \$ 100

Valuation of horse equipments, \$ 100

Remarks:

Book mark:

(358)

Talburt Copyist.

26 | 3 Cav. | U.S.C.T.

Hardee Henderson
Priv., Co. C, 3 Reg't U. S. Col'd Cavalry.

Appears on

Company Muster Roll

for May & June, 1865.

Present or absent Present

Stoppage, \$ 100 for

Due Gov't, \$ 100 for

Valuation of horse, \$ 100

Valuation of horse equipments, \$ 100

Remarks: Stop for 1 month &
Thong, 70¢ @ wrench
37. 1 P. wrench 31, 9
1.08,

Book mark:

Talbott

(358)

Copyist.

Ho | **3 Cav.** | **U.S.C.T.**

Hardee Henderson
Priv, Co. C, 3 Reg't U. S. Col'd Cavalry.

Appears on

Company Muster Roll

for July & Aug, 1865.

Present or absent Present

Stoppage, \$ 100 for

Due Gov't, \$ 100 for

Valuation of horse, \$ 100

Valuation of horse equipments, \$ 100

Remarks:

Book mark:

(358)

Talbot
Copyist.

H | **3 Cav.** | **U.S.C.T.**

Harold Henderson
Smith, Co. C, 3 Reg't U. S. Col'd Cavalry.

Appears on

Company Muster Roll

for *Sept & Oct*, 1865.

Present or absent *Present*

Stoppage, \$ *100* for

Due Gov't, \$ *100* for

Valuation of horse, \$ *100*

Valuation of horse equipments, \$ *100*

Remarks:

Book mark: _____

(358)

Smith
Copyist.

H | **3 Cav.** | **U.S.C.T.**

Hardee Henderson

Private, Co. C, 3 Reg't U. S. Col'd Cavalry.

Appears on

Company Muster Roll

for *Nov. & Dec*, 1865.

Present or absent *present*

Stoppage, \$ 100 for

Due Gov't, \$ 100 for

Valuation of horse, \$ 100

Valuation of horse equipments, \$ 100

Remarks:

Book mark: -----

(358)

Hardee
Copyist.

He | 3 Cav. | U.S.C.T.

Harde Henderson
Driver, Co. C, 3 Reg't U. S. Col'd Cavalry.

Appears on Co. Muster-out Roll, dated
Memphis, Tenn. Jan'y 26, 1866.

Muster-out to date Jan'y 26, 1866.

Last paid to June 30, 1865.

Clothing account:

Last settled....., 186 ; drawn since \$.....100

Due soldier \$ 31.05⁰⁵ / 100; due U. S. \$.....100

Am't for cloth'g in kind or money adv'd \$.....100

Due U. S. for arms, equipments, &c., \$.....100

Bounty paid \$.....100; due \$.....100

Remarks:.....

Book mark: 9570.2' dis. May 2. 68,

(861)

Copyist.

651

Henderson, Jacob
Co K, 3 U. S. Col'd Cav.

Private | Private

CARD NUMBERS.

1	5331198	26
2	5344035	27
3	5344161	28
4	5344796	29
5	9089487	30
6	40727517	31
7		32
8		33
9		34
10		35
11		36
12		37
13		38
14		39
15		40
16		41
17		42
18		43
19		44
20		45
21		46
22		47
23		48
24		49
25		50

Book Mark:

See also

A | **3 Cav.** | **U.S.C.T.**

Jacob Henderson,
Appears with rank of *Private* on
Muster and Descriptive Roll of a Detach-
ment of U. S. Vols. forwarded

for the 3 Reg't U. S. Col'd Cavalry. Roll dated

Vicksburg, Miss, Oct. 1, 1864.

Where born *Wilkinson Co., Miss.*

Age *23* y'rs; occupation *Farmer.*

When enlisted *Septbr. 26*, 1864.

Where enlisted *Vicksburg, Miss.*

For what period enlisted *three* years.

Eyes *black*; hair *black*;

Complexion *colored*; height *5* ft. *7* in.

When mustered in *Septbr. 27*, 1864.

Where mustered in *Vicksburg.*

Bounty paid \$ $\frac{\quad}{100}$; due \$ $\frac{300.00}{100}$

Where credited *State of Miss.*

Company to which assigned

Remarks:

Book mark:

(339)

R. J. Draumer

Copyist.

No. | **3 Cav.** | **U.S.C.T.**

Jacob Henderson
Pls, Co. K, 3 Reg't U. S. Col'd Cavalry.

Appears on

Company Muster Roll

for *Sept & Oct*, 186*4*

Present or absent *Present*

Stoppage, \$ 100 for

Due Gov't, \$ 100 for

Valuation of horse, \$ 100

Valuation of horse equipments, \$ 100

Remarks: *Entitled to Bounty*

Book mark: _____

Beacho

A | **3 Cav.** | **U.S.C.T.**

Jacob Henderson
Priv., Co. K, 3 Reg't U. S. Col'd Cavalry.

Appears on

Company Muster Roll

for *Nov. & Dec.*, 1864.

Present or absent

Stoppage, \$ 100 for

Due Gov't, \$ 100 for

Valuation of horse, \$ 100

Valuation of horse equipments, \$ 100

Remarks:

*Died of disease in Reg't
Hospital Vicksburg Miss.
Nov. 18th/64 Entitled to
full Bounty*

Book mark: *120240 E. R.*

391, 2 and. Apr. 5. 66.

Valentine

76, | 3 Cav. | U.S.C.T.

Jacob Henderson
Pvt., Co. K, 3 Reg't U. S. Colored Cav.

Appears on Returns as follows:

Sept. 1864, Gain Sept. 26/64
Vicksburg, Miss., Mustered
into Regt. & assigned to
Co.

Nov. 1864, Loss Nov. 18/64 V.
Burg, Miss., Died of
disease in Regt. Hosp.

Book mark :

(546)

J. B. Dittler

Copyist.

H | **3 Cav. | U.S.C.T.**

Jacob Henderson
Pvt., Co. *K*, 3 Reg't U. S. Col'd Cavalry.

Appears on **Co. Muster-out Roll**, dated
Memphis, Tenn., Jan. 26, 1866.

Muster-out to date _____, 1866 .

Last paid to _____, 1866 .
Never paid.

Clothing account:

Last settled _____, 1866 ; drawn since \$ _____ 100

Due soldier \$ _____ 100; due U. S. \$ _____ 100

Am't for cloth'g in kind or money adv'd \$ _____ 100

Due U. S. for arms, equipments, &c., \$ _____ 100

Bounty paid \$ _____ 100; due \$ _____ 100

Remarks: *Died of Disease*
Nov. 19, 1864.

Book mark: *120,240*

Died Nov. 18, 1864. E. B. III

(361)

Howard
Copyist.

H | 3 Cav. | U.S.C.T.

Jacob Henderson
....., Co. K, 3 Reg't U. S. Col'd Cav.

Appears on

Company Descriptive Book

of the organization named above.

DESCRIPTION.

Age 29 years; height 5 feet 7 inches.

Complexion Cold

Eyes Black; hair Black

Where born Wilkinson Co, Miss

Occupation Farmer

ENLISTMENT.

When Sept 26, 1864.

Where Vicksburg

By whom Lt. Col. Kinsley term 3 y'rs.

Remarks: Died of Disease
in Reg't Hospital
at Vicksburg, Miss
Nov. 19, 1864, Final
Statements sent
forward.

F. B. Smith

Henderson Jacob
Pvt, Co. 16, 3 Reg't 11th Cav

3 Enclosures.

Bed Cards	Final Statements 7
Burial Records	Furloughs or L. of A.
Certs. of Dis. for Discharge	Med. Certificates
C. M. Charges	Med. Des. Lists
Descriptive Lists	Orders
Discharge Certificates	Pris. of War Record
Enlistment Papers /	Resignations

Other papers relating to—

Admission to Hosp'l	Furlough or L. of A.
Casualty Sheet	Med. Examination
Confinement	Misc. Information
Contracts	Pay or Clothing
Death or Effects /	Personal Reports
Desertion	Rank
Discharge from Hosp'l	Transfer to Hosp'l
Discharge from Service	Transfer to V. R. C.
Duty	Transportation

NOTE 1.—This blank will be used for both enlistments and reenlistments—enlistment of veterans &c. &c. in the volunteer service. They will be made out in duplicate in all cases—one to accompany the recruiting return of the superintendent and the recruiting officer to the Adjutant General and one to accompany the returns of the officer who pays bounty, &c. The Regiment and Company in which the soldier is enlisted, must be given on the back.

NOTE 2.—An enlistment holds to service. A muster-in must, in all cases, be made by the Adjutant General. A muster-in roll must, in all cases, be filed in the Adjutant General's Office as evidence of muster-in. The recruiting officer, or assistant commissary of musters, as the case may be, will countersign both enlistments as having mustered the soldier into the service of the United States before either of them is given to the disbursing officer.

1700
 10/16/67

DECLARATION OF RECRUIT.

I, Jacob Henderson, desiring to VOLUNTEER as a Soldier in the Army of the United States, for the term of THREE YEARS. Do Declare, That I am Twenty three years and _____ months of age; that I have never been discharged from the United States service on account of disability or by sentence of a court martial, or by order before the expiration of a term of enlistment; and I know of no impediment to my serving honestly and faithfully as a soldier for three years.

GIVEN at Vicksburg Miss the 26th day of September 1867

Witness: R. F. Stevens Jacob Henderson

No. _____
 Name Frank Henderson
 Recruited at Vicksburg Miss
26th Sept 1867
 By W. L. Kinsey Lt Col
11th Regt of Miss
11th Regt of Miss

Enlistment: last served in Company ()
3rd Regt of Miss
 Discharged _____, 18__

CONSENT IN CASE OF MINOR.

I, _____, Do CERTIFY, That I am the _____ of _____; that the said _____ is _____ years of age; and I do hereby freely give my CONSENT to his volunteering as a SOLDIER in the ARMY OF THE UNITED STATES for the period of THREE YEARS.

GIVEN at _____ the _____ day of _____

Witness: _____

VOLUNTEER ENLISTMENT.

STATE OF

TOWN OF

Mississippi

Vicksburg



I, Jacob Henderson, born in Wilkerson Co in the State of Mississippi, aged twenty three years, and by occupation a Farmer, Do HEREBY ACKNOWLEDGE to have volunteered this twenty sixth day of September, 1864, to serve as a Soldier in the Army of the United States of America, for the period of THREE YEARS, unless sooner discharged by proper authority: Do also agree to accept such bounty, pay, rations, and clothing, as are, or may be, established by law for volunteers. And I, Jacob Henderson, do solemnly swear, that I will bear true faith and allegiance to the United States of America, and that I will serve them honestly and faithfully against all their enemies or opposers whomsoever; and that I will observe and obey the orders of the President of the United States, and the orders of the officers appointed over me, according to the Rules and Articles of War.

Sworn and subscribed to, at Vicksburg, Mississippi, this 26th day of September, 1864.

BEFORE Eli C Kusler, Notary Public

Holden P. Marshall, Assistant Marshal

I CERTIFY, ON HONOR, That I have carefully examined the above-named Volunteer, agreeably to the General Regulations of the Army, and that, in my opinion, he is free from all bodily defects and mental infirmity, which would in any way disqualify him from performing the duties of a soldier.

H. C. Southman

Surgeon (57) U.S.A. Examining Surgeon.

I CERTIFY, ON HONOR, That I have minutely inspected the Volunteer Jacob Henderson previously to his enlistment, and that he was entirely sober when enlisted; that, to the best of my judgment and belief, he is of lawful age; and that, in accepting him as duly qualified to perform the duties of an able-bodied soldier, I have strictly observed the Regulations which govern the recruiting service. This soldier has Black eyes, Black hair, Cold complexion, is five feet Seven inches high.

Lt. Col. Eli C Kusler, Assistant Marshal of Mass 7th Regiment of Volunteers.

Dist of Miss and Recruiting Officer.

(A. G. O. No. 74 & 76.)

Mustered into the service of the United States, for three years or during the war, from date of enlistment, in Company 3rd Regiment of U.S. Volunteers, on the 27th day of Sept 1864, at Vicksburg Miss

Single

Wm. H. ...

Chas. M. O.

Entitled to Bounty

Extract from Act of Congress.

SEC. 12. *And be it further enacted,* That the fees of agents and attorneys for making out and causing to be executed the papers necessary to establish a claim for a pension, bounty, and other allowance before the Pension Office, under this act, shall not exceed the following rates: For making out and causing to be duly executed a declaration by the applicant, with the necessary affidavits, and forwarding the same to the Pension Office, with the requisite correspondence, ten dollars; which sum shall be received by such agent or attorney in full for all services in obtaining such pension, and shall not be demanded or received, in whole or in part, until such pension shall be obtained; and the sixth and seventh sections of an act entitled "An act to grant pensions," approved July [fourteenth,] eighteen hundred and sixty-two, are hereby repealed.

SEC. 13. *And be it further enacted,* That any agent or attorney who shall, directly or indirectly, demand or receive any greater compensation for his services under this act than is prescribed in the preceding section of this act, or who shall contract or agree to prosecute any claim for a pension, bounty, or other allowance under this act, on the condition that he shall receive a per centum upon any portion of the amount of such claim, or who shall wrongfully withhold from a pensioner or other claimant the whole or any part of the pension or claim allowed and due to such pensioner or claimant, shall be deemed guilty of a high misdemeanor, and, upon conviction thereof, shall, for every such offense, be fined not exceeding three hundred dollars, or imprisoned at hard labor not exceeding two years, or both, according to the circumstances and aggravations of the offense.

Approved July 4, 1864.

NOTE 10.—If any soldier is charged a higher fee than that allowed by the above act, he should report the fact and the name of the agent to the Adjutant General, in order that steps may be taken to have the same refunded.

FINAL STATEMENT

OF

Jacob Henderson
3^d
C. K. Reg't of U. S. Cavalry

VOLUNTEERS.

NOTE 1.—Two of these certificates (or duplicates) are to be given to each Volunteer Soldier or drafted man who may be discharged without being mustered out, (Final Statements are never given to men mustered out of service,) that he may at once receive from the Paymaster the pay, &c., due him, and the captain or other COMMISSIONED officer commanding the company will certify to the act of the delivery of the duplicate certificates; with these certificates the Soldier is "entitled to" his discharge, and should also present his discharge to the Paymaster to have the payment endorsed on it. The discharge is to be given back to the Soldier by the Paymaster; the latter only retaining as his vouchers the duplicate certificates.

NOTE 2.—If the Soldier is entitled to pay for the use of his horse, the Company Commander will certify to that fact on the back of both these final statements, and also to the time he has pay due for having been so mounted on his own horse.

NOTE 3.—When a Soldier is furnished with final statements, his descriptive list, if he has one, should be taken up by the officer who gives the Soldier these statements, and endorsed with a statement to this effect by the officer. The endorsement should exhibit a full statement of the time for which the Soldier was allowed pay on his final statements, the clothing account, and all other charges against him or in his favor, so as to comprise a complete exhibit of his account. It will then be transmitted to the Company Commander of the Soldier, who will enter all the data necessary to a full understanding of the Soldier's account on the muster roll upon which the Soldier's discharge is reported. The descriptive list will then be destroyed. The object of this is, that the remaining portion of the Soldier's account may be settled upon the receipt of these muster rolls, and the Soldier receive any pay or allowances that may be due him at the time of his discharge, and which may not appear on his last final statements from the fact that his descriptive list is incomplete. These accounts for back pay, &c., are settled by the 2d Auditor of the Treasury Department.

NOTE 4.—Charges for loss or injury to ordnance, horse equipments, and other miscellaneous charges, should appear under the heading of "Other Stoppages."

NOTE 5.—Bounty paid by State authorities, and not by the United States, will not be entered on this statement.

NOTE 6.—Amounts due the Sutler and Laundress must be entered on the muster roll on which the discharge, death, desertion, &c., is reported, as well as on the final statement, otherwise the amount cannot be collected from the United States.

NOTE 7.—This blank will be used for deceased volunteers and drafted men, as well as for others.

NOTE 8.—Where a Soldier dies in Hospital or on detached service, his descriptive list, if he has one, should be sent with his final statements, in duplicate, to the Adjutant General, Washington, D. C.

NOTE 9.—If the soldier is a drafted man or substitute, the space for time, &c., of enrolled, should contain only the word *drafted* or *substitute*, as the case may be. If the Soldier is a "VETERAN," (or RECRUIT,) the words *as a veteran*, (or *recruit*;) as the case may be, should be interlined after the words *mustered into the service of the U.S.* A statement of all the installments of *Veteran or Recruit Bounty* RECEIVED by the Soldier must be made on the back of each final statement.

1864



I certify, on honor, that Jacob Henderson, a Private of
Captain A J Haynes Company (K) of the 3^d Regiment of W G Colden
VOLUNTEERS, of the State of _____, born in Wilkinson Co, State
of Miss, aged 23 years; 5' feet, 7 inches high; Cold complexion,
Black eyes, Black hair, and by occupation a Farmer, who joined for service
and was enrolled (see Note 9) on the Sept 26th day of Sept, 1864, at Vicksburg
by Lt Col Kinsley, for the period of Three years, and mustered into
the service of the United States on the 27th day of September, 1864, at
Vicksburg, by Lt Col Donaldson; and having served
HONESTLY and FAITHFULLY with his Company to the present date, is now entitled to a
DISCHARGE by reason of Death He died in Regt Hospt
at Vicksburg Miss Nov 19 1864 of Disease

The said Jacob Henderson was last paid by Paymaster
Pay due from Enrollment to include the 19 day of November 1864, and
has pay due him from that time to the present date; he is entitled to pay and subsistence for
TRAVELING to place of enrollment, and whatever other allowances are authorized to volunteer
soldiers, drafted men, or militia, so discharged. He has received from the United States **CLOTHING**
amounting to 36 $\frac{49}{100}$ dollars, since the 27th day of September
1864; when his clothing account was last settled. He has received from the United States
_____ $\frac{_____}{100}$ dollars advanced **BOUNTY**. Bounty due \$ 300

There is to be stopped from him, on account of the State of _____, or other
authorities, for **CLOTHING**, &c., received on entering service, _____ $\frac{_____}{100}$ dollars; and
for other stoppages, viz: _____
_____ $\frac{_____}{100}$ dollars.

He has been furnished with **TRANSPORTATION** in kind from the place of his discharge to
_____; and he has been **SUBSISTED** for **TRAVELING** to his
place of enrollment, up to the _____, 186 .

He is indebted to _____, **SUTLER**, _____ $\frac{_____}{100}$ dollars.

He is indebted to _____, **LAUNDRESS**, _____ $\frac{_____}{100}$ dollars.

Given in Duplicate, at Memphis Tenn, this 11th day
of July, 1865.

A J Haynes
Captain

Commanding Company.

ARTICLES OF WAR.

ART. 55. When any non-commissioned officer or soldier shall die, or be killed in the service of the United States, the then commanding officer of the troop or company shall, in the presence of two other commissioned officers, take an account of what effects he died possessed of, above his arms and accoutrements, and transmit the same to the office of the Department of War, which said effects are to be accounted for, and paid to the representatives of such deceased non-commissioned officer or soldier. And in case any of the officers, so authorized to take care of the effects of deceased officers and soldiers, should, before they have accounted to their representatives for the same, have occasion to leave the regiment or post, by preferment or otherwise, they shall, before they be permitted to quit the same, deposit in the hands of the commanding officer, or of the assistant military agent, all the effects of such deceased non-commissioned officers and soldiers, in order that the same may be secured for, and paid to, their respective representatives.

DIRECTIONS.

NOTE 1.—One copy of the inventories of the effects of deceased non-commissioned officers and soldiers, required by the 95th Article of War, will be forwarded to the Adjutant General, by the commander of the company to which the deceased belonged, and a duplicate of the same to the colonel of the regiment. Final statements of pay, clothing, &c., in duplicate, will be sent to the Adjutant General with one copy of the inventory. Both inventory and final statements should be forwarded, as a general rule, through Regimental Headquarters. When a soldier dies at a post or station absent from his company, it will be the duty of his immediate commander to furnish, direct to the Adjutant General, the required inventory and final statements, and, at the same time, to forward to the commanding officer of the company to which the soldier belonged, a report of his death, specifying the date, place, and cause; to what time he was last paid, and the money or other effects in his possession at the time of his decease; which report will be noted on the next muster roll of the company to which the man belonged. Each inventory will be endorsed, "Inventory of the effects of — — —, late of company (—) — — regiment of — — —, who died at — — —, the — — day of — — —, 186—." If a legal representative receive the effects, it will be stated in the report. If the soldier leave no effects, the fact will be reported on the blank for inventory.

NOTE 2.—Should the effects of a deceased non-commissioned officer or soldier not be administered upon within a short period after his decease, they shall be disposed of by a Council of Administration, under the authority of the commanding officer of the post, and the proceeds deposited with the Paymaster, to the credit of the United States, until they shall be claimed by the legal representatives of the deceased.

NOTE 3.—In all such cases of sales by the Council of Administration, a statement in detail, or account of the proceeds duly certified by the Council and commanding officer, (Form 5.) accompanied by the Paymaster's receipt for the proceeds, will be forwarded by the commanding officer to the Adjutant General. The statement will be endorsed, "Report of the proceeds of the effects of — — —, late of company (—) — — regiment of — — —, who died at — — —, the — — day of — — —, 186—."

NOTE 4.—The effects in all cases, when called for, should be turned over to the legal representative, without further authority from the Adjutant General. When the effects are turned over to the relatives of the deceased before these inventories are sent to the Adjutant General, their receipts therefor should be attached to the inventories. In all other cases, one copy will be sent with a letter of transmittal direct to the Adjutant General, and a duplicate retained by the officer.

NOTE 5.—Particular care should be taken to take receipts in duplicate from the Paymaster for any funds turned over to him; one copy should be sent direct to the Adjutant General and one retained by the officer.

INVENTORY OF THE EFFECTS

OF

Jacob Henderson

Late of Company *K*

3^d Reg't of *W. J. Colden*

Volunteers, who died at *Vicksburg Miss*

on the *19* day of *Nov* 186*4*.



INVENTORY

Inventory of the effects of Jacob Henderson late
 a Private of Captain Alfred Haynes Company K of
 the 3^d Regiment of U.S. Cold War Volunteers, who was enrolled as
 a Private at Vicksburg in the State of Miss on
 the 26th day of Sept 1864, and mustered into the service of the United
 States as Private on the 27 day of Sept 1864, at Vicksburg
 in Company K, 3^d Regiment of U.S. Cold War Volunteers, to serve Three
 years or during the war; he was born in Wilkinson Co in the State
 of Miss; he was 23 years of age, 5 feet 7 inches
 high, Gold complexion, Black eyes, Blond hair, and by occupation, when enrolled,
 a Farmer; he died in Regt Hospital, at
Vicksburg Miss on the 19th day of Nov 1864, by
 reason of Disease.

INVENTORY.					
ARTICLES.	No.	ARTICLES.	No.	ARTICLES.	No.
Hats.....		Pairs trousers.....		Knapsacks.....	
Caps.....		Pairs flannel drawers.....			
Forage caps.....		Pairs cotton drawers.....			
Great coats.....		Flannel shirts.....			
Uniform coats.....		Cotton shirts.....			
Uniform jackets.....		Pairs boots.....			
Flannel sack coats.....		Pairs shoes.....			
Blouses.....		Pairs socks.....			
Stable frocks.....		Blankets.....			
Fatigue overalls.....		Haversacks.....			
				MONEY.	
					Specie.....
				Notes.....	\$

I CERTIFY, ON HONOR, that the above inventory comprises all the effects of _____
 _____, deceased, and that the effects are in the hands
 of _____ at _____
 _____ to be disposed of by a Council of Administration.

(DUPLICATES.)

STATION: Memphis Tenn

DATE: July 11th 1865

[A. G. O. No. 104.]

Alfred Haynes
Captain
 Commanding the Company.

EXTRACT FROM ACT OF CONGRESS.

SEC. 12. *And be it further enacted,* That the fees of agents and attorneys for making out and causing to be executed the papers necessary to establish a claim for a pension, bounty, and other allowance before the Pension Office, under this act, shall not exceed the following rates: For making out and causing to be duly executed a declaration by the applicant, with the necessary affidavits, and forwarding the same to the Pension Office, with the requisite correspondence, ten dollars; which sum shall be received by such agent or attorney in full for all services in obtaining such pension, and shall not be demanded or received, in whole or in part, until such pension shall be obtained; and the sixth and seventh sections of an act entitled "An act to grant pensions," approved July [fourteenth,] eighteen hundred and sixty-two, are hereby repealed.

SEC. 13. *And be it further enacted,* That any agent or attorney who shall, directly or indirectly, demand or receive any greater compensation for his services under this act than is prescribed in the preceding section of this act, or who shall contract or agree to prosecute any claim for a pension, bounty, or other allowance under this act, on the condition that he shall receive a per centum upon any portion of the amount of such claim, or who shall wrongfully withhold from a pensioner or other claimant the whole or any part of the pension or claim allowed and due to such pensioner or claimant, shall be deemed guilty of a high misdemeanor, and, upon conviction, thereof, shall, for every such offense, be fined not exceeding three hundred dollars, or imprisoned at hard labor not exceeding two years, or both, according to the circumstances and aggravations of the offense.

Approved July 4, 1861.

NOTE 10.—If any soldier is charged a higher fee than that allowed by the above act, he should report the fact and the name of the agent to the Adjutant General, in order that steps may be taken to have the same refunded.

FINAL STATEMENT

OF

Jacob Henderson
3rd
Regt of U.S. Cold Cav.

VOLUNTEERS. 18th

NOTE 1.—Two of these certificates (or duplicates) are to be given to each Volunteer Soldier or drafted man who may be discharged without being mustered out, (Final Statements are never given to men mustered out of service.) that he may at once receive from the Paymaster the pay, &c., due him, and the captain or other COMMISSIONED officer commanding the company will certify to the act of the delivery of the duplicate certificates; with these certificates the Soldier is "entitled to" his discharge, and should also present his discharge to the Paymaster to have the payment endorsed on it. The discharge is to be given back to the Soldier by the Paymaster; the latter only retaining as his vouchers the duplicate certificates.

NOTE 2.—If the Soldier is entitled to pay for the use of his horse, the Company Commander will certify to that fact on the back of both these final statements, and also to the time he has pay due for having been so mounted on his own horse.

NOTE 3.—When a Soldier is furnished with final statements, his descriptive list, if he has one, should be taken up by the officer who gives the Soldier these statements, and endorsed with a statement to this effect by the officer. The endorsement should exhibit a full statement of the time for which the Soldier was allowed pay on his final statements, the clothing account, and all other charges against him or in his favor, so as to comprise a complete exhibit of his account. It will then be transmitted to the Company Commander of the Soldier, who will enter all the data necessary to a full understanding of the Soldier's account on the muster roll upon which the Soldier's discharge is reported. The descriptive list will then be destroyed. The object of this is, that the remaining portion of the Soldier's account may be settled upon the receipt of these muster rolls, and the Soldier receive any pay or allowances that may be due him at the time of his discharge, and which may not appear on his last final statements from the fact that his descriptive list is incomplete. These accounts for back pay, &c., are settled by the 2d Auditor of the Treasury Department.

NOTE 4.—Charges for loss or injury to ordnance, horse equipments, and other miscellaneous charges, should appear under the heading of "Other Stoppages."

NOTE 5.—Bounty paid by State authorities, and not by the United States, will not be entered on this statement.

NOTE 6.—Amounts due the Sutler and Laundress must be entered on the muster roll on which the discharge, death, desertion, &c., is reported, as well as on the final statement, otherwise the amount cannot be collected from the United States.

NOTE 7.—This blank will be used for deceased volunteers and drafted men, as well as for others.

NOTE 8.—Where a Soldier dies in Hospital or on detached service, his descriptive list, if he has one, should be sent with his final statements, in duplicate, to the Adjutant General, Washington, D. C.

NOTE 9.—If the soldier is a drafted man or substitute, the space for time, &c., of enrolled, should contain only the word *drafted* or *substitute*, as the case may be. If the Soldier is a "VETERAN," (or RECRUIT,) the words *as a veteran*, (or *recruit*,) as the case may be, should be interlined after the words *mustered into the service of the U. S.* A statement of all the installments of *Veteran* or *Recruit Bounty RECEIVED* by the Soldier must be made on the back of each final statement.

ADJUTANT GENERAL'S OFFICE.

July 21. 1865.

Duplicate with Inventory sent 2d Auditor.

I certify, on honor, that Jacob Henderson, a Private of
Captain A. J. Hayes Company (K) of the 3^d Regiment of U. S. & C. I.
VOLUNTEERS, of the State of _____, born in Wilkinson Co., State
of Miss, aged 23 years; 5' feet 7 inches high; Gold complexion,
Black eyes, Blond hair, and by occupation a Farmer, who joined for service
and was enrolled (see Note 9) on the 24th day of Sept., 1864, at Vicksburg
by Lt Col Kinsley, for the period of Three years, and mustered into
the service of the United States on the 27th day of Sept, 1864, at
Vicksburg, by Lt Col Donaldson; and having served
HONESTLY and FAITHFULLY with his Company to the present date, is now entitled to a
DISCHARGE by reason of Death He died in Regl Hospital
at Vicksburg Miss of disease Nov 19th 1864

The said Jacob Henderson was last paid by Paymaster
Pay due from Enrollment to include the 19th day of November 1864, and
has pay due him from that time to the present date; he is entitled to pay and subsistence for
TRAVELING to place of enrollment, and whatever other allowances are authorized to volunteer
soldiers, drafted men, or militia, so discharged. He has received from the United States **CLOTHING**
amounting to 36 ⁴⁹/₁₀₀ dollars, since the 27 day of September
1864, when his clothing account was last settled. He has received from the United States
100 dollars advanced **BOUNTY**. Bounty due \$ 300.

There is to be stopped from him, on account of the State of _____, or other
authorities, for **CLOTHING**, &c., received on entering service, _____ 100 dollars; and
for other stoppages, viz: _____

_____ 100 dollars.
He has been furnished with **TRANSPORTATION** in kind from the place of his discharge to
_____; and he has been **SUBSISTED** for **TRAVELING** to his
place of enrollment, up to the _____, 186 .

He is indebted to _____, **SUTLER**, _____ 100 dollars.

He is indebted to _____, **LAUNDRESS**, _____ 100 dollars.

Given in Duplicate, at Memphis Tenn, this 11th day
of July, 1865.

A. J. Hayes
Captain

Commanding Company.

638

Henderson, Moses

Co F, 3 U. S. Col'd Cav.

Private

Saddler

CARD NUMBERS.

1	5338880	26
2	5338967	27
3	5339055	28
4	5339129	29
5	5339188	30
6	5339261	31
7	5339347	32
8	5339429	33
9	5339535	34
10	5339631	35
11	5339724	36
12	5339812	37
13	5339893	38
14	5339972	39
15	9088956	40
16	40727452	41
17		42
18		43
19		44
20		45
21		46
22		47
23		48
24		49
25		50

Book Mark:

See also

A. 1130758 P.O. M T M
A. 2573000 And W D

J. M. Shannon
Ed
Pa

N | **3 Cav. | U.S.C.T.**

Moses Henderson

....., Co. *F*, 3 Reg't U. S. Col'd Cav.

Appears on

Company Descriptive Book
of the organization named above.

DESCRIPTION.

Age *35* years; height *5* feet *5* inches.

Complexion *Brown*

Eyes *Black*; hair *Black*

Where born *Richmond Va.*

Occupation *Farmer*

ENLISTMENT.

When *Dec 1*, 1863.

Where *Skipsville*

By whom *C. C. Spauld*; term *3* y'rs.

Remarks: *Artificer*

.....
.....
.....
.....
.....
.....
.....
.....
.....
.....

E. W. Stone

1177 040

H | **3 Cav.** | **U.S.C.T.**

Moses Henderson

Rot, Co. *F*, 1 Reg't Miss. Cav., Corps d'Afrique.*
ages 33 yrs
Appears on

Company Muster-in Roll

of the organization named above. Roll dated
Vicksburg Miss, Jan 26, 1864.
Muster-in to date *Dec 1, 1863.*

Joined for duty and enrolled:

When *Dec 1*, 186 *3*.
Where *Skipwith Miss.*
Period *3* years.

Valuation of horse, \$.....100

Valuation of horse equipments, \$.....100

Remarks :
.....
.....
.....

*This organization subsequently became Co. *F*, 3 Reg't U. S. Colored Cavalry.

Book mark :
.....

E. J. Richardson

14 | 3 Cav. | U.S.C.T.

Moses Henderson

B-t, Co. F, 1 Reg't Miss. Cav., Corps d'Afrique.*

Appears on

Company Muster Roll

for Dec 6/63 to Feb 29, 1864

Present or absent Present

Stoppage, \$ 100 for

Due Gov't, \$ 100 for

Valuation of horse, \$ 100

Valuation of horse equipments, \$ 100

Remarks:

*This organization subsequently became Co. F, 3 Reg't U. S. Colored Cavalry.

Book mark:

C. Richardson

14 | **3 Cav.** | **U.S.C.T.**

Moses Henderson
Pvt, Co. F, 3 Reg't U.S. Col'd Cavalry.

Appears on

Company Muster Roll

for Mar + Apr, 1864.

Present or absent Present

Stoppage, \$ 100 for

Due Gov't, \$ 100 for

Valuation of horse, \$ 100

Valuation of horse equipments, \$ 100

Remarks:

Book mark: -----

E. J. Richardson
Copyist.

14 | 3 Cav. | U.S.C.T.

Moses Henderson

Rot, Co. F, 3 Reg't U. S. Col'd Cavalry.

Appears on

Company Muster Roll

for May + June, 1864.

Present or absent Present

Stoppage, \$ 100 for

Due Gov't, \$ 100 for

Valuation of horse, \$ 100

Valuation of horse equipments, \$ 100

Remarks:

Book mark:

E. T. Richardson
Copyist.

H | **3 Cav.** | **U.S.C.T.**

Moses Henderson

Saddle, Co. F, 3 Reg't U. S. Col'd Cavalry.

Appears on

Company Muster Roll

for *July + Aug*, 186*4*.

Present or absent *Present*

Stoppage, \$ *100* for

Due Gov't, \$ *100* for

Valuation of horse, \$ *100*

Valuation of horse equipments, \$ *100*

Remarks: *Appointed May 1/64.*

Book mark: _____

E. Richardson

(358)

Copyist.

14 | 3 Cav. | U.S.C.T.

Moses Henderson

Saddler, Co. F, 3 Reg't U. S. Col'd Cavalry.

Appears on

Company Muster Roll

for Sept & Oct, 1864.

Present or absent Present

Stoppage, \$ 100 for

Due Gov't, \$ 100 for

Valuation of horse, \$ 100

Valuation of horse equipments, \$ 100

Remarks:

Book mark:

E. Richardson
Copyist.

No | **3 Cav.** | **U.S.C.T.**

Moses Henderson

Saddler, Co. F, 3 Reg't U. S. Col'd Cavalry.

Appears on

Company Muster Roll

for Nov & Dec, 1861

Present or absent present

Stoppage, \$ 1 ^{as} 100 for clothing

Due Gov't, \$ 100 for

Valuation of horse, \$ 100

Valuation of horse equipments, \$ 100

Remarks:

Book mark: _____

(358)

Moses
Copyist.

No. | **3 Cav.** | **U.S.C.T.**

Alfred Mendelsohn
Saddler, Co. F, 3 Reg't U. S. Col'd Cavalry.

Appears on

Company Muster Roll

for Jan + Feb, 1862

Present or absent Present

Stoppage, \$.....100 for

Due Gov't, \$.....100 for

Valuation of horse, \$.....100

Valuation of horse equipments, \$.....100

Remarks:

Book mark:

(358)

Alfred
Copyist.

No | **3 Cav.** | **U.S.C.T.**

Moses Henderson
Saddler, Co. F, 3 Reg't U. S. Col'd Cavalry.

Appears on

Company Muster Roll

for Memo Capt, 1865.

Present or absent present

Stoppage, \$ 100 for

Due Gov't, \$ 100 for

Valuation of horse, \$ 100

Valuation of horse equipments, \$ 100

Remarks:

Book mark: _____

(358)

Neal

Copyist.

46 | **3 Cav. | U.S.C.T.**

James Henderson

Saddles, Co. F, 3 Reg't U. S. Col'd Cavalry.

Appears on

Company Muster Roll

for *11th Reg't*, 186*5*.

Present or absent *present*

Stoppage, \$ *100* for

Due Gov't, \$ *100* for

Valuation of horse, \$ *100*

Valuation of horse equipments, \$ *100*

Remarks: *Stop (cost)*

received \$ 200.00

Book mark:

M | **3 Cav. | U.S.C.T.**

Moses Henderson
Saddler, Co. F, 3 Reg't U. S. Col'd Cavalry.

Appears on

Company Muster Roll

for *July 1865*, 1865.

Present or absent *present*

Stoppage, \$ *100* for

Due Gov't, \$ *100* for

Valuation of horse, \$ *100*

Valuation of horse equipments, \$ *100*

Remarks:

Book mark:

Mead
Copyist.

A-1 | **3 Cav. | U.S.C.T.**

James Henderson

T. H., Co. F, 3 Reg't U. S. Col'd Cavalry.

Appears on

Company Muster Roll

for *Sept. - Oct.*, 186*5*.

Present or absent *Present*

Stoppage, \$.....100 for

Due Gov't, \$.....100 for

Valuation of horse, \$.....100

Valuation of horse equipments, \$.....100

Remarks:

.....

.....

.....

.....

.....

.....

.....

.....

Book mark:

[Signature]

Copyist.

17 | **3 Cav.** | **U.S.C.T.**

James Henderson
Sudds, Co. F, 3 Reg't U.S. Col'd Cavalry.

Appears on

Company Muster Roll

for *James Henderson*, 186*2*.

Present or absent *Present*

Stoppage, \$ *100* for

Due Gov't, \$ *100* for

Valuation of horse, \$ *100*

Valuation of horse equipments, \$ *100*

Remarks:

Book mark:

H. | **3 Cav.** | **U.S.C.T.**

Moses Henderson

Art., Co. F, 3 Reg't U. S. Colored Cav.

Appears on **Returns** as follows:

Mar. 1865: Saddler,

Apr. & May 1865: On extra or
daily duty,

June 1865: Co. Saddler at R. 2.
m. Dept.

July to Oct. 1865: Co. saddler.

Book mark :

J. B. Sittler

(546)

Copyist.

A | **3 Cav. | U.S.C.T.**

Wm. Henderson

Said, Co. *F*, 3 Reg't U. S. Col'd Cavalry.

Appears on **Co. Muster-out Roll**, dated *Memphis, Tenn. Jan 26*, 186 *6*.

Muster-out to date *Jan 26*, 186 *6*.

Last paid to *Jan 30*, 186 *6*.

Clothing account:

Last settled 186 ; drawn since \$ 100

Due soldier \$ 100; due U. S. \$ 100

Am't for cloth'g in kind or money adv'd \$ 100

Due U. S. for arms, equipments, &c., \$ 100

Bounty paid \$ 100; due \$ 100

Remarks:

Book mark:

[Signature]

639

Henderson, Peter

Co C, 3 U. S. Col'd Cav.

Private

Private

CARD NUMBERS.

1	5334813	26
2	5334906	27
3	5334994	28
4	5335079	29
5	5335161	30
6	5335240	31
7	5335319	32
8	5335403	33
9	5335486	34
10	5335593	35
11	5335691	36
12	5335841	37
13	5331840	38
14	5336150	39
15	9088511	40
16	40727515	41
17		42
18		43
19		44
20		45
21		46
22		47
23		48
24		49
25		50

Book Mark: 640-13-89

See also

S 11 85 487 P O m m
D 1214576 P O m m
R P 424242
R P 426565

A M Shannon
Pa

S 11 85 487 P.O. m. m
D 1214576 P.O. m. m
RCP 424242
RCP 426565

A. M. Shannon
Esq

H | 3 Cav. | U.S.C.T.

Peter Henderson

....., Co. C, 3 Reg't U. S. Col'd Cav.

Appears on

Company Descriptive Book

of the organization named above.

DESCRIPTION.

Age 18 years; height 5 feet 1 inches.

Complexion Black

Eyes Black; hair Black

Where born Washington Co. Miss.

Occupation Farmer

ENLISTMENT.

When Nov 1, 1863.

Where Vicksburg - Miss.

By whom B. S. Wing; term 3 y'rs.

Remarks: Left on boat at
Gaine Landing, La. Jan.
28, 1865. (sick) while on
expedition. Was never
heard of after. Dropped
as deserter Aug. 12 -
1865.

F. A. Wright

H **3 Cav. U.S.C.T.**

Peter Henderson

Priv., Co. *C*, 1 Reg't Miss. Cav., A. D.†

Age *18* years.

Appears on

Company Muster-in Roll

of the organization named above. Roll dated

Vicksburg, Miss, Nov 1, 1863.

Muster-in to date *Nov 1, 1863.*

Joined for duty and enrolled:

When *Nov 1*, 1863.*

Where *Vicksburg, Miss.*

Period *3* years.*

Valuation of horse, \$ 100

Valuation of horse equipments, \$ 100

Remarks:

† This organization subsequently became Co. *C*, 3 Reg't U. S. Colored Cavalry.

* ~~See~~ Muster-in roll shows enrollment and muster-in of this company as of same date. See enrollment on subsequent card or cards

Book mark: *640-13-89*

R. Johnson
Copyist.

26 | 3 Cav. | U.S.C.T.

Peter Henderson

Priv., Co. C, 1 Reg't Miss. Cav., A. D.†

Appears on

Company Muster Roll

for Nov and Dec, 1863

Joined for duty and enrolled:

When Nov 1., 1863.*

Where Vicksburg *

Period 3 years.*

Present or absent Not stated

Stoppage, \$ 100 for

Due Gov't \$ 100 for

Valuation of horse, \$ 100

Valuation of horse equipments, 100

Remarks:

† This organization subsequently became Co. C, 3 Reg't U. S. Colored Cavalry.

* See enrollment on card from muster-in roll.

Book mark:

R. Johnson Copyist.

No. 26 | **3 Cav.** | **U.S.C.T.**

Peter Henderson
Plt, Co. C, 1 Reg't Miss. Cav., Corps d'Afrique.*

Appears on

Company Muster Roll

for Jan'y & Feby, 1864

Present or absent Present

Stoppage, \$ 100 for

Due Gov't, \$ 100 for

Valuation of horse, \$ 100

Valuation of horse equipments, \$ 100

Remarks: Atalo serv 1.
Walter, 2, 45, 1 Quarter
4 1/2.

*This organization subsequently became Co. C, 3 Reg't U. S. Colored Cavalry.

Book mark: _____

(358)

R. Blum
Copyist.

26 | 3 Cav. | U.S.C.T.

Peter Henderson
Pvt., Co. C, 3 Reg't U. S. Col'd Cavalry.

Appears on

Company Muster Roll
for March & April, 1864.

Present or absent Present

Stoppage, \$ 100 for

Due Gov't, \$ 100 for

Valuation of horse, \$ 100

Valuation of horse equipments, \$ 100

Remarks:

Book mark:

(358)

R. Johnson
Copyist.

76 | 3 Cav. | U.S.C.T.

Peter Henderson
Priv., Co. C, 3 Reg't U. S. Col'd Cavalry.

Appears on

Company Muster Roll

for *May and June*, 186*4*.

Present or absent *Present.*

Stoppage, \$ *100* for

Due Gov't, \$ *100* for

Valuation of horse, \$ *100*

Valuation of horse equipments, \$ *100*

Remarks: *Stop for March*
3rd

Book mark:

R. Johnson
Copyist.

26 | 3 Cav. | U.S.C.T.

Peter Henderson

Prvt., Co. C, 3 Reg't U. S. Col'd Cavalry.

Appears on

Company Muster Roll

for July & Aug., 1864

Present or absent Present

Stoppage, \$ 100 for

Due Gov't, \$ 100 for

Valuation of horse, \$ 100

Valuation of horse equipments, \$ 100

Remarks: Due M.D. for Ind-
-manee from last
Muster Roll 37 ct

Book mark:

R. Johnson

(358)

Copyist.

76 | **3 Cav.** | **U.S.C.T.**

Peter Henderson
Priv', Co. C, 3 Reg't U. S. Col'd Cavalry.

Appears on

Company Muster Roll
for Sept & Oct, 186 4

Present or absent Present

Stoppage, \$ 100 for

Due Gov't, \$ 100 for

Valuation of horse, \$ 100

Valuation of horse equipments, \$ 100

Remarks: Stop for 1 pr Spurs
& Traps 1. Carbine
(Traps) Sling & Swivel
\$32.52

Book mark: _____

Jalworth
Copyst.

H | **3 Cav.** | **U.S.C.T.**

Peter Henderson
Priv, Co. C, 3 Reg't U. S. Col'd Cavalry.

Appears on

Company Muster Roll

for *Nov & Dec*, 186*4*

Present or absent *Absent*

Stoppage, \$ *100* for

Due Gov't, \$ *100* for

Valuation of horse, \$ *100*

Valuation of horse equipments, \$ *100*

Remarks: *On account of*
U.S. for Ordnance from
last muster roll \$32.52
stopped 1. Pr spurs &
straps 1 Colts A. Revolver
\$52.35

Book mark:

(358)

Jalworth
Copyist.

26 | 3 Cav. | U.S.C.T.

Peter Henderson
Priv, Co. C, 3 Reg't U. S. Col'd Cavalry.

Appears on

Company Muster Roll

for Jan'y & Feb'y, 1865.

Present or absent Absent

Stoppage, \$ 100 for

Due Gov't, \$ 100 for

Valuation of horse, \$ 100

Valuation of horse equipments, \$ 100

Remarks: Sick in Gen Hosp -
itab. Stoppe for ordina
1. Healer 2. Curry Comb,
2 Horse Brushes, Belt
Woolen \$4.67,

Book mark:

(358)

Talbot
Copyist.

H
3 Cav. U.S.C.T.

Peter Henderson
Priv., Co. C, 3 Reg't U. S. Col'd Cavalry.

Appears on

Company Muster Roll

for *March & April*, 186*5*.

Present or absent *Absent*

Stoppage, \$ *100* for

Due Gov't, \$ *100* for

Valuation of horse, \$ *100*

Valuation of horse equipments, \$ *100*

Remarks: *Sick in Genl
Hospital at Memphis
Tenn. since May '65
Due U.S. for ord from
last must \$4.67.*

Book mark:

(358)

Talbot
Copyst.

76 | 3 Cav. | U.S.C.T.

Peter Henderson

Priv, Co. C, 3 Reg't U. S. Col'd Cavalry.

Appears on

Company Muster Roll

for May & June, 1865

Present or absent Absent

Stoppage, \$ 100 for

Due Gov't, \$ 100 for

Valuation of horse, \$ 100

Valuation of horse equipments, \$ 100

Remarks: Absent sick since
Jan 28, 65, don't
know where, due
U.S. for ordnance from
last muster 4.65

Book mark:

(358)

Palworth Copyist.

76 | **3 Cav.** | **U.S.C.T.**

Peter Henderson
Priv, Co. C, 3 Reg't U. S. Col'd Cavalry.

Appears on

Company Muster Roll

for July & Aug, 1865.

Present or absent.....

Stoppage, \$.....100 for.....

Due Gov't, \$.....100 for.....

Valuation of horse, \$.....100

Valuation of horse equipments, \$.....100

Remarks: Accepted at Mem-
phis Tenn, Aug 17,
1865,

Book mark:.....

(358)

Talbot
Copyist.

H | 3 cav | **U.S.C.T.**

Peter Henderson
Pvt, Co. C, 3 Reg't U. S. Col'd Cav

Appears on

Descriptive List of Deserters

dated Memphis Tenn Aug 31, 1865.

Deserted :

When Aug 2, 1865.

Where Memphis Tenn

Arrested :

When _____, 186 .

Where _____

Remarks : Ac'd M.S. for Advances
\$ 4.67

Book mark : _____

H. S. Miller

Ho. | 3 Cav. | U.S.C.T.

Peter Henderson
Pvt., Co. C, 3 Reg't U. S. Colored Cav.

Appears on **Returns** as follows:

Feb. & Mar, 1865. Absent sick in
Gen Hosp. Memphis Tenn,
since Jan. 28/65.

Apr. to July 1865. Absent sick
Gen. Hosp. since Jan. 28,
'65.

Aug, 1865. Lost Aug, 12/65 Mem-
phis, deserted, has been
sick since Jan. 28/65-
when he was put on
board of a Transport
(sick) bound for Memphis.
While part of the Company
(Commanded by 1st Sergt,
Rollin C. Baker) was with
Col. Osbonds Expedition
into La. & Ark, and has
not been heard of since.

Book mark :

(546)

J. B. Sittler

Copyist.

H | *3rd Cav* | **U. S. C. T.**

Peter Anderson
Pvt, Co. *C*, *3* Reg't U. S. Col'd *Cavalry*.

Appears on **Co. Muster-out Roll**, dated

Memphis Tenn Jan'y 26th, 186*6*.

Muster-out to date _____, 186*6*.

Last paid to *Aug. 31*, 186*6*.

Clothing account:

Last settled _____, 186*6* ; drawn since \$ _____ *100*

Due soldier \$ _____ *100*; due U. S. \$ _____ *100*

Am't for cloth'g in kind or money adv'd \$ _____ *100*

Due U. S. for arms, equipments, &c., \$ _____ *100*

Bounty paid \$ _____ *100* due \$ _____ *100*

Remarks: *Discharged at*

Memphis, Tenn, Aug 12, 65,

Book mark: _____

⁶⁴⁰
Henderson, William

Co. F, 3 U. S. Col'd Cav.

Private

Private

CARD NUMBERS.

5338879	26
5338966	27
5339095	28
5331656	29
5340079	30
9088955	31
40727453	32

26
27
28
29
30
31
32
33
34
35
36
37
38
39
40
41
42
43
44
45
46
47
48
49
50

Book Mark:

See also

A | **3 Cav. | U.S.C.T.**

William Henderson

....., Co. *F*, 3 Reg't U. S. Col'd Cav.

Appears on

Company Descriptive Book
of the organization named above.

DESCRIPTION.

Age *35* years; height *5* feet *4 1/2* inches.

Complexion *Black*

Eyes *Black*; hair *Blk.*

Where born *Warren Co. Miss*

Occupation *Warmer*

ENLISTMENT.

When *Dec 1*, 1863.

Where *Skippville*

By whom *C. C. Spaid*; term *3* y'rs.

Remarks: *Deserted at Haynes Bluffs*
Miss. Mar. 14, 1864. Had pay
due from enrollment - Had
received from U.S. Clothing
amounting to Thirty five dollars
and fifty four cents (\$35.54)

E. W. Stone

A | **3 Cav.** | **U.S.C.T.**

William Henderson

Plt, Co. *F*, 1 Reg't Miss. Cav., Corps d'Afrique.*

Age 35 yrs
Appears on

Company Muster-in Roll

of the organization named above. Roll dated

Vicksburg Miss, Jan 26, 1864.

Muster-in to date *Dec 1, 1863.*

Joined for duty and enrolled:

When *Dec 1*, 1863.

Where *Skipwiths Miss.*

Period *3* years.

Valuation of horse, \$ 100

Valuation of horse equipments, \$ 100

Remarks:

* This organization subsequently became Co. *F*, 3 Reg't U. S. Colored Cavalry.

Book mark:

E J Richardson

(356)

Copyist.

H | **3 Cav.** | **U.S.C.T.**

William Henderson
Pvt, Co. F, 1 Reg't Miss. Cav., Corps d'Afrique.*

Appears on

Company Muster Roll

for Dec 6/63 to Feb 29, 1864

Present or absent Present

Stoppage, \$ 100 for

Due Gov't, \$ 100 for

Valuation of horse, \$ 100

Valuation of horse equipments, \$ 100

Remarks:

*This organization subsequently became Co. F, 3 Reg't U. S. Colored Cavalry.

Book mark:

(358)

E. J. Richardson

Copyist.

A | 3000 | U.S.C.T.

Wm Henderson

Pvt., Co. H, 3 Reg't U. S. Col'd Cal.

Appears on

Descriptive List of Deserters

dated Haines Bluffs Miss Apr 14, 1864.

Deserted:

When March 14, 1864.

Where Haines Bluffs

Arrested:

When _____, 186 .

Where _____

Remarks: Stopped Ordnance.

\$8.42

Book mark: _____

H J Miller

(351)

Copyist.

H | **3 Cav.** | **U.S.C.T.**

William Henderson

Priv, Co. F, 3 Reg't U. S. Col'd Cavalry.

Appears on

Company Muster Roll

for Mar + Apr, 1864.

Present or absent.....

Stoppage, \$.....100 for.....

Due Gov't, \$.....100 for.....

Valuation of horse, \$.....100

Valuation of horse equipments, \$.....100

Remarks: Deserted at
Haynes Bluff
Miss. March 24/64.

Book mark:.....

(358)

E. J. Richardson

Copyist.

H. | **3 Cav.** | **U.S.C.T.**

N^m Henderson

Priv, Co. *F*, 3 Reg't U. S. Colored Cav.

Appears on **Returns** as follows:

Mar. 1864. Lose Mar. 14 Snyder's Bluffs - Deserted.

Book mark :

(546)

J. B. Sittler

Copyist.

N | **3 Cav. | U.S.C.T.**

William Henderson

Sgt, Co. *F*, 3 Reg't U. S. Col'd Cavalry.

Appears on **Co. Muster-out Roll**, dated *Memphis Tenn, Jan 26*, 186 *6*.

Muster-out to date _____, 186 .

Last paid to *Never Paid* _____, 186 .

Clothing account:

Last settled _____, 186 ; drawn since \$ _____ 100

Due soldier \$ _____ 100; due U. S. \$ _____ 100

Am't for cloth'g in kind or money adv'd \$ _____ 100

Due U. S. for arms, equipments, &c., \$ _____ 100

Bounty paid \$ _____ 100; due \$ _____ 100

Remarks: *Deserted at Kaynes Bluff Miss March 2nd 64*

Book mark: _____

(361)

Long

Copyist.

641 or Morden
Hemison, Mordecai

Co A, 3 U. S. Col'd Cav.

Private

Private

CARD NUMBERS.

1	5332113	26
2	5332202	27
3	5332292	28
4	5332398	29
5	5332451	30
6	5332528	31
7	5332606	32
8	5332724	33
9	5333422	34
10	9088236	35
11	40727518	36
12		37
13		38
14		39
15		40
16		41
17		42
18		43
19		44
20		45
21		46
22		47
23		48
24		49
25		50

Book Mark:

See also

S. 2887533

A. M. Shannon
Esq

4 | **3 Cav. | U.S.C.T.**

Moracca Henison

....., Co. A, 3 Reg't U. S. Col'd Cav.

Appears on

Company Descriptive Book
of the organization named above.

DESCRIPTION.

Age 22 years; height 5 feet 1 inches.

Complexion Black

Eyes Black; hair Black

Where born Madison Co. Miss.

Occupation Farmer

ENLISTMENT.

When Oct. 5, 1863.

Where Vicksburg - Miss.

By whom Cap. W. W. Webber; term 3 y'rs.

Remarks: Missing in ac-
tion March 5, 1864.

.....
.....
.....
.....
.....

F. A. Wright

f | **3 Cav.** | **U.S.C.T.**

Mordecai Herison

Pat, Co. *A*, 1 Reg't Miss. Cav., Corps d'Afrique.*

Age 22 yrs

Appears on

Company Muster-in Roll

of the organization named above. Roll dated

Vicksburg Miss, Oct 5, 1863.

Muster-in to date *Oct. 5, 1863.*

Joined for duty and enrolled:

When *Oct 5th*, 1863.

Where *Vicksburg, Miss*

Period *3* years.

Valuation of horse, \$ 100

Valuation of horse equipments, \$ 100

Remarks: _____

*This organization subsequently became Co. *A*, 3 Reg't U. S. Colored Cavalry.

Book mark: _____

C. U. Clark

H | 3 Cav. | U.S.C.T.

Mordica Hemison
Pat, Co. A, 1 Reg't Miss. Cav., Corps d'Afrique.*

Appears on

Company Muster Roll

for Oct 9, 1863 to Dec 31, 1863.

Present or absent Present

Stoppage, \$ 100 for

Due Gov't, \$ 100 for

Valuation of horse, \$ 100

Valuation of horse equipments, \$ 100

Remarks:

*This organization subsequently became Co. A, 3 Reg't U. S. Colored Cavalry.

Book mark:

C. N. Clark

H | 3 Cav. | U.S.C.T.

Mordica Henison
Pat. Co. A, 1 Reg't Miss. Cav., Corps d'Afrique.*

Appears on

Company Muster Roll

for Jan & Feb, 1864.

Present or absent Present,

Stoppage, \$ 0 ⁹⁰/₁₀₀ for Haversack & canteen; 7.60, helter, bridle, curry comb & brush.

Due Gov't, \$ 100 for

Valuation of horse, \$ 100

Valuation of horse equipments, \$ 100

Remarks:

*This organization subsequently became Co. A, 3 Reg't U. S. Colored Cavalry.

Book mark:

C. H. Clark

H | 3 Cav. | U.S.C.T.

Mordica Hemson
Pat, Co. A, 3 Reg't U. S. Col'd Cavalry.

Appears on

Company Muster Roll

for March & April, 1864.

Present or absent Present.

Stoppage, \$ 100 for

Due Gov't, \$ 100 for

Valuation of horse, \$ 100

Valuation of horse equipments, \$ 100

Remarks: Taken prisoner
at Yazoo City, Miss
5, 1864. Issued for
haversack & canteen,
halter & bridle, curry
comb & h brush.

Book mark:

C. M. Clark

A | **3 Cav.** | **U.S.C.T.**

Mordica Hemison

Pat, Co. A, 3 Reg't U.S. Col'd Cavalry.

Appears on

Company Muster Roll

for May & June, 1864.

Present or absent Absent

Stoppage, \$ 100 for

Due Gov't, \$ 100 for

Valuation of horse, \$ 100

Valuation of horse equipments, \$ 100

Remarks: Taken prisoner
by the enemy at Hazoo
City, March 5, 1864. Stop
for canteen, haversack,
halter, bridle, curry comb,
horse brush. Stoppage for 66
garrison equipment, \$0.90; for
ordinance, \$7.50

Book mark:

L. H. Clark

| **3 Cav.** | **U.S.C.T.**

Nordica Harrison
Pvt, Co. A, 3 Reg't U. S. Col'd Cavalry.

Appears on

Company Muster Roll

for July & Aug, 1864.

Present or absent Absent.

Stoppage, \$ 100 for

Due Gov't, \$ 100 for

Valuation of horse, \$ 100

Valuation of horse equipments, \$ 100

Remarks: Taken prisoner by
the enemy at Yazoo
city, Miss March 5,
1864. Stop for one havers
sack, canteen, C. Cumb,
horse brush halter & bridle.
Stop for ordinance \$7.50;
for C & G. Equipage \$50

Book mark:

C. M. Clark

H | **3 Cav.** | **U.S.C.T.**

Mordeca Henderson

Pvt., Co. A, 3 Reg't U. S. Col'd Cavalry.

Appears on

Company Muster Roll

for *Sept & Oct*, 186*4*.

Present or absent *Absent*.

Stoppage, \$ *100* for

Due Gov't, \$ *100* for

Valuation of horse, \$ *100*

Valuation of horse equipments, \$ *100*

Remarks: *Captured by the enemy at Yazoo City Miss. Mar. 5, 1864. Stop for H. Sack. Canteen, Comb & Brush, Halter & Bridle.*

Book mark:

P'Pool

A | **3 Cav.** | **U.S.C.T.**

Mordecai Menison,

Pat., Co. A, 3 Reg't U. S. Col'd Cavalry.

Appears on

Company Muster Roll

for Nov. + Dec., 186 4.

Present or absent.....

Stoppage, \$.....100 for.....

Due Gov't, \$.....100 for.....

Valuation of horse, \$.....100

Valuation of horse equipments, \$.....100

Remarks: Missing in action
at Yazoo City, Mar. 5/64.
(Not dropped previously
by error). Stop for
1 H. Sack, 1 Canteen, 1 S.
Comb, 1 H. Brush, 1 Halter
1 Bridle.

Book mark:.....

P. Pool

H. | **3 Cav.** | **U.S.C.T.**

Mordica Hemison

Priv., Co. A, 3 Reg't U. S. Colored Cav.

Appears on **Returns** as follows:

Mar. 1864. Loss Mar. 5 - Yazoo
City - Killed or captured

Nov. 1864. Loss Mar. 5/64 Yazoo
City, Taken prisoner at
Yazoo city, not dropt
from the Report before
by error.

Dec. 1864. Loss Mar. 5/64 Yazoo
City, Taken prisoner at
Yazoo City, dropt from
the Report.

Book mark :

J. B. Sittler

(548)

Copyist.

76 | 3 Cav. | U.S.C.T.

Morden Hemison
Ch, Co *A*, 3 Reg't U. S. Col'd Cavalry.

Appears on Co. Muster-out Roll, dated
Memphis Tenn Jan 26, 1866.

Muster-out to date _____, 186 .

Last paid to *Dec 31*, 1863.

Clothing account:

Last settled _____, 186 ; drawn since \$ _____ 100

Due soldier \$ _____ 100 ; due U. S. \$ _____ 100

Am't for cloth'g in kind or money adv'd \$ _____ 100

Due U. S. for arms, equipments, &c., \$ _____ 100

Bounty paid \$ _____ 100 ; due \$ _____ 100

Remarks: *Missing in action*
at Yazoo City Miss
March 4, 64 Dropped
from the rolls by order of
Col. E. D. Osburn

Book mark: *184 P 7. 69*

(861)

J. Jones
Copyist.

Harrison, Mordecai

B Co. A

3

U.S.C. Cav.

Reg't

Enclosures.

Bed Cards

Burial Records

Certs. of Dis. for Discharge

C. M. Charges

Med. Certificates

Descriptive Lists

Final Statements

Furloughs

Med. Des. Lists

Orders

Other papers relating to—

Admission to Hosp'l

Casualty Sheet (^{Pur.} Officer's)

Confinement

Contracts

Death or Effects

Desertions

Discharge from Hosp'l

Discharge from Service

Duty

Furlough

Med. Examination

Misc. Information

Pay or Clothing

Personal Reports

Rank

Transfer to Hosp'l

Transfer to V. R. C.

Transportation

MICROFILM PUBLICATION M 1819

COMPILED MILITARY SERVICE RECORDS
OF VOLUNTEER UNION SOLDIERS WHO
SERVED WITH THE USCT (US COLORED TROOPS)
3RD REGIMENT OF CAVALRY

PERSONAL PAPERS' TARGET SHEET

PLEASE NOTE THE CHECKED INFORMATION ABOUT THE PERSONAL PAPERS IN
THIS FILE:

- NO PERSONAL PAPERS WERE FOUND IN THIS FILE WHEN THE
RECORDS WERE ARRANGED FOR MICROFILMING.
- 1 PERSONAL PAPER(S) FOUND IN THIS FILE WHEN THE RECORDS
WERE ARRANGED FOR MICROFILMING.

CASUALTY SHEET

No.

Marion W. Wilson

Private of Company *A*

3^d Regiment of *Pa. S. C. Army*

State Volunteers.

NATURE OF CASUALTY.

Missing in Action

CASUALTY SHEET.

Name: *Horace Hanson*

Rank: *Private* Company: *5th* Regiment: _____

Arm: *U.S. Army* State: _____

Nature of Casualty: *Missing in action*

CAUSE OF CASUALTY—(NAME OF DISEASE, &c.)

Missing in action

BY WHOM DISCHARGED.

FROM WHAT SOURCE THIS INFORMATION WAS OBTAINED.

M. R. after dated Memphis Tenn. May 26 1900

DEGREE OF DISABILITY.

BY WHOM CERTIFIED.

REMARKS.

DATE OF DISCHARGE, DEATH, &c.

PLACE OF DISCHARGE, DEATH, &c.

A. H. Elliott

Clerk.

Henry, Charles
Co D, 3 U. S. Col'd Cav.

Private | Private

CARD NUMBERS.

1	5336184	26
2	5336335	27
3	5336367	28
4	5336487	29
5	5331654	30
6	5331655	31
7	5331635	32
8	5337527	33
9	9088646	34
10	110-03-1875	35
11	40727519	36
12		37
13		38
14		39
15		40
16		41
17		42
18		43
19		44
20		45
21		46
22		47
23		48
24		49
25		50

Book Mark: 110 & 11 Co. T. 75

See also

S.683872 2nd Aud.

S.683873 2nd Aud.

A. M. Shannon
Esq.

A | **3 Cav.** | **U.S.C.T.**

Charles Henry

Co. D, 3 Reg't U. S. Col'd Cav.

Appears on

Company Descriptive Book
of the organization named above.

DESCRIPTION.

Age *21* years; height *5* feet *9* inches.

Complexion *Black*

Eyes *Black*; hair *Black*

Where born *Columbus - Ky -*

Occupation *Laborer*

ENLISTMENT.

When *Nov. 16*, 186*3*.

Where *Skip witho Lag.*

By whom *S. G. Starr*; term *3* y'rs.

Remarks: *Deserted Dec.*
30, 1863, at Skip witho
Landing, Miss. Re-
turned voluntarily.
As all pay & allowances
stopped for time at-
sent ten (10) days.
Deserted March - 31 - 1864.

F. A. Wright

H | **3 Cav. | U.S.C.T.**

Charles Henry

Pri., Co. *D*, 1 Reg't Miss. Cav., Corps d'Afrique.*

age 21 yrs
Appears on

Company Muster-in Roll

of the organization named above. Roll dated

Shipwith Ldg. Miss Dec 9, 1863.

Muster-in to date *Nov 10*, 1863.

Joined for duty and enrolled:

When *Nov. 10*, 1863.

Where *Vicksburg Miss*

Period *3* years.

Valuation of horse, \$ *100*

Valuation of horse equipments, \$ *100*

Remarks: _____

*This organization subsequently became Co. *D*, 3 Reg't U. S. Colored Cavalry.

Book mark: _____

(356)

Avery

Copyist.

H | **3 Cav.** | **U.S.C.T.**

Charles Henry

Pri, Co. *D*, 1 Reg't Miss. Cav., Corps d'Afrique.*

Appears on

Company Muster Roll

for *Nov 16 to Dec 31*, 186*3*.

Present or absent.....

Stoppage, \$.....100 for.....

Due Gov't, \$.....100 for.....

Valuation of horse, \$.....100

Valuation of horse equipments, \$.....100

Remarks: *Disrupted Dec. 30, 1863*
Stopped for letters of our Col

*This organization subsequently became Co. *D*, 3 Reg't U. S. Colored Cavalry.

Book mark:.....

Avery

H | 3 cav | U.S.C.T.

Charles Henry
Pvt, Co. D, ^{(1 cav A.D. Miss (ols))} 3 Reg't U. S. Col'd Cav

Appears on

Descriptive List of Deserters

dated Skipwiths Landing Miss Jan 1, 1864.

Deserted :

When Dec 30, 186 .

Where Skipwiths Landing Miss

Arrested :

When, 186 .

Where

Remarks :

Book mark :

H. Miller

H | **3 Cav. | U.S.C.T.**

Charles Henry
Pi, Co. *D*, 1 Reg't Miss. Cav., Corps d'Afrique.*

Appears on

Company Muster Roll

for *Jan & Feb*, 1864.

Present or absent. *Present*

Stoppage, \$ *100* for

Due Gov't, \$ *100* for

Valuation of horse, \$ *100*

Valuation of horse equipments, \$ *100*

Remarks: *Stop pay and allow
ances (10) ten day by order
Court Martial.*

*This organization subsequently became Co. *D*, 3 Reg't U. S. Colored Cavalry.

Book mark :

Avery

H | 3^{cu} | **U.S.C.T.**

Charles Henry
1000 A.D. Miss vols)
Prvt, Co. H, 3^{cu} Reg't U. S. Col'd cu

Appears on

Descriptive List of Deserters

dated Naives Bluffs Miss. Feb 1, 1864.

Deserted:

When, 186 .

Where

Arrested:

When, 186 .

Where

Remarks: Returned June 16th 1864
restored to duty with loss of
pay for time absent by
GO No 1 Address Post of
Shipwiths Landing Miss

Book mark:

(351)

H. C. Miller
Copyist.

C | **3 Cav.** | **U.S.C.T.**

Henry Charles
Pri, Co. D, 3 Reg't U. S. Col'd Cavalry.

Appears on

Company Muster Roll
for *Mar & Apr*, 1864.

Present or absent.....

Stoppage, \$.....100 for.....

Due Gov't, \$.....100 for.....

Valuation of horse, \$.....100

Valuation of horse equipments, \$.....100

Remarks: *Deserted Mar. 31, 64.*

Book mark:.....

(358) *Avery* Copyist.

A | 3 Cav | **U.S.C.T.**

Charles Henry
Pvt, Co D, 3 Reg't U. S. Col'd Cav

Appears on

Descriptive List of Deserters

dated Haines Bluffs Miss Apr 14, 1864.

Deserted:

When , 1864.

Where Haines Bluffs

Arrested:

When , 186 .

Where

Remarks: Stopped 10 days pay
for previous desertion

Book mark:

(351)

A. J. Miller

Copyist.

H. | 3 Cav. | U.S.C.T.

Charles Henry
Pvt., Co. D, 3 Reg't U. S. Colored Cav.

Appears on Returns as follows:

Dec. 1863. (1 Miss Cav. A. D.)
Lose Dec. 30/63 - Deserted

Jan. 1864. Gain 16 J. Skipwiths
Ldg - Restored to duty from
Desertion by G.O. No. 1
Hd. Qrs. Post Skipwiths
Ldg Miss.

Mar. 1864. Lose Mar. 28 Snyder
dere Bluffs - Deserted.

Book mark :

(546)

J. B. Dittler

Copyist.

A. 13 Cav. | U.S.C.T.

Charles Henry
Pvt., Co. D, 3rd Reg't U. S. Col'd Cav

Appears on Co. Muster-out Roll, dated
Memphis Tenn, Jan 26, 1866.

Muster-out to date _____, 1866 .

Last paid to Never Paid, 1866 .

Clothing account:

Last settled _____, 1866 ; drawn since \$ _____ 100

Due soldier \$ _____ 100; due U. S. \$ _____ 100

Am't for cloth'g in kind or money adv'd \$ _____ 100

Due U. S. for arms, equipments, &c., \$ _____ 100

Bounty paid \$ _____ 100; due \$ _____ 100

Remarks: Deserted Ship
worth Landing Miss
Dec. 30/63

Book mark: A. 110. R. 11. C. T. 75.

Deserted March 31/64

Rhett

H. | 3 Cav. | W. C.

Charles Henry.

, Co. A, 3 Reg't W. C.

NOTATION.

F. B. 11. 438
Book mark: H. 110. C. I. 1875.

War Department,

Adjutant General's Office,

Washington, August 9th, 1875.

Dissected March 31, 1864.

A. M. Muzzy.

(438)

Copyist.

Henry, Charles,
Co. B,

3 Reg't U.S. Army

Enclosures.

Bed Cards	Final Statements
Burial Records	Furloughs or L. of A.
Certs. of Dis. for Discharge	Med. Certificates
C. M. Charges	Med. Des. Lists
Descriptive Lists	Orders
Discharge Certificates	Pris. of War Record
Enlistment Papers	Resignations

Other papers relating to—

Admission to Hosp'l	Furlough or L. of A.
Casualty Sheet	Med. Examination
Confinement	Misc. Information
Contracts	Pay or Clothing
Death or Effects	Personal Reports
Desertion	Rank
Discharge from Hosp'l	Transfer to Hosp'l
Discharge from Service	Transfer to V. R. C.
Duty	Transportation

Ellbrook

Wm. Henry Pitt
Co. 1st Reg. Cal. Inf.

Company

Adjutant General's Office,

COLORED TROOPS BRANCH,

January 1st, 1874

Vol. C. T., 187

Wanted in case of Henry "Quint", Co. D,

3rd Reg't U.S.C. Cav.

General Martin's Order.

He Re-Entered Dec. 1863. Deserted Dec. 20th 1863.

" January 1864. Present for duty. Pay & allowances
as if he had been sent by Order of the Adjutant General.

Adj. Gen. Order Dec 1. Heath return pay & report him
restored to duty from desertion by Lt. Col. 2nd Cav. with Edg. "Harris"

Respectfully,

W. W. Woodward.

J. H. Halton ^{Chief Clerk.}

Adjutant General's Office,

Record Rooms

Jan'y. 28th, 1874

Vol. C. T., 187

Reply in case of Chas. Henry, Co. D,

3rd Reg't U.S.C. Cav.

Reg't. Descriptive book shows: Deserted Dec. 30th - Returned
Jan'y. 10th - Deserted March 31st 1864.

No. Clothing book shows: Deserted Mar. 31st 1864.

No evidence of return from 2^d desertion. No Co. Descriptive & Mq.

Rep. book on file. on Reg't. Order book appears the following order
M^d Qr. of the Post, Shipwith's Landing Miss Jan'y 16th 64.

G.O. No. 1. Upon the recommendation of the Comdg. Officer Co. Dth 1st Miss. Cav.

A.D. Pvt. Chas. Henry Co. Dth 1st Miss. Cav. A.D., who was mustered as a deserter
in the Muster & Pay Rolls of his Co. Dec. 31st 63 and who has voluntarily returned

to duty with his Co.; is hereby restored to duty with loss of pay for time absent
By order of Col. C. D. Osband & E. Lovejoy

(Sd) E. Lovejoy
Post Adj't.

Henry "Quint"

W. W.

W. W.

Vertical handwritten notes on the right margin, including "Jan'y 16th 64" and "Shipwith's Landing Miss".

71 | **3 Cav.** | **U.S.C.T.**

George Henry

....., Co. A, 3 Reg't U. S. Col'd Cav.

Appears on

Company Descriptive Book

of the organization named above.

DESCRIPTION.

Age 36 years; height 5 feet 5 inches.

Complexion Black

Eyes Black; hair Black

Where born Clinton, Ky.

Occupation Farmer

ENLISTMENT.

When Oct. 5, 1863

Where Richsburg, Miss.

By whom Cap. W. W. Webster; term 3 y'rs.

Remarks: Scar of a burn

on right arm below

the elbow. Disd

Oct. 4, 1864 at

Goodrich's Ldg. La.

F. A. Wright

H | 3 bar. | **U.S.C.T.**

George Henry
Put, Co. A, 1st Reg't ^{Miss. Cav. Capt. d'Afrique} U.S. Col'd

Age 36 years.

Appears on

Company Muster-in Roll

of the organization named above. Roll dated

Vicksburg, Miss., Oct 9, 1863.

Muster-in to date Oct 5, 1863.

Joined for duty and enrolled:

When Oct 5th, 1863.

Where Vicksburg, Miss

Period 3 years.

Valuation of horse, \$ 100

Valuation of horse equipments, \$ 100

Remarks: _____

* This organization subsequently became
Co. A. 3d Regt, U.S. Col. Cav.

Book mark: _____

C M Clark

H | **3 Cav.** | **U.S.C.T.**

George Henry
Plt, Co. G., 1 Reg't Miss. Cav., Corps d'Afrique.*

Appears on

Company Muster Roll

for Oct 9 1863 to Dec 31, 1863.

Present or absent Present.

Stoppage, \$ 100 for

Due Gov't, \$ 100 for

Valuation of horse, \$ 100

Valuation of horse equipments, \$ 100

Remarks:
.....
.....
.....
.....
.....
.....
.....

*This organization subsequently became Co. A, 3 Reg't U. S. Colored Cavalry.

Book mark:

W M Clark

A | **3 Cav. | U.S.C.T.**

George Henry
Put, Co. *A*, 1 Reg't Miss. Cav., Corps d'Afrique.*

Appears on

Company Muster Roll

for *Jan & Feb*, 186*4*.

Present or absent *Present*.

Stoppage, \$ *100* for

Due Gov't, \$ *100* for

Valuation of horse, \$ *100*

Valuation of horse equipments, \$ *100*

Remarks:

*This organization subsequently became Co. *A*, 3 Reg't U. S. Colored Cavalry.

Book mark: _____

C. H. Clark
(358) Copyist.

H | 3 Cav. | U.S.C.T.

George Henry
Put, Co. A, 3 Reg't U. S. Col'd Cavalry.

Appears on

Company Muster Roll

for March + April, 1864.

Present or absent Present.

Stoppage, \$ 100 for

Due Gov't, \$ 100 for

Valuation of horse, \$ 100

Valuation of horse equipments, \$ 100

Remarks: Stop for one
burnt bridle.

Book mark:

C. H. Clark

H | **3 Cav.** | **U.S.C.T.**

George Henry
Pat, Co. A, 3 Reg't U. S. Col'd Cavalry.

Appears on

Company Muster Roll

for May & June, 1864.

Present or absent Present

Stoppage, \$ 100 for

Due Gov't, \$ 100 for

Valuation of horse, \$ 100

Valuation of horse equipments, \$ 100

Remarks:

Book mark: _____

W M Clark

H | 3 Cav. | U.S.C.T.

George Henry
Put, Co. A, 3 Reg't U. S. Col'd Cavalry.

Appears on

Company Muster Roll

for July & Aug, 1864.

Present or absent Present.

Stoppage, \$ 100 for

Due Gov't, \$ 100 for

Valuation of horse, \$ 100

Valuation of horse equipments, \$ 100

Remarks: One carbine
cartridge lost, stop
for one sabre, one
belt & one plate

Book mark:

C H Clark

H | 3 Cav. | U.S.C.T.

George Henry,

Priv., Co. A, 3 Reg't U.S. Col'd Cavalry.

Appears on

Company Muster Roll
for Sept. & Oct., 1864

Present or absent

Stoppage, \$ 100 for

Due Gov't, \$ 100 for

Valuation of horse, \$ 100

Valuation of horse equipments, \$ 100

Remarks: Died of Smallpox
at Goodrich's Edg., La.,
Clothing drawn since
enlistment. One Sabre,
One Belt & Plate, One Carbine
Slip & Swivel, 1 Cartridge Box
& Cap Pouch.

Book mark:

P'Pool

H. | 3 Cav. | U.S.C.T.

George Henry
Pvt., Co. A, 3 Reg't U. S. Colored Cav.

Appears on **Returns** as follows:

Oct. 1864, Lost Oct. 5/64 Good-
richs Ldg. Died in Pest
House of Small Pox

Book mark :

(546)

J. B. Sittler

Copyist.

26 | **3 Cav. | U.S.C.T.**

George Henry
Ch., Co. *A*, 3 Reg't U. S. Col'd Cavalry.

Appears on **Co. Muster-out Roll**, dated
Memphis Tenn. Jan 26, 1866.

Muster-out to date _____, 186 .

Last paid to *Dec 31*, 186 *3*.

Clothing account:

Last settled _____, 186 ; drawn since \$ _____ 100

Due soldier \$ _____ 100; due U. S. \$ _____ 100

Am't for cloth'g in kind or money adv'd \$ _____ 100

Due U. S. for arms, equipments, &c., \$ _____ 100

Bounty paid \$ _____ 100; due \$ _____ 100

Remarks: *Died at Goodrich's*
Sdg La Oct 4, 64 Small
pen

Book mark: *V 61 P 34 69*
(over)

H Jones
Copyist.

JAN. - 8

5333389

☆ 1891 ☆

Book mark - P 6 - Q 26, 68

Henry, George
A., Co. *a.*, **3** Reg't **U.S.C. Cav.**

Enclosures.

Bed Cards Burial Records Certs. of Dis. for Discharge C. M. Charges Med. Certificates	Descriptive Lists Final Statements Furloughs Med. Des. Lists Orders
---	---

• Other papers relating to—

Admission to Hosp'l Casualty Sheet (Officer's) Confinement Contracts Death or Effects Desertions Discharge from Hosp'l Discharge from Service Duty	Furlough Med. Examination Misc. Information Pay or Clothing Personal Reports Rank Transfer to Hosp'l Transfer to V. R. C. Transportation
--	---

I certify, on honor, that George Henry a Private of
 Captain Webbers Company (A) of the 3^d Regiment of U.S. Colored
VOLUNTEERS, of the State of _____, born in Clinton Co, State
 of Kentucky, aged 26 years; 5 feet 8 inches high; Blk complexion,
Blk eyes, Blk hair, and by occupation a Fanner, having joined the company on
 its original organization at Vicksburg Miss, and enrolled in it at the muster into
 the service of the United States at Vicksburg Miss, on the 9th day
 of October, 1863, (or was mustered in service as a recruit, by _____
 _____, at _____, on the _____ day of _____,
 186 , or was drafted and mustered into the service of the United States from the _____
 Enrollment District of the State of _____, at _____,
 on the _____ day of _____, 186), to serve in the Regiment, for
 the term of Three Years: and having served **HONESTLY** and
FAITHFULLY with his Company in the Field to the present date, is now
 entitled to a **DISCHARGE** by reason of Died in Post Hospital at Louisville
Contracting Cholera of Small Pox Oct. 5 - 1864

The said Private George Henry was last paid by Paymaster
Maj. Martin to include the 30th day of April, 1864, and has
 pay due him from that time to the present date; he is entitled to pay and subsistence for
TRAVELING to place of enrollment, and whatever other allowances are authorized to volunteer
 soldiers, drafted men, or militia, so discharged. He has received from the United States **CLOTHING**
 amounting to \$ 58⁰⁰ / 100 dollars, since the 9th day of October,
 1863, when his clothing account was last settled. He has received from the United States
100 dollars advanced **BOUNTY**.

There is to be stopped from him, on account of the State of _____, or other
 authorities, for **CLOTHING**, &c., received on entering service, _____ dollars; and
 for other stoppages, viz: One Carbine Ring and Scrim and Sabre One
Sabre Belt and Plate One Carbine Scrim and Box, One Camp Pouch

[Handwritten notes and signatures in the bottom section of the document, including "Comments" and "Held correct" with a signature.]

I certify, on honor, that George Henry a Private of
 Captain Robbers Company (A) of the 3^d Regiment of U.S. Colored
VOLUNTEERS, of the State of _____, born in Clinton Co, State
 of Kentucky, aged 26 years; 5 feet 8 inches high; Blk complexion,
Blk eyes, Blk hair, and by occupation a Fanner, having joined the company on
 its original organization at Vicksburg Miss, and enrolled in it at the muster into
 the service of the United States at Vicksburg Miss, on the 9th day
 of October, 1863, (or was mustered in service as a recruit, by _____
 _____, at _____, on the _____ day of _____,
 186 , or was drafted and mustered into the service of the United States from the _____

Enrollment District of the State of _____, at _____,
 on the _____ day of _____, 186), to serve in the Regiment, for
 the term of Three Years: and having served HONESTLY and
 FAITHFULLY with his Company in In the Field to the present date, is now
 entitled to a **DISCHARGE** by reason of Died in Post Hospital at Louisville
Contracting Gas of Small Pox Oct. 15th 1864

The said Private George Henry was last paid by Paymaster
Maj. Martin to include the 30th day of April, 1864, and has
 pay due him from that time to the present date; he is entitled to pay and subsistence for
 TRAVELING to place of enrollment, and whatever other allowances are authorized to volunteer
 soldiers, drafted men, or militia, so discharged. He has received from the United States **CLOTHING**
 amounting to \$ 58⁰⁰ 55⁰⁰ dollars, since the 9th day of October,
 1863, when his clothing account was last settled. He has received from the United States
100 dollars advanced **BOUNTY**.

There is to be stopped from him, on account of the State of _____, or other
 authorities, for **CLOTHING**, &c., received on entering service, _____ dollars; and
 for other stoppages, viz: One Carbine Rifle and Scabbard One Sabre One
Sabre Belt and Plate One leather Satchel Bag One Leap Pouch
Total Value \$ 12⁰⁰ 25⁰⁰ dollars.

He has been furnished with TRANSPORTATION in kind from the place of his discharge to
 _____; and he has been SUBSISTED for TRAVELING to his
 place of enrollment, up to the _____, 186 .

He is indebted to _____, **SUTLER**, _____ dollars.
 He is indebted to _____, **LAUNDRESS**, _____ dollars.

Given in Duplicate, at Memphis Tenn, this 27th day
 of January, 1865.

Frank W. Calver
1st Sgt. 3^d U.S. Col.
 Commanding Company.

644.
Henry, James
Co I, 3 U. S. Col'd Cav.

Private | Private

CARD NUMBERS.

1	5330989	26
2	5343045	27
3	5343139	28
4	5343238	29
5	5343325	30
6	5343414	31
7	5343490	32
8	5343564	33
9	9089403	34
10	40727521	35
11		36
12		37
13		38
14		39
15		40
16		41
17		42
18		43
19		44
20		45
21		46
22		47
23		48
24		49
25		50

Book Mark:

See also

N | **3 Cav. | U.S.C.T.**

James Henry
Co. *D*, 3 Reg't U. S. Col'd Cav.

Appears on

Company Descriptive Book

of the organization named above.

DESCRIPTION.

Age *19* years; height *5* feet *6 1/2* inches.

Complexion *Blk*

Eyes *blk*; hair *blk*

Where born *Ny*

Occupation *field hand*

ENLISTMENT.

When *Jan 6*, 1865.

Where *N Burg*

By whom *Wm. Main*; term *3* y'rs.

Remarks:

Hillman

Co. | 3 Cav. | U.S.C.T.

James Henry
Priv, Co., 3 Reg't U. S. Col'd Cav.

Age 19 years.

Appears on a

Detachment Muster-in Roll

of the organization named above. Roll dated
Vicksburg, Miss, Jan. 7, 1865.

Muster-in to date Jan. 7, 1865.

Joined for duty and enrolled:

When Jan. 6, 1865.

Where Vicksburg, Miss.

Period 3 years.

Valuation of horse, \$ 100

Valuation of horse equipments, \$ 100

Remarks: _____

Book mark : _____

Sitter

H | **3 Cav.** | **U.S.C.T.**

James Henry

Sgt., Co. I, 3 Reg't U. S. Col'd Cavalry.

Appears on

Company Muster Roll

for *July & Feb'y*, 1865.

Present or absent *Present*

Stoppage, \$ *100* for

Due Gov't, \$ *100* for

Valuation of horse, \$ *100*

Valuation of horse equipments, \$ *100*

Remarks:

Book mark:

Lucas

H | **3 Cav.** | **U.S.C.T.**

James Henry

Sgt, Co. I, 3 Reg't U. S. Col'd Cavalry.

Appears on

Company Muster Roll

for *March & April*, 1865

Present or absent *Absent*

Stoppage, \$ *100* for

Due Gov't, \$ *100* for

Valuation of horse, \$ *100*

Valuation of horse equipments, \$ *100*

Remarks: *Absent on expedition
Stop for one canteen one
Haversack. 1.00.*

Book mark:

Lucas

H | 3 Cav. | U.S.C.T.

James Henry
Pot, Co. I, 3 Reg't U. S. Col'd Cavalry.

Appears on

Company Muster Roll

for May & June, 1865:

Present or absent Present

Stoppage, \$ 1 $\frac{60}{100}$ for 6 + 4. E-

transf. from last muster roll

Due Gov't, \$ 100 for _____

Valuation of horse, \$ 100

Valuation of horse equipments, \$ 100

Remarks: Stop Cartridge Box
\$ 4.03-

Book mark: _____

(358)

J. Henderson

Copyist.

4 | 3 Cav. | U.S.C.T.

James Henry
(Priv.), Co. I, 3 Reg't U. S. Col'd Cavalry.

Appears on

Company Muster Roll

for July & Aug, 1865

Present or absent Present

Stoppage, \$ 100 for

Due Gov't, \$ 100 for

Valuation of horse, \$ 100

Valuation of horse equipments, \$ 100

Remarks:

Book mark:

Lucas

(358)

Copyist.

H | **3 Cav.** | **U.S.C.T.**

James Henry
Smith, Co. I, 3 Reg't U. S. Col'd Cavalry.

Appears on

Company Muster Roll

for Sept & Oct, 1865.

Present or absent Present

Stoppage, \$ 100 for

Due Gov't, \$ 100 for

Valuation of horse, \$ 100

Valuation of horse equipments, \$ 100

Remarks:
.....
.....
.....
.....
.....
.....
.....
.....
.....

Book mark:

Edmondson
(358) Copyist.

H | 3 Cav. | U.S.C.T.

James Henry
Srin., Co. I, 3 Reg't U. S. Col'd Cavalry.

Appears on

Company Muster Roll

for Nov & Dec, 1865.

Present or absent Present

Stoppage, \$ 100 for

Due Gov't, \$ 100 for

Valuation of horse, \$ 100

Valuation of horse equipments, \$ 100

Remarks:

Book mark:

Edward W.

(358)

Copyist.

H. | 3 Cav. | U.S.C.T.

James Henry
Pvt., Co. I, 3 Reg't U. S. Colored Cav.

Appears on Returns as follows:

Jan. 1865 - Gain Jan. 16/65 -
Memphis, Tenn. Enlist-
ed in Regt.

Book mark :

(548)

J. B. Dittler

Copyist.

H | **3 Cav.** | **U.S.C.T.**

James Henry
Griss, Co. D, 3 Reg't U. S. Col'd Cavalry.

Appears on **Co. Muster-out Roll**, dated
Memphis Tenn Jan 26, 1866
Muster-out to date Jan 26, 1866.
Last paid to Jan 30, 1865.

Clothing account:

Last settled _____, 1866 ; drawn since \$ _____ 100
Due soldier \$ 34 ²⁹ 100; due U. S. \$ _____ 100
Am't for cloth'g in kind or money adv'd \$ _____ 100

Due U. S. for arms, equipments, &c., \$ _____ 100
Bounty paid \$ _____ 100; due \$ _____ 100

Remarks: Bounty due 1st Install-
ment None paid

Book mark: _____

Edmond
(861) Copyist.

645

Henry, Lewis
Co L, 3 U. S. Col'd Cav.

Private | Private

CARD NUMBERS.

1	5344879	26
2	5344956	27
3	5345045	28
4	5345134	29
5	5345209	30
6	5345283	31
7	5345372	32
8	5345478	33
9	5345571	34
10	5345656	35
11	5345740	36
12	5345813	37
13	5345883	38
14	9089615	39
15	40727522	40
16		41
17		42
18		43
19		44
20		45
21		46
22		47
23		48
24		49
25		50

Book Mark:

See also

94 | 3 Cav. | U.S.C.T.

Lewis Henry

....., Co. L, 3 Reg't U. S. Col'd Cav.

Appears on

Company Descriptive Book
of the organization named above.

DESCRIPTION.

Age 23 years; height 5 feet 5 inches.

Complexion Brown

Eyes Black; hair Black

Where born New Orleans, La.

Occupation Carpenter

ENLISTMENT.

When Dec. 1, 1864.

Where Gaines Bluff

By whom Capt. Fritz; term 3 y'rs.

Remarks:

F. B. Smith

(383g)

Copist.

40 | 3 Cav. | U.S.C.T.

Louis Werry

Pvt, Co. *E*, 3 Reg't U. S. Col'd Cavalry.

Appears on

Company Muster-in and Descriptive Roll

of the organization named above. Roll dated

Winn's Bluff Miss, *Mar 1*, 186*4*.

Where born *New Orleans Louisiana*

Age *23* y'rs; occupation *Carpenter*

When enlisted *Mar 1*, 186*4*.

Where enlisted *Winn's Bluff*

For what period enlisted *3* years.

Eyes *Black*; hair *Black*

Complexion *Brown*; height *5* ft. *5* in.

When mustered in _____, 186 .

Where mustered in _____

Bounty paid \$ 100; due \$ 100

Where credited _____

Company to which assigned _____

Remarks: _____

Book mark: _____

W | **3 Cav.** | **U.S.C.T.**

Lewis Henry
Cap....., Co. L, 3 Reg't U.S. Col'd Cavalry.

Appears on

Company Muster Roll

for..... *Mar 9 1864*....., 1864.

Present or absent..... *Present*.....

Stoppage, \$..... *100* for.....

Due Gov't, \$..... *100* for.....

Valuation of horse, \$..... *100*

Valuation of horse equipments, \$..... *100*

Remarks:..... *appointed Corp April 1st 1864*.....

On march 16 at Harris Bluff miss

Book mark:.....

(358)

W. H. W.

Copyist.

40 | 3 Cav. | U.S.C.T.

Jervis Henry
Corp, Co. L, 3 Reg't U.S. Col'd Cavalry.

Appears on

Company Muster Roll

for *Period July 1, 1861.*

Present or absent *Present*

Stoppage, \$ 100 for

Due Gov't, \$ 100 for

Valuation of horse, \$ 100

Valuation of horse equipments, \$ 100

Remarks:

Book mark:

(358)

W. J. ...

Copyist.

WAR 432
W | **3 Cav.** | **U.S.C.T.**

Louis Henry
Cop, Co. L, 3 Reg't U. S. Col'd Cavalry.

Appears on

Company Muster Roll

for July & Aug, 1861

Present or absent Present

Stoppage, \$ 100 for

Due Gov't, \$ 100 for

Valuation of horse, \$ 100

Valuation of horse equipments, \$ 100

Remarks: Stop for one for Spurs
& Straps .37 ct

Book mark:

(358)

W. H. [Signature]

Copyist.

H | **3 Cav.** | **U.S.C.T.**

Jean's Henry
Capt, Co. L, 3 Reg't U. S. Col'd Cavalry.

Appears on

Company Muster Roll

for *Sept & Oct*, 186*1*.

Present or absent *Present*

Stoppage, \$ *100* for

Due Gov't, \$ *100* for

Valuation of horse, \$ *100*

Valuation of horse equipments, \$ *100*

Remarks:

Book mark:

(358)

W. J. ...

Copyist.

H | 3 Cav. | U.S.C.T.

Lewis Henry
Corpl., Co. L, 3 Reg't U. S. Col'd Cavalry.

Appears on

Company Muster Roll

for Nov + Dec, 1864.

Present or absent present

Stoppage, \$ 100 for

Due Gov't, \$ 100 for

Valuation of horse, \$ 100

Valuation of horse equipments, \$ 100

Remarks: Stop. S. Blanket
S. + S. Curry Comb,
Horse Brush, R.
Revolver, \$16.53

Book mark:

Saxton

A | 3 lev | U.S. I.

Lewis Henry
pr, Co. L, 3 Reg't U.S. Cav.

Appears on

Company Muster Roll

for Jany Gaby, 1865-
Present or absent present

Stoppage, \$ 100 for

Due Gov't, \$ 100 for

Valuation of horse, \$ 100

Valuation of horse equipments, \$ 100

Remarks: Stop for one
Remington revolver
\$12⁰⁰ one Burnside
carbine \$30⁰⁰

Book mark:

(359)

Estelle
Comp Co. 1st.

14 | 3 Co. | U.S.C.

Lewis Henry
priv, Co. L, 3 Reg't U.S.C. Cav

Appears on

Company Muster Roll

for March 1st, 1865!

Present or absent Absent

Stoppage, \$ 100 for

Due Gov't, \$ 100 for

Valuation of horse, \$ 100

Valuation of horse equipments, \$ 100

Remarks: Absent on
scout.

Book mark:

(359)

East Meekins
Comp. Capt.

H. | 3 Cav. | U.S.C.T.

Lewis Henry
Pot, Co. L, 3 Reg't U. S. Col'd Cavalry.

Appears on

Company Muster Roll

for May + June, 1865.

Present or absent present

Stoppage, \$ 100 for

Due Gov't, \$ 100 for

Valuation of horse, \$ 100

Valuation of horse equipments, \$ 100

Remarks: Stopped curry
Comb + H. Brush
\$1.01; Spurs + Straps
.52; Total \$1.53.

Book mark:

Daxton

H | 3 Cav. | U.S.C.T.

Lewis Henry
Rus, Co. L, 3 Reg't U. S. Col'd Cavalry.

Appears on

Company Muster Roll

for July & Aug, 1865.

Present or absent present

Stoppage, \$ 100 for

Due Gov't, \$ 100 for

Valuation of horse, \$ 100

Valuation of horse equipments, \$ 100

Remarks:

Book mark:

Saxton

No | **3 Cav.** | **U.S.C.T.**

Lewis Henry

Plt, Co. L, 3 Reg't U.S. Col'd Cavalry.

Appears on

Company Muster Roll

for *Sept 7 Oct.*, 186*5*.

Present or absent *Present*

Stoppage, \$ *100* for

Due Gov't, \$ *100* for

Valuation of horse, \$ *100*

Valuation of horse equipments, \$ *100*

Remarks:

Book mark:

C. B. Thompson

(358)

Copyist.

No | **3 Cav.** | **U.S.C.T.**

Lewis Henry
Pvt, Co. L, 3 Reg't U.S. Col'd Cavalry.

Appears on

Company Muster Roll

for *Nov + Dec*, 1865.

Present or absent *Present*

Stoppage, \$ *100* for

Due Gov't, \$ *100* for

Valuation of horse, \$ *100*

Valuation of horse equipments, \$ *100*

Remarks:

Book mark:

(358)

E. B. Thompson
Copyist.

Ho | **3 Cav.** | **U.S.C.T.**

Lewis Henry

Priv., Co. L., 3 Reg't U. S. Colored Cav.

Appears on **Returns** as follows:

Nov. & Dec, 1865; On duty de-
tailed in R. Q. M. Dept.
temporarily.

Book mark :

J. B. Sittler

(546)

Copyist.

10 | **3 Cav. | U.S.C.T.**

Lewis Henry
Pvt, Co. L, 3 Reg't U. S. Col'd Cavalry.

Appears on **Co. Muster-out Roll**, dated
Memphis Tenn, Jan 26, 1866.
Muster-out to date Jan 26, 1866.
Last paid to Jan 30, 1865.

Clothing account:

Last settled _____, 186 ; drawn since \$ _____ 100
Due soldier \$ _____ 100; due U. S. \$ _____ 20²¹/₁₀₀
Am't for cloth'g in kind or money adv'd \$ _____ 100

Due U. S. for arms, equipments, &c., \$ _____ 100
Bounty paid \$ _____ 100; due \$ _____ 100

Remarks: _____

Book mark: _____

(361) E. B. Thompson
Coryist.

646

Henry, William

Cool, 3 U. S. Col'd Cav.

Private

Private

CARD NUMBERS.

1	5342521	26
2	5342617	27
3	5342703	28
4	5342791	29
5	5342872	30
6	5342947	31
7	5343031	32
8	5343138	33
9	5343237	34
10	5343324	35
11	5343413	36
12	5343489	37
13	5343563	38
14	9089332	39
15		40
16		41
17		42
18		43
19		44
20		45
21		46
22		47
23		48
24		49
25		50

Book Mark:

See also

S. 1143915 - *powder*
S 2116639 *acid*
S-29639 *So. P.O. 711711*

J. M. Shannon
Esq

H | **3 Cav. | U.S.C.T.**

William Henry
....., Co. *C*, 3 Reg't U. S. Col'd Cav.

Appears on

Company Descriptive Book
of the organization named above.

DESCRIPTION.

Age *17* years; height *5* feet *6* inches.

Complexion *Blk*

Eyes *blk*; hair *blk*

Where born *Greenwood Miss*

Occupation *Field Hand*

ENLISTMENT.

When *Feb 24*, 1864.

Where *Haines Bluff*

By whom *Capt Brainard*; term *3* y'rs.

Remarks:

.....
.....
.....
.....
.....
.....

Hilton

A | **3 Cav.** | **U.S.C.T.**

William Henry

Priv., Co. *D*, 1 Reg't Miss. Cav., Corps d'Afrique.*
age 14 yrs
Appears on

Company Muster-in Roll

of the organization named above. Roll dated
Haines Bluffs Miss Feb 26, 1864.
Muster-in to date *Feb 24*, 1864.

Joined for duty and enrolled:
When *Feb 24*, 1864.
Where *Haines Bluffs Miss.*
Period *3* years.

Valuation of horse, \$.....100

Valuation of horse equipments, \$.....100

Remarks:-----

*This organization subsequently became Co *D*, 3 Reg't U. S. Colored Cavalry.

Book mark:-----

Bradshaw

(356) Copyist.

A | **3 Cav.** | **U.S.C.T.**

William Henry
Pvt, Co. I, 3 Reg't U. S. Col'd Cavalry.

Appears on

Company Muster Roll

for *Feb 24 to Apr 30*, 1864.

Present or absent *present*.

Stoppage, \$ *100* for

Due Gov't, \$ *100* for

Valuation of horse, \$ *100*

Valuation of horse equipments, \$ *100*

Remarks: *Stop for one*
Spur and Strap \$0.30;
one canteen \$0.41.

Book mark:

Bradshaw

(358)

Copyist.

A | **3 Cav. | U.S.C.T.**

William Henry
Priv, Co. I, 3 Reg't U. S. Col'd Cavalry.

Appears on

Company Muster Roll
for *May & June*, 186*4*.

Present or absent *present*

Stoppage, \$ *100* for

Due Gov't, \$ *100* for

Valuation of horse, \$ *100*

Valuation of horse equipments, \$ *100*

Remarks:

Book mark:

Bradshaw

(358)

Copyist.

A | **3 Cav.** | **U.S.C.T.**

William Henry
Plt, Co. I, 3 Reg't U. S. Col'd Cavalry.

Appears on

Company Muster Roll

for *July & Aug*, 186*4*.

Present or absent *present*

Stoppage, \$ 100 for

Due Gov't, \$ 100 for

Valuation of horse, \$ 100

Valuation of horse equipments, \$ 100

Remarks: *Wch for 120*
Haver suck 56 lbs.

Book mark:

Bradshaw

A | **3 Cav.** | **U.S.C.T.**

William Henry

Priv

, Co. I, 3 Reg't U. S. Col'd Cavalry.

Appears on

Company Muster Roll

for *Sept & Oct*, 186*4*.

Present or absent *present*.

Stoppage, \$ *100* for

Due Gov't, \$ *100* for

Valuation of horse, \$ *100*

Valuation of horse equipments, \$ *100*

Remarks: *Stop for one Cone
Wrench for pistol
56 cts, one Ganteenbocks.*

Book mark: _____

Bradshaw

(358)

Copyist.

A | **3 Cav.** | **U.S.C.T.**

William Henry

Priv., Co. I, 3 Reg't U. S. Col'd Cavalry.

Appears on

Company Muster Roll

for Nov. & Dec, 1864.

Present or absent Absent

Stoppage, \$ 100 for

Due Gov't, \$ 100 for

Valuation of horse, \$ 100

Valuation of horse equipments, \$ 100

Remarks: Absent on scout
since Dec 21/64

Book mark: _____

Lucas

H | **3 Cav.** | **U.S.C.T.**

William Henry

Plt, Co. I, 3 Reg't U. S. Col'd Cavalry.

Appears on

Company Muster Roll

for *Jan & Feb*, 186*5*

Present or absent *Present*

Stoppage, \$ *100* for

Due Gov't, \$ *100* for

Valuation of horse, \$ *100*

Valuation of horse equipments, \$ *100*

Remarks:

Book mark: *3*

Lucas

H | **3 Cav.** | **U.S.C.T.**

William Henry

Priv, Co. I, 3 Reg't U. S. Col'd Cavalry.

Appears on

Company Muster Roll

for March & April, 1865.

Present or absent Absent

Stoppage, \$ 100 for

Due Gov't, \$ 100 for

Valuation of horse, \$ 100

Valuation of horse equipments, \$ 100

Remarks: Absent on expedition
Stop for one remaining
Revolver one Carbine & sling one
Carbine sword one pistol Belt
Holdin one Curry comb one
horse brush 15-70 one canteen
one haversack 1.60.

Book mark: 358

Lucas

A | **3 Cav.** | **U.S.C.T.**

William Henry
Pvt, Co. I, 3 Reg't U. S. Col'd Cavalry.

Appears on

Company Muster Roll

for May & June, 1865:

Present or absent Present

Stoppage, \$ 1/100 for C. & G. E.
transf'd from last muster roll.

Due Gov't, \$ 100 for

Valuation of horse, \$ 100

Valuation of horse equipments, \$ 100

Remarks: Stop \$ 17.76 for
ordnance transf'd. from
last muster roll

Book mark:

(358) J Underwood Copyist.

4 | **3 Cav.** | **U.S.C.T.**

William Henry

Priv-, Co. I, 3 Reg't U. S. Col'd Cavalry.

Appears on

Company Muster Roll

for *July & Aug*, 1865:

Present or absent *Present-*

Stoppage, \$ 100 for

Due Gov't, \$ 100 for

Valuation of horse, \$ 100

Valuation of horse equipments, \$ 100

Remarks:

Book mark:

Lucas

H

3 Cav. U.S.C.T.

William Henry

Prin, Co. I, 3 Reg't U. S. Col'd Cavalry.

Appears on

Company Muster Roll

for Sept & Oct, 1865.

Present or absent Present

Stoppage, \$ 100 for

Due Gov't, \$ 100 for

Valuation of horse, \$ 100

Valuation of horse equipments, \$ 100

Remarks:

Book mark:

Edward

H | **3 Cav. | U.S.C.T.**

William Henry
Brin, Co. I, 3 Reg't U. S. Col'd Cavalry.

Appears on

Company Muster Roll

for *Nov & Dec*, 1865.

Present or absent *Present*

Stoppage, \$ *100* for

Due Gov't, \$ *100* for

Valuation of horse, \$ *100*

Valuation of horse equipments, \$ *100*

Remarks:

Book mark: _____

Edmund
(358) Copyist.

H | **3 Cav. | U.S.C.T.**

William Henry

Gris, Co. D, 3 Reg't U. S. Col'd Cavalry.

Appears on **Co. Muster-out Roll**, dated

Memphis Tenn Jan 26, 1866.

Muster-out to date Jan 26, 1866.

Last paid to Jan 30, 1865.

Clothing account:

Last settled....., 186 ; drawn since \$.....100

Due soldier \$.....100; due U. S. \$.....51⁶⁸/100

Am't for cloth'g in kind or money adv'd \$.....100

Due U. S. for arms, equipments, &c., \$.....100

Bounty paid \$.....100; due \$.....100

Remarks:.....

Book mark :.....

(861)

Edmund

Copyist.

64
Herd, Amos

Co K, 3 U. S. Col'd Cav.

Private | Private

CARD NUMBERS.

1	5343682	26
2	5343780	27
3	5343911	28
4	5331766	29
5	5331710	30
6	5331812	31
7	5330987	32
8	5344213	33
9	5344319	34
10	5344416	35
11	5344504	36
12	5344585	37
13	5344662	38
14	5344736	39
15	5344818	40
16	9089481	41
17	40727523	42
18		43
19		44
20		45
21		46
22		47
23		48
24		49
25		50

Book Mark:

See also

H | 3 Cav. | U.S.C.T.

Amos Herd

Co. K, 3 Reg't U. S. Col'd Cav.

Appears on

Company Descriptive Book

of the organization named above.

DESCRIPTION.

Age 24 years; height 5 feet 4 1/2 inches.

Complexion Black

Eyes Black; hair Black

Where born Talla, Miss

Occupation Farmer

ENLISTMENT.

When Feb. 24, 1864

Where Haines Bluff

By whom Capt. Haynes; term 3 y'rs.

Remarks: Deserted from
Vicksburg Miss. June 7"
1864. Returned to
duty on S. O. No. 5-2 H.
L. B. D. Memphis Tenn.
Jan. 6" 1865, with loss of
all pay and allowances
and to make good
(over)

F. B. Smith

MAY. 12

9089481

1891 *

the time lost by
desertion,
died at Memphis
Tenn. Jan. 25/66.

A. J. Chad | U.S.C.T.

Amos Hurd
Co. M, 3rd Reg't U. S. Col'd *Car*

Appears on

Company Muster-in and Descriptive Roll
of the organization named above. Roll dated

Haines Bluff Miss, Mich 1, 1864.

Where born *Falla Miss*

Age *24* y'rs; occupation *Farmer*

When enlisted *July 24*, 1864.

Where enlisted *Haines Bluff Miss*

For what period enlisted *3* years.

Eyes *Black*; hair *Black*

Complexion *Black*; height *5 ft. 4 1/2 in.*

When mustered in _____, 186 .

Where mustered in _____

Bounty paid \$ _____ 100; due \$ _____ 100

Where credited _____

Company to which assigned _____

Remarks: _____

**Became Co. K, 3rd Reg't U. S. C., Cal.*

Book mark: _____

Beach

H | 3 Cav. | U.S.C.T.

Amos Kent

For, Co. K, 3 Reg't U. S. Col'd Cavalry.

Appears on

Company Muster Roll

for Feb 24 to Apr 30, 1864

Present or absent Present

Stoppage, \$ 100 for

Due Gov't, \$ 100 for

Valuation of horse, \$ 100

Valuation of horse equipments, \$ 100

Remarks:

Mustered in Feb 24, 64
at Harris Bluffs

Book mark:

Beach

B | **3 Cav. U.S.C.T.**

Amos Herd

Rob, Co. K, 3 Reg't U. S. Col'd Cavalry.

Appears on

Company Muster Roll

for *May & June*, 186*4*

Present or absent

Stoppage, \$ 100 for

Due Gov't, \$ 100 for

Valuation of horse, \$ 100

Valuation of horse equipments, \$ 100

Remarks: *Decorated at
Vicksburg Miss June
4. 1864. Stabbed through
by Cannon fire*

Book mark:

Beach

H | 3 cav | **U.S.C.T.**

Amos Hurd

Pvt, Co. K, 3 Reg't U. S. Col'd Cav

Appears on

Descriptive List of Deserters

dated Vicksburg Miss June 30, 1864.

Deserted :

When June 7, 1864.

Where Vicksburg Miss

Arrested :

When _____, 186 .

Where _____

Remarks : Stopped for C. C. V
W. E. Goels

Book mark : _____

H. J. Miller

No. | 3 Cav. | U.S.C.T.

Amos Beard.

Priv, Co., 3 Reg't U. S. Col'd Cav.

Age 25 years.

Appears on a

Detachment Muster-in Roll

of the organization named above. Roll dated
Vicksburg Miss, Jan. 7, 1863.

Muster-in to date Jan. 7, 1863.

Joined for duty and enrolled:

When Jan. 6, 1863.

Where Vicksburg, Miss.

Period 3 years.

Valuation of horse, \$ 100

Valuation of horse equipments, \$ 100

Remarks:

Filed with Amos
Beard.

Book mark:

Sitter.

H | 3 Cav | U.S.C.T.

Amos Herd

Pvt., Co. K, 3 Reg't U. S. Col'd Cav.

Appears on

Descriptive List of Deserters

dated Memphis Tenn Feb 1, 1865.

Deserted:

When Jan 7, 1864.

Where Vicksburg Miss

Arrested:

When _____, 186 .

Where _____

Remarks: Returned Jan 19/65

Book mark: _____

H S Miller

(351)

Copyist.

A | **3 Cav.** | **U.S.C.T.**

Amos Herd

Priv., Co. K, 3 Reg't U. S. Col'd Cavalry.

Appears on

Company Muster Roll

for *Jan. & Feb.*, 1865.

Present or absent *Present*

Stoppage, \$ *100* for

Due Gov't, \$ *100* for

Valuation of horse, \$ *100*

Valuation of horse equipments, \$ *100*

Remarks:

Book mark:

Valentine

H | 3 Cav | U.S.C.T.

Amos, Herd
Pvt, Co. K, 3 Reg't U. S. Col'd Cav

Appears on

Descriptive List of Deserters

dated Memphis Tenn Mch 31, 1865.

Deserted :

When June, 1864.

Where Vicksburg

Arrested :

When, 186 .

Where

Remarks : Returned to his company
June 6/65 restored to duty
by S. O. No 52 Hd Qrs, Cav
Div & Capt M Tenn Mch
26/65

Book mark :

H. S. Miller

(351)

Copyist.

A | **3 Cav. | U.S.C.T.**

Amos Hera

Priv, Co. K, 3 Reg't U. S. Col'd Cavalry.

Appears on

Company Muster Roll

for *March & Apr*, 1865.

Present or absent *Present*.

Stoppage, \$ *100* for

Due Gov't, \$ *100* for

Valuation of horse, \$ *100*

Valuation of horse equipments, \$ *100*

Remarks: *Restored to duty per Sp. Ord. no 57 Hd Qrs. C.O.D. N. Tenn. Memphis Tenn Mar 26/65 with loss of all pay and allowances, and make good time lost by desertion, by order of Col. Osband, Jan 6th*

Book mark:

Valentine

A | **3 Cav.** | **U.S.C.T.**

Amos Herd

Priv., Co. K, 3 Reg't U. S. Col'd Cavalry.

Appears on

Company Muster Roll

for *May & June*, 1865.

Present or absent *Present*

Stoppage, \$ *4* $\frac{46}{100}$ for *ordnance*

lost or destroyed

Due Gov't, \$ *100* for

Valuation of horse, \$ *100*

Valuation of horse equipments, \$ *100*

Remarks: *Restored to duty Jan 6th 1865 per S. O. 1052 Address C. D. D., N. Tenn Memphis March 26th 1865 with loss of pay and allowance, and make good time lost by desertion, by order Col. Aband*

Book mark: _____

Valentine

A | **3 Cav.** | **U.S.C.T.**

Amos Herd

Priv, Co. K, 3 Reg't U. S. Col'd Cavalry.

Appears on

Company Muster Roll

for *July & Aug*, 1865.

Present or absent *Present.*

Stoppage, \$ 100 for

Due Gov't, \$ 100 for

Valuation of horse, \$ 100

Valuation of horse equipments, \$ 100

Remarks:

Book mark:

Valentine

(358)

Copyist.

H | **3 Cav.** | **U.S.C.T.**

Amos Herz
....., Co. K, 3 Reg't U. S. Col'd Cavalry.

Appears on

Company Muster Roll

for..... *Sept. and Oct.*....., 1865.

Present or absent..... *Present.*

Stoppage, \$..... *100* for.....

Due Gov't, \$..... *100* for.....

Valuation of horse, \$..... *100*

Valuation of horse equipments, \$..... *100*

Remarks: *Due U.S. for ord
nance lost \$27.50*

Book mark:.....

Howard
Copyist.

H | **3 Cav.** | **U.S.C.T.**

Amos Herd

Priv., Co. K, 3 Reg't U. S. Col'd Cavalry.

Appears on

Company Muster Roll

for *Nov, and Dec.*, 186*5*.

Present or absent *Present.*

Stoppage, \$ *100* for

Due Gov't, \$ *100* for

Valuation of horse, \$ *100*

Valuation of horse equipments, \$ *100*

Remarks: *Due list for ord
nance and carried forward
from the Sept and Oct. rolls.
\$27.50.*

Book mark:

(358)

Howard

Copyist.

Ho. | 3 Cav. | U.S.C.T.

Amos Herd

Pvt., Co. K, 3 Reg't U. S. Colored Cav.

Appears on Returns as follows:

June 1864. Loss June 7/64 Va. -
burg, Miss. - Deserted.
Due U.S. for Ordnance
1 Canteen 41 1 Haversack
49 = 90¢ charged on
muster Roll June 30/64.

Jan. 1865. Gain Jan. 19/65 - Mem-
phis, Tenn. Retired to duty
from desertion.

Book mark :

(546)

J. B. Sittler

Copyist.

H | **3 Cav. | U.S.C.T.**

Amos Reed

Priv., Co. *K*, 3 Reg't U. S. Col'd Cavalry.

Appears on **Co. Muster-out Roll**, dated
Memphis, Tenn. Jan. 26, 186*6*.

Muster-out to date _____, 186*6*.

Last paid to *June 30*, 186*5*.

Clothing account:

Last settled _____, 186*6* ; drawn since \$ _____ *100*

Due soldier \$ _____ *100*; due U. S. \$ _____ *100*

Am't for cloth'g in kind or money adv'd \$ _____ *100*

Due U. S. for arms, equipments, &c., \$ _____ *100*

Bounty paid \$ _____ *100*; due \$ _____ *100*

Remarks: *Died of disease*
Jan. 16, '66

Book mark: *Died Aug 25, 1866*
C. B. 126

(361)

Approved,
Copyist.

A | 3 Cav. | U.S.C.T.

Amos Hard

Reg't Co. A, 3 Reg't U. S. Col'd Cav.

Appears on Co. Muster-out Roll, dated
Memphis Tenn, Jan. 26, 1866.

Muster-out to date _____, 186 .

Last paid to June 30, 1865.

Clothing account:

Last settled _____, 186 ; drawn since \$ _____ 100

Due soldier \$ _____ 100; due U. S. \$ 43 ⁶⁶/₁₀₀

Am't for cloth'g in kind or money adv'd \$ _____ 100

Due U. S. for arms, equipments, &c., \$ _____ 100

Bounty paid \$ _____ 100; due \$ _____ 100

Remarks: Due U.S. for

advance \$27.85

Died since com-
pletion of roll.

* Entire entry cancelled by
line except remarks

Book mark:

A. A. Hall

(361)

Copist.

Comp.

Herd, Amos

P, Co. K

3 Reg't U. S. C. Cav.

3 Enclosures.

Bed Cards	Descriptive Lists
Burial Records	Final Statements /
Certs. of Dis. for Discharge	Furloughs
C. M. Charges	Med. Des. Lists
Med. Certificates	Orders /

Other papers relating to—

Admission to Hosp'l	Furlough
Casualty Sheet (Officer's)	Med. Examination
Confinement	Misc. Information /
Contracts	Pay or Clothing
Death or Effects	Personal Reports
Desertions	Rank
Discharge from Hosp'l	Transfer to Hosp'l
Discharge from Service	Transfer to V. R. C.
Duty	Transportation

FINAL STATEMENT

OF

Ames, Hesse

3^d Reg't of U.S. Colored

Dec Jan 25th 1866
VOLUNTEERS.

NOTE 1.—Two of these certificates (or duplicates) are to be given to each Volunteer Soldier or drafted man who may be discharged without being mustered out (Final Statements are never given to men mustered out of service) that he may at once receive from the Paymaster the pay, &c. due him, and that he, his, or other commanding officer commanding the company will certify to the act of the delivery of the duplicate certificates; with these certificates the Soldier is entitled to his discharge, and should also present his discharge to the Paymaster to have the payment endorsed on it. The discharge is to be given back to the Soldier by the Paymaster; the latter only retaining as his vouchers the duplicate certificates.

NOTE 2.—If the Soldier is entitled to pay for the use of his horse, the Company Commander will certify to that fact on the back of both these final statements, and also to the time he has pay due for having been so mounted on his own horse.

NOTE 3.—When a Soldier is furnished with final statements, his descriptive list, if he has one, should be taken up by the officer who gives the Soldier these statements, and endorsed with a statement of this effect by the officer. The endorsement should exhibit a final statement of the time for which the Soldier guaranteed pay on his final statements, the clothing received, and all other charges paid him or in his favor, so as to comprise a complete exhibit of his account. It will then be transmitted to the Company Commander of the regiment, who will enter all the data necessary to a full understanding of the Soldier's account on the muster roll upon which the Soldier's discharge is reported. The descriptive list will then be destroyed. The object of this is, that the remaining portion of the Soldier's account may be received upon the receipt of these muster rolls, and the Soldier receive any pay or allowances that may be due him at the time of his discharge, and will in any way appear on his last final statements from the fact that his descriptive list is complete. These accounts for back pay, &c., are settled by the Adjutant General of the Treasury Department.

NOTE 4.—Charges for loss or injury to equipment, horse equipments, and other miscellaneous charges, should appear under the heading of "Other Stoppages."

NOTE 5.—Bounty paid by State authorities, and not by the United States, will not be entered on this statement.

NOTE 6.—Amounts due the Suttler and Laundress must be entered on the muster roll on which the discharge, death, desertion, &c., is reported, as well as on the final statement, otherwise the amount cannot be collected from the United States.

NOTE 7.—This blank will be used for deceased volunteers and drafted men, as well as for others.

NOTE 8.—Where a Soldier dies in Hospital or on detached service, his descriptive list, if he has one, should be sent with his final statements, in duplicate, to the Adjutant General, Washington, D. C.

NOTE 9.—If the soldier is a drafted man or substitute, the space for time, &c., or enrolled, should contain only the word *drafted* or *substitute*, as the case may be. If the Soldier is a "VETERAN," (or RECRUIT,) the words as a *veteran*, (or *recruit*), as the case may be, should be interlined after the words *mustered into the service of the U. S.* A statement of all the instalments of *Veteran* or *Recruit* Bounty RECEIVED by the Soldier must be made on the back of each final statement.

See letter to 2^d and 3^d July 2 1876

[OFFICE INDORSEMENT.]

War Department,

ADJUTANT GENERAL'S OFFICE,

June 16, 1874,

The death of *Private Ames*
Hesse, Co. *H*, 3^d Reg't U. S.
Colored *Infantry*, is reported as follows:—

On Company Muster Roll.
For *Ames*, 1866, 186

Company Muster-out Roll.
Jan 16, 1866

Company Descriptive Book. 186

Company Morning Reports. 186

Soldier's Final Statement.
Jan 25, 1866

Soldier's Record of Death and Interment. 186

Soldier's Inventory of Effects. 186

Soldier's Certificate of Disability for Discharge. 186

Soldier's Individual Muster-out Roll. 186

Regimental Return.
For *Ames*, 1866, 186

Regimental Quarterly Returns. 186

Regimental Descriptive Book. 186

By Surgeon General. 186

Jan 25, 1866, is held to be
the correct date, and the Company *Muster Out*
Roll will be amended accordingly.

Thoma M. Luce
Asst. Adj. Gen.

ADJUTANT GENERAL'S OFFICE.

Oct 22 1866

Duplicate with Inspector sent 2d Auditor.

I certify, on honor, that Amos Reed, a Private of
 Captain A. G. Payne Company (D) of the 3d Regiment of Missouri
VOLUNTEERS, of the State of _____, born in Wisconsin, State
 of Ohio, aged 24 years; 5 feet 4 1/2 inches high; Blk complexion,
Blk eyes, Blk hair, and by occupation a Farmer, who joined for service
 and was enrolled (see Note 9) on the 24th day of Feb, 1864, at Haynes Bluff, Mo
 by Capt. A. G. Payne, for the period of 3 years, and mustered into
 the service of the United States on the 26th day of February, 1864, at
Haynes Bluff, Mo. by St. Callinan; and having served
 HONESTLY and FAITHFULLY with his Company to the present date, is now entitled to a
DISCHARGE by reason of Death at Fort Hayes, Mo
Jan 25, 1866

The said Amos Reed was last paid by Paymaster
Wm. C. ..., to include the 25th day of Jan, 1866, and
 has pay due him from that time to the present date; he is entitled to pay and subsistence for
TRAVELING to place of enrollment, and whatever other allowances are authorized to volunteer
 soldiers, drafted men, or militia, so discharged. He has received from the United States **CLOTHING**
 amounting to \$118 ¹⁰/₁₀₀ dollars, since the 24th day of February,
 1864, when his clothing account was last settled. He has received from the United States
 _____ ¹⁰⁰/₁₀₀ dollars advanced **BOUNTY**.

There is to be stopped from him, on account of the State of _____, or other
 authorities, for **CLOTHING, &c.**, received on entering service, _____ ¹⁰⁰/₁₀₀ dollars; and
 for other stoppages, viz: Outrance & subsistence
charged on Roll of Jan 26, 1866
of 27 ⁸⁵/₁₀₀ dollars.
 He has been furnished with **TRANSPORTATION** in kind from the place of his discharge to
 _____; and he has been **SUBSISTED** for **TRAVELING** to his
 place of enrollment, up to the _____, 186 .

He is indebted to A. L. Bruce, **SUTLER**, _____ ¹⁰/₁₀₀ dollars.
 He is indebted to _____, **LAUNDRESS**, _____ ¹⁰⁰/₁₀₀ dollars.

Given in Duplicate, at Memphis Tenn, this 26th day
 of January, 1866.

A. G. Payne
Capt 3d U.S. Col
 Commanding Company.

Head-Quarters Cavalry Division,
DISTRICT OF WEST TENN.,

Memphis, Tenn., March 26th 1865.

SPECIAL ORDERS,
No. 52

III. Private Ainos Herd "K"
Company 3rd W. S. Col'd. Cav. Deserted
the 1st day of June 1864 and having volunta-
rily Returned to his Regiment and Company
the 6th day of January 1865 is hereby
restored to duty with the loss of all pay
and allowances ^{due} to make good the time
lost by desertion.

All Expenses incurred by
the Provost-Marshal's Department for his
apprehension and delivery will be charged
against him on first-muster and Pay Rolls.

By Order of Col. G. P. Osburn
J. M. [Signature]
Capt 2^d Wis Vol. Cav. A. A. S.

A. C.

1st Lt. [Signature]

Ellerbrook

Amos Nord "Private"

@ "No" 3^d U.S. Sec. Can

Completed

Mr. E. J. Meyer

Adjutant General's Office,

COLORED TROOPS BRANCH,

Sept 17, 1874

Vol. C. T., 187

Wanted in case of *1st Reg't* *U.S.C.*,
Reg't *U.S.C.*

Date of return from desertion -
with report from desertion at
S.D. of the 1st Reg't U.S.C. Memphis Tenn. March 26 1865

Respectfully,

E. A. Woodward
Chief Clerk
J. Patton

Adjutant General's Office,

, 187

Vol. C. T., 187

Reply in case of _____, Co. _____,

Reg't
*Co. Morning Kept Book repts him June 7/64 absent without leave. June 9/64 Deserted,
Jan'y 18/65. Rept'd for duty from desertion since June 7/64.
Kedgew Car Div Dist of West Tenn. Memphis Tenn. March 26/65.*

Special Order
*No 57. II. Sgt Amos Word. K. Co. 3rd U.S. Col'd Cav. Deserted the 1st day of June 1864,
and having voluntarily returned to his regiment and Company the 6th day of Jan'y 1865. is hereby
restored to duty with loss of all Pay and Allowance, and to make good the time lost by
Desertion. All expenses incurred by the Provost Marshals Departments for his apprehension and
delivery will be charged against him on first Muster and Pay Rolls.*

By order of Col. E. D. Osband.
(Signed) *E. J. Meyer*, Capt.
2nd Div, Va. Cav. W. A. A. G.

207

640
Herd Thomas

Co K, 3 U. S. Col'd Cav.

Private

Corporal

CARD NUMBERS.

1	5343683	26
2	5343782	27
3	5343865	28
4	5343951	29
5	5344039	30
6	5344124	31
7	5344214	32
8	5344320	33
9	5344417	34
10	5344479	35
11	5344561	36
12	5344638	37
12	5344712	38
14	9089483	39
15	40727525	40
16		41
17		42
18		43
19		44
20		45
21		46
22		47
23		48
24		49
25		50

Book Mark: V88 P31 '69

See also

H | 3 Cav. | U.S.C.T.

Thomas Herd

....., Co. K, 3 Reg't U. S. Col'd Cav.

Appears on

Company Descriptive Book

of the organization named above.

DESCRIPTION.

Age 18 years; height 5 feet 6 1/2 inches.

Complexion Black

Eyes Black; hair Black

Where born Canton, Miss.

Occupation Farmer

ENLISTMENT.

When Feb. 24, 1864

Where Hannas Bluff.

By whom Capt. Haynes term 3 y'rs.

Remarks: Appointed Corp.

July 1st, 1865

Mustered out

Jan. 26/66 Memphis

Tenn. S. O. No. 167

Mil. Div. Tenn.

F. B. Smith

H. I. Cav | U.S.C.T.

Thomas Herd

1st Lt., Co. M., 3rd Reg't U. S. Col'd Cav

Appears on

Company Muster-in and Descriptive Roll
of the organization named above. Roll dated

Wilmington, N. C., March 1, 1864.

Where born

Beaumont, Miss.

Age

18 y'rs; occupation

Farmer

When enlisted

Feb'y 24, 1864.

Where enlisted

Wilmington, N. C.

For what period enlisted

3 years.

Eyes

Black; hair

Black

Complexion

Black; height

5 ft. 6 1/2 in.

When mustered in

....., 186 ..

Where mustered in

.....

Bounty paid \$

100; due \$

100

Where credited

.....

Company to which assigned

.....

Remarks:

.....

* Became Co K 3rd Reg't U.S.C., Cav.

Book mark:

.....

Beach

H. E. Carr U.S.C.T.

Thomas Herd

Co. M, 3rd Reg't U. S. Col'd Carr

Appears on

Company Muster-in and Descriptive Roll
of the organization named above. Roll dated

James Bluff Miss, March 1, 1864.

Where born Canton Miss

Age 18 y'rs; occupation Farmer

When enlisted Feby 24, 1864.

Where enlisted James Bluff Miss

For what period enlisted 3 years.

Eyes Black; hair Black

Complexion Black; height 5 ft. 6 1/2 in.

When mustered in _____, 186 .

Where mustered in _____

Bounty paid \$ 100; due \$ 100

Where credited _____

Company to which assigned _____

Remarks: _____

* Became Co K 3rd Reg't U.S.C. Carr.

Book mark: _____

Beach

H | **3 Cav.** | **U.S.C.T.**

Thomas Herd

Priv, Co. K, 3 Reg't U. S. Col'd Cavalry.

Appears on

Company Muster Roll

for *Feb 24 to Apr 30*, 186*4*

Present or absent *Present*

Stoppage, \$ *100* for

Due Gov't, \$ *100* for

Valuation of horse, \$ *100*

Valuation of horse equipments, \$ *100*

Remarks:

*Mustered in
Feb. 24. 64 at Hains
Bluffs*

Book mark:

Beach

H | **3 Cav.** | **U.S.C.T.**

Thomas Hord

For, Co. K, 3 Reg't U. S. Col'd Cavalry.

Appears on

Company Muster Roll

for *May & June*, 186*4*.

Present or absent *Present*

Stoppage, \$ *100* for

Due Gov't, \$ *100* for

Valuation of horse, \$ *100*

Valuation of horse equipments, \$ *100*

Remarks:

Book mark:

Beach

H | **3 Cav.** | **U.S.C.T.**

Thomas H. Cro

203, Co. K, 3 Reg't U. S. Col'd Cavalry.

Appears on

Company Muster Roll

for *July & Aug*, 186*4*

Present or absent *Present*

Stoppage, \$ *100* for

Due Gov't, \$ *100* for

Valuation of horse, \$ *100*

Valuation of horse equipments, \$ *100*

Remarks:

Book mark:

Beacho

10 | 3 Cav. | U.S.C.T.

Thomas Reed

Regt, Co. K, 3 Reg't U. S. Col'd Cavalry.

Appears on

Company Muster Roll

for Sept & Oct, 1864.

Present or absent. Present

Stoppage, \$ 100 for

Due Gov't, \$ 100 for

Valuation of horse, \$ 100

Valuation of horse equipments, \$ 100

Remarks:

Book mark:

Beacho

A | **3 Cav.** | **U.S.C.T.**

Thomas Herd

Priv, Co. K, 3 Reg't U. S. Col'd Cavalry.

Appears on

Company Muster Roll

for *Nov. & Dec.*, 1864.

Present or absent *Present.*

Stoppage, \$ *13*^{*23*}/₁₀₀ for *ordnance*
lost or destroyed.

Due Gov't, \$ *100* for

Valuation of horse, \$ *100*

Valuation of horse equipments, \$ *100*

Remarks:

absent on scout
since Dec 21st/64

Book mark:

Valentine

A | **3 Cav.** | **U.S.C.T.**

Thomas Werd

Priv., Co. K, 3 Reg't U. S. Col'd Cavalry.

Appears on

Company Muster Roll

for *Jan. & Feb.*, 1865.

Present or absent *Present*

Stoppage, \$ *13* ^{*93*}/_{*100*} for *gross amt*
ordnance lost or destroyed

Due Gov't, \$ *100* for

Valuation of horse, \$ *100*

Valuation of horse equipments, \$ *100*

Remarks:

Book mark:

Valentine

A | **3 Cav.** | **U.S.C.T.**

Thomas Herd

Priv., Co. K, 3 Reg't U. S. Col'd Cavalry.

Appears on

Company Muster Roll

for *March & Apr*, 1865.

Present or absent *Absent*

Stoppage, \$ 100 for

Due Gov't, \$ 100 for

Valuation of horse, \$ 100

Valuation of horse equipments, \$ 100

Remarks:

*Absent on expedition
since Apr 29th 1865*

Book mark:

Valentine

A | **3 Cav.** | **U.S.C.T.**

Thomas Herd

Priv, Co. K, 3 Reg't U. S. Col'd Cavalry.

Appears on

Company Muster Roll

for *May & June*, 1865.

Present or absent *Present*.

Stoppage, \$ *1* ^{*01*}/_{*100*} for *ordnance lost or destroyed*.

Due Gov't, \$ *100* for

Valuation of horse, \$ *100*

Valuation of horse equipments, \$ *100*

Remarks:

Book mark:

Valentine

N | **3 Cav.** | **U.S.C.T.**

Thomas Nerd,

Corp., Co. K, 3 Reg't U. S. Col'd Cavalry.

Appears on

Company Muster Roll

for *July & Aug*, 1865.

Present or absent *Present*

Stoppage, \$..... $\overline{100}$ for

Due Gov't, \$..... $\overline{100}$ for

Valuation of horse, \$..... $\overline{100}$

Valuation of horse equipments, \$..... $\overline{100}$

Remarks:

*Promoted from Private
July 1st 1865*

Book mark:

Valentine

H | 3 Cav. | U.S.C.T.

Thomas Herd
Corp., Co. K, 3 Reg't U. S. Col'd Cavalry.

Appears on

Company Muster Roll

for Sept. and Oct., 1863.

Present or absent Present

Stoppage, \$ 100 for

Due Gov't, \$ 100 for

Valuation of horse, \$ 100

Valuation of horse equipments, \$ 100

Remarks: Due Gov't for ord
nance lost 31 lbs.

Book mark:

H | **3 Cav. | U.S.C.T.**

Thomas Herd

Corp., Co. K, 3 Reg't U. S. Col'd Cavalry.

Appears on

Company Muster Roll

for *Nov. and Dec., 1865.*

Present or absent *Present.*

Stoppage, \$ *100* for

Due Gov't, \$ *100* for

Valuation of horse, \$ *100*

Valuation of horse equipments, \$ *100*

Remarks: *Due U.S. for ordnance
lost and carried forward from
the Sept. and Oct. Rolls 30 cts.*

Book mark:

Ho | 3 Cav. | U.S.C.T.

Thomas Herd

Priv., Co. K, 3 Reg't U. S. Colored Cav.
Corpl

Appears on Returns as follows:

Aug. 1864. On duty, det. Orderly
at Regt. Hd. Qrs. since
Aug. 21/64.

Sept. to Nov. 1864. On duty, det.
for Orderly at mustering
Office since Aug. 21/64
by order of Maj Cook
Comdg Regt.

* Dec. 1864. On duty, det. at Mus-
tering office since Aug. 21/64.

Aug. to Oct. 1865. (Corpl.) On duty
Color guard.

* Entry cancelled.

Book mark :

J. B. Sittler

(546)

Copyist.

H | **3 Cav.** | **U.S.C.T.**

Thomas Herd
Corp., Co. *Ko*, 3 Reg't U. S. Col'd Cavalry.

Appears on **Co. Muster-out Roll**, dated
Memphis, Tenn. Jan. 26, 1866.
Muster-out to date *Jan. 26*, 1866.
Last paid to *June 30*, 1865.

Clothing account:

Last settled 186 ; drawn since \$ 100
Due soldier \$ 100; due U. S. \$ ^{\$ 22} 100
Am't for cloth'g in kind or money adv'd \$ 100

Due U. S. for arms, equipments, &c., \$ 100
Bounty paid \$ 100; due \$ 100

Remarks: *Due U. S. for ord-*
nance \$ 0.25

Book mark: *V. 88 P. 31 '69.*

Howard
Copyist.

649 or Billy
Hoerd, William

Co K, 3 U. S. Col'd Cav.

Private

Private

CARD NUMBERS.

1	5343684	26
2	5343781	27
3	5343903	28
4	5344797	29
5	9089482	30
6	40727524	31
7		32
8		33
9		34
10		35
11		36
12		37
13		38
14		39
15		40
16		41
17		42
18		43
19		44
20		45
21		46
22		47
23		48
24		49
25		50

Book Mark:

See also

H. I. Caw | **U.S.C.T.**

William Herb

Priv, Co. M, I Reg't U. S. Col'd Caw

Appears on

Company Muster-in and Descriptive Roll
of the organization named above. Roll dated

Kanawha Bluff Miss, Dec 1, 1864.

Where born St Clair Ala.

Age 8 y'rs; occupation Farmer

When enlisted Feb 24, 1864.

Where enlisted Kanawha Bluff Miss

For what period enlisted 2 years.

Eyes Black; hair Black

Complexion Black; height 5 ft. 5 1/2 in.

When mustered in _____, 186 .

Where mustered in _____

Bounty paid \$ 100; due \$ 100

Where credited _____

Company to which assigned _____

Remarks: _____

x Became Co K 3rd Regt U.S.C. Cav.

Book mark: _____

Beach

H | **3 Cav.** | **U.S.C.T.**

Billy Herd

Bob, Co. K, 3 Reg't U. S. Col'd Cavalry.

Appears on

Company Muster Roll

for *Feb 24 to Apr 30*, 186 *✓*

Present or absent *Absent*

Stoppage, \$ *100* for

Due Gov't, \$ *100* for

Valuation of horse, \$ *100*

Valuation of horse equipments, \$ *100*

Remarks: *Sick in the Hospital*

Mustered in Feb 24 '64 at Harris Bluff

Book mark: _____

Beach

K | **3 Cav.** | **U.S.C.T.**

Wiley Kord

1st, Co. K, 3 Reg't U. S. Col'd Cavalry.

Appears on

Company Muster Roll

for *May & June*, 186*4*

Present or absent

Stoppage, \$ *100* for

Due Gov't, \$ *100* for

Valuation of horse, \$ *100*

Valuation of horse equipments, \$ *100*

Remarks: *Paid Reg'tt Corp's
at Newburg Miss
May 2, 1864.*

Book mark:

Beach

He, | 3 Cav. | U.S.C.T.

Billy Herd
Pvt, Co. K, 3 Reg't U. S. Colored Cav.

Appears on Returns as follows:

May 1864. Loss - May 3/64
Vicksburg, Miss. - Died
of disease in Regt. Hosp.

Book mark :

(548)

J. B. Sittler

Copyist.

H | **3 Cav. U.S.C.T.**

Billy Kerd
.....
Rob. K., Co. *K*, 3 Reg't U. S. Col'd Cavalry.

Appears on **Co. Muster-out Roll**, dated
Memphis, Tenn. Jan 26, 186*6*.

Muster-out to date, 186 ..

Last paid to *Apr. 30*, 186*4*.

Clothing account:

Last settled, 186 ; drawn since \$.....100

Due soldier \$.....100; due U. S. \$.....100

Am't for cloth'g in kind or money adv'd \$.....100

Due U. S. for arms, equipments, &c., \$.....100

Bounty paid \$.....100; due \$.....100

Remarks: *Died of Disease*
May 3, 1864.

Book mark :

(361)

Howard
Copyist.

H | 3 Cav. | U.S.C.T.

William Ford

....., Co. K, 3 Reg't U. S. Col'd Cav.

Appears on

Company Descriptive Book
of the organization named above.

DESCRIPTION.

Age 18 years; height 5 feet 5½ inches.

Complexion Black

Eyes Black; hair Black

Where born St Clair, Ala

Occupation Farmer

ENLISTMENT.

When Feb. 24, 1864

Where Gaines Bluff

By whom Capt. Hayes term 3 y'rs.

Remarks: Died in
Reg. Hosp. in Aug 3^d
Final statements
forwarded.

F. B. Smith

Herd, Wm

B, Co. A

3

U. S. C. Cav.
Reg't

2 Enclosures.

Bed Cards	Descriptive Lists
Burial Records	Final Statements 2
Certs. of Dis. for Discharge	Furloughs
C. M. Charges	Med. Des. Lists
Med. Certificates	Orders

Other papers relating to—

Admission to Hosp'l	Furlough
Casualty Sheet (Officer's)	Med. Examination
Confinement	Misc. Information
Contracts	Pay or Clothing
Death or Effects	Personal Reports
Desertions	Rank
Discharge from Hosp'l	Transfer to Hosp'l
Discharge from Service	Transfer to V. R. C.
Duty	Transportation

V

FINAL STATEMENT

OF 1864
Private William Reed
3d Reg't of W. S. Colden

VOLUNTEERS.

1864 - 1864

NOTE 1.—Two of these certificates (or duplicates) are to be given to each Volunteer Soldier or drafted man who may be discharged previously to the discharge of his company, that he may at once receive from the Paymaster the pay, &c., due him, and the captain or other COMMISSIONED officer commanding the company will certify to the act of the delivery of the duplicate certificates; on these certificates the Soldier is "entitled to" his discharge, and should also present his discharge to the Paymaster to have the payment endorsed on it. The discharge is to be given back to the Soldier by the Paymaster; the latter only retaining as his voucher the duplicate certificates.

NOTE 2.—If the Soldier is entitled to pay for the use of his horse, the Company Commander will certify to that fact on the back of both these final statements, and also to the time he has pay due for having been so mounted on his own horse.

NOTE 3.—When a Soldier is furnished with final statements, his descriptive list, if he has one, should be taken up by the officer who gives the Soldier these statements, and endorsed with a statement to this effect by the officer. This endorsement should exhibit a full statement of the time for which the Soldier was allowed pay on his final statements, the clothing account, and all other charges against him or in his favor, so as to comprise a complete exhibit of his account. It will then be transmitted to the company commander of the Soldier, who will enter all the data necessary to a full understanding of the Soldier's account on the muster roll upon which the Soldier's discharge is reported. The descriptive list will then be destroyed. The object of this is, that the remaining portion of the Soldier's account may be settled upon the receipt of these muster rolls, and the Soldier receive any pay or allowances that may be due him at the time of his discharge, and which may not appear on his final statements from the fact that his descriptive list is incomplete. These accounts for back pay, &c., are settled by the 2d Auditor of the Treasury Department.

NOTE 4.—Charges for loss or injury to ordnance, horse equipments, and other miscellaneous charges, should appear under the heading of "Other Stoppages."

NOTE 5.—Bounty paid by State authorities, and not by the United States, will not be entered on this statement.

NOTE 6.—Amounts due the Sutler and Laundress must be entered on the muster roll on which the discharge, death, desertion, &c., is reported, as well as on the final statement, otherwise the amount cannot be collected from the United States.

NOTE 7.—This blank will be used for deceased volunteers and drafted men, as well as for others.

NOTE 8.—Where a Soldier dies in Hospital or on detached service, his descriptive list, if he has one, should be sent with his final statements, in duplicate, to the Adjutant General, Washington, D. C.

ADJUTANT GENERAL'S OFFICE

May 30 1864

Duplicate with Treasury from 2d Auditor

I certify, on honor, that William Heed a Private of
 Captain A. J. Haynes Company (B) of the 3d Regiment of U.S. Colored Cav
VOLUNTEERS, of the State of _____, born in St. Clair, State
 of Alabama, aged 18 years; 5 feet 5/8 inches high, Black complexion,
Black eyes, Black hair, and by occupation a Farmer, having joined the company on
 its original organization at Haines Bluff Ala and enrolled in it at the muster into
 the service of the United States at Haines Bluff Ala on the 24th day
 of February, 1864, (or was mustered in service as a recruit, by _____
 _____, at _____, on the _____ day of _____,
 186 _____, or was drafted and mustered into the service of the United States from the _____
 Enrollment District of the State of _____, at _____,
 on the _____ day of _____, 186 _____,) to serve in the Regiment, for
 the term of Three years: and having served **HONESTLY** and
FAITHFULLY with his Company in the ranks to the present date, is now
 entitled to a **DISCHARGE** by reason of Death in Reg. Hospital at Vicksburg Miss
May 3d 1864 Deceased had no effects, was buried in his clothing.

The said William Heed was last paid by Paymaster
 _____ to include the _____ day of _____, 186 _____, and has
 pay due him from enrollment ~~that time~~ to the present date; he is entitled to pay and subsistence for
TRAVELING to place of enrollment, and whatever other allowances are authorized to volunteer
 soldiers, drafted men, or militia, so discharged. He has received from the United States **CLOTHING**
 amounting to 24 ^{4/100} dollars, since the _____ day of _____,
 186 _____, when his clothing account was last settled. He has received from the United States
 _____ ¹⁰⁰ dollars advanced **BOUNTY**.

There is to be stopped from him, on account of the State of _____, or other
 authorities, for **CLOTHING, &c.**, received on entering service, _____ ¹⁰⁰ dollars; and
 for other stoppages, viz: _____

_____ ¹⁰⁰ dollars.
 He has been furnished with **TRANSPORTATION** in kind from the place of his discharge to
 _____; and he has been **SUBSISTED** for **TRAVELING** to his
 place of enrollment, up to the _____, 186 _____.

He is indebted to _____, **SUTLER**, _____ ¹⁵ ¹⁰⁰ dollars.

He is indebted to _____, **LAUNDRESS**, _____ ¹⁰⁰ dollars.

Given in Duplicate, at Vicksburg Miss, this 3d day
 of May, 1864.

A. J. Haynes
Edw. M. Starnes, Corp.
 Commanding Company

FINAL STATEMENT.

OF

William Heard
3d Reg't of U. S. Cavalry

VOLUNTEERS.

NOTE 1.—Two of these certificates (or duplicates) are to be given to each Volunteer Soldier or drafted man who may be discharged previously to the discharge of his company, that he may at once receive from the Paymaster the pay, &c., due him, and the captain or other COMMISSIONED officer commanding the company will certify to the act of the delivery of the duplicate certificates; on these certificates the Soldier is "entitled to" his discharge, and should also present his discharge to the Paymaster to have the payment endorsed on it. The discharge is to be given back to the Soldier by the Paymaster; the latter only retaining as his voucher the duplicate certificates.

NOTE 2.—If the Soldier is entitled to pay for the use of his horse, the Company Commander will certify to that fact on the back of both these final statements, and also to the time he has pay due for having been so mounted on his own horse.

NOTE 3.—When a Soldier is furnished with final statements, his descriptive list, if he has one, should be taken up by the officer who gives the Soldier these statements, and endorsed with a statement to this effect by the officer. This endorsement should exhibit a full statement of the time for which the Soldier was allowed pay on his final statements, the clothing account, and all other charges against him or in his favor, so as to comprise a complete exhibit of his account. It will then be transmitted to the company commander of the Soldier, who will enter all the data necessary to a full understanding of the Soldier's account on the muster roll upon which the Soldier's discharge is reported. The descriptive list will then be destroyed. The object of this is, that the remaining portion of the Soldier's account may be settled upon the receipt of these muster rolls, and the Soldier receive any pay or allowances that may be due him at the time of his discharge, and which may not appear on his final statements from the fact that his descriptive list is incomplete. These accounts for back pay, &c., are settled by the 2d Auditor of the Treasury Department.

NOTE 4.—Charges for loss or injury to ordnance, horse equipments, and other miscellaneous charges, should appear under the heading of "Other Stoppages."

NOTE 5.—Bounty paid by State authorities, and not by the United States, will not be entered on this statement.

NOTE 6.—Amounts due the Sutler and Laundress must be entered on the muster roll on which the discharge, death, desertion, &c., is reported, as well as on the final statement, otherwise the amount cannot be collected from the United States.

NOTE 7.—This blank will be used for deceased volunteers and drafted men, as well as for others.

NOTE 8.—Where a Soldier dies in Hospital or on detached service, his descriptive list, if he has one, should be sent with his final statements, in duplicate, to the Adjutant General, Washington, D. C.

1864



I certify, on honor, that Billy Heerd a Private of
 Captain Andrew Payne Company (K) of the 3d Regiment of U.S. Colored
VOLUNTEERS, of the State of _____, born in St. Clair, State
 of Alabama, aged 18 years; 5 feet 5 1/2 inches high, Black complexion.
Black eyes, Black hair, and by occupation a Farmer, having joined the company on
 its original organization at Haines Bluff Miss and enrolled in it at the muster into
 the service of the United States at Haines Bluff Miss on the 24th day
 of February, 1864, (or was mustered in service as a recruit, by _____
 _____, at _____, on the _____ day of _____,
 186 , or was drafted and mustered into the service of the United States from the _____
 Enrollment District of the State of _____, at _____,
 on the _____ day of _____, 186), to serve in the Regiment, for
 the term of Three years: and having served **HONESTLY** and
FAITHFULLY with his Company in the Ranks to the present date, is now
 entitled to a **DISCHARGE** by reason of Death at Vicksburg Miss May 1864
Key in the apt. Deceased had no effect to us buried in clothing

The said _____ was last paid by Paymaster
 _____ to include the _____ day of _____, 186 , and has
 pay due him from ^{enrollment} ~~that time~~ to the present date; he is entitled to pay and subsistence for
TRAVELING to place of enrollment, and whatever other allowances are authorized to volunteer
 soldiers, drafted men, or militia, so discharged. He has received from the United States **CLOTHING**
 amounting to 24 ⁴⁴/₁₀₀ dollars, since the 24th day of February,
 1864, when his clothing account was last settled. He has received from the United States
 _____ ¹⁰⁰/₁₀₀ dollars advanced **BOUNTY**.

There is to be stopped from him, on account of the State of _____, or other
 authorities, for **CLOTHING**, &c., received on entering service, _____ ¹⁰⁰/₁₀₀ dollars; and
 for other stoppages, viz: _____

_____ ¹⁰⁰/₁₀₀ dollars.
 He has been furnished with **TRANSPORTATION** in kind from the place of his discharge to
 _____; and he has been **SUBSISTED** for **TRAVELING** to his
 place of enrollment, up to the _____, 186 .

He is indebted to _____, **BUTLER**, _____ ⁴⁵/₁₀₀ dollars.
 He is indebted to _____, **LAUNDRESS**, _____ ¹⁰⁰/₁₀₀ dollars.

Given in Duplicate, at Vicksburg Miss, this 3d day
 of May, 1864.

A. Payne
 Capt. U.S. Colored Corps
 Commanding Company

650

Herron, George

Co M, 3 U. S. Col'd Cav.

Private

Private

CARD NUMBERS.

5346014	26
5346109	27
5346193	28
5346282	29
5346381	30
5346454	31
5346562	32
5346664	33
5346759	34
5346857	35
5346942	36
5347023	37
5347102	38
9089889	39
9089764	40
40727527	41
	42
	43
	44
	45
	46
	47
	48
	49
	50

Book Mark:

ee also

26 | 3 Cav. | U.S.C.T.

George Hermon

Co. M 3 Reg't U. S. Col'd Cav.

Appears on

Company Descriptive Book

of the organization named above.

DESCRIPTION.

Age 7 5 years; height 5 feet 9 1/2 inches.

Complexion Black

Eyes Black, hair Black

Where born Franklin, Tenn.

Occupation Farmer

ENLISTMENT.

When Feb 24, 1864.

Where Mississippi

By whom Capt. Hylaid; term 3 y'rs.

Remarks:

H | **3 Cav. | U.S.C.T.**

George Herman

M, Co. *M*, 3 Reg't U. S. Col'd Cav.

Appears on

Company Descriptive Book

of the organization named above.

DESCRIPTION.

Age *45* years; height *5* feet *9 1/2* inches.

Complexion *Black*

Eyes *Black*; hair *Black*

Where born *Franklin Co. Tenn.*

Occupation *Farmer*

ENLISTMENT.

When *Feb. 24*, 186*4*.

Where *Mississippi*

By whom *Mr. Hyland*; term *3* y'rs.

Remarks:

.....
.....
.....
.....
.....
.....

J. B. Smith

36

3 Cav. U.S.C.T.

George Hornon

Priv., Co. M, 3 Reg't U. S. Col'd Cavalry.

Appears on

Company Muster-in and Descriptive Roll

of the organization named above. Roll dated

Waines Bluff Miss, Mch 1, 1864.

Where born Franklin Co Tenn

Age 45 y'rs; occupation Farmer

When enlisted Feby 24, 1864.

Where enlisted Mississippi

For what period enlisted 9 years.

Eyes Black; hair Black

Complexion Black; height 5 ft. 9/2 in.

When mustered in _____, 186 .

Where mustered in _____

Bounty paid \$ 100; due \$ 100

Where credited _____

Company to which assigned _____

Remarks: _____

Book mark: _____

R Richardson

(356d)

Copyist.

No | **3 Cav. | U.S.C.T.**

George Norman
Poni, Co. M, 3 Reg't U.S. Col'd Cavalry.

Appears on

Company Muster Roll

for *Meh + apl*, 1864

Present or absent *Present*

Stoppage, \$ 100 for

Due Gov't, \$ 100 for

Valuation of horse, \$ 100

Valuation of horse equipments, \$ 100

Remarks:

*(Oni marching
at Hays Bluff)*

Book mark:

R Richardson

(358)

Copyist.

No | **3 Cav.** | **U.S.C.T.**

George Hermon
Pri, Co. M, 3 Reg't U.S. Col'd Cavalry.

Appears on

Company Muster Roll

for *Apr 30 to Aug 31*, 186 *4*

Present or absent *Present*

Stoppage, \$ *100* for

Due Gov't, \$ *100* for

Valuation of horse, \$ *100*

Valuation of horse equipments, \$ *100*

Remarks :

Book mark :

R. Richardson
(358) Copyist.

26 | 3 Cav. | U.S.C.T.

George Sherman
Priv, Co. M, 3 Reg't U. S. Col'd Cavalry.

Appears on

Company Muster Roll

for May + June, 1864

Present or absent Present

Stoppage, \$ 100 for

Due Gov't, \$ 100 for

Valuation of horse, \$ 100

Valuation of horse equipments, \$ 100

Remarks:

Book mark:

R. Richardson

(358)

Copyist.

No | **3 Cav.** | **U.S.C.T.**

George Vernon
Prin, Co. M, 3 Reg't U. S. Col'd Cavalry.

Appears on

Company Muster Roll

for *Sept & Oct*, 186 *6*

Present or absent *Present*

Stoppage, \$ *100* for

Due Gov't, \$ *100* for

Valuation of horse, \$ *100*

Valuation of horse equipments, \$ *100*

Remarks:

Book mark:

R. Richardson

(358)

Copyist.

3d | **3 Cav. | U.S.C.T.**

George Hermon
priv., Co. M, 3 Reg't U. S. Col'd Cavalry.

Appears on

Company Muster Roll

for *Nov & Dec*, 1864.

Present or absent *absent*

Stoppage, \$ *2* $\frac{42}{100}$ for *two Curry Comb*
7 Brush one Pair of shoes

Due Gov't, \$ $\frac{100}{100}$ for

Valuation of horse, \$ $\frac{100}{100}$

Valuation of horse equipments, \$ $\frac{100}{100}$

Remarks: *on record*

Book mark:

Spaul Allen

H. | **3 Cav. | U.S.C.T.**

George Hannon
....., Co. M, 3 Reg't U. S. Col'd Cavalry.

Appears on

Company Muster Roll
for *Jan & Feb*, 1865.

Present or absent *present*

Stoppage, \$ 100 for

Due Gov't, \$ 100 for

Valuation of horse, \$ 100

Valuation of horse equipments, \$ 100

Remarks :

Book mark :

Wm. C. Allen
.....
(358) Copyist.

31 | **3 Cav. | U.S.C.T.**

George Brown
priv., Co. M, 3 Reg't U. S. Col'd Cavalry.

Appears on

Company Muster Roll

for *Mar + Apr*, 1865.

Present or absent *absent*.

Stoppage, \$ *100* for

Due Gov't, \$ *100* for

Valuation of horse, \$ *100*

Valuation of horse equipments, \$ *100*

Remarks: *on scout*

Book mark:

Am. Allen

H | **3 Cav. | U.S.C.T.**

George Harmon
priv, Co. M, 3 Reg't U. S. Col'd Cavalry.

Appears on

Company Muster Roll

for *May & June*, 1865.

Present or absent *present*

Stoppage, \$ *9 92* for *ordnance*
lost & destroyed

Due Gov't, \$ *100* for

Valuation of horse, \$ *100*

Valuation of horse equipments, \$ *100*

Remarks:

.....
.....
.....
.....
.....
.....
.....
.....
.....
.....

Book mark: *2200*

Paul Allen

31 | **3 Cav. | U.S.C.T.**

George Hermon
Sgt, Co. M, 3 Reg't U. S. Col'd Cavalry.

Appears on

Company Muster Roll

for *July & Aug*, 1865.

Present or absent *present*

Stoppage, \$ *992* / *100* for *ordnance*
lost & destroyed

Due Gov't, \$ *100* for

Valuation of horse, \$ *100*

Valuation of horse equipments, \$ *100*

Remarks:
.....
.....
.....
.....
.....
.....
.....
.....
.....

Book mark:

Spaul Allen

4 | **3 Cav. | U.S.C.T.**

George Vernon

Priv., Co. M, 3 Reg't U. S. Col'd Cavalry.

Appears on

Company Muster Roll
for *Sept. 4 Oct.*, 186*7*.

Present or absent *Present*

Stoppage, \$ *100* for

Due Gov't, \$ *100* for

Valuation of horse, \$ *100*

Valuation of horse equipments, \$ *100*

Remarks :

Book mark :

Loring

(358) *Loring* Copyist.

H | **3 Cav. | U.S.C.T.**

George Hermon
Priv., Co. M, 3 Reg't U. S. Col'd Cavalry.

Appears on

Company Muster Roll

for *Nov. & Dec.*, 1865.

Present or absent *Present*

Stoppage, \$ *100* for

Due Gov't, \$ *100* for

Valuation of horse, \$ *100*

Valuation of horse equipments, \$ *100*

Remarks:
.....
.....
.....
.....
.....
.....
.....
.....
.....
.....

Book mark:

Torrin
.....
.....

H. | **3 Cav.** | **U.S.C.T.**

George Hermon
Pvt., Co. M, 3 Reg't U. S. Colored Cav.

Appears on **Returns** as follows:

* June 1864. Co. Cook,

Sept. 1865. Co. Blacksmith,

Oct. 1865. Assistant to Co.
Blacksmith.

* Entry cancelled.

Book mark :

(546)

J. B. Sittler

Copyist.

✓ | **3 Cav. U.S.C.T.**

George Leeson
Pvt., Co. M, 3 Reg't U. S. Col'd Cavalry.

Appears on **Co. Muster-out Roll**, dated
Memphis Tenn., Jan. 26, 1866.

Muster-out to date *Jan. 26, 1866.*

Last paid to *June 30, 1865.*

Clothing account:

Last settled _____, 186 ; drawn since \$ _____ 100

Due soldier \$ *// 58* 100; due U. S. \$ _____ 100

Am't for cloth'g in kind or money adv'd \$ _____ 100

Due U. S. for arms, equipments, &c., \$ _____ 100

Bounty paid \$ _____ 100; due \$ _____ 100

Remarks: *Mustered out under*
S.C. 167 Mil. Div. of Tenn.

Book mark: _____

(861)

Leeson

Copyist.

651

Heron Jackson
Co A, 3 U. S. Col'd Cav.

Private Corporal

CARD NUMBERS.

1	5332114	26
2	5332203	27
3	5332291	28
4	5332370	29
5	5332450	30
6	5332527	31
7	5332604	32
8	5332685	33
9	5332784	34
10	5332886	35
11	5332950	36
12	5333047	37
12	5333139	38
14	5333225	39
15	5333308	40
16	9088235	41
17		42
18		43
19		44
20		45
21		46
22		47
23		48
24		49
25		50

Book Mark:

See also

A | 3 Cav. | U.S.C.T.

Jackson Heron

....., Co. A, 3 Reg't U. S. Col'd Cav.

Appears on

Company Descriptive Book
of the organization named above.

DESCRIPTION.

Age 25 years; height 5 feet 8 inches.

Complexion Black

Eyes Black; hair Black

Where born Huntsville, Ala.

Occupation Servant

ENLISTMENT.

When Oct. 5, 1863.

Where Vicksburg-Miss.

By whom Cap. W. W. Weber; term 3 y'rs.

Remarks: Scar of a cut on
the back of left hand.

F. A. Wright

A | **3 Cav.** | **U.S.C.T.**

Jackson Heron

Co. A, 1 Reg't Miss. Cav., Corps d'Afrique.*

Appears on

Age 25 - yrs

Company Muster-in Roll

of the organization named above. Roll dated

Vicksburg, Miss Oct 5, 1863.

Muster-in to date

Oct 5, 1863

Joined for duty and enrolled:

When Oct 5th, 1863.

Where Vicksburg, Miss

Period 3 years.

Valuation of horse, \$ 100

Valuation of horse equipments, \$ 100

Remarks: _____

*This organization subsequently became Co. A 3 Reg't U. S. Colored Cavalry.

Book mark: _____

E. U. Clark

(356)

Copyist.

H | 3 Cav. | U.S.C.T.

Jackson Heron
Pat, Co. A, 1 Reg't Miss. Cav., Corps d'Afrique.*

Appears on

Company Muster Roll

for Oct 9, 1863 to Dec. 31, 1863.

Present or absent Present.

Stoppage, \$ 100 for

Due Gov't, \$ 100 for

Valuation of horse, \$ 100

Valuation of horse equipments, \$ 100

Remarks:

*This organization subsequently became Co. A, 3 Reg't U. S. Colored Cavalry.

Book mark:

(358) C M Clark Copyist.

H | **3 Cav.** | **U.S.C.T.**

Jackson Heron
Pvt., Co. *A*, 1 Reg't Miss. Cav., Corps d'Afrique.*

Appears on

Company Muster Roll

for *Jan. & Feb.*, 1864.

Present or absent *Present.*

Stoppage, \$ *0* $\frac{49}{100}$ for *Haversack.*

Due Gov't, \$ *100* for

Valuation of horse, \$ *100*

Valuation of horse equipments, \$ *100*

Remarks:

*This organization subsequently became Co. *A*, 3 Reg't U. S. Colored Cavalry.

Book mark:

B. H. Clark
(358) Copyist.

H | 3 Cav. | U.S.C.T.

Jackson Hewn
Put, Co. A, 3 Reg't U.S. Col'd Cavalry.

Appears on

Company Muster Roll

for *March & April*, 1864.

Present or absent *Present*.

Stoppage, \$ 100 for

Due Gov't, \$ 100 for

Valuation of horse, \$ 100

Valuation of horse equipments, \$ 100

Remarks: *Stop for me
haverack.*

Book mark: _____

C. M. Clark
Copyist.

H | **3 Cav.** | **U.S.C.T.**

Jackson Heron
Put, Co. A, 3 Reg't U. S. Col'd Cavalry.

Appears on

Company Muster Roll

for *May & June*, 1864.

Present or absent *Present.*

Stoppage, \$ *100* for

Due Gov't, \$ *100* for

Valuation of horse, \$ *100*

Valuation of horse equipments, \$ *100*

Remarks:

Book mark : _____

C M Clark

H | **3 Cav.** | **U.S.C.T.**

Jackson Heron
Pat, Co. A, 3 Reg't U.S. Col'd Cavalry.

Appears on

Company Muster Roll

for July & Aug, 1864.

Present or absent Present

Stoppage, \$ 100 for

Due Gov't, \$ 100 for

Valuation of horse, \$ 100

Valuation of horse equipments, \$ 100

Remarks:

Book mark:

C. M. Clark

H | **3 Cav.** | **U.S.C.T.**

Jackson Heron,
Pat., Co. A, 3 Reg't U.S. Col'd Cavalry.

Appears on

Company Muster Roll

for Sept. & Oct., 1864.

Present or absent Present.

Stoppage, \$ 100 for

Due Gov't, \$ 100 for

Valuation of horse, \$ 100

Valuation of horse equipments, \$ 100

Remarks: Stop for one
Curry Comb, One Horse
Brush, One pr. Spurs
& Straps, One Halter.

Book mark: _____

P'Pool

H | **3 Cav.** | **U.S.C.T.**

Jackson Heron,
Pvt., Co. A, 3 Reg't U. S. Col'd Cavalry.

Appears on

Company Muster Roll

for Nov. + Dec., 1864.

Present or absent Present,

Stoppage, \$ 100 for

Due Gov't, \$ 100 for

Valuation of horse, \$ 100

Valuation of horse equipments, \$ 100

Remarks: Stop for 1 Curry
Comb, + Horse Brush,
1 Halter + Strap, 1 pair
Spurs + Straps,

Book mark: _____

P. Pool,

H | **3 Cav.** | **U.S.C.T.**

Jackson Heron,
Pat., Co. A, 3 Reg't U. S. Col'd Cavalry.

Appears on

Company Muster Roll

for Jan. & Feb., 1865.

Present or absent Present

Stoppage, \$ 100 for

Due Gov't, \$ 100 for

Valuation of horse, \$ 100

Valuation of horse equipments, \$ 100

Remarks: Stop for 1 Regt.
Revolver Cal. 44,

Book mark: _____

P'Pool

(358)

), Copyist.

H | **3 Cav.** | **U.S.C.T.**

Jackson Heron,
Priv., Co. A, 3 Reg't U. S. Col'd Cavalry.

Appears on

Company Muster Roll

for Mar. + Apr., 1865.

Present or absent Present.

Stoppage, \$ 100 for

Due Gov't, \$ 100 for

Valuation of horse, \$ 100

Valuation of horse equipments, \$ 100

Remarks:

Book mark: _____

P. Pool

H | **3 Cav.** | **U.S.C.T.**

Jackson Heron
Corpl, Co. A, 3 Reg't U. S. Col'd Cavalry.

Appears on

Company Muster Roll

for May & June, 1865.

Present or absent Present

Stoppage, \$ 100 for

Due Gov't, \$ 100 for

Valuation of horse, \$ 100

Valuation of horse equipments, \$ 100

Remarks: Promoted from
Private to Corpl. June 19,
'65.

Book mark: _____

P. Pool

71 | **3 Cav.** | **U.S.C.T.**

Jackson Heron
Corpl, Co. A, 3 Reg't U. S. Col'd Cavalry.

Appears on

Company Muster Roll

for July & Aug., 1865.

Present or absent Present

Stoppage, \$ 100 for

Due Gov't, \$ 100 for

Valuation of horse, \$ 100

Valuation of horse equipments, \$ 100

Remarks: _____

Book mark: _____

P. Pool

76 | **3 Cav.** | **U.S.C.T.**

Jackson Heron
Corp, Co. A, 3 Reg't U. S. Col'd Cavalry.

Appears on

Company Muster Roll

for Sept & Oct, 1865.

Present or absent Present

Stoppage, \$ 100 for

Due Gov't, \$ 100 for

Valuation of horse, \$ 100

Valuation of horse equipments, \$ 100

Remarks: Stop for one screw driver
& hang and brush wiper
77¢

Book mark: _____

W Jones

76 | 3 Cav. | U.S.C.T.

Jackson Henry
Corp., Co. A, 3 Reg't U. S. Col'd Cavalry.

Appears on

Company Muster Roll

for Nov & Dec, 1862

Present or absent Present

Stoppage, \$ 100 for

Due Gov't, \$ 100 for

Valuation of horse, \$ 100

Valuation of horse equipments, \$ 100

Remarks: Trip for screw driver
Honey & brush wiper 7/1

Book mark:

(358)

H Jones

Copyist.

76 | 3 Cav. | U.S.C.T.

Jackson Brown

Corp, Co *A*, 3 Reg't U. S. Col'd Cavalry.

Appears on **Co. Muster-out Roll**, dated

Memphis Tenn, Jan 26, 1866.

Muster-out to date *Jan 26, 1866.*

Last paid to *June 30, 1865.*

Clothing account:

Last settled....., 186 ; drawn since \$.....¹⁰⁰

Due soldier \$ *26*⁵²/₁₀₀; due U. S. \$.....¹⁰⁰

Am't for cloth'g in kind or money adv'd \$.....¹⁰⁰

Due U. S. for arms, equipments, &c., \$ — ⁷²/₁₀₀

Bounty paid \$ *200*⁰⁰/₁₀₀; due \$ *200*⁰⁰/₁₀₀

Remarks: *Steps for removal drawn
Hung & back*

Book mark :

(361)

M Jones

Copyist.

652

Herring Jesse

Co C, 3 U. S. Col'd Cav.

Private

Sergeant

CARD NUMBERS.

1	5334819	26
2	5334875	27
3	5334965	28
4	5335050	29
5	5335133	30
6	5335211	31
7	5335364	32
8	5336118	33
9	9088468	34
10	40727526	35
11		36
12		37
13		38
14		39
15		40
16		41
17		42
18		43
19		44
20		45
21		46
22		47
23		48
24		49
25		50

Book Mark: Q219, P217, 75

See also

S. 1523048 Porium

A. M. Hanna
Co

H | **3 Cav. | U.S.C.T.**

Jesse Herring
Pvt., Co. *C*, 1 Reg't Miss. Cav., A. D.†

Age *42* years.

Appears on

Company Muster-in Roll

of the organization named above. Roll dated

Vicksburg, Miss., Nov 1, 1863.

Muster-in to date *Nov 1, 1863.*

Joined for duty and enrolled:

When *Nov 1, 1863.**

Where *Vicksburg, Miss.*

Period *3* years.*

Valuation of horse, \$ *100*

Valuation of horse equipments, \$ *100*

Remarks: _____

† This organization subsequently became Co. *C*, 3 Reg't U. S. Cavalry.

* Muster-in roll shows enrollment and muster-in of this company same date. See enrollment on subsequent card or cards.

Bo - mark: _____

R. Johnson
Copyist.

76 | 3 Cav. | U.S.C.T.

Jesse Herring

Sgt., Co. C, 1 Reg't Miss. Cav., A. D.†

Appears on

Company Muster Roll

for Nov and Dec, 1863

Joined for duty and enrolled:

When Nov 1, 1863.*

Where Vicksburg *

Period 3 years.*

Present or absent Not stated

Stoppage, \$ 100 for

Due Gov't \$ 100 for

Valuation of horse, \$ 100

Valuation of horse equipments, 100

Remarks: Appointed Sergeant by Capt B. D. King Nov 20, 1863

† This organization subsequently became Co. C, 3 Reg't U. S. Colored Cavalry.

* See enrollment on card from muster-in roll.

Book mark:

R Johnson

Copyist.

(358d)

26

3 Cav. U.S.C.T.

Jesse Herring
Sgt., Co. C, 1 Reg't Miss. Cav., Corps d'Afrique.*

Appears on

Company Muster Roll

for Jan'y & Feby, 1864.

Present or absent Present

Stoppage, \$ 100 for

Due Gov't, \$ 100 for

Valuation of horse, \$ 100

Valuation of horse equipments, \$ 100

Remarks:

*This organization subsequently became Co. C, 3 Reg't U. S. Colored Cavalry.

Book mark:

R Johnson
Copyist.

26 | **3 Cav.** | **U.S.C.T.**

Jesse Herring
Sgt, Co. C, 3 Reg't U. S. Col'd Cavalry.

Appears on

Company Muster Roll
for March & April, 1864
Present or absent * Present

Stoppage, \$ 100 for

Due Gov't, \$ 100 for

Valuation of horse, \$ 100

Valuation of horse equipments, \$ 100

Remarks:

* Added by H. A. J. Nov. 11, 1897

Book mark: -----

R. Johnson

Copyist.

76 | 3 Cav. | U.S.C.T.

Jesse Herring
Sgt., Co. C, 3 Reg't U. S. Col'd Cavalry.

Appears on

Company Muster Roll

for *May and June*, 1864

Present or absent *Present*

Stoppage, \$ 100 for

Due Gov't, \$ 100 for

Valuation of horse, \$ 100

Valuation of horse equipments, \$ 100

Remarks: *Stop for 1 Bush
& Throng etc*

Book mark:

(358)

R. Johnson
Copyist.

40 | **3 Cav.** | **U.S.C.T.**

Jesse Herring
Sgt, Co. C, 3 Reg't U. S. Col'd Cavalry.

Appears on

Company Muster Roll

for July & Aug, 1864

Present or absent Present

Stoppage, \$ 100 for

Due Gov't, \$ 100 for

Valuation of horse, \$ 100

Valuation of horse equipments, \$ 100

Remarks: Blue M. S. for
Ordnance from last
muster Roll 40 &
Sergt since Nov 1/63

Book mark: _____

R. Johnson
Copyist.

Ho | **3 Cav.** | **U.S.C.T.**

Jesse Herring
Sergt, Co. C, 3 Reg't U. S. Col'd Cavalry.

Appears on

Company Muster Roll
for *Sept & Oct*, 186*4*

Present or absent.....

Stoppage, \$.....100 for.....

Due Gov't, \$.....100 for.....

Valuation of horse, \$.....100

Valuation of horse equipments, \$.....100

Remarks: *Died in Agll Hospital at Vicksburgh Miss Oct 1, 1864, Final statement furnished. Due U.S. for Ordnance 40¢*

Book mark:.....

(358)

Talbot Copyist.

A | 3 Cav. | U.S.C.T.

Jessy Ferring
7247, Co. C, 3 Reg't U. S. Col'd Cav.

Appears on

Company Descriptive Book
of the organization named above.

DESCRIPTION.

Age 72 years; height 5 feet 7½ inches.

Complexion Black

Eyes Black; hair Black

Where born Lemon Co., N.C.

Occupation Farmer

ENLISTMENT.

When Nov. 1, 1864

Where Vicksburg, Miss.

By whom B. D. King; term 3 y'rs.

Remarks: Died in Regt
Hospital at Vicksburg,
Miss. Oct. 1, 1864 of
Chronic Diarrhoea.
Final State memo
furnished.

(383g)

F. A. Wright

Copyist.

H. | 3 Cav. | U.S.C.T.

Jesse Herring
Sergt., Co. C, 3 Reg't U. S. Colored Cav.

Appears on Returns as follows:

Oct. 1864. Loss, Sept 30/64 Vicks-
burg. Died in Regt's
Hospital.

Book mark :

(546)

J. B. Dittler

Copyist.

A | **3 Cav. | U.S.C.T.**

Asse Ferring
Sgt C, Co., 3 Reg't U. S. Col'd Cavalry.

Appears on **Co. Muster-out Roll**, dated

Memphis Tenn. Miss. 1866

Muster-out to date, 186 .

Last paid to *Apr 30*, 1864 .

Clothing account:

Last settled, 186 ; drawn since \$.....100

Due soldier \$.....100; due U. S. \$.....100

Am't for cloth'g in kind or money adv'd \$.....100

Due U. S. for arms, equipments, &c., \$.....100

Bounty paid \$.....100; due \$.....100

Remarks: *Died at*

Vicksburg Miss. Oct 11. 64.
Final statements forwarded.

Book mark: *V 219 P 217 75*

Herring, Jesse
Sgt, Co. B, 3 Reg't U.S.C. Cav.

3 Enclosures.

Bed Cards	Descriptive Lists
Burial Records	Final Statements 3
Certs. of Dis. for Discharge	Furloughs
C. M. Charges	Med. Des. Lists
Med. Certificates	Orders

Other papers relating to—

Admission to Hosp'l	Furlough
Casualty Sheet (Officer's)	Med. Examination
Confinement	Misc. Information
Contracts	Pay or Clothing
Death or Effects	Personal Reports
Desertions	Rank
Discharge from Hosp'l	Transfer to Hosp'l
Discharge from Service	Transfer to V. R. C.
Duty	Transportation

FINAL STATEMENT

OF

Wm J. Herring
Co. 3^d Reg't of U.S. Cold. Cav

VOLUNTEERS.

NOTE 1.—Two of these certificates (or duplicates) are to be given to each Volunteer Soldier or drafted man who may be discharged previously to the discharge of his company, that he may at once receive from the Paymaster the pay, &c., due him, and the captain or other COMMISSIONED officer commanding the company will certify to the act of the delivery of the duplicate certificates; on these certificates the Soldier is "entitled to" his discharge, and should also present his discharge to the Paymaster to have the payment endorsed on it. The discharge is to be given back to the Soldier by the Paymaster; the latter only retaining as his voucher the duplicate certificates.

NOTE 2.—If the Soldier is entitled to pay for the use of his horse, the Company Commander will certify to that fact on the back of both these final statements, and also to the time he has pay due for having been so mounted on his own horse.

NOTE 3.—When a Soldier is furnished with final statements, his descriptive list, if he has one, should be taken up by the officer who gives the Soldier these statements, and endorsed with a statement to this effect by the officer. This endorsement should exhibit a full statement of the time for which the Soldier was allowed pay on his final statements, the clothing account, and all other charges against him or in his favor, so as to comprise a complete exhibit of his account. It will then be transmitted to the company commander of the Soldier, who will enter all the data necessary to a full understanding of the Soldier's account on the muster roll upon which the Soldier's discharge is reported. The descriptive list will then be destroyed. The object of this is, that the remaining portion of the Soldier's account may be settled upon the receipt of these muster rolls, and the Soldier receive any pay or allowances that may be due him at the time of his discharge, and which may not appear on his final statements from the fact that his descriptive list is incomplete. These accounts for back pay, &c., are settled by the 2d Auditor of the Treasury Department.

NOTE 4.—Charges for loss or injury to ordnance, horse equipments, and other miscellaneous charges, should appear under the heading of "Other Stoppages."

NOTE 5.—Bounty paid by State authorities, and not by the United States, will not be entered on this statement.

NOTE 6.—Amounts due the Sutler and Laundress must be entered on the muster roll on which the discharge, death, desertion, &c., is reported, as well as on the final statement, otherwise the amount cannot be collected in the United States.

NOTE 7.—This blank will be used for deceased volunteers and drafted men, as well as for others.

NOTE 8.—Where a Soldier dies in Hospital or on detached service, his descriptive list, if he has one, should be sent with his final statements, in duplicate, to the Adjutant General, Washington, D. C.

ADJUTANT GENERAL'S OFFICE

Co. 3^d 1864

Duplicate with Inventory sent 2d Auditor.

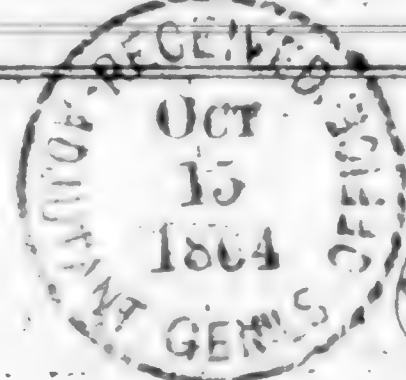

Quincy

I certify, on honor, that Jesse Herring a Sergt of
 Captain Benj. King's Company (10) of the 3rd Regiment of U.S. Colored Cav.
VOLUNTEERS, of the State of _____, born in Lenoire Co., State
 of North Carolina aged 42 years; 5 feet 7 1/2 inches high; Black complexion,
Black eyes, Black hair, and by occupation Farmer, having joined the company on
 its original organization at Vicksburg Miss., and enrolled in it at the muster into
 the service of the United States at Vicksburg Miss., on the 1st day
 of November, 1863, (or was mustered in service as a recruit, by _____
 _____, at _____, on the _____ day of _____,
 186 , or was drafted and mustered into the service of the United States from the _____
 Enrollment District of the State of _____, at _____,
 on the _____ day of _____, 186 ;) to serve in the Regiment, for
 the term of three years; and having served **HONESTLY** and
FAITHFULLY with his Company in the field to the present date, is now
 entitled to a **DISCHARGE** by reason of death, Died in Regt. Hosp.
at Vicksburg Miss. Oct. 1st day of Chronic Diarrhoea

The said Sergt. Jesse Herring was last paid by Paymaster
Wm. Martin to include the 25th day of April, 1864, and has
 pay due him from that time to the present date; he is entitled to pay and subsistence for
TRAVELING to place of enrollment, and whatever other allowances are authorized to volunteer
 soldiers, drafted men, or militia, so discharged. He has received from the United States **CLOTHING**
 amounting to forty two 30 dollars, since the 1st day of November,
 186 , when his clothing account was last settled. He has received from the United States
 _____ dollars advanced **BOUNTY**.

There is to be stopped from him, on account of the State of _____, or other
 authorities, for **CLOTHING**, &c., received on entering service, _____ dollars; and
 for other stoppages, viz: one brush and strong

_____ dollars.
 He has been furnished with **TRANSPORTATION** in kind from the place of his discharge to
 _____; and he has been **SUBSISTED** for **TRAVELING** to his
 place of enrollment, up to the _____, 186

He is indebted to A. B. Bice, **SUTLER**, Six dollars.

He is indebted to _____, **LAUNDRESS**, _____ dollars.

Given in Duplicate, at Vicksburg Miss., this 1st day
 of October, 1864

E. Parby
2nd Lieut.

 Commanding Company.

I certify, on honor, that Jesse Herring a Sergt of
 Captain Brig. King's Company (10) of the 3rd Regiment of U.S. Colored Cav.
VOLUNTEERS, of the State of _____, born in Lenore Co, State
 of North Carolina aged 42 years; 5 feet 7 1/2 inches high; Black complexion,
Black eyes, Black hair, and by occupation Farmer, having joined the company on
 its original organization at Vicksburg Miss, and enrolled in it at the muster into
 the service of the United States at Vicksburg Miss, on the 1st day
 of November, 1863, (or was mustered in service as a recruit, by _____
 _____, at _____, on the _____ day of _____,
 186 , or was drafted and mustered into the service of the United States from the _____
 Enrollment District of the State of _____, at _____,
 on the _____ day of _____, 186) to serve in the Regiment, for
 the term of three years; and having served **HONESTLY** and
FAITHFULLY with his Company in the field to the present date, is now
 entitled to a **DISCHARGE** by reason of death, died in Regt. Hosp.
at Vicksburg Miss Oct. 1st day of chronic diarrhoea.

The said Sergt. Jesse Herring was last paid by Paymaster
Maj. Martin to include the 30th day of April, 1864, and has
 pay due him from that time to the present date; he is entitled to pay and subsistence for
TRAVELING to place of enrollment, and whatever other allowances are authorized to volunteer
 soldiers, drafted men, or militia, so discharged. He has received from the United States **CLOTHING**
 amounting to forty two 30/100 dollars, since the 1st day of November,
 1863, when his clothing account was last settled. He has received from the United States
 _____ dollars advanced **BOUNTY**.

There is to be stopped from him, on account of the State of _____, or other
 authorities, for **CLOTHING**, &c., received on entering service, _____ dollars; and
 for other stoppages, viz: one month and three days
 _____ dollars.

He has been furnished with **TRANSPORTATION** in kind from the place of his discharge to
 _____; and he has been **SUBSISTED** for **TRAVELING** to his
 place of enrollment, up to the _____, 186 .

He is indebted to A. J. Birch, **SUTLER**, Six dollars.
 He is indebted to _____, **LAUNDRESS**, _____ dollars.

Given in Duplicate, at Vicksburg Miss, this 1st day
 of October, 1864

E. Parley
2nd Lieut.

 Commanding Company.

"R"
FINAL STATEMENT

OF

Sergeant James Merring
Co. C 3rd Reg't of U.S. Col'd Foot

VOLUNTEERS.

NOTE 1.—Two of these certificates (or duplicates) are to be given to each Volunteer Soldier or drafted man who may be discharged previously to the discharge of his company, that he may at once receive from the Paymaster the pay, &c., due him, and the captain or other COMMISSIONED officer commanding the company will certify to the act of the delivery of the duplicate certificates; on these certificates the Soldier is "entitled to" his discharge, and should also present his discharge to the Paymaster to have the payment endorsed on it. The discharge is to be given back to the Soldier by the Paymaster; the latter only retaining as his voucher the duplicate certificates.

NOTE 2.—If the Soldier is entitled to pay for the use of his horse, the Company Commander will certify to that fact on the back of both these final statements, and also to the time he has pay due for having been so mounted on his own horse.

NOTE 3.—When a Soldier is furnished with final statements, his descriptive list, if he has one, should be taken up by the officer who gives the Soldier these statements, and endorsed with a statement to this effect by the officer. This endorsement should exhibit a full statement of the time for which the Soldier was allowed pay on his final statements, the clothing account, and all other charges against him or in his favor, so as to comprise a complete exhibit of his account. It will then be transmitted to the company commander of the Soldier, who will enter all the data necessary to a full understanding of the Soldier's account on the muster roll upon which the Soldier's discharge is reported. The descriptive list will then be destroyed. The object of this is, that the remaining portion of the Soldier's account may be settled upon the receipt of these muster rolls, and the Soldier receive any pay or allowances that may be due him at the time of his discharge, and which may not appear on his final statements from the fact that his descriptive list is incomplete. These accounts for back pay, &c., are settled by the 2d Auditor of the Treasury Department.

NOTE 4.—Charges for loss or injury to ordnance, horse equipments, and other miscellaneous charges, should appear under the heading of "Other Stoppages."

NOTE 5.—Bounty paid by State authorities, and not by the United States, will not be entered on this statement.

NOTE 6.—Amounts due the Sutler and Laundress must be entered on the muster roll on which the discharge, death, desertion, &c., is reported, as well as on the final statement, otherwise the amount cannot be collected from the United States.

NOTE 7.—This blank will be used for deceased volunteers and drafted men, as well as for others.

NOTE 8.—Where a Soldier dies in Hospital or on detached service, his descriptive list, if he has one, should be sent with his final statements, in duplicate, to the Adjutant General, Washington, D. C.

1864



I certify, on honor, that James Marrison a Sergt of
Captain Benj. S. King's Company (C) of the 3rd Regiment of U.S. Colored Cavalry
VOLUNTEERS, of the State of _____, born in Lenoir Co., State
of North Carolina aged 42 years; 5 feet 7 1/2 inches high; Black complexion,
Black eyes, Black hair, and by occupation a Farmer, having joined the company on
its original organization at Vicksburg Miss and enrolled in it at the muster into
the service of the United States at Vicksburg Miss, on the 1st day
of November, 1863, (or was mustered in service as a recruit, by _____
at _____, on the _____ day of _____,
186 , or was drafted and mustered into the service of the United States from the _____
Enrollment District of the State of _____, at _____,
on the _____ day of _____, 186), to serve in the Regiment, for

the term of three years and having served **HONESTLY** and
FAITHFULLY with his Company in the field to the present date, is now
entitled to a **DISCHARGE** by reason of death. Died in Regt. Hospital
at Vicksburg Miss Oct. 1st 1864 of Chronic Diarrhoea

The said Sergt. James Marrison was last paid by Paymaster
Maj. Martin to include the 30th day of April, 1864, and has
pay due him from that time to the present date; he is entitled to pay and subsistence for
TRAVELING to place of enrollment, and whatever other allowances are authorized to volunteer
soldiers, drafted men, or militia, so discharged. He has received from the United States **CLOTHING**
amounting to Forty-four ⁷³/₁₀₀ dollars, since the 1st day of November,
1863, when his clothing account was last settled. He has received from the United States
 /₁₀₀ dollars advanced **BOUNTY**.

There is to be stopped from him, on account of the State of _____, or other
authorities, for **CLOTHING**, &c., received on entering service, /₁₀₀ dollars; and
for other stoppages, viz: Out Brush and Thong
 /₁₀₀ dollars.

He has been furnished with **TRANSPORTATION** in kind from the place of his discharge to
_____ ; and he has been **SUBSISTED** for **TRAVELING** to his
place of enrollment, up to the _____, 186

He is indebted to R. J. Birce, **SUTLER**, Six /₁₀₀ dollars.

He is indebted to _____, **LAUNDRESS**, /₁₀₀ dollars.

Given in Duplicate, at Vicksburg Miss, this 1st day
of November, 1864.

E. Parley
2nd Lieut.
Commanding Company.

FINAL STATEMENT

OF

Sergt James Herring
Co. 3^d Reg't of U.S. Col'd. Cav.

VOLUNTEERS.

J. B. A. C. J. 1864

NOTE 1.—Two of these certificates (or duplicates) are to be given to each Volunteer Soldier or drafted man who may be discharged previously to the discharge of his company, that he may at once receive from the Paymaster the pay, &c., due him, and the captain or other COMMISSIONED officer commanding the company will certify to the act of the delivery of the duplicate certificates; on these certificates the Soldier is "entitled to" his discharge, and should also present his discharge to the Paymaster to have the payment endorsed on it. The discharge is to be given back to the Soldier by the Paymaster; the latter only retaining as his voucher the duplicate certificates.

NOTE 2.—If the Soldier is entitled to pay for the use of his horse, the Company Commander will certify to that fact on the back of both these final statements, and also to the time he has pay due for having been so mounted on his own horse.

NOTE 3.—When a Soldier is furnished with final statements, his descriptive list, if he has one, should be taken up by the officer who gives the Soldier these statements, and endorsed with a statement to this effect by the officer. This endorsement should exhibit a full statement of the time for which the Soldier was allowed pay on his final statements, the clothing account, and all other charges against him or in his favor, so as to comprise a complete exhibit of his account. It will then be transmitted to the company commander of the Soldier, who will enter all the data necessary to a full understanding of the Soldier's account on the muster roll upon which the Soldier's discharge is reported. The descriptive list will then be destroyed. The object of this is, that the remaining portion of the Soldier's account may be settled upon the receipt of these muster rolls, and the Soldier receive any pay or allowances that may be due him at the time of his discharge, and which may not appear on his final statements from the fact that his descriptive list is incomplete. These accounts for back pay, &c., are settled by the 2d Auditor of the Treasury Department.

NOTE 4.—Charges for loss or injury to ordnance, horse equipments, and other miscellaneous charges, should appear under the heading of "Other Stoppages."

NOTE 5.—Bounty paid by State authorities, and not by the United States, will not be entered on this statement.

NOTE 6.—Amounts due the Sutler and Laundress must be entered on the muster roll on which the discharge, death, desertion, &c., is reported, as well as on the final statement, otherwise the amount cannot be collected from the United States.

NOTE 7.—This blank will be used for deceased volunteers and drafted men, as well as for others.

NOTE 8.—Where a Soldier dies in Hospital or on detached service, his descriptive list, if he has one, should be sent with his final statements, in duplicate, to the Second Auditor, Washington, D. C.

James Herring
Deputy

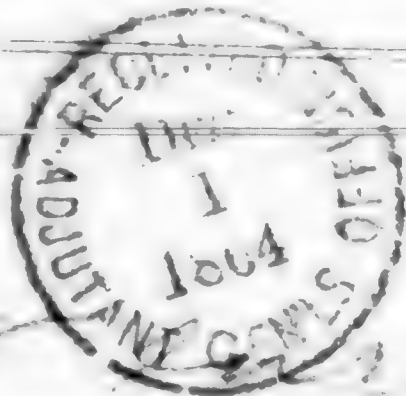

I certify, on honor, that Jesse Herring a Serjt. of
 Captain Benj. S. King's Company (6) of the 3^d Regiment of U.S. Colored Cavalry
VOLUNTEERS, of the State of _____, born in Senora Co., State
 of North Carolina aged 42 years; 5 feet 7 1/2 inches high; Black complexion.
Black eyes, Black hair, and by occupation a Farmer, having joined the company on
 its original organization at Vicksburg Miss., and enrolled in it at the muster into
 the service of the United States at Vicksburg Miss., on the 1st day
 of November, 1863, (or was mustered in service as a recruit, by _____
 _____, at _____, on the _____ day of _____,
 186 , or was drafted and mustered into the service of the United States from the _____
 Enrollment District of the State of _____, at _____
 on the _____ day of _____, 186), to serve in the Regiment, for

the term of three years; and having served **HONESTLY** and
FAITHFULLY with his Company in the field to the present date, is now
 entitled to a **DISCHARGE** by reason of death. Died in Regtl. Hosp't.
at Vicksburg, Miss. Oct. 1st 1864 of Chronic Diarrhoea.

The said Serjt. Jesse Herring was last paid by Paymaster
Maj. Martin to include the 30th day of April, 1864, and has
 pay due him from that time to the present date; he is entitled to pay and subsistence for
TRAVELING to place of enrollment, and whatever other allowances are authorized to volunteer
 soldiers, drafted men, or militia, so discharged. He has received from the United States **CLOTHING**
 amounting to Forty four - 72 dollars, since the 1st day of November,
 1863, when his clothing account was last settled. He has received from the United States
 _____ dollars advanced **BOUNTY**.

There is to be stopped from him, on account of the State of _____, or other
 authorities, for **CLOTHING**, &c, received on entering service, _____ dollars; and
 for other stoppages, viz: One Bush and Strong

 _____ dollars.

He has been furnished with **TRANSPORTATION** in kind from the place of his discharge to
 _____; and he has been **SUBSISTED** for **TRAVELING** to his
 place of enrollment, up to the _____, 186
 He is indebted to P. L. Pierce, **SUTLER**, Six dollars.
 He is indebted to _____, **LAUNDRESS**, _____ dollars.

Given in Duplicate, at Vicksburg Miss., this 1st day
 of November, 1864.

E. G. Arley
2nd Lieut.

 Commanding Company

653

Hewitt John

Co., 3 U. S. Col'd Cav.

Private

CARD NUMBERS.

1	5330993.	26
2		27
3		28
4		29
5		30
6		31
7		32
8		33
9		34
10		35
11		36
12		37
13		38
14		39
15		40
16		41
17		42
18		43
19		44
20		45
21		46
22		47
23		48
24		49
25		50

Book Mark:

See also

No. 3 Cav. U.S.C.T.

John Hewitt.
Pvt., Co. 3 Reg't U. S. Col'd Cav.

Age 20 years.

Appears on a

Detachment Muster-in Roll

of the organization named above. Roll dated
Vicksburg, Miss. Jan. 7, 1865.

Muster-in to date Jan. 7, 1865.

Joined for duty and enrolled:

When Jan. 6, 1865.

Where Vicksburg, Miss.

Period 3 years.

Valuation of horse, \$ 100

Valuation of horse equipments, \$ 100

Remarks: _____

Name not found
on rolls of reg't.

Book mark : _____

(337)

Sitter.

Copyist.

654

News Henry

COM, 3 U. S. Col'd Cav.

Private | *Private*

CARD NUMBERS.

1	26
2	27
3	28
4	29
5	30
6	31
7	32
8	33
9	34
10	35
11	36
12	37
13	38
14	39
15	40
16	41
17	42
18	43
19	44
20	45
21	46
22	47
23	48
24	49
25	50

Book Mark:

See also

655

Hicks, Andrew

Co I, 3 U. S. Col'd Cav.

Private

Private

CARD NUMBERS.

1	5330992	26
2	5343044	27
3	5343183	28
4	5343618	29
5	9089406	30
6	40727528	31
7	31691537	32
8		33
9		34
10		35
11		36
12		37
13		38
14		39
15		40
16		41
17		42
18		43
19		44
20		45
21		46
22		47
23		48
24		49
25		50

Book Mark:

See also

3 Cav. U.S.C.T.

Andrew Hicks

Co., 3 Reg't U. S. Col'd Cav.

Appears on

Company Descriptive Book

of the organization named above.

DESCRIPTION.

Age 19 years; height 5 feet 7 inches.

Complexion

Blk

Eyes

blk

hair

blk

Where born

Miss

Occupation

farmer

ENLISTMENT.

When

Jan 6

1865

Where

V. Burg

By whom

May Main

term

3 y'rs.

Remarks:

Died in the hospital
Memphis Tenn March 10 1865
Had pay due him from enrollment.
Had received clothing amounting to \$400
Indebted to the Govt for 1 canteen and one
Haversack \$150.

Final statements sent April 21 1865

Hutton

H. | 3 Cav. | U.S.C.T.

Andrew Hicks.

Priv. Co., 3 Reg't U. S. Col'd Cav.

Age 19 years.

Appears on a

Detachment Muster-in Roll

of the organization named above. Roll dated

Vicksburg, Miss Jan. 7, 1865.

Muster-in to date Jan. 7, 1865.

Joined for duty and enrolled:

When Jan. 6, 1865.

Where Vicksburg, Miss.

Period 3 years.

Valuation of horse, \$ 100

Valuation of horse equipments, \$ 100

Remarks:

Book mark:

(337)

Sitter.

Copyist.

H | 3 Cav. | U.S.C.T.

Andrew Hicks

Pvt., Co. I, 3 Reg't U. S. Col'd Cavalry.

Appears on

Company Muster Roll

for Jan & Feby, 1865

Present or absent Absent

Stoppage, \$ 100 for

Due Gov't, \$ 100 for

Valuation of horse, \$ 100

Valuation of horse equipments, \$ 100

Remarks: Absent - sick in
Genl Hospital at Memphis Tenn
since Jan 31 / 65

* marked by Commission

Book mark:

Lucas

He 30av 12507

Andrew Hicks
Priv, Co. C, 3 Reg't 1250 Cav

Appears on

Hospital Muster Roll

of Webster U. S. A. General Hospital,

at Memphis, Tenn.,

for Jan & Feb, 1865.

Attached to hospital:

When Jan 29, 1865.

How employed Sick

Last paid by Maj. _____

to _____, 1865.

Bounty paid \$ 100; due \$ 100

Present or absent Present

Remarks: _____

Book mark: _____

(848)

J. Underwood

Copyist.

H | **3 Cav.** | **U.S.C.T.**

Andrew Hicks

Priv, Co. I, 3 Reg't U. S. Col'd Cavalry.

Appears on

Company Muster Roll

for March & April, 1865.

Present or absent _____

Stoppage, \$ _____ 100 for _____

Due Gov't, \$ _____ 100 for _____

Valuation of horse, \$ _____ 100

Valuation of horse equipments, \$ _____ 100

Remarks: Died in Genl Hospital at
Memphis Tenn. March 10/65.
Stop from caution one
Haversack 1.60.

Book mark: _____

Lucas

Ho. | 3 Cav. | U.S.C.T.

Andrew Hicks

Priv., Co. I, 3 Reg't U. S. Colored Cav.

Appears on Returns as follows:

Jan. 1865. Gain Jan. 16/65 -
Memphis, Tenn. Enlisted
in Regt. Absent sick
Jan. 29 Gen. Hosp.

Feb. 1865. Absent sick since
Jan. 31/65.

Mar. 1865. Loss Mar. 13/65 - Mem-
phis, Tenn. - Died in Genl
Hosptl.

Book mark :

(540)

J. B. Dittler

Copyist.

H | **3 Cav. | U.S.C.T.**

Andrew Hicks

Bris, Co. D, 3 Reg't U. S. Col'd Cavalry.

Appears on **Co. Muster-out Roll**, dated

Memphis Tenn Jan 26, 1866.

Muster-out to date _____, 186 .

Last paid to * Never paid, 186 .

Clothing account:

Last settled _____, 186 ; drawn since \$ _____ 100

Due soldier \$ _____ 100; due U. S. \$ _____ 100

Am't for cloth'g in kind or money adv'd \$ _____ 100

Due U. S. for arms, equipments, &c., \$ _____ 100

Bounty paid \$ _____ 100; due \$ _____ 100

Remarks: Died in Genl Hospital

at Memphis Tenn. Mar. 10/65

Description Roll furnished

* necessary Coupon

Book mark: _____

HICKS, ANDREW

B, Co. *I*, **3** U. S. C. Cav.
Reg't

4 Enclosures.

Bed Cards	Descriptive Lists
Burial Records	Final Statements <i>2</i>
Certs. of Dis. for Discharge	Furloughs
C. M. Charges	Med. Des. Lists
Med. Certificates	Orders

Other papers relating to—

Admission to Hosp'l	Furlough
Casualty Sheet (Officer's)	Med. Examination
Confinement	Misc. Information <i>1</i>
Contracts	Pay or Clothing
Death or Effects <i>1</i>	Personal Reports
Desertions	Rank
Discharge from Hosp'l	Transfer to Hosp'l
Discharge from Service	Transfer to V. R. C.
Duty	Transportation

September

Andrew Hicks Pot.
60' 3' Uj. 50' 100'

Completed

!

2 Nov. Ellertson

Adjutant General's Office,

COLORED TROOPS BRANCH,

April 29th, 1874

Vol. C. T., 187

Wanted in case of Andrew Hicks "Pvt.", Co. "I",
3rd Reg't U. S. C. Cavalry

Cause of Death:
M.R. for March & Apr 1865 - reports him dead
in Genl Hsptl at Memphis Tenn. March 10th 1865 -

Respectfully,

H. W. Woodward

Chief Clerk.

J. J. Dalton

Adjutant General's Office,

Record Room

May 2nd, 1874

Vol. C. T., 187

Reply in case of Andrew Hicks Pvt, Co. "I",
3rd Reg't U. S. C. Cav.

Descriptive Book "D" above name
borne with following remarks, "died in
Webster Hosp at Memphis Tenn, March
10th 1865. of disease"

Co. Morning Report dated March 13th 1865:
above name borne with remark, "died in
Genl Hospital"

Regimental Descriptive Book.

date of death - "March 10 1865"

ETA, May 2-1874

A. H. C.

157
 A. B. O. June 17, 1865
 General's Office
 B. S. sent 20 and 10

FINAL STATEMENT

OF

Charles H. ...
 Reg't of *...*

VOLUNTEERS.

NOTE 1.—Two of these certificates (or duplicates) are to be given to each Volunteer Soldier or drafted man who may be discharged without being mustered out (Final Statements are never given to men mustered out of service,) that he may at once receive from the Paymaster the pay, &c., due him, and the captain or other COMMISSIONED officer commanding the company will certify to the act of the delivery of the duplicate certificates; with these certificates the Soldier is "entitled to" his discharge, and should also present his discharge to the Paymaster to have the payment endorsed on it. The discharge is to be given back to the Soldier by the Paymaster; the latter only retaining as his vouchers the duplicate certificates.

NOTE 2.—If the Soldier is entitled to pay for the use of his horse, the Company Commander will certify to that fact on the back of both these final statements, and also to the time he has pay due for having been so mounted on his own horse.

NOTE 3.—When a Soldier is furnished with final statements, his descriptive list, if he has one, should be taken up by the officer who gives the Soldier these statements, and endorsed with a statement to this effect by the officer. The endorsement should exhibit a full statement of the time for which the Soldier was allowed pay on his final statements, the clothing account, and all other charges against him or in his favor, so as to comprise a complete exhibit of his account. It will then be transmitted to the Company Commander, or the Soldier, who will enter all the data necessary to a full understanding of the Soldier's account on the muster roll upon which the Soldier's discharge is reported. The descriptive list will then be destroyed. The object of this is, that the remaining portion of the Soldier's account may be secured upon the receipt of these muster rolls, and the Soldier receive any pay or allowances that may be due him at the time of his discharge, and when a regular engagement has been reported from the fact that his descriptive list is completed. These accounts for back pay, &c., are settled by the 2d Auditor of the Treasury Department.

NOTE 4.—Charges for loss or injury to ordnance, horse equipments, and other miscellaneous charges, should appear under the heading of "Other Stoppages."

NOTE 5.—Bounty paid by State authorities, and not by the United States, will not be entered on this statement.

NOTE 6.—Amounts due the Sutler and Landdress must be entered on the muster roll on which the discharge, death, desertion, &c., is reported, as well as on the final statement, otherwise the amount cannot be collected from the United States.

NOTE 7.—This blank will be used for deceased volunteers and drafted men, as well as for others.

NOTE 8.—Where a Soldier dies in Hospital or on detached service, his descriptive list, if he has one, should be sent with his final statements, in duplicate, to the Adjutant General, Washington, D. C.

NOTE 9.—If the soldier is a drafted man or substitute, the space for time, &c., or entered, should contain only the word *drafted* or *substitute*, as the case may be. If the Soldier is a "VETERAN," (or RECRUIT,) the words *as a veteran* (or *recruit*;) as the case may be, should be interlined after the words *mustered into the service of the U. S.* A statement of all the installments of *Veteran* or *Recruit* Bounty RECEIVED by the Soldier must be made on the back of each final statement.

ADJUTANT GENERAL'S OFFICE.

Apr 29th 1865

Duplicate with Inventory sent 2d Auditor.

I certify, on honor, that Andrew Hicks, a Private of
 Captain Jesse Brainerd Company (3) of the C Regiment of 1st Cavalry
VOLUNTEERS, of the State of _____, born in _____, State
 of Ohio, aged 17 years; 5 feet 7 inches high; Light complexion,
Blue eyes, Black hair, and by occupation a Wine Merchant, who joined for service
 and was enrolled (see Note 9) on the 6 day of January, 1863, at Chillicothe
 by Prof. Chan, for the period of 3 years, and mustered into
 the service of the United States on the 6 day of January, 1863, at
Chillicothe, by T. M. Douglas; and having served
 HONESTLY and FAITHFULLY with his Company to the present date, is now entitled to a
DISCHARGE by reason of Death Epid in Fort Mifflin at Memphis's
Memphis Tenn Mar 10" 1865

The said Andrew Hicks has pay _____ was last paid by Paymaster
the pay roll to include the _____ day of _____, 1863, and
 has pay due him from that time to the present date; he is entitled to pay and subsistence for
TRAVELING to place of enrollment, and whatever other allowances are authorized to volunteer
 soldiers, drafted men, or militia, so discharged. He has received from the United States **CLOTHING**
 amounting to Sixty $\frac{31}{100}$ dollars, since the 6 day of January,
 1863, when his clothing account was last settled. He has received from the United States
 _____ $\frac{100}{100}$ dollars advanced **BOUNTY**.

There is to be stopped from him, on account of the State of _____, or other
 authorities, for **CLOTHING, &c.**, received on entering service, _____ $\frac{100}{100}$ dollars; and
 for other stoppages, viz: One Quarter One Cent

_____ $\frac{50}{100}$ dollars.
 He has been furnished with **TRANSPORTATION** in kind from the place of his discharge to
 _____; and he has been **SUBSISTED** for **TRAVELING** to his
 place of enrollment, up to the _____, 1863.

He is indebted to _____, **SUTLER**, _____ $\frac{100}{100}$ dollars.
 He is indebted to _____, **LAUNDRESS**, _____ $\frac{100}{100}$ dollars.

Given in Duplicate, at Memphis Tenn, this 31 day
 of April, 1865.

Jesse Brainerd
Captain

 Commanding Company.

22 FINAL STATEMENT

OF

Andrew Hicks
3rd Reg't of Inf col color

VOLUNTEERS.

NOTE 1.—Two of these certificates (or duplicates) are to be given to each Volunteer Soldier or drafted man who may be discharged without being mustered out (Final Statements are never given to men mustered out of service,) that he may at once receive from the Paymaster the pay, &c., due him, and the captain or other COMMISSIONED officer commanding the company will certify to the act of the delivery of the duplicate certificates; with these certificates the Soldier is "entitled to" his discharge, and should also present his discharge to the Paymaster to have the payment endorsed on it. The discharge is to be given back to the Soldier by the Paymaster; the latter only retaining as his vouchers the duplicate certificates.

NOTE 2.—If the Soldier is entitled to pay for the use of his horse, the Company Commander will certify to that fact on the back of both these final statements, and also to the time he has pay due for having been so mounted on his own horse.

NOTE 3.—When a Soldier is furnished with final statements, his descriptive list, if he has one, should be taken up by the officer who gives the Soldier these statements, and endorsed with a statement to this effect by the officer. The endorsement should exhibit a full statement of the time for which the Soldier was allowed pay on his final statements, the clothing account, and all other charges against him or in his favor, so as to comprise a complete exhibit of his account. It will then be transmitted to the Company Commander of the Soldier, who will enter all the data necessary to a full understanding of the Soldier's account on the muster roll upon which the Soldier's discharge is reported. The descriptive list will then be destroyed. The object of this is, that the remaining portion of the Soldier's account may be settled upon the receipt of these muster rolls, and the Soldier receive any pay or allowances that may be due him at the time of his discharge, and which may not appear on his last final statements from the fact that his descriptive list is incomplete. These accounts for back pay, &c., are settled by the 2d Auditor of the Treasury Department.

NOTE 4.—Charges for loss or injury to ordnance, horse equipments, and other miscellaneous charges, should appear under the heading of "Other Stoppages."

NOTE 5.—Bounty paid by State authorities, and not by the United States, will not be entered on this statement.

NOTE 6.—Amounts due the Sutler and Laundress must be entered on the muster roll on which the discharge, death, desertion, &c., is reported, as well as on the final statement, otherwise the amount cannot be collected from the United States.

NOTE 7.—This blank will be used for deceased volunteers and drafted men, as well as for others.

NOTE 8.—Where a Soldier dies in Hospital or on detached service, his descriptive list, if he has one, should be sent with his final statements, in duplicate, to the Adjutant General, Washington, D. C.

NOTE 9.—If the soldier is a drafted man or substitute, the space for time, &c., of enrolled, should contain only the word *drafted* or *substitute*, as the case may be. If the Soldier is a "VETERAN," (or RECRUIT,) the words *as a veteran*, (or *recruit*,) as the case may be, should be interlined after the words *mustered into the service of the U. S.* A statement of all the installments of *Veteran* or *Recruit Bounty* RECEIVED by the Soldier must be made on the back of each final statement.

1863

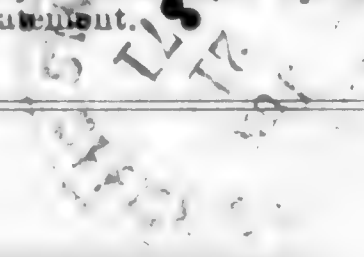

I certify, on honor, that Andrew Woods, a Private of
 Captain Jesse B. ... Company (9) of the 3 Regiment of U.S. Colored Cavalry
VOLUNTEERS, of the State of _____, born in _____, State
 of Miss, aged 19 years; 5 feet 7 inches high; Black complexion,
Black eyes, Black hair, and by occupation a Field Hand, who joined for service
 and was enrolled (see Note 9) on the 6 day of January, 1865, at Chattanooga
 by St. M. ..., for the period of 3 years, and mustered into
 the service of the United States on the 6 day of January, 1865, at
Chattanooga, by St. M. ...; and having served
 HONESTLY and FAITHFULLY with his Company to the present date, is now entitled to a
DISCHARGE by reason of Contract, since in line hospital at Memphis
Tenn. from 10th 1865

The said Andrew Woods was last paid by Paymaster
..., to include the _____ day of _____, 1865, and
 has pay due him from that time to the present date; he is entitled to pay and subsistence for
TRAVELING to place of enrollment, and whatever other allowances are authorized to volunteer
 soldiers, drafted men, or militia, so discharged. He has received from the United States **CLOTHING**
 amounting to 51³¹/₁₀₀ dollars, since the 6 day of January,
 1865, when his clothing account was last settled. He has received from the United States
 _____₁₀₀ dollars advanced **BOUNTY**.

There is to be stopped from him, on account of the State of _____, or other
 authorities, for **CLOTHING, &c.**, received on entering service, _____₁₀₀ dollars; and
 for other stoppages, viz: One hundred and ...
 _____₁₀₀ dollars.
 He has been furnished with **TRANSPORTATION** in kind from the place of his discharge to
 _____; and he has been **SUBSISTED** for **TRAVELING** to his
 place of enrollment, up to the _____, 1865.

He is indebted to _____, **SUTLER**, _____₁₀₀ dollars.
 He is indebted to _____, **LAUNDRESS**, _____₁₀₀ dollars.

Given in Duplicate, at Memphis Tenn, this 21st day
 of April, 1865.

Jesse B. ...
Captain
 Commanding Company.

1865

Inventory of the effects of *Andrew Hicks Private*
Company *F*, *3rd* Regiment *of 1st Cav*
who died in the *Reister's* General Hospital *Memphis*
Memphis *March 10th*, 1865.

CAPS		BLANKETS	/
DRESS COATS		KNAPSACKS	
OVERCOATS	/	CANTEENS	
JACKETS		HIVERSACKS	
TROUSERS		MUSKETS	
SHIRTS	/	BAYONETS	
DRAWERS		CARTRIDGE BOX	
BOOTS, pairs		BELT	
SHOES, pairs		MONEY	
STOCKINGS			

22

INVENTORY

OF THE EFFECTS OF

Andrew Hicks

Late of Company *D*, *3rd* Regiment

1st Cav, who died

at *Reister's* General

Hospital *Memphis* *March 10th*,

1865.



U. S. Army General Hospital,
Memphis Tenn March, 1865.

Commanding Officer, I Company,
3rd Regiment of Colored Cavalry

I have to inform you
that Andrew Hicks of your Company died in this
Hospital on March 17th 1865 of
Inflammation of the lungs

I enclose his ~~Prescriptive List, with Pay and Clothing Account,~~
and Inventory of his effects.

Very respectfully, yours, &c.,

Saml J. Jessop.
Appt Surgeon U. S. A.,

In charge of General Hospital

656

Hicks, Daniel
Co D, 3 U. S. Col'd Cav.

Private | Private

CARD NUMBERS.

1	5336186	26
2	5336276	27
3	5336371	28
4	5336450	29
5	5336519	30
6	5336636	31
7	5337504	32
8	9088645	33
9	40727573	34
10		35
11		36
12		37
13		38
14		39
15		40
16		41
17		42
18		43
19		44
20		45
21		46
22		47
23		48
24		49
25		50

Book Mark:

See also

8122867 And W.S.

A. M. Shannon
Esq

H | **3 Cav.** | **U.S.C.T.**

Daniel Hicks

....., Co. *10*, 3 Reg't U. S. Col'd Cav.

Appears on

Company Descriptive Book
of the organization named above.

DESCRIPTION.

Age *34* years; height *5* feet *7* inches.

Complexion *Black*

Eyes *Black*; hair *Black*

Where born *Carroll - Miss.*

Occupation *Laborer*

ENLISTMENT.

When *Nov. 16*, 1863.

Where *Trip witho Leg.*

By whom *G. L. Starr*; term *3* y'rs.

Remarks: *Died of Disease
in Regtl. Hospital at
Vicksburg - August -
18, 1864.*

F. A. Wright

H | **3 Cav.** | **U.S.C.T.**

Daniel Hicks

Pri, Co. D, 1 Reg't Miss. Cav., Corps d'Afrique.*

Age 34 yrs
Appears on

Company Muster-in Roll

of the organization named above. Roll dated

Skipwith Landj. Miss, Dec 9, 1863.

Muster-in to date Nov 16, 1863.

Joined for duty and enrolled:

When Nov. 16, 1863.

Where Skipwith Landj. Miss.

Period 3 years.

Valuation of horse, \$ 100

Valuation of horse equipments, \$ 100

Remarks: _____

*This organization subsequently became Co. D, 3 Reg't U. S. Colored Cavalry.

Book mark: _____

(356)

Army

Copyist.

H | **3 Cav.** | **U.S.C.T.**

Daniel Hicks

Pi., Co. *D*, 1 Reg't Miss. Cav., Corps d'Afrique.*

Appears on

Company Muster Roll

for *Nov. 16 to Dec 31*, 1863.

Present or absent *Present*

Stoppage, \$..... *100* for

Due Gov't, \$..... *100* for

Valuation of horse, \$..... *100*

Valuation of horse equipments, \$..... *100*

Remarks:

*This organization subsequently became Co. *D*, 3 Reg't U. S. Colored Cavalry.

Book mark:

(358)

Avery

Copyist.

H | 3 Cav. | U.S.C.T.

Daniel Hicks

Co. D, 1 Reg't Miss. Cav., Corps d'Afrique.*

Appears on

Company Muster Roll

for Jan & Feb, 1864.

Present or absent Present

Stoppage, \$ 100 for

Due Gov't, \$ 100 for

Valuation of horse, \$ 100

Valuation of horse equipments, \$ 100

Remarks:

*This organization subsequently became Co. G 3 Reg't U. S. Colored Cavalry.

Book mark:

Avery

76 | **3 Cav.** | **U.S.C.T.**

Daniel Hicks

Pri, Co. D, 3 Reg't U. S. Col'd Cavalry.

Appears on

Company Muster Roll

for Mar & Apr, 1864.

Present or absent Present

Stoppage, \$ 100 for

Due Gov't, \$ 100 for

Valuation of horse, \$ 100

Valuation of horse equipments, \$ 100

Remarks:

Book mark:

(358)

Amey

Copyist.

H | **3 Cav. U.S.C.T.**

Daniel Hicks

Pri, Co. D, 3 Reg't U. S. Col'd Cavalry.

Appears on

Company Muster Roll

for *May & June*, 1864.

Present or absent *Present*

Stoppage, \$ *100* for

Due Gov't, \$ *100* for

Valuation of horse, \$ *100*

Valuation of horse equipments, \$ *100*

Remarks:

Book mark:

(358)

Avery

Copyist.

1000010

N | **3 Cav.** | **U.S.C.T.**

Daniel Hicks

Pri, Co. D, 3 Reg't U. S. Col'd Cavalry.

Appears on

Company Muster Roll

for *July & Aug*, 1864.

Present or absent

Stoppage, \$ 100 for

Due Gov't, \$ 100 for

Valuation of horse, \$ 100

Valuation of horse equipments, \$ 100

Remarks: *Died August 18, 1864,
of Disease in Reg't, Hoeph.*

Book mark:

(358)

Avery

Copyist.

H. | 3 Cav. | U.S.C.T.

Daniel Hicks

Prvt, Co. D, 3 Reg't U. S. Colored Cav.
Corpl

Appears on Returns as follows:

Jan. 1864. (1 Miss Cav. A. D.)
Absent, detached service
since Jan. 28/64, Recruit-
ing.

Mar. 1864. (3 U.S.C.C.) Absent
with leave since Mar.
29/64.

Aug. 1864. Loss Aug. 18th Vicks-
burg - Died in Regtl
Hosptl. (Corpl)

Book mark :

J. B. Sittler

A. | 3 Cav. | U.S.C.T.

Daniel Hicks

Pvt, Co D, 3^d Reg't U. S. Col'd Cav

Appears on Co. Muster-out Roll, dated
Memphis Tenn, Jan 26, 1866.

Muster-out to date _____, 186 .

Last paid to April 30, 1864.

Clothing account:

Last settled _____, 186 ; drawn since \$ _____ 100

Due soldier \$ _____ 100; due U. S. \$ _____ 100

Am't for cloth'g in kind or money adv'd \$ _____ 100

Due U. S. for arms, equipments, &c., \$ _____ 100

Bounty paid \$ _____ 100; due \$ _____ 100

Remarks: Died in Regt Hoop
Vicksburg Miss Aug
18/64

Book mark: Y 141. P. 231. 72

(361)

Rhett
Copyist.

Hicks, Daniel

B, Co. D,

3

Reg't

U.S.C. Cav.

4 Enclosures.

Bed Cards	Descriptive Lists
Burial Records	Final Statements 3
Certs. of Dis. for Discharge	Furloughs
C. M. Charges	Med. Des. Lists
Med. Certificates	Orders

Other papers relating to—

Admission to Hosp'l	Furlough
Casualty Sheet (Officer's)	Med. Examination
Confinement	Misc. Information
Contracts	Pay or Clothing
Death or Effects /	Personal Reports
Desertions	Rank
Discharge from Hosp'l	Transfer to Hosp'l
Discharge from Service	Transfer to V. R. C.
Duty	Transportation

FINAL STATEMENT

OF

Daniel Hicks

3^d Reg't of U. S. Col. ^d Cav

VOLUNTEERS.

NOTE 1.—Two of these certificates (or duplicates) are to be given to each Volunteer Soldier or drafted man who may be discharged previously to the discharge of his company, that he may at once receive from the Paymaster the pay, &c., due him, and the captain or other COMMISSIONED officer commanding the company will certify to the act of the delivery of the duplicate certificates; on these certificates the Soldier is "entitled to" his discharge, and should also present his discharge to the Paymaster to have the payment endorsed on it. The discharge is to be given back to the Soldier by the Paymaster; the latter only retaining as his voucher the duplicate certificates.

NOTE 2.—If the Soldier is entitled to pay for the use of his horse, the Company Commander will certify to that fact on the back of both these final statements, and also to the time he has pay due for having been so mounted on his own horse.

NOTE 3.—When a Soldier is furnished with final statements, his descriptive list, if he has one, should be taken up by the officer who gives the Soldier these statements, and endorsed with a statement to this effect by the officer. This endorsement should exhibit a full statement of the time for which the Soldier was allowed pay on his final statements, the clothing account, and all other charges against him or in his favor, so as to comprise a complete exhibit of his account. It will then be transmitted to the company commander of the Soldier, who will enter all the data necessary to a full understanding of the Soldier's account on the muster roll upon which the Soldier's discharge is reported. The descriptive list will then be destroyed. The object of this is, that the remaining portion of the Soldier's account may be settled upon the receipt of these muster rolls, and the Soldier receive any pay or allowances that may be due him at the time of his discharge, and which may not appear on his final statements from the fact that his descriptive list is incomplete. These accounts for back pay, &c., are settled by the 2d Auditor of the Treasury Department.

NOTE 4.—Charges for loss or injury to ordnance, horse equipments, and other miscellaneous charges, should appear under the heading of "Other Stoppages."

NOTE 5.—Bounty paid by State authorities, and not by the United States, will not be entered on this statement.

NOTE 6.—Amounts due the Sutler and Laundress must be entered on the muster roll on which the discharge, death, desertion, &c., is reported, as well as on the final statement, otherwise the amount cannot be collected from the United States.

NOTE 7.—This blank will be used for deceased volunteers and drafted men, as well as for others.

NOTE 8.—Where a Soldier dies in Hospital or on detached service, his descriptive list, if he has one, should be sent with his final statements, in duplicate, to the Second Auditor, Washington, D. C.

1864



I certify, on honor, that Daniel Hicks a Private of
 Captain _____ Company "D" of the 23^d Regiment of U.S. Col 4th Cav
VOLUNTEERS, of the State of _____, born in Carroll Co., State
 of Mississippi, aged 34 years; 5 feet 7 inches high; Black complexion.
Black eyes, Black hair, and by occupation a Subser., having joined the company on
 its original organization at Shipwits Landing, and enrolled in it at the muster into
 the service of the United States at Shipwits Landing, on the 16th day
 of November, 1863, (or was mustered in service as a recruit, by _____
 _____, at _____, on the _____ day of _____,
 186 , or was drafted and mustered into the service of the United States from the _____
 Enrollment District of the State of _____, at _____,
 on the _____ day of _____, 186), to serve in the Regiment, for
 the term of Three Years: and having served HONESTLY and
 FAITHFULLY with his Company in The Field to the present date, is now
 entitled to a **DISCHARGE** by reason of Said Soldier died of
disease in Regtl Hospital August 18th 1864

The said Daniel Hicks was last paid by Paymaster
Martin to include the 30th day of April, 1864, and has
 pay due him from that time to the present date; he is entitled to pay and subsistence for
TRAVELING to place of enrollment, and whatever other allowances are authorized to volunteer
 soldiers, drafted men, or militia, so discharged. He has received from the United States **CLOTHING**
 amounting to sixty three ⁶⁶/₁₀₀ dollars, since Enlistment day of _____,
 186 , when his clothing account was last settled. He has received from the United States
 _____ ¹⁰⁰/₁₀₀ dollars advanced **BOUNTY**.

There is to be stopped from him, on account of the State of _____, or other
 authorities, for **CLOTHING**, &c, received on entering service, _____ ¹⁰⁰/₁₀₀ dollars: and
 for other stoppages, viz: _____

_____ ¹⁰⁰/₁₀₀ dollars.
 He has been furnished with **TRANSPORTATION** in kind from the place of his discharge to
 _____; and he has been **SUBSISTED** for **TRAVELING** to his
 place of enrollment, up to the _____, 186 .

He is indebted to _____, **SUTLER**, _____ ¹⁰⁰/₁₀₀ dollars.
 He is indebted to _____, **LAUNDRESS**, _____ ¹⁰⁰/₁₀₀ dollars.

Given in Duplicate, at Dicksburg Miss, this 20th day
 of August, 1864.

R. Taylor
1st Lt Co "D"

 Commanding Company

FINAL STATEMENT

OF

Daniel Hicks

3^d " Reg't of U.S. Col of Cav

VOLUNTEERS.

NOTE 1.—Two of these certificates (or duplicates) are to be given to each Volunteer Soldier or drafted man who may be discharged previously to the discharge of his company, that he may at once receive from the Paymaster the pay, &c., due him, and the captain or other COMMISSIONED officer commanding the company will certify to the act of the delivery of the duplicate certificates; on these certificates the Soldier is "entitled to" his discharge, and should also present his discharge to the Paymaster to have the payment endorsed on it. The discharge is to be given back to the Soldier by the Paymaster; the latter only retaining as his voucher the duplicate certificates.

NOTE 2.—If the Soldier is entitled to pay for the use of his horse, the Company Commander will certify to that fact on the back of both these final statements, and also to the time he has pay due for having been so mounted on his own horse.

NOTE 3.—When a Soldier is furnished with final statements, his descriptive list, if he has one, should be taken up by the officer who gives the Soldier these statements, and endorsed with a statement to this effect by the officer. This endorsement should exhibit a full statement of the time for which the Soldier was allowed pay on his final statements, the clothing account, and all other charges against him or in his favor, so as to comprise a complete exhibit of his account. It will then be transmitted to the company commander of the Soldier, who will enter all the data necessary to a full understanding of the Soldier's account on the muster roll upon which the Soldier's discharge is reported. The descriptive list will then be destroyed. The object of this is, that the remaining portion of the Soldier's account may be settled upon the receipt of these muster rolls, and the Soldier receive any pay or allowances that may be due him at the time of his discharge, and which may not appear on his final statements from the fact that his descriptive list is incomplete. These accounts for back pay, &c., are settled by the 2d Auditor of the Treasury Department.

NOTE 4.—Charges for loss or injury to ordnance, horse equipments, and other miscellaneous charges, should appear under the heading of "Other Stoppages."

NOTE 5.—Bounty paid by State authorities, and not by the United States, will not be entered on this statement.

NOTE 6.—Amounts due the Sutler and Laundress must be entered on the muster roll on which the discharge, death, desertion, &c., is reported, as well as on the final statement, otherwise the amount cannot be collected from the United States.

NOTE 7.—This blank will be used for deceased volunteers and drafted men, as well as for others.

NOTE 8.—Where a Soldier dies in Hospital or on detached service, his descriptive list, if he has one, should be sent with his final statements, in duplicate, to the Second Auditor, Washington, D. C.



I certify, on honor, that Daniel Hicks a Private of
Captain _____ Company (D) of the 3^d Regiment of U.S. Col^d Cal
VOLUNTEERS, of the State of _____, born in Canoll Co^y, State
of Mississippi, aged 34 years; 5 feet 7 inches high; Black complexion,
Black eyes, Black hair, and by occupation a Laborer, having joined the company on
its original organization at Shipwits Landing, and enrolled in it at the muster into
the service of the United States at Shipwits Landing, on the 16th day
of November, 1863, (or was mustered in service as a recruit, by _____
_____, at _____, on the _____ day of _____,
186 , or was drafted and mustered into the service of the United States from the _____
Enrollment District of the State of _____, at _____,
on the _____ day of _____, 186 .) to serve in the Regiment, for
the term of Three years: and having served **HONESTLY** and
FAITHFULLY with his Company in The Field to the present date, is now
entitled to a **DISCHARGE** by reason of Said Soldier died of
Disease in Regt Hospital August 10th 1864

The said Daniel Hicks was last paid by Paymaster
Martin to include the 30th day of April, 1864, and has
pay due him from that time to the present date; he is entitled to pay and subsistence for
TRAVELING to place of enrollment, and whatever other allowances are authorized to volunteer
soldiers, drafted men, or militia, so discharged. He has received from the United States **CLOTHING**
amounting to sixty three 66 dollars, since Enlistment day of _____,
186 , when his clothing account was last settled. He has received from the United States
_____ dollars advanced **BOUNTY**.

There is to be stopped from him, on account of the State of _____, or other
authorities, for **CLOTHING**, &c, received on entering service, _____ dollars: and
for other stoppages, viz: _____

_____ dollars.
He has been furnished with **TRANSPORTATION** in kind from the place of his discharge to
_____ ; and he has been **SUBSISTED** for **TRAVELING** to his
place of enrollment, up to the _____, 186 .

He is indebted to P. J. Buice, **SUTLER**, Two _____ dollars.

He is indebted to _____, **LAUNDRESS**, _____ dollars.

Given in Duplicate, at Picksburg Miss, this 20th day
of August, 1864.

R. Taylor
1st Lt Co "C"

Commanding Company

✓

FINAL STATEMENT

OF

Daniel Hicks

3^d Reg't of U.S. Col. & Cav

VOLUNTEERS.

Acct. Free 1864

NOTE 1.—Two of these certificates (or duplicates) are to be given to each Volunteer Soldier or drafted man who may be discharged previously to the discharge of his company, that he may at once receive from the Paymaster the pay, &c., due him, and the captain or other COMMISSIONED officer commanding the company will certify to the act of the delivery of the duplicate certificates; on these certificates the Soldier is "entitled to" his discharge, and should also present his discharge to the Paymaster to have the payment endorsed on it. The discharge is to be given back to the Soldier by the Paymaster; the latter only retaining as his voucher the duplicate certificates.

NOTE 2.—If the Soldier is entitled to pay for the use of his horse, the Company Commander will certify to that fact on the back of both these final statements, and also to the time he has pay due for having been so mounted on his own horse.

NOTE 3.—When a Soldier is furnished with final statements, his descriptive list, if he has one, should be taken up by the officer who gives the Soldier these statements, and endorsed with a statement to this effect by the officer. This endorsement should exhibit a full statement of the time for which the Soldier was allowed pay on his final statements, the clothing account, and all other charges against him or in his favor, so as to comprise a complete exhibit of his account. It will then be transmitted to the company commander of the Soldier, who will enter all the data necessary to a full understanding of the Soldier's account on the muster roll upon which the Soldier's discharge is reported. The descriptive list will then be destroyed. The object of this is, that the remaining portion of the Soldier's account may be settled upon the receipt of these muster rolls, and the Soldier receive any pay or allowances that may be due him at the time of his discharge, and which may not appear on his final statements from the fact that his descriptive list is incomplete. These accounts for back pay, &c., are settled by the 2d Auditor of the Treasury Department.

NOTE 4.—Charges for loss or injury to ordnance, horse equipments, and other miscellaneous charges, should appear under the heading of "Other Stoppages."

NOTE 5.—Bounty paid by State authorities, and not by the United States, will not be entered on this statement.

NOTE 6.—Amounts due the Sutler and Laundress must be entered on the muster roll on which the discharge, death, desertion, &c., is reported, as well as on the final statement, otherwise the amount cannot be collected from the United States.

NOTE 7.—This blank will be used for deceased volunteers and drafted men, as well as for others.

NOTE 8.—Where a Soldier dies in Hospital or on detached service, his descriptive list, if he has one, should be sent with his final statements, in duplicate, to the Second Auditor, Washington, D. C.

ADJUTANT GENERAL'S OFFICE.
Sept 9th 1864
Duplicate with Inventory sent 2d Auditor.

ADJUTANT GENERAL'S OFFICE
1864
Sept 9

I certify, on honor, that *Daniel Hicks* a *Private* of
 Captain Company "*D*" of the *3^d* Regiment of *U.S. Col. & Cav*
VOLUNTEERS, of the State of, born in *Canoll Co.*, State
 of *Mississippi*, aged *34* years; *5* feet *7* inches high; *Black* complexion,
Black eyes, *Black* hair, and by occupation a *Laborer*, having joined the company on
 its original organization at *Shipwits Landing*, and enrolled in it at the muster into
 the service of the United States at *Shipwits Landing*, on the *16th* day
 of *November*, 186*3*, (or was mustered in service as a recruit, by,
 at, on the day of,
 186 , or was drafted and mustered into the service of the United States from the
 Enrollment District of the State of, at,
 on the day of, 186 ,) to serve in the Regiment, for
 the term of *Three Years*: and having served **HONESTLY** and
FAITHFULLY with his Company in *The Field* to the present date, is now
 entitled to a **DISCHARGE** by reason of *Said Soldier died of*
Disease in Regtl Hospital August 18th 1864

The said *Daniel Hicks* was last paid by Paymaster
Martin to include the *30th* day of *April*, 1864, and has
 pay due him from that time to the present date; he is entitled to pay and subsistence for
TRAVELING to place of enrollment, and whatever other allowances are authorized to volunteer
 soldiers, drafted men, or militia, so discharged. He has received from the United States **CLOTHING**
 amounting to *sixty three* $\frac{66}{100}$ dollars, since ~~the~~ *Enlistment* day of,
 186 , when his clothing account was last settled. He has received from the United States
 $\frac{100}{100}$ dollars advanced **BOUNTY**.

There is to be stopped from him, on account of the State of, or other
 authorities, for **CLOTHING**, &c, received on entering service, $\frac{100}{100}$ dollars; and
 for other stoppages, viz:

..... $\frac{100}{100}$ dollars.
 He has been furnished with **TRANSPORTATION** in kind from the place of his discharge to
; and he has been **SUBSISTED** for **TRAVELING** to his
 place of enrollment, up to the, 186 .

He is indebted to *P. J. Bice*, **SUTLER**, *Two* $\frac{100}{100}$ dollars.
 He is indebted to, **LAUNDRESS**, $\frac{100}{100}$ dollars.

Given in Duplicate, at *Vicksburg Miss*, this *20th* day
 of *August*, 1864.

R. Taylor
1st Lt Co '6
 Commanding Company

ARTICLES OF WAR.

ART. 95. When any non-commissioned officer or soldier shall die, or be killed in the service of the United States, the then commanding officer of the troop or company shall, in the presence of two other commissioned officers, take an account of what effects he died possessed of, above his arms and accoutrements, and transmit the same to the office of the Department of War, which said effects are to be accounted for, and paid to the representatives of such deceased non-commissioned officer or soldier. And in case any of the officers, so authorized to take care of the effects of deceased officers and soldiers, should, before they have accounted to their representatives for the same, have occasion to leave the regiment or post, by preferment or otherwise, they shall, before they be permitted to quit the same, deposit in the hands of the commanding officer, or of the assistant military agent, all the effects of such deceased non-commissioned officers and soldiers, in order that the same may be secured for, and paid to, their respective representatives.

ARMY REGULATIONS—EDITION OF 1861.

DECEASED SOLDIERS.

Par. 152. Inventories of the effects of deceased non-commissioned officers and soldiers, required by the 95th Article of War, will be forwarded to the Adjutant General, by the commander of the company to which the deceased belonged, and a duplicate of the same to the colonel of the regiment. Final statements of pay, clothing, &c., will be sent with the inventories. When a soldier dies at a post or station absent from his company, it will be the duty of his immediate commander to furnish the required inventory, and, at the same time, to forward to the commanding officer of the company to which the soldier belonged, a report of his death, specifying the date, place, and cause; to what time he was last paid, and the money or other effects in his possession at the time of his decease: which report will be noted on the next muster roll of the company to which the man belonged. Each inventory will be endorsed, "Inventory of the effects of _____, late of company (—) _____ regiment of _____, who died at _____, the _____ day of _____, 186—." If a legal representative receive the effects, it will be stated in the report. If the soldier leave no effects, the fact will be reported.

Par. 153. Should the effects of a deceased non-commissioned officer or soldier not be administered upon within a short period after his decease, they shall be disposed of by a Council of Administration, under the authority of the commanding officer of the post, and the proceeds deposited with the Paymaster, to the credit of the United States, until they shall be claimed by the legal representatives of the deceased.

Par. 154. In all such cases of sales by the Council of Administration, a statement in detail, or account of the proceeds, duly certified by the Council and commanding officer, accompanied by the Paymaster's receipt for the proceeds, will be forwarded by the commanding officer to the Adjutant General. The statement will be endorsed, "Report of the proceeds of the effects of _____, late of company (—) _____ regiment of _____, who died at _____, the _____ day of _____, 186—."

NOTE 1.—The effects in all cases, when called for, should be turned over to the legal representative, without further authority from the Adjutant General. When the effects are turned over to the relatives of the deceased before these inventories are sent to the Adjutant General, their receipts therefor should be attached to the inventories. In all other cases, one copy will be sent with a letter of transmittal direct to the Adjutant General, and a duplicate retained by the officer.

NOTE 2.—Particular care should be taken to take receipts in duplicate from the Paymaster for any funds turned over to him; one copy should be sent direct to the Adjutant General and one retained by the officer.

INVENTORY OF THE EFFECTS

OF

Daniel Hicks

Late of Company "D"

23rd Reg't of U.S. Col & Cav.

Volunteers, who died at *Becksburg*
on the *18th* day of *November* 1864.



657

Hicks, Frank
Co D, 3 U. S. Col'd Cav.

Private Private

CARD NUMBERS.

1	5330883	26
2	5336451	27
3	5336520	28
4	5336634	29
5	5337505	30
6	9088648	31
7	40727529	32
8		33
9		34
10		35
11		36
12		37
13		38
14		39
15		40
16		41
17		42
18		43
19		44
20		45
21		46
22		47
23		48
24		49
25		50

Book Mark:

See also

H | 3 Cav. | U.S.C.T.

Frank Hicks.

Co. H, 3 Reg't U. S. Col'd Cav.

Appears on

Company Descriptive Book
of the organization named above.

DESCRIPTION.

Age 23 years; height 5 feet 8 inches.

Complexion Black

Eyes Black; hair Black

Where born Correll Co. Miss.

Occupation Laborer

ENLISTMENT.

When Apr. 1 - , 1864.

Where Gaines B Buff.

By whom E. D. Osband, term 3 y'rs.

Remarks: Died in Regt.
Hospital at Vicksburg,
Mississippi of Disease, Aug.
6, 1864.

F. A. Wright

H | **3 Cav.** | **U.S.C.T.**

Frank Hicks

Pri, Co. D, 3 Reg't U. S. Col'd Cavalry.

Appears on

Company Muster Roll

for Mar & Apr., 1864.

Present or absent Present

Stoppage, \$ 100 for

Due Gov't, \$ 100 for

Valuation of horse, \$ 100

Valuation of horse equipments, \$ 100

Remarks: joined April 1, 1864

x Directed by com. pr.

Book mark:

(358)

Avery
Copyist.

No. 3 Cav. U.S.C.T.

Frank Hicks

Priv, Co., 3 Reg't U. S. Col'd Cav.

Age 23 years.

Appears on a

Detachment Muster-in Roll

of the organization named above. Roll dated

Vicksburg, Miss, April 6, 1864.

Muster-in to date April 1, 1864.

Joined for duty and enrolled:

When April 1, 1864.

Where Haines Bluff, Miss,

Period 3 years.

Valuation of horse, \$ 100

Valuation of horse equipments, \$ 100

Remarks:

.....

.....

.....

.....

Book mark:

.....

Sitter.

H | **3 Cav.** | **U.S.C.T.**

Frank Hicks

Pri, Co. D, 3 Reg't U. S. Col'd Cavalry.

Appears on

Company Muster Roll

for *May & June*, 1864.

Present or absent *Present*

Stoppage, \$ *100* for

Due Gov't, \$ *100* for

Valuation of horse, \$ *100*

Valuation of horse equipments, \$ *100*

Remarks:

Book mark:

(358)

Avery

Copyist.

H | **3 Cav.** | **U.S.C.T.**

Frank Hicks

Pri, Co. D, 3 Reg't U. S. Col'd Cavalry.

Appears on

Company Muster Roll

for *July & Aug*, 186*4*.

Present or absent

Stoppage, \$ *100* for

Due Gov't, \$ *100* for

Valuation of horse, \$ *100*

Valuation of horse equipments, \$ *100*

Remarks: *Died Aug. 6, 1864. of
Disease in Right. Hospital.*

Book mark:

Avoy

H. | 3 Cav. | U.S.C.T.

Frank Hicke

Pvt., Co. 20, 3 Reg't U. S. Colored Cav.

Appears on Returns as follows:

Apr. 1864. Gain Apr. 1st Haines
Bluff, enlisted in the
Co.

Aug. 1864. Lose Aug. 6th Vicks-
burg - Died in Reg't
Hosptl.

Book mark :

(546)

J. B. Dittler

Copyist.

H. | 3 Cav. | U.S.C.T.

Frank Hicks

Pvt., Co. D, 3^d Reg't U. S. Col'd Cav.

Appears on Co. Muster-out Roll, dated
Memphis Tenn. Jan 26, 1866.

Muster-out to date _____, 186 .

Last paid to April 30, 1864.

Clothing account:

Last settled _____, 186 ; drawn since \$ _____ 100

Due soldier \$ _____ 100; due U. S. \$ _____ 100

Am't for cloth'g in kind or money adv'd \$ _____ 100

Due U. S. for arms, equipments, &c., \$ _____ 100

Bounty paid \$ _____ 100; due \$ _____ 100

Remarks: Died in Regt
Hosp Vicksburg Miss
Aug 6/64

Book mark: V 65. T 19. 69

Rhett

(361)

Copyist.

Hicks, Frank

B. Co. *D*

3

U. S. C. Cav.
Reg't

4 Enclosures.

Bed Cards	Descriptive Lists
Burial Records	Final Statements 3
Certs. of Dis. for Discharge	Furloughs
C. M. Charges	Med. Des. Lists
Med. Certificates	Orders

Other papers relating to—

Admission to Hosp'l	Furlough
Casualty Sheet (Officer's)	Med. Examination
Confinement	Misc. Information
Contracts	Pay or Clothing
Death or Effects /	Personal Reports
Desertions	Rank
Discharge from Hosp'l	Transfer to Hosp'l
Discharge from Service	Transfer to V. R. C.
Duty	Transportation

NARR 637
MICROFILM PUBLICATION M 1819

COMPILED MILITARY SERVICE RECORDS
OF VOLUNTEER UNION SOLDIERS WHO
SERVED WITH THE USCT (US COLORED TROOPS)
3RD REGIMENT OF CAVALRY

PERSONAL PAPERS' TARGET SHEET

PLEASE NOTE THE CHECKED INFORMATION ABOUT THE PERSONAL PAPERS IN
THIS FILE:

- NO PERSONAL PAPERS WERE FOUND IN THIS FILE WHEN THE
RECORDS WERE ARRANGED FOR MICROFILMING.
- 4 PERSONAL PAPER(S) FOUND IN THIS FILE WHEN THE RECORDS
WERE ARRANGED FOR MICROFILMING.

FINAL STATEMENT

OF

Company

Reg't of U.S. Army

VOLUNTEERS.

NOTE 1.—Two of these certificates (or duplicates) are to be given to each Volunteer Soldier or drafted man who may be discharged previously to the discharge of his company, that he may at once receive from the Paymaster the pay, &c., due him, and the captain or other COMMISSIONED officer commanding the company will certify to the act of the delivery of the duplicate certificates; on these certificates the Soldier is "entitled to" his discharge, and should also present his discharge to the Paymaster to have the payment endorsed on it. The discharge is to be given back to the Soldier by the Paymaster; the latter only retaining as his voucher the duplicate certificates.

NOTE 2.—If the Soldier is entitled to pay for the use of his horse, the Company Commander will certify to that fact on the back of both these final statements, and also to the time he has pay due for having been so mounted on his own horse.

NOTE 3.—When a Soldier is furnished with final statements, his descriptive list, if he has one, should be taken up by the officer who gives the Soldier these statements, and endorsed with a statement to this effect by the officer. This endorsement should exhibit a full statement of the time for which the Soldier was allowed pay on his final statements, the clothing account, and all other charges against him or in his favor, so as to comprise a complete exhibit of his account. It will then be transmitted to the company commander of the Soldier, who will enter all the data necessary to a full understanding of the Soldier's account on the muster roll upon which the Soldier's discharge is reported. The descriptive list will then be destroyed. The object of this is, that the remaining portion of the Soldier's account may be settled upon the receipt of these muster rolls, and the Soldier receive any pay or allowances that may be due him at the time of his discharge, and which may not appear on his final statements from the fact that his descriptive list is incomplete. These accounts for back pay, &c., are settled by the 2d Auditor of the Treasury Department.

NOTE 4.—Charges for loss or injury to ordnance, horse equipments, and other miscellaneous charges, should appear under the heading of "Other Stoppages."

NOTE 5.—Bounty paid by State authorities, and not by the United States, will not be entered on this statement.

NOTE 6.—Amounts due the Sutler and Laundress must be entered on the muster roll on which the discharge, death, desertion, &c., is reported, as well as on the final statement, otherwise the amount cannot be collected from the United States.

NOTE 7.—This blank will be used for deceased volunteers and drafted men, as well as for others.

NOTE 8.—Where a Soldier dies in Hospital or on detached service, his descriptive list, if he has one, should be sent with his final statements, in duplicate, to the Second Auditor, Washington, D. C.

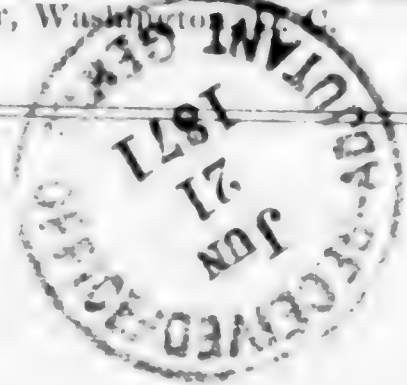

I certify, on honor, that Frank Hicks a Private of
Sicut ~~Company~~ B Taylor Company (D) of the 3rd Regiment of U.S. Colored Cavalry
VOLUNTEERS, of the State of _____, born in Carroll Co, State
 of Mississippi, aged 28 years; 5 feet 8 inches high; Black complexion.
Black eyes, Black hair, and by occupation a Salesman, having joined the company on
 its original organization at _____, and enrolled in it at the muster into
 the service of the United States at _____, on the _____ day
 of _____, 186____, (or was mustered in service as a recruit, by St. Catharine
 _____, at Reeves Bluff, Miss, on the First day of April,
 1864, or was drafted and mustered into the service of the United States from the _____
 Enrollment District of the State of _____, at _____
 on the _____ day of _____, 186____,) to serve in the Regiment, for
 the term of Three Years: and having served **HONESTLY** and
FAITHFULLY with his Company in The field to the present date, is now
 entitled to a **DISCHARGE** by reason of death. Died in Regimental Hospital
at Vicksburg Miss August 6th 1864 of ulceration of bowels

The said Frank Hicks was last paid by Paymaster
Prof Marti to include the 30th day of April, 1864, and has
 pay due him from that time to the present date; he is entitled to pay and subsistence for
TRAVELING to place of enrollment, and whatever other allowances are authorized to volunteer
 soldiers, drafted men, or militia, so discharged. He has received from the United States **CLOTHING**
 amounting to (2) Twenty seven 90 dollars, since the First day of April
 1864, when his clothing account was last settled. He has received from the United States
 _____ dollars advanced **BOUNTY**.

There is to be stopped from him, on account of the State of _____, or other
 authorities, for **CLOTHING**, &c, received on entering service, _____ dollars: and
 for other stoppages, viz: _____

_____ dollars.
 He has been furnished with **TRANSPORTATION** in kind from the place of his discharge to
 _____; and he has been **SUBSISTED** for **TRAVELING** to his
 place of enrollment, up to the _____, 186____.

He is indebted to _____, **SUTLER**, _____ dollars.
 He is indebted to _____, **LAUNDRESS**, _____ dollars.

Given in Duplicate, at Vicksburg Miss, this 6th day
 of August, 1864

Richard Taylor
1st Lieut

Commanding Company

I certify, on honor, that Frank Hicks a Private of
Sicut ~~Captain~~ R Taylor Company (D) of the 3^d Regiment of U.S. Colored Cavalry
VOLUNTEERS, of the State of _____, born in Carroll Co, State
 of Mississippi, aged 28 years; 5 feet 8 inches high; Black complexion.
Black eyes, Black hair, and by occupation a Salesman, having joined the company on
 its original organization at _____, and enrolled in it at the muster into
 the service of the United States at _____, on the _____ day
 of _____, 186____, (or was mustered in service as a recruit, by St. Gallivan
 _____, at Higgins Bluff, Miss, on the First day of April,
 1864, or was drafted and mustered into the service of the United States from the _____
 Enrollment District of the State of _____, at _____,
 on the _____ day of _____, 186____,) to serve in the Regiment, for
 the term of Three Years: and having served HONESTLY and
 FAITHFULLY with his Company in The field to the present date, is now
 entitled to a **DISCHARGE** by reason of death. Died in Regimental Hospital
at Vicksburg Miss August 6th 1864 of ulceration of bowels

The said Frank Hicks was last paid by Paymaster
Amos Marti to include the 30th day of April, 1864, and has
 pay due him from that time to the present date; he is entitled to pay and subsistence for
TRAVELING to place of enrollment, and whatever other allowances are authorized to volunteer
 soldiers, drafted men, or militia, so discharged. He has received from the United States **CLOTHING**:
 amounting to (2) Twenty seven 90 dollars, since the First day of April
 1864, when his clothing account was last settled. He has received from the United States
 _____ dollars advanced **BOUNTY**.

There is to be stopped from him, on account of the State of _____, or other
 authorities, for **CLOTHING**, &c, received on entering service, _____ dollars: and
 for other stoppages, viz: _____

_____ dollars.
 He has been furnished with **TRANSPORTATION** in kind from the place of his discharge to
 _____; and he has been **SUBSISTED** for **TRAVELING** to his
 place of enrollment, up to the _____, 186____.

He is indebted to _____, **SUTLER**, _____ dollars.
 He is indebted to _____, **LAUNDRESS**, _____ dollars.

Given in Duplicate, at Vicksburg Miss, this 6th day
 of August, 1864

Richard Taylor
1st Lieut

Commanding Company

✓ FINAL STATEMENT

OF

Robert Smith
.....
53 Reg't of *U.S. Cavalry*

VOLUNTEERS.

Robert Smith

NOTE 1.—Two of these certificates (or duplicates) are to be given to each Volunteer Soldier or drafted man who may be discharged previously to the discharge of his company, that he may at once receive from the Paymaster the pay, &c., due him, and the captain or other COMMISSIONED officer commanding the company will certify to the act of the delivery of the duplicate certificates; on these certificates the Soldier is "entitled to" his discharge, and should also present his discharge to the Paymaster to have the payment endorsed on it. The discharge is to be given back to the Soldier by the Paymaster; the latter only retaining as his voucher the duplicate certificates.

NOTE 2.—If the Soldier is entitled to pay for the use of his horse, the Company Commander will certify to that fact on the back of both these final statements, and also to the time he has pay due for having been so mounted on his own horse.

NOTE 3.—When a Soldier is furnished with final statements, his descriptive list, if he has one, should be taken up by the officer who gives the Soldier these statements, and endorsed with a statement to this effect by the officer. This endorsement should exhibit a full statement of the time for which the Soldier was allowed pay on his final statements, the clothing account, and all other charges against him or in his favor, so as to comprise a complete exhibit of his account. It will then be transmitted to the company commander of the Soldier, who will enter all the data necessary to a full understanding of the Soldier's account on the muster roll upon which the Soldier's discharge is reported. The descriptive list will then be destroyed. The object of this is, that the remaining portion of the Soldier's account may be settled upon the receipt of these muster rolls, and the Soldier receive any pay or allowances that may be due him at the time of his discharge, and which may not appear on his final statements from the fact that his descriptive list is incomplete. These accounts for back pay, &c., are settled by the 2d Auditor of the Treasury Department.

NOTE 4.—Charges for loss or injury to ordnance, horse equipments, and other miscellaneous charges, should appear under the heading of "Other Stoppages."

NOTE 5.—Bounty paid by State authorities, and not by the United States, will not be entered on this statement.

NOTE 6.—Amounts due the Sutler and Laundress must be entered on the muster roll on which the discharge, death, desertion, &c., is reported, as well as on the final statement, otherwise the amount cannot be collected from the United States.

NOTE 7.—This blank will be used for deceased volunteers and drafted men, as well as for others.

NOTE 8.—Where a Soldier dies in Hospital or on detached service, his descriptive list, if he has one, should be sent with his final statements, in duplicate, to the Second Auditor, Washington, D. C.

ADJUTANT GENERAL'S OFFICE

Aug 26th 1864

Duplicate with Inventory sent 2d Auditor.



I certify, on honor, that *Frank Hicks* a *Private* of
~~Company~~ *R Taylor* Company (*D*) of the *3^d* Regiment of *U.S. Col'd Cavalry*
VOLUNTEERS, of the State of _____, born in *Carroll Co*, State
 of *Miss*, aged *23* years; *5* feet *8* inches high; *Black* complexion.
Black eyes, *Black* hair, and by occupation a *Laborer*, having joined the company on
 its original organization at _____, and enrolled in it at the muster into
 the service of the United States at _____, on the _____ day
 of _____, 186____, (or was mustered in service as a recruit, by *St. Callinan*
 _____, at *Haines Bluff* on the *First* day of *April*,
 186*4*, or was drafted and mustered into the service of the United States from the
 Enrollment District of the State of _____, at _____
 on the _____ day of _____, 186____,) to serve in the Regiment, for
 the term of *three Years*; and having served HONESTLY and
 FAITHFULLY with his Company in *the field* to the present date, is now
 entitled to a **DISCHARGE** by reason of *death, Died in Regiment at*
hospital at Vicksburg Miss Aug 6th 1864 of Ulceration of Bowels

The said *Frank Hicks* was last paid by Paymaster
Max Martin to include the *20th* day of *April*, 186*4*, and has
 pay due him from that time to the present date; he is entitled to pay and subsistence for
TRAVELING to place of enrollment, and whatever other allowances are authorized to volunteer
 soldiers, drafted men, or militia so discharged. He has received from the United States **CLOTHING**
 amounting to *27 90* dollars, since the *First* day of *April*
 186*4*, when his clothing account was last settled. He has received from the United States
 _____ dollars advanced **BOUNTY**.

There is to be stopped from him, on account of the State of _____, or other
 authorities, for **CLOTHING**, &c, received on entering service, _____ dollars; and
 for other stoppages, viz: _____

_____ dollars.

He has been furnished with **TRANSPORTATION** in kind from the place of his discharge to
 _____; and he has been **SUBSISTED** for **TRAVELING** to his
 place of enrollment, up to the _____, 186____.

He is indebted to _____, **SUTLER**, _____ dollars.

He is indebted to _____, **LAUNDRESS**, _____ dollars.

Given in Duplicate, at *Vicksburg Miss*, this *6th* day
 of *August*, 186*4*

Richard Taylor
1st Lieut

Commanding Company

ARTICLES OF WAR.

ART. 95. When any non-commissioned officer or soldier shall die, or be killed in the service of the United States, the then commanding officer of the troop or company shall, in the presence of two other commissioned officers, take an account of what effects he died possessed of, above his arms and accoutrements, and transmit the same to the office of the Department of War, which said effects are to be accounted for, and paid to the representatives of such deceased non-commissioned officer or soldier. And in case any of the officers, so authorized to take care of the effects of deceased officers and soldiers, should, before they have accounted to their representatives for the same, have occasion to leave the regiment or post, by preferment or otherwise, they shall, before they be permitted to quit the same, deposit in the hands of the commanding officer, or of the assistant military agent, all the effects of such deceased non-commissioned officers and soldiers, in order that the same may be secured for, and paid to, their respective representatives.

ARMY REGULATIONS—EDITION OF 1861.

DECEASED SOLDIERS.

Par. 152. Inventories of the effects of deceased non-commissioned officers and soldiers, required by the 95th Article of War, will be forwarded to the Adjutant General, by the commander of the company to which the deceased belonged, and a duplicate of the same to the colonel of the regiment. Final statements of pay, clothing, &c., will be sent with the inventories. When a soldier dies at a post or station absent from his company, it will be the duty of his immediate commander to furnish the required inventory, and, at the same time, to forward to the commanding officer of the company to which the soldier belonged, a report of his death, specifying the date, place, and cause; to what time he was last paid, and the money or other effects in his possession at the time of his decease; which report will be noted on the next muster-roll of the company to which the man belonged. Each inventory will be endorsed, "Inventory of the effects of _____, late of company (—) _____ regiment of _____, who died at _____, the _____ day of _____, 186—." If a legal representative receive the effects, it will be stated in the report. If the soldier leave no effects, the fact will be reported.

Par. 153. Should the effects of a deceased non-commissioned officer or soldier not be administered upon within a short period after his decease, they shall be disposed of by a Council of Administration, under the authority of the commanding officer of the post, and the proceeds deposited with the Paymaster, to the credit of the United States, until they shall be claimed by the legal representatives of the deceased.

Par. 154. In all such cases of sales by the Council of Administration, a statement in detail, or account of the proceeds, duly certified by the Council and commanding officer, accompanied by the Paymaster's receipt for the proceeds, will be forwarded by the commanding officer to the Adjutant General. The statement will be endorsed, "Report of the proceeds of the effects of _____, late of company (—) _____ regiment of _____, who died at _____, the _____ day of _____, 186—."

NOTE 1.—The effects in all cases, when called for, should be turned over to the legal representative, without further authority from the Adjutant General. When the effects are turned over to the relatives of the deceased before these inventories are sent to the Adjutant General, their receipts therefor should be attached to the inventories. In all other cases, one copy will be sent with a letter of transmittal direct to the Adjutant General, and a duplicate retained by the officer.

NOTE 2.—Particular care should be taken to take receipts in duplicate from the Paymaster for any funds turned over to him; one copy should be sent direct to the Adjutant General and one retained by the officer.

INVENTORY OF THE EFFECTS

OF

Frank Smith

Late of Company _____

Co Reg't of U.S. Col'd Reg't

Volunteers, who died at Richsburg

on the 6th day of August 186 .



Inventory of the effects of Frank Hoeks late
 a Private of ~~Captain~~ Simon R Taylor Company "D" of
 the 3rd Regiment of U.S. Col'd Cav Volunteers, who was enrolled as
 a Private at Waines Bluff in the State of Mississippi on
 the First day of April 1864, and mustered into the service of the United
 States as a Private on the First day of April 1864, at Waines Bluff Miss
 in Company "D", 3rd Regiment of U.S. Col'd Cav Volunteers, to serve three
 years or during the war; he was born in Carroll Co in the State
 of Mississippi; he was 23 years of age, 5 feet 8 inches
 high, Black complexion, Black eyes, Black hair, and by occupation, when enrolled,
 a Laborer; he died in Regimental Hospital at
Nicksburg Miss on the 6th day of August 1864, by
 reason of Ulceration of the bowels

INVENTORY.					
ARTICLES.	No.	ARTICLES.	No.	ARTICLES.	No.
Hats	No 8 1/2 sets	Pairs trousers	No 8 1/2 sets	Knapsacks	
Caps		Pairs flannel drawers			
Forage caps		Pairs cotton drawers			
Great coats		Flannel shirts			
Uniform coats		Cotton shirts			
Uniform jackets		Pairs boots			
Flannel sack coats		Pairs shoes			
Blouses		Pairs socks			
Stable frocks		Blankets			
Fatigue overalls		Haversacks			
				MONEY.	
				Specie	\$
				Notes	\$

I CERTIFY, ON HONOR, that the above inventory comprises all the effects of Frank Hoeks, deceased, and that the effects are in the hands of _____ at _____

_____ to be disposed of by a Council of Administration.

(DUPLICATES.)

Richard Taylor 1st Lieut
Co "D"
 Commanding the Company "D"

STATION : _____

DATE : _____

FINAL STATEMENT

OF

Frank Smith
.....
B. Co. Reg't of U.S. Col'd Inf.

VOLUNTEERS.

NOTE 1.—Two of these certificates (or duplicates) are to be given to each Volunteer Soldier or drafted man who may be discharged previously to the discharge of his company, that he may at once receive from the Paymaster the pay, &c., due him, and the captain or other COMMISSIONED officer commanding the company will certify to the act of the delivery of the duplicate certificates; on these certificates the Soldier is "entitled to" his discharge, and should also present his discharge to the Paymaster to have the payment endorsed on it. The discharge is to be given back to the Soldier by the Paymaster; the latter only retaining as his voucher the duplicate certificates.

NOTE 2.—If the Soldier is entitled to pay for the use of his horse, the Company Commander will certify to that fact on the back of both these final statements, and also to the time he has pay due for having been so mounted on his own horse.

NOTE 3.—When a Soldier is furnished with final statements, his descriptive list, if he has one, should be taken up by the officer who gives the Soldier these statements, and endorsed with a statement to this effect by the officer. This endorsement should exhibit a full statement of the time for which the Soldier was allowed pay on his final statements, the clothing account, and all other charges against him or in his favor, so as to comprise a complete exhibit of his account. It will then be transmitted to the company commander of the Soldier, who will enter all the data necessary to a full understanding of the Soldier's account on the muster roll upon which the Soldier's discharge is reported. The descriptive list will then be destroyed. The object of this is, that the remaining portion of the Soldier's account may be settled upon the receipt of these muster rolls, and the Soldier receive any pay or allowances that may be due him at the time of his discharge, and which may not appear on his final statements from the fact that his descriptive list is incomplete. These accounts for back pay, &c., are settled by the 2d Auditor of the Treasury Department.

NOTE 4.—Charges for loss or injury to ordnance, horse equipments, and other miscellaneous charges, should appear under the heading of "Other Stoppages."

NOTE 5.—Bounty paid by State authorities, and not by the United States, will not be entered on this statement.

NOTE 6.—Amounts due the Sutler and Laundress must be entered on the muster roll on which the discharge, death, desertion, &c., is reported, as well as on the final statement, otherwise the amount cannot be collected from the United States.

NOTE 7.—This blank will be used for deceased volunteers and drafted men, as well as for others.

NOTE 8.—Where a Soldier dies in Hospital or on detached service, his descriptive list, if he has one, should be sent with his final statements, in duplicate, to the Second Auditor, Washington, D. C.

1864



1864

Lieut

I certify, on honor, that Frank Hicks a Private of Company (D) of the 3^d Regiment of U.S. Col'd Cavalry Volunteers, of the State of Miss, born in Carroll Co, State of Miss, aged 23 years; 5 feet 8 inches high; Black complexion. Black eyes, Black hair, and by occupation a Laborer, having joined the company on its original organization at _____, and enrolled in it at the muster into the service of the United States at _____, on the _____ day of _____, 1864, (or was mustered in service as a recruit, by St. Gallman, at Haines Bluff on the First day of April, 1864, or was drafted and mustered into the service of the United States from the Enrollment District of the State of _____, at _____ on the _____ day of _____, 1864,) to serve in the Regiment, for the term of Three Years: and having served HONESTLY and FAITHFULLY with his Company in the field to the present date, is now entitled to a **DISCHARGE** by reason of Death, Died in Regimental

Hospital at Vicksburg Miss Aug 8th 1864 of Ulceration of Bowels

The said Frank Hicks was last paid by Paymaster Maj Martin to include the 30th day of April, 1864, and has pay due him from that time to the present date; he is entitled to pay and subsistence for TRAVELING to place of enrollment, and whatever other allowances are authorized to volunteer soldiers, drafted men, or militia, so discharged. He has received from the United States **CLOTHING** amounting to 27 ¹⁰⁰/₁₀₀ dollars, since the First day of April, 1864, when his clothing account was last settled. He has received from the United States 100 dollars advanced **BOUNTY**.

There is to be stopped from him, on account of the State of _____, or other authorities, for **CLOTHING**, &c, received on entering service, _____ dollars: and for other stoppages, viz: _____

_____ dollars.
He has been furnished with TRANSPORTATION in kind from the place of his discharge to _____; and he has been SUBSISTED for TRAVELING to his place of enrollment, up to the _____, 1864.

He is indebted to _____, **SUTLER**, _____ dollars.
He is indebted to _____, **LAUNDRESS**, _____ dollars.

Given in Duplicate, at Vicksburg Miss, this 6th day of August, 1864.

Richard Taylor
1st Lieut
Commanding Company

658

Hicks, Robert
Co I, 3 U. S. Col'd Cav.

Private | Sergeant

CARD NUMBERS.

1	5342519	26
2	5342592	27
3	5342678	28
4	5342766	29
5	5342846	30
6	5342923	31
7	5342996	32
8	5343101	33
9	5343201	34
10	5343292	35
11	5343380	36
12	5343456	37
12	5343530	38
14	9089330	39
15	40727530	40
16		41
17		42
18		43
19		44
20		45
21		46
22		47
23		48
24		49
25		50

Book Mark:

See also

S. 1476350 PO, M. & M.,
P 2384557 P. O. Mail

S. 2532376 Ave. N. D.,
St. Paul, B. 7/15/29 - C. E. E.

W. M. Shannan
Esq.

A | **3 Cav. | U.S.C.T.**

Robert Hicks

, Co. 1, 3 Reg't U. S. Col'd Cav.

Appears on

Company Descriptive Book

of the organization named above.

DESCRIPTION.

Age *21* years; height *5* feet *6* inches.

Complexion *Yellow*

Eyes *blk*; hair *blk*

Where born *Clayton Miss*

Occupation *House Srv*

ENLISTMENT.

When *Feb 5*, 186*4*.

Where *Vicksburg*

By whom *McGallan*; term *3* y'rs.

Remarks:

Hilton

A/ | **3 Cav.** | **U.S.C.T.**

Robert Hicks

Plt, Co. *I*, 1 Reg't Miss. Cav., Corps d'Afrique.*

Age *21 yrs*
Appears on

Company Muster-in Roll

of the organization named above. Roll dated

Haines Bluffs Miss Feb 26, 1864.

Muster-in to date *Feb 24*, 1864.

Joined for duty and enrolled:

When *Feb 5*, 1864.

Where *Vicksburg Miss*

Period *3* years.

Valuation of horse, \$.....100

Valuation of horse equipments, \$.....100

Remarks:

*This organization subsequently became Co. *I*, 3 Reg't U. S. Colored Cavalry.

Book mark:

Bradshaw

(356)

Copyist.

A | **3 Cav.** | **U.S.C.T.**

Robert Hicks

Corpl, Co. I, 3 Reg't U. S. Col'd Cavalry.

Appears on

Company Muster Roll

for *Feb'y 24 to Apr 30*, 1864.

Present or absent *present*

Stoppage, \$ *100* for

Due Gov't, \$ *100* for

Valuation of horse, \$ *100*

Valuation of horse equipments, \$ *100*

Remarks: *Appointed Corpl.
March 1st 1864.*

Book mark:

Bradshaw

H | **3 Cav. | U.S.C.T.**

Robert Hicks

Compl, Co. I, 3 Reg't U. S. Col'd Cavalry.

Appears on

Company Muster Roll

for *May & June*, 1864.

Present or absent *Present*

Stoppage, \$ *100* for

Due Gov't, \$ *100* for

Valuation of horse, \$ *100*

Valuation of horse equipments, \$ *100*

Remarks: *Stop for one
canteen, one Haver-
sack \$0.90.*

Book mark:

Bradshaw

A | **3 Cav.** | **U.S.C.T.**

Robert Hicks

Corpl, Co. I, 3 Reg't U. S. Col'd Cavalry.

Appears on

Company Muster Roll

for July & Aug, 1864.

Present or absent present.

Stoppage, \$ 100 for

Due Gov't, \$ 100 for

Valuation of horse, \$ 100

Valuation of horse equipments, \$ 100

Remarks: Stop for one
guaranteed, one horse
saddl \$1.00; one for
spurs and straps
52 cts.

Book mark:

Bradshaw

A | **3 Cav.** | **U.S.C.T.**

Robert Hicks

Corpl, Co. I, 3 Reg't U. S. Col'd Cavalry.

Appears on

Company Muster Roll

for *Sept & Oct*, 186*4*

Present or absent *present*

Stoppage, \$ *100* for

Due Gov't, \$ *100* for

Valuation of horse, \$ *100*

Valuation of horse equipments, \$ *100*

Remarks: *Stop for one
Haversack one
Ganteen \$1⁰⁰.*

Book mark:

Bradshaw

(358)

Copyist.

W | **3 Cav. | U.S.C.T.**

Robert Hicks
Capt, Co. I, 3 Reg't U. S. Col'd Cavalry.

Appears on

Company Muster Roll

for Nov. & Dec, 1864.

Present or absent Absent

Stoppage, \$ 100 for

Due Gov't, \$ 100 for

Valuation of horse, \$ 100

Valuation of horse equipments, \$ 100

Remarks: Absent on account
since Dec 21/64

Book mark: _____

Lucas

H | 3 Cav. | U.S.C.T.

Robert Hicks

Capt., Co. I, 3 Reg't U. S. Col'd Cavalry.

Appears on

Company Muster Roll

for Jan & Feby, 1865

Present or absent Present

Stoppage, \$ 100 for

Due Gov't, \$ 100 for

Valuation of horse, \$ 100

Valuation of horse equipments, \$ 100

Remarks:

Book mark:

Lucas

(358)

Copyist.

H | 3 Cav. | U.S.C.T.

Robert Hicks

Capt, Co. I, 3 Reg't U. S. Col'd Cavalry.

Appears on

Company Muster Roll

for *March & April*, 1865.

Present or absent *Absent*

Stoppage, \$ $\frac{53}{100}$ for *ordnance;*

C & Gun Exp. 95-

Due Gov't, \$ $\frac{100}{100}$ for

Valuation of horse, \$ $\frac{100}{100}$

Valuation of horse equipments, \$ $\frac{100}{100}$

Remarks: *Absent on expedition
Stop for one sword driver for
Pistol one for Spurs and Straps
one Haversack.*

Book mark:

Lucas

A | **3 Cav.** | **U.S.C.T.**

Robert Hicks

Corp, Co. I, 3 Reg't U. S. Col'd Cavalry.

Appears on

Company Muster Roll

for May & June, 1865.

Present or absent Present

Stoppage, \$ 100 for

Due Gov't, \$ 83 for 100 for ordnance;

No. 93 - for G & S. E -

Valuation of horse, \$ 100

Valuation of horse equipments, \$ 100

Remarks: _____

Book mark: _____

(358)

J. Hubbard

Copyist.

H | **3 Cav.** | **U.S.C.T.**

Robert Hicks

Capt., Co. I, 3 Reg't U. S. Col'd Cavalry.

Appears on

Company Muster Roll

for July & Aug, 1865.

Present or absent Present

Stoppage, \$ 100 for

Due Gov't, \$ 100 for

Valuation of horse, \$ 100

Valuation of horse equipments, \$ 100

Remarks:

Book mark:

Lucas

H | 3 Cav. | U.S.C.T.

Robert Hicks

Sergeant, Co. I, 3 Reg't U. S. Col'd Cavalry.

Appears on

Company Muster Roll

for Sept & Oct, 1865.

Present or absent Present

Stoppage, \$ 100 for

Due Gov't, \$ 100 for

Valuation of horse, \$ 100

Valuation of horse equipments, \$ 100

Remarks: Promoted from Corporal
Sept 17 1865 as per A.O.
No 82

Book mark:

Edmundson

Jt | **3 Cav.** | **U.S.C.T.**

Robert Hicks

1 Serjeant, Co. I, 3 Reg't U. S. Col'd Cavalry.

Appears on

Company Muster Roll

for Nov & Dec, 1865.

Present or absent Absent

Stoppage, \$ 100 for

Due Gov't, \$ 100 for

Valuation of horse, \$ 100

Valuation of horse equipments, \$ 100

Remarks: Promoted from
Capt Sept 17/65 as per SO
No 82. to be stopped for
transportation furnished by
his Gov't \$2 ⁵/₁₀₀. Absent on
20 ds furlough since Dec
24 1865.

Book mark:

Edmund

H. | 3 Cav. | U.S.C.T.

Robert Hicks

....., Co. I, 3 Reg't U. S. Colored Cav.

Appears on Returns as follows:

Dec. 1875, Absent on furlough
Dec. 22"

Book mark :

(546)

J. B. Sittler

Copyist.

H | 3 Cav. | U.S.C.T.

Robert Hicks

Serj't, Co. D, 3 Reg't U. S. Col'd Cavalry.

Appears on Co. Muster-out Roll, dated

Memphis Tenn Jan 26, 1866.

Muster-out to date Jan 26, 1866.

Last paid to June 30, 1865.

Clothing account:

Last settled _____, 186 ; drawn since \$ _____ 100

Due soldier \$ _____ 100; due U. S. \$ 16 ⁹⁹/₁₀₀

Am't for cloth'g in kind or money adv'd \$ _____ 100

Due U. S. for arms, equipments, &c., \$ _____ 100

Bounty paid \$ _____ 100; due \$ _____ 100

Remarks: Promoted from Corporal
Sept 17/65 per Ad by Ad 20
3 msc To be stopped for
Transportation \$ 4 ⁶⁸/₁₀₀

Book mark: 1152 P 29, 77.

Edwards

(861)

Copyist.

659

Highland, Allen
Co G, 3 U. S. Col'd Cav.

Private | Private

CARD NUMBERS.

1	5340124	26
2	5340215	27
3	5340320	28
4	5341269	29
5	9089104	30
6	40727531	31
7		32
8		33
9		34
10		35
11		36
12		37
13		38
14		39
15		40
16		41
17		42
18		43
19		44
20		45
21		46
22		47
23		48
24		49
25		50

Book Mark:

See also

S, 10605-11 2^d and 3^d H.

A. M. Shannon
Esq

H | **3 Cav.** | **U.S.C.T.**

W. Allen Highland

....., Co. *G*, 3 Reg't U. S. Col'd Cav.

Appears on

Company Descriptive Book
of the organization named above.

DESCRIPTION.

Age *22* years; height *5* feet *3* inches.

Complexion *Dunk*

Eyes *black*; hair *black*

Where born *Warren Co Miss*

Occupation *Coachman*

ENLISTMENT.

When *June 13*, 186*4*.

Where *Wicksburg Miss*

By whom *Capt Geo Lloyd Kendall*, term *3* y'rs.

Remarks: *Killed in action*
Mar 31/64 at Reacher's Plantation

Hilton

H | 3 Cav. | U.S.C.T.

Allen Highland

Plt., Co. G, 1 Reg't Miss. Cav., Corps d'Afrique.*

Age 22 yrs

Appears on

Company Muster-in Roll

of the organization named above. Roll dated

Vicksburg Miss Jan 7th, 1864.

Muster-in to date Jan 15th, 1864.

Joined for duty and enrolled:

When Jan 15th, 1864

Where Vicksburg Miss

Period 3 years.

Valuation of horse, \$ 100

Valuation of horse equipments, \$ 100

Remarks:

*This organization subsequently became Co. G, 3 Reg't U. S. Colored Cavalry.

Book mark:

(356)

Posley

Copyist.

H | **3 Cav.** | **U.S.C.T.**

Allen Highland
Pot, Co. *G*, 1 Reg't Miss. Cav., Corps d'Afrique.*

Appears on

Company Muster Roll

for *Dec 24/63 to Feb 29*, 1864.

Present or absent *Present*

Stoppage, \$.....100 for

Due Gov't, \$.....100 for

Valuation of horse, \$.....100

Valuation of horse equipments, \$.....100

Remarks:

*This organization subsequently became Co. *G*, 3 Reg't U. S. Colored Cavalry.

Book mark:

(358)

Posley

Copyist.

H | 3 Cav. | U.S.C.T.

Allen Highland
Pat, Co. G, 3 Reg't U. S. Col'd Cavalry.

Appears on

Company Muster Roll
for *Mch & Apr*, 1864

Present or absent

Stoppage, \$ 100 for

Due Gov't, \$ 100 for

Valuation of horse, \$ 100

Valuation of horse equipments, \$ 100

Remarks: *Killed in action
at Roach's Plantation
Miss, March 31, 1864*

Book mark:

(358)

Tossey

Copyist.

Ho | 3 Cav. | U.S.C.T.

Allen Hiland
Priv., Co. G, 3 Reg't U. S. Colored Cav.

Appears on **Returns** as follows:

Mar. 1864. Lose Mar. 31/64
Roaches Plantation,
Killed in action (shot
through the body)

Book mark :

(546)

J. B. Sittler

Copyist.

A | **3 Cav. | U.S.C.T.**

Allen Highland

Plt, Co. *4*, 3 Reg't U. S. Col'd Cavalry.

Appears on **Co. Muster-out Roll**, dated
Memphis Tenn, Jan 26, 1866.

Muster-out to date _____, 186 .

Last paid to *Never Paid*, 186 .

Clothing account:

Last settled _____, 186 ; drawn since \$ _____ 100

Due soldier \$ _____ 100; due U. S. \$ _____ 100

Am't for cloth'g in kind or money adv'd \$ _____ 100

Due U. S. for arms, equipments, &c., \$ _____ 100

Bounty paid \$ _____ 100; due \$ _____ 100

Remarks: *Killed in action at Roachs
Plantation Miss March 31/64
Final statement forwarded
April 1/64*

Book mark:

(361)

Burnham

Copyist.

Highland, Allen

B., Co. G, 3 Reg't U.S.C. Cav.

Enclosures.

Bed Cards	Descriptive Lists
Burial Records	Final Statements /
Certs. of Dis. for Discharge	Furloughs
C. M. Charges	Med. Des. Lists
Med. Certificates	Orders

Other papers relating to—

Admission to Hosp'l	Furlough
Casualty Sheet (Officer's)	Med. Examination
Confinement	Misc. Information
Contracts	Pay or Clothing
Death or Effects	Personal Reports
Desertions	Rank
Discharge from Hosp'l	Transfer to Hosp'l
Discharge from Service	Transfer to V. R. C.
Duty	Transportation

V

FINAL STATEMENT

OF

Allen Highland
3^d Reg't of U. S. Cav. (Col'd)

VOLUNTEERS.

2d March 1864

NOTE 1.—Two of these certificates (or duplicates) are to be given to each Volunteer Soldier or drafted man who may be discharged previously to the discharge of his company, that he may at once receive from the Paymaster the pay, &c., due him, and the captain or other COMMISSIONED officer commanding the company will certify to the act of the delivery of the duplicate certificates; on these certificates the Soldier is "entitled to" his discharge, and should also present his discharge to the Paymaster to have the payment endorsed on it. The discharge is to be given back to the Soldier by the Paymaster; the latter only retaining as his voucher the duplicate certificates.

NOTE 2.—If the Soldier is entitled to pay for the use of his horse, the Company Commander will certify to that fact on the back of both these final statements, and also to the time he has pay due for having been so mounted on his own horse.

NOTE 3.—When a Soldier is furnished with final statements, his descriptive list, if he has one, should be taken up by the officer who gives the Soldier these statements, and endorsed with a statement to this effect by the officer. This endorsement should exhibit a full statement of the time for which the Soldier was allowed pay on his final statements, the clothing account, and all other charges against him or in his favor, so as to comprise a complete exhibit of his account. It will then be transmitted to the company commander of the Soldier, who will enter all the data necessary to a full understanding of the Soldier's account on the muster roll upon which the Soldier's discharge is reported. The descriptive list will then be destroyed. The object of this is, that the remaining portion of the Soldier's account may be settled upon the receipt of these muster rolls, and the Soldier receive any pay or allowances that may be due him at the time of his discharge, and which may not appear on his final statements from the fact that his descriptive list is incomplete. These accounts for back pay, &c., are settled by the 2d Auditor of the Treasury Department.

NOTE 4.—Charges for loss or injury to ordnance, horse equipments, and other miscellaneous charges, should appear under the heading of "Other Stoppages."

NOTE 5.—Bounty paid by State authorities, and not by the United States, will not be entered on this statement.

NOTE 6.—Amounts due the Sutler and Laundress must be entered on the muster roll on which the discharge, death, desertion, &c., is reported, as well as on the final statement, otherwise the amount cannot be collected from the United States.

NOTE 7.—This blank will be used for deceased volunteers and drafted men, as well as for others.

NOTE 8.—Where a Soldier dies in Hospital or on detached service, his descriptive list, if he has one, should be sent with his final statements, in duplicate, to the Adjutant General, Washington, D. C.

ADJUTANT GENERAL'S OFFICE.

May 2^d 1864

Duplicate with Inventory sent 2d Auditor.

Allen

I certify, on honor, that Allen Nighland a Servant of
Captain Geo Boykendall Company (G) of the 3^d Regiment of N. S. Ins (Col)
VOLUNTEERS, of the State of _____, born in Warren Co, State
of Miss, aged 22 years; 5 feet 5 inches high, Dark complexion,
Black eyes, Black hair, and by occupation a Coachman, having joined the company on
its original organization at Vicksburg Miss, and enrolled in it at the muster into
the service of the United States at Vicksburg Miss, on the 15th day
of January, 1864, (or was mustered in service as a recruit, by _____
at _____, on the _____ day of _____,
186 , or was drafted and mustered into the service of the United States from the _____
Enrollment District of the State of _____, at _____,
on the _____ day of _____, 186) to serve in the Regiment, for
the term of Three Years: and having served **HONESTLY** and
FAITHFULLY with his Company in The Field to the present date, is now
entitled to a **DISCHARGE** by reason of Death while in action at Roach's
Plantation Miss on March 31st 1864. No Effects

The said Allen Nighland was last paid by Paymaster
_____ to include the _____ day of _____, 186 , and has
pay due him from ~~that time~~ ^{Enlistment} to the present date; he is entitled to pay and subsistence for
TRAVELING to place of enrollment, and whatever other allowances are authorized to volunteer
soldiers, drafted men, or militia, so discharged. He has received from the United States **CLOTHING**
amounting to 35⁵⁴/₁₀₀ dollars, since the _____ day of Enlistment,
186 , when his clothing account was last settled. He has received from the United States
 dollars advanced **BOUNTY**.

There is to be stopped from him, on account of the State of _____, or other
authorities, for **CLOTHING, &c.**, received on entering service, _____ dollars; and
for other stoppages, viz: _____

_____ dollars.
He has been furnished with **TRANSPORTATION** in kind from the place of his discharge to
_____; and he has been **SUBSISTED** for **TRAVELING** to his
place of enrollment, up to the _____, 186 .

He is indebted to P. L. Bierce, **SUTLER**, 23⁵/₁₀₀ dollars.

He is indebted to _____, **LAUNDRESS**, _____ dollars.

Given in Duplicate, at Snyders Bluffs Miss, this 31st day
of March, 1864.

George Boykendall
Capt

Will, Alfred
Co I, 3 U.S. Col'd Cav.

Private Sergeant

CARD NUMBERS.

1	5342518	26
2	5342586	27
3	5342672	28
4	5342760	29
5	5342842	30
6	5342920	31
7	5342993	32
8	5343098	33
9	5343198	34
10	5343289	35
11	5343376	36
12	5343452	37
12	5343526	38
14	4089329	39
15		40
16		41
17		42
18		43
19		44
20		45
21		46
22		47
23		48
24		49
25		50

Book Mark:

See also

1864

D. Hill | **3 Cav.** | **U.S.C.T.**

Alfred Hill

....., Co., 3 Reg't U. S. Col'd Cav.

Appears on

Company Descriptive Book

of the organization named above.

DESCRIPTION.

Age *21* years; height *5* feet *9* inches.

Complexion *Blk*

Eyes *blk*; hair *blk*

Where born *Davidson Tenn*

Occupation *field hand*

ENLISTMENT.

When *Feb 5*, 1864.

Where *Vicksburg*

By whom *St. Eggleston*; term *1* y'rs.

Remarks:
.....
.....
.....
.....

Hill

A | **3 Cav.** | **U.S.C.T.**

Alfred Hill

Pvt., Co. *D*, 1 Reg't Miss. Cav., Corps d'Afrique.*
age 24 yrs
Appears on

Company Muster-in Roll

of the organization named above. Roll dated
Haines Bluffs Miss Feb 26, 1864.
Muster-in to date *Feb 24*, 1864.

Joined for duty and enrolled:

When *Feb 5*, 1864.

Where *Vicksburg Miss.*

Period *3* years.

Valuation of horse, \$.....100

Valuation of horse equipments, \$.....100

Remarks:

*This organization subsequently became Co. *D*, 3 Reg't U. S. Colored Cavalry.

Book mark:

(356)

Bradshaw

Copyist.

A | **3 Cav. | U.S.C.T.**

Alfred Hill

Sergt, Co. I, 3 Reg't U. S. Col'd Cavalry.

Appears on

Company Muster Roll

for *Feb'y 24 to Apr 30*, 1864.

Present or absent *present*

Stoppage, \$ _____ *100* for _____

Due Gov't, \$ _____ *100* for _____

Valuation of horse, \$ _____ *100*

Valuation of horse equipments, \$ _____ *100*

Remarks: *Appointed Sergt.*
March 1st 1864.

Book mark: _____

(358)

Bradshaw

Copyist.

A | **3 Cav. | U.S.C.T.**

Alfred Hill
Sergt, Co. I, 3 Reg't U. S. Col'd Cavalry.

Appears on

Company Muster Roll
for *May & June*, 1864
Present or absent *present*
Stoppage, \$ *100* for

Due Gov't, \$ *100* for

Valuation of horse, \$ *100*

Valuation of horse equipments, \$ *100*

Remarks: *Stop for one*
canteen 41 cents.

Book mark: _____

(358)

Bradshaw

Copyist.

A | **3 Cav.** | **U.S.C.T.**

Alfred Hill

Serjt, Co. I, 3 Reg't U. S. Col'd Cavalry.

Appears on

Company Muster Roll

for *July & Aug*, 186*4*.

Present or absent *present*

Stoppage, \$ *100* for

Due Gov't, \$ *100* for

Valuation of horse, \$ *100*

Valuation of horse equipments, \$ *100*

Remarks: *Stop for one
Carriage, one Haver-
sack \$1.00*

Book mark: _____

Bradshaw

A | **3 Cav. | U.S.C.T.**

Alfred Hill

Serjt, Co. I, 3 Reg't U. S. Col'd Cavalry.

Appears on

Company Muster Roll

for *Serjt & Co*, 186*4*.

Present or absent *present*

Stoppage, \$ *100* for

Due Gov't, \$ *100* for

Valuation of horse, \$ *100*

Valuation of horse equipments, \$ *100*

Remarks: *Stop pay on no
Haversack, one
Gumteen \$1.00*

Book mark:

Bradshaw

A | **3 Cav.** | **U.S.C.T.**

Alfred Hill

Sergeant, Co. I, 3 Reg't U. S. Col'd Cavalry.

Appears on

Company Muster Roll

for Nov. & Dec, 1864.

Present or absent Absent

Stoppage, \$ 100 for

Due Gov't, \$ 100 for

Valuation of horse, \$ 100

Valuation of horse equipments, \$ 100

Remarks: Absent on scout
Since Dec 21/64

Book mark: _____

Lucas

A | **3 Cav.** | **U.S.C.T.**

Alfred Hill
Supt, Co. I, 3 Reg't U. S. Col'd Cavalry.

Appears on

Company Muster Roll

for Jan & Feb, 1865

Present or absent Present

Stoppage, \$ 100 for

Due Gov't, \$ 100 for

Valuation of horse, \$ 100

Valuation of horse equipments, \$ 100

Remarks:

Book mark : _____

Lucas

H | 3 Cav. | U.S.C.T.

Alfred Hill

Syrt., Co. I, 3 Reg't U. S. Col'd Cavalry.

Appears on

Company Muster Roll

for *March & April*, 1865.

Present or absent *Absent*

Stoppage, \$ $\frac{56}{100}$ for *Ordinance;*

C & Quar. Exp \$160.

Due Gov't, \$ $\frac{100}{100}$ for

Valuation of horse, \$ $\frac{100}{100}$

Valuation of horse equipments, \$ $\frac{100}{100}$

Remarks: *Absent on expedition
note for one Sabre Knut one
canton one Traversack.*

Book mark:

Lucas

H | **3 Cav.** | **U.S.C.T.**

Alfred Hill

Sgt, Co. I, 3 Reg't U. S. Col'd Cavalry.

Appears on

Company Muster Roll

for May & June, 1865.

Present or absent Present

Stoppage, \$ 50 / 100 for ordnance

\$ 1.60 for b. & b. & -

Due Gov't, \$ 100 for _____

Valuation of horse, \$ _____ 100

Valuation of horse equipments, \$ _____ 100

Remarks: _____

Book mark: _____

(358)

J. M. Mendenhall
Copyist.

4 | **3 Cav.** | **U.S.C.T.**

Alfred Hill
Supt., Co. I, 3 Reg't U. S. Col'd Cavalry.

Appears on

Company Muster Roll

for July & Aug, 1865:

Present or absent Present

Stoppage, \$ 100 for

Due Gov't, \$ 100 for

Valuation of horse, \$ 100

Valuation of horse equipments, \$ 100

Remarks:

Book mark: _____

Lucas

(358)

Copyist.

H

3 Cav. U.S.C.T.

Alfred Hill

Serapt, Co. I, 3 Reg't U. S. Col'd Cavalry.

Appears on

Company Muster Roll

for Sept & Oct, 1865.

Present or absent Present

Stoppage, \$ 100 for

Due Gov't, \$ 100 for

Valuation of horse, \$ 100

Valuation of horse equipments, \$ 100

Remarks:

Book mark:

Edmund

H

3 Cav. U.S.C.T.

Alfred Hill

Sergeant, Co. I, 3 Reg't U. S. Col'd Cavalry.

Appears on

Company Muster Roll

for Nov & Dec, 1865.

Present or absent Present

Stoppage, \$ 100 for

Due Gov't, \$ 100 for

Valuation of horse, \$ 100

Valuation of horse equipments, \$ 100

Remarks:

Book mark:

Commander

H | **3 Cav.** | **U.S.C.T.**

Alfred Hill

Serjt, Co. D, 3 Reg't U. S. Col'd Cavalry.

Appears on **Co. Muster-out Roll**, dated

Memphis, Tenn Jan 26, 1866.

Muster-out to date Jan 26, 1866.

Last paid to June 30, 1865.

Clothing account:

Last settled....., 186 ; drawn since \$.....100

Due soldier \$.....100; due U. S. \$ 11 ⁰⁰/₁₀₀

Am't for cloth'g in kind or money adv'd \$.....100

Due U. S. for arms, equipments, &c., \$.....100

Bounty paid \$.....100; due \$.....100

Remarks:.....

Book mark:.....

(861)

Edmund
Copyist.

MAR 0 50

⁶⁶¹
Hill, Edmond
Co B, 3 U. S. Col'd Cav.

Private | Private

CARD NUMBERS.

1	5331074	26
2	5334139	27
3	5334251	28
4	5334346	29
5	5334435	30
6	5334527	31
7	5334610	32
8	5334686	33
9	9388440	34
10	40727532	35
11		36
12		37
13		38
14		39
15		40
16		41
17		42
18		43
19		44
20		45
21		46
22		47
23		48
24		49
25		50

Book Mark:

See also

S-1071013 - P.C. 9117 m
S 1498996 a100.

A.M. Shannon
Ed

H | 3 Cav. | U.S.C.T.

Edmond Hill

....., Co. B, 3 Reg't U. S. Col'd Cav.

Appears on

Company Descriptive Book

of the organization named above.

DESCRIPTION.

Age 18 years; height 5 feet 7 inches.

Complexion Yellow

Eyes Black; hair Black

Where born Columbus - Ga.

Occupation Waiter

ENLISTMENT.

When Janey - 6, 1865

Where Vicksburg

By whom Maj. Maine; term 3 y'rs.

Remarks:
.....
.....
.....
.....
.....
.....

F. A. Wright

H. | *3 Cav.* | **U.S.C.T.**

Edmond Hill.

Priv., Co., *3* Reg't U. S. Col'd *Cav.*

Age *18* years.

Appears on a

Detachment Muster-in Roll

of the organization named above. Roll dated

Vicksburg, Miss., *Jan. 7*, 1865.

Muster-in to date *Jan. 7*, 1865.

Joined for duty and enrolled:

When *Jan. 6*, 1865.

Where *Vicksburg, Miss.*

Period *3* years.

Valuation of horse, \$.....*100*

Valuation of horse equipments, \$.....*100*

Remarks:

Book mark :

Sitter.

N | **3 Cav. | U.S.C.T.**

William Hill

Private, Co. B, 3 Reg't U. S. Col'd Cavalry.

Appears on

Company Muster Roll

for *Jan. and Feb.*, 1865.

Present or absent *Present.*

Stoppage, \$ *100* for

Due Gov't, \$ *100* for

Valuation of horse, \$ *100*

Valuation of horse equipments, \$ *100*

Remarks:

Book mark:

(358)

J. B. James

Copyist.

A | **3 Cav.** | **U.S.C.T.**

Edmund Hill

Priv., Co. B, 3 Reg't U. S. Col'd Cavalry.

Appears on

Company Muster Roll

for March and April, 1868.

Present or absent Present.

Stoppage, \$ 100 for

Due Gov't, \$ 100 for

Valuation of horse, \$ 100

Valuation of horse equipments, \$ 100

Remarks: _____

Book mark: _____

(358)

J. B. Jones

Copyist.

N | **3 Cav.** | **U.S.C.T.**

Edmond Hill

Priv., Co. B, 3 Reg't U. S. Col'd Cavalry.

Appears on

Company Muster Roll

for *May and June*, 1865:

Present or absent *Present*

Stoppage, \$ 100 for

Due Gov't, \$ 100 for

Valuation of horse, \$ 100

Valuation of horse equipments, \$ 100

Remarks:

Book mark:

(358)

J. B. James Copyist.

A | **3 Cav.** | **U.S.C.T.**

Edmonds Hill

Pria....., Co. B, 3 Reg't U. S. Col'd Cavalry.

Appears on

Company Muster Roll

for July and August, 1865.

Present or absent Present.

Stoppage, \$.....100 for

Due Gov't, \$.....100 for

Valuation of horse, \$.....100

Valuation of horse equipments, \$.....100

Remarks:

Book mark:

(358)

J. B. Jones

Copyist.

H. | **3 Cav.** | **U.S.C.T.**

Edmund Hill
Priv't....., Co. B, 3 Reg't U. S. Col'd Cavalry.

Appears on

Company Muster Roll
for *Sept. & Oct.*....., 186*5*.

Present or absent *Present*

Stoppage, \$..... *100* for.....

Due Gov't, \$..... *100* for.....

Valuation of horse, \$..... *100*

Valuation of horse equipments, \$..... *100*

Remarks: *Stop for me for*
Spurs & Straps 52¢

Book mark :

H. E. Brandon

H. | **3 Cav.** | **U.S.C.T.**

Edmond Hill
Prot., Co. B, 3 Reg't U. S. Col'd Cavalry.

Appears on

Company Muster Roll

for *Nov. & Dec.*, 1865.

Present or absent *Present*

Stoppage, \$ *52*¹⁰⁰ for *Ordinance transferred from Oct. Roll*

Due Gov't, \$ *100* for

Valuation of horse, \$ *100*

Valuation of horse equipments, \$ *100*

Remarks:

Book mark:

J. E. Brandon

H. | 3 Cav. | U.S.C.T.

Edmon Hill

Pvt., Co. B, 3 Reg't U. S. Colored Cav.

Appears on Returns as follows:

Jan. 1865, Gain Jan. 6/65 -
Vicksburg - Recruit in
Co. Mustered in -
7/65 - by Lt M^c Dougall

Book mark :

(548)

J. B. Sittler

Copyist.

H. | **3 Cav.** | **U.S.C.T.**

Edmond Hill
Priv't, Co. *B*, 3 Reg't U. S. Col'd Cavalry.

Appears on **Co. Muster-out Roll**, dated
Memphis Tenn; Jan. 26, 1866.
Muster-out to date *Jan. 26*, 1866.
Last paid to *June 30*, 1865.

Clothing account:

Last settled....., 186 ; drawn since \$..... $\overline{100}$
Due soldier \$..... $\overline{100}$; due U. S. \$ *9* $\overline{36}$
Am't for cloth'g in kind or money adv'd \$..... $\overline{100}$

Due U. S. for arms, equipments, &c., \$..... $\overline{100}$
Bounty paid \$ *00* $\overline{100}$; due \$ *100* $\overline{100}$

Remarks: *Total Stoppages*
for Ordnance 52 cts.

Book mark: *V. 18, P. 188, 68*
V. 61, P. 26, 69 *44 $\frac{1}{2}$*

H. F. Brandon

662

Hill, Frederick
Co A, 3 U. S. Col'd Cav.

Private | Private

CARD NUMBERS.

1	5332115	26
2	5332204	27
3	5332293	28
4	5332371	29
5	5332452	30
6	5332529	31
7	5332605	32
8	5332686	33
9	5332785	34
10	5332887	35
11	5332985	36
12	5333080	37
12	5333174	38
14	5333260	39
15	5333342	40
16	4088237	41
17		42
18		43
19		44
20		45
21		46
22		47
23		48
24		49
25		50

Book Mark:

See also

J 1172490 P O 2007 M
J. 1442269 Ann. N. H.
P. 2544532 Acad. and

J. M. Shannon
Esq.

7777 124

F | **3 Cav.** | **U.S.C.T.**

Frederick Hill

....., Co. *A*, 3 Reg't U. S. Col'd Cav.

Appears on

Company Descriptive Book

of the organization named above.

DESCRIPTION.

Age *40* years; height *5* feet *2* inches.

Complexion *Black*

Eyes *Black*; hair *Black*

Where born *Fredericksburg - Va -*

Occupation *Shoemaker*

ENLISTMENT.

When *Oct. 5*, 1863.

Where *Ficksburg - Miss.*

By whom *Cap. W. W. Nibber*, term *3* y'rs.

Remarks: *Scars of a cut on
left wrist; scars of a
cut on right knee.*

F. A. Wright

H | **3 Cav.** | **U.S.C.T.**

Frederick Hill

Put., Co. *A*, 1 Reg't Miss. Cav., Corps d'Afrique.*
Age 40 yrs
Appears on

Company Muster-in Roll

of the organization named above. Roll dated
Vicksburg, Miss, Oct 5, 1863.
Muster-in to date *Oct 5, 1863.*

Joined for duty and enrolled:

When *Oct 5th*, 186*3*

Where *Vicksburg Miss*

Period *3* years.

Valuation of horse, \$ *100*

Valuation of horse equipments, \$ *100*

Remarks:
.....
.....
.....

*This organization subsequently became Co. *A*, 3 Reg't U. S. Colored Cavalry.

Book mark: *3*

G. M. Clark

(356)

Copyist.

H | **3 Cav. | U.S.C.T.**

Frederick Hill

Out, Co. *9*, 1 Reg't Miss. Cav., Corps d'Afrique.*

Appears on

Company Muster Roll

for *Oct 9, 1863* to *Dec 31, 1863*.

Present or absent *Present*

Stoppage, \$ *100* for

Due Gov't, \$ *100* for

Valuation of horse, \$ *100*

Valuation of horse equipments, \$ *100*

Remarks:

*This organization subsequently became Co. *A*, 3 Reg't U. S. Colored Cavalry.

Book mark:

S. M. Clark

(358)

Copyist.

L | **3 Cav. U.S.C.T.**

Fredric Hill

Pat, Co. *A*, 1 Reg't Miss. Cav., Corps d'Afrique.*

Appears on

Company Muster Roll

for *Jan. + Feb*, 1864.

Present or absent *Present*

Stoppage, \$ *100* for

Due Gov't, \$ *100* for

Valuation of horse, \$ *100*

Valuation of horse equipments, \$ *100*

Remarks:

*This organization subsequently became Co. *K*, 3 Reg't U. S. Colored Cavalry.

Book mark:

(358)

C. M. Clark

Copyist.

H | **3 Cav.** | **U.S.C.T.**

Frederic Hill
Put, Co. A, 3 Reg't U.S. Col'd Cavalry.

Appears on

Company Muster Roll
for *March & April*, 1864.

Present or absent *Present*

Stoppage, \$ *100* for

Due Gov't, \$ *100* for

Valuation of horse, \$ *100*

Valuation of horse equipments, \$ *100*

Remarks:

Book mark: _____

C. M. Clark

(358) Copyst.

16 | **3 Cav. | U.S.C.T.**

Frederick Hill

Pat, Co. A, 3 Reg't U.S. Col'd Cavalry.

Appears on

Company Muster Roll

for May & June, 1864.

Present or absent Present

Stoppage, \$ 100 for

Due Gov't, \$ 100 for

Valuation of horse, \$ 100

Valuation of horse equipments, \$ 100

Remarks:

Book mark:

(358)

C. H. Clark
Copyist.

H | **3 Cav.** | **U.S.C.T.**

Frederick Hill
Put, Co. A, 3 Reg't U.S. Col'd Cavalry.

Appears on

Company Muster Roll

for July & Aug, 1864.

Present or absent Present.

Stoppage, \$ 100 for _____

Due Gov't, \$ 100 for _____

Valuation of horse, \$ 100

Valuation of horse equipments, \$ 100

Remarks: _____

Book mark: _____

C. M. Clark
(358) Copyst.

H | **3 Cav.** | **U.S.C.T.**

Frederick Hill

Pvt., Co. A, 3 Reg't U. S. Col'd Cavalry.

Appears on

Company Muster Roll

for *Sept. & Oct.*, 186*4*.

Present or absent *Present*

Stoppage, \$ *100* for

Due Gov't, \$ *100* for

Valuation of horse, \$ *100*

Valuation of horse equipments, \$ *100*

Remarks:

Book mark:

P'Pool

(358)

Copyist.

H | **3 Cav.** | **U.S.C.T.**

Fredrick Hill,
Pvt., Co. A, 3 Reg't U. S. Col'd Cavalry.

Appears on

Company Muster Roll

for *Nov. & Dec.*, 186*4*.

Present or absent *Present.*

Stoppage, \$ *100* for

Due Gov't, \$ *100* for

Valuation of horse, \$ *100*

Valuation of horse equipments, \$ *100*

Remarks:

Book mark:

P'Pool,

74 | 3 Cav. | U.S.C.T.

Frederick Hill,

Priv., Co. A, 3 Reg't U.S. Col'd Cavalry.

Appears on

Company Muster Roll

for Jan, & Feb., 1865.

Present or absent Present

Stoppage, \$ 100 for

Due Gov't, \$ 100 for

Valuation of horse, \$ 100

Valuation of horse equipments, \$ 100

Remarks:

Book mark:

J Pool

(358)

Copyist.

H | **3 Cav.** | **U.S.C.T.**

Frederick Hill

Pvt., Co. A, 3 Reg't U.S. Col'd Cavalry.

Appears on

Company Muster Roll

for *Mar. & Apr.*, 1865.

Present or absent *Present*

Stoppage, \$ *100* for

Due Gov't, \$ *100* for

Valuation of horse, \$ *100*

Valuation of horse equipments, \$ *100*

Remarks:

Book mark:

P. Pool

H | **3 Cav.** | **U.S.C.T.**

Frederick Hill

Pvt., Co. A, 3 Reg't U. S. Col'd Cavalry.

Appears on

Company Muster Roll

for May + June, 1865.

Present or absent Present

Stoppage, \$ 100 for

Due Gov't, \$ 100 for

Valuation of horse, \$ 100

Valuation of horse equipments, \$ 100

Remarks:

Book mark:

O'Pool,

H | **3 Cav.** | **U.S.C.T.**

Frederick Hill,
Priv., Co. A, 3 Reg't U. S. Col'd Cavalry.

Appears on

Company Muster Roll

for *July & Aug.*, 1865.

Present or absent *Present*

Stoppage, \$ *100* for

Due Gov't, \$ *100* for

Valuation of horse, \$ *100*

Valuation of horse equipments, \$ *100*

Remarks:

Book mark: _____

J. Pool

H | **3 Cav.** | **U.S.C.T.**

Frederick Hill
F.H., Co. A, 3 Reg't U. S. Col'd Cavalry.

Appears on

Company Muster Roll

for *Sept & Oct*, 186*5*.

Present or absent *Present*

Stoppage, \$ 100 for

Due Gov't, \$ 100 for

Valuation of horse, \$ 100

Valuation of horse equipments, \$ 100

Remarks:

Book mark: -----

M Jones
(358) Copied.

H | **3 Cav. | U.S.C.T.**

Fredrick Hill
Ph, Co. A, 3 Reg't U. S. Col'd Cavalry.

Appears on

Company Muster Roll

for *Nov & Dec*, 1865.

Present or absent *Present*

Stoppage, \$ *100* for

Due Gov't, \$ *100* for

Valuation of horse, \$ *100*

Valuation of horse equipments, \$ *100*

Remarks:

Book mark: _____

(358)

M Jones

Copyist.

H | **3 Cav. | U.S.C.T.**

Frederick Hill
Ph, Co. *A*, 3 Reg't U. S. Col'd Cavalry.

Appears on **Co. Muster-out Roll**, dated
Memphis Tenn Jan 26, 1866.

Muster-out to date *Jan 26*, 1866.

Last paid to *June 30*, 1865.

Clothing account:

Last settled....., 186 ; drawn since \$..... $\overline{100}$

Due soldier \$ *3/28* $\overline{100}$; due U. S. \$..... $\overline{100}$

Am't for cloth'g in kind or money adv'd \$..... $\overline{100}$

Due U. S. for arms, equipments, &c., \$..... $\overline{100}$

Bounty paid \$ *000* $\overline{100}$; due \$ *000* $\overline{100}$

Remarks: *Stop for* —

Book mark :

(861)

M Jones
Copyist.

663
Hill, George

Co G, 3 U. S. Col'd Cav.

Private

Private

CARD NUMBERS.

1	5331256	26
2	5340505	27
3	5340592	28
4	5340690	29
5	5340796	30
6	5340892	31
7	5340975	32
8	5341059	33
9	5341133	34
10	5341210	35
11	1089108	36
12	40727533	37
13		38
14		39
15		40
16		41
17		42
18		43
19		44
20		45
21		46
22		47
23		48
24		49
25		50

Book Mark:

See also

S. 720599 P.O. N.Y. N.Y.
1402594 - P.O. N.Y.

J. M. Shannon

Co

N | **3 Cav. | U.S.C.T.**

George Hill
....., Co. *G*, 3 Reg't U. S. Col'd Cav.

Appears on
Company Descriptive Book
of the organization named above.

DESCRIPTION.

Age *22* years; height *5* feet *8* inches.

Complexion *Blk*

Eyes *blk*; hair *blk*

Where born *Charleston Va*

Occupation *Soldier*

ENLISTMENT.

When *Oct 12*, 186*4*.

Where *Vicksburg*

By whom *E. C. Kinsley*, term *3* y'rs.

Remarks:

.....
.....
.....

Hill

H. | **3 Cav.** | **U.S.C.T.**

George Hill,

Appears with rank of *Private* on

**Muster and Descriptive Roll of a Detach-
ment of U. S. Vols. forwarded**

for the 3 Reg't U. S. Col'd Cavalry. Roll dated
Vicksburg, Miss., Oct 20, 1864.

Where born *Charleston Va.*

Age *25* y'rs; occupation *Laborer.*

When enlisted *October 12 -*, 1864.

Where enlisted *Vicksburg, Miss.*

For what period enlisted *three* years.

Eyes *black*; hair *black,*

Complexion *col'd*; height *5 ft. 8 in.*

When mustered in *October 13*, 1864.

Where mustered in *Vicksburg, Miss.*

Bounty paid \$ *100.⁰⁰/₁₀₀*; due \$ *200.⁰⁰/₁₀₀*

Where credited *State of Mass.*

Company to which assigned

Remarks:

Book mark:

(339)

R. Brauner

Copyist.

H | **3 Cav.** | **U.S.C.T.**

George Hill

Priv, Co. G, 3 Reg't U. S. Col'd Cavalry.

Appears on

Company Muster Roll

for *Sept & Oct*, 186*4*.

Present or absent *Present*

Stoppage, \$ *100* for

Due Gov't, \$ *100* for

Valuation of horse, \$ *100*

Valuation of horse equipments, \$ *100*

Remarks: *Rec'd \$100.00 for
Bounty.*

Book mark : _____

W. J. Anderson

146 | **3 Cav. | U.S.C.T.**

George Hill

Dr, Co. G, 3 Reg't U. S. Col'd Cavalry.

Appears on

Company Muster Roll

for *Nov & Dec*, 186*4*.

Present or absent *Present*

Stoppage, \$ *100* for

Due Gov't, \$ *100* for

Valuation of horse, \$ *100*

Valuation of horse equipments, \$ *100*

Remarks: *\$100 Gov't Bounty rec'd
To be stopped Remington Revolver \$12,
Bridle cost \$11.45 Total \$13.45*

Book mark: _____

J. J. Jarvis
Copyist.

H | **3 Cav.** | **U.S.C.T.**

George Hill

priv, Co. G, 3 Reg't U. S. Col'd Cavalry.

Appears on

Company Muster Roll

for *Dated Feb 28*, 186 *5*.

Present or absent *Absent*

Stoppage, \$ *100* for

Due Gov't, \$ *100* for

Valuation of horse, \$ *100*

Valuation of horse equipments, \$ *100*

Remarks: *In confinement - absent.*
\$100 Govt Bond rec'd
To be stopped \$16.146

Book mark:

(358)

Jarvis
Copyist.

CG | **3 Cav.** | **U.S.C.T.**

George Hill

Pvt....., Co. G, 3 Reg't U. S. Col'd Cavalry.

Appears on

Company Muster Roll

for *March & Apr*....., 1865.

Present or absent..... *Absent*

Stoppage, \$..... 100 for.....

Due Gov't, \$..... 100 for.....

Valuation of horse, \$..... 100

Valuation of horse equipments, \$..... 100

Remarks: *In Confinement in
Military prison at Memphis Tenn*

Book mark :

(358)

Jarris
Copyist.

3 Cav. | U.S.C.T.

George Hill

R. H., Co. G, 3 Reg't U. S. Col'd Cavalry.

Appears on

Company Muster Roll

for May & June, 1865.

Present or absent

Present

Stoppage, \$ 100 for

Due Gov't, \$ 100 for

Valuation of horse, \$ 100

Valuation of horse equipments, \$ 100

Remarks: To be stopped for Outmaneu
brought forward from Mch & Apr rolls
\$29.45

Book mark:

(358)

J. Davis
Copyist.

11777 123
M | **3 Cav.** | **U.S.C.T.**

George Hill

Priv, Co. G, 3 Reg't U.S. Col'd Cavalry.

Appears on

Company Muster Roll

for *July & Aug*, 1865.

Present or absent *Present*

Stoppage, \$ 100 for

Due Gov't, \$ 100 for

Valuation of horse, \$ 100

Valuation of horse equipments, \$ 100

Remarks:

Book mark:

(358)

Jarvis
Copyist.

N | **3 Cav.** | **U.S.C.T.**

George Hill

Pl, Co. G, 3 Reg't U.S. Col'd Cavalry.

Appears on

Company Muster Roll

for *Sept & Oct*, 1865.

Present or absent *Present*

Stoppage, \$/ *01* for *ord lost*

Due Gov't, \$ *100* for

Valuation of horse, \$ *100*

Valuation of horse equipments, \$ *100*

Remarks: *1 H Boush 75 1 C Comb 26*
Stoppage for lost Ordnance carried
from July & Aug Rolls \$1.01

Book mark:

Burnham

A | **3 Cav.** | **U.S.C.T.**

George Hill

Pvt, Co. G, 3 Reg't U.S. Col'd Cavalry.

Appears on

Company Muster Roll

for *Nov & Dec*, 1865.

Present or absent *Present*

Stoppage, \$/ *01* for *red coat*

Due Gov't, \$ *100* for

Valuation of horse, \$ *100*

Valuation of horse equipments, \$ *100*

Remarks:

Book mark:

Bumham

H. | 3 Cav. | U.S.C.T.

George Hill
Pvt., Co. G, 3 Reg't U. S. Colored Cav.

Appears on Returns as follows:

Oct. 1864. Gained Oct. 14 Vicksburg, Miss. Enrolled

Dec. 1864 to Apr. 1865. Absent in confinement since Dec. 14 in Mil prison Memphis, Tenn. chg's preferred for aiding in theft.

Book mark :

(548)

J. B. Dittler

Copyist.

H | **3 Cav. U.S.C.T.**

George Hill

Pat, Co. B, 3 Reg't U. S. Col'd Cavalry.

Appears on **Co. Muster-out Roll**, dated

Memphis Tenn Jan 26 1866.

Muster-out to date Jan 26 1866.

Last paid to June 30 1865.

Clothing account:

Last settled _____, 186 ; drawn since \$ _____ 100

Due soldier \$ _____ 100; due U. S. \$ 38 $\frac{81}{100}$

Am't for cloth'g in kind or money adv'd \$ _____ 100

Due U. S. for arms, equipments, &c., \$ _____ 100

Bounty paid \$ 100 100; due \$ _____ 100

Remarks: Total stoppage for lost
ordnance \$1.01

Book mark : _____

Dunham

(361)

Copyist.

Hill, George,
Dy, Co. *3* Reg't *U.S. Navy.*

2 Enclosures.

Bed Cards	Final Statements
Burial Records	Furloughs or L. of A
Certs. of Dis. for Discharge	Med. Certificates
C. M. Charges	Med. Des. Lists
Descriptive Lists	Orders
Discharge Certificates	Pris. of War Record
Enlistment Papers	Resignations

Other papers relating to—

Admission to Hosp'l	Furlough or L. of A
Casualty Sheet	Med. Examination
Confinement	Misc. Information
Contracts	Pay or Clothing
Death or Effects	Personal Reports
Desertion	Rank
Discharge from Hosp'l	Transfer to Hosp'l
Discharge from Service	Transfer to V. R. C.
Duty	Transportation

1864

NOTE 1.—This blank will be used for both enlistments and reenlistments of veterans, &c., in the volunteer service. They will be made out in duplicate in all cases—one to accompany the recruiting return of the superintendent (not the recruiting officer) to the Adjutant General, and one to accompany the accounts of the officer who pays bounty, &c. The Regiment and Company in which the soldier last served should be given on the back.

NOTE 2.—An enlistment holds to service. A muster-in roll, in all cases, be filed in the Adjutant General's Office as evidence of muster-in. The mustering officer, commissary, or assistant commissary of musters, as the case may be, will countersign both enlistments as having mustered the soldier into the service of the United States before either of them is taken to the disbursing officer.

DECLARATION OF RECRUIT.

I, George Hill, desiring to VOLUNTEER as a Soldier in the Army of the United States, for the term of THREE YEARS. Do Declare, That I am Twenty five years and _____ months of age; that I have never been discharged from the United States service on account of disability or by sentence of a court martial, or by order before the expiration of a term of enlistment; and I know of no impediment to my serving honestly and faithfully as a soldier for three years.

GIVEN at Richburg Miss the 12 day of October 1864.

Witness: B. F. Stevens George Hill
made

No. 104

George Hill
 Volunteered at Richburg Miss
12 October 1864
 By E. S. Kusley Ad. Lieut
Co. 1st Regt. Mass.
Massachusetts

_____ enlistment; last served in Company ()

_____ Regt of _____

Discharged _____, 18 _____

Rec'd from 2nd. Aud. May 13th 1893

CONSENT IN CASE OF MINOR.

I, _____, Do CERTIFY, That I am _____ the _____ of _____; that the said _____ is _____ years of age; and I do hereby freely give my CONSENT to his volunteering as a SOLDIER in the ARMY OF THE UNITED STATES for the period of THREE YEARS.

GIVEN at _____ the _____ day of _____

Witness: _____

VOLUNTEER ENLISTMENT.

STATE OF

Mississippi

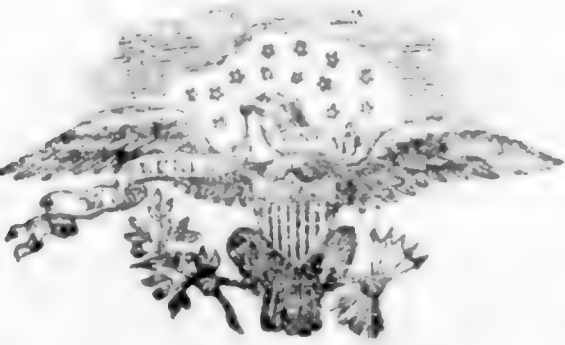

TOWN OF

Vicksburg

I, George Hill, born in Charlestown in the State of Virginia, aged twenty five years, and by occupation a Laborer. Do hereby acknowledge to have volunteered this 12th day of October, 1864, to serve as a Soldier in the Army of the United States of America, for the period of THREE YEARS, unless sooner discharged by proper authority: Do also agree to accept such bounty, pay, ration and clothing, as are, or may be, established by law for volunteers. And I, George Hill, do solemnly swear, that I will bear true faith and allegiance to the United States of America, and that I will serve them honestly and faithfully against all their enemies or opposers whatsoever; and that I will observe and obey the orders of the President of the United States, and the orders of the officers appointed over me, according to the Rules and Articles of War.

Enlisted to Germany

Sworn and subscribed to, at

this 12th day of

Vicksburg

October

George Hill

BEFORE

St. Col Asst. Prov. Marshal

Edw. C. Krueger

B. F. Stevens

I CERTIFY, ON HONOR, That I have carefully examined the above-named Volunteer, according to the General Regulations of the Army, and that, in my opinion, he is free from all bodily defects and mental infirmity, which would in any way disqualify him from performing the duties of a soldier.

H. B. Huntman
Surgeon
Examining Surgeon.

I CERTIFY, ON HONOR, That I have minutely inspected the Volunteer George Hill previously to his enlistment, and that he was entirely sober when enlisted; that, to the best of my judgment and belief, he is of lawful age; and that, in accepting him as duly qualified to perform the duties of an able-bodied soldier, I have strictly observed the Regulations which govern the recruiting service. This soldier has Black eyes, Black hair, Black complexion, is five feet 8 inches high.

St. Col. Edw. C. Krueger
Asst. Prov. Marshal of Major
Regiment of Volunteers,
Dist. of Miss. & RECRUITING OFFICER.

(A. G. O. No. 74 & 76.)

3
Mustered into the service of the United States, for three years or during the war, from date of enlistment, in Company
Regiment of 1st Va. Heavy Volunteers, on the 23rd day of October, 1864, at Vicksburg, Miss.

McNeill's

1st Va. Heavy Volunteers
Capt. W. H. ...

Chaplain

Herbrook

George Hill Vt.

July 3 1851 C. Lady

Completed

New Ellertson

Adjutant General's Office,

COLORED TROOPS BRANCH,

March 17, 1874

Vol. *C. T.*, 187

Wanted in case of *James Hill*, Co. *G*,

U.S. Cavalry

*House of Representatives - President of House
Regimental returns for Dec 1864 reports him confined in Military Prison
Memphis Tenn. Mr. T. Meade Feb 1865 - 4 months the same
Mr. R. Mayr June 865 - Present for duty -*

Respectfully,

W. A. Woodward

Chief Clerk.

J. H. Dalton

Adjutant General's Office,

A.H.E.

, 187

Vol. *C. T.*, 187

Reply in case of _____, Co. _____,

Reg't _____

*Co. Moving Capt. Beck up to him Dec 14/64 Confined in Mil Prison Memphis Tenn (Cause not given)
May 20/65. Released and returned to duty by Order of Maj Gen C. C. Washburn
S.O. 124. Par 2. Sect of Genl. Tenn. Memphis Tenn. May 25/65. "All untried men who have
been confined in Army Mil. Prison for the period of 14 days who have no charges preferred
against them will be at once released and sent to their respective commands." Maj Genl.
C.C. Washburn. Comdg.*

exp.

664

Bill James
Co I, 3 U. S. Col'd Cav.

Private | Private

CARD NUMBERS.

1	5330995	26
2	5343047	27
3	5343148	28
4	5343246	29
5	5343332	30
6	5343421	31
7	5343497	32
8	5343577	33
9	9089409	34
10		35
11		36
12		37
13		38
14		39
15		40
16		41
17		42
18		43
19		44
20		45
21		46
22		47
23		48
24		49
25		50

Book Mark:

See also

D. 1484410 - P.O. M.M.
D1805436 and N.S.

A. M. Shannon
Esq.

N | **3 Cav. | U.S.C.T.**

James Hill
Co., 3 Reg't U. S. Col'd Cav.

Appears on

Company Descriptive Book
of the organization named above.

DESCRIPTION.

Age *30* years; height *5* feet *7 1/2* inches.

Complexion *Blk*

Eyes *blk*; hair *blk*

Where born *Mayweather Co Ga*

Occupation *field hand*

ENLISTMENT.

When *Jan 6*, 186*5*.

Where *Burg*

By whom *Major Train*; term *3* y'rs.

Remarks:

.....
.....
.....
.....

Hill

No. 3 Cav. U.S.C.T.

James Hill.
Pvt. Co. 3 Reg't U. S. Col'd Cav.

Age 30 years.

Appears on a

Detachment Muster-in Roll

of the organization named above. Roll dated
Vicksburg, Miss, Jan. 7, 1865.
Muster-in to date Jan. 7, 1865.

Joined for duty and enrolled:

When Jan. 6, 1865.

Where Vicksburg, Miss.

Period 3 years.

Valuation of horse, \$ 100

Valuation of horse equipments, \$ 100

Remarks: _____

Book mark: _____

Sitter.

H | 3 Cav. | U.S.C.T.

James Hill

Pvt., Co. I, 3 Reg't U. S. Col'd Cavalry.

Appears on

Company Muster Roll

for Jan & Feb, 1865.

Present or absent Present

Stoppage, \$ 100 for

Due Gov't, \$ 100 for

Valuation of horse, \$ 100

Valuation of horse equipments, \$ 100

Remarks:

Book mark: Lucas

(358)

Copyist.

H | **3 Cav. U.S.C.T.**

James Hill

Priv-, Co. I, 3 Reg't U. S. Col'd Cavalry.

Appears on

Company Muster Roll

for *March & April*, 186 *5.*

Present or absent *Absent*

Stoppage, \$ *100* for

Due Gov't, \$ *100* for

Valuation of horse, \$ *100*

Valuation of horse equipments, \$ *100*

Remarks: *Absent on expectation
Stop for one canteen one
Haversack 100.*

Book mark: _____

Lucas

A | **3 Cav.** | **U.S.C.T.**

James Hill

(Pvt), Co. I, 3 Reg't U. S. Col'd Cavalry.

Appears on

Company Muster Roll

for May & June, 1865.

Present or absent Present

Stoppage, \$ 1 ⁶⁰/₁₀₀ for 6 + 9. 5

Transfd. from last muster roll

Due Gov't, \$ 100 for

Valuation of horse, \$ 100

Valuation of horse equipments, \$ 100

Remarks:

Book mark:

(358)

J. H. Anderson

Copyist.

H | **3 Cav.** | **U.S.C.T.**

James Hill

Pvt., Co. I, 3 Reg't U. S. Col'd Cavalry.

Appears on

Company Muster Roll

for *July & Aug*, 186 *J*

Present or absent *Present*

Stoppage, \$ 100 for

Due Gov't, \$ 100 for

Valuation of horse, \$ 100

Valuation of horse equipments, \$ 100

Remarks:

Book mark: *2*

Lucas

H | **3 Cav. | U.S.C.T.**

James Hill

Smith, Co. I, 3 Reg't U. S. Col'd Cavalry.

Appears on

Company Muster Roll

for *Sept 5 Oct*, 1865.

Present or absent *Present*

Stoppage, \$ *100* for

Due Gov't, \$ *100* for

Valuation of horse, \$ *100*

Valuation of horse equipments, \$ *100*

Remarks:

Book mark:

Edmondson

H | **3 Cav.** | **U.S.C.T.**

James Hill
.....
Prin....., Co. I, 3 Reg't U. S. Col'd Cavalry.

Appears on

Company Muster Roll

for *Sept 20*....., 1865.

Present or absent *Present*.....

Stoppage, \$..... 100 for

Due Gov't, \$..... 100 for

Valuation of horse, \$..... 100

Valuation of horse equipments, \$..... 100

Remarks:

Book mark:

(358)

Edmondson
.....
Copyist.

H | **3 Cav. | U.S.C.T.**

James Hill
Smith, Co. I, 3 Reg't U. S. Col'd Cavalry.

Appears on

Company Muster Roll

for *Nov + Dec*, 1865.

Present or absent *Present*

Stoppage, \$ *100* for

Due Gov't, \$ *100* for

Valuation of horse, \$ *100*

Valuation of horse equipments, \$ *100*

Remarks:

Book mark:

Samuel

H | **3 Cav. U.S.C.T.**

James Hill
Brid, Co. D, 3 Reg't U. S. Col'd Cavalry.

Appears on **Co. Muster-out Roll**, dated
Memphis Tenn Jan 26, 1866.
Muster-out to date Jan 26, 1866.
Last paid to Jun 30, 1865.

Clothing account:

Last settled _____, 186 ; drawn since \$ 100
Due soldier \$ 27⁷² 100; due U. S. \$ 100
Am't for cloth'g in kind or money adv'd \$ 100

Due U. S. for arms, equipments, &c., \$ 100
Bounty paid \$ 100; due \$ 100

Remarks: No money due 1st Installment None paid

Book mark: _____

Edmondson
(861) Copyist.

665

Hill, James

Co K, 3 U. S. Col'd Cav.

Private

Com. Sergeant

CARD NUMBERS.

1	5331311	26
2	5344034	27
3	5344085	28
4	5344171	29
5	5344278	30
6	5344379	31
7	5344467	32
8	5344549	33
9	5344626	34
10	5344700	35
11	9089489	36
12	40727534	37
13		38
14		39
15		40
16		41
17		42
18		43
19		44
20		45
21		46
22		47
23		48
24		49
25		50

Book Mark:

See also

H | 3 Cav. | U.S.C.T.

James Hill
Co. K, 3 Reg't U. S. Col'd Cav.

Appears on

Company Descriptive Book
of the organization named above.

DESCRIPTION.

Age 24 years; height 6 feet 1 inches.

Complexion colored

Eyes Black; hair Black

Where born Marion, Ky.

Occupation Carpenter

ENLISTMENT.

When Oct. 21, 1864.

Where Vicksburg

By whom Lt. Col. Kinsey term 3 y'rs.

Remarks: Promoted to
Sergeant Nov. 10/65
Mustered out Jan
26, 1866 at Memphis
Tenn. S. O. No. 167
Mil. Div. Tenn.

F. B. Smith

A | **3 Cav.** | **U.S.C.T.**

James Hall
Appears with rank of Pvt on

Muster and Descriptive Roll of a Detachment of U. S. Vols. forwarded

for the 3 Reg't U. S. Col'd Cavalry. Roll dated
Westbury, Mass. Oct. 21, 1864.

Where born Marion, Ky.

Age 24 y'rs; occupation Carpenter

When enlisted Oct. 21, 1864.

Where enlisted Westbury, Mass.

For what period enlisted 3 years.

Eyes Blue; hair Black

Complexion red; height 6 ft. 1 in.

When mustered in Oct. 21, 1864.

Where mustered in Westbury, Mass.

Bounty paid \$ 100⁰⁰/₁₀₀; due \$ 200⁰⁰/₁₀₀

Where credited State of Mass.

Company to which assigned _____

Remarks : _____

Book mark : _____

(339) J. J. J. J. Copyist.

No. | **3 Cav.** | **U.S.C.T.**

James Hill
Plt, Co. K, 3 Reg't U. S. Col'd Cavalry.

Appears on

Company Muster Roll
for *Sept & Oct*, 186 *4*

Present or absent *Present*

Stoppage, \$..... *100* for

Due Gov't, \$..... *100* for

Valuation of horse, \$..... *100*

Valuation of horse equipments, \$..... *100*

Remarks *Wounded Received \$100*
Wounded Paid \$200

Book mark:

Beach

(358)

Copyist.

A | **3 Cav.** | **U.S.C.T.**

James Hill
Sergt, Co. K, 3 Reg't U. S. Col'd Cavalry.

Appears on

Company Muster Roll

for *Nov. & Dec.*, 1864.

Present or absent *Present.*

Stoppage, \$ *100* for

Due Gov't, \$ *100* for

Valuation of horse, \$ *100*

Valuation of horse equipments, \$ *100*

Remarks: *Promoted from Private
Nov 10th /64 by order of Maj
Cook com^d 9 Reg't. County
rec'd \$100. County due \$200.*

Book mark: _____

(358)

Talentine

Copyist.

H | **3 Cav.** | **U.S.C.T.**

James Hill

Gergt, Co. K, 3 Reg't U. S. Col'd Cavalry.

Appears on

Company Muster Roll

for *Jan. & Feb.*, 1865.

Present or absent *Present*

Stoppage, \$ *100* for

Due Gov't, \$ *100* for

Valuation of horse, \$ *100*

Valuation of horse equipments, \$ *100*

Remarks:

*Promoted from Private
Nov. 10th/64, by order of
Maj Genl, Com^d 29 Regt.
County rec'd \$100.
County due \$200.*

Book mark:

Valentine

A | **3 Cav.** | **U.S.C.T.**

James Hill
Serg't, Co. K, 3 Reg't U. S. Col'd Cavalry.

Appears on

Company Muster Roll

for *March & Apr*, 1865.

Present or absent *Present,*

Stoppage, \$ *100* for

Due Gov't, \$ *100* for

Valuation of horse, \$ *100*

Valuation of horse equipments, \$ *100*

Remarks:

Book mark:

(358)

Valentine

Copyist.

A | **3 Cav.** | **U.S.C.T.**

James Hill
Serg't, Co. K, 3 Reg't U. S. Col'd Cavalry.

Appears on

Company Muster Roll

for *May & June*, 1865.

Present or absent *Present*

Stoppage, \$.....100 for

Due Gov't, \$.....100 for

Valuation of horse, \$.....100

Valuation of horse equipments, \$.....100

Remarks:

Book mark:

(358)

Valentine
Copyist.

A | **3 Cav.** | **U.S.C.T.**

James Hill
Sergeant, Co. K, 3 Reg't U. S. Col'd Cavalry.

Appears on

Company Muster Roll

for *July & Aug*, 1865.

Present or absent *Present*

Stoppage, \$ 100 for

Due Gov't, \$ 100 for

Valuation of horse, \$ 100

Valuation of horse equipments, \$ 100

Remarks:

Book mark:

Valentine

H | **3 Cav.** | **U.S.C.T.**

James Hill

Com. Supt., Co. K, 3 Reg't U. S. Col'd Cavalry.

Appears on

Company Muster Roll

for *Sept. and Oct.*, 1863.

Present or absent *Present*

Stoppage, \$ 100 for

Due Gov't, \$ 100 for

Valuation of horse, \$ 100

Valuation of horse equipments, \$ 100

Remarks:

Book mark:

(358)

Howard
Copyist.

H | **3 Cav.** | **U.S.C.T.**

James Hill
Serjt., Co. K, 3 Reg't U. S. Col'd Cavalry.

Appears on

Company Muster Roll

for *Nov. and Dec., 1864.*

Present or absent *Present.*

Stoppage, \$ *100* for

Due Gov't, \$ *100* for

Valuation of horse, \$ *100*

Valuation of horse equipments, \$ *100*

Remarks: *Due U. S. for transportation furnished from Memphis to Vicksburg \$2.65.*

Book mark: _____

(358)

Howard

Copyist.

HN 102
Ho. | 3 Cav. | U.S.C.T.

James Hill
Pvt., Co. K, 3 Reg't U. S. Colored Cav.

Appears on Returns as follows:

Oct. 1864. Gain Oct. 21/64
Vxburg, Miss. Inlisted
in Regt. & ass'd to Co.

Book mark :

(540)

J. B. Dittler

Copyist.

H | **3 Cav. U.S.C.T.**

James Hill
Com. Sgt., Co. K, 3 Reg't U. S. Col'd Cavalry.

Appears on **Co. Muster-out Roll**, dated
Memphis, Tenn., Jan. 26, 1866.

Muster-out to date *Jan. 26, 1866.*

Last paid to *June 30, 1865.*

Clothing account:

Last settled....., 186 ; drawn since \$..... 100

Due soldier \$..... 100; due U. S. \$..... ⁹³100

Am't for cloth'g in kind or money adv'd \$..... 100

Due U. S. for arms, equipments, &c., \$..... 100

Bounty paid \$..... 100; due \$..... 100

Remarks: *Due U.S. for trans-*
portation \$2.63 from Memphis
to Vicksburg. Bounty paid
\$100.00

Book mark: *7547-1880.*

(361)

Howard
Copyist.

Phill James

P, Co.

3

Reg't

1st Cav

2

Enclosures.

Bed Cards	Final Statements
Burial Records	Furloughs or L. of A.
Certs. of Dis. for Discharge	Med. Certificates
C. M. Charges	Med. Des. Lists
Descriptive Lists	Orders
Discharge Certificates	Pris. of War Record
Enlistment Papers	Resignations

Other papers relating to—

Admission to Hosp'l	Furlough or L. of A.
Casualty Sheet	Med. Examination
Confinement	Misc. Information
Contracts	Pay or Clothing
Death or Effects	Personal Reports
Desertion	Rank
Discharge from Hosp'l	Transfer to Hosp'l
Discharge from Service	Transfer to V. R. C.
Duty	Transportation

NOTE 1.—This blank will be used for both enlistments and re-enlistments—enlistment of veterans, &c., &c., in the volunteer service. They will be made out in duplicate in all cases—one to accompany the recruiting return of the superintendent (not the recruiting officer) to the Adjutant General, and one to accompany the accounts of the officer who pays bounty, &c. The Regiment and Company in which the soldier has served should be given on the back.

NOTE 2.—An enlistment holds to service. A muster-in must, in all cases, be paid. A muster-in roll must, in all cases, be filed in the Adjutant General's Office as evidence of muster-in. The recruiting officer, commissary, or assistant commissary of musters, as the case may be, will countersign both enlistments as having mustered the soldier into the service of the United States before either of them is given to the disbursing officer.

Henry
1509 1/2 14th St

DECLARATION OF RECRUIT.

I, James Hill, desiring to VOLUNTEER as a Soldier in the Army of the United States, for the term of THREE YEARS. Do Declare, That I am Twenty four years and X months of age; that I have never been discharged from the United States service on account of disability or by sentence of a court martial, or by order before the expiration of a term of enlistment; and I know of no impediment to my serving honestly and faithfully as a soldier for three years.

GIVEN at Vicksburg Miss the 16 day of October 1864
 Witness: James Hill

No. 116
James Hill
 Volunteered at Vicksburg Miss
21st October, 1864
 By E. L. Kinley Capt
1st Regt of Marshalls' Mass

Discharged _____, 13
 of _____
 enlistment; last served in Company ()

CONSENT IN CASE OF MINOR.

I, _____, Do CERTIFY, That I am the _____ of _____; that the said _____ is _____ years of age; and I do hereby freely give my CONSENT to his volunteering as a SOLDIER in the ARMY OF THE UNITED STATES for the period of THREE YEARS.

GIVEN at _____ the _____ day of _____

Witness: _____

VOLUNTEER ENLISTMENT.

STATE OF

TOWN OF

Mississippi



Vicksburg

I, James Hill, born in Marion in the State of Kentucky, aged Twenty four years, and by occupation a Carpenter, Do HEREBY ACKNOWLEDGE to have volunteered this Twenty first day of October, 1864, to serve as a Soldier in the Army of the United States of America, for the period of THREE YEARS, unless sooner discharged by proper authority: Do also agree to accept such bounty, pay, rations, and clothing, as are, or may be, established by law for volunteers. And I, James Hill, do solemnly swear, that I will bear true faith and allegiance to the United States of America, and that I will serve them honestly and faithfully against all their enemies or opposers whomsoever; and that I will observe and obey the orders of the President of the United States, and the orders of the officers appointed over me, according to the Rules and Articles of War.

single

Sworn and subscribed to, at Vicksburg, James Hill, this 21st day of October, 1864.

BEFORE Eli C. Kinchey, Wm. Mann, Lt Col & Lt Marshal, F. F. Fay

I CERTIFY, ON HONOR, that I have carefully examined the above-named Volunteer, agreeably to the General Regulations of the Army, and that, in my opinion, he is free from all bodily defects and mental infirmity, which would in any way disqualify him from performing the duties of a soldier.

H. C. Huntsman, Surg 50th U.S. Inf, EXAMINING SURGEON.

I CERTIFY, ON HONOR, That I have minutely inspected the Volunteer J. Hill previously to his enlistment, and that he was entirely sober when enlisted; that, to the best of my judgment and belief, he is of lawful age; and that, in accepting him as duly qualified to perform the duties of an able-bodied soldier, I have strictly observed the Regulations which govern the recruiting service. This soldier has Blue eyes, Blue hair, Ruddy complexion, is Six feet one inches high.

Lt Col Eli C. Kinchey, Lt Marshal of Mass, Dist of Miss and RECRUITING OFFICER.

(A. G. O. No. 74 & 76.)

Mustered into the service of the United States, for three years, during the war, from date of enlistment, in Company 31 Regiment of 11th Mass Volunteers on the 21st day of Oct 1864, at Vicksburg, Miss

Entitled to Bounty

Handwritten notes and signatures on the right margin.

NOTE 1.—This blank will be used for both enlistments and re-enlistments—enlistment of veterans, &c., &c., in the volunteer service. They will be made out in duplicate in all cases—one to accompany the recruiting return of the superintendent (not the recruiting officer) to the Adjutant General, and one to accompany the accounts of the officer who pays bounty, &c. The Regiment and Company in which the soldier last served should be given on the back.

NOTE 2.—An enlistment holds to service. A muster-in must, in all cases, precede payment of pay, bounty, pension, &c. A muster-in roll must, in all cases, be filed in the Adjutant General's Office as evidence of muster-in. The mustering officer, commissary, or assistant commissary of musters, as the case may be, will countersign both enlistments as having mustered the soldier into the service of the United States before either of them is given to the disbursing officer.

DECLARATION OF RECRUIT.

I, James Hill, desiring to VOLUNTEER as a Soldier in the Army of the United States, for the term of THREE YEARS, Do Declare, That I am about four years and 2 months of age; that I have never been discharged from the United States service on account of disability or by sentence of a court martial, or by order before the expiration of a term of enlistment; and I know of no impediment to my serving honestly and faithfully as a soldier for three years.

GIVEN at Vicksburg Miss the 2 day of October 1864

Witness:

J. T. Fay

James Hill
may

Rec'd from 2nd. Aud. May 13th 1893

Discharged _____, 18

enlistment; last served in Company ()
Reg't of _____

No. 199
Hill
Numbered Vicksburg Miss
2nd October, 1864
By Ellis Kinley Street
Sgt 10th Regiment of Miss

CONSENT IN CASE OF MINOR.

I, _____, Do CERTIFY, That I am the _____ of _____; that the said _____ is _____ years of age; and I do hereby freely give my CONSENT to his volunteering as a SOLDIER in the ARMY OF THE UNITED STATES for the period of THREE YEARS.

GIVEN at _____ the _____ day of _____

Witness:

VOLUNTEER ENLISTMENT.

STATE OF

TOWN OF

Mississippi

Vicksburg

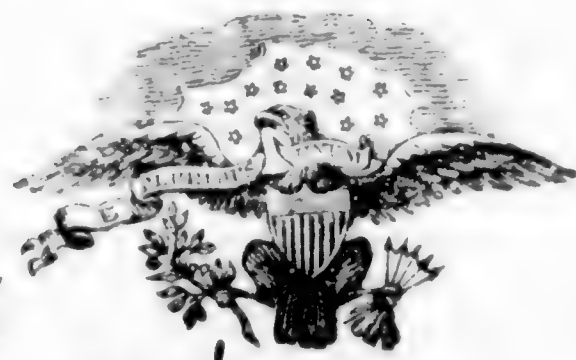

I, James Hill, born in Marion in the State of Kentucky, aged Twenty four years, and by occupation a Carpenter, Do HEREBY ACKNOWLEDGE to have volunteered this Twenty first day of October, 1864, to serve as a Soldier in the Army of the United States of America, for the period of THREE YEARS, unless sooner discharged by proper authority: Do also agree to accept such bounty, pay, rations and clothing, as are, or may be, established by law for volunteers. And I, Harry Hill, do solemnly swear, that I will bear true faith and allegiance to the United States of America, and that I will serve them honestly and faithfully against all their enemies or opposers whomsoever; and that I will observe and obey the orders of the President of the United States, and the orders of the officers appointed over me, according to the Rules and Articles of War.

Sworn and subscribed to, at Vicksburg, Mississippi, this 21 day of October, 1864, before me, Harry Hill, Captain, J. J. Fog, Major, and J. C. Bushy, Adjutant. I CERTIFY, ON HONOR, That I have carefully examined the above-named Volunteer, agreeably to the General Regulations of the Army, and that, in my opinion, he is free from all bodily defects and mental infirmity, which would in any way disqualify him from performing the duties of a soldier.

H. C. Huntman, Surg 50th U.S. Corp, EXAMINING SURGEON.

I CERTIFY, ON HONOR, That I have minutely inspected the Volunteer James Hill previously to his enlistment, and that he was entirely sober when enlisted; that, to the best of my judgment and belief, he is of lawful age; and that, in accepting him as duly qualified to perform the duties of an able-bodied soldier, I have strictly observed the Regulations which govern the recruiting service. This soldier has Blue eyes, Blue hair, Cold complexion, is 5 feet 10 inches high.

J. C. Bushy, a/pt Pro Marshal of Mass, Regiment of Volunteers, Dist of Miss, RECRUITING OFFICER.

Mustered into the service of the United States, for three years or during the war, from date of enlistment, in Company 3d Regiment of Vicksburg Volunteers, on the 1st day of October, 1864, at Vicksburg, Miss.

Entitled to Bounty

single

J. J. Fog

666

Hill, John
Co I, 3 U. S. Col'd Cav.

Private | Private

CARD NUMBERS.

1	5330996	26
2	5343046	27
3	5343147	28
4	5343245	29
5	5343331	30
6	5343420	31
7	5343496	32
8	5343570	33
9	9089408	34
10	40727535	35
11		36
12		37
13		38
14		39
15		40
16		41
17		42
18		43
19		44
20		45
21		46
22		47
23		48
24		49
25		50

Book Mark:

See also

\$1226526. P.O. New

\$1228399 P.O. New

\$12637141 Am. N. C.

A. M. Shannon
Esq

M | **3 Cav. | U.S.C.T.**

John Hill
....., Co., 3 Reg't U. S. Col'd Cav.

Appears on

Company Descriptive Book

of the organization named above.

DESCRIPTION.

Age *21* years; height *5* feet *4* inches.

Complexion *Blk*

Eyes *Blk*; hair *Blk*

Where born *Maryeethur Co Ga*

Occupation *Field hand*

ENLISTMENT.

When *Jan 6*, 1865.

Where *Burg*

By whom *Maj. Main*; term *3* y'rs.

Remarks:
.....
.....
.....
.....
.....
.....
.....

Hitter

Hc. | 3 Cav. | U.S.C.T.

John Hill,
Priv, Co., 3 Reg't U. S. Col'd Cav.

Age 22 years.

Appears on a

Detachment Muster-in Roll

of the organization named above. Roll dated

Vicksburg, Miss Jan. 7, 1865.

Muster-in to date

Jan. 7, 1865.

Joined for duty and enrolled:

When

Jan. 6, 1865.

Where

Vicksburg, Miss.

Period

3 years.

Valuation of horse, \$.....100

Valuation of horse equipments, \$.....100

Remarks:.....

Book mark :.....

Sitter.

H | **3 Cav.** | **U.S.C.T.**

John Hill

Plt, Co. I, 3 Reg't U. S. Col'd Cavalry.

Appears on

Company Muster Roll

for *Jan & Feb*, 186 *J*.

Present or absent *Present*

Stoppage, \$ *100* for

Due Gov't, \$ *100* for

Valuation of horse, \$ *100*

Valuation of horse equipments, \$ *100*

Remarks:

Book mark: *358*

Lucas

H

3 Cav. U.S.C.T.

John Hill

21, Co. I, 3 Reg't U. S. Col'd Cavalry.

Appears on

Company Muster Roll

for Mch + Apr, 1861

Present or absent Absent

Stoppage, \$ 100 for

Due Gov't, \$ 100 for

Valuation of horse, \$ 100

Valuation of horse equipments, \$ 100

Remarks: Absent on expedition
Stop for two camp ambes 12, one
canteen one Haversack 100

Book mark:

21 Lucas

A | 3 Cav. | U.S.C.T.

John Hill
Pot, Co. I, 3 Reg't U. S. Col'd Cavalry.

Appears on

Company Muster Roll

for *May June*, 1865.

Present or absent *Present*

Stoppage, \$ *1* ^{*60*}/_{*100*} for *b + b. &*
transf'd. from last muster roll

Due Gov't, \$ *100* for

Valuation of horse, \$ *100*

Valuation of horse equipments, \$ *100*

Remarks: *Stoppage for ordnance*
transf'd. from last muster
roll - \$ 5-20

Book mark:

(358)

J. Anderson

Copyist.

4 | 3 Cav. | U.S.C.T.

John Hill

Private, Co. I, 3 Reg't U. S. Col'd Cavalry.

Appears on

Company Muster Roll

for July & Aug, 1865.

Present or absent Present

Stoppage, \$ 100 for

Due Gov't, \$ 100 for

Valuation of horse, \$ 100

Valuation of horse equipments, \$ 100

Remarks:

Book mark:

Lucas

H | **3 Cav.** | **U.S.C.T.**

John Hill
Quin, Co. I, 3 Reg't U. S. Col'd Cavalry.

Appears on

Company Muster Roll

for Sept & Oct, 1865.

Present or absent Present

Stoppage, \$ 100 for

Due Gov't, \$ 100 for

Valuation of horse, \$ 100

Valuation of horse equipments, \$ 100

Remarks:

Book mark:

Prison and
(358) Prison and Copyist.

H | 3 Cav. | U.S.C.T.

Johnstie
Bris, Co. I, 3 Reg't U. S. Col'd Cavalry.

Appears on

Company Muster Roll

for Nov + Dec, 1865.

Present or absent Present

Stoppage, \$ 100 for

Due Gov't, \$ 100 for

Valuation of horse, \$ 100

Valuation of horse equipments, \$ 100

Remarks:

Book mark:

Edmondson

(358)

Copyist.

Hc. | 3 Cav. | U.S.C.T.

John Hill
Pvt., Co. I, 3 Reg't U. S. Colored Cav.

Appears on Returns as follows:

Jan. 1865: Gain Jan. 16/65 -
Memphis, Tenn. En-
listed in Regt.

Book mark :

(546)

J. B. Sittler

Copyist.

A | **3 Cav. | U.S.C.T.**

John Hill

Prin, Co. D, 3 Reg't U. S. Col'd Cavalry.

Appears on **Co. Muster-out Roll**, dated
Memphis Tenn Jan 26, 1866.

Muster-out to date Jan 26, 1866.

Last paid to June 30, 1865.

Clothing account:

Last settled....., 186 ; drawn since \$.....100

Due soldier \$ 24⁹100; due U. S. \$.....100

Am't for cloth'g in kind or money adv'd \$.....100

Due U. S. for arms, equipments, &c., \$.....100

Bounty paid \$.....100; due \$.....100

Remarks: Bounty due 1st Installment None paid

Book mark :

(361)

Edwards

Copyist.

667

Hinds, James
Co D, 3 U. S. Col'd Cav.

Private | Private

CARD NUMBERS.

1	5336183	26
2	5336274	27
3	5336369	28
4	5336447	29
5	5336517	30
6	5336635	31
7	5337506	32
8	9088641	33
9	40727536	34
10	/	35
11		36
12		37
13		38
14		39
15		40
16		41
17		42
18		43
19		44
20		45
21		46
22		47
23		48
24		49
25		50

Book Mark:

See also

A | **3 Cav.** | **U.S.C.T.**

James Hinds

....., Co. *D*, 3 Reg't U. S. Col'd Cav.

Appears on

Company Descriptive Book

of the organization named above.

DESCRIPTION.

Age *35* years; height *5* feet *5* inches.

Complexion *Black*

Eyes *Black*; hair *Black*

Where born *Carroll-Miss.*

Occupation *Laborer*

ENLISTMENT.

When *Nov. 10* - , 186*3*.

Where *Ship withs Ldg.*

By whom *G. B. Star*; term *3* y'rs.

Remarks: *Wounded in ac-*
tion at Yazoo City, Miss.
March, 5, 1864. Died
in Regimental Hos-
pital at Vicksburg.
Miss. August, 7, 1864. of
wounds rec'd in action at
Yazoo City.

F. A. Wright

H | **3 Cav. | U.S.C.T.**

James Hinds

Pri., Co. *D.*, 1 Reg't Miss. Cav., Corps d'Afrique.*

Age 35-yrs
Appears on

Company Muster-in Roll

of the organization named above. Roll dated

Skipwith Ldg. Miss. Dec 9, 1863.

Muster-in to date

Nov. 16, 1863.

Joined for duty and enrolled:

When *Nov. 16*, 1863.

Where *Skipwiths Ldg. Miss.*

Period *3* years.

Valuation of horse, \$ 100

Valuation of horse equipments, \$ 100

Remarks:

*This organization subsequently became Co. *D.* 3 Reg't U. S. Colored Cavalry.

Book mark:

(356)

Avery

Copyist.

76 | 3 Cav. | U.S.C.T.

James Hinds

Bn, Co. *D*, 1 Reg't Miss. Cav., Corps d'Afrique.*

Appears on

Company Muster Roll

for *Nov 16 to Dec 31*, 1863.

Present or absent *Present*

Stoppage, \$.....100 for

Due Gov't, \$.....100 for

Valuation of horse, \$.....100

Valuation of horse equipments, \$.....100

Remarks:.....

*This organization subsequently became Co. *D*, 3 Reg't U. S. Colored Cavalry.

Book mark :.....

Avery

He | **3 Cav.** | **U.S.C.T.**

James Hinds
Pl, Co. D, 1 Reg't Miss. Cav., Corps d'Afrique.*

Appears on

Company Muster Roll

for Jan & Feb, 1864.

Present or absent Present

Stoppage, \$ 100 for

Due Gov't, \$ 100 for

Valuation of horse, \$ 100

Valuation of horse equipments, \$ 100

Remarks:

*This organization subsequently became Co. D, 3 Reg't U. S. Colored Cavalry.

Book mark:

Avery
Copyist.

Hc | **3 Cav. U.S.C.T.**

James Hinds
Pri, Co. D, 3 Reg't U. S. Col'd Cavalry.

Appears on

Company Muster Roll

for *Mar & Apr.*, 1864.

Present or absent *Present*

Stoppage, \$ *100* for

Due Gov't, \$ *100* for

Valuation of horse, \$ *100*

Valuation of horse equipments, \$ *100*

Remarks:

Book mark:

(358)

Avery

Copyist.

Hc | **3 Cav.** | **U.S.C.T.**

James Hinds
Pri, Co. D, 3 Reg't U. S. Col'd Cavalry.

Appears on

Company Muster Roll

for *May & June*, 1864.

Present or absent *Present*

Stoppage, \$ *100* for

Due Gov't, \$ *100* for

Valuation of horse, \$ *100*

Valuation of horse equipments, \$ *100*

Remarks:

Book mark:

(358)

Avery

Copyist.

H | **3 Cav. | U.S.C.T.**

James H. ...
Plt, Co. D, 3 Reg't U. S. Col'd Cavalry.

Appears on

Company Muster Roll

for *July & Aug.*, 186 *4*.
Present or absent

Stoppage, \$ *100* for

Due Gov't, \$ *100* for

Valuation of horse, \$ *100*

Valuation of horse equipments, \$ *100*

Remarks: *Wounded in action at Yazoo City, Mich. 5/16/64.*

Book mark:

P. M. Williams
Compr.

(358)

Copyist.

H | **3 Cav.** | **U.S.C.T.**

James Hines*
Pvt., Co. D., 3 Reg't U. S. Colored Cav.

Appears on **Returns** as follows:

Mar. 1864. Wounded in ac-
tion at Yazoo City, Miss.
Mar. 5/64.

Aug. 1864. Loss Aug. 7" Vicks-
burg - Died in Reg't
Hospital.

* Name appears also as James
Hinds.

Book mark :

(646)

J. B. Dittler

Copyist.

A. | 3 Cav. | U.S.C.T.

James Hinds
Pat, Co. D, 3^d Reg't U. S. Col'd Cav,

Appears on Co. Muster-out Roll, dated
Memphis Tenn Jan 26, 1866.

Muster-out to date _____, 186 .

Last paid to April 30, 1864.

Clothing account:

Last settled _____, 186 ; drawn since \$ _____ 100

Due soldier \$ _____ 100; due U. S. \$ _____ 100

Am't for cloth'g in kind or money adv'd \$ _____ 100

Due U. S. for arms, equipments, &c., \$ _____ 100

Bounty paid \$ _____ 100; due \$ _____ 100

Remarks: Died from ef-
fects of wounds recd
in action. Vicks-
burg Miss Aug 7/64

Book mark: P. V 77. 118. 69

V 65. P 11. 69

(361)

Phelps

Copyist.

1917

--	--	--

Winds, James
B, Co. *D*, **3** Reg't **U. S. C. Cav.**

6 Enclosures.

Bed Cards	Descriptive Lists
Burial Records	Final Statements 3
Certs. of Dis. for Discharge	Furloughs
C. M. Charges	Med. Des. Lists
Med. Certificates	Orders

Other papers relating to—

Admission to Hosp'l	Furlough
Casualty Sheet (Officer's) /	Med. Examination
Confinement	Misc. Information
Contracts	Pay or Clothing
Death or Effects /	Personal Reports
Desertions	Rank
Discharge from Hosp'l	Transfer to Hosp'l
Discharge from Service	Transfer to V. R. C.
Duty	Transportation

9

CASUALTY SHEET
OF WOUNDED.

—•—

James Hines
Pat Company "D"

1st Regiment of Missouri

Volunteers at the battle of Yazoo

City Miss

March 5, 1864

(3rd Reg. O. C.)

CASUALTY SHEET.

Name, James Hines
 Rank, Pvt, Company "D", Regiment, 1st
 Arm, Miss Cav A Co, State, +
 Place of casualty, Yazoo City Miss
 Nature of casualty, Wounded severely
 Date of casualty, March 5th 1864

FROM WHAT SOURCE THIS INFORMATION WAS OBTAINED

Report of Killed, Wounded, and Missing of the _____ Regiment,
 _____ Brigade, _____ Division, _____ Corps, dated _____
Detached, from report signed by Jas H Hoats
Col 11th Ill Vols

Ind 50 @ no 4

Shp Broderick

Clerk.

✓ FINAL STATEMENT

OF
James H. Smith
30 Reg't of U.S. Col'd Cav

VOLUNTEERS.

Franklin D. ...

NOTE 1.—Two of these certificates (or duplicates) are to be given to each Volunteer Soldier or drafted man who may be discharged previously to the discharge of his company, that he may at once receive from the Paymaster the pay, &c., due him, and the captain or other COMMISSIONED officer commanding the company will certify to the act of the delivery of the duplicate certificates; on these certificates the Soldier is "entitled to" his discharge, and should also present his discharge to the Paymaster to have the payment endorsed on it. The discharge is to be given back to the Soldier by the Paymaster; the latter only retaining as his voucher the duplicate certificates.

NOTE 2.—If the Soldier is entitled to pay for the use of his horse, the Company Commander will certify to that fact on the back of both these final statements, and also to the time he has pay due for having been so mounted on his own horse.

NOTE 3.—When a Soldier is furnished with final statements, his descriptive list, if he has one, should be taken up by the officer who gives the Soldier these statements, and endorsed with a statement to this effect by the officer. This endorsement should exhibit a full statement of the time for which the Soldier was allowed pay on his final statements, the clothing account, and all other charges against him or in his favor, so as to comprise a complete exhibit of his account. It will then be transmitted to the company commander of the Soldier, who will enter all the data necessary to a full understanding of the Soldier's account on the muster roll upon which the Soldier's discharge is reported. The descriptive list will then be destroyed. The object of this is, that the remaining portion of the Soldier's account may be settled upon the receipt of these muster rolls, and the Soldier receive any pay or allowances that may be due him at the time of his discharge, and which may not appear on his final statements from the fact that his descriptive list is incomplete. These accounts for back pay, &c., are settled by the 2d Auditor of the Treasury Department.

NOTE 4.—Charges for loss or injury to ordnance, horse equipments, and other miscellaneous charges, should appear under the heading of "Other stoppages."

NOTE 5.—Bounty paid by State authorities, and not by the United States, will not be entered on this statement.

NOTE 6.—Amounts due the Sutler and Laundress must be entered on the muster roll on which the discharge, death, desertion, &c., is reported, as well as on the final statement, otherwise the amount cannot be collected from the United States.

NOTE 7.—This blank will be used for deceased volunteers and drafted men, as well as for others.

NOTE 8.—Where a Soldier dies in Hospital or on detached service, his descriptive list, if he has one, should be sent with his final statements, in duplicate, to the Second Auditor, Washington, D. C.

ADJUTANT GENERAL'S OFFICE.
Aug 24th 1861
Duplicate with Inventory sent 2d Auditor.



I certify, on honor, that *James Birds* a *Private* of
~~Captain~~ *Richard Taylor's* Company ("*D*") of the *3^d* Regiment of *U.S. Col'd Cav*
VOLUNTEERS, of the State of _____, born in *Carroll Co.*, State
 of *Miss*, aged *35* years; *5* feet *6* inches high; *Black* complexion.
Black eyes, *Black* hair, and by occupation a *Laborer*, having joined the company on
 its original organization at *Skippers Bluffs*, and enrolled in it at the muster into
 the service of the United States at *Skippers Bluffs*, on the *Sixteenth* day
 of *November*, 186*3*, (or was mustered in service as a recruit, by _____
 _____, at _____, on the _____ day of _____,
 186____, or was drafted and mustered into the service of the United States from the _____
 Enrollment District of the State of _____, at _____,
 on the _____ day of _____, 186____) to serve in the Regiment, for
 the term of *three years*: and having served **HONESTLY** and
FAITHFULLY with his Company in *the field* to the present date, is now
 entitled to a **DISCHARGE** by reason of *death. Disch. in Regimental*
Hospital at Vicksburg Miss Aug 7th 1864 of wounds rec'd in action
at Vicksburg

The said *James Birds* was last paid by Paymaster
May Martin to include the *30th* day of *April*, 186*4*, and has
 pay due him from that time to the present date; he is entitled to pay and subsistence for
TRAVELING to place of enrollment, and whatever other allowances are authorized to volunteer
 soldiers, drafted men, or militia, so discharged. He has received from the United States **CLOTHING**
 amounting to *43²⁸* dollars, since the *16th* day of *November*
 186*3*, when his clothing account was last settled. He has received from the United States
 _____ dollars advanced **BOUNTY**.

There is to be stopped from him, on account of the State of _____, or other
 authorities, for **CLOTHING**, &c, received on entering service, _____ dollars: and
 for other stoppages, viz: _____

_____ dollars.
 He has been furnished with **TRANSPORTATION** in kind from the place of his discharge to
 _____; and he has been **SUBSISTED** for **TRAVELING** to his
 place of enrollment, up to the _____, 186____.

He is indebted to _____, **SUTLER**, _____ dollars.
 He is indebted to _____, **LAUNDRESS**, _____ dollars.

Given in Duplicate, at *Vicksburg Mississippi*, this *8th* day
 of *August*, 186*4*.

Richard Taylor
1st Lieut. Col'd "D"
 Commanding Company "*D*"

FINAL STATEMENT

OF

James Hines "D" Co
3^d Reg't of U.S. Col'd Cav

VOLUNTEERS.

NOTE 1.—Two of these certificates (or duplicates) are to be given to each Volunteer Soldier or drafted man who may be discharged previously to the discharge of his company, that he may at once receive from the Paymaster the pay, &c., due him, and the captain or other COMMISSIONED officer commanding the company will certify to the act of the delivery of the duplicate certificates; on these certificates the Soldier is "entitled to" his discharge, and should also present his discharge to the Paymaster to have the payment endorsed on it. The discharge is to be given back to the Soldier by the Paymaster; the latter only retaining as his voucher the duplicate certificates.

NOTE 2.—If the Soldier is entitled to pay for the use of his horse, the Company Commander will certify to that fact on the back of both these final statements, and also to the time he has pay due for having been so mounted on his own horse.

NOTE 3.—When a Soldier is furnished with final statements, his descriptive list, if he has one, should be taken up by the officer who gives the Soldier these statements, and endorsed with a statement to this effect by the officer. This endorsement should exhibit a full statement of the time for which the Soldier was allowed pay on his final statements, the clothing account, and all other charges against him or in his favor, so as to comprise a complete exhibit of his account. It will then be transmitted to the company commander of the Soldier, who will enter all the data necessary to a full understanding of the Soldier's account on the muster roll upon which the Soldier's discharge is reported. The descriptive list will then be destroyed. The object of this is, that the remaining portion of the Soldier's account may be settled upon the receipt of these muster rolls, and the Soldier receive any pay or allowances that may be due him at the time of his discharge, and which may not appear on his final statements from the fact that his descriptive list is incomplete. These accounts for back pay, &c., are settled by the 2d Auditor of the Treasury Department.

NOTE 4.—Charges for loss or injury to ordnance, horse equipments, and other miscellaneous charges, should appear under the heading of "Other stoppages."

NOTE 5.—Bounty paid by State authorities, and not by the United States, will not be entered on this statement.

NOTE 6.—Amounts due the Sutler and Laundress must be entered on the muster roll on which the discharge, death, desertion, &c., is reported, as well as on the final statement, otherwise the amount cannot be collected from the United States.

NOTE 7.—This blank will be used for deceased volunteers and drafted men, as well as for others.

NOTE 8.—Where a Soldier dies in Hospital or on detached service, his descriptive list, if he has one, should be sent with his final statements, in duplicate, to the Second Auditor, Washington, D. C.

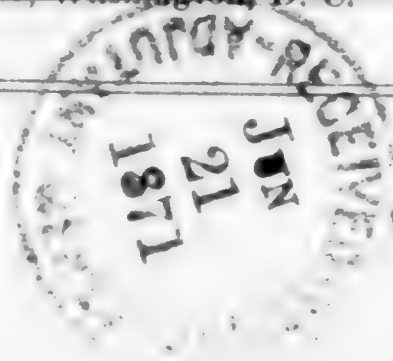

1864

I certify, on honor, that *James Heinds* a *Private* of
1st Lieut *Company "D"* of the *3^d* Regiment of *U.S. Colored*
VOLUNTEERS, of the State of _____, born in *Camoll Lee*, State
of *Miss*, aged *35* years; *5* feet *5* inches high; *Black* complexion.
Black eyes, *Black* hair, and by occupation a *Laborer*, having joined the company on
its original organization at *Skipwith De Miss* and enrolled in it at the muster into
the service of the United States at *Skipwith De Miss*, on the *Sixteenth* day
of *November*, 1863, (or was mustered in service as a recruit, by _____
_____, at _____, on the _____ day of _____,
186 , or was drafted and mustered into the service of the United States from the _____
Enrollment District of the State of _____, at _____
on the _____ day of _____, 186) to serve in the Regiment, for
the term of *three years*: and having served HONESTLY and
FAITHFULLY with his Company in *the field* to the present date, is now
entitled to a **DISCHARGE** by reason of *death. Died in Regimental*
Hospital at Vicksburg Miss Aug 7th 1864 of wounds recd in action at

The said *James Heinds* was last paid by Paymaster
May Martin to include the *30th* day of *April*, 1864, and has
pay due him from that time to the present date; he is entitled to pay and subsistence for
TRAVELING to place of enrollment, and whatever other allowances are authorized to volunteer
soldiers, drafted men, or militia, so discharged. He has received from the United States **CLOTHING**
amounting to *45.26* dollars, since the *16th* day of *November*
1863, when his clothing account was last settled. He has received from the United States
_____ dollars advanced **BOUNTY**.

There is to be stopped from him, on account of the State of _____, or other
authorities, for **CLOTHING**, &c, received on entering service, _____ dollars: and
for other stoppages, viz: _____

_____ dollars.
He has been furnished with **TRANSPORTATION** in kind from the place of his discharge to
_____; and he has been **SUBSISTED** for **TRAVELING** to his
place of enrollment, up to the _____, 186 .

He is indebted to _____, **SUTLER**, _____ dollars.
He is indebted to _____, **LAUNDRESS**, _____ dollars.

Given in Duplicate, at *Vicksburg Miss*, this *8th* day
of *August*, 1864.

Richard Taylor
1st Lieut. Co "B" "D"
Commanding Company "D"

FINAL STATEMENT

OF

James Harris
2d Reg't of U.S. Col'd Cav

VOLUNTEERS.

NOTE 1.—Two of these certificates (or duplicates) are to be given to each Volunteer Soldier or drafted man who may be discharged previously to the discharge of his company, that he may at once receive from the Paymaster the pay, &c. due him, and the captain or other COMMISSIONED officer commanding the company will certify to the act of the delivery of the duplicate certificates; on these certificates the Soldier is "entitled to" his discharge, and should also present his discharge to the Paymaster to have the payment endorsed on it. The discharge is to be given back to the Soldier by the Paymaster; the latter only retaining as his voucher the duplicate certificates.

NOTE 2.—If the Soldier is entitled to pay for the use of his horse, the Company Commander will certify to that fact on the back of both these final statements, and also to the time he has pay due for having been so mounted on his own horse.

NOTE 3.—When a Soldier is furnished with final statements, his descriptive list, if he has one, should be taken up by the officer who gives the Soldier these statements, and endorsed with a statement to this effect by the officer. This endorsement should exhibit a full statement of the time for which the Soldier was allowed pay on his final statements, the clothing account, and all other charges against him or in his favor, so as to comprise a complete exhibit of his account. It will then be transmitted to the company commander of the Soldier, who will enter all the data necessary to a full understanding of the Soldier's account on the muster roll upon which the Soldier's discharge is reported. The descriptive list will then be destroyed. The object of this is, that the remaining portion of the Soldier's account may be settled upon the receipt of these muster rolls, and the Soldier receive any pay or allowances that may be due him at the time of his discharge, and which may not appear on his final statements from the fact that his descriptive list is incomplete. These accounts for back pay, &c., are settled by the 2d Auditor of the Treasury Department.

NOTE 4.—Charges for loss or injury to ordnance, horse equipments, and other miscellaneous charges, should appear under the heading of "Other Stoppages."

NOTE 5.—Bounty paid by State authorities, and not by the United States, will not be entered on this statement.

NOTE 6.—Amounts due the Sutler and Laundress must be entered on the muster roll on which the discharge, death, desertion, &c., is reported, as well as on the final statement, otherwise the amount cannot be collected from the United States.

NOTE 7.—This blank will be used for deceased volunteers and drafted men, as well as for others.

NOTE 8.—Where a Soldier dies in Hospital or on detached service, his descriptive list, if he has one, should be sent with his final statements, in duplicate, to the Second Auditor, Washington, D. C.



I certify, on honor, that *James Hinds* a *Private* of *Company "D"* of the *3rd* Regiment of *U.S. Col'd Cav* *Volunteers*, of the State of *Miss*, born in *Carroll Co*, State of *Miss*, aged *35* years; *5* feet *6* inches high; *Black* complexion. *Black* eyes *Black* hair, and by occupation a *Laborer*, having joined the company on its original organization at *Skippwith's Co Miss*, and enrolled in it at the muster into the service of the United States at *Skippwith's Co Miss*, on the *Sixteenth* day of *November*, 186*3* (or was mustered in service as a recruit, by _____, at _____, on the _____ day of _____, 186*3*, or was drafted and mustered into the service of the United States from the Enrollment District of the State of _____, at _____, on the _____ day of _____, 186*3*), to serve in the Regiment, for the term of *three years*; and having served HONESTLY and FAITHFULLY with his Company in *the field* to the present date, is now entitled to a **DISCHARGE** by reason of *Death. Died in Regimental Hospital at Vicksburg Miss Aug. 7th 1864 of wounds received in action*

The said *James Hinds* was last paid by Paymaster *May Martin* to include the *30th* day of *April*, 186*4*, and has pay due him from that time to the present date; he is entitled to pay and subsistence for TRAVELING to place of enrollment, and whatever other allowances are authorized to volunteer soldiers, drafted men, or militia, so discharged. He has received from the United States **CLOTHING** amounting to *45.26* dollars, since the *16th* day of *November* 186*3*, when his clothing account was last settled. He has received from the United States _____ dollars advanced **BOUNTY**.

There is to be stopped from him, on account of the State of _____, or other authorities, for **CLOTHING**, &c, received on entering service, _____ dollars; and for other stoppages, viz: _____

_____ dollars.
He has been furnished with TRANSPORTATION in kind from the place of his discharge to _____; and he has been SUBSISTED for TRAVELING to his place of enrollment, up to the _____, 186*4*.

He is indebted to _____, **SUTLER**, _____ dollars.
He is indebted to _____, **LAUNDRESS**, _____ dollars.

Given in Duplicate, at *Vicksburg Mississippi*, this *8th* day of *August*, 186*4*.

Richard Taylor 1st Lieut.
Co "D"
Commanding Company *"D"*

I certify, on honor, that *James Hinds* a *Private* of *Company "D"* of the *3rd* Regiment of *U.S. Col'd Cav* *Volunteers*, of the State of *Miss*, born in *Carroll Co*, State of *Miss*, aged *35* years; *5* feet *6* inches high; *Black* complexion. *Black* eyes, *Black* hair, and by occupation a *Laborer*, having joined the company on its original organization at *Spikewiths Ldg Miss*, and enrolled in it at the muster into the service of the United States at *Spikewiths Ldg Miss*, on the *Sixteenth* day of *November*, 186*3* (or was mustered in service as a recruit, by _____, at _____, on the _____ day of _____, 186*3*, or was drafted and mustered into the service of the United States from the Enrollment District of the State of _____, at _____, on the _____ day of _____, 186*3*), to serve in the Regiment, for the term of *three years*; and having served HONESTLY and FAITHFULLY with his Company in *the field* to the present date, is now entitled to a **DISCHARGE** by reason of *Death. Died in Regimental Hospital at Vicksburg Miss Aug. 7th 1864 of wounds & exhaustion*

Spikewiths Ldg Miss

The said *James Hinds* was last paid by Paymaster *May Martin* to include the *30th* day of *April*, 186*4*, and has pay due him from that time to the present date; he is entitled to pay and subsistence for TRAVELING to place of enrollment, and whatever other allowances are authorized to volunteer soldiers, drafted men, or militia, so discharged. He has received from the United States **CLOTHING** amounting to *45.26* dollars, since the *16th* day of *November* 186*3*, when his clothing account was last settled. He has received from the United States _____ dollars advanced **BOUNTY**.

There is to be stopped from him, on account of the State of _____, or other authorities, for **CLOTHING, &c**, received on entering service, _____ dollars; and for other stoppages, viz:

_____ dollars.
He has been furnished with TRANSPORTATION in kind from the place of his discharge to _____; and he has been SUBSISTED for TRAVELING to his place of enrollment, up to the _____, 186*4*.

He is indebted to _____, **SUTLER**, _____ dollars.
He is indebted to _____, **LAUNDRESS**, _____ dollars.

Given in Duplicate, at *Vicksburg Mississippi*, this *8th* day of *August*, 186*4*.

Richard Taylor 1st Lieut.
Co "D"

Commanding Company *"D"*

ARTICLES OF WAR.

ART. 95. When any non-commissioned officer or soldier shall die, or be killed in the service of the United States, the then commanding officer of the troop or company shall, in the presence of two other commissioned officers, take an account of what effects he died possessed of, above his arms and accoutrements, and transmit the same to the office of the Department of War, which said effects are to be accounted for, and paid to the representatives of such deceased non-commissioned officer or soldier. And in case any of the officers, so authorized to take care of the effects of deceased officers and soldiers, should, before they have accounted to their representatives for the same, have occasion to leave the regiment or post, by preferment or otherwise, they shall, before they be permitted to quit the same, deposit in the hands of the commanding officer, or of the assistant military agent, all the effects of such deceased non-commissioned officers and soldiers, in order that the same may be secured for, and paid to, their respective representatives.

ARMY REGULATIONS—EDITION OF 1861.

DECEASED SOLDIERS.

Par. 152. Inventories of the effects of deceased non-commissioned officers and soldiers, required by the 95th Article of War, will be forwarded to the Adjutant General, by the commander of the company to which the deceased belonged, and a duplicate of the same to the colonel of the regiment. Final statements of pay, clothing, &c., will be sent with the inventories. When a soldier dies at a post or station absent from his company, it will be the duty of his immediate commander to furnish the required inventory, and, at the same time, to forward to the commanding officer of the company to which the soldier belonged, a report of his death, specifying the date, place, and cause; to what time he was last paid, and the money or other effects in his possession at the time of his decease; which report will be noted on the next muster roll of the company to which the man belonged. Each inventory will be endorsed, "Inventory of the effects of _____, late of company (—) _____ regiment of _____, who died at _____, the _____ day of _____, 186—." If a legal representative receive the effects, it will be stated in the report. If the soldier leave no effects, the fact will be reported.

Par. 153. Should the effects of a deceased non-commissioned officer or soldier not be administered upon within a short period after his decease, they shall be disposed of by a Council of Administration, under the authority of the commanding officer of the post, and the proceeds deposited with the Paymaster, to the credit of the United States, until they shall be claimed by the legal representatives of the deceased.

Par. 154. In all such cases of sales by the Council of Administration, a statement in detail, or account of the proceeds, duly certified by the Council and commanding officer, accompanied by the Paymaster's receipt for the proceeds, will be forwarded by the commanding officer to the Adjutant General. The statement will be endorsed, "Report of the proceeds of the effects of _____, late of company (—) _____ regiment of _____, who died at _____, the _____ day of _____, 186—."

NOTE 1.—The effects in all cases, when called for, should be turned over to the legal representative, without further authority from the Adjutant General. When the effects are turned over to the relatives of the deceased before these inventories are sent to the Adjutant General, their receipts therefor should be attached to the inventories. In all other cases, one copy will be sent with a letter of transmittal direct to the Adjutant General, and a duplicate retained by the officer.

NOTE 2.—Particular care should be taken to take receipts in duplicate from the Paymaster for any funds turned over to him; one copy should be sent direct to the Adjutant General and one retained by the officer.

INVENTORY OF THE EFFECTS

OF

James H. Smith

Late of Company "D"

3^d Reg't of *U.S. Col's Cav*

Volunteers, who died at *Wichita Springs*

on the *7* day of *August* 186*7*.



INVENTORY

Inventory of the effects of James Kinels late
 a Private of Captain D. R. Taylor's Company "D" of
 the 3^d Regiment of U.S. Col'd Cavalry Volunteers, who was enrolled as
 a Private at Skiveriths Idg in the State of Mississippi on
 the 16th day of November 1863, and mustered into the service of the United
 States as a Private on the 16th day of November 1863, at Skiveriths Idg Miss
 in Company "D", 3^d Regiment of U.S. Col'd Cav Volunteers, to serve Three
 years or during the war; he was born in Carroll Co in the State
 of Mississippi; he was 35 years of age, 5 feet 5 inches
 high Black complexion, Black eyes, Black hair, and by occupation, when enrolled,
 a Laborer; he died in Regimental Hospital, at
Vicksburg Miss on the 7th day of August 1864, by
 reason of Wounds rec'd in action at Gaxer City

INVENTORY.								
ARTICLES.	No.	ARTICLES.	No.	ARTICLES.	No.			
Hats.....	<u>No Effects</u>	Pairs trousers.....	<u>No Effects</u>	Knapsacks.....	<u>No Effects</u>			
Caps.....		Pairs flannel drawers.....						
Forage caps.....		Pairs cotton drawers.....						
Great coats.....		Flannel shirts.....						
Uniform coats.....		Cotton shirts.....						
Uniform jackets.....		Pairs boots.....						
Flannel sack coats.....		Pairs shoes.....						
Blouses.....		Pairs socks.....						
Stable frocks.....		Blankets.....						
Fatigue overalls.....		Haversacks.....						
				MONEY.			Specie.....	\$
							Notes.....	\$

I CERTIFY, ON HONOR, that the above inventory comprises all the effects of James Kinels, deceased, and that the effects are in the hands of _____ at _____ to be disposed of by a Council of Administration.

(DUPLICATES.)

STATION: Vicksburg Miss
 DATE: August - 8th / 64

Richard Taylor
1st Lieut. Co "B" "D"
 Commanding the Company.

668

Hines, Thomas

Co G, 3 U. S. Col'd Cav.

Private

Private

CARD NUMBERS.

1	5340123	26
2	5340214	27
3	5340289	28
4	5340367	29
5	5340432	30
6	5340504	31
7	5340591	32
8	5340689	33
9	5340795	34
10	5340891	35
11	5340974	36
12	5341058	37
13	5341132	38
14	5341209	39
15	4089103	40
16	40727537	41
17		42
18		43
19		44
20		45
21		46
22		47
23		48
24		49
25		50

Book Mark:

See also

A 3012443 and wd

A. M. Shannon
Esq

W | **3 Cav. | U.S.C.T.**

Thomas Hines

....., Co. *G*....., 3 Reg't U. S. Col'd Cav.

Appears on

Company Descriptive Book

of the organization named above.

DESCRIPTION.

Age *18* years; height *5* feet *3* inches.

Complexion *Black*

Eyes *Black*; hair *Black*

Where born *Wanamassa*

Occupation *Tr. Hand*

ENLISTMENT.

When *Dec 10*, 186*3*.

Where *Wicksburg Miss*

By whom *Capt. Geo. Coykendall*, term *3* y'rs.

Remarks: *In action Mar. 31/64*

at Reach's Plantation

Wilton

H | 3 Cav. | U.S.C.T.

Thomas Hines

Pvt, Co. G, 1 Reg't Miss. Cav., Corps d'Afrique.*
Age 18 yrs
Appears on

Company Muster-in Roll

of the organization named above. Roll dated
Vicksburg Miss, Jan 27, 1864.
Muster-in to date Dec 10, 1863.

Joined for duty and enrolled:

When Dec 10, 1863.
Where Vicksburg Miss
Period 3 years.

Valuation of horse, \$ 100

Valuation of horse equipments, \$ 100

Remarks:

*This organization subsequently became Co. G, 3 Reg't U. S. Colored Cavalry.

Book mark:

(356)

Pasey

Copyist.

H | **3 Cav.** | **U.S.C.T.**

Thomas Hoines

Pot, Co. *G*, 1 Reg't Miss. Cav., Corps d'Afrique.*

Appears on

Company Muster Roll

for *Dec 24/63 to Feb 29*, 1864.

Present or absent *Present*

Stoppage, \$ *100* for

Due Gov't, \$ *100* for

Valuation of horse, \$ *100*

Valuation of horse equipments, \$ *100*

Remarks:

*This organization subsequently became Co. *G*, 3 Reg't U. S. Colored Cavalry.

Book mark:

(358)

Posey

Copyist.

H | **3 Cav.** | **U.S.C.T.**

Thomas Hines

Pvt., Co. G, 3 Reg't U. S. Col'd Cavalry.

Appears on

Company Muster Roll

for March, 1861

Present or absent Present

Stoppage, \$ 100 for

Due Gov't, \$ 100 for

Valuation of horse, \$ 100

Valuation of horse equipments, \$ 100

Remarks:

Book mark:

Pusey

H | **3 Cav.** | **U.S.C.T.**

Thomas Hines

Pat, Co. G, 3 Reg't U. S. Col'd Cavalry.

Appears on

Company Muster Roll

for *May + June*, 1864.

Present or absent *Present*

Stoppage, \$.....100 for

Due Gov't, \$.....100 for

Valuation of horse, \$.....100

Valuation of horse equipments, \$.....100

Remarks:

.....
.....
.....
.....
.....
.....
.....
.....
.....

Book mark:

.....

(358)

Vasey

Copyist.

74 | 3 Cav. | U.S.C.T.

Thomas Hines

Det, Co. G, 3 Reg't U. S. Col'd Cavalry.

Appears on

Company Muster Roll

for July & Aug, 1864.

Present or absent Present

Stoppage, \$ 100 for

Due Gov't, \$ 100 for

Valuation of horse, \$ 100

Valuation of horse equipments, \$ 100

Remarks:

Book mark:

M. G. Anderson

24 | 3 Cav. | U.S.C.T.

Thomas Hines

Put, Co. G, 3 Reg't U. S. Col'd Cavalry.

Appears on

Company Muster Roll

for Sept & Oct, 1864.

Present or absent Present

Stoppage, \$ 100 for

Due Gov't, \$ 100 for

Valuation of horse, \$ 100

Valuation of horse equipments, \$ 100

Remarks:

Book mark:

Jos. Andrews

(358)

Copyist.

W | **3 Cav.** | **U.S.C.T.**

Thomas Hines

Det, Co. G, 3 Reg't U. S. Col'd Cavalry.

Appears on

Company Muster Roll

for *Nov + Dec*, 186*4*.

Present or absent *Present*

Stoppage, \$ *100* for

Due Gov't, \$ *100* for

Valuation of horse, \$ *100*

Valuation of horse equipments, \$ *100*

Remarks: -----

Book mark: -----

(358)

Hines

Copyist.

3 Cav. U.S.C.T.

Thomas Hines

priv, Co. G, 3 Reg't U. S. Col'd Cavalry.

Appears on

Company Muster Roll

for Dated Feb 28, 1865.

Present or absent Present

Stoppage, \$ 100 for

Due Gov't, \$ 100 for

Valuation of horse, \$ 100

Valuation of horse equipments, \$ 100

Remarks: To be stopped (Rem Revolver #12)

Book mark:

(358)

J. Hines Copyist.

26 | **3 Cav. | U.S.C.T.**

Thomas Gines

priv, Co. G, 3 Reg't U. S. Col'd Cavalry.

Appears on

Company Muster Roll

for *March & Apr*, 186 *5*.

Present or absent *Absent*

Stoppage, \$ *100* for

Due Gov't, \$ *100* for

Valuation of horse, \$ *100*

Valuation of horse equipments, \$ *100*

Remarks: *Absent on expedition since Apr 29.*

Book mark:

(358)

Jarvis
Copyist.

No | **3 Cav.** | **U.S.C.T.**

Thomas Lewis

Priv, Co. G, 3 Reg't U. S. Col'd Cavalry.

Appears on

Company Muster Roll

for *May & June*, 186*5*.

Present or absent *Present*

Stoppage, \$ *100* for

Due Gov't, \$ *100* for

Valuation of horse, \$ *100*

Valuation of horse equipments, \$ *100*

Remarks:

Book mark:

(358)

Lewis
Copyist.

35 | **3 Cav.** | **U.S.C.T.**

Thomas Hines

Priv, Co. G, 3 Reg't U. S. Col'd Cavalry.

Appears on

Company Muster Roll

for *July & Aug*, 1865.

Present or absent *Present*

Stoppage, \$ *100* for

Due Gov't, \$ *100* for

Valuation of horse, \$ *100*

Valuation of horse equipments, \$ *100*

Remarks: *To be stopped for 1 pair spurs
and strap, 52^{cts}*

Book mark:

[Signature]

H | **3 Cav.** | **U.S.C.T.**

Thomas Hines

Pl, Co. G, 3 Reg't U.S. Col'd Cavalry.

Appears on

Company Muster Roll

for *Sept & Oct*, 1865.

Present or absent *Present*

Stoppage, \$ *1* $\frac{27}{100}$ for *wd lost*

Due Gov't, \$ $\frac{100}{100}$ for

Valuation of horse, \$ $\frac{100}{100}$

Valuation of horse equipments, \$ $\frac{100}{100}$

Remarks: *1 H Brush⁷⁵ 1 Spur & Shaps³²*

*Stoppage for lost Ordnance carried
from July & Aug Rolls \$1.79*

Book mark:

Burnham

N | **3 Cav.** | **U.S.C.T.**

Thomas Hines

Plt, Co. G, 3 Reg't U. S. Col'd Cavalry.

Appears on

Company Muster Roll

for *Nov & Dec*, 1865.

Present or absent *Present*

Stoppage, \$ *1* $\frac{74}{100}$ for *cost lost*

Due Gov't, \$ $\frac{100}{100}$ for

Valuation of horse, \$ $\frac{100}{100}$

Valuation of horse equipments, \$ $\frac{100}{100}$

Remarks:

Book mark:

(358)

Barnham

Copyist.

H6 | 3 Cav. | U.S.C.T.

Thomas Hines
Pvt., Co. G, 3 Reg't U. S. Colored Cav.

Appears on Returns as follows:

Jan. 1864. Absent on detached
duty at Rect's camp at
Vicksburg, Miss. since
Jan. 27th (1 miss Cav. a,
20.)

Book mark :

(546)

J. B. Sittler

Copyist.

H | 3 Cav. | U.S.C.T.

Thomas Hines

Plt, Co. *G*, 3 Reg't U. S. Col'd Cavalry.

Appears on Co. Muster-out Roll, dated
Memphis Tenn Jan 26, 1866.

Muster-out to date *Jan 26*, 1866.

Last paid to *Feb 28*, 1865.

Clothing account:

Last settled....., 186 ; drawn since \$..... 100

Due soldier \$..... 100; due U. S. \$ *108* ^{*29*}/₁₀₀

Am't for cloth'g in kind or money adv'd \$..... 100

Due U. S. for arms, equipments, &c., \$..... 100

Bounty paid \$..... 100; due \$..... 100

Remarks: *Total stoppage for lost
ordnance \$9.83*

Book mark :

Buntam

(561)

Copyist.

669

Tomson, Frank

Co B, 3 U. S. Col'd Cav.

Private

Corporal

CARD NUMBERS.

1	5331075	26
2	5334140	27
3	5334252	28
4	5334347	29
5	5334436	30
6	5334500	31
7	5334583	32
8	5334659	33
9	9088441	34
10	40727538	35
11		36
12		37
13		38
14		39
15		40
16		41
17		42
18		43
19		44
20		45
21		46
22		47
23		48
24		49
25		50

Book Mark:

See also

S-10 24 483 - P.O. 1111

A. M. Shannon
Esq.

H | **3 Cav. | U.S.C.T.**

Frank Hinson

....., Co. *B*, 3 Reg't U. S. Col'd Cav.

Appears on

Company Descriptive Book
of the organization named above.

DESCRIPTION.

Age *24* years; height *5* feet *9½* inches.

Complexion *Black*

Eyes *Black*; hair *Black*

Where born *Applin Co. Ga.*

Occupation *Farmer*

ENLISTMENT.

When *Jan. 6 -*, 186 *5*.

Where *Vicksburg*

By whom *Maj. Maine*; term *3* y'rs.

Remarks: *App'td. Corp'l.*
Oct. 25, 1865.

F. A. Wright

76 | 3 Cav | **U.S.C.T.**

Frank W. Wilson
Piv. Co., 3 Reg't U. S. Col'd Cav.

Age 24 years.

Appears on a

Detachment Muster-in Roll

of the organization named above. Roll dated
Vicksburg, Miss. Jan. 7, 1865.

Muster-in to date Jan. 7, 1865.

Joined for duty and enrolled:

When Jan. 6, 1865.

Where Vicksburg, Miss.

Period 3 years.

Valuation of horse, \$ 100

Valuation of horse equipments, \$ 100

Remarks: _____

Book mark: _____

(337)

Sitter.

Copyist.

N | **3 Cav. | U.S.C.T.**

Frank Hinson

Priv., Co. B, 3 Reg't U.S. Col'd Cavalry.

Appears on

Company Muster Roll

for *Jan. and Feb.*, 1863.

Present or absent *Present.*

Stoppage, \$ *100* for

Due Gov't, \$ *100* for

Valuation of horse, \$ *100*

Valuation of horse equipments, \$ *100*

Remarks:

Book mark:

(358)

J. B. Jones Copyist.

A | **3 Cav.** | **U.S.C.T.**

Frank Hinson

Private, Co. B, 3 Reg't U. S. Col'd Cavalry.

Appears on

Company Muster Roll

for March and April, 1865.

Present or absent Absent

Stoppage, \$ 100 for

Due Gov't, \$ 100 for

Valuation of horse, \$ 100

Valuation of horse equipments, \$ 100

Remarks: Absent on scout since April 29/65.

Book mark: _____

(358)

J. B. James

Copyist.

A | **3 Cav.** | **U.S.C.T.**

Frank Nison

Private, Co. B, 3 Reg't U. S. Col'd Cavalry.

Appears on

Company Muster Roll

for May and June, 1865:

Present or absent Present

Stoppage, \$ 100 for

Due Gov't, \$ 100 for

Valuation of horse, \$ 100

Valuation of horse equipments, \$ 100

Remarks: _____

Book mark: _____

(358)

J. B. Jones Copyist.

A | **3 Cav.** | **U.S.C.T.**

Frank Hinson

Pvt., Co. B, 3 Reg't U. S. Col'd Cavalry.

Appears on

Company Muster Roll

for *July and August, 1865*.

Present or absent *Present*.

Stoppage, \$ *100* for

Due Gov't, \$ *100* for

Valuation of horse, \$ *100*

Valuation of horse equipments, \$ *100*

Remarks:

Book mark:

(358)

J. B. Jarvis Copyist.

H. | **3 Cav. | U.S.C.T.**

Frank Hinson
Capt., Co. B, 3 Reg't U. S. Col'd Cavalry.

Appears on

Company Muster Roll
for *Sept. & Oct.*, 1865.

Present or absent *Present*

Stoppage, \$ *100* for

Due Gov't, \$ *100* for

Valuation of horse, \$ *100*

Valuation of horse equipments, \$ *100*

Remarks: *Promoted from private Oct. 25/65 - Stop for one pr. Saddle & Tapes 52 cts.*

Book mark:

H. F. Bandon

(358)

Copyist.

H. | 3 Cav. | U.S.C.T.

Frank Hinson
Capt., Co. B, 3 Reg't U. S. Col'd Cavalry.

Appears on

Company Muster Roll
for Nov. 9th Dec. 1865.

Present or absent Present

Stoppage, \$.52¹⁰⁰ for Ordnance
transferred from Oct. Rolls

Due Gov't, \$ 100 for

Valuation of horse, \$ 100

Valuation of horse equipments, \$ 100

Remarks:

Book mark:

H. E. Brandon

H | 3 Cav. | U.S.C.T.

Frank Hinson

Pvt., Co. B, 3 Reg't U. S. Colored Cav.

Appears on Returns as follows:

Jan. 1865. Gained Jan. 6/65 -
Vicksburg - Recruit in Co.
mustered in - 7/65 - by
Lt. Mc Dougall.
Absent - 25/65 -

Book mark :

(546)

J. B. Sitter

Copyist.

H. | **3 Cav.** | **U.S.C.T.**

Frank Hinson
Capt. B., Co. *B.*, 3 Reg't U. S. Col'd Cavalry.

Appears on **Co. Muster-out Roll**, dated
Memphis Tenn., Jan. 26, 1866.

Muster-out to date *Jan. 26*, 1866.

Last paid to *Jan. 30*, 1865.

Clothing account:

Last settled _____, 186 ; drawn since \$ _____ 100

Due soldier \$ *3 89* _____ 100; due U. S. \$ _____ 100

Am't for cloth'g in kind or money adv'd \$ _____ 100

Due U. S. for arms, equipments, &c., \$ _____ 100

Bounty paid \$ *00* _____ 100; due \$ *100* _____ 100

Remarks: *Total Stoppages*

in Ordnance 52 cts.

Promoted from Private
Oct. 25th 1865

Book mark: *771. 1879*

H. F. Brandon

(861)

Copyist.

670

Winters, Levi
Co C, 3 U. S. Col'd Cav.

Private | *Private*

CARD NUMBERS.

1	5334817	26
2	5334910	27
3	5334998	28
4	5335081	29
5	5335163	30
6	5335242	31
7	5335321	32
8	5335405	33
9	5335488	34
10	5335595	35
11	5335693	36
12	5335786	37
13	5335878	38
14	5335960	39
15	5336043	40
16	9088575	41
17		42
18		43
19		44
20		45
21		46
22		47
23		48
24		49
25		50

Book Mark:

See also

A 600 277 P.O. 9204 52
S 802330. P090

S-2095416 and 173 20.11

A M Shannon
Ex 12

A | **3 Cav.** | **U.S.C.T.**

Levi Hunter

....., Co. C, 3 Reg't U. S. Col'd Cav.

Appears on

Company Descriptive Book
of the organization named above.

DESCRIPTION.

Age 23 years; height 5 feet 3 inches.

Complexion Black

Eyes Black; hair Black

Where born Madison Co. Miss.

Occupation Farmer

ENLISTMENT.

When Nov. 1, 1863.

Where Vicksburg - Miss.

By whom B. S. Wing; term 3 y'rs.

Remarks:

T. A. Wright

H | **3 Cav. U.S.C.T.**

Levi Hunter

Priv, Co. *C*, 1 Reg't Miss. Cav., A. D.†

Age *23* years.

Appears on

Company Muster-in Roll

of the organization named above. Roll dated

Vicksburg, Miss. Nov 1, 1863.

Muster-in to date *Nov 1, 1863.*

Joined for duty and enrolled:

When *Nov 1*, 186*3*.*

Where *Vicksburg, Miss.*

Period *3* years.*

Valuation of horse, \$.. 100

Valuation of horse equipments, \$ 100

Remarks

† This organization subsequently became Co. *C*, 3 Reg't U. S. Colored Cavalry.

* * * Muster-in roll shows enrollment and muster-in of this company as of same date. See enrollment on subsequent card or cards.

Boiled by :

A. Johnson
Copyist.

H | **3 Cav.** | **U.S.C.T.**

David Hunter

Put., Co. *C*, 1 Reg't Miss. Cav., A. D.†

Appears on

Company Muster Roll

for *Nov and Dec*, 1863

Joined for duty and enrolled:

When *Nov 1*, 1863.*

Where *Vicksburg* *

Period *3* years.*

Present or absent *Not stated*

Stoppage, \$ *100* for

Due Gov't \$ *100* for

Valuation of horse, \$ *100*

Valuation of horse equipments, *100*

Remarks:

† This organization subsequently became Co. *C*, 3 Reg't U. S. Colored Cavalry.

* See enrollment on card from muster-in roll.

Book mark:

R Johnson

(358d)

Copyist

No | **3 Cav.** | **U.S.C.T.**

Louis Hunter

C, Co. *C*, 1 Reg't Miss. Cav., Corps d'Afrique.*

Appears on

Company Muster Roll

for *Jan* and *Feb*, 186 *4*

Present or absent *Present*

Stoppage, \$ _____ $\overline{100}$ for _____

Due Gov't, \$ _____ $\overline{100}$ for _____

Valuation of horse, \$ _____ $\overline{100}$

Valuation of horse equipments, \$ _____ $\overline{100}$

Remarks: _____

*This organization subsequently became Co. *C*, 3 Reg't U. S. Colored Cavalry.

Book mark: _____

(358)

R. J. Hurm

Coptist.

76 | 3 Cav. | U.S.C.T.

Gen Hunter

Put, Co. C, 3 Reg't U. S. Col'd Cavalry.

Appears on

Company Muster Roll

for *March & April*, 1864.

Present or absent *Present*

Stoppage, \$ 100 for

Due Gov't, \$ 100 for

Valuation of horse, \$ 100

Valuation of horse equipments, \$ 100

Remarks:

Book mark:

R Johnson

H | **3 Cav. | U.S.C.T.**

Lewis Hunter

Priv, Co. C, 3 Reg't U. S. Col'd Cavalry.

Appears on

Company Muster Roll

for *May and June*, 186*4*

Present or absent *Present*

Stoppage, \$ *100* for

Due Gov't, \$ *100* for

Valuation of horse, \$ *100*

Valuation of horse equipments, \$ *100*

Remarks: *Stop for Muster
Brush & Throng \$2.43*

Book mark:

A. Johnson

HO | **3 Cav.** | **U.S.C.T.**

Levi Hunter
Pat, Co. C, 3 Reg't U. S. Col'd Cavalry.

Appears on

Company Muster Roll

for *July & Aug*, 186 *4*
Present or absent *Present*

Stoppage, \$ *100* for

Due Gov't, \$ *100* for

Valuation of horse, \$ *100*

Valuation of horse equipments, \$ *100*

Remarks: *Due U. S. for*
Ordnance from
Last Muster Roll
#2,43

Book mark:

R. Johnson
Copyst.

H | **3 Cav.** | **U.S.C.T.**

Lewis Hunter

H, Co. C, 3 Reg't U. S. Col'd Cavalry.

Appears on

Company Muster Roll

for *Sept & Oct*, 186 *4*

Present or absent *Present*

Stoppage, \$ *100* for

Due Gov't, \$ *100* for

Valuation of horse, \$ *100*

Valuation of horse equipments, \$ *100*

Remarks:

Book mark:

Talbot
Copyst.

76 | **3 Cav.** | **U.S.C.T.**

Levi Hinton
Priv, Co. C, 3 Reg't U. S. Col'd Cavalry.

Appears on

Company Muster Roll

for *Nov & Dec*, 1864.

Present or absent *Absent*

Stoppage, \$ *100* for

Due Gov't, \$ *100* for

Valuation of horse, \$ *100*

Valuation of horse equipments, \$ *100*

Remarks: *On scout, stopped
for 1. Curry Comb & Horse
Brush \$1.01*

Book mark:

Talburt
Copyist.

76 | **3 Cav.** | **U.S.C.T.**

Levi Hunter

Priv, Co. C, 3 Reg't U. S. Col'd Cavalry.

Appears on

Company Muster Roll

for *Jany & Heby*, 186 *6*

Present or absent *Present*

Stoppage, \$ *100* for

Due Gov't, \$ *100* for

Valuation of horse, \$ *100*

Valuation of horse equipments, \$ *100*

Remarks:
.....
.....
.....
.....
.....
.....
.....
.....

Book mark:

Talworth

(358)

Copyist.

Ho | **3 Cav.** | **U.S.C.T.**

Levi Hunter

Priv, Co. C, 3 Reg't U. S. Col'd Cavalry.

Appears on

Company Muster Roll

for *Mich & apl*, 186

Present or absent *Present*

Stoppage, \$ *100* for

Due Gov't, \$ *100* for

Valuation of horse, \$ *100*

Valuation of horse equipments, \$ *100*

Remarks:
.....
.....
.....
.....
.....
.....
.....
.....
.....

Book mark:

(358)

Talbot
Copyist.

760 | 3 Cav. | U.S.C.T.

Levi Hunter
Gri, Co. C, 3 Reg't U. S. Col'd Cavalry.

Appears on

Company Muster Roll

for May & June, 1865.

Present or absent Present

Stoppage, \$ 100 for

Due Gov't, \$ 100 for

Valuation of horse, \$ 100

Valuation of horse equipments, \$ 100

Remarks: 1. Saddle & Thong 40,
1. Carbine & Trunk 270/
77

Book mark:

(358)

Jalbert
Copyist.

H | **3 Cav. | U.S.C.T.**

Levi Hunter
Priv, Co. C, 3 Reg't U. S. Col'd Cavalry.

Appears on

Company Muster Roll

for *July & Aug*, 186*6*.

Present or absent *Present*

Stoppage, \$ *100* for

Due Gov't, \$ *100* for

Valuation of horse, \$ *100*

Valuation of horse equipments, \$ *100*

Remarks:

Book mark:

(358)

Talburt
Copyist.

H | 3 Cav. | U.S.C.T.

Levi Hunter

Hunter, Co. C, 3 Reg't U. S. Col'd Cavalry.

Appears on

Company Muster Roll

for Sept & Oct, 1865.

Present or absent Present

Stoppage, \$ 100 for

Due Gov't, \$ 100 for

Valuation of horse, \$ 100

Valuation of horse equipments, \$ 100

Remarks:

Book mark:

Copyist.

H | **3 Cav. | U.S.C.T.**

Levi Hinton

Private, Co. C, 3 Reg't U. S. Col'd Cavalry.

Appears on

Company Muster Roll

for *Nov Dec*, 1865.

Present or absent *Present*

Stoppage, \$ *100* for

Due Gov't, \$ *100* for

Valuation of horse, \$ *100*

Valuation of horse equipments, \$ *100*

Remarks:

Book mark:

H | **3 Cav. | U.S.C.T.**

Levi Winter

Quir, Co. *C*, 3 Reg't U. S. Col'd Cavalry.

Appears on **Co. Muster-out Roll**, dated
Memphis, Tenn. Jan'y 26, 1866.

Muster-out to date *Jan'y 26, 1866*.

Last paid to *June 30, 1865*.

Clothing account:

Last settled....., 186 ; drawn since \$.....100

Due soldier \$ *28 59*/100; due U. S. \$.....100

Am't for cloth'g in kind or money adv'd \$.....100

Due U. S. for arms, equipments, &c., \$.....100

Bounty paid \$.....100; due \$.....100

Remarks:.....

.....

.....

.....

.....

Book mark:.....

671

Winter, Solomon

Co C, 3 U. S. Col'd Cav.

Private

Private

CARD NUMBERS.

1	5334818	26
2	5334956	27
3	5336106	28
4	9088516	29
5	40727539	30
6		31
7		32
8		33
9		34
10		35
11		36
12		37
12		38
14		39
15		40
16		41
17		42
18		43
19		44
20		45
21		46
22		47
23		48
24		49
25		50

Book Mark:

See also

A | **3 Cav.** | **U.S.C.T.**

Solomon Hunter

....., Co. *C*, 3 Reg't U. S. Col'd Cav.

Appears on

Company Descriptive Book
of the organization named above.

DESCRIPTION.

Age *27* years; height *5* feet *5 1/2* inches.

Complexion *Black*

Eyes *Black*; hair *Black*

Where born *Warren Co. Miss.*

Occupation *Farmer*

ENLISTMENT.

When *Nov. 1 -*, 186 *3*.

Where *Vicksburg - Miss.*

By whom *B. S. King*; term *3* y'rs.

Remarks: *Died in hospital*
at Ship withs Landing
Miss. - Dec. 1 - 1863.

Final statement fur-
nished

F. A. Wright

26 3 Cav. U.S.C.T.

Solomon Hunter

Priv., Co. C, 1 Reg't Miss. Cav., A. D.†

Age 27 years.

Appears on

Company Muster-in Roll

of the organization named above. Roll dated

Vicksburg, Miss. Nov 1, 1863.

Muster-in to date Nov 1, 1863.

Joined for duty and enrolled:

When Nov 1, 1863.*

Where Vicksburg, Miss.

Period 3 years.*

Valuation of horse, \$ 100

Valuation of horse equipments, \$ 100

Remarks:

† This organization subsequently became Co. C, 3 Reg't U.S. Colored Cavalry.

* Muster-in roll shows enrollment and muster-in of this company as of same date. See enrollment on subsequent card or cards.

Book mark:

R. Johnson

(8566)

Apprat.

H | **3 Cav.** | **U.S.C.T.**

Colomon Hunter
Put *C*, Co. *C*, 1 Reg't Miss. Cav., A. D.†

Appears on

Company Muster Roll
for *Nov and Dec.*, 1863

Joined for duty and enrolled:

When *Nov 1.*, 1863.*

Where *Vicksburg* *

Period *3* years.*

Present or absent

Stoppage, \$ *100* for

Due Gov't \$ *100* for

Valuation of horse, \$ *100*

Valuation of horse equipments, *100*

Remarks: *Died in Regimental Hospital at Shipenby Landing Dec 1, 1863. Stofa over Carline Slings (Buff Leather)*

† This organization subsequently became Co. *C*, 3 Reg't U. S. Colored Cavalry.

••• See enrollment on card from muster-in roll.

Book mark:

(358d)

R. Johnson
Copyist.

H. | 3 Cav. | U.S.C.T.

Solomon Hunter
Pvt., Co. C, 3 Reg't U. S. Colored Cav.

Appears on Returns as follows:

Dec. 1863. (1 Miss. Cav. A. D.)
Loss Dec. 1st R. Hospital,
Died.

Book mark :

(546)

J. B. Sittler

Copyist.

H | **3 Cav.** | **U.S.C.T.**

Solomon Hunter
Pvt, Co. C, 3 Reg't U. S. Col'd Cavalry.

Appears on **Co. Muster-out Roll**, dated
Memphis, Tenn. June 6, 1866.

Muster-out to date _____, 186 .

Last paid to Newspain, 186 .

Clothing account:

Last settled _____, 186 ; drawn since \$ _____ 100

Due soldier \$ _____ 100; due U. S. \$ _____ 100

Am't for cloth'g in kind or money adv'd \$ _____ 100

Due U. S. for arms, equipments, &c., \$ _____ 100

Bounty paid \$ _____ 100; due \$ _____ 100

Remarks: Died at _____

Spivish's Hdq. Miss

Dec 1, 1863,

Final statements forwarded,

Book mark: _____

(861)

Koman
Copyist.

Hunter, Solomon

B., Co. *C*

3

Reg't

U.S.C. Cav.

3

Enclosures.

Bed Cards	Descriptive Lists
Burial Records	Final Statements <i>2</i>
Certs. of Dis. for Discharge	Furloughs
C. M. Charges	Med. Des. Lists
Med. Certificates	Orders

Other papers relating to—

Admission to Hosp'l	Furlough
Casualty Sheet (Officer's)	Med. Examination
Confinement	Misc. Information
Contracts	Pay or Clothing
Death or Effects <i>1</i>	Personal Reports
Desertions	Rank
Discharge from Hosp'l	Transfer to Hosp'l
Discharge from Service	Transfer to V. R. C.
Duty	Transportation

MICROFILM PUBLICATION M 1819

COMPILED MILITARY SERVICE RECORDS
OF VOLUNTEER UNION SOLDIERS WHO
SERVED WITH THE USCT (US COLORED TROOPS)
3RD REGIMENT OF CAVALRY

PERSONAL PAPERS' TARGET SHEET

PLEASE NOTE THE CHECKED INFORMATION ABOUT THE PERSONAL PAPERS IN
THIS FILE:

- NO PERSONAL PAPERS WERE FOUND IN THIS FILE WHEN THE
RECORDS WERE ARRANGED FOR MICROFILMING.
- 4 PERSONAL PAPER(S) FOUND IN THIS FILE WHEN THE RECORDS
WERE ARRANGED FOR MICROFILMING.

V

FINAL STATEMENT

OF

Solomon Cinter

1st Reg't of *Missouri*

3045
VOLUNTEERS.

NOTE 1.—Two of these certificates (or duplicates) are to be given to each volunteer soldier who may be discharged previously to the discharge of his company, that he may at once receive from the Paymaster the pay, &c., due him, and the captain or other officer commanding the company will certify to the act of the delivery of the duplicate certificates; on these certificates the Soldier is "entitled to" his discharge, and should also present his discharge to the Paymaster to have the payment endorsed on it. The discharge is to be given back to the Soldier by the Paymaster; the latter only retaining as his voucher the duplicate certificates.

NOTE 2.—If the Soldier is entitled to pay for the use of his horse, the Company Commander will certify to that fact, and also to the time he has pay due for having been so mounted on his own horse.

NOTE 3.—Amounts due the Sutler and Laundress must be entered on the Muster Roll on which the death, desertion, &c., is reported, as well as on the final statement, otherwise the amount cannot be collected from the United States.

NOTE 4.—This blank will be used for deceased volunteers as well as others.

3045

ADJUTANT GENERAL'S OFFICE

May 30th 1864

Duplicate with Inventory sent 2d Auditor.

I certify, on honor, that Solomon Hunter a Private of
Captain Benj. S. King Company (C) of the 1st Regiment of Mississippi
VOLUNTEERS, of the State of Mississippi, born in Unknown, State
of Unknown, aged 21 years; 5 feet 5 1/2 inches high; Black complexion,
Black eyes, Black hair, and by occupation a Gardner, having joined the company on
its original organization at Merisburg, and enrolled in it at the muster into
the service of the United States at Merisburg, on the 1st day
of November, 1863, (or was mustered in service as a recruit, by Benj. S. King
at Merisburg, on the 1st day of November
1863, to serve in the Regiment,) for the term of 3 years
and having served **HONESTLY** and **FAITHFULLY** with his Company in

to the present date, is now entitled to a **DISCHARGE** by reason of When he
died Without Effects his clothing having been
buried with him

The said Solomon Hunter was last paid by Paymaster
Gene from Cadisburg include the _____ day of _____, 1863, and has
pay due him from that time to the present date; he is entitled to pay and subsistence for
TRAVELING to place of enrollment and whatever other allowances are authorized to volunteer
soldiers, or militia, so discharged. He has received _____ dollars,
advanced by the United States on account of **CLOTHING**.

There is to be stopped from him, on account of the State of _____, or other
authorities for **CLOTHING**, &c., received on entering service, _____ dollars; also,
for expenses of **SUBSISTENCE** for **TRAVELING** from place of enrollment to the place of rendezvous,
amounting to _____ dollars: and on account of the United States for **EXTRA**
CLOTHING received in kind from _____ and for other
stoppages, viz:

1 Carbine Skives & Swivel 1 Carbine. Brush &
Shang & creuchial & amercion amounting to Five 27 dollars;
and he has been **SUBSISTED** for **TRAVELING** to his place of enrollment, up to the _____
_____, 1863.

He is indebted to _____, **SUTLER**, _____ dollars.

He is indebted to _____, **LAUNDRESS**, _____ dollars.

Given in Duplicate, at Stiput Wood this 1st day of Dec, 1863.

Benj. S. King

Captain

Commanding Company. "C"

1st Miss Cav 22

Exp. 3.8. 1861 for Jan 26

ARTICLES OF WAR.

INVENTORY OF THE EFFECTS

OF

Solomon C. ...

Late of Company 'C'

A Reg't of *Miss South*

Volunteers, who died at *Stonewall Landing*

on the *14* day of *December* 186*2*

Recd Ad Gen 11/03

ART. 95. When any non-commissioned officer or soldier shall die, or be killed in the service of the United States, the then commanding officer of the troop or company shall, in the presence of two other commissioned officers, take an account of what effects he died possessed of, above his arms and accoutrements, and transmit the same to the office of the Department of War, which said effects are to be accounted for, and paid to the representatives of such deceased non-commissioned officer or soldier. And in case any of the officers, so authorized to take care of the effects of deceased officers and soldiers, should, before they have accounted to their representatives for the same, have occasion to leave the regiment or post, by preferment or otherwise, they shall, before they be permitted to quit the same, deposit in the hands of the commanding officer, or of the assistant military agent, all the effects of such deceased non-commissioned officers and soldiers, in order that the same may be secured for, and paid to, their respective representatives.

ARMY REGULATIONS—EDITION OF 1861.

DECEASED SOLDIERS.

Par. 152. Inventories of the effects of deceased non-commissioned officers and soldiers, required by the 95th Article of War, will be forwarded to the Adjutant General, by the commander of the company to which the deceased belonged, and a duplicate of the same to the colonel of the regiment. Final statements of pay, clothing, &c., will be sent with the inventories. When a soldier dies at a post or station absent from his company, it will be the duty of his immediate commander to furnish the required inventory, and, at the same time, to forward to the commanding officer of the company to which the soldier belonged, a report of his death, specifying the date, place, and cause; to what time he was last paid, and the money or other effects in his possession at the time of his decease; which report will be noted on the next muster-roll of the company to which the man belonged. Each inventory will be endorsed, "Inventory of the effects of _____, late of company (—) _____ regiment of _____, who died at _____, the _____ day of _____, 186—." If a legal representative receive the effects, it will be stated in the report. If the soldier leave no effects, the fact will be reported.

Par. 153. Should the effects of a deceased non-commissioned officer or soldier not be administered upon within a short period after his decease, they shall be disposed of by a Council of Administration, under the authority of the commanding officer of the post, and the proceeds deposited with the Paymaster, to the credit of the United States, until they shall be claimed by the legal representatives of the deceased.

Par. 154. In all such cases of sales by the Council of Administration, a statement in detail, or account of the proceeds, duly certified by the Council and commanding officer, accompanied by the Paymaster's receipt for the proceeds, will be forwarded by the commanding officer to the Adjutant General. The statement will be endorsed, "Report of the proceeds of the effects of _____, late of company (—) _____ regiment of _____, who died at _____, the _____ day of _____, 186—."

NOTE 1.—The effects in all cases, when called for, should be turned over to the legal representative, without further authority from the Adjutant General. When the effects are turned over to the relatives of the deceased before these inventories are sent to the Adjutant General, their receipts therefor should be attached to the inventories. In all other cases, one copy will be sent with a letter of transmittal direct to the Adjutant General, and a duplicate retained by the officer.

NOTE 2.—Particular care should be taken to take receipts in duplicate from the Paymaster for any funds turned over to him; one copy should be sent direct to the Adjutant General and one retained by the officer.

Inventory of the effects of Solomon Hunter late
 a Private of Captain Benj. S. Wings Company "C" of
 the 1st Regiment of Miss Cav A. I. Volunteers, who was enrolled as
 a Private at Vicksburg in the State of Mississippi on
 the 14th day of November 1863, and mustered into the service of the United
 States as a Private on the 14th day of November 1863, at Vicksburg
 in Company C, 1st Regiment of Miss Cav A. I. Volunteers, to serve 3 Years
 years or during the war; he was born in Uniontown in the State
 of Uniontown; he was 21 years of age, 5 feet 5 1/2 inches
 high, Black complexion, Black eyes, Black hair, and by occupation, when enrolled,
 a Farmer; he died in 1st Miss Cav Hospital at
Shipwreck Landing on the 14th day of December 1863, by
 reason of

INVENTORY.					
ARTICLES.	No.	ARTICLES.	No.	ARTICLES.	No.
Hats		Pairs trousers		Knapsacks	
Caps		Pairs flannel drawers			
Forage caps		Pairs cotton drawers			
Great coats		Flannel shirts			
Uniform coats		Cotton shirts			
Uniform jackets		Pairs boots			
Flannel sack coats		Pairs shoes			
Blouses		Pairs socks			
Stable frocks		Blankets			
Fatigue overalls		Haversacks			
				MONEY.	
				Specie	\$
				Notes	\$

I CERTIFY, ON HONOR, that the above inventory comprises all the effects of Solomon Hunter, deceased, and that the effects are in the hands of Benjamin Wings at Shipwreck Landing Mississippi to be disposed of by a Council of Administration

(DUPLICATES.)

STATION :

Shipwreck Landing

DATE :

December 14th 1863

Benj. S. Wings

Commanding the Company, C

1st Mississippi Cav. & G.

ARTICLES OF WAR.

ART. 95. When any non-commissioned officer or soldier shall die, or be killed in the service of the United States, the then commanding officer of the troop or company shall, in the presence of two other commissioned officers, take an account of what effects he died possessed of, above his arms and accoutrements, and transmit the same to the office of the Department of War, which said effects are to be accounted for, and paid to the representatives of such deceased non-commissioned officer or soldier. And in case any of the officers, so authorized to take care of the effects of deceased officers and soldiers, should, before they have accounted to their representatives for the same, have occasion to leave the regiment or post, by preferment or otherwise, they shall, before they be permitted to quit the same, deposit in the hands of the commanding officer, or of the assistant military agent, all the effects of such deceased non-commissioned officers and soldiers, in order that the same may be secured for, and paid to, their respective representatives.

ARMY REGULATIONS—EDITION OF 1861.

DECEASED SOLDIERS.

Par. 152. Inventories of the effects of deceased non-commissioned officers and soldiers, required by the 95th Article of War, will be forwarded to the Adjutant General, by the commander of the company to which the deceased belonged, and a duplicate of the same to the colonel of the regiment. Final statements of pay, clothing, &c., will be sent with the inventories. When a soldier dies at a post or station absent from his company, it will be the duty of his immediate commander to furnish the required inventory, and, at the same time, to forward to the commanding officer of the company to which the soldier belonged, a report of his death, specifying the date, place, and cause; to what time he was last paid, and the money or other effects in his possession at the time of his decease; which report will be noted on the next muster-roll of the company to which the man belonged. Each inventory will be endorsed, "Inventory of the effects of _____, late of company (—) _____ regiment of _____, who died at _____, the _____ day of _____, 186—." If a legal representative receive the effects, it will be stated in the report. If the soldier leave no effects, the fact will be reported.

Par. 153. Should the effects of a deceased non-commissioned officer or soldier not be administered upon within a short period after his decease, they shall be disposed of by a Council of Administration, under the authority of the commanding officer of the post, and the proceeds deposited with the Paymaster, to the credit of the United States, until they shall be claimed by the legal representatives of the deceased.

Par. 154. In all such cases of sales by the Council of Administration, a statement in detail, or account of the proceeds, duly certified by the Council and commanding officer, accompanied by the Paymaster's receipt for the proceeds, will be forwarded by the commanding officer to the Adjutant General. The statement will be endorsed, "Report of the proceeds of the effects of _____, late of company (—) _____ regiment of _____, who died at _____, the _____ day of _____, 186—."

NOTE 1.—The effects in all cases, when called for, should be turned over to the legal representative, without further authority from the Adjutant General. When the effects are turned over to the relatives of the deceased before these inventories are sent to the Adjutant General, their receipts therefor should be attached to the inventories. In all other cases, one copy will be sent with a letter of transmittal direct to the Adjutant General, and a duplicate retained by the officer.

NOTE 2.—Particular care should be taken to take receipts in duplicate from the Paymaster for any funds turned over to him; one copy should be sent direct to the Adjutant General and one retained by the officer.

INVENTORY OF THE EFFECTS

OF

Harrison Under

Late of Company "C"

1st Reg't of *Miss Cal U.S.A.*

Volunteers, who died at *St. Republic, January*

on the *14* day of *December* 1863.



Inventory of the effects of Solomon Heintz late
 a Private of Captain Benj. S. King Company "C" of
 the 1st Regiment of Miss Cav A.S. Volunteers, who was enrolled as
 a Private at Vicksburg in the State of Mississippi on
 the 1st day of November 1863, and mustered into the service of the United
 States as a Private on the 1st day of November 1863, at Vicksburg
 in Company "C", 1st Regiment of Miss Cav A.S. Volunteers, to serve 30 Years
 years or during the war; he was born in Unknown in the State
 of Unknown; he was 21 years of age, 5 feet 5 1/2 inches
 high, Black complexion, Black eyes, Black hair, and by occupation, when enrolled,
 a Farmer; he died in 1st Miss Hospital at
Skipwich Landing on the 1st day of December 1863, by
 reason of

INVENTORY.					
ARTICLES.	No.	ARTICLES.	No.	ARTICLES.	No.
Hats		Pairs trousers		Knapsacks	
Caps		Pairs flannel drawers		<i>Great all his things which comprised all his effects</i>	
Forage caps		Pairs cotton drawers			
Great coats		Flannel shirts			
Uniform coats		Cotton shirts			
Uniform jackets		Pairs boots			
Flannel sack coats		Pairs shoes			
Blouses		Pairs socks			
Stable frocks		Blankets			
Fatigue overalls		Haversacks			
					MONEY.
				Specie	\$
				Notes	\$

I CERTIFY, ON HONOR, that the above inventory comprises all the effects of Private
Solomon Heintz, deceased, and that the effects are in the hands
 of Benjamin S. King at Skipwich Landing
Mississippi to be disposed of by a Council of Administration.

(DUPLICATES.)

STATION: Skipwich Landing
 DATE: December 1st 1863

Benj. S. King
Captain
 Commanding the Company. "C"
1st Miss Cav A.S.

FINAL STATEMENT

OF

Solomon Hunt

1st Reg't of *Miss Cal*

VOLUNTEERS.

NOTE 1.—Two of these certificates (or duplicates) are to volunteer soldier who may be discharged previously to his company, that he may at once receive from the Pay &c., due him, and the captain or other officer commanding will certify to the act of the delivery of the duplicate certificate the Soldier is "entitled to" his discharge, and sent his discharge to the Paymaster to have the payment The discharge is to be given back to the Soldier by the latter only retaining as his voucher the duplicate certificate.

NOTE 2.—If the Soldier is entitled to pay for the use of Company Commander will certify to that fact, and also has pay due for having been so mounted on his own horse.

NOTE 3.—Amounts due the Sutler and Laundress must be entered on the Muster Roll on which the death, desertion, &c., is reported, as well as on the final statement, otherwise the amount cannot be collected from the United States.

NOTE 4.—This blank will be used for deceased volunteers as well as others.



1869

I certify, on honor, that Solomon Hunt a Private of
 Captain Wm. S. Smith Company () of the 1st Regiment of Miss. Cav. Art.
VOLUNTEERS, of the State of Mississippi, born in Winstonown, State
 of Unknown, aged 21 years; 5 feet 5 inches high; Black complexion,
Blue eyes, Black hair, and by occupation a Farmer, having joined the company on
 its original organization at Winstonown, and enrolled in it at the muster into
 the service of the United States at Winstonown, on the 1st day
 of November, 1861, (or was mustered in service as a recruit, by
 _____, at _____, on the _____ day of _____
 1861, to serve in the Regiment,) for the term of Three Years
 and having served **HONESTLY** and **FAITHFULLY** with his Company in See Field
 to the present date, is now entitled to a **DISCHARGE** by reason of Medical Reason
not with in effect at entering having been
injured with him

The said _____ was last paid by Paymaster
Wm. S. Smith to include the _____ day of _____, 1861, and has
 pay due him from that time to the present date; he is entitled to pay and subsistence for
TRAVELING to place of enrollment and whatever other allowances are authorized to volunteer
 soldiers, or militia, so discharged. He has received _____ dollars,
 advanced by the United States on account of **CLOTHING**.

There is to be stopped from him, on account of the State of _____, or other
 authorities for **CLOTHING**, &c., received on entering service, _____ dollars; also,
 for expenses of **SUBSISTENCE** for **TRAVELING** from place of enrollment to the place of rendezvous,
 amounting to _____ dollars: and on account of the United States for **EXTRA**
CLOTHING received in kind from _____ and for other
 stoppages, viz:

1. Clothing, Shoes, Sundry, 1 Saddle, Brush & Sundry
 _____ amounting to Five dollars;
 and he has been **SUBSISTED** for **TRAVELING** to his place of enrollment, up to the _____
 _____, 1861.

He is indebted to _____, **SUTLER**, _____ dollars.
 He is indebted to _____, **LAUNDRESS**, _____ dollars.

Given in Duplicate, at Winstonown, this 2nd day of Dec, 1861.

 Commanding Company.
1st Regt. Miss. Cav. Art.

672

Hinton, Timothy
Co G, 3 U. S. Col'd Cav.

Private | Private

CARD NUMBERS.

1	5340125	26
2	5340178	27
3	5340262	28
4	5340343	29
5	5340402	30
6	5340469	31
7	5340554	32
8	5340638	33
9	5340747	34
10	5340846	35
11	5340976	36
12	5341060	37
13	5341163	38
14	5331867	39
15	5341307	40
16	2089105	41
17	40727540	42
18		43
19		44
20		45
21		46
22		47
23		48
24		49
25		50

Book Mark:

See also

N | **3 Cav. | U.S.C.T.**

Samuel Hillman

....., Co. *G*....., 3 Reg't U. S. Col'd Cav.

Appears on

Company Descriptive Book
of the organization named above.

DESCRIPTION.

Age *33* years; height *5* feet *8 1/4* inches.

Complexion *Black*

Eyes *Black*; hair *Black*

Where born *Chatham Co N.C.*

Occupation *Coachman*

ENLISTMENT.

When *Dec 15*, 186*3*.

Where *Wicksburg Miss*

By whom *Capt Geo Cykendall*, term *3* y'rs.

Remarks: *By Order Mar 31/64 at*

Reached Plantation.
Discharged December 20' 1865
Memphis Tenn

Hillman

H | **3 Cav.** | **U.S.C.T.**

Timothy Hamilton

Co. G, Co. *G*, 1 Reg't Miss. Cav., Corps d'Afrique.*
Age 23 yrs
Appears on

Company Muster-in Roll

of the organization named above. Roll dated
Wicksburg Miss, Jan 27, 1864.

Muster-in to date *Dec 15*, 1863.

Joined for duty and enrolled:

When *Dec 15*, 1863.

Where *Wicksburg Miss*

Period *3* years.

Valuation of horse, \$ *100*

Valuation of horse equipments, \$ *100*

Remarks :
.....
.....
.....

*This organization subsequently became Co. *G*, 3 Reg't U. S. Colored Cavalry.

Book mark:

(356)

Wesley

Copyist.

H | **3 Cav.** | **U.S.C.T.**

Timothy Hinton

Pvt., Co. *G*, 1 Reg't Miss. Cav., Corps d'Afrique.*

Appears on

Company Muster Roll

for *Dec 24/63 to Feb 29*, 1864.

Present or absent *Present*

Stoppage, \$ *100* for

Due Gov't, \$ *100* for

Valuation of horse, \$ *100*

Valuation of horse equipments, \$ *100*

Remarks:

*This organization subsequently became Co. *G*, 3 Reg't U. S. Colored Cavalry.

Book mark:

(358)

P. J. [unclear]
Copyist.

H | **3 Cav.** | **U.S.C.T.**

Timothy Hinton
Sgt, Co. G, 3 Reg't U. S. Col'd Cavalry.

Appears on

Company Muster Roll

for *March-April*, 1864.

Present or absent *Present*

Stoppage, \$ *100* for

Due Gov't, \$ *100* for

Valuation of horse, \$ *100*

Valuation of horse equipments, \$ *100*

Remarks:

Book mark: -----

T. S. J.

H | **3 Cav.** | **U.S.C.T.**

Timothy Hinton
Sgt, Co. G, 3 Reg't U.S. Col'd Cavalry.

Appears on

Company Muster Roll

for *May + June*, 1864

Present or absent *Present*

Stoppage, \$ 100 for

Due Gov't, \$ 100 for

Valuation of horse, \$ 100

Valuation of horse equipments, \$ 100

Remarks:

Book mark:

Boyer

H | 3 Cav. | U.S.C.T.

Timothy Hinton
Sgt., Co. G, 3 Reg't U. S. Col'd Cavalry.

Appears on

Company Muster Roll

for July & Aug, 1864.

Present or absent Present

Stoppage, \$ 100 for

Due Gov't, \$ 100 for

Valuation of horse, \$ 100

Valuation of horse equipments, \$ 100

Remarks: Appointed Sergeant,
Dec, 24, 1863.

Book mark:

(358)

Posey

Copyist.

A | **3 Cav.** | **U.S.C.T.**

Timothy Menton

Serjt, Co. G, 3 Reg't U. S. Col'd Cavalry.

Appears on

Company Muster Roll

for Sept + Oct, 1866.

Present or absent Present

Stoppage, \$ 100 for

Due Gov't, \$ 100 for

Valuation of horse, \$ 100

Valuation of horse equipments, \$ 100

Remarks: stopped one bullet
Army revolver \$124.14

Book mark: _____

W. J. Andrews

7 | **3 Cav. | U.S.C.T.**

Timothy Hinton
Sept, Co. G, 3 Reg't U. S. Col'd Cavalry.

Appears on

Company Muster Roll

for *Nov + Dec*, 186 *1*.

Present or absent *Present*

Stoppage, \$ *100* for

Due Gov't, \$ *100* for

Valuation of horse, \$ *100*

Valuation of horse equipments, \$ *100*

Remarks: *To be stopped from
September + Oct rolls for
Ordinance 5/4. 31.*

Book mark: _____

[Signature]
Copyist.

YH | **3 Cav.** | **U.S.C.T.**

Timothy Hinton
Sergeant, Co. G, 3 Reg't U.S. Col'd Cavalry.

Appears on

Company Muster Roll

for *Dated Feb 28*, 186*5*.

Present or absent *Present*

Stoppage, \$ *100* for

Due Gov't, \$ *100* for

Valuation of horse, \$ *100*

Valuation of horse equipments, \$ *100*

Remarks: *To be stopped from Sept
and Oct Rules \$19.31*

Book mark:

(358)

[Signature]
Copyist.

W | **3 Cav.** | **U.S.C.T.**

Timothy Hinton
Sgt, Co. G, 3 Reg't U. S. Col'd Cavalry.

Appears on

Company Muster Roll

for *March & April*, 1865.

Present or absent *Absent*

Stoppage, \$ 100 for

Due Gov't, \$ 100 for

Valuation of horse, \$ 100

Valuation of horse equipments, \$ 100

Remarks: *Absent on expedition*
Since Apr 29. To be stopped
for 1 Cap powder & Pick 45¢

Book mark: _____

(358)

J. J. Lewis
Copyist.

W | **3 Cav.** | **U.S.C.T.**

Timothy Hinton
Sept - , Co. G, 3 Reg't U. S. Col'd Cavalry.

Appears on

Company Muster Roll

for *May & June*, 1865.

Present or absent *Present*

Stoppage, \$ *100* for

Due Gov't, \$ *100* for

Valuation of horse, \$ *100*

Valuation of horse equipments, \$ *100*

Remarks: *To be stopped for one labor \$7.50
one Curry Comb. 26¢*

Book mark:

(358)

Jarvis
Copyist.

176 | **3 Cav.** | **U.S.C.T.**

Timothy Winston
for, Co. G, 3 Reg't U. S. Col'd Cavalry.

Appears on

Company Muster Roll

for *July + Aug*, 1865.

Present or absent *Present*

Stoppage, \$ 100 for

Due Gov't, \$ 100 for

Valuation of horse, \$ 100

Valuation of horse equipments, \$ 100

Remarks: *Reduced to ranks from Sgt -
Aug 24/65. To be stopped for One
Quarry Count 26^c.*

Book mark:

(358)

J. J. Harris
Copyist.

H | **3 Cav.** | **U.S.C.T.**

Timothy Hinton

Pl, Co. G, 3 Reg't U. S. Col'd Cavalry.

Appears on

Company Muster Roll

for Sept & Oct, 1865.

Present or absent

Stoppage, \$ 52 for Ordellet
100

Due Gov't, \$ 100 for

Valuation of horse, \$ 100

Valuation of horse equipments, \$ 100

Remarks: 1 Spuro & Straps⁵²
Reduced from Sergt Aug 22/65
Stoppage for lost ordnance carried
from July & Aug rolls 78⁸

Book mark:

Burnham

H | **3 Cav.** | **U.S.C.T.**

Timothy Hinton

Plt, Co. G, 3 Reg't U. S. Col'd Cavalry.

Appears on

Company Muster Roll

for *Nov & Dec*, 1865.

Present or absent

Stoppage, \$ *20* $\frac{50}{100}$ for *ordnance*

Due Gov't, \$ *100* for

Valuation of horse, \$ *100*

Valuation of horse equipments, \$ *100*

Remarks: *Deserted*

1 Colts Revolver

Total ordnance stopped \$ 20.52

Book mark:

Beerman

A | 3 Cav | U.S.C.T.

Timothy Hinlwa
Pot, Co. G, 3 Reg't U. S. Col'd Cav

Appears on

Descriptive List of Deserters

dated *Memphis Tenn Jan 1*, 1866.

Deserted :

When *Dec 20*, 1865.

Where *Memphis Tenn*

Arrested :

When _____, 186 .

Where _____

Remarks : *Stopped for Ordnance*
\$36.52

Book mark : _____

(351)

A S Miller

Copyist.

H. | 3 Cav. | U.S.C.T.

Timothy Hinton

Pvt., Co. G, 3 Reg't U. S. Colored Cav.

Appears on Returns as follows:

Dec. 1863. Lost Dec. 20/65
Memphis, Tenn. deserted.

Book mark :

(546)

J. B. Sittler

Copyist.

A | **3 Cav.** | **U.S.C.T.**

Timothy Hinton
Plt, Co. *G*, 3 Reg't U. S. Col'd Cavalry.

Appears on **Co. Muster-out Roll**, dated
Memphis Tenn Jan 26, 186*6*.

Muster-out to date _____, 186 .

Last paid to *June 30*, 186*5*.

Clothing account:

Last settled _____, 186 ; drawn since \$ _____ $\overline{100}$

Due soldier \$ _____ $\overline{100}$; due U. S. \$ _____ $\overline{100}$

Am't for cloth'g in kind or money adv'd \$ _____ $\overline{100}$

Due U. S. for arms, equipments, &c., \$ _____ $\overline{100}$

Bounty paid \$ _____ $\overline{100}$; due \$ _____ $\overline{100}$

Remarks: *Deserted Memphis Tenn*
Dec 20/65

Book mark: _____

(361)

Burnham

Copyist.

673

Hiram, John

Co F, 3 U. S. Col'd Cav.

Private

Private

CARD NUMBERS.

1	5330921	26
2	5339209	27
3	5339287	28
4	5339371	29
5	5339463	30
6	5339566	31
7	5339661	32
8	5339751	33
9	5339838	34
10	5339919	35
11	5339998	36
12	9088948	37
13	40727454	38
14		39
15		40
16		41
17		42
18		43
19		44
20		45
21		46
22		47
23		48
24		49
25		50

Book Mark:

See also

S937122 - Po mil.

A. M. Shannon
Dr
Dr

A | **3 Cav. | U.S.C.T.**

John Niram

....., Co. F, 3 Reg't U. S. Col'd Cav.

Appears on

Company Descriptive Book
of the organization named above.

DESCRIPTION.

Age 25 years; height 5 feet 2 inches.

Complexion Black

Eyes Black; hair Black

Where born Lagrange Tennessee

Occupation Farmer

ENLISTMENT.

When July 1, 1864

Where Vicksburg Miss.

By whom Col Coburn; term 3 y'rs.

Remarks:

.....

.....

.....

.....

.....

.....

.....

E. Arstein

No. | 3 | *Car* | **U.S.C.T.**

John Hiram
Co., Co., *3* Reg't U. S. Col'd *Car*
Age *25* years.

Appears on a

Detachment Muster-in Roll

of the organization named above. Roll dated
Vicksburg, Miss, July 22, 1864.

Muster-in to date *July 1, 1864.*

Joined for duty and enrolled:

When *July 1, 1864.*

Where *Vicksburg, Miss.*

Period *3* years.

Valuation of horse, \$ *100*

Valuation of horse equipments, \$ *100*

Remarks:

Book mark:

(337)

Sitters.

Copyist.

H | **3 Cav.** | **U.S.C.T.**

John Stiram

Pvt, Co. F, 3 Reg't U. S. Col'd Cavalry.

Appears on

Company Muster Roll

for July & Aug., 1864.

Present or absent Present

Stoppage, \$ 100 for

Due Gov't, \$ 100 for

Valuation of horse, \$ 100

Valuation of horse equipments, \$ 100

Remarks: Joined a recruit

July 1/64.

Detained at R. I. M.

Dept. as teamster

July 31/64 By order of

Maj. J. B. Cook

Comd'g. Regt.

Book mark: _____

E. Richardson

A | **3 Cav.** | **U.S.C.T.**

John Niram

Priv, Co. F, 3 Reg't U. S. Col'd Cavalry.

Appears on

Company Muster Roll

for Sept & Oct, 1864.

Present or absent Present

Stoppage, \$ 100 for

Due Gov't, \$ 100 for

Valuation of horse, \$ 100

Valuation of horse equipments, \$ 100

Remarks:

Book mark:

E J Richardson

(358)

Copyist.

26 | **3 Cav. | U.S.C.T.**

John W. Hiram

Pvt, Co. F, 3 Reg't U. S. Col'd Cavalry.

Appears on

Company Muster Roll

for Nov 1864, 1864.

Present or absent present

Stoppage, \$ 100 for

Due Gov't, \$ 100 for

Valuation of horse, \$ 100

Valuation of horse equipments, \$ 100

Remarks:

Book mark:

Mear

M | **3 Cav.** | **U.S.C.T.**

John Mirant

1st, Co. F, 3 Reg't U. S. Col'd Cavalry.

Appears on

Company Muster Roll

for *Jan & Feb*, 186*5*

Present or absent *present*

Stoppage, \$ *100* for

Due Gov't, \$ *100* for

Valuation of horse, \$ *100*

Valuation of horse equipments, \$ *100*

Remarks: *Detained as
sawyer at R.G.M.
Sept*

Book mark: _____

Mead

M | **3 Cav.** | **U.S.C.T.**

John Mirant

M, Co. F, 3 Reg't U. S. Col'd Cavalry.

Appears on

Company Muster Roll

for *March & April*, 1865.

Present or absent *present*

Stoppage, \$ *100* for

Due Gov't, \$ *100* for

Valuation of horse, \$ *100*

Valuation of horse equipments, \$ *100*

Remarks:

Book mark:

(358)

Mean

Copyist.

Mc | **3 Cav.** | **U.S.C.T.**

John Minant

14, Co. F, 3 Reg't U. S. Col'd Cavalry.

Appears on

Company Muster Roll

for May 29 June 1865, 1865.

Present or absent present

Stoppage, \$ 100 for

Due Gov't, \$ 100 for

Valuation of horse, \$ 100

Valuation of horse equipments, \$ 100

Remarks: _____

Book mark: _____

Mc
Copyist.

No. | **3 Cav. | U.S.C.T.**

John Hinman
Pvt, Co. F, 3 Reg't U. S. Col'd Cavalry.

Appears on

Company Muster Roll

for *July & Aug*, 1865.

Present or absent *present*

Stoppage, \$ _____ 100 for _____

Due Gov't, \$ _____ 100 for _____

Valuation of horse, \$ _____ 100

Valuation of horse equipments, \$ _____ 100

Remarks: _____

Book mark: _____

(358)

Mead

Copyist.

H **3 Cav. | U.S.C.T.**

John H. ...
.....
..., Co. F, 3 Reg't U.S. Col'd Cavalry.

Appears on

Company Muster Roll

for *Sept 1st*, 186*3*.

Present or absent *Present*

Stoppage, \$.....100 for

Due Gov't, \$.....100 for

Valuation of horse, \$.....100

Valuation of horse equipments, \$.....100

Remarks:

Book mark:

...

A | **3 Cav.** | **U.S.C.T.**

John A. Mearns
Det., Co. F, 3 Reg't U. S. Col'd Cavalry.

Appears on

Company Muster Roll

for Jan. 1861, 1861.

Present or absent Present

Stoppage, \$ 100 for

Due Gov't, \$ 100 for

Valuation of horse, \$ 100

Valuation of horse equipments, \$ 100

Remarks:

Book mark: _____

John A. Mearns

(358) Copyist.

Ho. | **3 Cav.** | **U.S.C.T.**

John Hiram

Priv., Co. *F*, 3 Reg't U. S. Colored Cav.

Appears on **Returns** as follows:

July 1864. Gained July 20/64
Vicksburg, Miss. Enlisted

Aug. 1864 to Apr. 1865. On duty,
Teamster at R. Q. M. Dept.

Book mark :

(546)

J. B. Dittler

Copyist.

J | **3 Cav. | U.S.C.T.**

John Smith
.....
Co. F, 3 Reg't U. S. Col'd Cavalry.

Appears on **Co. Muster-out Roll**, dated
August 1st, 186*6*.

Muster-out to date *August*, 186*6*.

Last paid to *June 30*, 186*5*.

Clothing account:

Last settled, 186 ; drawn since \$.....100

Due soldier \$.....100; due U. S. \$.....*6* ^{*92*}/_{*100*}

Am't for cloth'g in kind or money adv'd \$.....100

Due U. S. for arms, equipments, &c., \$.....100

Bounty paid \$.....100; due \$.....100

Remarks:

.....

.....

.....

Book mark:

Smith
.....
(361) Copyist.

674

Hitchens, John
Co F, 3 U. S. Col'd Cav.

Private | Private

CARD NUMBERS.

1	5331199	26
2	5339279	27
3	5339346	28
4	5339428	29
5	5339534	30
6	5339630	31
7	5339722	32
8	5339810	33
9	5339891	34
10	5339970	35
11	9088964	36
12	40727455	37
13		38
14		39
15		40
16		41
17		42
18		43
19		44
20		45
21		46
22		47
23		48
24		49
25		50

Book Mark: _____

See also _____

A | **3 Cav. | U.S.C.T.**

John A. Sutton

....., Co. *F*, 3 Reg't U. S. Col'd Cav.

Appears on

Company Descriptive Book
of the organization named above.

DESCRIPTION.

Age *28* years; height *5* feet *10* inches.

Complexion *Colored*

Eyes *Black*; hair *Black*.

Where born *Warren County, Kentucky*

Occupation *Black Smith*

ENLISTMENT.

When *Sept 27*, 1864.

Where *Licksburg Miss*

By whom *Carl Kinsley*; term *3* y'rs.

Remarks:

.....

.....

.....

.....

.....

.....

.....

.....

.....

.....

.....

.....

.....

E. W. ...

N. | **3 Cav.** | **U.S.C.T.**

John Hitchens,

Appears with rank of *Private* on

Muster and Descriptive Roll of a Detachment of U. S. Vols. forwarded

for the 3 Reg't U. S. Col'd Cavalry. Roll dated

Vicksburg, Miss., Oct. 1, 1864.

Where born *Warren Co., Ky.*

Age *28* y'rs; occupation *Blacksmith.*

When enlisted *Septbr. 27*, 1864.

Where enlisted *Vicksburg.*

For what period enlisted *three* years.

Eyes *black*; hair *black;*

Complexion *colored*; height *5* ft. *10* in.

When mustered in *Septbr. 27*, 1864.

Where mustered in *Vicksburg.*

Bounty paid \$ *100*; due \$ *300.⁰⁰/₁₀₀*

Where credited *State of Mass.*

Company to which assigned

Remarks:

Book mark:

(339)

M. Brauner

Copyist.

A | **3 Cav.** | **U.S.C.T.**

John Hitchens
Rt, Co. F, 3 Reg't U. S. Col'd Cavalry.

Appears on

Company Muster Roll

for Sept + Oct, 1864

Present or absent Present

Stoppage, \$ 100 for

Due Gov't, \$ 100 for

Valuation of horse, \$ 100

Valuation of horse equipments, \$ 100

Remarks: Joined a recruit
Sept 27/64.

Book mark:

E. S. Richardson

(358)

Copyist.

M | **3 Cav. | U.S.C.T.**

John Hitchcock

Wm Smith, Co. F, 3 Reg't U. S. Col'd Cavalry.

Appears on

Company Muster Roll

for Nov Dec, 1864

Present or absent Absent

Stoppage, \$ 100 for

Due Gov't, \$ 100 for

Valuation of horse, \$ 100

Valuation of horse equipments, \$ 100

Remarks: Absent on account
since Dec 21 1864

Book mark: _____

Mason
Copyist.

Mc | **3 Cav.** | **U.S.C.T.**

John Mitchell
Blksmith, Co. F, 3 Reg't U.S. Col'd Cavalry.

Appears on

Company Muster Roll

for Jan 1st Feb, 1865.

Present or absent present

Stoppage, \$.....100 for

Due Gov't, \$.....100 for

Valuation of horse, \$.....100

Valuation of horse equipments, \$.....100

Remarks:

.....

.....

.....

.....

.....

.....

.....

.....

Book mark:

Mason
Copyist.

M | **3 Cav.** | **U.S.C.T.**

John Mitchem

Blksmith, Co. F, 3 Reg't U. S. Col'd Cavalry.

Appears on

Company Muster Roll

for *March & April*, 1865.

Present or absent *Absent*

Stoppage, \$ 100 for

Due Gov't, \$ 100 for

Valuation of horse, \$ 100

Valuation of horse equipments, \$ 100

Remarks: *Absent on
squad since April
27/65*

Book mark:

Mead

Mr | **3 Cav.** | **U.S.C.T.**

John Matthews
sergeant, Co. F, 3 Reg't U. S. Col'd Cavalry.

Appears on

Company Muster Roll

for May 1st, 1861.

Present or absent present

Stoppage, \$ 100 for

Due Gov't, \$ 100 for

Valuation of horse, \$ 100

Valuation of horse equipments, \$ 100

Remarks:

Book mark: _____

Math
Copyist.

M | **3 Cav.** | **U.S.C.T.**

John Whitcomb
Parrot, Co. F, 3 Reg't U. S. Col'd Cavalry.

Appears on

Company Muster Roll

for *July 4 Aug*, 186*5*.

Present or absent *present*

Stoppage, \$ *100* for

Due Gov't, \$ *100* for

Valuation of horse, \$ *100*

Valuation of horse equipments, \$ *100*

Remarks:

Book mark: -----

Meach

A | **3 Cav.** | **U.S.C.T.**

John Hutchins
Sav, Co. F, 3 Reg't U. S. Col'd Cavalry.

Appears on

Company Muster Roll

for Sept & Oct, 1863.

Present or absent Present

Stoppage, \$ 100 for

Due Gov't, \$ 100 for

Valuation of horse, \$ 100

Valuation of horse equipments, \$ 100

Remarks:
.....
.....
.....
.....
.....
.....
.....
.....
.....

Book mark:

[Signature]
Copyist.

1 | **3 Cav.** | **U.S.C.T.**

J. H. Adams
100, Co. F, 3 Reg't U. S. Col'd Cavalry.

Appears on

Company Muster Roll

for Nov 1 1865, 1865.

Present or absent Present

Stoppage, \$ 100 for

Due Gov't, \$ 100 for

Valuation of horse, \$ 100

Valuation of horse equipments, \$ 100

Remarks:
.....
.....
.....
.....
.....
.....
.....
.....

Book mark:

J. H. Adams
Copyist.

26 | 3 Cav. | U.S.C.T.

John Hitchens ✓
Prof., Co. F, 3 Reg't U. S. Colored Cav.
Art

Appears on Returns as follows:

Sept 1864 Loss Sept 27/64
Vicksburg Enlisted

Mich 1865 Blacksmith
Apr 1865 On extra or daily duty
May 1865 Blacksmith
June to Sept 1865 (Artif)
Co. Blacksmith
Oct 1865 Farrier

Name appears also as
John Holmes

Book mark :

26 R Street

(540)

Copist.

3 Cav. | U.S.C.T.

John S. [unclear]
[unclear], Co. *H*, 3 Reg't U. S. Col'd Cavalry.

Appears on **Co. Muster-out Roll**, dated
September 10, 1864, 186 *4*.
Muster-out to date *Jan 26*, 186 *6*.
Last paid to *Jan 30*, 186 *6*.

Clothing account:

Last settled _____, 186 ; drawn since \$ _____ $\overline{100}$
Due soldier \$ _____ $\overline{100}$; due U. S. \$ *13* ^{*45*} $\overline{100}$
Am't for cloth'g in kind or money adv'd \$ _____ $\overline{100}$

Due U. S. for arms, equipments, &c., \$ _____ $\overline{100}$
Bounty paid \$ _____ $\overline{100}$; due \$ *100* ^{*00*} $\overline{100}$

Remarks: _____

Book mark: _____

[Signature]

Copyist.

675 or Joseph
Hobbs, Joe
Co K, 3 U. S. Col'd Cav.

Private | Private

CARD NUMBERS.

1	5 2 4 3 6 7 8	26
2	5 3 4 3 7 7 7	27
3	5 3 4 3 8 6 6	28
4	5 3 4 3 9 4 8	29
5	5 3 4 4 0 3 6	30
6	5 3 4 4 1 2 1	31
7	5 3 4 4 2 1 0	32
8	5 3 4 4 3 1 6	33
9	5 3 4 4 4 1 1	34
10	5 3 4 4 5 4 4	35
11	5 3 3 1 8 4 8	36
12	5 3 3 1 8 4 4	37
13	5 3 4 4 8 2 7	38
14	9 0 8 1 4 7 7	39
15	4 0 7 2 7 5 4 1	40
16		41
17		42
18		43
19		44
20		45
21		46
22		47
23		48
24		49
25		50

Book Mark:

See also

H | 3 Cav. | U.S.C.T.

Joe Hobbs
Co. K, 3 Reg't U. S. Col'd Cav.

Appears on

Company Descriptive Book

of the organization named above.

DESCRIPTION.

Age 18 years; height 5 feet 7 1/2 inches.

Complexion Black

Eyes Black; hair Black

Where born Limestone Ala.

Occupation Farmer

ENLISTMENT.

When Feb. 24, 1864.

Where Gaines Bluff

By whom Capt. Haynes, term 3 y'rs.

Remarks: Deserted Aug 15/65
at Memphis
Acct settled on
descriptive list

F. J. Smith

H. & Oar U.S.C.T.

Joe Hobbs
Co. M., 3 Reg't U. S. Col'd Cav

Appears on

Company Muster-in and Descriptive Roll
of the organization named above. Roll dated

Haines Bluff Miss, March 1, 1864.

Where born Limestone Ala

Age 3 yrs; occupation Farmer

When enlisted Feb 24, 1864.

Where enlisted Haines Bluff Miss

For what period enlisted 3 years.

Eyes Black, hair Black

Complexion Black, height 5 ft. 4 1/2 in.

When mustered in _____, 186 .

Where mustered in _____

Bounty paid \$ 100; due \$ 100

Where credited _____

Company to which assigned _____

Remarks : _____

* Became Cox 3rd Regt U.S.C. Cav

Book mark : _____

Beach

(356d) Copyist.

H | **3 Cav. | U.S.C.T.**

Joe Kabbs
Regt, Co. K, 3 Reg't U. S. Col'd Cavalry.

Appears on

Company Muster Roll
for *Feby 24 to Apt 30*, 186 *!*

Present or absent *Present*

Stoppage, \$ *100* for

Due Gov't, \$ *100* for

Valuation of horse, \$ *100*

Valuation of horse equipments, \$ *100*

Remarks:

Mustered in Feby
'64 at Harris Bluff

Book mark:

Beach

W | **3 Cav.** | **U.S.C.T.**

Joe Hobbs

704, Co. K, 3 Reg't U. S. Col'd Cavalry.

Appears on

Company Muster Roll

for *May & June*, 186*4*.

Present or absent *Present*

Stoppage, \$ *100* for

Due Gov't, \$ *100* for

Valuation of horse, \$ *100*

Valuation of horse equipments, \$ *100*

Remarks:

Book mark:

Beach

16 | **3 Cav. | U.S.C.T.**

Joe Hobbs
1st, Co. K, 3 Reg't U. S. Col'd Cavalry.

Appears on

Company Muster Roll

for July & Aug, 1864

Present or absent Present

Stoppage, \$ 100 for

Due Gov't, \$ 100 for

Valuation of horse, \$ 100

Valuation of horse equipments, \$ 100

Remarks: Stop for Curry comb,
brush, Spurs, Straps
157

Book mark:

Beach

H | **3 Cav. | U.S.C.T.**

Joseph Hobbs
Priv, Co. K, 3 Reg't U. S. Col'd Cavalry.

Appears on

Company Muster Roll

for *Sept & Oct*, 186*4*.

Present or absent *Present*

Stoppage, \$.....*100* for

Due Gov't, \$.....*100* for

Valuation of horse, \$.....*100*

Valuation of horse equipments, \$.....*100*

Remarks:

Book mark:

Beach
(358) *Beach* Copyist.

A | **3 Cav. U.S.C.T.**

Joseph Hobbs
Pvt, Co. K, 3 Reg't U. S. Col'd Cavalry.

Appears on

Company Muster Roll

for *Nov. & Dec*, 186*4*.

Present or absent *Present*

Stoppage, \$ *34* ^{*24*}/_{*100*} for *ordnance lost or destroyed*

Due Gov't, \$ *100* for

Valuation of horse, \$ *100*

Valuation of horse equipments, \$ *100*

Remarks:
absent on scout since Dec 21st/64

Book mark:

(358)

Talentrie
Copyist.

H | **3 Cav.** | **U.S.C.T.**

Joseph Hobbs

Pvt, Co. K, 3 Reg't U. S. Col'd Cavalry.

Appears on

Company Muster Roll

for *Jan. & Feb.*, 1865.

Present or absent *Present*.

Stoppage, \$ *34* ^{*24*}/_{*100*} for *gross amt*
ordnance lost or destroyed

Due Gov't, \$ _____ ^{*100*} for _____

Valuation of horse, \$ _____ ^{*100*}

Valuation of horse equipments, \$ _____ ^{*100*}

Remarks: _____

Book mark: _____

(358)

Valentine

Copyist.

A | 3 Cav. | **U.S.C.T.**

Joseph Hobbs
Priv., Co. K, 3 Reg't U. S. Col'd Cav.

Appears on

Company Muster Roll

for Mar. & Apr., 1865.

Present or absent Absent.

Stoppage, \$ 100 for

Due Gov't, \$ 100 for

Valuation of horse, \$ 100

Valuation of horse equipments, \$ 100

Remarks: Absent on ex-
pedition since Apr.
29, 65.

<u>4 sets com. tent poles @ 115</u>	<u>\$4.60</u>
<u>4 Hatchets @ 57¢</u>	<u>3.24</u>
<u>4 Hatchet Handles</u>	<u>.28</u>
	<u>\$ 8.12</u>

Book mark: ..

(358)

Asa Hall
Comptroller

A | **3 Cav.** | **U.S.C.T.**

Joseph Hobbs

Priv., Co. K, 3 Reg't U. S. Col'd Cavalry.

Appears on

Company Muster Roll

for *May & June*, 1865.

Present or absent *Present*

Stoppage, \$.....100 for

Due Gov't, \$.....100 for

Valuation of horse, \$.....100

Valuation of horse equipments, \$.....100

Remarks:

Book mark:

Valentine

A | **3 Cav.** | **U.S.C.T.**

Joseph Hobb
Priv., Co. K, 3 Reg't U. S. Col'd Cavalry.

Appears on

Company Muster Roll

for *July & Aug*, 1865.

Present or absent

Stoppage, \$ 100 for

Due Gov't, \$ 100 for

Valuation of horse, \$ 100

Valuation of horse equipments, \$ 100

Remarks:

Deserted at Mem-
phis Tenn. Aug. 15/65

Book mark:

(358)

Valentine

Copyist.

A | 3 Cav | **U.S.C.T.**

Joseph Hobbs
Pvt, Co K, 3 Reg't U. S. Col'd Cav

Appears on

Descriptive List of Deserters

dated Memphis Tenn Aug 31, 1865.

Deserted:

When Aug 11, 1865.

Where Memphis

Arrested:

When _____, 186 .

Where _____

Remarks: Worthless

Book mark: _____

(351)

H S Miller

Copyist.

N | 3rd Cav | **U.S.C.T.**

Joseph Hobbs
Pvt, Co. K, 3 Reg't U. S. Col'd Cav

Appears on

Descriptive List of Deserters

dated Memphis Tenn Aug 31, 1865.

Deserted:

When Aug 11, 1865.

Where Memphis Tenn

Arrested:

When _____, 186 .

Where _____

Remarks: worthless

Book mark: _____

(351)

H. J. Miller

Copyist.

Hobbs | **3 Cav.** | **U.S.C.T.**

Joseph Hobbs
Pvt., Co. K, 3 Reg't U. S. Colored Cav.

Appears on **Returns** as follows:

Aug. 1865, Loss Aug. 16/65 -
Memphis - Deserted.

Book mark :

(546) J. B. Dittler Copyist.

H | **3 Cav.** | **U.S.C.T.**

Joseph Hobbs
Priv., Co. *K*, 3 Reg't U. S. Col'd Cavalry.

Appears on **Co. Muster-out Roll**, dated
Memphis, Tenn., Jan. 26, 1866.

Muster-out to date _____, 186 .

Last paid to *Feb. 28, 1865.*

Clothing account:

Last settled _____, 186 ; drawn since \$ _____ 100

Due soldier \$ _____ 100; due U. S. \$ _____ 100

Am't for cloth'g in kind or money adv'd \$ _____ 100

Due U. S. for arms, equipments, &c., \$ _____ 100

Bounty paid \$ _____ 100; due \$ _____ 100

Remarks: *Deserted Aug. 15, 1865.*

Book mark: _____

(361)

Howard
Copyist.

676

Hodges, Henderson

Co F, 3 U. S. Col'd Cav.

Private

Private

CARD NUMBERS.

1	5338883	26
2	5339015	27
3	5340045	28
4	9088950	29
5	40727456	30
6		31
7		32
8		33
9		34
10		35
11		36
12		37
13		38
14		39
15		40
16		41
17		42
18		43
19		44
20		45
21		46
22		47
23		48
24		49
25		50

Book Mark:

See also

A | **3 Cav.** | **U.S.C.T.**

Henderson & Lodges,

....., Co. F., 3 Reg't U. S. Col'd Cav.

Appears on

Company Descriptive Book
of the organization named above.

DESCRIPTION.

Age 21 years; height 5 feet 10 inches.

Complexion Black.

Eyes Black; hair Black.

Where born Bolivar Miss.

Occupation Farmer.

ENLISTMENT.

When Jan 1, 1864.

Where C. C. Sp.

By whom C. C. Spaulds; term 3 y'rs.

Remarks: Died in Hospital at Haynes
Bluffs, Tely 15, 64. Had pay due
from Enrollment. to Feb 15, 1864.

Had received Clothing amounting to
Thirty five dollars and Seventy one
Cents (\$35.71.) Final Statement
sent - Feb 15, 1864.

E. Weston

N | **3 Cav.** | **U.S.C.T.**

Henderson Hodges

Priv, Co. *F*, 1 Reg't Miss. Cav., Corps d'Afrique.*

Age 21 yrs
Appears on

Company Muster-in Roll

of the organization named above. Roll dated

Vicksburg Miss, Jan 26, 1864.

Muster-in to date *Jan 1, 1864.*

Joined for duty and enrolled:

When *Jan 1*, 186 *4*

Where *Skipwiths Miss.*

Period *3* years.

Valuation of horse, \$ 100

Valuation of horse equipments, \$ 100

Remarks:

*This organization subsequently became Co. *F*, 3 Reg't U. S. Colored Cavalry.

Book mark:

E. J. Richardson

(356)

Copyist.

H | 3 Cav. | U.S.C.T.

Henderson Hodges

Priv., Co. F, 1 Reg't Miss. Cav., Corps d'Afrique.*

Appears on

Company Muster Roll

for Dec. 6/63 to Feb 29, 1864.

Present or absent

Stoppage, \$ 100 for

Due Gov't, \$ 100 for

Valuation of horse, \$ 100

Valuation of horse equipments, \$ 100

Remarks: Died of Dysentary in Hospital at Haines Bluff Feb. 15/64.

*This organization subsequently became Co. F, 3 Reg't U. S. Colored Cavalry.

Book mark:

E. Richardson

(358)

Copyist.

He. | 3 Cav. | U.S.C.T.

Henderson Hodges
Pvt., Co. F, 3 Reg't U. S. Colored Cav.

Appears on Returns as follows:

Feb, 1864. (1 Miss. Cav. a. 20.)
Loss Feb. 14 Haines Bluff
Died of disease.

Book mark :

(546)

J. B. Dittler

Copyist.

| **3 Cav.** | **U.S.C.T.**

 , Co. , 3 Reg't U. S. Col'd Cavalry.

Appears on **Co. Muster-out Roll**, dated , 186 .
Muster-out to date , 186 .
Last paid to Never Paid , 186 .

Clothing account:

Last settled , 186 ; drawn since \$ 100
Due soldier \$ 100; due U. S. \$ 100
Am't for cloth'g in kind or money adv'd \$ 100

Due U. S. for arms, equipments, &c., \$ 100
Bounty paid \$ 100; due \$ 100

Remarks:

Book mark:

Hodges, Henderson
B., Co. *4*, **3** Reg't **U.S.C. Cav.**

2 Enclosures.

Bed Cards	Descriptive Lists
Burial Records	Final Statements 2
Certs. of Dis. for Discharge	Furloughs
C. M. Charges	Med. Des. Lists
Med. Certificates	Orders

Other papers relating to—

Admission to Hosp'l	Furlough
Casualty Sheet (Officer's)	Med. Examination
Confinement	Misc. Information
Contracts	Pay or Clothing
Death or Effects	Personal Reports
Desertions	Rank
Discharge from Hosp'l	Transfer to Hosp'l
Discharge from Service	Transfer to V. R. C.
Duty	Transportation

FINAL STATEMENT

OF

Anderson Hodges
First Reg't of Miss Cav Co

VOLUNTEERS.

NOTE 1.—Two of these certificates (or duplicates) are to be given to each volunteer soldier who may be discharged previously to the discharge of his company, that he may at once receive from the Paymaster the pay, &c., due him, and the captain or other officer commanding the company will certify to the act of the delivery of the duplicate certificates; on these certificates the Soldier is "entitled to" his discharge, and should also present his discharge to the Paymaster to have the payment endorsed on it. The discharge is to be given back to the Soldier by the Paymaster; the latter only retaining as his voucher the duplicate certificates.

NOTE 2.—If the Soldier is entitled to pay for the use of his horse, the Company Commander will certify to that fact, and also to the time he has pay due for having been so mounted on his own horse.

NOTE 3.—Amounts due the Sutler and Laundress must be entered on the Muster Roll on which the death, desertion, &c., is reported, as well as on the final statement, otherwise the amount cannot be collected from the United States.

NOTE 4.—This blank will be used for deceased volunteers as well as others.



1864

I certify, on honor, that Alexander Hodges a Private of
 Captain W. C. Spruill Company (A) of the 14 Regiment of Cavalry of
VOLUNTEERS, of the State of Mississippi, born in Bolivar, State
 of Mississippi, aged 22 years; 5 feet 10 inches high; Black complexion,
Black eyes, Black hair, and by occupation a Farmer, having joined the company on
 its original organization at Harrods Run, and enrolled in it at the muster into
 the service of the United States at Washington, on the 17th day
 of January, 1864, (or was mustered in service as a recruit, by _____
 _____, at _____, on the _____ day of _____,
 186 , to serve in the Regiment,) for the term of Three years
 and having served **HONESTLY** and **FAITHFULLY** with his Company in the field
 to the present date, is now entitled to a **DISCHARGE** by reason of Lack
of necessary means as an Officer
and buried in his company

The said Alexander Hodges was last paid by Paymaster
was not paid to include the _____ day of _____, 186 , and has
 pay due him from that time to the present date; he is entitled to pay and subsistence for
TRAVELING to place of enrollment and whatever other allowances are authorized to volunteer
 soldiers, or militia, so discharged. He has received Thirty three 7/₁₀₀ dollars,
 advanced by the United States on account of **CLOTHING**.

There is to be stopped from him, on account of the State of _____, or other
 authorities for **CLOTHING**, &c., received on entering service, _____ 100 dollars; also,
 for expenses of **SUBSISTENCE** for **TRAVELING** from place of enrollment to the place of rendezvous,
 amounting to _____ 100 dollars: and on account of the United States for **EXTRA**
CLOTHING received in kind from _____ and for other
 stoppages, viz:

_____ amounting to _____ 100 dollars;
 and he has been **SUBSISTED** for **TRAVELING** to his place of enrollment, up to the _____
 _____, 186 .

He is indebted to _____, **SUTLER**, _____ 100 dollars.
 He is indebted to _____, **LAUNDRESS**, _____ 100 dollars.

Given in Duplicate, at Harrods Run, this 14th day of July, 1864.
W. C. Spruill
Capt.

 Commanding Company.

✓
FINAL STATEMENT

OF

Henderson Hodges
1st Reg't of Miss Cav'D.

Volunteer
VOLUNTEERS.

NOTE 1.—Two of these certificates (or duplicates) are to be given to each Volunteer Soldier or drafted man who may be discharged previously to the discharge of his company, that he may at once receive from the Paymaster the pay, &c., due him, and the captain or other COMMISSIONED officer commanding the company will certify to the act of the delivery of the duplicate certificates; on these certificates the Soldier is "entitled to" his discharge, and should also present his discharge to the Paymaster to have the payment endorsed on it. The discharge is to be given back to the Soldier by the Paymaster; the latter only retaining as his voucher the duplicate certificates.

NOTE 2.—If the Soldier is entitled to pay for the use of his horse, the Company Commander will certify to that fact on the back of both these final statements, and also to the time he has pay due for having been so mounted on his own horse.

NOTE 3.—When a Soldier is furnished with final statements, his descriptive list, if he has one, should be taken up by the officer who gives the Soldier these statements, and endorsed with a statement to this effect by the officer. This endorsement should exhibit a full statement of the time for which the Soldier was allowed pay on his final statements, the clothing account, and all other charges against him or in his favor, so as to comprise a complete exhibit of his account. It will then be transmitted to the company commander of the Soldier, who will enter all the data necessary to a full understanding of the Soldier's account on the muster roll upon which the Soldier's discharge is reported. The descriptive list will then be destroyed. The object of this is, that the remaining portion of the Soldier's account may be settled upon the receipt of these muster rolls, and the Soldier receive any pay or allowances that may be due him at the time of his discharge, and which may not appear on his final statements from the fact that his descriptive list is incomplete. These accounts for back pay, &c., are settled by the 2d Auditor of the Treasury Department.

NOTE 4.—Charges for loss or injury to ordnance, horse equipments, and other miscellaneous charges, should appear under the heading of "Other Stoppages."

NOTE 5.—Bounty paid by State authorities, and not by the United States, will not be entered on this statement.

NOTE 6.—Amounts due the Sutler and Laundress must be entered on the muster roll on which the discharge, death, desertion, &c., is reported, as well as on the final statement, otherwise the amount cannot be collected from the United States.

NOTE 7.—This blank will be used for deceased volunteers and drafted men, as well as for others.

NOTE 8.—Where a Soldier dies in Hospital or on detached service, his descriptive list, if he has one, should be sent with his final statements, in duplicate, to the Adjutant General, Washington, D. C.

ADJUTANT GENERAL'S OFFICE.

April 8th 1864

Duplicate with Inventory sent 2d Auditor.

I certify, on honor, that Alexander Hodges a Private of
 Captain W. D. Faid Company (B) of the 1st Regiment of Miss Cav A
VOLUNTEERS, of the State of Mississippi, born in Edivar, State
 of Mississippi, aged 21 years; 5 feet 10 inches high, Black complexion.
Black eyes, Black hair, and by occupation a Farmer, having joined the company on
 its original organization at Shipwiths Edg Miss, and enrolled in it at the muster into
 the service of the United States at Chickburg Miss, on the 26th day
 of January, 1864, (or was mustered in service as a recruit, by _____
 _____, at _____, on the _____ day of _____,

1864, or was drafted and mustered into the service of the United States from the _____
 Enrollment District of the State of _____, at _____,
 on the _____ day of _____, 1864,) to serve in the Regiment, for
 the term of Three Years: and having served **HONESTLY** and
FAITHFULLY with his Company in Chickburg to the present date, is now
 entitled to a **DISCHARGE** by reason of Death from "Typhoid" Dysentery
July 15th 1864 at Haynes Bluffs Miss "His Effects"

The said Alexander Hodges has pay due from enrollment was last paid by Paymaster
 _____ to include the _____ day of _____, 1864, and has
 pay due him from that time to the present date; he is entitled to pay and subsistence for
TRAVELING to place of enrollment, and whatever other allowances are authorized to volunteer
 soldiers, drafted men, or militia, so discharged. He has received from the United States **CLOTHING**
 amounting to \$ 33 ⁷¹/₁₀₀ dollars, since the _____ day of Enrollment
 1864, when his clothing account was last settled. He has received from the United States
 _____ dollars advanced **BOUNTY**.

There is to be stopped from him, on account of the State of _____, or other
 authorities, for **CLOTHING, &c.**, received on entering service, _____ dollars; and
 for other stoppages, viz: _____
 _____ dollars.

He has been furnished with **TRANSPORTATION** in kind from the place of his discharge to
 _____; and he has been **SUBSISTED** for **TRAVELING** to his
 place of enrollment, up to the _____, 1864.

He is indebted to _____, **SUTLER**, _____ dollars.
 He is indebted to _____, **LAUNDRESS**, _____ dollars.

Given in Duplicate, at Haynes Bluffs Miss, this 19th day
 of March, 1864

Commodore Copais
Capt.

 Commanding Company.

677

Hodges, Isaac
Co D, 3 U. S. Col'd Cav.

Private | Sergeant

CARD NUMBERS.

1	5336188	26
2	5336278	27
3	5336324	28
4	5336426	29
5	5336495	30
6	5336561	31
7	5336642	32
8	5336732	33
9	5336826	34
10	5336932	35
11	5337035	36
12	5337130	37
12	5337226	38
14	5337314	39
15	5337397	40
16	9088647	41
17	40727542	42
18		43
19		44
20		45
21		46
22		47
23		48
24		49
25		50

Book Mark:

See also

S1234758 - P.O. M. Hill

J. 2023194 Co. M, W.

S-2027727 P.O. Hill

als 1385955

S2866182 and W.S.

A. M. Shannon
Gen

A | **3 Cav.** | **U.S.C.T.**

Isaac Hodges

....., Co. *D*, 3 Reg't U. S. Col'd Cav.

Appears on

Company Descriptive Book
of the organization named above.

DESCRIPTION.

Age *24* years; height *5* feet *6* inches.

Complexion *Black*

Eyes *Black*; hair *Black*

Where born *Jackson Mo.*

Occupation

ENLISTMENT.

When *Nov. 10*, 186 *3*

Where *Vicksburg*

By whom *G. C. Starr*; term *3* y'rs.

Remarks:

.....
.....
.....

Isaac Hodges

F. A. Wright

H | **3 Cav.** | **U.S.C.T.**

Isaac Hodges

Pri., Co. D, 1 Reg't Miss. Cav., Corps d'Afrique.*
Age 24 yrs
Appears on

Company Muster-in Roll

of the organization named above. Roll dated

Shipwith Ldg, Miss, Dec. 9, 1863.

Muster-in to date Nov 10, 1863.

Joined for duty and enrolled:

When Nov 10, 1863.

Where Vicksburg Miss

Period 3 years.

Valuation of horse, \$ 100

Valuation of horse equipments, \$ 100

Remarks:

*This organization subsequently became Co. D, 3 Reg't U. S. Colored Cavalry.

Book mark:

(356)

Amey

Copyist.

He | 3 Cav. | U.S.C.T.

Isaac Hodges

Pri, Co. D, 1 Reg't Miss. Cav., Corps d'Afrique.*

Appears on

Company Muster Roll

for Nov 16 to Dec 31, 1863.

Present or absent Present

Stoppage, \$ 100 for

Due Gov't, \$ 100 for

Valuation of horse, \$ 100

Valuation of horse equipments, \$ 100

Remarks:

*This organization subsequently became Co. D, 3 Reg't U. S. Colored Cavalry.

Book mark:

(358)

Avery

Copyist.

76 | **3 Cav.** | **U.S.C.T.**

Isaac Hodges

Sgt. Co. D, 1 Reg't Miss. Cav., Corps d'Afrique.*

Appears on

Company Muster Roll

for Jan & Feb, 1864.

Present or absent Present

Stoppage, \$ 100 for

Due Gov't, \$ 100 for

Valuation of horse, \$ 100

Valuation of horse equipments, \$ 100

Remarks:

*This organization subsequently became Co. D, 3 Reg't U. S. Colored Cavalry.

Book mark:

(358)

Avery

Copyist.

26 | **3 Cav.** | **U.S.C.T.**

Isaac Hodges
Serjt., Co. D, 3 Reg't U. S. Col'd Cavalry.

Appears on

Company Muster Roll

for Mar & Apr., 1864.

Present or absent Present

Stoppage, \$ 100 for

Due Gov't, \$ 100 for

Valuation of horse, \$ 100

Valuation of horse equipments, \$ 100

Remarks:

Book mark:

(358)

Avery

Copyist.

H | **3 Cav.** | **U.S.C.T.**

Isaac Hodges
Singl., Co. D, 3 Reg't U. S. Col'd Cavalry.

Appears on

Company Muster Roll

for *May & June*, 1864.

Present or absent *Present*

Stoppage, \$ *100* for

Due Gov't, \$ *100* for

Valuation of horse, \$ *100*

Valuation of horse equipments, \$ *100*

Remarks:
.....
.....
.....
.....
.....
.....
.....
.....
.....

Book mark:

Avery
(358) Copyist.

N | **3 Cav. U.S.C.T.**

Isaac Hodges

Serjt, Co. D, 3 Reg't U. S. Col'd Cavalry.

Appears on

Company Muster Roll

for *July and Aug*, 1864.

Present or absent *Present*

Stoppage, \$ *100* for

Due Gov't, \$ *100* for

Valuation of horse, \$ *100*

Valuation of horse equipments, \$ *100*

Remarks:

Book mark:

Drown

358
No | 3 Cav. | U.S.C.T.

Isaac Hodges
Sgt., Co. D, 3 Reg't U. S. Col'd Cavalry.

Appears on

Company Muster Roll
for Sept 10th, 1864

Present or absent Present

Stoppage, \$ 100 for

Due Gov't, \$ 100 for

Valuation of horse, \$ 100

Valuation of horse equipments, \$ 100

Remarks:

Book mark:

(358) Taylor Copyist.

Mo | **3 Cav.** | **U.S.C.T.**

Isaac Hoelges
Sgt., Co. D, 3 Reg't U. S. Col'd Cavalry.

Appears on

Company Muster Roll

for Nov 1864, 1864.

Present or absent Present

Stoppage, \$ 90 for 1 Canteen
1 Haversack

Due Gov't, \$ 1 for 1 Ordnance

Valuation of horse, \$ 100

Valuation of horse equipments, \$ 100

Remarks:
.....
.....
.....
.....
.....
.....
.....
.....
.....

Book mark:

Blaylor
Copyist.

26 | **3 Cav. | U.S.C.T.**

Isaac Hodges
Sgt., Co. D, 3 Reg't U.S. Col'd Cavalry.

Appears on

Company Muster Roll

for *Jan'y & Feb'y*, 1865.

Present or absent *Present*

Stoppage, \$ 100 for

Due Gov't, \$ 100 for

Valuation of horse, \$ 100

Valuation of horse equipments, \$ 100

Remarks:

Book mark:

(358)

B. Taylor
Copyist.

No | **3 Cav.** | **U.S.C.T.**

Isaac Hodges
Sergeant, Co. D, 3 Reg't U.S. Col'd Cavalry.

Appears on

Company Muster Roll

for *March & April*, 186*5*

Present or absent *Absent*

Stoppage, \$ *100* for

Due Gov't, \$ *100* for

Valuation of horse, \$ *100*

Valuation of horse equipments, \$ *100*

Remarks: *Absent on Scout*
Wagon for one man &
Wagon & 40 cents

Book mark: _____

(358)

E. Taylor

Copyist.

No | **3 Cav.** | **U.S.C.T.**

Isaac Hodges
Sergeant, Co. D, 3 Reg't U. S. Col'd Cavalry.

Appears on

Company Muster Roll

for *May & June*, 1865.

Present or absent *Present*

Stoppage, \$ *90* for *W.C. & G.E.*

Due Gov't, \$ *100* for

Valuation of horse, \$ *100*

Valuation of horse equipments, \$ *100*

Remarks:
.....
.....
.....
.....
.....
.....
.....
.....
.....

Book mark:

J. Taylor
Copyist.

As | **3 Cav.** | **U.S.C.T.**

Isaac Hodges

Serjeant, Co. D, 3 Reg't U. S. Col'd Cavalry.

Appears on

Company Muster Roll

for July & Aug., 1865.

Present or absent Present

Stoppage, \$ 100 for

Due Gov't, \$ 100 for

Valuation of horse, \$ 100

Valuation of horse equipments, \$ 100

Remarks: _____

Book mark: _____

(858)

Hayler
Copyist.

A. | **3 Cav.** | **U.S.C.T.**

Isaac Hodges
Sergt., Co. D, 3 Reg't U. S. Col'd Cavalry.

Appears on

Company Muster Roll

for Sept. and Oct., 1865.

Present or absent Present

Stoppage, \$ 100 for

Due Gov't, \$ 100 for

Valuation of horse, \$ 100

Valuation of horse equipments, \$ 100

Remarks: To be stoped for
Ordnance, Sling &
Swivel \$2.02

Book mark: _____

(358)

Rhett

Copyist.

A. | **3 Cav.** | **U.S.C.T.**

Isaac Hodges
Sergeant, Co. D, 3 Reg't U. S. Col'd Cavalry.

Appears on

Company Muster Roll

for *Nov. and Dec.*, 1865.

Present or absent *Present*

Stoppage, \$ *100* for

Due Gov't, \$ *100* for

Valuation of horse, \$ *100*

Valuation of horse equipments, \$ *100*

Remarks:

Book mark:

Rhett

(358)

Copyist.

H. | 3 Cav. | U.S.C.T.

Isaac Hodges
Pvt., Co. D, 3 Reg't U. S. Colored Cav.

Appears on **Returns** as follows:

Jan. 1864 (1 Miss. Cav. A. D.)
Absent detached service
since Jan. 28/64,
Recruiting.

Book mark :

(546)

J. B. Sittler

Copyist.

A. | **3 Cav.** | **U.S.C.T.**

Isaac Hodges
Sergh, Co. D, 3 Reg't U. S. Col'd Cavalry.

Appears on **Co. Muster-out Roll**, dated
Memphis Tenn, Jan 26, 1866.

Muster-out to date Jan 26, 1866.

Last paid to June 3, 1865.

Clothing account:

Last settled....., 186 ; drawn since \$.....100

Due soldier \$.....100; due U. S. \$.....6 ⁵⁹/₁₀₀

Am't for cloth'g in kind or money adv'd \$.....100

Due U. S. for arms, equipments, &c., \$.....100

Bounty paid \$.....00100; due \$.....00100

Remarks: Ordnance due
U. S. \$2.02

Book mark :

(861)

Rhett

Copyist.

678

Hogans, Joseph
Co I, 3 U. S. Col'd Cav.

Private | Private

CARD NUMBERS.

1	5342524	26
2	5342662	27
3	5342748	28
4	5331668	29
5	5343645	30
6	9089335	31
7	40727543	32
8		33
9		34
10		35
11		36
12		37
13		38
14		39
15		40
16		41
17		42
18		43
19		44
20		45
21		46
22		47
23		48
24		49
25		50

Book Mark:

See also

H | **3 Cav. U.S.C.T.**

Joseph Hogan
Co., 3 Reg't U. S. Col'd Cav.

Appears on

Company Descriptive Book

of the organization named above.

DESCRIPTION.

Age *45* years; height *5* feet *7* inches.

Complexion *Blk*

Eyes *blk*; hair *blk*

Where born *Ind*

Occupation *Blk Smith*

ENLISTMENT.

When *Feb 24*, 1864.

Where *Haines Bluff*

By whom *Capt Brumard*, term *3* y'rs.

Remarks: *Rec'd from Haines Bluff
March 5/64*

Hillman

A | **3 Cav.** | **U.S.C.T.**

Joseph Hogans

Priv., Co. *D*, 1 Reg't Miss. Cav., Corps d'Afrique.*

Age *45 yrs*
Appears on

Company Muster-in Roll

of the organization named above. Roll dated

Haines Bluffs Miss Feb 26, 186*4*.

Muster-in to date *Feb 24*, 186*4*.

Joined for duty and enrolled:

When *Feb 24*, 186*4*.

Where *Haines Bluffs Miss.*

Period *3* years.

Valuation of horse, \$.....100

Valuation of horse equipments, \$.....100

Remarks:.....

*This organization subsequently became Co. *D*, 3 Reg't U. S. Colored Cavalry.

Book mark:.....

Bradshaw

(356)

Copyist.

N | **3 Cav.** | **U.S.C.T.**

Joseph Hoggans
Pvt, Co. I, 3 Reg't U. S. Col'd Cavalry.

Appears on

Company Muster Roll
for *Feb 24 to Apr 30*, 186*4*.

Present or absent.....

Stoppage, \$.....100 for.....

Due Gov't, \$.....100 for.....

Valuation of horse, \$.....100

Valuation of horse equipments, \$.....100

Remarks: *Deserted from*
Hairs Bluffs
March 5, 1864. Stop
for one Gardeen, one
Haversack \$0.90.

Book mark:.....

Bradshaw

(358)

Copyist.

A/ | **3 Cav.** | **U.S.C.T.**

Joseph Meyers

Priv., Co. I, 3 Reg't U. S. Col'd Cavalry.

Appears on

Company Muster Roll

for *May & June* -----, 186*4*

Present or absent -----

Stoppage, \$ ----- *100* for -----

Due Gov't, \$ ----- *100* for -----

Valuation of horse, \$ ----- *100*

Valuation of horse equipments, \$ ----- *100*

Remarks: *Deserted from*
Haines Bluffs March
5th 1864.
Stop for one quarter
one Haversack 90 cts.

Book mark: -----

Bradshaw

H | 3 Cav | **U.S.C.T.**

Joseph Hagan
Pvt, Co I, 3 Reg't U. S. Col'd Cav

Appears on

Descriptive List of Deserters

dated Haines Bluffs Miss Apr 14, 1864.

Deserted :

When March 5, 1864.

Where Haines Bluffs

Arrested :

When _____, 186 .

Where _____

Remarks :

Book mark : _____

H S Miller

H. | **3 Cav.** | **U.S.C.T.**

Joseph Hogans
Pvt., Co. I, 3 Reg't U. S. Colored Cav.

Appears on **Returns** as follows:

Mar. 1864. Loss - March 5"
Haine Bluffs - Deserted

Book mark :

(546)

J. B. Sittler

Copyist.

A | **3 Cav.** | **U.S.C.T.**

Joseph Hagens

Bris, Co. D, 3 Reg't U. S. Col'd Cavalry.

Appears on **Co. Muster-out Roll**, dated

Memphis Tenn Jan 26, 1866.

Muster-out to date _____, 1866.

Last paid to Turn, _____, 1866.

Clothing account:

Last settled _____, 1866 ; drawn since \$ _____ 100

Due soldier \$ _____ 100; due U. S. \$ _____ 100

Am't for cloth'g in kind or money adv'd \$ _____ 100

Due U. S. for arms, equipments, &c., \$ _____ 100

Bounty paid \$ _____ 100; due \$ _____ 100

Remarks: Resided at Hains

Bluff Miss March 5/64
Descriptive roll furnished

Mustering Captain

Book mark: _____

Edwards

679

Holland, Green

Co I, 3 U. S. Col'd Cav.

Private | Private

CARD NUMBERS.

1	5331347	26
2	5343039	27
3	5343188	28
4	5331802	29
5	5343651	30
6	9089393	31
7	40727544	32
8		33
9		34
10		35
11		36
12		37
13		38
14		39
15		40
16		41
17		42
18		43
19		44
20		45
21		46
22		47
23		48
24		49
25		50

Book Mark:

See also

N | **3 Cav. U.S.C.T.**

Gene Holland

....., Co., 3 Reg't U. S. Col'd Cav.

Appears on

Company Descriptive Book

of the organization named above.

DESCRIPTION.

Age *25* years; height *5* feet *10* inches.

Complexion *Blk*

Eyes *Dark*; hair *Blk*

Where born *Georgia*

Occupation *Slave*

ENLISTMENT.

When *Feb 1*, 1865.

Where *Memphis*

By whom *Maj. Main*; term *3* y'rs.

Remarks: *Enlisted in by S. M. Campbell*

to Galapagos enrollment

Deserted April 5 1865

Willow

H. | **3 Cav. | U.S.C.T.**

Green Holland

Appears with rank of *Priv.* on

Muster and Descriptive Roll of a Detachment of U. S. Vols. forwarded

for the 3 Reg't U. S. Col'd Cavalry. Roll dated

Memphis, Tenn., Feb 11, 1865.

Where born *Georgia,*

Age *25* y'rs; occupation *Slave*

When enlisted *Feb. 1*, 1865.

Where enlisted *Memphis, Tenn.,*

For what period enlisted *3* years.

Eyes *Dark*; hair *Black*

Complexion *Black*; height *5 ft. 10 in.*

When mustered in *Feb 1*, 1865.

Where mustered in *Memphis, Tenn.,*

Bounty paid \$ *100*; due \$ *100*

Where credited *Memphis, Tenn.,*

Company to which assigned

Remarks:

Book mark:

Joiner

A | **3 Cav.** | **U.S.C.T.**

Green Holland

Plt-, Co. I, 3 Reg't U. S. Col'd Cavalry.

Appears on

Company Muster Roll

for Jan & Feby, 186 J.

Present or absent Present

Stoppage, \$ 100 for

Due Gov't, \$ 100 for

Valuation of horse, \$ 100

Valuation of horse equipments, \$ 100

Remarks:

Book mark: 227399

Lucas

H | 3 Cav | **U.S.C.T.**

Green Holland
Pvt, Co. I, 3 Reg't U. S. Col'd Cav

Appears on

Descriptive List of Deserters

dated Memphis Tenn. Mch 31, 1865.

Deserted :

When Mch 26, 1865.

Where Memphis

Arrested :

When _____, 186 .

Where _____

Remarks : Stopped for ordnance
\$99.71

Book mark : _____

(351)

H J Miller

Copyist.

H | **3 Cav. | U.S.C.T.**

Green Holland

Pat-, Co. I, 3 Reg't U. S. Col'd Cavalry.

Appears on

Company Muster Roll

for March & April, 1861:

Present or absent.....

Stoppage, \$..... 100 for.....

Due Gov't, \$..... 100 for.....

Valuation of horse, \$..... 100

Valuation of horse equipments, \$..... 100

Remarks: Received from Memphis Tenn. March 28/61. Stop for one Sharp Carbine, one Remington Revolver, one Light Cavalry Sabre, two Carbine Slings, two Carbine, two Carbine Swords, one Sabre belt, one Plate, one curb bridle, one curry Comb, one horse brush, one

Book mark:.....

Lucas

JAN. - 8

5343188

1891

Saddle complete one saddle
blanket one for Spurs and straps
99 71. one canton one
Haversack. 1.60.

H6 | 3 Cav. | U.S.C.T.

Green Holland
Pvt., Co. I, 3 Reg't U. S. Colored Cav.

Appears on **Returns** as follows:

Feb. 1865, Gain Feb. 11/65 -
Memphis, Enlisted Feb.
2/65,
Loss Mar 28/65 - Memphis,
Tenn. Deserted from Co.

Book mark :

(546)

J. B. Sittler

Copyist.

H | **3 Cav.** | **U.S.C.T.**

Green Holland

Priv., Co. D, 3 Reg't U. S. Col'd Cavalry.

Appears on **Co. Muster-out Roll**, dated

Memphis Tenn Jan 26, 1866.

Muster-out to date _____, 1866 .

Last paid to * Temporary, 1866 .

Clothing account:

Last settled _____, 1866 ; drawn since \$ _____ 100

Due soldier \$ _____ 100 ; due U. S. \$ _____ 100

Am't for cloth'g in kind or money adv'd \$ _____ 100

Due U. S. for arms, equipments, &c., \$ _____ 100

Bounty paid \$ _____ 100 ; due \$ _____ 100

Remarks: Deserted at Memphis
Tenn Apr 5 1865. Descrip-
tive Roll furnished.

* monthly Coupon

Book mark : _____

Edmondson

680

Hollen Eli

Co No, 3 U. S. Col'd Cav.

Private | Private

CARD NUMBERS.

1	5346013	26
2	5346108	27
3	5346192	28
4	5346281	29
5	5346380	30
6	5346470	31
7	5346560	32
8	5346663	33
9	5346758	34
10	5346856	35
11	5346941	36
12	5347022	37
13	5347101	38
14	9089888	39
15	9089763	40
16		41
17		42
18		43
19		44
20		45
21		46
22		47
23		48
24		49
25		50

Book Mark:

See also

26 | **3 Cav. U.S.C.T.**

Ely Hallen

Co. M, 3 Reg't U. S. Col'd Cav.

Appears on

Company Descriptive Book

of the organization named above.

DESCRIPTION.

Age *19* years; height *5* feet *5* inches.

Complexion *Black*

Eyes *Black*, hair *Black*

Where born *Richmond, Va*

Occupation *Farmer*

ENLISTMENT.

When *Feb. 24*, 186*4*.

Where *Mississippi*

By whom *Capt. Hyland*; term *3* y'rs.

Remarks:

.....
.....
.....
.....
.....

F. B. Smith

H | 3 Cav. | U.S.C.T.

Eli Hollen

....., Co. M, 3 Reg't U. S. Col'd Cav.

Appears on

Company Descriptive Book

of the organization named above.

DESCRIPTION.

Age 19 years; height 5 feet 5 inches.

Complexion Black

Eyes Black; hair Black

Where born Richmond, Va.

Occupation Farmer

ENLISTMENT.

When Feb. 24, 1862.

Where Mississippi

By whom Wm. Hyland; term 3 y'rs.

Remarks:

.....
.....
.....
.....

.....
.....

F. B. Smith

No | **3 Cav. | U.S.C.T.**

Eli Hallen

Priv, Co. M, 3 Reg't U. S. Col'd Cavalry.

Appears on

Company Muster-in and Descriptive Roll

of the organization named above. Roll dated

Kainer Bluff Miss Uch, 1864.

Where born Richmond Va

Age 19 y'rs; occupation Farmer

When enlisted Feb 24, 1864.

Where enlisted Mississippi

For what period enlisted 3 years.

Eyes Black; hair Black

Complexion Black; height 5 ft. 5 in.

When mustered in _____, 186 .

Where mustered in _____

Bounty paid \$ 100; due \$ 100

Where credited _____

Company to which assigned _____

Remarks: _____

Book mark: _____

R. Richardson

(356d)

Copyist.

No 710 | **3 Cav. | U.S.C.T.**

Ely Hoallen
Point, Co. M, 3 Reg't U. S. Col'd Cavalry.

Appears on

Company Muster Roll
for March + April, 1864

Present or absent Present

Stoppage, \$ 100 for

Due Gov't, \$ 100 for

Valuation of horse, \$ 100

Valuation of horse equipments, \$ 100

Remarks :

(Mustered in March 1864
at Hayes Bluff)

Book mark :

R. H. Richardson

(358)

Copyist.

No | **3 Cav. | U.S.C.T.**

Ely Kollen
Pon, Co. M, 3 Reg't U. S. Col'd Cavalry.

Appears on

Company Muster Roll

for *May & June*, 1864.

Present or absent *Present*

Stoppage, \$ *100* for

Due Gov't, \$ *100* for

Valuation of horse, \$ *100*

Valuation of horse equipments, \$ *100*

Remarks: *Stop for one Rubber blanket 2'55"*

Book mark :

A. Richardson

76

3 Cav. | U.S.C.T.

Ely Hollen
Prsn

, Co. M, 3 Reg't U. S. Col'd Cavalry.

Appears on

Company Muster Roll

for Apr 30 to Aug 31, 1864.

Present or absent Present

Stoppage, \$ 100 for

Due Gov't, \$ 100 for

Valuation of horse, \$ 100

Valuation of horse equipments, \$ 100

Remarks :
.....
.....
.....
.....
.....
.....
.....
.....
.....

Book mark :

R. Richardson
Copyist.

No | **3 Cav. | U.S.C.T.**

Ely Nollen
Private, Co. M, 3 Reg't U. S. Col'd Cavalry.

Appears on

Company Muster Roll

for *Sept + Oct*, 186*4*.

Present or absent *Present*

Stoppage, \$ 100 for

Due Gov't, \$ 100 for

Valuation of horse, \$ 100

Valuation of horse equipments, \$ 100

Remarks:

Book mark:

R. Richardson

(358)

Copyist.

32 | **3 Cav.** | **U.S.C.T.**

Ely Holland
privt, Co. M, 3 Reg't U. S. Col'd Cavalry.

Appears on

Company Muster Roll

for *Nov & Dec*, 186*4*

Present or absent *absent*

Stoppage, \$ *100* for

Due Gov't, \$ *100* for

Valuation of horse, \$ *100*

Valuation of horse equipments, \$ *100*

Remarks: *on scout*

Book mark:

Am L Allen

30 | 3 Cav. | U.S.C.T.

Wm. Holden
Co. M, 3 Reg't U. S. Col'd Cavalry.

Appears on

Company Muster Roll

for *Jan & Feb*, 1865.

Present or absent *present*

Stoppage, \$ 100 for

Due Gov't, \$ 100 for

Valuation of horse, \$ 100

Valuation of horse equipments, \$ 100

Remarks :

Book mark : _____

Wm. Holden

2 | **3 Cav. | U.S.C.T.**

Ally Hollen
ser, Co. M, 3 Reg't U. S. Col'd Cavalry.

Appears on

Company Muster Roll

for *Mar & Apr*, 186*5*.

Present or absent *absent*

Stoppage, \$ *100* for

Due Gov't, \$ *100* for

Valuation of horse, \$ *100*

Valuation of horse equipments, \$ *100*

Remarks: *no record*

Book mark :

Ally Hollen

H. | **3 Cav. | U.S.C.T.**

Ely Hollan

H., Co. M, 3 Reg't U. S. Col'd Cavalry.

Appears on

Company Muster Roll

for *May & June*, 1865.

Present or absent *Present*

Stoppage, \$ *2* $\frac{52}{100}$ for *advance*

lost & destroyed

Due Gov't, \$ *100* for

Valuation of horse, \$ *100*

Valuation of horse equipments, \$ *100*

Remarks:

.....
.....
.....
.....
.....
.....
.....
.....

Book mark:

Sam Allen

37 | **3 Cav. | U.S.C.T.**

Cy. Rain

....., Co. M, 3 Reg't U. S. Col'd Cavalry.

Appears on

Company Muster Roll

for *July & Aug*, 1865.

Present or absent *present*

Stoppage, \$ *2*^{*52*}/_{*100*} for *ordnance*

lost & destroyed

Due Gov't, \$ *1*^{*00*}/_{*100*} for

Valuation of horse, \$ *1*^{*00*}/_{*100*}

Valuation of horse equipments, \$ *1*^{*00*}/_{*100*}

Remarks:

Book mark:

Wm. Allen

A | **3 Cav. | U.S.C.T.**

Ely Hoken
Priv., Co. M, 3 Reg't U. S. Col'd Cavalry.

Appears on

Company Muster Roll

for *Sept. & Oct.*, 1865.

Present or absent

Stoppage, \$ 100 for

Due Gov't, \$ 100 for

Valuation of horse, \$ 100

Valuation of horse equipments, \$ 100

Remarks :

Book mark :

(358)

Leaving

Copyist.

N | **3 Cav. | U.S.C.T.**

Geo. Haller
Pvt.

, Co. M, 3 Reg't U. S. Col'd Cavalry.

Appears on

Company Muster Roll

for *Nov. & Dec.*, 186*5*.

Present or absent *Present*

Stoppage, \$ *100* for

Due Gov't, \$ *100* for

Valuation of horse, \$ *100*

Valuation of horse equipments, \$ *100*

Remarks:

Book mark:

(358)

Loring

Copyist.

✓ | **3 Cav. | U.S.C.T.**

Cy Hollen

Co. M, 3 Reg't U. S. Col'd Cavalry.

Appears on **Co. Muster-out Roll**, dated
Memphis Tenn., Jan 20, 186*7*.

Muster-out to date *Jan 20*, 186*7*.

Last paid to *June 30*, 186*7*.

Clothing account:

Last settled _____, 186 ; drawn since \$ _____ 100

Due soldier \$ _____ 100; due U. S. \$ *67* ^{*50*}/₁₀₀

Am't for cloth'g in kind or money adv'd \$ _____ 100

Due U. S. for arms, equipments, &c., \$ *6* ^{*70*}/₁₀₀

Bounty paid \$ _____ 100; due \$ _____ 100

Remarks: *Mustered out under*
S.C. 16, Memphis Tenn.

Book mark: *V. 05, P. 27, 69*

(861)

L. J. ...

Copyist.

681

Hollway, Henry
Co E, 3 U. S. Col'd Cav.

Private | Private

CARD NUMBERS.

1	5337574	26
2	5337672	27
3	5337789	28
4	5337866	29
5	5338794	30
6	9088898	31
7	40727546	32
8		33
9		34
10		35
11		36
12		37
13		38
14		39
15		40
16		41
17		42
18		43
19		44
20		45
21		46
22		47
23		48
24		49
25		50

Book Mark:

See also

A | **3 Cav.** | **U.S.C.T.**

Henry Hollaway,

....., Co. E, 3 Reg't U. S. Col'd Cav.

Appears on

Company Descriptive Book
of the organization named above.

DESCRIPTION.

Age 22 years; height 5 feet 6 inches.

Complexion Black,

Eyes Black; hair Black,

Where born Mississippi.

Occupation Farmer.

ENLISTMENT.

When Nov. 20, 1863.

Where Stipaults, La.

By whom Capt. Cook; term 3 y'rs.

Remarks: killed in action at

Yazoo City, February 28, 1864,

.....

.....

.....

.....

.....

.....

E. Arslin

(383g)

Copyist.

26 | 3 Cav. | U.S.C.T.

Henry Holloway

Co. E, 1 Reg't Miss. Cav., Corps d'Afrique.*

Age 22.

Appears on

Company Muster-in Roll

of the organization named above. Roll dated

Stepwith Regt Miss Dec 9, 1863.

Muster-in to date Nov 20, 1863.

Joined for duty and enrolled:

When Nov 20, 1863

Where Stepwith Regt Miss

Period 3 years.

Valuation of horse, \$ 100

Valuation of horse equipments, \$ 100

Remarks:

*This organization subsequently became Co. E 3 Reg't U. S. Colored Cavalry.

Book mark:

Padu

No. **3 Cav. U.S.C.T.**

Henry Holloway
Co. *E*, 1 Reg't Miss. Cav., Corps d'Afrique.*

Appears on

Company Muster Roll

for *dated Dec 31, 1863*

Present or absent *Present*

Stoppage, \$ *100* for

Due Gov't, \$ *100* for

Valuation of horse, \$ *100*

Valuation of horse equipments, \$ *100*

Remarks:
.....
.....
.....
.....
.....
.....

*This organization subsequently became Co. *E* 3 Reg't U. S. Colored Cavalry.

Book mark:

Pruder

No. **3 Cav. U.S.C.T.**

Henry Holloway
Por, Co. *E*, 1 Reg't Miss. Cav., Corps d'Afrique.*

Appears on

Company Muster Roll

for *Jan'y & Feb'y*, 186*4*

Present or absent.....

Stoppage, \$.....100 for.....

Due Gov't, \$.....100 for.....

Valuation of horse, \$.....100

Valuation of horse equipments, \$.....100

Remarks: *Killed at Yazoo City Feb'y 28. 1864*

*This organization subsequently became Co. *E*, 3 Reg't U. S. Colored Cavalry.

Book mark:.....

Bradley

26 | 3 Cav. | U.S.C.T.

Henry Holloway
Pot, Co. E, 3 Reg't U.S. Col'd Cavalry.

Appears on

Company Muster Roll

for *Musgrave*, 1864.

Present or absent

Stoppage, \$ 100 for

Due Gov't, \$ 100 for

Valuation of horse, \$ 100

Valuation of horse equipments, \$ 100

Remarks: *Killed at Geyser
City July 28/1864*

Book mark:

Pradde

H. | 3 Cav. | U.S.C.T.

Henry Holloway
Pvt., Co. E, 3 Reg't U. S. Colored Cav.

Appears on Returns as follows:

Feb. 1864. Loss Feb. 28/64 Yazoo
City, Killed in action.
(1 miss. Cav. A. D.)

Book mark :

(546)

J. B. Sittler

Copyist.

47
40 | **3 Cav. | U.S.C.T.**

Henry Hollaway
.....
Pvt., Co. *E*, 3 Reg't U. S. Col'd Cavalry.

Appears on **Co. Muster-out Roll**, dated
Memphis Tenn Jan. 26, 1866 .
Muster-out to date _____, 186 .
Last paid to *Dec. 31*, 1863 .

Clothing account:

Last settled _____, 186 ; drawn since \$ _____ 100
Due soldier \$ _____ 100; due U. S. \$ _____ 100
Am't for cloth'g in kind or money adv'd \$ _____ 100

Due U. S. for arms, equipments, &c., \$ _____ 100
Bounty paid \$ _____ 100; due \$ _____ 100

Remarks: *Killed in action at*
Yazoo City Miss Feb. 28. 64.

Book mark :

(861)

Lewis
Copyist.

Holloway, Henry

B, Co. E, 3 Reg't U.S.C. Cav

3 Enclosures.

Bed Cards	Descriptive Lists
Burial Records	Final Statements 2
Certs. of Dis. for Discharge	Furloughs
C. M. Charges	Med. Des. Lists
Med. Certificates	Orders

Other papers relating to—

Admission to Hosp'l	Furlough
Casualty Sheet (Officer's)	Med. Examination
Confinement	Misc. Information
Contracts	Pay or Clothing
Death or Effects	Personal Reports
Desertions	Rank
Discharge from Hosp'l	Transfer to Hosp'l
Discharge from Service	Transfer to V. R. C.
Duty	Transportation

7

CASUALTY SHEET

No.

Henry Hallaway
Plt of Company *"E"*

1st Regiment of *Miss Cav. A.S.*
State Volunteers.

3rd U.S.C.

NATURE OF CASUALTY.

Killed

Y

MARCH 1862

CASUALTY SHEET.

Name: Kenny Hollaway
Rank: Private Company: "E" Regiment: 1st
Arm: Miss Cav. A. S. State: 1
Nature of Casualty: Killed

CAUSE OF CASUALTY—(NAME OF DISEASE, &C.)

BY WHOM DISCHARGED.

DEGREE OF DISABILITY.

FROM WHAT SOURCE THIS INFORMATION WAS OBTAINED.

BY WHOM CERTIFIED.

Detached from report signed by
John H. Coats Col 11th Ill. Cal.
REMARKS.

DATE OF DISCHARGE, DEATH, &C.

February 28th 1862

PLACE OF DISCHARGE, DEATH, &C.

Near Yazoo City Miss

Thos. Brannen

Clerk.

✓ FINAL STATEMENT

OF

Wesley Holloway
Reg't of *Miss Co*

VOLUNTEERS.

Dis. Feb 28th 1864

NOTE 1.—Two of these certificates (or duplicates) are to be given to each Volunteer Soldier or drafted man who may be discharged previously to the discharge of his company, that he may at once receive from the Paymaster the pay, &c., due him, and the captain or other COMMISSIONED officer commanding the company will certify to the act of the delivery of the duplicate certificates; on these certificates the Soldier is "entitled to" his discharge, and should also present his discharge to the Paymaster to have the payment endorsed on it. The discharge is to be given back to the Soldier by the Paymaster; the latter only retaining as his voucher the duplicate certificates.

NOTE 2.—If the Soldier is entitled to pay for the use of his horse, the Company Commander will certify to that fact on the back of both these final statements, and also to the time he has pay due for having been so mounted on his own horse.

NOTE 3.—When a Soldier is furnished with final statements, his descriptive list, if he has one, should be taken up by the officer who gives the Soldier these statements, and endorsed with a statement to this effect by the officer. This endorsement should exhibit a full statement of the time for which the Soldier was allowed pay on his final statements, the clothing account, and all other charges against him or in his favor, so as to comprise a complete exhibit of his account. It will then be transmitted to the company commander of the Soldier, who will enter all the data necessary to a full understanding of the Soldier's account on the muster roll upon which the Soldier's discharge is reported. The descriptive list will then be destroyed. The object of this is, that the remaining portion of the Soldier's account may be settled upon the receipt of these muster rolls, and the Soldier receive any pay or allowances that may be due him at the time of his discharge, and which may not appear on his final statements from the fact that his descriptive list is incomplete. These accounts for back pay, &c., are settled by the 2d Auditor of the Treasury Department.

NOTE 4.—Charges for loss or injury to ordnance, horse equipments, and other miscellaneous charges, should appear under the heading of "Other Stoppages."

NOTE 5.—Bounty paid by State authorities, and not by the United States, will not be entered on this statement.

NOTE 6.—Amounts due the Sutler and Laundress must be entered on the muster roll on which the discharge, death, desertion, &c., is reported, as well as on the final statement, otherwise the amount cannot be collected from the United States.

NOTE 7.—This blank will be used for deceased volunteers and drafted men, as well as for others.

NOTE 8.—Where a Soldier dies in Hospital or on detached service, his descriptive list, if he has one, should be sent with his final statements, in duplicate, to the Adjutant General, Washington, D. C.

F. W. Hazard
C. C.

ADJUTANT GENERAL'S OFFICE.
May 4th 1864
Duplicate with Inventory sent 2d Auditor.

I certify, on honor, that Henry Holloway a Private of
Captain F.A. Cross's Company (E) of the 1st Regiment of Cavalry
VOLUNTEERS, of the State of Miss, born in _____, State
of Miss, aged 22 years; 5 feet 6 inches high, Black complexion,
Black eyes, Black hair, and by occupation a Farmer, having joined the company on
its original organization at Stipwath City, and enrolled in it at the muster into
the service of the United States at Stipwath City, on the _____ day
of Dec, 1868, (or was mustered in service as a recruit, by _____
at _____, on the _____ day of _____,
186 , or was drafted and mustered into the service of the United States from the _____
Enrollment District of the State of _____, at _____,
on the _____ day of _____, 186), to serve in the Regiment, for

the term of Three Months: and having served **HONESTLY** and
FAITHFULLY with his Company in the Field to the present date is now
entitled to a **DISCHARGE** by reason of being killed in action at Stipwath City, Miss, Dec 21, 1868

Holloway died without effects being turned in his uniform

The said Henry Holloway was last paid by Paymaster
Wm. Martin to include the 31st day of Dec, 1868, and has
pay due him from that time to the present date; he is entitled to pay and subsistence for
TRAVELING to place of enrollment, and whatever other allowances are authorized to volunteer
soldiers, drafted men, or militia, so discharged. He has received from the United States **CLOTHING**
amounting to Twenty three ³³ dollars, since the _____ day of enrollment
186 , when his clothing account was last settled. He has received from the United States
_____ ¹⁰⁰ dollars advanced **BOUNTY**.

There is to be stopped from him, on account of the State of _____, or other
authorities, for **CLOTHING**, &c., received on entering service, _____ ¹⁰⁰ dollars; and
for other stoppages, viz: _____

_____ ¹⁰⁰ dollars.

He has been furnished with **TRANSPORTATION** in kind from the place of his discharge to
_____; and he has been **SUBSISTED** for **TRAVELING** to his
place of enrollment, up to the _____, 186 .

He is indebted to _____, **SUTLER**, _____ ¹⁰⁰ dollars.

He is indebted to _____, **LAUNDRESS**, _____ ¹⁰⁰ dollars.

Given in Duplicate, at Basin Bluff Miss, this 28th day
of Feb, 1864.

Francis Hood
Capt 1st Miss Cav Regt
Commanding Company.

FINAL STATEMENT

OF

Henry Holloway

1st Reg't of *Miss Cav*

VOLUNTEERS. *A. D.*

NOTE 1.—Two of these certificates (or duplicates) are to be given to each Volunteer Soldier or drafted man who may be discharged previously to the discharge of his company, that he may at once receive from the Paymaster the pay, &c., due him, and the captain or other COMMISSIONED officer commanding the company will certify to the act of the delivery of the duplicate certificates; on these certificates the Soldier is "entitled to" his discharge, and should also present his discharge to the Paymaster to have the payment endorsed on it. The discharge is to be given back to the Soldier by the Paymaster; the latter only retaining as his voucher the duplicate certificates.

NOTE 2.—If the Soldier is entitled to pay for the use of his horse, the Company Commander will certify to that fact on the back of both these final statements, and also to the time he has pay due for having been so mounted on his own horse.

NOTE 3.—When a Soldier is furnished with final statements, his descriptive list, if he has one, should be taken up by the officer who gives the Soldier these statements, and endorsed with a statement to this effect by the officer. This endorsement should exhibit a full statement of the time for which the Soldier was allowed pay on his final statements, the clothing account, and all other charges against him or in his favor, so as to comprise a complete exhibit of his account. It will then be transmitted to the company commander of the Soldier, who will enter all the data necessary to a full understanding of the Soldier's account on the muster roll upon which the Soldier's discharge is reported. The descriptive list will then be destroyed. The object of this is, that the remaining portion of the Soldier's account may be settled upon the receipt of these muster rolls, and the Soldier receive any pay or allowances that may be due him at the time of his discharge, and which may not appear on his final statements from the fact that his descriptive list is incomplete. These accounts for back pay, &c., are settled by the 2d Auditor of the Treasury Department.

NOTE 4.—Charges for loss or injury to ordnance, horse equipments, and other miscellaneous charges, should appear under the heading of "Other Stoppages."

NOTE 5.—Bounty paid by State authorities, and not by the United States, will not be entered on this statement.

NOTE 6.—Amounts due the Sutler and Laundress must be entered on the muster roll on which the discharge, death, desertion, &c., is reported, as well as on the final statement, otherwise the amount cannot be collected from the United States.

NOTE 7.—This blank will be used for deceased volunteers and drafted men, as well as for others.

NOTE 8.—Where a Soldier dies in Hospital or on detached service, his descriptive list, if he has one, should be sent with his final statements, in duplicate, to the Adjutant General, Washington, D. C.



1864

I certify, on honor, that Henry Holloway a Private of
 Captain A. Coats Company (E) of the 7th Regiment of Cavalry
VOLUNTEERS, of the State of Miss, born in _____, State
 of Miss, aged 22 years; 5 feet 6 inches high, Black complexion,
Black eyes, Black hair, and by occupation a Farmer, having joined the company on
 its original organization at Shipworths Ldg, and enrolled in it at the muster into
 the service of the United States at Shipworths Ldg, on the 9th day
 of Dec, 1868, (or was mustered in service as a recruit, by _____
 _____, at _____, on the _____ day of _____,
 186 _____, or was drafted and mustered into the service of the United States from the _____
 Enrollment District of the State of _____, at _____,
 on the _____ day of _____, 186 _____,) to serve in the Regiment, for
 the term of Three Years: and having served **HONESTLY** and
FAITHFULLY with his Company in the field to the present date, is now
 entitled to a **DISCHARGE** by reason of being killed in action. Henry
Holloway and various effects being buried in the
vicinity of _____

The said Henry Holloway was last paid by Paymaster
Maj. Martin to include the 9th day of Dec, 1868, and has
 pay due him from that time to the present date; he is entitled to pay and subsistence for
TRAVELING to place of enrollment, and whatever other allowances are authorized to volunteer
 soldiers, drafted men, or militia, so discharged. He has received from the United States **CLOTHING**
 amounting to Sixty nine ²⁸/₁₀₀ dollars, since the _____ day of enrollment
 186 _____, when his clothing account was last settled. He has received from the United States
 _____ ¹⁰⁰/₁₀₀ dollars advanced **BOUNTY**.

There is to be stopped from him, on account of the State of _____, or other
 authorities, for **CLOTHING**, &c., received on entering service, _____ ¹⁰⁰/₁₀₀ dollars; and
 for other stoppages, viz: _____

_____ ¹⁰⁰/₁₀₀ dollars.
 He has been furnished with **TRANSPORTATION** in kind from the place of his discharge to
 _____; and he has been **SUBSISTED** for **TRAVELING** to his
 place of enrollment, up to the _____, 186 _____.

He is indebted to _____, **SUTLER**, _____ ¹⁰⁰/₁₀₀ dollars.

He is indebted to _____, **LAUNDRESS**, _____ ¹⁰⁰/₁₀₀ dollars.

Given in Duplicate, at Boonville Miss, this 28th day
 of Feb, 1864.

Francis A Coats
Capt 1st Miss Cav. U.S.
 Commanding Company.

11111001

682

Holloway, Isaac
Co. E, 3 U. S. Col'd Cav.

Private Private

CARD NUMBERS.

1	5337573	26
2	5337646	27
3	5337731	28
4	5337810	29
5	5337905	30
6	5337970	31
7	5338034	32
8	5338105	33
9	5338200	34
10	5338311	35
11	5338410	36
12	5338495	37
12	5338585	38
14	5338659	39
15	5338725	40
16	9088780	41
17		42
18		43
19		44
20		45
21		46
22		47
23		48
24		49
25		50

Book Mark:

See also

MAR 1988

S 838784 - P090
S-739786 - P.O. MXM
S-2866206 And. P.O.

A. M. Shannon
Ev

N | **3 Cav. | U.S.C.T.**

Isaac Holloway
....., Co. *E*....., 3 Reg't U. S. Col'd Cav.

Appears on

Company Descriptive Book

of the organization named above.

DESCRIPTION.

Age *24* years; height *5* feet *6* inches.

Complexion *Black*.

Eyes *Black*; hair *Black*.

Where born *Mississippi*.

Occupation *Farmer*.

ENLISTMENT.

When *Nov. 20*, 1863.

Where *Shipwith Ldy.*

By whom *Capt Cook*; term *3* y'rs.

Remarks:

.....
.....
.....
.....
.....
.....

E. G. Foster

76 | 3 Cav. | U.S.C.T.

Isaac Holloway

Pvt., Co. E, 1 Reg't Miss. Cav., Corps d'Afrique.*

Age 26
Appears on

Company Muster-in Roll

of the organization named above. Roll dated

Stepworth Reg't, 1863.

Muster-in to date Nov 20, 1863.

Joined for duty and enrolled:

When Nov 20, 1863

Where Stepworth Reg't

Period 3 years.

Valuation of horse, \$ 100

Valuation of horse equipments, \$ 100

Remarks:

*This organization subsequently became Co. E, 3 Reg't U. S. Colored Cavalry.

Book mark:

Bradley

76 | 3 Cav. | U.S.C.T.

Isaac Holloway
Cpl, Co. E, 1 Reg't Miss. Cav., Corps d'Afrique.*

Appears on

Company Muster Roll

for *Acted Dec 31*, 186*3*

Present or absent *Present*

Stoppage, \$ *100* for

Due Gov't, \$ *100* for

Valuation of horse, \$ *100*

Valuation of horse equipments, \$ *100*

Remarks:

*M/in Dec 9/63 at Ship
with Landing.*

*This organization subsequently became Co. *E* 3 Reg't U. S. Colored Cavalry.

Book mark:

Biddle

(358)

Copyist.

No. | 3 Cav. | U.S.C.T.

Isaac Holloway
Cpl, Co. E, 1 Reg't Miss. Cav., Corps d'Afrique.*

Appears on

Company Muster Roll
for James T. Flby, 1864
Present or absent Present

Stoppage, \$ 100 for

Due Gov't, \$ 100 for

Valuation of horse, \$ 100

Valuation of horse equipments, \$ 100

Remarks:

*This organization subsequently became Co. E, 3 Reg't U. S. Colored Cavalry.

Book mark:

B. D. D. D.
(358) Copyist.

24 | **3 Cav.** | **U.S.C.T.**

Isaac Holloway
Cpl, Co. E, 3 Reg't U. S. Col'd Cavalry.

Appears on

Company Muster Roll

for *Muster*, 186*4*.

Present or absent *Present*

Stoppage, \$ *100* for

Due Gov't, \$ *100* for

Valuation of horse, \$ *100*

Valuation of horse equipments, \$ *100*

Remarks:
.....
.....
.....
.....
.....
.....
.....
.....
.....

Book mark:

Pruder

76 | 3 Cav. | U.S.C.T.

Doaac Holloway
Private, Co. E, 3 Reg't U. S. Col'd Cavalry.

Appears on

Company Muster Roll
for May & June, 1864
Present or absent Present

Stoppage \$ 2 ³/₁₀₀ for one
hacker

Due Gov't, \$ ¹⁰⁰/₁₀₀ for

Valuation of horse, \$ ¹⁰⁰/₁₀₀

Valuation of horse equipments, \$ ¹⁰⁰/₁₀₀

Remarks:

Book mark:

Biddle

76 | **3 Cav.** | **U.S.C.T.**

Isaac Hallaway
Priv, Co. E, 3 Reg't U. S. Col'd Cavalry.

Appears on

Company Muster Roll

for July & Aug, 186 4

Present or absent Present

Stoppage, \$ 1/⁷⁶₁₀₀ for Canteen

Haversack. Spurs & Traps

Due Gov't, \$ 100 for

Valuation of horse, \$ 100

Valuation of horse equipments, \$ 100

Remarks:

Book mark:

Prude

N. | **3 Cav.** | **U.S.C.T.**

James Holloway
Sgt., Co. E, 3 Reg't U. S. Col'd Cavalry.

Appears on

Company Muster Roll

for Sept. 10, 1864.

Present or absent Present

Stoppage, \$ 40 / 100 for 5 h. & 1/2 d.

Due Gov't, \$ 100 for

Valuation of horse, \$ 100

Valuation of horse equipments, \$ 100

Remarks: Wagon driver

Book mark: _____

(358)

[Signature]
Copyist.

T. H. | **3 Cav.** | **U.S.C.T.**

Charles Hollaway

Pl., Co. E, 3 Reg't U. S. Col'd Cavalry.

Appears on

Company Muster Roll

for *Nov. 1st*, 186*4*.

Present or absent *Present*

Stoppage, \$ *1.70* for *Examined*
for Co. & Co.

Due Gov't, \$ *1.00* for

Valuation of horse, \$ *1.00*

Valuation of horse equipments, \$ *1.00*

Remarks: *One che. U.S. Army*
Roll mustered for Co. & Co. 1.00
Roll for one Saddle & Traps
one Saddle Blanket, one Saddle
Traps & Traps, one Horse Brush
one Cantan, one Newspaper

Book mark:

B. H. G. J.

(358)

Copyist.

14 | **3 Cav. | U.S.C.T.**

James S. Newman
Pl, Co. E, 3 Reg't U. S. Col'd Cavalry.

Appears on

Company Muster Roll

for Jan 1 1867, 1867.

Present or absent Present

Stoppage, \$ 100 for

Due Gov't, \$ 100 for

Valuation of horse, \$ 100

Valuation of horse equipments, \$ 100

Remarks:

Book mark: -----

(358)

J. S. Newman
Copyist.

11 | **3 Cav.** | **U.S.C.T.**

Amos Holloman
W., Co. E, 3 Reg't U. S. Col'd Cavalry.

Appears on

Company Muster Roll

for Amos, v. Co. E, 1864.

Present or absent Present

Stoppage, \$ 100 for

Due Gov't, \$ 100 for

Valuation of horse, \$ 100

Valuation of horse equipments, \$ 100

Remarks:

Book mark: -----

(358)

Amos

Copyist.

A. J. **3 Cav. | U.S.C.T.**

Charles Holloway
C. J., Co. E, 3 Reg't U. S. Col'd Cavalry.

Appears on

Company Muster Roll

for May & June, 1865.

Present or absent Present

Stoppage, \$ 8 ¹⁷/₁₀₀ for Primaire

Due Gov't, \$ 100 for

Valuation of horse, \$ 100

Valuation of horse equipments, \$ 100

Remarks: 10 ft for 1 carbine, 10 ft for
10 ft for 10 ft for 10 ft for 10 ft for
10 ft for 10 ft for 10 ft for 10 ft for
10 ft for 10 ft for 10 ft for 10 ft for

Book mark:

(358)

W. J. [Signature]
Copyist.

21. | **3 Cav. | U.S.C.T.**

Amos Holloman
.....
1st, Co. E, 3 Reg't U.S. Col'd Cavalry.

Appears on

Company Muster Roll

for *1st Reg't U.S. Col'd Cavalry*, 186*1*.

Present or absent *Present*

Stoppage, \$.....100 for

Due Gov't, \$.....100 for

Valuation of horse, \$.....100

Valuation of horse equipments, \$.....100

Remarks:.....
.....
.....
.....
.....
.....
.....
.....
.....

Book mark :

(358)

[Signature]

Copyist.

46 | **3 Cav. | U.S.C.T.**

Isaac Hollaway

Pvt., Co. E, 3 Reg't U. S. Col'd Cavalry.

Appears on

Company Muster Roll

for *Sept & Oct.*, 1865.

Present or absent *Present.*

Stoppage, \$ *100* for

Due Gov't, \$ *100* for

Valuation of horse, \$ *100*

Valuation of horse equipments, \$ *100*

Remarks: *Stop for two Haversacks.
Stop for 1 Sabre Knot 32. 1 bone
w. for Carbine 35.*

Book mark: _____

(358)

Lewis
Copyist.

H | **3 Cav.** | **U.S.C.T.**

Isaac Holloway

Pr, Co. E, 3 Reg't U. S. Col'd Cavalry.

Appears on

Company Muster Roll

for *Nov. & Dec.*, 1865 .

Present or absent *Present.*

Stoppage, \$ *100* for

Due Gov't, \$ *100* for

Valuation of horse, \$ *100*

Valuation of horse equipments, \$ *100*

Remarks:

Book mark: _____

(358)

Lewis
Copyist.

H | **3 Cav. | U.S.C.T.**

Isaac Hollaway

Priv., Co. *C*, 3 Reg't U. S. Col'd Cavalry.

Appears on **Co. Muster-out Roll**, dated

Memphis, Tenn. Jan. 26, 1866 .

Muster-out to date *Jan. 26*, 1866 .

Last paid to *June 30*, 1865 .

Clothing account:

Last settled _____, 186 ; drawn since \$ _____ 100

Due soldier \$ *39* ^{*15*} / 100; due U. S. \$ _____ 100

Am't for cloth'g in kind or money adv'd \$ _____ 100

Due U. S. for arms, equipments, &c., \$ _____ / ^{*67*} _{*90*} 100

Bounty paid \$ _____ 100; due \$ _____ 100

Remarks: _____

Book mark: _____

(361)

F. Lewis
Copyist.

683

Holmes, Jerry

Co B, 3 U. S. Col'd Cav.

Private

Private

CARD NUMBERS.

1	5331073	26
2	5334141	27
3	5384253	28
4	5334348	29
5	5334481	30
6	5334757	31
7	9088442	32
8	40727547	33
9	31691532	34
10		35
11		36
12		37
13		38
14		39
15		40
16		41
17		42
18		43
19		44
20		45
21		46
22		47
23		48
24		49
25		50

Book Mark:

See also

A | **3 Cav. | U.S.C.T.**

Jerry Holmes

....., Co. *B*, 3 Reg't U. S. Col'd Cav.

Appears on

Company Descriptive Book
of the organization named above.

DESCRIPTION.

Age *38* years; height *5* feet *5* inches.

Complexion *Black*

Eyes *Black*; hair *Black*

Where born *Nashville - Tenn.*

Occupation *Farmer*

ENLISTMENT.

When *Jan. 6*, 1865

Where *Sicksburg -*

By whom *Maj. Maine*; term *3* y'rs.

Remarks: *Died June-29-*
1865 in Gen. Hospl.
at Memphis - Tenn.

C. A. Wright

76. | 3 Cav. | U.S.C.T.

Jerry Holmes.
Priv. Co., 3 Reg't U. S. Col'd Cav.

Age 38 years.

Appears on a

Detachment Muster-in Roll

of the organization named above. Roll dated

Vicksburg, Miss, Jan. 7, 1865.

Muster-in to date

Jan. 7, 1865.

Joined for duty and enrolled:

When Jan. 6, 1865.

Where Vicksburg, Miss.

Period 3 years.

Valuation of horse, \$ 100

Valuation of horse equipments, \$ 100

Remarks:

Book mark:

Sitter.

(337)

Copyist.

A | **3 Cav.** | **U.S.C.T.**

Jerry Adams
Private, Co. B, 3 Reg't U. S. Col'd Cavalry.

Appears on

Company Muster Roll

for Jan. and Feb., 1865.

Present or absent Absent

Stoppage, \$ 100 for

Due Gov't, \$ 100 for

Valuation of horse, \$ 100

Valuation of horse equipments, \$ 100

Remarks: In Gen. Hospital at
Memphis, Tenn. since Jan 27/65.

Book mark: _____

(358)

J. B. James Copyist.

No. 3000 10509

Jerry Homes
Pvt., Co. B, 3 Reg't U.S.C. Cav

Appears on

Hospital Muster Roll

of Webster U. S. A. General Hospital,

at Memphis, Tenn.,

for Jan & Feb, 1865.

Attached to hospital:

When Jan 27, 1865.

How employed Sick

Last paid by Maj. Pay due from enlistment
to _____, 186 .

Bounty paid \$ 100; due \$ 100

Present or absent Present

Remarks:

Book mark:

(843) J. Woodward
Copyright.

A | **3 Cav.** | **U.S.C.T.**

Jerry Holmes
Priv., Co. B, 3 Reg't U. S. Col'd Cavalry.

Appears on

Company Muster Roll

for March and April, 1865.

Present or absent Present.

Stoppage, \$ 100 for

Due Gov't, \$ 100 for

Valuation of horse, \$ 100

Valuation of horse equipments, \$ 100

Remarks:
.....
.....
.....
.....
.....
.....
.....
.....
.....

Book mark:

(358)

J. B. Jones

Copyist.

N | **3 Cav.** | **U.S.C.T.**

Jerry Holmes
Private, Co. B, 3 Reg't U. S. Col'd Cavalry.

Appears on

Company Muster Roll

for *May and June*, 1865.

Present or absent *Absent*

Stoppage, \$ *100* for

Due Gov't, \$ *100* for

Valuation of horse, \$ *100*

Valuation of horse equipments, \$ *100*

Remarks: *See Gen Hoop since June 17/65. Staped 1 P. & spur & straps 52.*

Book mark:

(358)

J. B. Jones Copyist.

H | **3 Cav. | U.S.C.T.**

Jerry Holmes
Pri., Co. B, 3 Reg't U. S. Col'd Cavalry.

Appears on

Company Muster Roll

for *July and August*, 1865.

Present or absent

Stoppage, \$ 100 for

Due Gov't, \$ 100 for

Valuation of horse, \$ 100

Valuation of horse equipments, \$ 100

Remarks: *died June 29/65 in Reg'tl Hospital.*

Book mark:

(358)

J. B. Jones

Copyist.

H. | 3 Cav. | U.S.C.T.

Jerry Holmes

Priv., Co. B, 3 Reg't U. S. Colored Cav.

Appears on Returns as follows:

Jan. 1865. Gain Jan. 6/65 -
Vicksburg - Recruit in Co.
mustered in - 7/65 - by
Lt. M^c Dougall.

Jan. to Mar. 1865. Absent sick
in Gen. Hosp. at Mem-
phis, Tenn. since Jan.
27/65.

June 1865. Absent in Gen. Hosp.
at Memphis, Tenn. since
June 17/65.

July 1865. Lost June 29th Mem-
phis - Died, Gen. Hosp.

Book mark :

J. B. Sittler

(546)

Copyist.

H. | **3 Cav.** | **U.S.C.T.**

Jerry Holmes
Co. *B*, 3 Reg't U. S. Col'd Cavalry.

Appears on **Co. Muster-out Roll**, dated
Memphis Tenn. Jan. 26, 1866.

Muster-out to date _____, 186 .

Last paid to _____, 186 .
Pay due from Enrollment

Clothing account:

Last settled _____, 186 ; drawn since \$ _____ 100

Due soldier \$ _____ 100 ; due U. S. \$ _____ 100

Am't for cloth'g in kind or money adv'd \$ _____ 100

Due U. S. for arms, equipments, &c., \$ _____ 100

Bounty paid \$ _____ 100 ; due \$ _____ 100

Remarks: *Died at Memphis*
Tenn. June 29, 1865 of
Typhoid Malarial
fever

Book mark : _____

J. E. Brandon

(361)

Copyist.

Holmes, Jerry
B, Co. B, 3 Reg U.S.C. Cav.

Enclosures.

Bed Cards	Descriptive Lists
Burial Records	Final Statements
Certs. of Dis. for Discharge	Furloughs
C. M. Charges	Med. Des. Lists
Med. Certificates	Orders

Other papers relating to—

Admission to Hosp'l	Furlough
Casualty Sheet (Officer's)	Med. Examination
Confinement	Misc. Information
Contracts	Pay or Clothing
Death or Effects	Personal Reports
Desertions	Rank
Discharge from Hosp'l	Transfer to Hosp'l
Discharge from Service	Transfer to V. R. C.
Duty	Transportation

MAR 1865

1196

FINAL STATEMENT

OF

Henry H. ...
Reg't of *...*

VOLUNTEERS.

...

Acc. Oct 28. 1865.

Approved for effect, value
sent 2d Auditor

H.

NOTE 1.—Two of these certificates (or duplicates) are to be given to each Volunteer Soldier or drafted man who may be discharged previously to the discharge of his company, that he may at once receive from the Paymaster the pay, &c., due him, and the captain or other COMMISSIONED officer commanding the company will certify to the act of the delivery of the duplicate certificates; on these certificates the Soldier is "entitled to" his discharge, and should also present his discharge to the Paymaster to have the payment endorsed on it. The discharge is to be given back to the Soldier by the Paymaster; the latter only retaining as his voucher the duplicate certificates.

NOTE 2.—If the Soldier is entitled to pay for the use of his horse, the Company Commander will certify to that fact on the back of both these final statements, and also to the time he has pay due for having been so mounted on his own horse.

NOTE 3.—When a Soldier is furnished with final statements, his descriptive list, if he has one, should be taken up by the officer who gives the Soldier these statements, and endorsed with a statement to this effect by the officer. This endorsement should exhibit a full statement of the time for which the Soldier was allowed pay on his final statements, the clothing account, and all other charges against him or in his favor, so as to comprise a complete exhibit of his account. It will then be transmitted to the Company Commander of the Soldier, who will enter all the data necessary to a full understanding of the Soldier's account on the muster roll upon which the Soldier's discharge is reported. The descriptive list will then be destroyed. The object of this is, that the remaining portion of the Soldier's account may be settled upon the receipt of these muster rolls, and the Soldier receive any pay or allowances that may be due him at the time of his discharge, and which may not appear on his final statements from the fact that his descriptive list is incomplete. These accounts for back pay, &c., are settled by the 2d Auditor of the Treasury Department.

NOTE 4.—Charges for loss or injury to ordnance, horse equipments, and other miscellaneous charges, should appear under the heading of "Other Stoppages."

NOTE 5.—Bounty paid by State authorities, and not by the United States, will not be entered on this statement.

NOTE 6.—Amounts due the Sutler and Laundress must be entered on the muster roll on which the discharge, death, desertion, &c., is reported, as well as on the final statement, otherwise the amount cannot be collected from the United States.

NOTE 7.—This blank will be used for deceased volunteers and drafted men, as well as for others.

NOTE 8.—Where a Soldier dies in Hospital or on detached service, his descriptive list, if he has one, should be sent with his final statements, in duplicate, to the Adjutant General, Washington, D. C.

ADJUTANT GENERAL'S OFFICE.
July 19. 1865.
Duplicate with Inventory sent 2d Auditor.

I certify, on honor, that Jerry Holmes a Private of
 Captain C. Farley Company (B) of the 3d Regiment of W. Co. Cavalry
VOLUNTEERS, of the State of _____, born in Nashville, State
 of Tenn., aged 28 years; 5 feet 5 inches high; Black complexion,
Black eyes, Black hair, and by occupation a Farmer, having joined the company on
 its original organization at _____, and enrolled in it at the muster into
 the service of the United States at Vicksburg, on the 7th day
 of Jan'y, 1865; (or was mustered in service as a recruit, by _____
 _____, at _____, on the _____ day of _____,
 186 , or was drafted and mustered into the service of the United States from the _____
 Enrollment District of the State of _____, at _____,
 on the _____ day of _____, 186) to serve in the Regiment, for
 the term of Three years: and having served HONESTLY and
 FAITHFULLY with his Company in The Trench to the present date, is now
 entitled to a **DISCHARGE** by reason of Having died in Rebel Hoop Gun Hospital
Memphis Tenn June 29 1865

The said Jerry Holmes was last paid by Paymaster
Sever. Paid to include the Pay due day of from Enlistment, 1865, and has
 pay due him from that time to the present date; he is entitled to pay and subsistence for
TRAVELING to place of enrollment, and whatever other allowances are authorized to volunteer
 soldiers, drafted men, or militia, so discharged. He has received from the United States **CLOTHING**
 amounting to \$ 18. 34 dollars, since the 7th day of Jan'y,
 1865, when his clothing account was last settled. He has received from the United States
 _____ dollars advanced **BOUNTY**.

There is to be stopped from him, on account of the State of _____, or other
 authorities, for **CLOTHING**, &c., received on entering service, _____ dollars; and
 for other stoppages, viz: Ordinance _____
 _____ dollars.

He has been furnished with **TRANSPORTATION** in kind from the place of his discharge to
 _____; and he has been **SUBSISTED** for **TRAVELING** to his
 place of enrollment, up to the _____, 186 .

He is indebted to P. L. Bance, **SUTLER**, \$4 00 dollars.
 He is indebted to _____, **LAUNDRESS**, _____ dollars.

Given in Duplicate, at Memphis Tennessee, this 29 day
 of June, 1865.

Chas. S. Jessop
Asst. Surg. U.S.A.
 _____ in charge
 Commanding Company.

684

Holsten, Baptist

Co H, 3 U. S. Col'd Cav.

Private | Sergeant

CARD NUMBERS.

1	5341349	26
2	5341420	27
3	5341507	28
4	5341592	29
5	5341676	30
6	5341766	31
7	5341858	32
8	5341962	33
9	5342060	34
10	5342147	35
11	5342227	36
12	5342304	37
13	5342378	38
14	9089212	39
15	40727548	40
16		41
17		42
18		43
19		44
20		45
21		46
22		47
23		48
24		49
25		50

Book Mark:

See also

J-938594 - P.O. MAXIM
D. 2129 145 P.O. Ret

A. M. Shannon
Esq

N | **3 Cav. | U.S.C.T.**

Ballist, Nettie
....., Co. *N*, 3 Reg't U. S. Col'd Cav.

Appears on
Company Descriptive Book
of the organization named above.

DESCRIPTION.

Age *23* years; height *5* feet *6 1/2* inches.
Complexion *Blk*
Eyes *blk* ; hair *blk*
Where born *Edmond Co. Mo.*
Occupation *field hand*

ENLISTMENT.

When *Feb 15*, 1864.
Where *Warren Bluff Miss*
By whom *Capt W. White*; term *3* y'rs.

Remarks:
.....
.....
.....
.....

Nettie

H | **3 Cav. | U.S.C.T.**

Baptist Holster
Priv, Co. H, 1 Reg't Miss. Cav. A. D.*

Age *23* years.

Appears on

Company Muster-in Roll

of the organization named above. Roll dated
Haines Bluff Miss, Feby 23, 1864.

Muster-in to date *Feby 15, 1864.*

Joined for duty and enrolled:

When *Feby 15*, 1864.

Where *Haines Bluff Miss*

Period *3* years.

Valuation of horse, \$ 100

Valuation of horse equipments, 100

Remarks:
.....
.....
.....

*This organization subsequently became Company H, 3 Reg't U. S. Colored Cavalry.

Book mark:

Wheat Scott
(356) Copyist.

H | **3 Cav.** | **U.S.C.T.**

Bartist Holsten

Serjt, Co. H, 3 Reg't U. S. Col'd Cavalry.

Appears on

Company Muster Roll

for *from Feb 23 to Apr 30*, 186*4*.

Present or absent *Present*

Stoppage, \$ *100* for

Due Gov't, \$ *100* for

Valuation of horse, \$ *100*

Valuation of horse equipments, \$ *100*

Remarks:

Book mark: _____

W. H. Scott

77 | **3 Cav.** | **U.S.C.T.**

Babster Holsten
Regt, Co. H, 3 Reg't U. S. Col'd Cavalry.

Appears on

Company Muster Roll
for May & June, 1864

Present or absent Present

Stoppage, \$ 100 for

Due Gov't, \$ 100 for

Valuation of horse, \$ 100

Valuation of horse equipments, \$ 100

Remarks:
.....
.....
.....
.....
.....
.....
.....
.....

Book mark:

M W Payne
(358) Copyist.

A | **3 Cav. U.S.C.T.**

Bastian Holsten

Sergt, Co. H, 3 Reg't U. S. Col'd Cavalry.

Appears on

Company Muster Roll

for *July & Aug*, 1864.

Present or absent *Present*

Stoppage, \$ *100* for

Due Gov't, \$ *100* for

Valuation of horse, \$ *100*

Valuation of horse equipments, \$ *100*

Remarks: *Review Feb 29, 64*
Appointed Sergt.

Book mark:

M. Sayre

H | **3 Cav.** | **U.S.C.T.**

Battist Holsten
Serjt, Co. H, 3 Reg't U. S. Col'd Cavalry.

Appears on

Company Muster Roll

for *Sept 1864*, 1864.

Present or absent *Present*

Stoppage, \$ *100* for

Due Gov't, \$ *100* for

Valuation of horse, \$ *100*

Valuation of horse equipments, \$ *100*

Remarks:

Book mark:

M. Sayre
Copyist.

H | **3 Cav.** | **U.S.C.T.**

Battist Holsten
Supt, Co. H, 3 Reg't U. S. Col'd Cavalry.

Appears on

Company Muster Roll

for Nov & Dec, 1864

Present or absent Present

Stoppage, \$ 100 for

Due Gov't, \$ 100 for

Valuation of horse, \$ 100

Valuation of horse equipments, \$ 100

Remarks: _____

Book mark: _____

M. Dayre
(358) Copyist.

53

A/ | **3 Cav.** | **U.S.C.T.**

Bablist Holstein

Sgt., Co. H, 3 Reg't U. S. Col'd Cavalry.

Appears on

Company Muster Roll

for Jan & Feb., 1864.

Present or absent present

Stoppage, \$ 100 for

Due Gov't, \$ 100 for

Valuation of horse, \$ 100

Valuation of horse equipments, \$ 100

Remarks:

Book mark:-----

Sumers
Copyist.

A | **3 Cav.** | **U.S.C.T.**

Babstist Holstun

Sgt., Co. H, 3 Reg't U. S. Col'd Cavalry.

Appears on

Company Muster Roll

for Mich & Apr, 1863.

Present or absent absent

Stoppage, \$ 100 for

Due Gov't, \$ 100 for

Valuation of horse, \$ 100

Valuation of horse equipments, \$ 100

Remarks: Absent on account
since Apr 29/63

Stop for transportation
from Memphis Tenn. to
Cairo Ill. \$243

Book mark:

Lomax

A | **3 Cav.** | **U.S.C.T.**

Babstist Holsten

Sgt., Co. H, 3 Reg't U. S. Col'd Cavalry.

Appears on

Company Muster Roll

for May & June, 1865.

Present or absent present

Stoppage, \$ 100 for

Due Gov't, \$ 100 for

Valuation of horse, \$ 100

Valuation of horse equipments, \$ 100

Remarks: Stop for transportation
\$243. Stop for horse brush
& Lariat \$120.

Book mark: _____

(358)

Loren

Copyist.

A | **3 Cav.** | **U.S.C.T.**

Babtie Holsten

Sgt., Co. H, 3 Reg't U. S. Col'd Cavalry.

Appears on

Company Muster Roll

for July & Aug, 1865.

Present or absent present

Stoppage, \$ 100 for

Due Gov't, \$ 100 for

Valuation of horse, \$ 100

Valuation of horse equipments, \$ 100

Remarks: Stop for transport
value \$243. Stop for ordnance
from last muster \$152

Book mark:

A | **3 Cav.** | **U.S.C.T.**

Babbit Holsten

Sgt., Co. H, 3 Reg't U. S. Col'd Cavalry.

Appears on

Company Muster Roll

for Sept & Oct., 1867.

Present or absent present

Stoppage, \$ 100 for

Due Gov't, \$ 100 for

Valuation of horse, \$ 100

Valuation of horse equipments, \$ 100

Remarks: Top for Curry comb
30¢

Book mark:

H. | **3 Cav.** | **U.S.C.T.**

Baptist Holsten
Sergt., Co. H, 3 Reg't U. S. Col'd Cavalry.

Appears on

Company Muster Roll

for Nov and Dec, 1864.

Present or absent Present

Stoppage, \$ 100 for

Due Gov't, \$ 100 for

Valuation of horse, \$ 100

Valuation of horse equipments, \$ 100

Remarks: Due the U.S.
for ordinance from
last muster, 30 cts.

Book mark: _____

J. J. J.

H. | **3 Cav.** | **U.S.C.T.**

Baptist Holston
Pvt., Co. H., 3 Reg't U. S. Colored Cav.

Appears on **Returns** as follows:

Mar. 1865, Absent on furlough,

Book mark :

(546)

J. B. Sittler

Copyist.

H | **3 Cav.** | **U.S.C.T.**

Ralph Holsten

Sergt, Co. *H*, 3 Reg't U. S. Col'd Cavalry.

Appears on **Co. Muster-out Roll**, dated *Memphis Tenn, Jun 26*, 1866.

Muster-out to date *Jan 26*, 1866.

Last paid to *June 30*, 1865.

Clothing account:

Last settled....., 186 ; drawn since \$..... $\overline{100}$

Due soldier \$ *6* $\frac{03}{100}$; due U. S. \$..... $\overline{100}$

Am't for cloth'g in kind or money adv'd \$..... $\overline{100}$

Due U. S. for arms, equipments, &c., \$..... $\frac{30}{100}$

Bounty paid \$..... $\overline{100}$; due \$..... $\overline{100}$

Remarks:.....

.....

.....

.....

.....

Book mark:.....

(861)

Jones

Copyist.

685

Holsten, Charles

Co H, 3 U. S. Col'd Cav.

Private | Bugler

CARD NUMBERS.

1	5341350	26
2	5341430	27
3	5341517	28
4	5341602	29
5	5341686	30
6	5341776	31
7	5341869	32
8	5341973	33
9	5342071	34
10	5342159	35
11	5342239	36
12	5342316	37
12	5342390	38
14	9089213	39
15	40727549	40
16		41
17		42
18		43
19		44
20		45
21		46
22		47
23		48
24		49
25		50

Book Mark:

See also

S 2350470 PORU.

also 136 37 24

S: 2566154 - audit

A. M. Shannon
Or
Cass

N | **3 Cav. | U.S.C.T.**

Charles Holsten

....., Co. *H*, 3 Reg't U. S. Col'd Cav.

Appears on

Company Descriptive Book

of the organization named above.

DESCRIPTION.

Age *18* years; height *5* feet *8 3/4* inches.

Complexion *Blk*

Eyes *blk*; hair *blk*

Where born *Holmes Co Miss*

Occupation *Shield hand*

ENLISTMENT.

When *Feb 13*, 186*11*.

Where *Haines Bluff Miss*

By whom *Capt W White*; term *3* y'rs.

Remarks:

.....
.....
.....
.....
.....

Wittan

H | **3 Cav. U.S.C.T.**

Charles Hoston
Co., Co. H, 1 Reg't Miss. Cav. A. D.*

Age *18* years.

Appears on

Company Muster-in Roll

of the organization named above. Roll dated

Haines Bluff Miss Feb 23, 186*4*.

Muster-in to date

Feb 15, 186*4*

Joined for duty and enrolled:

When

Feb 15, 186*4*

Where

Haines Bluff Miss

Period

9 years.

Valuation of horse, \$ 100

Valuation of horse equipments, 100

Remarks:

*This organization subsequently became Company H, 3 Reg't U. S. Colored Cavalry.

Book mark:

Wear Scott

H | **3 Cav. | U.S.C.T.**

Charles Holsten
Dugler, Co. H, 3 Reg't U. S. Col'd Cavalry.

Appears on

Company Muster Roll

for *from July 23 to Apr 30*, 186*1*.

Present or absent *Present*

Stoppage, \$ 100 for

Due Gov't, \$ 100 for

Valuation of horse, \$ 100

Valuation of horse equipments, \$ 100

Remarks:

Book mark: -----

Wm Scott

H | **3 Cav.** | **U.S.C.T.**

Charles Holsten
Rugler, Co. H, 3 Reg't U. S. Col'd Cavalry.

Appears on

Company Muster Roll

for May & June, 1864.

Present or absent Present

Stoppage, \$.....100 for

Due Gov't, \$.....100 for

Valuation of horse, \$.....100

Valuation of horse equipments, \$.....100

Remarks:.....

Book mark:.....

(358) M. W. Dayre Copyist.

H | **3 Cav. | U.S.C.T.**

Charles Holsten
Bugher, Co. H, 3 Reg't U. S. Col'd Cavalry.

Appears on

Company Muster Roll

for *July & Aug*, 1864.

Present or absent *Present*

Stoppage, \$.....100 for

Due Gov't, \$.....100 for

Valuation of horse, \$.....100

Valuation of horse equipments, \$.....100

Remarks:

Book mark:

W. W. Sayre

H | **3 Cav.** | **U.S.C.T.**

Charles Halsten
Ruger, Co. H, 3 Reg't U. S. Col'd Cavalry.

Appears on

Company Muster Roll

for Sept & Oct, 1864

Present or absent Present

Stoppage, \$.....100 for

Due Gov't, \$.....100 for

Valuation of horse, \$.....100

Valuation of horse equipments, \$.....100

Remarks:

Book mark:

M. M. Payne

A | **3 Cav.** | **U.S.C.T.**

Charles Holsten
Dugler, Co. H, 3 Reg't U. S. Col'd Cavalry.

Appears on

Company Muster Roll

for *Nov & Dec*, 1864

Present or absent *Present*

Stoppage, \$.....100 for

Due Gov't, \$.....100 for

Valuation of horse, \$.....100

Valuation of horse equipments, \$.....100

Remarks:

Book mark:

(358)

W. W. Payne

Copyist.

A | **3 Cav.** | **U.S.C.T.**

Charles Halston

Bugler, Co. H, 3 Reg't U. S. Col'd Cavalry.

Appears on

Company Muster Roll

for Jan & Feb., 1864.

Present or absent present

Stoppage, \$ 100 for

Due Gov't, \$ 100 for

Valuation of horse, \$ 100

Valuation of horse equipments, \$ 100

Remarks:

Book mark: _____

(358)

Loren

Copyist.

A | **3 Cav.** | **U.S.C.T.**

Charlie Holston

Bugler, Co. H, 3 Reg't U. S. Col'd Cavalry.

Appears on

Company Muster Roll

for March & April, 1865.

Present or absent present

Stoppage, \$ 100 for

Due Gov't, \$ 100 for

Valuation of horse, \$ 100

Valuation of horse equipments, \$ 100

Remarks:

Book mark: _____

Somer
(358) Copyist.

N | **3 Cav.** | **U.S.C.T.**

Charles Halsten

Buglers, Co. H, 3 Reg't U. S. Col'd Cavalry.

Appears on

Company Muster Roll

for May & June, 1865.

Present or absent present

Stoppage, \$ 100 for

Due Gov't, \$ 100 for

Valuation of horse, \$ 100

Valuation of horse equipments, \$ 100

Remarks: Stop forariat 75¢

Book mark: _____

Lomer

A | **3 Cav.** | **U.S.C.T.**

Charles Holsten

Bugler, Co. H, 3 Reg't U. S. Col'd Cavalry.

Appears on

Company Muster Roll

for July & Aug, 1867.

Present or absent present

Stoppage, \$ 100 for

Due Gov't, \$ 73 for Ordinance
from last muster

Valuation of horse, \$ 100

Valuation of horse equipments, \$ 100

Remarks:

Book mark: -----

Forner

(358) Copyist.

A | **3 Cav.** | **U.S.C.T.**

Charles Holsten

Bugler, Co. H, 3 Reg't U. S. Col'd Cavalry.

Appears on

Company Muster Roll

for *Sept & Oct*, 1863.

Present or absent *present*

Stoppage, \$ *100* for

Due Gov't, \$ *100* for

Valuation of horse, \$ *100*

Valuation of horse equipments, \$ *100*

Remarks: *Stop for cap pouch & pick
one horse brush \$1.45*

Book mark: _____

Somers

H. | **3 Cav.** | **U.S.C.T.**

Charles Holston

Bugler, Co. H, 3 Reg't U. S. Col'd Cavalry.

Appears on

Company Muster Roll

for Nov & Dec, 1865.

Present or absent Present.

Stoppage, \$ 100 for

Due Gov't, \$ 100 for

Valuation of horse, \$ 100

Valuation of horse equipments, \$ 100

Remarks: I was the U.S.
for ordinary work \$1.45

Book mark:

Joiner.

H. | **3 Cav.** | **U.S.C.T.**

Charles Holston
Mus., Co. H, 3 Reg't U. S. Colored Cav.

Appears on **Returns** as follows:

Apr. to Oct. 1865, Co. Bugler

Book mark :

(546)

J. B. Sittler

Copyist.

H | **3 Cav. | U.S.C.T.**

Charles H Astern

Bugler, Co. H, 3 Reg't U. S. Col'd Cavalry.

Appears on **Co. Muster-out Roll**, dated *Memphis Tenn, Jan 26*, 1866.

Muster-out to date *Jan 26*, 1866.

Last paid to *J 1830*, 1865.

Clothing account:

Last settled....., 186 ; drawn since \$.....100

Due soldier \$ *10*^{*14*}/₁₀₀; due U. S. \$.....100

Am't for cloth'g in kind or money adv'd \$.....100

Due U. S. for arms, equipments, &c., \$ *45*/₁₀₀

Bounty paid \$.....100; due \$.....100

Remarks:.....

Book mark:.....

(861)

joined

Copyist.

686

Hoover, Anthony
Co. I, 3 U. S. Col'd Cav.

Private | Private

CARD NUMBERS.

1		26	
2		27	
3	See Hoover	28	Anthony
4		29	
5		30	
6		31	
7		32	
8		33	
9		34	
10		35	
11		36	
12		37	
13		38	
14		39	
15		40	
16		41	
17		42	
18		43	
19		44	
20		45	
21		46	
22		47	
23		48	
24		49	
25		50	

Book Mark:

See also

687

Harston Thomas

Co *C*, **3** U. S. Col'd Cav.

Private | *Sergeant*

CARD NUMBERS.

1	26
2	27
3	<i>See Harston Thomas</i>
4	29
5	30
6	31
7	32
8	33
9	34
10	35
11	36
12	37
13	38
14	39
15	40
16	41
17	42
18	43
19	44
20	45
21	46
22	47
23	48
24	49
25	50

Book Mark:

See also

688

Horton, Andrew

Co A, 3 U. S. Col'd Cav.

Private

Private

CARD NUMBERS.

1	5-331254	26
2	5-332607	27
3	5-332687	28
4	5-332786	29
5	5-332888	30
6	5-332986	31
7	5-333081	32
8	5-333175	33
9	5-333261	34
10	5-333343	35
11	9088314	36
12	40727551	37
13	31688214	38
14	31688289	39
15		40
16		41
17		42
18		43
19		44
20		45
21		46
22		47
23		48
24		49
25		50

Book Mark:

See also

A | **3 Cav.** | **U.S.C.T.**

Andrew Horton

....., Co. *A*....., 3 Reg't U. S. Col'd Cav.

Appears on

Company Descriptive Book

of the organization named above.

DESCRIPTION.

Age *24* years; height *5* feet *7½* inches.

Complexion *Black*

Eyes *Black*; hair *Black*

Where born *Floyd, La.*

Occupation *Farmer*

ENLISTMENT.

When *Oct. 11* -, 186 *4*

Where *Vicksburg-Miss-*

By whom *Lt. Col. Kinsley*; term *3* y'rs.

Remarks: *Credited to
Mass. Quota.*

F. A. Wright

H | **3 Cav.** | **U.S.C.T.**

Andrew Horton,

Priv., Co. A, 3 Reg't U.S. Col'd Cavalry.

Appears on

Company Muster Roll

for Sept. & Oct., 1864.

Present or absent Present.

Stoppage, \$ 100 for

Due Gov't, \$ 100 for

Valuation of horse, \$ 100

Valuation of horse equipments, \$ 100

Remarks: Credited to Mass.
Quota entitled to
Bounty.

Book mark: _____

P. Pool,

A | **3 Cav.** | **U.S.C.T.**

Andrew Horton

....., Co. A., 3 Reg't U. S. Col'd Cav.

Appears on

Company Descriptive Book
of the organization named above.

DESCRIPTION.

Age 24 years; height 5 feet 7½ inches.

Complexion Black

Eyes Black; hair Black

Where born Floyd, La.

Occupation Farmer

ENLISTMENT.

When Oct. 11 - , 186 4

Where Vietsburg-Miss-

By whom Lt. Col. Kinsley; term 3 y'rs.

Remarks: Credited to
Mass. Quota.

F. A. Wright

24 | **3 Cav.** | **U.S.C.T.**

Andrew Norton,

Appears with rank of Private on

Muster and Descriptive Roll of a Detachment of U. S. Vols. forwarded

for the 3 Reg't U. S. Col'd Cavalry. Roll dated

Vicksburg, Miss., Oct 20, 1864.

Where born Vicksburg, Miss.

Age 20 y'rs; occupation farmer.

When enlisted October 11, 1864.

Where enlisted Vicksburg, Miss.

For what period enlisted three years.

Eyes black; hair black;

Complexion col'd; height 5 ft. 5 in.

When mustered in October 12, 1864.

Where mustered in Vicksburg, Miss.

Bounty paid \$ 100.⁰⁰/₁₀₀; due \$ 200.⁰⁰/₁₀₀

Where credited State of Mass.

Company to which assigned _____

Remarks: _____

Book mark: _____

(339)

R. Brauner

Copyist.

H | **3 Cav.** | **U.S.C.T.**

Andrew Horton,

Priv., Co. A, 3 Reg't U.S. Col'd Cavalry.

Appears on

Company Muster Roll

for Nov. + Dec., 1864.

Present or absent Present.

Stoppage, \$ 100 for

Due Gov't, \$ 100 for

Valuation of horse, \$ 100

Valuation of horse equipments, \$ 100

Remarks: Credited to Mass.
quota. entitled to
Bounty.

Book mark: _____

P' Pool.

(358)

Copyist.

H | **3 Cav.** | **U.S.C.T.**

Andrew Horton

Prvt., Co. A, 3 Reg't U. S. Col'd Cavalry.

Appears on

Company Muster Roll

for Jan. & Feb., 1865.

Present or absent Present

Stoppage, \$ 100 for

Due Gov't, \$ 100 for

Valuation of horse, \$ 100

Valuation of horse equipments, \$ 100

Remarks: Credited to Mast.
Quota. entitled to
Bounty. Stop for one
Rough Revolver.

Book mark: _____

P'Pool

(358)

/ Copyist.

H | **3 Cav.** | **U.S.C.T.**

Andrew Horton

Priv., Co. A, 3 Reg't U. S. Col'd Cavalry.

Appears on

Company Muster Roll

for Mar. + Apr., 1865.

Present or absent Absent.

Stoppage, \$ 100 for

Due Gov't, \$ 100 for

Valuation of horse, \$ 100

Valuation of horse equipments, \$ 100

Remarks: Absent sick in
Genl. Hospital at
Memphis, Tenn., since
March 15 / 65.

Book mark: _____

O'Pool,

H 1 3 Cav. U.S.C.

Andrew Horton
Priv., Co. A, 3 Reg't U.S.C.

Appears on

Hospital Muster Roll

of Small Pox U. S. A. General Hospital,

at Memphis, Tenn.,

for March + April, 1865.

Attached to hospital:

When March 5, 1865.

How employed Sick

Last paid by Maj. _____

to _____, 186 .

Bounty paid \$ 100, due \$ 100

Present or absent Not stated

Remarks : _____

Book mark : _____

Garn

1865
H | 3 Cav. | U.S.C.T.

Andrew Horton,

Pvt., Co. A, 3 Reg't U. S. Col'd Cavalry.

Appears on

Company Muster Roll

for May + June, 1865.

Present or absent Absent.

Stoppage, \$ 100 for

Due Gov't, \$ 100 for

Valuation of horse, \$ 100

Valuation of horse equipments, \$ 100

Remarks: Absent sick in
Genl. Hosl. Mem-
phis. Tenn, since
Mar. 10, '65.

Book mark: _____

J. Pool

76 | 3 Cav. U.S.C.

Andrew Horton

Pvt., Co. H, 3 Reg't U.S.C.

Appears on

Hospital Muster Roll

of Small Pox U. S. A. General Hospital,

at Memphis, Tenn.,

for May & June, 1865.

Attached to hospital:

When March 5, 1865.

How employed Sick

Last paid by Maj. Never paid

to _____, 1865.

Bounty paid \$ 100; due \$ 100

Present or absent Present

Remarks:

Book mark:

Gann

(343)

Copyist

H | **3 Cav.** | **U.S.C.T.**

Andrew Horton
Pvt., Co. A, 3 Reg't U. S. Col'd Cavalry.

Appears on

Company Muster Roll

for July + Aug, 1865.

Present or absent Present

Stoppage, \$ 100 for

Due Gov't, \$ 100 for

Valuation of horse, \$ 100

Valuation of horse equipments, \$ 100

Remarks:
.....
.....
.....
.....
.....
.....
.....
.....
.....

Book mark:

O'Neal

H | **3 Cav.** | **U.S.C.T.**

Andrew Horton
Pl, Co. A, 3 Reg't U. S. Col'd Cavalry.

Appears on

Company Muster Roll
for Sept 10, 1865.

Present or absent Present

Stoppage, \$ 100 for

Due Gov't, \$ 100 for

Valuation of horse, \$ 100

Valuation of horse equipments, \$ 100

Remarks Ship for crew driver
37 and thing obust wiper⁴⁰
77

Book mark: _____

(358)

W Jones

Copyist.

H | **3 Cav.** | **U.S.C.T.**

Andrew Hoston
Plk, Co. A, 3 Reg't U. S. Col'd Cavalry.

Appears on

Company Muster Roll

for Nov & Dec, 1865.

Present or absent Present

Stoppage, \$ 100 for

Due Gov't, \$ 100 for

Valuation of horse, \$ 100

Valuation of horse equipments, \$ 100

Remarks: Sp for one year
driver. Hung & bush
77¢

Book mark:

(358)

M Jones

Copyist.

H6 | 3 Cav. | U.S.C.T.

Andrew Horton
Priv., Co. A, 3 Reg't U. S. Colored Cav.

Appears on Returns as follows:

Oct. 1864, Gain Oct. 11 Vicks-
burg from miss quota,

Mar. to June 1865, Absent sick
in Gen. Hosp. at Mem-
phis, Tenn. since Mar.
15/65.

Book mark :

(546)

J. B. Dittler

Copyist.

H | **3 Cav. | U.S.C.T.**

Andrew Horton
Ph, Co., 3 Reg't U. S. Col'd Cavalry.

Appears on **Co. Muster-out Roll**, dated
Memphis Tenn, Jan 26, 1866.
Muster-out to date *Jan 26*, 1866.
Last paid to *June 30*, 1865.

Clothing account:

Last settled....., 186 ; drawn since \$..... $\overline{100}$
Due soldier \$..... $\overline{100}$; due U. S. \$..... $3\frac{34}{100}$
Am't for cloth'g in kind or money adv'd \$..... $\overline{100}$

Due U. S. for arms, equipments, &c., \$..... $\frac{72}{100}$
Bounty paid \$..... $\overline{100}$; due \$..... $\overline{100}$

Remarks: *Ship for service during*
hungry & thirsty

Book mark:

M. Jones
(861) Copyist.

Horton Andrew

P, Co., 3 Reg't U.S. Army

1 Enclosures.

Bed Cards	Final Statements
Burial Records	Furloughs or L. of A.
Certs. of Dis. for Discharge	Med. Certificates
C. M. Charges	Med. Des. Lists
Descriptive Lists	Orders
Discharge Certificates	Pris. of War Record
Enlistment Papers	Resignations

Other papers relating to—

Admission to Hosp'l	Furlough or L. of A.
Casualty Sheet	Med. Examination
Confinement	Misc. Information
Contracts	Pay or Clothing
Death or Effects	Personal Reports
Desertion	Rank
Discharge from Hosp'l	Transfer to Hosp'l
Discharge from Service	Transfer to V. R. C.
Duty	Transportation

NOTE 1.—This blank will be used for both enlistments and re-enlistments—enlistment of veterans, &c., &c., in the volunteer service. They will be made out in duplicate in all cases—one to accompany the recruiting return of the superintendent (not the recruiting officer) to the Adjutant General, and one to accompany the accounts of the officer who pays bounty, &c. The Regiment and Company in which the soldier last served should be given on the back.

NOTE 2.—An enlistment holds to service. A muster-in must, in all cases, precede payment of pay, bounty, pension, &c. A muster-in roll must, in all cases, be filed in the Adjutant General's Office as evidence of muster-in. The mustering officer, commanding, or assistant commissary of musters, or the case may be, will countersign both enlistments as having mustered the soldier into the service of the United States before either of them is given to the disbursing officer.

*Rec'd
22/10/1864*

DECLARATION OF RECRUIT.

I, Andrew Horton, desiring to VOLUNTEER as a Soldier in the Army of the United States, for the term of THREE YEARS. Do Declare, That I am Twenty years and 1 months of age; that I have never been discharged from the United States service on account of disability or by sentence of a court martial, or by order before the expiration of a term of enlistment; and I know of no impediment to my serving honestly and faithfully as a soldier for three years.

GIVEN at Willsburg, Miss. the 11th day of October, 1864

Witness: Frank McCalis Andrew Horton

No. 117

Andrew Horton
Volunteered at Willsburg, Miss.
11th October, 1864
By Bl. G. Sweeney St. Louis
and Capt. Br. Marshal of Peace,
Regiment of _____

331170
enlistment; last served in Company ()

Discharged _____, 18 _____
Regt of _____

CONSENT IN CASE OF MINOR.

I, _____, Do CERTIFY, That I am the _____ of _____; that the said _____ is _____ years of age; and I do hereby freely give my CONSENT to his volunteering as a SOLDIER in the ARMY OF THE UNITED STATES for the period of THREE YEARS.

GIVEN at _____ the _____ day of _____

Witness: _____

VOLUNTEER ENLISTMENT.

STATE OF

TOWN OF

Mississippi

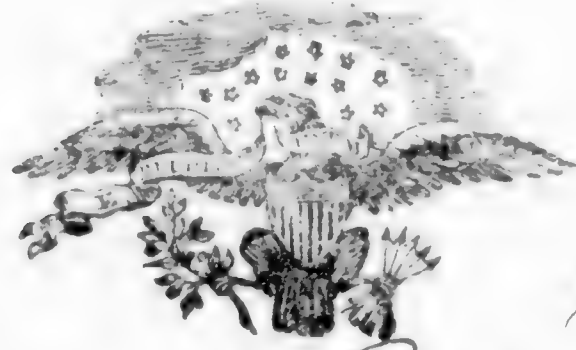

Vicksburg

I, Andrew Foster, born in Vicksburg in the State of Mississippi, aged Twenty years, and by occupation a Farmer. DO HEREBY ACKNOWLEDGE to have volunteered this Eleventh day of October, 1864, to serve as a **Soldier** in the **Army of the United States of America**, for the period of **THREE YEARS**, unless sooner discharged by proper authority: Do also agree to accept such bounty, pay, rations, and clothing, as are, or may be, established by law for volunteers. And I, Andrew Foster do solemnly swear, that I will bear true faith and allegiance to the **United States of America**, and that I will serve them honestly and faithfully against all their enemies or opposers whomsoever; and that I will observe and obey the orders of the President of the United States, and the orders of the officers appointed over me, according to the Rules and Articles of War.

Enlistment of Bounty

James K.

Sworn and subscribed to, at Vicksburg this 11th day of October 1864. Andrew Foster witness made by St. Col. E. C. Knolly and St. Col. E. C. Knolly asst. Pro Marshal Frank W. Calais

I CERTIFY, ON HONOR, That I have carefully examined the above-named Volunteer, agreeably to the General Regulations of the Army, and that, in my opinion, he is free from all bodily defects and mental infirmity, which would in any way disqualify him from performing the duties of a soldier.

H. C. Huston
Surgeon
EXAMINING SURGEON.

no parents in our line

I CERTIFY, ON HONOR, That I have minutely inspected the Volunteer Andrew Foster previously to his enlistment, and that he was entirely sober when enlisted; that, to the best of my judgment and belief, he is of lawful age; and that, in accepting him as duly qualified to perform the duties of an able-bodied soldier, I have strictly observed the Regulations which govern the recruiting service. This soldier has Blue eyes, Blue hair Light complexion, is Five feet Five 1/2 inches high.

St. Col. E. C. Knolly
asst. Pro Marshal of Mass
Regiment of Miss Volunteers,
Recruiting Officer.

(A. G. O. No. 74 & 76.)

Mustered into the service of the United States, for three years or during the war, from date of enlistment, in Company 34 Regiment of W. S. C. Cavalry on the 12 day of Oct, 1864, at St. Louis

W. S. C. Cavalry
St. Louis

689

Horton, Charles
Co G, 3 U. S. Col'd Cav.

Private | Private

CARD NUMBERS.

1	5330904	26
2	5340428	27
3	5340500	28
4	5340587	29
5	5340685	30
6	5340791	31
7	5340887	32
8	5340971	33
9	5341056	34
10	5341130	35
11	5341207	36
12	9089107	37
13	40727552	38
14		39
15		40
16		41
17		42
18		43
19		44
20		45
21		46
22		47
23		48
24		49
25		50

Book Mark:

See also

01367135 And up
01487752 And up
R40, 487024
J1979040 P O M M
SS, Va. 5/27/32

A. M. Shannon
Esq

1871
N | **3 Cav. | U.S.C.T.**

Charles Wilson

....., Co. *G*, 3 Reg't U. S. Col'd Cav.

Appears on

Company Descriptive Book
of the organization named above.

DESCRIPTION.

Age *18* years; height *5* feet *7* inches.

Complexion *Blk*

Eyes *blk*; hair *blk*

Where born *Winesburg*

Occupation *Hand*

ENLISTMENT.

When *July 11*, 186*1*.

Where *Winesburg*

By whom *Capt Coppindell*, term *3* y'rs.

Remarks:

Wilson

Co. | 3 Cav. | U.S.C.T.

Charles Horton

3rd Cav., Co., 3 Reg't U. S. Col'd Cav.

Age 18 years.

Appears on a

Detachment Muster-in Roll

of the organization named above. Roll dated

Vicksburg, Miss., July 22, 1864.

Muster-in to date July 11, 1864.

Joined for duty and enrolled:

When July 11, 1864.

Where Vicksburg, Miss.

Period 3 years.

Valuation of horse, \$ 100

Valuation of horse equipments, \$ 100

Remarks:

Book mark:

Sitter

H | **3 Cav.** | **U.S.C.T.**

Charles Hurton

Put, Co. G, 3 Reg't U. S. Col'd Cavalry.

Appears on

Company Muster Roll

for *July & Aug*, 1864.

Present or absent *Present*

Stoppage, \$ *100* for

Due Gov't, \$ *100* for

Valuation of horse, \$ *100*

Valuation of horse equipments, \$ *100*

Remarks:

Book mark:

W. J. Cuddeles

H | **3 Cav.** | **U.S.C.T.**

Charles Horton
Priv, Co. G, 3 Reg't U. S. Col'd Cavalry.

Appears on

Company Muster Roll
for Sept & Oct, 1864.

Present or absent Present

Stoppage, \$ 100 for

Due Gov't, \$ 100 for

Valuation of horse, \$ 100

Valuation of horse equipments, \$ 100

Remarks:

Book mark:

(358)

M. S. Anderson

Copyist.

Ch | **3 Cav. | U.S.C.T.**

Charles Horton

Priv, Co. G, 3 Reg't U. S. Col'd Cavalry.

Appears on

Company Muster Roll

for *Nov & Dec*, 186*1*.

Present or absent *Present.*

Stoppage, \$ *100* for

Due Gov't, \$ *100* for

Valuation of horse, \$ *100*

Valuation of horse equipments, \$ *100*

Remarks: *To be stopped / Haversack 67 / Canteen 48*
One Horse Brush 78. / Curry Comb 26.

Book mark: _____

(358)

Jervis
Copyist.

Ch | **3 Cav. | U.S.C.T.**

Charles Horton

priv, Co. G, 3 Reg't U. S. Col'd Cavalry.

Appears on

Company Muster Roll

for *Dated Feb 28*, 1865.

Present or absent *present*

Stoppage, \$ *100* for

Due Gov't, \$ *100* for

Valuation of horse, \$ *100*

Valuation of horse equipments, \$ *100*

Remarks: *To be stopped from Nov
& Dec Rolls #1, 12 & 101*

Book mark: _____

Jarvis
Copyist.

46 | **3 Cav.** | **U.S.C.T.**

Charles Barton

Priv, Co. G, 3 Reg't U. S. Col'd Cavalry.

Appears on

Company Muster Roll

for *Feb & Apr*, 1865.

Present or absent *Present*

Stoppage, \$ 100 for

Due Gov't, \$ 100 for

Valuation of horse, \$ 100

Valuation of horse equipments, \$ 100

Remarks:

Book mark:

(358)

Jarvis
Copyist.

CB | **3 Cav.** | **U.S.C.T.**

Charles Horton

Priv, Co. G, 3 Reg't U. S. Col'd Cavalry.

Appears on

Company Muster Roll

for *May & June*, 1865.

Present or absent *Present*

Stoppage, \$ *100* for

Due Gov't, \$ *100* for

Valuation of horse, \$ *100*

Valuation of horse equipments, \$ *100*

Remarks:
.....
.....
.....
.....
.....
.....
.....

Book mark:

.....
.....
Jarvis
.....
Copyist.

Ch | **3 Cav.** | **U.S.C.T.**

Charles Horton

Priv, Co. G, 3 Reg't U. S. Col'd Cavalry.

Appears on

Company Muster Roll

for *July & Aug*, 1865.

Present or absent *Present*

Stoppage, \$ *100* for

Due Gov't, \$ *100* for

Valuation of horse, \$ *100*

Valuation of horse equipments, \$ *100*

Remarks: *To be stopped for 1/2r Spurs & Straps 52^c One Curry Comb 20^c*

Book mark: _____

(358)

J. J. [Signature]
Copyist.

A | **3 Cav.** | **U.S.C.T.**

Charles Hoster

Plt, Co. G, 3 Reg't U. S. Col'd Cavalry.

Appears on

Company Muster Roll

for Sept & Oct, 1865.

Present or absent Present

Stoppage, \$ 25 for bed lost
100

Due Gov't, \$ 100 for _____

Valuation of horse, \$ 100

Valuation of horse equipments, \$ 100

Remarks: _____

Book mark: _____

Bumham

A | **3 Cav.** | **U.S.C.T.**

Charles Hoston

Plt, Co. G, 3 Reg't U. S. Col'd Cavalry.

Appears on

Company Muster Roll

for *Nov & Dec*, 1865.

Present or absent *Present*

Stoppage, \$ $\frac{78}{100}$ for *coldest*

Due Gov't, \$ $\frac{100}{100}$ for

Valuation of horse, \$ $\frac{100}{100}$

Valuation of horse equipments, \$ $\frac{100}{100}$

Remarks:

Book mark :

Burnham
(358) Copyist.

1871 186

H. | **3 Cav.** | **U.S.C.T.**

Charles Horton

Priv., Co. G, 3 Reg't U. S. Colored Cav.

Appears on **Returns** as follows:

July 1864, Gain July 11/64
Vicksburg, Miss. Enrolled,

Book mark :

(548)

J. B. Sittler

Copyist.

H | **3 Cav.** | **U.S.C.T.**

Charles Horton

Pvt, Co. E, 3 Reg't U. S. Col'd Cavalry.

Appears on **Co. Muster-out Roll**, dated
Memphis Tenn Jan 26 1866.

Muster-out to date Jan 26, 1866.

Last paid to June 30, 1865.

Clothing account:

Last settled _____, 186 ; drawn since \$ _____ 100

Due soldier \$ _____ 100; due U. S. \$ 20 ⁰³/₁₀₀

Am't for cloth'g in kind or money adv'd \$ _____ 100

Due U. S. for arms, equipments, &c., \$ _____ 100

Bounty paid \$ _____ 100; due \$ _____ 100

Remarks: Patel stoppage for lost
ordnance 78^c

Book mark : _____

Burnham
(361) Copyist.

690

Horton, George
Co L, 3 U. S. Col'd Cav.

Private | Corporal

CARD NUMBERS.

1	5331320	26
2	5345301	27
3	5345374	28
4	5345480	29
5	5345573	30
6	5345658	31
7	5345726	32
8	5345800	33
9	5345870	34
10	9089677	35
11	40727553	36
12		37
13		38
14		39
15		40
16		41
17		42
18		43
19		44
20		45
21		46
22		47
23		48
24		49
25		50

Book Mark:

See also

690

Horton, George
Co L, 3 U. S. Col'd Cav.

Private

Corporal

CARD NUMBERS.

1	5331320	26
2	5345301	27
3	5345374	28
4	5345480	29
5	5345573	30
6	5345658	31
7	5345726	32
8	5345800	33
9	5345870	34
10	9089677	35
11	40727553	36
12		37
13		38
14		39
15		40
16		41
17		42
18		43
19		44
20		45
21		46
22		47
23		48
24		49
25		50

Book Mark:

See also

G | **3 Cav. | U.S.C.T.**

George Horton
Co. *L*, 3 Reg't U. S. Col'd Cav.

Appears on

Company Descriptive Book
of the organization named above.

DESCRIPTION.

Age *27* years; height *5* feet *5* inches.

Complexion *Black*

Eyes *Black*; hair *Black*

Where born *Haywood co. Tenn.*

Occupation *Farmer*

ENLISTMENT.

When *Oct. 29, 1864.*

Where *Ticketsing Miss.*

By whom *Maj. Cook*; term *3* y'rs.

Remarks: *Received \$100*
U. S. Bounty Nov. 5, 1864,
Promoted to corp. as
per General Order
No. 10 Hd. Quarters
3rd U. S. C. C. Memphis
Tenn. Oct. 30, 1865.

F. B. Smith

(3830)

Copist.

H. | **3 Cav.** | **U.S.C.T.**

George Horton

Appears with rank of *Priv.* on

Muster and Descriptive Roll of a Detachment of U. S. Vols. forwarded

for the 3 Reg't U. S. Col'd Cavalry. Roll dated

Vicksburg Miss Nov 2, 1864.

Where born *Haywood Co. Tenn.*

Age *27* y'rs; occupation *Labourer*

When enlisted *Oct 29,* 1864.

Where enlisted *V. Burg Miss*

For what period enlisted *3* years.

Eyes *Black*; hair *Black*

Complexion *Good*; height *5 ft. 7 in.*

When mustered in *Oct 31,* 1864.

Where mustered in *V. Burg Miss.*

Bounty paid \$ *100* ^{*00*}/_{*100*}; due \$ *200* ^{*00*}/_{*100*}

Where credited *State of Mass*

Company to which assigned

Remarks:

Book mark:

J. J. J. J.

H | 3 Cav. | U.S.C.T.

George Horton
Priv., Co. L, 3 Reg't U. S. Col'd Cavalry.

Appears on

Company Muster Roll

for Nov + Dec, 1864.

Present or absent present

Stoppage, \$ 100 for

Due Gov't, \$ 100 for

Valuation of horse, \$ 100

Valuation of horse equipments, \$ 100

Remarks: Tap Curry Comb,
Horse Brush, \$1.01.
Rec'd. \$1.00. County
Feb. 5, 1864.

Book mark:

Dixon

H | 3 Cav. | U.S.C.T.

George Horton
Priv., Co. L, 3 Reg't U.S. Col'd Cavalry.

Appears on

Company Muster Roll

for Jan + Feb, 1865.

Present or absent present

Stoppage, \$ 100 for

Due Gov't, \$ 100 for

Valuation of horse, \$ 100

Valuation of horse equipments, \$ 100

Remarks:

Book mark:

Daxton
(358) Copyist.

H | 3 Cav. | U.S.C.T.

George Horton
Sut, Co. L, 3 Reg't U.S. Col'd Cavalry.

Appears on

Company Muster Roll
for *March + Apr*, 1865.

Present or absent *present*

Stoppage, \$ *100* for

Due Gov't, \$ *100* for

Valuation of horse, \$ *100*

Valuation of horse equipments, \$ *100*

Remarks:

Book mark:

Saxton

No. | **3 Cav.** | **U.S.C.T.**

George Harton
Pvt, Co. L, 3 Reg't U. S. Col'd Cavalry.

Appears on

Company Muster Roll

for *May + June*, 186*5*.

Present or absent *present*

Stoppage, \$ *100* for

Due Gov't, \$ *100* for

Valuation of horse, \$ *100*

Valuation of horse equipments, \$ *100*

Remarks: *Knapped Curry*
comb + H. Brush
\$1.01 Spurs, + Straps
52; Total \$1.53

Book mark:

Saxton

H | 3 Cav. | U.S.C.T.

George Barton

Priv., Co. L, 3 Reg't U. S. Col'd Cavalry.

Appears on

Company Muster Roll

for July & Aug, 1865.

Present or absent present

Stoppage, \$ 100 for

Due Gov't, \$ 100 for

Valuation of horse, \$ 100

Valuation of horse equipments, \$ 100

Remarks:

Book mark:

Saxton

No | 3 Cav. | U.S.C.T.

George Norton
Corp., Co. L, 3 Reg't U.S. Col'd Cavalry.

Appears on

Company Muster Roll

for Sept & Oct, 1865.

Present or absent Present

Stoppage, \$ 100 for

Due Gov't, \$ 100 for

Valuation of horse, \$ 100

Valuation of horse equipments, \$ 100

Remarks: Promoted from private to Corporal Oct 1, 1865 by order of Reg't commander

Book mark:

C. B. Thompson
Copyist.

16 | 3 Cav. | U.S.C.T.

George Norton
Corpl., Co. L, 3 Reg't U. S. Col'd Cavalry.

Appears on

Company Muster Roll

for Nov & Dec, 1865.

Present or absent Present

Stoppage, \$ 100 for

Due Gov't, \$ 100 for

Valuation of horse, \$ 100

Valuation of horse equipments, \$ 100

Remarks: Promoted from private
Oct. 1. /65

Book mark:

E. B. Thorne
Copyist.

H. | **3 Cav.** | **U.S.C.T.**

George Horton
Pvt, Co. L, 3 Reg't U. S. Colored Cav.

Appears on **Returns** as follows:

Nov. 1864. Gain Nov. 1/64
Vicksburg - Enlisted in
the Regt.

Book mark :

.....
.....
J. B. Dittler
.....

(546)

Copyist.

Mc | **3 Cav. | U.S.C.T.**

George Norton
Corp., Co. *L*, 3 Reg't U. S. Col'd Cavalry.

Appears on **Co. Muster-out Roll**, dated
Memphis Tennessee 26, 186*6*.

Muster-out to date *Jan 26*, 186*6*.

Last paid to *June 30*, 186*5*.

Clothing account:

Last settled _____, 186 ; drawn since \$ _____ 100

Due soldier \$ _____ 100; due U. S. \$ _____ *2 1/100*

Am't for cloth'g in kind or money adv'd \$ _____ 100

Due U. S. for arms, equipments, &c., \$ _____ 100

Bounty paid \$ *100.00* 100; due \$ _____ 100

Remarks: *Promoted from Private*
Oct 1. 65 by order of Col Cook

Book mark : _____

(361)

E. B. Thompson
Copyist.

MICROFILM PUBLICATION M 1819

COMPILED MILITARY SERVICE RECORDS
OF VOLUNTEER UNION SOLDIERS WHO
SERVED WITH THE USCT (US COLORED TROOPS)
3RD REGIMENT OF CAVALRY

PERSONAL PAPERS' TARGET SHEET

PLEASE NOTE THE CHECKED INFORMATION ABOUT THE PERSONAL PAPERS IN
THIS FILE:

- NO PERSONAL PAPERS WERE FOUND IN THIS FILE WHEN THE
RECORDS WERE ARRANGED FOR MICROFILMING.
- 1 PERSONAL PAPER(S) FOUND IN THIS FILE WHEN THE RECORDS
WERE ARRANGED FOR MICROFILMING.

NOTE 1.—This blank will be used for both enlistments and re-enlistments—enlistment of veterans, &c., &c., in the volunteer service. They will be made out in duplicate in all cases—one to accompany the recruiting return of the superintendent and the recruiting officer to the Adjutant General, and one to accompany the accounts of the officer who pays bounty, &c. The Regiment and Company in which the soldier is to be mustered should be given on the back.

NOTE 2.—All enlistment holds to service. A muster-in must in all cases, precede payment of pay, bounty, pension, &c. A muster-in roll must, in all cases, be filed in the Adjutant General's Office as evidence of muster-in. The mustering officer, commissary, or assistant commissary of musters, as the case may be, will countersign both enlistments as having mustered the soldier into the service of the United States before either of them is given to the disbursing officer.

Rec'd from 2nd. Aud. May 13th 1893

DECLARATION OF RECRUIT.

I, George Horton, desiring to VOLUNTEER as a Soldier in the Army of the United States, for the term of THREE YEARS, Do Declare, That I am twenty seven years and _____ months of age; that I have never been discharged from the United States service on account of disability or by sentence of a court martial, or by order before the expiration of a term of enlistment; and I know of no impediment to my serving honestly and faithfully as a soldier for three years.

GIVEN at Vicksburg the 29th day of October 1864

Witness:

B. F. Stevens

George Horton
his mark

No. 6
George Horton
Volunteered at Vicksburg, Miss
29th October, 1864
By B. F. Stevens, Lt. Col.
Adj. Gen. Mississippi
Regiment of Misses

_____ enlistment; last served in Company ()
Reg't of _____
Discharged _____, 18 _____

CONSENT IN CASE OF MINOR.

I, _____, Do CERTIFY, That I am the _____ of _____; that the said _____ is _____ years of age; and I do hereby freely give my CONSENT to his volunteering as a SOLDIER in the ARMY OF THE UNITED STATES for the period of THREE YEARS.

GIVEN at _____ the _____ day of _____

Witness:

VOLUNTEER ENLISTMENT.

STATE OF

TOWN OF

Mississippi

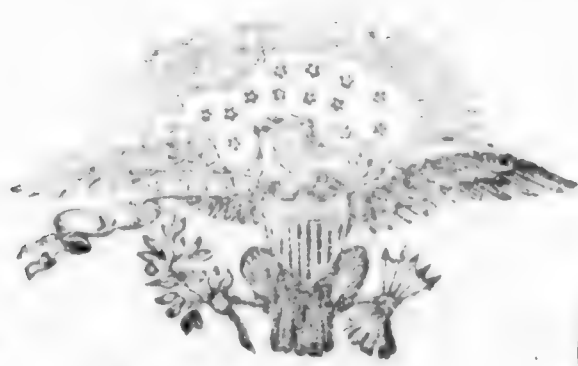

Vicksburg

I, George Horton, born in Haywood Co
 in the State of Tennessee, aged twenty seven years,
 and by occupation a Laborer, DO HEREBY ACKNOWLEDGE to have
 volunteered this twenty ninth day of October, 1864,
 to serve as a **Soldier** in the **Army of the United States of America**, for
 the period of **THREE YEARS**, unless sooner discharged by proper authority:
 Do also agree to accept such bounty, pay, rations, and clothing, as are, or may be,
 established by law for volunteers. And I, George Horton, do
 solemnly swear, that I will bear true faith and allegiance to the **United States**
of America, and that I will serve them honestly and faithfully against all
 their enemies or opposers whomsoever; and that I will observe and obey the
 orders of the President of the United States, and the orders of the officers
 appointed over me, according to the Rules and Articles of War.

Single

Mustered into the service of the United States, for three years or during the war, from date of enlistment, in Company
34 Regiment of W. G. Lewis Volunteers, on the 31 day of Oct, 1864, at Shreveport Miss

Sworn and subscribed to, at Vicksburg
 this 29th day of October, 1864, } George Horton his mark
 BEFORE Eli C. Kusley } Witness
1st Lt. & Asst. Prov. Marshal

I CERTIFY, ON HONOR, That I have carefully examined the above-named Volunteer, agreeably
 to the General Regulations of the Army, and that, in my opinion, he is free from all bodily defects and
 mental infirmity, which would in any way disqualify him from performing the duties of a soldier.

H. B. Huntman

Surf 50th U.S. Regt
 @ EXAMINING SURGEON.

I CERTIFY, ON HONOR, That I have minutely inspected the Volunteer George Horton
 previously to his enlistment, and that he was entirely sober when enlisted; that, to the best of my
 judgment and belief, he is of lawful age; and that, in accepting him as duly qualified to perform the
 duties of an able-bodied soldier, I have strictly observed the Regulations which govern the recruiting
 service. This soldier has Blk eyes, Blk hair, Red complexion, is five
 feet nine inches high.

1st Lt. Eli C. Kusley
Asst. Prov. Marshal of Mass

Regiment of Volunteers,

Lies of Mass and RECRUITING OFFICER.

Enlisted to Bounty

W. G. Lewis
1st Lt. 34th Regt
Vol. 11th P. O.

691

Horton, Jacob
Co I, 3 U. S. Col'd Cav.

Private | Private

CARD NUMBERS.

1	5330999	26
2	5343042	27
3	5343149	28
4	5343279	29
5	5343620	30
6	9089410	31
7	40727554	32
8	31691528	33
9		34
10		35
11		36
12		37
13		38
14		39
15		40
16		41
17		42
18		43
19		44
20		45
21		46
22		47
23		48
24		49
25		50

Book Mark:

See also

S 969281. 2land.

A. M. Shannon
Esq.

A | **3 Cav. | U.S.C.T.**

Jacob Hitter

....., Cb....., 3 Reg't U. S. Col'd Cav.

Appears on

Company Descriptive Book

of the organization named above.

DESCRIPTION.

Age *18* years; height *5* feet *6* inches.

Complexion *Yellow*

Eyes *Blk*; hair *blk*

Where born *Granada Miss*

Occupation *field hand*

ENLISTMENT.

When *Jan 6*, 1865.

Where *Burg*

By whom *Maj Train*; term *3* y'rs.

Remarks: *Died in Regimental Hospital at Memphis Tenn June 9 1865. Last paid by Paymaster Maj Mayburn to include 28 Feb 1865. Received clothing amounting to \$68.49. Incurred to Gov for two canteens and two Haversacks \$3.20 to Lt Bivens latter \$100 final statements and inventory sent June 9 1865*

Hitter

No. 3 Car. **U.S.C.T.**

Jacob Horton.
Priv. Co., 3 Reg't U. S. Col'd Car.

Age 24 years.

Appears on a

Detachment Muster-in Roll

of the organization named above. Roll dated

Vicksburg, Miss. Jan. 7, 1865.

Muster-in to date Jan. 7, 1865.

Joined for duty and enrolled:

When Jan. 6, 1865.

Where Vicksburg, Miss.

Period 3 years.

Valuation of horse, \$ 100

Valuation of horse equipments, \$ 100

Remarks: _____

Book mark: _____

Sitter.

H | **3 Cav.** | **U.S.C.T.**

Jacob. Horton

Priv., Co. I, 3 Reg't U. S. Col'd Cavalry.

Appears on

Company Muster Roll

for Jan & Feby, 1865.

Present or absent Absent

Stoppage, \$ 100 for

Due Gov't, \$ 100 for

Valuation of horse, \$ 100

Valuation of horse equipments, \$ 100

Remarks: Absent Sick in Genl
Hosp. at Memphis Tenn since
Jan 1. 65.

Book mark:

Lucas

H | *3 car USCT*
Jacob Horton
Pvt, Co I, 3 Reg't USCT

Appears on

Hospital Muster Roll

of Webster U. S. A. General Hospital,

at Memphis, Tenn.,

for *Jan & Feb*, 1865.

Attached to hospital:

When *Feb 23*, 1865.

How employed *Sick*

Last paid by *May* *Pay-due from enlistment*
to _____, 186 .

Bounty paid \$ *100*; due \$ *100*

Present or absent *Present*

Remarks: *Stoppage \$ 1.27*

Book mark :

J Underwood

H | 3 Cav. | U.S.C.T.

Jacob Horton

Priv., Co. I, 3 Reg't U. S. Col'd Cavalry.

Appears on

Company Muster Roll

for *March & April*, 1865

Present or absent *Present*

Stoppage, \$ *1.00* for

Due Gov't, \$ *1.00* for

Valuation of horse, \$ *1.00*

Valuation of horse equipments, \$ *1.00*

Remarks: *Stop for one canton
one Harness 1.00.*

Book mark:

Jacob

H | **3 Cav.** | **U.S.C.T.**

Jacob Horton
Pvt, Co. I, 3 Reg't U. S. Col'd Cavalry.

Appears on

Company Muster Roll

for *May & June*, 186*5*.

Present or absent

Stoppage, \$ 100 for

Due Gov't, \$ 100 for

Valuation of horse, \$ 100

Valuation of horse equipments, \$ 100

Remarks: *Died in Gen Hospital*
at Memphis Tenn June 9
1865. Stop for Canteens
& two Haversacks.
\$3.20

Book mark:

(358)

J. Hadenwood
Copyist.

H. | 3 Cav. | U.S.C.T.

Jacob Horton
Pvt., Co. I, 3 Reg't U. S. Colored Cav.

Appears on Returns as follows:

Jan. 1865. Gained Jan. 16/65
Memphis, Tenn. Enlisted
in Regt.

Feb. 1865. Absent sick since
Feb. 4/65.

Mar. 1865. Absent sick in
Gen. Hosp. Memphis,
Tenn. Feb. 23/65.

June 1865. Lost June 9 Mem-
phis. Died in Regt's
Hosptl.

Book mark :

(546)

J. B. Sittler

Copyist.

H | 3 Cav. | U.S.C.T.

Jacob Houston

Miss, Co. D, 3 Reg't U. S. Col'd Cavalry.

Appears on Co. Muster-out Roll, dated

Memphis Tenn Jan 26, 1866.

Muster-out to date _____, 186 .

Last paid to Feb 28, 1865.

Clothing account:

Last settled _____, 186 ; drawn since \$ _____ 100

Due soldier \$ _____ 100; due U. S. \$ _____ 100

Am't for cloth'g in kind or money adv'd \$ _____ 100

Due U. S. for arms, equipments, &c., \$ _____ 100

Bounty paid \$ _____ 100; due \$ _____ 100

Remarks: Died in Regt Hospital
at Memphis Tenn June 9 1865
of Chronic Diarrhea. Final
statement forwarded.

Book mark: 1171.200.71-4672.1880

(861)

Copyist.

JAN. - 8

5343620

1891 *

Y. 145. P. 47. 72

Horton Jacob

A, Co. I

3

Reg't U.S.C. Cav.

3

Enclosures.

Bed Cards	Descriptive Lists
Burial Records	Final Statements 2
Certs. of Dis. for Discharge	Furloughs
C. M. Charges	Med. Des. Lists
Med. Certificates	Orders

Other papers relating to—

Admission to Hosp'l	Furlough
Casualty Sheet (Officer's)	Med. Examination
Confinement	Misc. Information
Contracts	Pay or Clothing
Death or Effects /	Personal Reports
Desertions	Rank
Discharge from Hosp'l	Transfer to Hosp'l
Discharge from Service	Transfer to V. R. C.
Duty	Transportation

FINAL STATEMENT

OF

Private Jacob Horton
3rd Reg't of U.S. Col. Cav.
VOLUNTEERS.
Aug 15 1865

NOTE 1.—Two of these certificates (or duplicates) are to be given to each Volunteer Soldier or drafted man who may be discharged without being mustered out (Final Statements are never given to men mustered out of service) that he may at once receive from the Paymaster the pay, &c., due him, and the captain or other COMMISSIONED officer commanding the company will certify to the act of the delivery of the duplicate certificates; with these certificates the Soldier is "entitled to" his discharge, and should also present his discharge to the Paymaster to have the payment endorsed on it. The discharge is to be given back to the Soldier by the Paymaster; the latter only retaining as his vouchers the duplicate certificates.

NOTE 2.—If the Soldier is entitled to pay for the use of his horse, the Company Commander will certify to that fact on the back of both these final statements, and also to the time he has pay due for having been so mounted on his own horse.

NOTE 3.—When a Soldier is furnished with final statements, his descriptive list, if he has one, should be taken up by the officer who gives the Soldier these statements, and endorsed with a statement to this effect by the officer. The endorsement should exhibit a full statement of the time for which the Soldier was allowed pay on his final statements, the clothing account, and all other charges against him or in his favor, so as to comprise a complete exhibit of his account. It will then be transmitted to the Company Commander of the Soldier, who will enter all the data necessary to a full understanding of the Soldier's account on the muster roll upon which the Soldier's discharge is reported. The descriptive list will then be destroyed. The object of this is, that the remaining portion of the Soldier's account may be settled upon the receipt of these muster rolls, and the Soldier receive any pay or allowances that may be due him at the time of his discharge, and which may not appear on his last final statements from the fact that his descriptive list is incomplete. These accounts for back pay, &c., are settled by the 2d Auditor of the Treasury Department.

NOTE 4.—Charges for loss or injury to ordnance, horse equipments, and other miscellaneous charges, should appear under the heading of "Other Stoppages."

NOTE 5.—Bounty paid by State authorities, and not by the United States, will not be entered on this statement.

NOTE 6.—Amounts due the Sutler and Laundress must be entered on the muster roll on which the discharge, death, desertion, &c., is reported, as well as on the final statement, otherwise the amount cannot be collected from the United States.

NOTE 7.—This blank will be used for deceased volunteers and drafted men, as well as for others.

NOTE 8.—Where a Soldier dies in Hospital or on detached service, his descriptive list, if he has one, should be sent with his final statements, in duplicate, to the Adjutant General, Washington, D. C.

NOTE 9.—If the soldier is a drafted man or substitute, the space for time, &c., of enrolled, should contain only the word *drafted* or *substitute*, as the case may be. If the Soldier is a "VETERAN," (or RECRUIT,) the words as a *veteran*, (or *recruit*,) as the case may be, should be interlined after the words *mustered into the service of the U. S.* A statement of all the installments of *Veteran* or *Recruit* Bounty RECEIVED by the Soldier must be made on the back of each final statement.

ADJUTANT GENERAL'S OFFICE
Aug 15 1865
Duplicate with Inventory sent 2d Auditor.

I certify, on honor, that Jacob Heston, a Private of
 Captain Jesse Brainerd Company (B) of the 3rd Regiment of U.S. Col. Cav
VOLUNTEERS, of the State of _____, born in Granada, State
 of Mississippi, aged 18 years; 5 feet 6 inches high; yellow complexion,
 _____ eyes, _____ hair, and by occupation a _____, who joined for service
 and was enrolled (see Note 9) on the 1st day of January 1865, at Vicksburg Miss
 by Maj Main, for the period of three years, and mustered into
 the service of the United States on the 1st day of January 1865, at
Vicksburg Miss, by Lieut M D Jorgall; and having served
 HONESTLY and FAITHFULLY with his Company to the present date, is now entitled to a
DISCHARGE by reason of death, died in Regimental Hospital
at Memphis Tenn June 7th 1865 of Chronic Diarrhoea

The said Jacob Heston was last paid by Paymaster
Maj Maybourn, to include the 28th day of February, 1865, and
 has pay due him from that time to the present date; he is entitled to pay and subsistence for
TRAVELING to place of enrollment, and whatever other allowances are authorized to volunteer
 soldiers, drafted men, or militia, so discharged. He has received from the United States **CLOTHING**
 amounting to 68 49 dollars, since the date of enlistment day of _____
 1865, when his clothing account was last settled. He has received from the United States
 _____ dollars advanced **BOUNTY**.

There is to be stopped from him, on account of the State of _____, or other
 authorities, for **CLOTHING**, &c., received on entering service, _____ dollars; and
 for other stoppages, viz: Tax cartons 9th Tax Haversack
 _____ dollars.

He has been furnished with **TRANSPORTATION** in kind from the place of his discharge to
 _____; and he has been **SUBSISTED** for **TRAVELING** to his
 place of enrollment, up to the _____, 1865.

He is indebted to P. L. Pierce, **SUTLER**, _____ dollars.
 He is indebted to _____, **LAUNDRESS**, _____ dollars.

Given in Duplicate, at Memphis Tennessee, this 9th day
 of June, 1865.

Fredrick Fernald
Lieut 3rd U.S. Col. Cav
 Commanding Company.

28

FINAL STATEMENT

OF

Private Jacob Horton
300th Reg't of Inf Col cur

VOLUNTEERS.

NOTE 1.—Two of these certificates (or duplicates) are to be given to each Volunteer Soldier or drafted man who may be discharged without being mustered out (Final Statements are never given to men mustered out of service) that he may at once receive from the Paymaster the pay, &c., due him, and the captain or other COMMISSIONED officer commanding the company will certify to the act of the delivery of the duplicate certificates; with these certificates the Soldier is "entitled to" his discharge, and should also present his discharge to the Paymaster to have the payment endorsed on it. The discharge is to be given back to the Soldier by the Paymaster; the latter only retaining as his vouchers the duplicate certificates.

NOTE 2.—If the Soldier is entitled to pay for the use of his horse, the Company Commander will certify to that fact on the back of both these final statements, and also to the time he has pay due for having been so mounted on his own horse.

NOTE 3.—When a Soldier is furnished with final statements, his descriptive list, if he has one, should be taken up by the officer who gives the Soldier these statements, and endorsed with a statement to this effect by the officer. The endorsement should exhibit a full statement of the time for which the Soldier was allowed pay on his final statements, the clothing account, and all other charges against him or in his favor, as to comprise a complete exhibit of his account. It will then be transmitted to the Company Commander of the Soldier, who will enter all the data necessary to a full understanding of the Soldier's account on the muster roll upon which the Soldier's discharge is reported. The descriptive list will then be destroyed. The object of this is, that the remaining portion of the Soldier's account may be settled upon the receipt of these muster rolls, and the Soldier receive any pay or allowances that may be due him at the time of his discharge, and which may not appear on his last final statements from the fact that his descriptive list is incomplete. These accounts for back pay, &c., are settled by the 2d Auditor of the Treasury Department.

NOTE 4.—Charges for loss or injury to ordnance, horse equipments, and other miscellaneous charges, should appear under the heading of "Other Stoppages."

NOTE 5.—Bounty paid by State authorities, and not by the United States, will not be entered on this statement.

NOTE 6.—Amounts due the Sutler and Laundress must be entered on the muster roll on which the discharge, death, desertion, &c., is reported, as well as on the final statement, otherwise the amount cannot be collected from the United States.

NOTE 7.—This blank will be used for deceased volunteers and drafted men, as well as for others.

NOTE 8.—Where a Soldier dies in Hospital or on detached service, his descriptive list, if he has one, should be sent with his final statements, in duplicate, to the Adjutant General, Washington, D. C.

NOTE 9.—If the soldier is a drafted man or substitute, the space for time, &c., of enrolled, should contain only the word *drafted* or *substitute*, as the case may be. If the Soldier is a "VETERAN," (or RECRUIT,) the words *as a veteran*, (or *recruit*,) as the case may be, should be interlined after the words *mustered into the service of the U. S.* A statement of all the installments of *Veteran* or *Recruit*, *Bounty*, RECEIVED by the Soldier must be made on the back of each final statement.

1865

RECEIVED
ADJUTANT GENERAL
WASHINGTON

I certify, on honor, that Jacob Houston, a Private of
 Captain Jesse Baines Company (A) of the 3rd Regiment of U.S. Colored
VOLUNTEERS, of the State of _____, born in Granada, State
 of Mississippi, aged 18 years; 5 feet 6 inches high; tawny complexion,
Blk eyes, Blk hair, and by occupation a Field Hand, who joined for service
 and was enrolled (see Note 9) on the 6th day of Jan., 1865, at Vicksburg Miss.
 by Maj Main, for the period of three years, and mustered into
 the service of the United States on the 1th day of Jan, 1865, at
Vicksburg Miss., by Lieut-McDonnell; and having served
 HONESTLY and FAITHFULLY with his Company to the present date, is now entitled to a
DISCHARGE by reason of death, died in Regt-Hospit-at-
Memphis Tenn of Chronic Diarrhoea, June 9th 1865-

The said Jacob Houston was last paid by Paymaster
Maj Maybrow, to include the 38th day of February, 1865, and
 has pay due him from that time to the present date; he is entitled to pay and subsistence for
TRAVELING to place of enrollment, and whatever other allowances are authorized to volunteer
 soldiers, drafted men, or militia so discharged. He has received from the United States **CLOTHING**
 amounting to 68⁴⁹/₁₀₀ dollars, since the the date of his enlistment day of _____
 1865, when his clothing account was last settled. He has received from the United States
 _____ dollars advanced **BOUNTY**.

There is to be stopped from him, on account of the State of _____, or other
 authorities, for **CLOTHING**, &c., received on entering service, _____ dollars; and
 for other stoppages, viz: ~~One canteen and one Hooversack \$1.00~~
Two canteens and Two Hooversacks
 _____ 3²⁰/₁₀₀ dollars.

He has been furnished with **TRANSPORTATION** in kind from the place of his discharge to
 _____; and he has been **SUBSISTED** for **TRAVELING** to his
 place of enrollment, up to the _____, 1865.

He is indebted to P. L. Bierce, **SUTLER**, _____ 1⁰⁰/₁₀₀ dollars.

He is indebted to _____, **LAUNDRESS**, _____ 1⁰⁰/₁₀₀ dollars.

Given in Duplicate, at Memphis Tennessee, this 9th day
 of June, 1865.

Frederick Female
Lieut-3rd U.S. Col'd Cav
 Commanding Company.

MAR 14 1865

I certify, on honor, that Jacob Houston, a Private of
 Captain James Brainerd Company (A) of the 3rd Regiment of U.S. Col'd Cav
VOLUNTEERS, of the State of _____, born in Granada, State
 of Mississippi, aged 18 years; 5 feet 4 inches high; yellow complexion,
Blk eyes, Blk hair, and by occupation a Field Hand, who joined for service
 and was enrolled (see Note 9) on the 6th day of Jan., 1865, at Vicksburg Miss.
 by Maj Main, for the period of three years, and mustered into
 the service of the United States on the 1st day of Jan, 1865, at
Vicksburg Miss., by Lieut Mc Donnell; and having served
 HONESTLY and FAITHFULLY with his Company to the present date, is now entitled to a
DISCHARGE by reason of death, died in Reg-Hosp at
Memphis Tenn of Chronic Diarrhoea, June 9th 1865-

The said Jacob Houston was last paid by Paymaster
Maj Maybrow, to include the 28th day of February, 1865, and
 has pay due him from that time to the present date; he is entitled to pay and subsistence for
TRAVELING to place of enrollment, and whatever other allowances are authorized to volunteer
 soldiers, drafted men, or militia, so discharged. He has received from the United States **CLOTHING**
 amounting to 18 ⁴⁹/₁₀₀ dollars, since the 1st day of the date of his enlistment-
 1865, when his clothing account was last settled. He has received from the United States
 _____ ¹⁰⁰/₁₀₀ dollars advanced **BOUNTY**.

There is to be stopped from him, on account of the State of _____, or other
 authorities, for **CLOTHING**, &c., received on entering service, _____ ¹⁰⁰/₁₀₀ dollars; and
 for other stoppages, viz: ~~One canteen and one Hooversack \$1.00~~
Two canteens and Two Hooversacks
 _____ ^{3 20}/₁₀₀ dollars.

He has been furnished with **TRANSPORTATION** in kind from the place of his discharge to
 _____; and he has been **SUBSISTED** for **TRAVELING** to his
 place of enrollment, up to the _____, 1865.

He is indebted to P. L. Bierce, **SUTLER**, _____ ^{1 00}/₁₀₀ dollars.

He is indebted to _____, **LAUNDRESS**, _____ ¹⁰⁰/₁₀₀ dollars.

Given in Duplicate, at Memphis Tennessee, this 9th day
 of June, 1865.

Fredrick Femald
Lieut 3rd U.S. Col'd Cav
 Commanding Company.

ARTICLES OF WAR.

ART. 95. When any non-commissioned officer or soldier shall die, or be killed in the service of the United States, the then commanding officer of the troop or company shall, in the presence of two other commissioned officers, take an account of what effects he died possessed of, above his arms and accoutrements, and transmit the same to the office of the Department of War, which said effects are to be accounted for, and paid to the representatives of such deceased non-commissioned officer or soldier. And in case any of the officers, so authorized to take care of the effects of deceased officers and soldiers, should, before they have accounted to their representatives for the same, have occasion to leave the regiment or post, by preferment or otherwise, they shall, before they be permitted to quit the same, deposit in the hands of the commanding officer, or of the assistant military agent, all the effects of such deceased non-commissioned officers and soldiers, in order that the same may be secured for, and paid to, their respective representatives.

DIRECTIONS.

NOTE 1.—One copy of the inventories of the effects of deceased non-commissioned officers and soldiers, required by the 95th Article of War, will be forwarded to the Adjutant General, by the commander of the company to which the deceased belonged, and a duplicate of the same to the colonel of the regiment. Final statements of pay, clothing, &c. in duplicate, will be sent to the Adjutant General with one copy of the inventory. Both inventory and final statements should be forwarded, as a general rule, through Regimental Headquarters. When a soldier dies at a post or station absent from his company, it will be the duty of his immediate commander to furnish, direct to the Adjutant General, the required inventory and final statements, and, at the same time, to forward to the commanding officer of the company to which the soldier belonged, a report of his death, specifying the date, place, and cause; to what time he was last paid, and the money or other effects in his possession at the time of his decease; which report will be noted on the next muster bill of the company to which the man belonged. Each inventory will be endorsed, "Inventory of the effects of _____, late of company (—) _____ regiment of _____, who died at _____, the _____ day of _____, 186—." If a legal representative receive the effects, it will be stated in the report. If the soldier leave no effects, the fact will be reported on the blank for inventory.

NOTE 2.—Should the effects of a deceased non-commissioned officer or soldier not be administered upon within a short period after his decease, they shall be disposed of by a Council of Administration, under the authority of the commanding officer of the post, and the proceeds deposited with the Paymaster, to the credit of the United States, until they shall be claimed by the legal representatives of the deceased.

NOTE 3.—In all such cases of sales by the Council of Administration, a statement in detail, or account of the proceeds duly certified by the Council and commanding officer, (Form 5) accompanied by the Paymaster's receipt for the proceeds, will be forwarded by the commanding officer to the Adjutant General. The statement will be endorsed, "Report of the proceeds of the effects of _____, late of company (—) _____ regiment of _____, who died at _____, the _____ day of _____, 186—."

NOTE 4.—The effects in all cases, when called for, should be turned over to the legal representative, without further authority from the Adjutant General. When the effects are turned over to the relatives of the deceased before these inventories are sent to the Adjutant General, their receipts therefor should be attached to the inventories. In all other cases, one copy will be sent with a letter of transmittal direct to the Adjutant General, and a duplicate retained by the officer.

NOTE 5.—Particular care should be taken to take receipts in duplicate from the Paymaster for any funds turned over to him; one copy should be sent direct to the Adjutant General and one retained by the officer.

INVENTORY OF THE EFFECTS

OF

Private Jacob Norton

Late of Company *D*

300 Reg't of *U.S. Colored*

Volunteers, who died at *Memphis Tenn*

on the *9th* day of *June* 1865.



Inventory of the effects of Jacob Horton late
 a Private of Captain Jesse B. Rainard Company "I" of
 the 300 Regiment of U.S. Col. Cav Volunteers, who was enrolled as
 a Private at Jackson in the State of Mississippi on
 the 1st day of January 1865, and mustered into the service of the United
 States as a Private on the 1st day of January 1865, at Jackson Miss
 in Company I, 300 Regiment of U.S. Col. Cav Volunteers, to serve 3⁰
 years or during the war; he was born in Canada in the State
 of Miss; he was 18 years of age, 3 feet 1 inches
 high, yellow complexion, Blk eyes, Blk hair, and by occupation, when enrolled,
 a Field Hand; he died in Hot Springs, at
Memphis Tenn on the 9th day of June 1865, by
 reason of Chronic Dysentery

INVENTORY.					
ARTICLES.	No.	ARTICLES.	No.	ARTICLES.	No.
Hats.....		Pairs trousers.....		Knapsacks.....	
Caps.....		Pairs flannel drawers.....			
Forage caps.....		Pairs cotton drawers.....			
Great coats.....		Flannel shirts.....			
Uniform coats.....		Cotton shirts.....			
Uniform jackets.....		Pairs boots.....			
Flannel sack coats.....		Pairs shoes.....			
Blouses.....		Pairs socks.....			
Stable frocks.....		Blankets.....			
Fatigue overalls.....		Haversacks.....			
				MONEY.	
				Specie.....	\$
				Notes.....	\$

I CERTIFY, ON HONOR, that the above inventory comprises all the effects of Private
Jacob Horton deceased, and that the effects are in the hands
 of _____ at _____
 _____ to be disposed of by a Council of Administration.

(DUPLICATES.)

STATION Memphis Tenn
 DATE: June 9th 1865

Jesse B. Rainard
Jesse B. Rainard
 Commanding the Company.

692

Horton, Thomas
Co I, 3 U. S. Col'd Cav.

Private | Private

CARD NUMBERS.

1	5331000	26
2	5343041	27
3	5343150	28
4	5343247	29
5	5343333	30
6	5343422	31
7	5343498	32
8	5343572	33
9	9089411	34
10	40727555	35
11		36
12		37
13		38
14		39
15		40
16		41
17		42
18		43
19		44
20		45
21		46
22		47
23		48
24		49
25		50

Book Mark:

See also

31 | **3 Cav. | U.S.C.T.**

Thomas Norton

....., Col. *3*, 3 Reg't U. S. Col'd Cav.

Appears on

Company Descriptive Book

of the organization named above.

DESCRIPTION.

Age *20* years; height *5* feet *6 1/2* inches.

Complexion *Yellow*

Eyes *Blk*; hair *Blk*

Where born *Palmer Co Miss*

Occupation *field hand*

ENLISTMENT.

When *Jan 6*, 186*5*.

Where *Burg*

By whom *Mag Train*; term *3* y'rs.

Remarks:
.....
.....
.....
.....
.....
.....

Hittor

H | **3 Cav.** | **U.S.C.T.**

Thomas Horton

Plt-, Co. I, 3 Reg't U. S. Col'd Cavalry.

Appears on

Company Muster Roll

for Jan + Feby, 186 J.

Present or absent Present

Stoppage, \$ 100 for

Due Gov't, \$ 100 for

Valuation of horse, \$ 100

Valuation of horse equipments, \$ 100

Remarks:

Book mark: 23500

Lucas

H.C. | *3 Cav.* | **U.S.C.T.**

Thomas Horton.

3rd Cav., Co., *3* Reg't U. S. Col'd *Cav.*

Age *20* years.

Appears on a

Detachment Muster-in Roll

of the organization named above. Roll dated

Vicksburg, Miss. Jan. 7, 1865.

Muster-in to date *Jan. 7, 1865.*

Joined for duty and enrolled:

When *Jan. 6*, 1865.

Where *Vicksburg, Miss.*

Period *3* years.

Valuation of horse, \$.....100

Valuation of horse equipments, \$.....100

Remarks:

Book mark :

Sitter.

H | **3 Cav.** | **U.S.C.T.**

Thomas Horton

Priv, Co. I, 3 Reg't U. S. Col'd Cavalry.

Appears on

Company Muster Roll

for *May & June*, 186 *5*.

Present or absent *Present*

Stoppage, \$ *1* ^{*60*}/_{*100*} for *6 & G. & S*
transfr. from last muster roll

Due Gov't, \$ *100* for

Valuation of horse, \$ *100*

Valuation of horse equipments, \$ *100*

Remarks: *Stop Carbine*
wrench 37cts

Book mark:

(358)

J. Anderson
Copyist.

4 | **3 Cav. | U.S.C.T.**

Thomas Horton

Private, Co. I, 3 Reg't U. S. Col'd Cavalry.

Appears on

Company Muster Roll

for March + April, 1865.

Present or absent Absent

Stoppage, \$ 100 for

Due Gov't, \$ 100 for

Valuation of horse, \$ 100

Valuation of horse equipments, \$ 100

Remarks: Absent on expedition
Stop for one canteen once
Haversack 1.60.

Book mark: Lucas

4 | **3 Cav. | U.S.C.T.**

Thomas Horton

Plt, Co. I, 3 Reg't U. S. Col'd Cavalry.

Appears on

Company Muster Roll

for July & Aug, 186 5

Present or absent Present

Stoppage, \$ 100 for

Due Gov't, \$ 100 for

Valuation of horse, \$ 100

Valuation of horse equipments, \$ 100

Remarks: _____

Book mark: _____

Lucas

H | 3 Cav. | U.S.C.T.

Thomas Horton

Private, Co. I, 3 Reg't U. S. Col'd Cavalry.

Appears on

Company Muster Roll

for Sept & Oct, 1865.

Present or absent Present

Stoppage, \$ 100 for

Due Gov't, \$ 100 for

Valuation of horse, \$ 100

Valuation of horse equipments, \$ 100

Remarks:

Book mark:

(358)

Edwardson
Copyist.

It | **3 Cav.** | **U.S.C.T.**

Thomas Horton

Brig., Co. I, 3 Reg't U. S. Col'd Cavalry.

Appears on

Company Muster Roll

for Nov Dec, 1865.

Present or absent Present

Stoppage, \$ 100 for

Due Gov't, \$ 100 for

Valuation of horse, \$ 100

Valuation of horse equipments, \$ 100

Remarks:

Book mark:

Boydman

H. | **3 Cav.** | **U.S.C.T.**

Thomas Horton

Priv., Co. I, 3 Reg't U. S. Colored Cav.

Appears on **Returns** as follows:

Jan. 1865. Gain Jan. 16/63-
Memphis, Tenn. Enlisted
in Regt.
Absent sick Jan. 20 Genl
Hosptl.

Book mark :

(546)

J. B. Dittler

Copyist.

H | 3 Cav. | U.S.C.T.

Thomas Horton

Bris., Co. I, 3 Reg't U. S. Col'd Cavalry.

Appears on Co. Muster-out Roll, dated

Memphis Tenn Jan 26, 1865.

Muster-out to date Jan 26, 1865.

Last paid to June 30, 1865.

Clothing account:

Last settled _____, 1865 ; drawn since \$ 100

Due soldier \$ 46 100; due U. S. \$ 100

Am't for cloth'g in kind or money adv'd \$ 100

Due U. S. for arms, equipments, &c., \$ 100

Bounty paid \$ 100; due \$ 100

Remarks: Bounty due "Installment None paid."

Book mark:

Eden ...

(361)

Copyist.

Horton, Thomas

B, Co. *✓*, _____

3 U.S.C. Cav.
Reg't _____

Enclosures.

Bed Cards	Descriptive Lists
Burial Records	Final Statements
Certs. of Dis. for Discharge	Furloughs
C. M. Charges	Med. Des. Lists
Med. Certificates	Orders

Other papers relating to—

Admission to Hosp'l	Furlough
Casualty Sheet (Officer's)	Med. Examination
Confinement	Misc. Information
Contracts	Pay or Clothing
Death or Effects	Personal Reports
Desertions	Rank
Discharge from Hosp'l	Transfer to Hosp'l
Discharge from Service	Transfer to V. R. C.
Duty	Transportation

Complete :
CASUALTY SHEET.

No.

Thomas Horton

Private of Company *D.*

50 Regiment of *U.S.C. Cav.*

State Volunteers.

NATURE OF CASUALTY.

Accepted in service
1st Reg. U.S. Cavalry

CASUALTY SHEET.

Name: *Thomas Boston*

Rank: *Private*

Company: *D*

Regiment: *3^d*

Arm: *W. D. Col. Cav.*

State: _____

Nature of Casualty: _____

Death

CAUSE OF CASUALTY—(NAME OF DISEASE)

Not stated

BY WHOM DISCHARGED.

FROM WHAT SOURCE THIS INFORMATION WAS
OBTAINED.

W. H. H. Vol. 3, R. C. D. 1866

DEGREE OF DISABILITY.

BY WHOM CERTIFIED.

*James M. Wilson
Ass. P. M. U. S. A.*

DATE OF DISCHARGE, DEATH, &c.—

not given

PLACE OF DISCHARGE, DEATH, &c.

Memphis Tenn.

REMARKS.

*W. H. H. Vol. 3 R. C. D. 1866
and discharge sent 2^d
Auditor, Feb'y. 9 1866.*

James Beckwith
Clerk.

693

Horton, William

Co E, 3 U. S. Col'd Cav.

Private

Corporal

CARD NUMBERS.

1	5337572	26
2	5337670	27
3	5337750	28
4	5337826	29
5	5337904	30
6	5337969	31
7	5338033	32
8	5338104	33
9	5338199	34
10	5338310	35
11	5338409	36
12	5338477	37
12	5338561	38
14	5338636	39
15	5338703	40
16	9088779	41
17		42
18		43
19		44
20		45
21		46
22		47
23		48
24		49
25		50

Book Mark:

See also

S. 1605870 P. 0. 1/2 m

S. 1901574 P. 0. 1/2 m

S. 2049527 P. 0. 0. 1/2 m

S. 2629649 P. 0. 1/2 m

S. 2626772 P. 0. 1/2 m

A. M. Shannon
Esq.

N | **3 Cav. U.S.C.T.**

William Horton

....., Co. *E*, 3 Reg't U. S. Col'd Cav.

Appears on

Company Descriptive Book

of the organization named above.

DESCRIPTION.

Age *22* years; height *5* feet *7* inches.

Complexion *Black*

Eyes *Black*; hair *Black*

Where born *Mississippi*

Occupation *Farmer*

ENLISTMENT.

When *Nov. 20*, 1863.

Where *Skippithody*

By whom *Capt. Cook*; term *3* y'rs.

Remarks:
.....
.....
.....
.....
.....

E. Weston

No | 3 Cav. | U.S.C.T.

William Weston

Sgt., Co. C, 1 Reg't Miss. Cav., Corps d'Afrique.*

Age 22
Appears on

Company Muster-in Roll

of the organization named above. Roll dated

Stepwith Leguis also 9, 1863.

Muster-in to date Nov 20, 1863

Joined for duty and enrolled:

When Nov 20, 1863

Where Stepwith Leguis
3

Period 3 years.

Valuation of horse, \$ 100

Valuation of horse equipments, \$ 100

Remarks:

*This organization subsequently became Co. C, 3 Reg't U. S. Colored Cavalry.

Book mark:

Bradley

H | **3 Cav. U.S.C.T.**

William Norton
Por, Co. *E*, 1 Reg't Miss. Cav., Corps d'Afrique.*

Appears on

Company Muster Roll
for *Dated Dec 31*, 186*3*

Present or absent *Present*

Stoppage, \$.....*100* for

Due Gov't, \$.....*100* for

Valuation of horse, \$.....*100*

Valuation of horse equipments, \$.....*100*

Remarks:

*This organization subsequently became Co. *E* 8 Reg't U. S. Colored Cavalry.

Book mark:

Bradley

H | **3 Cav.** | **U.S.C.T.**

William Norton

Co. E, Co., 1 Reg't Miss. Cav., Corps d'Afrique.*

Appears on

Company Muster Roll

for *Jan'y & Feb'y*, 186*4*

Present or absent *Present*

Stoppage, \$ *100* for

Due Gov't, \$ *100* for

Valuation of horse, \$ *100*

Valuation of horse equipments, \$ *100*

Remarks:

*This organization subsequently became Co. *E* 3 Reg't U. S. Colored Cavalry.

Book mark:

Bradley

H | **3 Cav.** | **U.S.C.T.**

William Keaton

Priv, Co. E, 3 Reg't U. S. Col'd Cavalry.

Appears on

Company Muster Roll

for *Must Apr*, 186*4*

Present or absent *Present*

Stoppage, \$ *100* for

Due Gov't, \$ *100* for

Valuation of horse, \$ *100*

Valuation of horse equipments, \$ *100*

Remarks:

Book mark: _____

Bruce

26 | 3 Cav. | U.S.C.T.

William Weston

Over, Co. E, 3 Reg't U. S. Col'd Cavalry.

Appears on

Company Muster Roll

for May 1864

Present or absent Present

Stoppage, \$ 100 for

Due Gov't, \$ 100 for

Valuation of horse, \$ 100

Valuation of horse equipments, \$ 100

Remarks:

Book mark:

Bradde

26 | **3 Cav.** | **U.S.C.T.**

William Keeton

Pvt, Co. E, 3 Reg't U. S. Col'd Cavalry.

Appears on

Company Muster Roll

for *July & Aug*, 186 .

Present or absent *Present*

Stoppage, \$ *7*/₁₀₀ for *Bridle & Saddle blanket*

Due Gov't, \$ *1*/₁₀₀ for

Valuation of horse, \$ *1*/₁₀₀

Valuation of horse equipments, \$ *1*/₁₀₀

Remarks:

Book mark: -----

Bridle

3 Cav. U.S.C.T.

William H. ...
Co. E, 3 Reg't U.S. Col'd Cavalry.

Appears on

Company Muster Roll

for ... 186

Present or absent

Stoppage, \$... for

Due Gov't, \$... for

Valuation of horse, \$...

Valuation of horse equipments, \$...

Remarks: ...

Book mark:

(358)

Copyist

W. **3 Cav. U.S.C.T.**

William H. ...
..., Co. E, 3 Reg't U. S. Col'd Cavalry.

Appears on

Company Muster Roll

for *...*, 186*...*

Present or absent *Present*

Stoppage, \$ *...* for *...*

... for *...*

Due Gov't, \$ *...* for *...*

Valuation of horse, \$ *...*

Valuation of horse equipments, \$ *...*

Remarks: *...*
...
...

Book mark: *...*

[Signature]
Copied.

No. | **3 Cav.** | **U.S.C.T.**

William Robert
....., Co. E, 3 Reg't U. S. Col'd Cavalry.

Appears on

Company Muster Roll

for *Jan. & Feb.*, 186*5*.

Present or absent *Present*

Stoppage, \$ 100 for

Due Gov't, \$ 100 for

Valuation of horse, \$ 100

Valuation of horse equipments, \$ 100

Remarks:

Book mark:

(358)

Wm. Robert
Coyist.

01. | **3 Cav. | U.S.C.T.**

William Horton
.....
(P), Co. E, 3 Reg't U. S. Col'd Cavalry.

Appears on

Company Muster Roll

for *Jan, & April*, 186*5*.

Present or absent *Present*

Stoppage, \$.....*100* for

Due Gov't, \$.....*100* for

Valuation of horse, \$.....*100*

Valuation of horse equipments, \$.....*100*

Remarks:

Book mark:

(358)

W. Horton
.....
Copyist.

A. **3 Cav. | U.S.C.T.**

William Norton

Pvt., Co. E, 3 Reg't U. S. Col'd Cavalry.

Appears on

Company Muster Roll

for *May & June*, 186*5*.

Present or absent *Present*

Stoppage, \$ *20* ^{*54*}/_{*100*} for *Provincias*

Due Gov't, \$ *100* for

Valuation of horse, \$ *100*

Valuation of horse equipments, \$ *100*

Remarks: *Prof for 1 R.R. 1 3/4 hrs*
left & returned 1 Braid 1 1/2 hrs
1 1/2 hrs 1 1/2 hrs 1 1/2 hrs

Book mark:

W. H. H. H.

(358)

Copyist.

24. | **3 Cav. | U.S.C.T.**

William P. Gordon

Com. 21, Co. E, 3 Reg't U. S. Col'd Cavalry.

Appears on

Company Muster Roll

for *July & Aug.*, 186*3*.

Present or absent *Present*

Stoppage, \$ *100* for

Due Gov't, \$ *100* for

Valuation of horse, \$ *100*

Valuation of horse equipments, \$ *100*

Remarks: *Warranted July 1863*

Book mark: _____

(358)

J. A. [Signature]

Copyist.

46 | **3 Cav. | U.S.C.T.**

William Horton

2 Corp., Co. E, 3 Reg't U. S. Col'd Cavalry.

Appears on

Company Muster Roll

for Sept. & Oct., 1865.

Present or absent Present.

Stoppage, \$ 100 for

Due Gov't, \$ 100 for

Valuation of horse, \$ 100

Valuation of horse equipments, \$ 100

Remarks: Promoted to Corp from
Private July 10. 65.

Stop for two Haversacks.

Book mark: _____

(358)

Lewis
Copyist.

76 | **3 Cav.** | **U.S.C.T.**

William Horton

Capt., Co. E, 3 Reg't U. S. Col'd Cavalry.

Appears on

Company Muster Roll

for Nov. & Dec., 1865.

Present or absent Present.

Stoppage, \$ 100 for

Due Gov't, \$ 100 for

Valuation of horse, \$ 100

Valuation of horse equipments, \$ 100

Remarks Promoted from private
July 10. 65.

Book mark:

(358)

Lewis
Copyist.

H | 3 Cav. | U.S.C.T.

William Horton

Corp., Co. E., 3 Reg't U. S. Col'd Cavalry.

Appears on Co. Muster-out Roll, dated
Memphis, Tenn. Jan. 26., 1866.

Muster-out to date Jan. 26., 1866.

Last paid to June 30., 1865.

Clothing account:

Last settled _____, 186 ; drawn since \$ 100

Due soldier \$ 100; due U. S. \$ 21 ⁴⁵/₁₀₀

Am't for cloth'g in kind or money adv'd \$ 100

Due U. S. for arms, equipments, &c., \$ 1 ⁹⁰/₁₀₀

Bounty paid \$ 100; due \$ 100

Remarks: Promoted from private
July 10. 65.

Book mark: V. 88. P. 67. 09.

(361)

Lewis
Copyist.

694

Hoostan, Charles

Co H, 3 U. S. Col'd Cav.

Private

Bugler

CARD NUMBERS.

1	26
2	27
3	See Hoostan, Charles
4	29
5	30
6	31
7	32
8	33
9	34
10	35
11	36
12	37
13	38
14	39
15	40
16	41
17	42
18	43
19	44
20	45
21	46
22	47
23	48
24	49
25	50

Book Mark:

See also

695

Houston, Samuel

Co A, 3 U. S. Col'd Cav.

Private

Private

CARD NUMBERS.

1	5351399	26
2	5332787	27
3	5332889	28
4	5332029	29
5	5333400	30
6	9088815	31
7	40727567	32
8		33
9		34
10		35
11		36
12		37
12		38
14		39
15		40
16		41
17		42
18		43
19		44
20		45
21		46
22		47
23		48
24		49
25		50

Book Mark:

See also

S. 1143916 ~~po~~ ^{Ret.}
O. 12104766 And W. 20.

A. M. Shannon
Esq

H | 3 Cav. | U.S.C.T.

Samuel Huston

....., Co. A, 3 Reg't U. S. Col'd Cav.

Appears on

Company Descriptive Book
of the organization named above.

DESCRIPTION.

Age 25 years; height 5 feet 6 inches.

Complexion Black

Eyes Black; hair Black

Where born Monroe Co. La.

Occupation Farmer

ENLISTMENT.

When Feb. 5, 1865.

Where Memphis - Tenn.

By whom Maj. Main; term 3 y'rs.

Remarks: Died in Reg'tl.
Hospital - May - 10 -
1865.

F. A. Wright

17. | 3 Cav. | U.S.C.T.

Samuel Houston

Appears with rank of *Priv* on

Muster and Descriptive Roll of a Detachment of U. S. Vols. forwarded

for the 3 Reg't U. S. Col'd Cavalry. Roll dated *Memphis Tenn, Mar 8, 1865.*

Where born *Mourshouse B. La.*

Age *43* y'rs; occupation *Farmer*

When enlisted *Feb 15*, 1865.

Where enlisted *Memphis Tenn.*

For what period enlisted *3* years.

Eyes *Black*; hair *Black*

Complexion *Black*; height *5 ft. 4 in.*

When mustered in *Feb 15*, 1865.

Where mustered in *Memphis Tenn.*

Bounty paid \$ *100*; due \$ *100*

Where credited *Chillicothe Co. Ark.*

Company to which assigned *F*

Remarks :

Book mark :

(339)

Joiner.

Copyist.

H | 3 Cav. | U.S.C.T.

Samuel Houston
Pot., Co. A, 3 Reg't U. S. Col'd Cavalry.

Appears on

Company Muster Roll

for Jan. & Feb., 1865.

Present or absent Present

Stoppage, \$ 100 for

Due Gov't, \$ 100 for

Valuation of horse, \$ 100

Valuation of horse equipments, \$ 100

Remarks: Entitled to
Bounty.

Book mark:

P. Pool

(358)

Copyist.

H | **3 Cav.** | **U.S.C.T.**

Samuel Houston
Priv., Co. A, 3 Reg't U.S. Col'd Cavalry.

Appears on

Company Muster Roll

for Mar. + Apr., 1865.

Present or absent Present

Stoppage, \$ 100 for

Due Gov't, \$ 100 for

Valuation of horse, \$ 100

Valuation of horse equipments, \$ 100

Remarks: Sick in Regt.
Hospital.

As shown on roll.

Book mark: _____

P'Pool

(358)

Copyist.

H | 3 Cav. | U.S.C.T.

Samuel Houston,
Pot., Co. A, 3 Reg't U. S. Col'd Cavalry.

Appears on

Company Muster Roll

for May & June, 1865.

Present or absent.

Stoppage, \$ 100 for

Due Gov't, \$ 100 for

Valuation of horse, \$ 100

Valuation of horse equipments, \$ 100

Remarks: Stop for Bridle,
Saddle Blanket, Re-
volver, & Surcingle.
Died.

Book mark:

P'Pool,

(358)

Copyist.

Ho. | 3 Cav. | U.S.C.T.

Samuel Huston*
Pvt., Co. A, 3 Reg't U. S. Colored Cav.

Appears on Returns as follows:

Feb. 1865. Gain Feb. 15/65 - Mem-
phis, Tenn. Enlisted
in Regt.

Mar. 1865. Absent sick in Hosp.
at Memphis, Tenn. since
Mar. 25/65.

May 1865. Loss May 10/65 - Mem-
phis, Tenn. Died in
Regtl Hosp.

* Name appears also as, Samuel
Houston.

Book mark :

(546)

J. B. Dittler

Copyist.

H | 3 Cav. | U.S.C.T.

Samuel Houston
Ch, Co. A, 3 Reg't U. S. Col'd Cavalry.

Appears on Co. Muster-out Roll, dated
Memphis Tenn, Jan 26, 1866.

Muster-out to date _____, 186 .

Last paid to _____, 186 .

Pay due from enrollment

Clothing account:

Last settled _____, 186 ; drawn since \$ _____ 100

Due soldier \$ _____ 100; due U. S. \$ _____ 100

Am't for cloth'g in kind or money adv'd \$ _____ 100

Due U. S. for arms, equipments, &c., \$ _____ 100

Bounty paid \$ _____ 100; due \$ _____ 100

Remarks: Died in hosp'l at
Memphis Tenn May 10, 65
Acute Diarrhoea

Book mark: Pl. 11 P. 112, 69
(over)

(361)

H. Jones
Copyist.

JAN. - 8

5333400

1891 *

Book mark = P. 6 P. 226
68. - V. 61 P. 137. 69

Houston, Samuel

B, Co. A

3

Reg't

U. S. C. Cav.

1 Enclosures.

Bed Cards	Descriptive Lists
Burial Records	Final Statements /
Certs. of Dis. for Discharge	Furloughs
C. M. Charges	Med. Des. Lists
Med. Certificates	Orders

Other papers relating to—

Admission to Hosp'l	Furlough
Casualty Sheet (Officer's)	Med. Examination
Confinement	Misc. Information
Contracts	Pay or Clothing
Death or Effects	Personal Reports
Desertions	Rank
Discharge from Hosp'l	Transfer to Hosp'l
Discharge from Service	Transfer to V. R. C.
Duty	Transportation

(OFFICE INDORSEMENT.)

War Department,

ADJUTANT GENERAL'S OFFICE,

Sept 4th, 1865.

The death of Samuel Houston, Co. A, 3rd Reg't U.S. Colored Cavalry, is reported as follows:

On Company Muster Roll. For May & June 1865, to date, 1865.

Company Muster-out Roll. May 10th, 1865.

Company Descriptive Book. May 10th, 1865.

Company Morning Reports. May 10th, 1865.

Soldier's Final Statement. May 10th, 1865.

Soldier's Record of Death and Interment. May 10th, 1865.

Soldier's Inventory of Effects. 1865.

Soldier's Certificate of Disability for Discharge. 1865.

Soldier's Individual Muster-out Roll. 1865.

Regimental Return. 1865.

For May, 1865, May 12, 1865. Regimental Quarterly Returns.

25th Apr 1865 May 10th, 1865. Regimental Descriptive Book.

May 10th, 1865. By Surgeon General.

May 10th, 1865.

May 10th, 1865, is held to be the correct date, and the Company Muster Roll will be amended accordingly.

W. Parker Assistant Adjutant General.

L.B. 14 740 noted s.b.

FINAL STATEMENT

OF

Prof Samuel Houston

3rd Reg't of U.S. Colored Cavalry

VOLUNTEERS.

Prof May 10th 1865

NOTE 1.—Two of these certificates (or duplicates) are to be given to each Volunteer Soldier or drafted man who may be discharged without being mustered out (Final Statements are never given to men mustered out of service) that he may at once receive from the Paymaster the pay, &c., due him, and the captain or other COMMISSIONED officer commanding the company will certify to the act of the delivery of the duplicate certificates; with these certificates the Soldier is "entitled to" his discharge, and should also present his discharge to the Paymaster to have the payment endorsed on it. The discharge is to be given back to the Soldier by the Paymaster; the latter only retaining as his vouchers the duplicate certificates.

NOTE 2.—If the Soldier is entitled to pay for the use of his horse, the Company Commander will certify to that fact on the back of both these final statements, and also to the time he has pay due for having been so mounted on his own horse.

NOTE 3.—When a Soldier is furnished with final statements, his descriptive list, if he has one, should be taken up by the officer who gives the Soldier these statements, and endorsed with a statement to this effect by the officer. The endorsement should exhibit a full statement of the time for which the Soldier was allowed pay on his final statements, the clothing account, and all other charges against him or in his favor, so as to comprise a complete exhibit of his account. It will then be transmitted to the Company Commander of the Soldier, who will enter all the data necessary to a full understanding of the Soldier's account on the muster roll upon which the Soldier's discharge is reported. The descriptive list will then be destroyed. The object of this is, that the remaining portion of the Soldier's account may be settled upon the receipt of these muster rolls, and the Soldier receive any pay or allowances that may be due him at the time of his discharge, and which may not appear on his last final statements from the fact that his descriptive list is incomplete. These accounts for back pay, &c., are settled by the 2d Auditor of the Treasury Department.

NOTE 4.—Charges for loss or injury to ordnance, horse equipments, and other miscellaneous charges, should appear under the heading of "Other Stoppages."

NOTE 5.—Bounty paid by State authorities, and not by the United States, will not be entered on this statement.

NOTE 6.—Amounts due the Sutler and Laundress must be entered on the muster roll on which the discharge, death, desertion, &c., is reported, as well as on the final statement, otherwise the amount cannot be collected from the United States.

NOTE 7.—This blank will be used for deceased volunteers and drafted men, as well as for others.

NOTE 8.—Where a Soldier dies in Hospital or on detached service, his descriptive list, if he has one, should be sent with his final statements, in duplicate, to the Adjutant General, Washington, D. C.

NOTE 9.—If the soldier is a drafted man or substitute, the space for time, &c., of enrolled, should contain only the word drafted or substitute, as the case may be. If the Soldier is a "VETERAN," (or RECRUIT,) the words as a veteran, (or recruit,) as the case may be, should be interlined after the words mustered into the service of the U. S. A statement of all the installments of Veteran or Recruit Bounty RECEIVED by the Soldier must be made on the back of each final statement.

(OFFICE INDORSEMENT.)

War Department,

ADJUTANT GENERAL'S OFFICE,

Sept 4th, 1862.

The death of Samuel Houston, Co. A, 3rd Reg't U. S. Colored Cavalry, is reported as follows:

On Company Muster Roll.

For May & June 1865, to date, 1865.

Company Muster-out Roll.

May 10th, 1865.

Company Descriptive Book.

May 10th, 1865.

Company Morning Reports.

May 10th, 1865.

Soldier's Final Statement.

May 10th, 1865.

Soldier's Record of Death and Interment.

Soldier's Inventory of Effects.

Soldier's Certificate of Disability for Discharge.

Soldier's Individual Muster-out Roll.

FINAL STATEMENT

OF

Priv. Samuel Houston

3rd Reg't of U. S. Col. Cav.

VOLUNTEERS.

Priv. May 10th 1865.

NOTE 1.—Two of these certificates (or duplicates) are to be given to each Volunteer Soldier or drafted man who may be discharged without being mustered out (Final Statements are never given to men mustered out of service) that he may at once receive from the Paymaster the pay, &c., due him, and the captain or other COMMISSIONED officer commanding the company will certify to the act of the delivery of the duplicate certificates; with these certificates the Soldier is "entitled to" his discharge, and should also present his discharge to the Paymaster to have the payment ordered on it. The discharge is to be given back to the Soldier by the Paymaster; the latter only retaining as his vouchers the duplicate certificates.

NOTE 2.—If the Soldier is entitled to pay for the use of his horse, the Company Commander will certify to that fact on the back of both these final statements, and also to the time he has pay due for having been so mounted on his own horse.

NOTE 3.—When a Soldier is furnished with final statements, his descriptive list, if he has one, should be taken up by the officer who gives the Soldier these statements, and endorsed with a statement to this effect by the officer. The endorsement should exhibit a full statement of the time for which the Soldier was allowed pay on his final statements, the clothing account, and all other charges against him or in his favor, so as to comprise a complete exhibit of his account. It will then be transmitted to the Company Commander of the Soldier, who will enter all the data necessary to a full understanding of the Soldier's account on the muster roll upon which the Soldier's discharge is reported. The descriptive list will then be destroyed. The object of this is, that the remaining portion of the Soldier's account may be settled upon the receipt of these muster rolls, and the Soldier receive any pay or allowances that may be due him at the time of his discharge, and which may not appear on his last final statements from the fact that his descriptive list is incomplete. These accounts for back pay, &c., are settled by the 2d Auditor of the Treasury Department.

NOTE 4.—Charges for loss or injury to ordnance, horse equipments, and other miscellaneous charges, should appear under the heading of "Other Stoppages."

NOTE 5.—Bounty paid by State authorities, and not by the United States, will not be entered on this statement.

NOTE 6.—Amounts due the Sutler and Laundress must be entered on the muster roll on which the discharge, death, desertion, &c., is reported, as well as on the final statement, otherwise the amount cannot be collected from the United States.

NOTE 7.—This blank will be used for deceased volunteers and drafted men, as well as for others.

NOTE 8.—Where a Soldier dies in Hospital or on detached service, his descriptive list, if he has one, should be sent with his final statements, in duplicate, to the Adjutant General, Washington, D. C.

NOTE 9.—If the soldier is a drafted man or substitute, the space for time, &c., of enrolment, should contain only the word drafted or substitute, as the case may be. If the Soldier is a "VETERAN," (or RECRUIT,) the words as a veteran, (or recruit) as the case may be, should be interlined after the words mustered into the service of the U. S. A statement of all the installments of Veteran or Recruit Bounty RECEIVED by the Soldier must be made on the back of each final statement.

ADJUTANT GENERAL'S OFFICE

May 24th 1865.

Duplicate with Inventory sent 2d Auditor.

MAY 1865

I certify, on honor, that Samuel Houston, a Private of
 Captain William W. Webber Company (A) of the 3^d Regiment of U.S. Colored Troops,
VOLUNTEERS, of the State of _____, born in Morehouse Pa., State
 of Louisiana, aged 25 years; 5 feet 6 inches high; Black complexion,
Black eyes, Black hair, and by occupation a Farmer, who joined for service
 and was enrolled (see Note 9) on the 15th day of February, 1865, at Memphis Tenn
 by Capt W W Webber, for the period of Three years, and mustered into
 the service of the United States on the 15th day of February, 1865, at
Memphis Tenn, by Lieut Campbell; and having served
 HONESTLY and FAITHFULLY with his Company to the present date, is now entitled to a
DISCHARGE by reason of Death Died in Regt. Hosp't, at
Memphis Tenn May 10th 1865 Disease Acute Diarrhea
 The said Private Samuel Houston was last paid by Paymaster
Pay Due from Enlistment to include the _____ day of _____, 186 , and
 has pay due him from that time to the present date; he is entitled to pay and subsistence for
TRAVELING to place of enrollment, and whatever other allowances are authorized to volunteer
 soldiers, drafted men, or militia, so discharged. He has received from the United States **CLOTHING**
 amounting to 42 35/₁₀₀ dollars, since the 15th day of February
 186 , when his clothing account was last settled. He has received from the United States
 _____₁₀₀ dollars advanced **BOUNTY**.

There is to be stopped from him, on account of the State of _____, or other
 authorities, for **CLOTHING**, &c., received on entering service, _____₁₀₀ dollars; and
 for other stoppages, viz: One Remington Revolver \$21.00
One curb Bridle \$4.75 One Shelter Tent \$4.00 One Sarcinle
\$1.16 One Saddle Blanket \$3.00 Total 36 62/₁₀₀ dollars.
 He has been furnished with **TRANSPORTATION** in kind from the place of his discharge to
 _____; and he has been **SUBSISTED** for **TRAVELING** to his
 place of enrollment, up to the _____, 186 .

He is indebted to Philip Berse, **SUTLER**, 4 10/₁₀₀ dollars.

He is indebted to _____, **LAUNDRESS**, _____₁₀₀ dollars.

Given in Duplicate, at Memphis Tenn, this 13th day
 of May, 186 .

James S. Matthews
Second Lieutenant
 Commanding Company.

Mr A.
Where is F. S.?
Cud

[OFFICE ENDORSEMENT.]

War Department,
ADJUTANT GENERAL'S OFFICE,

....., 187 .

The death of Samuel
Houston, private, Co A, 3rd Reg't U. S.
Colored Cavalry, is reported as follows:

On Company Muster Roll.

For May & June, 1865, no date, 186
Company Muster-out Roll.

May 10th, 1865

Company Descriptive Book.
Died at Memphis, Tenn. of acute
diarrhea contracted in line of duty, May 10th 1865

Company Morning Reports.

Died in R. Hosp. May 10th, 1865
Soldier's Final Statement.

May 10th, 1865

Soldier's Record of Death and Interment.

....., 186

Soldier's Inventory of Effects.

....., 186

Soldier's Certificate of Disability for Discharge.

....., 186

Soldier's Individual Muster-out Roll.

....., 1-6

Regimental Return.

For May, 1865, May 12th, 1865

Regimental Quarterly Returns.

2nd qr./65, May 10th, 1865.

Regimental Descriptive Book.

Died in R. Hosp. May 10th, 1865

By Surgeon General.

(May 10) , 186

....., 1865, is held to be
the correct date, and the Company Muster Roll will
be amended accordingly.

W. B. ...
W. B. ...

Assistant Adjutant General.

Ch. Blacklock
Wm. ...
Edward ...

696

Hoover, Anthony

Co I, 3 U. S. Col'd Cav.

Private

Private

CARD NUMBERS.

1	5331002	26
2	5343048	27
3	5343151	28
4	5343248	29
5	5343362	30
6	5331595	31
7	5343600	32
8	90894151	33
9	40727550	34
10	31691534	35
11	31691840	36
12		37
12		38
14		39
15		40
16		41
17		42
18		43
19		44
20		45
21		46
22		47
23		48
24		49
25		50

Book Mark:

EB 11 P 63

See also

N | **3 Cav. | U.S.C.T.**

Anthony Scores

Col, 3 Reg't U. S. Col'd Cav.

Appears on
Company Descriptive Book
of the organization named above.

DESCRIPTION.

Age *20* years; height *5* feet *6* inches.

Complexion *Blk*

Eyes *blk*; hair *blk*

Where born *Mip*

Occupation

ENLISTMENT.

When, 186 .

Where

By whom; term y'rs.

Remarks: *Mustered out May 20, 1865*
by reason of Gen Ord. No 77 War
Dept

No. 3 Cav. U.S.C.T.

Anthony Hoover,
Pvt, Co. 3 Reg't U. S. Col'd Cav.

Age 18 years.

Appears on a

Detachment Muster-in Roll

of the organization named above. Roll dated
Vicksburg Miss, Jan. 7, 1865.
Muster-in to date Jan. 7, 1865.

Joined for duty and enrolled:

When Jan. 6, 1865.

Where Vicksburg, Miss.

Period 3 years.

Valuation of horse, \$ 100

Valuation of horse equipments, \$ 100

Remarks: _____

Book mark: _____

Sittler

H | 3 Cav. | U.S.C.T.

Anthony Hoover

Pvt., Co. I, 3 Reg't U. S. Col'd Cavalry.

Appears on

Company Muster Roll

for *Jan & Feb*, 1865

Present or absent *Absent*

Stoppage, \$ *100* for

Due Gov't, \$ *100* for

Valuation of horse, \$ *100*

Valuation of horse equipments, \$ *100*

Remarks: *Absent sick in Genl
Hospital at Memphis Tenn
since Jan 31. 65.*

Book mark:

Lucas

H 1 3 car 1 use 9

Anthony Hoover
Priv., Co. I 3, Reg't U.S.C.

Appears on

Hospital Muster Roll

of Webster U. S. A. General Hospital,

at Memphis, Tenn.,

for Jan & Feb, 1865.

Attached to hospital:

When Jan 27, 1865.

How employed Sick

Last paid by Major Pay due from enlistment
to _____, 1865.

Bounty paid \$ 100; due \$ 00

Present or absent Present

Remarks :

Book mark : _____

J. Anderson

H 1 3 car 10101

Anthony Hoover

Pvt, Co⁹ C, 2 Reg't U.S.C. Cav

Appears on

Hospital Muster Roll

of **Webster U. S. A. General Hospital,**

at **Memphis, Tenn,**

for March & April, 1865.

Attached to hospital:

When Jan 27, 1865.

How employed Dick

Last paid by Maj. Pay due from enlistment
to _____, 1865.

Bounty paid \$ 100 ; due \$ 100

Present or absent Present

Remarks _____

Book mark: _____

(848)

J. Henderson

Copvist.

H | **3 Cav.** | **U.S.C.T.**

Anthony Hoover

Priv, Co. I, 3 Reg't U. S. Col'd Cavalry.

Appears on

Company Muster Roll

for March & April, 1865:

Present or absent Absent

Stoppage, \$ 100 for

Due Gov't, \$ 100 for

Valuation of horse, \$ 100

Valuation of horse equipments, \$ 100

Remarks: Absent in Genl Hospital
at Memphis Tenn

Book mark: 358

Lucas

It | **3 Cav.** | **U.S.C.T.**

Anthony Hoover
Pat, Co. I, 3 Reg't U. S. Col'd Cavalry.

Appears on

Company Muster Roll

for May June, 1865.

Present or absent Absent

Stoppage, \$ 100 for

Due Gov't, \$ 100 for

Valuation of horse, \$ 100

Valuation of horse equipments, \$ 100

Remarks: absent in Gen
Joseph A Memphis
Tenn since Jan 31/65

Book mark:

(358)

J. H. Anderson
Copyist.

H | **3 Cav.** | **U.S.C.T.**

Anthony Hoover

Priv., Co. I, 3 Reg't U. S. Col'd Cavalry.

Appears on

Company Muster Roll

for July - Aug, 1865

Present or absent

Stoppage, \$ 100 for

Due Gov't, \$ 100 for

Valuation of horse, \$ 100

Valuation of horse equipments, \$ 100

Remarks: Mustered out May 28/65-
at Memphis Tenn by reason of
G.O. No. 77. War Dept. A G. O.
Washington D. C. 1865-

Book mark * Picked May 26. 65 - EP VII P 68
Mounted by Companion

Lucas

(358)

Copyist.

H | 3 Cav. | U.S.C.T.

Anthony Hoover
Co. D, 3 Reg't U. S. Col'd Cav.

Appears on an

Individual Muster-out Roll

of the organization named above. Roll dated

Memphis, Tenn., May 24, 1865.

Muster-out to date June 4, 1865.

Last paid to _____, 186 .

Clothing account:

Last settled _____, 186 ; drawn since \$ 100

Due soldier \$ 100; due U. S. \$ 100

Am't for cloth'g in kind or money adv'd \$ 100

Due U. S. for arms, equipments, &c., \$ 100

Bounty paid \$ 100 due \$ 100

Remarks: Clothing account
never settled, amount
of clothing drawn since
enlistment \$36.00 Bounty
due \$ 100 Mustered out
in accordance with

Book mark: _____

W. S. Thompson

(348)
(over)

Copyist.

1280

JAN. - 7

5331595

★ 1891 ★

instructions in telegram
from the War Dept.
dated May 3, 1863
to date from the day
of May 26th 1863

Ho | 3 Cav. | U.S.C.T.

Anthony Hoover

Pvt, Co. I, 3 Reg't U. S. Colored Cav.

Appears on Returns as follows:

Jan. 1865; Gain Jan. 16/65 -
Memphis, Tenn. Enlisted
in Regt.

Feb. to June 1865. Absent sick in
Gen. Hosp. at Memphis,
Tenn. since Jan. 31/65.

July 1865. Loss May 28" Mem-
phis, Tenn. Mustered
out under G.O. no. 77
War Dept. Did not rec.
notice till in July.

Book mark :

J. B. Dittler

(546)

Copyist.

A | **3 Cav.** | **U.S.C.T.**

Anthony Hoover

Co. D, 3 Reg't U. S. Col'd Cavalry.

Appears on **Co. Muster-out Roll**, dated

Memphis Tenn June 26, 1866.

Muster-out to date _____, 186 .

Last paid to Never paid, 186 .

Clothing account:

Last settled _____, 186 ; drawn since \$ _____ 100

Due soldier \$ _____ 100; due U. S. \$ _____ 100

Am't for cloth'g in kind or money adv'd \$ _____ 100

Due U. S. for arms, equipments, &c., \$ _____ 100

Bounty paid \$ _____ 100; due \$ _____ 100

Remarks: Discharged at

Memphis Tenn May 28, 1865
by provisions of 47
War Dept

inserted by Comptroller

Book mark: Discharged May 26/65

Edmond

JAN. - 8

5343600

1891 *

Edw. H. B. Co.

Hoover, Anthony

P, Co. I,

8 Regt U.S.C. Cav.

/ Enclosures.

Bed Cards	Descriptive Lists
Burial Records	Final Statements
Certs. of Dis. for Discharge	Furloughs
C. M. Charges	Med. Des. Lists
Med. Certificates	Orders

Other papers relating to—

Admission to Hosp'l	Furlough
Casualty Sheet (Officer's)	Med. Examination
Confinement	Misc. Information
Contracts	Pay or Clothing
Death or Effects	Personal Reports
Desertions	Rank
Discharge from Hosp'l	Transfer to Hosp'l
Discharge from Service /	Transfer to V. R. C.
Duty	Transportation

WAR DEPARTMENT,

ADJUTANT GENERAL'S OFFICE,

May 5, 1874

The Discharge of Private Anthony
Hewner, Co. D, 3d Reg't U.S.

Colored Cavalry, is reported as follows:

On Company Muster Roll	
For July, 1865, May 28, 1865	
Company Muster-out Roll.	
May 28, 1865	
Company Descriptive Book.	186
Company Morning Reports.	186
Soldier's Final Statement.	186
Soldier's Record of Death and Interment.	186
Soldier's Inventory of Effects.	186
Soldier's Certificate of Disability for Discharge.	186
Soldier's Individual Muster-out Roll.	186
Regimental Return.	186
For July, 1865, May 28, 1865	
Regimental Quarterly Returns.	186
Regimental Descriptive Book.	186
By Surgeon General.	186

() May 26, 1865, is held to be
the correct date, and the Company Muster
Roll will be amended accordingly.

Thomas M. Stewart

Assistant Adjutant General.

C.B. 11
63.

Noted 26, 11
Adjutant General

697

Howard, Bill

Co L, 3 U. S. Col'd Cav.

Private

Bugler

CARD NUMBERS.

1	5344874	26
2	5344976	27
3	5345660	28
4	5345138	29
5	5345213	30
6	5345286	31
7	5345358	32
8	5345465	33
9	5345558	34
10	5345644	35
11	5345728	36
12	5345802	37
13	5345872	38
14	9089610	39
15	40727556	40
16		41
17		42
18		43
19		44
20		45
21		46
22		47
23		48
24		49
25		50

Book Mark:

See also

S. 6876 19 P.C. m + m.
 S. 512 068 P.O. aff.
 S-927708 - P.O. aff.
 S. 1165365 P.O. aff.
 S. 3070410 P.O. aff.

AmShannon
 Ex

94 | 3 Cav. | U.S.C.T.

Bill Howard
Co. L, 3 Reg't U. S. Col'd Cav.

Appears on

Company Descriptive Book
of the organization named above.

DESCRIPTION.

Age 23 years; height 5 feet 6 inches.
Complexion Black
Eyes Black; hair Black
Where born Carroll Co, Miss.
Occupation Farmer

ENLISTMENT.

When Mch. 1, 1864.
Where Haines Bluff
By whom Capt. Fratz; term 3 y'rs.
Remarks:

F. B. Smith

H | **3 Cav. | U.S.C.T.**

Will Howard

H, Co. *L*, 3 Reg't U. S. Col'd Cavalry.

Appears on

Company Muster-in and Descriptive Roll

of the organization named above. Roll dated

Warrior Bluff Miss, Mar 1, 1864.

Where born *Lumbia Co, Mississippi.*

Age *23* y'rs; occupation *Farmer*

When enlisted *Mar 1*, 186*4*.

Where enlisted *Warrior Bluff*

For what period enlisted *3* years.

Eyes *Black*; hair *Black*

Complexion *Black*; height *5* ft. *6* in.

When mustered in _____, 186*4*.

Where mustered in _____

Bounty paid \$ *100*; due \$ *100*

Where credited _____

Company to which assigned _____

Remarks : _____

Book mark : _____

(356d,

W. Howard

Co. *g* 1st.

H | **3 Cav.** | **U.S.C.T.**

Roll Howard

Pr, Co. L, 3 Reg't U. S. Col'd Cavalry.

Appears on

Company Muster Roll

for *March 1864*, 1864.

Present or absent *Present*

Stoppage, \$ *100* for

Due Gov't, \$ *100* for

Valuation of horse, \$ *100*

Valuation of horse equipments, \$ *100*

Remarks:

*Mustered in March 1864
at Hain's Bluff Miss*

Book mark:

Howard

H | **3 Cav.** | **U.S.C.T.**

Pie Howard

141, Co. L, 3 Reg't U.S. Col'd Cavalry.

Appears on

Company Muster Roll

for *Deated July 1, 1864*

Present or absent *Present*

Stoppage, \$ *100* for

Due Gov't, \$ *100* for

Valuation of horse, \$ *100*

Valuation of horse equipments, \$ *100*

Remarks:

Book mark:

W. J. ...

W | 3 Cav. | U.S.C.T.

Bill Howard

Reg't, Co. L, 3 Reg't U.S. Col'd Cavalry.

Appears on

Company Muster Roll

for *July and Aug*, 186*4*.

Present or absent *Absent*

Stoppage, \$ 100 for

Due Gov't, \$ 100 for

Valuation of horse, \$ 100

Valuation of horse equipments, \$ 100

Remarks:

Book mark:

(358)

W. Howard

Copyist.

W. | 3 Cav. | U.S.C.T.

Paul Howard
Regt., Co. L, 3 Reg't U.S. Col'd Cavalry.

Appears on

Company Muster Roll

for *Sep & Oct*, 186*1*.

Present or absent *Present*

Stoppage, \$ *100* for

Due Gov't, \$ *100* for

Valuation of horse, \$ *100*

Valuation of horse equipments, \$ *100*

Remarks:

Book mark:

W. Howard

W | 3 Cav. | U.S.C.T.

Geo Howard
Regt, Co. L, 3 Reg't U.S. Col'd Cavalry.

Appears on

Company Muster Roll

for *Sep & Oct*, 186*4*.

Present or absent *Present*

Stoppage, \$ *100* for

Due Gov't, \$ *100* for

Valuation of horse, \$ *100*

Valuation of horse equipments, \$ *100*

Remarks:

Book mark:

copyist

H | 3 Cav. | U.S.C.T.

Bill Howard
Bugler, Co. L, 3 Reg't U. S. Col'd Cavalry.

Appears on

Company Muster Roll

for Nov & Dec, 1864.

Present or absent present

Stoppage, \$ 100 for

Due Gov't, \$ 100 for

Valuation of horse, \$ 100

Valuation of horse equipments, \$ 100

Remarks: Stop 1 Halter,
D.S., Curry Comb,
Horse Brush. \$ 3.43

Book mark:

Daxton

H | 3 Cav. | U.S.C.T.

Bill Howard
Bugler, Co. L, 3 Reg't U.S. Col'd Cavalry.

Appears on

Company Muster Roll

for Jan + Feb, 1865.

Present or absent present

Stoppage, \$ 100 for

Due Gov't, \$ 100 for

Valuation of horse, \$ 100

Valuation of horse equipments, \$ 100

Remarks:

Book mark:

Daxton

H | **3 Cav.** | **U.S.C.T.**

Bill Howard

Dugler, Co. L, 3 Reg't U. S. Col'd Cavalry.

Appears on

Company Muster Roll

for *March + Apr*, 186 *5*.

Present or absent *absent*

Stoppage, \$ *100* for

Due Gov't, \$ *100* for

Valuation of horse, \$ *100*

Valuation of horse equipments, \$ *100*

Remarks: *Absent on Scout.*

Book mark:

Daxton

H | 3 Cav. | U.S.C.T.

Bill Howard

Bugler, Co. L, 3 Reg't U.S. Col'd Cavalry.

Appears on

Company Muster Roll

for May & June, 1865.

Present or absent present

Stoppage, \$ 100 for

Due Gov't, \$ 100 for

Valuation of horse, \$ 100

Valuation of horse equipments, \$ 100

Remarks: Stopped Curry
comb & H. Brush \$1.00,
Spurs & Straps .53,
Total 1.53.

Book mark:

Daxton

H | **3 Cav.** | **U.S.C.T.**

Bill Howard

Bugler, Co. L, 3 Reg't U. S. Col'd Cavalry.

Appears on

Company Muster Roll

for *July & Aug*, 186*5*.

Present or absent *present*

Stoppage, \$ *100* for

Due Gov't, \$ *100* for

Valuation of horse, \$ *100*

Valuation of horse equipments, \$ *100*

Remarks:

Book mark:

Saxton

No | **3 Cav.** | **U.S.C.T.**

Bill Howard

Bugler, Co. L, 3 Reg't U. S. Col'd Cavalry.

Appears on

Company Muster Roll

for *Sept & Oct.*, 186*5*.

Present or absent *Present*

Stoppage, \$ *100* for

Due Gov't, \$ *100* for

Valuation of horse, \$ *100*

Valuation of horse equipments, \$ *100*

Remarks:
.....
.....
.....
.....
.....
.....
.....
.....

Book mark:

E. B. Thompson
(358) Copyist.

No | **3 Cav.** | **U.S.C.T.**

Bill Howard
Bugler, Co. L, 3 Reg't U. S. Col'd Cavalry.

Appears on

Company Muster Roll

for *Nov & Dec.*, 1865.

Present or absent *Present*

Stoppage, \$ *100* for

Due Gov't, \$ *100* for

Valuation of horse, \$ *100*

Valuation of horse equipments, \$ *100*

Remarks:

Book mark:

E. D. Thompson
Copyist.

Ho | 3 Cav. | U.S.C.T.

Bill Howard
Mus, Co. L, 3 Reg't U. S. Colored Cav.

Appears on **Returns** as follows:

Mar. to Aug. 1865. Co. Bugler.

Oct. 1865. Co. Bugler.

Book mark : _____

(546)

J. B. Dittler

Copyist.

H | **3 Cav. U.S.C.T.**

Bill Howard
Bugler Co., 3 Reg't U. S. Col'd Cavalry.

Appears on **Co. Muster-out Roll**, dated
Memphis Tenn Jan 26, 186*6*.
Muster-out to date *Jan 26*, 186*6*.
Last paid to *June 3* 186*5*.

Clothing account:

Last settled, 186 ; drawn since \$ 100
Due soldier \$ 100; due U. S. \$ 100 *1.44*
Am't for cloth'g in kind or money adv'd \$ 100

Due U. S. for arms, equipments, &c., \$ 100
Bounty paid \$ 100; due \$ 100

Remarks:

Book mark:

E. B. Thompson
(361) Copyist.

698

Howard, Henry
Co E, 3 U. S. Col'd Cav.

Private

Private

CARD NUMBERS.

1	5337973	26
2	5338037	27
3	5338108	28
4	5338263	29
5	5338796	30
6	9088783	31
7	40727557	32
8	31691433	33
9		34
10		35
11		36
12		37
13		38
14		39
15		40
16		41
17		42
18		43
19		44
20		45
21		46
22		47
23		48
24		49
25		50

Book Mark: C.B. 510 P 696

See also

A/ | **3 Cav. | U.S.C.T.**

Henry Howard
....., Co. *E*, 3 Reg't U. S. Col'd Cav.

Appears on

Company Descriptive Book
of the organization named above.

DESCRIPTION.

Age *27* years; height *5* feet *6 1/2* inches.

Complexion *Yellow*

Eyes *Black*; hair *Black*

Where born *Maryland*

Occupation *Farmer*

ENLISTMENT.

When *May 1*, 1864.

Where *Meribury Miss.*

By whom *Maj. Train*; term *3* y'rs.

Remarks: *Died at Memphis Tenn.*
Jan 14. 1865.

(383g)

E. A. Weston
.....
Copyist.

H | **3 Cav.** | **U.S.C.T.**

Henry Howard
Pvt, Co. E, 3 Reg't U.S. Col'd Cavalry.

Appears on

Company Muster Roll

for *July Aug*, 186 *4*

Present or absent *Present*

Stoppage, \$ *100* for

Due Gov't, \$ *100* for

Valuation of horse, \$ *100*

Valuation of horse equipments, \$ *100*

Remarks:

*Enrolled & M/in Aug 13/64
at Goodrich Landing
for 3 years.*

Book mark:

Bruder

A. | **3 Cav.** | **U.S.C.T.**

Henry Edmund

U., Co. E, 3 Reg't U.S. Col'd Cavalry.

Appears on

Company Muster Roll

for *Sept. v Oct.*, 186*4*.

Present or absent *Present*

Stoppage, \$ 100 for

Due Gov't, \$ 100 for

Valuation of horse, \$ 100

Valuation of horse equipments, \$ 100

Remarks:

Book mark:

(358)

D. P. [Signature]
Copyist.

A. | **3 Cav.** | **U.S.C.T.**

Henry Howard
H., Co. E, 3 Reg't U. S. Col'd Cavalry.

Appears on

Company Muster Roll
for *Nov, 1st Dec.*, 186*4*.

Present or absent *Absent*

Stoppage, \$ *100* for

Due Gov't, \$ *100* for

Valuation of horse, \$ *100*

Valuation of horse equipments, \$ *100*

Remarks: *Absent sick since*
Nov. 29th 1864

Book mark:

H. G. Hoff
Copyist.

H. 3 Cav USCF
Henry Howard
Pvt, Co. E, 3 Reg't. 11th Cav

Appears on

Hospital Muster Roll

of Webster U. S. A. General Hospital,

at Memphis, Tenn.,

for *Nov & Dec*, 186*4*

Attached to hospital:

When *Dec 30*, 186*4*.

How employed *sick*

Last paid by Maj.

to, 186 ..

Bounty paid \$ *100*; due \$ *100*

Present or absent *Present*

Remarks: *Has no descriptive List*

Book mark :

Madison

24. 3 Cav. U.S.C.T.

Henry Howard
Co. E, 3 Reg't U.S. Col'd Cavalry.

Appears on

Company Muster Roll

for Jan. 1. 1865.

Present or absent

Stoppage, \$ 48 ³⁴/₁₀₀ for

Due Gov't, \$ 100 for

Valuation of horse, \$ 100

Valuation of horse equipments, \$ 100

Remarks: (Died)
at San Antonio Texas Jan
11. 1865

Book mark: Discharge 4.65.65
P. 596

[Signature]

1871 204

Hc. | 3 Cav. | U.S.C.T.

Henry Howard
Priv., Co. E, 3 Reg't U. S. Colored Cav.

Appears on Returns as follows:

Dec. 1864. Absent sick in Gen.
Hosp. Memphis, Tenn.

Jan. 1865. Lost Jan. 14 Mem-
phis, Tenn. - Died in Gen.
Hosp. Jan. 14/64.

Book mark :

(546)

J. B. Dittler

Copyist.

H | 3 Cav. | U.S.C.T.

Henry Howard

Pvt., Co. E., 3 Reg't U. S. Col'd Cavalry.

Appears on Co. Muster-out Roll, dated
Memphis, Tenn. Jan. 26, 1866 .

Muster-out to date _____, 186 .

Last paid to Aug. 31, 1864 .

Clothing account:

Last settled _____, 186 ; drawn since \$ _____ 100

Due soldier \$ _____ 100; due U. S. \$ _____ 100

Am't for cloth'g in kind or money adv'd \$ _____ 100

Due U. S. for arms, equipments, &c., \$ _____ 100

Bounty paid \$ _____ 100; due \$ _____ 100

Remarks: Died at Memphis, Tenn.
Jan. 14. 65.

Book mark: Dict. Jan. 4. 65. E. B.
v. 10. P. 596.

(861)

Lewis
Copyist.

Howard, Henry

B., Co. E, 3 Regt U. S. C. Cav.

3 Enclosures.

Bed Cards	Descriptive Lists
Burial Records	Final Statements
Certs. of Dis. for Discharge	Furloughs
C. M. Charges	Med. Des. Lists
Med. Certificates	Orders
<i>Enlistment 1</i>	

Other papers relating to—

Admission to Hosp'l	Furlough
Casualty Sheet (Officer's)	Med. Examination
Confinement	Misc. Information
Contracts	Pay or Clothing
Death or Effects	Personal Reports
Desertions	Rank
Discharge from Hosp'l	Transfer to Hosp'l
Discharge from Service	Transfer to V. R. C.
Duty	Transportation

123456789

NOTE 1.—This blank will be used for both enlistments and re-enlistments—enlistment of veterans, &c., &c., in the volunteer service. They will be made out in duplicate in all cases—one to accompany the recruiting return of the superintendent (not the recruiting officer) to the Adjutant General, and one to accompany the accounts of the officer who pays bounty, &c. The Regiment and Company in which the soldier last served should be given on the back.

NOTE 2.—An enlistment holds to service. A muster-in must, in all cases, precede payment of pay, bounty, pension, &c. A muster-in roll must, in all cases, be filed in the Adjutant General's Office as evidence of muster-in. The mustering officer, commissary, or assistant commissary of musters, as the case may be, will countersign both enlistments having mustered the soldier into the service of the United States before either of them is given to the disbursing officer.

DECLARATION OF RECRUIT.

I, Henry Howard desiring to VOLUNTEER as a Soldier in the Army of the United States, for the term of THREE YEARS, Do Declare, That I am Twenty Seven years and Seven months of age; that I have never been discharged from the United States service on account of disability or by sentence of a court-martial, or by order before the expiration of a term of enlistment; and I know of no impediment to my serving honestly and faithfully as a soldier for three years.

GIVEN at Northburg Mich the Thirteenth day of August 1864

Witness: S. S. Read Henry Howard
mark

No. _____

Henry Howard
Volunteered at Northburg Mich
Aug 13th 1864
By S. S. Read Recruiting
Agent for the State Michigan

Enlistment; last served in Company ()

Reg't of _____

Discharged _____ 18 _____

CONSENT IN CASE OF MINOR.

I, _____ DO CERTIFY, That I am the _____ of _____; that the said _____ is _____ years of age; and I do hereby freely give my CONSENT to his volunteering as a SOLDIER in the ARMY OF THE UNITED STATES for the period of THREE YEARS.

GIVEN at _____ the _____ day of _____

Witness: _____

Handwritten notes:
From _____

VOLUNTEER ENLISTMENT.

STATE OF

Mississippi

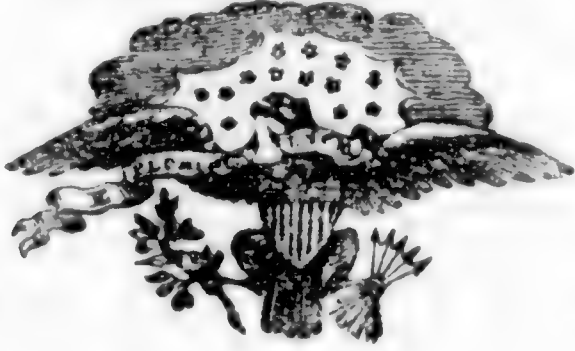

TOWN OF

Pickensburg

I, *Henry Steward* born in *Baltimore Co*
in the State of *Maryland* aged *Twenty Seven* years,
and by occupation a *Salmon* Do HEREBY ACKNOWLEDGE to have
volunteered this *Thirtieth* day of *August* 1864
to serve as a **Soldier** in the **Army of the United States of America**, for the
period of **THREE YEARS**, unless sooner discharged by proper authority: Do also
agree to accept such bounty, pay, rations, and clothing, as are, or may be, estab-
lished by law for volunteers. And I, *Henry Steward* do
solemnly swear, that I will bear true faith and allegiance to the **United States
of America**, and that I will serve them honestly and faithfully against all their
enemies or opposers whomsoever; and that I will observe and obey the orders of
the President of the United States, and the orders of the officers appointed over
me, according to the Rules and Articles of War.

Sworn and subscribed to, at *Pickensburg* this *Thirtieth* day of *Aug* 1864 by *Henry Steward*
BEFORE *S. S. Read Recruiting Agent for the State Michigan*

I CERTIFY, ON HONOR, That I have carefully examined the above-named Volunteer, agreeably
to the General Regulations of the Army, and that, in my opinion, he is free from all bodily defects and
mental infirmity, which would in any way disqualify him from performing the duties of a soldier.

J. C. Drury Surgeon
46 West 1st St
EXAMINING SURGEON.

I CERTIFY, ON HONOR, That I have minutely inspected the Volunteer, *H Steward*
previously to his enlistment, and that he was entirely sober when enlisted; that, to the best of my
judgment and belief, he is of lawful age; and that, in accepting him as duly qualified to perform the duties
of an able-bodied soldier, I have strictly observed the Regulations which govern the recruiting service.
This soldier has *Black* eyes, *Black* hair, *Black* complexion, is *Five* feet
Six inches high.

S. S. Read Recruiting Agent for the State Michigan
RECRUITING OFFICER.

Mustered into the service of the United States, in Company *F*
the *13th* day of *Aug*, 1864 at *Pickensburg*
Regiment of *Volunteers*
on *13th* day of *Aug* 1864

J. P. [Signature]
13th Aug 1864
at Pickensburg

Inventory of the effects of *Private Henry Howard*
Company B 2nd Regiment U.S. Army
 who died in the *Webster General Hospital Memphis*
Tenn 4th January 1865.

CAPS.....		BLANKETS.....	/
DRESS COATS.....		KNAPSACKS.....	/
OVERCOATS.....	/	CANTEENS.....	
JACKETS.....		HIVERSACKS.....	
TROUSERS.....		MUSKETS.....	
SHIRTS.....	/	BAYONETS.....	
DRAWERS.....	2	CARTRIDGE BOX.....	
BOOTS, prs.....	/	BELT.....	
SHOES, prs.....		MONEY.....	<i>Measure, Notes \$2.00</i>
STOCKINGS.....			

Inventory
 of the effects of *Private*
Henry Howard
 late of *Co. B 2nd Regiment*
U.S. Army, who died
 at *Webster General*
Hospital Memphis, Tenn. 4th January
 1865.



Wester U. S. Army General Hospital,
Memphis Tennessee, 1864
4th Jan'y

Commanding Officer Eth Company,
3rd Regt. U. S. Col. Cavalry

I have to inform you
that Henry Howard of your Company, died
in this hospital on 4th January 1864
of Pneumonia

I inclose his descriptive list, with pay and clothing account,
and inventory of his effects. P^{to} include 31 Aug/64, M^{of} leave
Clothing returns 31 Aug/64

Very respectfully yours, &c.,

M^W

Surgeon U. S. Army

In charge of General Hospital.

[OFFICE INDORSEMENT.]
War Department,

Final Statement of
Henry Howard
Rvt Co E 3rd Regt Col
Died June 4th 1865

A.G.O.
Paymaster receipt for
\$3 sent 2^d Aug 5.
H.R.



Am
H.R.

ADJUTANT GENERAL'S OFFICE
June 18th 1865
Duplicate with Inventory sent 2d Auditor.

ADJUTANT GENERAL'S OFFICE,

February 23rd, 1874

The death of Henry Howard,
Howard, Co. E, 3rd Reg't U. S.
Colored Cavalry, is reported as follows:—

- On Company Muster Roll.
- For January 2nd, 1865, January 11th, 1865
- Company Muster-out Roll.
- June 11th, 1865
- Company Descriptive Book.
-, 1865
- Company Morning Reports.
-, 1865
- Soldier's Final Statement.
- June 11th, 1865
- Soldier's Record of Death and Interment.
-, 1865
- Soldier's Inventory of Effects.
-, 1865
- Soldier's Certificate of Disability for Discharge.
-, 1865
- Soldier's Individual Muster-out Roll.
-, 1865
- Regimental Return.
- For, 1865,, 1865
- Regimental Quarterly Returns.
-, 1865
- Regimental Descriptive Book.
-, 1865
- By Surgeon General.
-, 1865

June 4th, 1865, is held to be
the correct date, and the Company Muster
Roll will be amended accordingly.

Theresa M. Howard
S.P. 10
596
Asst. Adj. Gen.
One letter to 2d Auditor
Mar 10th 1874

re of
any
also
16
16

MAR 12 1862

CERTIFICATE

TO BE GIVEN TO VOLUNTEERS AT THE TIME OF THEIR DISCHARGE TO ENABLE THEM TO RECEIVE THEIR PAY, Etc.

I Certify, On honor that *Henry Howard* a *Private*
of *Captain* *Quint* *Company* (*C*) of the *3*
Regiment of *U.S. Col's Cavalry* ~~Volunteers of the State of~~ *the United States* born in
State of *Maryland* aged *27* years; *5* feet
inches high; *Yellow* complexion, *Black* eyes, *Black* hair, and
by occupation a *Farmer* was enrolled or enlisted at *Godrich's Landing*
Pocomoke and mustered in service by *Quint* *Company* at
Sticksburg on the *18* day of *August* 186 to serve in
the Regiment for the term of three years; and having served honestly and faithfully with his Company in

to the present date, ~~is now entitled to a discharge by reason of *~~
*State particularly the cause of discharge: if for disability, whether the disability existed prior to the date of muster, or was contracted after.]
Died in the Webster Hospital, Memphis
Tenn. 4 Jan'y. 1865 of Pneumonia

The said *Henry Howard* was last paid by Paymaster
Map' Canby to include the *31* day of *August*
186 , and has pay due him from that time to the present date, and also pay for the use of his
(having been mounted during the time) and he is entitled to pay and subsistence for traveling to to place of enrollment,
and whatever other allowances are authorized to volunteer soldiers, or militia, so discharged.

He has received Clothing from the United States, not paid for, amounting to _____ dollars.

He has received Clothing from the State of _____ not paid for,
amounting to _____ dollars.

He is entitled to Clothing pay from the *31* day of *August* 186 to the
time of ~~discharge.~~ *death*

He is indebted for other stoppages than above _____

He has been subsisted for traveling to his place of enrollment, up to the _____ 186

He is indebted to _____ Sutler, _____ dollars.

GIVEN in duplicates at *Memphis Tenn* this *4* day of *January* 186 -

Wm
Surgeon
in charge of Hospital
Commanding Company.

NOTE.—Two of these certificates (or duplicates) are to be given to each volunteer soldier who may be discharged previously to the discharge of his company, that he may at once receive from the Paymaster the pay, etc., due him, and the captain or other officer commanding the company, will certify to the act of the delivery of the duplicate certificates; on these certificates the soldier is "entitled to" his discharge, and should also present his discharge to the Paymaster to have the payment endorsed on it. The discharge is to be given back to the Soldier by the Paymaster:—the latter only retaining as his voucher the duplicate certificates.

NOTE.—When Descriptive Roll has been given to a Soldier, no Final Certificate should be given until he returns his Descriptive Roll.

699

Howard, William
Co I, 3 U. S. Col'd Cav.

Private

Private

CARD NUMBERS.

1	5330986	26
2	5343087	27
3	5331759	28
4	5343649	29
5	9089419	30
6	40727559	31
7		32
8		33
9		34
10		35
11		36
12		37
13		38
14		39
15		40
16		41
17		42
18		43
19		44
20		45
21		46
22		47
23		48
24		49
25		50

Book Mark:

See also

W | **3 Cav. | U.S.C.T.**

William Howard

....., *Co. L*, 3 Reg't U. S. Col'd Cav.

Appears on

Company Descriptive Book

of the organization named above.

DESCRIPTION.

Age *19* years; height *5* feet *8* inches.

Complexion *Yellow*

Eyes *blk*; hair *blk*

Where born *Maine La*

Occupation *field hand*

ENLISTMENT.

When *Jan 6*, 186*5*.

Where *2 Burg.*

By whom *Wm Train*; term *3* y'rs.

Remarks: *Rec'd Jan 20 1865*

.....
.....
.....
.....
.....
.....

Wilton

H. | 3 Cav. | U.S.C.T.

William Howard.
Priv, Co., 3 Reg't U. S. Col'd Cav.

Age 25 years.

Appears on a

Detachment Muster-in Roll

of the organization named above. Roll dated

Vicksburg Miss, Jan. 7, 1865.

Muster-in to date Jan. 7, 1865.

Joined for duty and enrolled:

When Jan. 6, 1865.

Where Vicksburg, Miss.

Period 3 years.

Valuation of horse, \$ 100

Valuation of horse equipments, \$ 100

Remarks:

Book mark :

Sitter.

H | **3 Cav.** | **U.S.C.T.**

William Howard

Plt, Co. I, 3 Reg't U. S. Col'd Cavalry.

Appears on

Company Muster Roll

for Jan & Feb., 1865.

Present or absent _____

Stoppage, \$ _____ 100 for _____

Due Gov't, \$ _____ 100 for _____

Valuation of horse, \$ _____ 100

Valuation of horse equipments, \$ _____ 100

Remarks: Presented at Vicksburg
Miss June 19/65-

Book mark: _____

Lucas

A | 3 Cav | **U.S.C.T.**

Sam Howard

Pvt, Co. D, 3 Reg't U. S. Col'd Cav

Appears on

Descriptive List of Deserters

dated Memphis Tenn Feb 1, 1865.

Deserted :

When Jan 12, 1865.

Where Vicksburg

Arrested :

When _____, 186 .

Where _____

Remarks : _____

Book mark : _____

(351)

F. A. Miller

Copyist.

H. | 3 Cav. | U.S.C.T.

Win Howard ✓

Priv., Co. I, 3 Reg't U. S. Colored Cav.

Appears on Returns as follows:

Jan. 1865, Gain Jan. 16/65-
Memphis, Tenn. Enlisted
in Regt.

Jan 1865 Loss Jan
Memphis Tenn Deserted

✓ Name appears also as
Weller Howard

Book mark :

(546)

J. B. Sittler

Copyist.

H | 3 Cav. | U.S.C.T.

William Howard

Priv., Co. D, 3 Reg't U. S. Col'd Cavalry.

Appears on Co. Muster-out Roll, dated

Memphis Tenn Jan 26, 1866.

Muster-out to date _____, 186 .

Last paid to * Memphis _____, 186 .

Clothing account:

Last settled _____, 186 ; drawn since \$ _____ 100

Due soldier \$ _____ 100; due U. S. \$ _____ 100

Am't for cloth'g in kind or money adv'd \$ _____ 100

Due U. S. for arms, equipments, &c., \$ _____ 100

Bounty paid \$ _____ 100; due \$ _____ 100

Remarks: Presented at Vicksburg
Miss Jan 20 1866. Descriptive
Roll furnished.

* Member of Company

Book mark: _____

Edmondson

700

Hubbard, Anthony

Co L, 3 U.S. Col'd Cav.

Private

Private

CARD NUMBERS.

1	5331404	26
2	5345075	27
3	5345487	28
4	5345574	29
5	5345659	30
6	5345742	31
7	5345815	32
8	5345885	33
9	9089708	34
10	40727560	35
11		36
12		37
13		38
14		39
15		40
16		41
17		42
18		43
19		44
20		45
21		46
22		47
23		48
24		49
25		50

Book Mark:

See also

96 | **3 Cav.** | **U.S.C.T.**

Anthony Hubbard

....., Co. *L*, 3 Reg't U. S. Col'd Cav.

Appears on

Company Descriptive Book
of the organization named above.

DESCRIPTION.

Age *31* years; height *6* feet *3* inches.

Complexion *Black*

Eyes *Black*; hair *Black*

Where born *Butler Co, Ala*

Occupation *Labourer*

ENLISTMENT.

When *Feb. 10*, 1865.

Where *Memphis*

By whom *Maj. Main*; term *3* y'rs.

Remarks:

.....
.....
.....

.....

J. B. Smith

HC | 3 Cav. | U.S.C.T.

Anthony Hubbard
Priv, Co. L, 3 Reg't U. S. Col'd Cavalry.

Appears on

Company Muster Roll

for Jan & Feb, 1865.

Present or absent present

Stoppage, \$ 100 for

Due Gov't, \$ 100 for

Valuation of horse, \$ 100

Valuation of horse equipments, \$ 100

Remarks:

Book mark:

Daxton

A | **3 Cav.** | **U.S.C.T.**

Anthony Hubbard

Appears with rank of *Priv* on

Muster and Descriptive Roll of a Detachment of U. S. Vols. forwarded

for the 3 Reg't U. S. Col'd Cavalry. Roll dated

Memphis Tenn, Mar 8, 1865.

Where born *Butts Co. Ala*

Age *20* y'rs; occupation *Farmer*

When enlisted *Feb 15*, 1865.

Where enlisted *Memphis Tenn.*

For what period enlisted *3* years.

Eyes *Black*; hair *Black*

Complexion *Black*; height *6* ft. in.

When mustered in *Feb 15*, 1865.

Where mustered in *Memphis Tenn.*

Bounty paid \$ *100*; due \$ *100*

Where credited *Chillicothe Co. Ark.*

Company to which assigned *D.*

Remarks:

Book mark:

(339)

Joiner.

Copyist.

H | 3 Cav. | U.S.C.T.

Anthony Hubbard
Pos, Co. L, 3 Reg't U. S. Col'd Cavalry.

Appears on

Company Muster Roll

for *March + April*, 1865.

Present or absent *present*

Stoppage, \$ *100* for

Due Gov't, \$ *100* for

Valuation of horse, \$ *100*

Valuation of horse equipments, \$ *100*

Remarks:

Book mark:

Taxton

(358)

Copyist.

H | 3 Cav. | U.S.C.T.

Anthony Hubbard
Pos, Co. L, 3 Reg't U. S. Col'd Cavalry.

Appears on

Company Muster Roll
for May & June, 1865.

Present or absent present

Stoppage, \$ 100 for

Due Gov't, \$ 100 for

Valuation of horse, \$ 100

Valuation of horse equipments, \$ 100

Remarks: Stopped leather comb
& H. Brush \$1.01; Spurs
& Straps .52; Total
\$1.53.

Book mark:

Doxton

H | **3 Cav.** | **U.S.C.T.**

Anthony Hubbard
Plt, Co. L, 3 Reg't U. S. Col'd Cavalry.

Appears on

Company Muster Roll

for July + Aug, 1865.

Present or absent present

Stoppage, \$ 100 for

Due Gov't, \$ 100 for

Valuation of horse, \$ 100

Valuation of horse equipments, \$ 100

Remarks:

Book mark:

Axton

MAR 12 1865

No | **3 Cav.** | **U.S.C.T.**

Anthony Hubbard
Pvt., Co. L, 3 Reg't U. S. Col'd Cavalry.

Appears on

Company Muster Roll

for *Sept + Oct.*, 1865 .

Present or absent *Present*

Stoppage, \$ *8⁶⁵*/₁₀₀ for *Ordnance*

Due Gov't, \$ *100* for

Valuation of horse, \$ *100*

Valuation of horse equipments, \$ *100*

Remarks: *Stopped one Sabre \$6.50*
Leather belt + plate 2.15

Book mark: _____

(358)

E. B. Thompson

Copyist.

No | 3 Cav. | U.S.C.T.

Anthony Hubbard
Pvt., Co. L, 3 Reg't U.S. Col'd Cavalry.

Appears on

Company Muster Roll

for Nov & Dec., 1865.

Present or absent Present

Stoppage, \$ 8.65/100 for Ordnance

Due Gov't, \$ 100/100 for

Valuation of horse, \$ 100/100

Valuation of horse equipments, \$ 100/100

Remarks:

Book mark:

E. B. Thompson
Copyist.

H. | 3 Cav. | U.S.C.T.

Anthony Hubbard
Priv., Co. L, 3 Reg't U. S. Colored Cav.

Appears on Returns as follows:

Feb. 1865. Gave Feb. 25/65 -
Memphis, Tenn. - Enlisted
in Regt.

Book mark :

(546)

J. B. Dittler

Copyist.

No | **3 Cav. U.S.C.T.**

Anthony Hubbard
Pt. Co. *D*, 3 Reg't U. S. Col'd Cavalry.

Appears on **Co. Muster-out Roll**, dated
Memphis Tenn Jan 26, 1866 .
Muster-out to date *June 26*, 1866 .
Last paid to *June 30* 1865 .

Clothing account:
Last settled _____, 186 ; drawn since \$ _____ 100
Due soldier \$ *1973* / 100; due U. S. \$ _____ 100
Am't for cloth'g in kind or money adv'd \$ _____ 100

Due U. S. for arms, equipments, &c., \$ *8.65* / 100
Bounty paid \$ _____ 100; due \$ *100.00* / 100

Remarks: _____

Book mark: _____

E. B. Thompson
(361) Copyist.

701

Hubbard, Washington
Co I, 3 U. S. Col'd Cav.

Private | Private

CARD NUMBERS.

1	5330998	26
2	5343040	27
3	5343152	28
4	5343249	29
5	5343365	30
6	5343622	31
7	9089407	32
8	40727575	33
9	31688035	34
10	31692000	35
11		36
12		37
13		38
14		39
15		40
16		41
17		42
18		43
19		44
20		45
21		46
22		47
23		48
24		49
25		50

Book Mark:

See also

N | **3 Cav. | U.S.C.T.**

Washington Hubbard

....., Co. *J*, 3 Reg't U. S. Col'd Cav.

Appears on

Company Descriptive Book

of the organization named above.

DESCRIPTION.

Age *18* years; height *5* feet *4* inches.

Complexion *Blk*

Eyes *blk*; hair *blk*

Where born *Grenada Wip*

Occupation *farmer*

ENLISTMENT.

When *Jan 6*, 186 *3*.

Where *W Burg*

By whom *Wag Main*; term *3* y'rs.

Remarks: *Spied in W. C. to Gen. Hoop*

Memphis Tenn. June July 3, 1863

* *Had pay due from enrollment*

* *Had received clothing amounting to*

\$4.00. Indebted to the govt for one

* *Cartridge and one harness*

* *Appears on Roll*

Witter

1865

No. 3 Cav. **U.S.C.T.**

Washington Hubbard
Priv. Co. 3 Reg't U. S. Col'd Cav.

Age 18 years.

Appears on a

Detachment Muster-in Roll

of the organization named above. Roll dated

Vicksburg, Miss Jan. 7, 1865.

Muster-in to date Jan. 7, 1865.

Joined for duty and enrolled:

When Jan, 6, 1865.

Where Vicksburg, Miss.

Period 3 years.

Valuation of horse, \$.....100

Valuation of horse equipments, \$.....100

Remarks:.....
.....
.....
.....

Book mark :.....

Sitter.
(337) Copyist.

H. | 3 Cav. U.S.C.T.

Washington Hubbard
Pvt., Co. I 3 Reg't U.S.C.C.

Appears on

Hospital Muster Roll

of Small Pox U. S. A. General Hospital,

at Memphis, Tenn.,

for Jan & Feb, 1865.

Attached to hospital :

When Feb. 18, 1865.

How employed Sick.

Last paid by Maj. _____

to _____, 1865.

Bounty paid \$ 100 ; due \$ 100

Present or absent Present,

Remarks : _____

Book mark: _____

Ramsey
Copyist

A | **3 Cav.** | **U.S.C.T.**

Washington Hubbard

Plt-, Co. I, 3 Reg't U. S. Col'd Cavalry.

Appears on

Company Muster Roll

for *Jan & Feby*, 186*5*

Present or absent *Absent*

Stoppage, \$ *100* for

Due Gov't, \$ *100* for

Valuation of horse, \$ *100*

Valuation of horse equipments, \$ *100*

Remarks: *Absent sick in Genl
Hospital at Memphis Tenn since
Feb 2/65.*

Book mark: *Lucas*

Lucas

H | 3 Cav. | U.S.C.T.

Washington Hubbard
Pvt., Co. I, 3 Reg't U. S. Col'd Cavalry.

Appears on

Company Muster Roll

for March + April, 1865.

Present or absent Present

Stoppage, \$ 100 for

Due Gov't, \$ 100 for

Valuation of horse, \$ 100

Valuation of horse equipments, \$ 100

Remarks:

Book mark:

Linear

U : 3 Car 1 USCT

Washington Hubbard
Pvt., Co. G, 3 Reg't USCT Car

Appears on

Hospital Muster Roll

of Webster U. S. A. General Hospital,

at Memphis, Tenn.,

for May & June, 1865

Attached to hospital:

When June 16, 1865

How employed Sick

Last paid by Maj. Maybourne
to Feb 25, 1865

Bounty paid \$ 100; due \$ 100

Present or absent Present

Remarks: Stoppage \$ 1.60

Book mark:

(843)

J. Underwood

Copyright.

H | **3 Cav.** | **U.S.C.T.**

Washington Hubbard
Pot, Co. I, 3 Reg't U. S. Col'd Cavalry.

Appears on

Company Muster Roll

for *Mays June*, 1865.

Present or absent *Absent*

Stoppage, \$ *100* for

Due Gov't, \$ *100* for

Valuation of horse, \$ *100*

Valuation of horse equipments, \$ *100*

Remarks: *- absent in*
Gen Hoptt at Mem
phis Tenn since
June 17/65

Book mark:

(358)

J. Hadenwood

Copyist.

H | **3 Cav.** | **U.S.C.T.**

Washington Hubbard

Pvt, Co. I, 3 Reg't U. S. Col'd Cavalry.

Appears on

Company Muster Roll

for July & Aug, 1865.

Present or absent _____

Stoppage, \$ _____ 100 for _____

Due Gov't, \$ _____ 100 for _____

Valuation of horse, \$ _____ 100

Valuation of horse equipments, \$ _____ 100

Remarks: Died in Genl Hospital
at Memphis Tenn July 5/65-
Stop Canton & Haversack \$1.60

Book mark: _____

Inca

H. | 3 Cav. | U.S.C.T.

Washington Hubbard
Pvt, Co. I, 3 Reg't U. S. Colored Cav.

Appears on Returns as follows:

Jan. 1865. Gain Jan. 16/65
Memphis, Tenn. En-
listed in Regt.

Feb. 1865. Absent sick since
Jan. 31/65.

June 1865. Absent sick in Gen.
Hosp. at Memphis, Tenn.
since June 17/65.

July 1865. Lost July 5 - Mem-
phis, Tenn. Died in
Webster Gen. Hosp.

Book mark :

(546)

J. B. Sittler

Copyist.

H | 3 Cav. | U.S.C.T.

Washington Hubbard
Priv., Co. I, 3 Reg't U. S. Col'd Cavalry.

Appears on Co. Muster-out Roll, dated
Memphis, Tenn Jan 26, 1866.

Muster-out to date _____, 186 .

Last paid to Feb 28, 1865' .

Clothing account:

Last settled _____, 186 ; drawn since \$ _____ 100

Due soldier \$ _____ 100; due U. S. \$ _____ 100

Am't for cloth'g in kind or money adv'd \$ _____ 100

Due U. S. for arms, equipments, &c., \$ _____ 100

Bounty paid \$ _____ 100; due \$ _____ 100

Remarks: Died in Webster's Hospital at Memphis Tenn July 5 1865 of Chronic Dysentery. Final statement forwarded

Book mark:

(361)

Copyist.

Hubbard, Washington
A. Co. I, 3 U.S.C. Cav.
Reg't

2 Enclosures.

Bed Cards	Descriptive Lists
Burial Records	Final Statements
Certs. of Dis. for Discharge	Furloughs
C. M. Charges	Med. Des. Lists
Med. Certificates	Orders

Other papers relating to—

Admission to Hosp'l	Furlough
Casualty Sheet (Officer's)	Med. Examination
Confinement	Misc. Information
Contracts	Pay or Clothing
Death or Effects	Personal Reports
Desertions	Rank
Discharge from Hosp'l	Transfer to Hosp'l
Discharge from Service	Transfer to V. R. C.
Duty	Transportation

Wester U. S. Army General Hospital,

Memphis Tenn July 5, 1865.

Commanding Officer, "A" Company,

3^d Regiment Illinois Cavalry

I have to inform you

that Pvt Washington H. H. H. of your Company died in this
Hospital on the 5 of July 1865 of

Chronic Dysentery

I enclose his Descriptive List, with Pay and Clothing Account,
and Inventory of his effects.

Very respectfully, yours, &c.,

Chas. S. Jessop

Asst. Surgeon U. S. Army

In charge of General Hospital

Inventory of the effects of *Washington Hubbard*
 Company "B", 30th Regiment *U.S. Cavalry*
 who died in the *Webster U.S. General Hospital Memphis*
 Tenn July 5, 1865.

CAPS	BLANKETS
DRESS COATS	KNAPSACKS
OVERCOATS	CANTEENS
JACKETS	HIVERSACKS
TROUSERS	MUSKETS
SHIRTS	BAYONETS
DRAWERS	CARTRIDGE BOX
BOOTS, pairs	BELT
SHOES, pairs	MONEY
STOCKINGS	

RECEIVED
 JUN 21 1871

30

30

30

INVENTORY

OF THE EFFECTS OF

Washington Hubbard
 Late of Company "B", 30th Regiment
U.S. Cavalry who died
 at *Webster U.S. General*
Hospital Memphis July 5,
 1865.

30

NARRATIVE

A. G. O.

Company 22 - 20th

140 Oct 28 1865.
G. M. not for effect value
50¢ sent 2d Auditor.
J. H.

FINAL STATEMENT

OF

Washington Hubbard

B. Reg't of *11th Co Cavalry*

VOLUNTEERS.

11th Co Cavalry
1865

NOTE 1.—Two of these certificates (or duplicates) are to be given to each Volunteer Soldier or drafted man who may be discharged previously to the discharge of his company, that he may at once receive from the Paymaster the pay, &c., due him, and the captain or other COMMISSIONED officer commanding the company will certify to the act of the delivery of the duplicate certificates; on these certificates the Soldier is "entitled to" his discharge, and should also present his discharge to the Paymaster to have the payment endorsed on it. The discharge is to be given back to the Soldier by the Paymaster; the latter only retaining as his voucher the duplicate certificates.

NOTE 2.—If the Soldier is entitled to pay for the use of his horse, the Company Commander will certify to that fact on the back of both these final statements, and also to the time he has pay due for having been so mounted on his own horse.

NOTE 3.—When a Soldier is furnished with final statements, his descriptive list, if he has one, should be taken up by the officer who gives the Soldier these statements, and endorsed with a statement to this effect by the officer. This endorsement should exhibit a full statement of the time for which the Soldier was allowed pay on his final statements, the clothing account, and all other charges against him or in his favor, so as to comprise a complete exhibit of his account. It will then be transmitted to the Company Commander of the Soldier, who will enter all the data necessary to a full understanding of the Soldier's account on the muster roll upon which the Soldier's discharge is reported. The descriptive list will then be destroyed. The object of this is, that the remaining portion of the Soldier's account may be settled upon the receipt of these muster rolls, and the Soldier receive any pay or allowances that may be due him at the time of his discharge, and which may not appear on his final statements from the fact that his descriptive list is incomplete. These accounts for back pay, &c., are settled by the 2d Auditor of the Treasury Department.

NOTE 4.—Charges for loss or injury to ordnance, horse equipments, and other miscellaneous charges, should appear under the heading of "Other Stoppages."

NOTE 5.—Bounty paid by State authorities, and not by the United States, will not be entered on this statement.

NOTE 6.—Amounts due the Sutler and Laundress must be entered on the muster roll on which the discharge, death, desertion, &c., is reported, as well as on the final statement, otherwise the amount cannot be collected from the United States.

NOTE 7.—This blank will be used for deceased volunteers and drafted men, as well as for others.

NOTE 8.—Where a Soldier dies in Hospital or on detached service, his descriptive list, if he has one, should be sent with his final statements, in duplicate, to the Adjutant General, Washington, D. C.

ADJUTANT GENERAL'S OFFICE.

July 19 1865.

Duplicate with Inventory sent 2d Auditor.

I certify, on honor, that William H. Hubbard a Private of
 Captain Lord F. Smith Company (B) of the 3^d Regiment of Volunteers
VOLUNTEERS, of the State of Ohio, born in Granville, State
 of Ohio, aged 13 years; 5 feet 4 inches high; Fair complexion,
Blue eyes, Blk hair, and by occupation a Farmer, having joined the company on
 its original organization at Granville, and enrolled in it at the muster into
 the service of the United States at Victoria, on the 6 day
 of January, 1865, (or was mustered in service as a recruit, by
Wm. H. Hubbard, at Granville, on the 6 day of January,
 1865, or was drafted and mustered into the service of the United States from the
 Enrollment District of the State of Ohio, at Granville,
 on the 6 day of January, 1865,) to serve in the Regiment, for
 the term of Three years: and having served **HONESTLY** and
FAITHFULLY with his Company in Ohio to the present date, is now
 entitled to a **DISCHARGE** by reason of being drafted by the Government
at Memphis, Tenn. July 5, 1865

The said William H. Hubbard was last paid by Paymaster
Wm. H. Hubbard to include the 23 day of February, 1865, and has
 pay due him from that time to the present date; he is entitled to pay and subsistence for
TRAVELING to place of enrollment, and whatever other allowances are authorized to volunteer
 soldiers, drafted men, or militia, so discharged. He has received from the United States **CLOTHING**
 amounting to 79 ⁴⁶/₁₀₀ dollars, since the 6 day of January,
 1865, when his clothing account was last settled. He has received from the United States
100 dollars advanced **BOUNTY**.

There is to be stopped from him, on account of the State of Ohio, or other
 authorities, for **CLOTHING**, &c., received on entering service, 100 dollars; and
 for other stoppages, viz: Contract for House rent 106
100 dollars.

He has been furnished with **TRANSPORTATION** in kind from the place of his discharge to
Granville; and he has been **SUBSISTED** for **TRAVELING** to his
 place of enrollment, up to the 6 day of January, 1865.

He is indebted to Granville, **SUTLER**, 100 dollars.
 He is indebted to Granville, **LAUNDRESS**, 100 dollars.

Given in Duplicate, at Memphis, Tennessee, this 5 day
 of July, 1865.

Wm. S. Jessop
Asst. Surg. U.S. Army
 Commanding Company.

702

Next number

702-a

Hudson, Berry

Co I, 3 U. S. Col'd Cav.

Private

Private

CARD NUMBERS.

1	5330988	26
2	5343084	27
3	5331757	28
4	5343648	29
5	9089416	30
6	40727562	31
7		32
8		33
9		34
10		35
11		36
12		37
13		38
14		39
15		40
16		41
17		42
18		43
19		44
20		45
21		46
22		47
23		48
24		49
25		50

Book Mark:

See also

A.Y. 2398810

A. M. Shannon
Esq

N | **3 Cav.** | **U.S.C.T.**

Berry Hudson

....., Co. *D*, 3 Reg't U. S. Col'd Cav.

Appears on

Company Descriptive Book

of the organization named above.

DESCRIPTION.

Age *19* years; height *5* feet *10* inches.

Complexion *Blk*

Eyes *blk*; hair *blk*

Where born *Granada, Ind*

Occupation *field hand*

ENLISTMENT.

When *Jan 6*, 1865.

Where *W. Va*

By whom *Maj Train*; term *3* y'rs.

Remarks: *Rec'd Jan 20' 1865*

A. Hillen

No. | 3 Cav. | U.S.C.T.

Berry Hudson.
Priv. Co., 3 Reg't U. S. Col'd Cav.

Age 31 years.

Appears on a

Detachment Muster-in Roll

of the organization named above. Roll dated

Vicksburg, Miss, Jan. 7, 1865.

Muster-in to date

Jan. 7, 1865.

Joined for duty and enrolled:

When

Jan. 6, 1865.

Where

Vicksburg, Miss,

Period

3 years.

Valuation of horse, \$ 100

Valuation of horse equipments, \$ 100

Remarks:

Book mark :

Sitter.

H | 3 Cav. | U.S.C.T.

Beray Hudson

Pvt., Co. I, 3 Reg't U. S. Col'd Cavalry.

Appears on

Company Muster Roll

for *Jan & Feb*, 186*5*

Present or absent

Stoppage, \$ *100* for

Due Gov't, \$ *100* for

Valuation of horse, \$ *100*

Valuation of horse equipments, \$ *100*

Remarks: *Present at Vicksburg*

Miss Jan 19/65

Book mark:

Lucas

H | 3 Cav | U.S.C.T.

Benjamin Hudson
Pvt, Co C, 3 Reg't U. S. Col'd Cav

Appears on

Descriptive List of Deserters

dated Memphis Tenn Feb 1, 1865.

Deserted:

When Jan 10, 1865.

Where Vicksburg

Arrested:

When, 186 .

Where

Remarks:

File with Berry
Hudson,

Book mark:

(351)

A. J. Miller

Copyist.

76. | 3 Cav. | U.S.C.T.

Berry, Hudson

Pvt., Co. D, 3 Reg't U. S. Colored Cav.

Appears on Returns as follows:

Jan 1865. Gain Jan. 16/65 - Mem-
phis, Tenn. - Enlisted in
Regt.
Loss, Jan. - Memphis, Tenn.
Deserted.

Book mark :

(546)

J. B. Dittler

Copyist.

H | 3 Cav. | U.S.C.T.

Denny Anderson
Bris, Co. D, 3 Reg't U. S. Col'd Cavalry.

Appears on Co. Muster-out Roll, dated
Memphis Tenn Jan 26, 1866.

Muster-out to date _____, 186 .

Last paid to ⁺ Memphis _____, 186 .

Clothing account:

Last settled _____, 186 ; drawn since \$ _____ 100

Due soldier \$ _____ 100; due U. S. \$ _____ 100

Am't for cloth'g in kind or money adv'd \$ _____ 100

Due U. S. for arms, equipments, &c., \$ _____ 100

Bounty paid \$ _____ 100; due \$ _____ 100

Remarks: He settled at Vicksburg
Tenn Jan 26. Descriptive
Roll furnished

⁺ Mustered by Company

Book mark:

Edmonds

702-a

Hudson, George C.
Co., 3 U. S. Col'd

Lieutenant

CARD NUMBERS.

1	26
2	27
3	28
4	29
5	30
6	31
7	32
8	33
9	34
10	35
11	36
12	37
13	38
14	39
15	40
16	41
17	42
18	43
19	44
20	45
21	46
22	47
23	48
24	49
25	50

Name not borne on
rolls of 3 Regt U.S.C. Cav
See personal papers
herein, and R.P. 368536,

July 3/93
H.C.J.

Number of personal papers herein 2

Book Mark:

See also

RIP 368536

Write nothing above this line.

Mr Johnson:

Make envelope
for Hudson, George
E. - 3 U.S.C. Car,
and file the ac-
companying pps.
with it; also add
on flap of envelope
R.V.P. 368536.

M. W. V.
6/28/93,

Bed C

Burial

Certs.

C. M.

Med.

Admi

Casual

Confu

Contr

Death

Desert

Discha

Discha

Duty..

Hudson, Geo. E.

St., Co. _____, 3 Reg't _____

✓

Enclosures.

Bed Cards _____

Descriptive Lists _____

Burial Records _____

Final Statements _____

Certs. of Dis. for Discharge _____

Furloughs _____

C. M. Charges _____

Med. Des. Lists _____

Med. Certificates _____

Orders ✓

Other papers relating to—

Admission to Hosp'l _____

Furlough _____

Casualty Sheet (Officer's) _____

Med. Examination _____

Confinement _____

Misc. Information _____

Contracts _____

Pay or Clothing _____

Death or Effects _____

Personal Reports _____

Desertions _____

Rank _____

Discharge from Hosp'l _____

Transfer to Hosp'l _____

Discharge from Service _____

Transfer to V. R. C. _____

Duty _____

Transportation _____

Mrs E Hudson

34 S. 1st St

His Honor the District Judge
Campbell in the Year 1841

James (C. S.)
1841

On the 1st of the present month
in the case of the Union, as well as of
his incompetency as an officer, being
& the same as the Court have
advised from a most careful
study of the facts of the case
to state it to be a case of
of such a nature as to require
conduct - It is not a case of
mistake - but any violation of the
will be not with a trial by the
Court.

Officers of the Command will
not be permitted hereafter to plead their
want of knowledge of the rules of the Army
in defence of various and disgraceful
accident while under the influence of

1871
since, Sergeants must at all times
be respected and obeyed while in the
performance of their proper duties,
and hereafter when any Officer or
Sergeant shall insult or abuse a Soldier
of this Regiment while in the performance
of his duty, the offender shall be placed
in close arrest by the Officer of the day
Brigade, or Regimental Adjutant or upon
whose lines the offence is committed.

By Command of
Major Genl. H. C. W. H. C. W.
Solon A. Carter
Capt. U. S. A.

Ed. W. Hinks Division
Camp Hamilton Va April 30/64

General Orders No 12.
St. Hudson 3rd US Cold Cav.
released from arrest.
Sentinels to be respected. No
officer to be excused for riotous
conduct.

Geo E Hudson
LT. 3 U.S.C. Cav

Reeds. May 1. 1864 near
Hampton Va

1230
The 2d Artillery Division
Camp Hamilton Va April 30 1864

General Order }
No 12 }

On account of his previous service in the
Cause of the Union as well as of his inexperience as an
officer, Lieut George E Hudson 3^d U.S. Cold Cavalry is
hereby released from arrest and will return to duty.
This act of leniency will not be construed into a
license for the repetition of such un-officer-like
and ungentlemanly conduct as Lt Hudson was
guilty of on the 25th, but any recurrence of like
offence will meet with a trial by general court martial

Officers in this Command
will not be permitted hereafter to plead their
want of knowledge of the rules of the Army, in
defense of riotous and disgraceful conduct while
under the influence of Liquor.
Sentinels must at all times be respected and obeyed
while in the performance of their proper duties and
hereafter when any officer or soldier shall insult
or abuse a sentinel of this Command while in the
performance of his duty the offender shall be placed
in close arrest by the officer of the Day, Brigade or
Regiment within or upon whose lines the offence
is committed (over)

By Command of
Brig Genl E W Hinkes
(Signed) John A Carter
Capt & Adl Genl

Adj Lt 1st Brigade
May 15th 1864

Official
Aram W. Allen
1st Lt USA Genl

Previous number

703

787-a

Hues Alexander

Co E, 3 U. S. Col'd Cav.

Private

CARD NUMBERS.

1	5338830	26
2	9088781	27
3		28
4		29
5		30
6		31
7		32
8		33
9		34
10		35
11		36
12		37
13		38
14		39
15		40
16		41
17		42
18		43
19		44
20		45
21		46
22		47
23		48
24		49
25		50

Book Mark:

See also

A | **3 Cav.** | **U.S.C.T.**

Alexander Hues

....., Co. *E*....., 3 Reg't U. S. Col'd Cav.

Appears on

Company Descriptive Book

of the organization named above.

DESCRIPTION.

Age *35* years; height *5* feet *7* inches.

Complexion *Black*.

Eyes *Black*; hair *Black*.

Where born *Mississippi*.

Occupation *Farmer*.

ENLISTMENT.

When *Nov. 20*, 1863.

Where *Skipwith Ldy*.

By whom *Capt Cook*; term *3* y'rs.

Remarks; *Deserted at Skipwith Ldy*
Miss. Dec 3, 1863.

E. H. Hues

447 | **3 Cav. U.S.C.T.**

Alexander Hues

Priv., Co. E, 3 Reg't U. S. Col'd Cavalry.

Appears on **Co. Muster-out Roll**, dated
Memphis. Tenn. Jan. 2.6., 1866 .

Muster-out to date _____, 186 .

Last paid to _____, 186 .
(Pay due from enrollment.)

Clothing account:

Last settled _____, 186 ; drawn since \$ _____ 100

Due soldier \$ _____ 100 ; due U. S. \$ _____ 100

Am't for cloth'g in kind or money adv'd \$ _____ 100

Due U. S. for arms, equipments, &c., \$ _____ 100

Bounty paid \$ _____ 100 ; due \$ _____ 100

Remarks: Deserted at Skipwith's
Edg. Miss. Dec. 3. 63.

Enrolled & M/ in Nov
20/63 at Skipwith's Land-
ing for 3 years
Age 38 - Not borne on prior
rolls.

Book mark: _____

Lewis

704

Huggins, Burges

Co E, 3 U. S. Col'd Cav.

Private

Sergeant

CARD NUMBERS.

1	5337627	26
2	5337635	27
3	5337788	28
4	5337865	29
5	5338781	30
6	9088778	31
7	40727561	32
8		33
9		34
10		35
11		36
12		37
13		38
14		39
15		40
16		41
17		42
18		43
19		44
20		45
21		46
22		47
23		48
24		49
25		50

Book Mark:

See also

A | **3 Cav. | U.S.C.T.**

Bunges Higgins,
....., Co. *E*, 3 Reg't U. S. Col'd Cav.

Appears on

Company Descriptive Book

of the organization named above.

DESCRIPTION.

Age *28* years; height *5* feet *8* inches.

Complexion *Black*.

Eyes *Black*; hair *Black*.

Where born *Mississippi*

Occupation *Harmer*.

ENLISTMENT.

When *Nov. 20*, 1863.

Where *Skipswith Lodge*

By whom *Capt Cook*; term *3* y'rs.

Remarks: *Died at Harmer Bluffs*
Miss. Feb 5, 1864.

H. | **3 Cav.** | **U.S.C.T.**

Bruce Huggins

Pr, Co. *E*, 1 Reg't Miss. Cav., Corps d'Afrique.*

Age 28
Appears on

Company Muster-in Roll

of the organization named above. Roll dated

Okepurtho Ldg Miss Dec 9, 1863.

Muster-in to date *Nov 25*, 1863

Joined for duty and enrolled:

When *Nov 25*, 1863.

Where *Okepurtho Ldg Miss*

Period *3* years.

Valuation of horse, \$.....100

Valuation of horse equipments, \$.....100

Remarks:

*This organization subsequently became Co. *E* 3 Reg't U. S. Colored Cavalry.

Book mark:

Prude

76 | 3 Cav. | U.S.C.T.

Burgis Muggins
Sgt, Co. E, 1 Reg't Miss. Cav., Corps d'Afrique.*

Appears on

Company Muster Roll

for date Dec 31, 1863

Present or absent Present

Stoppage, \$ 100 for

Due Gov't, \$ 100 for

Valuation of horse, \$ 100

Valuation of horse equipments, \$ 100

Remarks:

M/in Dec 9/63 at
Skipworth Landing

*This organization subsequently became Co. E 3 Reg't U. S. Colored Cavalry.

Book mark:

Bradley

H | **3 Cav.** | **U.S.C.T.**

Berger Huggins
Co. *E*, 1 Reg't Miss. Cav., Corps d'Afrique.*

Appears on

Company Muster Roll
for *Jan'y & Feby*, 1864

Present or absent.....

Stoppage, \$.....100 for.....

Due Gov't, \$.....100 for.....

Valuation of horse, \$.....100

Valuation of horse equipments, \$.....100

Remarks: *Died in Hosp*
Feby 5. 1864

*This organization subsequently became Co. *E* 2 Reg't U. S. Colored Cavalry.

Book mark :.....

Brade

H | **3 Cav.** | **U.S.C.T.**

Berger Huggins

Cor, Co. E, 3 Reg't U. S. Col'd Cavalry.

Appears on

Company Muster Roll

for *Murray*, 1864.

Present or absent

Stoppage, \$ 100 for

Due Gov't, \$ 100 for

Valuation of horse, \$ 100

Valuation of horse equipments, \$ 100

Remarks: *Died in Hosp
Feb 5. 1864*

Book mark:

Prader

H. | 3 Cav. | U.S.C.T.

Burgis Huggins
Sergt., Co. E, 3 Reg't U. S. Colored Cav.

Appears on Returns as follows:

Feb. 1864 (1 Miss. Cav. A. 20.) Loss-
Feb. 5/64 Haines Bluff
Died of disease.

Book mark :

(546)

J. B. Sittler

Copyist.

16 | 3 Cav. | U.S.C.T.

Burgess Higgins
Sgt., Co. E., 3 Reg't U. S. Col'd Cavalry.

Appears on Co. Muster-out Roll, dated
Memphis Tenn. Jan. 26, 1866.

Muster-out to date _____, 186 .

Last paid to _____, 186 .
Pay due from Enrollment.

Clothing account:

Last settled _____, 186 ; drawn since \$ _____ 100

Due soldier \$ _____ 100; due U. S. \$ _____ 100

Am't for cloth'g in kind or money adv'd \$ _____ 100

Due U. S. for arms, equipments, &c., \$ _____ 100

Bounty paid \$ _____ 100; due \$ _____ 100

Remarks: Died at Harris Bluffs, Miss.
Feb. 5, 64. of Congestive Chills.

Book mark: U. S. P. 73. 09.

(361) _____ Lewis
Copyist.

Huggins, Burges

Lt., Co. *E*, **3** **U.S.C. Cav.**
Reg't

4 Enclosures.

Bed Cards	Descriptive Lists
Burial Records	Final Statements <i>4</i>
Certs. of Dis. for Discharge	Furloughs
C. M. Charges	Med. Des. Lists
Med. Certificates	Orders

Other papers relating to—

Admission to Hosp'l	Furlough
Casualty Sheet (Officer's)	Med. Examination
Confinement	Misc. Information
Contracts	Pay or Clothing
Death or Effects	Personal Reports
Desertions	Rank
Discharge from Hosp'l	Transfer to Hosp'l
Discharge from Service	Transfer to V. R. C.
Duty	Transportation

FINAL STATEMENT

OF

Burys Huggins

1st Reg't of New York

VOLUNTEERS.

NOTE 1.—Two of these certificates (or duplicates) are to be given to each volunteer soldier who may be discharged previously to the discharge of his company, that he may at once receive from the Paymaster the pay, &c., due him, and the captain or other officer commanding the company will certify to the act of the delivery of the duplicate certificates; on these certificates the Soldier is "entitled to" his discharge, and should also present his discharge to the Paymaster to have the payment endorsed on it. The discharge is to be given back to the Soldier by the Paymaster; the latter only retaining as his voucher the duplicate certificates.

NOTE 2.—If the Soldier is entitled to pay for the use of his horse, the Company Commander will certify to that fact, and also to the time he has pay due for having been so mounted on his own horse.

NOTE 3.—Amounts due the Sutler and Laundress must be entered on the Muster Roll on which the death, desertion, &c., is reported, as well as on the final statement, otherwise the amount cannot be collected from the United States.

NOTE 4.—This blank will be used for deceased volunteers as well as others.



1864

Vertical handwritten notes in the right margin, including "1864" and "Adjutant General's Office".

I certify, on honor, that Burgis Huggins a Serjt of
Captain F. A. Cooks Company (E) of the 1st Regiment of Cavalry
VOLUNTEERS, of the State of Miss., born in _____, State
of Miss., aged 28 years; 5 feet 8 inches high; Black complexion,
Black eyes, Black hair, and by occupation a Farmer, having joined the company on
its original organization at Skipwiths City, and enrolled in it at the muster into
the service of the United States at Skipwiths City, on the 9th day
of December 1863, (or was mustered in service as a recruit, by _____
at _____, on the _____ day of _____,
186 , to serve in the Regiment,) for the term of Three Years
and having served HONESTLY and FAITHFULLY with his Company in the field
to the present date, is now entitled to a **DISCHARGE** by reason of Death

The said Burgis Huggins has pay due from _____ was last paid by Paymaster
enrollment to include the _____ day of _____, 186 , and has
pay due him from that time to the present date; he is entitled to pay and subsistence for
TRAVELING to place of enrollment and whatever other allowances are authorized to volunteer
soldiers, or militia, so discharged. He has received Twenty Seven ⁰⁸/₁₀₀ dollars,
advanced by the United States on account of **CLOTHING**.

There is to be stopped from him, on account of the State of _____, or other
authorities for **CLOTHING**, &c., received on entering service, _____ ⁰⁰/₁₀₀ dollars; also,
for expenses of SUBSISTENCE for TRAVELING from place of enrollment to the place of rendezvous,
amounting to _____ ⁰⁰/₁₀₀ dollars: and on account of the United States for **EXTRA**
CLOTHING received in kind from _____ and for other
stoppages, viz: The said Burgis Huggins died without

effects amounting to _____ ⁰⁰/₁₀₀ dollars;
and he has been SUBSISTED for TRAVELING to his place of enrollment, up to the _____
_____, 186 .

He is indebted to _____, **SUTLER**, _____ ⁰⁰/₁₀₀ dollars.

He is indebted to _____, **LAUNDRESS**, _____ ⁰⁰/₁₀₀ dollars.

Given in Duplicate, at Hains Bluff this 5 day of Feb, 1864.

Francis A. Cook
Capt Co 1st Min Co A
Commanding Company.

FINAL STATEMENT

OF

Burgess Huggins
Reg't of *Miss Car*
VOLUNTEERS. *Ad.*

NOTE 1.—Two of these certificates (or duplicates) are to be given to each Volunteer Soldier or drafted man who may be discharged previously to the discharge of his company, that he may at once receive from the Paymaster the pay, &c., due him, and the captain or other COMMISSIONED officer commanding the company will certify to the act of the delivery of the duplicate certificates; on these certificates the Soldier is "entitled to" his discharge, and should also present his discharge to the Paymaster to have the payment endorsed on it. The discharge is to be given back to the Soldier by the Paymaster; the latter only retaining as his voucher the duplicate certificates.

NOTE 2.—If the Soldier is entitled to pay for the use of his horse, the Company Commander will certify to that fact on the back of both these final statements, and also to the time he has pay due for having been so mounted on his own horse.

NOTE 3.—When a Soldier is furnished with final statements, his descriptive list, if he has one, should be taken up by the officer who gives the Soldier these statements, and endorsed with a statement to this effect by the officer. This endorsement should exhibit a full statement of the time for which the Soldier was allowed pay on his final statements, the clothing account, and all other charges against him or in his favor, so as to comprise a complete exhibit of his account. It will then be transmitted to the company commander of the Soldier, who will enter all the data necessary to a full understanding of the Soldier's account on the muster roll upon which the Soldier's discharge is reported. The descriptive list will then be destroyed. The object of this is, that the remaining portion of the Soldier's account may be settled upon the receipt of these muster rolls, and the Soldier receive any pay or allowances that may be due him at the time of his discharge, and which may not appear on his final statements from the fact that his descriptive list is incomplete. These accounts for back pay, &c., are settled by the 2d Auditor of the Treasury Department.

NOTE 4.—Charges for loss or injury to ordnance, horse equipments, and other miscellaneous charges, should appear under the heading of "Other Stoppages."

NOTE 5.—Bounty paid by State authorities, and not by the United States, will not be entered on this statement.

NOTE 6.—Amounts due the Sutler and Laundress must be entered on the muster roll on which the discharge, death, desertion, &c., is reported as well as on the final statement, otherwise the amount cannot be collected from the United States.

NOTE 7.—This blank will be used for deceased volunteers and drafted men, as well as for others.

NOTE 8.—Where a Soldier dies in Hospital or on detached service, his descriptive list, if he has one, should be sent with his final statements, duplicate, to the Adjutant General, Washington, D. C.

1864



I certify, on honor, that Burgess Higgins a Sergeant of
 Captain H. A. Coates Company (E) of the 1st Regiment of Cavalry
VOLUNTEERS, of the State of Miss, born in _____, State
 of Miss, aged 28 years; _____ feet _____ inches high, Blue complexion,
Black eyes, Black hair, and by occupation a Farmer, having joined the company on
 its original organization at Stippswiths Ldg, and enrolled in it at the muster into
 the service of the United States at Stippswiths Ldg, on the 9th day
 of Dec, 1863, (or was mustered in service as a recruit, by _____
 _____, at _____, on the _____ day of _____,
 186 , or was drafted and mustered into the service of the United States from the _____
 Enrollment District of the State of _____, at _____,
 on the _____ day of _____, 186 .) to serve in the Regiment, for
 the term of Three Years; and having served **HONESTLY** and
FAITHFULLY with his Company in the Field to the present date, is now
 entitled to a **DISCHARGE** by reason of Death Burgess Higgins
died without effects being buried in his uniform

The said Burgess Higgins was last paid by Paymaster _____
 _____ to include the _____ day of _____, 186 , and has
~~pay due him from that time~~ to the present date; he is entitled to pay and subsistence for
TRAVELING to place of enrollment, and whatever other allowances are authorized to volunteer
 soldiers, drafted men, or militia, so discharged. He has received from the United States **CLOTHING**
 amounting to Twenty Seven ²⁸/₁₀₀ dollars, since the _____ day of enrollment,
 186 , when his clothing account was last settled. He has received from the United States
 _____ ¹⁰⁰/₁₀₀ dollars advanced **BOUNTY**.

There is to be stopped from him, on account of the State of _____, or other
 authorities, for **CLOTHING, &c.**, received on entering service, _____ ¹⁰⁰/₁₀₀ dollars; and
 for other stoppages, viz: _____

_____ ¹⁰⁰/₁₀₀ dollars.
 He has been furnished with **TRANSPORTATION** in kind from the place of his discharge to
 _____; and he has been **SUBSISTED** for **TRAVELING** to his
 place of enrollment, up to the _____, 186 .

He is indebted to _____, **SUTLER**, _____ ¹⁰⁰/₁₀₀ dollars.

He is indebted to _____, **LAUNDRESS**, _____ ¹⁰⁰/₁₀₀ dollars.

Given in Duplicate, at Winn's Bluff Miss., this 5th day
 of Feb, 1864.

Francis A. Coates
Capt 1st Miss Cav. U.S.
 Commanding Company.

Extract from Act of Congress.

SEC. 12. *And be it further enacted,* That the fees of agents and attorneys for making out and causing to be executed the papers necessary to establish a claim for a pension, bounty, and other allowance before the Pension Office, under this act, shall not exceed the following rates: For making out and causing to be duly executed a declaration by the applicant, with the necessary affidavits, and forwarding the same to the Pension Office, with the requisite correspondence, ten dollars; which sum shall be received by such agent or attorney in full for all services in obtaining such pension, and shall not be demanded or received, in whole or in part, until such pension shall be obtained; and the sixth and seventh sections of an act entitled "An act to grant pensions," approved July [fourteenth,] eighteen hundred and sixty-two, are hereby repealed.

SEC. 13. *And be it further enacted,* That any agent or attorney who shall, directly or indirectly, demand or receive any greater compensation for his services under this act than is prescribed in the preceding section of this act, or who shall contract or agree to prosecute any claim for a pension, bounty, or other allowance under this act, on the condition that he shall receive a per centum upon any portion of the amount of such claim, or who shall wrongfully withhold from a pensioner or other claimant the whole or any part of the pension or claim allowed and due to such pensioner or claimant, shall be deemed guilty of a high misdemeanor, and, upon conviction thereof, shall, for every such offense, be fined not exceeding three hundred dollars, or imprisoned at hard labor not exceeding two years, or both, according to the circumstances and aggravations of the offense.

Approved July 4, 1834.

NOTE 10.—If any soldier is charged a higher fee than that allowed by the above act, he should report the fact and the name of the agent to the Adjutant General, in order that steps may be taken to have the same refunded.

FINAL STATEMENT

or
Burges Higgins
3^d Reg't of U.S. Col'd Cav

VOLUNTEERS.

NOTE 1.—Two of these certificates (or duplicates) are to be given to each Volunteer Soldier or drafted man who may be discharged without being mustered out. (Final Statements are never given to men mustered out of service) that he may at once receive from the Paymaster the pay, &c. due him, and the captain or other COMMISSIONED officer commanding the company will certify to the act of the delivery of the duplicate certificates; with these certificates the Soldier is "entitled to" his discharge, and should also present his discharge to the Paymaster to have the payment endorsed on it. The discharge is to be given back to the Soldier by the Paymaster; the latter only retaining as his vouchers the duplicate certificates.

NOTE 2.—If the Soldier is entitled to pay for the use of his horse, the Company Commander will certify to that fact on the back of both these final statements, and also to the time he has pay due for having been so mounted on his own horse.

NOTE 3.—When a Soldier is furnished with final statements, his descriptive list, if he has one, should be taken up by the officer who gives the Soldier these statements, and endorsed with a statement to this effect by the officer. The endorsement should exhibit a full statement of the time for which the Soldier was allowed pay on his final statements, the clothing account, and all other charges against him or in his favor, so as to comprise a complete exhibit of his account. It will then be transmitted to the Company Commander of the Soldier, who will enter all the data necessary to a full understanding of the Soldier's account on the muster roll upon which the Soldier's discharge is reported. The descriptive list will then be destroyed. The object of this is, that the remaining portion of the Soldier's account may be settled upon the receipt of these muster rolls, and the Soldier receive any pay or allowances that may be due him at the time of his discharge, and which may not appear on his last final statements from the fact that his descriptive list is incomplete. These accounts for back pay, &c., are settled by the 2d Auditor of the Treasury Department.

NOTE 4.—Charges for loss or injury to ordnance, horse equipments, and other miscellaneous charges, should appear under the heading of "Other Stoppages."

NOTE 5.—Bounty paid by State authorities, and not by the United States, will not be entered on this statement.

NOTE 6.—Amounts due the Sutler and Laundress must be entered on the muster roll on which the discharge, death, desertion, &c., is reported, as well as on the final statement, otherwise the amount cannot be collected from the United States.

NOTE 7.—This blank will be used for deceased volunteers and drafted men, as well as for others.

NOTE 8.—Where a Soldier dies in Hospital or on detached service, his descriptive list, if he has one, should be sent with his final statements, in duplicate, to the Adjutant General, Washington, D. C.

NOTE 9.—If the soldier is a drafted man or substitute, the space for time, &c., of enrolled, should contain only the word *drafted* or *substitute*, as the case may be. If the Soldier is a *VETERAN*, (or *RECRUIT*), the words *as a veteran*, (or *recruit*), as the case may be, should be interlined after the words *mustered into the service of the U. S.* A statement of all the installments of *Veteran* or *Recruit* *Money* *RECEIVED* by the Soldier must be made on the back of each final statement.

I certify, on honor, that Burges Huggins, a Sergeant of
Captain F. A. Cook Company (O) of the 3rd Regiment of U.S. Col. Cav
VOLUNTEERS, of the State of _____, born in _____, State
of Mississippi, aged 28 years; 5 feet 8 inches high; Black complexion,
Black eyes, Black hair, and by occupation a Farmer, who joined for service
and was enrolled (see Note 9) on the 20th day of November, 1863, at Skipwiths Ldg
by Capt Cook, for the period of 3 years, and mustered into
the service of the United States on the 20th day of November, 1863, at
Skipwiths Ldg, by Lt K Knox; and having served
HONESTLY and FAITHFULLY with his Company to the present date, is now entitled to a
DISCHARGE by reason of Death of Congestive Chills
on the 5th day of February 1864

The said Burges Huggins was last paid by Paymaster
Pay due from Enrollment, to include the _____ day of _____, 186____, and
has pay due him from that time to the present date; he is entitled to pay and subsistence for
TRAVELING to place of enrollment, and whatever other allowances are authorized to volunteer
soldiers, drafted men, or militia, so discharged. He has received from the United States **CLOTHING**
amounting to \$27.⁰⁸/₁₀₀ dollars, since the 20th day of November,
1863, when his clothing account was last settled. He has received from the United States
_____ ^{_____}/₁₀₀ dollars advanced **BOUNTY**.

There is to be stopped from him, on account of the State of _____, or other
authorities, for **CLOTHING, &c.**, received on entering service, _____ ^{_____}/₁₀₀ dollars; and
for other stoppages, viz: _____
_____ ^{_____}/₁₀₀ dollars.
He has been furnished with **TRANSPORTATION** in kind from the place of his discharge to
_____; and he has been **SUBSISTED** for **TRAVELING** to his
place of enrollment, up to the _____, 186____.

He is indebted to _____, **SUTLER**, _____ ^{_____}/₁₀₀ dollars.
He is indebted to _____, **LAUNDRESS**, _____ ^{_____}/₁₀₀ dollars.

Given in Duplicate, at Memphis Tennessee, this 19th day
of July, 1865.

Howard Cook
1st Lieut
Commanding Company.

FINAL STATEMENT

OF

Burges Huggins
3^d Reg't of W. S. Col's Cav

VOLUNTEERS.

Wm. J. ...

NOTE 1.—Two of these certificates (or duplicates) are to be given to each Volunteer Soldier or drafted man who may be discharged previously to the discharge of his company, that he may at once receive from the Paymaster the pay, &c., due him, and the captain or other commissioned officer commanding the company will certify to the net of the delivery of the duplicate certificates; on these certificates the Soldier is "entitled to" his discharge, and should also present his discharge to the Paymaster to have the payment endorsed on it. The discharge is to be given back to the Soldier by the Paymaster; the latter only retaining as his voucher the duplicate certificates.

NOTE 2.—If the Soldier is entitled to pay for the use of his horse, the Company Commander will certify to that fact on the back of both these final statements, and also to the time he has pay due for having been so mounted on his own horse.

NOTE 3.—When a Soldier is furnished with final statements, his descriptive list, if he has one, should be taken up by the officer who gives the Soldier these statements, and endorsed with a statement to that effect by the officer. This endorsement should exhibit a full statement of the time for which the Soldier was allowed pay on his final statements, the clothing account, and all other charges against him or in his favor, so as to comprise a complete exhibit of his account. It will then be transmitted to the company commander of the Soldier, who will enter all the data necessary to a full understanding of the Soldier's account on the muster roll upon which the Soldier's discharge is reported. The descriptive list will then be destroyed. The object of this is, that the remaining portion of the Soldier's account may be settled upon the receipt of these musters, and the Soldier receive any pay or allowances that may be due him at the time of his discharge, and which may not appear on his final statements from the fact that his descriptive list is incomplete. These accounts for back pay, &c., are settled by the 2d Auditor of the Treasury Department.

NOTE 4.—Charges for loss or injury to ordnance, horse equipments, and other miscellaneous charges, should appear under the heading of "Other Stoppages."

NOTE 5.—Bounty paid by State authorities, and not by the United States, will not be entered on this statement.

NOTE 6.—Amounts due the Sutler and Laundry must be entered on the muster roll on which the discharge, death, desertion, &c., is reported, as well as on the final statement, otherwise the amount cannot be collected from the United States.

NOTE 7.—This blank will be used for deceased volunteers and drafted men, as well as for others.

NOTE 8.—Where a Soldier dies in Hospital or on detached service, his descriptive list, if he has one, should be sent with his final statements, in duplicate, to the Second Auditor, Washington, D. C.

ADJUTANT GENERAL'S OFFICE
July 28, 1860.
Duplicate with Inventory sent 2d Auditor.

NARRATIVE

I certify, on honor, that Burges Huggins a Sergeant of
Captain F. A. Cook's Company (E) of the 3^d Regiment of U.S. Col. Cav
VOLUNTEERS, of the State of _____, born in _____, State
of Mississippi, aged 28 years; 5 feet 8 inches high; Black complexion,
Black eyes, Black hair, and by occupation a Farmer, having joined the company on
its original organization at Shipwiths Ldg Miss, and enrolled in it at the muster into
the service of the United States at Shipwiths Ldg Miss, on the 20th day
of November, 1863, (or was mustered in service as a recruit, by _____
_____, at _____, on the _____ day of _____,
186—, or was drafted and mustered into the service of the United States from the _____
Enrollment District of the State of _____, at _____,
on the _____ day of _____, 186—), to serve in the Regiment, for
the term of Three Years: and having served **HONESTLY** and
FAITHFULLY with his Company in The field to the present date, is now
entitled to a **DISCHARGE** by reason of Death of Congestive Chills
on the 5th day of February 1864

The said Burges Huggins was last paid by Paymaster
Pay due from Enlistment to include the _____ day of _____, 186—, and has
pay due him from that time to the present date; he is entitled to pay and subsistence for
TRAVELING to place of enrollment, and whatever other allowances are authorized to volunteer
soldiers, drafted men, or militia, so discharged. He has received from the United States **CLOTHING**
amounting to \$27. 08 dollars, since the 20th day of November,
1863, when his clothing account was last settled. He has received from the United States
_____ dollars advanced **BOUNTY**.

There is to be stopped from him, on account of the State of _____, or other
authorities, for **CLOTHING**, &c., received on entering service, _____ dollars; and
for other stoppages, viz: _____

_____ dollars.
He has been furnished with **TRANSPORTATION** in kind from the place of his discharge to
_____ ; and he has been **SUBSISTED** for **TRAVELING** to his
place of enrollment, up to the _____, 186—.

He is indebted to _____, **SUTLER**, _____ dollars.

He is indebted to _____, **LAUNDRESS**, _____ dollars.

Given in Duplicate, at Memphis Tennessee, this 19th day
of July, 1865.

Howard Cook
1st Lieut

Commanding Company.

705

Huggins, John
Co E, 3 U. S. Col'd Cav.

Private | Corporal

CARD NUMBERS.

1	5337629	26
2	5337643	27
3	5337728	28
4	5337808	29
5	5337887	30
6	5337953	31
7	5338017	32
8	5338082	33
9	5338259	34
10	5338758	35
11	9088782	36
12	40727574	37
13	30877182	38
14	30877319	39
15	30877433	40
16		41
17		42
18		43
19		44
20		45
21		46
22		47
23		48
24		49
25		50

Book Mark: C. B. U. S. P 257

See also

51945183 2010

W Shannon
Em

A | **3 Cav.** | **U.S.C.T.**

John Higgins
....., Co. *E*, 3 Reg't U. S. Col'd Cav.

Appears on

Company Descriptive Book
of the organization named above.

DESCRIPTION.

Age *22* years; height *5* feet *8* inches.

Complexion *Black*.

Eyes *Black*; hair *Black*.

Where born *Mississippi*

Occupation *Farmer*.

ENLISTMENT.

When *Nov. 20*, 1863.

Where *Skippwith Rdg.*

By whom *Capt Cook*; term *3* y'rs.

Remarks: *Discharged by Order
Maj Genl Dana, Jan 28 1864*

E. Weston

76 | 3 Cav. | U.S.C.T.

John Neugebauer
Cor. E, 1 Reg't La. Cav., Corps d'Afrique.*

Age 22
Appears on

Company Muster-in Roll

of the organization named above. Roll dated

Shepwith Reg't Dec 9, 1863.

Muster-in to date Nov 25, 1863.

Joined for duty and enrolled:

When Nov 25, 1863

Where Shepwith Reg't
3

Period 3 years.

Valuation of horse, \$ 100

Valuation of horse equipments, \$ 100

Remarks:

*This organization subsequently became Co. E, 3 Reg't U.S. Colored Cavalry.

Book mark:

Pratt

26 | 3 Cav. | U.S.C.T.

John Huggins
Cpl, Co. E, 1 Reg't Miss. Cav., Corps d'Afrique.*

Appears on

Company Muster Roll

for dated Dec 31, 1863

Present or absent Present

Stoppage, \$ 100 for

Due Gov't, \$ 100 for

Valuation of horse, \$ 100

Valuation of horse equipments, \$ 100

Remarks:

M/in Dec 9/63 at
Shipwiths Landing

*This organization subsequently became Co. E, 3 Reg't U. S. Colored Cavalry.

Book mark:

Biddle

76 | 3 Cav. | U.S.C.T.

John Huggins
Cpl., Co. 2, 1 Reg't Miss. Cav., Corps d'Afrique.*

Appears on

Company Muster Roll

for *Jan'y & Feb'y*, 186*4*

Present or absent *Present*

Stoppage, \$ 100 for

Due Gov't, \$ 100 for

Valuation of horse, \$ 100

Valuation of horse equipments, \$ 100

Remarks:

*This organization subsequently became Co. *2*, 3 Reg't U. S. Colored Cavalry.

Book mark:

B. M. M.

(358)

Copyist.

No | 3 Cav. | U.S.C.T.

John Huggins
Cpl, Co. E, 3 Reg't U.S. Col'd Cavalry.

Appears on

Company Muster Roll

for *Must Ape*, 1864.

Present or absent *Present*

Stoppage, \$ 100 for

Due Gov't, \$ 100 for

Valuation of horse, \$ 100

Valuation of horse equipments, \$ 100

Remarks:

Book mark:

B. W. W.

H | **3 Cav.** | **U.S.C.T.**

John Huggins

Opl, Co. E, 3 Reg't U. S. Col'd Cavalry.

Appears on

Company Muster Roll

for *May June*, 186*X*.

Present or absent *Present*

Stoppage, \$.....*100* for

Due Gov't, \$.....*100* for

Valuation of horse, \$.....*100*

Valuation of horse equipments, \$.....*100*

Remarks:

Book mark:

Prader

(358)

Copyist.

26 | 3 Cav. | U.S.C.T.

John Huggins
Cpl

, Co. E, 3 Reg't U.S. Col'd Cavalry.

Appears on

Company Muster Roll

for July 1864, 1864

Present or absent Absent

Stoppage, \$ 100 for

Due Gov't, \$ 100 for

Valuation of horse, \$ 100

Valuation of horse equipments, \$ 100

Remarks Sick in Hosp at Vicksburg Miss

Book mark:

Bull

10001024

L. C. 3 Cav. U.S.A.

John Suggs
Corp, Co. E, 3 Reg't U.S.Cav.

Appears on

Hospital Muster Roll

of No. 3 U. S. A. General Hospital,

at Vicksburg, Miss.,

for *July & Aug*, 186*4*.

Attached to hospital:

When *July 30*, 186*4*.

How employed *Sick*.

Last paid by Maj. *Martin*.

to *Apr 30*, 186*4*.

Bounty paid \$ *100*; due \$ *100*

Present or absent *Present*

Remarks:

Book mark:

W. Harbott

11. | **3 Cav. | U.S.C.T.**

Robert Cunningham
100
100
Co. E, 3 Reg't U.S. Col'd Cavalry.

Appears on

Company Muster Roll

for *Feb. 1 1861*, 1861

Present or absent *absent*

Stoppage, \$ *100* for

Due Gov't, \$ *100* for

Valuation of horse, \$ *100*

Valuation of horse equipments, \$ *100*

Remarks: *Lost in Wash.*
House, N. Burg. Miss.

Book mark:

R. A. [Signature]
Copyist.

He | 3 Cav. | U.S.A.

Jo Lm Huggins
Corp, Co. E, 3 Regt U.S. C. Cav.

Appears on

Hospital Muster Roll

of **No. 3 U. S. A. General Hospital,**

at **Vicksburg, Miss.,**

for Sept - Oct, 1864.

Attached to hospital:

When July 30, 1864.

How employed Sick

Last paid by Maj. Martin
to April 30, 1864.

Bounty paid \$ 100; due \$ 100

Present or absent Present

Remarks:

Book mark:

(343)

B A Johnson

Copyist.

A.P. | **3 Cav. | U.S.C.T.**

John Huggins
Co. E, 3 Reg't U. S. Col'd Cavalry.

Appears on

Company Muster Roll

for March & Decr., 1864.

Present or absent Absent

Stoppage, \$ 70 for Indemnity

& 100 for h. h. & Q. B.

Due Gov't, \$ 100 for

Valuation of horse, \$ 100

Valuation of horse equipments, \$ 100

Remarks: (Absent from R.)

Due Gov't, Decr. for h. h. & Q. B. from
last muster \$100 due for Indemnity
from last muster 70

Book mark:

[Handwritten Signature]

(358)

Copyist.

76 | 9 Car U.S.C.G.

John Huggins
Cop, Co. E, 2 Reg't U.S.C. Car

Appears on

Hospital Muster Roll

of **No. 3 U. S. A. General Hospital,**

at **Vicksburg, Miss.,**

for Nov & Dec, 1864.

Attached to hospital:

When July 30, 1864.

How employed Sick

Last paid by Maj. Dickey
to Oct 31, 1864.

Bounty paid \$ 100; due \$ 100

Present or absent Present

Remarks:

* 3^d U.S.C. in pencil on roll

Book mark:

B. A. Johnson
(343) Copyist.

M. | **3 Cav.** | **U.S.C.T.**

John Wiggins
Prvt., Co. E, 3 Reg't U.S. Col'd Cavalry.

Appears on

Company Muster Roll
for *Jan. & Feb.*, 186*4*.

Present or absent.....

Stoppage, \$.....100 for.....

Due Gov't, \$.....100 for.....

Valuation of horse, \$.....100

Valuation of horse equipments, \$.....100

Remarks: *Wid. returned
at Westburg, Va. Feb
25, 1865 by order of
Genl. & General.*

* Immediately over Feb is written
in red ink "C. G. O. J. J. J."

Book mark: *Genl. O. B. V 8 P 215-2*

(358)

[Signature]
Copyist.

Ho. | 3 Cav. | U.S.C.T.

John Huggins

Corpl, Co. E, 3 Reg't U. S. Colored Cav.
Sergt.

Appears on Returns as follows:

Feb. 1864. (1 Miss, Cav. A, 20.)

Wounded in action at

Yazoo City Feb. 28/64.

Mar. & Apr. 1864, Absent sick
in Hosp, at Sniders Bluff,
Miss.

* July 1864. July 30 Goodrich's
Ldg, gone to Gen. Hosp.
Vicksburg, Miss. (Sgt)

July 1864. Absent sick in Hosp.
from July 30/64.

Aug. 1864. Absent sick in Hosp.
at Vicksburg.

Sept. & Oct. 1864 (Corpl) Absent sick
in Gen. Hosp, at Vicksburg,
Miss.

Nov. 1864. Absent sick in Gen. Hosp.

Jan. 1865. Absent sick in Gen.
Hosp. Vicksburg, Miss.

Feb. 1865. Lost Feb. 28/65, Vicksburg,
Miss. Disch'd by reason

Book mark :

(over)

J. B. Sittler

(546)

Copyist.

JAN. 18

40727574

1899.

of Disability.

* *Cancelled.*

| **3 Cav.** | **U.S.C.T.**

John Huggins

Corp., Co. E, 3 Reg't U. S. Col'd Cavalry.

Appears on **Co. Muster-out Roll**, dated Memphis Tenn Jan 26, 1866 .

Muster-out to date _____, 186 .

Last paid to Oct. 31, 1864 .

Clothing account:

Last settled _____, 186 ; drawn since \$ _____ 100

Due soldier \$ _____ 100 ; due U. S. \$ _____ 100

Am't for cloth'g in kind or money adv'd \$ _____ 100

Due U. S. for arms, equipments, &c., \$ _____ 100

Bounty paid \$ _____ 100 ; due \$ _____ 100

Remarks: Discharged at Vicksburg
Miss. Feb. 28. 65.

Book mark: 234-564-
V. 96. P. 72. 69. See E.B. V. 8. P. 257.

(361)

Lewis
Copyist.

Huggins, John
Cpl, Co. E, 3 Reg't U.S.C. Cav.

7 Enclosures.

Bed Cards	Descriptive Lists
Burial Records	Final Statements
Certs. of Dis. for Discharge	Furloughs
C. M. Charges	Med. Des. Lists
Med. Certificates	Orders

Other papers relating to—

Admission to Hosp'l	Furlough
Casualty Sheet (Officer's) /	Med. Examination
Confinement	Misc. Information
Contracts	Pay or Clothing
Death or Effects	Personal Reports
Desertions	Rank
Discharge from Hosp'l	Transfer to Hosp'l
Discharge from Service	Transfer to V. R. C.
Duty	Transportation

8

CASUALTY SHEET
OF WOUNDED.

John Higgins
Corporal Company 'E'
1st Regiment of Miss Cav. Ar.

Volunteers at the battle of near
Yazoo City Miss.
July 28th / 64
(3rd U. S. C. C.)

CASUALTY SHEET.

Name, John Higgins
 Rank, Corporal, Company "E", Regiment, 1st
 Arm, Miss Cav. A.D., State, T
 Place of casualty, New York City Miss
 Nature of casualty, wounded severely
 Date of casualty, February 28th 1864.

FROM WHAT SOURCE THIS INFORMATION WAS OBTAINED.

Report of Killed, Wounded, and Missing of the _____ Regiment,
 _____ Brigade, _____ Division, _____ Corps, dated _____
Detached, from report signed by Jas H
Coats, local 11th Ill vols.

Inds 500004.
Wth Broderick
 Clerk.

NOTE 1.

The company commander will here add a statement of all the facts known to him concerning the disease or wound, or cause of disability of the soldier; the time, place, manner, and all the circumstances under which the injury occurred, or disease originated or appeared; the duty, or service, or situation of the soldier at the time the injury was received or disease contracted, stating particularly whether the injury was received or the disease contracted in the line of his duty; and whatever other facts may aid a judgment as to the cause, immediate or remote, of the disability, and the circumstances attending it.

When the facts are not known to the company commander, the certificate of any officer, or affidavit of other person having such knowledge, will be appended—as the surgeon in charge of a hospital, the officer commanding a detachment of recruits, &c., &c.

NOTE 2.

When a probable case for pension, special care must be taken to state the degree of disability—as $\frac{1}{2}$, $\frac{3}{4}$, &c., &c.; to describe particularly the disability, wound, or disease; the extent to which it deprives him of the use of any limb or faculty, or affects his health, strength, activity, constitution, or capacity to labor or earn his subsistence. The surgeon will add, from his knowledge of the facts and circumstances, and from the evidence in the case, his professional opinion of the cause or origin of the disability. In the case of discharges by Medical Inspectors, the last paragraph will state that the "discharge was given by consent of the soldier, after a personal examination, and for disability, the nature, degree, and origin of which are correctly described in the within certificate."

Par. 1260 Regulations, Edit. 1861.

Medical officers, in giving certificates of disability, are to take particular care in all cases that have not been under their charge; and especially in epilepsy, convulsions, chronic rheumatism, derangement of the urinary organs, ophthalmia, ulcers, or any obscure disease liable to be feigned or purposely produced; and in no case shall such certificate be given until after sufficient time and examination to detect any attempt at deception.

DIRECTIONS.

This certificate will be made out in duplicate by the soldier's company commander, or other officer commanding the separate detachment to which he belongs and sent by him to the surgeon who has charge of the hospital where the soldier is sick. The surgeon will then fill out and sign the surgeon's certificate, and forward these papers to the regimental, detachment, or post commander, who will forward them, with his action endorsed thereon, through the proper channel, to his division commander; or, if the troops are not attached to a division, to his corps, department, or other commander or officer to whom the authority to discharge enlisted men may be specially delegated.

These certificates, after having received the action of the highest authority to which they are required to be sent, will be returned through the same channel to the regimental, post, or detachment commander, who will, if the discharge is authorized by the endorsement of the proper authority, sign the soldier's discharge, and the last certificate on this paper; see that the soldier is furnished with the proper final statements in duplicate, and forward ~~them~~ of these certificates direct to the Adjutant General United States Army, at ~~the Adjutant General's Office~~.

ADJUTANT GENERAL'S OFFICE

McK 21st 1865.

Duplicate with Inventory sent 2d Auditor.

CERTIFICATE OF DISABILITY FOR DISCHARGE

IN THE CASE OF

John Huggins
a. *Private* Co. *C*
3^d Reg't of *US Caval*

Head-Quarters Department of Mississippi.

Memphis, Tenn., *Jan 23rd* 1865.

To be Discharged.

By order of Major General N. J. T. DANA,

J. M. Miller
Asst. Adj. Genl.

Received (A. G. Office) _____, 186 .

Enon R. K. [Signature]

Head Quarters Dept. of Miss.
Medical Director's Office
Memphis Tenn. Jan. 22nd 1865.

Approved:
George S. Kautle
Surgeon U. S. A.
Medical Director.

Adjutant General's Office
Washington D. C. Decr 6/69
E. B. vol. 8. Page 257.

The Muster and Muster-out Rolls of Co "E" 2^d U. S. Cavalry report the Discharge of Corporal *John Huggins* January 28th 1865.

The Surgeon's Certificate of Disability on which the discharge was based reports date of discharge January 28, 1865.

The latter date (January twenty eighth 1865) is held to be correct and the Company Rolls will be amended accordingly.

J. P. [Signature]
Brig Colonel U. S. A.

In Charge Bureau Col^d Troops

John [Signature]
In Charge of
Jan. 11. 69 to [Signature]

ARMY OF THE UNITED STATES

CERTIFICATE

OF DISABILITY FOR DISCHARGE.

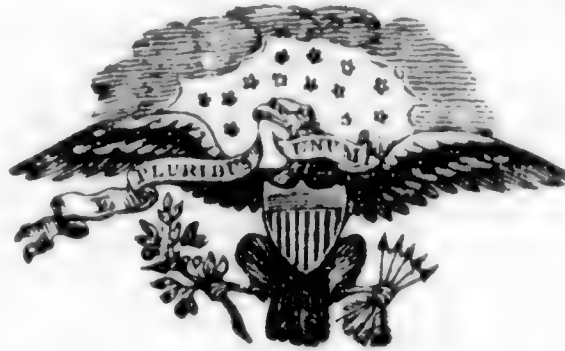

Capt John Huggins of Captain Frank A
Book Company, (E) of the 3d Regiment of United States
Col Cardy was enlisted by Captain Book of
the 3d Regiment of Infantry at Richmond Miss
on the 9th day of December 1863, to serve 3 years; he was born
in _____ in the State of Mississippi is Twenty two
years of age, 5 feet 8 inches high, Black complexion, Black eyes,
Black hair, and by occupation when enlisted a Farmer During the last two
months said soldier has been unfit for duty 60 days.*

Said Capt John Huggins being absent
from his Reg't in U.S. General Hospital No. 3
at Vicksburg Miss his Company Commander
has not been obtained

STATION: Vicksburg Miss
DATE: Jan 16th 1865

W. S. Field U.S. Surg
47th U.S. Inf in charge
U.S. General Hospital No. 3
Commanding Company

I CERTIFY, that I have carefully examined the said Corporal John Huggins of
Captain F. A. Book's Company, and find him incapable of performing the duties of a soldier
because of gun shot wounds, received in action at Vicksburg, Miss, 28th Dec 1864. The ball
entering just below right eye, and passing entirely through the head, lodging beneath
the skin, covering the mastoid process of the left temporal bone, from which place
it was cut out by Regt. Surgeon. This injury impairs his mental faculties and
interferes with acts of deglutition and mastication, and renders him entirely unfit for
service in the U.S.A. or Veterans Reserve Corps. Injury was while in the line of duty
Grade of Disability (2/3) Two thirds

W. S. Field
U.S. Surg
47th U.S. Inf in charge U.S. General Hospital No. 3

DISCHARGED, this 28th day of January 1865, at U.S. General
Hospital No. 3 Vicksburg Miss

W. S. Field U.S. Surg
47th U.S. Inf in charge

The soldier desires to be addressed at _____ near
Town _____ County Nashville State Tenn

* See Note 1 on the back of this. * See Note 2 on the back of this.

R. S. Stratton

706

Houghs, Henry
Co M, 3 U. S. Col'd Cav.

Private | Private

CARD NUMBERS.

1	5346012	26
2	5346107	27
3	5346191	28
4	5346280	29
5	5346379	30
6	5346469	31
7	5346561	32
8	5346662	33
9	5346757	34
10	5346855	35
11	5346939	36
12	5347021	37
13	5347100	38
14	9089762	39
15	9089887	40
16		41
17		42
18		43
19		44
20		45
21		46
22		47
23		48
24		49
25		50

Book Mark:

See also:

S-723611. P. G. M. & M. Rtd.
L. 2204619 POKH.

A. M. Sharma
En

N | 3 Cav. | U.S.C.T.

Henry Hughes

....., Co. M, 3 Reg't U. S. Col'd Cav.

Appears on

Company Descriptive Book

of the organization named above.

DESCRIPTION.

Age 23 years; height 5 feet 5 inches.

Complexion Black

Eyes Black; hair Black

Where born Brunsey Co., Va.

Occupation Farmer

ENLISTMENT.

When Feb 24, 1864.

Where Mississippi

By whom Wm Hyland term 3 y'rs.

Remarks:

.....
.....
.....
.....
.....
.....

F. B. Smith

96 | 3 Cav. | U.S.C.T.

Henry Hughes

Co. M 3 Reg't U. S. Col'd Cav.

Appears on

Company Descriptive Book

of the organization named above.

DESCRIPTION.

Age 23 years; height 5 feet 5 inches.

Complexion Black

Eyes Black; hair Black

Where born Brunsey Co. Va.

Occupation Farmer

ENLISTMENT.

When Feb 24, 1864.

Where Mississippi

By whom Capt. Dyland term 3 y'rs.

Remarks:

H. B. Smith

(383g)

Copist.

76

3 Cav. | U.S.C.T.

Henry Hughs
Priv., Co. M, 3 Reg't U. S. Col'd Cavalry.

Appears on

Company Muster-in and Descriptive Roll

of the organization named above. Roll dated
Wains Bluff Miss, Feb 1, 1864.

Where born Brunsey Co Va

Age 23 y'rs; occupation Farmer

When enlisted Feb 24, 1864

Where enlisted Mississippi

For what period enlisted 3 years.

Eyes Black; hair Black

Complexion Black; height 5 ft. 5 in.

When mustered in _____, 186 .

Where mustered in _____

Bounty paid \$ 100; due \$ 100

Where credited _____

Company to which assigned _____

Remarks : _____

Book mark : _____

R. S. Richardson

(356d)

Copyist.

No | **3 Cav.** | **U.S.C.T.**

Henry Hough
Priv, Co. M, 3 Reg't U. S. Col'd Cavalry.

Appears on

Company Muster Roll

for *March & April*, 186 *4*

Present or absent *Present*

Stoppage, \$ *100* for

Due Gov't, \$ *100* for

Valuation of horse, \$ *100*

Valuation of horse equipments, \$ *100*

Remarks :

*(Mustered in March
1 & 4 at Hayes Bluff)*

Book mark :

A. Richardson

(358)

Copyist.

26 | 3 Cav. | U.S.C.T.

Henry Houghs
Pvt., Co. M, 3 Reg't U.S. Col'd Cavalry.

Appears on

Company Muster Roll

for May + June, 1864.

Present or absent Present

Stoppage, \$ 100 for

Due Gov't, \$ 100 for

Valuation of horse, \$ 100

Valuation of horse equipments, \$ 100

Remarks:

Book mark:

R Richardson

76 | 3 Cav. | U.S.C.T.

Henry Hughes
Priv, Co. M, 3 Reg't U. S. Col'd Cavalry.

Appears on

Company Muster Roll

for Apl 30 to Aug 31, 1864

Present or absent Present

Stoppage, \$ 100 for

Due Gov't, \$ 100 for

Valuation of horse, \$ 100

Valuation of horse equipments, \$ 100

Remarks:

Book mark:

R. S. Richardson
Copyist.

No | **3 Cav.** | **U.S.C.T.**

Henry News
Pon, Co. M, 3 Reg't U. S. Col'd Cavalry.

Appears on

Company Muster Roll

for *Sept + Oct*, 1864

Present or absent *Present*

Stoppage, \$ *100* for

Due Gov't, \$ *100* for

Valuation of horse, \$ *100*

Valuation of horse equipments, \$ *100*

Remarks:

Book mark: _____

R. M. Richardson
Copyist.

H. | 3 Cav. | U.S.C.T.

Henry Hughes
Sgt., Co. M, 3 Reg't U. S. Col'd Cavalry.

Appears on

Company Muster Roll

for Nov & Dec, 1864

Present or absent absent

Stoppage, \$ 100 for

Due Gov't, \$ 100 for

Valuation of horse, \$ 100

Valuation of horse equipments, \$ 100

Remarks: on scout

Book mark:

Sam Allen

32 | **3 Cav. | U.S.C.T.**

Henry Hughes
227, Co. M, 3 Reg't U. S. Col'd Cavalry.

Appears on

Company Muster Roll

for *Jan & Feb*, 1865.

Present or absent *present*

Stoppage, \$ *100* for

Due Gov't, \$ *100* for

Valuation of horse, \$ *100*

Valuation of horse equipments, \$ *100*

Remarks :

Book mark :

Wm Allen

H. | **3 Cav.** | **U.S.C.T.**

Henry Hughes
priv., Co. M, 3 Reg't U. S. Col'd Cavalry.

Appears on

Company Muster Roll

for *Mar & Apr*, 1865.

Present or absent *absent*

Stoppage, \$ *100* for

Due Gov't, \$ *100* for

Valuation of horse, \$ *100*

Valuation of horse equipments, \$ *100*

Remarks: *on scout*

Book mark:

Wm L Allen

31 | **3 Cav. | U. S. C. T.**

Henry A. [unclear]
107, Co. M, 3 Reg't U. S. Col'd Cavalry.

Appears on

Company Muster Roll

for May - June, 1865.

Present or absent present

Stoppage, \$ 3/28 for ordnance
lost & destroyed

Due Gov't, \$ 100 for

Valuation of horse, \$ 100

Valuation of horse equipments, \$ 100

Remarks: _____

Book mark: _____

John Allen

36. | **3 Cav. | U.S.C.T.**

Henry Hughes

priv., Col M, 3 Reg't U. S. Col'd Cavalry.

Appears on

Company Muster Roll

for *July & Aug*, 1865.

Present or absent *present*

Stoppage, \$ *31* ^{*28*}/₁₀₀ for *ordnance*

lost & destroyed

Due Gov't, \$ *100* for

Valuation of horse, \$ *100*

Valuation of horse equipments, \$ *100*

Remarks:
.....
.....
.....
.....
.....
.....
.....
.....
.....

Book mark:

Am L Allen

3 Cav. | U.S.C.T.

Henry ...
Pvt., Co. M, 3 Reg't U. S. Col'd Cavalry.

Appears on

Company Muster Roll

for *Sept. & Oct.*, 1865.

Present or absent *Present*

Stoppage, \$ 100 for

Due Gov't, \$ 100 for

Valuation of horse, \$ 100

Valuation of horse equipments, \$ 100

Remarks:

Book mark:

Lerrin

H | 3 Cav. | U.S.C.T.

Henry Hume
Pvt., Co. M, 3 Reg't U. S. Col'd Cavalry.

Appears on

Company Muster Roll

for Nov. 4th Dec., 1865.

Present or absent Present

Stoppage, \$ 100 for

Due Gov't, \$ 100 for

Valuation of horse, \$ 100

Valuation of horse equipments, \$ 100

Remarks:

Book mark:

Loring

3 Cav. U.S.C.T.

George Hughes
Pvt., Co. M, 3 Reg't U. S. Col'd Cavalry.

Appears on Co. Muster-out Roll, dated
Memphis Tenn, Jan. 26, 1866.
Muster-out to date Jan. 26, 1866.
Last paid to June 30, 1865.

Clothing account:

Last settled 186 ; drawn since \$ 100
Due soldier \$ 100; due U. S. \$ 9 46 / 100
Am't for cloth'g in kind or money adv'd \$ 100

Due U. S. for arms, equipments, &c., \$ 100
Bounty paid \$ 100; due \$ 100

Remarks: Mustered out under
S.C. 167 Mil. Div. of Tenn.

Book mark :

(361) Leering Copyist.

707

Hunt, Henry
Co A, 3 U. S. Col'd Cav.

Private | *Sergeant*

CARD NUMBERS.

1	5332117	26
2	5332205	27
3	5332294	28
4	5332340	29
5	5332421	30
6	5332496	31
7	5332575	32
8	5332655	33
9	5332732	34
10	5332840	35
11	5332941	36
12	5333038	37
13	5333131	38
14	5333217	39
15	5333300	40
16	9088229	41
17	40727563	42
18		43
19		44
20		45
21		46
22		47
23		48
24		49
25		50

Book Mark:

See also

S 1581703 Dooff -

S 2349953 And MD

S 2558647 And MD net

A. M. Shannon
Esq

A | **3 Cav. | U.S.C.T.**

Henry Hunt

....., Co. E, 3 Reg't U. S. Col'd Cav.

Appears on

Company Descriptive Book

of the organization named above.

DESCRIPTION.

Age 28 years; height 5 feet 7 inches.

Complexion Black

Eyes Black; hair Black

Where born Jackson, Miss.

Occupation Carpenter

ENLISTMENT.

When Oct. 5, 1863.

Where Jackson, Miss.

By whom Capt. W. W. Webster; term 3 y'rs.

Remarks: Scar of cut on
left thumb. Pro-
moted to 1st. Sergt
March. 1, 1864.

F. A. Wright

H | 3 Cav. | U.S.C.T.

Henry Hunt
Pat., Co. A, 1 Reg't Miss. Cav., Corps d'Afrique.*
Age 39 yrs
Appears on

Company Muster-in Roll

of the organization named above. Roll dated
Vicksburg, Miss, Oct 2, 1863.
Muster-in to date Oct 5, 1863.

Joined for duty and enrolled:

When Oct. 5th, 1863.

Where Vicksburg, Miss.

Period 3 years.

Valuation of horse, \$ 100

Valuation of horse equipments, \$ 100

Remarks:

*This organization subsequently became Co. A, 3 Reg't U. S. Colored Cavalry.

Book mark:

C. M. Clark

H | 3 Cav. | U.S.C.T.

Henry Hunt
Pat, Co. A, 1 Reg't Miss. Cav., Corps d'Afrique.*

Appears on

Company Muster Roll

for Oct 9, 1863 to Dec. 31, 1863.

Present or absent Present

Stoppage, \$ 100 for

Due Gov't, \$ 100 for

Valuation of horse, \$ 100

Valuation of horse equipments, \$ 100

Remarks:

*This organization subsequently became Co. A, 3 Reg't U. S. Colored Cavalry.

Book mark:

G. M. Clark

H | **3 Cav.** | **U.S.C.T.**

Henry Hunt

Pat, Co. *A*, 1 Reg't Miss. Cav., Corps d'Afrique.*

Appears on

Company Muster Roll

for *Jan & Feb*, 186*4*.

Present or absent *Present*.

Stoppage, \$ *0* $\frac{49}{100}$ for *Haversack*.

Due Gov't, \$ *0* $\frac{49}{100}$ for *Haversack*.

Valuation of horse, \$ *0* $\frac{49}{100}$

Valuation of horse equipments, \$ *0* $\frac{49}{100}$

Remarks:

*This organization subsequently became Co. *A*, 3 Reg't U. S. Colored Cavalry.

Book mark:

C M Clark

H | **3 Cav.** | **U.S.C.T.**

Henry Hunt
Serjt., Co. A, 3 Reg't U. S. Col'd Cavalry.

Appears on

Company Muster Roll

for March & April, 1864.

Present or absent Present.

Stoppage, \$ 100 for

Due Gov't, \$ 100 for

Valuation of horse, \$ 100

Valuation of horse equipments, \$ 100

Remarks: Promoted to
Serjt.
Stop for one hauer-
sack.

Book mark: 2

C. M. Clark

H | 3 Cav. | U.S.C.T.

Henry Hunt
Sergt., Co. A, 3 Reg't U. S. Col'd Cavalry.

Appears on

Company Muster Roll

for July & Aug, 1864.

Present or absent Present

Stoppage, \$ 100 for

Due Gov't, \$ 100 for

Valuation of horse, \$ 100

Valuation of horse equipments, \$ 100

Remarks:

Book mark:

C. M. Clark

14 | 3 Cav. | U.S.C.T.

Henry Hunt
Sergt., Co. A, 3 Reg't U. S. Col'd Cavalry.

Appears on

Company Muster Roll

for Sept. & Oct., 1864.

Present or absent Present

Stoppage, \$ 100 for

Due Gov't, \$ 100 for

Valuation of horse, \$ 100

Valuation of horse equipments, \$ 100

Remarks: Stop for one yr.
Spurs & Straps, one
Starrs Army Revolver
Cal. 44.

Book mark:

P. Poal

H | **3 Cav.** | **U.S.C.T.**

Henry Hunt
Sergt., Co. A, 3 Reg't U. S. Col'd Cavalry.

Appears on

Company Muster Roll

for Nov. + Dec., 1864.

Present or absent Present.

Stoppage, \$ 100 for

Due Gov't, \$ 100 for

Valuation of horse, \$ 100

Valuation of horse equipments, \$ 100

Remarks: Stops for 1 pair
Spurs + Straps, 1 Star
Army Revolver Cal. (44).

Book mark: _____

P. Pool,

(358)

Copyist.

H | **3 Cav.** | **U.S.C.T.**

Henry Hunt
Serjt., Co. A, 3 Reg't U. S. Col'd Cavalry.

Appears on

Company Muster Roll

for Jan. & Feb., 1865.

Present or absent Present.

Stoppage, \$ 100 for

Due Gov't, \$ 100 for

Valuation of horse, \$ 100

Valuation of horse equipments, \$ 100

Remarks: Stop for 1 Reuyt.
Revolver Cal. 44.

Book mark:

P. Pool

H | **3 Cav.** | **U.S.C.T.**

Henry Hunt
Serjt., Co. A, 3 Reg't U. S. Col'd Cavalry.

Appears on

Company Muster Roll

for Mar. + Apr., 1865.

Present or absent Absent.

Stoppage, \$ 100 for

Due Gov't, \$ 100 for

Valuation of horse, \$ 100

Valuation of horse equipments, \$ 100

Remarks: Absent on secret
since Apr. 29, '65.

Book mark: _____

(358)

P. Pool,

Copyist.

H | **3 Cav.** | **U.S.C.T.**

Henry Hunt

Sergt., Co. A, 3 Reg't U. S. Col'd Cavalry.

Appears on

Company Muster Roll

for *May & June*, 1865.

Present or absent *Present.*

Stoppage, \$ *100* for

Due Gov't, \$ *100* for

Valuation of horse, \$ *100*

Valuation of horse equipments, \$ *100*

Remarks:

Book mark:

J' Pool

1865

A | **3 Cav.** | **U.S.C.T.**

Henry Hunt,
Sergt., Co. A, 3 Reg't U. S. Col'd Cavalry.

Appears on

Company Muster Roll

for July & Aug., 1865.

Present or absent Present

Stoppage, \$ 100 for

Due Gov't, \$ 100 for

Valuation of horse, \$ 100

Valuation of horse equipments, \$ 100

Remarks:

Book mark:

P'Pool,

36 | **3 Cav.** | **U.S.C.T.**

Henry Hunt
Sgt, Co. A, 3 Reg't U. S. Col'd Cavalry.

Appears on

Company Muster Roll

for *Sept - Oct*, 186*5*.

Present or absent *Not stated*

Stoppage, \$ 100 for

Due Gov't, \$ 100 for

Valuation of horse, \$ 100

Valuation of horse equipments, \$ 100

Remarks:

Book mark:

M Jones

76 | 3 Cav. | U.S.C.T.

Henry Hunt
Sgt., Co. A, 3 Reg't U. S. Col'd Cavalry.

Appears on

Company Muster Roll

for Nov & Dec, 1865.

Present or absent Present

Stoppage, \$ 100 for

Due Gov't, \$ 100 for

Valuation of horse, \$ 100

Valuation of horse equipments, \$ 100

Remarks:

Book mark:

(358)

M. Jones
Copyist.

H. | 3 Cav. | U.S.C.T.

Henry Hunt
Sgt., Co. A, 3 Reg't U. S. Colored Cav.

Appears on Returns as follows:

Oct. 1865. Absent on furlough
for 30 days from Sept.
13/65.

Book mark :

(546)

J. B. Sittler

Copyist.

H | 3 Cav. | U.S.C.T.

Henry Hunt
Sgt., Co. A, 3 Reg't U. S. Col'd Cavalry.

Appears on Co. Muster-out Roll, dated
Memphis Tenn, Jan 26, 1866.

Muster-out to date Jan 26, 1866.

Last paid to June 30, 1865.

Clothing account:

Last settled....., 186 ; drawn since \$.....100

Due soldier \$ 10¹⁴/₁₀₀; due U. S. \$.....100

Am't for cloth'g in kind or money adv'd \$.....100

Due U. S. for arms, equipments, &c., \$.....100

Bounty paid \$ 00⁰⁰/₁₀₀; due \$ 00⁰⁰/₁₀₀

Remarks:
.....
.....
.....
.....
.....

Book mark:

(361) W. Jones Copyist.

708

Hunter, Jerry
Co I, 3 U. S. Col'd Cav.

Private | Private

CARD NUMBERS.

1	5330994	26
2	5343088	27
3	5331761	28
4	5343646	29
5	9089424	30
6	40727564	31
7		32
8		33
9		34
10		35
11		36
12		37
13		38
14		39
15		40
16		41
17		42
18		43
19		44
20		45
21		46
22		47
23		48
24		49
25		50

Book Mark:

See also

21 | *3* Co. | **U.S.C.T.**

Jerry G. Hunter
Hunter
....., Co. *D*, *3* Reg't U.S. Col'd *Can*

Appears on
Company Descriptive Book
of the organization named above.

DESCRIPTION.

Age *21* years; height *5* feet *7/8* inches.

Complexion *Blk*

Eyes *blk*; hair *blk*

Where born *Canoll, Pa. Va.*

Occupation

ENLISTMENT.

When *Jan 6*, 186*5*.

Where *W. Burg*

By whom *Maj. Main*; term *3* y'rs.

Remarks: *Enlisted Jan 26, 1865*

Corrected by register
Hillman

76. | 3 Cav. | U.S.C.T.

Jerry Hunter.
Priv. Co., 3 Reg't U. S. Col'd Cav.

Age 36 years.

Appears on a

Detachment Muster-in Roll

of the organization named above. Roll dated

Vicksburg Miss, Jan. 7, 1865.

Muster-in to date Jan. 7, 1865.

Joined for duty and enrolled:

When Jan. 6, 1865.

Where Vicksburg, Miss.

Period 3 years.

Valuation of horse, \$ 100

Valuation of horse equipments, \$ 100

Remarks:

Book mark:

(337)

Copyist.

Sitter.

A | **3 Cav.** | **U.S.C.T.**

Jerry Hunter
Pvt., Co. I, 3 Reg't U. S. Col'd Cavalry.

Appears on

Company Muster Roll

for Jan & Feb, 1865.

Present or absent.....

Stoppage, \$..... 100 for

Due Gov't, \$..... 100 for

Valuation of horse, \$..... 100

Valuation of horse equipments, \$..... 100

Remarks: Deserted at Vicksburg
this June 19/65.

Book mark:

Lucas

H | 3 Cav | **U.S.C.T.**

Gerry Hunter
Pvt., Co. D, 3 Reg't U. S. Col'd Cav

Appears on

Descriptive List of Deserters

dated Memphis Tenn Feb 1, 1865.

Deserted :

When June 1st, 1865.

Where Vicksburg

Arrested :

When _____, 186 .

Where _____

Remarks : _____

Book mark : _____

(351)

H S Miller

Copyist.

H. | 3 Cav. | U.S.C.T.

Jerry Hunter
Pvt., Co. I, 3 Reg't U. S. Colored Cav.

Appears on Returns as follows:

Jan. 1865. Gains Jan. 16/65 -
Memphis, Tenn. Enlisted
in Regt.

Book mark : _____

(546)

J. B. Sittler

Copyist.

H | **3 Cav.** | **U.S.C.T.**

Jerry Hunter
Brist, Co. D, 3 Reg't U. S. Col'd Cavalry.

Appears on **Co. Muster-out Roll**, dated
Memphis Tenn Jan 26, 1866.

Muster-out to date _____, 1866 .

Last paid to Memphis, 1866 .

Clothing account:

Last settled _____, 1866 ; drawn since \$ _____ 100

Due soldier \$ _____ 100; due U. S. \$ _____ 100

Am't for cloth'g in kind or money adv'd \$ _____ 100

Due U. S. for arms, equipments, &c., \$ _____ 100

Bounty paid \$ _____ 100; due \$ _____ 100

Remarks: Deserted at Vicksburg
Aug Miss Jan 20/65
Descriptive Roll fur-
nished

* Deserted by Comrade

Book mark : _____

(861)

Edmondson

Copyist.

709

Hunting, Alexander

Co C, 3 U. S. Col'd Cav.

Private

Private

CARD NUMBERS.

1	5334821	26
2	5334912	27
3	5335000	28
4	5335083	29
5	5335165	30
6	5335243	31
7	5335322	32
8	5335406	33
9	5335489	34
10	5335596	35
11	5335694	36
12	5335787	37
13	5335879	38
14	5335961	39
15	5336044	40
16	7088078	41
17		42
18		43
19		44
20		45
21		46
22		47
23		48
24		49
25		50

Book Mark:

See also

MARK 1382

D. 2033810 P.O. m m

A. M. Shannon
Esq

A | **3 Cav. | U.S.C.T.**

Alexander Hunting

....., Co. C, 3 Reg't U. S. Col'd Cav.

Appears on

Company Descriptive Book
of the organization named above.

DESCRIPTION.

Age 18 years; height 5 feet 3 inches.

Complexion Yellow

Eyes Black; hair Black

Where born Memphis - Tenn.

Occupation House servant.

ENLISTMENT.

When Nov. 1 -, 186 3.

Where Sickaburg -

By whom B. S. Wing; term 3 y'rs.

Remarks:

.....

.....

.....

.....

.....

.....

(383g)

F. A. Wright

Copyist.

H **3 Cav. U.S.C.T.**

Alexander Hunting
Priv, Co. *C*, 1 Reg't Miss. Cav., A. D.†

Age *18* years.

Appears on

Company Muster-in Roll

of the organization named above. Roll dated

Vicksburg, Miss, Nov 1, 1863.

Muster-in to date *Nov 1, 1863.*

Joined for duty and enrolled:

When *Nov 1*, 1863.*

Where *Vicksburg, Miss.*

Period *3* years.*

Valuation of horse, \$ 100

Valuation of horse equipments, \$ 100

Remarks:

† This organization subsequently became Co. *C*, 3 Reg't U. S. Colored Cavalry.

* * * Muster-in roll shows enrollment and muster-in of this company as of same date. See enrollment on subsequent card or cards.

Book mark:

(3566)

R. Johnson
Copyist.

H | **3 Cav. | U.S.C.T.**

Alexander Hunting
Pvt., Co. C, 1 Reg't Miss. Cav., A. D.†

Appears on

Company Muster Roll
for *Nov and Dec*, 1863

Joined for duty and enrolled:

When *Nov 1*, 1863.*

Where *Vicksburg* *

Period *3* years.*

Present or absent *Not stated*

Stoppage, \$ 100 for

Due Gov't \$ 100 for

Valuation of horse, \$ 100

Valuation of horse equipments, 100

Remarks:

† This organization subsequently became Co. C, 3 Reg't U. S. Colored Cavalry.

* See enrollment on card from muster-in roll.

Book mark:

(358d)

R Johnson
Copyist.

1871 10 30

H | **3 Cav.** | **U.S.C.T.**

Alexander H. Hunt
Put, Co. *C*, 1 Reg't Miss. Cav., Corps d'Afrique.*

Appears on

Company Muster Roll

for *Jan'y & Feby*, 186*4*.

Present or absent *Pres. Put*

Stoppage, \$.....*100* for

Due Gov't, \$.....*100* for

Valuation of horse, \$.....*100*

Valuation of horse equipments, \$.....*100*

Remarks:

*This organization subsequently became Co. *C*, 3 Reg't U. S. Colored Cavalry.

Book mark:

R. Johnson
Copyist.

70 | **3 Cav.** | **U.S.C.T.**

Alexander Huntington
Prst, Co. C, 3 Reg't U. S. Cold Cavalry.

Appears on

Company Muster Roll

for March & April, 186 4

Present or absent Present

Stoppage, \$ 100 for

Due Gov't, \$ 100 for

Valuation of horse, \$ 100

Valuation of horse equipments, \$ 100

Remarks:

Book mark: -----

(358)

R. Shuman
Copyist.

76 | **3 Cav.** | **U.S.C.T.**

Alexander Huntington
Put, Co. C, 3 Reg't U. S. Col'd Cavalry.

Appears on

Company Muster Roll

for May & June, 1864

Present or absent Present

Stoppage, \$ 100 for

Due Gov't, \$ 100 for

Valuation of horse, \$ 100

Valuation of horse equipments, \$ 100

Remarks: Stop for Cartridge
box Cap Punch &
Price \$1.27

Book mark: _____

(358)

R. J. Hurson
Copyist.

26 | 3 Cav. | U.S.C.T.

Alexander Humbert
Put, Co. C, 3 Reg't U. S. Col'd Cavalry.

Appears on

Company Muster Roll

for July & Aug., 1864.

Present or absent Present

Stoppage, \$ 100 for

Due Gov't, \$ 100 for

Valuation of horse, \$ 100

Valuation of horse equipments, \$ 100

Remarks: Due U.S. for
Ordnance from last
Muster Roll #127

Book mark:

(358)

R. Johnson
Copyist

76 | 3 Cav. | U.S.C.T.

Alexander Hunting
Priv, Co. C, 3 Reg't U. S. Col'd Cavalry.

Appears on

Company Muster Roll
for Sept & Oct, 1864
Present or absent Present

Stoppage, \$ 100 for

Due Gov't, \$ 100 for

Valuation of horse, \$ 100

Valuation of horse equipments, \$ 100

Remarks: Stop for 1. Bridle
1 pr Spurs & straps,
\$ 4.98,

Book mark:

(358)

Talbot
Copyright

17771531
H | 3 Cav. | U.S.C.T.

Alexander Hunting
Priv, Co. C, 3 Reg't U. S. Col'd Cavalry.

Appears on

Company Muster Roll

for Nov & Dec, 1864

Present or absent Absent

Stoppage, \$ 100 for

Due Gov't, \$ 100 for

Valuation of horse, \$ 100

Valuation of horse equipments, \$ 100

Remarks: On Scout, due us for
Ordnance from last
muster \$4.08. Stopped
for Spurs & Straps \$5.50.

Book mark:

(358)

Talbot
Copyist.

Ho | **3 Cav.** | **U.S.C.T.**

Alexander Hunting
Priv, Co. C, 3 Reg't U. S. Col'd Cavalry.

Appears on

Company Muster Roll

for Jan'y 7 Feby, 1865

Present or absent Present

Stoppage, \$ 100 for

Due Gov't, \$ 100 for

Valuation of horse, \$ 100

Valuation of horse equipments, \$ 100

Remarks:

Book mark:

(358)

Talbot
Copyist.

76 | 3 Cav. | U.S.C.T.

Alex Hunting
Priv, Co. C, 3 Reg't U. S. Col'd Cavalry.

Appears on

Company Muster Roll

for *March & April*, 1865.

Present or absent

Absent

Stoppage, \$ 100 for

Due Gov't, \$ 100 for

Valuation of horse, \$ 100

Valuation of horse equipments, \$ 100

Remarks:

*Overexpedition
since Apr 29, 1865.*

Book mark:

(358)

Talbott
Copyist.

HC | 3 Cav. | U.S.C.T.

Alexander Hunting
Drii, Co. C, 3 Reg't U. S. Col'd Cavalry.

Appears on

Company Muster Roll

for May & June, 1865.

Present or absent Present

Stoppage, \$ 100 for

Due Gov't, \$ 100 for

Valuation of horse, \$ 100

Valuation of horse equipments, \$ 100

Remarks: Stop for 1 Pr Spurs,
& Straps, 52,

Book mark:

Talworth

H | **3 Cav.** | **U.S.C.T.**

Alexander Hunting
Pr, Co. C, 3 Reg't U. S. Col'd Cavalry.

Appears on

Company Muster Roll

for *July & Aug*, 186*5*.

Present or absent *Present*

Stoppage, \$.....100 for

Due Gov't, \$.....100 for

Valuation of horse, \$.....100

Valuation of horse equipments, \$.....100

Remarks:

Book mark:

(358)

Talbot
Copyist.

76

3 Cav. U.S.C.T.

Alexander Fleming

Private, Co. C, 3 Reg't U. S. Col'd Cavalry.

Appears on

Company Muster Roll

for Sept 2 Oct, 1865.

Present or absent Present

Stoppage, \$ 100 for

Due Gov't, \$ 100 for

Valuation of horse, \$ 100

Valuation of horse equipments, \$ 100

Remarks:

Book mark:

H | **3 Cav.** | **U.S.C.T.**

Alexander Hunting
Priest, Co. C, 3 Reg't U. S. Col'd Cavalry.

Appears on

Company Muster Roll

for *Nov & Dec*, 1865.

Present or absent *Present*

Stoppage, \$ 100 for

Due Gov't, \$ 100 for

Valuation of horse, \$ 100

Valuation of horse equipments, \$ 100

Remarks:

Book mark:

(358)

[Signature]
Copyist.

96 | **3 Cav. | U.S.C.T.**

Alexander Hunting
Drut, Co. *C*, 3 Reg't U. S. Col'd Cavalry.

Appears on **Co. Muster-out Roll**, dated
Memphis Tenn *Jan'y 26*, 1866.
Muster-out to date *Jan'y 26* 1866.
Last paid to *June 30* 1865.

Clothing account:

Last settled....., 186 ; drawn since \$..... 100
Due soldier \$..... 100; due U. S. \$..... *389*/₁₀₀
Am't for cloth'g in kind or money adv'd \$..... 100

Due U. S. for arms, equipments, &c., \$..... 100
Bounty paid \$..... 100; due \$..... 100

Remarks:.....
.....
.....
.....

Book mark: *2098, 1882*

(861)

[Signature]
Copyist.

710

Hurd, Bartly
Co A, 3 U. S. Col'd Cav.

Private | Private

CARD NUMBERS.

1	5332116	26
2	5332250	27
3	5331616	28
4	5333413	29
5	7088238	30
6	R4J. 382,132	31
7	40727565	32
8		33
9		34
10		35
11		36
12		37
13		38
14		39
15		40
16		41
17		42
18		43
19		44
20		45
21		46
22		47
23		48
24		49
25		50

Book Mark: R4J. 382,132.

See also

R.P. 382132.

A. M. Shannon
Esq

A | 3 Cav. | U.S.C.T.

Barley Howard

....., Co. *A*, 3 Reg't U. S. Col'd Cav.

Appears on

Company Descriptive Book
of the organization named above.

DESCRIPTION.

Age *28* years; height *5* feet *7* inches.

Complexion *Black*

Eyes *Black*; hair *Black*

Where born *Jackson-Miss-*

Occupation *Farmer*

ENLISTMENT.

When *Oct. 5*, 186 *3*.

Where *Vicksburg-Miss.*

By whom *Capt. W. A. Webb*; term *3* y'rs.

Remarks: *Deserted Nov. 7-*
1863 at Vicksburg
Miss.

F. A. Wright

H | 3 Cav. | U.S.C.T.

Bartley Hurd
Pat, Co. A, 1 Reg't Miss. Cav., Corps d'Afrique.*
Age 25 yrs
Appears on

Company Muster-in Roll

of the organization named above. Roll dated

Vicksburg, Miss. Oct 9, 1863.

Muster-in to date Oct 5, 1863

Joined for duty and enrolled:

When Oct 5th, 1863.

Where Vicksburg, Miss.

Period 3 years.

Valuation of horse, \$ 100

Valuation of horse equipments, \$ 100

Remarks:

*This organization subsequently became Co. A, 3 Reg't U. S. Colored Cavalry.

Book mark: R.P. 382,132.

(356)

G. M. Clark

Copyist.

H | 3 Cav. | U.S.C.T.

Bartley Huref

Plat, Co. A, 1 Reg't Miss. Cav., Corps d'Afrique.*

Appears on

Company Muster Roll

for Oct 9 1863 to Dec 31, 1863.

Present or absent.....

Stoppage, \$ 3 ⁵⁰/₁₀₀ for Ordinance

Due Gov't, \$ 100 for

Valuation of horse, \$ 100

Valuation of horse equipments, \$ 100

Remarks: Deserted Nov 9
'863, at Vicksburg, Miss.

*This organization subsequently became Co. J, 3 Reg't U. S. Colored Cavalry.

Book mark:

C. M. Clark

4 | 3 Cav | U.S.C.T.

Barth Hurd
Pvt., Co. A, 3 Reg't U. S. Col'd Cav
(Miss (Cav A.L. vols))

Appears on

Descriptive List of Deserters

dated *Skipwith Landing Miss Nov 3, 1863*

Deserted:

When *Nov 7*, 1863.

Where *Vicksburg*

Arrested:

When _____, 186 .

Where _____

Remarks: *Stopped Corn Br. Brush
879 Halter #55
Spurs & traps 68 C*

Book mark: _____

(351)

H S Miller
Copyist.

76. | 3 Cav. | U.S.C.T.

Bartley, Hurd
Priv., Co. A, 3 Reg't U. S. Colored Cav.

Appears on Returns as follows:

Nov. 1863, (1 Miss. Cav. A. 20.)
Loss - Nov. 7/63, Vicksburg,
Miss. Deserted.

Book mark :

(546)

J. B. Sittler

Copyist.

H | **3 Cav. U.S.C.T.**

Bartley Hurd

Co. A, 3 Reg't U. S. Col'd Cavalry.

Appears on **Co. Muster-out Roll**, dated *Memphis Tenn. Jan 26*, 1866.

Muster-out to date _____, 186 .

Last paid to _____, 186
Pay due from enrollment

Clothing account:

Last settled _____, 186 ; drawn since \$ _____ 100

Due soldier \$ _____ 100; due U. S. \$ _____ 100

Am't for cloth'g in kind or money adv'd \$ _____ 100

Due U. S. for arms, equipments, &c., \$ _____ 100

Bounty paid \$ _____ 100; due \$ _____ 100

Remarks: *Deserted Nov 7, 63*
at Vicksburg Miss

Book mark : _____

H. Jones
Copyist.

N 3 Cav. U.S.C.

Bartley Hurd

Co. A, 3 Reg't U.S.C. Cav.

NOTATION.

Book mark: R. P. 382137

Record and Pension Office,

WAR DEPARTMENT,

Washington, Feb. 13, 1897.

Application for removal of the charge of desertion and
for an honorable discharge has been denied.

A. G. N.

(487)

Copyist.

Hurd, David^{7th}

Co M, 3 U. S. Col'd Cav.

Private

Private

CARD NUMBERS.

1	5346017	26
2	5346112	27
3	5346195	28
4	5346283	29
5	5346382	30
6	5346471	31
7	5346563	32
8	5346665	33
9	5346760	34
10	5346858	35
11	5346943	36
12	5347024	37
13	5347103	38
14	9089892	39
15	9089767	40
16		41
17		42
18		43
19		44
20		45
21		46
22		47
23		48
24		49
25		50

Book Mark:

See also

MAR 14 1909

S-2027109- PO. NYM

A. M. Shannon
Esq

H | 3 Cav. | U.S.C.T.

David Hurd

....., Co. M, 3 Reg't U. S. Col'd Cav.

Appears on

Company Descriptive Book
of the organization named above.

DESCRIPTION.

Age 38 years; height 5 feet 8 1/2 inches.

Complexion Black

Eyes Black; hair Black

Where born Florence Ala.

Occupation Farmer

ENLISTMENT.

When Feb 24, 1864.

Where Mississippi

By whom Capt. Hyland; term 3 y'rs.

Remarks:

.....
.....
.....
.....
.....

(3830)

F. B. Smith

Copyist.

H | **3 Cav.** | **U.S.C.T.**

David Hurd

....., Co. *M*, 3 Reg't U. S. Col'd Cav.

Appears on

Company Descriptive Book

of the organization named above.

DESCRIPTION.

Age *38* years; height *5* feet *8½* inches.

Complexion *Black*

Eyes *Black*; hair *Black*

Where born *Lourence Co. Ala.*

Occupation *Farmer*

ENLISTMENT.

When *Feb. 24, 1864.*

Where *Mississippi*

By whom *Wm Heyland* term *3* y'rs.

Remarks:

.....

.....

.....

.....

.....

.....

J. S. Smith

No

3 Cav. | U.S.C.T.

David Henry
.....
Priv, Co. *M*, 3 Reg't U. S. Col'd Cavalry.

Appears on

Company Muster-in and Descriptive Roll

of the organization named above. Roll dated
Naimes Bluff Miss, Dec 1, 1864.

Where born *Florence Co Alabama*

Age *38* y'rs; occupation *Farmer*

When enlisted *July 24*, 1864.

Where enlisted *Mississippi*

For what period enlisted *3* years.

Eyes *Black*; hair *Black*

Complexion *Black*; height *5 ft. 8 1/2 in.*

When mustered in, 186 .

Where mustered in

Bounty paid \$ *100*; due \$ *100*

Where credited

Company to which assigned

Remarks :

.....

.....

Book mark :

R Richardson

(356d)

Copyist.

No | **3 Cav.** | **U.S.C.T.**

David Hunt
Porri, Co. M, 3 Reg't U. S. Col'd Cavalry.

Appears on

Company Muster Roll

for *Week + apt*, 1864.

Present or absent *Present*

Stoppage, \$ *100* for

Due Gov't, \$ *100* for

Valuation of horse, \$ *100*

Valuation of horse equipments, \$ *100*

Remarks:

*(Mustered in March 64
at Harpers Bluff)*

Book mark:

R Richardson

No. | **3 Cav. | U.S.C.T.**

David Ward
Priv....., Co. M, 3 Reg't U. S. Col'd Cavalry.

Appears on

Company Muster Roll

for May + June....., 1864

Present or absent Present

Stoppage, \$..... 100 for.....

Due Gov't, \$..... 100 for.....

Valuation of horse, \$..... 100

Valuation of horse equipments, \$..... 100

Remarks :.....
.....
.....
.....
.....
.....
.....
.....
.....

Book mark :.....

R Richardson

(358)

Copyist.

26

3 Cav. | U.S.C.T.

David Hurd
Priv, Co. M, 3 Reg't U. S. Col'd Cavalry.

Appears on

Company Muster Roll

for Apl 30 to Aug 31, 1864

Present or absent Present

Stoppage, \$ 100 for

Due Gov't, \$ 100 for

Valuation of horse, \$ 100

Valuation of horse equipments, \$ 100

Remarks :

Book mark :

R. Richardson

(358)

Copyist.

46

3 Cav. | U.S.C.T.

David Hurd
Pon, Co. M, 3 Reg't U. S. Col'd Cavalry.

Appears on

Company Muster Roll

for *Sept & Oct*, 1864

Present or absent *Present*

Stoppage, \$ 100 for

Due Gov't, \$ 100 for

Valuation of horse, \$ 100

Valuation of horse equipments, \$ 100

Remarks:

Book mark:

R. Richardson

(358)

Copyist.

H. | **3 Cav. | U.S.C.T.**

Ward Ford
....., Co. M, 3 Reg't U. S. Col'd Cavalry.

Appears on

Company Muster Roll

for *Nov & Dec*, 186 *7*.

Present or absent *present*

Stoppage, \$ *100* for

Due Gov't, \$ *100* for

Valuation of horse, \$ *100*

Valuation of horse equipments, \$ *100*

Remarks: *Own saddle & harness*

Book mark:

Wm L Allen

3 | **3 Cav. | U.S.C.T.**

David Howard
1st, Co. M, 3 Reg't U. S. Col'd Cavalry.

Appears on

Company Muster Roll
for Jan + Feb, 1865.

Present or absent present

Stoppage, \$ 100 for

Due Gov't, \$ 100 for

Valuation of horse, \$ 100

Valuation of horse equipments, \$ 100

Remarks :

Book mark :

Paul Allen

20 | **3 Cav. | U. S. C. T.**

David H. ...

..., Co. M, 3 Reg't. U. S. Col'd Cavalry.

Appears on

Company Muster Roll

for *Mar & Apr*, 186*5*.

Present or absent *present*

Stoppage, \$ *100* for

Due Gov't, \$ *100* for

Valuation of horse, \$ *100*

Valuation of horse equipments, \$ *100*

Remarks:

Book mark: *...*

...

H. | **3 Cav. | U.S.C.T.**

David Hurd

Hurd, Co. M, 3 Reg't U. S. Col'd Cavalry.
Appears on

Company Muster Roll
for *May & June*, 1865.

Present or absent *Present*

Stoppage, \$ *100* for

Due Gov't, \$ *100* for

Valuation of horse, \$ *100*

Valuation of horse equipments, \$ *100*

Remarks:
.....
.....
.....
.....
.....
.....
.....
.....
.....
.....

Book mark:

Wm. Allen

2 | **3 Cav. | U.S.C.T.**

David Ford

1st, Co. M, 3 Reg't U. S. Col'd Cavalry.

Appears on

Company Muster Roll

for *July & Aug*, 1865.

Present or absent *Present*

Stoppage, \$ *100* for

Due Gov't, \$ *100* for

Valuation of horse, \$ *100*

Valuation of horse equipments, \$ *100*

Remarks:

.....
.....
.....
.....
.....
.....
.....
.....
.....
.....

Book mark:

Wm Allen

H | **3 Cav. | U.S.C.T.**

David Hurd
Pvt., Co. M, 3 Reg't U. S. Col'd Cavalry.

Appears on

Company Muster Roll

for *Sept. & Oct.*, 186*2*.

Present or absent *Present*

Stoppage, \$ *100* for

Due Gov't, \$ *100* for

Valuation of horse, \$ *100*

Valuation of horse equipments, \$ *100*

Remarks:
.....
.....
.....
.....
.....
.....
.....
.....
.....
.....

Book mark:

Lucina
(358) *Lucina* Copyist.

✓ | **3 Cav. | U.S.C.T.**

Javia Hurd
.....
Pvt......, Co. M, 3 Reg't U. S. Col'd Cavalry.

Appears on

Company Muster Roll

for *Nov. 1, 1865*....., 1865.

Present or absent *Present*.....

Stoppage, \$..... 100 for

Due Gov't, \$..... 100 for

Valuation of horse, \$..... 100

Valuation of horse equipments, \$..... 100

Remarks:.....

Book mark:.....

(358)

Loring

Copyist.

4 | 3 Cav. | U.S.C.T.

David Surd

Cpt., Co. M., 3 Reg't U. S. Col'd Cavalry.

Appears on Co. Muster-out Roll, dated
Memphis Tenn., Jan. 26, 1866.

Muster-out to date Jan. 26, 1866.

Last paid to June 30, 1865.

Clothing account:

Last settled _____, 186 ; drawn since \$ 100

Due soldier \$ ^{16 46} 100; due U. S. \$ 100

Am't for cloth'g in kind or money adv'd \$ 100

Due U. S. for arms, equipments, &c., \$ 100

Bounty paid \$ 100; due \$ 100

Remarks: Mustered out under S.O.
167 Mil. Div of Tenn.

Book mark: 245553

(361)

L. J. ...

Copyist.

Hurd, ⁷¹² John

Co M, 3 U. S. Col'd Cav.

Private

Private

CARD NUMBERS.

1	5346564	26
2	5346666	27
3	5346761	28
4	5346859	29
5	5346944	30
6	5347025	31
7	5347104	32
8	9089893	33
9	40727566	34
10		35
11		36
12		37
13		38
14		39
15		40
16		41
17		42
18		43
19		44
20		45
21		46
22		47
23		48
24		49
25		50

Book Mark:

See also

S. 1099675. P. 9 in run
S 2865956 and W E

W. Shannon
E. W.

APR 1921

26 | 3 Cav. | U.S.C.T.

John Hurd
Co. M, 3 Reg't U. S. Col'd Cav.

Appears on

Company Descriptive Book

of the organization named above.

DESCRIPTION.

Age 22 years; height 5 feet 8 inches.

Complexion Black

Eyes Black; hair Black

Where born Carroll Co, Miss

Occupation Laborer

ENLISTMENT.

When Jan. 6, 1865.

Where Vicksburg

By whom Maj. Main; term 3 y'rs.

Remarks:
.....
.....
.....
.....
.....

(3830)

F. B. Smith

Copyist.

H6 | **3 Cav.** | **U.S.C.T.**

John Hurd

Priv., Co. M, 3 Reg't U. S. Colored Cav.

Appears on **Returns** as follows:

Jan. 1865. Gain - Vicksburg,
Miss. Recruited Jan.
6/65.

Book mark :

J. P. Sittler

(546)

Copyist.

H. | **3 Cav. | U.S.C.T.**

John Howard
Priv., Co. M, 3 Reg't U. S. Col'd Cavalry.

Appears on

Company Muster Roll

for *Jan & Febr*, 1865.

Present or absent *present*

Stoppage, \$ *100* for

Due Gov't, \$ *100* for

Valuation of horse, \$ *100*

Valuation of horse equipments, \$ *100*

Remarks:

*Enrolled and miss
Jan 6. 65 at Vicksburg
Miss. for 3 yrs*

Book mark:

Am Lacey

3
H. | **3 Cav. | U.S.C.T.**

John F. Card
.....
John F. Card, Co. M, 3 Reg't U. S. Col'd Cavalry.

Appears on

Company Muster Roll

for *March & Apr*, 1865.

Present or absent *absent*

Stoppage, \$.....100 for

Due Gov't, \$.....100 for

Valuation of horse, \$.....100

Valuation of horse equipments, \$.....100

Remarks: *absent*

Book mark:

Paul Allen

H. | **3 Cav. | U.S.C.T.**

John Heard
Sgt., Co. M, 3 Reg't U. S. Col'd Cavalry.

Appears on

Company Muster Roll

for *July & Aug*, 1865.

Present or absent *present*

Stoppage, \$ *100* for

Due Gov't, \$ *100* for

Valuation of horse, \$ *100*

Valuation of horse equipments, \$ *100*

Remarks:
.....
.....
.....
.....
.....
.....
.....
.....
.....

Book mark:

Am. Allen

A | **3 Cav.** | **U.S.C.T.**

John Nurd
Pvt., Co. M, 3 Reg't U. S. Col'd Cavalry.

Appears on

Company Muster Roll

for Sept. & Oct., 1865.

Present or absent Present

Stoppage, \$ 100 for

Due Gov't, \$ 100 for

Valuation of horse, \$ 100

Valuation of horse equipments, \$ 100

Remarks :
.....
.....
.....
.....
.....
.....
.....
.....

Book mark :
.....

Levin
Copyist.

H. | **3 Cav. | U.S.C.T.**

John Hurd
....., Co. M, 3 Reg't U. S. Col'd Cavalry.

Appears on

Company Muster Roll

for *May & June*, 186*7*.

Present or absent *present*

Stoppage, \$.....*100* for

Due Gov't, \$.....*100* for

Valuation of horse, \$.....*100*

Valuation of horse equipments, \$.....*100*

Remarks:

Book mark:

John Hurd

4 | 3 Cav. | U.S.C.T.

John Hurd

Pvt., Co. M, 3 Reg't U. S. Col'd Cavalry.

Appears on

Company Muster Roll

for *Nov. & Dec.*, 186*5*.

Present or absent. *Present*

Stoppage, \$ *100* for

Due Gov't, \$ *100* for

Valuation of horse, \$ *100*

Valuation of horse equipments, \$ *100*

Remarks:-----

Book mark:-----

Loring

(358) Copyist.

✓ | 3 Cav. | U.S.C.T.

John Surr

Pvt., Co. *M*, 3 Reg't U. S. Col'd Cavalry.

Appears on Co. Muster-out Roll, dated
Memphis Tenn., Jan. 26, 1866.

Muster-out to date *Jan. 26*, 1866.

Last paid to *Jan. 26*, 1865.

Clothing account:

Last settled _____, 186 ; drawn since \$ _____ 100

Due soldier \$ _____ 100; due U. S. \$ *35* ^{*29*}/₁₀₀

Am't for cloth'g in kind or money adv'd \$ _____ 100

Due U. S. for arms, equipments, &c., \$ *8* ^{*12*}/₁₀₀

Bounty paid \$ *100* 100; due \$ _____ 100

Remarks: *Mustered out under*
S.C. 167 4th. div. of Tenn.

(Age 22 yrs)

Book mark : _____

(861)

Surr

Copyist.

713
Huster, David

Co _____, 3 U. S. Col'd Cav.

Prints

CARD NUMBERS.

1	533 / 153,	26
2		27
3		28
4		29
5		30
6		31
7		32
8		33
9		34
10		35
11		36
12		37
13		38
14		39
15		40
16		41
17		42
18		43
19		44
20		45
21		46
22		47
23		48
24		49
25		50

Book Mark: _____

See also _____

1451
S. | 3 Cav. | U.S.C.T.

David Hunter,

Appears with rank of *Private* on

Muster and Descriptive Roll of a Detachment of U. S. Vols. forwarded

for the 3 Reg't U. S. Col'd Cavalry. Roll dated

Vicksburg, Miss., August 20, 1864.

Where born *Vicksburg, Miss.*

Age *18* y'rs; occupation *Laborer.*

When enlisted *August 18*, 1864.

Where enlisted *V. Burg, Miss.*

For what period enlisted *three* years.

Eyes *black*; hair *black*;

Complexion *black*; height *5* ft. — in.

When mustered in *August 18*, 1864.

Where mustered in *V. Burg, Miss.*

Bounty paid \$ *100*; due \$ *300.⁰⁰/₁₀₀*

Where credited *Ellington, 31 Dist, N.Y.*

Company to which assigned

Remarks:

*Name not taken up
on rolls of regt.*

Book mark:

S. D. Drimmer

(339)

Copyist.

Thurston David
P, Co. *3* Reg't *U.S. Cavalry*
2 Enclosures.

Bed Cards	Final Statements
Burial Records	Furloughs or L. of A.
Certs. of Dis. for Discharge	Med. Certificates
C. M. Charges	Med. Des. Lists
Descriptive Lists	Orders
Discharge Certificates	Pris. of War Record
Enlistment Papers <i>21</i>	Resignations

Other papers relating to—

Admission to Hosp'l	Furlough or L. of A.
Casualty Sheet	Med. Examination
Confinement	Misc. Information
Contracts	Pay or Clothing
Death or Effects	Personal Reports
Desertion	Rank
Discharge from Hosp'l	Transfer to Hosp'l
Discharge from Service	Transfer to V. R. C.
Duty	Transportation

NOTE 1.—This blank will be used for both enlistments and re-enlistments—enlistment of veterans, &c., &c., in the volunteer service. They will be made out in duplicate in all cases—one to accompany the recruiting return of the superintendent (not the recruiting officer) to the Adjutant General, and one to accompany the accounts of the officer who pays bounty, &c. The Regiment and Company in which the soldier last served should be given on the back.

NOTE 2.—An enlistment holds to service. A muster-in must, in all cases, precede payment of pay, bounty, pension, &c. A muster-in roll must, in all cases, be filed in the Adjutant General's Office as evidence of muster-in. The mustering officer, commissary, or assistant commissary of musters, as the case may be, will countersign both enlistments as having mustered the soldier into the service of the United States before either of them is given to the disbursing officer.

DECLARATION OF RECRUIT.

I, David Hunter desiring to VOLUNTEER as a Soldier in the Army of the United States, for the term of THREE YEARS Do Declare, That I am twenty years and _____ months of age; that I have never been discharged from the United States service on account of disability or by sentence of a court-martial, or by order before the expiration of a term of enlistment; and I know of no impediment to my serving honestly and faithfully as a soldier for three years.

GIVEN at Washington Miss the 19th day of August 1874

Witness: B. B. Read David Hunter

..... enlistment; last served in Company ()
 Reg't of
 Discharged 18

Volunteered at Washington
August 19th 1874
 By W. H. ...
Adjutant General
of Maryland

No. 27
...

CONSENT IN CASE OF MINOR.

..... Do CERTIFY, That I am the of; that the said is years of age; and I do hereby freely give my CONSENT to his volunteering as a SOLDIER in the ARMY OF THE UNITED STATES for the period of THREE YEARS.

GIVEN at the day of

Witness:

VOLUNTEER ENLISTMENT.

STATE OF

Mississippi

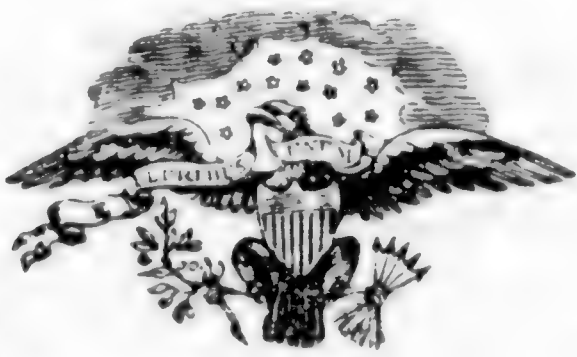

TOWN OF

Vicksburg

I, *David Hustee* born in *Vicksburg*
 in the State of *Mississippi* aged *Eighteen* years,
 and by occupation a *Labourer* DO HEREBY ACKNOWLEDGE to have
 volunteered this *19th* day of *August* 1864,
 to serve as a **Soldier** in the Army of the United States of America, for the
 period of **THREE YEARS**, unless sooner discharged by proper authority: Do also
 agree to accept such bounty, pay, rations, and clothing, as are, or may be, estab-
 lished by law for volunteers. And I, do
 solemnly swear, that I will bear true faith and allegiance to the **United States
 of America**, and that I will serve them honestly and faithfully against all their
 enemies or opposers whomsoever; and that I will observe and obey the orders of
 the President of the United States, and the orders of the officers appointed over
 me, according to the Rules and Articles of War.

Sworn and subscribed to, at *Vicksburg*

this *19th* day of *August* 1864

BEFORE

L. D. Coff Recruiting Agent
 for the State of *Mississippi*
his *David Hustee*
Mark

I CERTIFY, ON HONOR, That I have carefully examined the above-named Volunteer, agreeably
 to the General Regulations of the Army, and that, in my opinion, he is free from all bodily defects and
 mental infirmity, which would in any way disqualify him from performing the duties of a soldier.

E. C. Perry Surgeon

46th Regt Ill Vol

EXAMINING SURGEON.

I CERTIFY, ON HONOR, That I have minutely inspected the Volunteer, *D. Hustee*
 previously to his enlistment, and that he was entirely sober when enlisted; that, to the best of my
 judgment and belief, he is of lawful age; and that, in accepting him as duly qualified to perform the duties
 of an able-bodied soldier, I have strictly observed the Regulations which govern the recruiting service.
 This soldier has *black* eyes, *black* hair, *black* complexion, is *5* feet
 inches high.

L. D. Coff Recruiting Agent
 for the State of *Mississippi*
 Regiment of Volunteers,

RECRUITING OFFICER

Mustered into the service of the United States, in Company
 the *19th* day of *Aug*, 1864 at *Vicksburg Miss*
 Regiment of *U. S. Cav*
 Volunteers, on

W. B. Paul
13th Regt Ill Vol
W. B. Paul
13th Regt Ill Vol

overed

NOTE 1.—This blank will be used for both enlistments and re-enlistments—enlistment of veterans, &c., in the volunteer service. They will be made out in duplicate in all cases—one to accompany the recruiting return of the superintendent (not the recruiting officer) to the Adjutant General, and one to accompany the accounts of the officer who pays bounty, &c. The Regiment and Company in which the soldier last served should be given on the back.

NOTE 2.—An enlistment holds to service. A muster-in must, in all cases, precede payment of pay, bounty, pension, &c. A muster-in roll must, in all cases, be filed in the Adjutant General's Office as evidence of muster-in. The mustering officer, commissary, or assistant commissary of musters, as the case may be, will countersign both enlistments as having mustered the soldier into the service of the United States before either of them is given to the disbursing officer.

DECLARATION OF RECRUIT.

I, Daniel Hunter desiring to VOLUNTEER as a Soldier in the Army of the United States, for the term of THREE YEARS Do Declare, That I am Eighteen years and _____ months of age; that I have never been discharged from the United States service on account of disability or by sentence of a court-martial, or by order before the expiration of a term of enlistment; and I know of no impediment to my serving honestly and faithfully as a soldier for three years.

GIVEN at Robtburg Mississippi the 19th day of August 1864

Witness: S. B. Read Adjutant General State of New York his Daniel Hunter Mark

Discharged _____ 18 _____
Regt of _____
enlistment, last served in Company () _____
By S. B. Read Adjutant General State of New York
Volunteered at Robtburg August 19th 1864
Daniel Hunter

No. _____

CONSENT IN CASE OF MINOR.

I, _____ Do CERTIFY, That I am the _____ of _____; that the said _____ is _____ years of age; and I do hereby freely give my CONSENT to his volunteering as a SOLDIER in the ARMY OF THE UNITED STATES for the period of THREE YEARS.

GIVEN at _____ the _____ day of _____

Witness: _____

VOLUNTEER ENLISTMENT.

STATE OF

Mississippi

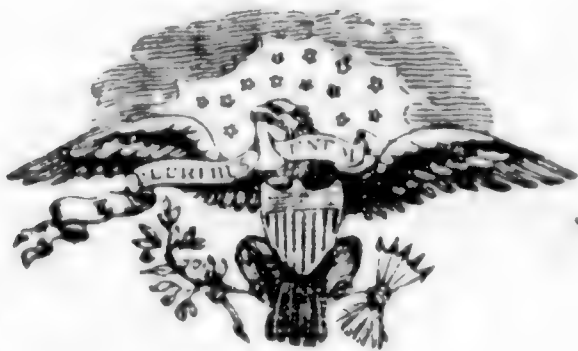

TOWN OF

Rehoboth

I, *David Heister* born in *Rehoboth* in the State of *Mississippi* aged *Eighteen* years, and by occupation a *Labourer* Do HEREBY ACKNOWLEDGE to have volunteered this *19th* day of *August* 1864, to serve as a **Soldier** in the **Army of the United States of America**, for the period of **THREE YEARS** unless sooner discharged by proper authority: Do also agree to accept such bounty, pay, rations, and clothing, as are, or may be, established by law for volunteers. And I, *David Heister* do solemnly swear, that I will bear true faith and allegiance to the **United States of America**, and that I will serve them honestly and faithfully against all their enemies or opposers whomsoever; and that I will observe and obey the orders of the President of the United States, and the orders of the officers appointed over me, according to the Rules and Articles of War.

Sworn and subscribed to, at *Rehoboth* his
this *19th* day of *August* 1864, *David Heister*
BEFORE *J. D. Copp Recruiting Agent* *State of New York*

I CERTIFY, ON HONOR, That I have carefully examined the above-named Volunteer, agreeably to the General Regulations of the Army, and that, in my opinion, he is free from all bodily defects and mental infirmity, which would in any way disqualify him from performing the duties of a soldier.

E. C. de Russ Surgeon
46th Regt N.Y. Vols

EXAMINING SURGEON.

I CERTIFY, ON HONOR, That I have minutely inspected the Volunteer, *D. Heister* previously to his enlistment, and that he was entirely sober when enlisted; that, to the best of my judgment and belief, he is of lawful age; and that, in accepting him as duly qualified to perform the duties of an able-bodied soldier, I have strictly observed the Regulations which govern the recruiting service. This soldier has *black* eyes, *black* hair, *black* complexion, is *5* feet *3* inches high.

J. D. Copp Recruiting Agent
for the State of New York
Recruiting Officer

(A. G. O. No. 74 & 75.)

Mustered into the service of the United States, in Company *A* the *19th* day of *August* 1864, at *Rehoboth Miss*

Regiment of

46th Regt N.Y. Vols

Volunteers, on

service

J. D. Copp
Recruiting Agent
for the State of New York
1864

714
Wyatt Isaac

Co C, 3 U. S. Col'd Cav.

Private | Sergeant

CARD NUMBERS

1	26
2	27
3	28
4	29
5	30
6	31
7	32
8	33
9	34
10	35
11	36
12	37
13	38
14	39
15	40
16	41
17	42
18	43
19	44
20	45
21	46
22	47
23	48
24	49
25	50

see Wyatt Isaac

Book Mark:

See also

75
Hoyland, William
Co M, 3 U. S. Col'd Cav.

Captain | Captain

CARD NUMBERS.

1	5345983	26
2	5346065	27
3	5346151	28
4	5346235	29
5	5346325	30
6	5346418	31
7	5346506	32
8	5346609	33
9	5346707	34
10	5346803	35
11	5346891	36
12	5346974	37
13	5347053	38
14	9435708	39
15	40727568	40
16		41
17		42
18		43
19		44
20		45
21		46
22		47
23		48
24		49
25		50

Book Mark H-146-11611 69-76

See also 4 Ill Carij

MAR 14 40

H | **3 Cav. | U.S.C.T.**

William Heyland

Capt, Co. *M*, 3 Reg't U. S. Col'd Cavalry.

Appears on

Company Muster-in and Descriptive Roll

of the organization named above. Roll dated

Waines Bluffs Miss, Uch 1, 186*4*.

Where born *Canada Great Britain*

Age *35* y'rs; occupation *Farmer*

When enlisted _____, 186 .

Where enlisted _____

For what period enlisted _____ years.

Eyes *Blue* ; hair *Brown*

Complexion *Light* ; height *5 ft. 10 1/2 in.*

When mustered in _____, 186 .

Where mustered in _____

Bounty paid \$ _____ *100* ; due \$ _____ *100*

Where credited _____

Company to which assigned _____

Remarks: *The said William Heyland*
was appointed Captain of M Com-
pany, 1st Min Cav A. D. from 4th Sergt
of Comp 4th Illinois Cavalry Vols

Book mark : _____

R. S. Richardson

(356d)

Copyist.

76

3 Cav. | U.S.C.T.

William Heyland
Capt, Co. M, 3 Reg't U. S. Col'd Cavalry.

Appears on

Company Muster Roll

for March + April, 1864.

Present or absent Present

Stoppage, \$ 100 for

Due Gov't, \$ 100 for

Valuation of horse, \$ 100

Valuation of horse equipments, \$ 100

Remarks: William Heyland
was appointed from a Sergt
in Co D 4 Ills Cav Vols to
a Captain in the 3rd U S
Col'd Cav Nov 4th 1863

(Enrolled Nov 4.64* at
Vicksburg miss + m/c
March 6.64 at Hays Bluff
for 3 yrs
* last appears on roll Aug Oct. 1/67

Book mark :

R. Richardson

26

3 Cav. | U.S.C.T.

William Heyland
Capt, Co. M, 3 Reg't U. S. Col'd Cavalry.

Appears on

Company Muster Roll

for Sept 30 to Aug 31, 1864

Present or absent Present

Stoppage, \$ 100 for

Due Gov't, \$ 100 for

Valuation of horse, \$ 100

Valuation of horse equipments, \$ 100

Remarks:

Book mark:

R. Richardson

(358)

Copyist.

46

3 Cav. | U.S.C.T.

William Heyland
Capt, Co. M, 3 Reg't U. S. Col'd Cavalry.

Appears on

Company Muster Roll

for May & June, 1864.

Present or absent Present

Stoppage, \$ 100 for

Due Gov't, \$ 100 for

Valuation of horse, \$ 100

Valuation of horse equipments, \$ 100

Remarks :

Book mark :

R. Richardson

(358)

Copyist.

26

3 Cav. U.S.C.T.

William Heyland
Capt, Co. M, 3 Reg't U. S. Col'd Cavalry.

Appears on

Company Muster Roll

for Sept & Oct, 1864.

Present or absent Present

Stoppage, \$ 100 for

Due Gov't, \$ 100 for

Valuation of horse, \$ 100

Valuation of horse equipments, \$ 100

Remarks :

Book mark :

R Richardson

22

3 Cav. | U.S.C.T.

William Hyland

Capt., Co. M, 3 Reg't U. S. Col'd Cavalry.

Appears on

Company Muster Roll

for *Nov + Dec*, 186*4*.

Present or absent *present*

Stoppage, \$ 100 for

Due Gov't, \$ 100 for

Valuation of horse, \$ 100

Valuation of horse equipments, \$ 100

Remarks :

Book mark :

Am L Allen

W. | **3 Cav. | U.S.C.T.**

William Hylton
Capt., Co. M, 3 Reg't U.S. Col'd Cavalry.

Appears on

Company Muster Roll

for *Jan + Feb*, 1865.

Present or absent *present*

Stoppage, \$ *100* for

Due Gov't, \$ *100* for

Valuation of horse, \$ *100*

Valuation of horse equipments, \$ *100*

Remarks :

Book mark :

Wm L Allen
Copyist.

50 | **3 Cav. | U.S.C.T.**

William Ryland
Capt., Co. M, 3 Reg't U. S. Col'd Cavalry.

Appears on

Company Muster Roll

for *Mar - Apr*, 1865.

Present or absent *Present*

Stoppage, \$ 100 for

Due Gov't, \$ 100 for

Valuation of horse, \$ 100

Valuation of horse equipments, \$ 100

Remarks :
.....
.....
.....
.....
.....
.....
.....
.....
.....

Book mark :

Am L. Allen
Copyist.

32. | **3 Cav. | U.S.C.T.**

William Heyland
Capt., Co. M, 3 Reg't U. S. Col'd Cavalry.

Appears on

Company Muster Roll

for *May & June*, 1865.

Present or absent *Present*

Stoppage, \$ *100* for

Due Gov't, \$ *100* for

Valuation of horse, \$ *100*

Valuation of horse equipments, \$ *100*

Remarks:

Book mark:

Wm L Allen

H | **3 Cav.** | **U.S.C.T.**

William H. Land
Capt., Co. M, 3 Reg't U. S. Col'd Cavalry.

Appears on

Company Muster Roll

for *July + Aug*, 186 *5*.

Present or absent *Absent*

Stoppage, \$ *100* for

Due Gov't, \$ *100* for

Valuation of horse, \$ *100*

Valuation of horse equipments, \$ *100*

Remarks: *Absent since Aug 1st / 65*

Book mark: *[illegible]*

Am L Allen

9 | 3 Cav. | U.S.C.T.

William Hycan
Capt., Co. M, 3 Reg't U. S. Col'd Cavalry.

Appears on

Company Muster Roll

for Sept & Oct, 1865.

Present or absent Present

Stoppage, \$ 100 for

Due Gov't, \$ 100 for

Valuation of horse, \$ 100

Valuation of horse equipments, \$ 100

Remarks: Absent with leave
from July 17th 1865 to Sept.
18th 1865

Book mark :

(358)

Loring

Copyist.

7 | 3 Cav. | U.S.C.T.

William Hyland
Capt., Co. M, 3 Reg't U. S. Col'd Cavalry.

Appears on

Company Muster Roll

for Nov. & Dec, 1865.

Present or absent Present

Stoppage, \$ 100 for

Due Gov't, \$ 100 for

Valuation of horse, \$ 100

Valuation of horse equipments, \$ 100

Remarks:

Book mark:

Tearing

Ho. | 3 Cav. | U.S.C.T.

William Hyland
Capt, Co. M, 3 Reg't U. S. Colored Cav.

Appears on **Returns** as follows:

Mar. 1864. Present, date of ap-
pointment Nov. 4/63. Date
of muster Mar. 1. 1864.

Apr. to June 1864. Present.

July 1864. Absent with leave.

Aug. 1864. Present, detailed on
Gen. Court martial.

Sept. to Nov. 1864. Present.

Dec. 1864. Absent with leave.

Jan. 1865. Absent, home with
leave, sick.

Feb. to May 1865. Present.

June 1865. Present sick in Drs.

July 1865. Absent with leave

Aug. 1865. Absent without leave
since Aug. 1/65.

Sept. 1865. Present assumed com-
mand Sept. 9/65.

Oct. 1865. Present.

Nov. & Dec. 1865. Present sick.

Book mark :

H | 3 Cav. | U.S.C.T.

William Hyland
Capt., Co. M., 3 Reg't U. S. Col'd Cavalry.

Appears on Co. Muster-out Roll, dated
Memphis Tenn., Jan. 26, 1866.

Muster-out to date Jan. 26, 1866.

Last paid to June 30, 1865.

Clothing account:

Last settled _____, 186 ; drawn since \$ _____ 100

Due soldier \$ _____ 100; due U. S. \$ _____ 100

Am't for cloth'g in kind or money adv'd \$ _____ 100

Due U. S. for arms, equipments, &c., \$ _____ 100

Bounty paid \$ _____ 100; due \$ _____ 100

Remarks: Exhibited originally in Co. D
4th Ill. Vol. Cav. at Joliet Ill.
Sept. 4th /61. Was appointed Capt.
in 1st Ill. Cav. A. I.

Nov. 4/63 and mustered into
said Regt. Mich. 1/64 over

Book mark: N. 146. Vol. 11. P. 5-76

Lerring

JAN. - 8

5347053

1891 *

Mustered out under
S.C. 167 Mid. Div. Term

3 unccat

Hyland, Wm

Capt, Co. M

8 Reg't U.S.C. Cav.

6 Enclosures.

Bed Cards	Descriptive Lists
Burial Records	Final Statements
Certs. of Dis. for Discharge	Furloughs
C. M. Charges	Med. Des. Lists
Med. Certificates 2	Orders 3

Other papers relating to—

Admission to Hosp'l	Furlough 1 2
Casualty Sheet (Officer's)	Med. Examination
Confinement	Misc. Information 1
Contracts	Pay or Clothing
Death or Effects	Personal Reports
Desertions	Rank
Discharge from Hosp'l	Transfer to Hosp'l
Discharge from Service	Transfer to V. R. C.
Duty	Transportation

MICROFILM PUBLICATION M 1819

COMPILED MILITARY SERVICE RECORDS
OF VOLUNTEER UNION SOLDIERS WHO
SERVED WITH THE USCT (US COLORED TROOPS)
3RD REGIMENT OF CAVALRY

PERSONAL PAPERS' TARGET SHEET

PLEASE NOTE THE CHECKED INFORMATION ABOUT THE PERSONAL PAPERS IN
THIS FILE:

- NO PERSONAL PAPERS WERE FOUND IN THIS FILE WHEN THE
RECORDS WERE ARRANGED FOR MICROFILMING.
- 8 PERSONAL PAPER(S) FOUND IN THIS FILE WHEN THE RECORDS
WERE ARRANGED FOR MICROFILMING.

H. C. 551
2 11 11 8 3131

21st 3rd Regt I. I. C.
Memphis Tenn June 29th 1865
H. C. 551
Transmits application for
leave of absence for 20 days
for reasons set forth in accom-
panying surgeons certificate

Approved and
Respectfully forwarded
E. M. Mann
Major Command Regt

Approved and respectfully
forwarded
J. D. Cooke
Surg 3rd Regt I. I. C.
Commanding Regt

Approved, and respectfully
recommended
Wm. L. Beards
Surg 3rd Regt I. I. C.
Surg in Chief

Respectfully forwarded
B. D. Roberts
Surg 1st Regt

(167)

OFFICE SURGEON IN CHIEF,
DIST. WEST TENN.,

Memphis, Tenn July 1st 1865.

Approved.

R. F. Stratton

SURGEON U. S. ARMY
Surgeon in Chief, D. W. T.

10 1/2 1/2 1/2
10 1/2 1/2 1/2

Camp 32nd U.S. Col'd Cavalry
Memphis Tenn June 27th 1865
Great Brig General W.H. Morgan
Asst Adjt General District West Tenn
Tenn.

I have the honor to request
a leave of absence for (20) twenty
days to visit my home in Will
Co. Tenn on the grounds set forth in
accompanying surgeons Certificate

Very Respectfully Your Obedt Servt
William H. Laird
Capt Co. M 32nd U.S. Col'd Cavalry

Handwritten text, possibly a signature or date, located in the middle-left section of the page.

Captain William H. Land of the Third
 Regiment of U. S. Col. Cad., having applied
 for a Certificate upon which to ground an
 Application for leave of absence, I do
 hereby certify that I have carefully
 examined this officer, and find that
 he is seriously afflicted with "Chronic
 Dysentery" and that in consequence thereof
 he is, in my opinion, unfit for duty.
 I further declare my belief that he will not be able
 to resume his duties in a less period than
 twenty days. I further state that in
 my opinion a change of climate is
 positively necessary to save life in this
 case.

Given at Memphis Tenn.
 This 27th day of June 1865

P. H. Keith
 Asst. Surg.
 3rd U.S.C.,
 in charge

Personally Examined
 and Approved

W. L. Beall
 Surg. 3rd U.S.C.
 Surg. in Chief Cavalry

Wm Hyland

Capt. M. 3 U.S.C.

Leave of absence.

MAR 14 64

Head Quarters, District of Vicksburg,

VICKSBURG, MISS. July 4th 1864.

SPECIAL ORDERS,
No. 99

EXTRACT:

Leave of absence for twenty (20) days
is granted
Capt. Wm. H. England Co. 3^d U.S. Cav^y Cavalry
with permission to proceed beyond the limits of the Dept

BY COMMAND OF MAJOR GENERAL H. W. SLOCUM:

H. C. Rogers

ASSISTANT ADJUTANT GENERAL.

Co. 3^d U.S. Cav^y

No^o Cms Dist^o Vicksburg.
Vicksburg, Miss. July 4th 1864.

Special Orders

No 60 } Extract

II. Granting leave of
absence to Capt William
Hysand, Co "M", 3rd U. S. Cav^o
Per. of twenty (20) days

MAR 14 1864

Head Quarters Dist' Vicksburg.
Vicksburg, Miss. July 4th 1864.

Special Orders }
No 60) Extract
II " " Leave of absence for twenty (20)
is granted

Capt Wm Hylaud "M" Co. 3^d U.S. Col^d Cavalry.

with permission to proceed beyond the limits of
the Department.

* * *
By command of Major Genl H. W. Stocum.
(Signed) H. C. Rodgers
Asst Adjutant General.

Official
Frank S. Lovjoy
Adj. 3^d U.S. Col^d Cav

H+246

(25)

1864

W. A. P. Cannon Gen Insp
H. C. # 217
Vicksburg, Miss. Dec 19/64

William Highland
Capt 7th Co. 3rd U.S. Cav.

✓ Gen Insp, Dec 23/64

Asks Leave of Absence for
(20) Twenty Days.

Med Director's Office
Dist Vicksburg
Dec. 19th 1864

Respectfully forwarded

Approved

R. F. Stratton

Surgeon 11th Ill. Cav.

Med. Dir. Dist Vicksburg

Hd. Qrs. Dist - Vicksburg
Vicksburg, Miss. Dec 20/64
Respectfully forwarded
"Approved"

C. S. Washburn

Major "Genl"

Recd. Hd. Qrs. Dept of Miss. Dec. 23/64
Hd. Qrs. Dist Vicksburg Dec. 19/64

M. P. Person Gen. & Cap. A.
Vicksburg, Miss, Dec 19th 1864.

W. H. Morgan.
A. A. Gen.
Dist. of Vicksburg.

Sir:

I would respectfully
request Leave of Absence, for (20) Twenty days,
based on accompanying Surgeon's Certificate
of Disability.

I am Sir,

Very Respy

Wm. H. Person
Capt. M. C. 3^d U. S. Col. Cal.

No. 2100 (B.T.) 1860

[Faint, illegible handwritten text, possibly bleed-through from the reverse side of the page]

Medical Certificate.

Capt. William H. H. Co., 3^d U.S.C., Cav.,
having applied for a certificate on which
to base an application for Leave of
Absence:

I do hereby certify that I have
carefully examined this officer and
find him suffering from Debility, con-
sequent upon Chronic Dysentery, the result
of which, he is, in my opinion, rendered
unfit for duty.

I do further declare my belief
that he will be unable to resume
his duties in a less period than
twenty days, and that a removal
from the Military Department is
necessary to save life, or prevent permanent
disability.

E. Powell

Surgeon 72 Ill. Inf.
in Chg. M. Hospital Gen. Hosp.

Vicksburg, Miss., Dec 19th 1864.

Admission into Gul
Isip. Hyland

Wm Hyland

Capt. M. 3 U.S. 6,

MAR 1865

Post and Defense
Head-Quarters, District of Memphis,

Memphis, Tenn., 3 January 1865

SPECIAL ORDERS,

No. 2,

Part II,

Upon Surgeon's Certificate of Disability, The following named officers are hereby permitted to enter Officer's Hospital for medical treatment:

Capt. Wm. Myland Co "M" 3^d U.S. Cav.

James C. Hatch
By order of Brig. Gen'l R. P. BUCKLAND,

[Signature]

Capt. and Acting Assistant Adjutant General.

[Faint handwritten notes]

Militerum Commissioni
Preceduntur
A. H. H. H.

Capt. E. H. H. H.

War Department,

ADJUTANT GENERAL'S OFFICE,

Washington, April 5th 1865.

To the

Commanding Officer,

3rd U. S. Colored Cavalry
Memphis Tennessee

Sir:

The proceedings of the Military Commission instituted
by Sp. Or. No. 65, 25, from Head Quarters, District of West Tennessee in the case
of Captain William Highland of your Regiment
have been approved by the Secretary of War.

The bar to his receiving pay is hereby removed.

I am, Sir, very respectfully,

Your obedient servant,

A. H. Reckwold
Assistant Adjutant General.

116

Ingraham George

Co B, 3 U. S. Col'd Cav.

Private | Private

CARD NUMBERS.

1	5333461	26
2	5333546	27
3	5333633	28
4	5333723	29
5	5333797	30
6	5333874	31
7	5333958	32
8	5334015	33
9	5334105	34
10	5334212	35
11	5334306	36
12	5334397	37
13	5334487	38
14	5334571	39
15	5334647	40
16	9088362	41
17	40727576	42
18		43
19		44
20		45
21		46
22		47
23		48
24		49
25		50

Book Mark:

See also

S. 1457216 and W. S.
S. 1460056 Pomeroy

J. G. Gault

11/19

2 | 3 Cav. | U.S.C.T.

George Ingraham

....., Co. B, 3 Reg't U. S. Col'd Cav.

Appears on

Company Descriptive Book

of the organization named above.

DESCRIPTION.

Age 19 years; height 5 feet 6 1/2 inches.

Complexion Black

Eyes Black; hair Black

Where born Charleston - S. C.

Occupation Field hand

ENLISTMENT.

When Oct. 11 - , 186 3.

Where Hicksburg - Miss -

By whom Cap. A. Emery; term 3 y'rs.

Remarks:

.....
.....
.....
.....
.....
.....

F. A. Emery

9 | **3 Cav.** | **U.S.C.T.**

George Ingraham
Pvt, Co. B, 1 Reg't Miss. Cav., Corps d'Afrique.*

Appears on age 19.

Company Muster-in Roll

of the organization named above. Roll dated
Wicksburg Miss Oct 20, 1863

Muster-in to date Oct 11, 1863

Joined for duty and enrolled:

When Oct 11, 1863

Where Wicksburg, Miss

Period 3 years.

Valuation of horse, \$.....100

Valuation of horse equipments, \$.....100

Remarks :
.....
.....
.....

*This organization subsequently became Co. B. 3 Reg't U. S. Colored Cavalry.

Book mark :
.....

(356)

W. W. Wrayre
Coryst.

J | **3 Cav. | U.S.C.T.**
George Ingraham
Plt, Co. *B*, 1 Reg't Miss. Cav., Corps d'Afrique.*

Appears on

Company Muster Roll
for *Oct 20 to Dec 31*, 186*3*

Present or absent *Present*

Stoppage, \$ *100* for

Due Gov't, \$ *100* for

Valuation of horse, \$ *100*

Valuation of horse equipments, \$ *100*

Remarks:
.....
.....
.....
.....
.....
.....

*This organization subsequently became Co *B*, 3 Reg't U. S. Colored Cavalry.

Book mark:

M Wayne
Copyist.

9 | **3 Cav. | U.S.C.T.**

George Ingraham
Pvt, Co. B, 1 Reg't Miss. Cav., Corps d'Afrique.*

Appears on

Company Muster Roll

for Jan & Feb, 1864

Present or absent, Present

Stoppage, \$ 49 / 100 for exp. c.

Due Gov't, \$ 60 / 100 for Ord.

Valuation of horse, \$ 100

Valuation of horse equipments, \$ 100

Remarks: Stop for Haverme
spurs & straps

*This organization subsequently became Co. B, 3 Reg't U. S. Colored Cavalry.

Book mark: _____

W. W. Sayre

9 | **3 Cav.** | **U.S.C.T.**

George Ingraham
Pvt, Co. B, 3 Reg't U. S. Col'd Cavalry.

Appears on

Company Muster Roll

for Mich & Apple, 1864.

Present or absent Present

Stoppage, \$ 100 for

Due Gov't, \$ 100 for

Valuation of horse, \$ 100

Valuation of horse equipments, \$ 100

Remarks:

Book mark:

W. Mayre
(358) Copyist.

000001400

D | **3 Cav. | U.S.C.T.**

George Ingraham
Pr
....., Co. B, 3 Reg't U. S. Col'd Cavalry.

Appears on

Company Muster Roll
for *May & June*, 186 *4*
Present or absent *Present*

Stoppage, \$..... *100* for

Due Gov't, \$..... *100* for

Valuation of horse, \$..... *100*

Valuation of horse equipments, \$..... *100*

Remarks:

Book mark:

(358)

Mosey
Copyist.

9 | 3 Cav. | U.S.C.T.
George Ingraham
Pvt., Co. B, 3 Reg't U. S. Col'd Cavalry.

Appears on

Company Muster Roll
for July & Aug, 1864.
Present or absent Present

Stoppage, \$ 100 for

Due Gov't, \$ 100 for

Valuation of horse, \$ 100

Valuation of horse equipments, \$ 100

Remarks:

Book mark:

(358)

W. W. Payne
Copyist.

S | **3 Cav.** | **U.S.C.T.**

George Ingraham
Prin., Co. B, 3 Reg't U. S. Col'd Cavalry.

Appears on

Company Muster Roll

for *Sept. and Oct.*, 1864.

Present or absent *Present.*

Stoppage, \$ *100* for

Due Gov't, \$ *100* for

Valuation of horse, \$ *100*

Valuation of horse equipments, \$ *100*

Remarks:

Book mark:

(358)

J. B. Jones

Copyist.

J | **3 Cav. | U.S.C.T.**

George Ingraham
Capt., Co. B, 3 Reg't U. S. Col'd Cavalry.

Appears on

Company Muster Roll

for *Nov and Dec.*, 1864.

Present or absent *Absent.*

Stoppage, \$ *100* for

Due Gov't, \$ *100* for

Valuation of horse, \$ *100*

Valuation of horse equipments, \$ *100*

Remarks: *On scout. Permitted
Capt. Nov. 3. Col's revolver,
Spurs and straps #24,74.*

Book mark:

(358)

J. B. Jones

Copyist.

1 | **3 Cav.** | **U.S.C.T.**

George Ingraham
Capt., Co. B, 3 Reg't U. S. Col'd Cavalry.

Appears on

Company Muster Roll

for *Jan and Feb.*, 1865.

Present or absent *Present*

Stoppage, \$ *100* for

Due Gov't, \$ *100* for

Valuation of horse, \$ *100*

Valuation of horse equipments, \$ *100*

Remarks:

Book mark:

(358)

J. B. James Copyist.

01 | **3 Cav. | U.S.C.T.**

George Ingraham
Sgt., Co. B, 3 Reg't U. S. Col'd Cavalry.

Appears on

Company Muster Roll

for *March and April*, 1865.

Present or absent *Absent*

Stoppage, \$ 100 for

Due Gov't, \$ 100 for

Valuation of horse, \$ 100

Valuation of horse equipments, \$ 100

Remarks: *Absent on account since*
April 29/65. Promoted from Capt
to Sgt. March 20/65.

Book mark: _____

(358)

J. B. James

Copyist.

I | **3 Cav.** | **U.S.C.T.**

George Ingraham
Sgt., Co. B, 3 Reg't U. S. Col'd Cavalry.

Appears on

Company Muster Roll

for *May and June*, 186 *5*.

Present or absent *Present*.

Stoppage, \$ *100* for

Due Gov't, \$ *100* for

Valuation of horse, \$ *100*

Valuation of horse equipments, \$ *100*

Remarks: *Promoted from Capt
March 20/65.*

Book mark: _____

(358)

J. B. James Copyist.

I | **3 Cav.** | **U.S.C.T.**

George Ingraham
Sgt., Co. B, 3 Reg't U. S. Col'd Cavalry.

Appears on

Company Muster Roll

for July and August, 1865:

Present or absent Present

Stoppage, \$ 100 for

Due Gov't, \$ 100 for

Valuation of horse, \$ 100

Valuation of horse equipments, \$ 100

Remarks:

Book mark:

(358)

J. B. James Copyist.

I | **3 Cav.** | **U.S.C.T.**

George Ingraham
Serjt, Co. B, 3 Reg't U. S. Col'd Cavalry.

Appears on

Company Muster Roll
for *Sept. & Oct.*, 186 *5*.

Present or absent *Present*

Stoppage, \$ *100* for

Due Gov't, \$ *100* for

Valuation of horse, \$ *100*

Valuation of horse equipments, \$ *100*

Remarks: *Stop for one*
per. Spurs + Straps
524

Book mark:

H. S. Brandon

(358)

Copyist.

I | 3 Cav. | U.S.C.T.

George Ingraham
Sergt, Co. B, 3 Reg't U. S. Col'd Cavalry.

Appears on

Company Muster Roll

for *Nov. & Dec.*, 186*5*.

Present or absent *Present*

Stoppage, \$ *.52* ¹⁰⁰ for *Ordinance*
transferred from Oct. Roll

Due Gov't, \$ *100* for

Valuation of horse, \$ *100*

Valuation of horse equipments, \$ *100*

Remarks:
.....
.....
.....
.....
.....
.....
.....

Book mark:

H. S. Brandon

I | 3 Cav. | U.S.C.T.

George Ingraham
Pvt.
Corpl., Co. B, 3 Reg't U. S. Colored Cav.

Appears on Returns as follows:

Dec. 1863, (1 Miss, Cav, A, 20.)
Wounded in action at
Beauff River, Ark, Dec,
13/63,

Nov. 1864, (3 U.S.C.C.) Nov. 3/64
Vicksburg, Miss, appoint-
ed Corpl by order of
Capt. Andrew Emery
(Corpl)

Book mark :

(546)

J. B. Dittler

Copyist.

A | **3 Cav. U.S.C.T.**

George Ingraham
Serg't., Co. *B*, 3 Reg't U. S. Col'd Cavalry.

Appears on **Co. Muster-out Roll**, dated
Memphis Tenn. Jan 26, 1866.

Muster-out to date *Jan 26*, 1866.

Last paid to *June 30*, 1865.

Clothing account:

Last settled, 186 ; drawn since \$..... 100

Due soldier \$..... 100; due U. S. \$ *14* ^{*70*}/₁₀₀

Am't for cloth'g in kind or money adv'd \$..... 100

Due U. S. for arms, equipments, &c., \$..... 100

Bounty paid \$..... 100; due \$..... 100

Remarks: *Total Stoppages*
for Ordnance 52 cts.

Book mark :

H. G. Brandon

717

Ingraham Joseph

Co B, 3 U. S. Col'd Cav.

Private | Private

CARD NUMBERS.

1	✓ 333462	26
2	✓ 333593	27
3	✓ 333679	28
4	✓ 331627	29
5	✓ 334768	30
6	1088363	31
7	40727577	32
8		33
9		34
10		35
11		36
12		37
13		38
14		39
15		40
16		41
17		42
18		43
19		44
20		45
21		46
22		47
23		48
24		49
25		50

Book Mark:

See also

3 | 3 Cav. | U.S.C.T.

Joseph Ingraham

Co. B, 3 Reg't U. S. Col'd Cav.

Appears on

Company Descriptive Book
of the organization named above.

DESCRIPTION.

Age 32 years; height 5 feet 5 inches.

Complexion Brown

Eyes Black; hair Black

Where born County not known N. C.

Occupation Field hand

ENLISTMENT.

When Dec. 11, 1863.

Where Vicksburg - Miss -

By whom Ab. A. Emery; term 3 y'rs.

Remarks: Deserted Nov. 5, 1863

at Vicksburg, Miss.

Indebtedness for cloth-

ing \$26.35; for curren-

colt & brush, spurs &

straps, canteen and

haversack.

F. A. Wright

9 | **3 Cav.** | **U.S.C.T.**

Joseph Ingraham

Pvt, Co B, 1 Reg't Miss. Cav., Corps d'Afrique.*

Appears on age 32

Company Muster-in Roll

of the organization named above. Roll dated Veicksburg, Miss, Oct 20, 1863.

Muster-in to date Oct 11, 1863

Joined for duty and enrolled:

When Oct 11, 1863

Where Veicksburg, Miss

Period 3 years.

Valuation of horse, \$.....100

Valuation of horse equipments, \$.....100

Remarks:.....
.....
.....
.....

*This organization subsequently became Co B, 3 Reg't U. S. Colored Cavalry.

Book mark:.....

W. W. Sayre

(356)

Copyist.

I | *3* *Cow* | **U.S.C.T.**

Joseph Ingraham
(1 Miss cap A.D. vols)
Pvt, Co. *B*, *3* Reg't U. S. Col'd *Cow*

Appears on

Descriptive List of Deserters

dated *Sept with standing miss Nov 30*, 1863.

Deserted:

When *Nov 5*, 1863.

Where *Vicksburg*

Arrested:

When _____, 186 .

Where _____

Remarks: *Stoped comb, brush
canteen, haversack spurs,
2 traps \$2.47*

Book mark: _____

(351)

H S Miller

Copyist.

9

3 Cav. U.S.C.T.

Joseph Ingraham

Pvt, Co. B, 1 Reg't Miss. Cav., Corps d'Afrique.*

Appears on

Company Muster Roll

for Oct 20 to Dec 31, 1863

Present or absent

Stoppage, \$ 27 ³⁵/₁₀₀ for Cr. & G. Equipage

Due Gov't, \$ ¹⁰⁰/₁₀₀ for

Valuation of horse, \$ ¹⁰⁰/₁₀₀

Valuation of horse equipments, \$ ¹⁰⁰/₁₀₀

Remarks: Deserted Nov. 5th 1863 at Nicksburg, Miss. Stop for Ordnance \$1.47

*This organization subsequently became Co. B, 3 Reg't U. S. Colored Cavalry.

Book mark:

W. W. Sayre

(358)

Copyist.

2 | 3 Cav. | U.S.C.T.
Joseph Ingraham
Pvt, Co. B, 1 Reg't Miss. Cav., Corps d'Afrique.*

Appears on

Company Muster Roll
for Jano Feb, 1864.

Present or absent

Stoppage, \$ 27 ³⁵/₁₀₀ for C. Co. G. K.

Due Gov't, \$ 1 ⁴⁹/₁₀₀ for Ora

Valuation of horse, \$ 100

Valuation of horse equipments, \$ 100

Remarks: Deserted Nov 5. 63
at Vicksburg, Miss

*This organization subsequently became Co. B 3 Reg't U. S. Colored Cavalry.

Book mark:

(358)

M. Dayre
Copyist.

I | 3 Cav. **U.S.C.T.**

Joseph Ingraham
Co. B, 3 Reg't U. S. Col'd Cavalry

Appears on **Co. Muster-out Roll**, dated
Memphis Tenn. Jan 26th, 1866.

Muster-out to date _____, 186 .

Last paid to _____, 186 .

Clothing account:

Last settled _____, 186 ; drawn since \$ _____ 100

Due soldier \$ _____ 100; due U. S. \$ _____ 100

Am't for cloth'g in kind or money adv'd \$ _____ 100

Due U. S. for arms, equipments, &c., \$ _____ 100

Bounty paid \$ _____ 100; due \$ _____ 100

Remarks: Discharged at
Vicksburg Miss
Nov. 5, 1863

Book mark: _____

H. J. Brandon

718
Ingraham Thomas

Co B, 3 U. S. Col'd Cav.

Private Private

CARD NUMBERS.

1	5333460	26
2	5333545	27
3	5333632	28
4	5333722	29
5	5333796	30
6	5333873	31
7	5333959	32
8	5334051	33
9	5334142	34
10	5334254	35
11	5334349	36
12	5334437	37
13	5334559	38
14	5334730	39
15	9088361	40
16	40727578	41
17		42
18		43
19		44
20		45
21		46
22		47
23		48
24		49
25		50

Book Mark:

See also

D | **3 Cav. | U.S.C.T.**

Thomas Ingraham

....., Co. B, 3 Reg't U. S. Col'd Cav.

Appears on

Company Descriptive Book
of the organization named above.

DESCRIPTION.

Age 24 years; height 5 feet 7½ inches.

Complexion Black

Eyes Black; hair Black

Where born Jackson - Tenn.

Occupation Field-hand.

ENLISTMENT.

When Oct. 11 -, 1863

Where Nicksburg - Miss.

By whom Cap. A. Emery; term 3 y'rs.

Remarks: Discharged on
Surg. Certificate of
Disability, Sept. 5 -
1865.

F. A. Wright

9 | 3 Cav. | U.S.C.T.

Thomas Ingraham

Priv., Co B, 1 Reg't Miss. Cav., Corps d'Afrique.*

Appears on page 24.

Company Muster-in Roll

of the organization named above. Roll dated

Merksburg, Miss, Oct 20, 1863.

Muster-in to date Oct 11, 1863

Joined for duty and enrolled:

When Oct 11, 1863.

Where Merksburg, Miss

Period 3 years.

Valuation of horse, \$ 100

Valuation of horse equipments, \$ 100

Remarks:

*This organization subsequently became Co B, 3 Reg't U. S. Colored Cavalry.

Book mark:

M. M. Sayre

I **3 Cav. U.S.C.T.**

Thomas Ingraham
Mr. B, Co. *B*, 1 Reg't Miss. Cav., Corps d'Afrique.*

Appears on

Company Muster Roll

for *Oct 20 to Dec 31*, 186*3*.

Present or absent *Present*

Stoppage, \$.....*100* for

Due Gov't, \$.....*100* for

Valuation of horse, \$.....*100*

Valuation of horse equipments, \$.....*100*

Remarks:

*This organization subsequently became Co. *B*, 3 Reg't U. S. Colored Cavalry.

Book mark:

W. Mayre
(358) Copyist.

9 | 3 Cav. | U.S.C.T.

Thomas Ingoaham

Private, Co. B, 1 Reg't Miss. Cav., Corps d'Afrique.*

Appears on

Company Muster Roll

for Jan & Feb, 1864

Present or absent Present

Stoppage, \$ 41/100 for Canteen

Due Gov't, \$ 100 for

Valuation of horse, \$ 100

Valuation of horse equipments, \$ 100

Remarks:

*This organization subsequently became Co. B, 3 Reg't U. S. Colored Cavalry.

Book mark:

Mrs. Daye Copyist.

I | **3 Cav.** | **U.S.C.T.**

Thomas Ingraham
Priv....., Co. B, 3 Reg't U. S. Col'd Cavalry.

Appears on

Company Muster Roll

for *Mehzaple*....., 186*4*.

Present or absent *Present*.....

Stoppage, \$..... *100* for.....

Due Gov't, \$..... *100* for.....

Valuation of horse, \$..... *100*

Valuation of horse equipments, \$..... *100*

Remarks:.....

Book mark :.....

W. Mayre

(358)

Copyist.

9

3 Cav. U.S.C.T.

Thomas Ingraham

Priv

Co. B, 3 Reg't U. S. Col'd Cavalry.

Appears on

Company Muster Roll

for May June, 1864

Present or absent Present

Stoppage, \$ 100 for

Due Gov't, \$ 100 for

Valuation of horse, \$ 100

Valuation of horse equipments, \$ 100

Remarks:

Book mark

M. Sayre

(358)

Copyist.

9 | **3 Cav. U.S.C.T.**

Thomas Ingraham
Pvt, Co. B, 3 Reg't U. S. Col'd Cavalry.

Appears on

Company Muster Roll

for July & Aug, 1864

Present or absent Present

Stoppage, \$ 100 for

Due Gov't, \$ 100 for

Valuation of horse, \$ 100

Valuation of horse equipments, \$ 100

Remarks: _____

Book mark: _____

(358)

W. Sayre
Copyist.

J | **3 Cav.** | **U.S.C.T.**

Thomas Ingraham

Pvt., Co. B, 3 Reg't U. S. Col'd Cavalry.

Appears on

Company Muster Roll

for *Sept. and Oct.*, 186*4*.

Present or absent *Present.*

Stoppage, \$ *100* for

Due Gov't, \$ *100* for

Valuation of horse, \$ *100*

Valuation of horse equipments, \$ *100*

Remarks:

.....
.....
.....
.....
.....
.....
.....
.....

Book mark:

(358) *J. B. Jones* Copyist.

J | **3 Cav. | U.S.C.T.**

Thomas Ingraham
Priv., Co. B, 3 Reg't U. S. Col'd Cavalry.

Appears on

Company Muster Roll

for *Nov. and Dec.*, 186*4*.

Present or absent *Present*

Stoppage, \$ *100* for

Due Gov't, \$ *100* for

Valuation of horse, \$ *100*

Valuation of horse equipments, \$ *100*

Remarks: *Stoppage: 1 Brush wiper
Chang, screw driver & case
wrench 77 P.*

Book mark: _____

(358)

J. B. James Copyist.

J | **3 Cav. | U.S.C.T.**

Thomas Ingraham
Priv., Co. B, 3 Reg't U. S. Col'd Cavalry.

Appears on

Company Muster Roll

for *June and Feb.*, 1863.

Present or absent *Present*

Stoppage, \$ *100* for

Due Gov't, \$ *100* for

Valuation of horse, \$ *100*

Valuation of horse equipments, \$ *100*

Remarks:

Book mark:

(358)

J. B. James Copyist.

I | **3 Cav.** | **U.S.C.T.**

Thomas Ingraham
Private, Co. B, 3 Reg't U. S. Col'd Cavalry.

Appears on

Company Muster Roll

for March and April, 1865.

Present or absent Absent

Stoppage, \$ 100 for

Due Gov't, \$ 100 for

Valuation of horse, \$ 100

Valuation of horse equipments, \$ 100

Remarks: Absent on scout since
April 29/65.

Book mark:

(358)

J. B. Jones

Copyist.

I | **3 Cav.** | **U.S.C.T.**

Thomas Ingraham
Private, Co. B, 3 Reg't U. S. Col'd Cavalry.

Appears on

Company Muster Roll

for *May and June*, 186*6*.

Present or absent. *Present*

Stoppage, \$..... *100* for

Due Gov't, \$..... *100* for

Valuation of horse, \$..... *100*

Valuation of horse equipments, \$..... *100*

Remarks:

Book mark:

(358)

J. B. Jones Copyist.

I | **3 Cav.** | **U.S.C.T.**

Thomas Ingraham
Pri., Co. B, 3 Reg't U. S. Col'd Cavalry.

Appears on

Company Muster Roll

for *July and August*, 1865.

Present or absent *Present.*

Stoppage, \$ *100* for

Due Gov't, \$ *100* for

Valuation of horse, \$ *100*

Valuation of horse equipments, \$ *100*

Remarks: *Stopped for one yr.
spurs and straps 52¢.*

Book mark:

(358)

J. B. Jones

Copyist.

I | 3 Cav. | U.S.C.T.

Thomas Ingraham
Privt, Co. B, 3 Reg't U. S. Col'd Cavalry.

Appears on

Company Muster Roll
for Sept. & Oct., 1865.

Present or absent

Stoppage, \$ 100 for

Due Gov't, \$ 100 for

Valuation of horse, \$ 100

Valuation of horse equipments, \$ 100

Remarks: Discharged for
Disability Sept. 5th 1865
by order of Maj. Gen.
Stoneman. Stop for one
pr. Spurs & Staps 52¢

Book mark:

H. S. Brandon

I | 3 Cav. | U.S.C.T.

Thomas Ingraham
Pvt., Co. B, 3 Reg't U. S. Colored Cav.

Appears on Returns as follows:

Sept. 1863. Lost Sept. 5/65-
Memphis, Tenn. Dis-
charged for disability.

Book mark :

J. B. Dittler

(546)

Copyist.

I | **3 Cav. | U.S.C.T.**

Thomas Ingraham
Privt., Co. B., 3 Reg't U. S. Col'd Cavalry.

Appears on **Co. Muster-out Roll**, dated
Memphis Tenn. Jan. 26th, 1866.

Muster-out to date _____, 186 .

Last paid to *Feb. 28th*, 1865 .

Clothing account:

Last settled _____, 186 ; drawn since \$ _____ 100

Due soldier \$ _____ 100; due U. S. \$ _____ 100

Am't for cloth'g in kind or money adv'd \$ _____ 100

Due U. S. for arms, equipments, &c., \$ _____ 100

Bounty paid \$ _____ 100; due \$ _____ 100

Remarks: *Discharged Sept.*
5th 1865 on Surgeons
Certificate of Disability
at Memphis Tennessee

Book mark: *Discharged Sept. 1/65*
E. B. 514 C.D.

H. E. Brandon

Ingraham, Thomas

B., Co. B,

Reg't

Enclosures.

Bed Cards	Descriptive Lists
Burial Records	Final Statements
Certs. of Dis. for Discharge	Furloughs
C. M. Charges	Med. Des. Lists
Med. Certificates	Orders

Other papers relating to—

Admission to Hosp'l	Furlough
Casualty Sheet (Officer's)	Med. Examination
Confinement	Misc. Information
Contracts	Pay or Clothing
Death or Effects	Personal Reports
Desertions	Rank
Discharge from Hosp'l	Transfer to Hosp'l
Discharge from Service	Transfer to V. R. C.
Duty	Transportation

[OFFICE INDORSEMENT.]

War Department,

ADJUTANT GENERAL'S OFFICE,

Number 26, 1873.

The discharge of John Thomas
Ingram, Co. B, 3^d Reg't U. S.
Colored Cavalry, is reported as follows:—

- On Company Muster Roll. For Sept and Oct., 1865, Sept 5, 1865, Company Muster-out Roll. September 3, 1865, Company Descriptive Book. 186 Company Morning Reports. 186 Soldier's Final Statement. 186 Soldier's Record of Death and Interment. 186 Soldier's Inventory of Effects. 186 Soldier's Certificate of Disability for Discharge. September 1st, 1865, Soldier's Individual Muster-out Roll. 186 Regimental Return. For September, 1865, Sept 5, 1865, Regimental Quarterly Returns. 186 Regimental Descriptive Book. 186 By Surgeon General. 186 () September 1st, 1865, is held to be the correct date, and the Company Muster Roll will be amended accordingly.

Thomas M. Stewart
E.B. 10
514 Asst. Adj. Gen.

Held on M. O. Roll May 1st 1876

S. B. 3. A. W. T. 1865.

CERTIFICATE OF DISABILITY FOR DISCHARGE

IN THE CASE OF

Thomas Ingram
a Private Co. B
3^d Reg't of U.S. Cavalry

Extract furnished to
creditor May 9th 1865

HEAD-QUARTERS DEPT. OF TENNESSEE.

MEMPHIS, TENN., Sept. 1st 1865.

TO BE DISCHARGED.

BY COMMAND OF MAJ. GENERAL GEORGE STONEMAN

Wm. M. Cannon CAPT. & A. A. G.

Received (A. G. Office.) _____, 186

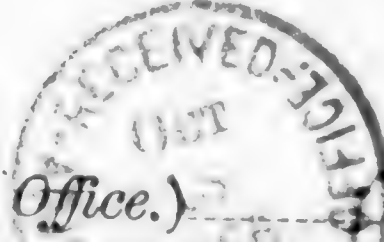

Wm. M. Cannon

Ad Gps 3^d U.S. Cavalry
Memphis Tenn Aug 7/65

I certify that the
within named soldier
is in my opinion
unfit for duty in the
Veteran Reserve Corps
E. M. Wain
Major Comd'g Regt

OFFICE SURGEON IN CHIEF,
DIST. WEST TENN.

Memphis, Tenn. Aug 31st 1865.

Approved.

P. F. Stratton
SURGEON 11th Ill. Cav.
Surgeon in Chief, D. W. T.

S. B. 3. A. W. T. 1865
31

NOTE 1.

The company commander will here add a statement of all the facts known to him concerning the disease or wound, or cause of disability of the soldier; the time, place, manner, and all the circumstances under which the injury occurred, or disease originated or appeared; the duty, or service, or situation of the soldier at the time the injury was received or disease contracted, stating particularly whether the injury was received or the disease contracted in the line of his duty; and whatever other facts may aid a judgment as to the cause, immediate or remote, of the disability, and the circumstances attending it.

When the facts are not known to the company commander, the certificate of any officer or affidavit of other person having such knowledge, will be appended—as the surgeon in charge of a hospital, the officer commanding a detachment of recruits, &c., &c.

NOTE 2.

When a probable case for pension, special care must be taken to state the degree of disability—as $\frac{1}{2}$, $\frac{3}{4}$, &c., &c.; to describe particularly the disability, wound, or disease; the extent of which it deprives him of the use of any limb or faculty, or affects his health, strength, activity, constitution, or capacity to labor or earn his subsistence. The surgeon will add, from his knowledge of the facts and circumstances, and from the evidence in the case, his professional opinion of the cause or origin of the disability. In the case of discharges by Medical Inspectors, the last paragraph will state that the "discharge was given by consent of the soldier, after a personal examination, and for disability, the nature, degree and origin of which are correctly described in the within certificate."

Par. 1260 Regulations, Edit. 1861.

Medical officers, in giving certificates of disability, are to take particular care in all cases that have not been under their charge; and especially in epilepsy, convulsions, chronic rheumatism, derangement of the urinary organs, ophthalmia, ulcers, or any obscure disease liable to be feigned or purposely produced; and in no case shall such certificate be given until after sufficient time and examination to detect any attempt at deception.

DIRECTIONS.

This certificate will be made out in duplicate by the soldier's company commander, or other officer commanding the separate detachment to which he belongs, and sent by him to the surgeon who has charge of the hospital where the soldier is sick. The surgeon will then fill out and sign the surgeon's certificate, and forward these papers to the regimental, detachment, or post commander, who will forward them, with his action endorsed thereon, through the proper channel, to his division commander; or, if the troops are not attached to a division, to his corps, department, or other commander or officer to whom the authority to discharge enlisted men may be specially delegated.

These certificates, after having received the action of the highest authority to which they are required to be sent, will be returned through the same channel to the regimental, post, or detachment commander, who will, if the discharge is authorized by the endorsement of the proper authority, sign the soldier's discharge, and the last certificate on this paper; see that the soldier is furnished with the proper final statements in duplicate, and forward both of these certificates direct to the Adjutant General United States Army, at Washington, D. C.; they will not, under any circumstances, be given into the hands of the soldier.

ADJUTANT GENERAL'S OFFICE

176 23. 1865

Duplicate sent the Pension Office.

CERTIFICATE OF DISABILITY FOR DISCHARGE

IN THE CASE OF

Thomas L. ...

a Private Co. B

3rd Reg't of ...

Extract furnished to ...

HEAD-QUARTERS DEPT. OF TENNESSEE.

MEMPHIS, TENN., Sept. 1st 1865.

TO BE DISCHARGED.

BY COMMAND OF MAJ. GENERAL GEORGE STONEMAN

[Signature] CAPT. & A. G.



Received (A. G. Office.) 186

[Signature]

Ad Genl 3 US Army
Memphis Tenn Aug 27/65

I certify that the within named soldier is in my opinion unfit for duty in the Veteran Reserve Corps
E. M. ...
Major Genl Regt

OFFICE SURGEON IN CHIEF,
DIST. WEST TENN.

Memphis, Tenn., Aug 31st 1865.

Approved.

[Signature]
SURGEON
Surgeon in Chief, D. W. T.

ARMY OF THE UNITED STATES
CERTIFICATE

OF DISABILITY



FOR DISCHARGE

Sergeant *Thomas G. Graham* Captain *Andrew Emery*
Company, (B) of the *Third* Regiment of the United States
Cavalry was enlisted by *Captain Andrew Emery* of
the *3rd* Regiment of *Artillery* at *Chickburg, Miss*
on the *11th* day of *October*, 1863, to serve *3* years; he was born
in *Jackson* in the State of *Mississippi*, is *24*
years of age, *5* feet *7 1/2* inches high, *Black* complexion, *Black* eyes,
Black hair, and by occupation when enlisted a *Freight hand*. During the last two
months said soldier has been unfit for duty *60* days.* *Disease contracted*
by exposure during the winter of 64 & 85
since last enlistment in the line of duty

STATION: *Memphis, Tenn*
DATE: *August 26th 65*

A. Emery
Captain
Commanding Company.

I CERTIFY, that I have carefully examined the said *Thomas G. Graham*
of Captain *Emery's* Company, and find him incapable of performing the duties of a
soldier because of *"Debility from miasmatic disease"*. *Said soldier was attacked by inflammation*
of the lungs in January 1865 which has stubborn and his recovery was when in February 1865
had an attack of rheumatism in his feet which he has never recovered from. He is much debilitated
and complains of pain at "pit of the stomach". He is unfit for a soldier's service
for duty in U.S. Army Corps. Degree of Disability 75%

Price Keith
Surgeon.

DISCHARGED, this *11th* day of *September*, 1865, at *Memphis, Tenn*

by order of Wm's Genl. Stone
J. B. Cook
Commanding the Reg't.

The Soldier desires to be addressed at

Town.....County.....State.....

*See Note 1 on the back of this. † See Note 2 on the back of this.

719

Irving James
Co. B, 3 U. S. Col'd Cav.
Private Private

CARD NUMBERS.

1	26
2	27
3 <i>See Irwin</i>	28 <i>James</i>
4	29
5	30
6	31
7	32
8	33
9	34
10	35
11	36
12	37
13	38
14	39
15	40
16	41
17	42
18	43
19	44
20	45
21	46
22	47
23	48
24	49
25	50

Book Mark:

See also

720

Brown Eli

Co H, 3 U. S. Col'd Cav.

Private Private

CARD NUMBERS.

1	5341351	26
2	5341446	27
3	5341531	28
4	5341619	29
5	5341705	30
6	5341794	31
7	5341949	32
8	5342465	33
9	9089214	34
10	40727579	35
11	31691398	36
12		37
13		38
14		39
15		40
16		41
17		42
18		43
19		44
20		45
21		46
22		47
23		48
24		49
25		50

Book Mark:

See also

3 Cav. U.S.C.T.

Eli. Irvine

Co. H, 3 Reg't U. S. Col'd Cav.

Appears on

Company Descriptive Book

of the organization named above.

DESCRIPTION.

Age 24 years; height 5 feet 7 inches.

Complexion Blk

Eyes Blk; hair Blk

Where born Sunflower Co Miss

Occupation Field hand

ENLISTMENT.

When Oct 13, 1864.

Where Vicksburg Miss

By whom Capt H. White; term 3 y'rs.

Remarks: Died in Genl Hospital Memphis Tenn Oct 4 1864
Description list sent to Surg in Chg of Hospital

Hilton

I | **3 Cav. | U.S.C.T.**

Eli Swin

Pos, Co. H, 1 Reg't Miss. Cav. A. D.*

Age *24* years.

Appears on

Company Muster-in Roll

of the organization named above. Roll dated

Harris Bluff Miss, Feb 28, 1864.

Muster-in to date *Feb 15, 1864.*

Joined for duty and enrolled:

When *Sept 15*, 1864.

Where *Harris Bluff Miss*

Period *3* years.

Valuation of horse, \$ *100*

Valuation of horse equipments, *100*

Remarks:

* This organization subsequently became Company H, 3 Reg't U. S. Colored Cavalry.

Book mark:

Walter Scott

(356)

Copyist.

I | **3 Cav.** | **U.S.C.T.**

Eli Irwin
Plt....., Co. H, 3 Reg't U. S. Col'd Cavalry.

Appears on

Company Muster Roll

for *from July 23 to Apr 30*....., 186*1*.

Present or absent..... *Present*

Stoppage, \$.....*100* for

Due Gov't, \$.....*100* for

Valuation of horse, \$.....*100*

Valuation of horse equipments, \$.....*100*

Remarks:.....
.....
.....
.....
.....
.....
.....
.....
.....

Book mark:.....

W. H. Scott

9 | 3 Cav. | U.S.C.T.

Eli Brown
Pvt, Co. H, 3 Reg't U. S. Col'd Cavalry.

Appears on

Company Muster Roll
for Mayofune, 1864
Present or absent Present

Stoppage, \$ 100 for

Due Gov't, \$ 100 for

Valuation of horse, \$ 100

Valuation of horse equipments, \$ 100

Remarks:

Book mark:

(358) M. Payne Copyist.

I | **3 Cav.** | **U.S.C.T.**

Eli Irwin
Pvt, Co. H, 3 Reg't U. S. Col'd Cavalry.

Appears on

Company Muster Roll
for *July & Aug*, 1864.
Present or absent *Present*

Stoppage, \$ *100* for

Due Gov't, \$ *100* for

Valuation of horse, \$ *100*

Valuation of horse equipments, \$ *100*

Remarks:

Book mark: _____

(358)

W. Mayre
Copyist.

J | **3 Cav.** | **U.S.C.T.**

Eli Irwin
Prvt, Co. H, 3 Reg't U. S. Col'd Cavalry.

Appears on

Company Muster Roll
for *Sept & Oct*, 1864.
Present or absent *Present*

Stoppage, \$ *100* for

Due Gov't, \$ *100* for

Valuation of horse, \$ *100*

Valuation of horse equipments, \$ *100*

Remarks:

Book mark: _____

M. B. Payne
(358) *M. B. Payne* Copyist.

9 | 3 Cav. | U.S.C.T.

Eli Irwin

Pvt., Co. H, 3 Reg't U. S. Col'd Cavalry.

Appears on

Company Muster Roll

for Nov & Dec, 1864.

Present or absent Absent

Stoppage, \$ 100 for

Due Gov't, \$ 100 for

Valuation of horse, \$ 100

Valuation of horse equipments, \$ 100

Remarks: Absent sick
since Dec 24, 64.
Stop for one Carbide
Blind, & Ammel, one Cart
Box, one cap Box, one Sad-
dle Blanket, one Surewingle,
one pr Spurs & Straps, one cur-
ry comb one Horse brush, one
bridle, \$13.61

Book mark:

W. Wayne

(358)

Copyst.

I : 3 car 1 use 9

Eli Irwin
Pot, Co, H, 3 Reg't U.S. Cav

Appears on

Hospital Muster Roll

of Webster U. S. A. General Hospital,

at Memphis, Tenn.,

for Nov & Dec, 1864

Attached to hospital:

When Dec 24, 1864

How employed Sick

Last paid by Maj. Gander

to Aug 31, 1864

Bounty paid \$ 100; due \$ 100

Present or absent Present

Remarks:

Book mark:

J. Anderson

(548)

Copyist.

1 | **3 Cav. | U.S.C.T.**

Eli Drvin

507, Co. H, 3 Reg't U. S. Col'd Cavalry.

Appears on

Company Muster Roll

for Jan & Feb., 1865.

Present or absent _____

Stoppage, \$ _____ 100 for _____

Due Gov't, \$ _____ 100 for _____

Valuation of horse, \$ _____ 100

Valuation of horse equipments, \$ _____ 100

Remarks: Killed in Gen. Hospital
Feb. 7 / 65

Book mark: P. N. 4. 1 Oct. / 65. Killed
same

Louisa

(358)

Copyist.

JAN. - 8

5341949

1891

Feb. 4/65. E.B.N. 11. P. 46.

I. | 3 Cav. | U.S.C.T.

* Eli Irwin
Pvt., Co. H, 3 Reg't U. S. Colored Cav.

Appears on Returns as follows:

Dec. 1864. Absent sick in Gen. Hosp. Memphis, Tenn.

Jan. 1865. Absent sick, Hosp. Dec. 24"

Feb. 1865. Loss Feb. 7/65 - Memphis, Tenn. - Died of disease.

* Name appears also as Levi Irwin.

Book mark :

(546)

J. B. Dittler

Copyist.

J | **3 Cav.** | **U.S.C.T.**

Eli J. J. J. J.

Pvt., Co. H., 3 Reg't U. S. Col'd Cavalry.

Appears on **Co. Muster-out Roll**, dated Memphis Tenn Jan 26, 1866.

Muster-out to date _____, 1866.

Last paid to Aug 31, 1864.

Clothing account:

Last settled _____, 1866 ; drawn since \$ _____ 100

Due soldier \$ _____ 100; due U. S. \$ _____ 100

Am't for cloth'g in kind or money adv'd \$ _____ 100

Due U. S. for arms, equipments, &c., \$ _____ 100

Bounty paid \$ _____ 100; due \$ _____ 100

Remarks: Laid in U.S.G.
Post Hospital at Mem-
phis Tenn. Feb 4 1865

Book mark: P.V. 4 P. 104/68. E 28. vol 13.

2748-79, 1868

(361)

J. J. J.

Copyist.

Irwin, Eli

B., Co. A,

3

U. S. C. Cav.
Reg't

Enclosures.

Bed Cards

Burial Records

Certs. of Dis. for Discharge

C. M. Charges

Med. Certificates

Descriptive Lists

Final Statements

Furloughs

Med. Des. Lists

Orders

Other papers relating to—

Admission to Hosp'l

Casualty Sheet (Officer's)

Confinement

Contracts

Death or Effects

Desertions

Discharge from Hosp'l

Discharge from Service

Duty

Furlough

Med. Examination

Misc. Information

Pay or Clothing

Personal Reports

Rank

Transfer to Hosp'l

Transfer to V. R. C.

Transportation

[OFFICE INDORSEMENT.]

War Department,

ADJUTANT GENERAL'S OFFICE,

May 14, 1871

The South of the 1st
Reg't, Co. H, 3rd Reg't U. S.

Colored troop, is reported as follows:

- On Company Muster Roll.
- For Jan 1st, 1865, May 7, 1865
- Company Muster-out Roll.
- Feb 4, 1865
- Company Descriptive Book.
-, 186
- Company Morning Reports.
-, 186
- Soldier's Final Statement.
- Feb 4, 1865
- Soldier's Record of Death and Interment.
-, 186
- Soldier's Inventory of Effects.
-, 186
- Soldier's Certificate of Disability for Discharge.
-, 186
- Soldier's Individual Muster-out Roll.
-, 186
- Regimental Return of
- For Feb 4, 1865, May 7, 1865
- Regimental Quarterly Returns.
-, 186
- Regimental Descriptive Book.
-, 186
- By Surgeon General.
-, 186

Feb 4, 1865, is held to be

the correct date, and the Company Muster-out Roll will be amended accordingly.

See letter to 7 and copy of it
Thomas M. Furent

E. B. 11
46

Assistant Adjutant General.

Noted 11/11

FINAL STATEMENT

OF

Eli' Inwin

3rd Reg't of U.S. Col.

VOLUNTEERS.

NOTE 1.—Two of these certificates (or duplicates) are to be given to each Volunteer Soldier or drafted man who may be discharged previously to the discharge of his company, that he may at once receive from the Paymaster the pay, &c., due him, and the captain or other COMMISSIONED officer commanding the company will certify to the act of the delivery of the duplicate certificates; on these certificates the Soldier is "entitled to" his discharge, and should also present his discharge to the Paymaster to have the payment endorsed on it. The discharge is to be given back to the Soldier by the Paymaster; the latter only retaining as his voucher the duplicate certificates.

NOTE 2.—If the Soldier is entitled to pay for the use of his horse, the Company Commander will certify to that fact on the back of both these final statements, and also to the time he has pay due for having been so mounted on his own horse.

NOTE 3.—When a Soldier is furnished with final statements, his descriptive list, if he has one, should be taken up by the officer who gives the Soldier these statements, and endorsed with a statement to this effect by the officer. This endorsement should exhibit a full statement of the time for which the Soldier was allowed pay on his final statements, the clothing account, and all other charges against him or in his favor, so as to comprise a complete exhibit of his account. It will then be transmitted to the company commander of the Soldier, who will enter all the data necessary to a full understanding of the Soldier's account on the muster roll upon which the Soldier's discharge is reported. The descriptive list will then be destroyed. The object of this is, that the remaining portion of the Soldier's account may be settled upon the receipt of these muster rolls, and the Soldier receive any pay or allowances that may be due him at the time of his discharge, and which may not appear on his final statements from the fact that his descriptive list is incomplete. These accounts for back pay, &c., are settled by the 2d Auditor of the Treasury Department.

NOTE 4.—Charges for loss or injury to ordnance, horse equipments, and other miscellaneous charges, should appear under the heading of "Other Stoppages."

NOTE 5.—Bounty paid by State authorities, and not by the United States, will not be entered on this statement.

NOTE 6.—Amounts due the Sutler and Laundress must be entered on the muster roll on which the discharge, death, desertion, &c., is reported, as well as on the final statement, otherwise the amount cannot be collected from the United States.

NOTE 7.—This blank will be used for deceased volunteers and drafted men, as well as for others.

NOTE 8.—Where a Soldier dies in Hospital or on detached service, his descriptive list, if he has one, should be sent with his final statements, in duplicate, to the Adjutant General, Washington, D. C.

11/11

[OFFICE INDORSEMENT.]

War Department,

ADJUTANT GENERAL'S OFFICE,

May 11, 1864

The South of *the* *1st*
Reg't, Co. *H*, 3rd Reg't U. S.

Colored Cavalry, is reported as follows:

On Company Muster Roll.	
For <i>February</i> , 186 <i>4</i> , <i>March 7</i> , 186 <i>4</i>	
Company Muster-out Roll.	
<i>Feb 4</i> , 186 <i>4</i>	
Company Descriptive Book.	186
	186
Company Morning Reports.	186
	186
Soldier's Final Statement.	
<i>Feb 4</i> , 186 <i>4</i>	186
Soldier's Record of Death and Interment.	186
	186
Soldier's Inventory of Effects.	186
	186
Soldier's Certificate of Disability for Discharge.	186
	186
Soldier's Individual Muster-out Roll.	186
	186
Regimental Return	
For <i>Feb 4</i> , 186 <i>4</i> , <i>March 7</i> , 186 <i>4</i>	186
Regimental Quarterly Returns.	186
	186
Regimental Descriptive Book.	186
	186
By Surgeon General.	186

Feb 4, 186*4*, is held to be

the correct date, and the Company Muster-out Roll will be amended accordingly.

See order to 2^d and copy 19 7th
Thomas M. French

E. B. 11
46.

Assistant Adjutant General.

Noted 28.11

FINAL STATEMENT

OF

Eli Irwin

3rd Reg't of *U. S. Cavalry*

VOLUNTEERS.

NOTE 1.—Two of these certificates (or duplicates) are to be given to each Volunteer Soldier or drafted man who may be discharged previously to the discharge of his company, that he may at once receive from the Paymaster the pay, &c., due him, and the captain or other COMMISSIONED officer commanding the company will certify to the act of the delivery of the duplicate certificates; on these certificates the Soldier is "entitled to" his discharge, and should also present his discharge to the Paymaster to have the payment endorsed on it. The discharge is to be given back to the Soldier by the Paymaster; the latter only retaining as his voucher the duplicate certificates.

NOTE 2.—If the Soldier is entitled to pay for the use of his horse, the Company Commander will certify to that fact on the back of both these final statements, and also to the time he has pay due for having been so mounted on his own horse.

NOTE 3.—When a Soldier is furnished with final statements, his descriptive list, if he has one, should be taken up by the officer who gives the Soldier these statements, and endorsed with a statement to this effect by the officer. This endorsement should exhibit a full statement of the time for which the Soldier was allowed pay on his final statements, the clothing account, and all other charges against him or in his favor, so as to comprise a complete exhibit of his account. It will then be transmitted to the company commander of the Soldier, who will enter all the data necessary to a full understanding of the Soldier's account on the muster roll upon which the Soldier's discharge is reported. The descriptive list will then be destroyed. The object of this is, that the remaining portion of the Soldier's account may be settled upon the receipt of these muster rolls, and the Soldier receive any pay or allowances that may be due him at the time of his discharge, and which may not appear on his final statements from the fact that his descriptive list is incomplete. These accounts for back pay, &c., are settled by the 2d Auditor of the Treasury Department.

NOTE 4.—Charges for loss or injury to ordnance, horse equipments, and other miscellaneous charges, should appear under the heading of "Other Stoppages."

NOTE 5.—Bounty paid by State authorities, and not by the United States, will not be entered on this statement.

NOTE 6.—Amounts due the Sutler and Laundress must be entered on the muster roll on which the discharge, death, desertion, &c., is reported, as well as on the final statement, otherwise the amount cannot be collected from the United States.

NOTE 7.—This blank will be used for deceased volunteers and drafted men, as well as for others.

NOTE 8.—Where a Soldier dies in Hospital or on detached service, his descriptive list, if he has one, should be sent with his final statements, in duplicate, to the Adjutant General, Washington, D. C.

FINAL STATEMENT

OF

Eli Irwin

3rd Reg't of U.S. Cavalry

VOLUNTEERS.

Company 115

NOTE 1.—Two of these certificates (or duplicates) are to be given to each Volunteer Soldier or drafted man who may be discharged previously to the discharge of his company, that he may at once receive from the Paymaster the pay, &c., due him, and the captain or other COMMISSIONED officer commanding the company will certify to the act of the delivery of the duplicate certificates; on these certificates the Soldier is "entitled to" his discharge, and should also present his discharge to the Paymaster to have the payment endorsed on it. The discharge is to be given back to the Soldier by the Paymaster; the latter only retaining as his voucher the duplicate certificates.

NOTE 2.—If the Soldier is entitled to pay for the use of his horse, the Company Commander will certify to that fact on the back of both these final statements, and also to the time he has pay due for having been so mounted on his own horse.

NOTE 3.—When a Soldier is furnished with final statements, his descriptive list, if he has one, should be taken up by the officer who gives the Soldier these statements, and endorsed with a statement to this effect by the officer. This endorsement should exhibit a full statement of the time for which the Soldier was allowed pay on his final statements, the clothing account, and all other charges against him or in his favor, so as to comprise a complete exhibit of his account. It will then be transmitted to the company commander of the Soldier, who will enter all the data necessary to a full understanding of the Soldier's account on the muster roll upon which the Soldier's discharge is reported. The descriptive list will then be destroyed. The object of this is, that the remaining portion of the Soldier's account may be settled upon the receipt of these muster rolls, and the Soldier receive any pay or allowances that may be due him at the time of his discharge, and which may not appear on his final statements from the fact that his descriptive list is incomplete. These accounts for back pay, &c., are settled by the 2d Auditor of the Treasury Department.

NOTE 4.—Charges for loss or injury to ordnance, horse equipments, and other miscellaneous charges, should appear under the heading of "Other Stoppages."

NOTE 5.—Bounty paid by State authorities, and not by the United States, will not be entered on this statement.

NOTE 6.—Amounts due the Sutler and Laundress must be entered on the muster roll on which the discharge, death, desertion, &c., is reported, as well as on the final statement, otherwise the amount cannot be collected from the United States.

NOTE 7.—This blank will be used for deceased volunteers and drafted men, as well as for others.

NOTE 8.—Where a Soldier dies in Hospital or on detached service, his descriptive list, if he has one, should be sent with his final statements, in duplicate, to the Adjutant General, Washington, D. C.

AGO

Desc list sent 2^d Auditor

371

ADJUTANT GENERAL'S OFFICE.

July 14th 1865.

Duplicate with Inventory sent 2d Auditor.

Stewart

I certify, on honor, that Oli Swain Private of
 Captain Samson White's Company (26) of the 3rd Regiment of U.S. Col. Cav.
VOLUNTEERS, of the State of _____, born in Sumflower, State
 of Mississippi, aged 24 years; 5 feet 1 inches high; Blk complexion,
Blk eyes, Blk hair, and by occupation a Field Hand, having joined the company on
 its original organization at Hains Bluff, and enrolled in it at the muster into
 the service of the United States at Hains Bluff, on the 23rd day
 of February, 1864, (or was mustered in service as a recruit, by _____
 _____, at _____, on the _____ day of _____,
 186 , or was drafted and mustered into the service of the United States from the _____
 Enrollment District of the State of _____, at _____,
 on the _____ day of _____, 186) to serve in the Regiment, for
 the term of Three Years : and having served **HONESTLY** and
FAITHFULLY with his Company in The field to the present date, is now
 entitled to a **DISCHARGE** by reason of death Died in Small Pox
Hospital Memphis Tenn. Feb 4th 1865 of Small Pox

The said Oli Swain was last paid by Paymaster
Maj. Leander to include the 31st day of August, 1864, and has
 pay due him from that time to the present date; he is entitled to pay and subsistence for
TRAVELING to place of enrollment, and whatever other allowances are authorized to volunteer
 soldiers, drafted men, or militia, so discharged. He has received from the United States **CLOTHING**
 amounting to 24 ⁴⁰/₁₀₀ dollars, since the 31st day of August,
 1864, when his clothing account was last settled. He has received from the United States
 _____ 100 dollars advanced **BOUNTY**.

There is to be stopped from him, on account of the State of _____, or other
 authorities, for **CLOTHING**, &c, received on entering service, _____ 100 dollars; and
 for other stoppages, viz: _____
 _____ 100 dollars.

He has been furnished with **TRANSPORTATION** in kind from the place of his discharge to
 _____; and he has been **SUBSISTED** for **TRAVELING** to his
 place of enrollment, up to the _____, 186 .

He is indebted to _____, **SUTLER**, _____ 100 dollars.
 He is indebted to _____, **LAUNDRESS**, _____ 100 dollars.

Given in Duplicate, at Memphis Tennessee, this 4th day
 of February, 1865.

A. H. Huntington
 | Co. Surgeon U.S. in Chg. Hosp.
 Commanding Company

I certify, on honor, that Oli Swain Private of
Captain Samson White's Company (26) of the 3rd Regiment of U.S. Col. Cav.
VOLUNTEERS, of the State of _____, born in Sumflower, State
of Mississippi, aged 24 years; 5 feet 1 inches high; Blk complexion,
Blk eyes, Blk hair, and by occupation a Field Hand, having joined the company on
its original organization at Hains Bluff, and enrolled in it at the muster into
the service of the United States at Hains Bluff, on the 23rd day
of February, 1864, (or was mustered in service as a recruit, by _____
at _____, on the _____ day of _____,
186 , or was drafted and mustered into the service of the United States from the _____
Enrollment District of the State of _____, at _____,
on the _____ day of _____, 186) to serve in the Regiment, for

the term of Three Years : and having served **HONESTLY** and
FAITHFULLY with his Company in The field to the present date, is now
entitled to a **DISCHARGE** by reason of death Died in Small Pox
Hospital Memphis Tenn. Feb 4th 1865 of Small Pox

The said Oli Swain was last paid by Paymaster
Maj. Candu to include the 31st day of August, 1864, and has
pay due him from that time to the present date; he is entitled to pay and subsistence for
TRAVELING to place of enrollment, and whatever other allowances are authorized to volunteer
soldiers, drafted men, or militia, so discharged. He has received from the United States **CLOTHING**
amounting to 24 ⁴⁰/₁₀₀ dollars, since the 31st day of August,
1864, when his clothing account was last settled. He has received from the United States
100 dollars advanced **BOUNTY**.

There is to be stopped from him, on account of the State of _____, or other
authorities, for **CLOTHING**, &c, received on entering service, _____ dollars; and
for other stoppages, viz: _____

_____ dollars.
He has been furnished with **TRANSPORTATION** in kind from the place of his discharge to
_____ ; and he has been **SUBSISTED** for **TRAVELING** to his
place of enrollment, up to the _____, 186 .

He is indebted to _____, **SUTLER**, _____ dollars.

He is indebted to _____, **LAUNDRESS**, _____ dollars.

Given in Duplicate, at Memphis Tennessee, this 4th day
of February, 1865.

A. H. Huntington

1st Lieut Surgeon U.S. in Chg Hosp
Commanding Company

721
Brown James

Co. B, 3 U. S. Col'd Cav.

Private Private

CARD NUMBERS.

1	J 331143	26
2	J 333875	27
3	J 333960	28
4	J 334052	29
5	J 334143	30
6	J 334255	31
7	J 334350	32
8	J 334438	33
9	J 334528	34
10	J 334612	35
11	J 334688	36
12	9088417	37
13	40727580	38
14		39
15		40
16		41
17		42
18		43
19		44
20		45
21		46
22		47
23		48
24		49
25		50

Book Mark:

See also

I | 3 Cav. | U.S.C.T.

James Irwin -

Co. B, 3 Reg't U. S. Col'd Cav.

Appears on

Company Descriptive Book
of the organization named above.

DESCRIPTION.

Age 22 years; height 5 feet 4½ inches.

Complexion Colored

Eyes Black; hair Black

Where born Warren Co. Miss.

Occupation Laborer

ENLISTMENT.

When June 17, 1864

Where Pickens

By whom Walter N. Hall; term 3 yrs.

Remarks:

F. A. Wright

I. | 3 Cav. | U.S.C.T.

James Irving

Appears with rank of *Private* on

Muster and Descriptive Roll of a Detachment of U. S. Vols. forwarded

for the 3 Reg't U. S. Col'd Cavalry. Roll dated

Vicksburg, Miss., Aug. 20, 1864.

Where born *Warren Co., Miss.*

Age *23* y'rs; occupation *Laborer.*

When enlisted *August 17*, 1864.

Where enlisted *Vicksburg, Miss.*

For what period enlisted *three* years.

Eyes *black*; hair *black*;

Complexion *coloured*; height *5 ft. 4 1/2 in.*

When mustered in *August 17*, 1864.

Where mustered in *Vicksburg, Miss.*

Bounty paid \$ *100*; due \$ *300.⁰⁰/₁₀₀*

Where credited *Charlotte, 31 Diet, N.Y.*
Chautauqua Co.

Company to which assigned

Remarks:

Book mark:

W. Grauner

(339)

Copyist.

9 | 3 Cav. | U.S.C.T.

James Irwin
Pvt, Co. B, 3 Reg't U. S. Col'd Cavalry.

Appears on

Company Muster Roll
for July & Aug, 1864
Present or absent Present

Stoppage, \$ 100 for

Due Gov't, \$ 100 for

Valuation of horse, \$ 100

Valuation of horse equipments, \$ 100

Remarks:

Book mark:

(358)

M. Maye
Copyist.

I | **3 Cav.** | **U.S.C.T.**

James Irvine

Priv., Co. B, 3 Reg't U. S. Col'd Cavalry.

Appears on

Company Muster Roll

for *Sept and Oct.*, 186*4*.

Present or absent *Present*

Stoppage, \$ *100* for

Due Gov't, \$ *100* for

Valuation of horse, \$ *100*

Valuation of horse equipments, \$ *100*

Remarks: -----

Book mark : -----

(358)

J. B. James

Copyist.

J | **3 Cav.** | **U.S.C.T.**

James Irwin

Pvt., Co. B, 3 Reg't U. S. Col'd Cavalry.

Appears on

Company Muster Roll

for *Nov. and Dec.*, 1864.

Present or absent *absent*

Stoppage, \$ *100* for

Due Gov't, \$ *100* for

Valuation of horse, \$ *100*

Valuation of horse equipments, \$ *100*

Remarks: *On receipt*

Book mark:

(358)

J. B. Jones Copyist.

A | **3 Cav. | U.S.C.T.**

James Francis
Pratt, Co. B, 3 Reg't U. S. Col'd Cavalry.

Appears on

Company Muster Roll

for Jan. and Feb., 1866.

Present or absent Present

Stoppage, \$ 100 for

Due Gov't, \$ 100 for

Valuation of horse, \$ 100

Valuation of horse equipments, \$ 100

Remarks:

Book mark:

(358)

J. B. Jones
Cpyist.

I | **3 Cav.** | **U.S.C.T.**

James Irwin
Priv., Co. B, 3 Reg't U. S. Col'd Cavalry.

Appears on

Company Muster Roll

for March and April, 1865:

Present or absent Present.

Stoppage, \$ 100 for

Due Gov't, \$ 100 for

Valuation of horse, \$ 100

Valuation of horse equipments, \$ 100

Remarks:

Book mark:

(358)

J. B. Jones Copyist.

J | **3 Cav.** | **U.S.C.T.**

James Irwin
Co., Co. B, 3 Reg't U. S. Col'd Cavalry.

Appears on

Company Muster Roll

for *May and June*, 186*6*.

Present or absent *Present*

Stoppage, \$.....*100* for

Due Gov't, \$.....*100* for

Valuation of horse, \$.....*100*

Valuation of horse equipments, \$.....*100*

Remarks:

Book mark:

(358)

J. B. James Copyist.

I | **3 Cav.** | **U.S.C.T.**

James Irwin
Private, Co. B, 3 Reg't U. S. Col'd Cavalry.

Appears on

Company Muster Roll

for July and August, 1865.

Present or absent Present

Stoppage, \$ 100 for

Due Gov't, \$ 100 for

Valuation of horse, \$ 100

Valuation of horse equipments, \$ 100

Remarks: _____

Book mark: _____

(358)

J. P. Jones Copyist.

I | **3 Cav. U.S.C.T.**

James Irwin
Privt, Co. B, 3 Reg't U. S. Col'd Cavalry.

Appears on

Company Muster Roll
for *Sept. & Oct.*, 1865.

Present or absent *Present*

Stoppage, \$ *100* for

Due Gov't, \$ *100* for

Valuation of horse, \$ *100*

Valuation of horse equipments, \$ *100*

Remarks: *Stop for one pr.*
Spurs & Straps 52¢

Book mark: _____

H. F. Brandon

I | 3 Cav. | U.S.C.T.

James Irwin
Priv., Co. B, 3 Reg't U. S. Col'd Cavalry.

Appears on

Company Muster Roll
for Nov. 1865.

Present or absent Present

Stoppage, \$.52¹⁰⁰ for Ordnance

Due Gov't, \$ 100 for

Valuation of horse, \$ 100

Valuation of horse equipments, \$ 100

Remarks:

Book mark:

H. C. Brandon

J. | **3 Cav.** | **U.S.C.T.**

James Irwin
Pvt, Co. B, 3 Reg't U. S. Colored Cav.

Appears on **Returns** as follows:

Aug. 1864. Gain Aug. 17/64
Vicksburg, Miss. Enlisted
as a recruit.

Jan. 1865, Absent - 18/65-

Book mark :

(546)

J. B. Sittler

Copyist.

I | **3 Cav.** | **U.S.C.T.**

James Irwin
Priv't, Co. B., 3 Reg't U. S. Col'd Cavalry.

Appears on **Co. Muster-out Roll**, dated
Memphis Tenn, Jan 26, 1866.

Muster-out to date Jan 26, 1866.

Last paid to June 30, 1865.

Clothing account:

Last settled, 186 ; drawn since \$.....100

Due soldier \$.....100; due U. S. \$ 9 13.....100

Am't for cloth'g in kind or money adv'd \$.....100

Due U. S. for arms, equipments, &c., \$.....100

Bounty paid \$ 00 100; due \$ 100 100

Remarks: Total Stoppage
for Ordnance 52 cts.

Book mark: V, 248, P. 34. 77

J. F. Brandon

(861)

Copyist.

722

Jackson, Andrew.

Co C., 3 U. S. Col'd Cav.

Private | Sergeant

CARD NUMBERS.

1	5-334824	26
2	5-334915	27
3	5-335003	28
4	5-335086	29
5	5-335168	30
6	5-335246	31
7	5-335324	32
8	5-335408	33
9	5-335491	34
10	5-335571	35
11	5-335668	36
12	5-335762	37
13	5-335852	38
14	5-335937	39
15	5-336020	40
16	9085521	41
17		42
18		43
19		44
20		45
21		46
22		47
23		48
24		49
25		50

Book Mark:

See also

S 763 332 P.O. 90
S 1215114 P.O. W.M.

R. V. Bayle
Esq.

44771053

J | **3 Cav. | U.S.C.T.**

Andrew Jackson

....., Co. *C*, 3 Reg't U. S. Col'd Cav.

Appears on

Company Descriptive Book
of the organization named above.

DESCRIPTION.

Age *20* years; height *5* feet *4* inches.

Complexion *Black*

Eyes *Black*; hair *Black*

Where born *Warren Co. Miss.*

Occupation *Farmer*

ENLISTMENT.

When *Nov. 1-*, 186 *3*

Where *Vicksburg Miss.*

By whom *B. S. Wing*; term *3* y'rs.

Remarks: *Promoted to
Sergt.*

.....
.....
.....
.....
.....
.....

F. A. Wright

ARR 1054

3 Cav. U.S.C.T.

J. Andrew Jackson
Priv., Co. *C*, 1 Reg't Miss. Cav., A. D.†

Age *20* years.

Appears on

Company Muster-in Roll

of the organization named above. Roll dated

Vicksburg, Miss. Nov 1, 1863.

Muster-in to date *Nov 1, 1863.*

Joined for duty and enrolled:

When *Nov. 1, 1863.**

Where *Vicksburg, Miss.*

Period *3* years.*

Valuation of horse, \$ *100*

Valuation of horse equipments, \$ *100*

Remarks:

† This organization subsequently became Co. *C*, 3 Reg't U. S. Colored Cavalry.

* * * Muster-in roll shows enrollment and muster-in of this company as of same date. See enrollment on subsequent card or cards.

Book mark:

A. Johnson
Copyist.

1863

J. | **3 Cav. | U.S.C.T.**
Andrew Jackson
Put, Co. *C*, 1 Reg't Miss. Cav., A. D.†

Appears on

Company Muster Roll
for *Nov and Dec*, 1863

Joined for duty and enrolled:

When *Nov 1*, 1863.*

Where *Wicksburg* *

Period *3* years.*

Present or absent *Not stated*

Stoppage, \$ *100* for

Due Gov't \$ *100* for

Valuation of horse, \$ *100*

Valuation of horse equipments, *100*

Remarks:

† This organization subsequently became Co. *C*, 3 Reg't U. S. Colored Cavalry.
* See enrollment on card from muster-in roll

Book mark:

(358d)

R Johnson
Copyist.

3 Cav. U.S.C.T.

Andrew Jackson
Put, Co. C, 1 Reg't Miss. Cav., Corps d'Afrique.*

Appears on

Company Muster Roll

for *Jan'y & Feby*, 186*4*.

Present or absent *Present*

Stoppage, \$ *100* for

Due Gov't, \$ *100* for

Valuation of horse, \$ *100*

Valuation of horse equipments, \$ *100*

Remarks: *Stopped for 1*
sun shine # 116

*This organization subsequently became Co. C, 3 Reg't U. S. Colored Cavalry.

Book mark:

(358)

C. Johnson
Coppist.

1864

J. | **3 Cav. | U.S.C.T.**

Andrew Jackson

Privt, Co. C, 3 Reg't U. S. Col'd Cavalry.

Appears on

Company Muster Roll

for *March & April*, 186*4*.

Present or absent *Present*

Stoppage, \$ *100* for

Due Gov't, \$ *100* for

Valuation of horse, \$ *100*

Valuation of horse equipments, \$ *100*

Remarks:
.....
.....
.....
.....
.....
.....
.....
.....
.....

Book mark:

R. Johnson
Copyist.

J. | **3 Cav.** | **U.S.C.T.**

Andrew Jackson
Put, Co. C, 3 Reg't U. S. Col'd Cavalry.

Appears on

Company Muster Roll

for *May and June*, 186 *4*.

Present or absent *Present*

Stoppage, \$ *100* for

Due Gov't, \$ *100* for

Valuation of horse, \$ *100*

Valuation of horse equipments, \$ *100*

Remarks:

Book mark: _____

(358)

R. Johnson
Copyist.

J | **3 Cav.** | **U.S.C.T.**

Andrew Jackson
Pat, Co. C, 3 Reg't U. S. Col'd Cavalry.

Appears on

Company Muster Roll
for *July & Aug.*, 186*4*.
Present or absent *Present*

Stoppage, \$ *100* for

Due Gov't, \$ *100* for

Valuation of horse, \$ *100*

Valuation of horse equipments, \$ *100*

Remarks:

Book mark: _____

R. Johnson

(358) Copyst.

J | **3 Cav.** | **U.S.C.T.**

Andrew Jackson
Pat, Co. C, 3 Reg't U. S. Col'd Cavalry.

Appears on

Company Muster Roll
for July & Aug., 1864.
Present or absent Present

Stoppage, \$ 100 for _____

Due Gov't, \$ 100 for _____

Valuation of horse, \$ 100

Valuation of horse equipments, \$ 100

Remarks: _____

Book mark: _____

R. Johnson

(358) Copyist.

J

3 Cav. U.S.C.T.

Andrew Jackson
Priv, Co. C, 3 Reg't U. S. Col'd Cavalry.

Appears on

Company Muster Roll

for Sept & Oct, 1864.

Present or absent Present

Stoppage, \$ 100 for

Due Gov't, \$ 100 for

Valuation of horse, \$ 100

Valuation of horse equipments, \$ 100

Remarks:

Book mark:

(358)

Talbot Copyist.

MARR 10 72

J | **3 Cav. | U.S.C.T.**

Andrew Jackson
Triv, Co. C, 3 Reg't U. S. Col'd Cavalry.

Appears on

Company Muster Roll

for *Nov & Dec*, 186*4*.

Present or absent *Absent*

Stoppage, \$ 100 for

Due Gov't, \$ 100 for

Valuation of horse, \$ 100

Valuation of horse equipments, \$ 100

Remarks: *Out scout*

Book mark:

(358)

Talbot
Copyist.

APR 1875

J | **3 Cav.** | **U.S.C.T.**

Andrew Jackson
Priv, Co. C, 3 Reg't U. S. Col'd Cavalry.

Appears on

Company Muster Roll
for *Jany & Kelly*, 186*5*.
Present or absent *Present*

Stoppage, \$.....100 for

Due Gov't, \$.....100 for

Valuation of horse, \$.....100

Valuation of horse equipments, \$.....100

Remarks:.....
.....
.....
.....
.....
.....
.....
.....
.....

Book mark:.....

(358)

Galvorth
Copyist.

J

3 Cav. | U.S.C.T.

Andrew Jackson
Corp, Co. C, 3 Reg't U. S. Col'd Cavalry.

Appears on

Company Muster Roll

for *March & April*, 186*5*.

Present or absent *absent*

Stoppage, \$ *100* for

Due Gov't, \$ *100* for

Valuation of horse, \$ *100*

Valuation of horse equipments, \$ *100*

Remarks: *Promoted from Priv-
ate March 1/65. By O. of,
Maj Chapin Co, Regt, on
expedition Apr 29/65*

Book mark: _____

Talbot
Copyist.

J | **3 Cav. | U.S.C.T.**

Andrew Jackson
Corp, Co. C, 3 Reg't U. S. Col'd Cavalry.

Appears on

Company Muster Roll

for *May & June*, 186*5*.

Present or absent *Present*

Stoppage, \$ 100 for

Due Gov't, \$ 100 for

Valuation of horse, \$ 100

Valuation of horse equipments, \$ 100

Remarks:
.....
.....
.....
.....
.....
.....
.....
.....

Book mark:

(358)

Talburt
Copyist.

J | **3 Cav. | U.S.C.T.**

Andrew Jackson
Corp, Co. C, 3 Reg't U. S. Col'd Cavalry.

Appears on

Company Muster Roll
for *July & Aug*, 186*5*.
Present or absent *Present*

Stoppage, \$.....100 for

Due Gov't, \$.....100 for

Valuation of horse, \$.....100

Valuation of horse equipments, \$.....100

Remarks:

Book mark:

(358)

Talburt
Copyist.

J | **3 Cav. | U.S.C.T.**

Andrew Jackson
Sgt, Co. C, 3 Reg't U. S. Col'd Cavalry.

Appears on

Company Muster Roll

for *Sept Oct*, 1865.

Present or absent *Present*

Stoppage, \$ *100* for

Due Gov't, \$ *100* for

Valuation of horse, \$ *100*

Valuation of horse equipments, \$ *100*

Remarks *Dismissed from Corp'l*
Sept. 1. 1865,

Book mark:

1867

J. | **3 Cav. | U.S.C.T.**

Andrew Jackson
Sgt., Co. C, 3 Reg't U. S. Col'd Cavalry.

Appears on **Co. Muster-out Roll**, dated
Memphis, Tenn. July 26, 1866.
Muster-out to date July 26, 1866.
Last paid to June 30, 1865.

Clothing account:

Last settled _____, 186__ ; drawn since \$ _____ 100
Due soldier \$ ^{48 43} 100; due U. S. \$ _____ 100
Am't for cloth'g in kind or money adv'd \$ _____ 100

Due U. S. for arms, equipments, &c., \$ _____ 100

Bounty paid \$ _____ 100; due \$ _____ 100

Remarks: _____

Book mark: _____

(861)

Kuman
Copyist.

723 on Andrew S.
Jackson Andrew
Co E., 3 U. S. Col'd Cav.

Private | *Private*

CARD NUMBERS.

1	5-331323	26
2	5-338114	27
3	5-338206	28
4	5-3383157	29
5	5-338414	30
6	5-338497	31
7	5-338587	32
8	5-338662	33
9	5-338728	34
10	9088882	35
11	40727591	36
12		37
13		38
14		39
15		40
16		41
17		42
18		43
19		44
20		45
21		46
22		47
23		48
24		49
25		50

Book Mark:

See also

S 2866084 and W.D.
P.O. M.M. Cl. 740487 3/28/14 JHS
Certf. in lieu furnished 7-24-20 JHS

W. Vel. Bur.
1/18/27 ec.

Rev. Bayle
Ep.

4 | 3 Cav. | U.S.C.T.

Andrew S. Jackson

....., Co. E, 3 Reg't U. S. Col'd Cav.

Appears on

Company Descriptive Book

of the organization named above.

DESCRIPTION.

Age 22 years; height 5 feet 7 inches.

Complexion Black

Eyes Black; hair Black

Where born Bedford Co., Tennessee

Occupation Farmer

ENLISTMENT.

When Nov 12, 1864

Where Newport Ky

By whom Capt. Cook; term 3 y'rs.

Remarks:
.....
.....
.....
.....
.....
.....
.....

E. W. W. W.

J. | **3 Cav. U.S.C.T.**

Andrew Jackson

Appears with rank of *Pvt.* on

Muster and Descriptive Roll of a Detachment of U. S. Vols. forwarded

for the, 3 Reg't U. S. Col'd Cavalry. Roll dated

Vicksburg Miss, Nov 2, 1864.

Where born *Bedford Co. Tenn.*

Age *22* y'rs; occupation *Labourer*

When enlisted *Nov 2*, 1864.

Where enlisted *Vicksburg, Miss.*

For what period enlisted *3* years.

Eyes *Black*; hair *Black*

Complexion *Colored*; height *5* ft. *7* in.

When mustered in *Nov 2*, 1864.

Where mustered in *Vicksburg Miss.*

Bounty paid \$ *100* ^{*00*}/_{*100*}; due \$ *200* ^{*00*}/_{*100*}

Where credited *State of Mass.*

Company to which assigned

Remarks:

Book mark:

Joiner.

(339)

Copyist.

J. | 3 Cav. | U.S.C.T.

Andrew Jackson
Pvt., Co. E, 3 Reg't U. S. Colored Cav.

Appears on Returns as follows:

Nov. 1864. Gain Nov. 2^d Vicksburg - Recruit.

Book mark :

(546)

J. B. Sittler

Copyist.

3 Cav. U.S.C.T.

Wm. H. ...

....., Co. E, 3 Reg't U.S. Col'd Cavalry.

Appears on

Company Muster Roll

for *Dec 1861*, 1861.

Present or absent *Present*

Stoppage, \$.....100 for

Due Gov't, \$.....100 for

Valuation of horse, \$.....100

Valuation of horse equipments, \$.....100

Remarks:

Book mark:

J. | **3 Cav.** | **U.S.C.T.**

Andrew Jackson

W., Co. E, 3 Reg't U.S. Col'd Cavalry.

Appears on

Company Muster Roll

for *Aug 4* *1862*, 186*2*.

Present or absent *Present*

Stoppage, \$ *100* for

Due Gov't, \$ *100* for

Valuation of horse, \$ *100*

Valuation of horse equipments, \$ *100*

Remarks:

Book mark:

(358)

J. A. Hall
Coyt.

J. | **3 Cav. | U.S.C.T.**
Andrew Jackson
Co. E, Co. E, 3 Reg't U. S. Col'd Cavalry.

Appears on

Company Muster Roll
for *Jan. & Feb.*, 186*7*.

Present or absent *Present*

Stoppage, \$ *100* for

Due Gov't, \$ *100* for

Valuation of horse, \$ *100*

Valuation of horse equipments, \$ *100*

Remarks:

Book mark: -----

(358)

[Signature]

Copyist.

4 | **3 Cav. | U.S.C.T.**

Amos J. ...

..., Co. E, 3 Reg't U.S. Col'd Cavalry.

Appears on

Company Muster Roll

for *...*, 186*5*.

Present or absent *Present*

Stoppage, \$ *14*/₁₀₀ for *Provision*

Due Gov't, \$ *100* for *...*

Valuation of horse, \$ *100*

Valuation of horse equipments, \$ *100*

Remarks: *...*
...
...

Book mark: *...*

...
Copyist.

3 Cav. U.S.C.T.

William A. Ryan
....., Co. E, 3 Reg't U.S. Col'd Cavalry.

Appears on

Company Muster Roll

for *April & May*, 186*9*.

Present or absent *Present*

Stoppage, \$ *100* for

Due Gov't, \$ *100* for

Valuation of horse, \$ *100*

Valuation of horse equipments, \$ *100*

Remarks:

Book mark:

W. A. Ryan

3 Cav. U.S.C.T.

Andrew Jackson

1st, Co. E, 3 Reg't U.S. Col'd Cavalry.

Appears on

Company Muster Roll

for *Sept 25th & 30th*, 1865.

Present or absent *Present.*

Stoppage, \$ 100 for

Due Gov't, \$ 100 for

Valuation of horse, \$ 100

Valuation of horse equipments, \$ 100

Remarks:

Book mark:

(358)

J. Lewis
Copyist.

1866 JAN 26

3 Cav. U.S.C.T.

Andrew Jackson

Cpt., Co. E., 3 Reg't U. S. Col'd Cavalry.

Appears on **Co. Muster-out Roll**, dated
Memphis, Tenn. Jan. 26., 1866 .

Muster-out to date *Jan. 26., 1866 .*

Last paid to *June 30., 1865 .*

Clothing account:

Last settled, 186 ; drawn since \$..... 100

Due soldier \$ *100⁰⁸*; due U. S. \$..... 100

Am't for cloth'g in kind or money adv'd \$..... 100

Due U. S. for arms, equipments, &c., \$ *1⁶⁷/₁₀₀*

Bounty paid \$..... 100; due \$..... 100

Remarks: *Bounty due 1st installment
\$100. None paid.*

Book mark :

(361)

Lewis
Copyist.

Jackson, Andrew J.

Co. 3 Reg't U.S.C. Cav.

3 Enclosures.

Bed Cards	Final Statements
Burial Records	Furloughs or L. of A.
Certs. of Dis. for Discharge	Med. Certificates
C. M. Charges	Med. Des. Lists
Descriptive Lists	Orders
Discharge Certificates	Pris. of War Record
Enlistment Papers	Resignations

Other papers relating to—

Admission to Hosp'l	Furlough or L. of A.
Casualty Sheet	Med. Examination
Confinement	Misc. Information
Contracts	Pay or Clothing
Death or Effects	Personal Reports
Desertion	Rank
Discharge from Hosp'l	Transfer to Hosp'l
Discharge from Service	Transfer to V. R. C.
Duty	Transportation

S of S Ry 1

NOTE 1.—This blank will be used for both enlistments and reenlistments—enlistment of veterans, &c., &c., in the volunteer service. They will be made out in duplicate in all cases—one to accompany the returning return of the soldier, and the other to be sent to the Adjutant General and one to accompany the accounts of the officer who pays bounty, &c. The Regiment and Company, if known, should be given on the back.

NOTE 2.—An enlistment book is to be used in all cases. A master-roll must, in all cases, be filed in the Adjutant General's Office as evidence of muster. The commanding officer, commanding or assistant commissary of musters, as the case may be, will countersign both enlistments as having mustered the soldier into the service of the United States before either of them is given to the disbursing officer.

DECLARATION OF RECRUIT.

*, Andrew J Jackson, desiring to VOLUNTEER as a Soldier in the Army of the United States, for the term of THREE YEARS, Do Declare, That I am Twenty two years and _____ months of age; that I have never been discharged from the United States service on account of disability or by sentence of a court martial, or by order before the expiration of a term of enlistment; and I know of no impediment to my serving honestly and faithfully as a soldier for three years.

GIVEN at Vicksburg Miss the 2nd day of November 1864

Witness: John McCarthy Andrew J Jackson

No. Andrew J Jackson

Volunteered at Vicksburg Miss

1st November 1864

By Chas. Kincaid West
Sgt. 3rd Mississippi
Regiment of _____

enlistment; last served in Company () B

Reg't of _____
Discharged _____, 18 _____



CONSENT IN CASE OF MINOR.

I, _____, Do CERTIFY, That I am the _____ of _____; that the said _____ is _____ years of age; and I do hereby freely give my CONSENT to his volunteering as a SOLDIER in the ARMY OF THE UNITED STATES for the period of THREE YEARS.

GIVEN at _____ the _____ day of _____

Witness: _____

VOLUNTEER ENLISTMENT.

STATE OF

TOWN OF

Mississippi



Vicksburg

I, Andrew Jackson, born in Reelfoot in the State of Mississippi, aged Twenty-two years, and by occupation a Laborer, Do HEREBY ACKNOWLEDGE to have volunteered this Second day of November, 1864, to serve as a **Soldier** in the Army of the United States of America, for the period of **THREE YEARS**, unless sooner discharged by proper authority: Do also agree to accept such bounty, pay, rations, and clothing, as are, or may be, established by law for volunteers. And I, Andrew Jackson, do solemnly swear, that I will bear true faith and allegiance to the **United States of America**, and that I will serve them honestly and faithfully against all their enemies or opposers whomsoever; and that I will observe and obey the orders of the President of the United States, and the orders of the officers appointed over me, according to the Rules and Articles of War.

Sworn and subscribed to, at Vicksburg this 2nd day of November, 1864.

BEFORE Eli C Knudly Stobart Marshal

I CERTIFY, ON HONOR, That I have carefully examined the above-named Volunteer, agreeably to the General Regulations of the Army, and that, in my opinion, he is free from all bodily defects and mental infirmity, which would in any way disqualify him from performing the duties of a soldier.

H. H. Armstrong

Surgeon
EXAMINING SURGEON.

I CERTIFY, ON HONOR, That I have minutely inspected the Volunteer Andrew Jackson previously to his enlistment, and that he was entirely sober when enlisted; that, to the best of my judgment and belief, he is of lawful age; and that, in accepting him as duly qualified to perform the duties of an able-bodied soldier, I have strictly observed the Regulations which govern the recruiting service. This soldier has Blue eyes, Blue hair, Clear complexion, is Five feet None inches high.

Le Col Eli C Knudly
apt Marshal of Mass
Regiment of Volunteers,
Dist of Miss and RECRUITING OFFICER.

(A. G. O. No. 74 & 76.)

Mustered into the service of the United States, for three years or during the war, from date of enlistment, in Company 3 Regiment of 25th Iowa Volunteers on the 2 day of Nov, 1864, at St Louis

Merrill

W. J. Donohue
at St Louis

Chas M. D.

Enlisted to County

VOLUNTEER ENLISTMENT.

STATE OF

TOWN OF

Mississippi

Vicksburg



I, *Andrew Jackson*, born in *Bedford* in the State of *Tennessee*, aged *Twenty two* years, and by occupation a *Laborer*, Do HEREBY ACKNOWLEDGE to have volunteered this *Second* day of *November*, 1864, to serve as a **Soldier** in the Army of the United States of America, for the period of **THREE YEARS**, unless sooner discharged by proper authority: Do also agree to accept such bounty, pay, rations, and clothing, as are, or may be, established by law for volunteers. And I, *Andrew Jackson* do solemnly swear, that I will bear true faith and allegiance to the **United States of America**, and that I will serve them honestly and faithfully against all their enemies or opposers whomsoever; and that I will observe and obey the orders of the President of the United States, and the orders of the officers appointed over me, according to the Rules and Articles of War.

Sworn and subscribed to, at *Vicksburg* this *2nd* day of *Novem*, 1864.

BEFORE *Eli C Kusby* *Wm J McCarthy*
Sto Capt Pro Marshal

I CERTIFY, ON HONOR, That I have carefully examined the above-named Volunteer, agreeably to the General Regulations of the Army, and that, in my opinion, he is free from all bodily defects and mental infirmity, which would in any way disqualify him from performing the duties of a soldier.

H. H. Huntman
Singor M. S. S. S.
 EXAMINING SURGEON.

I CERTIFY, ON HONOR, That I have minutely inspected the Volunteer *Andrew Jackson* previously to his enlistment, and that he was entirely sober when enlisted; that, to the best of my judgment and belief, he is of lawful age; and that, in accepting him as duly qualified to perform the duties of an able-bodied soldier, I have strictly observed the Regulations which govern the recruiting service. This soldier has *black* eyes, *black* hair, *tanned* complexion, is *five* feet *nine* inches high.

Le Col Eli C Kusby
apt Pro Marshal of Mass
 Regiment of *Volunteers*,
District of Miss and RECRUITING OFFICER.

(A. G. O. No. 74 & 76.)

Enlisted to Company

Mustered into the service of the United States, for three years or during the war, from date of enlistment, in
 Regiment of *3* *W. G. B. Smith* Volunteers on the *2nd* day of *Nov*, 1864, at *St Louis Mo*
Company
St Louis Mo
St Louis Mo
St Louis Mo

Statement of Service Reference Slip.

Office Pension

Claim No. 740487

Andrew Jackson
(Name.)

, Co. E, 3 Reg't 1st Cal Cav

To med file 3/25, 1914

For med history

no med for ppo

Johnson
J.H.S.
7a

Med. serv. made
✓ 7 cds. rtd

Statement furnished March 28, 1914

(Form 447, A. G. O.)
Ed. Mar. 13-20,000.

J.H.S.
w-244

MAR 1955

724

Jackson Andrew

Co F., 3 U. S. Col'd Cav.

Private | Corporal

CARD NUMBERS.

1	5331306	26
2	5339289	27
3	5339373	28
4	5339467	29
5	5339570	30
6	5339664	31
7	5339754	32
8	5339809	33
9	5339889	34
10	5339968	35
11	9088975	36
12	40727582	37
13		38
14		39
15		40
16		41
17		42
18		43
19		44
20		45
21		46
22		47
23		48
24		49
25		50

Book Mark:

See also

3-1010302 - P.O. MEM
D2086848 P.O. MEM.

Rev Bayles
E.

3 Cav. U.S.C.T.

Andrew Jackson

Appears with rank of *1st* on

Muster and Descriptive Roll of a Detachment of U. S. Vols. forwarded

for the 3 Reg't U. S. Col'd Cavalry. Roll dated *Vicksburg Miss Oct 24*, 1864.

Where born *Memphis Ky.*

Age *24* y'rs; occupation *Farmer*

When enlisted *Oct. 24*, 1864.

Where enlisted *V. Burg Miss*

For what period enlisted _____ years.

Eyes *Black*; hair *Black*

Complexion *Old*; height *5 ft. 7 in.*

When mustered in _____, 186 .

Where mustered in _____

Bounty paid \$ ~~more~~ *100*; due \$ *300* ^{*00*}/_{*100*}

Where credited _____

Company to which assigned _____

Remarks : _____

Book mark : _____

Y. J. J. J.

J | **3 Cav. | U.S.C.T.**

Andrew Jackson

Priv., Co. F, 3 Reg't U.S. Col'd Cavalry.

Appears on

Company Muster Roll

for Sept + Oct, 1864.

Present or absent Present

Stoppage, \$ 100 for

Due Gov't, \$ 100 for

Valuation of horse, \$ 100

Valuation of horse equipments, \$ 100

Remarks: Joined a recruit

Oct 26/64.

(Miss Vicksburg)

Book mark:

E Richardson

(358)

Copyst.

J | **3 Cav. | U.S.C.T.**

Andrew Jackson

1st, Co. F, 3 Reg't U. S. Col'd Cavalry.

Appears on

Company Muster Roll

for *Nov & Dec*, 1864.

Present or absent *Present*

Stoppage, \$ *87* for *ordnance*

Due Gov't, \$ *100* for

Valuation of horse, \$ *100*

Valuation of horse equipments, \$ *100*

Remarks: *Present on desert*
since Feb 21 1864

Book mark:

Mead

J | **3 Cav. | U.S.C.T.**

Andrew Jackson

Pl....., Co. F, 3 Reg't U. S. Col'd Cavalry.

Appears on

Company Muster Roll

for *Nov & Dec*....., 186*4*

Present or absent *Absent*

Stoppage, \$.....*87* for *ordnance*

Due Gov't, \$.....*100* for

Valuation of horse, \$.....*100*

Valuation of horse equipments, \$.....*100*

Remarks: *Absent on desert*
since Apr 21 1864

Book mark:

Mead

J | **3 Cav. | U.S.C.T.**

Andrew Jackson
1st, Co. F, 3 Reg't U. S. Col'd Cavalry.

Appears on

Company Muster Roll

for Jan & Feb, 1865

Present or absent present

Stoppage, \$ 100 for

Due Gov't, \$ 100 for

Valuation of horse, \$ 100

Valuation of horse equipments, \$ 100

Remarks: _____

Book mark: _____

J | **3 Cav.** | **U.S.C.T.**

Andrew Jackson
Priv, Co. F, 3 Reg't U. S. Col'd Cavalry.

Appears on

Company Muster Roll

for Mar & April, 1865.

Present or absent Absent

Stoppage, \$ 100 for

Due Gov't, \$ 100 for

Valuation of horse, \$ 100

Valuation of horse equipments, \$ 100

Remarks: Absent on passport
since Apr 27/65

Book mark: _____

Meach

J | **3 Cav. | U.S.C.T.**

Andrew Jackson

1st, Co. F, 3 Reg't U. S. Col'd Cavalry.

Appears on

Company Muster Roll

for *May 1st*, 1865.

Present or absent *present*

Stoppage, \$ *100* for

Due Gov't, \$ *100* for

Valuation of horse, \$ *100*

Valuation of horse equipments, \$ *100*

Remarks: *Left service
served some weeks
specimens to 12/25/65*

Book mark:

Meade

G | **3 Cav. | U.S.C.T.**

Andrew Jackson
Pl....., Co. F, 3 Reg't U. S. Col'd Cavalry.

Appears on

Company Muster Roll

for *July & Aug*....., 1865.

Present or absent *present*.....

Stoppage, \$.....100 for.....

Due Gov't, \$.....100 for.....

Valuation of horse, \$.....100

Valuation of horse equipments, \$.....100

Remarks:.....
.....
.....
.....
.....
.....
.....
.....
.....

Book mark:.....

Mead

J | **3 Cav. | U.S.C.T.**

Andrew Jackson
Cap, Co. F, 3 Reg't U. S. Col'd Cavalry.

Appears on

Company Muster Roll

for *Sept 20*, 186*1*.

Present or absent *Present*

Stoppage, \$ *100* for

Due Gov't, \$ *100* for

Valuation of horse, \$ *100*

Valuation of horse equipments, \$ *100*

Remarks: *Promoted to Major*
private Oct 29 61

Book mark:

Copyist

J. | 3 Cav. | U.S.C.T.

Andrew Jackson
Pvt., Co. F, 3 Reg't U. S. Colored Cav.

Appears on Returns as follows:

Oct. 1864. Gain Oct. 26/64
Vicksburg - Enlisted

Book mark :

(546)

J. B. Sittler

Copyist.

3 Cav. | U.S.C.T.

William Jackson
Co. *G*, 3 Reg't U. S. Col'd Cavalry.

Appears on **Co. Muster-out Roll**, dated
Sept 20, 186*4*.

Muster-out to date *June 26*, 186*6*.

Last paid to *June 3*, 186*5*.

Clothing account:

Last settled , 186 ; drawn since \$ 100

Due soldier \$ 100; due U. S. \$ *10* ³/₁₀₀

Am't for cloth'g in kind or money adv'd \$ 100

Due U. S. for arms, equipments, &c., \$ 100

Bounty paid \$ 100; due \$ *100* 100

Remarks: *Discharged from service*
June 26 1866

Book mark :

Copyist

725

Jackson Andrew

Co H., 3 U. S. Col'd Cav.

Private Private

CARD NUMBERS.

1	5-33175-8	26
2	5-341707	27
3	5-341496	28
4	5-341899	29
5	5-341997	30
6	5-3421314	31
7	5-342449	32
8	5-331596	33
9	9089282	34
10	40727664	35
11	31688219	36
12		37
13		38
14		39
15		40
16		41
17		42
18		43
19		44
20		45
21		46
22		47
23		48
24		49
25		50

Book Mark: E. M. V. 11. P 45.

See also

2552114 Quind

8-837468-P.O. M. & M.

09702 - 2200 P.O.

S. 2045539 P.O. M & M

S. 2047285 P.O. M & M

R. A. Bayles
Es.

3 Cav. U.S.C.T.

J
Andrew Jackson
Co. *H*, 3 Reg't U. S. Col'd Cav.

Appears on
Company Descriptive Book
of the organization named above.

DESCRIPTION.

Age *25* years; height *5* feet *10* inches.
Complexion *Blk*
Eyes *blk*; hair *blk*
Where born *Wilkinson Co Miss*
Occupation *field hand*

ENLISTMENT.

When *Oct 12*, 186*4*.
Where *Vicksburg Miss*
By whom *E. C. Kinley*; term *3* y'rs.
Remarks: *Discharged by order of*
Brev. Maj Gen. Smith June 7 1865

J. H. Hatten

J. | 3 Cav. | U.S.C.T.

Andrew Jackson

Appears with rank of *Private* on

Muster and Descriptive Roll of a Detachment of U. S. Vols. forwarded

for the 3 Reg't U. S. Col'd Cavalry. Roll dated
Vicksburg, Miss., Oct 20, 1864.

Where born *Wilkinson Co., Miss.*

Age *27* y'rs; occupation *Laborer.*

When enlisted *October 12*, 1864.

Where enlisted *Vicksburg, Miss.*

For what period enlisted *three* years.

Eyes *black*; hair *black;*

Complexion *red*; height *5* ft. *10* in.

When mustered in *October 13*, 1864.

Where mustered in *Vicksburg, Miss.*

Bounty paid \$ *100.*⁰⁰/₁₀₀; due \$ *200.*⁰⁰/₁₀₀

Where credited *State of Miss.*

Company to which assigned

Remarks:

Book mark:

R. Brauner

(339)

Copyist.

J | 3 Cav. | U.S.C.T.

Andrew Jackson
Pvt, Co. H, 3 Reg't U. S. Col'd Cavalry.

Appears on

Company Muster Roll

for Sept 20th, 1864.

Present or absent Present

Stoppage, \$ 100 for

Due Gov't, \$ 100 for

Valuation of horse, \$ 100

Valuation of horse equipments, \$ 100

Remarks: Has rec'd \$100.
Gov't Bounty.

Book mark:

M. Mayre
(358) Copyist.

J | 3 Cav. | U.S.C.T.

Andrew Jackson
Pvt, Co. H, 3 Reg't U. S. Col'd Cavalry.

Appears on

Company Muster Roll

for Nov & Dec, 1864

Present or absent Present

Stoppage, \$ 100 for

Due Gov't, \$ 100 for

Valuation of horse, \$ 100

Valuation of horse equipments, \$ 100

Remarks: Has received \$100.
Gov't Bounty.

Book mark:

M. Sayre

J | **3 Cav. | U.S.C.T.**

Andrew Jackson

priv., Co. H, 3 Reg't U. S. Col'd Cavalry.

Appears on

Company Muster Roll

for *Jan & Feb.*, 186*3*.

Present or absent *present*

Stoppage, \$ *100* for

Due Gov't, \$ *100* for

Valuation of horse, \$ *100*

Valuation of horse equipments, \$ *100*

Remarks:

Book mark: -----

Sumner

1871 1521

J | **3 Cav. | U.S.C.T.**

Andrew Jackson

priv., Co. H, 3 Reg't U. S. Col'd Cavalry.

Appears on

Company Muster Roll

for *Mich & Apr*, 186 *3*.

Present or absent *Absent*

Stoppage, \$ *100* for

Due Gov't, \$ *100* for

Valuation of horse, \$ *100*

Valuation of horse equipments, \$ *100*

Remarks: *Absent sick in
Small Pox Hospital
since Mch. 30/63*

Book mark:

Somer
(358) Copyist.

J | 3 Cav. U.S.C.T
Andrew Jackson
Pvt, Co. H, 3 Reg't U.S.C.C

Appears on

Hospital Muster Roll

of Small Pox U. S. A. General Hospital,

at Memphis, Tenn.,

for *March + Apr.*, 1865.

Attached to hospital:

When *March 4*, 1865.

How employed *Sick*

Last paid by Maj. _____

to _____, 186 .

Bounty paid \$ 100 ; due \$ 100

Present or absent *Not stated*

Remarks : _____

Book mark : _____

Gann

J | **3 Cav.** | **U.S.C.T.**

Andrew Jackson

priv., Co. H, 3 Reg't U. S. Col'd Cavalry.

Appears on

Company Muster Roll

for May to June, 1865.

Present or absent

Stoppage, \$ 100 for

Due Gov't, \$ 100 for

Valuation of horse, \$ 100

Valuation of horse equipments, \$ 100

Remarks: Discharged June 7,
Stop pay for spurs & straps

Book mark: Discharged June 6/65,
E. B. V. 11. P. 45.

Somers

(358)

Copyist.

J. S. Carr | **U.S.C.T.**

Frederick Jackson
Co. H, 3 Reg't U. S. Col'd

Appears on an
Individual Muster-out Roll
of the organization named above. Roll dated
Memphis Tenn., June 6, 1865.
Muster-out to date *June 6, 1865.*
Last paid to _____, 186 .

Clothing account:
Last settled _____, 186 ; drawn since \$ _____ 100
Due soldier \$ _____ 100; due U. S. \$ _____ 100
Am't for cloth'g in kind or money adv'd \$ *34* ^{*06*} / 100

Due U. S. for arms, equipments, &c., \$ _____ 100
Bounty paid \$ _____ 100 due \$ _____ 100

Remarks: *clothing due from*
enlistment, drawn since
34 ⁰⁶ / 100 due U.S. for Ordnance
13. ²³ / 100 Mustered out in
accordance with the instructions
in telegram from

Book mark: _____

W. S. Thompson
(348)
(over) Copyist.

JAN. - 7

5331596

1891

War Dept. dated May
3, 1865 To date from
June 6, 1863.

APR 1865

J. | 3 Cav. | U.S.C.T.

Andrew Jackson
Pvt., Co. H, 3 Reg't U. S. Colored Cav.

Appears on Returns as follows:

Oct. 1864. Gain Oct. 12" Vicks-
burg. Enlisted in Co.

Mar. 1865. Absent sick Gen.
Hosp. Mar. 30/65.

Apr. 1865. Absent sick, Small
pox Hosp.

May 1865. Absent sick Gen.
Hosp. Mar. 30/65.

June 1865. Lose June 23/65 -
Memphis, Tenn. Disch'd

Book mark :

(546)

J. B. Sittler

Copyist.

P

J. | **3 Cav. | U.S.C.T.**

Andrew Jackson
Pvt., Co. H., 3 Reg't U. S. Col'd Cavalry.

Appears on **Co. Muster-out Roll**, dated
Memphis's Term, Jan 26, 1866.

Muster-out to date _____, 186 .

Last paid to *Never Paid*, 186 .

Clothing account:

Last settled _____, 186 ; drawn since \$ _____ 100

Due soldier \$ _____ 100; due U. S. \$ _____ 100

Am't for cloth'g in kind or money adv'd \$ _____ 100

Due U. S. for arms, equipments, &c., \$ _____ 100

Bounty paid \$ _____ 100; due \$ _____ 100

Remarks: *Discharged June 7th 1865 By order of
Br. Maj. Gen. J. E. Smith.*

Book mark: *Discharged June 6/65
E.B. V. 11. P 45.*

(861)

J. J. J. J.

Copyist.

Jackson, Andrew
P, Co. H., 8 Regt U.S.C. Cav.

2 Enclosures.

- | | |
|------------------------------|-------------------|
| Bed Cards | Descriptive Lists |
| Burial Records | Final Statements |
| Certs. of Dis. for Discharge | Furloughs |
| C. M. Charges | Med. Des. Lists |
| Med. Certificates | Orders |

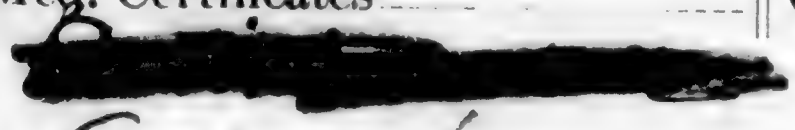

Enclures / Other papers relating to—

- | | |
|----------------------------|----------------------|
| Admission to Hosp'l | Furlough |
| Casualty Sheet (Officer's) | Med. Examination |
| Confinement | Misc. Information |
| Contracts | Pay or Clothing |
| Death or Effects | Personal Reports |
| Desertions | Rank |
| Discharge from Hosp'l | Transfer to Hosp'l |
| Discharge from Service | Transfer to V. R. C. |
| Duty | Transportation |

....., 1874.
The [unclear] [unclear] [unclear]
Jackson, Co. "H", 3rd Reg't U.S.
Colored Cavalry, is reported as follows:

- On Company Muster Roll.
- For May June, 1865, June 7th, 1865
Company Muster-out Roll.
- June 7th, 1865
Company Descriptive Book.
-, 186
- Company Morning Reports.
-, 186
- Soldier's Final Statement.
-, 186
- Soldier's Record of Death and Interment.
-, 186
- Soldier's Inventory of Effects.
-, 186
- Soldier's Certificate of Disability for Discharge.
-, 186
- Soldier's Individual Muster-out Roll.
- June 6th, 1865
Regimental Return.
- For June, 1865, June 23rd, 1865
Regimental Quarterly Returns.
-, 186
- Regimental Descriptive Book.
-, 186
- By Surgeon General.

(.....), 186
June 6, 1865, is held to be
the correct date, and the Company Muster
Roll will be amended accordingly.

Thomas D. Stewart
E.B. 4
45 Assistant Adjutant General.

Noted ~~See letter to Board~~
Hedl. May 19. 74.
Entered on Register

NOTE 1.—This blank will be used for both enlistments and re-enlistments of veterans, &c., &c., in the volunteer service. They will be made out in duplicate in all cases—one to accompany the recruiting return of the superintendent (not the recruiting officer) to the Adjutant General, and one to accompany the accounts of the officer who pays bounty, &c. The Regiment and Company in which the soldier next served should be given on the back.

NOTE 2.—An enlistment holds to service. A muster-in must, in all cases, precede payment of pay, bounty, pension, &c. A muster-in roll must, in all cases, be filed in the Adjutant General's Office as evidence of muster-in. The muster-roll, commissary, or assistant commissary of musters, as the case may be, will countersign both enlistments as having mustered the soldier into the service of the United States before either of them is given to the disbursing officer.

DECLARATION OF RECRUIT.

I, Andrew Jackson, desiring to VOLUNTEER as a Soldier in the Army of the United States, for the term of THREE YEARS. Do Declare, That I am twenty four years and _____ months of age; that I have never been discharged from the United States service on account of disability or by sentence of a court martial, or by order before the expiration of a term of enlistment; and I know of no impediment to my serving honestly and faithfully as a soldier for three years.

GIVEN at Wicksburg Miss the 12th day of October, 1864

Witness: F. F. Fog Andrew Jackson

Rec'd from 2nd. Aud. May 13th 1893

No. 105
Andrew Jackson
 Volunteered at Wicksburg Miss.
October 12th 1864.
 By W. S. Kennedy
Rec't for. Mississippi Inst.
 Regiment of _____
 _____ enlistment; last served in Company () _____
 Reg't of _____
 Discharged _____ 18 _____

CONSENT IN CASE OF MINOR.

I, _____ Do CERTIFY, That I am the _____ of _____; that the said _____ is _____ years of age; and I do hereby freely give my CONSENT to his volunteering as a SOLDIER in the ARMY OF THE UNITED STATES for the period of THREE YEARS.

GIVEN at _____ the _____ day of _____

Witness: _____

VOLUNTEER ENLISTMENT.

STATE OF

TOWN OF

Mississippi

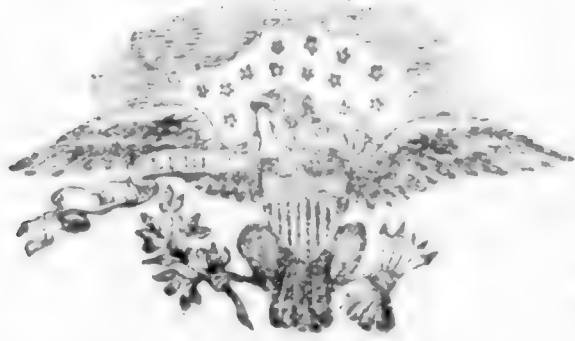

Deer Hunting

I, Andrew Jackson, born in Wilkinson Co in the State of Mississippi, aged twenty four years, and by occupation a Laborer, DO HEREBY ACKNOWLEDGE to have volunteered this Twelfth day of October, 1864, to serve as a Soldier in the Army of the United States of America, for the period of THREE YEARS, unless sooner discharged by proper authority: Do also agree to accept such bounty, pay, rations, and clothing, as are, or may be, established by law for volunteers. And I, Andrew Jackson, do solemnly swear, that I will bear true faith and allegiance to the United States of America, and that I will serve them honestly and faithfully against all their enemies or opposers whomsoever; and that I will observe and obey the orders of the President of the United States, and the orders of the officers appointed over me; according to the Rules and Articles of War.

Sworn and subscribed to, at Dickerson, this 12th day of October, 1864,

BEFORE Eli C. Kinsey, Lt. Col & Asst. Pro. Marshal

Andrew Jackson, Witness

I CERTIFY, ON HONOR, That I have carefully examined the above-named Volunteer, agreeably to the General Regulations of the Army, and that, in my opinion, he is free from all bodily defects and mental infirmity, which would in any way disqualify him from performing the duties of a soldier.

A. C. Huntman, Surg 50th WSB Regt, Examining Surgeon.

I CERTIFY, ON HONOR, That I have minutely inspected the Volunteer Andrew Jackson previously to his enlistment, and that he was entirely sober when enlisted; that, to the best of my judgment and belief, he is of lawful age; and that, in accepting him as duly qualified to perform the duties of an able-bodied soldier, I have strictly observed the Regulations which govern the recruiting service. This soldier has Black eyes, Black hair, Black complexion, is five feet two inches high.

Eli C. Kinsey, Asst. Pro. Marshal of Mass., Regiment of Dist of Miss, Volunteers, RECRUITING OFFICER.

(A. G. O. No. 74 & 76.)

Mustered into the service of the United States, for three years or during the war, from date of enlistment, in Company 32 Regiment of WSB Regt, on the 13 day of October, 1864, at Deer Hunting Regt

Approved

Entitled to Bounty

726 or answer.
Jackson Andrew

Co. L., 3 U. S. Col'd Cav.

Private | Corporal.

CARD NUMBERS.

1	5336593	26
2	5336679	27
3	5336773	28
4	5336876	29
5	5336976	30
6	5337078	31
7	5337141	32
8	5337239	33
9	5337326	34
10	5337409	35
11	9088656	36
12	40727590	37
13		38
14		39
15		40
16		41
17		42
18		43
19		44
20		45
21		46
22		47
23		48
24		49
25		50

Book Mark:

See also

MAR 18 1893

A 2080829
Q 2084801
O 2113736
O 2381126
SS . 203

E. Bentley

A 2060829 P. Curran

Q 2084501 P. Ret

Q 2113736 P. Curran

Q 2381126 P. Off

SS. 203 3/28/30

J. Bentley

J | **3 Cav. U.S.C.T.**

Andrew Jackson

, Co. *D*, 3 Reg't U. S. Col'd Cav.

Appears on

Company Descriptive Book

of the organization named above.

DESCRIPTION.

Age *19* years; height *5* feet. *7* inches.

Complexion *Blk.*

Eyes *Blk.*; hair *Blk.*

Where born *Jackson Miss.*

Occupation *Laborer*

ENLISTMENT.

When *Aug. 15*, 186 *7*.

Where *Ficksburg*

By whom *J. E. Read*; term *3* y'rs.

Remarks:

F. A. Wright

J | **3 Cav. U.S.C.T.**

Andrew Jackson
Pri, Co. D, 3 Reg't U. S. Col'd Cavalry.

Appears on

Company Muster Roll

for *July & Aug*, 1864.

Present or absent *Present*

Stoppage, \$ *100* for

Due Gov't, \$ *100* for

Valuation of horse, \$ *100*

Valuation of horse equipments, \$ *100*

~~Remarks:~~ *Enrolled & Mustered*
Aug 5/64 at Vicksburg
for 3 years.

Book mark:

Avery
(358) *Avery* Copyist.

9 | **3 Cav. | U.S.C.T.**

Andrew Jackson

Pvt, Co. D, 3 Reg't U. S. Col'd Cavalry.

Appears on

Company Muster Roll

for *Jan'y 5*, 1863:

Present or absent *Present*

Stoppage, \$ 100 for

Due Gov't, \$ 75 for *ordnance*

Valuation of horse, \$ 100

Valuation of horse equipments, \$ 100

Remarks: *No harness on H. / crush. 73*

Book mark:

Bayler

J | **3 Cav.** | **U.S.C.T.**

Andrew Jackson
Pvt., Co. D, 3 Reg't U. S. Col'd Cavalry.

Appears on

Company Muster Roll

for *March & Apr*, 186*5*.

Present or absent *Absent*

Stoppage, \$ *—* ^{*90*}/_{*100*} for *one blanket*
and haversack

Due Gov't, \$ *—* ^{*100*}/_{*100*} for *—*

Valuation of horse, \$ *—* ^{*100*}/_{*100*}

Valuation of horse equipments, \$ *—* ^{*100*}/_{*100*}

Remarks: *Absent on scout*
since April 29th 65

Book mark: *—*

J | **3 Cav.** | **U.S.C.T.**

Andrew Jackson
Pvt, Co. D, 3 Reg't U. S. Col'd Cavalry.

Appears on

Company Muster Roll

for *May, June*, 1865.

Present or absent *Present*

Stoppage, \$ *90* for *A.C. & E.*

Due Gov't, \$ *100* for

Valuation of horse, \$ *100*

Valuation of horse equipments, \$ *100*

Remarks:
.....
.....
.....
.....
.....
.....
.....
.....

Book mark:

B. Taylor

J | **3 Cav.** | **U.S.C.T.**

Andrew Jackson
Corp, Co. D, 3 Reg't U. S. Col'd Cavalry.

Appears on

Company Muster Roll

for *July & Aug*, 186*5*.

Present or absent *Present*.

Stoppage, \$ *100* for

Due Gov't, \$ *100* for

Valuation of horse, \$ *100*

Valuation of horse equipments, \$ *100*

Remarks: *Promoted Corp'l. July 16/65-*

x *discharged by comdr.*

Book mark:

Blayler

J. | **3 Cav.** | **U.S.C.T.**

Andrew Jackson
Corpl., Co. D, 3 Reg't U. S. Col'd Cavalry.

Appears on

Company Muster Roll

for *Sept. and Oct.*, 1865.

Present or absent *Present*

Stoppage, \$ *100* for

Due Gov't, \$ *100* for

Valuation of horse, \$ *100*

Valuation of horse equipments, \$ *100*

Remarks: *Promoted from private to Corpl. July 17th 1865.*

Book mark:

J | **3 Cav.** | **U.S.C.T.**

Andrew Jackson
Corpl., Co. D, 3 Reg't U. S. Col'd Cavalry.

Appears on

Company Muster Roll

for *Nov. and Dec.*, 1865.

Present or absent *Present*

Stoppage, \$ *100* for

Due Gov't, \$ *100* for

Valuation of horse, \$ *100*

Valuation of horse equipments, \$ *100*

Remarks: *Promoted Corpl.*
July 17" 1865-

Book mark:

Phelps

J. | 3 Cav. | U.S.C.T.

Andrew Jackson

Priv., Co. D, 3 Reg't U. S. Colored Cav.

Appears on Returns as follows:

Aug. 1864, Gain Aug. 15/64
Vicksburg - by enlistment.

Book mark :

J. B. Sittler

(546)

Copyist.

J. | **3 Cav. | U.S.C.T.**

Andrey Jackson
Corp, Co. *D*, 3 Reg't U. S. Col'd Cavalry.

Appears on **Co. Muster-out Roll**, dated
Memphis Tenn Jan 26, 1866.

Muster-out to date *Jan 26*, 1866.

Last paid to *June 30*, 1865.

Clothing account:

Last settled, 186 ; drawn since \$ 100

Due soldier \$ *9*^{*82*}/₁₀₀; due U. S. \$ 100

Am't for cloth'g in kind or money adv'd \$ 100

Due U. S. for arms, equipments, &c., \$ 100

Bounty paid \$ *00*/₁₀₀; due \$ *100*^{*00*}/₁₀₀

Remarks: *Promoted from*
Private to Corp July
17/65

Book mark: *2848, 1880*

Rhett

Jackson Andrew

Co. D, 3 Reg't 4-S-C-Cav.

Enclosures.

Bed Cards	Final Statements
Burial Records	Furloughs or L. of A
Certs. of Dis. for Discharge	Med. Certificates
C. M. Charges	Med. Des. Lists
Descriptive Lists	Orders
Discharge Certificates	Pris. of War Record
Enlistment Papers	Resignations

Other papers relating to—

Admission to Hosp'l	Furlough or L. of A
Casualty Sheet	Med. Examination
Confinement	Misc. Information
Contracts	Pay or Clothing
Death or Effects	Personal Reports
Desertion	Rank
Discharge from Hosp'l	Transfer to Hosp'l
Discharge from Service	Transfer to V. R. C.
Duty	Transportation

MICROFILM PUBLICATION M 1819

COMPILED MILITARY SERVICE RECORDS
OF VOLUNTEER UNION SOLDIERS WHO
SERVED WITH THE USCT (US COLORED TROOPS)
3RD REGIMENT OF CAVALRY

PERSONAL PAPERS' TARGET SHEET

PLEASE NOTE THE CHECKED INFORMATION ABOUT THE PERSONAL PAPERS IN
THIS FILE:

- NO PERSONAL PAPERS WERE FOUND IN THIS FILE WHEN THE
RECORDS WERE ARRANGED FOR MICROFILMING.
- 1 PERSONAL PAPER(S) FOUND IN THIS FILE WHEN THE RECORDS
WERE ARRANGED FOR MICROFILMING.

NOTE 1.—This blank will be used for both enlistments and re-enlistments—enlistment of veterans, &c., &c., in the volunteer service. They will be made out in duplicate in all cases—one to accompany the recruiting return of the superintendent (not the recruiting officer) to the Adjutant General, and one to accompany the accounts of the officer who pays bounty, &c. The Regiment and Company in which the soldier last served should be given on the back.

NOTE 2.—An enlistment holds to service. A muster-in must, in all cases, precede payment of pay, bounty, pension, &c. A muster-in roll must, in all cases, be filed in the Adjutant General's Office as evidence of muster-in. The mustering officer, commissary, or assistant commissary of musters, as the case may be, will countersign both enlistments as having mustered the soldier into the service of the United States before either of them is given to the disbursing officer.

344, 1864
 1864

I, _____ of _____, that the said _____ is _____ years of age; and I do hereby freely give my consent to his volunteering as a Soldier in the Army of the United States for the period of THREE YEARS.

GIVEN at _____ the _____ day of _____

Witness: _____

(A. G. O. No. 74 & 76.)

CONSENT IN CASE OF MINOR.

No. _____

Volunteered at Andrew Jackson

Aug 15 1864

By W. H. Read Recruiting Agent for the State of Michigan

_____ ()
 Enlistment; last served in Company ()

_____ Reg't of _____

Discharged _____ 18 _____

I, Andrew Jackson, desiring to VOLUNTEER as a Soldier in the Army of the United States, for the term of THREE YEARS, Do Declare, That I am _____ years and _____ months of age; that I have never been discharged from the United States service on account of disability or by sentence of a court-martial, or by order before the expiration of a term of enlistment; and I know of no impediment to my serving honestly and faithfully as a soldier for three years.

GIVEN at Michigan the _____ day of _____ 1864.

Witness: W. H. Read Recruiting Agent for the State of Michigan

DECLARATION OF RECRUIT.

4

NOTE 1.—This blank will be used for both enlistments and re-enlistments—enlistment of veterans, &c., &c., in the volunteer service. They will be made out in duplicate in all cases—one to accompany the recruiting return of the superintendent (not the recruiting officer) to the Adjutant General, and one to accompany the accounts of the officer who pays bounty, &c. The Regiment and Company in which the soldier last served should be given on the back.

NOTE 2.—An enlistment holds to service. A muster-in must, in all cases, precede payment of pay, bounty, pension, &c. A muster-in roll must, in all cases, be filed in the Adjutant General's Office as evidence of muster-in. The mustering officer, commissary, or assistant commissary of musters, as the case may be, will countersign both enlistments as having mustered the soldier into the service of the United States before either of them is given to the disbursing officer.

DECLARATION OF RECRUIT.

I, Andrew Jackson desiring to VOLUNTEER as a Soldier in the Army of the United States, for the term of THREE YEARS, Do Declare, That I am 41 years and _____ months of age; that I have never been discharged from the United States service on account of disability or by sentence of a court-martial, or by order before the expiration of a term of enlistment; and I know of no impediment to my serving honestly and faithfully as a soldier for three years.

GIVEN at McKechny, Miss the 15 day of August 1864

Witness: W. W. McElvain Andrew Jackson

No. _____

Andrew Jackson

Volunteered at McKechny

Aug 15 1864

By W. W. McElvain

Agent for the State of Michigan

5114th Regt

First enlistment; last served in Company ()

Reg't of _____

Discharged _____ 18 _____

CONSENT IN CASE OF MINOR.

I, _____ Do CERTIFY, That I am the _____ of _____ that the said _____ is _____ years of age; and I do hereby freely give my CONSENT to his volunteering as a SOLDIER in the ARMY OF THE UNITED STATES for the period of THREE YEARS.

GIVEN at _____

Witness: _____ the _____ day of _____

920

VOLUNTEER ENLISTMENT.

STATE OF

TOWN OF

Mississippi

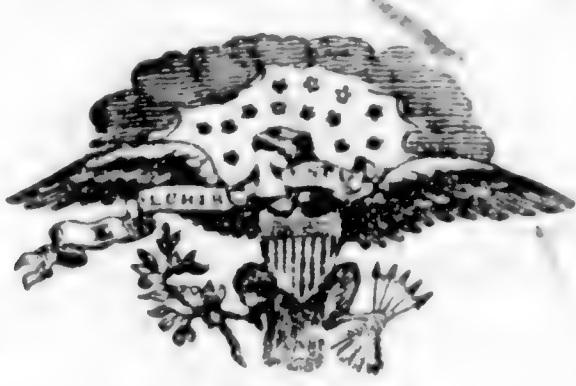

Nickberry

I, Andrew Jackson born in Jackson in the State of Mississippi aged nineteen years, and by occupation a Laborer Do HEREBY ACKNOWLEDGE to have volunteered this Fifteenth day of August 1864, to serve as a Soldier in the Army of the United States of America, for the period of THREE YEARS, unless sooner discharged by proper authority: Do also agree to accept such bounty, pay, rations, and clothing, as are, or may be, established by law for volunteers. And I, Andrew Jackson do solemnly swear, that I will bear true faith and allegiance to the United States of America, and that I will serve them honestly and faithfully against all their enemies or opposers whomsoever; and that I will observe and obey the orders of the President of the United States, and the orders of the officers appointed over me, according to the Rules and Articles of War.

Sworn and subscribed to, at Archburg this fifteenth day of August 1864 before S. S. Head Recruiting Agent for the State of Michigan

I CERTIFY, ON HONOR, That I have carefully examined the above-named Volunteer, agreeably to the General Regulations of the Army, and that, in my opinion, he is free from all bodily defects and mental infirmity, which would in any way disqualify him from performing the duties of a soldier.

Examining Surgeon 46" Hgt. Vol.

EXAMINING SURGEON.

I CERTIFY, ON HONOR, That I have minutely inspected the Volunteer, Andrew Jackson previously to his enlistment, and that he was entirely sober when enlisted; that, to the best of my judgment and belief, he is of lawful age; and that, in accepting him as duly qualified to perform the duties of an able-bodied soldier, I have strictly observed the Regulations which govern the recruiting service. This soldier has black eyes, black hair, black complexion, is five feet seven inches high.

S. S. Head Recruiting Agent for the State of Michigan

RECRUITING OFFICER.

Mustered into the service of the United States, in Company 3 Regiment of W. S. Cal Volunteers, on the 15 day of Aug, 1864, at Archburg Miss

Handwritten signatures and notes on the right side of the document.

727

Jackson, Benjamin

Co. F., 3 U. S. Col'd Cav.

Private | Private

CARD NUMBERS.

1	5338895	26
2	5338979	27
3	5339065	28
4	5339138	29
5	5339210	30
6	5339288	31
7	5339372	32
8	5339466	33
9	5339569	34
10	5339663	35
11	5339753	36
12	5339840	37
13	5339921	38
14	5340000	39
15	9088900	40
16		41
17		42
18		43
19		44
20		45
21		46
22		47
23		48
24		49
25		50

Book Mark:

See also

1863

J | **3 Cav.** | **U.S.C.T.**

Benjamin Jackson
....., Co. *F*., 3 Reg't U. S. Col'd Cav.

Appears on

Company Descriptive Book
of the organization named above.

DESCRIPTION.

Age *20* years; height *5* feet *4* inches.

Complexion *Ginger*

Eyes *Black*; hair

Where born *Warren Co. Miss*

Occupation

ENLISTMENT.

When *Dec 1*, 1863.

Where *Skippville*.

By whom *C. C. Spauld*; term *3* y'rs.

Remarks:

.....
.....
.....
.....
.....
.....

(383g)

E. W. Stear

Copyist.

J | 3 Cav. | U.S.C.T.

Benjamin Jackson
Pvt, Co. F, 1 Reg't Miss. Cav., Corps d'Afrique.*

Appears on

Company Muster-in Roll

of the organization named above. Roll dated

Vicksburg Miss, Jan 26, 1864.

Muster-in to date Dec 1, 1863.

Joined for duty and enrolled:

When Dec 1, 1863.

Where Skipwiths Miss.

Period 3 years.

Valuation of horse, \$ 100

Valuation of horse equipments, \$ 100

Remarks: (page 20).

* This organization subsequently became Co. F, 3 Reg't U. S. Colored Cavalry.

Book mark:

E. Richardson
Copyist.

J | **3 Cav.** | **U.S.C.T.**

Benjamin Jackson

B. Co. F, 1 Reg't Miss. Cav., Corps d'Afrique.*

Appears on

Company Muster Roll

for Dec 6/63 to Feb 29, 1864

Present or absent Present

Stoppage, \$ 100 for

Due Gov't, \$ 100 for

Valuation of horse, \$ 100

Valuation of horse equipments, \$ 100

Remarks: _____

*This organization subsequently became Co. F, 3 Reg't U. S. Colored Cavalry.

Book mark: _____

E. T. Richardson
Copyist.

J | **3 Cav. | U.S.C.T.**

Benjamin Jackson
Priv, Co. F, 3 Reg't U.S. Col'd Cavalry.

Appears on

Company Muster Roll

for Mar 1864, 1864.

Present or absent Present

Stoppage, \$ 100 for

Due Gov't, \$ 100 for

Valuation of horse, \$ 100

Valuation of horse equipments, \$ 100

Remarks:

Book mark: _____

(358)

E J Richardson
Copyist.

J | 3 Cav. | U.S.C.T.

Benjamin Jackson
Pot, Co. F, 3 Reg't U. S. Col'd Cavalry.

Appears on

Company Muster Roll

for May & June, 1864

Present or absent Present

Stoppage, \$ 100 for

Due Gov't, \$ 100 for

Valuation of horse, \$ 100

Valuation of horse equipments, \$ 100

Remarks:

Book mark:

E. Richardson
Copyist.

(358)

J | **3 Cav. | U.S.C.T.**

Benjamin Jackson
Rot, Co. F, 3 Reg't U.S. Col'd Cavalry.

Appears on

Company Muster Roll

for July + Aug, 1864.

Present or absent Present

Stoppage, \$ 60 for Ordnance
100

Due Gov't, \$ 100 for

Valuation of horse, \$ 100

Valuation of horse equipments, \$ 100

Remarks:

Book mark:

E. Richardson

(358)

Copyist.

J | **3 Cav. | U.S.C.T.**

Benjamin Jackson

Priv, Co. F, 3 Reg't U.S. Col'd Cavalry.

Appears on

Company Muster Roll

for Sept & Oct, 186 4

Present or absent Present

Stoppage, \$ 100 for

Due Gov't, \$ 100 for

Valuation of horse, \$ 100

Valuation of horse equipments, \$ 100

Remarks:

Book mark:

E. Richardson

(358)

Copyist.

3 Cav. U.S.C.T.

Benjamin Jackson

1111, Co. F, 3 Reg't U. S. Col'd Cavalry.

Appears on

Company Muster Roll

for Nov & Dec, 1864.

Present or absent Absent

Stoppage, \$ 1 ^{no}/₁₀₀ for clothing

Due Gov't, \$ 100 for

Valuation of horse, \$ 100

Valuation of horse equipments, \$ 100

Remarks: Absent on scout
since Dec 21 1864
Stoppage for ordnance
16, 42

Book mark:

(358)

Mean
Copyist.

4 | **3 Cav. | U.S.C.T.**

Benjamin Jackson

PH, Co. F, 3 Reg't U. S. Col'd Cavalry.

Appears on

Company Muster Roll

for *Jan & Feb*, 1865.

Present or absent *present*

Stoppage, \$ 100 for

Due Gov't, \$ 100 for

Valuation of horse, \$ 100

Valuation of horse equipments, \$ 100

Remarks:

Book mark:

Mean

1865

J | **3 Cav. | U.S.C.T.**

Benjamin Jackson
PL, Co. F, 3 Reg't U. S. Col'd Cavalry.

Appears on

Company Muster Roll

for *March & April*, 1865.

Present or absent *Absent*

Stoppage, \$.....100 for

Due Gov't, \$.....100 for

Valuation of horse, \$.....100

Valuation of horse equipments, \$.....100

Remarks: *Absent on*
so on since Apr
27/65

Book mark:

(358)

Mean
Copyist.

1865

J | **3 Cav. | U.S.C.T.**

Benjamin Jackson

Pvt, Co. F, 3 Reg't U. S. Col'd Cavalry.

Appears on

Company Muster Roll

for *May & June*, 1865.

Present or absent *Present*

Stoppage, \$ 100 for

Due Gov't, \$ 100 for

Valuation of horse, \$ 100

Valuation of horse equipments, \$ 100

Remarks: *Not Remunerated
New Order Not entered
\$12.37*

Book mark:

Mean

J | **3 Cav. | U.S.C.T.**

Benjamin Jackson
W, Co. F, 3 Reg't U. S. Col'd Cavalry.

Appears on

Company Muster Roll

for *Sept & Oct*, 186*3*.

Present or absent *Present*

Stoppage, \$ 100 for

Due Gov't, \$ 100 for

Valuation of horse, \$ 100

Valuation of horse equipments, \$ 100

Remarks:

Book mark : -----

W. C. [Signature]

J. J. ... | **3 Cav.** | **U.S.C.T.**

J. J. ...

J. J. ..., Co. F, 3 Reg't U. S. Col'd Cavalry.

Appears on

Company Muster Roll

for *J. J. ...*, 186*3*.

Present or absent *Present*

Stoppage, \$ *100* for -----

Due Gov't, \$ *100* for -----

Valuation of horse, \$ *100*

Valuation of horse equipments, \$ *100*

Remarks: -----

Book mark: -----

J. J. ...

3 Cav. U.S.C.T.

Benjamin Jackson
Co. *F*, 3 Reg't U. S. Col'd Cavalry.

Appears on Co. Muster-out Roll, dated
Memphis Tenn Jan 26, 186 ⁶.

Muster-out to date *Jan 26*, 186 ⁶.

Last paid to *Jan 30*, 186 ⁵.

Clothing account:

Last settled 186 ; drawn since \$ 100

Due soldier \$ 100; due U. S. \$ *4/82* 100

Am't for cloth'g in kind or money adv'd \$ 100

Due U. S. for arms, equipments, &c., \$ 100

Bounty paid \$ 100; due \$ 100

Remarks:

Book mark:

728

Jackson Perry.

Co I., 3 U. S. Col'd Cav.

Private.

Private.

CARD NUMBERS.

1	5342539	26
2	5342637	27
3	5342682	28
4	5342802	29
5	5342881	30
6	5342956	31
7	5343050	32
8	5343157	33
9	5343254	34
10	5343337	35
11	5343426	36
12	5343502	37
13	5343576	38
14	9089350	39
15	40727592	40
16		41
17		42
18		43
19		44
20		45
21		46
22		47
23		48
24		49
25		50

Book Mark:

See also

MAR 16 1958

D. 2250083 P.O. Retn

D. 2625229 And. H. O.

R. W. Bayless
Co.
Ch.

1864

J | **3 Cav. U.S.C.T.**
Berry Jackson
....., Co. *B*, 3 Reg't U. S. Col'd Cav.

Appears on
Company Descriptive Book
of the organization named above.

DESCRIPTION.

Age *23* years; height *5* feet *6* inches.
Complexion *Blk*
Eyes *blk*; hair *blk*
Where born *Haines Trip*
Occupation *field hand*

ENLISTMENT.

When *Feb 24*, 186*4*.
Where *Haines Bluff*
By whom *Capt Branard*, term *3* y'rs.

Remarks:
.....
.....
.....
.....
.....

J. Hiltner
(3830) Copyist.

J | **3 Cav.** | **U.S.C.T.**

Berry Jackson
Pot, Co. *J*, 1 Reg't Miss. Cav., Corps d'Afrique.*

Appears on

Company Muster-in Roll

of the organization named above. Roll dated

Haines Bluffs Miss Feb 26, 1864.

Muster-in to date *Feb 24*, 1864.

Joined for duty and enrolled:

When *Feb 24*, 1864.

Where *Haines Bluffs Miss.*

Period *2* years.

Valuation of horse, \$ 100

Valuation of horse equipments, \$ 100

Remarks: *(Age 23)*

*This organization subsequently became Co. *J*, 3 Reg't U. S. Colored Cavalry.

Book mark:

Bradshaw

ARRIVED

J | **3 Cav. | U.S.C.T.**

Beriz Jackson
Priv, Co. I, 3 Reg't U. S. Col'd Cavalry.

Appears on

Company Muster Roll

for *Feb 24 to Apr 30*, 1864.

Present or absent *present*

Stoppage, \$ *100* for

Due Gov't, \$ *100* for

Valuation of horse, \$ *100*

Valuation of horse equipments, \$ *100*

Remarks:
.....
.....
.....
.....
.....
.....
.....
.....

Book mark:

Bradshaw

ARRIVED

J | **3 Cav.** | **U.S.C.T.**

Berry Jackson
Bugler, Co. I, 3 Reg't U. S. Col'd Cavalry.

Appears on

Company Muster Roll
for *May & June*, 1864.

Present or absent *Present*

Stoppage, \$ *100* for

Due Gov't, \$ *100* for

Valuation of horse, \$ *100*

Valuation of horse equipments, \$ *100*

Remarks:
.....
.....
.....
.....
.....
.....
.....
.....
.....

Book mark:

Bradshaw
(358) Copyist.

J | **3 Cav. | U.S.C.T.**

Berry Jackson
Priv., Co. I, 3 Reg't U. S. Col'd Cavalry.

Appears on

Company Muster Roll

for July & Aug, 1864.

Present or absent present

Stoppage, \$ 100 for

Due Gov't, \$ 100 for

Valuation of horse, \$ 100

Valuation of horse equipments, \$ 100

Remarks: Stop for one Cavalry
team one Trussack \$100.

Book mark:

Bradshaw
Copyist.

3 Cav. U.S.C.T.

Berry Jackson
Priv., Co. I, 3 Reg't U. S. Col'd Cavalry.

Appears on

Company Muster Roll

for Sept & Oct, 1864

Present or absent present

Stoppage, \$ 100 for

Due Gov't, \$ 100 for

Valuation of horse, \$ 100

Valuation of horse equipments, \$ 100

Remarks: Staps for iron
Carriage Ground and
Brush, one Gene
" much for pistol
\$1.53; one Havers-
sack 40 cents.

Book mark:

Bradshaw

(358)

Copyist.

J | **3 Cav.** | **U.S.C.T.**

Benny Jackson
Private, Co. I, 3 Reg't U. S. Col'd Cavalry.

Appears on

Company Muster Roll

for *Nov. & Dec*, 1864.

Present or absent *Absent*

Stoppage, \$ *100* for

Due Gov't, \$ *100* for

Valuation of horse, \$ *100*

Valuation of horse equipments, \$ *100*

Remarks: *Absent on account
since Dec 21. / 64*

Book mark:

Lucas

J. | **3 Cav.** | **U.S.C.T.**

Berry Jackson

P. 1-, Co. I, 3 Reg't U. S. Col'd Cavalry.

Appears on

Company Muster Roll

for *July & Feby*, 1865.

Present or absent *Present*

Stoppage, \$ *100* for

Due Gov't, \$ *100* for

Valuation of horse, \$ *100*

Valuation of horse equipments, \$ *100*

Remarks:

Book mark:

Lucas

J **3 Cav. U.S.C.T.**

Wm Jackson

Pr-, Co. I, 3 Reg't U. S. Col'd Cavalry.

Appears on

Company Muster Roll

for March + April, 1865.

Present or absent Present

Stoppage, \$ 100 for

Due Gov't, \$ 100 for

Valuation of horse, \$ 100

Valuation of horse equipments, \$ 100

Remarks: Stoppage one Remington
Revolver one Pistol Belt-Holster
one thing for Carbine 13.15.
one canteen one Harness 1.00

Book mark: _____

Lucas

J | **3 Cav. | U.S.C.T.**

Berry Jackson
Pvt, Co. I, 3 Reg't U. S. Col'd Cavalry.

Appears on

Company Muster Roll

for *May & June*, 186*5*.

Present or absent *Present*

Stoppage, \$ *60* / *100* for *6 + 5. &*

transferred from a last muster roll.

Due Gov't, \$ *100* for

Valuation of horse, \$ *100*

Valuation of horse equipments, \$ *100*

Remarks: *Stoppage for ordi
nance transferred from
last muster roll \$13.15*

Book mark:

(358)

J. Henderson

Copyist.

9 | **3 Cav.** | **U.S.C.T.**

Benny Jackson

Pr-----, Co. I, 3 Reg't U. S. Col'd Cavalry.

Appears on

Company Muster Roll

for July & Aug-----, 1865.

Present or absent Present

Stoppage, \$----- 100 for -----

Due Gov't, \$----- 100 for -----

Valuation of horse, \$----- 100

Valuation of horse equipments, \$----- 100

Remarks: -----

Book mark: -----

Lucas

3 Cav. U.S.C.T.

Benny Jackson

Private, Co. I, 3 Reg't U. S. Col'd Cavalry.

Appears on

Company Muster Roll

for Sept & Oct, 1865.

Present or absent Present

Stoppage, \$ 100 for

Due Gov't, \$ 100 for

Valuation of horse, \$ 100

Valuation of horse equipments, \$ 100

Remarks:

Book mark:

B. Jackson
(358) Copyist.

7 | **3 Cav. | U.S.C.T.**

Berry Jackson
Smith, Co. I, 3 Reg't U. S. Col'd Cavalry.

Appears on

Company Muster Roll

for Nov & Dec, 1865.

Present or absent Present

Stoppage, \$ 100 for

Due Gov't, \$ 100 for

Valuation of horse, \$ 100

Valuation of horse equipments, \$ 100

Remarks:

Book mark: _____

(358)

Berry Jackson
Copyist.

J. | 3 Cav. | U.S.C.T.

Berry Jackson
mus, Co. I, 3 Reg't U. S. Colored Cav.

Appears on Returns as follows:

Mar. 1864, Co. Bugler.

Book mark :

(548)

J. B. Sittler

Copyist.

§ | **3 Cav. | U.S.C.T.**

Benny Jackson
Sers., Co. *D*, 3 Reg't U. S. Col'd Cavalry.

Appears on **Co. Muster-out Roll**, dated
Memphis Tenn Jan 26, 1866.
Muster-out to date *Jan 26*, 1866.
Last paid to *June 30*, 1865.

Clothing account:

Last settled....., 186 ; drawn since \$.....100
Due soldier \$.....100; due U. S. \$ *86* ^{*5*}/₁₀₀
Am't for cloth'g in kind or money adv'd \$.....100

Due U. S. for arms, equipments, &c., \$.....100
Bounty paid \$.....100; due \$.....100

Remarks:.....
.....
.....
.....

Book mark :.....

Edmondson
(361) Copyist.

729

Jackson George

Co F., 3 U. S. Col'd Cav.

Private | Sergeant

CARD NUMBERS.

1	5338594	26
2	5338946	27
3	5339031	28
4	5331697	29
5	5339169	30
6	5340081	31
7	9088967	32
8	467275831	33
9		34
10		35
11		36
12		37
13		38
14		39
15		40
16		41
17		42
18		43
19		44
20		45
21		46
22		47
23		48
24		49
25		50

Book Mark:

See also

1863

A. | **3 Cav. | U.S.C.T.**

George Jackson,
Co. *F.*, 3 Reg't U. S. Col'd Cav.

Appears on

Company Descriptive Book

of the organization named above.

DESCRIPTION.

Age *21* years; height *5* feet *9* inches.

Complexion *Ringer*

Eyes *Black*; hair

Where born *St. Louis Mo.*

Occupation

ENLISTMENT.

When *Dec 1*, 1863.

Where *St. Louis*

By whom *C. C. Spaid*; term *3* y'rs.

Remarks: *Deserted at Vicksburg Miss*
June 1864. Last paid by pay
Master Martin to include the 30
day of April 1864. Has received from
U. S. on account of clothing forty seven
dollar and thirty four cents (\$47.34.)
And U. S. for Ordnance twenty five
dollar and seventy cents (\$25.70.)

C. Weston

J | **3 Cav. | U.S.C.T.**

George Jackson

Priv, Co. *F*, 1 Reg't Miss. Cav., Corps d'Afrique.*

Appears on

Company Muster-in Roll

of the organization named above. Roll dated
Vicksburg Miss Jan 26, 186*4*.
Muster-in to date *Dec 1*, 186*3*.

Joined for duty and enrolled:

When *Dec 1*, 186*3*.
Where *Skipwith Miss.*
Period *3* years.

Valuation of horse, \$.....100

Valuation of horse equipments, \$.....100

Remarks: *(Age 21)*

*This organization subsequently became Co. *F*, 3 Reg't U. S. Colored Cavalry.

Book mark:.....

E J Richardson
(356) Copyist.

J | **3 Cav.** | **U.S.C.T.**

George Jackson
Sergt, Co. F, 1 Reg't Miss. Cav., Corps d'Afrique.*

Appears on

Company Muster Roll

for Dec 6/63 to Feb 29, 1864.

Present or absent Present

Stoppage, \$ 100 for

Due Gov't, \$ 100 for

Valuation of horse, \$ 100

Valuation of horse equipments, \$ 100

Remarks:
.....
.....
.....
.....
.....
.....
.....

*This organization subsequently became Co. F, 3 Reg't U. S. Colored Cavalry.

Book mark:

E. Richardson
Copyist.

J | **3 Cav.** | **U.S.C.T.**

George Jackson
Sergt., Co. F, 3 Reg't U. S. Col'd Cavalry.

Appears on

Company Muster Roll

for Mar + Apr, 1864.

Present or absent Present

Stoppage, \$ 100 for

Due Gov't, \$ 100 for

Valuation of horse, \$ 100

Valuation of horse equipments, \$ 100

Remarks: Appointed
Sergt. Jan. 1/64.

Book mark:

E. Richardson
Copyist.

J | **3 Cav.** | **U.S.C.T.**

George Jackson
Priv, Co. F, 3 Reg't U. S. Col'd Cavalry.

Appears on

Company Muster Roll

for May + June, 1864

Present or absent.....

Stoppage, \$ 25 ⁷⁰/₁₀₀ for Ordinance.

Due Gov't, \$..... 100 for

Valuation of horse, \$..... 100

Valuation of horse equipments, \$..... 100

Remarks: Deserted at
Vicksburg Miss.
June 6/64.

Book mark:.....

E. Richardson

(358)

Copyist.

J | 3000 | U.S.C.T.

George Jackson
Serg't, Co F, 3 Reg't U. S. Col'd Cav

Appears on

Descriptive List of Deserters

dated Vicksburg Miss June 30, 1864.

Deserted:

When June 6, 1864.

Where Vicksburg Miss

Arrested:

When _____, 186 .

Where _____

Remarks: Stopped for ordnance
25.70 loss

Book mark: _____

H. S. Miller

(351)

Copyist.

J. | 3 Cav. | U.S.C.T.

George Jackson
Pvt, Co. F, 3 Reg't U. S. Colored Cav.

Appears on Returns as follows:

June 1864. Loss June 6/64
Vicksburg, Miss. - Deserted

Book mark :

(546) J. B. Sittler Copyist.

1865

3 Cav. | U.S.C.T.

Henry Jackson
Sgt., Co. *D*, 3 Reg't U. S. Col'd Cavalry.

Appears on **Co. Muster-out Roll**, dated
Memphis Tenn Jan 25, 186*0*.

Muster-out to date _____, 186 ____ .
Last paid to *Apr 30*, 186*0*.

Clothing account:

Last settled _____, 186 ____ ; drawn since \$ _____ *100*
Due soldier \$ _____ *100*; due U. S. \$ _____ *100*
Am't for cloth'g in kind or money adv'd \$ _____ *100*

Due U. S. for arms, equipments, &c., \$ _____ *100*
Bounty paid \$ _____ *100*; due \$ _____ *100*

Remarks: *Discharged at Wash.*
for 1 Miss from 10. Co.

Book mark: *V. 65. P 32. 67*

Long
(561) Copyist.

730 Harvey
Jackson Harvey

Co M., 3 U. S. Col'd Cav.

Private | Private.

CARD NUMBERS.

1	5346024	26
2	5346118	27
3	5346201	28
4	5346286	29
5	5346387	30
6	5346475	31
7	5346568	32
8	5346669	33
9	5346764	34
10	5346887	35
11	5347151	36
12	9089902	37
13	9089776	38
14	8-79-03-1874	39
15	40727592	40
16		41
17		42
18		43
19		44
20		45
21		46
22		47
23		48
24		49
25		50

Corrected by H. A. J. Mch 20, 1903

Book Mark: J. 9 T. 10. 69-74.
EB- Mill. P. 179.

See also

J. 685011 B. m + m

RP 375-250-

S 150826 9 P.O. 9/1

J 1749353

O. 2387913 P.O. Rita

Rita Bayles
E.
M.

2/1

3 Cav. U.S.C.T.

J
Henry Jackson

Co. *M*, 3 Reg't U. S. Col'd Cav.

Appears on

Company Descriptive Book

of the organization named above.

DESCRIPTION.

Age *30* years; height *5* feet *9* inches.

Complexion *Yellow*

Eyes *Black*; hair *Black*

Where born *Pulaski Co. Ky.*

Occupation *Farmer*

ENLISTMENT.

When *Feb. 24, 1864.*

Where *Mississippi*

By whom *Capt. Hyland's* term *3* y'rs.

Remarks: *died Aug. 15 / 65*
at Memphis Tenn. of
chronic diarrhea.

F. B. Smith

47771070

J | **3 Cav. | U.S.C.T.**
Harry Jackson
....., *Com*....., 3 Reg't U. S. Col'd Cav.

Appears on

Company Descriptive Book

of the organization named above.

DESCRIPTION.

Age *35* years; height *5* feet *9* inches.
Complexion *Yellow*
Eyes *Black*; hair *Black*
Where born *Pulaski Co., Ky.*
Occupation *Farmer*

ENLISTMENT.

When *Feb 24*, 186*4*.
Where *Mississippi*
By whom *Wm. Hyland*; term *3* y'rs.
Remarks: *died in Regt. Hosp't at Memphis Tenn. Aug. 15-1865*

F. B. Smith

(383g)

Copyist.

APR 1874

J | **3 Cav. | U.S.C.T.**

Harvey Jackson
Pow, Co. *M*, 3 Reg't U. S. Col'd Cavalry.

Appears on

Company Muster-in and Descriptive Roll

of the organization named above. Roll dated

Maines Bluff Miss, Mehl, 1864.

Where born *Pulaski Co Kentucky*

Age *35* y'rs; occupation *Farmer*

When enlisted *July 24*, 1864.

Where enlisted *Mississippi*

For what period enlisted *3* years.

Eyes *Black*; hair *Black*

Complexion *Yellow*; height *5 ft. 9 in.*

When mustered in _____, 186 .

Where mustered in _____

Bounty paid \$ 100; due \$ 100

Where credited _____

Company to which assigned _____

Remarks: _____

Book mark: *879-05-1874*

R Richardson

(356d)

Copyist.

J | **3 Cav. | U.S.C.T.**

Monvey Jackson
Poin, Co. *M*, 3 Reg't U. S. Col'd Cavalry.

Appears on

Company Muster Roll

for *March + April*, 186*4*.

Present or absent *Present*

Stoppage, \$ *100* for

Due Gov't, \$ *100* for

Valuation of horse, \$ *100*

Valuation of horse equipments, \$ *100*

~~Remarks~~: *Winn March 1/64*
at Hayes Bluff.

Book mark:

R Richardson

MAR 10 99

J. | **3 Cav. | U.S.C.T.**

Harvey Jackson
Foni, Co. M, 3 Reg't U. S. Col'd Cavalry.

Appears on

Company Muster Roll

for *May & June*, 186*4*

Present or absent *Present*

Stoppage, \$ 100 for

Due Gov't, \$ 100 for

Valuation of horse, \$ 100

Valuation of horse equipments, \$ 100

Remarks :

Book mark :

R. Richardson

(358)

Copyist.

J. | **3 Cav. | U.S.C.T.**

Monny Jackson
Priv, Co. M, 3 Reg't U. S. Col'd Cavalry.

Appears on

Company Muster Roll

for *Apr 30 to Aug 31*, 186 *4*

Present or absent *Present*

Stoppage, \$ *100* for

Due Gov't, \$ *100* for

Valuation of horse, \$ *100*

Valuation of horse equipments, \$ *100*

Remarks :

Book mark :

R. Richardson

(358)

Copyist.

J. | **3 Cav. | U.S.C.T.**

Harvey Jackson
Pon, Co. M, 3 Reg't U. S. Col'd Cavalry.

Appears on

Company Muster Roll

for *Sept & Oct*, 186*4*.

Present or absent *Present*

Stoppage, \$ *100* for

Due Gov't, \$ *100* for

Valuation of horse, \$ *100*

Valuation of horse equipments, \$ *100*

Remarks :

Book mark : _____

R. Richardson

J. | 3 Cav. | U.S.C.T.

Harry Jackson
Co. M, 3 Reg't U. S. Col'd Cavalry.

Appears on

Company Muster Roll

for Nov & Dec, 1864.

Present or absent absent

Stoppage, \$ 100 for

Due Gov't, \$ 100 for

Valuation of horse, \$ 100

Valuation of horse equipments, \$ 100

Remarks: on scout

Book mark:

Paul Allen

3 Cav. | U.S.C.T.

J. Henry Jackson

107, Co. M, 3 Reg't U. S. Col'd Cavalry.

Appears on

Company Muster Roll

for *Jan + Febr*, 186*5*.

Present or absent *present*

Stoppage, \$ *100* for _____

Due Gov't, \$ *100* for _____

Valuation of horse, \$ *100*

Valuation of horse equipments, \$ *100*

Remarks: _____

_____ *U* _____

Book mark: _____

Wm L Allen

(358)

Copyist.

C. | **3 Cav. | U.S.C.T.**

Harvey Jackson

1st Lt., Co. M, 3 Reg't U. S. Col'd Cavalry.

Appears on

Company Muster Roll

for *Mar & Apr*, 1865.

Present or absent *present*

Stoppage, \$ 100 for

Due Gov't, \$ 100 for

Valuation of horse, \$ 100

Valuation of horse equipments, \$ 100

Remarks:

Book mark:

Amos Allen

7

3 Cav. | U.S.C.T.

Harry Jackson
Sgt., Co. M, 3 Reg't U. S. Col'd Cavalry.

Appears on

Company Muster Roll

for *May & June*, 1865.

Present or absent *At. & Abs.*

Stoppage, \$ *3⁹⁶*/₁₀₀ for *expense*
lost & destroyed

Due Gov't, \$ *100* for

Valuation of horse, \$ *100*

Valuation of horse equipments, \$ *100*

Remarks:
.....
.....
.....
.....
.....
.....
.....
.....
.....
.....

Book mark:

Harry Jackson

3 Cav. | U.S.C.T.

Harry Jackson

1st, Co. M, 3 Reg't U. S. Col'd Cavalry.

Appears on

Company Muster Roll

for *July & Aug*, 1865.

Present or absent

Stoppage, \$ *13* ^{*96*}/_{*100*} for *ordnance*
lost & destroyed

Due Gov't, \$ *100* for

Valuation of horse, \$ *100*

Valuation of horse equipments, \$ *100*

Remarks: *Wied in Regt*
Left at Memphis Tenn
July 15th 65

Book mark: *Wied Aug 15, 65 E.R. V. 11. P. 179*
22. 560. P. 45. P. 203. 68

Am L Allen

J. | **3 Cav.** | **U.S.C.T.**

Henry Jackson
Pvt., Co. M, 3 Reg't U. S. Colored Cav.

Appears on **Returns** as follows:

Aug. 1865. Loss Aug. 15/65 -
Memphis - Died in
Regtl Hosp. of disease

Book mark :

(546)

J. B. Sittler

Copyist.

4771190

3 Cav. U.S.C.T.

Henry Jackson
Co. *M*, 3 Reg't U. S. Col'd Cavalry.

Appears on, Co. Muster-out Roll, dated
Memphis Tenn Jan. 26, 186*6*.

Muster-out to date _____, 186 .
Last paid to *Feb. 28*, 186*5*.

Clothing account:

Last settled _____, 186 ; drawn since \$ _____ *100*
Due soldier \$ _____ *100*; due U. S. \$ _____ *100*
Am't for cloth'g in kind or money adv'd \$ _____ *100*

Due U. S. for arms, equipments, &c., \$ _____ *100*
Bounty paid \$ _____ *100*; due \$ _____ *100*

Remarks: *with disease in*
East. Hosp. at Memphis
Tenn Aug. 15/65

Book mark: *122.560 - J. P. W. C. T. 74*
P. V. S. P. 203.68

(361)

Leaving

Copyist.

J. 3 Cav, USCT.
Harvey Jackson,
Co. M, 3 Reg't U.S. Cav.

NOTATION.

Book mark: J. 79-09-1874.

Record and Pension Office,

WAR DEPARTMENT.

This book mark refers only to a report from the medical records, made by the Surgeon General to the Adjutant General, relative to the above-named man. As the medical records have since been carded, no transcript of this report is made hereon.

(491) Wm E. Newman
Copyist.

Jackson, Harvey
P. Co. 16, 3 Reg't U. S. C. Cav.

2 Enclosures.

Bed Cards	Descriptive Lists
Burial Records	Final Statements /
Certs. of Dis. for Discharge	Furloughs
C. M. Charges	Med. Des. Lists
Med. Certificates	Orders

Other papers relating to—

Admission to Hosp'l	Furlough
Casualty Sheet (Officer's)	Med. Examination
Confinement	Misc. Information /
Contracts	Pay or Clothing
Death or Effects	Personal Reports
Desertions	Rank
Discharge from Hosp'l	Transfer to Hosp'l
Discharge from Service	Transfer to V. R. C.
Duty	Transportation

[OFFICE INDORSEMENT.]

Final to Surge General Aug 15 1865

FINAL STATEMENT

OF

Harvey Jackson
3d Reg't of N.C. Col'd Co.

VOLUNTEERS.

From Aug 15, 1865

NOTE 1.—Two of these certificates (or duplicates) are to be given to each Volunteer Soldier or drafted man who may be discharged without being mustered out (Final Statements are never given to men mustered out of service) that he may at once receive from the Paymaster the pay, &c., due him, and the captain or other COMMISSIONED officer commanding the company will certify to the act of the delivery of the duplicate certificates; with these certificates the Soldier is entitled to his discharge, and should also present his discharge to the Paymaster to have the payment endorsed on it. The discharge is to be given back to the Soldier by the Paymaster; the latter only retaining as his vouchers the duplicate certificates.

NOTE 2.—If the Soldier is entitled to pay for the use of his horse, the Company Commander will certify to that fact on the back of both these final statements, and also to the time he has pay due for having been so mounted on his own horse.

NOTE 3.—When a Soldier is furnished with final statements, his descriptive list, if he has one, should be taken up by the officer who gives the Soldier these statements, and endorsed with a statement to this effect by the officer. The endorsement should exhibit a full statement of the time for which the Soldier was allowed pay on his final statements, the clothing account, and all other charges against him or in his favor, so as to comprise a complete exhibit of his account. It will then be transmitted to the Company Commander of the Soldier, who will enter on the muster roll upon which the Soldier's discharge is reported. The descriptive list will then be destroyed. The object of this is, that the remaining portion of the Soldier's account may be settled upon the receipt of these muster rolls, and the Soldier receive any pay or allowances that may be due him at the time of his discharge, and which may not appear on his last final statements from the fact that his descriptive list is incomplete. These accounts for back pay, &c., are settled by the 2d Auditor of the Treasury Department.

NOTE 4.—Charges for loss or injury to ordnance, horse equipments, and other miscellaneous charges, should appear under the heading of "Other Stoppages."

NOTE 5.—Bounty paid by State authorities, and not by the United States, will not be entered on this statement.

NOTE 6.—Amounts due the Sutler and Laundress must be entered on the muster roll on which the discharge, death, desertion, &c., is reported, as well as on the final statement, otherwise the amount cannot be collected from the United States.

NOTE 7.—This blank will be used for deceased volunteers and drafted men, as well as for others.

NOTE 8.—Where a Soldier dies in Hospital or on detached service, his descriptive list, if he has one, should be sent with his final statements, in duplicate, to the Adjutant General, Washington, D. C.

NOTE 9.—If the soldier is a drafted man or substitute, the space for time, &c., of enrolled, should contain only the word drafted or substitute, as the case may be. If the soldier is a VETERAN, (OR RECRUIT) the words as a veteran, (or recruit) may be interlined after the words mustered into service of the U. S. A statement of all the instansments of Veteran or Recruit RECEIVED by the Soldier must be made on the back of each final statement.

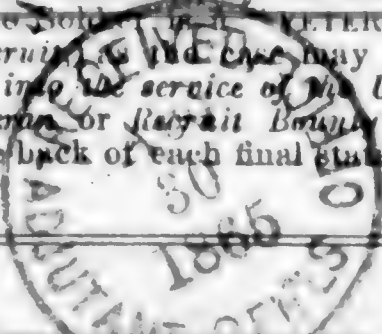

ADJUTANT GENERAL'S OFFICE

Aug 30 1865

Duplicate with Inventory sent 2d Auditor.

[OFFICE INDORSEMENT.]

War Department,

ADJUTANT GENERAL'S OFFICE,

Sept 22, 1874

The death of late Harvey Jackson, Co. "H", 3^d Reg't U. S. Colored Infantry, is reported as follows:

On Company Muster Roll.
For July 8 Aug., 1865, July 15, 1865
Company Muster-out Roll.
Aug 15, 1865
Company Descriptive Book.
Aug 15, 1865
Company Morning Reports.
Aug 15, 1865
Soldier's Final Statement.
Aug 15, 1865

Soldier's Record of Death and Interment. , 186

Soldier's Inventory of Effects. , 186

Soldier's Certificate of Disability for Discharge. , 186

Soldier's Individual Muster-out Roll. , 186

Regimental Return. For Aug 15, 1865, Aug 15, 1865

Regimental Quarterly Returns. , 186

Regimental Descriptive Book. No evidence of death, 186

By Surgeon General. (Aug 15), 1865

Aug 15, 1865, is held to be the correct date, and the Company Muster Roll will be amended accordingly.

Thomas M. Sweet

E. B. II
Noted 31st 79. Assistant Adjutant General.

Vertical handwritten notes on the right margin, including "1874" and other illegible text.

I certify, on honor, that Harvey Jackson, a Private of
Captain Wm Highland Company (112) of the 34th Regiment of M.D. Col. Cal.
VOLUNTEERS, of the State of _____, born in Pulaski County, State
of Kentucky, aged 35 years; 5 feet 9 inches high; Yellow complexion,
Black eyes, Black hair, and by occupation a Farmer, who joined for service
and was enrolled (see Note 9) on the 24 day of February, 1864, at Haynes Bluff
by William Highland, for the period of 3 yrs years, and mustered into
the service of the United States on the 1st day of March, 1864, at
Haynes Bluff, Miss., by Lt. Callinan; and having served
HONESTLY and FAITHFULLY with his Company to the present date, is now entitled to a
DISCHARGE by reason of Death Died at Post Hosp of Quarterm
on the 15th day of August 1865

The said Harvey Jackson was last paid by Paymaster
Maj Campbell, to include the 28 day of February, 1865, and
has pay due him from that time to the present date; he is entitled to pay and subsistence for
TRAVELING to place of enrollment, and whatever other allowances are authorized to volunteer
soldiers, drafted men, or militia, so discharged. He has received from the United States **CLOTHING**
amounting to Seventy one $\frac{83}{100}$ dollars, since the 31st day of August
1864, when his clothing account was last settled. He has received from the United States
100 dollars advanced **BOUNTY**.

There is to be stopped from him, on account of the State of _____, or other
authorities, for **CLOTHING**, &c., received on entering service, _____ dollars; and
for other stoppages, viz: For arrears

_____ 13 $\frac{46}{100}$ dollars.
He has been furnished with **TRANSPORTATION** in kind from the place of his discharge to
_____; and he has been **SUBSISTED** for **TRAVELING** to his
place of enrollment, up to the _____, 186 .

He is indebted to _____, **SUTLER**, _____ dollars.

He is indebted to _____, **LAUNDRESS**, _____ dollars.

Given in Duplicate, at Memphis Tenn, this 20 day
of August, 1865.

William H. Chapin
2nd Lieut

Ellenbrook

"Marion Jackson" 1871

(6) No 3" 11/2" 10.0000

Completed

Mr. Ellertson

Adjutant General's Office,

COLORED TROOPS BRANCH,

July 0, 187*4*

Vol. C. T., 187

Wanted in case of *Harvey Jackson* "Private, Co. No. 3",
Reg't *U. S. C. Gary*

Cause of Absence: Mr. R. May, June 1865 reports him absent without remark.

Respectfully,

W. A. Woodward
Chief Clerk.

P. H.

Adjutant General's Office,

, 187

Vol. C. T., 187

Reply in case of _____, Co. _____,
Reg't _____

*Regtl. Des. Book bears his name without remark.
Co. Des. Book reports him "Died in
Regtl. Hosp. at Memphis, Tenn. Aug. 15-1865.
of Chronic Diarrhea."*

No evidence of absence from Co. in 1865.

*A. D. C. J.
7-9-74.*

MICROCOOPY

100%

100%

30

END

IMAGE EVALUATION TEST TARGET (QA-3)

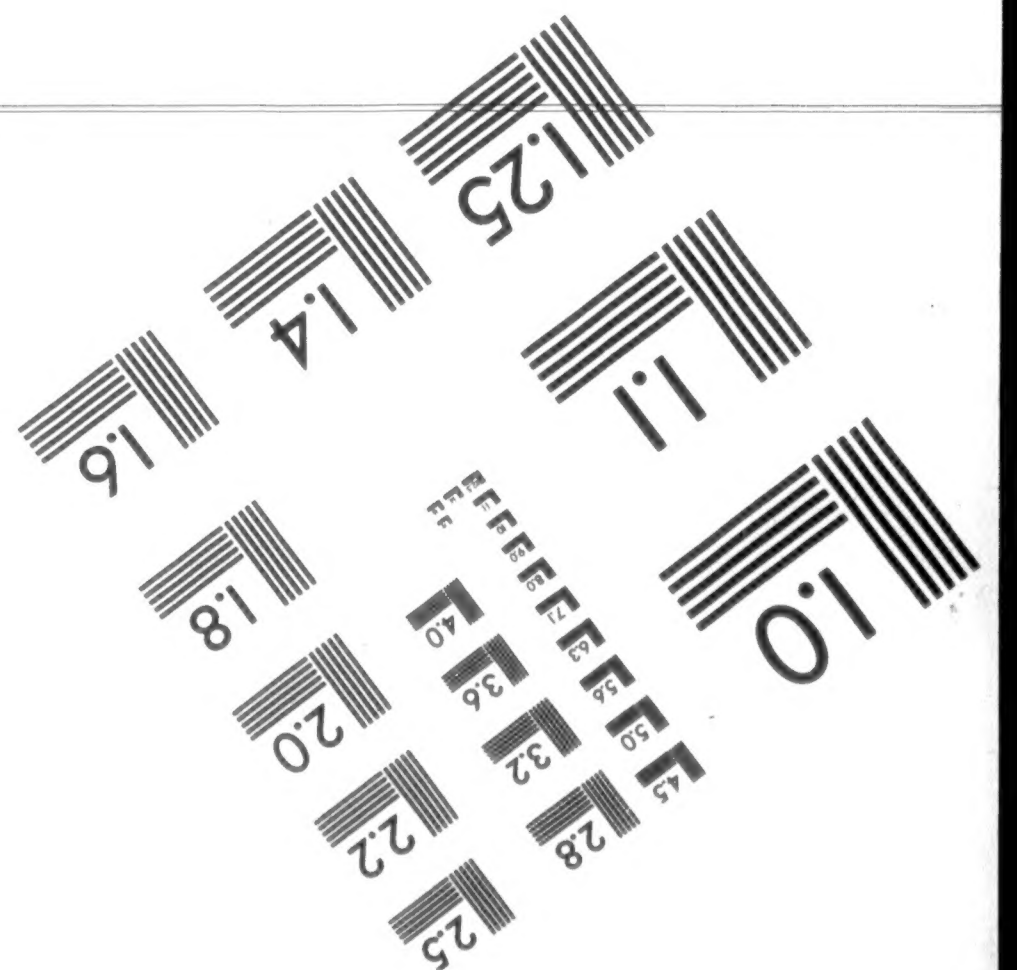
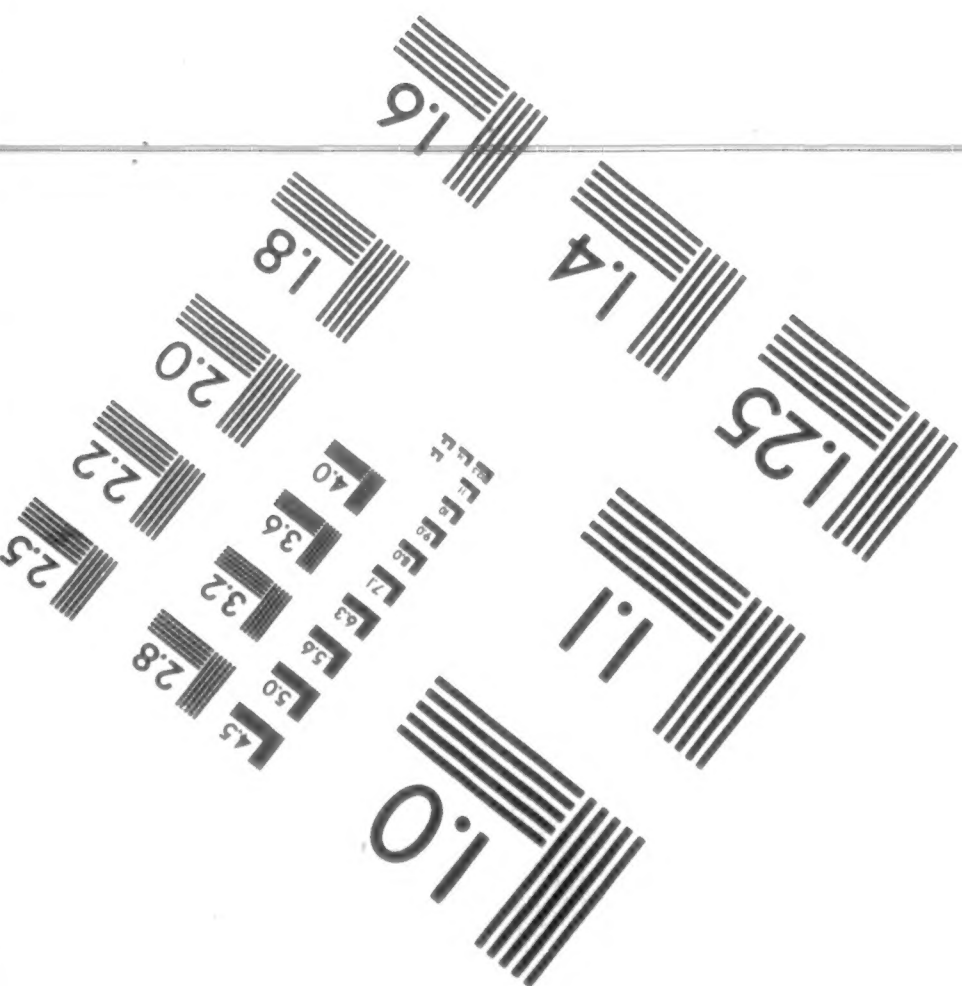
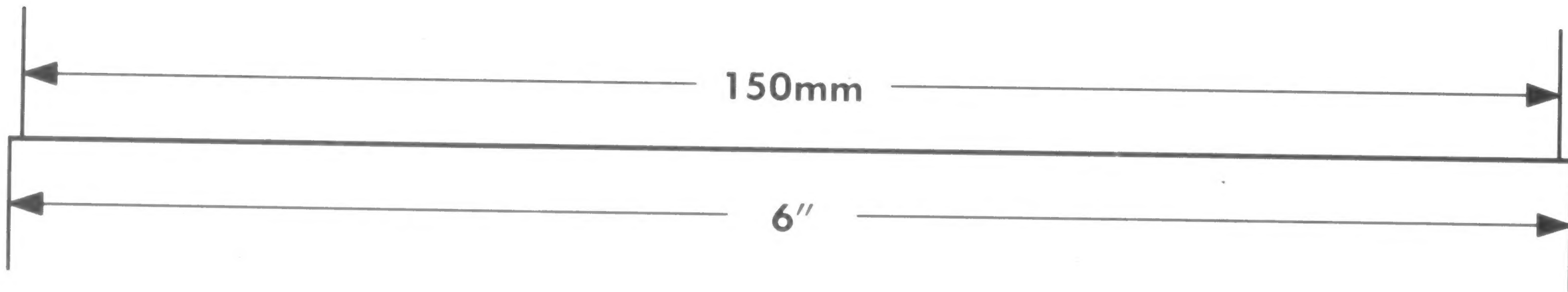
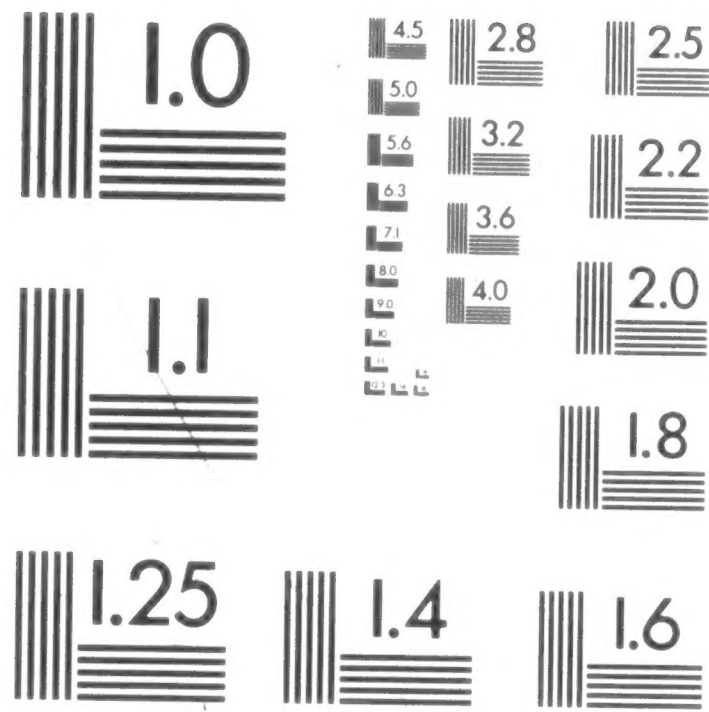
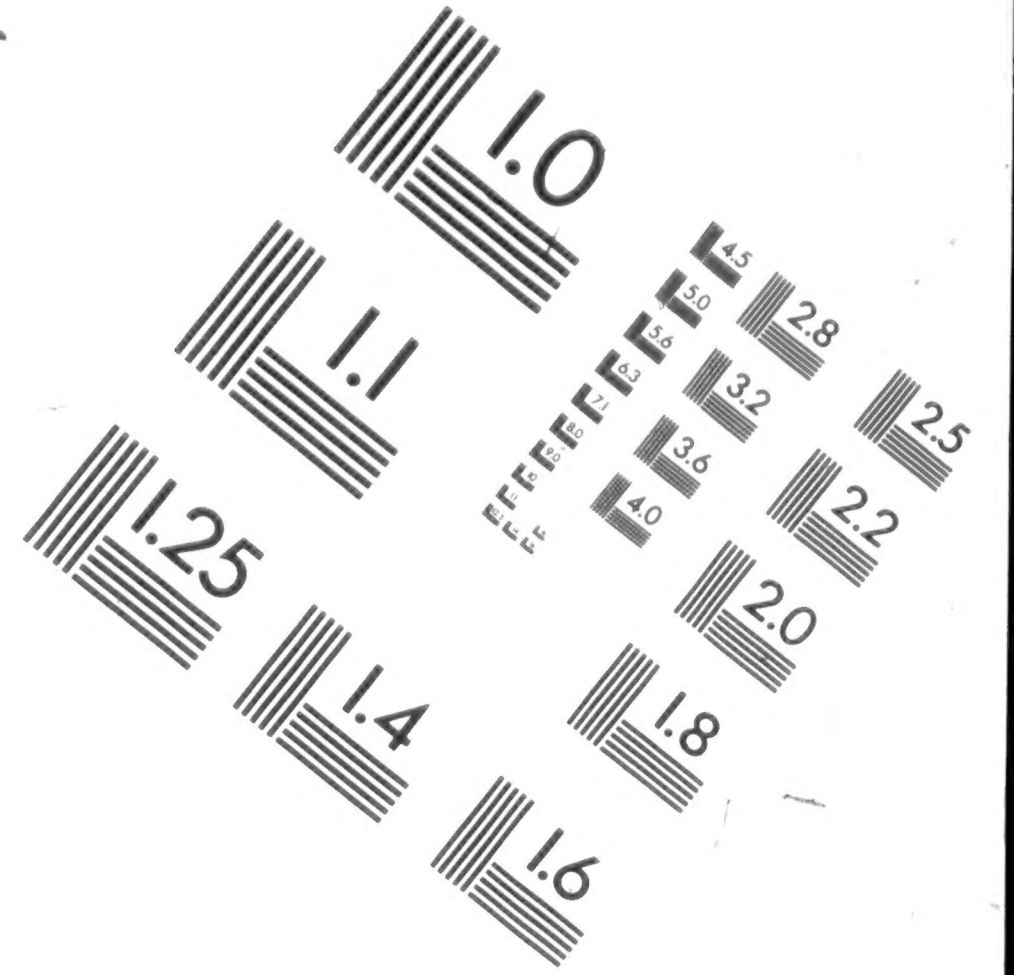
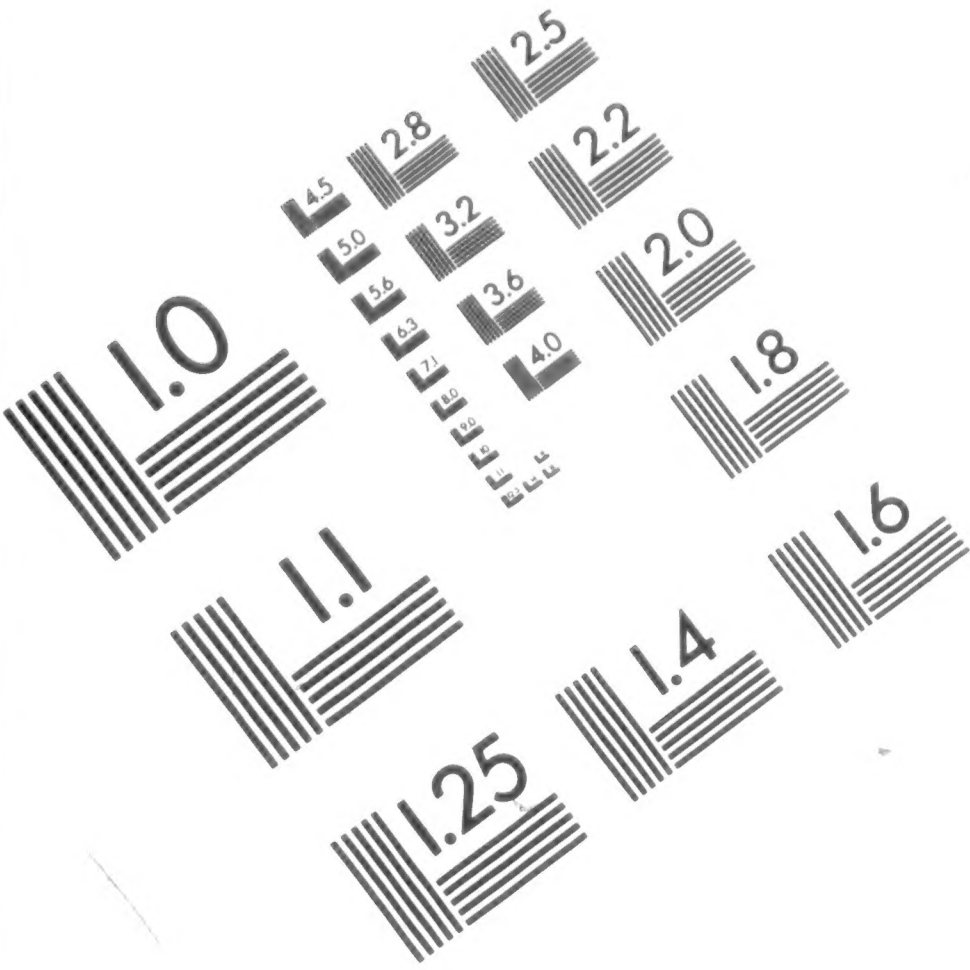

APPLIED IMAGE, Inc
1653 East Main Street
Rochester, NY 14609 USA
Phone: 716/482-0300
Fax: 716/288-5989

© 1993, Applied Image, Inc., All Rights Reserved

THE END

PLEASE

REWIND